

J R PHILLIPS

# BBC ENGINEERING



Number 106

April 1977

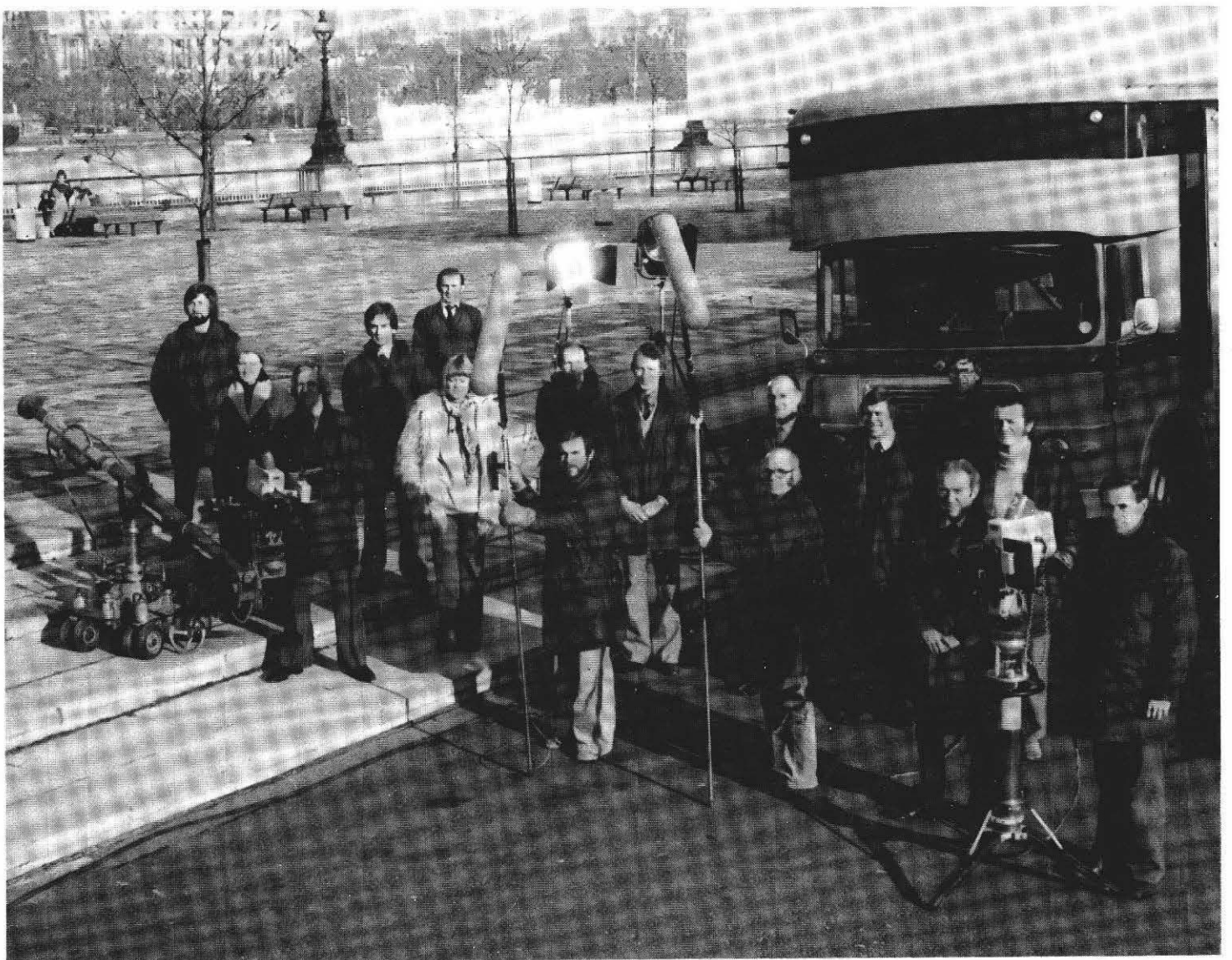

# BBC Engineering

including Engineering Division Monographs

A record of BBC technical experience and developments  
in radio and television broadcasting

Published approximately four times per year by  
BBC Publications,  
35 Marylebone High Street,  
London W1M 4AA.  
ISSN 0308-2369  
ISBN 0 563 173742

Edited by  
BBC Engineering Information Department,  
Broadcasting House,  
London W1A 1AA.

Printed by  
The Yale Press Ltd,  
London SE25 5LY.

Price  
80p or \$2.00 per issue post free.  
Annual Subscription  
£3.00 or \$8.00 for 4 issues post free.

Articles are copyright © 1977 by the  
British Broadcasting Corporation  
and may not be reproduced in whole  
or part without written permission.

## Contents

Editorial	2
<b>Principal articles</b>	
The Nature of Broadcasting <i>James Redmond</i>	4
The Development of a Location Production Unit Using Lightweight Electronic Cameras <i>I. Leiper, R. Vitty, and A. J. Woolford</i>	17
Low-cost Relay Stations for the Extension of the UHF Colour Television Service to Small Populations <i>D. C. Davis</i>	24
The SHF Link System from Rosemarkie to Eitshal <i>R. R. Durling and D. W. Grant</i>	30
<b>Short items</b>	
Quadraphony	3
Research Department Reports	16
BBC Test Card No. 61: Flesh Tone Reference	34
Contributors to this issue	35

The cover picture shows a complete production crew with the  
Location Production Unit vehicle described in the article on page 17.

## Editorial

---

The start of a new broadcasting service often entails the development of new equipment and the exploitation of novel techniques. Enormous efforts may be required to put at the disposal of the programme-maker the wherewithal to originate the signal. Additional toil is usually called for to solve the problems of conveying the signals from studio to transmitter and of building a transmitter to handle the new form of signal. At the other end of the broadcasting chain, receivers for the new service are often a cause of major headaches for the industry. Once these efforts have been made, however, the first transmitting station is likely to serve a very large number of people — in the United Kingdom, a fifth of the entire population, or more.

An incautious engineer not experienced in broadcasting matters might be tempted to suppose the rest to be plain sailing. One simply applies the experience gained to building more links and more transmitting stations — five should be enough, surely — and complete coverage of the population falls comfortably into one's lap. This optimistic view, alas, is far from the truth for it takes no account of many of the facts of broadcasting life.

One of these inconvenient facts is that transmitting stations operating in the same channel interfere with each other unless they are very much further apart than twice their service range: thus, many channels are required. Another is the rather unhelpful attitude of the public at large, which seems inclined to choose its homes on the bases of tradition, surroundings, cost, and nearness to places of work rather than clustering together in a few large and easily served conurbations. The number of available channels is never large enough to permit the solution one would like, and certainly there is never enough money to pay for it.

There is one kind of shortage of which the broadcasting engineer need never complain — a shortage of problems on which to exercise ingenuity. Many ingenious engineers have been drawn to the BBC which has a commendable record of innovation in many fields, including signal origination and the extension of coverage. In all branches of broadcasting it is wise to review practices to see whether improvements or economies can be made, and this is a policy which can be discerned behind a great many of the innovations introduced. The article in this issue by Leiper, Vitty, and Woolford, for example, is concerned with changes in production methods for location drama which give rise to both improvements *and* economies.

The other three articles refer to problems associated with providing transmitting stations to extend the coverage of a service. The paper by Redmond, adapted from his recent Appleton lecture, shows us that coverage problems have been with us since the early days of broadcasting. Davis's article is concerned with devising low-power relay station installations which are cheap enough to be considered for provision by the hundred while performing well enough to give a satisfactory service. The work of Durling and Grant deals with a link to convey the television signals from one side of Scotland to the other across land which can be highly desirable to the tourist but is thoroughly hostile to the transmission of electromagnetic waves.

The need for such a link presented a classical challenge: the signals had to be conveyed across very difficult terrain to serve a small number of people — not likely to exceed one percent of the population of Scotland or one tenth of one percent of the population of the United Kingdom even when further relay stations are completed. Cost was of the essence of the problem, and the employment of unorthodox techniques led to a substantially cheaper solution than the conventional one.

The project had an air of pioneering and adventure and should, perhaps, inspire a poem called 'How they brought the television services from Rosemarkie to Eitshal', though the parallels with Browning's classic would necessarily be limited. One horse *was* involved but clearly lacked the dedication of Roland and was even guilty of desertion. The engineers, however, were made of sterner stuff and brought the undertaking to a very successful conclusion.

Both the link paper (Durling and Grant) and the relay station one (Davis) are concerned with the same concept — the reconciliation of the need to provide the television services to more and more people with the limited amount of capital available for the job. Already more people can obtain good reception of 625-line services than ever could see the 405-line programmes to a satisfactory standard, although nearly everyone could receive some sort of 405-line pictures if enough effort was expended on the aerial installation. As time goes on and the work bears more fruit a very small proportion of the population will be provided with good television reception for the first time.

Although the proportion is very small the number of people is quite large, running well into six figures, and the people affected are in general living in small, isolated com-

munities, where the availability of television services can be regarded as a great boon. In fact, considering the matter from a standpoint of pure social justice, one might be inclined to say that such communities should have priority of service, but hard economics dictate otherwise. The big battalions would not be prepared to pay a substantially higher licence fee for ten or fifteen years while the new services gradually spread over the country, starting at a coverage of, perhaps, a few thousand people. Nor could the most

talented performers be expected to flock to the studios in order to make their work available in a few remote villages.

The order of priorities must, therefore, be based on increasing the coverage of the population as rapidly as possible at all times: we must be gratified that we have now reached the stage of bringing television to many of the small communities who have hitherto, by reason of their remoteness, had little or nothing.

## Quadraphony

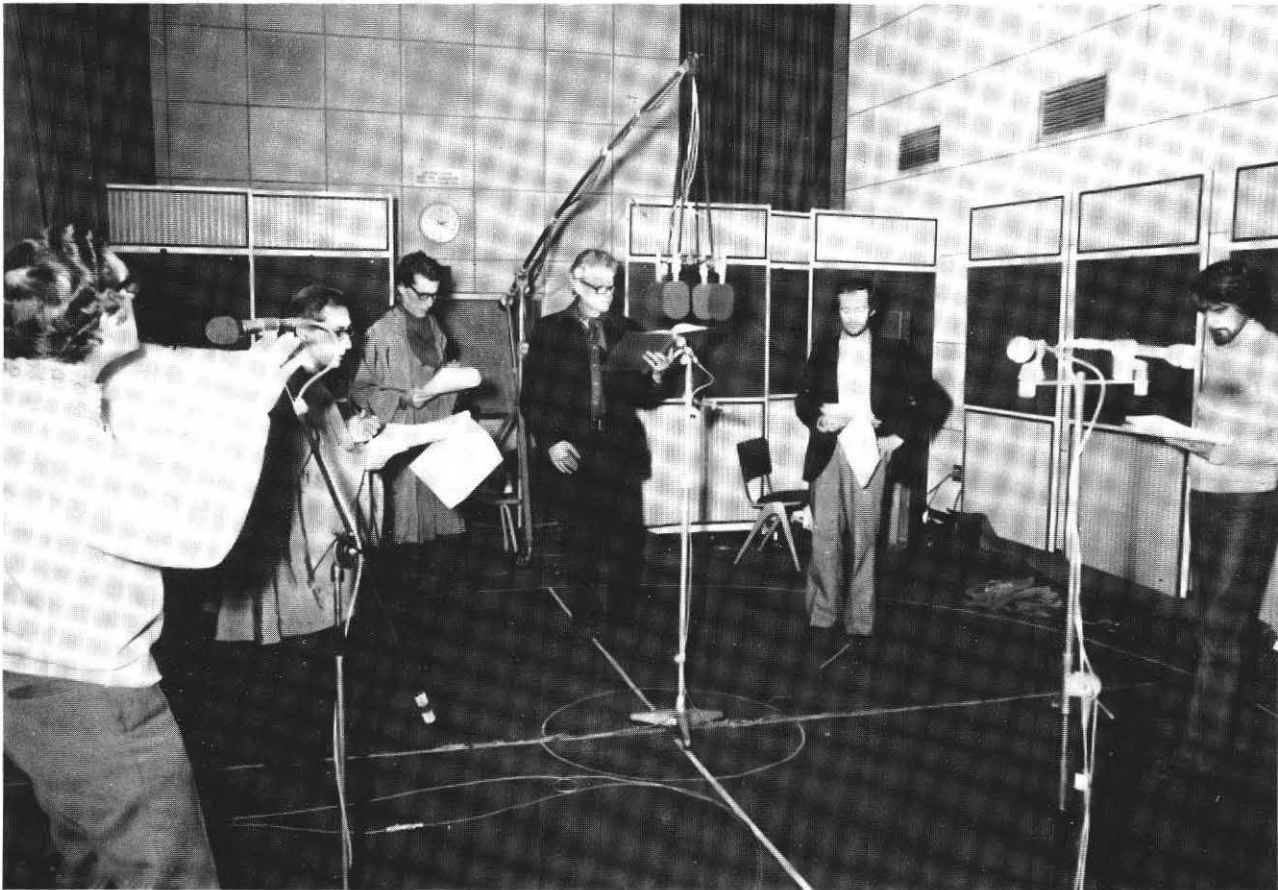

At about the time this issue is published, BBC Radio begins a series of experimental quadraphonic broadcasts, using the Matrix H encoding system developed by BBC Research Department\*. A maximum of five broadcasts each month

are planned for the coming year.

The photograph was taken during a quadraphonic recording of Shakespeare's 'The Tempest' which will be featured in one of the first of the broadcasts.

The BBC's techniques in the preparation and presentation of quadraphonic programmes will be described in a future issue of 'BBC Engineering'.

\*The development of a compatible 4-2-4 quadraphonic matrix system, BBC Matrix H, D.J. Meares and P.A. Ratliff, EBU Review — Technical, No 159 (October 1976).

# The Nature of Broadcasting\*

James Redmond, CEng., FIEE

Director of Engineering

---

**Summary:** Broadcasting has developed in step with the extension of knowledge about electronic techniques and the factors which affect the propagation of the transmitted signals. Understanding of the latter was greatly improved by Sir Edward Appleton's research work, in some of which the BBC co-operated.

Mr. Redmond describes how broadcasting is dependent upon the nature of ionospheric and other factors and how these have influenced the move up the frequency scale from the medium and low frequencies on which broadcasting started to the ultra-high frequencies now used. The possibility of direct broadcasting from satellites and the need to re-engineer Band I when the 405-line television transmissions cease provide opportunities to introduce broadcast services using standards which are different from those in current use.

- 1 Introduction
- 2 Low and medium frequencies
  - 2.1 Traffic information broadcasting
- 3 High frequencies
- 4 Very high frequencies
- 5 Ultra high frequencies
- 6 Broadcasting from satellites
- 7 Conclusions

## 1 Introduction

Sir Edward Appleton's close association with broadcasting began in the earliest days of the BBC, and continued throughout the rest of his lifetime. It was even rumoured — so I read in Ronald Clark's biography — that when the BBC was being set up Appleton was offered the post of Chief Engineer. If that offer was made, he certainly did not accept it, the first holder of this post being, as is well known, a friend of his, Peter Eckersley. However, as the present incumbent of that post, now graced by the term Director of Engineering, it gives me great pleasure to present this paper. I have called it 'The Nature of Broadcasting' because I want to deal, in the main, with the nature of those ionospheric and other factors which affect the propagation of broadcast signals: how we communicate in spite of, or sometimes with the help of, these natural phenomena; and what we might do in the future. Almost all of what follows is based on the better understanding of the ionosphere and of propagation which we now have, and which Appleton initiated.

Sir Edward himself, although interested mostly in the effects of the free ranging electron, whether in the

atmosphere or the thermionic valve, was a man of wide ability. He was an able experimenter, and his practical work finds mention in many text books, notably his discovery of the Appleton layer. At the other end of the scale, his major contribution to the theory of wave propagation in the ionosphere is equally well recorded, recognition coming notably in terms of the Appleton-Hartree formula.

Returning to the Appleton layer, modern students will no doubt hasten to say that it is now called the F layer. But it is perhaps an indication of Appleton's character that the man who proposed this designation was Appleton himself. He was not quite sure at the time how many distinct layers might exist below or above the first discovered layer at about 100km, but he thought the letter E might be right for that one. In the event, we have needed only the letters D, E and F but it is a convenient notation which the world has been happy to retain.

It seems likely that Appleton's known liking for the BBC, which grew as the years went by, and was warmly reciprocated, began as a sort of cupboard love. We had the transmitters and Appleton's academic and experimental studies always seemed to be relevant to the frequency bands that were being developed at the time for broadcasting. The original choice of frequencies around one megahertz was dictated mainly by limitations of transmitting and receiving equipment. It was not long after the first transmitter started in regular operation late in 1922 that Appleton approached the BBC to make an experiment. Fluctuations of signal level had been noted at night at places towards the outer limits of reception of the London transmitter; in particular at Cambridge where Appleton was working.

The existence of ionisation in some form in the upper atmosphere had been postulated almost simultaneously by Kennelly in the United States and Heaviside in Britain to explain the results of Marconi's experimental transmissions

\*This article is an edited version of the Appleton lecture delivered by Mr. Redmond at the Institution of Electrical Engineers, London, on January 6, 1977. It is reproduced by courtesy of the Institution.

across the Atlantic. There was, however, great uncertainty as to where this ionisation was and whether it was concentrated in a well defined layer or layers. Appleton recognised that the night-time fluctuations at shorter ranges may also be due to some kind of reflection from banks of ionisation in the atmosphere, but there was no experimental proof. If, he said, a transmitter could make a fairly rapid change of its operating frequency over a small range, and the effect on the signal strength be observed, it would be possible to deduce the path length of the major component reflected from any ionised layer. This in turn would give the height at which reflection from the ionosphere occurs. The BBC agreed to participate and the transmitter chosen was Bournemouth, 6BM.

Thus it was that Appleton, together with a New Zealander, M.A.F. Barnett, was able to perform the classic experiment after the close of broadcasting on December 11, 1924. As 6BM steadily changed frequency, corresponding to a wavelength change from 385 to 395 metres, the signal fluctuated through seven maxima, and treatment of this finding according to previously published studies\* led to the deduction that the sky-wave path exceeded the ground-wave path by some 100km. This indicated a reflection height of the order of 90km above the Earth's surface.

Figure 1 shows the positions of the various layers as we now know them. The D layer, whose existence was recognised by Appleton in the nineteen-thirties, is present in daytime at a slightly lower height than the E layer, but largely disappears at night. Because of the higher electron collision rate at this level, a relatively low electron density can cause heavy absorption of waves passing through the D layer. This daytime absorption is most marked in the medium-wave band. At night when the D layer disappears, medium and long waves are reflected mainly by the E layer and short waves mainly by the F layer.

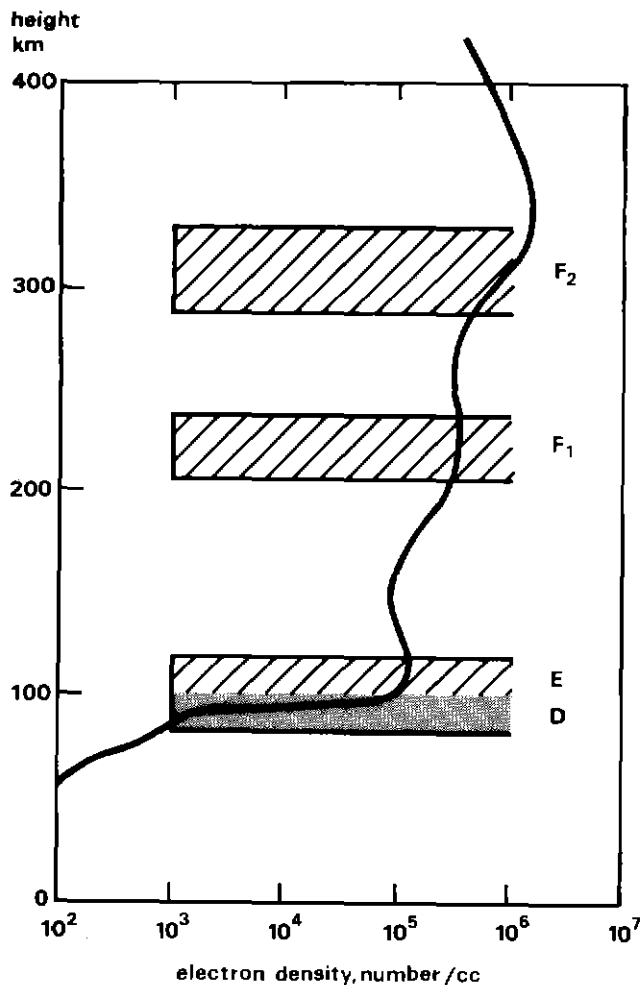

Fig.1 The ionosphere, showing the D (absorption), E (Kennelly-Heaviside), and F<sub>1</sub> and F<sub>2</sub> (Appleton) layers

## 2 Low and medium frequencies

I shall develop the theme of the 'Nature of Broadcasting' by starting with the lower frequencies and then moving upward through the frequency scale. In the far off, happy days when it all began and there were relatively few stations operating, fading and distortion were caused by the ground-wave of the wanted transmission being interfered with by its own reflected wave from the ionosphere. Today in the crowded state of the low- and medium-frequency bands the effective service range of most stations at night-time is reduced by ionospheric reflections from distant transmitters rather than by their own reflected waves. In the United Kingdom only two stations, Radio 2 at Droitwich on 200kHz, and Radio 3 at Daventry on 647kHz, have a natural effective service area limited only by their own sky-wave reflections. As I describe later, these two, and particularly 647kHz, will suffer from distant ionospheric reflections when the additional stations authorised in the new international frequency plan are brought into service after November 1978.

The effect of ionospheric reflections at medium and low frequencies is to give rise to an interfering signal at many \*Evidence for downward atmospheric reflection', E. V. Appleton and M. A. Barnett, Proceedings of the Royal Society, 1925.

times the range which gives adequate signal strength for reception via the ground-wave. This can be seen from the propagation curves in figure 2. When one remembers that the signal from an interfering transmitter must be 30dB below a wanted signal on the same channel for an acceptable service, it is apparent that, at 1MHz, a typical useful service range is up to 120km, but the interfering range might be as high as 3,000km.

A good example of the effect of interference from a distant transmitter can be seen by considering the 647kHz service from Daventry, before and after the revised frequency allocations resulting from the recent ITU Conference (1975). At present the night-time range is limited only by the transmitter's own interfering sky-wave signal and extends to about 100 miles in all directions. When the new assignments are taken up after November 1978, the night-time range will shrink to about fifty miles, the principal offender being an Albanian station 2,500km distant.

The practical situation in Europe has become very much a transmitter power game, and the main results of the recent Conference confirm, as we feared, that, for a given power,

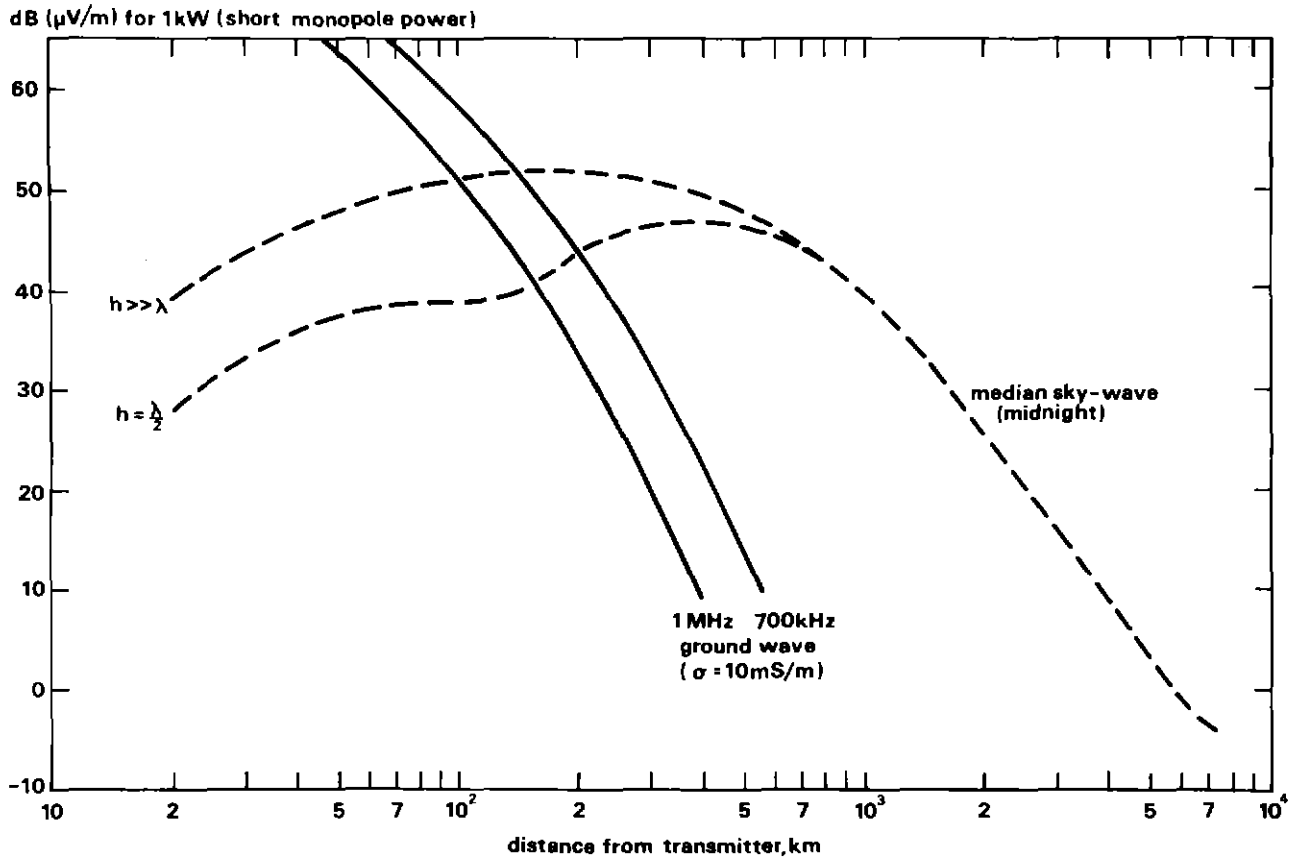

Fig. 2 MF propagation curve

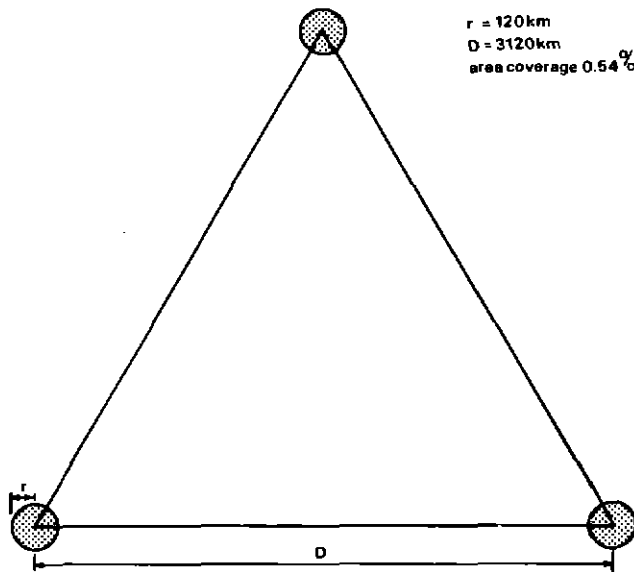

Fig. 3 MF coverage per channel

long- and medium-wave broadcasts will become subject to more interference than before, so that each station effectively will have a shorter useful range, particularly by night. It seems that negotiation for higher power has been the only way to hold one's own.

The range of the ground-wave is dependent on the frequency used; the lower the frequency or the longer the wavelength the better the ground-wave propagation and hence, in the absence of interference, the greater is the range of the transmission. The improvement is reduced to some extent by the higher levels of man-made and atmospheric noise at the lower frequencies but even so the advantages were clearly recognised by the pioneers.

The BBC's first long-wave transmitter, 5XX, came about largely through the efforts of Ditcham of the Marconi Company and Peter Eckersley. Following initial experiments at Chelmsford, the installation at Daventry was completed in July 1925 and could provide a power of 25 kilowatts — considerably above the power of the medium-wave transmitters in use at the time.

The problem of coverage range and interference range can be clarified by examining the area coverage that can be obtained at night by the use of a single frequency. The figures which I mentioned earlier determine the spacing that is needed between two transmitters to avoid interference. Figure 3 shows three transmitters so spaced at the corners of an equilateral triangle. The length of the side of the triangle represents the minimum spacing of the transmitters,



determined as described above, yet the service areas are represented by the small circles. The utilisation is in effect something in the order of a half of one per cent.

At long waves the situation is improved because of the better ground-wave propagation, but the utilisation still reaches only about two per cent.

The foregoing discussion is concerned with transmitters on a single frequency and radiating different programmes. There is a technique for increasing the coverage of a single channel and we call it synchronous working. When a group of transmitters is operated on the same frequency and they carry the same programme, the interfering signal level can rise to 8dB below the wanted signal before causing audible disturbance. This compares with the 30dB ratio required for co-channel signals with different programmes. As a result, the transmitters may be considerably closer. By day the interfering range is small, being due to the ground-wave alone and the percentage area covered in an ideal network comes up to about 46 per cent, as illustrated in figure 4, which has been calculated for good ground conductivity and a frequency of 700kHz. At night the percentage area coverage is still somewhat limited. It is interesting that with an interference-limited synchronised network the percentage coverage in daytime is actually increased at higher frequencies and poorer ground conductivity, rising for example to 60 per cent area coverage at 1500kHz. A practical example is the network of seventeen transmitters which at present carry the BBC Radio 1 service on 1214kHz. The service areas shown in figure 5 have been drawn on the assumption that the Radio 1 service is acceptable for a co-channel protection ratio of 6dB. Within the southern half of the United Kingdom it can be seen that the daytime area coverage is quite large — it is well over 50 per cent. At night, the coverage is very much less; nevertheless, roughly one third of the United Kingdom is well served by this single frequency at night. The day-time coverage is in many places limited by the so-called mush areas between transmitters, where the signal levels are not very different. We have experimented with a method of reducing the mush area by arranging that the audio modulation from two transmitters arrives at the difficult area in phase. As a result of encouraging tests, we have already installed the necessary audio delay and phase equaliser to reduce mush in the Bedford area between Brookmans Park and Droitwich.

Another application of synchronised transmitters is to be found in our proposals to improve the long-wave coverage in Scotland. We negotiated at the Geneva Conference for the use of 227kHz from 1978 in addition to our 200kHz assignment which is at present used only by the high-power transmitter at Droitwich. If, therefore, we can use 227kHz to cover a large proportion of the heavily populated Forth/Clyde area from Westerglen, a second transmitter on 200kHz at Burghead carrying the same programme can cover the northern part of Scotland. This would extend the long-wave coverage considerably, although we can only approach complete coverage by day and must still accept significant unserved areas at night.

As a part of our study of the proposal to use 227kHz in Scotland, recent measurements, as well as some probing into earlier experimental work, has indicated that during the winter months November to March, a daytime sky-wave

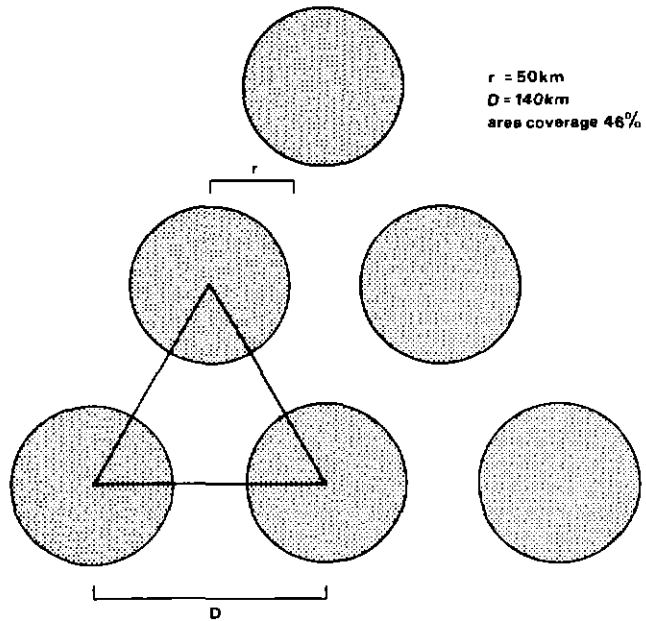

Fig. 4 Coverage of MF synchronised network (daytime)

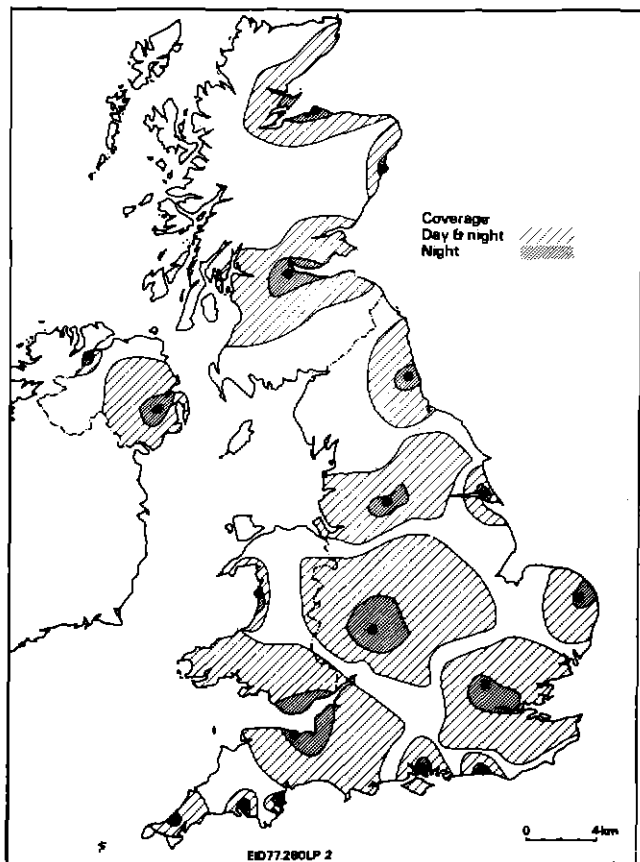

Fig. 5 Radio 1 coverage on 1214kHz



signal is propagated at a strength which, while considerably less than at night, can nevertheless have a more significant effect on coverage than has hitherto been assumed. It is an indication that we are still learning about low frequency propagation more than 50 years after Appleton's experiments at Oxford.

The ionosphere can react most awkwardly to very high-power transmissions. The modulation of a powerful transmitter — often on long waves — can become cross-modulated upon the sky-wave of another transmitter. It has been called the Luxembourg effect, because the long-wave transmitter at Luxembourg, with its central position in Europe, was often the culprit in pre-war observations of the effect. This again is an area where the BBC has been able to assist University experimenters by arranging special transmissions, notably for Huxley at Birmingham and Ratcliffe at Cambridge. What happens is that the temperature of the free electrons in the ionosphere can be significantly increased by the high-power transmission, fluctuating at audio frequency in sympathy with the modulation applied. Because ionospheric absorption varies with temperature, the ionosphere can impose this modulation on other transmissions. As it is the sky-wave that is affected, the phenomenon does not, fortunately, represent a major problem in receiving properly planned ground-wave services, but it is often an important limitation in the quality of sky-wave reception at night.

In spite of the propagation difficulties, we must, in a competitive world, continue to use the long- and medium-wave bands. The transistor portable with built-in ferrite rod aerial is cheap to buy and is easy to use. It can receive long- and medium-wave transmissions virtually anywhere — indoors, outdoors and while mobile. In most places there is a wide choice of programmes. In daylight, when most people listen in this country, BBC coverage is almost nationwide without disturbance by interference. After dark, when most people watch television, radio reception is often unsatisfactory, but it is usually possible to listen to some nearby stations, and to others that are far distant.

VHF/FM transmissions with their freedom from interference and with high quality mono, stereo and (soon) quadraphony, have simply added other options for the listener. They have not reduced the use of long- and medium-wave receivers. I will come back to the alternatives later, but in the meantime it is enough to say that we must continue to do our best to reach the listeners to the long- and medium-wave bands. That means it is as important now as it was in Appleton's experimental days to understand the peculiarities of propagation in these bands.

Before dealing with some of the lessons, I should emphasise the importance of the ground-wave. In the daytime on the long- and medium-wave bands, propagation is entirely via the ground-wave, the sky-wave being absorbed in the D layer of the ionosphere. The range of the usable ground-wave is dependent not only on the frequency as I mentioned earlier but also on the conductivity of the ground which it traverses, propagating well over ground of high conductivity and poorly over poorly conducting soil. Here nature helps the broadcaster. Over the centuries, man has tended to settle on soil of high conductivity; not because he measured it before pitching his tent, but because that is the

nature of good farmland. For the same sort of reason he has avoided nature's insulators — mountainous, rocky country. So nature has provided a bonus for the broadcaster — a grouping of his audience on soil over which it is easy to communicate at the low and medium frequencies. At least that was the situation until man polluted good farmland by covering it with insulating concrete!

For some time there has been concern about the low ground-wave field strengths from medium-wave transmitters received in built-up areas. In fact, it was discussed in IEE meetings as far back as 1928 and Appleton joined in these discussions. But so far it has not been possible to calculate the effect in advance.

It has become more of a problem in recent years for a number of reasons, including the erection of taller buildings, often containing a lot of metal, and also the return of local radio serving cities, and restricted to low-power transmitters by the congestion in the medium-wave band.

The BBC Research Department has recently studied this problem. Measurements of field strength from the Brookmans Park 908kHz transmitter were made along two radials through central London. The graph in figure 6 gives an indication, with some smoothing, of the results obtained on one of the radials. The nature of these plots is interesting because of the way the field is at first higher than the expected value, then suddenly reduces in the densely built-up area and subsequently recovers. A computer programme has been written based on a new technique which is readily able to calculate results for an inhomogeneous profile. The main parameter employed is surface impedance, but variations in heights of terrain along the profile line are also allowed for. The density and height of unipole-like objects, such as lamp-posts, steel framing, house wiring and plumbing, were part of the data for the computer programme and are shown at the bottom of the diagram. It also shows the results of the new calculation as a dotted line; the agreement is good, although work is still in progress on the subject and further improvements may be made.

## 2.1 Traffic information broadcasting

A new development stems from the experience in this country that medium or long waves are on the whole received more consistently and reliably than VHF in motorcars and the receivers are cheaper. The fact that the motoring audience is frequently as high as 13 per cent of all listeners is an important factor in continuing with long- and medium-wave transmissions. But, apart from general news and entertainment, the motorist often wishes to have specific news about traffic and road conditions. There is then a conflict, because a programme which gives the optimum amount of motoring information could hardly remain good entertainment value to a wider audience — whether in the car or at home. The BBC has, therefore, been taking the initiative in seeking a method that would overcome this conflict.

We propose the setting-up of a lattice of about 70 stations (figure 7) all using a single frequency in the medium-wave band; most of them could be at existing BBC sites. The transmitters would operate in time-division multiplex and

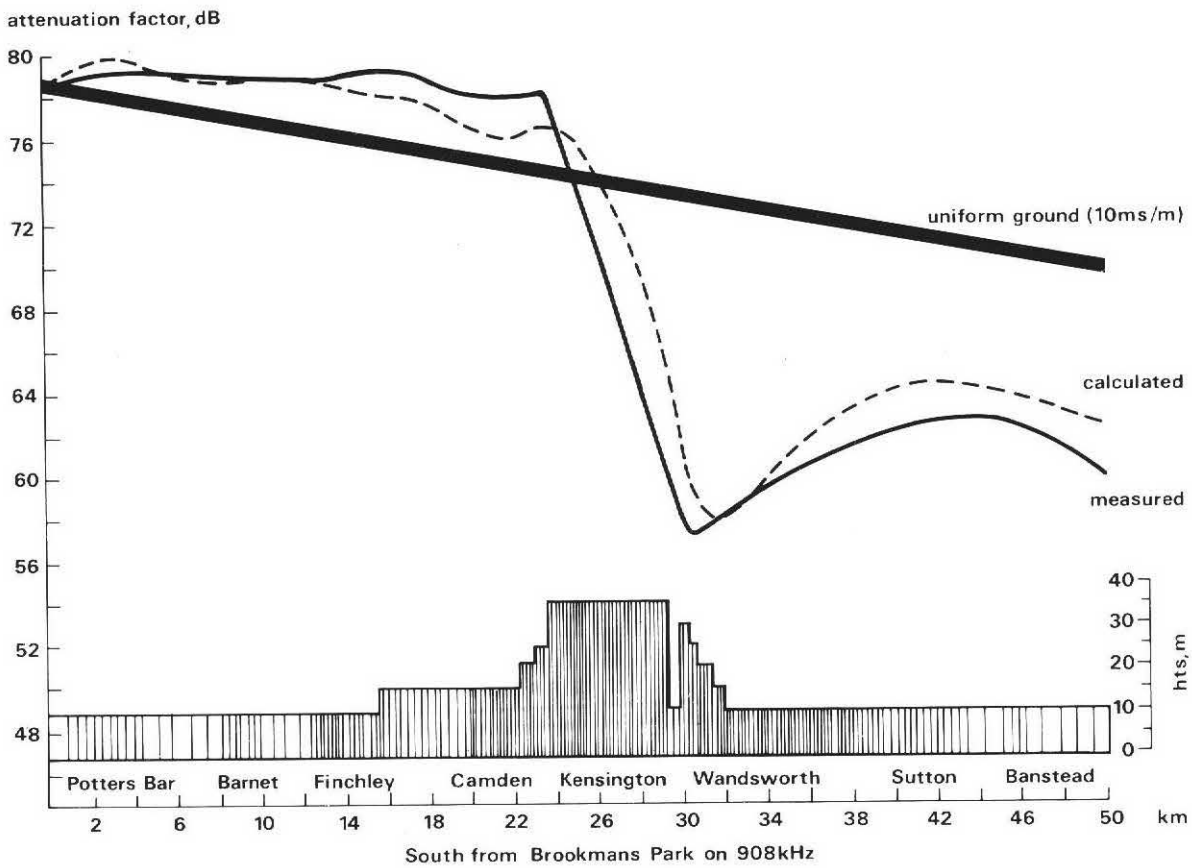

Fig. 6 MF ground-wave propagation

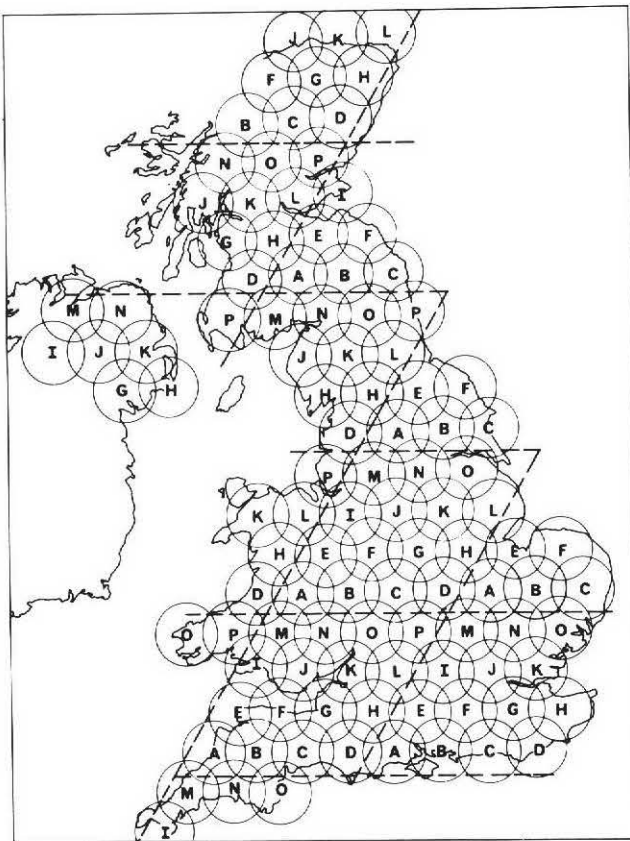

Fig. 7 Traffic information service: transmitter lattice



Fig. 8 Traffic information service module in standard car receiver

stations transmitting simultaneously would be far enough apart to avoid interference; each would broadcast information related only to the area which it served.

The receiver in the motor-car could be extraordinarily simple in that it would not require adjustable tuning and could use a ceramic filter to select the dedicated frequency. The development and detailed design would, of course, be left to the receiver industry but we have made one or two prototypes and figure 8 shows how one of these could be fitted inside a conventional car set.

With this type of broadcasting there would be nothing to prevent the world-wide use of a single frequency. Road traffic experts are very interested in the proposal, which could solve many problems.

'BBC Engineering' has already carried a description of our proposal\* but we have recently further developed the system to ensure that only the transmission from the nearest station, which carries the relevant information, is received in the car. In this development† control signals which activate the car receiver to reproduce a message (and return it to standby when the message is completed) are conveyed by frequency-modulating the medium-wave transmitter carrier. The capture effect of FM reception enhances the discrimination between wanted and unwanted messages by some ten to twenty times. The message itself may be carried by amplitude modulation of the same carrier or it could employ any of the alternative systems of modulation.

### 3 High Frequencies

In dealing with the part of the radio-frequency spectrum between 3 and 30MHz, the high-frequency band, credit should be given to the amateur radio experimenters who, in the nineteen-twenties, proved that long-distance transmission on short waves was possible. Appleton's exploration of the ionosphere, which moved from medium frequencies to high frequencies in 1924, started to fill in the gaps in our knowledge and explain the results which the amateurs were getting. Some gaps remain and efforts are still being made to reach a full understanding of the vagaries of high-frequency propagation caused by changes in the refracting layers which are only partly predictable in terms of time of day and season of year.

It has taken us a long time to work out a system of prediction which gives reliable results and in its External Services the BBC devotes much time and effort to preparing schedules for high-frequency broadcasting.

Initially, the overseas listener was a rather special type of person — often expatriate — and prepared to devote a good deal of attention and money to his receiving installation. Gradually, however, the pattern and concept has changed over the years, but short-wave broadcasting has been a consistent growth industry in terms of the number of receivers in use throughout the world. Now, with the battery transistor portable, we have many listeners, mostly citizens in their own countries, receiving the BBC services either in English or in one of the forty or so other languages used. Receivers have adapted to needs. We are familiar with the simple medium-wave receiver but in one large factory in East Africa the cheapest radio produced is a short-wave receiver.

Long-distance short-wave transmissions may be reflected two or three times from the ionosphere to earth and back again before reaching the listener's aerial. Each reflection introduces attenuation. Because of this, and the congestion and interference on the short-wave bands, very high effective radiated powers of the order of 30MW are becoming common. Even so the BBC has found it necessary to build high-power relay stations as near to the audience as possible; preferably close enough to reach the audience with only one ionospheric reflection.

\*A traffic information service employing time division multiplex transmission, Sandell R. S. and Harman M. W., BBC Engineering Number 100, June 1975.

†British Patent Application No. 49919/76.

Some of the programme links to the relay stations use single-sideband transmission from the United Kingdom. One important advantage is the freedom from distortion during deep fading — an advantage which can also be realised by single-sideband reception of a standard transmission. At our relay stations we use diversity reception using spaced aerials to receive the signals from the United Kingdom. It is interesting that the additional benefit from diversity reception has been found rather small when receiving single-sideband transmissions. However, recent work in the BBC on a method of combining the signals with a rapidly adapting phase adjustment has led to a much greater benefit.

Another technique used to increase the effectiveness of overseas broadcasting is the use of programme compression to increase the apparent loudness without noticeably degrading quality. The latest method makes judicious use of momentary changes of frequency response instead of relying solely on changing the gain over the whole audio band.

### 4 Very high frequencies

When we come to the very high frequency bands — those used for 405-line television and FM radio — we are in a region of the spectrum where propagation is affected by several different influences. At these frequencies the ground wave has too short a range to be useful and propagation must be from elevated aerials over line-of-sight paths or a little beyond. This is the 'normal' mode of propagation and frequency allocations and transmitter siting are based on it.

Under certain circumstances, however, propagation over much greater distances occurs and severe interference can result. For example, signals may be refracted and follow the curvature of the earth because of abnormal temperature gradients in the atmosphere during anticyclonic weather. Fortunately, its occurrence is infrequent — between one and two per cent of the time.

At the lower frequencies in the VHF bands the ionosphere is occasionally responsible for long-distance propagation by reflection from areas of enhanced ionisation of the E layer, especially in summer. Even Appleton's F layer can occasionally cause propagation over very long distances for the lower frequencies in the band.

Such abnormal modes of propagation are a nuisance to broadcasters and the BBC has collaborated in international programmes to measure the effects and devise techniques for prediction. Studies of this sort are necessarily a formidable task, because the ionosphere varies over the eleven year sunspot cycle. Therefore, any measurement campaign likely to offer a comprehensive answer must have a duration of at least that period.

The coming of television in the nineteen-thirties placed a premium on the development of VHF technology. The scanning standards and resolution of the television system had to be chosen so that they did not exceed the highest practicable modulating frequency, while the need to provide a carrier for these video frequencies (which could be of the order of 3MHz), automatically prescribed the use of transmission in the VHF band. The skill with which Blumlein and his colleagues chose the technical parameters for the world's first high-definition television system, opened by the BBC just over 40 years ago, has been recognised everywhere.

So our use of VHF began with television in Band I with the vision signal radiated on a 45MHz carrier and the sound on 41.5MHz. As waves at these frequencies do not normally propagate far beyond the horizon good coverage necessitated a high site. To cover the London area, Alexandra Palace or the Crystal Palace were obvious choices; we began at the former and moved to the latter twenty years later. The transmitting aerial at Alexandra Palace was about 600 feet above sea level and the vision transmitter, with an effective radiated power of 34kW, had a useful range of some 25 miles in all directions.

The great progress made in valve and circuit design during the war and soon afterwards, opened up possibilities for the broadcasters to move into parts of the spectrum hitherto unused. The higher the frequency, the fewer the problems with unwanted long-distance propagation, and the more exclusive the service became. In 1955, we moved into part of Band II, 87.5 to 97.6MHz, to set up networks of frequency-modulated transmitters carrying the main sound programmes in very high quality, first in mono, later in stereo and soon in quadrphony.

Finally, to complete the VHF story, commercial television was introduced in Band III in 1955 using the 405-line standard.

This may mark the point in my survey where reflections from the ionosphere cease to be a major source of difficulty in reception, and reflections from hills or man-made objects take their place. Fixed or moving objects comparable or greater in size than the wavelength in use can act as reflectors to cause interfering wave patterns. The television screen is, unfortunately, very effective in displaying delayed signals for all to see as a secondary image displaced to the right of that derived from the wanted (direct) signal. The problems of multipath reception at frequencies in the VHF, and also the UHF, bands are frequently encountered, but unlike those caused by the ionosphere at lower frequencies, it is very often possible to do something about it.

In each of the three VHF bands, the domestic aerial can be small enough to be specifically related to a half-wavelength. This is of very great assistance in devising an efficient receiving system having directive properties which can be exploited to discriminate against signals which do not arrive direct from the transmitter. The higher the frequency, the more directive and discriminating an aerial can be within a given physical size.

Just as the television receiver has an unfortunate tendency to display the effects of reflected signals, so can the VHF/FM radio receiver be affected by multipath propagation, with consequent severe distortion. Wishing to study this effect in detail the BBC was, I believe, the first to use what might be called a portable Appleton and Barnett machine. This was in 1958. From a combination of laboratory and field studies we established that FM broadcasts are particularly sensitive to combinations of direct and long-delayed signals, where the difference in path lengths is more than 8km. Although reflections of shorter delay are often stronger, they cause less multipath distortion.

Once again, a directive aerial can be of very great value in reducing the effect of multipath propagation, and where the listener is prepared to take enough trouble with his

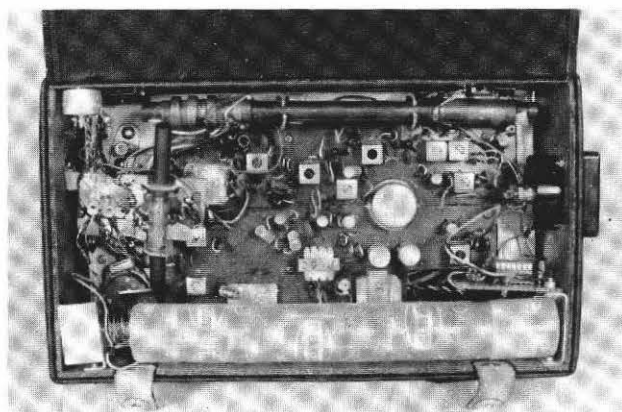

Fig. 9 Transistor receiver with (at left) ferrite aerial for VHF

installation, distortion can usually be reduced to negligible proportions. We do, however, encounter resistance to the idea that a proper aerial installation is necessary for Band II reception. The reason is not difficult to find. The willingness of a medium-wave portable receiver to produce entertainment under almost any circumstances without a visible aerial, leads the listener to expect his VHF radio set to perform in a similar manner. After all it is usually in the same cabinet.

At the present time, nearly 40 per cent of all the radio receivers in the hands of the public have a VHF section. Allowing for the fact that most households have more than one radio receiver, we have established that about 60 per cent of homes have VHF radio. But only about 20 per cent actually use it. The BBC carried out an elaborate survey of listening habits in 1975 and found that most people use LF or MF reception, and are inclined to take the receiver from room to room as required. In the evening, about 8 per cent of the population settles to listen to a fixed installation stereo receiver which may do justice to the quality of the VHF/FM transmissions.

This is frankly disappointing, but it is no fault of the ionosphere. Local reflections, standing waves, inadequate aerials on portable receivers and a very cramped tuning scale all militate against the otherwise deserved popularity of VHF radio. Ferrite material suitable for use in the VHF radio band is now available and we have had promising results from a prototype aerial with FET amplifier built into an inexpensive transistor set (figure 9). Its performance is as good as that of the standard telescopic rod and it is much more convenient; also it does not suffer from hand-capacity effects. Broadcasters look to the receiver industry for further development of the VHF portable set.

The broadcaster cares a lot about FM sound broadcasting, because it permits the highest quality in mono, stereo and quadrphony. The freedom from sky-wave interference and the very infrequent incidence of tropospheric propagation give the VHF/FM listener reliable and troublefree reception. It also permits much more efficient coverage than is possible on MF. This is because the propagation curve gives a fairly steep fall of signal with distance beyond the radio horizon, and also because a high-quality service can be planned on the basis of a protection ratio between co-channel stations of only 28dB for 99% of

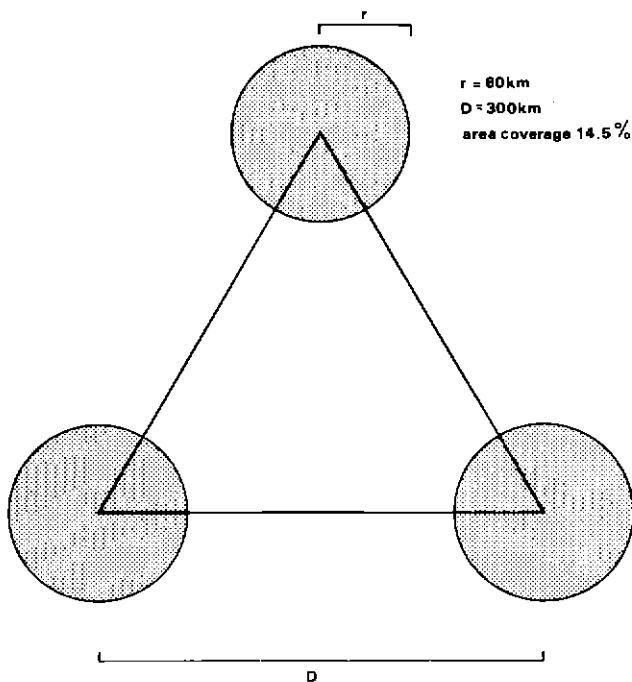

Fig. 10 FM coverage per channel

the time. As a result the coverage range may be some 60km from a high-power station and the interfering range 240km. The area coverage in an ideal network now rises to about 14.5% from the use of one frequency channel of nominal 200kHz width (figure 10).

The 405-line monochrome television VHF transmissions in Bands I and III are technically obsolescent and are due to be closed down, probably in the early 1980s. Clearly, much thought will have to be given to the future alternative uses of the two bands and the BBC has made certain proposals to the Annan Committee. We have said that, on the one hand, Band III is an exceedingly useful band for television and that it should be replanned for new 625-line television services to the same standard as those broadcast in UHF. There might be an additional national network or a series of regional or local stations. Band I, however, is a less attractive proposition for television because of its susceptibility to long-distance interference via ionospheric reflections (Sporadic E) but it has a valuable potential for other services. It may offer an opportunity for the United Kingdom to pioneer new forms of sound and data broadcasting. For sound transmissions, either wideband FM or PCM systems would be attractive and could provide a robust system of sound broadcasting which could be received easily nationwide throughout the 24 hours, on portables and in cars. A new system, departing from the conventional AM or FM could give good coverage without high powers, and with a more favourable protection ratio. The area coverage per channel could be large and this would make the system efficient in spectrum usage (figure 11). A comparison has been made of a number of different modulation systems and from this it would appear that the best coverage for a given power density in the frequency spectrum would be achieved by a form of PCM. The PCM system could use, at one extreme, one channel per carrier or,

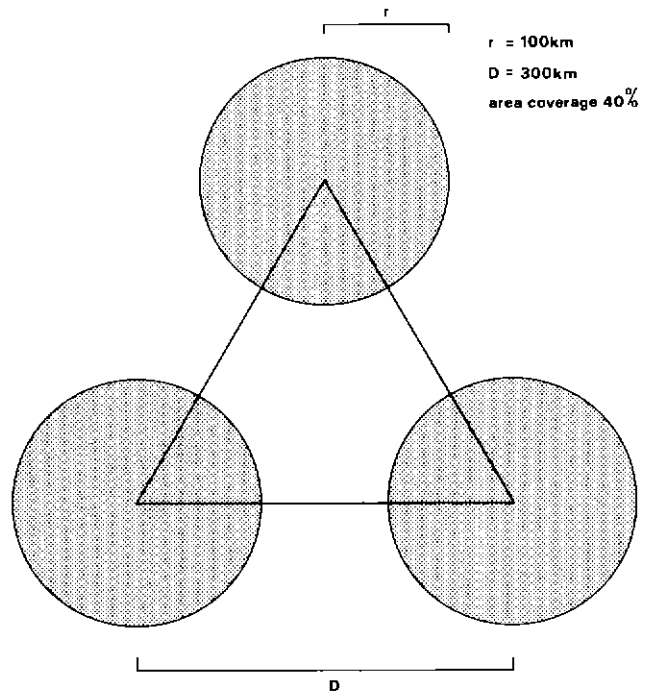

Fig. 11 Wideband FM or PCM coverage per channel

at the other extreme, a multi-channel transmission of high bit rate carrying many sound channels. Work on the performance under multipath conditions needs to be carried out before making a final choice.

As we shall need new receivers to make use of the channel vacated by the closure of 405-line transmitters, we should not be afraid to design completely new receivers taking advantage of new techniques that have become economic with integrated circuits. Also there seems little doubt that the old unsightly Band I 'H' aerial could be superseded by an aerial within the set or a probe and high impedance amplifier.

## 5 Ultra high frequencies

In 1962, the Pilkington Committee recommended that there should be a gradual change from the original 405-line television service to the 625-line standard being adopted in most countries of Europe, and that the programmes should be broadcast in the ultra high frequency bands. Technology had continued to make progress and the design of suitably powerful UHF transmitters with broad-band modulation had become practicable, while satisfactory receiver performance could be achieved on a mass-production scale. Television broadcasting in the UHF band began in 1964 with the opening of BBC2 in black-and-white. When colour was introduced in 1967 on BBC2 and in 1969 on BBC1 and ITV, it became possible to simplify the television set to single-standard working and the growth of UHF viewing was very rapid thereafter.

In UHF we have no problem with the ionosphere and there is very little connection with the early work of Sir Edward Appleton, although he gave invaluable service to

the BBC as Chairman of its Scientific Advisory Committee at the time when these major changes were being considered. The problem that faced us then, and indeed still does, was that propagation in UHF is virtually line-of-sight and, therefore, many more stations are needed for complete coverage than is the case in VHF; the ratio is 6 or 7 to 1.

Coverage of the United Kingdom with UHF television will involve about 420 main or relay stations to bring the service to nearly every group of 1,000 or more people, and another 250 stations if we are to serve communities down to 500 souls. Only a few of this total receive their input signals from a high quality microwave distribution network developed and operated by the Post Office. The remainder derive their inputs by receiving off-air the signals broadcast from a main station or another relay station. They then translate the signals to another frequency and re-broadcast them locally. The power of the transmitter is chosen according to the coverage achievable and the limits of coverage are, more often than not, determined by interference from the direct wave of another station rather than diminishing field strength. In the UHF Bands IV and V, there are 44 television channels and each station is allocated four of these channels. For the most part we can select only nine basic groups of four to be used repeatedly; the remaining channels can only be used to a limited extent. This means that each channel will be shared by at least 40 transmitters in different parts of the country. The problems of predicting propagation, making channel allocations, and choosing the power to be radiated present us with an exceedingly complicated task. In such a densely-packed network, every possible step must be taken to minimise the effects of co-channel and adjacent-channel interference. The natural obstructions in hill country which make such a large number of transmitters necessary, can be turned to advantage in providing screens between stations that would otherwise produce intolerable mutual interference. It is necessary to take note of the direction which most aerials in a town will be pointing to the local transmitter and make sure that there is not another station along the same axis, though more distant, which can interfere. Help can also be gained by minor adjustment of the precise frequency on which each transmitter operates to give the minimum of visibility to the interfering pattern when it is displayed upon the line structure of the television receiver. The planning of a UHF network is a mixture of high technology and tedious calculation. Fortunately, the latter can be handled these days with the aid of a powerful computer supported by a *great bank of data which are acquired through continuous and detailed survey*. Without the precision which this permits, many fewer people would be able to receive the colour television programmes.

At the end of 1976, the networks of BBC and IBA UHF transmitters covered about 97.5 per cent of the population from 48 main stations and 215 relay stations. Nearly 400 more stations will be needed to reach the next 2 per cent of the population.

We have, as you will have realised, placed the main stream of television firmly in the UHF band. Interference problems arise from the necessary overcrowding of stations into the band and we do have occasional periods when reflection from the troposphere produces unwanted interference from

distant stations, but it is rare. The vast majority of colour television viewers regularly receive high quality interference-free transmission.

## 6 Broadcasting from satellites

My outline of the Nature of Broadcasting would be very incomplete without acknowledgement of what broadcasting already owes to satellites and a reference to the possibilities for the future. The main interest lies in the so-called geostationary satellites which, in orbit at a height of some 36,000 kilometres above the equator, can be kept at a fixed point in the sky. We use them daily via the Post Office station at Goonhilly Down for intercontinental programme collection and distribution.

Several things may be said, in general terms, about the possibilities of *direct* satellite broadcasting into the home. First, as a means of transmission, it comes closer to the ideal of broadcasting than anything that we have had hitherto. In the 12GHz SHF band, propagation is entirely by line-of-sight. Over 99.8 per cent of all people in the United Kingdom, given a suitable telescope, could see their roof tops from a satellite 36,000km above the equator due south of Britain! Signals at these frequencies pass through the layers of the ionosphere without attenuation and are affected only by rain although not critically so in a typical European climate.

With directional aerials on the satellite it would be possible to produce narrow beam transmissions to serve the whole of the United Kingdom (figure 12), although it would be difficult to concentrate transmissions on areas much smaller than that. On the 12GHz band it is possible to provide four or five 625-line television programmes for each country in Europe, and several sound programmes or other narrow band services such as data in visual or print-out form.

Thus direct broadcasting by satellite has the great virtue that it could provide signals overnight to the whole country — that is if the services were wanted or financially viable. The public would have to be willing to invest in the necessary new equipment and pay directly or indirectly for the additional programmes.

At the minimum a new receiving aerial would be needed — probably a dish of about 75cm in diameter pointed at the satellite with an accuracy of half a degree — together with an SHF-to-UHF frequency converter connected to the input of the existing domestic receiver. The cost could not be less than £75 at the most optimistic estimate for each installation, a national expenditure of £1,400M or more for the 18 million houses and flats likely to be equipped with television aerials by the early nineteen-eighties. It would also cost about £16M a year for the satellite itself — and additional programmes come extra. Is it worth it? Can the country afford it? Do viewers want more than the five or six networks that can be provided via orthodox terrestrial transmitters; networks that can be programmed regionally or locally and need not be restricted to nationwide coverage as is the case with satellite transmissions?

I think the answer to these questions is 'No' — at least for as long as the programmes via satellite are similar in content, screen size and technical standards to those from



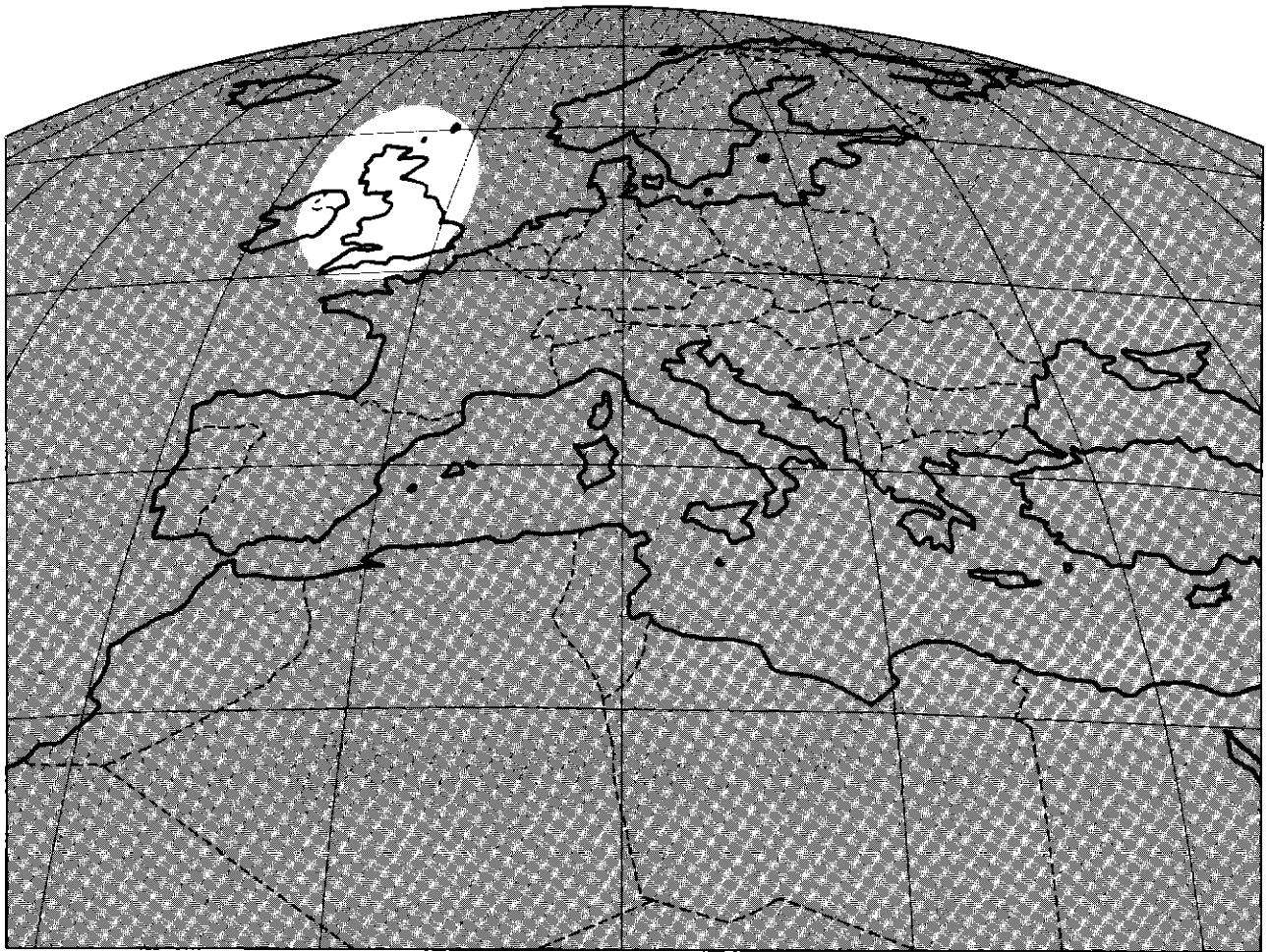

Fig. 12 Europe as seen from a satellite, with the United Kingdom illuminated by one transmission beam

the terrestrial 625-line stations.

Do we need to change standards? After all we have not yet completed the changeover from 405 to 625 lines. I am not suggesting replacing the 625-line PAL standard which serves us so well, and will continue to do so for as long as we are restricted to screens of the size and brightness we now use. But the ideal size of a viewing screen for a typical living room is much larger, as we know from our experience of projecting holiday slides and films. A screen 2m wide by 1m high could be of the right order, but no development of the cathode ray tube is likely to provide screens of this size.

The display of the future is almost certain to be a solid-state device, possibly in the form of millions of integrated circuits in sheets which will be put on the wall of the living room. This fundamental change of display technology will have a far-reaching effect on the television waveform, since it will no longer be necessary to allow the comparatively long periods for fly-back of the scanning spot. There will be no wasted time and, therefore, greater efficiency in using bandwidth. Solid-state displays are still relatively primitive, but it is reasonable to assume that the technology will continue to develop, and there seems to be no limit to the complexity of integrated circuits. A screen 1m high would need at least 1,500 elements vertically, and to give equal resolution horizontally it would have 3,000 elements in the

conventional line direction if it were 2m wide. Each picture element would be of the order of 0.7mm square. Semiconductor technology is already such that it would be possible to include quite a large amount of electronics within each picture element to permit both storage and display.

If one thinks of every element being separately up-dated 25 times a second, a display of the resolution that I have described, and having little or no redundancy in the form of synchronising or flyback time, leads to the concept of a video signal bandwidth of 50 to 60MHz. Each element would receive specific information and maintain its brightness until there came a change of instruction; hence, there would be no flicker and we know that a field rate of 50 per second gives excellent portrayal of motion. Some further economy in bandwidth may be possible by transmitting the data required only to up-date selected picture elements to portray moving objects. The saving that could be achieved would be dependent upon the statistics of normal picture content and the fact that the eye requires less detail of a moving object than a static one.

Of course, I am not suggesting that we can adopt a standard of this kind tomorrow, or perhaps even in the next 10 years, nor in fact that the eventual standard will necessarily be the one I have described. Before large screen television is technically and economically viable, much



innovation is necessary, including the development of the large screen display itself. Camera resolution and signal-to-noise ratio will be big problems and the television system must be brought closer to the performance of the combination of eye and brain which works well over a wide range of light levels. Satellite transmitter powers would have to be higher than now. But none of these problems would appear to be insuperable. When we are ready to go ahead, we shall need the wide bandwidths that only the 12GHz band can carry. I am sure the band will be used more extensively for other purposes before we are ready for large screen television. However, there is a reasonable prospect that we can arrange these other uses in such a way that they will not impede the introduction of large screen television when we are ready for it.

## 7 Conclusions

There is much more that broadcasters can do to ensure that people are informed, educated and entertained. We must continue to adapt to changing conditions and, if necessary, absorb the functions of older methods of communication as they are overtaken by economic events. The number of cinemas continues to fall and the live theatre survives only in the largest centres. Already most people rely on broadcasting for most of their entertainment. Newspapers are steadily going out of business in the western world and postal services are being reduced in frequency because of rising costs. Broadcasting will have to be ready in the years ahead to provide some of the services which would otherwise be lost, together with new services, not yet clearly defined as public needs. CEEFAX and traffic information are two that we have defined. It will not be easy to do these new things. Money is scarce and so are frequencies but both can be found when the need is clear.

The broadcaster is only one of many users of the radio frequency spectrum. There are others with claims on the available space. But the case for broadcasting is strong. It is by far the cheapest way of communicating with the public and it is very popular with them. It is unusual these days to find a home which does not make considerable use of both radio and television.

A World Conference is arranged for 1979 to re-allocate the entire frequency spectrum. What should the broadcasters seek?

As I have tried to make clear, some of the bands allocated to broadcasting are excellent for the purpose and others are unsatisfactory for reasons that Appleton began to explain 53 years ago.

In radio, the VHF Band II is extremely satisfactory for FM sound broadcasting in mono, stereo and quadraphony. Better aerials and simpler tuners are possible, as I have shown; and when they are available, FM listening should become more popular. However, only a very small part of the band is allocated to broadcasting in the United Kingdom — 88 to 97.6MHz, sufficient for only three national networks and some local radio stations. A small increase — to 100MHz will begin to become available for broadcasting after 1978. The BBC has recommended to the Annan Committee that this should be used for a national network

devoted to educational broadcasting to bring together and add to the large amount of educational broadcasting at present scattered somewhat indiscriminately throughout the networks.

Even more space is needed if radio is to be able to develop as it should. Most FM receivers that we buy will tune up the band to either 104 or 108MHz because these higher frequencies are used for broadcasting in many other parts of the world. Simply by re-allocating more of the band to United Kingdom broadcasting, FM listeners could enjoy more programmes in high quality without having to buy a new set.

The long- and medium-wave bands are very satisfactory for daytime listening at home and in the car. Something like 40 million sets — an average of two per household — are in regular use throughout the United Kingdom. We must, therefore, in spite of the poor night-time coverage, continue to make use of these bands until we find an alternative which is acceptable to the public. The BBC has made proposals for a complete re-arrangement of its programmes on the two bands. The aim is to achieve comprehensive daytime coverage, and the best that can be done in the way of night-time coverage when a new International Frequency Plan has to be implemented in 1978. To take account of devolution, we are proposing that in Scotland, Wales and Northern Ireland listeners should be able to receive their locally-originated Radio 4 as well as the United Kingdom edition. In all cases the daytime coverage should be excellent but in some cases the night-time coverage is likely to be worse than now because of the increased congestion on the bands. It is a very unsatisfactory prospect for both listener and broadcaster. Our earlier hopes that FM broadcasting on Band II would ultimately replace long- and medium-wave broadcasting now look unlikely to be realised. The modern long- and medium-wave transistor portable is so convenient, so cheap and so easy to use everywhere, that the public will not lightly give it up. But if we are to serve the listener well throughout the 24 hours, we have to find an effective alternative. Our studies suggest that pulse code modulation in Band I could fill this role.

For external sound broadcasting to distant countries, geostationary satellites could provide reliable coverage on existing or new broadcasting bands. But many countries do not want their subjects to hear news and views from elsewhere. They have successfully negotiated rules for the control of direct satellite broadcasting, of both sound and television, which restricts coverage to the country of origin. It will be necessary, therefore, for overseas broadcasters to continue to use the short-wave bands with all their problems of variable propagation and overcrowding. More space for broadcasting on these bands is urgently needed if countries are to be able to continue to broadcast to each other.

In television, Bands IV and V are proving to be extremely satisfactory for broadcasting in 625-line colour and I am confident that it will be a very long time before we switch off the transmitters in these two bands. You will remember that they can carry four television networks. A fifth, or perhaps many local television stations, can be provided in Band III which is also very satisfactory for television. The 405-line transmitters in that band are due to be shut down in the nineteen-eighties. Band I, also carrying 405-line black-and-

white television at present, is less satisfactory for television broadcasting, mainly because of sporadic reflections from the E layer of the ionosphere. Unless by the mid-nineteen-eighties we have a pressing need for a sixth national television network it would be more desirable to re-allocate Band I for other uses, including the pulse code modulation sound broadcasting I have mentioned. Other forms of digital broadcasting such as multipage CEEFAX and facsimile would also propagate well in Band I.

In the longer prospect we will undoubtedly reach the time when large screen television becomes possible and economic in the home. When it is we will need a new television transmission standard to do justice to the larger picture. The right place for this service is in the 12GHz band which can handle the bandwidths needed.

Sir Edward Appleton was Chairman of the BBC's Scientific Advisory Committee until his death in April 1965. Throughout most of his professional lifetime, he regularly

guided and stimulated us. In all of that time the available technology virtually decided the parts of the spectrum to be used for broadcasting. At the beginning we could not make transmitting valves that would oscillate much above 1MHz; hence radio had to be on the medium-wave band regardless of its ionospheric peculiarities. When we started black-and-white television with a modulation bandwidth of 3MHz, we had to have a carrier of at least 40MHz and we could not make valves that would go much higher anyway. When we started colour television with a bandwidth of 5MHz and a channel spacing of 8MHz and a need to provide three or four networks we had to go to UHF.

Now the technology is advancing so rapidly that, for almost the first time, broadcasting services and their technical methods can be matched more accurately to the nature of the available spectrum.

I hope we will do this, and I am sure Appleton would have said we should.

---

### BBC Research Department Reports

Each year the BBC Research Department publishes about 35 reports on its work in the field of broadcasting technology. Titles of some recent issues are:

- 1977/1 A 4-phase differential-phase-shift-keying stereo sound system: carrier recovery methods.
- 1977/2 Quadrphony: developments in Matrix H decoding.
- 1977/3 Factors in the design of loudspeaker cabinets.
- 1977/4 Two audio test-signal generators for assessing programme-modulated noise in digital companders.
- 1977/5 Airborne television transmission.
- 1977/6 CEEFAX: measurement techniques.
- 1977/7 Satellite broadcasting: slant path attenuation through rain storms.
- 1977/8 Film lighting using metal-halide lamps: the effect of intensity ripple asymmetry.

- 1977/9 An experimental digital picture store.
- 1977/10 UHF scatter propagation across the English Channel.
- 1977/11 A Band II ferrite aerial unit for portable receivers.
- 1977/12 LF and MF propagation: a study of sky-wave field-strength variation.

A subscription to BBC Research Reports costs £25.00 per year. Further information and subscription forms are available from:

Research Executive,  
BBC Research Department,  
Kingswood Warren,  
TADWORTH,  
Surrey, England.

# The Development of a Location Production Unit Using Lightweight Electronic Cameras

I. Leiper

R. Vitty, CEng., MIEE

A. J. Woolford, BSc., CEng., MIEE

Television Outside Broadcasts Department

**Summary:** The use of electronic, rather than film, production methods on location can lead to more economical operation as well as easing the problem of matching location shots with studio material. The article describes the layout and equipment of a vehicle designed to exploit these advantages for location drama work and discusses operational experience. Complete drama productions have so far formed the major part of its use, rather than location inserts for studio productions for which it was originally proposed.

- 1 Development
  - 1.1 Background
  - 1.2 The prototype
  - 1.3 Operational experience
  - 1.4 Design requirements for the LPU
  - 1.5 Design and layout
- 2 Operations
  - 2.1 General
  - 2.2 Cameras and camera mountings
  - 2.3 Lighting
  - 2.4 Sound
  - 2.5 Power supply
- 3 Conclusions
- 4 References

## 1 Development

### 1.1 Background

By 1973 the use of Outside Broadcasts units for shooting location inserts for studio drama productions was increasing steadily<sup>1</sup> because of the advantages it offered, including:

- a) Instant replay of scenes, immediately after recording.
- b) Ability to erase unsuccessful takes.
- c) Continuity maintained more easily, particularly in dialogue scenes.
- d) Ease of matching location shots with studio material.

The advantages led to lower shooting ratios and simplified editing.

The system was, however, still far from ideal. Standard Outside Broadcasts units provide more facilities than are normally required for location drama work and are therefore bigger, heavier, and more expensive than necessary for the job. The conventional electronic cameras they use are also cumbersome and impose limitations on the types of scene which can be shot and on the speed of re-setting for a different scene. A technique of operation partially overcomes this difficulty by 'leap-frogging' pairs of cameras: one pair is used for recording a given scene while the other

pair is being moved and lined up for the next scene.

These considerations led the Television Service to plan a unit specifically for location drama work. A unit operating in a rather similar manner to a film unit — i.e. highly mobile cameras with a minimum of associated equipment — was initially envisaged.

### 1.2 The prototype

An experimental prototype unit was proposed as a suitable first step so that experience of operation could be obtained before embarking on major capital expenditure.

The initial concept of a very small and highly manoeuvrable unit was soon found inadequate for location drama work and a larger vehicle was chosen in order to accommodate all the facilities required. A vehicle which had originally been used as a two-camera black-and-white 'Roving Eye' was chosen and equipped with two colour camera channels, a three-channel vision mixer, and an eight-channel sound desk.

The vehicle's length was 5.69m (18'8") and space could not be found for a normal-size VTR. Developments in the field of helical-scan machines fostered hope that a model capable of suitable quality might be obtained to be installed beside the driver's seat, but these hopes were disappointed and a lightweight quadruplex recorder was fitted instead. This machine was capable of recording to full broadcast quality but had serious limitations for location drama work: replay was of low quality and not in colour; there was no erasing head and so recording over unusable takes was not possible; the tape duration was only 20 minutes, which was inconveniently short, particularly without the ability to record over discarded shots.

The need for a more suitable VTR was pressing and it had to be accepted that a separate video tape vehicle would have to be used. That vehicle was fitted with a machine with larger spools and better (but still not fully-compensated) playback facilities.

### 1.3 Operational experience

The prototype unit was made available to all programme departments and a close watch was kept on the various production problems encountered. The experience thus obtained revealed that the new unit was being used for two quite distinct types of work:

- a) location recording, mainly drama.
- b) small-scale outside broadcasts requiring two cameras with a great deal of camera movement.

This pointed to a need for two different types of unit, each tailored to serve its specific purpose. The first requirement calls for a Location Production Unit (LPU) which is the subject of this article: the second for a Lightweight Mobile Control Room (LMCR) which is not considered further here. (An article about it is planned for a future issue of BBC Engineering.)

A requirement for the very small, highly mobile unit with limited facilities was also identified.

### 1.4 Design requirements for the LPU

Largely as a result of the operational experience, many important design requirements were deduced. The principal considerations were:

1. A VTR was invariably required and space must be found for it in the vehicle.
2. Directors often preferred to concentrate on the artistic performance, leaving the actual cutting between cameras to someone else. Space was therefore required for a vision mixer.
3. The production area should be made as large as possible to allow room for those responsible for design, make-up, and costume, and other members of the team to check that their contributions to the programme were satisfactory.
4. Sound quality monitoring in a combined production area presented difficulties. Consequently, a separate sound area was needed.
5. Two separate radio systems were required: one for production and one for technical staff to enable directions to be relayed quickly to performers and technical operators without their being tied to a cable.
6. Some of the crew spend a high proportion of their working lives in the vehicle. Hence, adequate heating and air-conditioning were essential.
7. The roof should be strong enough to walk on and to support cameras.
8. Most camera-mounting needs could be met fully by types in common use for film cameras. Tripods and dollies were used for most of the work, but special mounts (e.g. for car doors) were needed for some purposes. Very few shots called for hand-held operation.
9. An oil-burning space heater was required to keep the technical equipment warm and ready for very quick starts and to allow heating where electrical power supply is limited.
10. The vehicle would clearly have to be longer than the prototype in order to accommodate all the important features but its length should not exceed about 8m

(26'3") in order to avoid undue difficulty with parking, manoeuvring, etc.

11. A technical support vehicle is required to carry supplies and equipment for which space could not readily be found in the LPU itself. Among the items involved are microphones, booms, dollies, tripods, ladders, and cables.
12. It did not seem necessary to equip the vehicle with its own power generator: lighting requirements usually overshadowed technical power consumption and a separate generator/lighting vehicle was therefore preferred.

### 1.5 Design and layout

Behind the driver's cab the technical equipment is arranged in four areas for different functions: sound, production, vision control, and video tape. Although each member of the team has specific duties the team sense is strong and is encouraged by the layout of the vehicle. The arrangement is shown in figure 1. The vehicle's 'vital statistics' are

Length 7·8m (25'7")  
 Width 2·5m (8'2")  
 Height 3·5m (11'6")  
 Weight 10·8 tonnes

The production control desk is fitted transversely and the staff seated at it have a clear view, over the vision control engineers' heads, of one colour monitor and four black-and-white monitors (to show the signals from the two cameras, the caption scanner, and the VTR) mounted high on the main monitor stack. Some of the vision equipment is mounted under the desk and the top is fitted with the three-channel vision mixer and preview matrix. Four seats are shown at the production control desk in figure 1 in accordance with requirement 2 of section 1.4. When only three people are needed, however, a more comfortable seat spacing is possible and this is the arrangement seen in figure 2.

The mixer is of BBC design and provides for the selection of various sources and test signals and their connection to the picture and waveform monitors as well as permitting cutting and mixing to produce the programme output to the VTR. Any source can be connected to a 'black edger' to enable captions to be inlaid into the output. Cutting can be controlled remotely by means of a small 'cut box' which enables a director to work at the scene of the action instead of inside the vehicle.

This arrangement of the vision control and production control areas permits complete independence of action where it is needed without impairing the close contact between the various members of the team which is essential for full co-operation. The vision control desk is positioned in front of the equipment racks which carry the main production monitors (see figure 3). It is at a lower level than the production control desk and thus the vision control engineers do not obstruct the director's view of the monitors. Experience has shown that for the best picture quality the vision control engineers need to be able to examine colour monitors independently and two are therefore provided directly in front of the control positions. The equipment in these racks also includes the CCUs, two

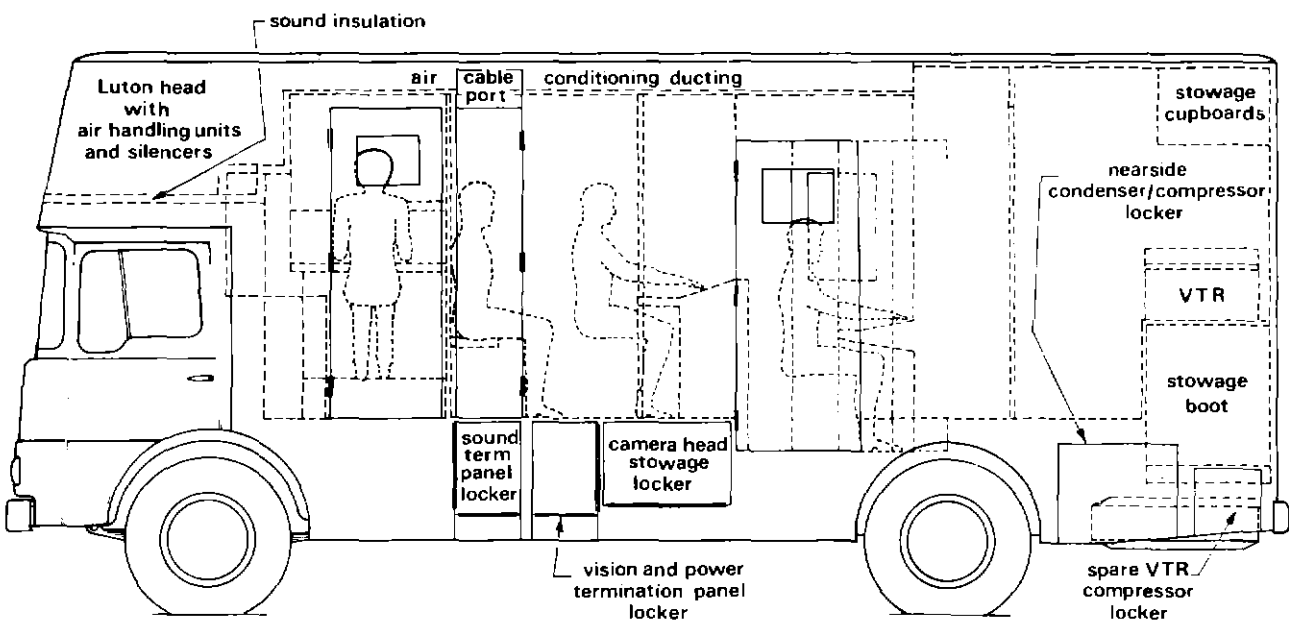
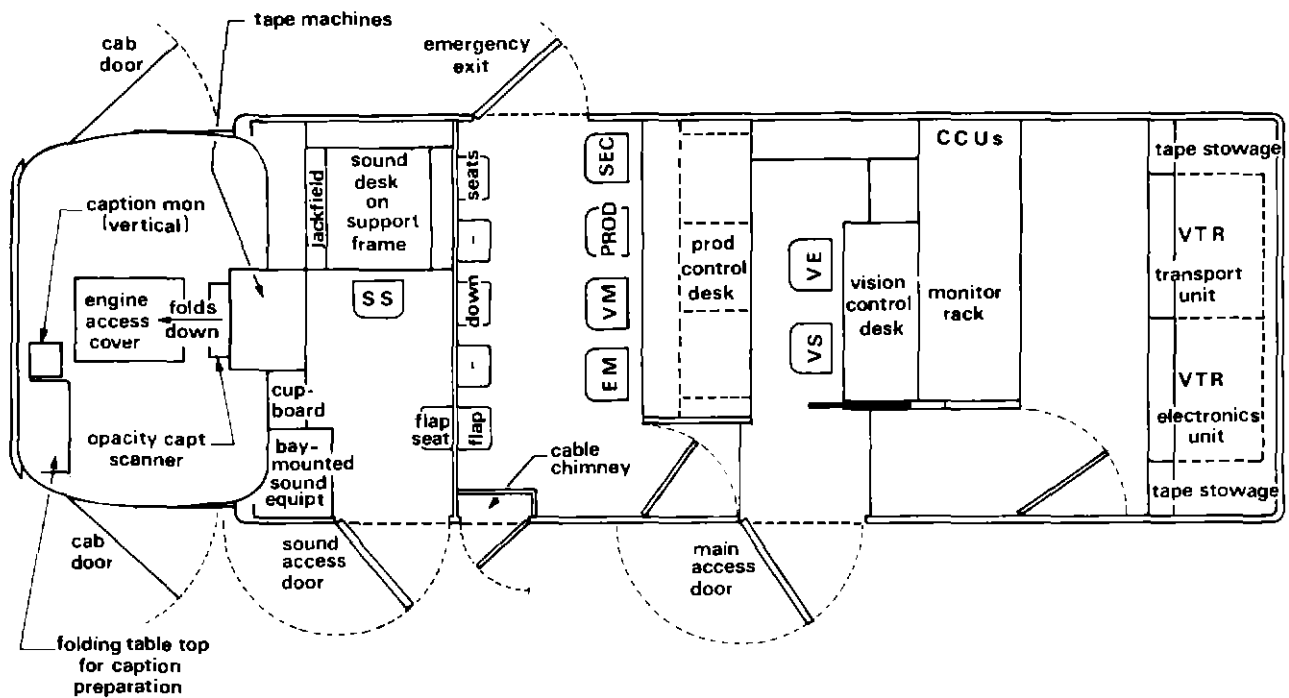

Fig. 1 Layout of the Location Production Unit.

waveform monitors, a vectorscope, and a maintenance oscilloscope which can be removed easily for use elsewhere, e.g. in the VT area.

This arrangement is compact and convenient, making all the vision equipment accessible in a single area so that the vision control engineers can check line-ups, deal with faults, and operate the camera control panels with very little physical movement.

The video tape area (figure 4) at the rear of the vehicle contains a quadruplex video tape machine which operates to full broadcast standards, including replay. To make the best use of the space, the deck and the electronics unit have been fitted side by side on the top of a large locker, with access from outside the vehicle, for carrying a basic load of cable, tripods, etc. Additional cupboards are provided inside the video tape area for storage of tape and other small items and



**Fig. 2** The production control position with the vision control position beyond.



**Fig. 3** Vision control position. The camera control units can be seen in the background.

there is a maintenance bench over the electronics unit of the VTR.

In addition to the equipment associated with operation of the VTR — time code generator and reader, monitor, etc. — a video cassette recorder is provided to enable directors to take away 'rushes' for preliminary planning of the editing. Control of the VTR from the vision control position is also possible when required.

The caption scanner is housed in the driver's cab and is based on a black-and-white camera. There are also facilities for monitoring the output.

The sound area is immediately behind the cab and is separated from the production area by a partition to provide quieter conditions for sound quality monitoring. Two black-and-white picture monitors are mounted above the sound

desk but a window in the partition between the sound and production areas enables the Sound Supervisor to see the main monitor stack also. The window can be slid open for personal contact with staff in the production area. See figure 5.

The desk is an eight-channel two-group unit providing pre-fade listen, foldback selection, and two limiter/compressors. Programme level is checked by means of a Peak Programme Meter and quality is monitored using a BBC loudspeaker type LS3/4B. A tape recorder is installed in the area for 'wild-track' recording and audio inserts: time code may be added to either track. In addition, a portable recorder is carried for making wild-track recordings away from the vehicle.

Other equipment in the sound area provides for phantom powering of capacitor microphones (thus obviating the need for individual battery packs or mains units), for the use of the talkback microphone for 'slating' idents into the main output, for general test purposes, and for intercommunication between different working areas.

In addition to the normal intercommunication facilities between the different areas and with the camera operators, two VHF systems are provided for communication between the vehicle and the scene of action, as indicated in requirement 5 of section 1.4.

A Post Office Radiophone is installed in the entrance lobby of the vehicle to provide connection to the public system.

The main aim in designing the Location Production Unit was to provide a flexible instrument for location recording but the comfort and convenience of the crew have not been overlooked, as foreshadowed in section 1.4, item 6. Care was taken, therefore, to provide adequate heating, ventilation, and air-conditioning. The main air-handling units are housed in the vehicle's Luton head above the driver's cab and the compressors are in side lockers. The video tape area has a separate unit.

The power consumption of the technical equipment is 5kW and the overall maximum demand, including air-conditioning, is 12.5kW. An oil-burning heater is also provided for situations where it is inconvenient to obtain adequate power supplies and also for keeping the equipment warm overnight to facilitate quick starts.

## 2 Operations

### 2.1 General

The new unit has made substantial contributions to higher productivity. It has already been mentioned in section 1.1 that electronic production methods can result in more economic operation than film techniques, but the design of this relatively simple installation offers important advantages over the use of a large conventional OB vehicle for location drama work. One, obviously, is the cost of the vehicle and equipment and the number of staff required, but another (less obvious) is the drastic reduction in the setting-up time required. It is common for the whole system to be ready to record within one hour of arrival at the chosen location. This fact results in a very different work pattern



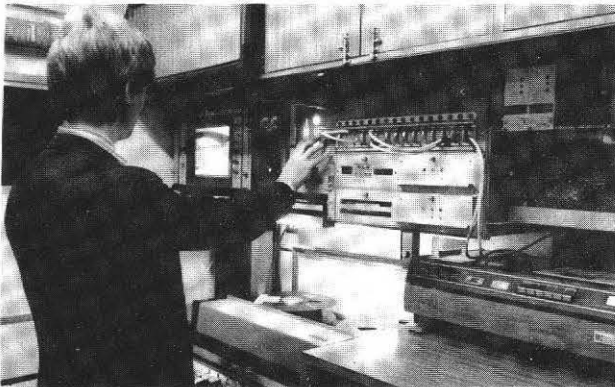

**Fig. 4** Video tape area. The transport unit is in front of the operator and the cassette recorder is on the bench on his right.

for the crew, compared with that associated with a conventional OB unit: for example, the rigger/drivers form a much more integrated part of the team.

In order to take full advantage of the potential productivity, as much of the work as possible should make use of both cameras: this yields sequences which require substantially less editing time. Occasionally, however, it can be better to accept the limitation of single-camera working if the use of both cameras gives rise to too great an increase in the complexity of the production requirements or of the lighting and sound balance. It is also good practice to erase and record over 'takes' which can be reliably classed as rejects at the time, in order to reduce editing time by minimising the amount of spooling required.

The original purpose of the unit, to provide location inserts for mainly studio-originated programmes, has accounted for only a small proportion of its actual work. It has been used for several different types of programme but by far the greatest part of its work has been for complete dramatic production of 50 minutes duration or longer.

## 2.2 Cameras and camera mountings

Two colour cameras are connected to the CCUs in the vehicle by up to 800m (880 yds) of 14mm (5/8") diameter multicore cable. Each camera initially had a lens with motor-operated iris and zoom offering viewing angles from 5.6° to 56°, though other lenses are available and coming into regular use, including a 15:1 zoom. When the cameras are used on mountings the standard monocular viewfinders may be replaced by modified 7.5m (3") monitors which allow more relaxed viewing and minimise eyestrain. The cameras (figure 6) are much smaller and lighter than normal studio cameras and these advantages are of great importance in location work. A price has to be paid, of course, and it includes reduced lens performance and increased maintenance problems due to the tight packing of the electronics. For location drama use these are sacrifices well worth making for the advantage of high mobility.

Although the cameras were developed for hand-held use they are only used in this way in LPU operations for shots which cannot otherwise be obtained. They have been adapted to fit a fluid panning head, giving excellent control



**Fig. 5** The sound desk seen through the sliding window separating sound and production areas.



**Fig. 6** Colour camera mounted on fluid panning head as frequently used.

of pan and tilt. This head permits the use of any of the wide range of mountings current in the film industry. The one most frequently used for development shots is a spider, running on track or rubber tyres. A jib arm is a widely used attachment.

Shots with action or dialogue in moving vehicles present a major problem which does not arise with film cameras — the camera cable. Provided the scene is not too long, however, or it can be broken up with cut-aways, successful operation can be achieved by prelaying the cable along the route to be covered. Up to 300 metres at a time can be shot in



this way. For this type of shot the mountings have included special door clamps developed by the BBC Film Department, a tripod on the back of an open Landrover, and even a special mounting to attach a camera to a coach which was drawn (at the gallop) up the drive of a stately home.

### 2.3 Lighting<sup>2</sup>

Lighting for two cameras for location interiors in dramatic productions can be a very difficult problem. In the studio one can expect to have substantial space outside the set where equipment such as cameras, lighting, microphone booms, etc., can be placed. On location there is rarely much room for such things and they nearly always have to be contained within what can be regarded as the set.

Inevitably, few domestic interiors have ceilings higher than 2·6m (8'6") and in such cases it is usually impossible to suspend lamps without producing serious flare or even getting the lamps in shot. Good shielding of the camera lens is essential, and a 'french flag' fitted above the lens soon became a standard extra for interior work. Traditional three- or four-point lighting is often impossible and sometimes the only solution if there is a suitable ceiling is to bounce the light from high-intensity sources off it. Another difficulty is the preponderance of white or near-white walls, which preclude the production of low-key pictures.

The introduction of metal-halide discharge lamps<sup>3</sup> such as the HMI 575W, 1·2kW, 2·5kW and the CSI 1kW at about the same time as the LPU went into service has greatly enhanced flexibility in lighting for exterior sequences. The HMI lamp has a colour similar to daylight and a luminous efficiency approaching 100 lumens per watt. This reduces the need for 225A carbon-arc 'Brutes' with all their problems of carbon life and large d.c. generators. The CSI lamp has a warmer colour and can conveniently be filtered to provide a good match either to daylight or to standard incandescent-filament sources with a colour temperature of 3,200°K.

The limited contrast range presents a serious lighting problem at times with any type of camera, particularly when shooting against the skyline, but the introduction of anti-comet-tail tubes will reduce the difficulties.

### 2.4 Sound

The main differences between sound operations with the Location Production Unit and other OB sound operations are the high mobility required (arising from the high mobility of the cameras) and the need for improvisation arising from the cramped nature of some interiors. The techniques are based on an amalgam of studio and film operations and much of the equipment is derived from one field or the other. Full-size microphone booms, 'fishing rods', hidden microphones, and radio systems are examples. A simple device, thought to have been originated in BBC Television OB operations, which also plays a very important part, is a pole of adjustable length, terminating in a Y-piece. It is used as a support for a fishing rod and the combination is equivalent to a highly mobile small microphone boom. Muscular strain is greatly reduced compared with the use of



Fig. 7 A hypercardioid microphone mounted on a fishing rod supported by a Cox rod.

the fishing rod alone and much longer periods of operation are therefore possible. For use in confined spaces the Y-piece can be removed and the pole alone used as a short fishing rod. The device is known as a 'Cox rod', after its inventor, and can be seen in use in figure 7.

Space problems often rule out the use of full-size microphone booms but even where there is sufficient room their unwieldiness makes them inappropriate if high mobility of the boom is required — and, quite frequently, it is. Fishing rods and Cox rods can therefore be regarded as the norm.

When overhead microphones are to be used in drama productions, close co-operation between the sound and lighting staffs is essential. The difficulties of lighting 'from within the set' are considerable even without microphones and in very small interiors it is simply out of the question to use rods. In such cases the microphones are often held by operators who are sometimes hidden behind — or even under — furniture.

Capacitor microphones are used almost exclusively. They range from the largest 'rifles', which are mostly used for exteriors, to the 'personal' type, which can readily be concealed about the set. Cardioid microphones are

commonly used for interiors but some short hypercardioids are available if required.

The large 'rifles' are very suitable for exterior work in noisy surroundings or for long shots because of their very good discrimination against off-axis sources and their remarkable 'pull'. This very advantage does, of course, bring with it the need for careful handling to avoid rejection of the wanted dialogue by an inaccurate aim.

When an interior is particularly difficult because of noise or bad acoustics it is sometimes tempting to try to tackle the problem by using hypercardioid microphones. This approach can be of some value but it is usually better to attack the difficulties at source. Excess noise can often be reduced or stopped by negotiation with those who are making it, and bad acoustics (almost invariably too 'live') can usually be improved by hanging heavy drapes on the unseen walls of the room, putting carpet on the floor, etc. In one case where a temporary structure was installed to suspend lighting, carpet was even placed overhead, to great effect. The aim should not necessarily be to eliminate background noises entirely or to produce standardised acoustics: one of the reasons for shooting on location is to capture the natural ambience which must be allowed to come through on the sound track.

Radio microphones are occasionally used but most action can be covered very effectively and more readily by other means. There can be serious difficulties in obtaining enough radio channels for more than a small cast and the installation on the performers can take up a great deal of valuable time. Consequently their use is restricted to very unusual cases.

Normal practice in electronic production differs from film procedure in that the Sound Supervisor follows a programme right through from the planning stage to the final dub which he normally handles personally. An article

about the dubbing facilities used is planned for a future issue of BBC Engineering.

## 2.5 Power supply

The lighting load will normally dominate the power requirement. If the lighting is simple a 30kW generator might be sufficient, but it is more usual to need a 50kW or 100kW unit. However, the LPU has operated from an 8kW trailer generator and even (with reduced facilities and no air conditioning) from local 13A sockets.

## 3 Conclusions

The LPU is a valuable and versatile production tool. As the original planning proceeded and as experience was gained from operation with the prototype, it became clear that location drama production would benefit from a larger and more comprehensive vehicle than had initially been contemplated. The success of the unit can be judged from the constant demand for its use.

There is, however, still a need for a highly mobile unit with a single camera and a recorder. This concept also should therefore be pursued although it is recognised that many problems of staffing and maintenance will need to be solved.

## 4 References

1. Cook, G.D. Lightweight Colour Mobile Control Rooms. BBC Engineering, Nov. 1973, No 96, pp.4-8.
2. Wilkes, B.P. Television Outside Broadcasts Lighting Operations. JSMPTE, Jun. 1975 pp.463-469.
3. Aldworth, R.C. The Application of CSI Lamps. BKSTS Journal, July 1976 pp.198-201.

# Low-cost Relay Stations for the Extension of the UHF Colour Television Service to Small Populations

D. C. Davis, BSc.(Eng), CEng., MIEE

Transmitter Capital Projects Department

**Summary:** Engineering Division has always been very aware of the importance of finding cheaper ways of solving technical problems and thus reducing capital or revenue expenditure or both.

The search for economies is a continuous process, but each extension of the broadcast services provides an opportunity for a re-examination of previous practice and a review of the technical standards required. The article outlines proposals for UHF relay stations to serve communities of between 500 and 1000 people. A low-cost transposer using units originally designed for cable television and a lightweight tubular lattice tower are described, both of which were specifically developed for relay stations serving small communities.

- 1 Introduction
- 2 Forecast of requirements
- 3 The options
  - 3.1 Transposers
    - 3.1.1 Equipment
    - 3.1.2 First prototype
    - 3.1.3 Second prototype
    - 3.1.4 Other sources of equipment
  - 3.2 Equipment housing
  - 3.3 Aerial systems
    - 3.3.1 General
    - 3.3.2 Aerials
    - 3.3.3 Splitting and combining equipment
  - 3.4 Support structures
    - 3.4.1 Types of structure
    - 3.4.2 The BBC-designed lattice tower
- 4 Field trials
- 5 Sites and security
- 6 Maintenance
- 7 Relative cost of stations to serve small communities
- 8 Conclusions
- 9 References

## 1 Introduction

The current programme of building UHF relay stations (Phase I) deals with communities of 1000 or more. This programme involves the building of some 370 relay stations and will be virtually complete by the end of 1979. Phase II will extend the UHF services to small communities of between 500 and 1000 people, and the first of these stations should be brought into service during 1978.

Phase II is intended to bring colour television to about an additional 150,000 people (0.3% of the UK population) in approximately 250 areas, increasing the total coverage to

99.1%. However, the cheapest Phase I station costs about £40,000 for the facilities required to transmit BBC 1 and BBC 2 which corresponds to £10,000,000 for 250 stations. There is, therefore, a very strong incentive to investigate cheaper approaches.

The aerial support structures, aerial systems, equipment housings and transposer equipment have been re-examined with a view to finding the most economic ways of meeting the majority of the requirements contained in the BBC Research Department forecast of Phase II relay station characteristics. The most significant departure from current relay station practice proposed is the use of transposer equipment housed in a metal box mounted on the aerial support structure.

The proposals outlined are the result of development work and discussions both within the BBC and with representatives of contractors. They also take account of the experience of broadcasting authorities in Europe.

## 2 Forecast of requirements

The initial planning work for Phase II was based on the assumption that a significant proportion of the stations would require transposer power of 2W or less, mast heights would be between 15m and 30m (50' and 100'), and simple aerial arrays would be satisfactory for both receiving and transmitting purposes.

A log-periodic aerial was produced by Research Department in 1973<sup>1</sup> and it was established that the characteristics of this aerial (in particular the low wind loading), made it potentially suitable for a large proportion of the sites likely to be used. At the time the initial planning work was undertaken neither transposer equipment nor suitable aerial support structures were available at low cost in this country. Work in the appropriate BBC specialist departments was therefore directed towards investigating ways of reducing

the costs of such items.

A preliminary analysis of the requirements of about 250 sites was issued by Research Department in September 1975, and the results are summarised below:

	Approximate Proportion of sites
<b>Mast height:</b>	
15m (50')	40%
21m (70')	40%
30m (100')	20%
<b>Transposer power:</b>	
up to 0.5W	30%
0.5W — 2W	40%
2W — 10W	25%
10W — 20W	5%
<b>Aerial type:</b>	
Log-periodic	70%
Cardioid	30%

The items from which the stations could be built are discussed in the following section.

### 3 The options

#### 3.1 Transposers

##### 3.1.1 Equipment

As expected, the power output required at nearly three-quarters of the stations considered is 2W or less and the search to find a really low-cost transposer to meet this requirement had already started in 1974. In early consultations with manufacturers it became apparent that offering specification relaxations alone would not enable the traditional suppliers of broadcasting equipment to offer significantly cheaper versions of established designs. To

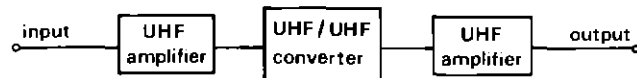

Fig. 1 Block diagram of a simple transposer

obtain such cost reductions it would be necessary to adopt completely new designs to relaxed standards of both mechanical construction and performance. The manufacturers were understandably reluctant to make the necessary investment because of the uncertain return. The possibility of using equipment manufactured for cable television distribution systems was therefore examined.

A wide range of standard units is available for such systems. The cost is low compared with professional broadcasting equipment, but the pictures produced by properly planned and installed systems compare favourably with direct reception in the same locality<sup>2</sup>. Furthermore, good reliability is required because, for economic reasons, equipment is not duplicated, and subscribers are very intolerant when breakdowns occur. In addition individual units are designed for interchangeability and plug-in replacement to permit rapid restoration of service in the event of a fault, and to be no more difficult to repair than domestic television receivers. There is therefore no fundamental reason why equipment designed and manufactured for the cable television market should not be used for low-cost broadcast relay stations.

The modules available from a number of manufacturers were examined. Two, an amplifier and a UHF/UHF converter<sup>3,4,5</sup> appeared to offer a promising basis for a transposer. A block diagram of a simple transposer based on these two units is shown in figure 1.

This configuration allows only a restricted number of channel transpositions but, by the addition of a second UHF/UHF converter and the use of an intermediate UHF channel, this limitation can be circumvented. The other limitation is the carrier frequency stability. The converter has a crystal-controlled local oscillator but the crystal temperature is not stabilised by means of an oven.

##### 3.1.2 First prototype

Calculations based on the individual specifications established that a transposer with a reasonable transmission

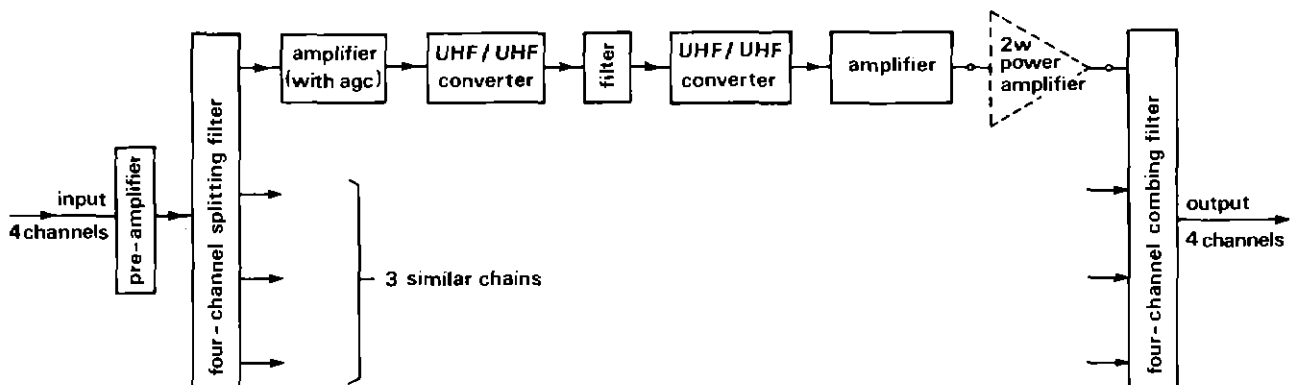

Fig. 2 Block diagram of prototype four-channel transposer system.

performance could be made from the two types of unit. A prototype four-channel transposer system was produced consisting of four transposers mounted on a standard panel with a four-channel pre-amplifier, four-channel splitting filter and four-channel combining filter from the same range of equipment. A block diagram of the system is shown in figure 2.

At this stage the aim was to assess the potential of a system consisting purely of an assembly of standard units. No attempt was made to lay down and meet any particular specification. This prototype equipment was bought on the basis of the supply of the equipment, including panels and power supply units, together with a set of overall system performance measurements.

The equipment was aligned on the channels appropriate to Grinton Lodge, a relay station in North Yorkshire. Grinton Lodge is, in fact, a Phase I station, but has a small service area where low-power equipment could be used and where, because of the terrain, normal relay station carrier-frequency stability is not essential to avoid co-channel interference problems.

The mechanical layout was designed to permit maintenance by replacing faulty units. Four transposers were mounted on a single small panel, each transposer using two UHF/UHF converters so that the most complex arrangement which could occur in practice could be evaluated: in particular, the extent of any interaction between four transposers working on the same site could be assessed.

The results obtained were generally encouraging and confirmed that the idea was worth pursuing.

### 3.1.3 Second prototype

The first prototype was very compact and so the possibility of housing transposers in a metal cubicle or box, instead of a conventional building, was re-examined in detail. Past experience with valved VHF transposers had highlighted the problems which can arise with this type of housing, but more recent experience in Europe has shown that it can be satisfactory for all-solid-state equipment even in locations subject to extremes of ambient temperature and weather conditions.

A second prototype four-channel transposer system was therefore bought with a number of major mechanical changes to make the equipment more suitable for housing in a metal box. Each individual transposer and power supply unit was mounted on a separate chassis designed for rack mounting and provision was made on each chassis to accommodate power amplifiers with sufficient gain to deliver between 2W and 3W. The arrangement of equipment is illustrated in figures 3 and 4.

Provision was also made to accommodate separate oven-controlled oscillator units to provide a stable local oscillator frequency for the UHF/UHF converters.

Measurements confirmed the early promising results, transmission performance generally meeting the current specification for UHF relay stations. As expected, however, the level of out-of-band radiation was relatively high due to the limited performance of the filters. The measured levels were nevertheless considered acceptable for low-power

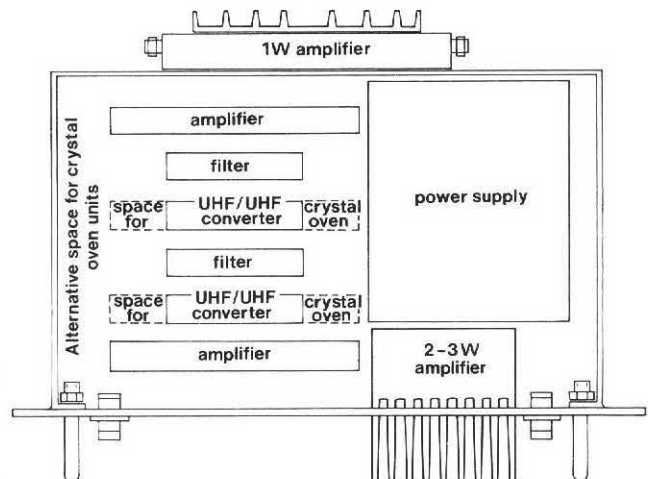

Fig. 3 Second prototype: arrangement of single transposer chassis.

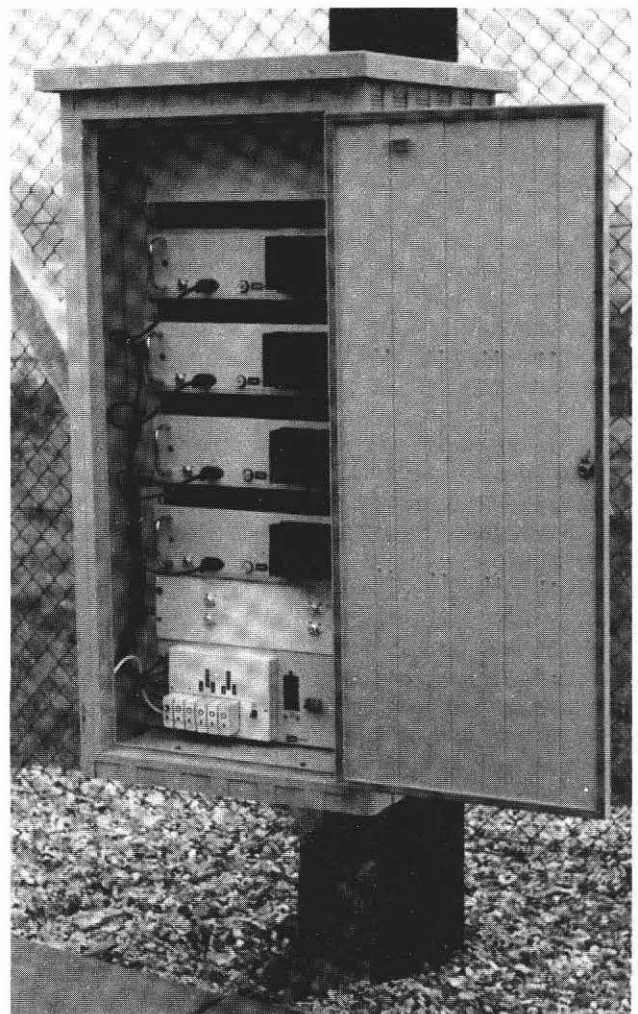

Fig. 4 Four-channel transposer system installed at Tidworth on the Hampshire/Wiltshire border.

equipment which is unlikely to cause interference to other stations in the broadcasting network. When problems do arise, because of the lack of terrain screening or the proximity of vulnerable service areas, it will be possible to use better filters.

The latest estimates indicate that the cost of this equipment and the necessary spares should be about half the cost of using the cheapest conventional equipment currently available.

### 3.1.4 Other sources of equipment

Transposers with outputs of up to 2W are obtainable from a number of sources. A French design suitable for housing in metal boxes is available quite cheaply, but for stations where transposers based on cable television equipment are not suitable for any reason it is proposed to use the new BBC Designs Department transposer type EP16M/501A.\* This equipment, which fully meets the requirements of BBC specification UHF/4, uses broad-band units and was designed for modular maintenance without external test equipment. It is also cheaper than existing commercial transposers. At stations requiring powers between 2W and 10W it is most likely that the Designs Department equipment will be used in conjunction with suitable power amplifiers which are obtainable from several manufacturers.

## 3.2 Equipment housing

Various types of equipment housing have been considered, including small conventional buildings, steel cabins, GRP building of various shapes and sizes, free-standing metal cubicles and pole-mounted metal boxes.

The two types of equipment housing now considered most suitable are a small GRP building based on a commercially available shell and metal boxes mounted at a convenient working height on the aerial support structure.

Metal boxes are significantly cheaper than GRP buildings when delivery and installation costs are taken into account, but have the important disadvantage that they provide no shelter for maintenance staff. With the types of equipment currently available, and ignoring the problem of shelter, the metal box is suitable for stations requiring power outputs up to 2W.

## 3.3 Aerial systems

### 3.3.1 General

All UHF transmitting sites are shared by the BBC and the IBA, and all relay stations use four-channel aeriels both for reception and transmission. It is therefore necessary to provide channel-selection equipment to obtain the individual feeds required for each transposer input, and a channel combiner to connect the transposer outputs to the common transmitting aerial. The arrangement is illustrated in figure 2.

\*An article about this transposer will appear in an early issue of BBC Engineering

### 3.3.2 Aeriels

Extensive use will be made of log-periodic arrays for both transmitting and receiving. In addition, a simple transmitting aerial with a cardioid radiation pattern is being developed, but standard transmitting panels of the type currently in use at Phase I stations may be required at a few sites.

### 3.3.3 Splitting and combining equipment

There are several types of equipment available or under investigation for the purposes of splitting and combining the channels, referred to in section 3.3.1. These include:

- (i) Cable television filters for splitting and low-power combining applications.
- (ii) a lumped-constant network and a conventional hybrid network being developed by Transmitter Capital Projects Department for combining applications up to 10W.
- (iii) standard splitters of the type used at Phase I stations, which could be used as combiners at 2W stations.
- (iv) Designs Department distribution amplifiers used in conjunction with bandpass filters to provide a splitter particularly suitable for stations where the received signal is weak.

## 3.4 Support structures

### 3.4.1 Types of structure

In the interests of standardisation aerial support structures of only three heights will be used (17m, 25m, and 30m) and surveys of proposed new sites will take this into account. At sites needing a 17m structure a wooden pole will be the usual mast, and at the remaining sites a BBC-designed 25m or 30m tubular lattice tower of triangular cross section will be used. At sites where a lattice structure is unacceptable to the Planning Authority, consideration will be given to the use of a pole of the motorway lamp standard type. This is more expensive, however, and poses aerial access and maintenance problems; its use will therefore be avoided whenever possible.

### 3.4.2 The BBC-designed lattice tower

Because the aerial support structure accounts for a significant proportion of the cost of any transmitting station, it makes a prime target for attempts at cost reduction. Clearly, a lighter (and therefore cheaper) structure can be used if the aerial load or wind resistance can be reduced.

The log-periodic has the lowest wind drag of any aerial so far tested. For the tower, the use of circular steel tube instead of angle reduced the wind drag on the structural members themselves and facilitated the construction of a triangular tower of minimum overall wind resistance. By these means a substantial reduction of overall loading was achieved and a slim tower 30m high but weighing only 2 tonnes was produced. Such a design is more acceptable to Planning Authorities than the square-section towers of



conventional angle construction now in use.

Access to the aerial system will be by means of a ladder attached to one leg and fitted with a personnel safety device. As figure 5 shows, the general appearance is one of simple clean lines, uncomplicated by platforms and other accessories, while the galvanized protection and simple structural details should reduce maintenance to a new minimum.

The tower will be stocked in 25 and 30m versions, with a 20m height available if required. The 'single slab' foundation design incorporates a setting-up template, which will enable a small team to carry out the installation simply and quickly. A second team will then follow to erect the steelwork, an operation greatly facilitated by the light weight and small size of the tower components.

Because wind loading specifications depend on site location, ground profile, and other factors, the aerial support capacity will vary from site to site, thus providing spare capacity, in many cases, for the installation of communications aerials.

#### 4 Field trials

Some of the items listed for possible use at low-cost stations are already established as broadcasting equipment; for example, the log-periodic aerial and the Designs Department transposer are already in service use. Other items, in particular the transposers using cable television units, still need to be subjected to field trials under operational conditions before being adopted for general use.

Two experimental sites were selected for these field trials: Tidworth on the Hampshire/Wiltshire border and Grinton Lodge in North Yorkshire. Trials started at Tidworth in November 1976 and are planned for Grinton Lodge in the summer of 1977.

At the same time the detailed appraisal of the cable television equipment under laboratory conditions will continue.

#### 5 Sites and security

It is anticipated that many sites will be found in locations near existing metalled roads. This will avoid high access works costs which are often a major item for a new site. The use of the designs described in this article should assist this process by permitting the purchase of smaller sites.

The cost of security precautions to prevent other than casual vandalism would be disproportionately high at a low-cost station. It is therefore proposed that site fencing should only be provided if this is a condition of the site purchase or lease, or where it is necessary to prevent animals approaching the equipment housing, or if the station is in an area where vandalism is likely.

#### 6 Maintenance

The maintenance procedures will depend upon the type of equipment housing and upon the outcome of the field trials at Tidworth and Grinton Lodge. If metal boxes mounted on the aerial support structures are used maintenance at the site will probably be restricted to replacing the complete faulty

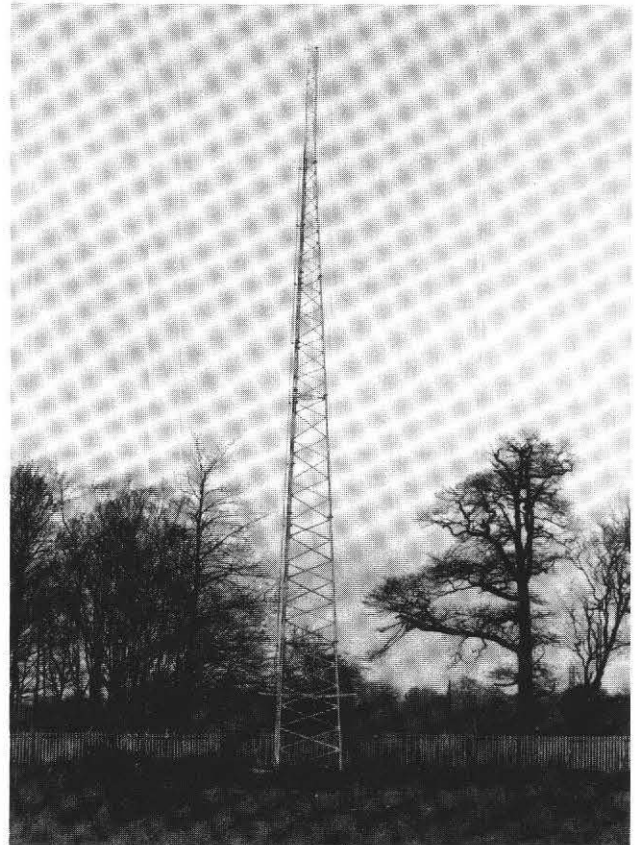

Fig. 5 The BBC-designed triangular lattice tower constructed from tubular steel members.

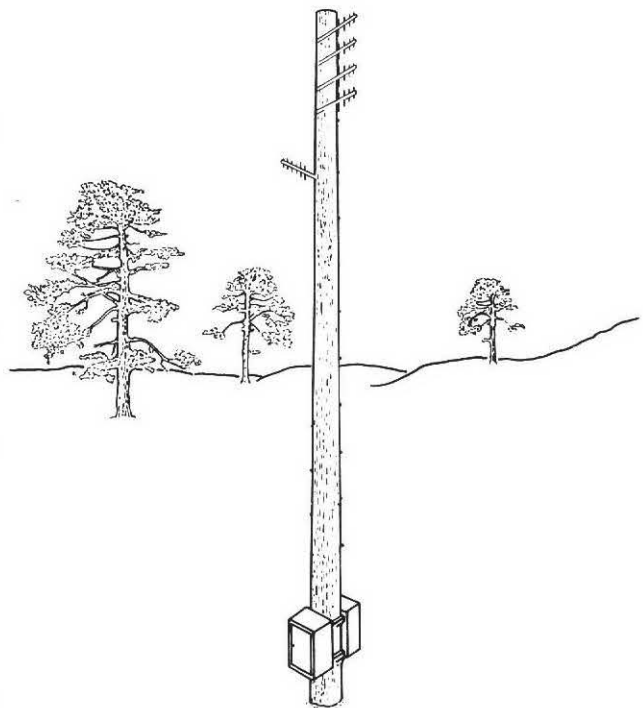

Fig. 6 The cheapest Phase II station might appear like this.



transposer. Repair of the faulty equipment would then be carried out at base. It was for this reason that the transposers in the second prototype design were each mounted on a separate chassis: this permits a complete equipment to be removed without interfering with the other services operating from the same site. Where small buildings are used the equipment could be maintained either by replacing faulty units or by replacing the complete equipment.

The cable television transposer uses units which can operate in any UHF channel but they are normally supplied tuned to a specific channel. The equipment is designed for modular maintenance, a faulty module being replaced by one pre-tuned to the appropriate channel. There is no built-in metering and it is therefore essential that faulty individual units are replaced in a small building or at a maintenance base where test equipment is available.

## 7 Relative cost of stations to serve small communities

The cheapest Phase II station (see figure 6) could probably be constructed for about one quarter of the cost of the cheapest Phase I station, but the most expensive is likely to approach three quarters of the cost of a standard station built to current specifications.

Maintenance costs must be kept within reasonable limits and it cannot be expected that the standard of service provided for small communities will match that provided by a main transmitting station serving a densely populated urban area. Maintenance teams will have to give priority to stations serving more people so that failures will, on

average, be of longer duration for stations serving only a few hundred people.

## 8 Conclusions

The difference in cost between the cheapest option and the most expensive is considerable so that stations to serve small communities can only be built economically if the simplest possible arrangement of equipment is adopted at each site.

Until field trials at Tidworth and Grinton Lodge, and the outstanding laboratory tests, are complete it will not be known how extensively the cable television transposer can be used. Results so far are promising, however, and there is a good deal of hope that the efforts expended on developing simplified designs for low-power relay stations will yield substantial economies.

## 9 References

1. J.L. RILEY. Ruggedised UHF log-periodic aerials. BBC Engineering No. 101, December 1975.
2. L.A. ISAACSON and G.H. BARLOW. Hybrid VHF to UHF cable television systems. Cable Television Engineering Vol. 10, No. 7, December 1975.
3. G.A. AXE. The development of dual cable systems for new towns. The Post Office Electrical Engineers Journal, Vol 69, Part 1, April 1976.
4. G.H. BARLOW, J.B. HAWKES, C.H. ROBBINS. Translation equipment for British Post Office local-line wideband systems. The Post Office Electrical Engineers Journal, Vol. 69, Part 1, April 1976.
5. B. SANDFORD. Exorcise your left hand ghost. Cable Television Engineering, Vol. 10, No. 3, April 1974.

# The SHF Link System from Rosemarkie to Eitshal

R. R. Durling, CEng., MIERE

D. W. Grant, CEng., MIEE

Transmitter Capital Projects Department

**Summary:** The opening, in July 1976, of a UHF television transmitting station on the Isle of Lewis was the culmination of a great deal of work not only in providing the station and its equipment, but also in bringing the necessary signals from the nearest existing station at Rosemarkie at the other side of Scotland. This article outlines the planning, design, and construction of the link carrying the BBC1, BBC2 and ITV programmes.

- 1 Introduction
- 2 Planning the route
  - 2.1 Rosemarkie to Glen Docherty
  - 2.2 Melvaig to Eitshal
- 3 Surveying the route
- 4 Engineering and construction
  - 4.1 Channels
  - 4.2 Electronics
  - 4.3 Civil engineering
- 5 Testing the completed system
- 6 Conclusions

## 1 Introduction

The BBC was responsible for the provision of the shared facilities such as buildings, towers, power supplies, and aerials at the BBC/IBA UHF television transmitting station at Eitshal, and this responsibility extended to the programme links from Rosemarkie.

The substantial distance of 160km between Rosemarkie and Eitshal meant that direct reception at Eitshal of the Rosemarkie transmissions would not provide satisfactory signals even if the intervening ground were less difficult. Intermediate repeaters were clearly essential and the cost of the system was likely to be lower if use could be made of two BBC stations which already existed. The planning of the route was therefore based on the assumption that repeaters would be installed at Glen Docherty (where there was a link station) and at Melvaig (a 405-line television and VHF radio transmitting station). Figure 1 shows the relative positions of the sites.

## 2 Planning the route

There is a good, unobstructed path between Glen Docherty and Melvaig and in consequence detailed route problems needed to be considered only between Rosemarkie and Glen Docherty and between Melvaig and Eitshal.

### 2.1 Rosemarkie to Glen Docherty

The usual practice in the provision of programme links from one transmitting station to another is to cover the first hop by direct reception of the broadcast signal. This possibility was rejected in the present case for two main reasons: two planned Norwegian stations were liable to cause significant co-channel interference at the available sites which might otherwise have been quite attractive; and reliance on the signal broadcast by Rosemarkie would have meant that the two stations must always radiate the same programmes. A link using SHF throughout will allow Eitshal (and other stations in the north-west of Scotland) to radiate Gaelic and other material originating in Inverness while Rosemarkie is transmitting network programmes.

It was clear from map studies that because of the mountains the signal path would be far from direct and it appeared that to establish a conventional route from Rosemarkie to Glen Docherty would require at least three new active repeater sites. Each of these would have been very expensive in terms of buildings, masts, power supplies, access tracks, and, in at least one case, a new road. In order to avoid this daunting prospect, considerable further study was made of the terrain, both from maps and survey visits.

One of the main obstacles in the path was a 580m peak (Sgurr Marcasaidh). The high ground to the south of the summit offered a promising site for a repeater from the point of view of signal propagation but a thoroughly unsuitable one if the cost of power supplies and access tracks had to be taken into consideration. Even then, reception from Rosemarkie would not be feasible at the site although a site above Glenmarksie, only 3.7km to the east, afforded line-of-sight paths to Rosemarkie and to Sgurr Marcasaidh. The Glenmarksie site also was accessible only with difficulty, being over 3km from the road and about 245m higher.

Passive repeaters can be used in SHF link circuits provided that they are sufficiently near one of the active terminals. With the transmitted power permitted for this link and with practical sizes of aerials the maximum accept-

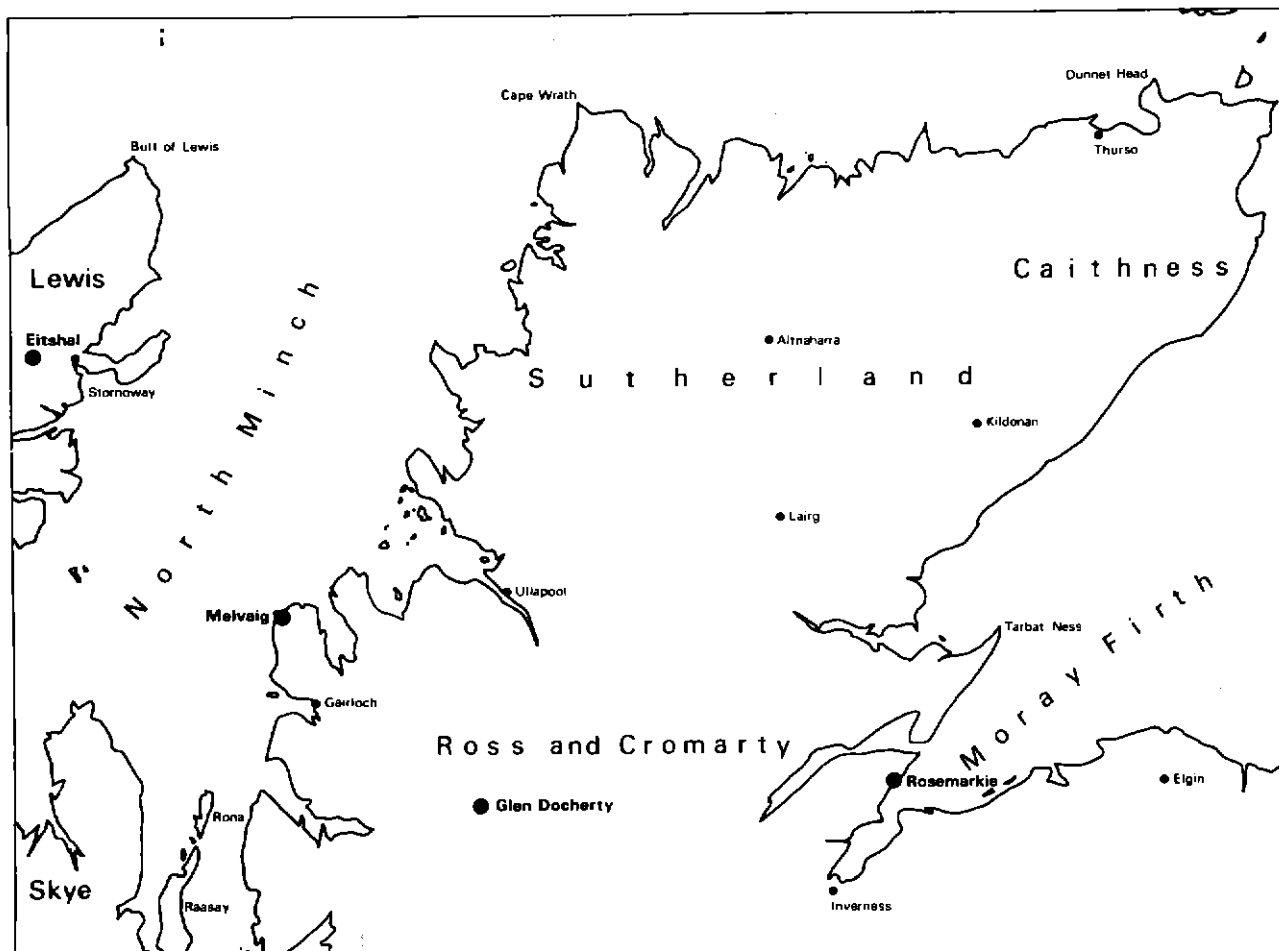

Fig. 1 Location of Eitshal in relation to Rosemarkie, Glen Docherty and Melvaig

able distance between a passive repeater and an active terminal is about 4km at 7GHz. When the direction of propagation is to be changed by a large angle (say 90° or more) it is reasonable to use a plane reflector, but where the change of direction is small a plane reflector would have to be very large to intercept a useful proportion of the incident power. In such cases it is better to use back-to-back paraboloid aerials. The solution, therefore, appeared to be to establish passive repeaters at Glenmarksie and Sgurr Marcasaidh and an active terminal at some more convenient nearby site with a clear view of both. Once the passive repeaters had been set up there should be little need for maintenance visits and none for power supplies. The very costly access tracks need not, therefore, be built.

The proposed route became:

1. Rosemarkie to Falls of Conon via a plane passive repeater at Glenmarksie;
2. Falls of Conon to Glen Docherty via a back-to-back aerial passive repeater at Sgurr Marcasaidh.

Figure 2 illustrates the details of the route diagrammatically. The Falls of Conon site is adjacent to a road and an electricity sub-station and thus minimises the capital outlay required.

### 2.2 Melvaig to Eitshal

The length of the route from Melvaig to Eitshal is about 62km which can normally be covered by a single SHF hop. Much of the route is over sea, however, and the presence of a sea-surface reflection would make reception more difficult. Considerable study was made of possible receiving sites in the hope of finding one which afforded land shielding of the sea reflection but none was found which also offered

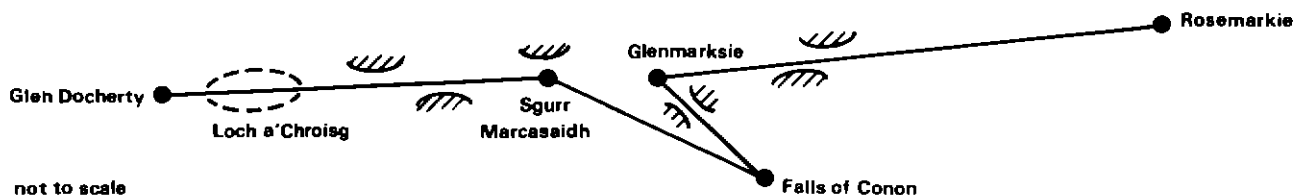

not to scale

Fig. 2 Diagrammatic representation of the route from Rosemarkie to Glen Docherty showing the principal obstacles

satisfactory population coverage when regarded as a transmitting station site. Either the receiving site and the transmitting site had to be separate, therefore, or space diversity reception of the incoming signal had to be employed. The latter solution was adopted as the more economic.

### 3. Surveying the route

Once a likely route had been established from maps and visits to individual sites, a more detailed survey became necessary to confirm the existence of satisfactory propagation paths.

The first phase of the surveying work consisted of an examination of the terrain using binoculars, prismatic compass, and theodolite to determine the best locations to provide the necessary ground clearances for the radio beam. The path between Glenmarksie and Falls of Conon passes between large rock outcrops and the locations of the aerials at both sites are therefore critical. Loch a'Chroisg, near Glen Docherty, threatened to provide a water-surface reflection of the signal from Sgurr Marcasaidh, and the siting of the aerial at the latter site had to be carefully chosen to avoid illuminating the water.

In order to carry out the necessary surveys, visibility over considerable distances was required and this led to several visits to some of the sites. For example, the ascent of Sgurr Marcasaidh was repeated on four successive days before a positive sighting of Glen Docherty was made.

The second phase of the survey was a series of SHF propagation tests and kept four engineers busy for about two weeks. At Sgurr Marcasaidh it was necessary to climb about 450m over a distance of 3km carrying equipment including a paraboloid aerial, an SHF receiver, and a radio telephone. At Glenmarksie it was necessary also to take a 12m telescopic mast to carry out height gain measurements to determine the effects of local obstructions. Fortunately this ascent is somewhat less strenuous — about 245m in 3km —

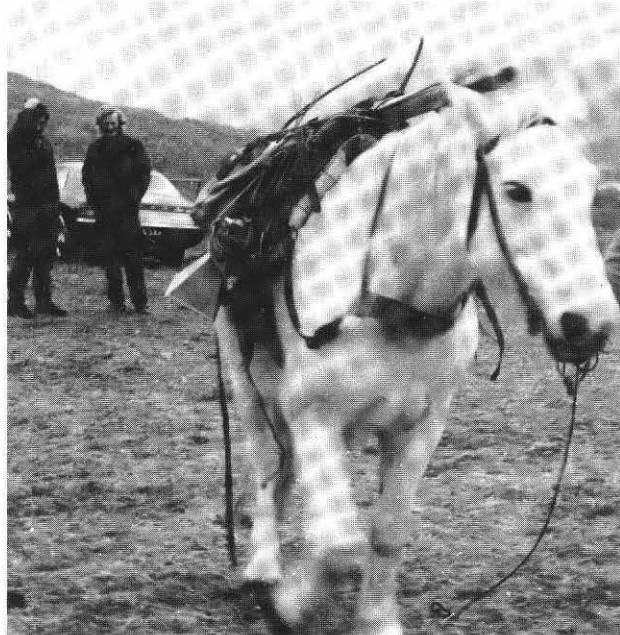

Fig. 3 The ascent to the Glenmarksie passive repeater site begins

and the services of a shepherd's pony in the role of pack horse were obtained (figure 3). While the tests were being carried out, however, the pony broke loose and made off so that the engineers were obliged to carry all the equipment unaided on the return journey.

The tests confirmed that the proposed route would provide satisfactory propagation paths and calculations established that the extra losses introduced by passive repeaters could be accommodated. To achieve the required fading margin of at least 20dB it was necessary to make the plane reflector at Glenmarksie 3·66m × 4·88m and to use 3·66m diameter dishes at Sgurr Marcasaidh.

### 4. Engineering and construction

Once the route had been determined, the task of providing the necessary hardware could begin. The planning and design of the system, including buildings, aerials, and aerial support structures started in August 1973.

#### 4.1 Channels

The Home Office allocations were based on an adjacent-channel spacing of only 24·5MHz. Dual polarisation was necessary, with alternate channels using opposite polarisation, in order to give satisfactory combination of four channels into a single aerial.

#### 4.2 Electronics

Solid-state equipment is used throughout and at each site main and standby equipment is provided for each service, BBC1 and BBC2. (The IBA provides its own electronic equipment for connection to the waveguide feeders.) When a fault is indicated on the main equipment for either service, the corresponding standby equipment is automatically switched in to replace it. Because it operates on the same frequency, there is no need to arrange for simultaneous switching at another repeater.

The audio signal modulates the frequency of a 7·5MHz sub-carrier which is then added to the video signal: the combination is carried as frequency modulation of the SHF carrier. The intermediate repeaters change channels without demodulation in the main signal path.

To establish a link across the Highlands for Outside Broadcast purposes would be a very costly process and simply would not be contemplated for any but the most important occasions. Minor additional items at the active repeater stations, however, have been provided to enable OB engineers to connect their own SHF equipment and make use of the system's aerials for any section or sections of the route in either direction.

#### 4.3 Civil engineering

The reason for choosing to establish passive, rather than active, repeaters at Glenmarksie and Sgurr Marcasaidh was the difficulty of access to the sites. Access for construction was, however, essential, and the possibility of transporting materials by helicopter was examined.

Aerial support structures exert large upward forces on

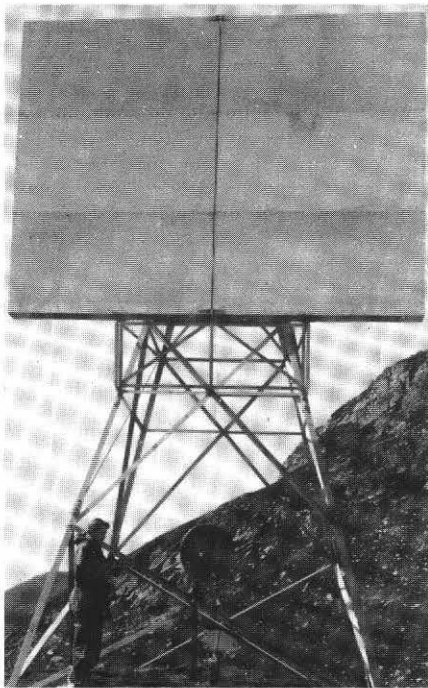

Fig. 4 The plane reflector at Glenmarksie

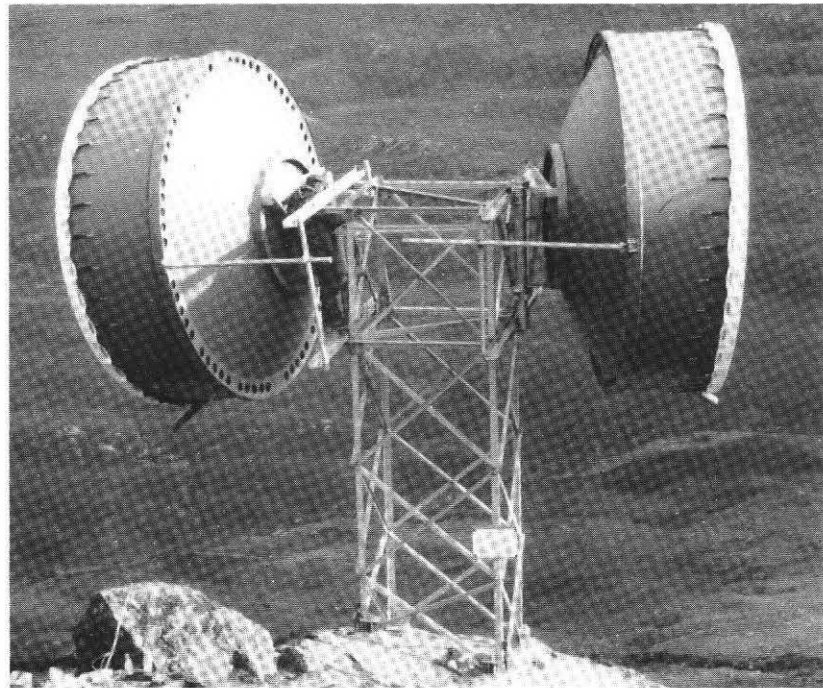

Fig. 5 The passive repeater at Sgurr Marcasaidh uses back-to-back paraboloid aeriels

their bases when winds are strong, thus requiring very secure foundations. To construct the foundations at the two passive repeater sites on conventional lines would have required the transport of thirty tons of material to the sites. The nearest available helicopters were based at Inverness and were not capable of carrying more than half a ton, and sixty or more loads would have been very expensive.

Fortunately, the rock outcrops near the sites were found to be good schist rock with adequate bearing resistance and it was possible, therefore, to use rod anchors bonded into the rock with resin grout. This sufficiently reduced the quantity of materials required to make helicopter transport economically acceptable. The completed installations can be seen in figures 4 and 5.

## 5 Testing the completed system

The system has five terminals, the last of which operates on a space-diversity basis. Consequently, there are 64 possible

combinations of main/standby equipment for each channel. Great care had therefore to be taken in commissioning tests to avoid spending a great deal of time testing every possible combination while at the same time ensuring that sufficient information would be obtained to confirm that the performance of the system would be satisfactory.

## 6 Conclusions

The Eitshal transmitting station began operation in June 1976, deriving its signals from the link system described in this article — the longest television link system engineered by the BBC, with a route length of 176km. As a result of painstaking route analysis and the use of unconventional techniques, the cost of the system was far lower than that of a conventional system over such difficult terrain. The measured performance meets the requirements laid down and agrees closely with the calculations made in the course of the planning work.



## BBC Test Card No. 61: Flesh Tone Reference

From the earliest days of colour television one of the most important problems of camera alignment has been that of obtaining adequate matching between the cameras in the same studio — human observers are, naturally, far more critical of changes in colour rendering between shots than they are of simple colorimetric errors. The subject matter for which the eye is most intolerant is human skin tones for which its sensitivity is such that it can detect colour changes which are very difficult to measure. The problem is further complicated by the fact that this high sensitivity only applies to colours which are seen on actual people or on representations of people: a plain rectangle which produces the same physical colour simply does not evoke the same critical appraisal.

For these reasons it has been the practice in the BBC, in common with many other broadcasting organisations, to use a girl's face as the reference for the final critical adjustments of the cameras in the colour studios. This procedure involved significant expense and therefore provoked thought about how to effect savings. The obvious approaches were a picture and a dummy head.

The dummy head, usually of plaster, sometimes painted, and sometimes with a wig of real hair has been used in many organisations, but has important disadvantages:

- a) the difficulty of painting to an acceptable colour in substantial quantities
- b) the high initial and maintenance costs of wigs
- c) variations caused by viewing the three-dimensional object from different directions. (This problem also occurs with live models, of course.)

A colour transparency of what was thought to be a suitable model was therefore passed to a company experienced both in television test chart work and in high-quality fine art reproductions. Experiments using this photograph gave promising results: there appeared to be a good chance of producing prints to the required standard but the wrong model had been chosen.

Knowledge of the problems of camera matching had led to a specification that the model's hair should be black and that there should be no colour cast in the shadows. This, indeed, still appears to be the ideal but the problems of photographing jet-black hair without a magenta cast in the deep shadows proved too difficult. Furthermore, the contrast with the hair tended to make the face appear sallow. A new model was therefore chosen with dark, but not black, hair.

Several good transparencies were produced and the best one was submitted to the same company. After a good deal of experimental work and testing the final version was produced as a seven-colour-plus-black print, together with a neutral tone to reduce the brightness and a clear varnish to



Ordinary colour printing processes cannot do justice to the new test card and so only a black-and-white illustration is given.

protect the print.

The accuracy with which the new test chart represents true flesh tones is acceptable to the eye and permits fine adjustments to camera colour balance controls as would a live model. Photometric tests carried out in the BBC Research Department have shown not only that the chromaticity of the facial tones is very close to that accepted for average measurements on live models but also that the spectral reflectance characteristic is very similar to that of real skin tones, including the characteristic sharp rise at 580-600nm.

The chart is mounted on stiff card or hardboard of such a size that it will rest on the bottom ledge of a BBC grey-scale test chart (No. 57) and it has a hinged strut at the top to enable it to be tilted forward by about 15°. Normal procedure is to group the cameras in front of the grey scale for preliminary balancing and, when this is completed, to place the new chart in front of it, tilted forward to avoid any specular reflections. The critical adjustment of the colour balance controls can then be made.

A roll-up PVC cover is fitted to protect the print from mechanical damage and light fading when not in use. The pigments used are probably much more stable than photographic dyes but cannot be expected to last for ever. What life can be expected from the chart is not yet known but it is unlikely to be less than a year if handled with reasonable care.

The chart provides a far more accurate reference than a photographic print at a far lower cost than using a live model and with the additional advantage of presenting a two-dimensional image. It thus puts accurate colour balance between cameras within reach of a far wider range of users.

## Contributors to this issue



**David Davis** came to the BBC in 1963 after a graduate apprenticeship with Metropolitan Vickers, followed by several years designing waveguide components for high power radar systems. He joined Transmitter Capital Projects Department as an engineer, and nearly all his time with the BBC has been spent in this Department, where he has been concerned with the planning and development of the UHF television transmitter and relay station network from its inception.



**Ross Durling** was prevented from studying agriculture at Durham University and first became associated with radio in the RAF — on Lancasters and Lincolns. Subsequently he returned to college and qualified in agriculture but, after a period as a farm manager, in 1957 he joined the Ministry of Civil Aviation Flying Unit. For the next six years he was concerned with the flight testing and calibration of navigational aids and pursued studies which brought him his formal engineering qualifications.

In 1963 Mr. Durling moved to the BBC, joining the Transmitter Unit of Planning and Installation Department (later Transmitter Capital Projects Department) and was involved with the design and planning of VHF, MF and UHF transmitter and standards converter installations.

Becoming Senior Engineer in Links Unit in 1970, he has been primarily concerned with link system planning involving choice of routes, locations, and equipment: the projects covered include, in addition to that described, the links from London to Wrotham and to Holme Moss for PCM stereo distribution.



**David Grant** joined the BBC in July 1953 as a Technical Assistant at Daventry. He transferred to the Television Section of Communications Department one year later. In 1961 he moved to the Links Unit of Planning and Installation Department (later Transmitter Capital Projects Department) and has been head of that Unit since 1970.



**Ian Leiper** joined the Weapons Division of Fairey Aviation in 1956. He was with their Film Department and covered many missile and aircraft trials, including the first flight of the Rotodyne helicopter. He joined the BBC in 1958 and worked in various posts in Television Studios Sound Section and saw the exciting times of the building and opening of the Television Centre. He transferred to Outside Broadcasts in 1966 where he became a Sound Supervisor in 1969, working on programmes over the whole spectrum of Outside Broadcast activity.





**James Redmond** has been Director of Engineering of the British Broadcasting Corporation since 1968.

He was born in 1918, educated at Graeme High School, Falkirk, and Caledonian Wireless College, Edinburgh. After a year as a Marine Radio Officer, he joined the BBC in 1937. He was a Sound Engineer in Edinburgh during 1937/8, later moving to London where he was a Vision Mixer in the Television Service in 1938/9.

During the war Mr. Redmond returned to the Merchant Navy and served in various ships until he rejoined the BBC in 1945. He was a Planning and Installation Engineer until 1954 and then became Assistant Superintendent Engineer Television (Film), a post which he held until 1960 when he was promoted to Superintendent Engineer Television Recording. He became Superintendent Engineer Television Regions and Outside Broadcasts in 1962, Senior Superintendent Engineer Television in 1963, and in 1967 was appointed Assistant Director of Engineering.

Mr. Redmond is a Fellow of the Institution of Electrical Engineers, a Member of the Institution of Electrical and Electronic Technician Engineers, a Fellow of the Society of Electronic and Radio Technicians, and a Fellow of the British Institute of Management. For three years from 1973 he was a Vice-President of the Institution of Electrical Engineers.



**Roy Vitty** joined the BBC in 1960 and during the next four years worked in many areas throughout the country as a technical trainee, during breaks from college studies. In 1964, he joined Video Tape Department where he was involved in operating, maintaining, and editing, and in 1967 was appointed Senior Television Engineer in charge of Video Tape maintenance at the Television Centre. Since 1974, he has been with Television Outside Broadcasts and is now Engineer-in-Charge of Engineering Services. In this capacity he is responsible for the engineering operation and maintenance of Television Outside Broadcast equipment in London.

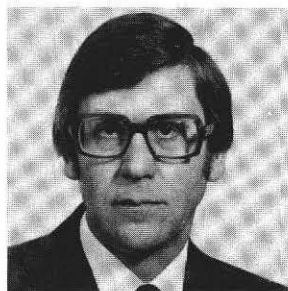

**Alan Woolford** joined the BBC in 1953, direct from National Service with the Royal Signals. After a short stay in Radio, he joined Television Outside Broadcasts as a Technical Assistant. In 1958, he began a four-year sandwich course at the Borough Polytechnic which led to a first-class honours degree.

He joined the Engineering Training Department in 1962 and after just over a year was appointed Station Instructor with Television OBs. He was appointed to his present post as an Engineering Manager in 1965 and since that date has been involved in the planning of many of the most complex programmes.

He was closely involved in the launching and operation of the location production unit described in this issue.