

**ENGINEERING
DIVISION
TRAINING
MANUAL**

1942

THE BRITISH BROADCASTING CORPORATION

ENGINEERING
DIVISION
TRAINING MANUAL



1942

THE BRITISH BROADCASTING CORPORATION

‘ Where there is much desire to learn, there of necessity will be much arguing, much writing, many opinions ; for opinion in good men is but knowledge in the making.’
Milton’s *Areopagitica*

CONTENTS

	PAGE
FOREWORD	5
LIST OF PLATES	6
CHAPTER I FUNDAMENTAL PRINCIPLES	7
<p>Atoms and electric currents. Generating electricity. Effects of a current. Energy, voltage, current, and resistance. Resistances in series and parallel. Potential difference and potential dividers. Magnetism. Electromagnetism. Electromagnetic generator. The transformer. Some Practical Applications of Electromagnetism. Relays. Microphones. Loudspeakers and telephones. Self-induction. Condensers and capacity. The use of graphs. Graphs in practice.</p>	
CHAPTER II THE NATURE OF SOUND	33
<p>The sense of hearing. The nature of sound. Wave-motion. Wavelength and frequency. Complex waves and harmonics. The study of acoustics. The loudness of sound. A scale of loudness,—the decibel. The control of volume. Measurement of volume.</p>	
CHAPTER III CONVERSION OF SOUND TO ELECTRICITY, AND THE BROADCASTING CHAIN	50
<p>The simple telephone. Separating D.C. and A.C. Development of the ‘Broadcasting Chain’. The studio and listening room. The control room. Programme control and monitoring. Sending the programme to line. The receiving end of a line. Transmitting the programme,—‘Wireless’. Outside broadcasts. Additional studio facilities.</p>	
CHAPTER IV PRACTICAL BROADCASTING APPARATUS	63
<p>The carbon microphone. The moving-coil microphone. The ribbon microphone. The decibel again. Microphone mixers. The control potentiometer. The balanced line. The gramophone unit. Control room wiring. Plugs and jacks. ‘Normal’ wiring of breakjacks. The chain in detail. Switching arrangements. Private wiring. Alarm circuits. Another type of mixer.</p>	
CHAPTER V THE THERMIONIC VALVE	90
<p>Historical development. The diode. The triode. The triode as an amplifier. Grid bias. Obtaining greater amplification. Multi-stage amplifiers. Variable gain amplifiers. Trap valves. Practical amplifiers in the broadcasting chain. Mains rectification. The O.B.A./8. Negative feed-back. The programme meter.</p>	
CHAPTER VI. LINKING BY WIRE	90
<p>General requirements of a wire link. Line characteristics. Inductance and loading. Equalization. Harmonic distortion. Noise. Balanced lines. Phantom working. Repeaters. Line testing. D.C. tests by the P.O. ‘Clock’ Insulation resistance. The Wheatstone bridge. Out-of-balance tests. A.C. Tests. The sending circuit. Measurement of received level,—The amplifier detector.</p>	

CHAPTER VII RADIO TRANSMISSION

PAGE
131

The production of electromagnetic waves. Wave-motion and wavelength. The generation of high frequency currents. The valve oscillator. Receiving the signal. The modulation of high frequency currents. Class B modulation. Bandwidth occupied by modulated waves. Side-bands. Wave-bands available for broadcasting. Reception of electromagnetic waves. Drives. Production of high D.C. voltages, and other power supplies. High-power transmitting valves. Protective devices. Limiters.

CHAPTER VIII THE PROPAGATION OF ELECTROMAGNETIC WAVES

161

Medium and long-wave propagation. Service area. Short-wave propagation.

CHAPTER IX AERIALS FOR BROADCASTING STATIONS

169

General requirements of an aerial. Aerials for medium and long waves. Aerials for short waves. Polar diagrams of aerials. Power distribution diagrams. Short-wave broadcasting. A method of designating aerials.

CHAPTER X SOUND RECORDING APPLIED TO BROADCASTING

182

General requirements of a recording system. The 'Marconi-Stille' steel tape system,—historical. Principles of magnetic recording. Speed control and other mechanical features. Disc recording,—historical. The disc. Mechanical arrangements of the disc machine. The cutter head. Quality of disc reproduction. The reproducing turn-table (TD/7) and editing. 33 $\frac{1}{3}$ r.p.m. Disc recording. 'Philips-Miller' film recording,—general principles. Film machine mechanism. Recording and reproducing heads. Film editing. General.

APPENDIXES

203

- I. General Letter Symbols of Electrical Quantities
- II. Standard Symbols used in Drawing
- III. Formulae and Tables. An 'ABAC'
- IV. Attenuation Curves of Ground-wave Radiation
- V. Modern Control Rooms, and 'Continuity' Working

BIBLIOGRAPHY

221

INDEX

223

ERRATA

- P. 11 Line 17 Insert "approx." before 6,000,000,000,000,000.
- P. 29 Fig. 20 Delete "O" on Frequency scale; amend to read "25."
- P. 30 Fig. 21 Delete "O" on Frequency scale; amend to read "25."
- P. 35 Line 20 Delete "Slowly"; amend to read "Quickly."
- P. 129 Line 36 Delete "Capacity"; amend to read "Capacitances."
- P. 166 Fig. 123 Delete "1 kw. Transmitted" at foot of Diagram.
- P. 209 Line 27 Insert "Series" before "Circuit."

FOREWORD

THERE are, of course, many text books on electrical engineering and that branch of it known as 'telecommunications', but up to now there has never been a book describing the technical practice and equipment of the BBC.

This book has been written by F. C. Brooker, one of the instructors of the BBC Engineering School. It has been edited and amplified by L. W. Hayes, Head of Overseas and Engineering Information Department. It is not intended to do more than serve as a training manual both for those who have little technical knowledge, and for those who need to brush up the things that have been forgotten. The task of writing a text book readily understandable by those joining the BBC with more enthusiasm to do a job of war-work than the technical knowledge of how to do it has not been easy, particularly when it is borne in mind that many engineers will be waiting to tear to shreds any mis-statements or false analogies! Furthermore, all explanations have been made without the use of mathematics, covering both the latest technical practice as well as any obsolescent equipment still in use. How well Mr. Brooker has succeeded is best left to the judgment of the reader.

The classic definition of an engineer is someone who can make for twopence what it would cost anyone else a shilling to produce. Another way of putting it is someone who really can make for a shilling what everyone else *thinks* they can make for twopence. This merely underlines the necessity of practical experience and it is not suggested that those who thoroughly study this book will automatically become fully trained radio engineers, but by doing so will have placed themselves in a position to become useful members of the staff of the Engineering Division of the BBC, and should have obtained that sound basic understanding of the working of the equipment on which further progress can be built up.

One of the best ways of understanding how a thing works is to formulate your own theories on the subject and then ask others whether you are right. Your ideas may be wrong, so may his or hers; but it will probably lead to a healthy argument and an appeal to somebody who really does know. It is to prompt discussions of this sort that questions have been included at the end of the chapters. There has been some argument among the departmental heads of the Engineering Division concerning the strictly correct answers to some of these questions, so no junior need feel ashamed to ask help from his S.M.E. or E.i.c. I sincerely hope that anyone who does not understand any part of this book or who cannot answer any of the questions will ask some other member of the staff of his station to explain it more fully, and will go on asking until he really does understand it. In turn, the senior staff of stations have been asked to let us know what parts of this book have not been easily understood, so that they can be clarified in future editions.

I trust that everyone receiving a copy of this book will make a study of every chapter, even though some of them may not at present appear to have a direct bearing on their present work, for in this way an interest may be generated in the reader's mind which almost certainly will be of practical use sooner or later.

N. ASHBRIDGE

LIST OF PLATES

- PLATE I A typical broadcasting studio for large orchestras
- PLATE II General view of a Control Room, showing control positions and amplifier bays
- PLATE III Outside Broadcast equipment ; showing 4-channel mixer, OBA/8 amplifier, and Mains unit
- PLATE IV Three types of microphone used by the BBC : Reisz, moving coil, and ribbon
- PLATE V Miscellaneous apparatus used in control rooms ; plugs and jack, potentiometer, relays, and switch
- PLATE VI (a) Distribution jackfield, and telephone indicators
(b) Main distribution frame (MDF)
- PLATE VII The peak programme meter
- PLATE VIII A.C. testing equipment, showing T.P.M., T.M.S., oscillator and amplifier, amplifier detector, and variable attenuator
- PLATE IX General view of a transmitter hall
- PLATE X Large water-cooled valve being wheeled into position
- PLATE XI Two mast radiators at a BBC transmitting station
- PLATE XII Short-wave aerial arrays, for 17, 14 and 19 metres
- PLATE XIII (a) Marconi-Stille steep-tape recording machine
(b) Philips-Miller film recording machine
- PLATE XIV (a) 78 r.p.m. disc recording machines
(b) The groove locating unit on a gramophone desk, type TD/7
- PLATE XV Control position bays in a wartime control room
- PLATE XVI The control position bay in a Continuity suite

CHAPTER I

FUNDAMENTAL PRINCIPLES

IN order to understand how broadcasting works, it is necessary to know the nature of the 'agent' which conveys the intelligence, be it speech or music, over wires and starts it off on its wireless journey from place to place. This agent is 'electricity'; it will be met in many different guises—some perhaps already well known, others not quite so familiar to the man-in-the-street. Therefore, it is proposed to devote some considerable space to the study of fundamental principles.

First, then, we want to know the answer to the question . . . 'What is electricity?' Now we are going to consider only the theories accepted by modern scientists ; for to give a complete history of the progress of this science and of the work of its pioneers would tend to confuse the reader ; besides which, many excellent books treat the subject far more completely than can be attempted here.

It will soon be learned that electricity, energy, and matter are intimately bound up with each other, so let us start by considering the structure of matter. Suppose we take any substance and divide it into extremely small particles. If we could go on dividing it into smaller and smaller particles we should ultimately reach a stage where we could no longer sub-divide a particle again without its losing its resemblance to the parent piece. Such a minute particle, a true 'chip of the old block', is called a 'molecule'. Further division of molecules would split them up into their component parts, known as 'atoms'.

ATOMS AND ELECTRIC CURRENTS

The earlier scientists who investigated the structure of matter came to the conclusion that the smallest particles of matter were indivisible, and that is how the atom got the name, for the word 'atom' means 'indivisible'. Now, these scientists came to some very definite conclusions about atoms, including the astounding fact that there is only a relatively small number of different types of atoms in existence . . . about 92. These few types of atoms combine in different ways to form the almost infinite variety of molecules, and hence of matter. If the atoms in a particular molecule are all of the same type, then we call that substance an 'element'; if of different types, the substance is a 'chemical compound'. Thus a molecule of Hydrogen, which is an element, is made up of two atoms of Hydrogen ; but water molecules are composed of two atoms of Hydrogen plus one atom of Oxygen ; water is therefore a compound.

Whilst the study of atoms in combination is very fascinating, it would lead us into the province of the chemist—whereas we are trying to follow the path which leads to an understanding of the nature of electricity. Our very next step, however, discloses the relationship between atoms and electricity, for what we intend to do is to 'split the atom' . . . at least, in theory. We find that atoms, of all types, are composed of nothing more than minute charges of electricity ! These charges are of two types, viz. 'positive' ones called

Protons, and 'negative' ones called Electrons. Once again it is the manner in which these two fundamental units are combined that gives us the different types of atoms. It is not only numbers that count, but also the arrangement of the charges in a sort of planetary system, rather like our solar system; some of the electrons revolve round a central nucleus composed of the protons and the remainder of the electrons. The velocity of rotation of the 'free' electrons is great, and it is obvious that a great amount of energy must be locked up in each of these minute 'worlds'. So far as the general effect is concerned, the positive and negative electric charges tend to cancel each other because the atom normally contains equal numbers of electrons and protons, so that the substance is electrically neutral. It is quite possible that in the 'jostling' that goes on between neighbouring atoms, a certain number may lose one or more of their free electrons; but an atom which has lost some of its electrons (i.e. negative charges) is positively charged and therefore tends to attract electrons, and so to entice its wandering electron back, or else to borrow one from a neighbouring atom. If we can forcibly remove one or more of the 'free' electrons from their normal orbits (we call this 'applying a positive charge') there will be a general tendency for 'free' electrons from neighbouring atoms to fill the ranks in the deficient atoms. And their neighbours will also give up electrons; and so on, and so on, until the breach is filled—if possible. If, instead of removing electrons from some of the atoms, we had added some (i.e. applied a 'negative charge'), there would have been a tendency for electrons to drift away from the point where we applied the charge to any part of the substance where there was a deficiency of electrons. These movements of electrons are electric currents, and it will be observed that the electrons do not themselves move great distances—probably not farther than from one atom to another in ordinary substances—but there is a general 'drift' of electrons in one direction or the other. If the drift is easily set up, the substance is called a 'conductor'; whilst if it is difficult, because the 'free' electrons are hard to detach from their orbits, it is known as an 'insulator'.

We have spoken of this electron movement in a fairly matter-of-fact way, but it is as well to realize the enormous numbers of these tiny particles that are agitated for even such a small operation as lighting a lamp. For when we switch on a 100-watt lamp across the 200 volts 'mains' it means that there is a continuous 'drift' of approximately 3,000,000,000,000,000,000 electrons per second through the filament. No wonder it gets hot! Figures like this do not really convey much to the mind, but just imagine the above mentioned number of electrons being allowed to pass at the rate of only 1 million per second along the wire. Then it would take 100,000 years instead of a second for them all to get through.

It should be noted that an excess of electrons is known as a 'negative' charge, whilst a deficiency of electrons becomes a 'positive' charge. Modern electron theory neatly explains an electric current as a flow of electrons from an overcrowded or negative point to a less dense or positive point, and as we are only dealing with modern theories in this book we shall ignore all older theories which may conflict. It would be difficult to understand the action of a valve, for example, without bringing in the new conception of electrons drifting from negative to positive.

So much for theory; but how do we generate an electric current? That is, how do we bring about this drift of electrons? In practice, there are several

ways, and we shall deal with most of them here, although some of them are of much greater practical importance than others.

GENERATING ELECTRICITY

First comes the friction, or 'static' method, from which electricity got its name. It was found that when a piece of amber (Greek: 'elektron') was rubbed with fur, the amber exhibited certain characteristics, such as a power to attract small pieces of paper, dust, etc. Other substances showed similar properties when rubbed, and further experiments disclosed that two kinds of electricity were formed, viz. one in the 'rubbed' and another in the 'rubber'; and that objects that were similarly charged repelled each other, whilst those that were oppositely charged attracted one another. Although it was not understood at the time of these pioneer observations, we can now see the reason for this in the light of the electron theory. For all that was happening was that electrons were being given up by one substance and held by the other. The name 'static' electricity was given because these observations were confined to insulating materials, where the deficiency (or excess) could not be made good by a drift of electrons in the material. So the 'charge' remained at one place, or was 'static'. It was not realized that a conductor was capable of being charged, because the charge always leaked away as soon as it was formed, unless precautions were taken to insulate it, and it was not until other means of producing electricity were discovered that 'current', or flowing electricity, came into its own.

The next method of generating electricity is the chemical one. As we might expect from our new conception of matter, certain chemical reactions bring about a disarrangement of electrons. Such a state of affairs is easily proved to exist when plates of certain dissimilar metals are immersed in solutions of acids or salts. One plate acquires an excess of electrons at the expense of the other; and if a conducting path is provided between the plates (external to the 'battery', or 'cell', as it is called) a flow of electrons will result. This flow is an electric current. At this point it may be useful to know what we mean by 'voltage', for so far we have dealt only with current. Voltage is the name given to the electric 'pressure' which exists between two points having a difference in electric charge, such that a current would tend to flow from one to the other if a conducting path were provided between them. Other names are also used to denote this pressure, e.g. 'electromotive force' (abbrev., e.m.f.) 'potential', or 'potential difference' (abbrev., p.d.) according to the way in which it acts—but it is always measured in volts.

There is one point about batteries which may be mentioned here: they fall into two classes, known as 'primary' and 'secondary' cells. The former are those which produce electricity by the primary reaction of certain metals and chemicals, and the voltage produced from individual sets of plates is usually about 1 to 1½ volts (but this can be multiplied by means to be described later). The secondary cell, however, does not give rise to electricity straight away; but, when a voltage is applied to the plates, chemical changes take place which have the effect of 'storing' the electricity for future use. These cells are known as 'accumulators' and the voltage to be expected from each pair of plates is usually of the order of 2 volts.

Finally, there is the electromagnetic method of generating electricity, which is very important and will be given special attention toward the end of this

chapter. For the moment it may be said that the electrons in a conductor may be disturbed by the proximity of a magnet. It will be learned later that it is relative movement between the magnet and the conductor that really matters, and this causes a voltage to be set up across the conductor.

There are other ways of producing electricity, such as the photo-electric and thermo-electric methods, but these will not be discussed here.

EFFECTS OF A CURRENT

A brief note on some of the effects produced by the flow of an electric current may probably aid the better understanding of its nature. Really, the effects are the converse phenomena to the methods of production, which is only to be expected. One of the first things to be observed when a current flows along a conductor is the production of heat. This is quite natural, for heat is defined as being the agitation of molecules. In fact, it now becomes necessary to add an additional definition of electricity as a 'form of energy'; it can be converted into other forms, such as heat, light, mechanical energy, and chemical energy.

Another effect of electricity is a chemical one; often called the 'electrolytic effect'. By applying potentials we can split up certain compounds into their component parts. A simple example of this is to pass a current through water, which is a chemical compound whose molecules each consist of 2 atoms of Hydrogen and 1 atom of Oxygen (H_2O). The electrolytic action is to split up the water into Hydrogen (H_2) and Oxygen (O). In commercial practice, this electrolytic effect is put to use in such processes as electroplating and the production of pure metals.

Then we come to the electromagnetic effect which is so important that it will be given full account in the latter half of this chapter. Stated as a converse to the method of generation, it is that a conductor carrying an electric current will itself create a magnetic field which will, in turn, react with other magnetic fields, and by so doing, will bring about mechanical movement. This is the principle underlying the operation of an electric motor, as well as countless other devices.

ENERGY, VOLTAGE, CURRENT, AND RESISTANCE

It will be noticed that all these effects are examples of changes in the form of energy; chemical energy, heat, or mechanical energy has been changed into electricity—or vice versa. Consequently, it falls readily under the most fundamental law of science which states that: 'Energy can neither be created, nor destroyed; but may only be converted from one form into another; the total amount of energy in the Universe remaining constant'. This is known as the 'Principle of Conservation of Energy' and cannot be ignored when talking of electrical phenomena any more than in other spheres. Thus we cannot expect to find any electrical machines or apparatus more than 100 per cent. efficient; the energy produced cannot be more than the energy absorbed. This point is often overlooked when one first comes across such things as amplifiers which have a greater 'output' than 'input'. But it must be remembered that there has to be a separate supply of energy (in, perhaps, a different form) in order to make the amplifier work, and the total electrical input is very much greater than the electrical output, the difference being 'lost' in heat.

It now becomes necessary to define more clearly what we mean by current and voltage, as well as to fix units by which to measure these, and other electrical quantities. To do this, it is useful to have an analogy, and the flow of water suits our purpose very well.

Electromotive Force and Potential Difference, are two names which we have given to voltage; they have also been described as being the 'pressure' which is exerted between two points, such that a flow of electrons would result if these points were joined by a conductor. Electromotive force may be likened to water pressure, or 'head' as it is called, which is measured in pounds per square inch.

The rate of flow of water in a pipe connected to such a head of water would depend on two factors, viz. (i) the pressure and (ii) the resistance (diameter) that the pipe offered to the flow. This rate would be measured in gallons per min. and the equivalent electrical effect is the current, whose unit is the Ampere and which is defined as being the passage of one coulomb per sec. (the coulomb being the practical unit 'quantity', which is more convenient to use than the corresponding number of electrons, $6,000,000,000,000,000,000$ of which must flow to constitute one coulomb).

The amount of work that is done in a given time by the passage of a current is a measure of power; in the same way that the rate of doing work in the mechanical sense (measured in ft. lbs. per sec.) gives a measure of horsepower. Electrically, 'power' is given by the product of current and voltage, and is measured in watts. Thus:

$$1 \text{ Watt} = 1 \text{ Ampere} \times 1 \text{ Volt} \\ \text{or } W = I \times E$$

(where W = power in watts; I = current in amperes, and E = e.m.f. in volts). It may be noted that the various units of power, whether referring to electrical or mechanical energy, are interchangeable.

$$1 \text{ Horsepower (or 550 ft. lbs. per sec.)} = 746 \text{ watts.}$$

We likened the passage of current in a conductor to the flow of water in a pipe, and noted that this flow depended on the 'resistance' offered by the pipe. In the same way, the resistance of the conductor will depend upon its diameter, length, and the material from which it is made. Furthermore, there is a definite relation between the current that will flow in a given conductor and the voltage applied to its ends. If the voltage is doubled, the current will be doubled, and so on. This relationship between voltage, current, and resistance was discovered by Ohm, and his law (known as Ohm's law) states that 'the current flowing in a conductor is directly proportional to the voltage, and inversely proportional to its resistance'. The unit of resistance is the 'Ohm', which is so chosen that, expressed in equation form:

$$I = \frac{E}{R}$$

(where I = current in amperes; E = e.m.f. in volts; R = resistance in ohms).

By simple algebraic transposition, this equation may also be written as:

$$E = I.R. \text{ or } R = \frac{E}{I}$$

Similarly, the power (number of watts) dissipated in a resistance may be expressed in terms of voltage and resistance, or current and resistance, thus :

$$W = I.E. = \frac{E^2}{R}; \text{ or } W = I^2 R$$

However good a conductor may be for carrying electric currents, it must always have some resistance. Many substances, particularly the metals, have very low resistances (and the resistance becomes less as the temperature is lowered). Thus we have wires made of copper to carry currents where we wish to lose as little energy as possible in the form of heat. But high resistances are also required, and special alloys are often used to make wires with this property, a very useful one being 'eureka'. Carbon is another substance which can be made up into the form of 'resistances'. Such resistances may be of a few ohms' value to many thousands, or even millions, of ohms. When we speak of 'millions of ohms', we usually abbreviate it to 'megohms'. But it must be remembered that such figures attached to resistances give no indication of their physical size.

RESISTANCES IN SERIES AND PARALLEL

Whilst it is not intended to introduce any more calculations or mathematics into this book than are absolutely necessary, the method of calculation for resistances arranged in series or in parallel will probably be of assistance in understanding later problems. We talk of resistances being in 'series' when they are connected end to end, as in Fig. 1.*

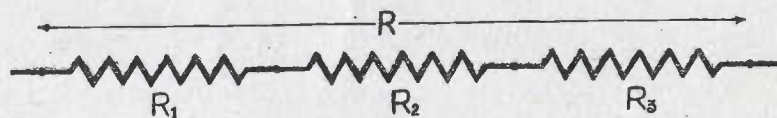

FIG. 1. RESISTANCES IN SERIES

Here we have resistance R_1 , R_2 , and R_3 connected end to end, and it is desired to find the total resistance, R . It is not proposed to give even the very simple proof of the calculation, but merely to state the answer, which is $R = R_1 + R_2 + R_3$. In other words, the combined resistance of a number of resistances connected together in series is given by the sum of their individual resistances.

As an example of this, let us take the case of an ordinary P.O. telephone line. This consists of two wires, which, if they are of any reasonable length, are quite likely to have an appreciable resistance, maybe hundreds, or even thousands, of ohms. It is customary to designate the resistance of such a line by its 'loop resistance', which simply means that we have looped (or joined) the two wires at one end, leaving the other ends free on which to make our measurements (Fig. 2a).

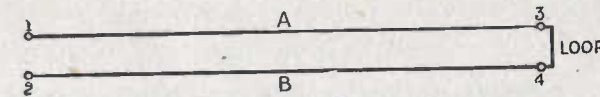

FIG. 2a. SINGLE LINE ; LOOPED AT ONE END



FIG. 2b. TWO LINES ; JOINED TOGETHER, AND LOOPED

It will be seen that the loop consists of joining points 3 and 4 of wires A and B ; and the total, or loop resistance, is measured across points 1 and 2. In actual practice, that is just what we do, viz. measure the loop resistance, and from this figure we can deduce the value of each wire (because they are supposed to be the same).

Thus, if the loop resistance were found to be 1,334 ohms, then we know—from our formula—that this must be equal to $R_A + R_B$. But if $R_A = R_B$ then $R_{Loop} = 2R_A$, or $= 2R$

$$\therefore R_A = \frac{1,334}{2} = 667 \text{ ohms}$$

Carrying this example a stage further, let us suppose that we add on another section of line, $A' B'$, as in Fig. 2b, and we now wish to find the total loop resistance. There is no need to find each separate wire resistance . . . it is simply a matter of adding the two loop resistances. If the loop resistance of the second section is 548 ohms, then the total loop resistance = $1,334 + 548 = 1,882$ ohms.

Resistances 'in parallel' present a slightly more difficult sum, but it is really quite easy. When we put resistances in parallel we mean that one end of each is connected to a common point (Fig. 3).

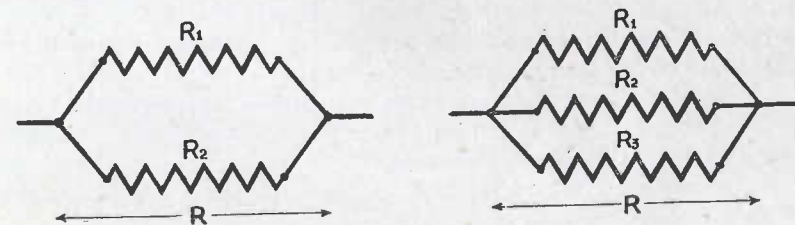

FIG. 3. RESISTANCES IN PARALLEL

The result found is that :

$$\frac{1}{R} = \frac{1}{R_1} + \frac{1}{R_2} + \frac{1}{R_3} \dots \text{etc.},$$

which may be expressed by saying that 'the reciprocal of the combined resistance of a number of resistances in parallel is equal to the sum of their individual reciprocals'. For calculating the combined resistance of only two resistances in parallel, the answer can be expressed straight away, and the 'right way up', as

* A list of conventional symbols used in drawing diagrams of electrical circuits is given in Appendix II.

$$R = \frac{R_1 R_2}{R_1 + R_2}$$

Frequently, we shall be required to add two, or more, resistances in parallel when we come to the job of connecting a number of amplifiers to the same input. For the input and output of an amplifier may be regarded as being a certain 'resistance' (actually we use the term 'impedance' but it is still measured in ohms ; you'll see why, later on) and the effect of putting two amplifiers in parallel, as in Fig. 4, results in a combined impedance of value which is less than either, as obtained from the formula

$$R = \frac{R_1 R_2}{R_1 + R_2}$$

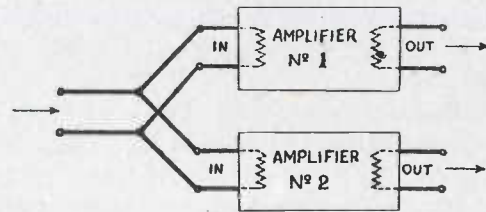

FIG. 4. TWO AMPLIFIERS, WITH THEIR INPUTS CONNECTED IN PARALLEL

You will often come across amplifiers with an input 'impedance' of 600 ohms or 300 ohms ; so if, in the above example, we make the two amplifiers of those values respectively, we can find the resultant, or combined impedance, by the formula thus :

$$R = \frac{R_1 R_2}{R_1 + R_2} = \frac{600 \times 300}{600 + 300} = \frac{180,000}{900} = 200 \text{ ohms}$$

Hence, putting these two amplifiers together would have exactly the same effect, so far as 'load' is concerned, as using *one* amplifier of 200 ohms' input impedance. (Note that the combined resistance of a number of resistances in parallel is always less than the smallest of them.)

When calculating 'networks' of resistances, such as an assortment of resistances in series and parallel, it is wisest to tackle the problem by first considering those resistances, or groups of resistance, which are in parallel. Having done this, the groups may each be regarded as single resistances and added to the other series resistances.

When calculating the voltages of batteries or cells in series or parallel, a

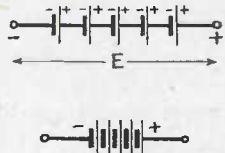

Usual method of drawing several cells in series

FIG. 5a. BATTERY OF CELLS CONNECTED IN SERIES

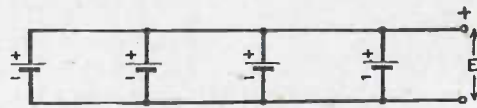

FIG. 5b. CELLS CONNECTED IN PARALLEL

similar procedure is adopted. Cells connected in series (Fig. 5a) give a total voltage (E) which is the sum of the total cell voltages.

Cells connected in parallel (Fig. 5b) give the same voltage as only one of the individual cells. As it is never the practice to connect cells of differing voltages in parallel (due to the production of circulating currents which would be detrimental to the cells) that problem need not concern us. The reason why batteries are connected in parallel is, of course, in order to allow a greater current to be produced ; the extra current capacity being the product of the number of cells and their individual capacities.

In actual practice, another factor has to be taken into consideration when calculating currents and voltages produced by batteries, viz. that the battery itself has an 'internal' resistance. If such calculations have to be made, the main point to be remembered is that the internal resistance must be simply regarded as having to be added to the total external resistance, in series fashion. Thus the current will be equal to the electromotive force (e.m.f.) of the battery divided by the total resistance in the circuit (the external resistance connected across the terminals of the battery plus the internal resistance of the battery). The voltage at the terminals of the battery will, however, be less than the e.m.f. of the battery by the voltage drop in the battery (i.e. by the product of the current multiplied by the internal resistance).

If we are dealing with large external resistances compared with that of the battery (which may be only a few ohms, or a fraction of an ohm) then we can afford to neglect the internal resistance in our calculations, because the terminal voltage of the battery will be very nearly equal to its e.m.f. But let us work out an example where we have a fairly low external resistance, say 10 ohms, connected to a 3-volt battery whose internal resistance is 2 ohms.

Were we to ignore the 2 ohms, the current would work out to $\frac{3}{10} = .3$ amp.

Experiment would show that the internal resistance, through bringing up the total circuit resistance to 10 + 2, or 12 ohms, gives the resultant current as $\frac{3}{12} = .25$ amp.

Looking at the same example but changing the external resistance to 1,000 ohms, the answer found by neglecting the internal resistance comes out to $\frac{3}{1,000} = .003$ amps. whilst taking the extra 2 ohms into account gives us $\frac{3}{1,002} = .002994$ amps. which is not enough to worry us for most practical purposes.

POTENTIAL DIFFERENCE AND POTENTIAL DIVIDERS

A word on 'potential' and 'potential dividers' would not be out of place here. The word 'potential' has already been used as an alternative to the expression 'potential difference'. The reason why the 'difference' part can usually be dropped is that we assume, when speaking of a point being at a certain potential, that what we really mean is that the point has a potential difference between it and earth. It has been found convenient to assume that the earth is at 'zero potential' and that it contains an infinite number of electrons.

Therefore, it can always accept a few more, or give up some, without affecting its general state of neutrality. So we can say that a point is at a 'positive potential' if electrons would flow from earth to that point, and similarly we speak of a point having a 'negative potential' if electrons would flow from that point to earth.

Much use is made of this assumption that the earth is at zero potential, for it means that we can often dispense with one wire of a circuit by providing what is known as an 'earth return'. As an example, instead of running two wires to operate an electric bell (Fig. 6) :

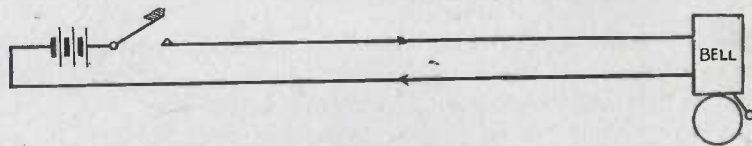

FIG. 6. SIMPLE BELL CIRCUIT

we can replace the return wire from the bell to the battery by an earth return (Fig. 7) :

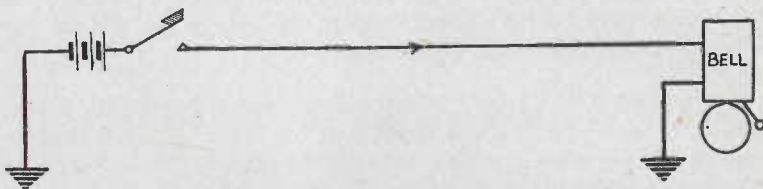

FIG. 7. BELL CIRCUIT, USING 'EARTH RETURN'

If we imagine a resistance connected across a source of supply (say, a battery) then we say that there is a 'potential drop' through that resistance. For example, let us place a 10-ohm resistance across a battery of 6 volts, as in Fig. 8 :

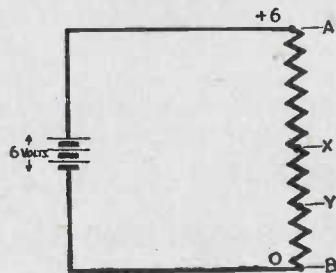

FIG. 8. ILLUSTRATION OF 'POTENTIAL DROP'

Then (neglecting the internal resistance of the battery) the potential drop through the 10-ohm resistance AB is 6 volts. If we take a point X which is the exact centre of AB (i.e. AX = 5 ohms, and XB = 5 ohms) two facts stand out. First, the voltage, or potential difference, between A and X equals 3 volts, and that between X and B is also 3 volts. Secondly, this result does not depend on the total resistance of 10 ohms ; we could have made it 100 ohms, and the result would have been the same. Further, if we take a point Y,

which is one quarter of the way up from B, the potential difference between Y and B is 1.5 volts ; and between A and Y is 4.5 volts.

To generalize, we state that a 'potential gradient' exists throughout the resistance. This should be fairly obvious if the total resistance is considered as a number of tiny resistances, or 'elements', all equal in value and arranged in series. The current through all these resistances is the same (owing to their being in series) and, by 'Ohm's law, the voltage across each element will be the same. Therefore, the total potential is 'divided' into elementary potentials and from this feature derives its name of potential divider. It will be seen that it gives us a method of deriving any fraction of a given potential difference. For we can arrange to have a variable sliding arrangement, as shown diagrammatically in Fig. 9, which will give us any desired fraction of the input voltage.

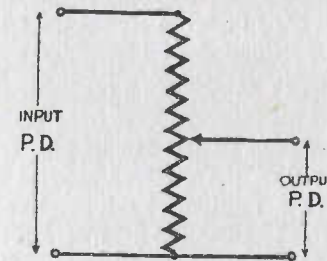

FIG. 9. VARIABLE POTENTIAL DIVIDER

Potential dividers are not always variable, and are met in very many forms, sometimes under names such as 'potentiometer' (a misnomer derived from the fact that one form of potential measurer used a potential divider), 'volume control', 'fader', etc., depending on the particular use to which each is put. But these will be described in detail later, it being necessary only to understand the general principle at this stage.

MAGNETISM

At the beginning of this chapter, the electromagnetic effects and the relation which magnetism bears to electricity were lightly touched upon, but so important is this subject that it will be necessary to study it more closely before we proceed any further.

A magnet is a piece of iron or steel which possesses certain natural properties. The first is that if such a magnet is suspended freely, so that it may rotate in a horizontal plane, it will always come to rest in a definite direction. One end will point towards the North magnetic pole of the earth, and is known as the 'North-seeking' (or, more generally, the 'North') pole of the magnet, whilst the other will be the 'South-seeking' or 'South' pole. Another feature of magnets is that two of them, when placed in proximity, will exert forces of attraction and repulsion on each other. It is found that 'like poles' (e.g. two North poles) will repel each other, and 'unlike poles' (e.g. a South pole and a North pole) attract each other. The term 'pole' is used because the magnetism is found to be concentrated at each end, which is another way of saying that the end may be considered as having an amount of magnetism of such-and-such 'polarity' (i.e. North or South). Magnets also have the power of attracting pieces of iron which are not themselves magnets ; the reason

being that these pieces of iron become 'temporary' magnets whilst under the influence of the 'permanent' one.

The region in the vicinity of the poles is called the 'magnetic field', because it is in this region that the effects of attraction and repulsion may be observed. Such effects are stronger the nearer one approaches the actual pole of the magnet. In actual fact, the force between two poles is found to vary inversely as the square of the distance between them. We are not immediately concerned with this law except that it naturally leads us to expect that if we wish to create a strong magnetic field, then one way is to reduce the distance (or 'gap') between the two poles.

ELECTROMAGNETISM

So much for the magnet itself; now we must consider how magnetism and electricity are bound up with each other. Perhaps the best way is to take the converse of the method of production of electricity and discuss that first.

If a current is passed through a conductor, a magnetic field is found to exist surrounding that conductor. This magnetic field has the same properties as one produced by a permanent magnet, except for its shape, which is a circular one for a straight wire. However, if the wire be coiled on a long tube (thus forming a helix or spiral), the resultant field produced by the individual elements of wire becomes a concentrated 'field of force' exactly similar to that produced by a permanent magnet. This arrangement is called a 'solenoid' and has quite a number of uses in commercial practice. However, it will not be found much in our work, and we will pass on to a slight modification of this arrangement. For if a bar of iron is inserted in the tube carrying the coil, the resulting magnetic field is found to be much stronger. If the iron is of a type known as 'soft iron', the magnetism induced into it will not be retained on switching off the current. Steel, on the other hand, will usually be found to retain at least some of the magnetism, and is said to be more 'retentive' than soft iron. It is, however, the former type of iron that interests us most, for reasons which will be appreciated later. The arrangement of a coil surrounding a piece of soft iron is called an 'electromagnet' and its applications in practice are innumerable. A few of these will be discussed towards the end of this chapter.

It follows that if a conductor carrying an electric current creates a magnetic field, this field will react with any other magnetic field in its neighbourhood, whether this second field be produced by a permanent magnet or by an electromagnet. The attraction or repulsion will make the conductor move under the influence of the combined fields. Such is the principle of the electric motor, and of one particular type of loudspeaker; in both cases we wish to turn electrical energy into energy of movement.

ELECTROMAGNETIC GENERATOR

Now let us return to the generation of electricity by magnetic methods. It was discovered by Michael Faraday that when a conductor 'cuts' the lines of force of a magnetic field (e.g. is caused to pass between the poles of a magnet), a voltage is set up across that conductor. The current is proportional to the strength of the field, the length of conductor, and the velocity at which it moves through the field. The last factor is particularly important, because

it follows that when the conductor is stationary, with respect to the field, no current is produced in it. There is, however, one slight variation which may not be apparent at first sight; the conductor may be stationary, and the field—whilst being 'stationary' in the usually accepted sense—can be varied in strength.

A simple form of generator or dynamo could be made up as shown in Fig. 10.

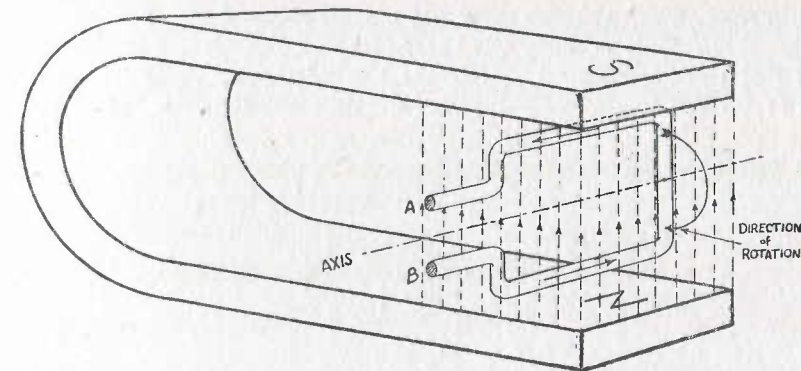

FIG. 10. SIMPLE A.C. GENERATOR

When the loop of wire is rotated in a clockwise direction, voltages will be set up across each of the straight 'active' portions of the coil which are at right angles to the lines of force existing between the poles of the magnet. The polarity of these voltages bears a definite relation to the direction of the moving conductor with respect to the direction of the lines of force. It will be seen that in this case they will aid each other because they are both in the same direction round the loop. If end 'A' is connected to end 'B' externally, a current will force its way round this external circuit in the direction 'A' to 'B'. This will only be true for the half-revolution when wire 'A' is at the top half of its cycle. When this half-revolution has finished, the other wire ('B') takes its place and current will now 'come out of' 'B' and flow back into 'A'. Thus the current is continually changing its direction according to which side of the coil is passing a particular pole. Such a current is called an alternating current (abbrev. A.C.) and it is extremely important to understand its general principles, as well as some of the phenomena connected with it. A current which always flows in the same direction is called a direct current (abbrev. D.C.). The type of machine just illustrated would be very inefficient for the production of anything like a reasonable supply of electricity. Nevertheless, its fundamental principles are embodied in every alternator that is used to light our cities and supply huge quantities of power.

One important feature, common to large and small machines alike, is that the current does not suddenly reverse its direction. It gradually builds up to a maximum value in one direction (this is when the conductors are cutting the lines of force at right angles, and at the greatest velocity); then slowly decreases to zero (when the conductors are moving parallel to the lines of force, and therefore not 'cutting' them at all); finally, it repeats this build-up and decay in the opposite direction. The complete sequence of events, viz. from zero to maximum and back to zero, followed by maximum in reverse and again back

to zero, is called a 'cycle' and will, of course, be accomplished in a definite period of time. The number of cycles that are completed in one second is known as the 'frequency' of the alternating current. Most Electric Supply Companies supply A.C. in this country, and fix the frequency at 50 cycles per second. In the U.S.A. the standard is 60 cycles per second. To the newcomer to this science of electricity, this may seem quite a rapid number of changes to occur in one second, but it is dwarfed by the frequencies which will be met with in radio, which run into many millions per second ! Whilst it may seem strange that A.C. is so much more favoured than D.C. it will be appreciated later that there are many more devices that operate on A.C. than on D.C. One of these is worthy of immediate attention and it is the 'transformer'.

THE TRANSFORMER

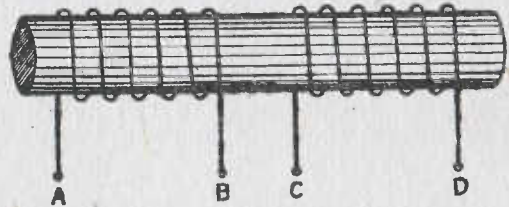

FIG. 11. PRINCIPLE OF THE TRANSFORMER

Imagine a coil of wire 'AB' wound round a piece of soft iron, Fig. 11. If a current is passed through the coil, a state of magnetism will be induced into the iron. The strength of the magnetic field will depend on the value of the current ; thus if an alternating current be fed into 'AB', an alternating magnetic field will result. Now, we have learned that Faraday, in his electro-magnetic discoveries, stated that a conductor could be stationary and the magnetic field variable to fulfil the conditions whereby a voltage would be induced across that conductor. So that if we have another coil 'CD', wound round the same piece of soft iron as the first coil 'AB', a voltage will be induced across 'CD' by the varying magnetic field. Put briefly, it means that an alternating voltage applied to coil 'AB' (which we call the primary winding) will produce an alternating voltage across 'CD' (which we call the secondary winding). At first sight, this may not seem an outstanding discovery, especially as the device is not 100 per cent. efficient, no matter how good the design is. But if we consider the voltages applied and induced, the usefulness of the transformer is at once disclosed. For it is also a fact that the voltage is proportional to the number of turns of wire in the coil ; and if there are twice as many turns in 'CD' as in 'AB', the voltage induced in 'CD' will be twice that of the originating voltage.

Expressed generally, it may be stated that the 'voltage ratio' is the same as the 'turns ratio' of primary to secondary windings. In practice, the iron part is not a straight, open-ended bar, but is in the form of a closed loop. Two of the most common arrangements are in Figs. 12 (a) and (b). The iron cores are not made of solid pieces of iron, but are specially 'split' into layers or 'laminated'. The reason for this is to prevent internal circulating currents in the iron (because iron itself is a conductor) from thereby losing some of the power in heating up the core. Some of the smaller 'ring' type cores are made

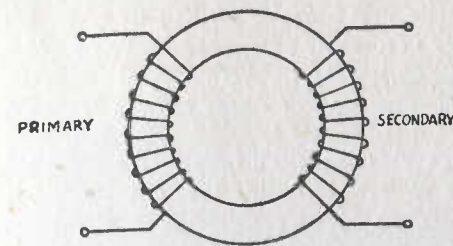

FIG. 12a.
TRANSFORMER, USING 'RING' TYPE CORE

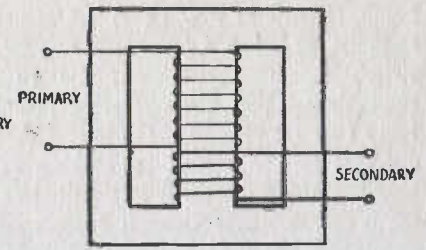

FIG. 12b.
TRANSFORMER, WITH SQUARE CORE

of particles of iron dust, moulded together by an insulating binding material. In all cases, however, the conventional method of representation is as in Fig. 13.

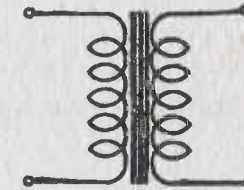

FIG. 13.
CONVENTIONAL DIAGRAM
FOR TRANSFORMER

The parallel lines represent the iron 'core', but it doesn't always follow that every transformer must have an iron core. A coil of wire is quite capable of inducing a voltage across a neighbouring coil, without any iron circuit, but the transfer of power is not so great. Such a transformer, known as 'air-cored', will be found in use when we come to the very high frequency alternating currents.

Meanwhile, whilst on the subject of 'efficiency', it is well to observe that although it is possible to produce greater voltages at the output than are put in to the input, the amount of power transferred from primary to secondary cannot be greater than 100 per cent. It is obvious, therefore, that the increase in voltage is at the expense of the current ; for power (in watts) is equal to the product of voltage and current. In practice, transformers are quite efficient pieces of apparatus, 95 per cent. to 98 per cent. being typical figures. Later it will be learned that transformers are put to many important uses other than that of simple voltage changing.

SOME PRACTICAL APPLICATIONS OF ELECTROMAGNETISM

Some typical electromagnetic devices will now be investigated. They will be described in principle only, as the detailed working of, say, a microphone will be given in the chapter on 'Practical Apparatus'.

RELAYS

One of the simplest pieces of apparatus is the 'relay'. It consists of a coil of wire surrounding a piece of soft iron, and when a current is passed through the coil, the iron becomes magnetized. The magnet attracts another, generally smaller, piece of iron (called the 'armature') towards it. In doing this, the resultant movement can be made to operate switch contacts and so make, or

break, circuits in which they are connected. It probably seems a lot of trouble to make, or break, a contact in this way ; especially as there has to be a manual switch in the operating (coil) circuit, anyway ! However, it must be remembered that the operating switch may be any distance away from the relay that we care to make it and that it is possible to make and break heavy currents in one circuit by making and breaking weak ones in the operating circuit. Furthermore, it is possible to perform switching at a distance. It is these features that make it such a valuable device, and it has multitudinous applications in the job of broadcasting.

MICROPHONES

Microphones are obviously of paramount importance and there are two types in particular which embody the principles of electromagnetic induction. They are the Moving-coil and Ribbon microphones and we will only consider the general principle of them now. In both cases there is a magnetic system which is arranged to produce a very strong 'field' in the gap between the poles. In this gap a conductor is suspended so that it may move to and fro easily. When sound waves impinge on the microphone, it is arranged that the air movement they produce causes the conductor to move, either directly or by means of a diaphragm. This movement of a conductor in a strong magnetic field will, of course, cause a voltage to be set up across the conductor. The direction and strength of the resulting current will depend on the movement and hence on the nature of the sound.

Because the conductor is following a 'to and fro' motion, the voltage will be an alternating one ; its 'frequency' being identical with that of the sound wave producing it. Naturally, the voltage produced across the ends of the conductor is extremely small—perhaps less than 1 millionth of a volt—so that it has to be magnified considerably before it can be 'transmitted' from place to place. In one type of microphone, the ribbon microphone, the 'conductor' is a corrugated metal ribbon ; in another type, the moving-coil microphone, it is a coil of wire attached to a diaphragm.

LOUDSPEAKERS AND TELEPHONES

Devices for re-converting electrical impulses (previously produced by microphones, etc.) back into sound also work on the electromagnetic principle. One of the most obvious ways is to use a similar arrangement to the moving-coil microphone. This is actually done in the moving-coil loudspeaker. Here we have a coil of wire suspended in a strong magnetic field. If alternating currents are passed through the coil, they set up varying magnetic fields which react with the permanent field of the magnet, and movement of the coil results ; and if the coil is connected (mechanically) to a diaphragm, the latter will also move with it. Such movements will create sound waves in the air, which are of the same frequency and relative strength as the alternating currents responsible for them. Thus, speech currents are reconstituted into sound.

Headphones, or telephones, are rather more crude arrangements for doing the same thing as the moving-coil loudspeaker just described. In their case, the alternating currents are applied to small electromagnets and the resultant 'pull' of the magnet attracts an iron diaphragm to a degree dependent upon the frequency and strength of the current. This 'phone is held close to the

ear and the air vibrations set up by the diaphragm are heard by the ear as sound. Devices which rely on the movement of iron are called 'moving iron' instruments. So much for a few of the practical applications of electromagnetic properties.

SELF-INDUCTION

There is still one phase of this subject of electromagnetic phenomena that has not been discussed, and it is a rather important one called 'self-induction'. Let us reconsider the case of a coil of wire to which a battery is suddenly connected. We know that a current will 'build up' in the wire, but investigation would show that it does not reach its maximum value as quickly as it would had the same piece of wire been pulled out straight. The reason for this is that the current begins to create a magnetic field as soon as it begins to flow, and this magnetic field, in turn, will create a voltage across any conductor that it happens to 'cut'. In the single coil we are considering there is no 'secondary' winding, so it must be this coil across which the 'secondary' voltage is induced. As might be expected, the resulting current acts in opposition to the original current and so tends to reduce it. It will be observed that it is only changing currents which are thus affected, because it is only a changing magnetic field that will induce voltages across a fixed conductor. Consequently, in the case of our battery and coil, it is only the initial 'build-up' period that is affected ; and once a steady value has been reached (delayed by this 'self-inductance' as it is called) no further effect is noticed until we switch off. Then the 'self-induced' currents will again come into action, this time opposing the fall in current, and thus delaying the decay of current to zero.

Now let us consider an alternating voltage applied to such a coil. This will produce a current of continually changing value and so we may expect that the results will be rather interesting. What happens is that the current begins to build up to its maximum in one direction, but is delayed for the reason shown. Before it gets to the value that it would have obtained had the wire been straight (i.e. with practically no self-inductance) the current will begin to decrease because it is alternating. Similar 'opposition' to the continual changes will be met at each cycle, and so the current will never reach its normal value. A coil of wire, then, behaves in a way that suggests more 'resistance' to the passage of alternating current than it would to the passage of direct current. Actually, we call it 'impedance',* but still measure it in ohms, just as if it were resistance. There is one important difference, however ; the frequency of the current will have something to do with the amount of current that will be passed by a particular coil. The higher the frequency, the greater will be the 'impedance' of the coil.

It should also be observed that the self-inductance (and, therefore, the impedance at a particular frequency) of the coil could be increased by making the resultant magnetic field greater. The obvious way to do this is to include iron in the magnetic system, and this is what, in fact, is done. There are limits to the number of reversals per second that magnetism in iron can be made to undergo, and above a certain frequency the presence of iron serves

* The term 'impedance' has been used in preference to the more strictly accurate word 'reactance', as it is not intended to delve deeply into the mathematics of A.C. theory.

no useful purpose. It is usual, but not invariable, for inductances which are used at radio frequencies (i.e. those which are above 15,000 cycles per sec.) to have coils which are 'air-cored'.

CONDENSERS AND CAPACITY

Although the subject of capacities and condensers has nothing to do with the electromagnetic effects, they are very much bound up with the question of impedance, and will therefore be described in this chapter.

A condenser consists essentially of two plates of metal which are close to each other, but separated by some insulating substance, or 'dielectric' as it is called. If a potential difference is applied to the plates (i.e. one is made positive with respect to the other) a state of electrical 'strain' or 'tension' exists between them. If the potential is increased, this strain may become so great that the dielectric breaks down and a spark will jump across the plates. This is a feature which should not interest us because it is unpopular to use condensers in that manner! The interesting point is that when the source of potential is removed, the 'strain' remains. In other words, the plates remain 'charged' with their respective excess and deficit of electrons. Consequently, if a conducting path is now provided in place of the source of potential, the condenser will 'discharge', i.e. electrons will flow round this conducting path in order to attain a neutral state. They will not do this in one simple journey, because the electrons—in their haste to regain their positions—are inclined to 'overshoot the mark'. In consequence, the plates get charged up the opposite way round but to a lesser extent. This 'oscillation' of electrons between the plates goes on, getting less and less, until equilibrium is reached. The number of oscillations per second—the frequency—depends on the size of the condenser. The larger the condenser, the longer it takes to charge-up and discharge; hence, the lower the frequency. It is evident that there is some connection between condensers and inductances in the matter of frequency, but this particular feature will be reserved until the subject of 'tuned circuits' is reached. At the moment, the relation of alternating currents to condensers will help us to line up their behaviour as 'impedances'.

It has been stated that when a potential is applied across a condenser, the plates become charged. To do this, there must have been a flow of electrons, and this will continue (getting smaller and smaller) until the plates are fully charged. When this state is reached, no more current will flow. A condenser will not, therefore, pass direct current, except for the fraction of a second after switching on.

Now consider what happens when an alternating voltage is applied to a condenser. What we are really doing is to apply a potential to one plate with respect to the other, then to remove that potential and apply it to the opposite plate. We have already seen that a current will flow during the actual period of charge or discharge; it is only when the potential is steady that the current flow ceases. So with an alternating voltage, which is never steady for one moment, there will be a continual change of current. It should also be fairly evident that, for any given A.C. potential, the amount of current will be greater if we make the condenser larger; it will also be greater, the more alternations there are in a second. This dependence of current (and therefore 'impedance') on frequency in a condenser is the reason for including it in this section. It behaves, in fact, in a somewhat similar way to an inductance, except

that it is easier for a condenser to pass high frequencies than low frequencies, whereas the inductance found it more difficult to pass the high frequencies.

For the moment, that is as far as we will pursue the subject of inductances and condensers, but it does not require much imagination to foresee that a combination of them will be capable of some quite surprising effects; and that is actually what we shall find later in the book.

THE USE OF GRAPHS

It is always rather difficult to describe the workings of electrical phenomena without the use of mathematics, but as it is much easier for many to understand them without mathematics it has been decided to attempt to do so in this book. Nevertheless, there exists a sort of alternative method by which the behaviour of circuits may be observed, and that is by the use of 'graphs'. We are probably all familiar with graphs of some sort, possibly under the title of 'chart', and recognize these as 'pictures' of progressive events . . . whether they show the number of Messerschmitts shot down per day, or the less exciting record of our fluctuating temperatures when in hospital. In either case, we could have represented the figures in question in tabular form, but this would have meant a pretty thorough scrutiny in order to reveal any particular changes.

Let us take the temperature chart and see how it is drawn. The essential parts are two lines, one horizontal and one vertical, which are usually (but not invariably) drawn along the lower and left-hand edges respectively of a piece of 'squared' paper (Fig. 14). In practice, the 'squares' may come out as rectangles . . . it is simply a matter of convenience to use ready-ruled paper.

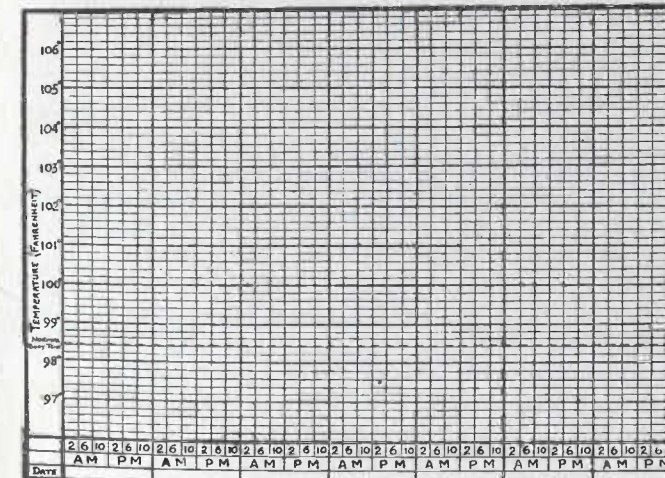

FIG. 14. THE 'BARE CANVAS' OF A DOCTOR'S CHART

The vertical line is divided up into a 'scale' of markings corresponding to, say, the range of temperatures that are likely to be encountered from the readings of a clinical thermometer. Likewise, the horizontal line is also divided into a scale—this time, a time-scale, probably in hours. The use of squared paper will, of course, make this easy. Incidentally, these two lines are known as 'co-ordinates' or 'axes', in the world of mathematics.

Now let us see how the 'blank' squared paper is filled in. Every time the patient's temperature is taken, the thermometer reading and the time that it

was taken are noted. If these are simply recorded in figure form, we get our 'table' which—although perfectly correct—does not give us a mental picture of what is going on.

So instead of writing them down in two columns, we put a point (say, a small 'X') on the graph to represent both temperature and time (Fig. 15) :

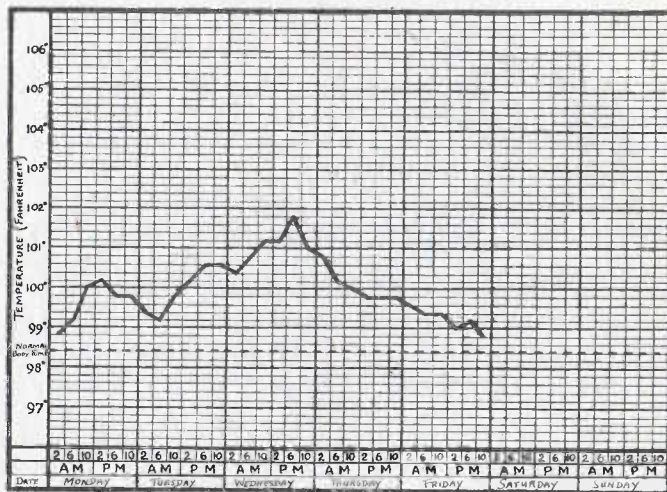

FIG. 15.
THE COMPLETED
CHART

Each point will be similarly marked as the day progresses, and it is usual to join up the points by a line. The result, as seen above, is not unlike a picture of the Alps, but from it we can immediately see the whole chain of events, the maximum and minimum temperatures, whether the rises and falls were acute, when such changes occurred, and how near the patient came to the 'normal' temperature. The latter is shown by drawing the horizontal broken line at 98.4° F.

There is one important difference between such a graph and the type you are likely to meet in the study of electricity. Nurses make a habit of joining their points by means of straight lines, which lead to a rather curious conclusion. This is, that the nurse appears to arrive at the scene just when a change is about to take place! Take the case above, at 6 p.m. on the Wednesday. Just before the temperature was taken, it was seen to be rising rapidly; and immediately after this time, it fell just as rapidly. Is it likely that this really happened? The answer is 'No', and the explanation is that the points should not have been joined by straight lines, but by a gradual 'curve'. Such a curve gives a much truer picture, especially if we wish to interpolate intermediate figures other than those actually recorded.

GRAPHS IN PRACTICE

We have taken rather a long time to get this procedure of 'plotting' graphs made clear, because it is very important. Let us now see how these 'time pictures' are applied to electrical phenomena. It will be good practice if some of the effects spoken of earlier are illustrated graphically. Let us plot out what happens when we switch on a battery in series with an inductance. We should need a device for measuring the current (called an 'ammeter') and a timing device. A stop-watch would not be much good, because we wish to

observe changes of current during the 'build-up' period which take place in a period of, perhaps, less than a thousandth of a second! So we will assume that we are allowed to use one of the beautiful scientific instruments called a 'recording oscillograph', which will accomplish this feat. As a matter of fact, such an instrument actually draws the graph for us, and the result would be something like Fig. 16.

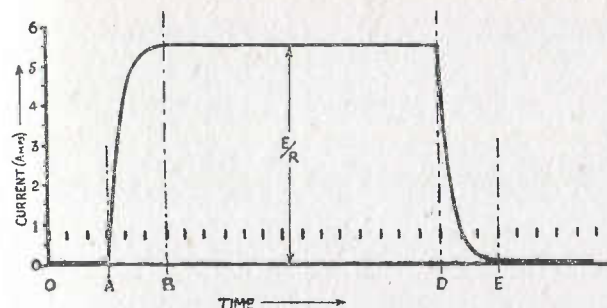

FIG. 16.
OSCILLOGRAPH OF THE
BUILD-UP AND DECAY OF A
DIRECT CURRENT

The short, vertical, marks are 'drawn' by the oscillograph itself, and represent hundredths of a second

The switch was closed at the time represented by 'A' and it will be seen that the current did not immediately rise to its full value; it took until time 'B' before this was reached. Here it remains steady at the value determined by the ohmic resistance of the circuit and the battery voltage.

At time 'D', the switch was opened, and the current fell to zero; again, not at once, but after a lapse of time represented by 'DE'. All these times may be observed accurately because the oscillograph can be made to mark the scale of time (possibly in hundredths of a second) on the graph itself. These would appear as dots along the horizontal scale.

The next and very important graph is that representing what happens in an alternating current circuit. To take our simple generator of A.C. we want to know how the current, or voltage, obtained from the rotating coil, varies with time. This graph is best laid out in a slightly different way from those previously shown, because we wish to show currents flowing in both directions. To do this, we use the conventional 'plus' sign (+) for current flowing in one direction, and the 'minus' sign (-) when it flows in the opposite direction. It is therefore necessary to place the horizontal line in the centre of the paper, instead of along the bottom edge, and this cuts the vertical line at a point which we still call zero. The '+' current will be represented in an upward direction from O, whilst '-' current will be shown as increasing in a downward direction. The sketch (Fig. 17) should make this clear. If now we rotate the coil and measure the current in an external resistance connected to it, we should find the following results. For convenience, the position of the coil (in section, through the 'poles' of the magnet) at certain points has been included. The result when plotted on the graph shows that we obtain one complete cycle of alternating current for every complete revolution of the coil. This particular shape of curve is known as a 'sine wave' (a mathematical term) and its obvious resemblance to a 'wave' gives us another expression which we must soon commit to memory, viz. 'wavelength'. For the present, we need only remember that the wavelength is the length (in feet, metres, etc.) of one complete cycle. No doubt you will be wondering how on earth 'distance'

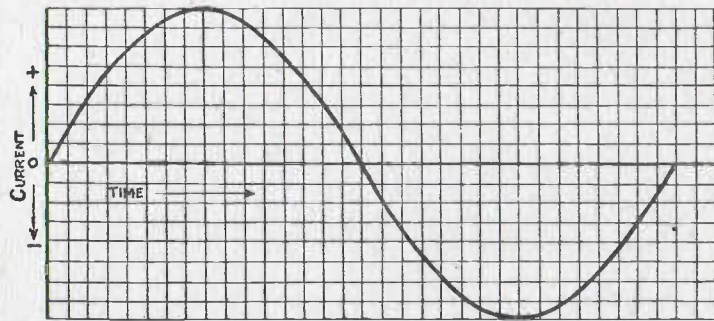
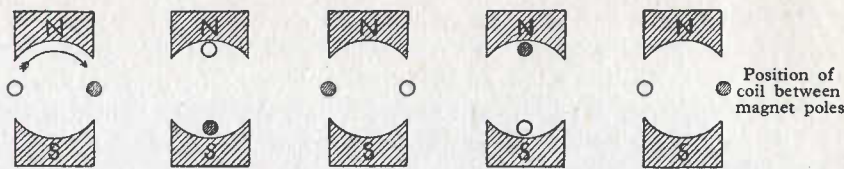

FIG. 17. GRAPH SHOWING DEVELOPMENT OF AN A.C. 'SINE WAVE'

has crept into the story, when the graph clearly shows one cycle marked off in time (seconds). Whilst it is not intended to give details of that part of the story at this stage, the idea that distance and time are related must, of course, be considered wherever we have movement; and an electric current is movement of electrons, after all.

So far, we have dealt only with graphs in which a quantity (temperature or current) is plotted against time, but they are not confined to this, as we shall see now. Consider Ohm's law, and let us draw a graph of the behaviour of the current flowing through a resistance of, say, 2 ohms when a voltage is applied to it. For this, we need to mark off the voltage and current along the horizontal and vertical ordinates respectively (Fig. 18). When the voltage is 2 volts the current is 1 ampere, when the voltage is 4 volts the current is 2 amperes, and so on. Thus, if we take current readings (I) for each new voltage (E) applied, the resultant 'curve' is found to be a straight line and its slope depends on the resistance. To a mathematician (who, by the way,

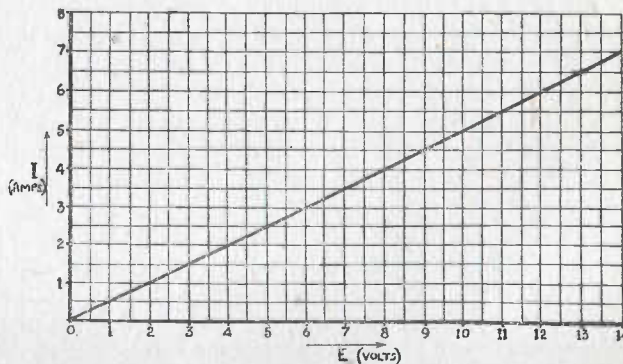

FIG. 18. GRAPH ILLUSTRATING OHM'S LAW

always considers a straight line as merely a special case of a curve) this sort of graph would indicate 'linearity', which is only another way of saying that one thing is 'directly proportional' to the other. This may be so obvious that there appears little reason to have mentioned it, but our next example will show that not all relationships between electrical 'factors' are so simple.

The next example, therefore, is to show the dependence of current upon frequency, for inductances and condensers. Suppose we had two circuits

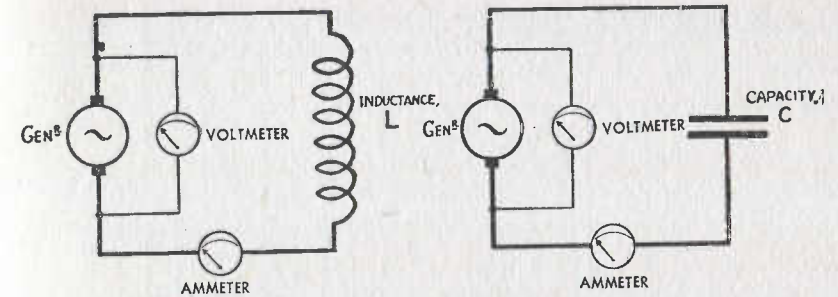

FIG. 19. CIRCUITS FOR DETERMINING THE DEPENDENCE OF CURRENT UPON FREQUENCY

as shown in Fig. 19, whereby we may pass currents of various (known) frequencies through either an inductance L or condenser C. It is assumed that we have instruments for measuring the current; also for measuring the voltage and keeping it constant. The two experiments are quite separate ones, of course, but we shall put the results on one graph—which we have prepared with the axes marked off in current and frequency scales (Fig. 20). Notice that the frequency scale is not marked off at equal frequency intervals; instead it goes up in 'octaves', a reason for which will be given in the following chapter.

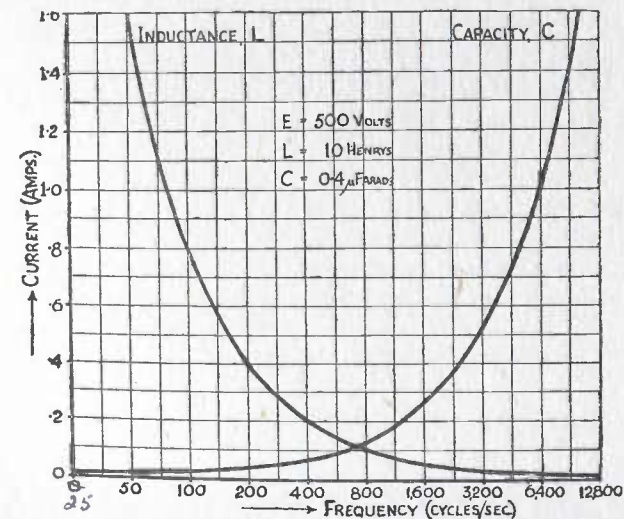

FIG. 20. THE COMPLETED GRAPHS OF 'I/F'

There is certainly a similarity between the curves in that they have the same sort of shape, but one is the mirror image of the other. We could have plotted the impedance of these two things instead of the current, simply by doing a

small calculation, viz., dividing 'E' by 'I', and using these figures on our vertical scale. The curves (Fig. 21) are seen to have retained their characteristic shape, but have reversed their positions. At zero frequency (D.C.) the impedance of the condenser is infinite, and that of the inductance is theoretically

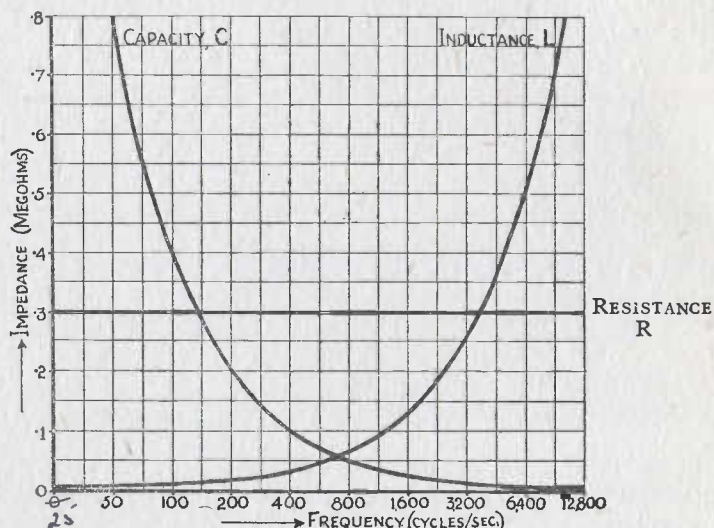

FIG. 21. IMPEDANCE/FREQUENCY GRAPHS

zero. In addition, a 'curve' for a pure resistance of 0.3 megohms is shown for comparison.

If these curves had been drawn from actual practice, we should have found some slight modifications, owing to the fact that it is impossible to find 'pure' inductances and 'pure' condensers in practice. However, it is only the general idea that is required; special cases will be dealt with in their turn.

Having got some idea of the 'alphabet' of electricity, together with a little trick of 'illustrating' its effects, we can now really start to build up our story.

QUESTIONS ON CHAPTER I

- (1) How many different kinds of atoms are there? Is this the same as the number of chemical elements? If so, why?
- (2) If an atom has an excess of electrons, is it positively (+) or negatively (-) charged?
- (3) What is the principle of the conservation of energy? Define (a) energy, (b) work, and (c) power.
- (4) How was the figure 3,000,000,000,000,000,000 on page 8 derived?
- (5) State Ohm's law. What current would flow if 200-volt mains were connected across a 50-ohm resistance? What power (in horse-power) would be dissipated, and how would this power manifest itself?

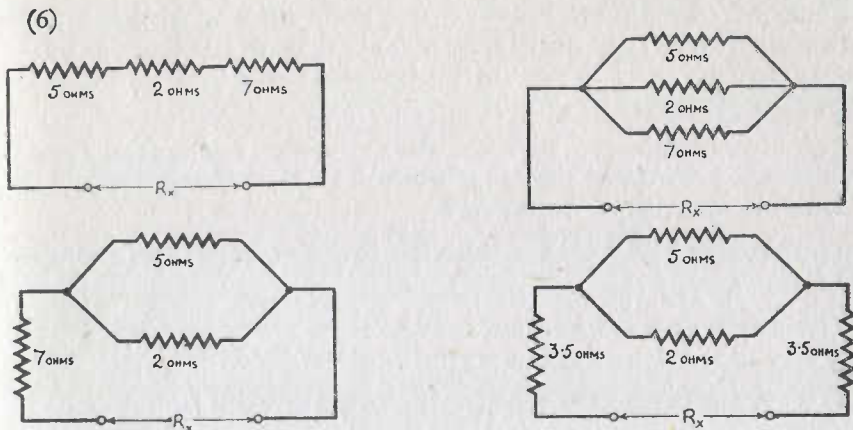

- (a) What is the total resistance measured at R_x of the four networks shown above, assuming the wires joining the resistances have negligible resistance?
- (b) If 100 volts were applied from a source, assumed to have no internal resistance, what current would flow in each limb of the four networks shown above?

(7)

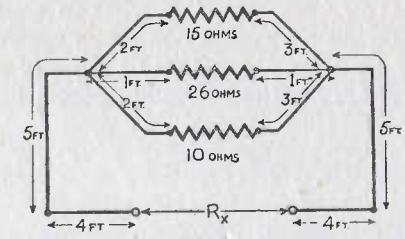

- (a) The network shown consists of three resistances of values shown connected up with wire which has a resistance of 2 ohms per foot length. The dimensions of each section of the network are given in feet. What is the resistance of the whole network measured across R_x ?
- (b) If a 100-volt battery, having an internal resistance of 3 ohms, were applied at R_x , what current would flow in each section of the network, and what power would the battery deliver?

(8)

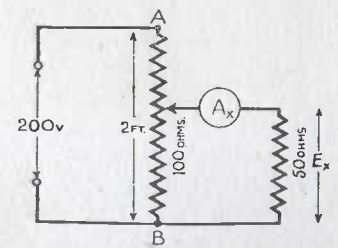

In the potentiometer circuit shown above, the slider is moved slowly from

'A' to 'B'. Draw a graph showing the current which would flow through an ammeter, 'A_x', connected in series with the slider, as it is moved in 3 inch steps from 'A' to 'B'; and the corresponding voltage, 'E_x', across the 50-ohm resistance load.

(9) If you suspended a bar magnet so that it were free to move about a vertical and a horizontal axis, what would it do (a) in London, (b) at the North Pole, and (c) at the South Pole?

(10) Explain how a dynamo generates electricity. How does a dynamo differ from a motor?

(11) Explain the difference between alternating current and direct current. If a loop of wire is rotated in a magnetic field, why does it generate A.C.?

(12) A transformer has 150 turns on its primary and 225 turns on its secondary. Its secondary is loaded with 150 ohms' resistance, and the voltage applied to the primary is 200 volts. If the transformer has no loss, what will be the currents in the primary winding, and in the 150 ohms' load? Why is it that a transformer can never in practice be 100 per cent. efficient (i.e. have no loss)?

(13) What is the resemblance in principle of operation between (a) a moving-coil microphone and a dynamo, and (b) a loudspeaker and a motor?

(14) What is meant by 'impedance'? Explain what happens when (a) a direct current, and (b) an alternating current, is applied to a coil. What would be the effect of wrapping the coil round a bar of soft iron? Can the effective resistance of a coil ever be less to alternating current than to direct current?

(15) If the plates of a charged condenser are joined by a short length of conductor it will discharge itself in an oscillatory manner at a given frequency. Suppose the length of the conductor were increased, would the frequency of these oscillations change? If the conductor, without increasing its physical length, were made into a coil instead of a large flat loop, would the oscillation frequency remain the same?

(16) Draw a graph showing the change in magnitude and direction of current flowing in a loop of wire which is being rotated in a uniform magnetic field.

CHAPTER II

THE NATURE OF SOUND

THE SENSE OF HEARING

THE story of sound and the sense of hearing is well worth our thought for at least a few moments. Without some knowledge of it we cannot appreciate many of the problems which arise at the two ends of the broadcasting chain.

For the reader who is interested enough to delve further into the subject than this book can go, the works of Sir James Jeans (especially *Science and Music*), John Mills's *Fugue in Cycles and Bels*, and R. T. Beatty's *Hearing in Man and Animals* are thoroughly recommended.

Let us think of the ear as an extremely sensitive pressure-gauge; for it is the minute variations of air pressure which, as we shall see, constitute sound waves, that impress themselves on the ear-drum and are translated into nerve-pulses which in turn are sent to the brain for 'appreciation'. That this pressure-gauge is so sensitive may be judged from the fact that it will detect

changes of pressure equivalent to less than $\frac{1}{1,000,000,000}$ lbs./sq. in., whereas

a sensitive barometer will record changes of only $\frac{1}{200}$ lbs./sq. in. To put it

another way, the ear would appreciate a change of pressure equivalent to that experienced in vertical ascent of as little as $\frac{1}{30,000}$ inch, whilst the best

'altimeter' (provided it works on a barometric principle) can only register differences of approximately 10 feet. We have to qualify this statement by saying that the ear is most sensitive to changes of pressure occurring between one thousand and three thousand times per second, and is relatively insensitive to slow changes.

THE NATURE OF SOUND

So much for what the ear can do; but why has it to be such a sensitive pressure-gauge? This brings us to the nature of sound,* and we find that all sounds are transmitted by vibrations of the particles of the material substance through which the sounds pass, e.g. air, brick walls, etc. Take away the air, and there is no sound, even if the exciting influence still carries on. This can easily be proved by a simple experiment. An electric bell is placed in a glass jar and set ringing. The sound can be heard outside the jar if the jar is full of air. But now let us connect a vacuum pump to the jar and proceed to suck the air out. The sound of the bell grows weaker and weaker until, when

* The word 'sound' is used for both the physical waves and the sensation produced by them.

all the air has been withdrawn, the bell can no longer be heard. It is not quite true to say that air must be the medium through which sound is transmitted; other gases and, in fact, many substances will do the work as well. We shall see that this is so when the actual mechanism of this sound transference is discussed. Another experiment is required here, and we shall describe it rather carefully because it will help to clear up at least some of the usual misconceptions associated with 'wave-motion'. For we have already mentioned sound waves in air and it is important to get it quite clear in one's mind as to what a wave 'looks' like. The most general way is to use the analogy of a pebble dropped into a pool of water, but, excellent as this may seem (especially when it is compared with the 'wave' of our A.C. curve), it is apt to be confusing when we learn that the air particles do not bob up and down at all! The confusion arises partly from the fact that we are trying to explain pressure waves in air by an analogy in which we consider waves on the *surface* of a pond.

You can perform this little experiment for yourself if you can obtain some hard balls, such as seven or eight snooker balls, or the heavy steel 'ball-bearings' that are used for miniature bagatelle boards. They should be arranged in a row, all touching each other, and preferably lying along a 'channel' formed, say, by two rulers placed side by side. The end ball is now removed and then rolled back so that it hits one end of the row of balls sharply (see Fig. 22). The result is surprising, for only the ball at the far



FIG. 22. AN EXPERIMENT TO ILLUSTRATE 'WAVE-MOTION'

end moves, the intermediate ones remaining almost stationary! Another point to be observed is that the end ball flies away almost simultaneously with the moving one making contact. Now repeat the experiment, this time having small spaces between the balls. Two slight modifications are now observed. First, that the end ball does not fly off with such vigour; and second, that there is a greater lapse of time between its movement and the time of impact. Both of these facts have come about because the intermediate balls have had to move slightly, and in doing so have absorbed a certain amount of the original energy, as well as taking time to perform their individual movements.

But in each case, the most important fact is that there was no real transference of matter from one end to the other. An equivalent action had been brought about by transferring the energy of the first ball to the second, the second to the third, etc., until the last ball has received most of the initial energy, but not having another one to lose it to, expends it in movement. This, then, is the way in which the particles of air convey vibrations from one place to another. If there is no air, there are no particles to jostle one another. In the experiment with the glass jar, it should now be evident why the sound was weaker when the air became more rarefied, because the particles were few and far between.

It should be noted, though, that solids and liquids as well as gases will transmit sound—as we could have demonstrated by filling the jar up with water. And when we have practical experience in broadcasting studios we

shall find that special precautions have to be taken to prevent the spurious transmission of sound from one studio to another through walls, floors, etc.

WAVE-MOTION

This method of transferring energy is often described as 'wave-motion', and the reason for this will now be considered.

Take the example of a tuning fork which is sounded by striking its prongs. The prongs vibrate to and fro; this can be proved simply by touching them lightly with the finger. By the mechanism already described, the particles of air near the fork prongs are first pushed away and then 'sucked' back. Considering the outward movement first, the particles start this 'shunting' action upon adjacent particles so that, after a short time, particles which are quite a distance away are being affected. There is said to be a definite 'wave' of pressure which travels outward from the fork in all directions. This condition, i.e. for the very first movement of the fork prong, is shown in Fig. 23. The

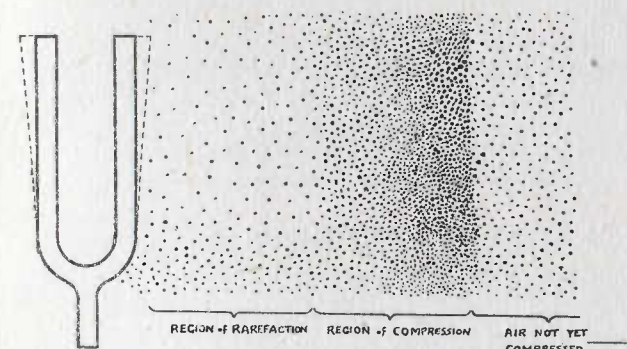

FIG. 23. THE START OF A SOUND WAVE

speed at which this zone of compression will travel outwards is determined by the closeness and mass of the particles it is acting upon, and is the speed of sound. For air at normal atmospheric pressure and temperature it is found to be approximately 1,100 ft. per sec. or roughly 750 m.p.h. If the particles, or molecules, of the medium employed are heavier than those of air, we should expect the sound to travel more *slowly*; and this is proved to be the case in practice. *quickly*

WAVELENGTH AND FREQUENCY

So far we have sent out only one wave, and we must return to the fork prongs to see what happens next. The prong will return to its mid-position because of its natural elasticity, overshoot the mark because of its inertia, and move to the other side. In doing this, it will create a vacuum in its 'wake' which will suck back the particles of air in its immediate vicinity. It will be too late to draw back the crowded particles in the compression wave which has now reached some distance from the prongs, but this 'band' of rarefaction, as soon as it has been released from the sucking action of the vacuum, will follow the compression wave.

The prong then starts its 'pushing' stroke all over again, sending out a second compression wave to follow the first. Now, here is an important question: how far are the two compression waves apart? We know that the waves are all travelling outward at the same speed, viz. 1,100 ft./sec. and that

they follow each other, in time, by $\frac{1}{f}$ secs. (where 'f' is the number of times that the prongs vibrate per sec.). Therefore the distance between compression waves, or wavelength, must be $\frac{1,100}{f}$ feet. If this method of arriving at the

relation between frequency, wavelength, and velocity is thoroughly mastered, then there should be no difficulty in following later the similar relationship which exists in electrical phenomena. The next diagram (Fig. 24) will perhaps make it even clearer.

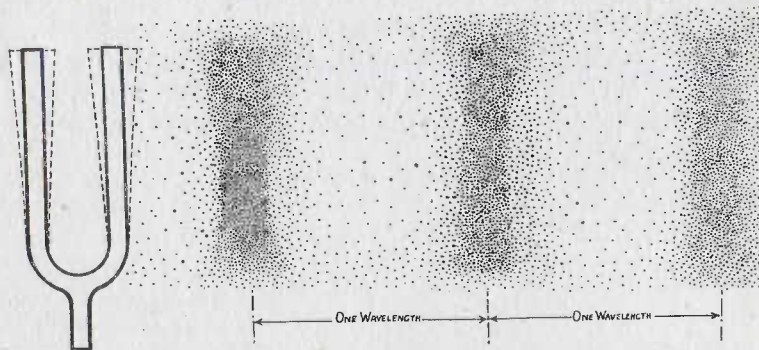

FIG. 24. SOUND WAVES AND WAVELENGTH

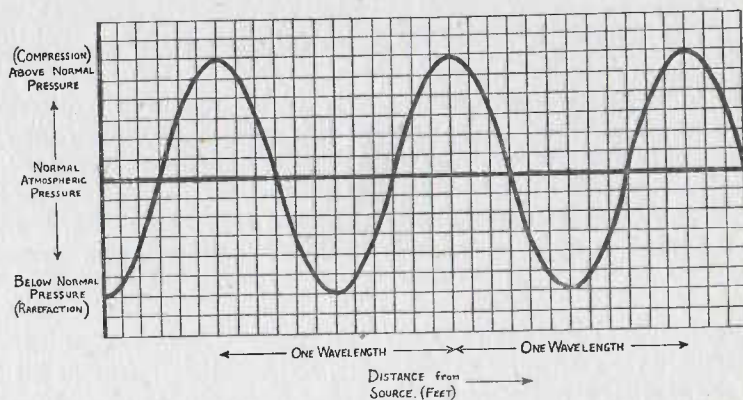

FIG. 25. GRAPH SHOWING PRESSURES OF AIR DISTURBED BY A TUNING FORK

Suppose we now draw a graph of this relationship, indicating the variations in pressure in, say, pounds per square inch on the vertical scale and the distance from the prongs on the horizontal scale. Of course, the pressure variation will be very small, and not actually measurable by direct physical methods, but it can be done quite easily in a roundabout way. Let us trust our physicists to do the job for us : their results would be something like the graph in Fig. 25. You will probably recognize the shape as a sine wave—which is perfectly correct. It is, but do not mix up the two meanings of the word 'wave'. The actual physical wave is nearly always a series of variations in stress or strain,

difficult to imagine because it spreads out in three dimensions, but the wave of the mathematician is such an easy, obvious thing to visualize, that we nearly all make the mistake of thinking it is a true picture instead of a graph.

Before proceeding any further, let us revise the relationship we found between wavelength, frequency, and speed (i.e. velocity). It was :

$$\begin{aligned} \text{Wavelength (in feet)} \times \text{Frequency (vibrations per sec.)} \\ = \text{Velocity of sound (ft./sec.)} \end{aligned}$$

If, therefore, we consider a tuning fork vibrating at 261.6 times per sec. (which is the note of 'middle C'), the equivalent wavelength would be $\frac{1,100}{261.6}$ or just about 4 ft. 2½ ins.

Now it should be fairly common knowledge that 'high' and 'low' notes are really nothing more than high or low frequencies. The lowest note of a piano causes the air to be vibrated at 27.5 cycles per second whilst the highest note on a 7¼ octave piano has a frequency of approximately 5,600 cycles per second. There is one interesting point about the way in which the ear 'appreciates' increases in frequency, and it is that 'octaves' constitute a doubling of the frequency. For example, note 'A' (below middle C) has a frequency of 220 cycles/sec. ; the octave above this ('A') is 440 cycles/sec., 'A'' is 880 cycles/sec., 'A''' is 1,760 cycles/sec., and so on. In a similar way, smaller 'intervals' than the octave are always obtained by multiplying the lower frequency by a given factor. For example, the interval known in music as the 'fifth' ('fifth', because it is the interval between any two notes

in the scale which are five notes apart) is simply a ratio of $\frac{3}{2}$ on the diatonic

scale. Thus, the two musical notes 'A' and 'E', which constitute an interval of a 'fifth', no matter in which octave they occur, have this $\frac{3}{2}$ frequency

relationship, so that if 'A' = 220, 'E' will be 330 ; or, because A' = 440, then E' must be 660. In practice, a 'keyed' instrument, such as a piano or organ, cannot be tuned to a true 'diatonic' scale, and the 'equal-tempered' scale is used. This is a compromise in which the exact frequency ratio is not accomplished.

COMPLEX WAVES AND HARMONICS

So far, only simple vibrations, like those of a tuning fork, have been considered ; but it is obvious that there must be something more going on than a simple vibration when we strike the same note C on a piano, or 'bow' it on a violin. What makes the difference in quality ?

The answer is that musical instruments do not give simple, or 'pure', vibrations. If the note from a violin is analysed, it is found to contain not only the fundamental frequency, but a number of other frequencies also. These frequencies have a striking characteristic about them, for they are all multiples of the fundamental. Thus, the note corresponding to a frequency of 250 cycles, will also contain frequencies of 500, 750, 1,000, 1,250, 1,500 cycles, etc. These multiples are called 'harmonics', or 'overtones', and it

is the proportion which each bears to the fundamental that decides the quality, or 'timbre', of the instrument producing it.

The reason why we are so interested in this discovery is because it means that we shall have to cater for these higher frequencies when the job of transmitting them comes along. It means, for instance, that if the fifth harmonic is really essential for the appreciation of the true timbre of the violin, then we must be able to transmit faithfully frequencies as high as 10,000 cycles/sec. in order to hear the note of 2,000 cycles (which is about three octaves above middle C) properly. If we don't reproduce these harmonics, then the timbre of the note, whilst not perhaps destroyed, is certainly altered so as to sound differently.

An examination of the graphical waveform of such a complex note shows something quite unlike our smooth sine wave.

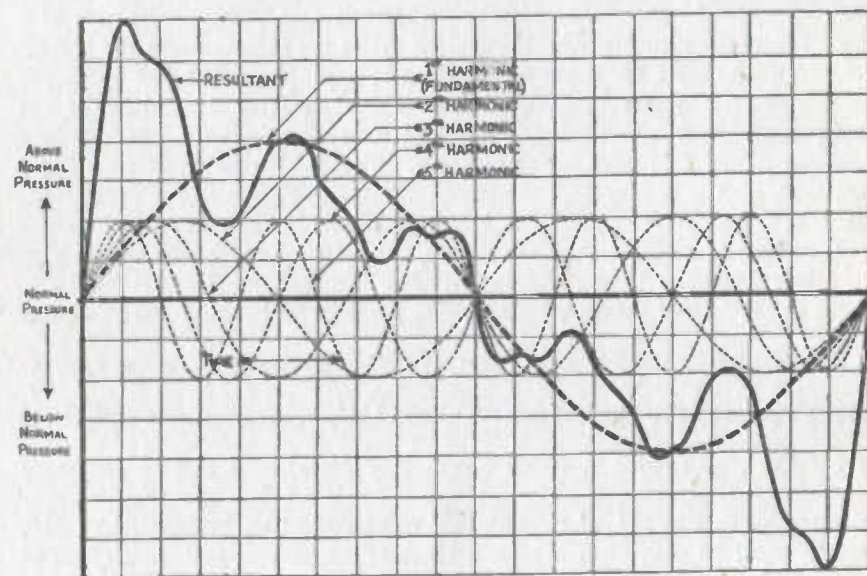

FIG. 26. PRESSURE GRAPH OF A COMPLEX WAVE

Fig. 26 is a waveform which contains several 'additions' to the fundamental pure sine wave (shown dotted for comparison).

It was found by a mathematician named Fourier, that any complex waveform may be analysed into a series of simple sine waves which are each exact multiples of the fundamental. So we should not be surprised to find that the waveforms of the complicated sounds given by the various musical instruments, and, indeed, even speech, are really only a number of simple sine waves all acting together. Neither should it surprise us to hear that the converse is true, e.g. that we can take a series of pure tones and, by judicious combination, produce an 'artificial' quality of tone. This latter possibility has been exploited in such instruments as the 'Hammond' and 'Novachord' organs. In both these instruments, pure tones are produced by electrical means and 'blended' whilst still in their alternating current form. Means are provided for altering the proportions of the overtones or harmonics, and, when the final mixture is heard on the loudspeaker, a wide range of tone colour results!

THE STUDY OF ACOUSTICS

We now know a little about music; at least, we have seen how sound waves are produced, and we know the connection between tones, timbre, and frequencies. We also know how music travels from the source to the ear, or microphone. Or are we going just a little too fast? Can anything happen to the music between the time it leaves the instrument and the time it arrives at the ear? An experiment will help to answer that question—an experiment which you may well perform each day in your bath. Why do you break into song? . . . it's quite likely that you will. It is because your voice will sound rich and 'full', and quite different from the most disappointing noise you may well make if you sing the same song in your bedroom. It is disappointing, isn't it? No matter how hard you try, it just won't give you the same satisfying result.

Clearly then, it must be the surroundings that have caused the difference, for it is the same voice in both cases. Lest you should think it could have been a psychological effect, try the experiment again with a portable gramophone or wireless. Yes, there is a difference, and it needs an inquiry to discover the reason.

The solution seems to rest in the definition we gave to the bathroom tenor, viz. that his voice was 'rich and full', compared with the same effort in the bedroom. In other words, it had something extra; and if we get to know what that extra quality is, and where it came from, then the question is answered.

Let us go back to the source of sound and trace its path, through the atmosphere, to the ear. It is fairly obvious that not all the sound from the source goes to the ear; otherwise, only one person could hear the sound! Indeed, it must be realized that usually it is only an extremely small portion of the originating energy that could possibly arrive at the eardrum, in the same way that a small receptacle would catch only a small proportion of the total water given off by a fountain. Unlike the fountain, however, we have got to consider what happens to the sound which does not hit the ear directly. These waves travel on until they meet the walls, ceiling or floor of the room in question. Here, two things can happen. In common with other types of waves, they will either be reflected or absorbed, probably a bit of each. The energy which is absorbed will not, of course, be 'heard' any more; but the reflected sound will bounce off at the same angle that it hit the wall; it will again travel through the air until it encounters a second obstacle. Again it will suffer part absorption and part reflection, the reflected portion continuing on its journey until, perhaps after several such reflections, it will have become so weak that it is inaudible. (The question of when a sound is loud enough to be audible will be considered later in this chapter.)

What effect have all these reflections on the listener? One effect is that more energy is received by the ear because it is in the path of some of the reflected waves as well as the direct waves. Hence the explanation of greater 'fullness'. Secondly, owing to the greater distance the reflected waves have to travel, the sound will be prolonged. We call this effect 'reverberation', and if the room is so constructed that there are many reflections, the time of reverberation will be quite appreciable, sometimes several seconds. Whether reverberation is always desirable we shall see in a minute. Meanwhile, it is well to see how the reflecting properties of the surfaces of various materials differ. Considerable study and research has been made on the types of material that

would be suitable for either building or treating the surface of buildings, particularly by Professor W. C. Sabine.

It is found, for example, that tiles absorb about 2 per cent. of sound at each reflection, whereas a wood panelled wall absorbs 15 per cent. In an all-tiled bathroom, the sound would be reflected over 100 times before even 80 per cent. had been absorbed, whilst in a panelled dining room 80 per cent. would be absorbed in about 10 reflections.

Immediately we can see the difference in that extra 'fullness' that the bathroom gives, but the figures given above are true for only one simple note, of pitch about middle C, and they are not the same for other notes. It so happens that it is nearly always the high notes that are absorbed more than the low notes for any given substance. Hence, tiles will absorb nearly 6 per cent. at each absorption for a note which is four octaves higher than middle C, but only 2 per cent. at middle C. An exception to this is the case of wood panelling where, owing to the 'resonance' effect, the low frequencies are absorbed more than the high frequencies.

The size of the room must also play its part, because the larger it is the longer will be the path of sound and the longer the period of reverberation for any given absorption quality of the walls. If the room is made very reverberant, then speech is masked by the 'echo' of preceding words, and music becomes blurred, the notes losing their clarity by running into each other. However, a certain amount of reverberation is desirable; and it is the job of the musician and engineer to get together and design a room which is suitable for the particular purpose to which it has to be put. The science of such design is called that of 'acoustics' and is obviously of prime importance in broadcasting.

Measurements have been made of the absorbent qualities of various materials to determine which are suitable for the treatment of the walls, ceiling, and floors (as well as the furniture) of a broadcasting studio, which is to be used for any particular purpose. If the studios are new, then all this can be done at the outset in collaboration with the architect. If existing rooms or halls have to be used for broadcasting, alterations have often to be made to make them acoustically suitable. It must not be thought that this is just a question of hanging up draperies which will absorb sound just to cut down the overall reverberation. We must always remember the high notes, which seem to have a penchant for getting lost; without them, the music would be robbed of its brilliance. It is usually a question of compromise, and rarely can we obtain a perfect room. Plate I shows a view of a typical studio which has been specially built and acoustically treated for use by fairly large orchestras.

Some of the materials which have been found suitable for temporary treatment are: rock wool (a sort of glass wool) packed into frames which are placed against the walls; Cabot Quilting (a special type of dried seaweed sewn between canvas); wood panelled screens; etc.

An ideal studio would be one that absorbed all frequencies equally, and of a size to give just the amount of reverberation time which has been found, by experience, to be best for a particular type of music. Apart from needing a large number of studios, the fact remains that the performers themselves are not always agreed upon whether they can play with satisfaction in a particular room which may be 'ideal' for broadcasting.

So far, we have not even got our music out of the room; and we cannot place our microphone in position until we know a bit more about sound. The thing we have not yet considered fully is 'loudness'. We know, or should now know, something about the frequency of the vibrations which we call 'sound'; but what about the intensity of these vibrations?

THE LOUDNESS OF SOUND

Suppose we listen to a continuous sound, say, a tuning fork, and the vibrations are allowed to get weaker and weaker until the sound 'dies away'. Does it mean that because we cannot hear it, there is no sound, i.e. the fork has ceased vibrating? A very convincing proof that it has not, may be made by holding the fork in the hand until the sound can just not be heard: then place the handle on a 'sounding board', when the remaining weak vibrations will be reinforced sufficiently to make the sound heard again.

Clearly, then, there must be a certain degree of 'loudness', above which the ear can hear a sound, and below which it cannot. This degree of intensity is called the 'threshold of hearing', and we must now consider just how much energy is necessary to produce this faint impression. Again we must rely on our scientists to obtain the answer, for the rather crude experiment of the tuning fork does not give us exact measurements. They would provide us with a loudspeaker* which had measuring devices to say just how much power (in watts) was being given off, a source of supply to give any desired frequency on the loudspeaker, and—what is most important—an absolutely quiet room for you, the observer, to listen in.

Such a room would have to be built in the heart of the country, away from all external noises, and would probably consist of one room within another, each solidly built. Now keep quiet. What can you hear? Why—those bangs are none other than the beating of your heart, so that won't do. You must leave your heart outside if it is going to interfere with scientific research; and this is what you would have to do. Build another room inside the one you're in and stick only your head in this time. Now we can proceed.

A note of 1,000 cycles is put on to the loudspeaker at a very low volume and gradually increased until it can just be heard. This, then, is our threshold of hearing, and the power which produced it can be calculated from the scientific instruments used; always taking into account the fact that the unit we are really interested in is one of pressure. When this has been done, it would be shown that the pressure variation, at which the 1,000 cycles note could first be heard, would be about $\frac{1}{10,000}$ dynes per sq. cm. This is probably

a new unit to most of you, but as we are not going to use it for long, it is not worth going into precise details of definition. What we are more interested in is comparative values, so let us proceed with our listening tests, and resign ourselves to the fact that 'dynes per sq. cm.' is simply a unit of atmospheric pressure, in the same way that 'pounds per sq. in.' is, only that it is very much smaller.

* The scientists' 'loudspeaker' is an extremely delicate instrument called a 'thermo-phone', which consists of a gold wire of known characteristics, and through which an accurately measured alternating current is passed. The alternate heating and cooling of the wire causes the surrounding air particles to suffer increases and decreases of pressure, so creating sound waves, whose actual pressure is calculated and known.

The next question is, does the threshold of hearing have the same value (in pressure) for all frequencies? Or, to put it another way, are our ears equally sensitive to all pitches? Our instruments will tell us that they are not; that they are most sensitive at a frequency of approximately 2,750 cycles per second, where a variation of pressure of only $\frac{1}{12,500}$ dynes per sq. cm. can be detected. Also, that for frequencies on either side of this, there is a decline of sensitivity which is not exactly uniform, but which drops as low as $\frac{1}{1,000}$ dynes per sq. cm. for notes of 12,000 and 180 cycles; and even lower (1 dyne/sq. cm.) for the bottom note of the piano, 27 cycles.

The threshold of hearing having been determined, what happens next? Surely it is to determine the loudest sound we can hear. To find this, we can use similar apparatus again, increasing the loudness until . . . until what? It is not quite the same as the first experiment where we either did, or did not, hear the sound. Perhaps we had better do the experiment first and see what happens; then we shall know what to look for the next time. When the sound gets very loud—about as loud as a nearby pneumatic drill—the ears begin to feel uncomfortable, and may be said to 'feel' the noise rather than hear it pleasantly. If the sound is increased still further, the uncomfortable feeling gives way to acute pain, and eventually, actual damage to the ear-drum.

The border line of hearing and discomfort is known as the 'threshold of pain' or, more usually, the 'threshold of feeling'. It is also found to vary with pitch, but not so much as the threshold of hearing. It is approximately 300 dynes per sq. cm., except near the top octave of the piano, where it falls to 100 dynes per sq. cm. Fig. 27 shows a graph which gives the curves for the two limits of hearing. From it, we can see how much more sensitive the ear is at about 2,750 cycles than at any other point.

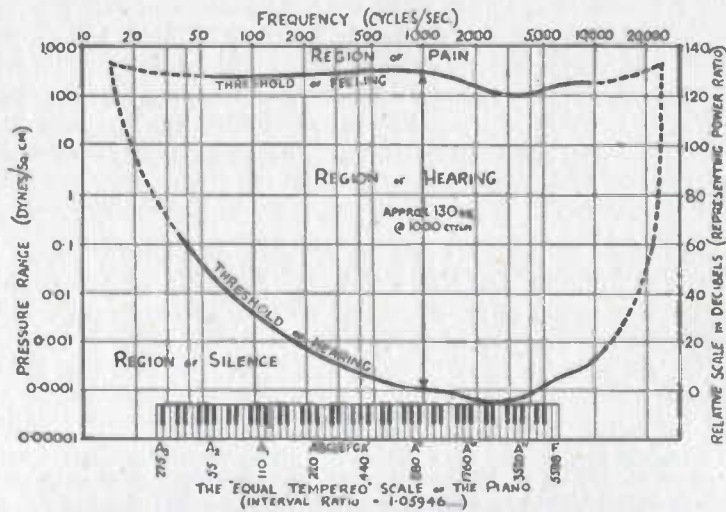

FIG. 27. GRAPH OF AVERAGE LIMITS OF AUDITORY SENSATION

If we take the extreme limits of sensitivity, it will be seen that the ear has to deal with sound intensities (i.e. pressure variation) which lie between $\frac{1}{12,500}$ and 300 dynes per sq. cm., or a ratio of $\frac{3,750,000}{1}$ in pressure values. This represents an even greater ratio in power units . . . since the power is proportional to the square of the pressure. For example, the graph shows that, at 1,000 cycles, the limits of hearing and feeling are represented by pressures of $\frac{1}{10,000}$ dynes/sq. cm. and approximately 300 dynes/sq. cm., for the thresholds of hearing and feeling, respectively. This represents a pressure ratio of $\frac{300}{\frac{1}{10,000}}$, or $\frac{3,000,000}{1}$. If we wish to convert this to a power ratio, we must 'square' this figure, making it $\frac{9,000,000,000,000}{1}$.

Now, it would be useful to have a 'scale' of loudness. In other words, we want to find some steps other than those at each end of the scale. Suppose, just for example, that we took 100 divisions and made each step represent an increase of the same number of pressure units. This would not be a good scale because we should find that equal increases in pressure did not give rise to equal increases in loudness.

Let us therefore try another idea. Instead of dividing up into equal pressure differences, let us take equal sound intensity intervals. After all, we want to be able to say 'this sound is "X" units louder than that', so we may as well make our units correspond to the impression received by the ear. Then each successive step will sound exactly so much louder than its predecessor, no matter whereabouts on the scale it comes. The size of the step was 'discovered' in a rather ingenious, yet perfectly logical, way by Alexander Graham Bell, and we call the unit after him.

Using the same type of experiment that was used to find the threshold of hearing, he (and others) set out to determine the minimum difference of sound intensity that could just be perceived by the ear. Of course, it had to be an experiment of 'averages' taken with a large number of observations, but a surprising result was noted. It was that this 'minimum perceptible difference' was always occasioned by raising the power (remember that this is proportional to the square of the pressure) which went to produce the sound intensities by 26 per cent., no matter whereabouts in the loudness scale it was taken. This is not strictly true for all frequencies; neither is it true for the extremes of weak or loud sounds, but it is true of the majority of sounds.

This small unit has been decided upon for the equal steps, and it has been found that there are, very approximately, 130 of them between the two 'thresholds'. In other words, starting off with the quietest sound audible we should be able to raise this sound by just perceptible intervals, one hundred and thirty times, when the sound would be unbearable. This may at first seem odd, but you will soon see how this scale lines up with the energy scale.

A SCALE OF LOUDNESS : THE DECIBEL

You will remember we said that the power had to be raised by 26 per cent. in order to produce the equal steps of loudness. Another way of stating this is to say that we multiply the power by 1.26, (i.e. $1 + \frac{26}{100}$) to produce equal additive increments. If the scales were drawn side by side, they would look like this :

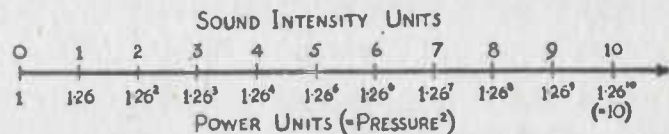

It is at this juncture that the mathematicians get a little 'break', for we find that 1.26¹⁰ is almost exactly equal to 10. (Don't be frightened of the little 10, nor any other number that is placed in that position, it is simply a sort of shorthand which means '1.26 × 1.26 × 1.26, etc., etc.', as many times as stated by the 'index', as it is called.) This saves us a lot of trouble, because 10 is such an easy number to deal with, as can be seen when the scale is extended further than 10 'intensity units'. By the way, we haven't given the unit its name yet. It was decided to call the whole 10 units '1 Bel', and so the smaller unit (the minimum perceptible interval) becomes the 'decibel', meaning 'one tenth of a Bel'.

Let us extend the above scale to cover 13 Bels (or 130 decibels) and compare it with the equivalent power scale.

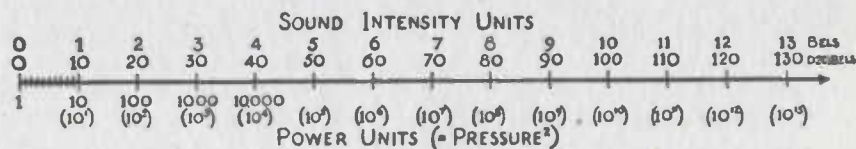

If we go on raising the power units (which are purely arbitrary in the scale shown; although we could have put it in dynes/sq. cm.) by 1.26 we simply find that 20 such intervals give 100-fold increase of power, 30 units give 1,000-fold increase, and so on. This explains how the enormous ratio of 9,000,000,000,000

1 between the powers needed to give the two thresholds at 1,000 cycles, is quickly reached by multiplying by 1.26 a matter of only 129 times. Not only that, but examination of the scale with its rapidly mounting ratios on one side and the easy steps on the other, gives us a clue to another method of working out the number of decibels which are equivalent to a given power ratio.

You will notice that the number of Bels is always equal to the index of the '10' which corresponds to it on the power side of the scale. For example, we say that a 10,000 power increase is equal to 4 Bels, and we could have written 10,000 as 10⁴ (spoken of as '10 raised to the fourth power' or as '10 to the fourth'). Now mathematicians have yet another way of writing down

large numbers. They say that, if we always use the figure 10 as a 'base', then any number can be written down as 10 raised to some power. This power is known as the 'logarithm' of the number. Put briefly, it means that the logarithm of a number is the power to which a given base (in our case 10) has to be raised to equal that number.

As an example : because 10³ = 1,000
 then log₁₀ 1,000 = 3
 or 10⁵ = 100,000
 therefore log₁₀ 100,000 = 5

(By the way, note that the 'index' figure gives the number of 0's.)

We have only taken simple examples, but it is equally true for all numbers even if the 'powers' are not whole numbers, which they will not be if the number is not a multiple of 10.

Looking at the scale again, we see at once that the number of Bels is given by the logarithm of the power ratio. Written as a formula, it comes out as :

$$N \text{ (bels)} = \log_{10} \frac{P_1}{P_2} \text{ where } P_1 \text{ and } P_2 \text{ are the relative powers which go to}$$

make the sounds we are trying to compare.

To use the smaller unit, the formula is modified to :

$$N \text{ (db)} = 10 \log_{10} \frac{P_1}{P_2}$$

This last expression is a very important one, for it enables us to compare two sounds, and to know by how many decibels one differs from the other, simply by knowing the ratio of the two powers which went to produce them. Such things as the 'gain' of amplifiers, which multiply by a certain factor the power (watts) of the programme currents put into them, are best expressed in decibels because we are interested in 'how much louder has the amplifier made the programme?' When we get to a later chapter, the subject of the decibel will be brought up again, because we shall want to know more about its relation to electrical units. Meanwhile, we have discovered quite a lot about its development, but the mathematical digression rather put us off the main issue, viz. how sounds can vary in intensity as well as frequency. Before leaving the subject entirely, you may like to know where a few examples of everyday noises come on the decibel scale. Notice how they are all compared with a standard, or 'zero' level, this being the threshold of hearing.

Threshold of hearing	0 decibels
Rustle of leaves in gentle breeze	10 "
Sounds in 'quiet' suburban street	35 "
Normal conversation	55 "
Busy street in London	70 "
Full orchestra, playing 'ff'	85 "
Sounds in a riveting shop	100 "
Nearby aeroplane engine	120 "

The above table is not strictly accurate, as the question of pitch is an important one when comparative measurements are made. When we have to consider the different pitches at which sound may occur, the scientist tends to make things even more difficult for us by introducing yet another unit—

the 'phon'. We shall not go into this very deeply, except to state that so long as we limit ourselves to sounds of 1,000 cycles the phon is the same as the decibel. For sound of a frequency different from 1,000 cycles, we say that it has a loudness of 'X' phons, when it sounds the same as a 1,000-cycle note of 'X' decibels. This is because two sounds of different pitch are said to have the same number of phons, in loudness, when they sound equally loud to the ear; whereas on the decibel scale two sounds of different pitch, and the same number of decibels above the threshold of hearing, would not sound equally loud. This subject is rather too long to be discussed here, and the reader who is interested is advised to read one of the many books on modern acoustics.

To sum up—we now know what sound is; how it is carried by pressure waves; what pitch, frequency, and wavelength are; something about harmonics; a little about acoustics; and have learned how to fix the loudness of sound on a scale.

The job of broadcasting includes the 'transmission' of all the above features from one place to another with as great fidelity as possible.

What are the limitations? It will be learned later that there are, in the main, two. First, we cannot send all the high frequencies we should like, a top limit of 10,000 cycles being considered a good quality transmission, whilst often we are limited to very much lower frequencies. Secondly, we cannot even send the range of loudness that we wish. Let us see why this is so.

THE CONTROL OF VOLUME

What is the range of sounds to be encountered in everyday life? In theory, it would be from the threshold of hearing to the threshold of feeling, or approximately 130 db. In practice, there is nearly always some faint sound present; even in a so-called 'quiet' room this may be as much as 20 db. We usually try to avoid sounds which give us pain, so that the loudest pleasant sound would not be much louder than 85 db. The range, therefore, would be 65 db., and for perfect transmission, this should be accommodated. We have taken rather extreme cases, however, and usually in a modern concert hall we are unlikely to encounter a range of more than 50 db., to 60 on an average. But this is already far greater than we can transmit by radio or other means, for the following reason. First let us consider the loud sounds. Owing to the fact that we have to use amplifying devices in our 'chain' of transmission, the higher levels are fixed by the limitations which the valve amplifiers can handle if overloading and consequent distortion is to be avoided.

So much for the upper limit, but why can't we have an infinitely low lower limit, seeing that we can always amplify the sounds later? We shall find that the lower limit is always fixed by 'noise' coming into the picture. Noise is present in different amounts throughout the broadcasting chain—in the studio, or in the concert hall, in the microphone, amplifiers, lines, transmitters, in the ether, receiver, and in the listener's room, and if we endeavour to transmit the weakest sounds we shall be 'below the noise level' and subsequent amplification will merely amplify noise and programme alike.

As a matter of fact, we cannot allow the programme currents to approach nearer to the region of 'noise' than about 40 db., otherwise the noise becomes audible as an unpleasant background. For example, on a good gramophone

record, needle scratch is about 40 db. below the programme recorded on it. These points will be discussed in detail later. For the moment, we may generalize by saying that the lower level of intensity is fixed by the necessity of maintaining a good programme/noise ratio. The nett result is that the final permissible range has to be a comparatively small one, approximately 24 db. This means that compression of the volume range has to be made; the louder passages being reduced in volume and the weaker ones brought up.

This compression, or 'control', as it is more usually called, could be effected at the very source of sound, e.g. we could ask a conductor of an orchestra never to let the range exceed a certain amount during a broadcast. But, apart from the fact that musicians would have great difficulty in assessing what really constituted a range of 24 db., (it is doubtful whether the average musician has ever heard of a decibel!) there is a much easier, and more exact way of controlling. This is the electrical method, which we shall consider in general principles only for the moment.

You will remember that if we placed a source of potential across a resistance, there was said to be a 'potential gradient' existing along the resistance. A tapping could therefore be made of any value of this potential by suitable connection, the whole device becoming what is known as a 'potential divider' or 'potentiometer'. Fig. 28 gives the circuit, as a reminder:

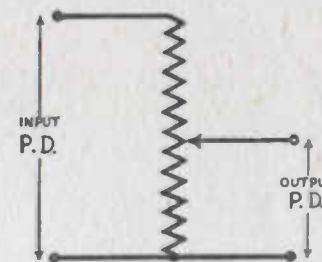

FIG. 28. VARIABLE POTENTIAL DIVIDER

By sliding the arrow up or down the resistance, a greater or smaller fraction of the input potential can be drawn off. Now it does not matter whether our source of potential is D.C. or A.C., the principle still applies. Hence its usefulness for controlling programme volume; for as soon as sound has been converted to electricity by the microphone we have A.C. All we need is some mechanical device for causing the slider to make contact with various points of the resistance. Generally, the mechanical arrangement consists of a rotating arm which is operated by a knob.

There is just one little point in connection with the potentiometer which is worthy of attention if only because it is so often overlooked. When the slider is at the top of the resistance, it will be seen that the whole of the input is obtained at the output. With this arrangement, let us start to control a programme and see what happens. After a few minutes the orchestra may build up to a crashing climax which is far too great to be handled by subsequent transmission apparatus. All right; down comes the slider to decrease the volume. When the orchestra returns to average, we shall bring it back to the top end again. Now comes a soft melody, and we wish to bring up the volume. What do we do now? The answer is, that we cannot increase the output to any more than the input value. We have a potential divider, not a multiplier. So we have to compromise and start off the programme with

the slider in the middle of the resistance. It means, of course, that we have agreed to lose half of the available potential, and to put it as a sort of 'bank balance' on which we can draw when the occasion demands it. This need not worry us unduly, as it is a very simple matter to amplify programme in order to make good this average loss which a control potentiometer gives.

Finally, it must be remembered that it is difficult, if not impossible, for the human ear to assess relative loudness accurately. Therefore, it is essential for us to have some artificial aid to know exactly with what levels we are dealing.

MEASUREMENT OF VOLUME

Some form of electrical measuring 'instrument' is indicated, but it is not quite as simple as just putting a voltmeter across the output of an amplifier. Certainly it would work, in the sense that the pointer would move in sympathy with the (average) voltage applied. This, in turn, would be an indication of the amount of power that was passing through the amplifier. But we have seen that power differences do not mean much to the ear, which appreciates sound intensities according to the logarithm of the power ratio. An ordinary voltmeter scale, with its equal divisions to represent equal voltage differences, would look something like Fig. 29 if it were recalibrated to the decibel scale.

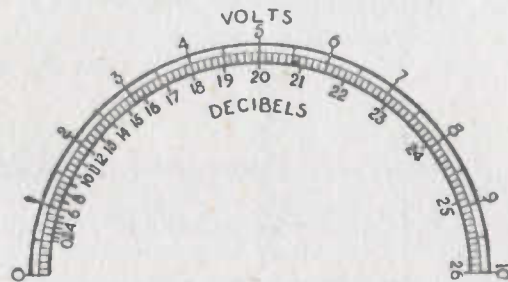
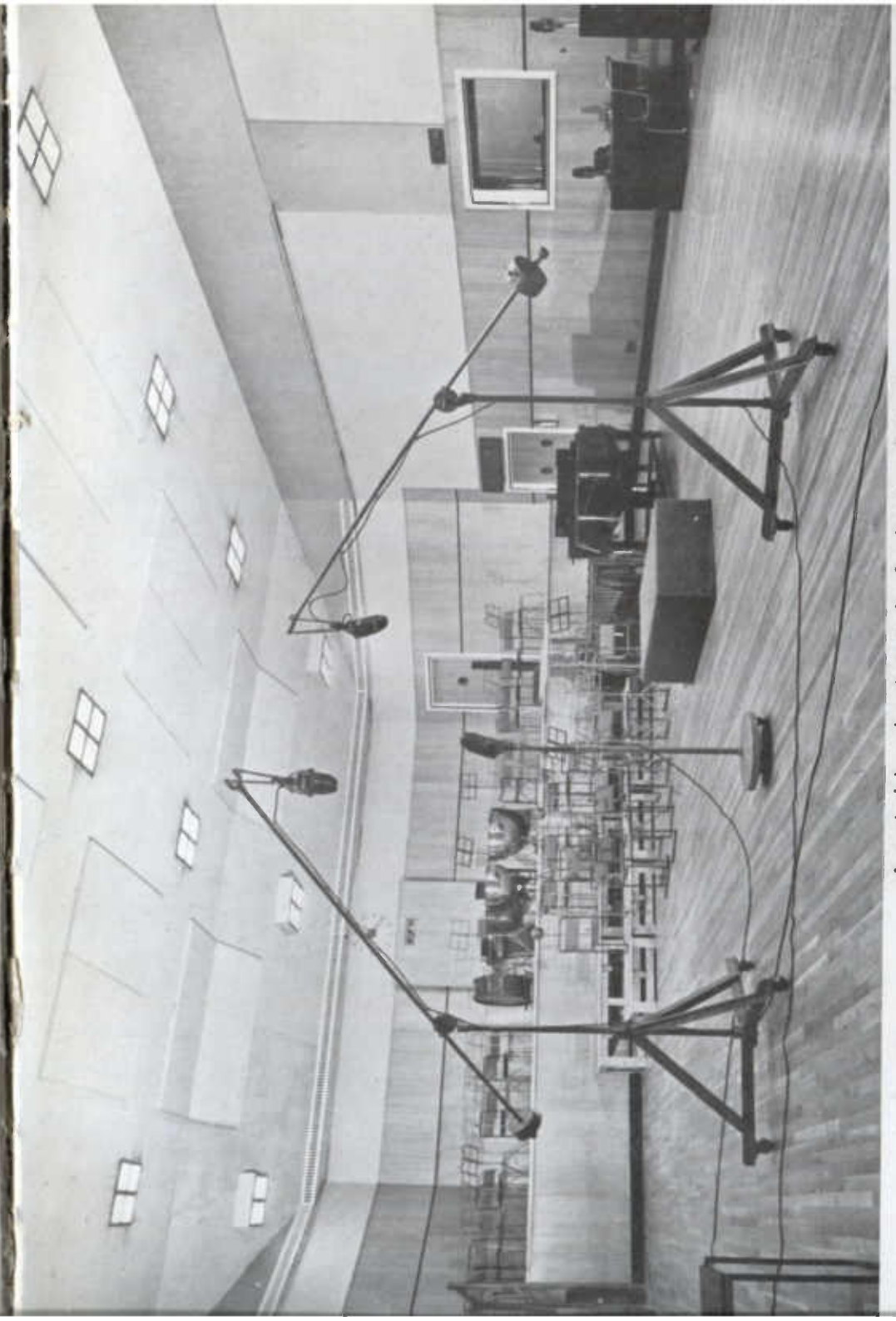

FIG. 29. SCALE OF A VOLTMETER ; RECALIBRATED TO READ DECIBELS

(N.B. The figures given bear no actual significance as far as actual values are concerned ; it is only the relative proportions that are important to note.) It will be seen that the decibel scale would be very much cramped on the left-hand side of the scale. Visual and aural co-ordination would thereby become practically impossible.

There is only one way to overcome this, and that is by designing the meter so as to close up the voltage scale at the higher levels. Exactly how this is done will be described when we come to the more detailed treatment of control room apparatus.



A typical broadcast studio for large orchestras

QUESTIONS ON CHAPTER II

(1) At what speed does sound travel in air at normal temperature and pressure ?

If the length of a sound wave were 2.5 ft., what would be its frequency ?

(2) Why do two instruments, e.g. a flute and a violin, playing the same fundamental note, sound different ?

(3) Give the reason for the 'fuller' effect when you sing in your bath. What is meant by 'reverberation' ?

Do 'reverberation' and 'echo' mean the same thing ?

(4) Are high notes or low notes more readily absorbed by the ordinary furnishings of a room ?

Draw a reverberation/frequency curve for a typical sitting-room.

(5) If C has a frequency of 261.6 c/s, what are the frequencies of C^I, C^{II}, C^{III}, and C^{IV} ?

What are the frequencies of the harmonics of C ?

What are the frequencies of its 'fifths' ?

(6) Draw a graph showing how the 'threshold of hearing' and the 'threshold of feeling' vary with the audible frequencies.

(7) A sound is increased in power by an amplifier fifteen times. How many decibels gain is this ?

Express in db. a change in pressure ratio of 500:1.

(8) How many db. represent the widest variations in volume-range of a full orchestra ?

To what extent has this range to be compressed for broadcasting ?

Why is compression necessary, and how is it achieved ?

General view of a control room, showing control positions and amplifier bays
Plate II

CHAPTER III

CONVERSION OF SOUND TO ELECTRICITY AND THE BROADCASTING CHAIN

WE now come to the business of converting sound waves into electric currents in order that they may ultimately undergo transmission. The simplest example of this is to be found in the everyday action of telephoning; and as this was virtually the forerunner of radio, we shall do well to ponder on the exact principles of its operation.

THE SIMPLE TELEPHONE

It consists essentially of two parts, a carbon microphone and a telephone earpiece. The carbon microphone consists of a 'box' which has one side covered with a light diaphragm, and is filled with carbon granules. A section of the carbon microphone is shown in Fig. 30.

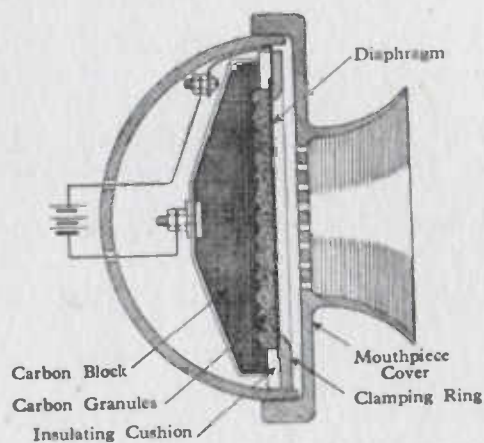

FIG. 30. SECTION OF A TELEPHONE MICROPHONE

The diaphragm, which may be of rubber, is coated on the inside with carbon dust, to which electrical connection is made by a metallic ring which is clamped against it. The 'box' is made of solid carbon and connection to this is also made by a metal casing. In between the diaphragm and a slight cavity in the carbon block are the carbon granules. There will be a conducting path between the two terminals, and through this we can pass a current by means of a small battery. The current will depend on the resistance of the carbon granules and under steady conditions it will remain steady. When two carbon surfaces are in contact, however, they have the property of changing their 'contact resistance' with the pressure applied to them. Actually, this variation is approximately in inverse ratio to the pressure. Now the pressure between all these carbon granules will depend on the pressure applied to the diaphragm. Consequently, when we allow sound waves to impinge on the diaphragm, the

variations in pressure so produced will cause the current to vary in sympathy with the sound waves.

Now let us consider the telephone receiver. In this we find a small permanent magnet, whose pole pieces are shaped so as to be side by side, i.e. in horse-shoe form, as shown in Fig. 31. Over each of the poles is wound a bobbin of many

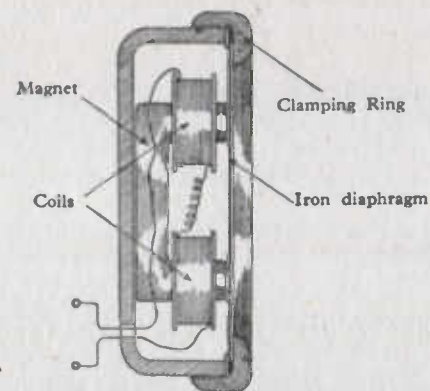

FIG. 31. SECTION OF A TELEPHONE EARPIECE

turns of wire, the two bobbins being connected in series and the wires brought out to suitable connecting terminals. In front of the pole pieces is a circular iron diaphragm, which is clamped by the casing of the earpiece all round its edges in such a way that it nearly, but not quite, touches the pole faces. Even with no current passing through the coils, the diaphragm will be attracted. But now consider what happens when we connect up a carbon microphone to it in the way to be described. Fig. 32 shows the battery, microphone, and telephone all connected in series. When sound waves impinge on the diaphragm

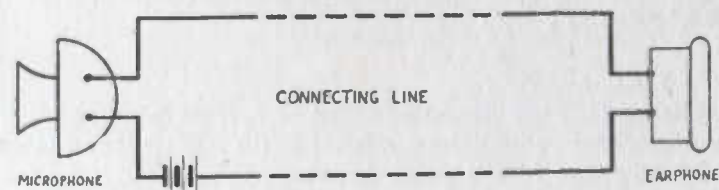

FIG. 32. A SIMPLE, ONE-WAY, TELEPHONE CIRCUIT

of the microphone, the varying pressure causes the resistance of the carbon to vary. This in turn produces current variations in the circuit, which are fed through the coils of the receiving telephone. When the current in the coils increases, the electromagnetic effect can be made to increase the pull of the permanent magnet, thus drawing the diaphragm still closer to the poles. On the other hand, when the current decreases—or is sent round in the opposite direction—the electromagnetic effect is in opposition to the permanent magnet and its pull will be decreased. Thus the diaphragm will be alternately pulled and let go in accordance with the current variations, and the air in front of the diaphragm will be set in motion and will create sound waves which should be a true replica of those which impinged on the microphone.

The wires which connect the two pieces of apparatus may be made quite long—many miles, in fact—so that it is possible for speech to be sent to great

CONVERSION OF SOUND TO ELECTRICITY AND THE BROADCASTING CHAIN

distances. If the simple arrangement shown above is used, it is only possible to speak in one direction. There are two modifications which would enable us to obtain two-way conversation without the use of more than two wires. They both entail putting a microphone and receiver in series, but as one method brings in a rather important principle, they will both be described. The first is shown diagrammatically in Fig. 33. The action is really no

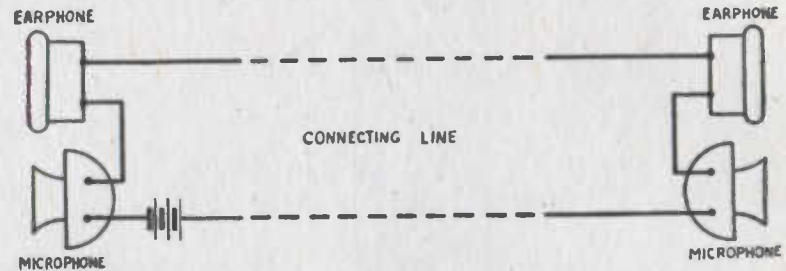

FIG. 33. EXTENSION TO TELEPHONE CIRCUIT TO PROVIDE TWO-WAY CONVERSATION

different from the previous arrangement because it only means that the two sets of speech currents will be mixed. It has the disadvantage that it is rather disconcerting to hear one's own voice loudly in one's own earphone, and this has been overcome to a large extent in modern telephone design. The circuit diagrams are, however, somewhat complicated and do not enter the field covered by this book.

Let us return to the single microphone action and re-consider what happens. It has been stated that the current in the circuit is a steady, direct one when the diaphragm is steady. Pressure variations then cause the current to vary in strength. The important thing to notice is that the current is still D.C. but that it is a 'pulsating current'.

SEPARATING D.C. AND A.C.

Has pulsating D.C. any connection with A.C.? If we connect a transformer between microphone and telephone receiver in the manner shown below, will the result be the same? The answer is that it will work and in the following

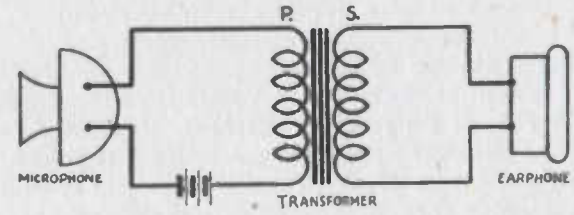

FIG. 34. THE USE OF A TRANSFORMER TO SEPARATE D.C. AND A.C.

way. The primary winding of the transformer is connected in series with the microphone and battery (Fig. 34) taking the place of the earphone of the earlier diagram (Fig. 32). When variations of air pressure cause the resistance of the carbon to vary, the current in the transformer primary winding will vary accordingly. Now the steady D.C. from the battery has been causing no effect on the secondary winding because it is only a changing magnetic

field that will induce an alternating voltage. But when the D.C. is caused to vary in intensity there is a changing field, with the result that true A.C. comes out of the secondary. Fig. 35 shows the graphs of the primary and secondary currents in the transformer. It will be seen that the total effect has been

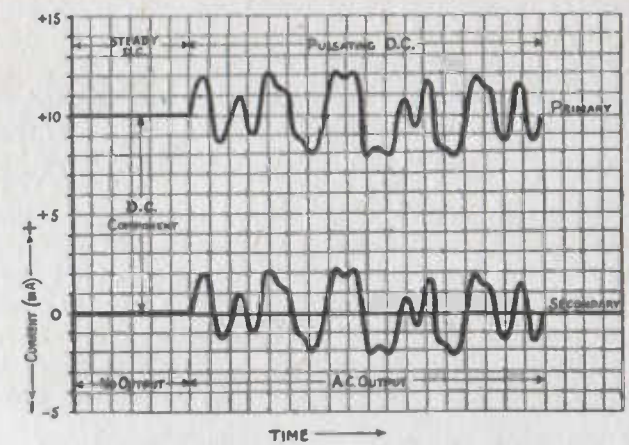

FIG. 35. GRAPH OF PRIMARY AND SECONDARY CURRENTS IN A TELEPHONE TRANSFORMER

to remove what is known as the 'D.C. component'. By using a transformer at each end we have no need, therefore, to pass direct current over the line. The theoretical arrangement would then become as shown in Fig. 36. It must

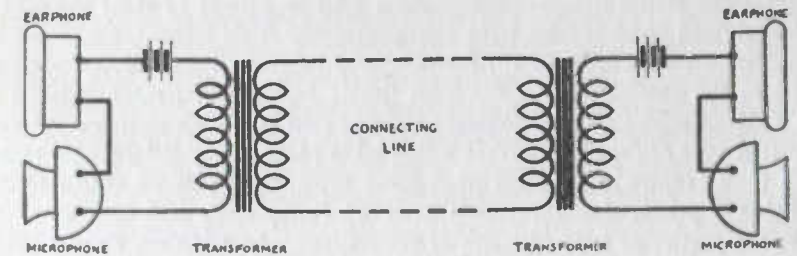

FIG. 36. THE COMPLETED, 'D.C.-LESS', CIRCUIT

be borne in mind that this is only the general principle of the telephone, and that in actual practice the circuit is very much modified. It includes such arrangements as 'blocking' the D.C. from passing through the receiver by means of a condenser; also a means of preventing most of the energy from the microphone being heard in the local receiver (known as 'side-tone').

What has been described above is enough to show that the transmission of speech over a distance is a comparatively simple matter. To do the same with high quality music and other programme material is one of the main jobs of the broadcasting engineer, for it is by 'telephone' wires that the programmes are carried from microphone to transmitter. We should perhaps interpolate here that in Great Britain the Postmaster-General has a monopoly of telephone transmission and that all telephone wires or 'lines' used for broadcasting are rented by the BBC from the Post Office. They are generally known as P.O. lines.

DEVELOPMENT OF THE 'BROADCASTING CHAIN'

The chain of events that is required to take place between the microphone and the listeners' loudspeaker is popularly known as the 'broadcasting chain'. Before we go on to outline the chain, it is best to learn a new type of drawing, as it will simplify considerably its understanding. So far, when drawing electrical circuits, we have always considered it essential to show the complete 'circuit'. By this we mean that the wires necessary for the flow of current right round the circuit are drawn; and for drawings involving telephone lines it has meant showing two wires. It was explained in the first chapter that there was only one exception to this, viz. when an 'earth return' was used. However, our new drawing is going to look like a contradiction of the above rule, because we are henceforth going to draw one wire as indicating the 'pair'.

Most of the apparatus, too, will be simplified to the extent of using 'blocks' to represent it, the exact function being described by a letter or other symbol. The whole arrangement is known as a 'block schematic', and, as a very simple example, we will draw the telephone chain previously described in circuit form (Fig. 37). Nothing could be simpler than that, could it? In a similar way



FIG. 37. 'BLOCK SCHEMATIC' TYPE OF DRAWING

but on a larger scale we put whole control rooms in little square or circular 'blocks' and join them by single lines to show P.O. line connections. Such an arrangement would be incorporated on a map of Britain to show the way in which various BBC centres were interconnected. This scheme, known as the Simultaneous Broadcast (S.B.) System, will be treated more fully when we come to the specialized discussion on lines. Just now we want to build up the whole scheme in a very general way, and then take each section separately. The first part of the chain is that which takes place at any BBC studio centre. This term 'centre' may itself need some explanation and we shall define it as being a group of studios, each designed (acoustically and architecturally) to suit a particular type and size of programme. In addition, there must be a central control room for the selection and control of programmes, together with other necessary equipment for its ultimate distribution by P.O. lines.

Our aim, therefore, is to build up, in the form of a chain, a complete picture of events from microphone to line. If you refer to the finished block schematic (Fig. 38) the result may look pretty formidable, but taking each item step by step, it will be seen that only the essentials are shown at this stage.

THE STUDIO AND LISTENING ROOM

First then we have the studios themselves. We have shown only three in the picture, and they are of two types. Number 2 shows a single microphone, the sort of studio that would be used for News. Numbers 1 and 3 are known as 'multi-microphone' studios, where—as the name implies—there would be two or more microphones. They would also have a 'listening room' or 'control cubicle' adjacent to them. The listening room is acoustically insulated from the studio, but is connected to it visually by a glass window and aurally by 'talk-back'. It is possible that gramophone records may form

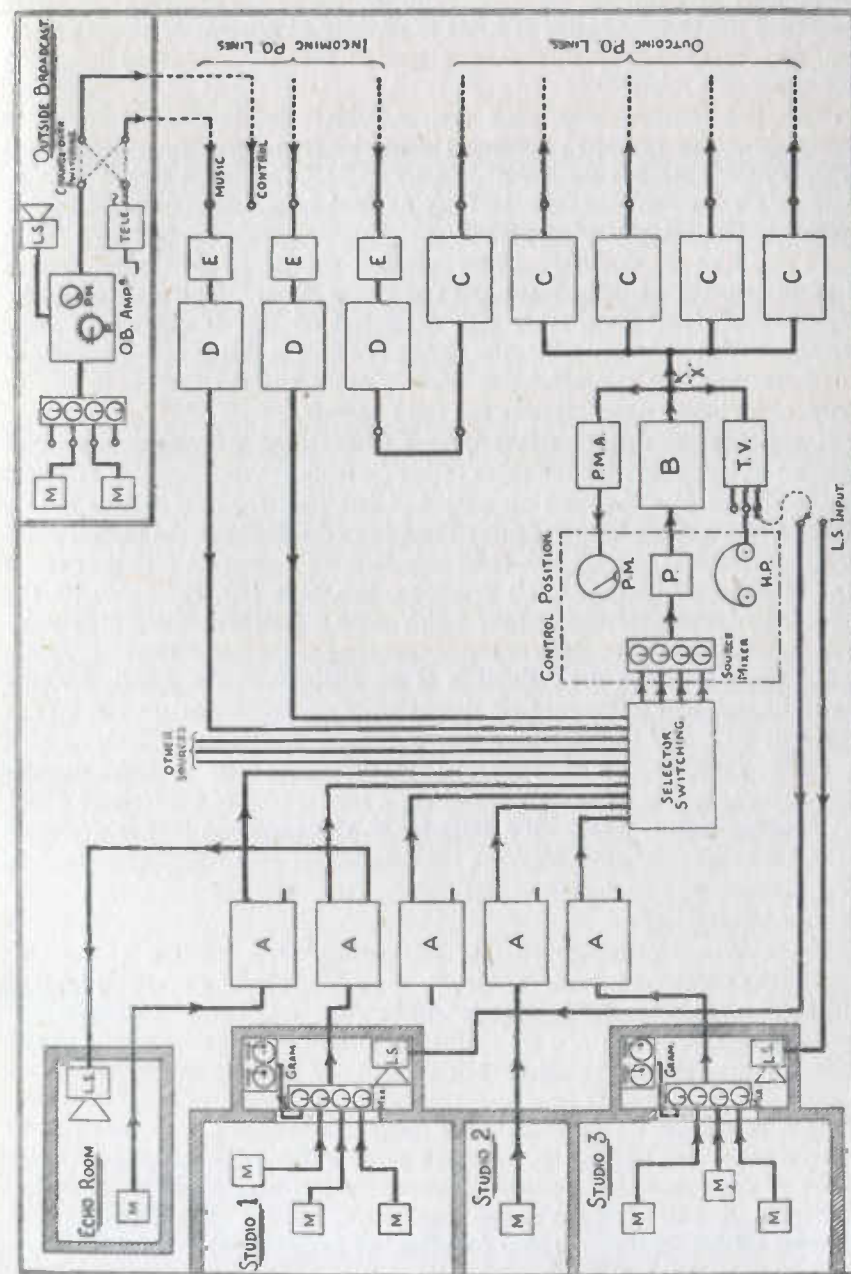

FIG. 38. THE BROADCASTING CHAIN

part of the programme, and facilities for reproduction are provided. The sound produced by a gramophone is not picked up from the record by a microphone but, instead, by a gramophone 'pick-up', by means of which the sound track of the record is made to produce an alternating current. This can then be dealt with in the same way as the A.C. produced by sound impinging on a microphone.

With this form of alternating current (which, incidentally, is known as 'audio-frequency currents', 'speech currents', 'programme currents', or just 'programme') we can do almost endless tricks. Our main object, though, is to retain the A.F. currents in their original form, even though they are eventually sent many hundreds of miles.

To return to the studio, it will be seen that the output of each microphone is taken into the listening room and fed into a mixer. This device will be described in detail later, when it will be learned that it consists of some arrangement of variable resistances. The net result is that it enables us either to switch from one microphone to another or to mix the outputs of two or more microphones, superimposing one upon another.

It must not be forgotten that we are still dealing with extremely small voltages and currents, for the types of high quality microphone now favoured by the BBC sometimes have an output of less than one-millionth of a volt. Nevertheless, we still have to convey them from the studio to the control room by wire and this is no easy task. Not only have we to contend with the normal laws of attenuation (i.e. 'loss') according to Ohm's law, but also with the induction of electrical interference which gives a proportionately high noise level in comparison with the very low output level of the microphone.

If something is not done about it at an early stage, the speech currents would be completely drowned by the noise. One precaution we can take is to screen each pair of wires by a metallic sheath and to connect this screen to earth. Another way of reducing any interference that does get through the screening is to balance the line and use a special type of transformer called a 'repeating coil'. It is a little early for us to understand how it works, so we will take it for granted and leave the explanation until later.

THE CONTROL ROOM

We have now arrived at the control room, where we can proceed to amplify the programme currents. At this stage, the 'block' method of drawing will be particularly useful because it will be some time before we understand how an amplifier works. So we shall have to content ourselves with a 'box' which apparently has the miraculous property of pushing out more than is put in!

From this point we could pass the programme on to a P.O. line and so to the broadcasting transmitter, but it is a practical BBC that we are describing, and a programme which emanated from one studio only would not be much fun! So we pass from the studio amplifier to another mixing arrangement whereby several studios (or other 'sources' of programme) may be mixed or faded in and out at will.

These programme sources are too numerous to be permanently connected to a control-room mixer in the same way that the microphones were connected to the studio-cubicle mixer. If they were permanently wired, the mixer would have to be exceedingly large, as well as being 'wasteful'; so between the

source amplifier and source mixer we usually find some form of switching arrangement. This may take one of many forms, from simple plug-and-jack methods to an automatic system not unlike the P.O. automatic telephone, and no attempt will be made to describe any of them here.

All the apparatus now being described is located in the control room—the electrical 'nerve-centre' for all the programmes. The essential parts of the chain can really be divided into two parts; the switching or operational section, and the 'static' apparatus such as amplifiers. Indeed they are generally divided physically in most control rooms. The amplifiers and similar gear are all 'rack-mounted' apparatus, quite divorced from the operational side which is situated at a sort of desk called the 'control position'. However, for the purpose of our drawing, the scheme is developed simply as a chain of events, and physical positions of the apparatus in an actual control room would bear little or no relation to the diagram. Plate II shows a typical control room, with its control positions and apparatus racks.

PROGRAMME CONTROL AND MONITORING

We have reached the position where we can select any source of programme and fade from one to another according to a time schedule. The output from the mixer is, therefore, a complete 'programme'—complete, that is, with the exception that the volume range at any moment might be anywhere within very wide limits which, as we know, will not do for broadcasting. We had better do something about that straight away, so the next item is a control potentiometer. The output of this will, if it has been used correctly, be within the agreed limits of volume range. Unfortunately, the average volume will have been considerably reduced at the same time, owing to the need for introducing the 'average loss' which we discussed at the end of the last chapter. We can easily make good this loss by the introduction of another amplifier, and that is what is done. It is called the control amplifier, and it will be seen on the diagram marked with a 'B'. This is the recognized method of describing the function of each amplifier in the chain. The source amplifier is known as the 'A' amplifier.

You will notice that we have put in a control potentiometer to compress the volume range, but so far have neither listened to the programme nor measured it in any way. Obviously, the place to do this is after the control potentiometer . . . at point 'X' on the diagram. So at this point the listening device, either headphones or loudspeaker, and programme meter are connected. But is it wise to put headphones across the line in this way in parallel with the output wires of the 'B' amplifier? If, for instance, the 'phones develop 'scratches' (which are either momentary breaks or 'short-circuits') due to a faulty cord, those same scratches will be virtually on the output of the 'B' amplifier and will be heard at all subsequent stages of the chain. For this and other reasons, the 'phones or loudspeakers must be isolated in some way. To do this we need a one-way arrangement, and we have just such a device in the thermionic valve, the action of which will be described in detail in Chapter V.

SENDING THE PROGRAMME TO LINE

So, at point 'X', we have at last got the complete programme, correctly mixed and compressed in volume, also monitored both visually and aurally.

It only remains to pass it on to the P.O. line. If there are many transmitters to feed, there is almost certain to be more than one P.O. line to feed with programme. And for the same reason that a pair of headphones are not put directly in parallel with the 'B' output, so must we guard against putting P.O. lines in parallel. If it were done that way, and one of the lines developed a fault, it would affect all the other lines. So again, an isolating amplifier is inserted in each line to act as a trap valve. It is called the 'C', or sending amplifier, as it forms the third amplifier in the actual chain. The word amplifier as applied to the 'C' may seem rather a misnomer, because quite often it does not amplify at all; it sometimes even decreases the volume. However, its main function is to isolate, whilst a secondary feature is to allow the adjustment of each output separately, in case a certain line requires a different level from others. There are also other reasons, bound up with 'impedance matching', which make it desirable to use separate sending amplifiers, but these are too technical to worry about here.

THE RECEIVING END OF A LINE

Let us now jump a few miles to the other end of one of the P.O. lines, and see what happens when it enters the next BBC control room. First, let us take the case of an intermediate control room, which is concerned mainly with passing on the programme.

Were we to listen to the programme just as it arrived, it would not sound exactly the same as it did when it left the other end of the line. Besides getting weaker because of the resistance of the telephone line, the quality will have become peculiarly lacking in brightness. Measurement would show that the high notes have got lost on the way more than the low notes. To overcome this, we resort to a trick with inductances and condensers, which has the effect of dropping the low notes by an amount equal to the loss already sustained by the high ones. This is called 'equalizing' the line, and it can be done quite effectively within limits. These limits, however, are quite real and form one of the reasons why we are unable to transmit faithfully all the frequencies we should like.

As regards the loss of strength in programme, this can easily be restored by another amplifier—the 'D'. It depends on the nature of the studio centre and the particular programme in question whether it has to be passed on to another line, or whether it has to be taken through a control position. Both are shown on the diagram. Whilst looking at this diagram, it might be as well to mention something which has been purposely left out for the sake of simplicity. Remember that at point 'X' we have a completed programme to be fed to any number of lines. Now we have just seen that there may be other complete programmes passing through the control room, also requiring to be fed to one or more outgoing lines. This can be quite a complex matter, especially when there may have to be 'snappy' changes from one line to another. It may be necessary to have a second switching arrangement just in front of the 'C' amplifiers, called the 'C Input Switching'. It enables us to join any 'C' amplifier to any 'B' amplifier, as well as to certain 'D' amplifiers as well.

Before leaving the subject of P.O. lines, it may be asked what precautions have to be taken against noise induction. After all, if it were risky to send the programme currents over a matter of yards from the studio to the control

room, is it not likely that we shall run into even greater trouble when the distance is increased to miles? Yes, unfortunately, that does happen. You will remember that the main reason for volume compression was to keep the 'programme to noise ratio' as high as possible, and it is on P.O. lines that it is most difficult to do. For this reason the lines have to be carefully constructed, especially with regard to 'balance' (of which, more later) and if the line is very long, intermediate amplifiers have to be provided en route. These amplifiers are called 'repeaters' and form part of the 'music circuit' rented from the P.O.

TRANSMITTING THE PROGRAMME ; 'WIRELESS'

The final link in the chain is now reached, the radio, or wireless transmitter. As far as the programme is concerned, it is treated in the same way as any studio centre would treat it on arrival. That is, we have first to 'equalize' the last length of line to restore the lost quality, and then to amplify it. Part of the transmitting station, therefore, consists of normal control room apparatus.

It is now necessary to digress a little, and consider some fundamental principles. It will be remembered that A.C. applied to a coil of wire could be made to induce an alternating current in another coil, even though there were no physical connection between the two. We explained this by showing that an electromagnetic 'field' existed around one coil which affected any conductor placed near it. It could have been shown that the existence of this field did not depend on the presence of air as sound waves do. In a similar way, a high potential 'charge' on a conductor causes an 'electro-static field' which surrounds the conductor. Now the important thing to remember is that these electric fields of strain are not built up instantaneously, but take a certain time. Those places which are further removed from the source are affected later than the nearer points. In fact, the 'field' travels outward in all directions in a way very similar to the action of sound, and we call these intangible fields of electromagnetic and electrostatic strain by the same name, viz. 'waves' . . . 'wireless' waves. The fact that they do not depend on air, or indeed on any form of known matter for their propagation, makes it difficult to prove that they are propagated by 'wave motion'. However, you must take it that they are so propagated. The scientists have postulated a medium which they call the 'æther', which is supposed to be everywhere and through which the electromagnetic waves are propagated.

Unfortunately, the alternating currents of the relatively low audio frequencies we have been discussing are not capable of spreading their influence very far from the source of excitation, and it is only much higher frequencies that can cause these electromagnetic or wireless waves to be radiated to great distances. How then can the audio frequencies be put across? We shall learn about that in Chapter VII; let it now suffice to say that the high frequency wireless waves are used to 'carry' the low frequency (or A.F.) current by a process of 'modulation'. Chapter VII will also tell us how to generate and radiate these high frequencies.

It has taken rather a long time to introduce the actual business of 'wireless' into the story, and, like the treatment of the rest of the links in the broadcasting chain, it will be discussed in detail later.

To finish this chapter, let us return to the studio centre and see whether there are any ways in which we can improve or augment the service.

OUTSIDE BROADCASTS

We have considered only programmes which emanate from BBC premises, whereas it is obvious that much material must exist which is suitable for broadcasting and yet which occurs outside the studio centre. For example, sports meetings of all types, church services, orchestral concerts from public halls, cinema organs, etc., are all events which it may not be possible or convenient to transplant to a studio centre. The alternative is to take the studio centre outside; or, at least, those parts which are necessary, viz. the microphone and the essential parts of the control room. Such an arrangement is called an 'Outside Broadcast' (O.B.) and it involves taking out apparatus to the site, and rigging up a miniature temporary control room. Here the outputs of the microphones are mixed, amplified, monitored, and sent out by P.O. lines to the nearest studio centre, where such 'contributions' are fitted into a programme as if they were from a local studio source.

The diagram (Fig. 38) shows such an arrangement, and it is arranged that the special amplifier performs all the functions of the 'A' amplifier, control potmeter, 'B' amplifier and programme meter in one 'box'. It is all arranged in a very compact and portable form (see Plate III) and it is usual to have duplicate equipment at every O.B. in case of failure of any unit. Two P.O. lines are always required, one to carry the programme and the other for telephone control purposes, cues, etc. If possible, these two circuits are made interchangeable, so that one is selected for carrying the programme and the other then acts as a standby. The diagram shows dotted lines to represent such change-over arrangements, but in actual fact all this is incorporated in the OBA/8 amplifier by means of special switches.

ADDITIONAL STUDIO FACILITIES

A few other points of interest found in most control rooms are now enumerated, although they may not appear on the diagram as they would tend to confuse it.

In the studio listening rooms we usually find a loudspeaker placed there for the producer or other person in charge of the programme to hear the result. This loudspeaker has to be 'fed' from the control room with the completed output of the programme; hence the trap-valve output is the right source from which to feed this loudspeaker. In addition to this, other facilities—not shown on the diagram—are also given to the programme producer. For instance, during a rehearsal it will most certainly be necessary for the producer to talk to the artists in the studio. There is no need to install another chain of amplifiers to make this work—there is already a set for the normal programme chain, and it is necessary only to arrange switches to change over studio and listening room microphones simultaneously with the loudspeakers in the listening room and studio.

You will notice on the diagram an 'echo room', and are probably wondering what this is for. For certain productions, particularly dramatic ones, we may be required to give the effect of a scene in a very reverberant room, e.g. a cavern or cathedral. There is no need to build a studio which has such peculiar acoustical properties, especially as it may only be required for a

few minutes. Another instance calling for special acoustic treatment via the echo room is that of the dance-band that wants a 'dead' studio (i.e. little or no reverberation) in order to play with precision, and yet wishes the listener to hear a performance that has all the brightness and fullness given by a very 'live' studio. The echo room is in fact the means by which artificial echo, or reverberation, is added, and this is done in the following way. Each source amplifier (whether it be an 'A' or 'D') is provided with two separate outputs. One of these is connected to a channel of the source mixer in the usual way. The other is taken to the echo room, which is simply an empty room with bare, hard, walls, floor, and ceiling, giving a maximum of reflection, and therefore very reverberant. The sound is reproduced on a loudspeaker and goes echoing round and round the walls as it would in a cavern. A microphone picks up this much-reflected sound and conveys it back to the control room, there to be amplified by an 'A' amplifier and fed into another channel of the source mixer. It is now possible to fade up as much as this artificial echo as we wish, and superimpose it on the original programme. It must be admitted that it is not always quite as realistic as one could wish, but it is very useful for many purposes, particularly for dramatic productions.

We have now built up quite an imposing control room with apparently sufficient apparatus and facilities to carry out nearly every type of programme that could be imagined. But in the years that broadcasting has progressed, producers have become more and more ambitious. For certain shows, they demand very many more studios than can be accommodated on the four-channel source mixer provided in the control room. So an additional multi-channel mixer, known as a 'production panel', which can have the outputs of the 'A' amplifiers of anything up to 12 or 15 studios connected to it, has been devised. At this panel the producer sits and directs his programme in such a way as to obtain the correct continuity; the final output being fed to the source selector on one pair of wires.

You will notice that the word 'channel' has been used repeatedly to describe, in the main, an electrical 'path' or circuit. That is sufficient for the moment, but later you may meet the same word with quite a different meaning. The 'four-channel mixer' simply means a mixing device with four separate input paths which are combined, by the operation of individual mixing 'knobs', to give one output 'channel'.

We have missed out one important point in the running of our programme, for no means of starting or stopping programmes has yet been mentioned. This is accomplished by means of 'cues'—often in the form of signalling lights. In fact, to many an artist, the flickering 'red light' is the only indication that there is any work going on 'behind the scenes' or anyone listening at all! In addition to cue light arrangements, which will be described in detail later, there are numerous telephone circuits to interconnect studios and control room, as well as between studio centres.

It is hoped that the foregoing has given some idea of the general requirements of a broadcasting chain, and the sort of apparatus to be found at a studio centre. It may possibly seem very complicated; but long experience has shown that to provide a reliable and fully flexible service this type of control room is necessary. The O.B. gear which has been developed was said to possess all the necessary features of the control room, and yet to

be extremely compact, but no claim was made for 'flexibility' which is quite an important point in modern broadcasting. However, under wartime conditions where some flexibility has had to be sacrificed in the cause of compactness, simplicity, and standardization, O.B. apparatus has been found to be extremely useful and is, in fact, used in wartime control rooms.

QUESTIONS ON CHAPTER III

- (1) Draw a simple carbon microphone showing its essential components, and describe how it is able to convert air pressure waves into electrical currents.
- (2) Draw a telephone earpiece showing its essential components, and describe how it is able to convert electrical currents into air pressure waves.
- (3) Draw the circuit diagram of a simple telephone for two-way working, which has no direct current in the wires connecting the two distant ends.
- (4) Show in block schematic form the arrangements of a studio and its control cubicle, assuming there to be three microphones in the studio and a gramophone in the cubicle.
- (5) Give a block schematic for an O.B. using six microphones. Show how the second or standby amplifier could quickly be brought into circuit if the working amplifier failed.
- (6) Why do trap-valve amplifiers have to be used ?
- (7) Draw the block schematic of a typical control room for a centre possessing two large general purpose studios each with four microphones and a gramophone in their cubicles, one single-microphone talks studio with a gramophone in its cubicle, and one single-microphone news studio. The centre possesses an echo room, has two incoming music lines, and is feeding five outgoing music lines. Two other programmes are also being passed through it.
- (8) Why is the expression 'echo room' a misnomer ?

CHAPTER IV

PRACTICAL BROADCASTING APPARATUS

THE chapters which have gone before have told of the bare requirements of the broadcasting chain, and it is now time to take each item separately and study just how it works in practice.

First, the microphone. At present there are three main types of microphone (Plate IV) but one—the carbon type—is obsolescent. However, it is still in use for some purposes and so we shall include a description of it.

THE CARBON MICROPHONE

There is a slight difference in construction when compared with its forerunner, the telephone type of carbon microphone mentioned in Chapter III, although its principle is exactly the same. The BBC use two makes, the Reisz and B.T.H. types, both of which make use of the same principle, i.e. the variation of pressure on carbon granules causing the resistance to vary. We will describe the Reisz type only.

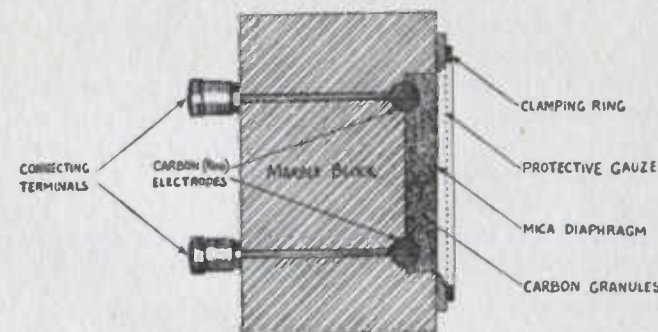

FIG. 39. SECTION OF REISZ TYPE OF CARBON MICROPHONE

A heavy marble block has a shallow cavity excavated in one 'face', and this cavity is filled with carbon granules (see Fig. 39). They are retained in a loosely packed condition by means of a thin non-conducting diaphragm—unlike the telephone type, which has one side of the diaphragm covered with carbon. At one time the diaphragm was made of mica, but this caused certain troubles in that some frequencies were accentuated because of the 'resonance' of the mica. Don't be frightened of the term 'resonance', which simply means that the mica had a 'natural vibration' at a certain frequency (about 4,500 cycles per second) and that it responded better to that frequency than to any other. The later types of microphone are modified by using a special impregnated paper diaphragm which has not this disadvantage.

The two connections are made by means of carbon electrodes which come in from the back of the microphone. Current therefore passes across the carbon granules in a direction which is parallel to the diaphragm, but at

right angles to the axis along which the microphone faces. For this reason it is known as the 'transverse' current type, and this is the main difference between it and the telephone microphone. The action is, nevertheless, the same in both cases and has already been discussed. But now a few notes about its special features, especially its disadvantages and why it is no longer used.

The main drawback is the inherent 'hiss' which exists, due to the passage of current through the loosely packed granules. It has also a tendency to 'pack'; which means that the granules fall to the bottom of the cavity and get packed closely together. When this happens, the microphone will not be so sensitive, but the 'hiss' remaining more or less constant, the noise/speech ratio will become too high. The microphone will not handle large volumes of sound without overloading, or 'blasting' as it is called; neither are all frequencies amplified equally, the higher frequencies being over-emphasized with the result that sibilants in speech become accentuated.

Special speaking technique is usually required because of these latter failings, the announcer having to speak 'across' the face of the microphone rather than directly into it. Finally, it is uni-directional and its frequency 'response' varies with the direction from which the sound emanates. Consequently, it is unsuitable for anything except fairly intimate programmes such as talks, announcements, etc.

THE MOVING-COIL MICROPHONE

Let us now turn to the two modern types, the 'moving-coil' and the 'ribbon' microphones. As has already been mentioned, they both rely on the same principle, viz. electromagnetic induction.

The moving-coil type consists essentially of a strong permanent magnet system in which a conductor (the coil) is caused to move when sound waves impinge on it. To some people, the conception of the magnet 'system' seems rather baffling because it is a circular magnet. However, the first sketch (Fig. 40a) which shows the magnet only with part cut away should make this clear, and it will be observed that the whole object is to secure an intensely strong magnetic field in an annular (circular) gap. In this field,

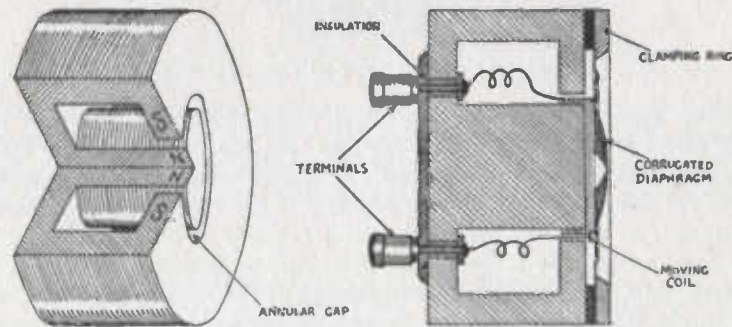
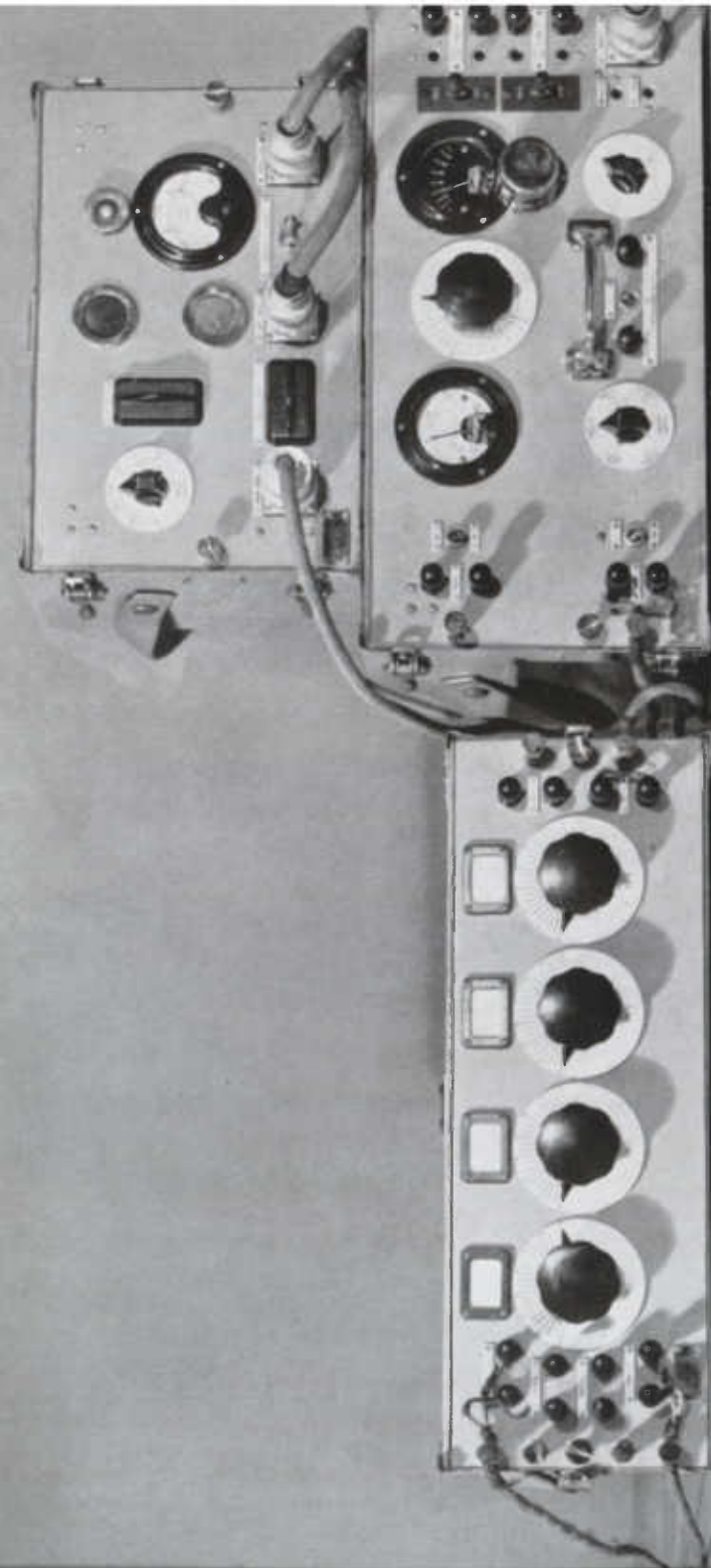

FIG. 40a. MAGNET SYSTEM OF MOVING COIL MICROPHONE

FIG. 40b. SECTION OF COMPLETE MICROPHONE

the coil of aluminium flat wire, wound on edge and held together (or is it apart?) by an insulating varnish, is suspended. It is not allowed to touch the magnets, of course, and the front edge of the coil is attached to the diaphragm. This diaphragm is of duralumin, slightly corrugated, having



Outside Broadcast equipment: showing 4-channel mixer, OBA 8 amplifier, and Mains unit
Plate III

a dome-shaped centre portion, and clamped firmly all around its outer edge. The sectional drawing (Fig. 40b) shows the essential parts.

The two ends of the coil are taken out to terminals at the back of the microphone (through insulating 'bushes' in holes drilled in the magnet). The action then is as follows. When sound pressure waves impinge on the diaphragm, it moves backwards and forwards, moving the coil in a like manner so that it cuts the magnetic field. Thus, an alternating voltage is set up across the ends of the coil, and this constitutes the output. The output is only small, and special precautions have to be taken to convey the tiny voltages to the amplifier. One of these precautions is to 'match' the impedances of the coil and the circuits which follow it. The question of impedance matching has not been tackled yet, and as it would involve mathematical formulæ which are a little too advanced for us, we shall have to content ourselves with a simple analogy. Suppose we had a large water main, say of 2 ft. diameter, in which a large quantity of water was flowing. If this pipe were suddenly reduced in diameter to 1 inch, and the quantity of water which flows in this new pipe measured, it would be found that it had been reduced out of all proportion to that which would have been expected, simply from a consideration of the relative frictional resistances. What has happened is that at the junction of the two different-sized pipes a state of turbulence has been created by the oncoming water suddenly meeting the restriction. If the pipe had been tapered gradually to the smaller diameter, the efficiency of transfer would have been greatly increased. This, in fact, is what the tapered nozzle of the fireman's hose does. It is not a perfect analogy for the electrical equivalent where the loss of transfer efficiency is due to 'reflections', but it is necessary to find an equivalent for this 'tapering' in the electrical sense. Such a matching device is found in the transformer.

To return to the microphone, we insert a matching transformer, whose impedance ratio is 1/10 (see Chap. I. for 'impedance' in connection with inductances) and which therefore matches the output impedance of the microphone (30 ohms) to that of the line feeding the amplifier (300 ohms). This transformer is usually located somewhere behind the skirting board of the studio, and comes directly after the plug and socket to which the flexible lead from the microphone is attached.

By the way, it is important that even the flexible lead is screened, and this is done by means of a metallic braid covering, over which another (insulating) cover is usually found. There is a protective cover for the diaphragm in the form of a perforated metal grid covered with silk. This cover, together with the body of the magnet, form an electrostatic shield for the moving coil, and are connected to an 'earth' terminal which, in turn, is connected to the cable shielding.

Now let us see how the moving-coil microphone scores over the carbon type. First, the 'response' of the microphone is relatively uniform throughout the frequency range of approximately 50 to 10,000 cycles, except that it has a slightly increased response between 4,000 and 6,000 cycles. Above 10,000 cycles, the output falls off rapidly, but it must be borne in mind that 10,000 cycles represents very good quality. It is nearly an octave higher than the highest note on the piano.

Next, it does not suffer from the drawback of 'hiss'—neither can it ever 'pack'. It is robust and reliable, and does not need batteries to work it.

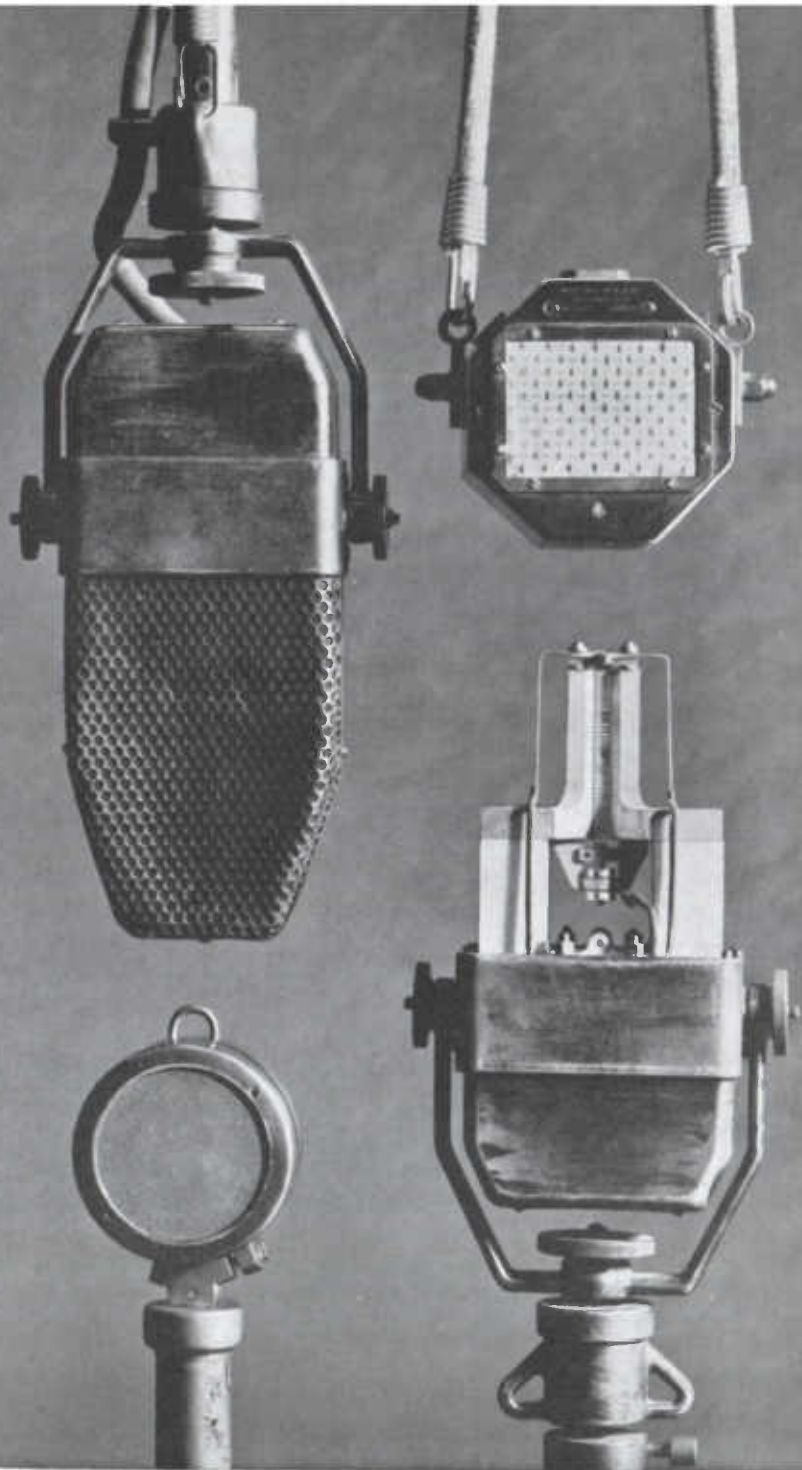

Three types of microphone used by the BBC: Reisz, moving coil, and ribbon

As regards its directional properties, it is like the carbon type in being one-sided, and therefore most suitable for the close-up technique of talks. But being free from 'blasting', it can also be used for a greater range of volume, and is reasonably good for orchestral and general work. It is however considerably less sensitive than the carbon microphone.

THE RIBBON MICROPHONE

Last, but by no means least, is the ribbon microphone. The models used are a BBC development based on principles which date back as far as 1913. However, it was not until 1934/5 that the present model was produced, and it has not yet been superseded. The actual principle of operation is the same as the moving-coil in that it consists of a conductor which moves in a magnetic field; but this time the whole of the moving element is the conductor.

Fig. 41 shows the principal parts in elevation and section.

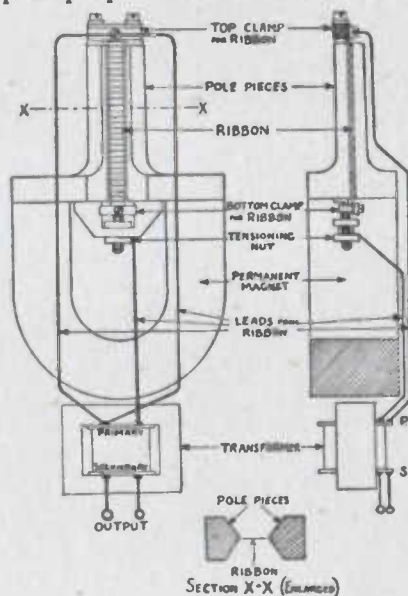

FIG. 41. RIBBON MICROPHONE : FRONT AND SIDE VIEW (WITHOUT COVERS) AND SECTION

A strong, horseshoe-shaped permanent magnet has a specially shaped pole-piece attached to each of the two poles. They form a very intense but narrow field over a gap which is about $2\frac{1}{2}$ " long and $\frac{1}{4}$ " wide. In this gap is suspended a 'ribbon' of aluminium foil, only .0002" thick and delicately tensioned so that its edges are just clear of the pole-pieces. It is corrugated for reasons to be described later. The action is quite straightforward. When sound waves impinge on the corrugated 'face' of the ribbon, it vibrates backwards and forwards and so 'cuts' the magnetic field. This, of course, causes alternating voltages to be set up across the ribbon conductor and these voltages constitute the microphone output. It is an extremely small voltage that appears across the ends of the ribbon, and again we have the problem of matching the impedance of the ribbon (this time, only 0.15 ohm) to that of the succeeding apparatus (300 ohms) in order not to lose the output by inefficient transfer. So a transformer is incorporated in the microphone itself

to perform this impedance step-up. Its 'turns ratio' is 1:45, because the impedance ratio is proportional to the square of the turns ratio (see Appendix III).

One of the first things to be noticed is that the microphone presents two 'faces', and is equally sensitive to sound on either face; a very important feature, as will be realized soon. On the other hand, the pole-pieces themselves shield the ribbon from sound waves approaching it from each side. Such waves would also form equal and cancelling pressures on each face of the ribbon. The net result is that the sides of the microphone are virtually 'dead' areas as far as sounds coming from that area are concerned. In fact, a plan of the relative response areas could be drawn as in Fig. 42. It means that both

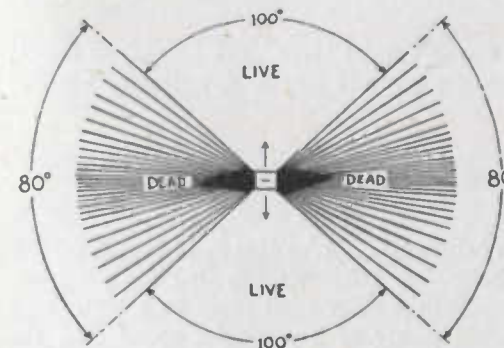

FIG. 42. DIAGRAM SHOWING DIRECTIONAL PROPERTIES OF RIBBON MICROPHONE

in front and behind the microphone, a sector which is 100° wide embraces the area in which the sensitivity is practically uniform. Of course, the usual rule applies that the further one gets away within that angle the weaker the output will be. But if one moves into the 'shaded' angle of 80° , the relative output gets gradually weaker as one approaches the exact plane of the ribbon. At this point it is absolutely dead, although it may not be apparent in actual practice. This is due to the fact that we rarely listen to sounds which come from one point only. As has been explained before, nearly all sounds in nature are reinforced by reverberations which come from surrounding walls, objects, etc. Therefore, unless the studio is quite 'dead', we shall probably hear something even if the source of the sound is in the 'dead area'.

Before going on to discuss the merits of the ribbon microphone, we will consider the remaining features of its construction. The reasons for the corrugations in the ribbon are threefold. Firstly, they increase the effective length and, therefore, the impedance of the ribbon. Secondly, they allow of delicate tensioning; in fact the ribbon itself is the 'spring'. Lastly, the sound waves hitting the ribbon are 'scattered' by the corrugations, thereby producing a more uniformly distributed movement over the whole length of the ribbon.

The overall frequency response is extremely good, being almost equally sensitive from 20 to 16,000 cycles. There is a slight increase in sensitivity at the very low frequencies, and a very small drop at the higher frequencies, but these can easily be compensated for in the design of the amplifiers which follow.

The finished microphone is always fitted with protective screens or covers. These not only protect the ribbon from injury or dust, but serve a very

special purpose. When a singer, particularly a soprano, is singing near the microphone, the ribbon is not only vibrated in the normal way, but is often subjected to 'puffs' of air. These puffs would blow the ribbon out in a bowed form and the conductor would therefore be right out of the gap! The microphone response would be materially altered and serious distortion would result. So the screens (there are two, one inside the other) are made of some material which will not stop the sound waves, but will effectively cut off the puffs of air. Chiffon was found to be the most suitable material, and this is glued on to perforated metal screens. Even so, there are still some sopranos who are guaranteed to blow the ribbon out of the gap at 10 feet! So a later type of microphone has been modified to incorporate three such screens.

Finally, the microphone is built with special 'lugs' and fixings, so that it may be put on a stand or slung from wires, and may be swivelled or tilted to any position.

THE DECIBEL AGAIN

It has been stated that the outputs of each of the microphones, particularly of the ribbon and moving coil, are 'extremely low'. This is, of course, far too vague and some scale of measurement is obviously required for precision. Here our old friend, the decibel, will help. For what could be a better unit to represent the equivalent electrical power of a particular sound than the unit which was used to compare the relative levels of sound itself? You will notice we have said that the decibel is a unit which is used to measure the relative or comparative sound volumes, because that is all the decibel is—a ratio. If one sound is louder than another, we say that it is 'so many decibels above the other' because its ratio is greater than unity and its logarithm will be positive. For example, a sound will be 20 db. above another if its power ratio is 100 times greater than the first, or ratio of $\frac{100}{1}$. On the other hand, we could say that one sound became weakened by 30 db. (or had a 'loss' of 30 db., usually written as -30 db.) if its power fell to $\frac{1}{1,000}$ of its original value.

The above shows how useful the decibel is when dealing with electrical speech currents; for we are constantly amplifying (multiplying) by valve amplifiers, and we want to know how much louder the equivalent sound will appear on the output as compared with the input. Such an amplification would be called the 'gain' and conveniently expressed in decibels. Likewise, the loss of speech currents due to resistance or impedance will be expressed in decibels, with the negative sign in front of it to denote the ratio of less than unity.

But note that we still do not know the actual, or absolute, power referred to simply by quoting the magic word 'decibel'. It has only told us the ratio between two quantities: rather like one man asking another how much he pays his servant, and getting the reply: 'Oh, I pay him one-tenth of my own salary'. Now if we only knew how much the employer was getting, it would be quite a different matter. Similarly, if we could say that a certain

volume of sound (or its electrical equivalent) were so many decibels above or below a standard power, more usually termed a 'zero level', it would immediately disclose the absolute value.

We saw in Chapter II that the 'zero' of sound had been so fixed; it was the 'threshold of hearing'. But electrical engineers, or at least, that branch of them called telecommunication engineers, have fixed their zero level in terms of electrical units, and it is laid down as being 1 milliwatt.* It is from this reference level that all absolute measurements are taken. Let us see how this works out by one or two examples. We talk of +4 db. as being the usual level which we feed to a P.O. line. What is this in milliwatts? Well, the ratio corresponding to +4 db. is given by the familiar formula:

$$10 \log_{10} \frac{P_1}{P_2} = 4$$

Therefore $\log_{10} \frac{P_1}{P_2} = 0.4$ and (there's no need to look it up: its done for

you) we find $\frac{P_1}{P_2} = 2.512$. So the actual power represented by the expression '4 db above zero', to give its full (but not often quoted) title, is 2.512 milliwatts.

Now let us go to the other end of the scale and see what we really mean when we vaguely talk of the output of a ribbon microphone being 'extremely low'. Suppose instead we become precise and say it is '-75 db' or even '-75 db below zero level'; the corresponding ratio works out to approximately

$$\frac{1}{31,620,000}$$

* It is sometimes convenient to compare two voltages instead of two powers. Provided the comparisons are made with the voltages measured across the same resistance, or impedance, this can be done by a slight modification of the general formula. For, instead of a power 'P' which is dissipated in a resistance 'R', we can always write the equivalent voltage E which must have developed across that resistance. Thus:

$P = \frac{E^2}{R}$; and applying this to the general formula:

$$N(\text{db}) = 10 \log_{10} \frac{P_1}{P_2}, \text{ we can write:}$$

$$\begin{aligned} N(\text{db}) &= 10 \log_{10} \frac{\frac{E_1^2}{R}}{\frac{E_2^2}{R}} \\ &= 10 \log_{10} \left(\frac{E_1}{E_2} \right)^2 \\ &= 20 \log_{10} \frac{E_1}{E_2} \end{aligned}$$

When we come to work out the equivalent zero level for voltage, we usually like to think of the voltage being developed across a 600-ohm resistance. So we simply have to find what voltage, applied to 600 ohms, would cause 1 milliwatt to be dissipated in it. Or, algebraically expressed:

$$\begin{aligned} \frac{1}{1,000} &= \frac{E^2}{600} \\ E^2 &= 0.6 \\ E &= 0.775 \text{ volts} \end{aligned}$$

So we say that zero voltage level is 0.775 volts R.M.S. developed across a 600-ohm resistance.

which gives us the remarkably small output power of approximately 0.0000003 milliwatts.

Now compare that with the power which is liberated when you have amplified it up to the ultimate 100 kilowatts that the broadcast transmitter pumps out into the aerial. We have magnified the original output of the microphone by 3,000,000,000,000,000 times. The moral is, of course, never to say anything in front of a microphone that you wouldn't like your friends at the transmitter to hear !

Perhaps some of you will be wondering what relation these 'electrical decibels' bear to their acoustical cousins of Chapter II. The ratio part is, as already explained, the same in each case ; for they are both obtained from the formula, $10 \log_{10} \frac{P_1}{P_2}$. But it should be quite obvious that the two 'zero' levels are different, otherwise it would imply that the threshold of hearing was equivalent to 1 milliwatt. Just how wrong that would be is proved by taking the case of ordinary conversation which was quoted as being 55 db. above the threshold of hearing. That would work out to 316 watts, enough to boil a kettle in a few minutes . . . hot air indeed !

The acoustical zero is a very small value compared with the electrical one, and is actually found to be 70 db below 1 milliwatt. Perhaps we could get a clearer picture if we were to draw the scales as in Fig. 43. That has been rather a long digression on the decibel again—particularly as this Chapter

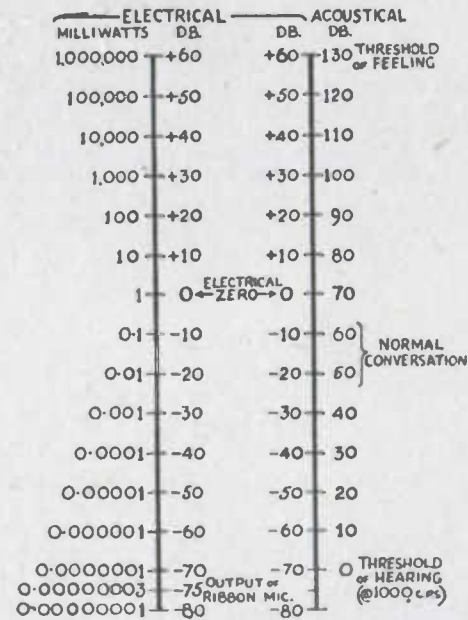

FIG. 43. COMPARISON OF ELECTRICAL AND ACOUSTICAL DECIBEL SCALES

is headed 'Practical Apparatus'—but it really is important to understand the unit which is so much used in broadcast engineering.

Before leaving the subject of microphones, we might as well find out their output levels, this being the reason for the above diversion. The Reisz type gives approximately -35 db.; the moving coil type gives an average output of -55 db., whilst the ribbon has only -75 db. to offer us. When we talk of average output, it means that the actual output will vary above and below this according to the range of sound impressed upon it. Thus, if the range between 'pp' and 'ff' of an orchestra is 40 db., then the output of the ribbon microphone may be as low as -95 db., and as high as -55 db.

MICROPHONE MIXERS

The next link in the broadcasting chain is the mixing of the outputs of several microphones. Let us take the output of one microphone and try to add the output of another one to it. This can be done quite simply by joining the two sets of output wires in parallel. Thus the two outputs will be well and truly mixed—electrically—and if subsequently amplified and listened to on a loudspeaker, the two sources of sound will be heard as one. If we didn't want them mixed, then we could employ a switch to cut the undesirable one out. That sounds very simple but there is a snag in it, for supposing we found that one of the microphones picked up too much and 'drowned' the other; or supposing we wished to make a gradual change from one microphone to another, the switch wouldn't be suitable. How then can we reduce the output of a microphone, short of moving it further from the source of sound ?

If you remember Ohm's law, you will see that the current produced by a given voltage is inversely proportional to the resistance in the circuit. Let the 'given voltage' be the output of the microphone; the current is what we want reduced, so the resistance must be the reducing agent. That is exactly what is done; the only thing is that it must be a variable resistance if we want to obtain varying degrees of reduction. The circuit for one single microphone and its 'fader' would then become as in Fig. 44.

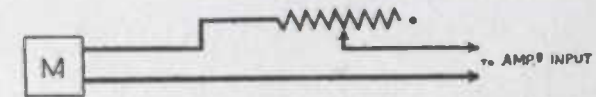

FIG. 44. A SIMPLE 'FADE-UNIT'

It is a simple step to extend this into a mixing unit for more than one microphone, and the next diagram (Fig. 45) shows how this is done :

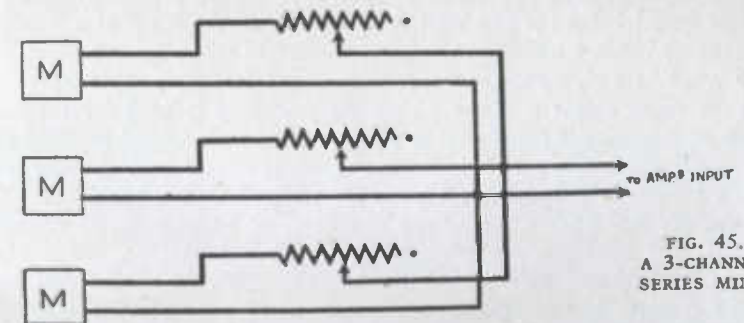

FIG. 45. A 3-CHANNEL SERIES MIXER

The example in Fig. 45, which is a very practical piece of apparatus found in every listening room of multi-microphone studios, is not the only way of doing the job. As a matter of fact, it suffers from certain disadvantages, mostly bound up with the question of 'unbalance'. This business of unbalance simply means that it is important to keep the resistance of each wire of the pair (between the microphone and amplifier) equal in value. We shall soon see the reason for this, but meanwhile let us just look into some other means of constructing a mixing unit.

A refinement of the method shown above is to put a variable resistance in each wire from the microphones (these wires are often referred to as the two 'legs' of the line). Then, when the knob of the mixer is turned, it is arranged to move both of the sliding points together. Such an arrangement forms the basis of the type of fade unit used on O.B. work, and is shown diagrammatically in Fig. 46. One small point about this mixer (or to give it its proper title,

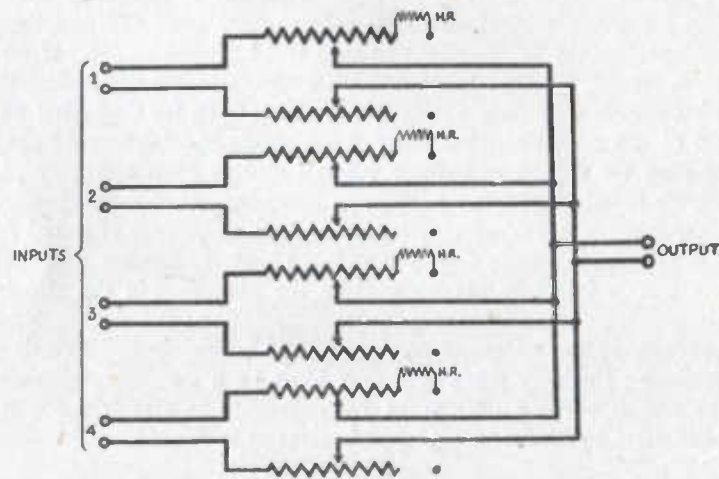

FIG. 46. 4-CHANNEL, BALANCED SERIES FADE UNIT

the 'four-channel balanced series fade unit') is the inclusion of the high resistance (H.R.) between the last stud of the variable resistance and the 'off' stud of one leg of each microphone circuit. It is a static leak and has a value of 20 megohms, its purpose being to preserve continuity even when the microphone is faded out, and so allow any potential which might develop on the microphone leads (e.g. static charges) to leak away gradually. Otherwise, a charge would build up and wait to leak away in the form of a sharp flow of current, or 'click', whenever the microphone was faded up.

The word 'stud', mentioned above, may call for some explanation. You may have come across a variable resistance, such as is used for the volume controls of commercial radio sets, in which the movable 'arm' revolves round, and actually touches, the resistance wire which is wound on a circular former. Such an arrangement may be adequate for commercial receivers, but it is not good enough for BBC work, where one click or rustle may be reproduced on millions of receivers. A more robust design is called for, and the 'stud-by-stud' method not only fulfils this but also does something else for us. It enables us to fix the resistance element between each two studs, so that

every step of movement represents a definite 'loss' which can be marked off on the knob-scale. It is shown in Fig. 47 in both diagrammatic and pictorial form; and Plate V shows a photograph of one particular type. It will be

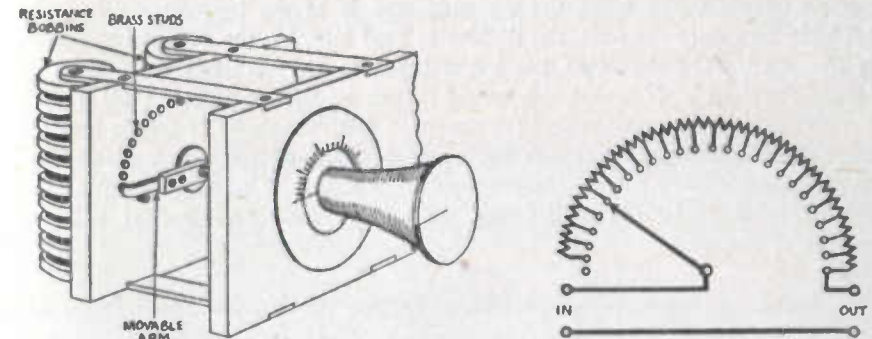

FIG. 47. PICTORIAL AND DIAGRAMMATIC SKETCHES OF A 'STUD-BY-STUD' VARIABLE RESISTANCE

seen that the resistance is split up in little sections, or elements, joined in series, their junctions being soldered to the brass studs. Over these studs moves the arm or 'brush' which makes very good contact owing to its switch-like construction.

A third type of mixer, usually found on the gramophone unit, utilizes the potential divider for its operation; this is because a series type cannot easily be designed with the extremely high resistance that would be needed to secure a gradual fade; for the impedance of the gramophone pick-up is high, and the resistance of the fade unit has to be comparable with it.

THE CONTROL POTENTIOMETER

Before leaving the fade units likely to be found in broadcasting, let us look ahead a little, and study the construction of the special type of volume control known as the 'control potentiometer'. This, as has been stated earlier, is on the potential divider principle, but it is not quite as simple as it looks. One of the requirements of a potentiometer at this particular stage is that it should present a 'constant impedance', not only to the output of the 'A' amplifier, but also to the input of the 'B' amplifier. If we look at the state of affairs that would exist with an ordinary potential divider in circuit, it would come out as in Fig. 48. A little careful study will show that when the arm is at the top of the potential divider, the 'A' amplifier is feeding into a

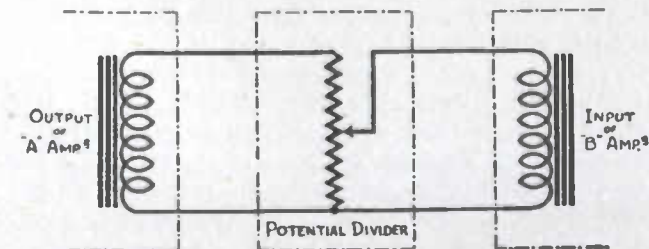

FIG. 48. A SIMPLE POTENTIAL DIVIDER USED BETWEEN AMPLIFIERS

total resistance made up of two resistances in parallel (i.e. the potential divider, plus the 'B' input transformer). Similar conditions prevail for the total resistance which forms the input circuit of the 'B' amplifier. To take the other extreme case; when the movable arm is at the bottom position, the 'A' has now only the potential divider to feed into, i.e. the output impedance is increased. On the other hand, the input to the 'B' has been virtually 'short-circuited'. Not that this would matter on that particular ('off') stop, but think of the conditions in between these two extremes. It means that the impedance 'matching' changes for every position of the potential divider. Since mis-matching causes distortion (due to a variety of reasons which are too technical to be discussed here), we must use an arrangement whereby

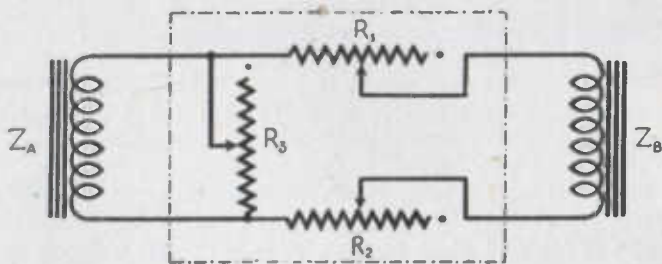

FIG. 49. THE 'P.3' OR CONSTANT-IMPEDANCE POTENTIOMETER

the impedance does not change, and Fig. 49 shows how this is done. The three arms of R_1 , R_2 , and R_3 are mechanically coupled together, and move in such a way that when the series portions (R_1 and R_2) are increased, the shunt portion (R_3) decreases its resistance. In this way the total impedance (not forgetting to take the input and output impedances, Z_A and Z_B of the 'A' and 'B' amplifiers, into consideration) is kept constant. The whole device is popularly known by its type number, 'P3', but it also enjoys variations such as 'control potentiometer', 'potential divider', 'potentiometer', or 'pot'meter' . . . whilst 'P3' is often applied (quite wrongly) to fade units which are not of that type.

THE BALANCED LINE

Having dealt with all these types of mixers, etc., let us return to the listening room and follow the route of the still tiny microphone currents. We had reached the stage where the 'programme' had left the mixer on two wires, and at a level of -75 db. The problem is now, 'Can these two wires be extended to the control room, perhaps more than 50 yards away, without any trouble being experienced?' The answer is, unfortunately, that they cannot. This is because there is almost bound to be a wealth of 'interference' from electrical equipment in a large modern building, in the form of stray electrostatic and electromagnetic fields. These fields are caused by power supplies, switch contacts sparking, lift and fan motors, and a hundred and one other sources. All of these are waiting to bear down on our -75 db. output and get themselves superimposed on the programme. How, then, can we keep them off?

The first method is by screening, which means surrounding the two wires

by a metallic sheath (usually lead-covered cable is employed) and earthing this sheath or screen. The result is to minimize the effect of electrostatic fields inside the shield, but electromagnetic interference is rather more difficult to counteract. Another method has to be employed, and it is rather a cunning one. It will be described in detail here, because it uses a principle which is even more important in our later work on transmission over long P.O. lines.

If we consider a pair of wires over which programmes (that is, alternating currents) have to be sent, the important thing to remember is that at any one instant the current is flowing along one wire and back in the reverse direction over the other wire. Let us draw such a line (Fig. 50) and terminate each end by a transformer. The arrows show the direction of such a programme current

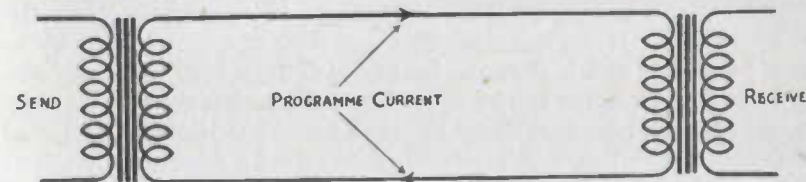

FIG. 50. BALANCED LINE, SHOWING (INSTANTANEOUS) DIRECTION OF PROGRAMME CURRENT

at a particular instant, and this current will flow through the primary winding of the receiving transformer. Consequently, there will be a corresponding programme current induced in the secondary, which is what we want.

Now let us introduce a source of interference at some point along the line. It will have to be some sort of electromagnetic induction, because we have assumed the pair to be screened against electrostatic fields; and this is shown on the next diagram (Fig. 51) in the form of a neighbouring coil. Let us

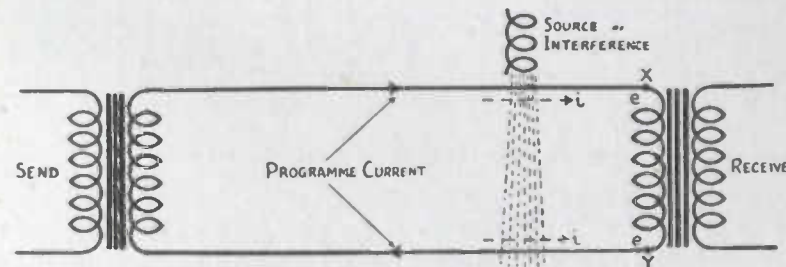

FIG. 51. BALANCED LINE, WITH INTERFERENCE CURRENTS INTRODUCED

consider the effects of this induction on the line. The line itself consists of two wires which are closely twisted together. Therefore, if a current is induced in a given direction and of a certain strength in one wire, it is almost certain to be induced in equal strength, and in the same direction, in the other wire (as shown by the dotted arrows, marked 'i'). These 'noise currents' will travel along the two wires and eventually arrive at the receiving transformer. If the two wires are exactly 'balanced'—and that means that they must have exactly the same ohmic resistance, the same insulation resistance to earth, and the same capacity to earth—then the two little 'i's' will produce

equal voltages 'e' at each end, 'X' and 'Y', of the transformer winding, or, in other words, there will not be any 'potential difference' between 'X' and 'Y' due to the electromagnetic interference. And if there's no potential difference, there is nothing to drive a current through the coil. Therefore, no magnetic field is created in the transformer by these 'longitudinal' currents, as they are called, and the interference is not passed on to the secondary.

Another way of looking at it is to imagine that the two voltages 'e' do cause a current to flow through the primary winding; for example, we may connect the exact centre point of the winding to earth. But the currents will flow from each extremity to the centre, and these are in opposite directions. Consequently, they will set up opposing magnetic fields which will, in turn, cancel each other and there will be no effect on the secondary winding. These transformers, which are carefully made pieces of apparatus—themselves carefully balanced as regards resistance and capacity—are known by the name of 'repeating coils'. You will hear more of them later, especially when we come to P.O. lines, but just let us see how the complete microphone circuit looks. By the way, this arrangement gives us a method of joining 'unbalanced' to 'balanced' apparatus, and is another reason for its use here. When the BBC changed over to ribbon microphones, a lot of the existing apparatus, e.g. the mixer unit, was of the unbalanced type and it was not economical to replace it all. Hence the usefulness of the repeating coil. The completed diagram of the microphone to 'A' amplifier may now be drawn (Fig. 52) and should be self-explanatory.

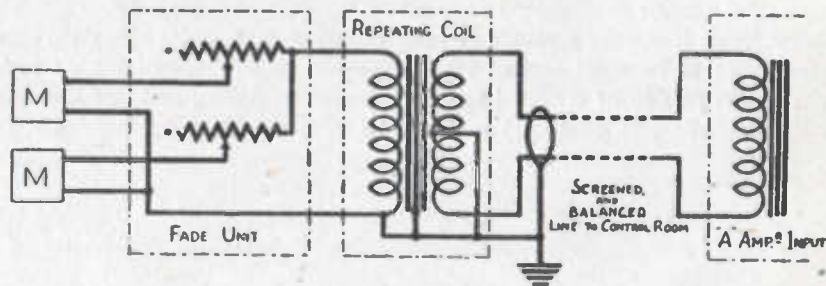

FIG. 52. COMPLETED MICROPHONE CIRCUIT

THE GRAMOPHONE UNIT

A note on the general arrangement of the gramophone unit would not be out of place before leaving the listening room, although a complete description of its detailed working will be given under the chapter on recording.

The unit consists of twin, electrically driven, turn-tables, with the two 'pick-ups' controlled individually by their own mixers. As has been explained earlier, these are not of the series type, but of a special potentiometer arrangement. The combined output, carrying the programme currents, cannot be mixed in with the microphone circuits straight away for two reasons. First, the output of the pick-ups is not considered to be 'ideal' as regards quality and a certain amount of correction has to take place. This is done by a specially designed circuit which incorporates 'bass correction and scratch filter' (BC/SF on the diagram), and which is included to improve the quality. The second operation to be performed is to decrease the level of

the gramophone output. This is necessary because the output of a pick-up is very much higher than that of a microphone and the two would not be easy to mix: unless we remembered to keep the gramophone fader on a very low stop, and so decrease the available range. So an attenuator is put in circuit before the mixing unit, and the complete scheme looks like Fig. 53.

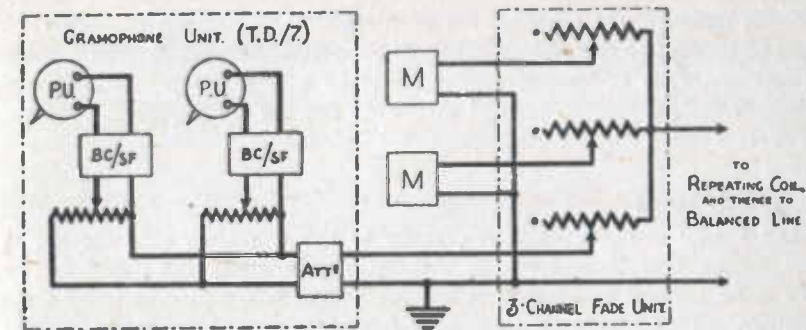

FIG. 53. MICROPHONE AND GRAMOPHONE CIRCUIT

We can now arrive in the control room with the pair of wires carrying the programme and we must follow its progress to the point of leaving on the P.O. lines. We have already seen how careful we must be in the wiring itself, and this care has to be exercised throughout; yet, at the same time, we have got to preserve 'flexibility' and so cannot join up the chain of amplifiers permanently.

CONTROL ROOM WIRING

To the casual onlooker, the final result of the wiring scheme which has been adopted may look unwieldy and far too elaborate. Nevertheless, it is the scheme which has been found from long experience to be the only one which is completely satisfactory. What, then, is the method?

The 'pair' which comes from the studio is brought up to a 'main distribution frame' (M.D.F.) in company with every other pair that either enters or leaves the control room. The M.D.F. is simply an iron framework on to which are fixed a number of ebonite blocks; each block having a large number of small 'soldering tags' projecting from it. A pair of wires can be soldered to each pair of tags, and generally each particular block is reserved for a group of similar units, e.g. all studio output lines, or all listening room loudspeaker lines (outgoing). Thus another block on the frame would be wired up to certain apparatus in the control room itself, and it now becomes necessary to interconnect these tag-blocks. This is done by means of 'jumper-wiring', which—as its name implies—means pairs of wires which 'jump' across from one tag-block to another. The result of this is rather an 'orderly chaos'; and can be regarded as a sort of 'Clapham Junction' of all the circuits (Plate VIb).

If we continue to follow our programme wires, we find ourselves leaving the particular block marked "'A" amplifier inputs' and the wires are again of the lead-covered, single pair, type, known as 'one pair 10'. (This is a P.O. term by which the size of wire is designated: it means that one mile of one of the twin conductors would weigh 10 lbs.) This pair will travel along underneath the floor—in ducts—to the apparatus bays. All the apparatus

in the control room is mounted in 'bays' and known as 'rack-mounted' equipment. The bays themselves consist of two steel uprights, provided with fixing holes for screwing on standard-sized panels on which the various pieces of apparatus are mounted. At the back of each bay, at the foot near the ducts, is another tag-block. It is here that the pairs from the M.D.F. are soldered.

From these tags is a further set of wires which travel up the sides of the bay and connect to the various pieces of apparatus, whether they be amplifiers or switches, coils or 'jacks' (to be described very shortly). All this wiring is known as 'permanent wiring' and, once decided by the specific design of the control room, will remain in position indefinitely.

PLUGS AND JACKS

The wiring is not connected directly to the amplifier, etc., for the very good reason that these links in the chain may easily fail; and we must have some method of taking out the faulty link and replacing it by a spare instantly. This brings us to a very humble piece of apparatus which is, at the same time, an extremely important one, the 'breakjack'.

The best way to regard the breakjack and its companion—the 'plug'—is to compare it with the simple domestic 'plug and socket'. You must know that if you wish to connect, say, a vacuum cleaner to the electric supply mains, you do not get hold of the two bare wires and twist them round similarly bared mains wires! Instead, you have an outlet in the form of a socket which is permanently connected across the mains. In a similar manner, the flexible connection to the vacuum cleaner will be fitted with a two-pin or three-pin plug which will fit into the socket. When the operation is completed, the two wires of the vacuum-cleaner will be connected, neatly and safely, to the two mains wires. The third pin, if there be one, will make a connection between frame or case of the vacuum cleaner, and 'earth'.

So we do a similar operation to connect control room apparatus and lines, but the plug and socket are quite different from the mains variety. The type of plug used has been in use for years by the G.P.O. and is found in large numbers on all telephone switchboards. The essential parts, the 'pins' to which the wires have to be connected, seem to have got lost; but they are there, in concentric form. Fig. 54 and Plate V shows the plug, and it will

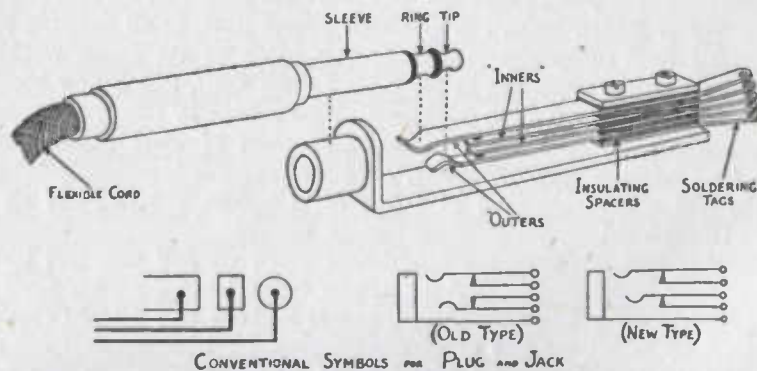

FIG. 54. PLUG AND BREAKJACK (WITH CONVENTIONAL SYMBOLS)

be seen that the two contacting parts are the 'tip' and the 'ring'. By its side will be seen the special socket which is made to accommodate the plug, and this is the breakjack. Viewed from the front, it simply gives the appearance of a 'hole in the panel', and takes up a very small space indeed. When the plug is pushed home, the tip and ring make contact with the two bent springs called the 'outers' on to which the programme-carrying wires are soldered. So far, the action is identical with our vacuum-cleaner plug and socket; but what are all the other little 'refinements'? First is the 'hole' itself. It is made of brass, and in addition to acting as a guide for the plug, it will be seen that the brass body, or 'sleeve', of the plug makes contact with it. This is a very useful feature for it enables us to continue the electrical connection of the 'screening' which is usually found round the pair. Fig. 55 shows how this is done more clearly than can be described. In fact, the 'sleeve' may be

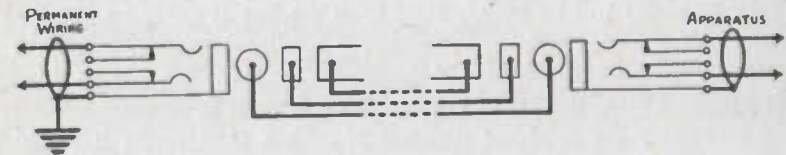

FIG. 55. USE OF THE 'SLEEVE' CIRCUIT

likened to the third pin often found on domestic plugs and sockets; especially as this is usually connected to 'earth' in both cases.

The second addition seen on the breakjack is the feature which gives it its name, viz. the two inner contacts, which press on the outer contacts and make contact with them. That is, they make contact when there is no plug in the jack; but as soon as the plug is inserted, the outer springs are pushed apart and break contact with the 'inners'. The whole arrangement forms, in fact, a kind of 'switch plug'.

'NORMAL' WIRING OF BREAKJACKS

Now to what sort of use can we put this? Consider the case where the programme has arrived on a pair of wires and this pair is soldered to the 'outers' of the jack. We then have another jack, whose 'outers' go off to an amplifier input. That is the sort of thing that occurs hundreds, if not thousands, of times in the broadcasting chain, and the job that has to be done is to connect the 'line' to the 'apparatus'. Right! What about using a flexible cord with a plug at each end (hereafter referred to as a 'double-ended cord') and using that to connect the two jacks? Admittedly it will do the job, but there are two small drawbacks. Firstly, it would need a lot of double-ended cords to connect up all pieces of apparatus; which, besides being untidy would be expensive. Secondly, and more important, is the difficult job of changing over the amplifier if it developed a fault. It would mean pulling out the plug, with consequent break in programme, and putting it back into the jack of the spare amplifier.

Now let us connect the two inners of one jack to the inners of the other jack. Fig. 56 shows the arrangement, and it will be observed that the line has been connected to the amplifier without the use of plugs. The wiring which connects the inners together is called 'normal wiring' because it



FIG. 56. BREAKJACKS 'NORMALLY' CONNECTED

means that the line will be normally connected to the amplifier without any external connection. The saving in cords and plugs is obvious and at the same time there is a second advantage. It is that of being able to plug up a spare amplifier without a break in programme. For it is now possible to put one plug of a double-ended cord into the apparatus jack of the spare and then to insert the plug at the other end into the line jack of the line feeding the original (faulty) amplifier. When this operation is performed, the faulty amplifier will be broken away from the line at the same time as the new amplifier makes contact. Naturally, a similar operation will have to be performed simultaneously on the output of the amplifier, but as this will also be provided with 'normalised breakjacks', it is quite easy.

Before drawing the complete diagram of such a changeover, it would be as well to mention a little refinement that is found on certain sets of breakjacks. It still remains true that the essential jacks are the two . . . 'line' and 'apparatus' . . . but you will often come across them in sets of three. The use to which we put the third one is this. Let us suppose that an amplifier in the chain was suspected of being faulty and we wished to listen to its output to make sure before changing it. For convenience, all pairs of headphones are terminated by means of a plug, and this plug can be plugged into any jack to make contact with any pair of 'programme' wires. If we had only the two-jack arrangement, which one would you plug the 'phones into to listen to the amplifier? Those who suggest the 'apparatus' jack would be quite right in so far as they would quite definitely hear the output of the amplifier. The only trouble is that whilst they are hearing the programme, nobody else will!! We can easily overcome this state of affairs by the provision of a third jack, called the 'listen' jack, and it is wired up to form a famous trio, as in Fig. 57.

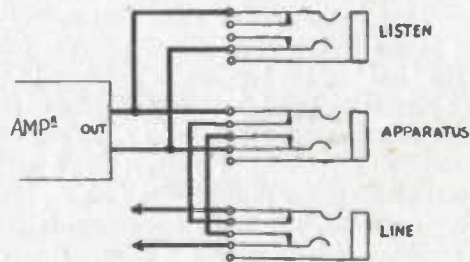

FIG. 57. THE USE OF A 'LISTEN' JACK

The operation should be fairly obvious. Incidentally, it comes in very useful in another way; for instance, we may want to put a second amplifier in parallel with another one (not instead of it). To do this, we can 'double-end' the 'listen' jack of the first to the 'apparatus' jack of the second. This scheme, together with the operation of changing over to a spare, will be seen combined in Fig. 58. It may look a trifle complicated, but the actual operation is

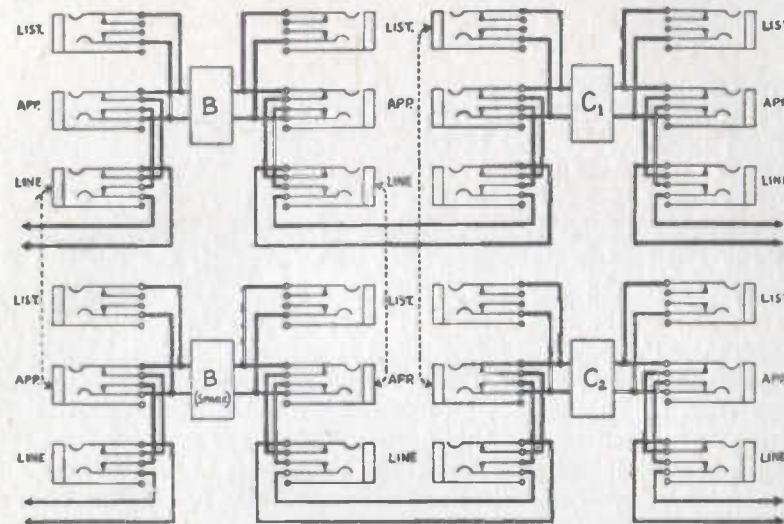

FIG. 58. CHANGING AND PARALLELING AMPLIFIERS BY MEANS OF BREAKJACKS

extremely simple. The use of breakjacks in a control room is so extensive, and proves so useful, that broadcasting engineers should become very well acquainted with the method of wiring. If you can visualize the connection simply by gazing at hundreds of little round holes (they are, of course, all clearly labelled as to their function) then more than half the battle of knowing the control room is already won.

We can summarize the wiring arrangements in this way. The connection of apparatus is made in two ways, viz. by permanent (screened) wiring, or by flexible wiring. The permanent wiring is connected to breakjacks which are, in turn, 'normalised' to successive breakjacks; flexible cords make connection to the jacks by means of plugs. The complete scheme (Plate VIa) allows of great flexibility in the way of using any piece of apparatus as a spare to another; it is neat and orderly; the permanent wiring is adequately 'screened', and the sleeve-circuits of jacks automatically extend the earthing of such screening to other cables.

THE 'CHAIN' IN DETAIL

With the above wiring, we now follow the chain of amplifiers, etc., a little further. The first amplifier is the 'A' amplifier and its function is to raise the level of the microphone output (-75 db.) to a 'reasonable value'. This level has been decided upon as being -10 db. Why that is cannot be discussed here, but you will see—as we go along—that our aim is to raise the level from the low microphone output to the level of +4 db., which is the maximum level we can put on a P.O. line. Just why it is not convenient to do it in one step should become obvious before the end of this chapter.

The 'A' amplifier, then, is a device that gives us a gain of 65 db. If we were to feed it with the output of a moving coil microphone, whose average output is -55 db., and kept the gain at 65 db., then the level would be raised to +10 db. But this is 20 db. above what we agreed was 'reasonable', and so we arrange for the 'A' amplifier to have what is called 'variable

gain', and adjust it to be 20 db. less when using a moving-coil microphone.

SWITCHING ARRANGEMENTS

The output of the 'A', via its usual set of breakjacks, then goes to the 'B input switching' (it will be advisable to refer to the block schematic, Fig. 38, of the previous chapter). Just how this switching is accomplished cannot be described in detail, for there is more than one method, and it can be quite complicated! It could, of course, be done by simply plugging the output of any 'A' to the input of any mixer channel, and this is a good 'standby' should the automatic devices go wrong! One automatic system is very much on the lines of a 'dial' type telephone exchange. Another, and more usual design, will be described in general terms here; but it must be remembered that the real scheme is very much more complicated. The scheme relies for its operation on remote-controlled switches called 'relays' (which will be dealt with in detail later). There are many of these relays arranged in vertical and horizontal rows; the sources of programme such as 'A' and 'D' outputs are wired to each vertical row of relay contacts, and the horizontal rows are wired to the mixer channel inputs. Fig. 59 shows this for five sources and two mixers, each with two channels; but it may be extended to any number of sources and channels. The particular conditions

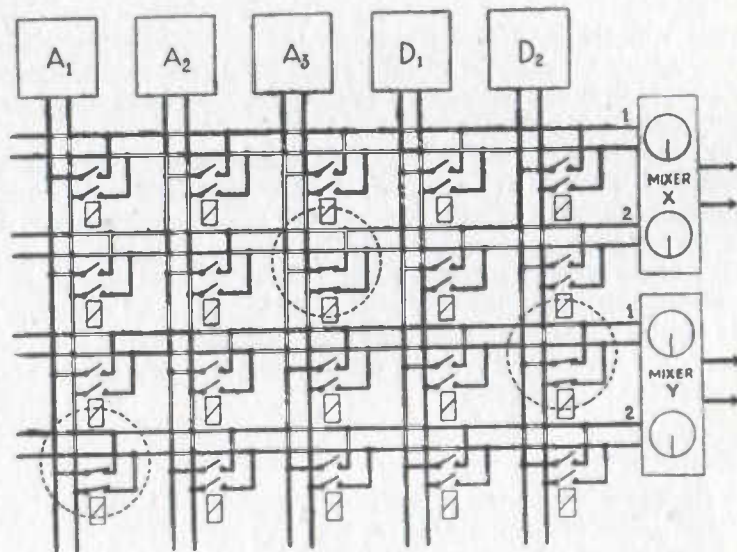

FIG. 59. GENERAL SCHEME FOR CHANNEL INPUT SWITCHING

shown indicate that channel 1 of mixer 'X' has nothing connected to it; channel 2 has source 'A₁'; channel 1, mixer 'Y' has got 'D₂', and channel 2 of that mixer has 'A₁', switched on to it. The switch contacts are the things which are operated remotely, and this gives us a method of being able to have several sets of operating switches for one set of programme switches. In this way all the programme apparatus may be kept grouped together on its rack-mounted fixing, whilst the operators can be seated around at the various control desks. The arrangement shown does a little more than

switch any source to any channel; it 'interlocks' by special circuits, the finished operation, so that two sources cannot be accidentally put on to one channel. It also switches on the power supplies to the whole chain of amplifiers concerned, and usually causes some sort of indicating lamps to light up as well.

The little device which does all this work for us is the relay, and whilst (like jacks) there may be thousands of them in a control room, if you know how one works, you can easily follow the rest of the working. It is an electro-magnetic device, and consists of a small core of iron surrounded by a coil of wire (see Fig. 60 and Plate V). When a current is passed through the

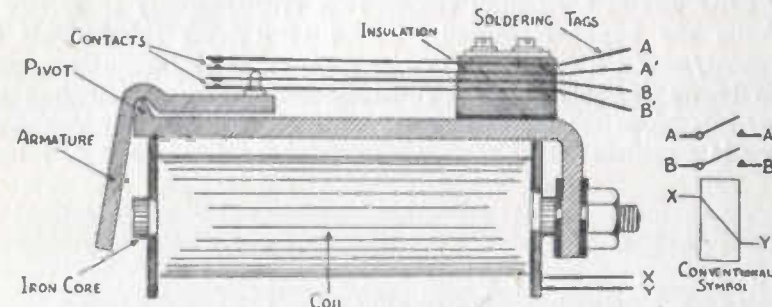

FIG. 60. THE RELAY

coil, the iron core becomes magnetized and attracts the iron 'armature' (the technical name given to any piece of iron which moves under the influence of a magnetic field). The armature is pivoted so that, when it moves, the other end pushes together (or apart) some switch contacts. The number and type of these secondary contacts may vary considerably; as many as eight 'make' and 'break' contacts being permissible. Such a relay would appear at every junction of the vertical and horizontal lines of programme switching; and this alone would account for thousands of them in a large control room where, say, the number of sources may be 50 and the number of channels equally large.

The type of switch which is used to complete the operating circuit (coil) is usually either of the 'key' or 'push-button' type. These are shown diagrammatically in Fig. 61 (and Plate V) and, like the relay, may be simple or complicated, according to the particular job they have to do.

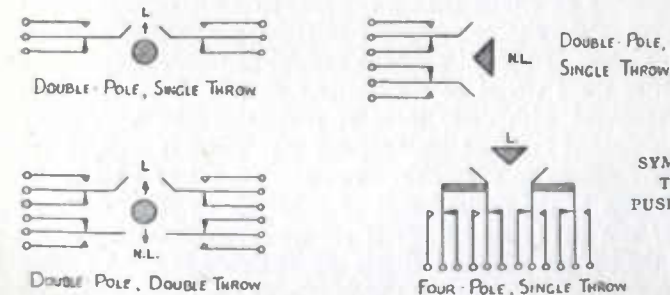

FIG. 61. SYMBOLIC DIAGRAMS OF TYPES OF KEY, AND PUSH-BUTTON SWITCHES

The small round circle which mechanically pushes the spring contacts is actuated by pressing the little 'handle' which projects through the front

panel on which the switch is mounted. Because it is pivoted, it therefore moves in the opposite direction to that shown on the diagram (which is always drawn as if looking from the back) and this must be borne in mind when reading drawings. The letters 'L' or 'NL' simply mean 'locking' or 'non-locking' and refer to the particular action, i.e. whether they stay put or not when pressed.

'PRIVATE WIRING'

Besides the operations already described, manually operated switches have many other uses in the control room. It is often necessary to be able to switch on any amplifier manually, instead of it being switched via the programme/relay system. To do this we make use of auxiliary relays, and a system known as 'private wire' switching. We will also introduce still another method in the same diagram, just to show how easily things can be done in a modern control room. On the left-hand side of Fig. 62 a small

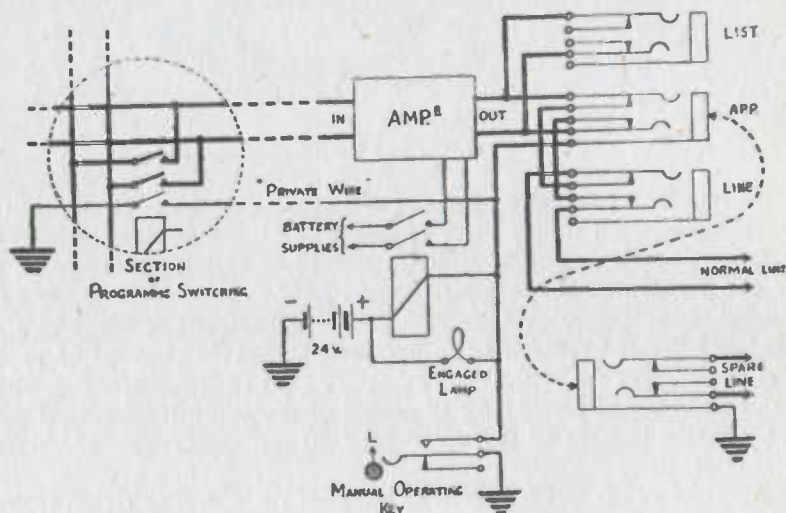

FIG. 62. ILLUSTRATION OF 'PRIVATE WIRE' SWITCHING

portion of the programme switching (which has already been described) and one only of the relays is shown. In addition to the two main contacts for programme switching, there is a third one, one contact of which is connected to 'earth' (in practice there would be six contacts on this particular relay, but we are only concerned with these three at present). The wire which leads away from the contact is called the 'private wire', and it leads to the amplifier which it is supposed to switch on. You can trace it to a relay, the other side of which goes to the positive side of a 24-volt battery. Now as the negative pole of this particular battery is always earthed, the relay will operate every time the private wire is earthed, and in doing so can be made to perform several operations. This time we want it to switch on the amplifier, so we connect the secondary contacts to the low tension (L.T.) supply and this will do the job. You will learn why in the next chapter. At the same time, a small lamp connected across the relay will light up and indicate that

the amplifier is 'engaged'. Now we have said that earthing the private wire will operate the relay which switches on the amplifier; so that we need only extend this private wire to a manual switch and arrange for this key to put an earth on it, and the same operation will be performed. This is very useful, for, to cross-plug to a spare amplifier could not easily be accomplished if all the 'normal' amplifiers in the chain had to be switched on solely by the automatic devices, and a spare could not be switched on manually.

Finally, the other method of switching it on would be to extend the private wire to the sleeve-circuit of the apparatus jack. Then, if we were to plug the output-jack to a line-jack whose sleeve-circuit was earthed, again the amplifier would be switched on.

Another use to which 'keys' are put is in signalling, or other cue circuits. This means that we wish to operate a coloured light (red or green) in the studio from a remote place, say the control room. This looks a fairly easy job on the face of it, but remember that the contacts on these switches are fairly 'delicate' and not capable of carrying the large currents that would be required to operate the 'mains' lamps in a studio. Neither would it be advisable to have large currents constantly being switched (with the inevitable 'clicks') in close proximity to all the programme-carrying wires of the control room. So we only call upon the key-switches to perform the light duty of operating a relay, which itself is situated in the studio. The secondary contacts of this relay are then used to complete the mains circuit to the studio signalling lamps.

ALARM CIRCUITS

Other uses of keys and relays are so great that a complete catalogue would be impossible in a book of this size. However, we will finish up with just one more example which is rather interesting. It is one of the many alarm arrangements that are called for in a control room, for it must be obvious that there is such a lot of apparatus that it cannot all be watched at once. Therefore, if anything goes wrong, it should more or less 'cry out for help', whereupon the fault can be rectified before the piece of apparatus is next required.

Let us take as a simple example an ordinary 'fuse'. Fuses are very necessary in every circuit where power supplies are concerned, whether they are for 3 or 300 volts. The type which is of particular interest to us is the self-alarm type as used by the P.O. When the fuse wire melts due to an overload, it releases a spring on either end of it. The front spring drops a little 'flag' which makes it conspicuous in that particular row or panel of fuses. At the same time, a rear spring makes contact with a bar of metal which runs along the back of each row of fuses. When this happens, it causes a relay to operate. From now on it is only a matter of clever design to do practically anything! In practice, the operations are these. The relay causes a lamp to light at the end of that particular row of fuses; it causes another lamp to light over the bay of fuses (there may be many such bays in a large control room); and finally, it causes an alarm bell to ring. Fig. 63 (which is part-pictorial, and part-circuit diagram) shows the seemingly complicated happenings every time a fuse blows, and it is a good exercise to try and trace the sequence of events.

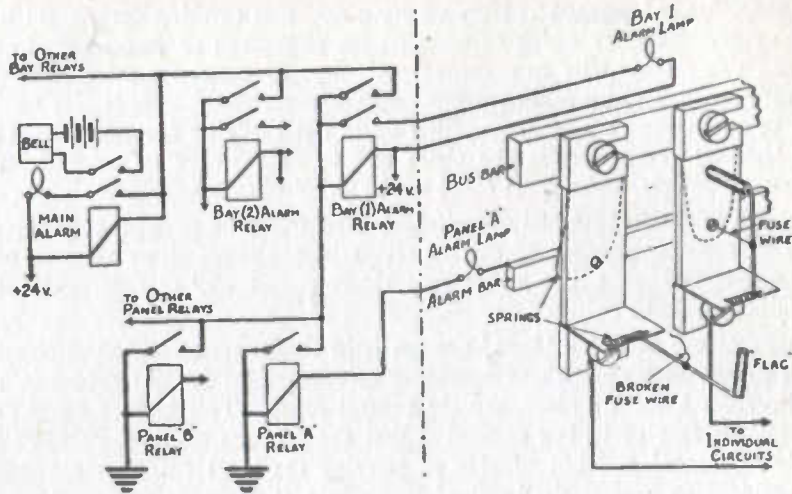

FIG. 63. FUSE ALARM CIRCUIT

ANOTHER TYPE OF 'MIXER'

If we return to the programme in whose route we were particularly interested earlier in the chapter, we shall find that we had got as far as the 'source mixer'. As has been said before, this can be of the same type as the microphone mixer, and, indeed, often is. But there is another type which is worthy of our attention, and which was at one time a feature of every control room. Its operation will therefore be described here very briefly. The main difference is that it employs only one knob for two channels; the two fade units being coupled together mechanically as well as electrically. Fig. 64 shows only one 'leg' of each channel, whereas the full circuit is really a balanced one, with a similar circuit in each leg.

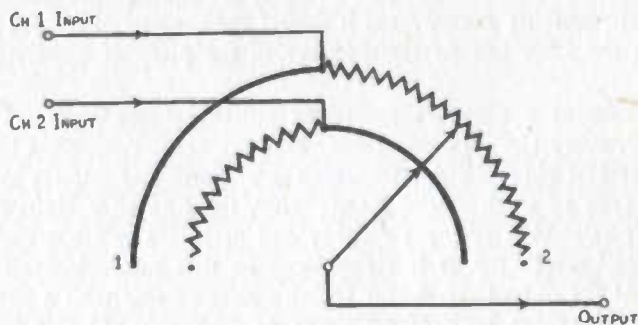

FIG. 64. TWO-CHANNEL FADE UNIT

The operation should be fairly clear. When the moving arm is completely over to the left, it picks up only that which is on channel 1. When it is moved up on to the first stud, it continues to pick up channel 1 at full strength, but also begins to superimpose a small amount of channel 2. As the movement in a clockwise direction is continued, channel 2 is mixed more and more

strongly until, at the mid position, both channels are mixed together equally. Further turning keeps channel 2 at a maximum, but channel 1 gradually fades out. That looks, and is, fairly simple: but consider now how four channels are so treated. The first requirement is another similar device for mixing channels 3 and 4. This naturally leaves us with two 'outputs', and the problem is what to do with those. Fig. 65 shows that this is answered by taking them to a third mixer, called a 'central mixer', of a similar type to the others.

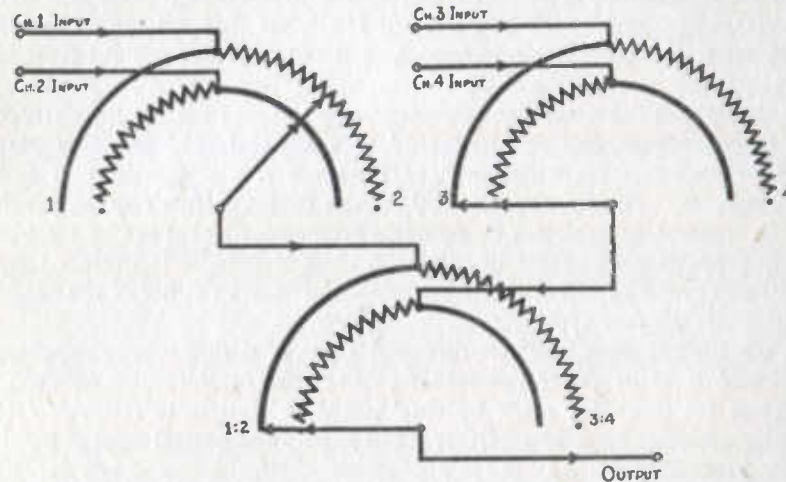

FIG. 65. FOUR-CHANNEL FADE UNIT

One fact should stand out from the above (apart from any criticisms as to its ease, or otherwise, of operation) and that is that at no position can every channel be faded out. We can have three of them in the 'off' position, but it always leaves one completely 'in'. Is that an advantage or a disadvantage? That will best be answered when we see what it implies, which is that we are forced to do our main fading in and out on the control potentiometer. In the particular circumstances, which are bound up with the electrical and mechanical design of the control potentiometer, this is the best way to fade a programme. It means, of course, that an extra operation has to be performed as compared with the usual procedure on a 'one-knob-per-source' type mixer, but the knack is soon acquired by practice, and the final choice of type becomes mainly one of psychology, or 'which type will inspire least operating errors?', and the answer will be left to the operator.

Having mixed, or faded, any source of programme and put it into its correct place in the chain, we have, at the output of the mixer, a complete programme. But reference to the general outline of the broadcasting chain tells us that the volume range of this programme is not all it should be, and will have to be compressed. This is done by the control potentiometer, and as this has been described in detail earlier in this chapter, we shall not spend any more time on it here.

After its compression, the 'loss' in the potentiometer is made up by the 'B' amplifier, and thence the programme passes out to the various P.O. lines via the 'C' amplifiers. The wiring between units is carried out in exactly

the same way as described earlier, with all the usual breakjacks. The only difference is where the pair of wires leaves the building in the form of P.O. lines. Here, instead of the lines in the cable (there may be anything from 10 pairs to 200, or more) being soldered to the same type of tag-block as has been described for 'internal' cable wiring, they are wired to 'fuse-blocks'. These are a sort of modified tag-block which are arranged to hold fuses (in clips) in order to protect the lines and associated apparatus from accidental damage, should a high voltage be put on them.

To summarize the apparatus found in the broadcasting chain (excluding the transmitter, which will be described later), we find the most important points are these. First, the microphone must not only give faithful reproduction; it must be robust and reliable as well. The pair of wires which is used throughout the chain must be adequately screened against interference: also long sections must be 'balanced' to mitigate noise; and to separate balanced sections from unbalanced ones we use special transformers called repeating coils. Thirdly, the electrical outputs from different sources, whether they be separate microphones or complete programme items, can be combined in any proportion by means of mixers. These mixers or faders are simply special arrangements of variable resistances, and may be either of the 'series' or 'potential divider' type.

In the control room itself we discussed types of wiring between apparatus and found it to be either permanent (normal) or flexible. Connections to apparatus are invariably made by the 'breakjack' system to facilitate cross-plugging of faulty apparatus. Other items to help the general smooth running of the control room are 'gadgets' such as switch-keys and relays, alarm fuses and indicating lamps. Finally, the apparatus in a control room falls into two main categories, the 'rack-mounted' section which includes all the amplifiers, relays, etc., and the 'control positions' which are simply desks on which are mounted the mixing, controlling, and signalling arrangements. (Plate II.)

In the next chapter we shall learn something about the amplifier.

QUESTIONS ON CHAPTER IV

- (1) Describe with a sketch the construction and method of working of
 - (a) a Reisz microphone,
 - (b) a moving-coil microphone,
 and (c) a ribbon microphone.

- (2) A source of sound moves round in a circular path at the centre of which is a microphone. Draw a diagram showing how the output of—(a) a moving-coil microphone and (b) a ribbon microphone varies in strength as the source of sound moves round the microphone.
How can these diagrams be exploited in balancing a programme?

- (3) What is the purpose of a microphone transformer? Why is it necessary to be so careful in screening the wiring between a microphone and its first amplifier?
What is meant by a balanced cable?

- (4) The average output of a Reisz microphone is given as -35 db. and of a moving-coil as -55 db. What would be their average output powers in milliwatts?

- (5) Show by a circuit diagram the output of one amplifier connected to the input of another by a control potentiometer, type P.3, which is three-quarters faded up. Does this type of potentiometer present a 'constant impedance' to both amplifiers?

- (6) Show the normal method of wiring a trio of 'line, listen, and apparatus' jacks. What would be the effect on the programme if you plugged a pair of 'phones with a short circuit on their cord into the listen jack?

- (7) Show in schematic form the circuit diagram of a control room to handle four studios, two incoming S.B. lines and one incoming O.B. line and to feed out two programmes via two 3-channel mixers.
Draw a close-up of the relay switching showing how the programme circuits and the amplifiers can be switched remotely.

- (8) Draw in schematic form the complete chain of equipment from a general purpose studio (with gramophones) to the input of the P.O. lines, marking at the input of each piece of apparatus the level of the programme at that point.

CHAPTER V

THE THERMIONIC VALVE

WE come now to the 'heart' of the broadcasting system, the thermionic valve. Without it, radio, or even long-distance line telephony, would be impossible; and it is essential that we understand its operation. Many books have been written about the thermionic valve alone, and we refer you to them if you want to know more than the fundamental principles of its operation.

HISTORICAL DEVELOPMENT

What, then, is this wonderful object, when and by whom was it invented, and how does it work? It all started with the invention of the ordinary electric lamp back in the last century when Edison noticed a peculiar effect on his early lamps. This was about the year 1883, when he was using a carbon filament. The action of the electric light 'bulb' should be well known to all of you: it simply relies on the fact that if we pass a current through a fine wire (it needn't be copper; any conductor, or partial-conductor, will do), then that wire, or filament, will get hot. We can make it so hot that it gets 'white hot', when it will emit a fair amount of light. One of the precautions that has to be taken is to exclude all air from its vicinity, otherwise the wire would burn away completely; and this is done by enclosing it in the familiar glass bulb from which the air is evacuated.

As stated above, Edison used a filament made of carbon, and after the lamp had been working for several hours, he noticed that the inside of the bulb had become blackened in places. In fact, it left a sort of 'shadow' of the filament on the glass. This he believed to be composed of fine particles of carbon which had shot off the filament, but how this happened was not at once apparent. The truth of the matter seemed to be that the molecules had become so agitated by the heating effect, that 'something' was shot off into space and eventually hit the glass bulb. Now Edison did not know anything about electrons; their existence was not discovered until sixteen years later in 1899, by J. J. Thomson. Nevertheless, he had a pretty good idea that this continual rush of 'somethings' was bound up with a conducting path for an electric current, as his next experiment will show.

In this, he took one of his ordinary electric lamps and placed a small metallic plate in it, near to the filament but not touching it (see Fig. 66) and then applied a positive potential to it.

This was accomplished by connecting a battery as shown, viz. the positive end joined to the plate, and the other end to the filament. An ammeter was included in the battery/plate circuit to measure any current that might flow. The following results were recorded.

If the filament were not heated, no current would flow. When the filament was switched on, current flowed round the circuit; just as if a complete

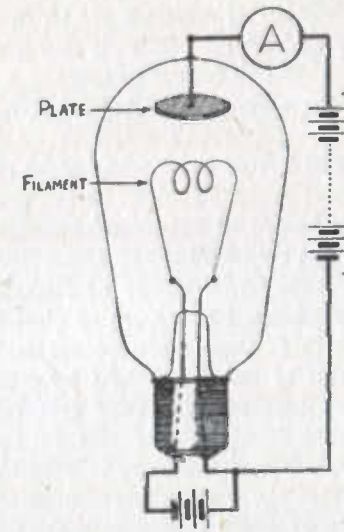

FIG. 66.
EDISON'S EXPERIMENT

conducting path had been created in the space between the filament and the plate. Lastly, if the plate were made negative (by reversing the battery connections) no current would flow. This showed that the device was unidirectional in the matter of passing an electric current, and—although its famous inventor did not know it—the arrangement and action formed the basis of all modern valve practice.

THE DIODE

It was not until 1904 that the device came to the fore again, this time with the beginnings of radio as a background to its development. This time it was Fleming who was the investigator, and his researches were in connection with the reception of radio signals. He used exactly the same arrangement of filament and plate because he was concerned with the process of 'rectifying', which means turning alternating currents into direct currents. This is done by applying the alternating current between the plate and filament (instead of the battery), whereupon the plate will be made alternately positive and negative. Current will only flow, however, when the plate is positive, so that only the positive half cycles will be passed through the device. These unidirectional pulses can be developed across a resistance which is put in series with the

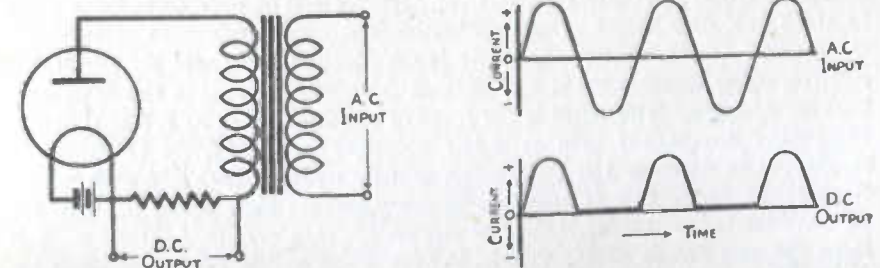

FIG. 67. THE ACTION OF A DIODE

source of supply, and so the job of converting A.C. to D.C. has been accomplished. Fig. 67 shows this, both schematically and graphically, but we shall not go into its uses further than that for the moment.

Let us, instead, study the action of the valve by the light of the modern electron theory. By the way, you will notice that we have started calling it a 'valve'; it gets the name from its one-way action, which has its counterpart in the mechanical valve found in water, or air, systems. The particular valve mentioned above is known as a 'diode' because it has two parts, or 'electrodes', the filament and the plate.

If you will remember the electron theory of electricity, we assumed that the atoms in a conductor consisted of groups of electrons revolving round a nucleus of protons. Certain of these electrons are said to be 'free', which means that they are capable of being dislodged by externally applied forces. However, we were only concerned with their removal for the purpose of creating a 'drift' of other free electrons and so constituting an electric current. When no such force was applied, the velocity of the electrons in their natural orbits was such that the force of attraction to the protons exactly balanced the centrifugal force which tended to make them fly off into space. If, then, we could increase the velocity of the free electrons, it is quite likely that they would be able to fly off from their orbits, whence they would be free to be attracted to any positively charged body (i.e. one with a deficit of electrons) in the vicinity. One way of increasing the electron velocity is to heat the conductor, and this is exactly what is done when the 'filament' of the lamp has an electric current passed through it. Now it must be remembered that it is due to the heating effect only that this result comes about, and it has nothing to do with the passage of the current through the wire. That this is so can be proved by the use of an 'indirectly heated' element, which has an electrode that surrounds (but is electrically insulated from) the filament: the same effects of uni-directional conduction between this electrode and the plate are still observed.

The electrons shot off by the heated wire may have sufficient velocity to reach the glass bulb, and (as Edison found) they may even dislodge actual particles of carbon and carry them on their journey, depositing them with considerable force on to the inside of the glass bulb. This property is of no more use to us than it was to Edison, who was extremely annoyed to find his bulbs blackened in this way. We are, however, interested to know what the behaviour of the electron is when it has left the filament. First of all, it has acquired sufficient energy to leave the conductor; but no sooner has it left than the conductor has, of course, become positively charged owing to the deficit. Not only this, but the 'free' electron very soon finds itself in the midst of a cloud of other negative electrons which have already left the filament. There are, therefore, two forces which tend to make the wandering electron return home. One is the force of attraction between it and the (now) positive filament. The other is the force of repulsion from its fellow negative electrons. So that, as soon as it has expended its energy, the electron will return to the filament and the process will be repeated over and over again. Such is the action that is going on in every electric light bulb; but now let us consider the action of the extra electrode. Incidentally, we may as well learn the two Greek names that have been given to the two electrodes of a diode. They are 'cathode' and 'anode', for the filament and plate respectively.

When we apply a positive potential to the anode we are really making it deficient in electrons. Now if a 'free' electron, emerging from the cathode, manages to get far enough from it to come under the attractive influence of this positive body, it will travel rapidly towards it. Thus we get a constant stream of electrons from cathode to anode; and an electron stream is an electric current. This explains Edison's experiment, and why the current will only pass in one direction. In Chapter I we stated that an electric current was a flow of electrons from an overcrowded, or negative, point to a less dense, or positive, point; and it will now be seen that the action of a valve just can't be explained if we stick to the old convention for direction of current flow which was in the opposite sense. That is the simple story of the diode. The amount of current will depend on three factors, viz. the quantity of electrons given off by the cathode; the distance between cathode and anode; and the anode potential. The first factor is determined by the material from which the cathode is made, as well as its temperature. Usually, 'tungsten' or 'thorium' are the materials employed, either individually or in the combined form known as 'thoriated tungsten'. Other rare metals and alloys are sometimes used, amongst which are platinum, barium oxide, and strontium.

The distance factor is one which is bound up with the particular use for which the valve is designed. While the anode potential is, of course, an obvious determinant of the current, there is a point where increasing the anode voltage cannot draw off any more electrons than are being emitted by the cathode, and this value is called the 'saturation voltage'.

Apart from its use as a rectifier, the diode was, and still is, of little use. Certainly very little success was met with by any of the early experimenters who tried to use the diode as an amplifier.

THE TRIODE

The next step was the addition of a third electrode, and this was where

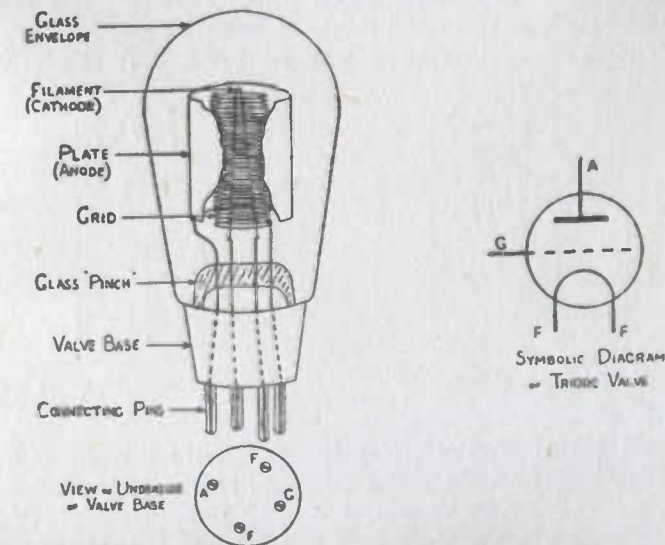

FIG. 68. THE TRIODE

things really leaped ahead. It was in 1907 that an American by the name of Lee de Forest, working on the diode, decided to try the effect of introducing another electrode between the cathode and anode. He called it a 'grid' because it had a mesh-like form, and this name has stuck ever since, no Greek '-ode' being found to describe it better. The final result looked something like Fig. 68, which also shows the conventional diagram for a 'triode' as it is called.

First we shall describe its construction, and follow this by the principles of operation and application. The filament is supported on wires which keep it in a fairly taut suspension. As in the diode, and, in fact, in all valves, this filament is usually of some special material which will give off a maximum of electrons when heated. Around this, but spaced accurately at a distance which is important in determining the characteristics of the valve, is the 'grid'. In the diagram shown, it is in the form of a spiral of wire, this method being an extremely simple and efficient method of construction. Old-type valves invariably had completely circular grids and anodes, but many modern ones favour the 'box' arrangement. The geometry of the valve raises problems which are of greater interest to the designer than to us, and it is not necessary for us to consider them in detail. On the outside of the grid is the anode, which in this case is a metallic, cylindrical affair, perhaps made of nickel. As in the case of the filament, both the grid and anode are supported on stiff wires, one of which (in each case) will be sealed into the glass 'pinch' at the foot of the bulb. All air and traces of gas are very carefully excluded from the valve. The essential wires are then extended down through the insulated valve 'base' and soldered to the appropriate 'pins'. The pins are disposed asymmetrically, but according to an agreed standard, so that they will only go into the standard valve holder the right way round.

So much for its construction; and now, how does it work? In the first place, the grid itself—without any external connection—will produce no different effect from the ordinary diode. But de Forest's first experiment was to connect the grid to a small source of potential, say, a battery of 1 or 2 volts. The anode was supplied with its usual H.T. (High Tension;

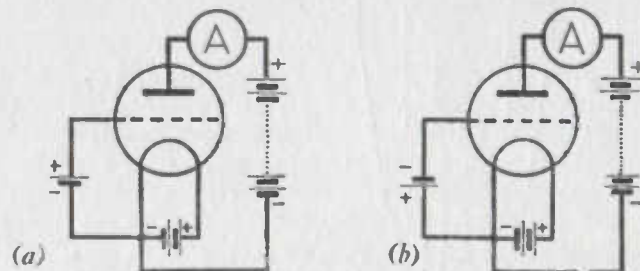

FIG. 69. DE FOREST'S EXPERIMENT TO SHOW CHANGE OF ANODE CURRENT WITH GRID VOLTAGE

which simply means high voltage) battery, and an ammeter included in the circuit to measure the anode current. The first observation is that current flows even when no connection is made to the grid. Then a small battery is connected as in Fig. 69a, so that the grid is made positive with respect to the filament. When this is done, it will be observed that the anode

current is considerably increased. Next, the grid battery is reversed so that the grid is made negative with respect to the filament (Fig. 69b). As you will probably guess, the anode current is then found to fall below the original value.

Let us see whether these actual results line up with the electron theory. In the first case, when we make the grid positive, it means that the electrons leaving the hot cathode will be attracted towards it and, because the grid is of a fairly 'open' formation, will shoot through the spaces to the further attraction exerted by the anode. The grid, being comparatively close to the cathode, will be able to attract lots of those electrons which previously had not sufficient velocity to get away from the cathode; and these, too, will be given that 'little extra' so that they may join the stream and so increase the anode current.

In the other case, with grid negative, the emerging electrons will come up against a grid which has got an excess of electrons already, and which will therefore repel any oncomers. The effect, therefore, is to reduce the number of electrons reaching the anode, which confirms our practical observations.

THE TRIODE AS AN AMPLIFIER

If, therefore, the grid is subjected to alternate positive and negative charges, the anode current will also fluctuate, higher and lower, in accordance with those grid alterations. In other words, an alternating voltage applied to the grid will produce a pulsating current in the anode circuit, which we can convert into an alternating current by using a transformer as we did in Chapter III (Fig. 35). It only remains for us to see how big these changes are, relative to each other. For this purpose we need to 'convert' our anode current into a voltage, and then we can really compare the two. This we can do by a simple application of Ohm's law, so let us include a resistance in the anode circuit, and measure the voltage across it. Then, because the resistance is a fixed one, a pulsating current in it will produce a pulsating voltage across it.

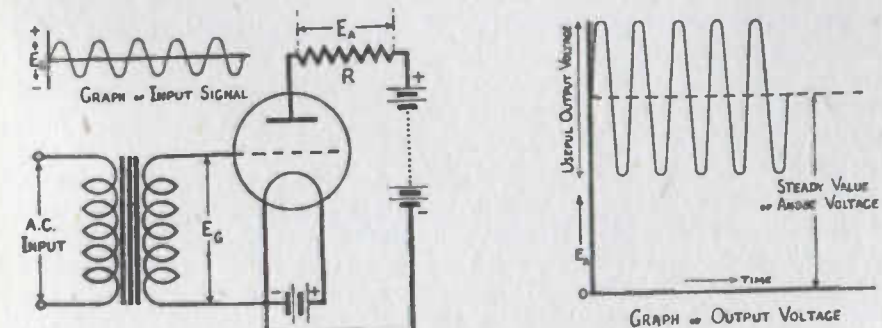

FIG. 70. THE TRIODE AMPLIFIER

Fig. 70 shows how such an alternating voltage (E_G) is applied to the grid of the valve, and where the output voltage (E_A) is obtained. In practice, quite small changes of grid voltage will produce large changes of voltage in the anode circuit, and so the valve is acting as an amplifier of alternating voltages.

To the mathematically minded reader, this may be better explained by the use of a graph. If we set up a simple circuit consisting of a triode, with its

associated battery supplies, we can measure the changes of anode current for successive changes of grid voltage. These figures, plotted on a graph, produce a curve known as the grid voltage/anode current (E_g/I_a) curve, an example of which is shown in Fig. 71.

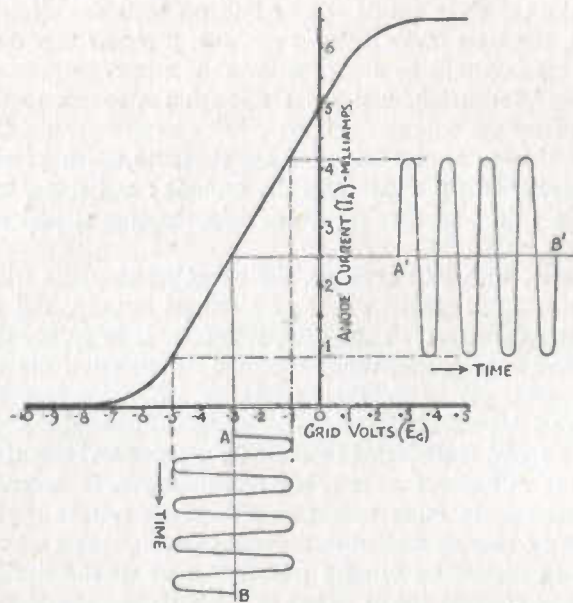
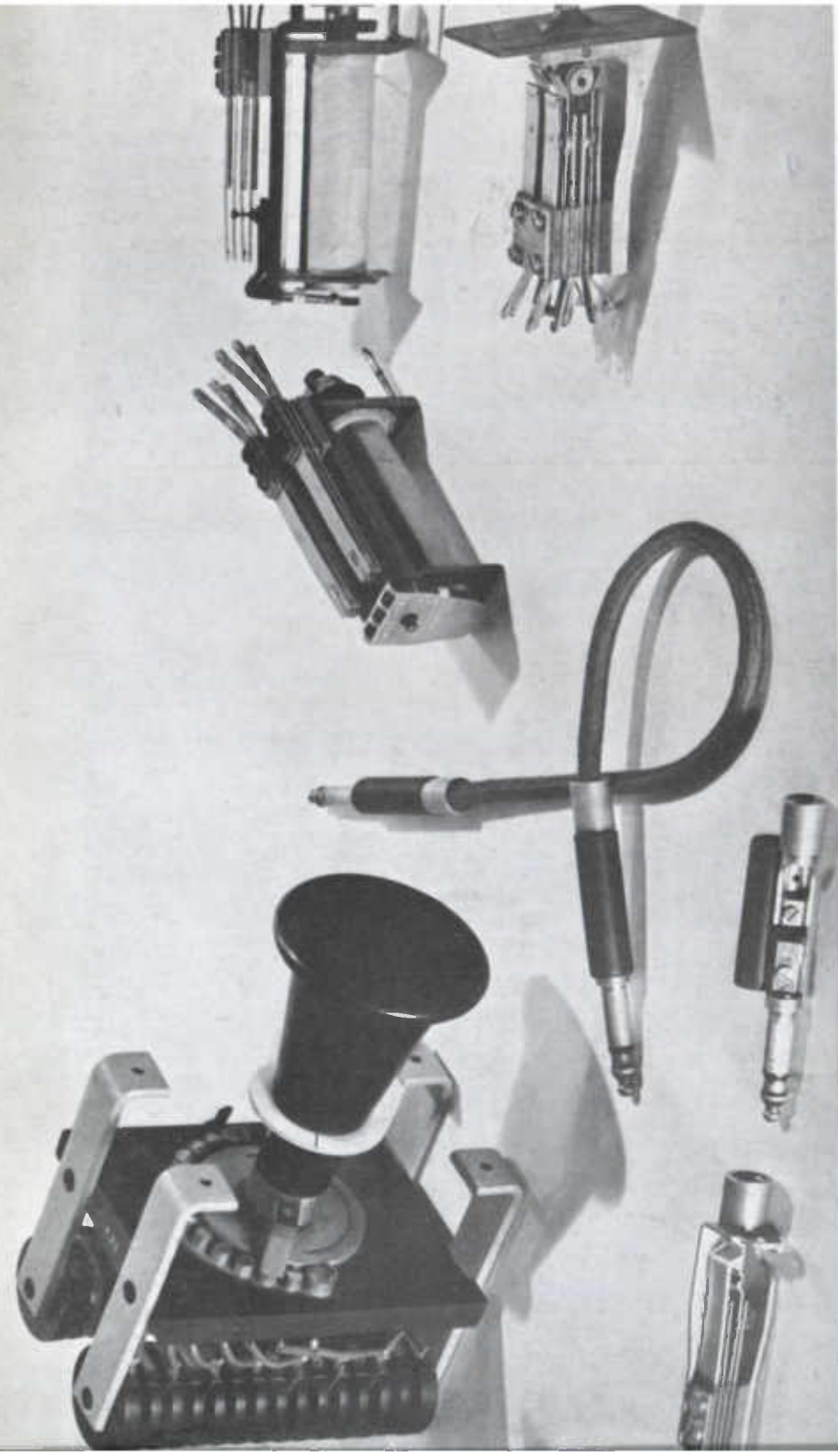

FIG. 71. GRAPHICAL REPRESENTATION OF THE ACTION OF A TRIODE USED AS AN AMPLIFIER (THE ' E_g/I_a ' CURVE)

GRID 'BIAS'

In addition, a few 'waves' of A.C. input voltage are shown in order to illustrate how fluctuations of grid voltage produce exactly similar fluctuations of anode current. Two important details are also made clear. First, that in order to obtain a true reproduction of wave shape, with both half-cycles amplified equally, the valve must be worked on the straight portion of the curve. Second, it will be noticed that the whole of the input range is confined to working in the negative region of grid voltage, even for the positive half-cycles of grid input. This is necessary because if we were to make the grid positive at any time it would certainly accelerate the electron flow, with a resultant increase in anode current, but there are additional complications in that the grid itself, being positive, will absorb electrons. When this happens, we say it takes 'grid current', and the output at the anode no longer follows the input voltage faithfully. In order to overcome this drawback, we can always add sufficient steady D.C. to our input to 'bias' the grid negatively, and this may be done in two ways. The first way is to include a battery, or some other source of steady voltage, in series with the A.C. input. Fig. 72 shows the circuit arrangement for providing bias by means of a small battery. The grid will then be permanently negative, at a steady value, if no A.C. input is applied. The A.C. has the effect of turning this steady voltage into one which goes alternately less negative (for the +ve half-cycles) and more negative (during the -ve half cycles). A second, and more modern way, is to use 'automatic bias'. This utilizes the anode current, on its return to the cathode, to develop a voltage across a small resistance. If the



Miscellaneous apparatus used in control rooms: plugs and jacks, potentiometer, relays, and switch
Plate V

Main distribution frame (MDF)

Plate Vlb

Distribution jackfield, and telephone indicators

Plate Vla

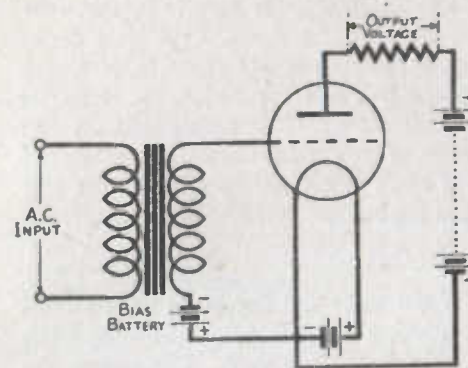

FIG. 72. BATTERY BIAS

'right' end of this resistance be taken it will be negative with respect to the cathode. Hence the A.C. input may now be applied between grid and this negative point, whence it performs the same function as the grid bias battery. The latter arrangement is shown in Fig. 73, this time using an 'indirectly heated valve' (i.e. with cathode insulated from the heater or filament) so that the diagram may be simplified. It is, indeed, the usual method of biasing such valves.

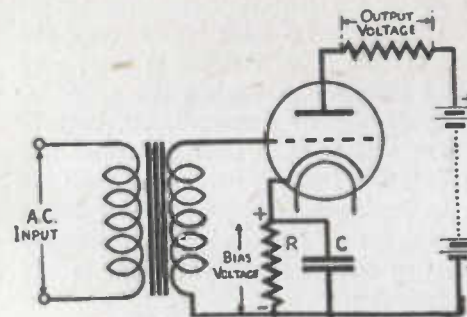

FIG. 73. AUTOMATIC CATHODE BIAS

The condenser 'C' serves a very special purpose, and is known as a 'bypass' condenser. It will be obvious that the fluctuating current which is in the anode circuit must also appear in the anode return, or cathode, circuit. The bias voltage developed across 'R' would therefore be a fluctuating one which would be added (or subtracted) from the input voltage. In order to avoid this state of affairs the condenser 'C' is put in to drain away the fluctuating component, leaving steady D.C. for biasing purposes.

Having taken all these precautions, the valve still works as an amplifier. Just how much this amplification is depends entirely upon the type of valve, and ranges from as high as 80 to as low as a little over 1, with different types of triode.

Some of you may well ask why we need a valve to do the job of multiplying an alternating voltage because, you will say, we had a perfectly good voltage-multiplier in the step-up transformer. Yes, that does step up the voltage, but what happens to the current? We only got that voltage increase at the expense of the current; the power did not increase at all. And that is what the valve does. It is really a power amplifier, although we often find it

convenient to speak of the 'voltage amplification'. It may look, therefore, as if we have beaten the law of Conservation of Energy and have got a device from which we can take more power out than we put in! This is, of course, absurd, and we must look for the explanation of the paradox. It is simply that the extra power has come from the steady D.C. supply and all that we have done is to 'trigger off' bursts of power by means of the control grid; rather like the small pressure of one's finger on the trigger of a rifle releasing the relatively large force behind the bullet.

OBTAINING GREATER AMPLIFICATION

Incidentally, the real development of the valve did not begin until several years after Lee de Forest's discovery (during the war years 1914-18) when improved methods of evacuating the bulb were discovered. Until then, the valves were 'soft', which means that a poor state of vacuum exists, in which case the electrons suffer many collisions with the molecules of gas which remain in the bulb. Thus, many more electrons get dislodged from the gas molecules, so that the final number reaching the anode does not bear a true relation to the number leaving the cathode. Soft valves have little use in modern practice, their place being taken by 'hard' valves, which have a very high order of vacuum, (usually of 10^{-7} m.m. of mercury, for those who know what that implies).

In addition to improvements in evacuation, the thermionic valve has undergone development in other directions. The addition of other 'grids' (supplied with certain potentials to operate them correctly) has resulted in some very high 'amplification factors'. It is not intended to explain the action of anything more complicated than the triode already described, but only to mention the names of other valves. The first addition after the triode was an extra grid called the 'screening grid', and from this the valve took the name 'screen-grid valve'; or, from its having four electrodes, was called a 'tetrode'. Still further research produced the 'pentode' or five-electrode valve with which, under suitable operating conditions, amplification factors of anything from 100 to 250 times are obtainable.

MULTI-STAGE AMPLIFIERS

If it is desired to obtain greater amplification than can be obtained from any single valve, then the obvious thing to do is to use more than one, and to apply the output voltage from the anode of the first to the grid of the second, and so on, if more than two are required. We will not delve too deeply into the exact design of such 'coupling' arrangements, this being a very specialized job for the designer. But one thing should be obvious, namely, that we cannot make a direct connection between the anode of the first and the grid of the second valve because it would bring the very high positive voltage of the first valve's anode on to the grid of the second. This would not be satisfactory because even a tiny positive charge on the grid would accelerate the electrons to a great extent. Our job is to pass on the fluctuating, or alternating component, only; and this we can do by two methods—one, the transformer method, the other by means of a condenser. Both of these devices offer a path to A.C. but will effectively 'block' the passage of D.C. Fig. 74 shows the two methods in simple form.

The first diagram will probably be fairly obvious, but the second one may

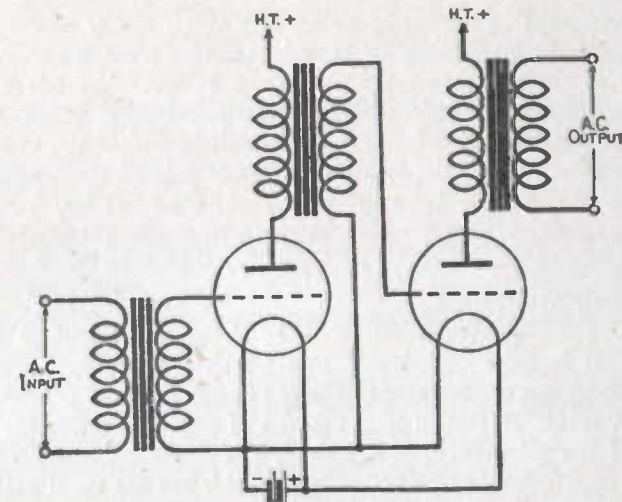

2 VALVES, TRANSFORMER COUPLED

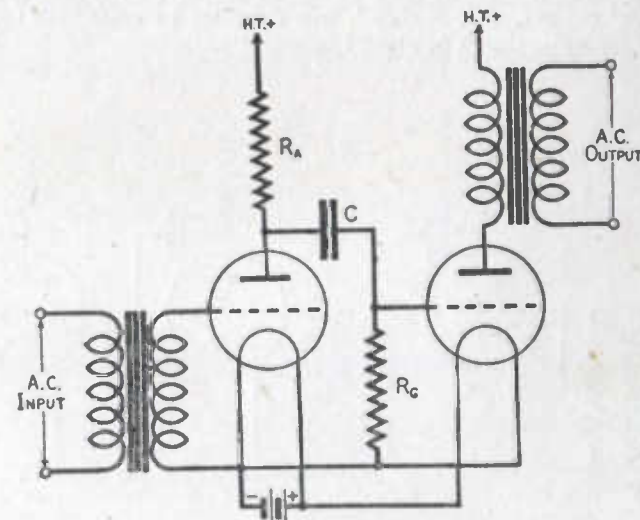

2 VALVES, RESISTANCE-CAPACITY COUPLED

FIG. 74. METHODS OF COUPLING VALVES TOGETHER

present some little difficulty as to the reason for the resistances ' R_A ' and ' R_G '. They are necessary, however, and the reader who is anxious to learn more about the construction of amplifiers is referred to one of the many books available on the subject. Here let it suffice to say that much of the design work on amplifiers is concerned with so proportioning the values of the coupling elements, whether transformers or condensers and resistances, that amplification is maintained at the desired value at all frequencies required, and thus one type of amplifier may be designed to amplify equally all audio-frequencies between say 30 and 10,000 cycles per second—another all radio-frequencies between say 500,000 and 1,500,000 cycles per second (that is between 600 and 200 metres).

We have already mentioned the use of a transformer as a means of removing

the D.C. component in the anode circuit of a valve, and it will now be seen that the same transformer can be used to transfer the output of the valve to the grid of the succeeding valve in an amplifier. We can exploit the possibilities of the transformer still further by obtaining a voltage step-up between the valves and thus increase the overall 'gain' of the amplifier. In addition, we now see that the transformer is one way of preventing the high tension from getting on to the succeeding grid; the other way being the use of a coupling condenser—from which, however, we cannot get any voltage gain.

VARIABLE GAIN AMPLIFIERS

One more point in connection with the design of amplifiers should be mentioned. It is quite conceivable that we shall not always want to use the full amplification of the valve or valves; in other words, a 'variable gain' amplifier is wanted. In certain cases this can be done by altering the operating conditions of the valve itself, and, indeed, this is the method used in radio receivers to accomplish 'automatic gain control', but the usual practice is to include some sort of potential divider in the intermediate circuits. It is possible to calibrate such a variable control accurately (in decibels, if need be).

The 'gain' control, as it is called, will therefore be something like one or other of the examples shown in Fig. 75.

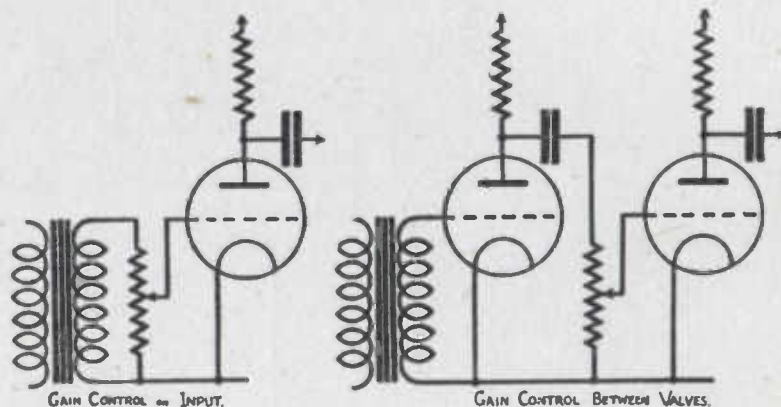

FIG. 75. GAIN CONTROL OF AMPLIFIERS

So by means of one or more valves, appropriately connected, we can build up amplifiers which will give very great voltage amplification, e.g. of as much as 30,000 or more. This, in fact, is what is done in the BBC portable type amplifier used on O.B. work (the OBA/8) which has a maximum 'gain' of just over 90 db., and if you work that out by the formula :

$$N \text{ (db)} = 20 \log_{10} \frac{E_2}{E_1}$$

you will see that $\frac{E_2}{E_1} = 31,620$. The total gain of 90 db. is obtained by the use of two pentodes, plus the voltage gain from the specially designed input transformer.

TRAP VALVES

The thermionic valve amplifier gives us, then, a fine piece of apparatus for bringing up the tiny alternating currents from the microphone output to that 'reasonable level' we talked of earlier. There is another feature of the valve which is a very valuable one in radio . . . its inherent property of being a one-way device. It means that if we tried to push any sort of signal into the anode circuit, it would not have any effect on the grid circuit. Similarly, if the anode circuit developed a fault, such as an open, or short circuit, the grid circuit would be entirely unaffected. We call such a valve a 'trap valve' and, whilst every valve has this property, some 'amplifiers' will be specially designed to utilize the trap-valve feature only and not be required to amplify; as, for instance, when we wish to feed several P.O. lines with a programme from a single source.

Were we to parallel all the lines to the common programme output (as in Fig. 76a below), then a short circuit on line 2 would be virtually a short circuit on every other line.

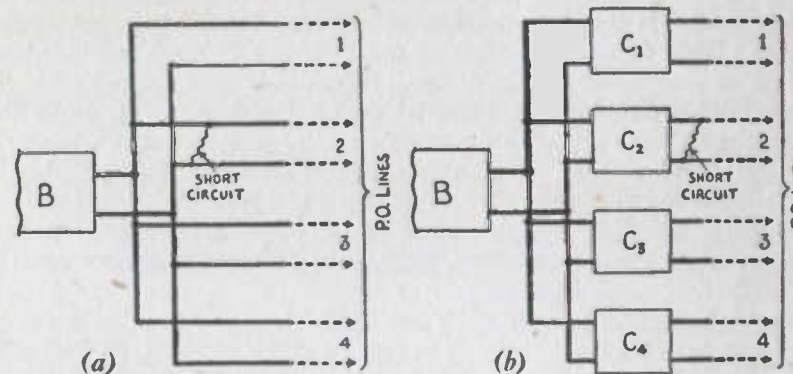

FIG. 76. THE USE OF THE TRAP VALVE

If, however, we insert a trap-valve amplifier, as shown in Fig. 76b, the same short circuit would affect only that particular line; for the input circuit of 'C₂' would be unaffected and therefore the input of all the other 'C's' would not be affected. The trap valves are shown as being 'C' amplifiers, because they are the third amplifiers in the normal broadcasting chain.

PRACTICAL AMPLIFIERS IN THE BROADCASTING CHAIN

Now for a brief description of some of the actual amplifiers used in the control room. The first one, the 'A', is a three-stage amplifier having twin outputs. The input is fed into a specially designed transformer (you will remember that this forms the other end of the balanced line from the listening room) and the secondary winding of this goes to the grid of the first valve—a high amplification triode. The anode of the valve is coupled, by resistance-capacity coupling and a variable potentiometer control, to the grid of the next valve. This is another triode with not quite so large an amplification factor. Its anode is again resistance-capacity coupled to each of the grids of the two output valves, both triodes of the 'small-power output' class. The idea of these two outputs, each of which acts as a trap valve to the other,

is to provide a feed to a source of echo (see Chapter III). The total voltage amplification of the three stages is approximately 2000 (with the gain control at its maximum position) which, expressed in decibels, is approx. 66 db. Hence, it will raise the output level of a ribbon microphone to -10 db. It is found convenient to introduce a little 'correction' for slight deficiencies in the response of the ribbon microphone in the 'A' amplifier. This is done by the use of suitably placed condensers and chokes in the coupling circuits; for it will be remembered how these components react differently to high and low frequencies.

Next comes the 'B' amplifier, which is used to boost up the output of the control potentiometer from -30 db. to $+10$ db. This means that we require at least 40 db. gain; but it is usual to have a little in hand, and to provide a gain control to adjust to the actual value required. There have been several designs of 'B' amplifier, some having three stages and others only two. They mostly have their gain controls between the input transformer and the first valve, and the interstage coupling is of the resistance-capacity type.

The 'C' amplifier comes next, and this, as has been stated, often need not amplify at all. It is a single-stage amplifier with a variable gain, but we now come to a slight departure in amplifier design, known as 'push-pull' working. Two valves are used and the input signal is divided between the two grids, the output being recombined by a special output transformer. If, as in this amplifier, each valve works on the straight portion of the curve, the system is called 'class A' working. But there is another method of working whereby the valves are biased so that each handles only a half-cycle of the wave, the two halves being 'married' together again in the output transformer. Such a system is called 'class B' working, and will be described in greater detail in Chapter VII.

The 'D' amplifier is very much like the 'A', as it has to do a similar job of bringing up a low input level (it may be almost anything, depending on the loss in the line plus equalizer) to the -10 db. required for the mixer input.

Trap-valves are too numerous to tabulate in detail, because they vary in size according to their special requirements . . . some having to feed only one pair of headphones or a loudspeaker amplifier whilst others may have to feed many dozens of such appliances. A common method of construction is to include several trap-valves in one 'box' to economize in space; in which case, all the grids of the valves are connected to one input. There is a particular example of this in the 4-output trap-valve unit designed to follow the OBA/8 equipment when this has to feed more than one P.O. line. Each valve has its own 'gain control' and the whole unit is supplied from a small mains unit (see later in this chapter).

Mention has just been made of trap-valves being used to feed loudspeakers. Now to operate a loudspeaker needs something not less than 1 watt, i.e. a level of $+30$ db. This could quite easily be done in the trap-valve amplifier by the use of a suitable valve, and the output could be fed by line to loudspeakers in various parts of the building, e.g. listening rooms, much in the same way that a domestic radio has an 'extension speaker'. There is a snag in this when microphone and other low-level circuits will almost surely have to come in close proximity to the speaker distribution lines. We have mentioned the difficulty in keeping microphone circuits free from induction, and to run cables together with more than 100 db. difference in level between them is

asking for trouble! So the trap-valves do not deliver more than 0 db. (usually less) and the necessary step-up is provided at the loudspeaker unit itself. This L.S.M. amplifier, as it is called, is a mains-operated unit employing two stages of amplification, transformer coupled, the output stage being in 'push-pull'. This second stage is one of the many examples of the necessity for using 'push-pull' when a large power is required.

'MAINS' RECTIFICATION

The mains-operation which has been mentioned here and previously is a method whereby the 50-cycle mains is converted into the necessary H.T. and L.T. voltages required by the valves in the amplifier. Such valves are usually of the 'indirectly-heated' type, so that they can be heated by 4 volts A.C. But, for the H.T. we have got to convert A.C. to D.C., and this is done by a rectifying valve, called a 'double diode'. The circuit for a simple 'Mains Unit' is shown in Fig. 77.

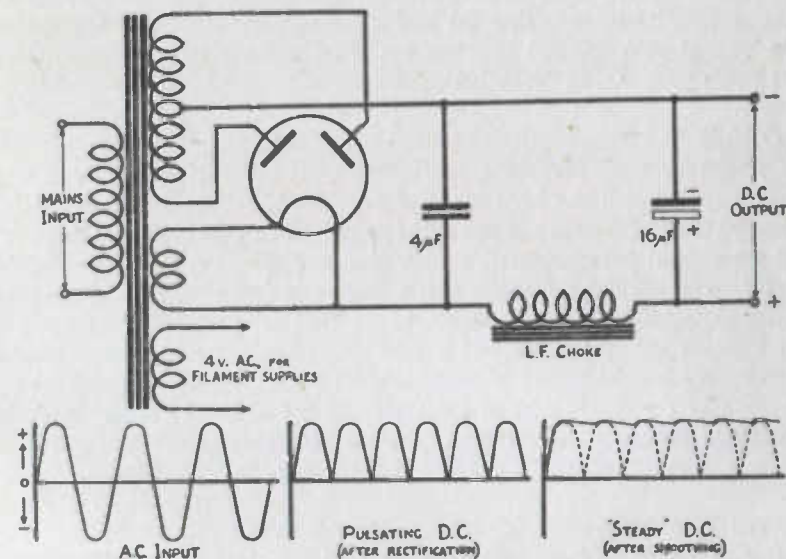

FIG. 77. A SIMPLE 'MAINS UNIT'

The action of the double-diode is that the diodes alternately become positive. When this happens, the electrons will flow to whichever is positive through the transformer winding to the centre point of it, through the output load, back to the cathode of the rectifier. The electrons can never flow from anode to cathode, and so the output consists of pulses of D.C. obtained from reversing, or 'rectifying', the negative half-cycles of A.C. Were we to use this type of D.C. for our amplifying valves the pulsations would be heard as a heavy 100-cycle hum. To overcome this, a 'smoothing' circuit is used, consisting of an arrangement of condensers and chokes. The principle of operation is this: a pulse of current charges up the first condenser almost instantaneously. During the 'decay' period of this pulse, the condenser proceeds to discharge through the output load, via the large iron-cored choke. The choke does not like changes of current, and so delays the decay of the condenser discharge. It has hardly dropped to much below the maximum

when along comes the second pulse to charge up the condenser again. Each pulse goes almost entirely to charging the first condenser because, as has been said, the inductance no more likes increases of current than it likes decreases. If, however, a 'ripple' does get through, then it can be regarded as an A.C. component superimposed on a D.C. component, and the method of reducing the value of the A.C. component is to 'by-pass' it by means of a very large condenser placed after the choke. This is the reason why it is shown to be such a large one, $16\mu\text{F.}$, (microfarads) and it is sometimes even twice that value. An ordinary condenser of $32\mu\text{F.}$ would be inconveniently large and expensive if constructed in the usual way; so a different type is employed. It is called an 'electrolytic condenser' which, by utilizing the chemical reaction caused when a current is passed through the dielectric, the effective capacity is greatly increased. There is one important point to remember in connection with electrolytics and that is, they must only be connected one certain way round; and the +ve end is always clearly marked by the manufacturer. They cannot, therefore, be used on A.C. Before leaving the mains unit let us note that the mains transformer can be so arranged to give a voltage step-up, and that we can therefore get H.T. voltages which can be much greater than the mains volts.

THE OBA/8

To turn to amplifiers in general use by the BBC, there is one very important type which has been especially developed for outside broadcasting. It is known as the OBA/8, and not only incorporates a very high gain amplifier, but also a control potentiometer, a peak programme meter, and line-switching facilities. The amplifier itself is a two-stage one using modern 'high-gain' pentodes giving a total amplification of 91 db. The control potentiometer comes between the two valves and is very much like any other potentiometer, with one little exception. It is really two controls 'ganged' together on one knob. Whilst the major part of the scale (26 out of the 35 studs) works on the ordinary potential divider principle, the remainder controls the volume in a new way.

NEGATIVE FEED-BACK

This new principle is called 'negative feed-back' and its action consists

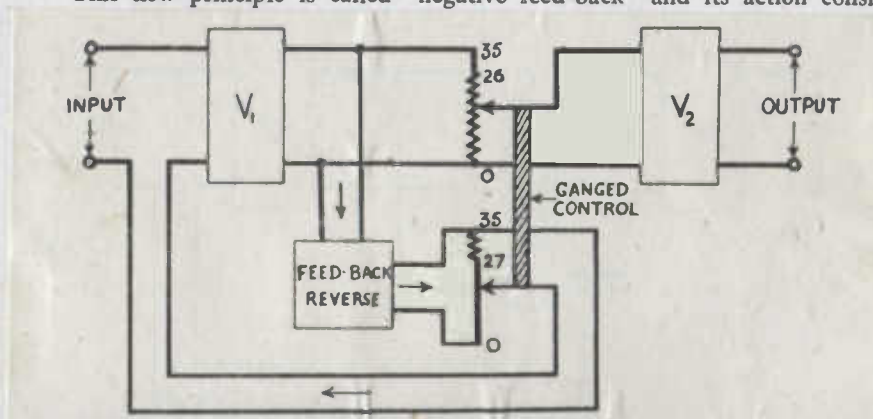

FIG. 78. THE BASIC CIRCUIT OF THE GAIN CONTROL OF AN OBA/8

in feeding back a little of the anode output of a valve to its grid circuit. The reason it is called negative is because it is arranged to subtract from the input voltage and this, whilst it reduces the effective gain of the valve, enables it to handle greater inputs without distortion. In our particular case, negative feed-back is applied all the time the control potentiometer is working on studs 0 to 26, for it will naturally be handling large inputs if the control has to be turned down to cope with them. From stud 26 onwards, the potential divider part of it remains at full gain, but we now start to reduce the negative feed-back over the 9 remaining studs of the control. Perhaps Fig. 78 will help to make it clear. In actual practice we do not have the 'box' which is shown here for the purpose of reversing the feed-back; there is just such a reversing device to be found in the cathode circuit of the valve.

THE PROGRAMME METER

So much for ordinary amplifiers which are intended for giving the essentially faithful amplification of the input signal. Distortionless amplification is naturally necessary for the above job, and to put it in scientific terms we say that the amplifier has to be 'linear', or that the output has to be directly proportional to the input and that the amplifier must amplify all the audio frequencies equally. There is one task which we wish to perform, however, where we do not require linear amplification, and this is in the programme meter. You will remember that when we compared the voltage/decibel scale, how 'cramped' the decibels were corresponding to the lower end of the voltage scale. In order to 'open this up', we really want to have an amplifier that will amplify small voltage inputs more than larger ones. Such an amplifier would sound intolerable were we to listen at its output, but it is not intended that it should be listened to. We want to measure the output by a visual indicator. By the use of a pentode valve operating under unusual conditions, we can obtain the required amplification characteristic, viz. according to a logarithmic law.

The old type programme meters used two pentodes in a push-pull arrangement, each operating as a diode rectifier; and the value of the rectified current obtained was measured on a millimeter in the anode circuit. By suitable adjustment of the voltage on the 'screen grids' of the pentodes, the rectified current can be made to vary in proportion to the logarithm of the input signal voltage. Thus, variations of input voltage (A.C.) caused the needle of the millimeter to move over a scale which could be calibrated in decibels.

That type of programme meter is rapidly falling into disuse because a much improved type, the 'peak programme meter', has been designed and is not only simpler but has considerable advantages. One of the disadvantages of the old type P.M. was its sluggishness in operation. If a heavy but sudden 'peak' of volume came along, the needle had not reached its maximum before it was 'all over'. Now, if the meter is speeded up by having a more active movement (i.e. less 'damping'), the needle will move back and forth so rapidly that it would be very tiring to the eyes to try to follow. Let us see now how the peak programme meter overcomes these defects.

As before, we use a 'distorting' pentode which amplifies according to a logarithmic law instead of linearly. This is arranged by operating it at the special voltages on its screen and cathode which have been found, by research, to give such a characteristic. Also, the 'meter' itself is again in the anode

circuit, only this time the valve is not working as a diode but as a pentode amplifier. Like any other valve amplifier, the anode will have a certain initial current which will be read off on the meter. We get rid of this, as well as overcoming another difficulty, in a rather cunning way. Instead of using the normal type of meter that has its zero resting position (i.e. with no current flowing) on the left-hand side, this meter has been specially constructed with the spring acting round the other way to give it a 'right-hand zero'. The initial anode current is then arranged to move the needle over to the left, where it comes to rest at the more usual zero. We shall see in a minute how the signals are made to cause reductions in anode current; this will cause the needle to move towards the right because it indicates less current. The other part of the trick is this. Movements to the right-hand side are aided by the action of the spring, whilst those to the left are opposed by it. This, in addition to the fact that it is a very lightly damped movement, will enable the needle to 'flick' up to its position when a rapid peak is applied in just under 4 milliseconds. We do not want it to return to the left-hand side with that rapidity, otherwise the eye would not be able to follow it. The method of slowing it down is accomplished in another way, but perhaps it is better to go right to the input of the P.P.M. now and follow the complete working of it. Fig. 79 should help to understand it better; only the essentials being shown for clearness.

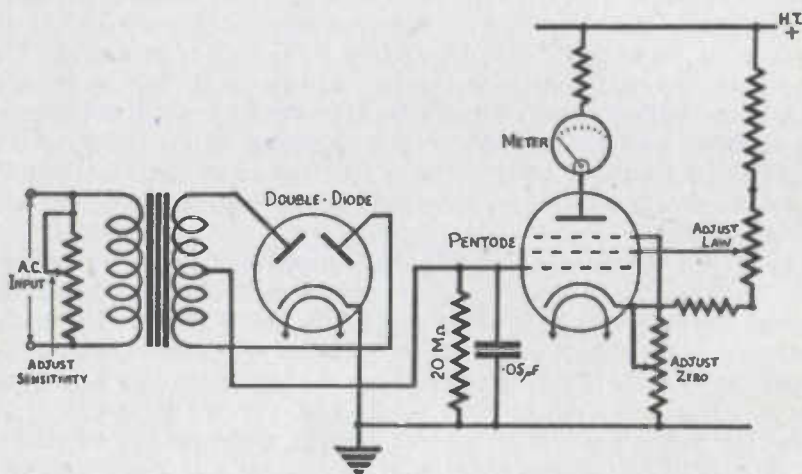

FIG. 79. THE ESSENTIAL CIRCUIT OF THE PEAK PROGRAMME METER

The A.C. input is passed through a transformer having a centre-tapped secondary, the outers of which are applied to the two anodes of a double-diode rectifying valve. We have already discussed the action of this type of valve under the heading of Mains Units, although this particular type will not handle large currents nor will any smoothing be required. As before, the cathode will become the positive side of the D.C., and the centre-tap of the transformer will be negative. It is these negative pulses which are applied to the grid of the pentode, and they will cause decreases in the anode current, measured on the meter. It will be seen that in addition to being applied to the grid, the negative pulses are also made to charge up the $0.05 \mu\text{F}$ condenser

across it. This it will do almost instantaneously, but when the peak has passed, the negative charge will remain and hold the grid at that value. So the needle of the meter would remain at the point it reached if we made no other arrangements. What we want to do is to make the needle return to the left-hand side slowly, and we can do this by letting the condenser discharge very slowly through the 20 megohm resistance across it. The actual time taken for the needle to return to zero from full deflection is just over 3 seconds. In this way, the indications of the meter are made to correspond very closely to the peak levels in a programme, and at the same time they are easy to read.

Now a few words about the various 'adjustments' shown. The 'adjust zero' is a variable resistance in the cathode circuit, and this decides how much initial current will flow in the anode circuit. With no signal input, it is varied until the needle of the meter points to the '0' mark on the left-hand side. This control appears on the front of the unit, because it has to be checked up prior to every broadcast. Likewise, the 'adjust sensitivity' has also to be adjusted, and it is done in this way. A known input voltage, usually of pure 1,000 cycle 'tone' which has been measured by accurate measuring instruments, is applied to the input transformer. If this is measured as being at zero level and the meter has been designed to read zero level, then the sensitivity (or gain) of the whole unit is adjusted until the meter reads 5. This brings us to a definition of 'zero programme volume' which is: 'A programme is said to be at zero volume if it causes a peak programme meter, calibrated to read 5 on tone at 1,000 cycles at zero level, to peak to "7" during loud passages of the programme'.

It will be remembered that the scale of the meter is divided into 7, each division between 1 and 7 representing 4 db. (Plate VII).

In the case of OBA/8 units, which incorporates a P.P.M. of the above design, we naturally have no source of accurately measured 1,000 cycle tone for calibration purposes. Instead, we use part of the 50 cycle mains (actually, from the 4 volt filament supply) and apply this to the input in roughly the same way as before. The value of this 50 cycle supply is previously checked up on the laboratory test bench.

Finally, the 'adjust law' is to fix the screen voltage so that the pentode has the correct logarithmic characteristic. It only calls for adjustment when a new valve is inserted, and is then checked on the test bench with special measuring apparatus.

The operation of the P.P.M. has been treated fairly thoroughly because it is an unusual application of the valve, whereas ordinary amplifiers can be studied in practically every book on radio; and because it will be in constant use and will therefore have to be 'calibrated' frequently.

QUESTIONS ON CHAPTER V

(1) Show with a circuit diagram how a diode can convert pure A.C. into pulsating D.C.

(2) Describe the construction of a triode showing the symbol by which it is indicated on drawings and the position of the electrodes in the valve-holder.

(3) Give the circuit diagram of de Forest's experiment which showed the changes of anode current with changes of grid voltage.

(4) An A.C. input is fed to a triode through an input transformer which has 1,000 turns in its primary and 3,500 turns in its secondary. The grid of the valve is biased with a battery and its output is taken across a resistance in its anode. Draw a circuit diagram of this arrangement showing the H.T. and L.T. batteries. If the amplification factor of the valve was 25 and the A.C. input was 0.5 volts, what would be the maximum voltage you could expect from its output?

(5) Draw a 'grid-voltage/anode-current' curve for a triode, which is supplied by a constant H.T. source, between the limits of full negative grid bias and full anode current.

Show in graphical form how a small alternating voltage applied to the grid will appear as a greater pulsating voltage in the anode circuit, both when the grid voltage is applied at the straight part of the curve and near the bends of the curve. What would happen to your curve if you first halved and then doubled the H.T. voltage?

(6) Draw the circuit diagram of a 3-stage amplifier which is 'resistance-capacity coupled' between the first and second valves and 'transformer coupled' between the second and third valves; grid bias to be applied to all three valves. A gain control should be shown.

In early days transformer-coupled amplifiers were liable to give poor quality? What do you think was the trouble, and why did it occur?

(7) Why are 'trap valves' used? Explain their function. Show in schematic form a 'B' amplifier feeding three Post Office lines, and one loudspeaker, via trap valves. Give a close-up of the complete circuit of one of the trap valves.

(8) Explain, with a circuit diagram, the working of a full-wave valve rectifier. Why is it necessary to smooth the D.C., and how is this done?

(9) What is meant by 'a programme meter'? Discuss some of the principles of design and draw the essential parts of a peak programme meter circuit. If you wish to lengthen the time which the meter would take to return to zero from a full-scale reading, how would you do it?

(10) A peak programme meter, calibrated to read 5 on zero level of 'pure' 1,000 cycle tone, peaks up to 6 four of five times a minute on a certain programme. What is the R.M.S. voltage of the calibrating tone? What is the programme volume and the programme voltage in these programme peaks?

CHAPTER VI

LINKING BY WIRE

GENERAL REQUIREMENTS OF A WIRE LINK

As has been explained in the general outline of the broadcasting chain, telephone lines play an extremely important part in the service. The transmission of high quality music, or any other broadcast where faithfulness of reproduction is required, demands two essential factors.

One is that all frequencies shall be treated equally over a wide range, say from 30 to 8,000 or 10,000 cycles per second; by this we mean that any frequency shall bear the same (power) ratio to any other frequency at the end of the transmission system as it had at the beginning. The other requirement is that we do not want the output from the line to contain anything that was not put in; for instance noise, which not only includes random noises such as 'hiss', 'scratches', 'crackles', etc., but the noises induced from neighbouring circuits or strong electro-magnetic fields. Another undesirable 'output' may possibly be introduced in a line which includes several intermediate amplifiers. This is in the form of spurious 'harmonics' which are generated by valves when they are not operated correctly, or have too large an input and are 'overloaded'.

These factors will be considered in turn and in detail, but we shall start off with the question of what happens to various frequencies when we attempt to pass them over a simple telephone line.

LINE CHARACTERISTICS

A pair of wires in a cable can be looked on as two conductors separated by an insulating material, in other words, as a condenser. Therefore the line is also a condenser, and one of the properties of a condenser is its ability to pass an alternating current. Fig. 80 is a diagrammatic representation of a line connecting a sending to a receiving circuit. The small condensers represent the distributed capacity of the line.

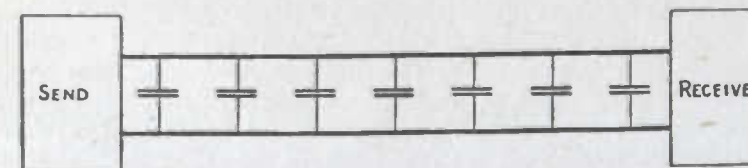

FIG. 80. THE DISTRIBUTED CAPACITY OF A LINE

It will be seen that the capacities provide an alternative path for the alternating current which, at any given instant, is going along one wire and back along the other. This means that, quite apart from the ordinary loss

due to the 'ohmic' resistance of the wires, not all the power which is sent out reaches the other end, because it is by-passed by the capacity effect. Unfortunately, we know that a condenser does not pass all frequencies equally; therefore the higher frequencies will take the easy way across the wires to a greater degree than will the lower ones. So it comes about that the various frequencies which constitute our programme are transmitted unequally, the lower frequencies getting through to the other end better than the higher ones.

INDUCTANCE AND 'LOADING'

If the line consisted solely of distributed resistance and capacity the response characteristic would be that shown as Curve (a) on Fig. 81; but lines have a third quality, inductance. Even though the wire is not coiled up, a magnetic field is created round the conductors by the flow of current, although it is quite a small one because the wires of a pair are close together and the current flows in opposite directions in the two wires. Nevertheless, this small field induces a 'back e.m.f.' which opposes the change in current, and the circuit therefore has inductance. The effect of distributed inductance can be seen from Curve (b) Fig. 81, which gives the response of 25 miles of an actual circuit consisting of conductors weighing 40 lbs. per mile. It will be seen that at the higher frequencies the inductance gives a big improvement in response.

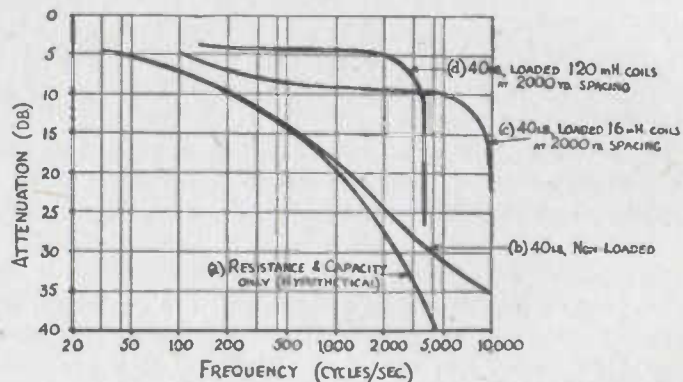

FIG. 81. CHARACTERISTIC CURVES FOR 25 MILES OF VARIOUS CABLE CIRCUITS

This fact was demonstrated by Oliver Heaviside in his mathematical treatise. (You will hear of another of his contributions to the science of long-distance communication when we come to Chapter VIII.) He showed further that if inductance coils were added to the circuit at regular intervals, an even more desirable effect could be produced. Unfortunately, the fact that this added inductance from considerations of cost has to be 'lumped' at definite intervals (and is therefore not distributed like the capacity) introduces another effect. The response is improved up to a certain frequency, but then rapidly declines to a sudden 'cut-off'. Curve (c) shows a similar circuit to that shown in (b), but with 16 millihenry inductance coils added at intervals of 2,000 yards. It is interesting to compare the two curves (b) and (c). Over the greater part of the music frequency range the response is much improved

by the loading, but in the neighbourhood of 8,000 cycles/sec. the response falls sharply and very soon falls below that of Curve (b). What happens if the inductance of the loading coil is increased? Curve (d) shows the same type of circuit loaded with 120 millihenry coils, and it can be seen that the response is still further improved but over a more restricted frequency range. In this case the sharp decline has set in by 3,000 cycles/sec.

The circuit of Curve (c) is suitable for music transmission because the response does not fall off too steeply until about 8,000 cycles/sec. and equalizers can be made to correct for the response up to this frequency. The circuit of Curve (d) would be quite unsuitable for music transmission, however, because of the restricted frequency range, but such circuits are quite suitable for telephone control line purposes. Thus it will be seen that not every circuit is suitable for music transmission; it must be of the right type.

The lumped inductances, or 'loading coils' as they are called, are wound on circular cores, and several hundred may be put in one 'pot' and wired into the many circuits of the cable at regular intervals—usually 2,000 yards. Fig. 82 shows the electrical connection of these coils.

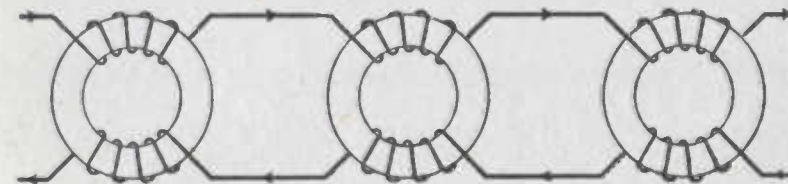

FIG. 82. LOADING COILS, SHOWING METHOD OF CONNECTION

The arrows on the lines show the direction of the speech current at a particular instant of time, and the effect of the current passing round the coils in those directions is to aid each other in creating a large magnetic field, and so to give the line a large inductance.

The question might well be asked: 'what can be done to obtain a music circuit if all the pairs on a particular cable route are heavily loaded, and giving a response like Curve (d) in Fig. 81?' This is not an academic problem, but one that has to be faced frequently. There is only one way out of this difficulty, and that is to remove the loading inductance from the

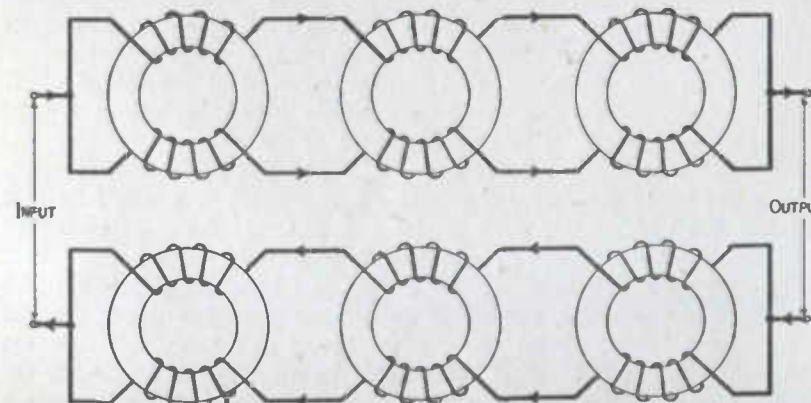

FIG. 83. TWO LOADED LINES 'BUNCHED' TOGETHER

line! This doesn't mean that they have to be physically removed, for we can resort to a trick whereby the effect of the inductance is cancelled, but it means using two such loaded lines to do the job. The method of connection is shown in Fig. 83, and again the arrows, showing an instantaneous direction of current, have been drawn to facilitate explanation.

The action of this arrangement, known as 'bunching', is as follows. The current passing along either pair of wires now flows in the same direction along each leg of the pair, and this causes the magnetic induction in the coils to cancel out. Thus the effect of loading has been neutralized and the total circuit behaves as an ordinary, unloaded line.

From the preceding discussion on lines it is seen that, in all the cases considered, various frequency components are not transmitted with equal efficiency, and at the beginning of this chapter it was laid down that this equality of efficiency was a necessary condition to distortionless transmission. Networks, called 'Equalizers', have therefore to be added at the terminals to compensate for the line deficiency, so that the combination of line plus equalizer does transmit all frequency components with equal efficiency.

EQUALIZATION

If resistance, capacity, and inductance in line circuits distort the frequency response, then it is reasonable to suppose that, by a judicious arrangement of these same elements at the end of the circuit, a compensation of this distortion might be obtainable. We stated earlier that condensers have the property of passing higher frequencies more freely than lower frequencies, and because the natural capacity of a line acts in shunt, the higher frequencies get reduced more rapidly than the lower ones. It follows that a condenser in series will act in an opposite manner and will cause less loss at higher frequencies than at the lower. From this can be seen the principle of equalization. Although it would be too much to hope that a simple series condenser would compensate for the distributed condensers along the line, it can be said that the use of the simple elements of resistance, capacity, and inductance can produce complete equalization. The complexity of such a network depends upon the shape and steepness of the line curve. For example, Curve (b) of Fig. 81 shows a uniform slope which is not too steep and therefore can be equalized with a relatively simple network, which might consist in principle of a capacity and resistance in shunt, placed in series with the line. Curve (c) is more complex because it consists of two distinct steps, one from 100 cycles/sec. to 1,000 cycles/sec. and the second above 5,000 cycles/sec. Such a line would have to be equalized by two sections of network, each one separately looking after each of the steps.

The steepness of the loss curve to be equalized plays an important part. A simple condenser arrangement provides a characteristic which follows a simple law but which has a limit on its steepness. It therefore cannot be used to equalize a line whose characteristic is steeper than this limit. What, then, can we do? Fortunately, the answer lies in a phenomenon which we hinted at in Chapter I, but which we did not discuss in detail, viz. the principle of the 'tuned circuit' or combination of inductance and capacity. If you remember, both of these components had a 'time factor'; i.e. the condenser took a certain time to charge and discharge, and the inductance set a time limit on the current being built up in it. When these elements

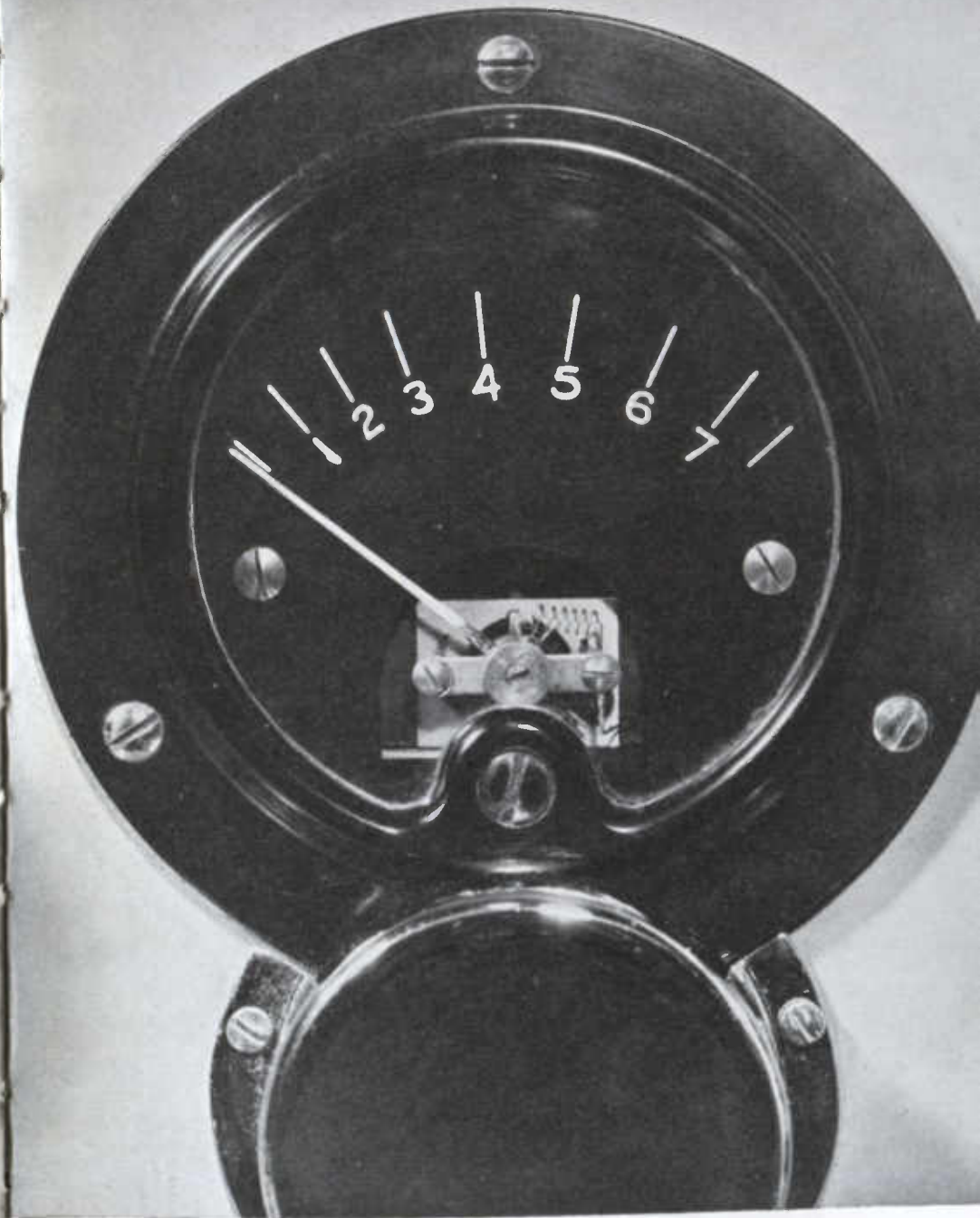

The peak programme meter



A.C. testing equipment, showing T.P.M., T.M.S., oscillator and amplifier, amplifier detector, and variable attenuator

Plate VIII

are brought together, it is hardly surprising that there will be an alternating current of a certain frequency (or 'time') which is more suited to passing back and forth through this tuned circuit than any other frequency. This critical frequency is known as the resonant frequency, and the behaviour of the two types of tuned circuit will be examined in a little more detail here. The two types are the 'series' and 'parallel' arrangements, and there is an essential difference between them. For, although they both exhibit this resonant effect (in fact, the formula for determining the resonant frequency from the sizes of inductance and capacity is the same for both circuits if no resistance is present; see Appendix II), it reveals itself in entirely opposite ways for the two cases. In the series arrangement, the circuit has a minimum impedance at resonance, and therefore passes maximum current at this frequency. If the curve of impedance against frequency were drawn for the series circuit, it would look very much like the case of the pure condenser at the lower frequencies (see Chapter I, Fig. 21), but that the effect of the inductance is to hasten the reduction of the impedance.

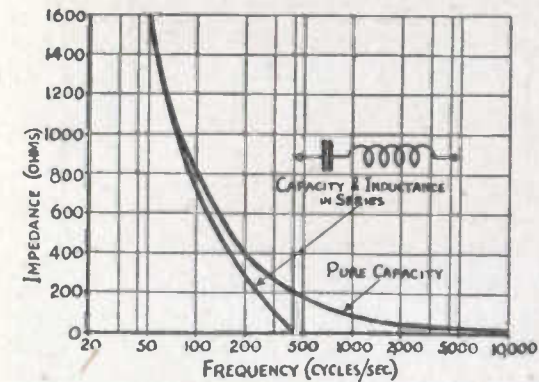

FIG. 84. IMPEDANCE/FREQUENCY CURVES FOR CAPACITY, AND SERIES TUNED CIRCUIT

This curve has been repeated (but with different figures) in Fig. 84, together with the new curve for the inductance in series with the condenser. It will be noticed that not only has it made the curve steeper, but that the impedance has been brought down to zero at a certain frequency. This, of course, is the resonant frequency, and its value is determined by the size of inductance and capacity; in the example given, it has come out at 400 cycles/sec. At frequencies above the resonant frequency, the impedance will

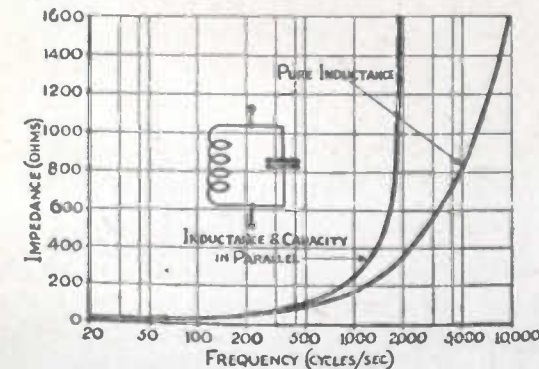

FIG. 85. IMPEDANCE/FREQUENCY CURVES FOR INDUCTANCE, AND PARALLEL TUNED CIRCUIT

rise again, but we need not examine that in detail, because it would lead us into complications of a change of 'sign'.

If we now consider the parallel case, a different effect is produced. This time we can compare the start of the curve with that of a simple inductance, again repeated in Fig. 85.

Once more we see that the effect of the combination is to steepen the curve, but this time the total impedance is hastened on to infinity at resonant frequency (2,000 cycles/sec. in this case : it will fall again as the frequency increases). The parallel circuit therefore passes minimum current at resonance—the exact opposite of the series circuit.

These two differing effects give us a clue as to how the two types of circuit must be used in an equalizer. The series arrangement (Fig. 86a) has been found to be a modification of the simple capacity/resistance type and will therefore be put in series with the line.

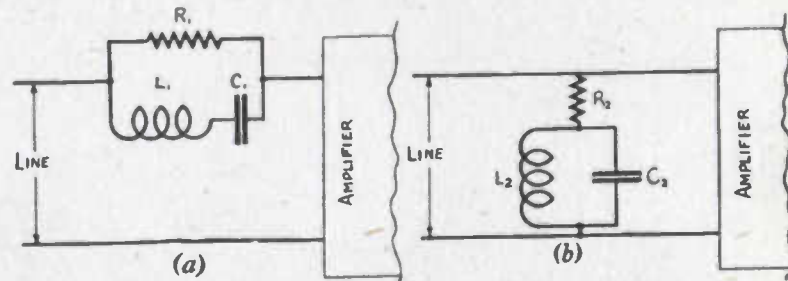

FIG. 86. SERIES AND PARALLEL TUNED CIRCUIT EQUALIZERS

The parallel type (see Fig. 86b) is put across the terminals of the line, so that it acts as a 'shunt'. At high frequencies (i.e. at, or near, the resonant frequency) the impedance of this circuit will be large and it will therefore not allow much current to be shunted, but at frequencies lower than and progressively further away from resonance, more and more current will be by-passed according to the 'law' of the curve. An example of an actual line characteristic, together with the resultant curve after a parallel type of equalizer has been used, is shown in Fig. 87.

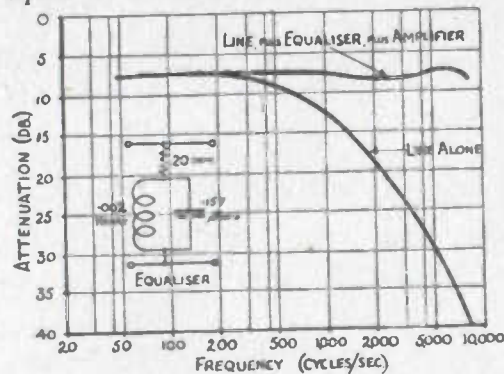

FIG. 87. GRAPHS TO SHOW CHARACTERISTICS OF LINE WITH AND WITHOUT EQUALIZER

Both the simple series and parallel arrangements suffer from the defect that their impedance changes extensively with frequency, and thus the impedance across the end of the line is likewise changed with frequency. This variation of 'termination', as it is called, means that the measured loss of

the line does not correspond to the working loss when the equalizer is added. The resultant behaviour of line plus equalizer is therefore difficult to predict and leads to an adjustment by trial and error. Thus, an equalizer setting is first made as near as possible to the estimated values, and the line plus equalizer are then tested together. If the resultant is not quite right, the settings are altered and further tests made; each result getting nearer the ideal.

We can overcome this difficulty of a non-constant impedance by combining the series and parallel elements as in Fig. 88.

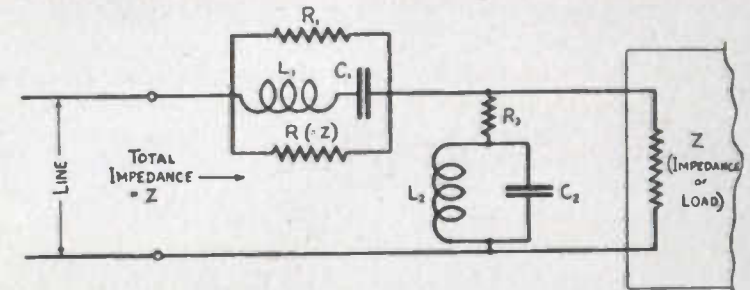

FIG. 88. CONSTANT IMPEDANCE EQUALIZER

The extra resistance 'R' across the series element is made equal to the impedance of the load, 'Z'; and provided this is a pure resistance and a suitable choice of values of the elements is made, the impedance of the whole network is kept constant (and equal to 'Z') although its loss varies with frequency. This means that the termination of the line is exactly as it was before the equalizer was added. This permits the components of the equalizer to be predicted with accuracy, which is a great advantage. This notable property, which leads to the name 'constant resistance' equalizer, is widely used, although it is more expensive in the number of elements than the simple equalizer.

Permanent lines, such as those between BBC studio centres and transmitters, will naturally have fixed equalizers which are permanently wired into the terminal apparatus of the line. For temporary lines (O.B.'s etc.), it would be very uneconomical to provide fixed equalizers, and so we use variable ones. They have components which can be varied, within limits, by switches and/or dials and these settings can be altered to suit the particular line, provided that the right type of equalizer has been chosen.

HARMONIC DISTORTION

The next essential is to avoid picking up currents that were not part of the original programme sent to line. One of these is the harmonic distortion already spoken about. It may be stated here and now that the simple wires themselves that constitute a line cannot be responsible for 'overloading', which is the main cause of the introduction of spurious harmonics. This form of distortion must be due to some intermediate apparatus, such as an amplifier, or in certain exceptional cases a coil or transformer. Amplifiers are required on long lines as will be seen from the following paragraphs on noise.

NOISE

A cable consists of many pairs of wires laid together inside a lead

sheath. These other wires will possibly be carrying other programmes, or telephone speech, or teleprinter traffic, as well as sundry switching clicks and the countless codes and signalling sounds bound up with modern telephone practice. Each and every one of these provides a source of electromagnetic induction which is trying to induce spurious voltages into our particular pair of wires. On top of this there are all the electromagnetic fields which are outside the cable, such as electric light and power cables with their attendant switching clicks and inevitable 'hum'. One of the first requirements that the G.P.O. lays down is that a level of +4 db. is the maximum that they will allow to be put on a line. This is in order to minimize the danger of 'cross-talk' induction on to neighbouring circuits. Even so, enough noise gets on to the line to make it a serious drawback to the range of volume that can be sent to line. Let us suppose that the inherent noise, even after all possible precautions have been taken, is at a level of -80 db. If we put a maximum programme level of +4 db. on the line, and this particular line has a transmission loss of 30 db. (we shall only consider the loss at one frequency for convenience in this example, although the extra loss at high frequencies makes it even more pronounced), then this high volume programme will arrive at -26 db., or 54 db. above noise level. This is quite a good programme/noise ratio, and would be quite satisfactory if the volume of all programme were high. But if, during the quiet passages of our programme, the level were to drop to -40 db., this would arrive at the far end of the line at -70 db., or only 10 db. above noise level. This ratio would not do at all, and you can see now why the sending volume range has to be restricted. If it is compressed to 24 db., the softest programme will now be at -20 db., which arrives at -50 db. or 30 db. above noise level. It has been found that the noise level as measured on a peak programme meter should never be worse than 45 db. below programme peaks measured on the same instrument. There are even some exceptions to this—a very low frequency hum may not be objectionable at a slightly higher level.

The above example is by no means the worst encountered, and it shows that we are up against a fairly big problem. You have already had a foretaste of the method of keeping the noise level down in the chapter on control room apparatus, but we will run over it again because of its importance.

BALANCED LINES

The pair of wires in a cable are very carefully made and twisted closely together. For this reason, any stray field that induces an e.m.f. into one wire will almost certainly induce a similar e.m.f., both in strength and 'sign', in the other wire. Any lack of symmetry which does not ensure this equality is one of the important causes of noise. The two conductors must not only have the same ohmic resistance, which the manufacturers take particular care to obtain, even going to the trouble of seeing that both wires of one pair come off the same reel, but must have the same leakage resistance (insulation) to other wires and to earth. Also the capacity of each wire to other conductors and to earth must be the same all along the line. With all this care in 'balancing' the two wires, let us follow the progress of the programme and noise in the pair.

Fig. 89 shows the line terminated at each end by a repeating coil, which is nothing more than a carefully made transformer, itself constructed so that

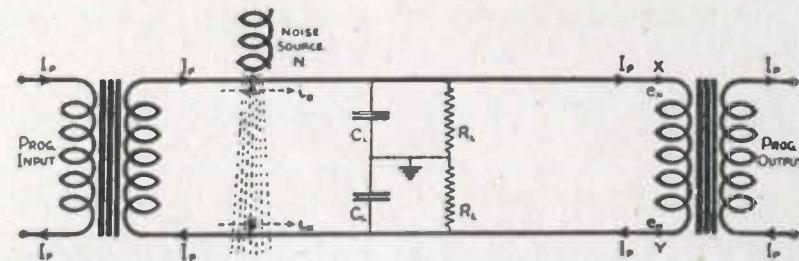

FIG. 89. THE CONDITIONS OBTAINING IN A BALANCED LINE

the capacities of every winding are equally balanced to earth and to other parts of the transformer. Let us consider the programme currents at any one particular instant flowing through the primary of the input transformer (i.e. in one end and out of the other). This flow of current will induce a similar current in the secondary winding which will, in turn, pass through the primary of the distant repeating coil. It may therefore be regarded as a circulating current, which at any particular instant is always going in opposite directions in the two wires. Because it goes through the second repeating coil primary it will induce a current in the secondary, and this is passed on to whatever piece of apparatus requires it. All these programme currents, with their directions, have been shown as ' I_p '.

Now let us consider a 'noise' being induced from a local source 'N'. Owing to the closeness of the wires, it will induce equal voltages in both, and for simplicity, it will be assumed that they cause equal currents, ' i_n ', to flow in both wires at points, 'A' and 'B', which are diametrically opposite in the pair. The two currents will each travel along to the ends of the line (only one end is dealt with here, although an exactly similar state of affairs exists at the other end) and will arrive at the two ends 'X' and 'Y', of the repeating coil. They will not have the same value as the original ' i_n ', because a certain amount will have leaked away due to imperfect insulation and the capacity of the lines, not only between wires, but between each wire and earth. These resistance and capacity 'leaks' are shown on the diagram as ' R_L ' and ' C_L ' respectively and are, of course, distributed along the whole length of the cable, not 'lumped' together as shown. In addition, there is the ohmic resistance of the wires themselves, and this also causes a drop in current. But, and this is really important, if all the factors of resistance, leakage, capacity, etc., are made exactly equal for each wire, then the two equal currents, ' i_n ', will cause equal voltages ' e_n ', to be set up at the points 'X' and 'Y'. Not only will they be at equal potential, but of equal 'sign', viz. either both positive or both negative, at any particular instant. Therefore there will be no potential difference between them, and because it is only a difference in potential that can drive a current through a conductor, there will be no current through the repeating coil primary. Hence the noise currents, ' i_n ', have no effect on the coil and will not be heard in the secondary. This is true only if the lines are exactly balanced; for if, because of either leakage or unbalance of the conductors, more current is lost in one wire than the other, then the initially equal currents, ' i_n ', will not produce equal voltages, ' e_n ', at 'X' and 'Y'. In that case,

there will be a potential difference and a certain amount of noise current will flow through the primary, and subsequently be heard superimposed on the programme.

In practice, it is possible for the P.O. to provide us with circuits having a high degree of balance, and with consequently low noise level. It is always necessary to check the line for these factors, and methods of testing will be described at the end of the chapter. Not only does the use of balanced lines and repeating coils keep down the noise, but the principle may be extended to provide extra facilities. Let us suppose that the repeating coils have their windings very carefully split, or 'centre-tapped', as it is called. Fig. 90 shows this arrangement in which each centre-tap is connected to earth.

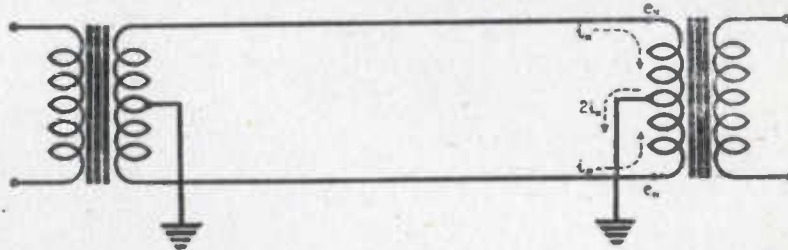

FIG. 90. EARTHING THE 'CENTRE-TAP' OF A REPEATING COIL

Consideration of the circuit shows us that if noise voltages, ' e_n ', are produced at each end of the coil they will now send currents, ' i_n ', through the two halves of the winding, combining at the centre to form a current of ' $2i_n$ ', which flows to earth. The important point to remember is that the two currents flow in opposite directions through the repeating coil, and so their total magnetic effect is nil. The lines and coils can be so well balanced that even heavy currents will be cancelled out. In practice there will generally be no need to earth the centre point of the coils, but the principle described is made use of in 'phantom working'.

PHANTOM WORKING

Use is actually made of this to carry extra 'intelligence' over a pair of wires that is already handling its normal traffic. For example, it would be possible to send current pulses into the centre-tap of one transformer, along both wires at once to the far end, combine them at the centre-tap of the

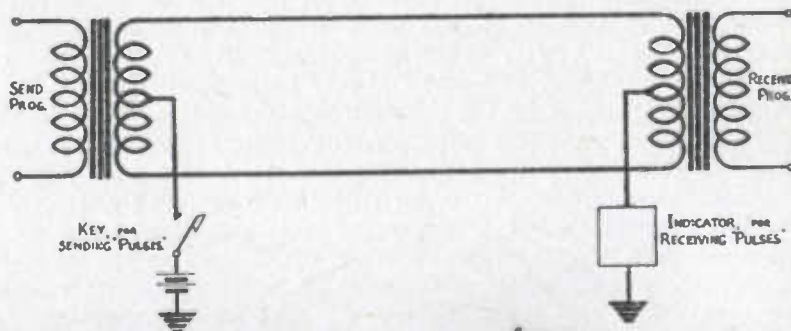

FIG. 91. A SIMPLE 'PHANTOM' CIRCUIT

second coil, and return via earth to the source. Fig. 91 shows how this is done, and, of course, the 'pulses' can be replaced by a second telephone circuit.

Such a device is called a 'phantom circuit', although it is not always advisable to use an 'earth return' because any unbalance that exists is accentuated. Instead, we use another pair of wires on which to superimpose the return circuit, the final circuit looking like Fig. 92.

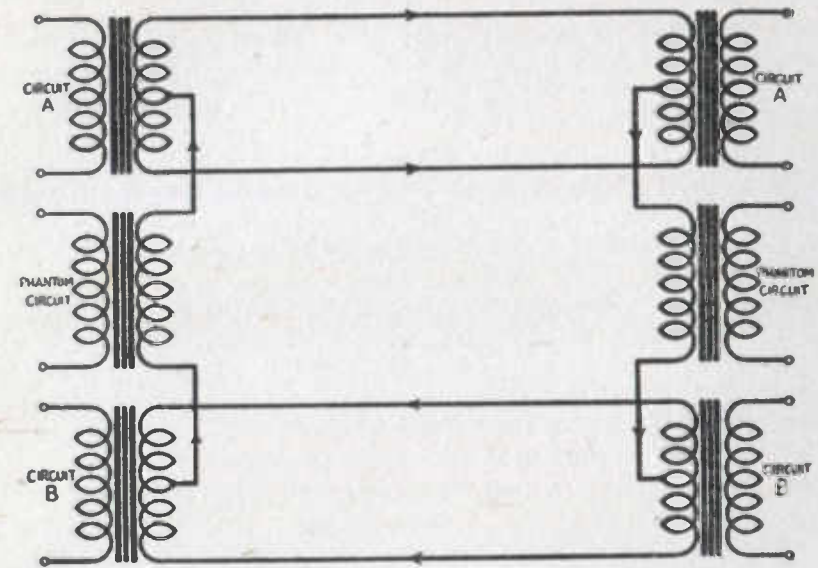

FIG. 92. PHANTOM CIRCUIT ON TWO SIDE CIRCUITS

The arrows show the direction of the current in the phantom circuit at any particular instant, and it should be obvious that as far as 'A' and 'B' circuits are concerned, they are always equal and cancelling. But what happens to noise on a phantom or 'bunched loaded' circuit (for 'bunching' is only a special case of phantom working in which the side-circuits are not used)? The P.O. use cables which have sets of two closely twisted pairs in them, each pair twisted upon itself and the two pairs twisted together, called 'quads'. Such twin pairs then follow the same rules of having noise currents induced into all four wires in the same direction, and the repeating coils look after the rest of the business.

So much for one way of getting rid of noise; only unfortunately, it is never perfect. There is generally some lack of balance; or perhaps the e.m.f.'s are not equally induced to start with. The inherent noise on a line depends, of course, on its construction as well as the proximity of stray fields, and it may be of almost any value, and occur at any, or many, points along the line. If, therefore, a programme is put on to the line at a given level (not more than +4 db., you will remember) it will get progressively weaker because of the material 'attenuation' of the line. It is not so much the loudest programme that we are interested in, as the weakest; so if the permissible range is 24 db., it will mean that the weakest level will start off at -20 db. This would get weaker and weaker until, if nothing were done

about it, on long lines it would drop to below noise level. Actually, we do not want the weak sounds to approach nearer than about 30 db. to the noise level, because if the ratio of programme to noise gets lower than this, the noise becomes objectionable.

REPEATERS

To overcome the progressive attenuation of a line, amplifiers (called 'repeaters') are inserted at intermediate points on the line to boost up the level when it drops to anywhere within the audible range of noise.

The repeaters are amplifiers which are fitted and maintained by the Post Office at repeater stations which are found on all main trunk telephone routes in the country. There are occasions when, for a temporary (O.B.) line, a BBC repeater, with an engineer to look after it, will be set up at a P.O. Exchange. The spacing of these repeaters will depend upon the loss characteristic of the line used. Referring back to Fig. 81 the repeater spacing when 40 lb. non-loaded circuit is used could be about 25 miles, but other conditions usually fix the spacing at about 20 miles. For 16 mH loaded circuits the repeater spacing is 50 miles. There are such things as 'two-way repeaters', but their peculiar construction involves the restriction of the frequency band to about 2,500 cycles per second, thus making them suitable only for transmission of telephone speech. A second result of the use of repeaters is the overloading effect to which we have already referred. Amplifiers have definite limitations in the amount of power they can supply, and if this limit is exceeded a great many tones other than those applied to the amplifier appear in its output. Further, the valves age, and this effect may then occur at normal levels. It is, therefore, important not to attempt to work a circuit at a higher level than the one designated.

Usually, a repeater incorporates an equalizer to 'straighten up' each section of the line preceding it before passing it on to the next section. Another point to remember is that 'phantom circuits' would not be possible on a repeated line, unless precautions were taken to preserve the electrical continuity. This might be done by connecting the centre-taps of the input and output repeating coils of the repeater as in Fig. 93, but frequently the phantom circuit is repeated at the same point as the physicals from which it is derived. In this case a phantom coil group, as shown in Fig. 92, is provided at the input and output of the repeaters.

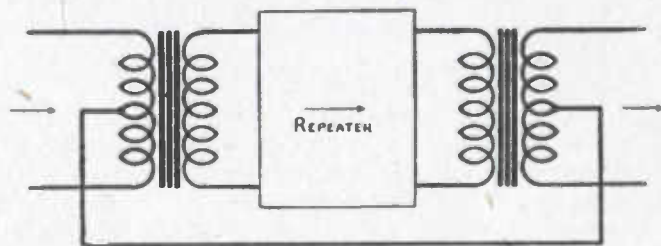

FIG. 93. METHOD OF BY-PASSING A REPEATER FOR PHANTOM WORKING

It will be seen from the foregoing that there is very much more in 'lines' than being able to regard them simply as pairs of wires which need no care or attention. The G.P.O. lease excellent lines to the BBC, which conform

to the highest specification. Nevertheless, means must be available for testing them, not only to find whether they are mechanically and electrically sound, but also to find out their particular characteristics so that we may attach the correct terminal apparatus.

LINE TESTING

The testing of lines falls into two classes to cover the above requirements, known as D.C. and A.C. tests respectively. One of the first things we want to know about a line is its conductor resistance, and how well the conductors are insulated from each other, and from earth. There are one or two pieces of apparatus that will do these jobs, and they will be described in turn.

D.C. TESTS BY THE P.O. 'CLOCK'

One of the simplest instruments is the P.O. 'clock', as it is popularly called, due to its somewhat similar appearance to a clock face of about 8 inches diameter. The circuit is simply that of a battery in series with a sensitive milliammeter, and with it we can do the tests shown in Figs. 94 (a), (b), and (c).

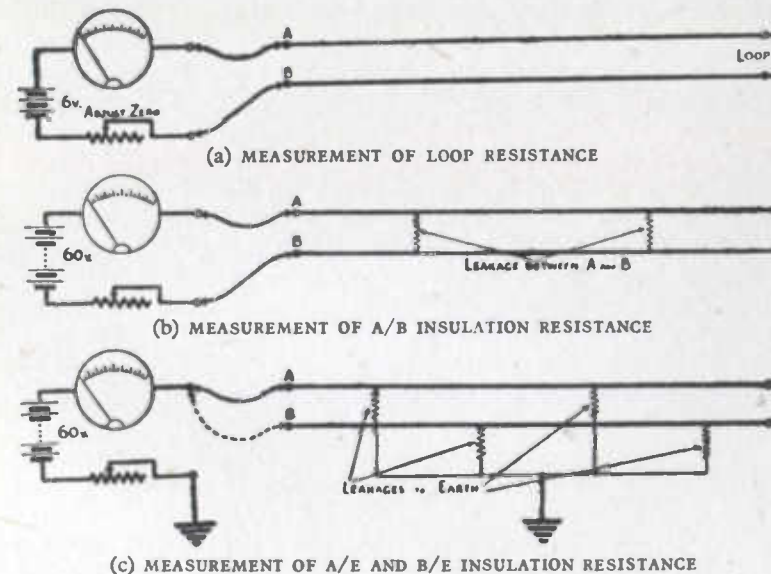

FIG. 94. D.C. TESTS BY THE 'P.O. CLOCK'

Diagram (a) shows the circuit diagram for finding the 'loop resistance' of the conductors 'A' and 'B' which form one line. (The two wires are often referred to as the 'A leg' and 'B leg' of the line.) In order to carry out the test, it is necessary to get the far ends of the legs looped together. The battery, 6 volts, will now force a current round the circuit and the value of the current will depend on the loop resistance, according to Ohm's law. If we could be sure that the battery voltage is of a given constant value (say, 6 volts) then we could well have the meter scale calibrated direct in ohms instead of milliamps. This, in fact, is what is done, and to ensure that the battery is correct, a small variable resistance is included (marked 'adjust zero') in series with the rest of the circuit. As a check before

each measurement, a short-circuit is put on the test points instead of a line. The meter should then, of course, read 'zero', which is full right-hand deflection of the needle. If it doesn't, then the resistance is adjusted until it does, when it is ready to do its tests correctly. The test of loop resistance is useful in two ways. Firstly, it enables us to recognize a line as being the one we expected to receive from the P.O., for its resistance is a fair guide as to its length, and because it is unlikely that two dissimilar lines would have exactly the same loop resistance. Secondly, it reveals whether there is any break in the line which would show up as 'infinite' resistance. This method of measuring resistance is not very accurate, but it is rapid and good enough for routine tests.

INSULATION RESISTANCE

The real use of the P.O. clock lies in the second test, that of measuring insulation resistance. We should like the conductors to be perfectly insulated from each other, and from 'earth'. In practice, the insulators in general use (such as paper, cotton, etc.), will always allow a small leakage current to pass, and it is necessary to know how much this is. Practically all trunk cables are paper insulated, and the insulation depends upon the paper remaining dry. If the lead sheath gets damaged, the paper becomes damp and the fault is first observed by a fall of insulation resistance. Later, if the paper becomes really wet, the circuit becomes unusable; therefore, insulation tests are important because they detect incipient faults. Fig. 94 (b) and (c) show this leakage resistance in 'lumped form', but it is, of course, distributed all along the wires. Owing to the fact that we expect the resistance to be high (many millions of ohms, in fact), the current that a 6-volt battery could push through would be extremely small and would scarcely show on the meter. We must therefore increase the battery to 60 volts, when an appreciable reading may be observed for even 20 megohms. The change-over to the higher voltage and the arrangements for checking the new 'zero' are all done by key switches (not shown on the diagram). Diagram (b)

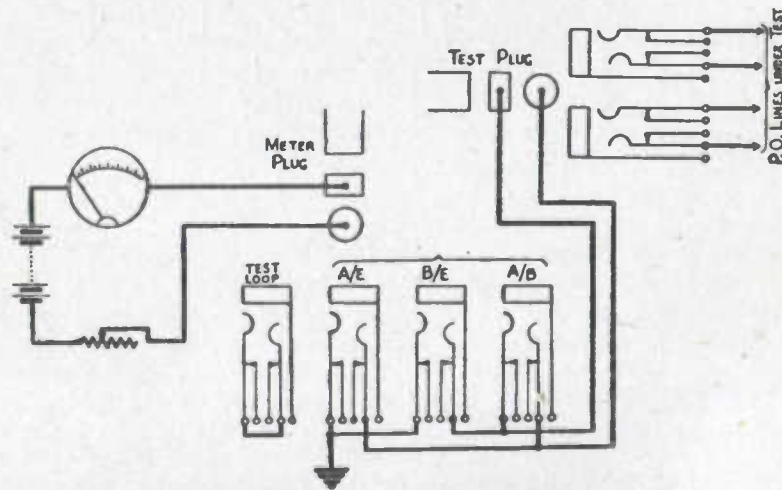

FIG. 95. ARRANGEMENT OF JACKS FOR MAKING RAPID D.C. TESTS

shows how the insulation resistance between 'A' and 'B' legs is measured; whilst (c) shows how the insulation between either 'A' and Earth, or 'B' and Earth, is obtained.

Because the lines in a control room usually terminate on jacks, it is usual to arrange for the connections to the P.O. clock also to be made via a set of jacks. They are wired in the manner shown in Fig. 95, whence it can be seen that the connections for testing 'A/B', 'A/E', 'B/E' may be made rapidly.

The above tests all pre-suppose that there is somebody at the far end of the line to put on the loop and take it off again when necessary. There are many occasions when there is no one to do this; but there is a way of overcoming the difficulty if, as is usually the case, two lines are available. It is known as 'looping A to A, and B to B' and it is a strict rule that this simple operation is carried out before any O.B. lines are left unattended. Fig. 96 (a, b, and c) show how this may be done; the first (a) being the obvious interpretation. However, since the terms 'A leg' or 'B leg' have no particular significance, it is equally correct to loop them as in (b) but this leads to confusion with condition (c), which is definitely wrong.

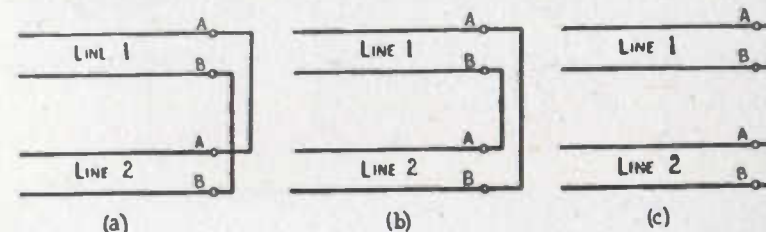

FIG. 96. RIGHT AND WRONG METHODS OF LOOPING A LINE

The reason for the loop is to make it possible to do all the testing from the control room end of the lines. For there we need only connect our testing apparatus to one pair, and the second pair is available at our side, either for applying a loop, or leaving open, according to whether low or high resistance is to be measured.

There is another instrument for measuring the insulation resistance of a line which proves very effective, and is often more convenient, for it is portable. It is called by its trade name, the 'Megger', and, as its name implies, it is used to measure 'megohms'. In one way it is rather like the P.O. clock in that it measures the current driven through the leakage resistance by means of a given potential. The difference lies in (a) the method of obtaining the potential which is done by means of a hand-driven generator; and (b) a special circuit arrangement which makes the readings practically independent of the generator voltage. The maximum voltage is limited by the use of a 'slipping clutch' so that, if the handle is turned too quickly, the clutch slips and the dynamo armature does not exceed a given maximum speed. The meter itself has a scale not unlike the P.O. clock, and is calibrated to read from about 10,000 ohms to 50 megohms but is not accurate below or above this range, the next divisions being 'zero' and 'infinity' respectively. There is also a considerable modification of the meter 'movement', which is a patent of the manufacturers, and need not really concern us here. The voltage developed by the generator is specially

reduced to 250 (instead of the 500 volts usually found on the commercially available model) because the G.P.O. will not allow a greater voltage than this, to avoid the breaking-down of the insulation of the line.

THE WHEATSTONE BRIDGE

So much for measuring high resistance; the low resistance measurements obtained on the P.O. clock are not accurate, its main use being the rapidity with which many lines can be checked for approximate values. In order to measure low resistance, we have to resort to rather less simple methods, and the 'Wheatstone bridge' is probably the most famous and popular device in use.

A little theory is needed here, and we shall revert to potential dividers to explain it.

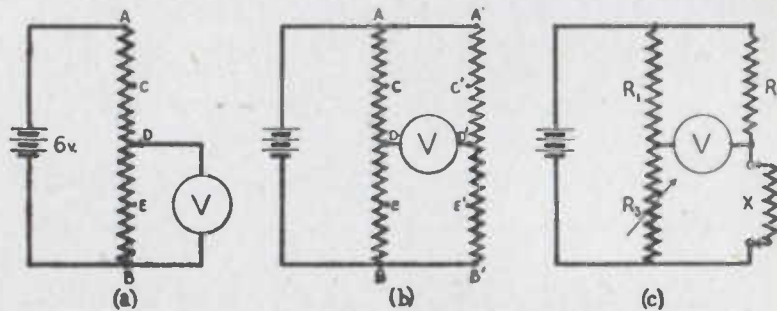

FIG. 97. DEVELOPMENT OF A BRIDGE CIRCUIT

Consider Fig. 97 (a) where we have a battery of 6 volts (it will be learned later that the actual voltage is quite immaterial) across which is a resistance 'AB'. If we select points 'C', 'D', 'E' on the resistance such that $AC = CD = DE = EB$ (which is another way of saying that the resistance has been divided into quarters) then a voltmeter, 'V', placed between point 'B' and any other of those points will read 6 volts between 'AB'; 4.5 volts between 'CB'; 3 volts between 'DB'; and 1.5 volts between 'EB'. These figures will be quite independent of the actual resistance of 'AB', and the only thing of importance will be the accuracy with which the resistance is divided up.

Now suppose we have another resistance, 'A'B'', connected across the same 6 v. battery, as in the second diagram (b). It may be of any value, not necessarily the same as the first, but we will again divide it into four parts, so that 'A'B'' = 6 volts; 'C'B'' = 4.5 volts; 'D'B'' = 3 volts; and 'E'B'' = 1.5 volts. If we place the voltmeter across points 'DD'', what do we expect it to read? Well, since both of those points are at a potential of 3 volts, i.e. equal potentials, there will be no potential difference and no reading will be observed on the instrument. Similarly, there will be no potential difference between 'C' and 'C'', or 'E' and 'E''. Another way of expressing this result is in terms of the resistances which go to make up the two potential dividers, such as:

$$\frac{AC}{CB} = \frac{A'C'}{C'B'} \text{ or } \frac{AD}{DB} = \frac{A'D'}{D'B'} \text{ etc., etc.}$$

Let us go a stage further and consider diagram (c). Here we have the same arrangement except that we have given the sections different names, viz. 'R₁', 'R₂', 'R₃', and 'X'. The last one is the interesting one because it is the 'unknown' resistance. 'R₃' is made variable and is calibrated so that its value is known. With this set up, we can vary 'R₃' until there is no reading shown on the voltmeter, i.e. until the network is 'balanced', and then we know that:

$$\frac{R_1}{R_3} = \frac{R_2}{X} \text{ or, } X \text{ (unknown)} = \frac{R_2 \times R_3}{R_1}$$

If 'R₃' equals 'R₁', the ratio, $\frac{R_2}{R_1}$ becomes unity, and $X = R_2$. Thus,

by obtaining a condition of balance, we have found the value of our unknown resistance, 'X'.

The usual way of drawing the network is shown in Fig. 98, and it is known as a 'bridge'.

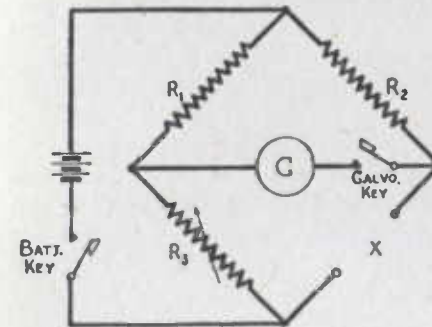

FIG. 98. CONVENTIONAL METHOD OF DRAWING THE WHEATSTONE BRIDGE

Some usual modifications to be observed are the provision of two 'keys', one to break the battery circuit, and the other in the galvanometer circuit.

The word 'galvanometer' may be new to some of you, but it simply means an instrument which is sensitive to small electric currents. It is often arranged to have a 'centre zero' and to indicate the current in either direction. Thus we can tell whether R₃ has to be increased or decreased to obtain the correct balance.

There is an interesting point about the Wheatstone bridge, and that is when R₁ is not equal to R₂. Suppose we make R₁ = 10.R₂; then, by the previous formula, R₃ will be 10.X. Now it is not usually convenient to make R₃ read more than 10,000 ohms, and variable in steps of less than 1 ohm. If, therefore, we have a low resistance, 'X', to measure, it would be much better to obtain as many 'figures' as possible on 'R₃' and apply the division by 10 afterwards. For example, suppose 'X' is about 90 ohms and we try to measure it under the ordinary conditions where R₁ = R₂. Then R₃ might possibly give a result that indicated a balance somewhere between 91 and 92 ohms. But making R₁ = 10.R₂ we could find a more

perfect balance when R₃ = 917. Therefore $X = \frac{917}{10} = 91.7$ ohms. Simi-

larly, we can make $R_1 = 100.R_2$, or even $1,000 .R_2$ for measuring still lower resistances or make $R_2 = 10.R_1$; $100.R_1$; or $1,000R_1$ for measuring very high resistances. On practical bridges, the adjustment of the 'ratio arms', as ' R_1 ' and ' R_2 ' are called, is often done by a single switch which indicates by a pointer the decimal calculation to be made. The use of the bridge is obvious when we wish to measure the loop resistance of lines, most of which range between 200 and 2,000 ohms for a single line (or up to 4,000 ohms, if an 'A-A', 'B-B' loop is taken), and the accuracy is fairly good to 3 figures on the average control room model. There is an interesting model which is in portable form and combines with the ordinary Megger to make a 'Bridge Megger'. The principle is exactly the same, but the potential now obtained from the same generator as the Megger part of it. When a switch is thrown, the appropriate connections are made, including a reduction of voltage from the generator, and the resistance ' R_1 ' is varied by a set of knobs calibrated in thousands, hundreds, tens, and units.

In general, line testing apparatus is fitted with jacks for the input connections, because of the standard arrangements in control rooms for terminating lines. Where a portable instrument is used, a small unit with several jacks is connected by terminals to the free wires of a line, and this immediately gives us facilities for picking up A/E, B/E or A/B connections as already described under the P.O. clock.

OUT-OF-BALANCE TESTS

There is now another feature of P.O. lines that has to be checked and that is their state of balance. The importance of having both legs of a line exactly equal, in order to mitigate noise troubles, cannot be stressed too much. A rather clever way of measuring the 'out-of-balance' has been worked out by a Mr. Varley, whose name has been given to the particular modification of the Wheatstone bridge called the 'Varley test'. Fig. 99(a) below shows that the battery, instead of being joined to the junction of ' R_1 ' and ' X ', has been connected to earth. The far end of the line has also been earthed, as well as looped.

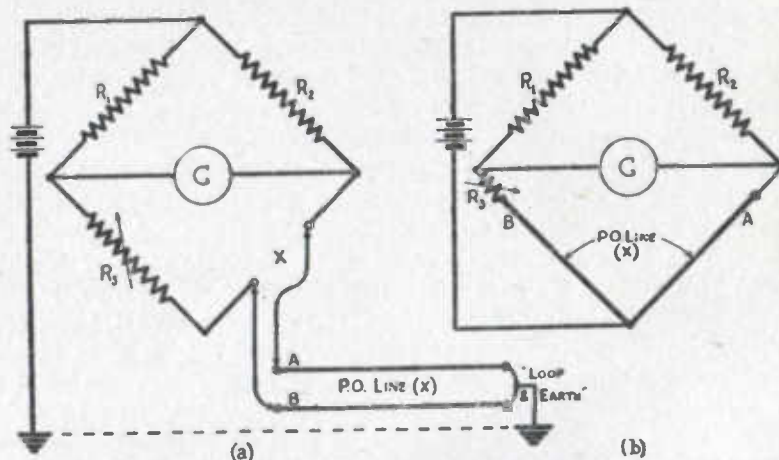

FIG. 99. THE VARLEY LOOP TEST

If you now look at the second diagram (b) you will see that, although it is laid out differently, the circuit is really identical. Now the resistance of 'A-leg' should be exactly equal to the resistance of 'B-leg', in which case, a balance would be found when $R_3 = 0$. Suppose $A = 2$ ohms more than B ; then we would have to make $R_3 = 2$ ohms to make up the difference. So R_3 becomes a measure of the out-of-balance between 'A' and 'B'. And if 'B' is greater than 'A' you just take off the connections and reverse them!

It should be noted that in all these tests we have been finding out something about the physical properties of the line. The results will tell us whether the line is mechanically sound and 'fit for use'. If it does not come up to our expectations, e.g. it shows low insulation, out-of-balance, etc., according to pre-arranged standards, then there is little we can do about it, except to hand it back to the P.O. Engineers who will do their best to put the matter right.

A.C. TESTS

Having got the line safely through these preliminary D.C. tests, we now have to find its 'characteristic'. This is found by a rather complicated test which, since it utilizes alternating current of various frequencies, is known as the A.C. test. The apparatus required consists of three main parts, an 'oscillator', or 'tone-source', to generate the pure frequency tones which have to be sent over the line; a 'sender-circuit' which ensures that the correct level of tones is sent; and a measuring device at the receiving end to determine the exact level of received tone (Plate VIII).

THE SENDING CIRCUIT

The oscillator (which will not be described in detail here because it is a device fully described in the next chapter on transmitters) will produce audio frequency alternating currents according to the adjustments made on calibrated dials or switches on its panel. The first step is to measure the output of the tone source and adjust it to the correct sending level. This is most easily done by feeding it into a potential divider, of known resistance,

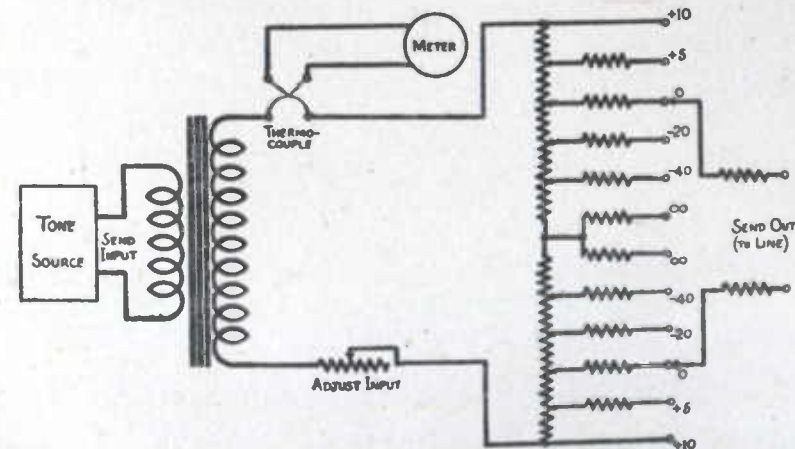

FIG. 100. THE SENDER CIRCUIT

and measuring the current flowing through it. By tapping off a certain percentage of the voltage developed across the potential divider, a known level can be sent to line. Adjustment is made by an additional series resistance so that the current may always be brought to a certain value. Fig. 100 shows the complete circuit, leaving out special arrangements for calibrating the meter which operates by means of a thermo-couple. A thermo-couple is really a method of producing electricity by means of two dissimilar metals which are joined at one end. When the junction is heated, a current is produced which is measurable on a sensitive instrument (a galvanometer) and is proportional to the temperature of the junction. This particular junction is heated by the passage of an alternating current through a wire, and therefore gives a method of producing D.C. from A.C. and of measuring small A.C. currents.

The complicated-looking potential divider, which is a 'balanced' one, is made so because of the extra series elements. These are to make the total impedance of the circuit always constant, and equal to 600 ohms. Initial adjustments to the sending circuit are made by the variable resistance 'adjust input', and then the required level is selected from the potential divider by switches.

MEASUREMENT OF RECEIVED LEVEL : THE 'AMPLIFIER DETECTOR'

Now, at the far end of the line we have to solve a fairly big problem. The incoming level is not only low, but the range of levels between the strongest (low frequency) and weakest (high frequency) signals may be very great, perhaps 50 db. or more. An ordinary voltmeter could not register this range accurately because it means that the louder signal is perhaps three or four hundred times as great as the weaker. Even a scale which is six inches long would have its divisions, representing volts, only 1/50th inch apart; and such an instrument is not a commercial proposition. So, with the use of quite simple apparatus, we resort to a trick. The incoming signal is fed into an amplifier, and the output of this is measured on a special sort of meter which for the moment we will call a 'detector'. This meter is arranged to measure only one value of level, and the gain of the amplifier is adjusted to give this level, the amount by which we have to increase or reduce the gain of the amplifier being a measure of the relative strength of the received tone.

Fig. 101 should make this clearer.

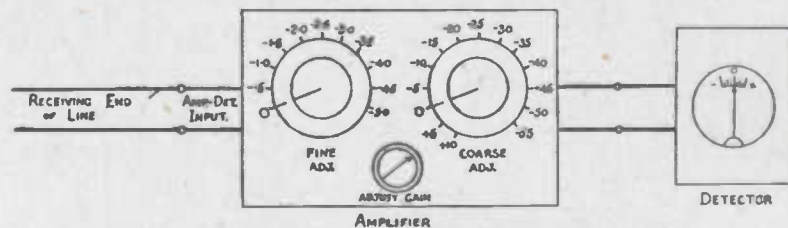

FIG. 101. SCHEMATIC ARRANGEMENT OF THE AMPLIFIER DETECTOR

The gain of the amplifier is controlled by two calibrated volume controls, one 'coarse' and one 'fine'. The coarse control is in steps of 5 db. over

a range of 60 db. (from 10 db. to -50 db.) and the fine control in 1/2 db. steps over a 5 db. range. Thus the gain can be varied over a range of 65 db. in 1/2 db. steps.

As an example of its working, let us suppose that the dials are both set at 'zero', and an A.C. input of zero level causes the meter to read mid-scale deflection. Next we wish to measure an unknown and, possibly, much lower level. This is fed into the amplifier and the gain increased by the two dials until the output of the amplifier again causes the meter to read the same mid-scale deflection. We might find that the controls have been turned to give a total gain of 37.5 db. Therefore, the 'unknown' level must be 37.5 db. below zero level, or -37.5 db. To save time and to avoid confusion, the dials are actually calibrated in the reverse sense so as to read 'direct'.

We need not consider the actual working of the detector, or meter, but there is one point that should be noted. It concerns the initial calibration that has to be carried out. Although valve circuits have now been made very stable, it is desirable to provide means of checking that no changes have taken place. You will remember that amongst our A.C. measuring gear we have a good 'sending circuit' whose job it is to deliver an accurately measured amount of A.C. We can thus put a known level, say zero level, into the amplifier detector, and, with the dials set at zero, the meter should read zero (mid-scale). If it doesn't, then we can use a third gain control, marked 'adjust gain', on the amplifier to bring the meter back to its correct zero. The 'adjust gain' is then left untouched for subsequent tests, which should now be correctly related to the attested zero level.

There is a very similar piece of apparatus to this which is not quite so accurate, because the meter is not so sensitive a type, but which works on the same principle. It is called the 'test programme meter' (T.P.M.) and the main difference is that it employs an orthodox programme meter in place of the 'detector'. It can be used for taking frequency characteristics, but its main use is in checking programme volume which is not steady. The dials are simply turned until the 'flicks' on the T.P.M. peak to 7, and the programme volume is then read on the dials.

Armed with the above equipment, the engineer can probe into the characteristics of a line in much the same way as a doctor diagnoses his patient's troubles, but the medicine the engineer prescribes is in the form of a network of resistances, inductances, and capacity, with a thermionic valve to act as a tonic to restore the general level. *capacitance*

QUESTIONS ON CHAPTER VI

- (1) What is meant by the 'distributed capacity' of a line? What effect does this have on the frequency response of a long line if no steps are taken to counteract it?

(2) What is meant by a 'loaded' line ?

Draw an attenuation/frequency graph showing :—

- (a) an imaginary line having resistance and capacity only.
- (b) a 25 lb. non-loaded line and the same line loaded at regular intervals with inductance. Indicate what would be the effect of loading on the same.

What would be the effect if the spacing of the loading coils was increased or the spacing kept the same and the inductance of the loading coils increased ?

Show with a circuit diagram how loading coils are normally inserted in a line, and the loading coil arrangement if two pairs of lines are bunched.

(3) (a) A series resonant circuit consists of resistance, inductance, and capacity. Assuming the circuit was tuned to 1,000 cycles, sketch its impedance/frequency graph from, say, 100 to 10,000 cycles (don't worry about the sign of the impedance).

What effect would increasing or decreasing the resistance have on the shape of this curve ?

(b) A parallel resonant circuit consisting of inductance and capacity is tuned to 1,000 cycles. Sketch its associated impedance/frequency graph.

(4) Show how resonant circuits can be used to restore the loss of high frequencies in an unloaded line.

(5) What would be the resonant frequency of the circuit shown ?

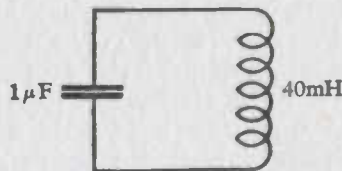

(6) What is meant by harmonic distortion ? How does it get produced and what does it sound like ?

(7) What is meant by 'signal-to-noise ratio' ?

Discuss the practical levels encountered at the sending and receiving ends of a long line, both for programme and noise. Show, with a diagram, what is meant by a balanced line and why it is that a balanced line greatly reduces noise.

Why is it necessary to control the volume range of a programme, and where is the best place to do it ?

(8) Show the fundamental circuits for measuring the loop, and the insulation, resistances of a line. Draw the arrangements of the jacks for a loop test and insulation tests A/E, B/E and A/B.

(9) What is a 'Wheatstone bridge' ? Show, by developing the circuit of a potentiometer, how a Wheatstone bridge circuit is formed.

(10) Show in diagram form the arrangement of a tone source feeding a measurable level to line.

CHAPTER VII

RADIO TRANSMISSION

THE PRODUCTION OF ELECTROMAGNETIC WAVES

WE have seen that an electric current (i.e. a movement of electrons) flowing in a wire or in a coil of wire always produces a magnetic effect in the neighbourhood of the wire. The region where this magnetic effect can be detected (by a magnetic needle placed near the wire) is called the 'magnetic field'. If the current flows steadily in one direction the magnetic field is constant in strength and in direction ; if the current varies in strength, or if it is an alternating current, the magnetic field will be a varying, or alternating, one.

Although we need a compass needle or a piece of iron to detect the magnetic field, the field exists whether there is any magnetic material for it to act upon or not, and we shall see presently how important this is.

We have seen also that a moving magnetic field will set up a drift of electrons (i.e. an electric current) in any conductor which lies within the field, if the conductor provides a closed circuit in which the current can flow. (If there is no closed circuit there can be no current, but there will be a potential difference between the ends of the conductor.) If the magnetic field is constant and stationary there will be no tendency for a current to flow in the wire, unless the wire itself is moving. There must be relative movement between the field and the conductor. Thus we have :

- (a) A movement of electrons sets up a magnetic field (whether any magnetic material is present or not).
- (b) A moving magnetic field sets up a movement of electrons (if a conductor is present in the magnetic field).

Remembering, however, that an electron sets up an electrostatic field in its neighbourhood, just as a magnet sets up a magnetic field, (a) and (b) can also be expressed thus :

- (c) A moving electrostatic field sets up a magnetic field (whether a magnetic material is present or not).
- (d) A moving magnetic field sets up an electrostatic field (if a conductor is present in the magnetic field).

These two statements now present a more satisfying pattern except for the qualifications in brackets. Can anything be done to fit them into the pattern ? It could if we could say truthfully that the statement (d) would be correct even if no conductor were present in which an electron drift could be set up. We said above that a magnetic field would not cease to exist merely because we had no compass needle to show its existence by its movement. We may equally well say that an electrostatic field would not cease to exist just because we had no conductor to show its existence by the movement of electrons (i.e. the flow of a current) in it. We will go a step further and say that an electrostatic field can exist even if no electrons are present to be affected by it. We can now present our twin statements as follows :—

- (e) A moving electrostatic field sets up a magnetic field (whether a magnetic material is present or not).
- (f) A moving magnetic field sets up an electrostatic field (whether electrons are present or not).

The statements are now complementary to each other and form a symmetrical pattern.

This may seem rather like an academic exercise in logic, but it is the fundamental explanation (first propounded by James Clerk Maxwell many years before wireless was discovered) of the production of wireless waves. For we know that a magnetic field of the greatest strength which we can produce can be detected only at distances of a few feet. The same applies to an electrostatic field. But now suppose that we produce a magnetic field by means of a current flowing in a wire and then suddenly alter the strength or the direction of the current. The magnetic field will suddenly alter in strength or in direction—it will become a moving magnetic field in the sense in which we have used the expression in the second of our statements (b), (d), and (f). Therefore it must produce an electrostatic field as decreed by the second statements, (d) and (f). Now this electrostatic field will produce in its turn a magnetic field as laid down by the first statement, (c) and (e), but only if the electrostatic field is moving. If we arrange the flow of the electrons in the wire so that they are not only moving (so producing a current), but constantly changing their rate of movement in such a way as to produce an alternating current, we shall have the following state of affairs :—

- (1) alternating current in the wire, producing
- (2) alternating magnetic field near the wire, causing
- (3) alternating electrostatic field, causing
- (4) alternating magnetic field, causing
- (5) alternating electrostatic field . . . and so ad infinitum.

If energy is continuously supplied to the wire, a succession of magnetic and electrostatic fields will be created resulting in electromagnetic waves which pass out into space, even if no magnetic materials or electrons are present anywhere, except for the electrons in the wire which set up the initial disturbance (1). Thus we have a succession of waves which are radiated into space far beyond the distance at which the initial magnetic field (2) can be detected. But this will occur only if the current in the wire (1) is alternating, and it will occur most effectively when the current is alternating rapidly, that is, when it is alternating at a high frequency—20,000 cycles per second or more.

WAVE-MOTION AND WAVELENGTH

If we make ripples on the surface of a pond by dropping a stone into it, the ripples travel outwards in all directions from the source of the disturbance although the water in the neighbourhood of the stone rises up and down only a fraction of an inch.

A similar effect occurs if we take a long helical (spiral) spring and give it a blow at one end. A wave of compression can be seen to travel along the spring from end to end. It looks like Fig. 102. Such a wave can be made to travel long distances, whereas the actual metal of which the spring is composed will move only a few inches. The blow which we have applied produces a movement of the spring which, like the initial magnetic field,

dies out after a short distance, but like the magnetic field sets up an endless succession of waves, which travel along the spring and continue to do so as long as we continue to strike repeated blows on the end (so long as we apply the rapidly alternating current).

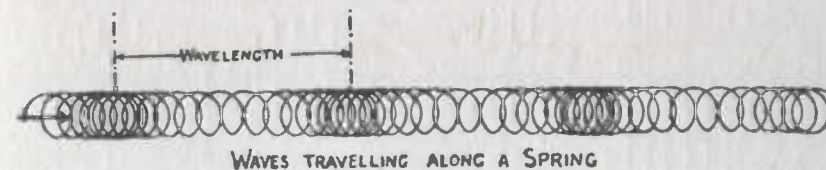

FIG. 102. AN EXPERIMENT TO ILLUSTRATE WAVE-MOTION

We have now a picture of a wave-motion set up by a disturbance, whether it is a wave in a spring set up and maintained by a succession of blows, or a wave in water set up and maintained by a succession of stones, or a wireless wave (electromagnetic wave) in space set up by a rapidly alternating current. The size (or amplitude) of the waves depends on the magnitude of the disturbance which sends them off; their rate of travel (velocity) depends only on the medium in which they move. Sound waves travel through air at about 1,100 feet per second (they cannot travel through a vacuum). Wireless waves and light waves (which are both electromagnetic waves) travel through empty space at 186,000 miles (300,000,000 metres) per second. (They can travel through a vacuum because as we have seen they do not need the presence of electrons for their propagation.) The length of the wave, that is, the distance between two successive crests or troughs, will be determined by the frequency of the disturbance (that is, the frequency of the rapidly alternating current) and the velocity; and is, in fact, equal to the velocity divided by the frequency. Thus we can write :

$$\text{Wavelength in metres} = \frac{\text{Velocity (in metres per second)}}{\text{Frequency (in cycles per second)}} = \frac{300,000,000}{\text{Frequency}}$$

for electromagnetic waves.

In practice we usually have to deal with high frequencies, and it is convenient to have a larger unit of frequency than the cycle per second, and kilocycles per second (thousands of cycles per second) or megacycles per second (millions of cycles per second) are used. So we can rewrite the relationship thus :

$$\text{Wavelength in metres} = \frac{300,000}{\text{Frequency, in kc/s.}} \text{ or } \frac{300}{\text{Frequency, in Mc/s.}}$$

- Examples :
- If Wavelength = 3,000 metres
then Frequency = 100 kc/s, or 0.1 Mc/s.
 - If Wavelength = 300 metres
then Frequency = 1,000 kc/s, or 1 Mc/s.
 - If Wavelength = 30 metres
then Frequency = 10,000 kc/s, or 10 Mc/s.
 - If Wavelength = 3 metres
then Frequency = 100,000 kc/s, or 100 Mc/s.

Let us now try and represent graphically the production of electromagnetic waves from a 'radiator' consisting of a wire, part of which is vertical and part horizontal—and which we can recognize as a wireless 'aerial'. Let us

RADIO TRANSMISSION

assume that the rapidly alternating current is produced by a high frequency generator (G) whose frequency can be set to some convenient value (Fig. 103).

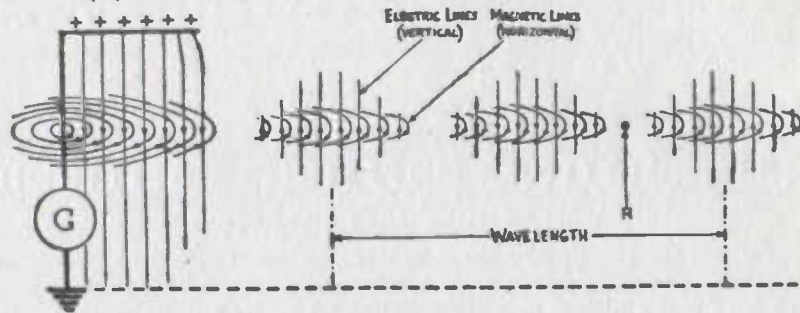
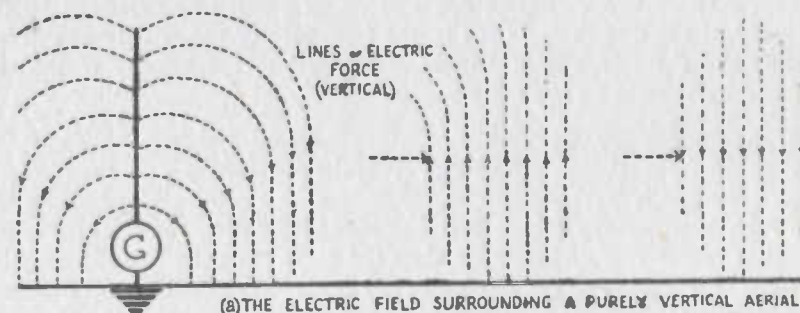

FIG. 103. REPRESENTATION OF 'WAVE' RADIATION FROM AN AERIAL

Note that the lines of magnetic force are horizontal and that the lines of electric force are vertical. Electromagnetic waves in which this relationship holds are said to be 'vertically polarized', those in which the electric force is horizontal are said to be 'horizontally polarized'; the former are radiated from an aerial which has some vertical portion, the latter from one which is entirely horizontal.

A horizontal portion is, however, not necessary, and in modern broadcasting stations where the mast itself is used as the radiator, does not exist. Fig. 104 illustrates the lines of electric and magnetic force near to a purely vertical aerial.



(a) THE ELECTRIC FIELD SURROUNDING A PURELY VERTICAL AERIAL

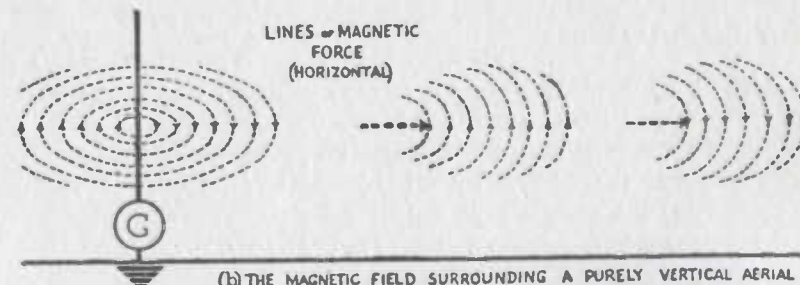

(b) THE MAGNETIC FIELD SURROUNDING A PURELY VERTICAL AERIAL

FIG. 104. DIAGRAMMATICAL REPRESENTATION OF THE ELECTRIC AND MAGNETIC FIELDS FROM A VERTICAL AERIAL

The diagram in Fig. 103 shows a state where the horizontal portion of the wire is just fully positive, and the conventional directions which are given

to the lines of force are indicated by arrows. It also shows a few pulses, or waves, that have been 'released' by preceding half-cycles of A.C. If we consider a receiving point, R, at some distance from the transmitter we should 'see' these waves as regions of alternate high and low electric and magnetic density rushing past us. Hence a receiving aerial rigged there would be subject to an alternating field of electric and magnetic lines; and would thus have alternating currents set up in it of a frequency equal to that of the electromagnetic waves. If we can detect the presence of these alternating currents, then we have succeeded in sending a high frequency message across space. Our next steps are to find out: (a) how to produce high frequencies, because we are going to use frequencies of the order of millions of cycles per second (and moving machinery, e.g. alternators, cannot be made to do this without great complication and difficulty); (b) how to use the H.F. to carry the L.F., because the H.F. is too high to hear, and the L.F. is too low to radiate efficiently, and (c) how a receiver is made to select one set of waves out of the large number sent out from other transmitters, and how it sorts out the L.F. from the H.F.

THE GENERATION OF HIGH FREQUENCY CURRENTS

How, then, do we produce these very high frequencies? If we take a condenser and connect a source of potential (say, a battery) across it, we find that it 'charges up', i.e. one plate will become positive and the other negative. It will take time to do this, depending on the size of the condenser; the larger the condenser the longer will it take. Let us now connect together, by means of a conductor, the plates of the fully charged condenser. The excess of electrons on the negative plate will rush round this conducting path to make up the deficiency on the other plate. This will also take time, but there is another point which is observable. The electrons, in their hurry to establish equilibrium, will overshoot the mark, with the result that they find themselves facing up on the opposite plates to those from which they started, only to do the same thing over again. Each time the electron flow becomes weaker because of the resistance 'losses' in the conductor; and so it does not take very many 'cycles' before the flow has completely stopped. If we were to draw this state of affairs graphically it would appear as in Fig. 105.

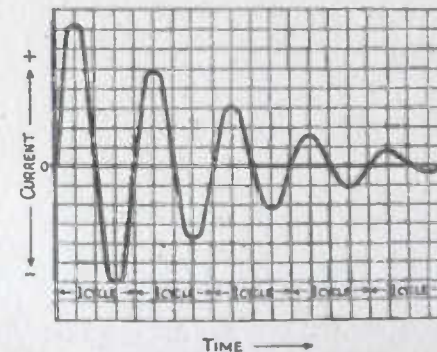

FIG. 105. GRAPH OF THE OSCILLATORY CURRENT PRODUCED BY A CONDENSER DISCHARGE

The interesting point to note is that the time of each complete cycle is the same no matter what the amplitude. The actual time factor is determined by

the size of the condenser, and the 'electrical' length of the wire short circuiting its terminals.

Next let us include a coil of wire—an inductance, in the circuit. Experiment shows that an exactly similar type of oscillatory discharge will take place, but that the time factor will be influenced by the size of the coil. This is to be expected, for you will remember that an inductance opposes the flow of current, and it takes time to build up to a maximum; the smaller the inductance, the quicker will the current build up. The nett result of this circuit is that we can obtain an oscillatory current of a frequency which is determined by the values of the condenser and inductance. By making the values sufficiently small we can produce frequencies which are extremely high. We shall not go into the mathematics of the tuned circuit, as it is called; but for those readers who delight in formulæ, the 'natural' frequency of such a

circuit is given by: $f = \frac{1}{2\pi\sqrt{LC}}$ cycles/sec. where 'f' is the frequency

(in cycles per second); 'L' the inductance of the coil (in Henrys) and 'C' the capacity of the condenser (in Farads).

As an example, let us find out what frequency a coil of 50 microhenrys would tune to if connected across a condenser of .0005 microfarads.

$$f = \frac{1}{2 \times 3.1416 \sqrt{\frac{50}{10^6} \times \frac{.0005}{10^6}}} = \frac{10^6}{6.2832 \sqrt{.025}} = 1,007,300 \text{ cycles/sec.}$$

(approx.) or 1,007.3 kilocycles/sec. To find the wavelength:

$$\lambda = \frac{\text{velocity}}{\text{frequency}} = \frac{300,000,000}{1,007,300} = 297.8 \text{ metres}$$

THE VALVE OSCILLATOR

Having obtained an oscillatory discharge, the next step is to keep it going, for the above arrangement shows that the current dies down after a very few cycles. If by some means we could replace the amount lost each time, then we should have a continuous oscillation, and this may be done by the introduction of the thermionic valve which operates in the following way. We 'tap off' a fraction of the oscillatory discharge, feed it into the grid of a valve, amplify it, and add it back into the tuned circuit again. Let us draw it out in circuit diagram form (Fig. 106) to see one of the many ways in which it may be done.

The tuned circuit, LC, is shown in the anode circuit of the valve. When the filament is heated, anode current will flow in the coil and build up to a maximum.

A voltage will be developed across it which, in turn, will charge up the condenser. Note that there is a small coil marked FB (feed-back) near the main inductance, L. These two coils will act as a transformer, and a voltage will be induced across FB when current flows in L. We can apply this feed-back voltage to the grid of the valve in such a way that when the current reaches a maximum in the coil L, the grid will be made negative. This will, of course, reduce the current through the valve and hence through the coil.

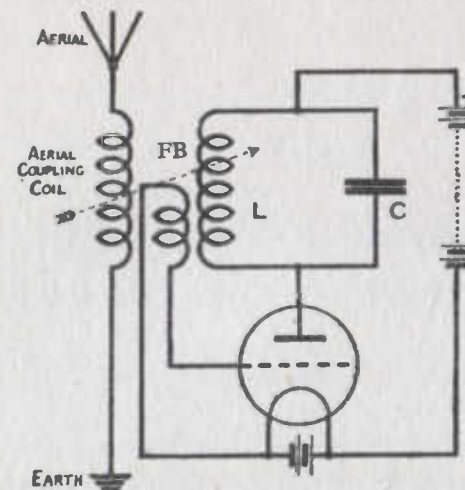

FIG. 106. THE SIMPLE VALVE OSCILLATOR, COUPLED TO AN AERIAL

When current has ceased flowing, there will be no voltage across the coil due to that current, but the condenser still has its charge. It will therefore proceed to discharge itself through the inductance in the opposite direction. The reverse current will induce a reverse voltage in the feed-back coil and make the grid more positive. So the anode current increases again in the 'forward' direction, and the whole cycle starts all over again. Thus, a continuous oscillating current is produced and this may be coupled to the aerial system of the transmitter by the simple process of using yet another coil in transformer fashion. This is shown on the diagram, and the fact that the coupling is variable is indicated in conventional manner by means of the arrow. It should be noted that the aerial coil, together with the aerial capacity across it, form another tuned circuit. It is found desirable to make the values of these latter 'components' such that they also have the frequency of the oscillations we wish to transmit; for then we can be sure that the maximum amount of energy is transmitted.

RECEIVING THE SIGNAL

We have now produced, by the simplest means, a current of high frequency which we are going to put into an aerial for radiation. An aerial, situated some distance away from the transmitting aerial, will 'intercept' some of the electromagnetic waves that are travelling past it, and it will have an alternating e.m.f. of the same frequency as the waves induced into it which will cause an alternating current to flow in it. Of course, there is nothing to prevent radiations from all other transmitters being picked up, as indeed they are. How can they be sorted out? Once again, the tuned circuit comes to the rescue in this way. The very complex mixture of numbers of high frequency currents is induced into the receiving aerial and conveyed to the 'aerial coil' of the receiving set. For the moment, we shall picture only three of them diagrammatically (Fig. 107).

All of these waves A, B, and C, are pictured as being received at equal strength (amplitude) at the aerial. The alternating voltages they induce into the aerial are applied to the tuned circuit consisting of the inductance, L, tuned by the condenser, C. It will be seen that the condenser has an 'arrow' through it, which means that it is a variable one. When we turn the tuning

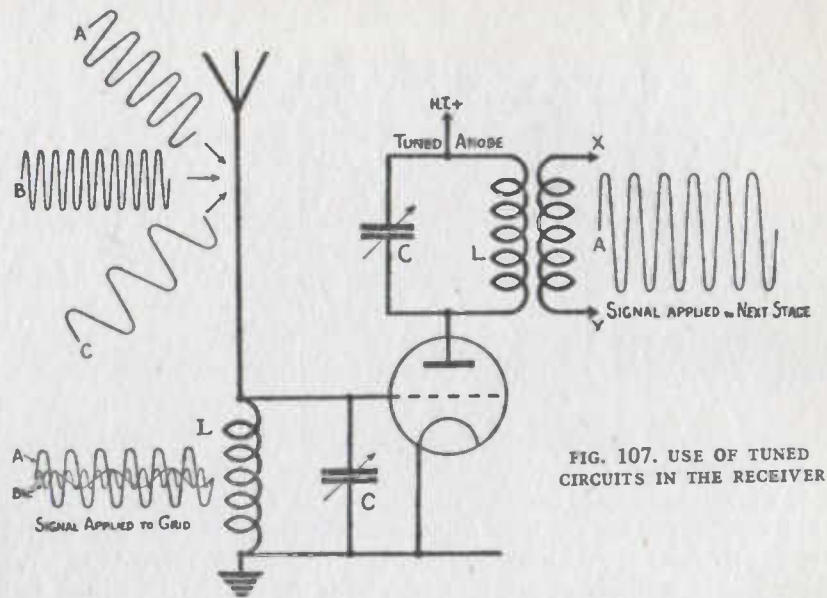

FIG. 107. USE OF TUNED CIRCUITS IN THE RECEIVER

knob on our broadcast receiver, all we are doing is to vary the capacity of this tuning condenser and so to alter the resonant frequency of the tuned circuit. Let us suppose that it has been tuned so as to resonate at frequency 'A'. This frequency will produce a much greater e.m.f. across the circuit than the other two, and therefore a greater current through the coil. The other two frequencies can be regarded as being almost 'lost' in the circuit, and the complete state of affairs is shown in graphical form near the tuned-grid circuit. At the anode of the valve, a similar proportion of wanted/unwanted signal will be found, only much amplified, and this is again applied to a tuned circuit which still further reduces the strength of the unwanted frequencies. At this point, XY on the diagram, let us leave the 'pure' signal for the moment. We have done what we set out to do, namely, to separate, or 'select', a particular radio frequency from any of the large number that are picked up on the aerial. Only the simplest of selective tuning arrangements has been shown in the diagram; in practice there are many different forms, some of which do not employ a valve at all, relying entirely on tuned circuits to provide the selectivity desired.

We have now transmitted a certain frequency or wavelength and have seen how it may be received to the exclusion of other frequencies. But what good has it done? It is too high to be heard, so it is no good connecting a loud-speaker across the points XY of the last diagram. Also we know it is no good sending low frequencies, since they will not be radiated from the transmitting aerial. So let us see what can be done and how we can send a message by radio.

THE MODULATION OF HIGH FREQUENCY CURRENTS

If we had some means of detecting whether the H.F. signal is being received or not then we could arrange a simple code such as the Morse code, in which the H.F. radiation is started and stopped so as to produce short or long

'bursts'. Or, instead of actually cutting off the radiation altogether, we could vary the amplitude of the H.F. wave, whereupon the receiver would get a miniature reproduction of these variations and the 'detector' could perhaps be made to disclose the nature of them. Alternatively, we could alter the frequency of the transmitted wave so that it no longer affected the tuned circuits of the receiver.

These methods may seem rather crude, but they are actually used for sending this sort of message. Now let us consider what we have to do to transmit speech and music, which are merely (in their electrical forms) variations in amplitude which follow each other at certain rates which we call the frequency.

Admittedly, the variations of amplitude may be wide and rapid, but it is a question of degree, and if we can vary the amplitude of the radio (or high) frequency 'carrier' current in accordance with the low frequencies of our speech or music, we can then produce a current varying similarly in amplitude (although on a much smaller scale) at the receiver.

This process of varying the amplitude of the high frequency carrier current by the low frequency speech or music currents is called amplitude modulation. It should be noted that an unmodulated carrier wave produces no 'intelligence' at the receiver, and in practice it is therefore important to use as high a level of modulation as possible. The wave is said to be modulated to 100 per cent. when its amplitude is varied between zero and double its unmodulated value.

We shall discuss three of the many possible methods of modulation, and to do this in as simple a way as possible we will revert to the first type of oscillator discussed, viz. the tuned circuit type. Considering only this part of the circuit in the diagram (Fig. 108) we find it generating a pure 'carrier' wave, which is radiated from the aerial and is depicted in graphical form as an 'unmodulated carrier'.

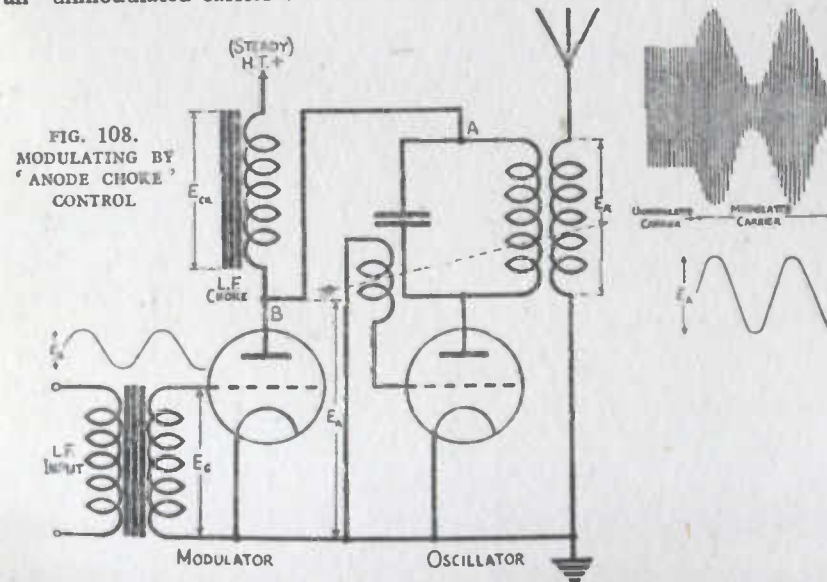

FIG. 108. MODULATING BY 'ANODE CHOKE' CONTROL

The frequency of this wave we have already determined by the values of coil and condenser, but the amplitude can be made to depend entirely upon

the amount of H.T. voltage we apply to the circuit, i.e. the voltage at point 'A'. If we double it, the amplitude will be doubled, if halved the amplitude will be halved, and so on. It is equivalent to taking the point 'A' and, instead of connecting it to a source of steady H.T., connecting it to some point which is varying in accordance with the 'message' to be sent. Here is one way of doing it. The low frequency (speech) input is applied to the grid of an ordinary amplifying valve, as shown in the diagram. This valve gets its H.T. from any steady source, but it is drawn through an iron-cored coil called 'low frequency' or 'L.F. choke'. The action of this L.F. choke is as follows. The L.F. alternating current passing through it will produce an alternating voltage across it, (E_{ch}) which is directly proportional to the value of the current (Ohm's law again). In fact, it acts just like the 'anode resistance' which we discussed under the heading of the simple thermionic valve amplifier, with the exception that the impedance will also vary with the frequency of the applied L.F. and the choke has to be made large enough to have the desired impedance at the lowest audio frequency we want to transmit.

What, then, is happening to the voltage at point 'B', the anode end of the L.F. choke? If one end of the choke has a steady potential applied to it, and there is a varying voltage across the two ends, then the other end must also be varying. This second voltage (point 'B') is denoted by E_A , and it is from this point that we take the supply to the oscillator valve anode. The small graphs which accompany the circuit should be self-explanatory.

This is only one of the very many methods of achieving modulation of the carrier wave, and it is called 'anode choke modulation'. Obviously, any method of supplying point 'A' (on the previous diagram) with a L.F. voltage will do the same thing, and Fig. 109 depicts one other way which is used in certain transmitters.

The diagram shows an oscillator valve which gets its H.T. via the anode/

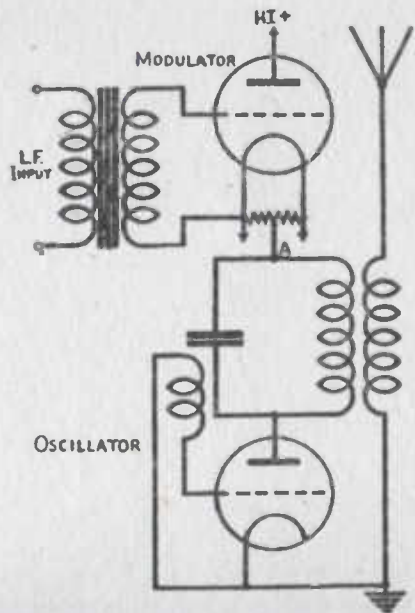

FIG. 109.
SERIES MODULATION

cathode path of the modulator valve which is in series with the main H.T. supply.

This method, known as 'series modulation', has two slight disadvantages, which, in practice, can be overcome. One is that the total voltage has to be more than twice that normally employed, because it is comprised of the voltage across the oscillator plus that across the modulator. Secondly, the grid/cathode circuit of the modulator is at a high potential above earth, and special precautions have to be taken to insulate the secondary of the L.F. input transformer as well as the filament circuit (including its associated heating circuit, generator, etc.). If we note that the L.F. input to the modulator valve causes a varying voltage across it, the rest of the action should be clear. It should also be fairly obvious that it makes little difference whether the modulator valve is put in the positive lead of the H.T., or the negative, and some transmitters have the modulator valve on top of the oscillator whilst others have the oscillator anode connected to H.T. +, and its cathode connected to the anode of the modulator. Still other transmitters use more complicated modulation systems which are sometimes combinations of these and other methods. A more recent development is called 'Class B' modulation which is a highly efficient system, and efficiency of power consumption is important when dealing with aerial powers of 100 kilowatts and more. Since Class B modulation is used a great deal, a short description will be helpful but first it should be noted that modulation can be carried out at 'low' or 'high' power.

In both the choke and series modulation examples quoted above, modulation was performed in the last stage. This means that if the transmitter is a large one, say with a hundred kilowatts in the aerial, these two valves (oscillator and modulator) will both have to be very large ones, with very large voltages on their anodes and capable of dissipating very large powers. Large enough valves can be made, but the drawback to 'high power' modulation, as it is called, is that (a) if we use series modulation, the double voltage becomes extremely high, e.g. 20,000 volts; or (b) if we use choke modulation, the L.F. choke has to carry very heavy currents at any frequency between 10 and 10,000 cycles, and this is a difficult and bulky piece of apparatus to design and construct. In practice it can be done, and in the most modern transmitters using 'high power' class B modulation two separate chains of valves are used, one to amplify the high frequency currents, the other to amplify the low frequency ones. The class B refers to the type of amplifier in the last stage of the modulator in which power is drawn from the mains in proportion to the depth of the modulation.

In 'low power' modulation, as the name implies, modulation takes place at low power, and the modulated carrier wave is subsequently amplified by stages of high frequency amplification of ever increasing size. Low-power modulation avoids the difficulties mentioned above, but introduces others of which the principal is that the amplifying stages which follow the modulated stage have to be capable of amplifying a band of high frequencies and not just a carrier wave; (the reason for this will appear in a subsequent section). In transmitters where the wavelength is scarcely, if ever, changed, this difficulty can easily be overcome, but the method necessary to secure accurate adjustment of circuits takes some time and thus presents difficulties in transmitters which have to change wave frequently and in a short time, as in the short-wave

services. For this, and for reasons of power economy, high-power modulation is at present favoured for large broadcasting transmitters.

CLASS B MODULATION

It should be realized that the valve which we normally call 'the modulator' is really an amplifier, and that basically the principle of modulation is the same whether 'Class A' or 'Class B' modulators are used. That is to say, in both cases the modulated amplifier is anode modulated. The difference lies in the system of amplification, and we can therefore talk about a Class A or Class B amplifier. The essential difference between the two methods of amplification is in the choice of operating point on the grid volts/anode current characteristic of the valve. In Class A amplification the valve is normally worked entirely on the straight portion of the characteristic and in the region of negative grid voltage—no grid current being allowed to flow even for the positive half-cycles of grid input. (See Chapter V. p. 96.) The mean value of anode current does not vary, and its value must be at least equal to the mean value of the anode current of the modulated amplifier if a high degree of modulation is to be obtained. The power consumed by the amplifier will be very high, at least as high as the total power input to the modulated amplifier. If we assume that the efficiency of the modulated amplifier is, say, 75 per cent., then for 100 kW output the input to the anode of the modulated amplifier will be 133 kW, and if we were to use a Class A amplifier, rather more than 133 kW would be required for the amplifier, or as we miscall it, the modulator. Let us say that the power required would be 140 kW, then the total power input would be 273 kW and the efficiency including the power consumed by the modulator would be only 36.6 per cent., and this efficiency (as far as the carrier is concerned) remains constant whether any modulation is present or not.

In the case of a Class B amplifier, however, which is essentially much more efficient, at least a pair of valves is required and each valve of a pair amplifies only one half-cycle of the audio-frequency; the grid bias is sufficiently negative for the anode current (when no modulation is present) to be relatively small.

If we consider very roughly the efficiency of a Class B modulation system in the carrier condition on the same terms as a Class A system, and reckon that the steady value of anode current to the Class B valves during the condition of no modulation is one-fifth of the anode current to the modulated amplifier valve, then the power absorbed by the modulators would also be one-fifth of the power input to the modulated amplifiers. Thus, if the power input is 133 kW then the power absorbed by the modulators will be 26.6 kW. The total now becomes approximately 160 kW, and the overall efficiency in the carrier condition will be 62.5 per cent. as against 36.6 per cent. for Class A. It will, however, be realized that the anode current is not steady during modulation, so that the mean value of current taken during modulation is greater than that without modulation, but still very much less than is the case with a Class A system.

If valves had ideal characteristics such that the curvature at the point where anode current started to flow was extremely sharp, then it would be possible to reduce the idle current in Class B systems to zero, so that anode current would only occur in each valve when modulation was present and only during

each half-cycle. It would then be possible to marry the two valves, and consequently the alternate half-cycles, with no distortion. However, as valves (like most other things in this world) are imperfect, the grid bias has to be chosen fairly carefully in order that they produce a minimum of distortion when the currents from the two valves are married together.

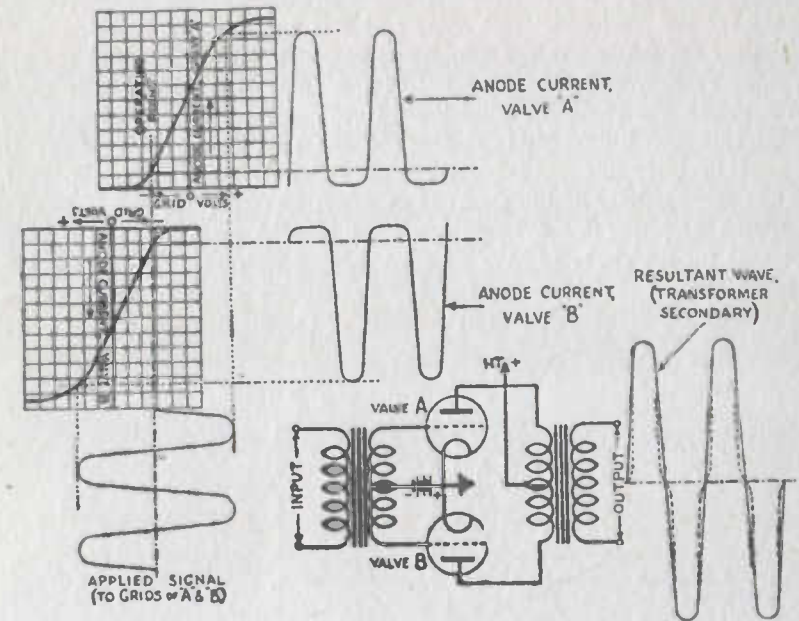

FIG. 110. THE OPERATION OF 'CLASS B' AMPLIFICATION

The operation of the Class B amplifier from the point of view of valve characteristics is shown in Fig. 110, while the dotted lines indicate in a somewhat exaggerated manner the type of distortion which may occur. The distortion is rather more objectionable than that of a Class A amplifier since it occurs for small amplitudes as well as for large, and the percentage distortion for small amplitudes in the Class B amplifier is greater than for large amplitudes, whereas in the Class A amplifier the distortion at small amplitudes is negligible. The distortion, however, can be made fairly small in practice and can be reduced very considerably in effect by the use of negative feed-back.

In a Class B amplifier it is practically essential to use an output transformer. It will be seen, further, by reference to the diagram in Fig. 110, that the anode currents through each half of the primary of the output transformer are in opposite directions, so that the D.C. component of the flux in the iron is cancelled. This is a very great convenience in designing the transformer, since if the iron had to carry D.C. flux its permeability would be reduced and the bulk of iron required would be considerably greater in order to avoid distortion. The design of the transformer is nevertheless complicated. It is essential to have very large magnetic coupling and very small electrostatic coupling between windings, together with a low self capacity, and while such desirable qualities are not difficult to obtain in small transformers, they are more difficult to obtain in the larger sizes required for high-power trans-

mitters. It was thought many years ago, when the Class B system was first proposed, that the iron distortion introduced by working the iron at very high flux densities and by using large masses of iron would be such as to make the system unworkable in practice, but this is not so. Although the currents in the two halves of the primary winding are in opposite phase and cancel, the secondary of the transformer would normally have to carry the direct current for the modulated amplifier, and this would saturate the core. To avoid this, the current to the modulated amplifier is normally fed through a choke or reactor, and the secondary of the Class B transformer is coupled to the anode circuit of the modulated amplifier through a condenser. The overall cost and bulk of this method is less than if the transformer were designed to carry the D.C. for the modulated amplifier. It is important that the self capacity of the choke is sufficiently small so as not to shunt the modulated amplifier by a low impedance at high frequencies. It is also important for the choke to have a high inductive resistance at low frequencies in order that it shall not form a low impedance shunt to the modulated amplifier at low frequencies. The capacity of the coupling condenser to earth

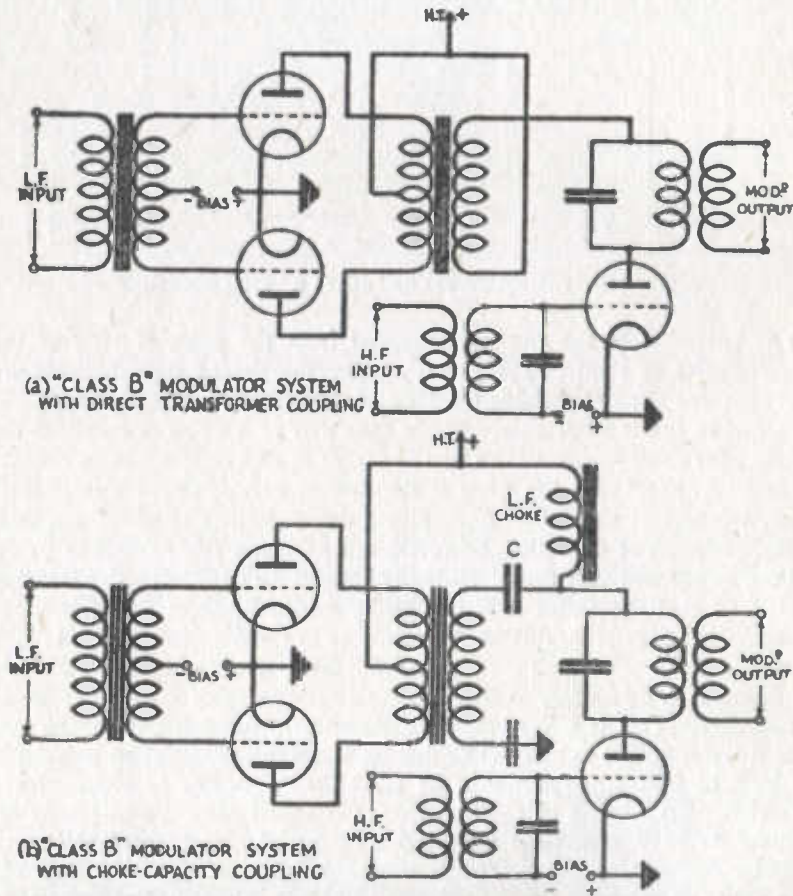
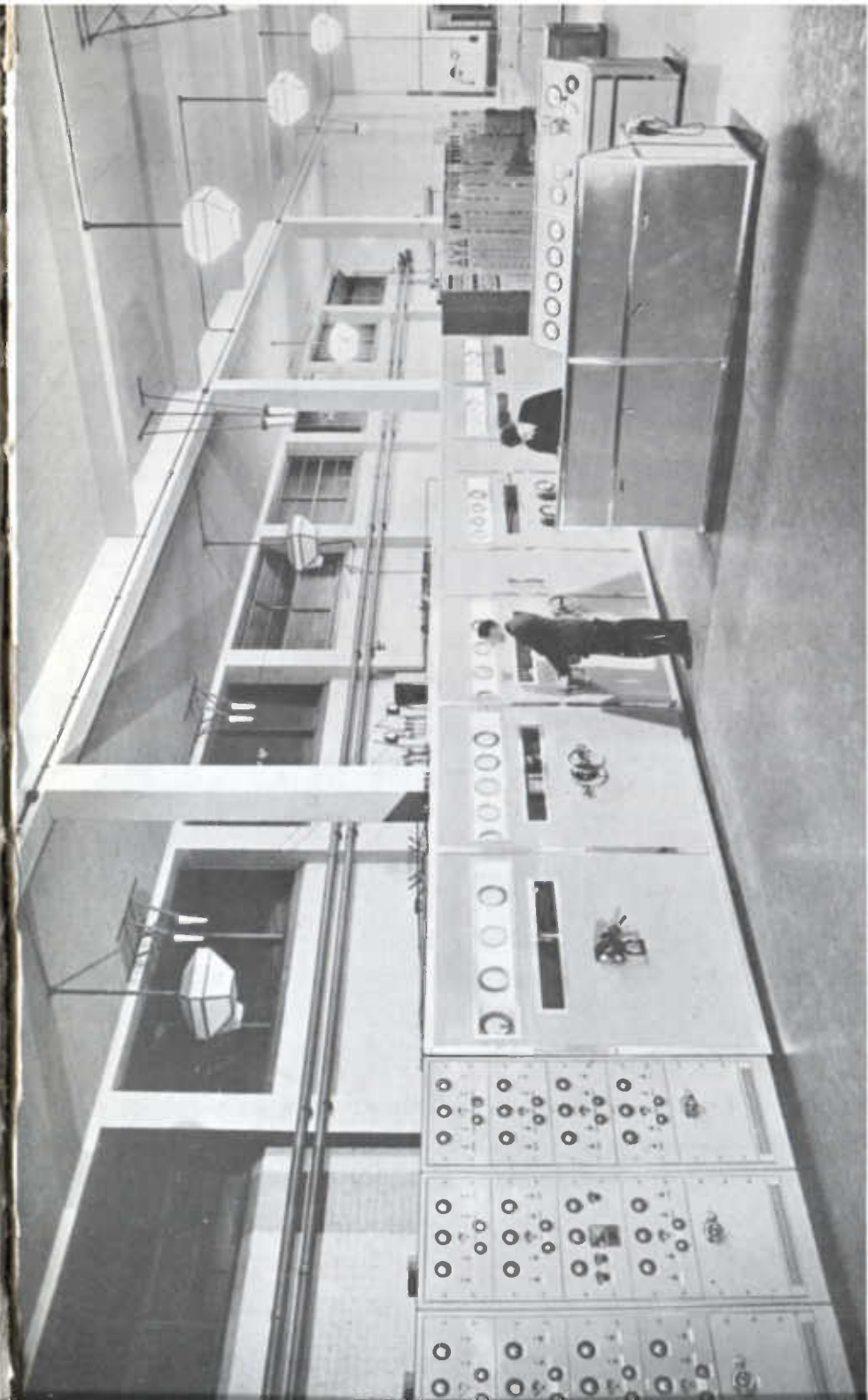

FIG. 111. TWO METHODS OF APPLYING 'CLASS B' AMPLIFICATION TO MODULATE A CARRIER WAVE



General view of a transmitter hall
Plate IX



Large water-cooled valve being wheeled into position

Plate X

also has a shunting effect at the high frequencies, and this condenser is frequently connected in the earthy end of the transformer (as shown dotted in Fig. 111b). This maintains the secondary winding at high potential, but as the primary is also at high potential, the total potential difference between windings is less than in the other method of connection. Two methods of connecting a Class B amplifier to a modulated amplifier are shown in Fig. 111.

Class A amplifiers normally work without grid current, and this tends to limit the overall efficiency of the valve. In a class B amplifier the grid is driven positive, although some negative bias may be used. Driving the grid positive results in an increase of efficiency, but the grid current presents a varying load to the previous stage. If resistance capacity connection is used, the grid current causes distortion by loading the anode circuit of the previous valve with a varying resistance, and also varies the grid bias (since the mean value of grid current flowing through the grid leak will result in a voltage drop across this resistance, and a variable grid bias). It is necessary therefore to provide a path for the grid current which has a low resistance to D.C. and a low impedance to A.C., i.e. low compared to the resistance of the grid filament path. This is usually achieved in practice by the use of a suitable designed transformer coupling from the previous stage. The low resistance D.C. path is readily provided by this means and the low impedance by a suitable transformer turns ratio.

Comparing the overall efficiency of the older type 'low-power' class 'A' modulation system transmitter with a modern 'high-power' class 'B' modulation system transmitter, we find that the former would take about 550 kW from the mains for every 100 kW delivered to the aerial, whereas the latter would take but 300 kW for the same output.

BANDWIDTH OCCUPIED BY MODULATED WAVES

Suppose, for some reason, that we wished to amplify equally a small band of frequencies in the H.F. region; for example, all frequencies between 990,000 and 1,010,000 cycles per second (i.e. 990 and 1,010 kc/s). The use of an amplifier with a simple-tuned circuit might well be considered, but its sharply peaked resonance curve indicates that whereas it would amplify the frequencies in the middle of the band, viz. 1,000,000 cycles per second, strongly, those on either side will not be amplified so much. In fact, examination of a typical curve obtained from a simple arrangement of one or two tuned circuits might well be like that shown in Fig. 112a.

It will be seen that at 1,000 kc/s, the amplification is 30 db. (which is 32 times, in voltage ratio) greater than at the frequencies at either end of the band. What we require is something approaching the curve which is shown dotted giving a 'band pass', and we will glance briefly at the methods before considering the reasons. One way would be to have successive tuned circuits tuned to slightly different frequencies; for example, five tuned circuits tuned respectively to 992, 996, 1,000, 1,002, and 1,004 kc/s. This would give a rather 'bumpy' resultant curve, and is by no means ideal. The usual way is to pay special attention to the type of 'coupling' between tuned circuits. There are two methods of passing on H.F. power from one circuit to another, one by electrostatic (condenser) the other by electromagnetic (coupled coils) coupling, and both these methods have the effect of modifying the final response curve in this way. Instead of a sharp peak, the top of the

curve becomes flatter; and the tighter the coupling is made, the broader it becomes, until the peak becomes double humped (Fig. 112b).

FIG. 112a. THE RESONANCE CURVE OF A SIMPLE TUNED CIRCUIT

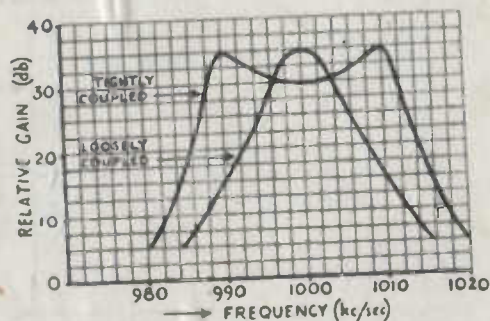
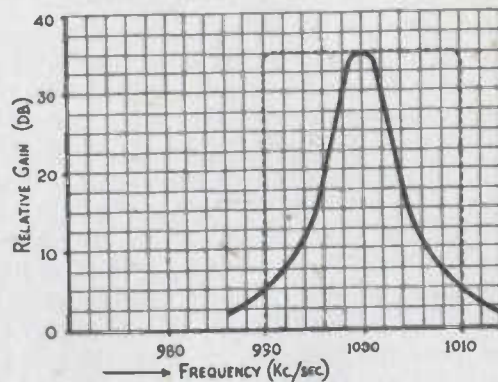

FIG. 112b. RESONANCE CURVES OF COUPLED CIRCUITS SHOWING 'BAND-PASS' EFFECT

Rather extreme examples have been taken, but they will serve to illustrate what is needed. It is difficult to attain the ideal, and in practice resistance has to be added to the circuit in order to obtain a compromise that gives a 'reasonably flat' response over the desired frequency band.

SIDE-BANDS

Why is it necessary to provide for this band of frequencies? Let us start by considering three frequencies which differ from each other by a few cycles—say 55, 60, and 65 cycles per second—and try adding them together. The graphs can be drawn of the three frequencies, the amplitudes at each point added together, and the result is rather surprising, as shown in Fig. 113.

The final diagram is strangely reminiscent of the 'modulated carrier'. We have chosen very simple and low frequencies for this illustration; but mathematicians can prove that any complex frequency really consists of a combination of pure frequencies. The interesting part about it is the relation which the modulation frequency bears to those other frequencies. In the example chosen, the low-frequency modulation has come out to be one of 5 cycles/sec. on a 'carrier' of 60 cycles; and it is to be observed that we could have defined 55 and 65 cycles as being '60 minus 5' and '60 plus 5' cycles. That being so, there seems to be some basis for saying that a carrier wave of frequency 'f' modulated by a frequency of 'f_m' gives rise to three separate

waves, of frequencies $(f - f_m)$, f , and $(f + f_m)$ cycles. That is for a single modulating frequency, but it is obvious that there must be a whole lot of these 'sum and difference' frequencies when we are modulating with a whole band of frequencies, as found in programme transmission. These extra frequencies are called 'side-bands', and it is now evident why we have to make arrangements to transmit, not one frequency, but a band of frequencies. The

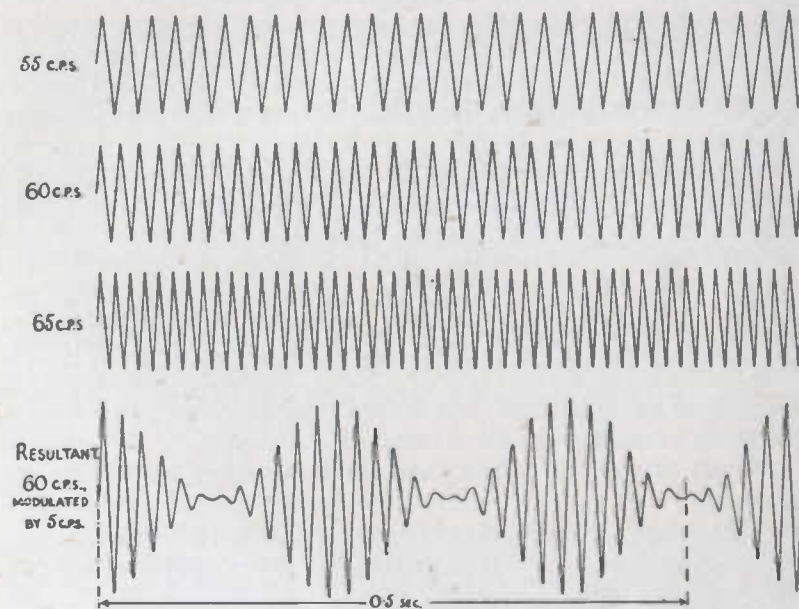

FIG. 113. THE ADDITION OF THREE FREQUENCIES TO PRODUCE A 'MODULATED' WAVE

same problem confronts us when we come to the receiver, and 'band-pass' circuits are similarly employed in order to receive all the modulation frequencies at equal strength—otherwise a loss of quality will result. It will be noticed that the low-audio frequencies are those responsible for the side-band frequencies very close to the carrier, while the highest audio frequencies produce side-bands which are furthest removed from the carrier. Once again it is the high frequencies which are most easily lost.

Why cannot the receiving circuits be made to respond over such a wide band that the bandwidth required for good quality (about $\pm 10,000$ cycles per second, or ± 10 kilocycles per second) is well within it? They could if there were only one or two transmitting stations, but in practice it is a question of 'elbow-room' between adjacent stations, and wavelengths are so precious that as many stations as possible have to be fitted into a given wave-band. Fortunately, it is found that the side-bands of two stations can overlap provided that the one it is desired to receive is many times stronger than the unwanted one, and a purely arbitrary separation of 10 kc/s has been fixed as giving a satisfactory compromise. In Europe this has unfortunately had to be reduced to 9 kc/s between most stations with a consequent sacrifice in quality or increase in interference, according to how the receiver is adjusted.

This separation of 10 kc/s, which is desirable in practice, is independent

of wavelength. Let us work out one or two examples to see what it means in metres.

- (a) In the long wave-band 200 kc/s = 1,500 metres
 190 kc/s = 1,579 "
 - i.e. 10 kc/s is equivalent to 79 "
- (b) In the medium wave-band 1,000 kc/s = 300 "
 - 990 kc/s = 303 "
 - i.e. 10 kc/s is equivalent to 3 "
 - 1,500 kc/s = 200 "
 - 1,490 kc/s = 201.3 "
 - i.e. 10 kc/s is equivalent to 1.3 "
- (c) In the short wave-band 6,000 kc/s = 50 "
 - 6,010 kc/s = 49.92 "
 - i.e. 10 kc/s is equivalent to 0.08 "
 - 20,000 kc/s = 15 "
 - 20,010 kc/s = 14.99 "
 - i.e. 10 kc/s is equivalent to 0.011 "

Perhaps the above examples will explain why it is helpful to get used to thinking in terms of frequency rather than in terms of wavelength.

WAVE-BANDS AVAILABLE FOR BROADCASTING

The bands of waves in which European broadcasting stations can work are as follows :

- The long wave-band 155 to 285 kc/s (1,935 to 1,053 metres)
- " medium " 545 to 1,560 kc/s (550 to 192.3 metres)

The short wave-bands :

- The 49 metre band from 6,000 to 6,200 kc/s (50.00 to 48.39 metres)
- " 41 " " " 7,200 to 7,300 " (41.67 to 41.10 ")
- " 31 " " " 9,500 to 9,700 " (31.58 to 30.93 ")
- " 25 " " " 11,700 to 11,900 " (25.63 to 25.21 ")
- " 19 " " " 15,100 to 15,350 " (19.87 to 19.54 ")
- " 16 " " " 17,750 to 17,850 " (16.9 to 16.81 ")
- " 13 " " " 21,450 to 21,750 " (13.99 to 13.79 ")
- " 11 " " " 25,600 to 26,600 " (11.72 to 11.28 ")

The 11-metre band is not used for broadcasting in this country—while as a wartime measure the BBC has been authorized by the Post Office to use several short wavelengths just outside some of the internationally agreed short wave-bands given above—the extreme congestion in these bands making it impossible to find clear channels for the Overseas and European services.

A comprehensive receiver would have to 'cover', or be tunable to all the above wave-bands, and 'all-wave' receivers do exist on which some, if not all, of these wave-bands can be received. The tuning arrangements of a receiver should also be made to compromise—or better, to give a choice—between (a) listening to a stronger station at high quality (i.e. with wide bandwidth) or (b) listening to a distant station at reduced quality (i.e. with narrower bandwidth) but free from interference from its louder neighbour. These two conditions are brought about by judicious design of the tuning circuits, and we refer to the ability of a receiver to separate two stations as its 'selectivity'.

Variable selectivity is thus desirable. It should be observed that attempts to increase the selectivity of a receiver usually result in a poorer quality of reception ; the tone becomes 'boomy' and 'woolly' as a result of the loss of the higher frequencies contained in the outer side-bands.

RECEPTION OF ELECTROMAGNETIC WAVES

Now for a few notes on how the rest of the receiver works. So far we have seen how the required signal is selected and (if necessary) amplified in order to obtain a miniature reproduction of the transmitted aerial current. It would not be any good feeding this waveform into a loudspeaker, however strong it was, for the following reason. If we consider any one half-cycle of this modulated H.F. current, we can regard it as attempting to move the loudspeaker diaphragm (or cone) in a certain direction. Then, about one half-millionth of a second later, the succeeding half-cycle attempts to pull it the other way. The diaphragm is unable to respond so rapidly and remains in the middle position. Another way of looking at it is to say that the average value of the alternating current is zero when taken over a period which is long compared with the time of one cycle.

Let us look at the diagrams in Fig. 114. The diagram (a) shows an H.F. wave, amplitude modulated by an L.F. one. Underneath it, (b), we have taken the same wave but have 'wiped out' the bottom (or negative) half-cycles of current variations. The result is equivalent to having a lot of pulses of D.C., each varying slightly in amplitude, the dotted line showing the average current of these rapid pulsations.

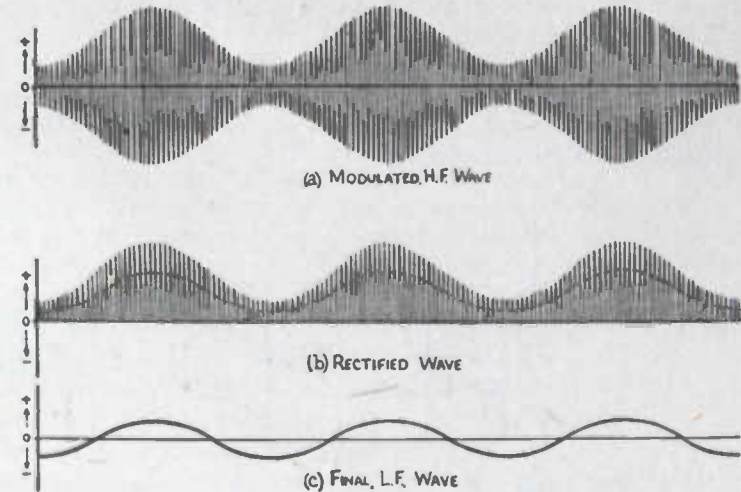

FIG. 114. THE PROCESS OF 'DETECTION' OF A MODULATED SIGNAL

This 'average' current is seen to be all on the positive side of the baseline, which indicates that it has a 'D.C. component', and, if necessary, this can be eliminated (e.g. by a transformer, as in the case of a carbon microphone) ; the H.F. pulses, too, can be filtered out by means of a small condenser which would by-pass H.F. but leave the final L.F. wave (c) with which we can operate the loudspeaker or headphones.

The process of rectification, or 'detection', as it is more usually called, can be performed by any device which has a one-way action, provided the action is quick enough. Ideally, the 'detector' should have no resistance in one direction, and infinite resistance in the other; but devices which have less resistance one way than the other would also serve as 'partial rectifiers'.

It so happens that there are certain substances which, when in contact with one another, exhibit the peculiar property of passing a current more easily in one direction than the other. The reason for this may seem to be a contradiction of Ohm's law; but remember that Ohm did not specify the direction of current flow; his statement assumes that a particular set of circumstances remain for the duration of the experiment. The explanation of the phenomena seems to be that there is a 'potential barrier' between the two surfaces in contact, brought about by the fact that one substance is more rich in free electrons than the other; and that it is easier for the electrons to migrate from the richer side to the poorer than the other way round. (An interesting side-light may be the comparison with a similar sort of phenomenon found in the generation of electricity by the 'thermo-electric' method. Here, two dissimilar metals are joined together and the junction is heated; whereupon an electric current is found to flow, if the other ends are also connected to form a circuit. The explanation is that more free electrons are liberated by one hot metal than by the other, and so an electron flow results.)

To return to the detector, such minerals as silicon, galena, bormite, zincite, tellurium, carborundum, etc., are found to possess the property of being partial rectifiers, and these formed the well-known 'crystals' in the early wireless receivers. Sometimes two such minerals were used in contact, but at others only one mineral in contact with a metallic contact—the familiar 'catswhisker' forming the latter.

Unless we wish to raise enough power to work a loudspeaker, there is no need to use a valve to amplify the received signal. A very simple arrangement of tuned circuit, crystal detector, and a pair of headphones will suffice, and the final circuit might resemble Fig. 115.

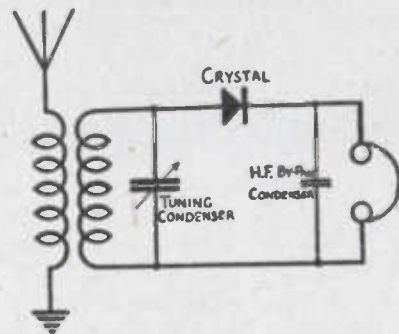

FIG. 115.
THE CRYSTAL
DETECTOR

An even better arrangement is found in the thermionic valve. A diode is a satisfactory rectifier, whether it is of the single anode type (half-wave rectifier) or the double-diode, which gives full-wave rectification; or we can use the amplifier valve (triode) in such a way as to amplify only the positive half-cycles. There are many variations on this type of detection, and the reader is advised to consult text-books on the subject if further details are wanted.

Before we leave the simple radio receiver, it is well to define the different 'stages' found in it. If the incoming H.F. signal is amplified by means of a valve, or valves, before it is rectified, those valves and their circuits are called 'H.F. stages'. Then comes the 'detector stage', which changes the variations of amplitude of H.F. into L.F. currents or voltages, and finally the L.F. stages which amplify the detector output as much as is needed to feed the loudspeaker, there to be re-converted into sound waves.

Before leaving the subject of radio transmission, there are several matters of practical application which it is interesting to mention. For instance, how is the frequency or wavelength kept constant in practice—how can the high D.C. voltages required be obtained—what is a large transmitting valve like, etc.?

DRIVES

Earlier in the chapter the simplest method of generating H.F. oscillations by using a resonant circuit was mentioned and it is indeed a cheap, simple, and convenient method of doing so, but the frequency of the oscillator is dependent on the values of capacity and inductance in the circuit. If these vary, then the frequency will vary. In practical broadcasting it is essential that the frequency should not vary, and it is up to each broadcasting organization to keep its transmitters closely to their allocated frequencies to within extremely fine limits.

Why should the inductance or capacity vary? First of all there is the temperature at which the components operate. Ordinary components will expand when heated, and the change of physical size will effect a change of electrical size. Many attempts have been made to bring about automatic compensation for this change, and some surprisingly good results have been achieved. But this is not the whole story and even the best of temperature-compensated circuits (e.g. the 'Franklin master oscillator') can give an accuracy not much greater than 1 part in 25,000. In some practical applications in broadcasting the phenomenal stability of 1 part in 10,000,000 is required and to achieve this we have to make use of another principle. It is called the Piezo-electric effect (meaning 'pressure-electric') and is found to exist in certain crystalline substances, notably quartz and tourmaline. Generally, quartz is found to be most suitable, and it exhibits the peculiar property that when a slice of it is subjected to mechanical pressure, then an electrical potential is produced across its faces.

The converse is also true, viz. an electric potential applied to the faces will produce a change in physical shape of the crystal. Now the crystal will, when subject to a mechanical strain, utilize its natural elastic property to return to its normal shape, and—like any other body possessing inertia—will overshoot the mark and continue to 'vibrate' until all its energy is expended. We can keep the crystal vibrating continuously by applying a small voltage at the right time (in somewhat the same way that we kept the current oscillating in the circuit containing inductance and capacity) and this is conveniently done by the use of a valve circuit. We will not go into the detailed arrangements of the circuit, of which there are many variations, but merely state that the high frequency alternating voltage obtained is applied to a succession of amplifying valves, coupled together by means of tuned circuits. The

whole unit is, in the case of BBC apparatus, always arranged to give an H.F. output of 4 watts, and is called the 'crystal drive'. This drive then forms the basic part of any transmitter where high stability of frequency is required, however big the ultimate output power, whether 100 kilowatts or 100 watts.

It is extremely important that the temperature of the crystal be kept constant, and this is ensured by putting it in a thermostatically controlled 'oven'. This keeps the temperature of the air in the oven to within $\pm 0.1^\circ \text{C}$., but since the crystal itself is enclosed in a further container it is possible to limit the temperature variation to within $\pm 0.01^\circ \text{C}$., or even less. There is a particular 'cut' or 'slice' of crystal for which the frequency changes least with temperature—or in other words for which the 'temperature coefficient' is smallest. The oven temperature is usually maintained around 40° to 50°C ., which is convenient because it is much easier to make a thing hotter than normal atmospheric temperature and let it cool down, than to keep it lower than normal temperature and let it warm up!

With these precautions it is possible to obtain an accuracy of 1 part in 100,000,000, although 1 part in 10,000,000 is generally sufficient for practical working. In order to appreciate what these figures mean, a comparison can be drawn in this way. Suppose two crystals were used to drive separate clocks (as, in fact, they are by several observatories) and these clocks were allowed to run together for one whole year. Suppose, too, that one of the crystals differed in frequency by the amount stated above (i.e. 1 part in 10^8) so that it would drive its clock a little faster than the other. At the end of the year, the difference in time due to this inaccuracy would be less than one-third of a second!

At first, when it was required to have an accurate frequency control instead of the tuned circuit, another type of mechanical resonator was tried—the tuning fork drive, but this has been gradually superseded by the crystal. Since one of the principles involved also comes into certain crystal drive arrangements we will briefly look into that part of it. It will be realized that a tuning fork is a low frequency device, but its property of emitting sound waves is ignored in this particular application. Here we make the vibrating prongs create a varying magnetic field and thereby cause a low frequency alternating current to be induced into a pick-up coil system. The fork is 'maintained' (i.e. the vibrations are prevented from dying down) by means of suitable valve and feed-back circuits, but the main feature is that a low frequency output is generated and has to be converted to a high frequency for use as a drive.

This is accomplished by means of 'frequency multiplying' stages, which depend for their action on the principle of the tuned circuit. If we take any alternating current that is supposed to have a perfect sine-wave form, we usually find that this is not quite true, and that it actually consists of a fundamental frequency plus several (weak) harmonics. This is particularly true of A.C. that has been produced by vibrating mechanisms, but even if it were not, we could easily introduce these harmonics by means of a valve amplifier producing a distorted output.

In discussing the resonant frequency of a tuned circuit it was found that, for a given size of condenser and inductance, there was a certain frequency of oscillation which was preferred, and to which the circuit would respond in preference to other frequencies. So, if complex A.C., consisting of a

fundamental frequency plus its several harmonics, is passed through a series of tuned circuits and valve amplifiers, and if the tuned circuits resonate at some given multiple of the fundamental (say, twice or three times), then the desired harmonic can be amplified much more than the fundamental. In this way, the low frequency produced by a tuning fork can easily be stepped up to a high frequency.

Incidentally, it is important to keep the temperature of the fork constant because the change in frequency brought about by a change of temperature would, although quite small at low frequencies, be multiplied up to an appreciably large error at the final radio frequency. Tuning-fork drives are not generally used in the BBC nowadays, but the principle of frequency multiplication (and division, too) in this manner is also useful when dealing with crystals. It is found that a crystal is of convenient dimensions (about the size of a postage stamp and 1/16th inch thick) for frequencies up to the order of a million, and is capable of being ground to the desired frequency without any very great difficulty. At very much higher frequencies, however, the crystal would be correspondingly thinner until a frequency is reached at which it would be too thin to handle without fear of fracture. So for frequencies greater than the order of one million per second we use a 'multiplier' to step-up the frequency to the final carrier frequency required, which may be as high as 21.5 million cycles per second (or 21.5 Mc/s) which is equivalent to a wavelength of 13.97 metres.

PRODUCTION OF HIGH D.C. VOLTAGES AND OTHER POWER SUPPLIES

One of the more obvious ways of producing high voltage D.C. (often known as E.H.T., which means 'extra high tension') is by means of rotating machinery. As you know, alternating current is produced by conductors which move past north and south poles of a magnet system, and if we wish to change this we can do so by a sort of rotating mechanical switch, carried on the same shaft as the revolving coils and known as the 'commutator'. The unidirectional pulses are then collected by means of 'brushes', and if it is so arranged that the brushes collect only pulses which are at the peak of their value, and if there are sufficient coils, a reasonably good 'D.C.' is the result. The voltage which such a machine gives is (among other things) proportional to the number of turns in the 'active' coils (i.e. those which are having their e.m.f. collected from them) and the number of these coils which can be connected in series, by using multipolar machines with a number of brushes. But there is a practical limit to the voltage that can safely be taken from each coil, not because of the difficulty of insulating the coil, but because of the difficulty of constructing the commutator. The 'bars' which form this part of the machine are narrow bars of copper, separated by thin slips of mica insulation, and the maximum voltage which can safely be placed upon individual bars—with respect to 'earth' or to neighbouring bars—is limited by the mechanical design. Although a machine was produced which gave 10,000 volts on one commutator, it was considered unwise to design for more than 3,000 volts on one commutator and the 12,000 volts needed was obtained by using four commutators in series. The scheme is shown in Fig. 117.

The generators really consist of four electrically separated ones, although it looks like only two. Each commutator, however, is connected to entirely

separate sets of coils on each machine; they 'share' the magnet system. Special precautions have to be taken with the insulation of the coils and commutators relative to the shaft and the frame of the machine. This was the type of machine first used at the BBC Regional transmitters (in 1929) and the machines are still giving good service. The 12,000 volts obtained is used on choke modulated, low-power, systems, but was not enough for the series modulated transmitter erected at Droitwich in 1934. Here the two stages

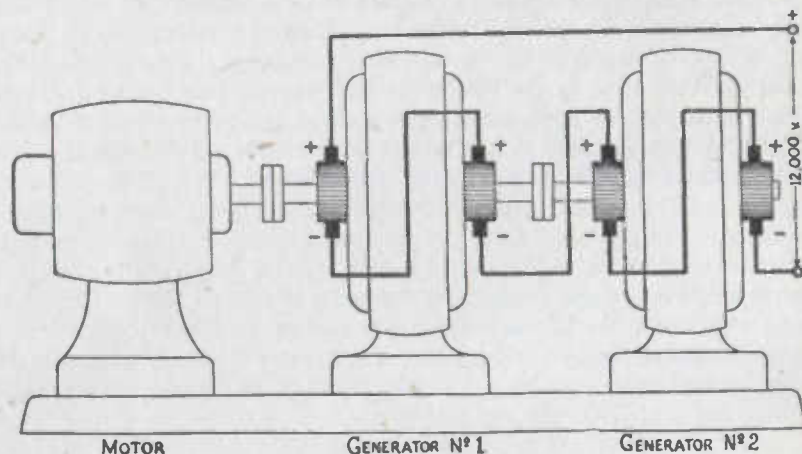

FIG. 116. PRODUCING A HIGH D.C. VOLTAGE BY MEANS OF GENERATORS IN SERIES

(modulator, and modulated amplifier) each required 10,000 volts in series, making 20,000 volts in all. Following the modulated amplifier stage was a final amplifier using a type of valve which would take 20,000 volts on its anode and which would be able to utilize the same 20,000-volt supply. The method of obtaining such a large voltage was, in principle, the same as that just described, except that two sets of motor generators were used (not mechanically coupled) and these could be run up separately and then connected in series. In fact, each of these generators had only two commutators each capable of generating up to 6,000 volts. ($4 \times 6,000 = 24,000$ volts.)

Simultaneously with the development of these later high-voltage machines came a new development—that of the high-voltage mercury-arc rectifier. The idea of rectifying A.C. by means of unidirectional 'valves' was not, of course, new; and many units using some form of 'diode' were deservedly popular. It was found that greatly increased current capacity could be obtained by having a certain amount of mercury vapour instead of the usual vacuum. The development of larger and larger units seemed only a matter of time and, indeed, quite large voltages were managed in this way. The 'bottle' was always a glass one and was, therefore, subject to mechanical damage. Then came a slightly different version of the mercury-arc rectifier; the type enclosed in a steel tank and continuously evacuated by means of vacuum pumps. Starting off with low voltage (e.g. 600 volts), high current (used principally for electric traction purposes) it was not long before its potentialities were realized in the field of broadcasting transmitter supply at high voltage. It was not entirely successful at first, but eventually the 'teething troubles' were overcome and high-voltage mercury-arc rectifiers are now reliable pieces of

apparatus which are to be found at all modern high-power broadcasting stations.

One of the main advantages of this type of conversion is the low maintenance cost, as well as high efficiency, 98 per cent. (for mercury arc) instead of 86 per cent. (for motor generator) which means a lot when dealing with hundreds (maybe thousands) of kilowatts. For instance, a transmitter taking 1,000 kW from the mains would cost 10s. per hour less for power if the E.H.T. were taken from an arc, as compared with rotating E.H.T. generators.

In general, the other supplies for the transmitters are obtained from motor generator sets. The low tension supplies to the valve filaments are most easily obtained—and regulated—this way; for most big valves require about 32 volts at fairly large currents (300 ampères, or more) and they have to be regulated so as to start from about 1 volt and gradually be increased to their maximum.

The voltages for grid bias may be surprisingly high, as much as $-2,000$ volts in the later stages of the transmitter, but relatively little current is required, and the total power is small.

The input to all these machines, and/or the rectifiers, is generally alternating current obtained from the Central Electricity Board's 'grid' system, via direct feeders from the nearest supply station. Generally, two routes for the feeder are chosen, lest one should accidentally fail. As a further precaution, the transmitting station has its own stand-by plant in the form of Diesel engines, driving generators or alternators. The earlier stations generated all their own power, but now the 'grid' is used, with Diesel engines as a stand-by.

HIGH-POWER TRANSMITTING VALVES

Although the valves that handle thousands of volts on their anodes and hundreds of amperes through their filaments are fundamentally the same as a receiving valve, they are not just enlarged editions of it. Due to the large powers involved, something has to be done about dissipating a large quantity of heat, and a system of cooling (generally by water) has to be provided.

The main essential is that the anode, instead of being inside the glass bulb, forms part of the 'bulb' itself and thus becomes exposed to the outside atmosphere. This alone would effect a considerable increase in the cooling surface, but it is not sufficient and the heat is conducted away by water, by enclosing the anode in a 'water jacket' and allowing cold water to circulate around it (see Fig. 117, and Plate X).

This particular diagram is essentially that of the 'C.A.T. 14' type (C.A.T. is a Marconi type designation and means cooled anode transmitting) and is one of the largest types in use. Its anode, of pure copper $\frac{1}{4}$ " thick, is approximately 20" long and 6" diameter. The total length of the valve is 3' 6" and it weighs nearly $\frac{1}{2}$ cwt. The filament is composed of sixteen straight rods of tungsten, each about 16" long and bunched together at the bottom end; thus giving a 'loop' of eight wires in parallel (only a few are shown in the diagram for the sake of clearness) and it is hardly surprising that it will take a large amount of power to heat it; in fact, it takes nearly 15 kilowatts (460 amps. at 32 volts). The whole filament assembly weighs $1\frac{1}{4}$ lbs. and this weight has to be taken by the 'filament seal'.

The grid is in the form of the familiar wire spiral, but has additional vertical rods welded to it to give strength. Some valves have a grid consisting of a perforated metal cylinder; others of a wire mesh.

A valve of this size will handle 150 kilowatts continuously with 20,000 volts on its anode; but if this is insufficient, several valves can be used, connected together in push-pull and/or in parallel. With the large amount of

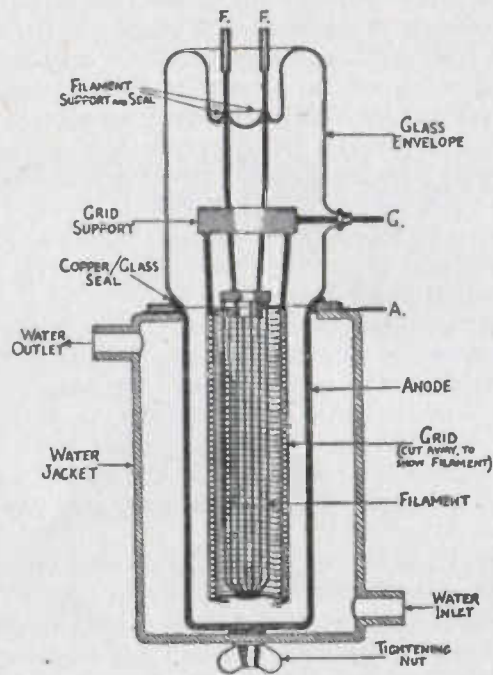

FIG. 117. SECTION OF A LARGE WATER-COOLED VALVE, SHOWING ESSENTIAL PARTS

heat generated, the 'seals' (i.e. where the copper anode is joined to the glass, for instance) have to be specially cooled by a secondary cooling system—usually an air blast.

LIMITERS

When dealing with modern high-power transmitters it is the practice to modulate as deeply as possible in order to preserve the maximum signal/noise ratio at the listener's receiver, but if the depth of modulation is allowed to exceed a predetermined value serious distortion will occur.

A 'limiter' is a piece of apparatus devised to limit the depth of modulation so that it does not at any time exceed a predetermined level. Briefly, a limiter is a 'variable gain' amplifier whose gain is controlled by the amplitude of the signal passing through it, when the level of signal exceeds a certain pre-set value. The actual way it is done is to make use of the properties of a 'variable-mu' valve, which is a type whose gain alters with the amount of bias applied to the control grid.

The circuit, which is shown in skeleton form only in Fig. 118 is arranged so that part of the output is diverted into a 'side chain', where it is first rectified (to give the necessary D.C. for biasing), and then taken back to the

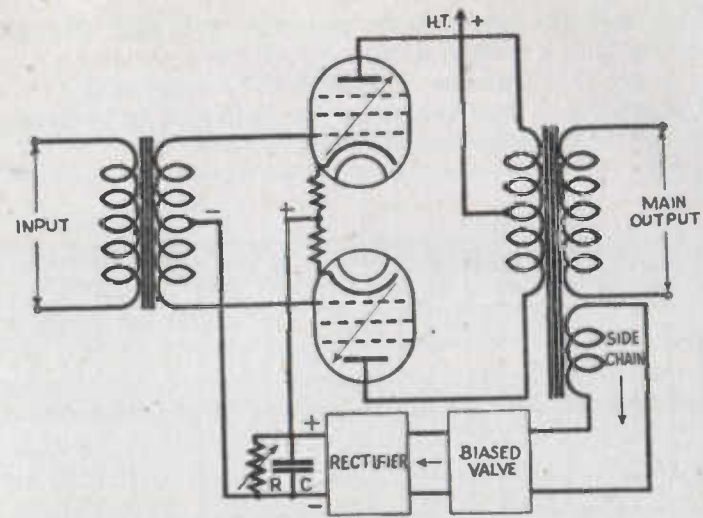

FIG. 118. SCHEMATIC DIAGRAM OF LIMITER CIRCUIT

variable-mu input valves. Two modifications are essential to this otherwise simple arrangement. First, the biasing must not take place until a given level is reached; this is accomplished by using an extra valve in the side-chain which is so biased beyond its 'cut-off' point that the signal has to exceed this bias value before any output is obtained from the side-chain. The output is then rectified and the D.C. used to charge a condenser across the bias circuit of the main-chain valves. This condenser 'C' would remain charged indefinitely were it not for the discharge resistance, 'R', shunted across it. The 'restoration time' (i.e. the time taken for the amplifier to return to its normal gain conditions) is determined by making this resistance of a suitable value.

If we wish to regard the action of the limiter in a more mathematical light, the graph of its operating characteristic should be studied. Fig. 119a shows the input plotted against the output, and it will be seen that up to a certain level (in this case 0 db.) the 'law' is linear (curve 'A'). Thus, for example, an applied signal of -2 db. would give an output of -2 db.

But now consider an input of anything above 0 db., say 8 db. Immediately this signal arrives, the gain of the variable-mu valves alters so that the law of the amplifier now becomes that of curve 'B'. It is important to note that the signal does not operate on a 'bent curve' except for an exceedingly short space of time—when the valve is changing from one characteristic to another, and any distortion introduced is not apparent to the ear. As has been stated, the valves would remain at this new operating condition (curve 'B') if it were not for the restoration arrangement. The discharging condenser has the effect of bringing curve 'B' slowly back to position 'A' provided no other signal with an input greater than 0 db. level arrives in the interval. In describing the action of the limiter zero level has been taken as an example of the limiting level, but in practice the limiters used in the Corporation require an average input level of -23 db. to avoid the overloading of valves, and it is necessary to use a 'D' amplifier in between the limiter and the transmitter.

The 'limiter' should not be confused with a 'compressor' which in action is much more like the 'automatic gain control' of a modern receiver. The

'compressor' increases gain when the programme is below a given level and decreases gain when it is above a (higher) given level. A 'limiter' does give a certain degree of compression of volume if it is worked so that the applied level of programme is high enough for the instrument to be limiting continuously, and the restoration time is sufficiently rapid.

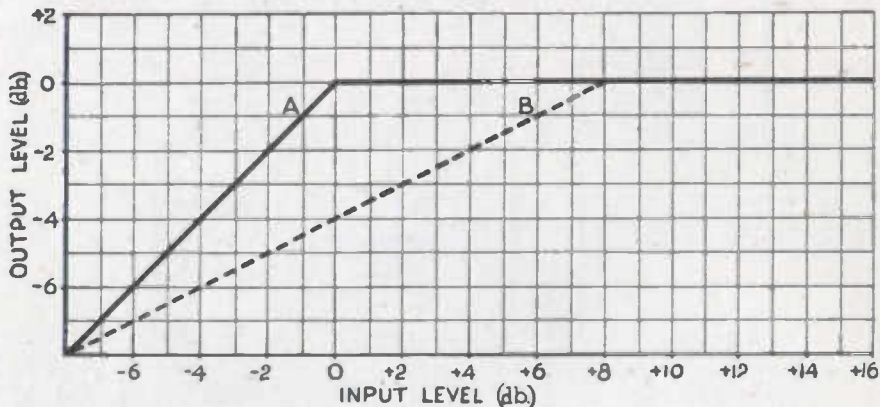

FIG. 119a. GRAPHS TO SHOW THE ACTION OF A LIMITER

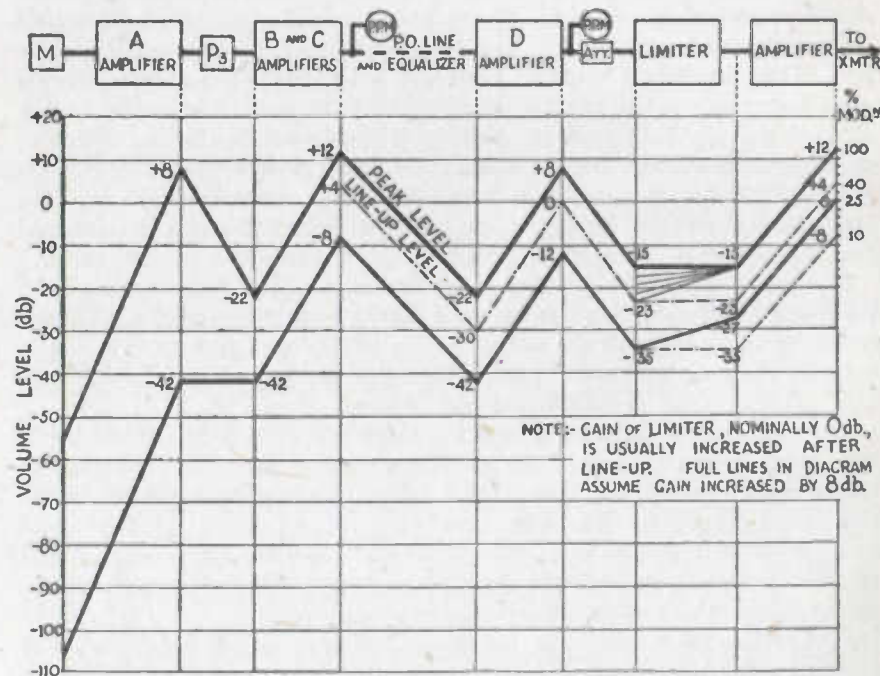

FIG. 119b. VOLUME LEVEL DIAGRAM OF PROGRAMME CHAIN

The way in which the limiter is applied to a transmitter is to 'line-up' the chain of amplifiers so that the operating value of the limiter (in this case, still shown as 0 db.) corresponds to the maximum permissible modulation of the transmitter. When programme is applied, it is allowed to peak just over this value so that the allowable range—already determined by the manual control earlier in the chain—is kept right up to the maximum value in terms of

percentage modulation. On short-wave transmitters it is adjusted to give some degree of compression of volume and thus still further to increase the average depth of modulation of the transmitter.

The volume level diagram given in Fig. 119b shows what happens to the volume level and range when it passes through the various parts of the broadcasting chain, not only at the transmitter but right from the microphone.

PROTECTIVE DEVICES

It is obvious that we cannot afford to take liberties with the enormous voltages and currents that are used in large transmitters; both from the point of view of risk to personnel and to apparatus. Dealing with the latter point first, it should be noted that the supplies to the valves must be switched on in the correct order, otherwise irreparable damage will result. For example, the water must be flowing past the anodes at the correct rate before the filament voltage is applied. Next, it is not permissible to apply the full filament voltage to the cold valve, because the resistance of the filament when cold is very much less than when hot, and the initial current taken from the generators would be unduly high and would result in a distortion of the valve filament due to the large magnetic field which would be created in the vicinity of the filament by the very rapidly increasing current. And so we must make sure that only a low voltage is first applied, gradually to be brought up to full value. After this, grid bias may be applied, and finally, the H.T. put on to the anodes, but here again, not at full value. It is brought up gradually to a maximum.

It is not wise to risk valuable apparatus by relying on the operator's knowledge—only one slip is needed to cause damage costing hundreds of pounds. A C.A.T. 14 valve, for instance, costs over £800. To guard against this sort of human error, auxiliary interlocking arrangements are used, mainly consisting of relay circuits, whereby switching operations cannot be performed except in the correct sequence.

As regards the protection of staff, similar safety interlocks are provided, incorporated in the doors of the protecting enclosures. The opening of any such door will shut off the power supplies and discharge any condensers that would otherwise 'hold' a possible lethal voltage.

QUESTIONS ON CHAPTER VII

(1) What wavelengths correspond to the following frequencies :—150 kc/s, 1,500 kc/s, 1.5 Mc/s, 877 kc/s, 9.45 Mc/s, and 100 Mc/s ?

What frequencies correspond to the following wavelengths :—1,500 m., 449.1 m., 203.5 m., 41 m., 298 m., and 100 m. ?

(2) Show with a diagram the creation and release of electromagnetic waves from a radiator. What is meant by horizontal and vertical polarization ?

(3) What would be the resonant frequency and wavelength of the circuit shown below ?

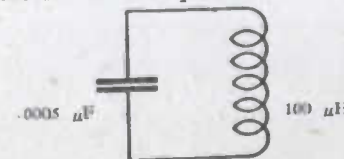

What would the frequency become :—

- (a) if the condenser was reduced to $0.000125 \mu\text{F}$ and
- (b) if the inductance was reduced to $25 \mu\text{H}$?
- (c) If you wanted to double the wavelength without changing the capacity of the condenser, what value would you have to make the inductance ?

(4)

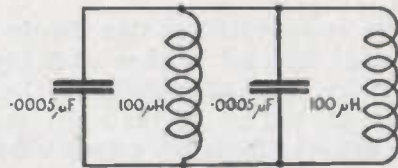

What would be the wavelength of the above circuit ?

(5) Draw the circuit of a simple choke-modulated transmitter, showing the wave form :

- (a) at the anode end of the low frequency choke, and
- (b) at the grid of the oscillator.

(6) Explain the working of 'class B' amplification and show how it may be applied to the process of modulation. Why is this method of modulation preferred on modern high powered transmitters, and what are some of the difficulties and disadvantages of the system ?

(7) What is meant by bandwidth ? Show diagrammatically how two waves slightly different in frequency combine to make a wave whose frequency is their difference.

Over what range of wavelength should a receiver respond to reproduce faithfully a 5,000 cycle pure note being transmitted from a 1,500 m. station ?

- (8) Draw the circuit diagram of a receiver having :
- (a) a crystal detector
 - (b) a diode valve detector, and
 - (c) a triode valve detector.

Indicate the values of the components for reception of a 400 m. station if the aerial of the receiver has a capacity of $0.0002 \mu\text{F}$.

(9) What standard of stability can be attained by means of crystal drives ?

Describe with a diagram how a BBC medium wavelength crystal drive circuit functions. Why are frequency multipliers used on short waves and how do they work ?

(10) Describe two well-known methods of obtaining D.C. high tension for high-power transmitting stations. What are their relative advantages ?

(11) What is the over-all efficiency of a modern transmitter ? Enumerate the various points at which power is lost.

(12) If high-power transmitting valves have their anodes cooled by water, why is it that the whole water-cooling system does not have to be insulated from earth ?

(13) A peak programme meter is peaking 6 when it should be peaking 7. What percentage of the peak aerial power of the station is being lost ?

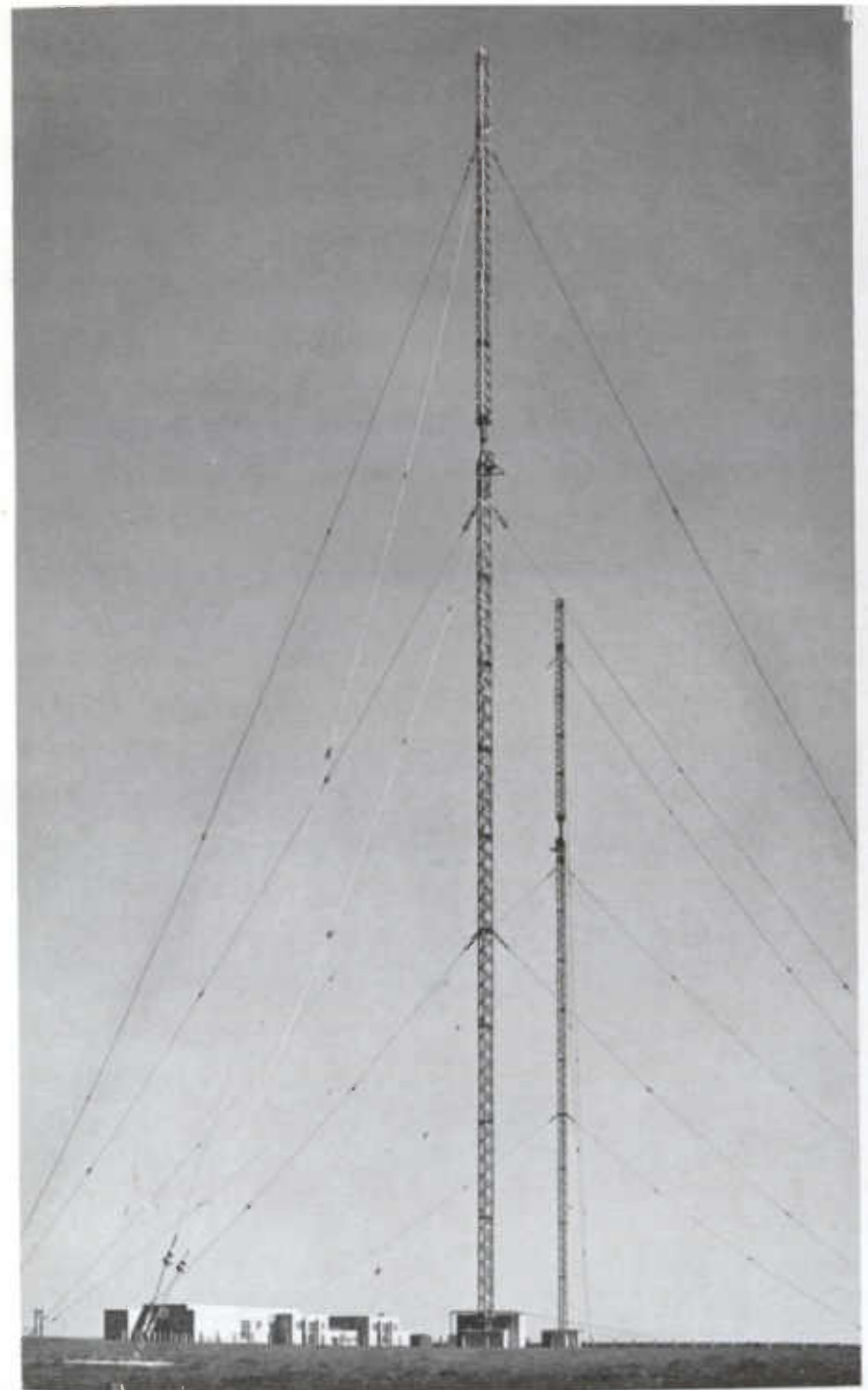

Two mast radiators at a BBC transmitting station

CHAPTER VIII

THE PROPAGATION OF ELECTROMAGNETIC WAVES

WE have rather taken it for granted in Chapter VII that once a radio wave has left the transmitting aerial it will eventually be picked up by somebody's receiving aerial. Practical observation shows that there is a very wide variation in the results obtained under different operating conditions. For example, it seemed that, in theory, the higher the frequency the greater the efficiency of radiation; yet, when we come to listen at some distance from the transmitter, the behaviour of waves of different frequencies seems erratic, and sometimes the lower radio frequencies are received more strongly than the high ones. It would appear that daylight and darkness, and summer and winter, also influence the strength of reception, particularly on the higher frequencies. Even more surprising is the fact that the short waves can be picked up at great distances, whilst being practically inaudible near to the transmitter. What is happening en route?

MEDIUM AND LONG-WAVE PROPAGATION

Let us assume that we have a transmitter which can radiate the same power (1 kW) on any wavelength; now let us find out how it is received at different distances as we change the wavelength. For this purpose we need a piece of apparatus called a 'field strength measurer', with which

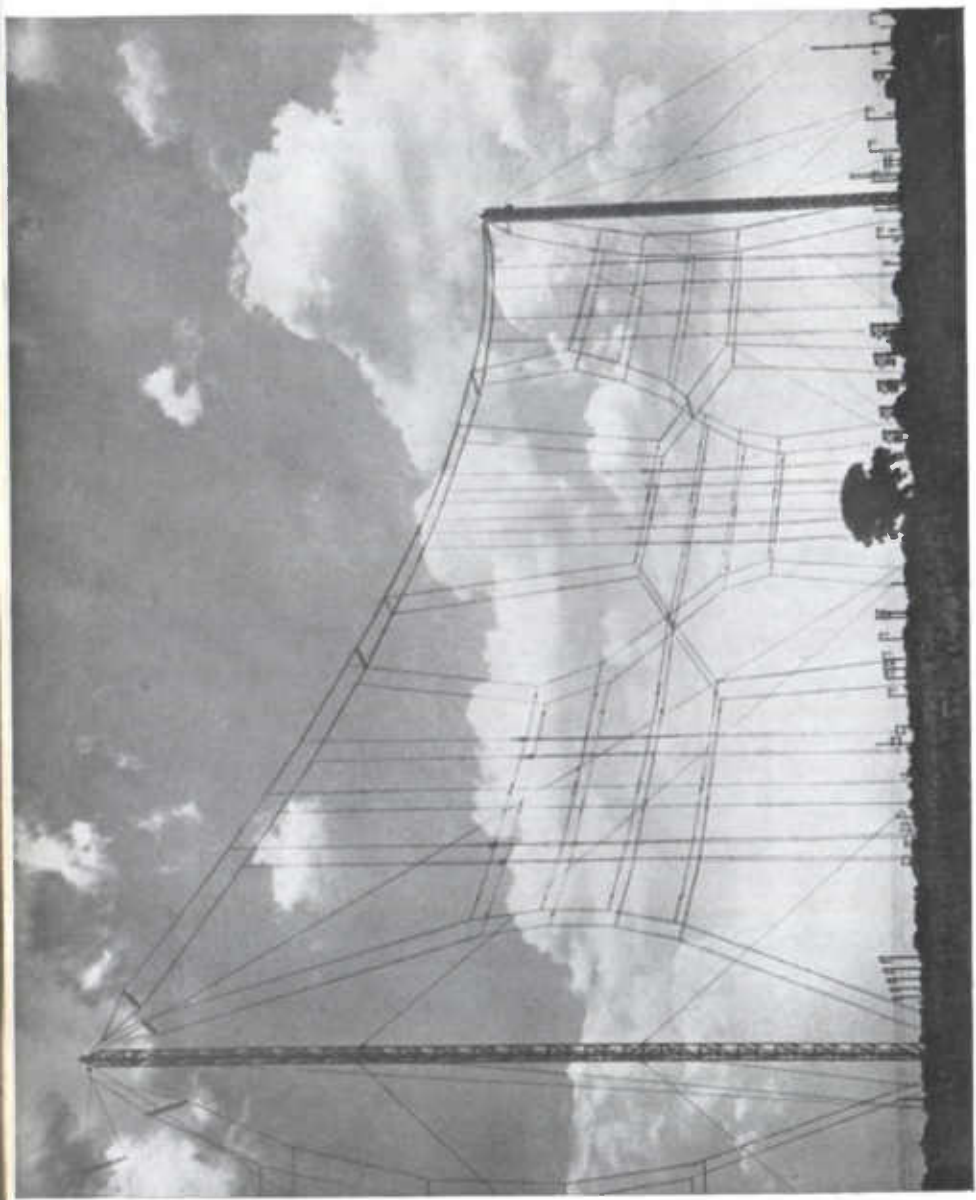

Short-wave aerial arrays for 17, 14, and 19 metres
Plate XII

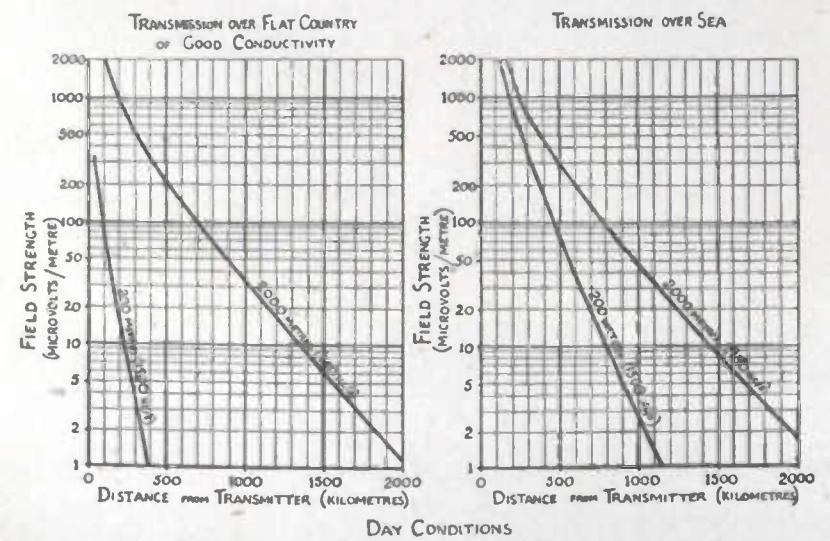

FIG. 120. GRAPHS SHOWING VARIATION OF SIGNAL STRENGTH WITH DISTANCE (DAYTIME)

we can measure the strength of reception at different distances and for different wavelengths. If we did this and then plotted the results in the form of a graph, we should get something like Fig. 120. Incidentally, we should find that the field was proportional to the square root of the power, i.e. to double the field we should need four times the power. Note from the above that (a) the long waves travel better than the medium, (b) the waves of a given length travel better over sea than over land. The curves are drawn for average flat land such as is to be found in pastoral England, but over mountainous country we should find that the waves did not travel so well, and the range of the transmitter would be even more restricted. Note that the curves drawn refer solely to daytime. If we were also to listen whilst measuring, we should find that at a certain distance we should no longer hear the transmitter because its signals would be weaker than noise which the receiver would pick up, and, as the curves show, the shorter the wavelength the shorter the distance. We might therefore conclude that a 15-metre wave would be a very poor performer and decide not to use so short a wavelength for a long-distance broadcasting service. But we should be wrong in our decision, for having explored a little further afield we should find the 15-metre wave to be audible at greater distances—at distances of several thousands of kilometres away; where, in fact, the medium and long waves were quite inaudible.

(Note : Curves for other wavelengths, and shorter distances, are given in Appendix IV.)

Now let us repeat the experiment at night and plot more curves. Fig. 121 shows the results obtained. By comparing the day and night curves (drawn

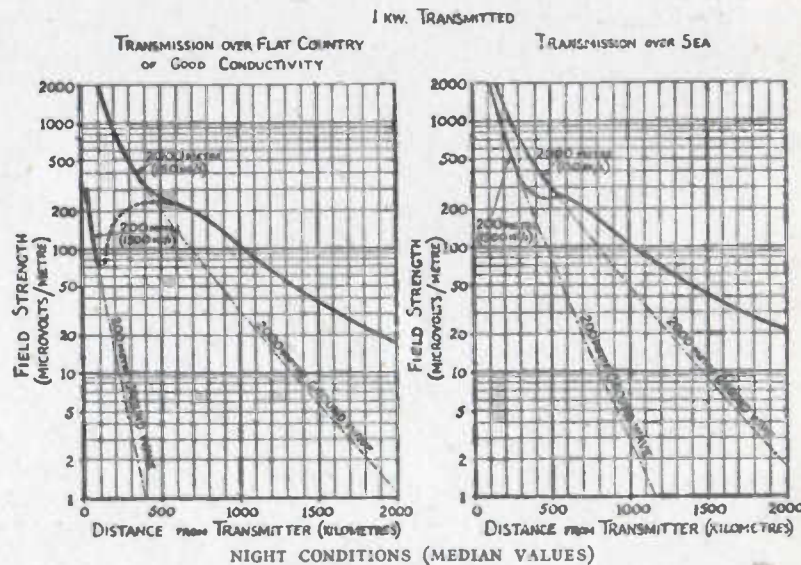

FIG. 121. GRAPHS SHOWING VARIATION OF SIGNAL STRENGTH WITH DISTANCE (NIGHT)

together in Fig 121) you will see that quite different things happen at night. There is no change in nearby field of all the waves, but the strength of the medium wave after some 300 kilometres or so is much greater. By listening we should find that it is by no means constant, and at the distances where the

strength is very variable we have found it difficult to know what values to plot on the curves. In fact, we have had to record the changing value of field on a moving chart and have then had to work out from that chart what the value was which was exceeded for half the time. That all sounds very complicated, but just remember that it is called the 'median value' and that it is the most probable value for a quantity which is varying at random.

Another thing we should find is that the short-wave signal on 15 metres is no longer audible at a great distance. Now what is causing these changes at night—stronger but fading signals on long and medium waves at greater distances, and no distant reception of the shortest waves at these distances? And why do waves travel better over sea than over land? Let us try to answer the last question first.

The fact is that sea water is a better electrical conductor than earth, and, generally speaking, the earth in a flat pastoral country is a better conductor than in hilly country, and also than the various kinds of rock of which mountains are made. The hills and mountains also constitute physical obstacles which hinder the passage of electromagnetic waves. The shorter the wave the higher the frequency, and as certain of the losses which reduce the amplitude of the wave occur at each cycle, it follows that the higher frequency (or shorter wave) suffers the greater loss, and is thus received less strongly at a given distance than the lower frequency (or longer wave).

SERVICE AREA

So much for radiation near to the transmitter. Note that so far we have assumed that the waves have been travelling over the surface of the earth; what happens to the waves which have left the transmitting aerial at an angle above the earth's surface? They will travel up into the atmosphere—getting weaker as they go, but not weakening so rapidly as the waves which have travelled over the earth's surface because of the absence of obstacles. Now, in daylight the medium and long waves which thus reach the upper atmosphere will be absorbed there at a height of approximately 60 to 80 kilometres, and we do not hear of them again. At night, in the absence of sunlight, the absorbing stratum disappears and discloses a layer of atmosphere at about 100 kilometres height, which is quite a good reflector of medium and long electromagnetic waves, which are reflected down again to combine with the radiation which has reached the receiver over the ground (we call it the 'direct' or 'ground' radiation) and this produces the fading signal of our experiment. But why does it fade rather than take up some steady intermediate value?

At the distance where both 'direct' and 'indirect' radiation are received, the fading will be due principally to the changing phase between these two components. If both arrive 'in phase' they will add up, and if they are out of phase they will subtract. At the distance where, and at the time when, direct and indirect radiation are equal, the resultant reception will range from zero up to double the 'direct' or daytime value. Nearer to the transmitter the direct radiation will predominate, and there will be little or no fading, whereas further out the indirect radiation will predominate, and although there will be fading it will not be so marked. For medium and long-wave stations we have therefore a primary service area where reception is good and strong by day and by night, then an annular ring in which reception is steady and good by day but hopeless by night, and then an outer area where reception

is absent or poor by day, but is reasonably satisfactory by night on fairly good receivers fitted with automatic gain control to compensate in part for the fading. At night we have in fact two fading areas, the nearer of which is sometimes called the 'near-fading area', and we shall see in Chapter IX that it is possible to increase the inner radius of this (and thus the primary service area of the station) by suitable aerial design—e.g. by the use of an 'anti-near-fading aerial', as the Germans call it.

The size of the primary service area will also be increased as the direct ray is increased—that is, as the wavelength is raised and as the conductivity of the earth is greater. In other words, it will be better over sea than over land. Note that the fading range will not alter with increase in power, for both 'direct' or 'ground' wave and 'indirect' or 'sky' wave will increase equally. Fig. 122a depicts night propagation of medium or long waves.

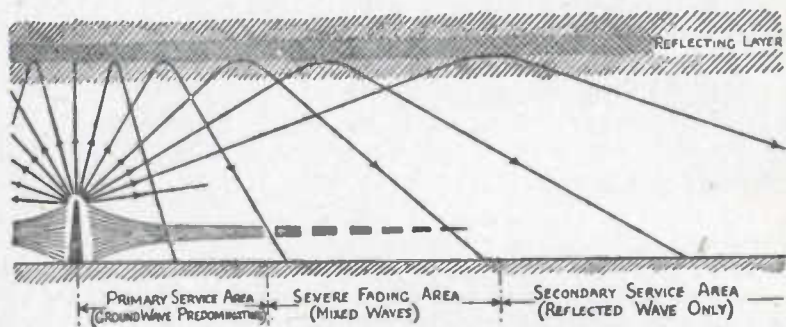

MEDIUM AND LONG WAVE PROPAGATION AT NIGHT

FIG. 122a. PICTORIAL REPRESENTATION OF WAVE PROPAGATION (MEDIUM AND LONG WAVES) VIA THE IONOSPHERE

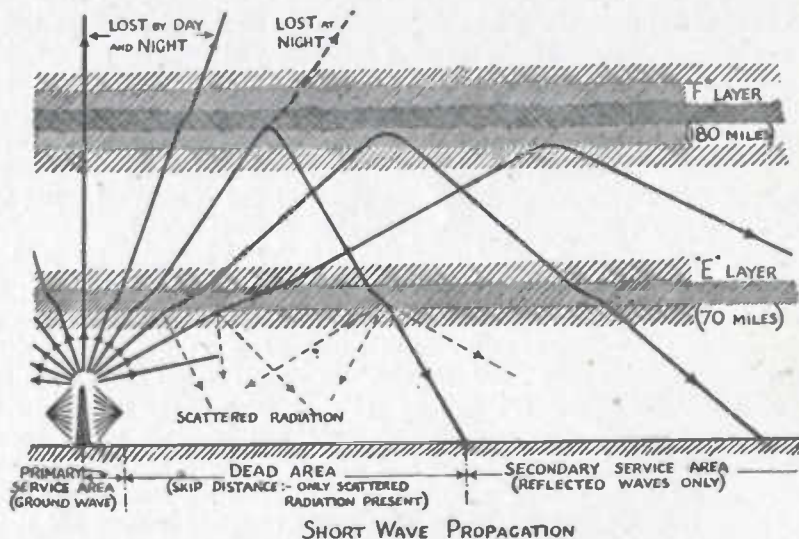

SHORT WAVE PROPAGATION

FIG. 122b. PICTORIAL REPRESENTATION OF WAVE PROPAGATION (SHORT WAVES) VIA THE IONOSPHERE

So far we have spoken of service area in terms of strength of the signal, and although we said that a point was reached at which the signal 'would be weaker than noise which the receiver would pick up', we have not said what ratio of signal to noise is necessary for good reception; nor have we taken account of the fact that the noise also varies with wavelength and, in fact, increases roughly in proportion to increase in the wavelength (double the wavelength, double the noise). We should find that in tropical countries (India, for instance) the noise increases even more rapidly as the wavelength is increased, and at certain seasons increases as the square of the wavelength (four times the noise if the wavelength is doubled). The result is that the long waves are not quite as useful in increasing service area as we might have supposed, especially in tropical countries, although of course they do increase the non-fading range at night. In temperate climates higher power can be used to compensate, at least partially, for the increased noise and to restore the desirable signal-to-noise ratio—which is generally taken as at least 40 db. for a high-grade service.

The noise so far considered is that due to atmospheric—or natural—causes, but interference or noise is also produced by industrial and domestic electrical apparatus and is called 'man-made static'. The apparatus—such as a lift motor, a tram car, a trolley bus, a vacuum cleaner, etc., acts as a radio transmitter quite incidentally to its normal operation, and sends out waves which are capable of interfering with radio reception and in effect increase the natural noise level. These interferences are worse in large towns than in the country, and it is found that they are worse as the wavelength is increased. Whilst it is possible to reduce this interference at its source by treating the interfering apparatus, much domestic and industrial plant remains untreated, and the noise level in towns on long waves may be extremely high. The table below shows the approximate values of field in millivolts per metre necessary to ensure a noise-free broadcasting service on different wavelengths in different locations. It is assumed that the modulation of the transmitter peaks at 80 per cent.

Wavelength in metres	Field strength, in millivolts per metre		
	Large city	Small town	Country
200	2 to 15	1 to 5	0.5 to 2
500	3 to 20	1 to 5	0.5 to 3
1,500	5 to 30	2 to 10	0.5 to 3

SHORT-WAVE PROPAGATION

Let us now return to the propagation of waves and see what happens to the short waves. They will usually pass through the stratum or layer mentioned above both by day and night, but there is yet another layer produced by the action of the sun on the atmosphere at a height of some 300 kilometres, which will reflect the 15-metre wave back to earth in the daytime, but not at night. That is the reason for the wave being audible by day but inaudible by night at a distance. Fig. 122b depicts the short-wave transmission mechanism. This knowledge of the presence of reflecting layers is the result of observation and experiment over a number of years. The necessity for the presence

of some such agent was postulated many years ago by the mathematician Oliver Heaviside in this country, and independently by Professor Kennelly in the U.S.A., to account for long-distance transmission of electromagnetic waves round the curvature of the earth. Since waves travel in straight lines, unless some agent is present to reflect or refract them, long-distance transmission would be impossible over a curved earth, in the absence of some such layer. Marconi's first trans-Atlantic transmission in 1901 demonstrated that waves were bent round the curvature of the earth, and it was assumed that Heaviside's and Kennelly's postulate accounted for the result. It was not till many years later that these regions of the upper atmosphere came to be explored, by what now seems to be a simple expedient, that of sending up messengers to find out what was happening. These messengers are in fact short pulses of radio waves, and by measuring the time between the departure of the waves sent up vertically, and the time of their arrival back on earth again, it is possible to work out the apparent height at which they have been reflected because we know the speed at which they travel on the way up and down, namely 300,000,000 metres per second.

Now if we change the wavelength, we can find the height at which different wavelengths are reflected, and in this way we can find out much about the layers—how they vary with the height of the sun above the horizon (a diurnal variation)—with the season of the year, etc. And if we carry out the experiments over a long enough period, we shall find that there is a long period variation taking about eleven years. The fact that there is a diurnal variation shows that the sun is the agent by which the gases in the upper atmosphere are electrified, and the other variations are all due to changes in the sun's action—the eleven-year cycle corresponding with the cycle of sunspot activity.

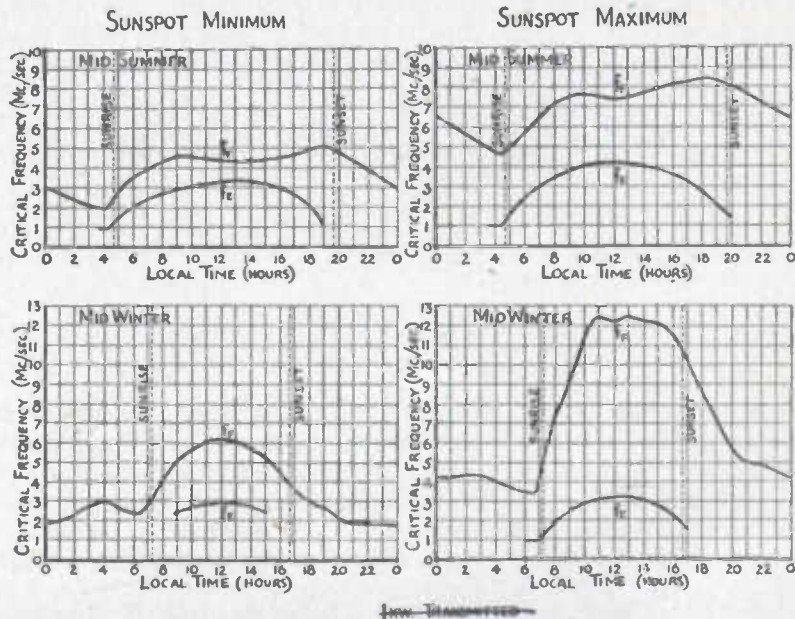

FIG. 123. GRAPHS OF THE CRITICAL FREQUENCY AT VARIOUS PERIODS

It is in fact the ultra violet light from the sun which ionizes the rarefied gas in the earth's atmosphere. Ionization simply means that the atoms of gas have had electrons 'knocked off', leaving positively charged 'ions', and it is the presence of these free electrons that makes the regions capable of bending or reflecting electromagnetic waves. The reason for stratification is not easy to see, but it may be taken for granted that the lower 'E', or Kennelly-Heaviside, layer is mostly ionized oxygen; and the upper 'F', or Appleton, layer is mostly ionized nitrogen. (The bibliography contains references to works which may be read by those who wish to know more about this subject.) At certain times of the day there are in fact more than two layers, and the whole of the ionized region is called the Ionosphere.

The density of the ionization in the layers controls their critical frequency, i.e. the highest frequency which the layer will reflect if the waves impinge on the layer at right angles to its surface, and in England this is about 2.8 Mc/s for the 'E' layer and 5.8 Mc/s for the 'F' layer at midday at the equinox. The critical frequencies vary greatly with latitude.

Fig. 123 shows the variation of critical frequency of the 'E' and 'F' layers over twenty-four hours at Washington, in midsummer and midwinter of sunspot minimum and sunspot maximum years. The curves labelled 'f_F' give the critical frequency of the 'F' layer and those labelled 'f_E' that of the 'E' layer. From such curves it is possible to find out the most effective wavelength for long-distance short-wave transmission. Remember that if the wave is too short (above the critical frequency) it will penetrate the layers and be lost, and if it is too long it will be unduly absorbed in the 'E' layer. Indeed medium and long waves in the daytime will never reach the 'E' layer—and so a compromise has to be made. One more point to remember is that the angle at which the wave hits the layer also controls reflection. For instance, if a wave just above the critical frequency is used, it will penetrate the layers if it is sent up vertically—but if it hits the layer at an acute angle it will be reflected, and in practice it is possible to use waves of up to four times the critical frequency for long-distance transmission.

When the waves reach the earth again, they are reflected there (the earth is a conductor) and continue on their journey up into the ionosphere again only to return to earth after another reflection. In this way the waves travel by a series of hops in between the earth and the 'F' layer; as many as three hops being required to reach India, and six or seven to reach Australia from this country. For each hop the waves have to pass twice through the 'E'

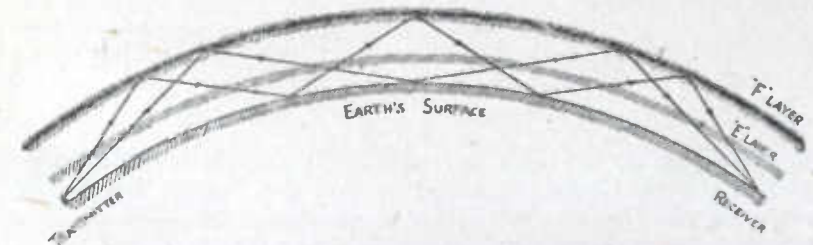

FIG. 124. ILLUSTRATING MULTI-HOP PASSAGE OF SHORT WAVES TO A DISTANT POINT

layer, where they will suffer absorption, and be reflected once by the 'F' layer (Fig. 124).

The selection of wavelength for the longest distances (e.g. New Zealand) is complicated, for if the first reflection takes place at midday in midsummer, the last will take place at nearly midnight in midwinter, and the wave chosen must be short enough to avoid excessive absorption at the first hop, yet long enough to secure reflection at the last hop. In practice this is not always possible, and short wave transmission to the antipodes without intermediate relay cannot generally be assured throughout the twenty-four hours, even if the wavelength and direction are selected to secure the most favourable propagation conditions.

The practical application of the propagation of short waves through the ionosphere to secure a world-wide broadcasting service is dealt with in the next chapter, which also deals with aerials for medium, as well as for short-wave, broadcasting stations.

QUESTIONS ON CHAPTER VIII

(1) If 5 millivolts per metre is considered the minimum workable signal for a satisfactory interference-free broadcasting service on a wavelength of 2,000 metres, what would be the daylight radius of service over pastoral country of a 2,000 metre transmitter working on the following powers :— 1 kW, 10 kW, 50 kW, and 100 kW ?

(2) Why is it uneconomical to use powers of the order of 100 kW for broadcasting transmitters working on wavelengths of the order of 200 m. when we are interested only in the primary service area ?

(3) In the quiet passages of a programme the peak programme meter will read 2 for comparatively long periods. A 500 m. transmitter is 50 km. away and the local interference noise level is 40 microvolts per metre. What power should the transmitter radiate so as to maintain a 40 db. programme to noise ratio at these low modulation levels ? Assume the noise field to be 100 per cent. modulated and the transmission to be over pastoral country.

(4) Start Point was built as a 285 m. regional transmitter for the south-west and south coast of England. Why was that site chosen and why was a reflecting aerial employed ?

(5) What are the 'E' and 'F' layers ? Show with a diagram their effect on waves of 20, 200, and 2,000 metres striking them at 90° , 45° , and 17° , (a) at midday in midsummer, (b) at midnight in midwinter ?

(6) What sets (a) the high limit and (b) the low limit to the band of frequencies for short-wave communication over any distance at any time ? What is the effect of a large increase in the transmitted power on (a) the high limiting frequency and (b) the low limiting frequency ?

(7) Is atmospheric noise of the same intensity on all frequencies in the broadcast band ? Is it of the same intensity in all parts of the world ? If not, give reasons and state approximately how it varies with frequency.

CHAPTER IX

AERIALS FOR BROADCASTING STATIONS

GENERAL REQUIREMENTS OF AN AERIAL

HAVING obtained a modulated wave, it is essential to radiate it as efficiently as possible. It is not sufficient to connect the output of the transmitter to any old piece of wire and to hope that the energy will be 'broadcast' effectively. Two main problems arise : (a) to make the aerial and its connecting link (called the 'feeder') as efficient as possible, by which we mean that the aerial should radiate as much of the energy delivered to it as possible, and that the feeder should not waste or radiate any ; and (b) to examine the possibility of directing, or concentrating, the energy in any particular direction that may be required.

In an earlier chapter we noted that the aerial circuit itself constituted a 'tuned circuit', and that it was desirable to have it tuned to the radiating frequency. In one example given, a conventional aerial consisting of part vertical and part horizontal wires was depicted (in Fig. 103), and it was stated that an entirely vertical aerial gave 'vertical polarization' of the waves, whilst an entirely horizontal one gave 'horizontal polarization'. For clarity, the diagram rather suggested that the (vertical) lines of electric force emanated only from the top part (which also suggested that this was the capacitative part of the tuned circuit), and that the (horizontal) magnetic force was produced only by the vertical wire (which suggested that this was the inductive part). Fig. 104 showed that the vertical lines of electric force could also emanate from a vertical aerial. In actual fact we cannot differentiate between these two components as simply as Fig. 103 suggested, because both wires will carry current, and both will have capacity and inductance ; so that in the 'inverted L' or 'T' type of aerial the polarization is not only in one particular plane. If the horizontal portion is made large in comparison with the vertical portion, the polarization becomes predominantly horizontal, and vice versa. It should be noted, too, that if an aerial does consist of a conductor, all of which is vertical, or all of which is horizontal, then the polarization of the waves will be vertical or horizontal respectively. If the waves travel over earth of high conductivity (e.g. over sea water) the initial polarization will remain undisturbed, but, by passage through an ionized medium (e.g. the 'E' or 'F' layers in the ionosphere) the polarization will be disturbed.

Apart from the polarization, is there any great difference in the performance of a horizontal and a vertical aerial ? Is either more efficient than the other ; in other words, which radiates the higher proportion of energy applied to it ? At first sight it might seem that there would be little difference ; and in the theoretical case of an aerial in free space, away from all other conductors,

there would be no difference in radiation efficiency. If the wire were vertical it would radiate equally in all directions in the horizontal plane, but in the vertical plane there would be no radiation 'end on' to the wire (i.e. vertically up and down) and maximum radiation at right angles to the wire. If the wire were horizontal there would still be no radiation 'end on' to the wire—but now this would be in directions in the horizontal plane—while in the vertical plane the wire would radiate equally at all angles. In practice we do not usually deal with wires in free space—particularly at broadcasting stations. The presence of the earth near the wire profoundly modifies the result, and we get radiation characteristics in the vertical plane quite different from those mentioned above. As we shall see later, we can, too, modify the characteristics by introducing other conductors near to the aerial wire.

The efficiency of an aerial also depends on its length, and in general terms, if the aerial is not connected to earth, it is most efficient when the wire has a physical length of about half the length of the wave. A straight aerial which is not directly connected to earth and is substantially one half-wavelength long is called a 'dipole'. Again the presence of the earth profoundly modifies the result, and the length of a vertical aerial having its lower end connected to earth can be any convenient value, determined only by the diagram of radiation required in the vertical plane.

Let us look a little closer into the working of the vertical aerial, referring first to the type of vertical aerial having a height of less than one quarter of a wavelength (a type of aerial largely due to Marconi and sometimes named after him).

The earth is a conductor, and what is in effect an electrical 'image' of the aerial is formed immediately below it; just as a visual image would be formed if the vertical aerial stood on a mirror. The radiation pattern is the resultant of radiations from the aerial wire and from its image, which add or cancel in different directions, depending on their relative phase. The vertical wire one quarter of a wavelength long therefore becomes electrically equivalent to a wire half a wavelength long. (Later on we shall describe a method of drawing the distribution of radiation from an aerial in the form of a graph called a 'polar diagram', and we shall then be able to compare easily the radiation patterns of different types of aerial.) This type of aerial radiates much of the energy along the ground, but if we make it about half a wavelength high the radiation along the ground and at low angles of elevation will be increased while that at higher angles of elevation will be reduced, so that the inner limit of the 'near-fading' area can be pushed out sometimes by as much as 25 per cent. to 30 per cent. in radius, due to reduction of the sky wave at night (see Chapter VIII p. 164).

Let us now consider the horizontal aerial. This too has an electrical image formed in the ground below it, but the radiation from this image is reversed in phase and tends to cancel radiation from the aerial along the ground. When we come to the polar diagrams we shall see that the horizontal aerial radiates most of its energy up into the sky, and that none is radiated horizontally along the earth's surface. It follows that purely horizontal aerials are unsuitable for use for medium and long-wave broadcasting stations where the maximum primary service area is usually wanted, and that is why vertical aerials are generally used.

AERIALS FOR MEDIUM AND LONG WAVES

If an aerial is to be physically half a wavelength high it will be seen that a practical limit will be reached in the medium wave-band—where on 540 metres, for instance, a vertical height of 270 metres, or nearly 900 feet, would be required. One mast of just over 1,000 ft. has been erected for the Budapest station in order to secure the maximum area free from fading, but it is more usual, and indeed essential on the long waves, to add some inductance or capacity to the vertical aerial (which is often the mast structure itself), so that its physical length can be reduced while keeping its electrical length equivalent to the desired figure. If an aerial is physically too short, a 'lumped' inductance in the form of a coil at the lower end can be used, but this inductance will itself contribute nothing to the radiation of the aerial. Another method is to bend over the top of the aerial to form a horizontal portion, but here again the lost vertical portion will result in a decrease in radiation in the horizontal plane, for we have already seen that a horizontal aerial near to the earth does not contribute much horizontal radiation. On the other hand, the effect of this horizontal portion is to act as a 'lumped' capacity at the top end, and this results in a more favourable distribution of current in the vertical portion. An aerial of this type may not always be in the form of an 'inverted L' with the vertical portion connected at one end of the horizontal portion, but may be in the form of a 'T' with the vertical portion connected to the centre of the horizontal portion.

Where a (totally) vertical aerial is used, the mast itself can be made to act as a radiator, and in this case it is not unusual to have an adjustable top portion to the mast in the form of radial 'spokes' which can be raised or lowered by a winch. This gives an increased top-capacity which, like the top portion of the 'inverted L' aerial, makes the current distribution in the mast more favourable. The electrical length to give the greatest primary service area depends on the wavelength and the conductivity of the earth, but for the most effective 'anti-near-fading' properties, a figure of between $\cdot 52$ and $\cdot 58$ wavelength is frequently used.

Another method of adjusting the electrical length of the mast is to divide the mast into two portions—an upper and a lower—separated electrically by an insulator across which an inductance of a desired value can be connected, so as to secure the most favourable distribution of current. The photograph (Plate XI) shows two such radiators at a BBC station, in which two masts are erected in order to concentrate the radiation in the desired horizontal direction. The masts are 450 ft. high, and when they were adjusted to transmit on a wavelength of 285 metres (1,050 kc/s), no added inductance was necessary. The electrical length of the mast was then $0\cdot 65$ wavelength, the physical mast height being approximately $0\cdot 52$ wavelength.

In the foregoing paragraphs the 'most favourable distribution of current' has been referred to, and it should be mentioned here that in general this means that in a vertical aerial the maximum current in the aerial should be as high above the earth as possible. It should be realized that the current in an aerial is not uniform but varies over the length of the aerial. If the latter is exactly half a wavelength long, the current will be small at the bottom, a maximum half-way up the aerial, and zero again at the top. With a quarter-wave aerial, the current will be a maximum at bottom and zero at the top.

Fig. 125 shows the distribution of voltage and current in quarter- and half-wavelength vertical aerials.

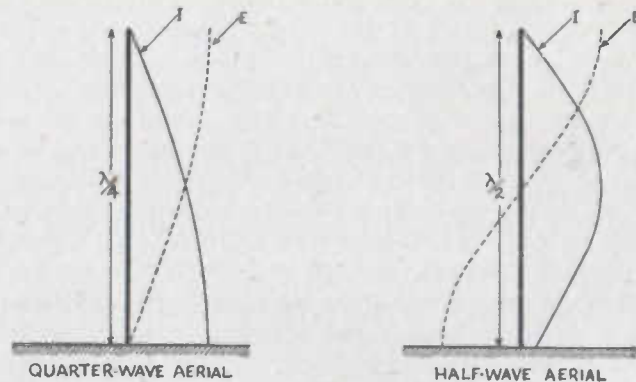

FIG. 125. RELATIVE VOLTAGE AND CURRENT DISTRIBUTION IN QUARTER, AND HALF-WAVE VERTICAL AERIALS

We have so far mentioned only aerials for medium waves, but it was noted that the practical height of mast was reached for the longest of the medium waves. It follows therefore that in the broadcasting long-wave band (between 1,132 and 2,000 metres) it is out of the question to use a half-wave vertical aerial, and in practice it is generally necessary to add lumped inductance at the base to tune it to a quarter-wave. Proposals have been made in France, in Germany, and in this country, to achieve an anti-near-fading aerial for long waves by using a number of aerials each tuned to about a quarter of a wavelength, spaced and phased so that radiation at certain undesired angles of elevation is suppressed. An aerial of this type is believed to have been erected at the French long-wave station at Allouis, but no technical details of its performance have yet been published.

AERIALS FOR SHORT WAVES

So much for vertical, or mainly vertical, aerials. It has already been stated that horizontal aerials have no radiation in the horizontal plane—that is, along the ground—but that their radiation is sent up into space at an angle above the horizon. It will therefore be realized that such aerials are quite suitable for broadcasting where the direct or ground radiation is not required, e.g. on short waves, where the propagation is by reflection or refraction in the ionosphere. In fact, either vertical or horizontal aerials can be used for short-wave broadcasting and both have certain advantages, although experience over a number of years has led the Corporation to prefer to use horizontal aerials for the short-wave services. In practice it seems easier to control the angle of radiation in the vertical plane, and a series of experiments which were carried out over several months resulted in stronger reception being obtained all over the world when the appropriate directional horizontal aerial was used in place of a vertical aerial, calculated to have the same performance. The problem of choosing the most efficient aerial for broadcasting on short waves (where the wavelength is sufficiently small to make it possible to use arrays of aerials several half-waves long and several half-waves high, and thus to achieve 'beam' transmission both in the horizontal and vertical planes) will be

explained later in this chapter, but it is convenient first to deal with the question of 'polar diagrams' of aerials.

POLAR DIAGRAMS OF AERIALS

The particular type of graph which we have called a 'polar diagram' is really nothing more than a graph which, instead of having axes which are formed by straight lines at right angles to each other, has concentric circles for one axis and radii for the other. To obtain a polar diagram to depict field strength around a transmitter, a field-strength measuring set is moved around the transmitter at a fixed radius and the strength of signal is measured. The results are then plotted on this 'circular graph', where signal strength is represented by length of radii in the various directions. If the signal were of equal strength all round, the resultant polar diagram would be a circle centred on the transmitter. Note that the measurements have to be made at short distances, usually of the order of a few miles or so, where attenuation due to poor earth conductivity is negligible. This 'polar diagram' should not be confused with a somewhat similar but essentially different type of diagram in which the results of a number of measurements of the field strength of a transmitter are plotted on a map, and in which lines are drawn to join up all the points of equal field strength. The result is a series of 'contours' very much like the contour lines on a map, giving in effect a 'radio-field contour map'. The shape of this contour map will depend not only on the 'polar diagram' of the transmitter in question but also on the conductivity of the soil over which the waves have travelled.

Polar diagrams can be drawn not only for the horizontal, but also for the vertical plane, and indeed for inclined planes; and it will be seen that to convey complete information about the radiation from an aerial into space, either a number of polar diagrams are needed—or else a solid polar diagram.

By way of illustration let us draw the horizontal polar diagram for a purely vertical aerial one-quarter of a wavelength high assuming a perfectly conducting earth and a power of 1 kilowatt radiated. Fig. 126 shows both this and the corresponding vertical polar diagram. While it is possible to take a field strength measurement up in a balloon and so to measure the radiation in the vertical plane, this is not frequently done in practice, and more general use is

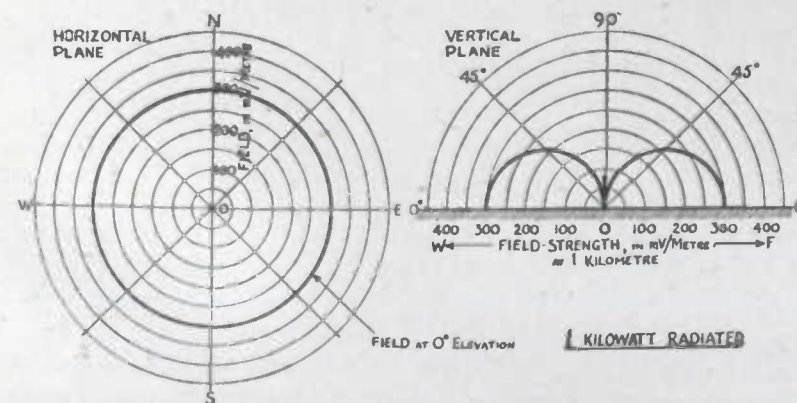
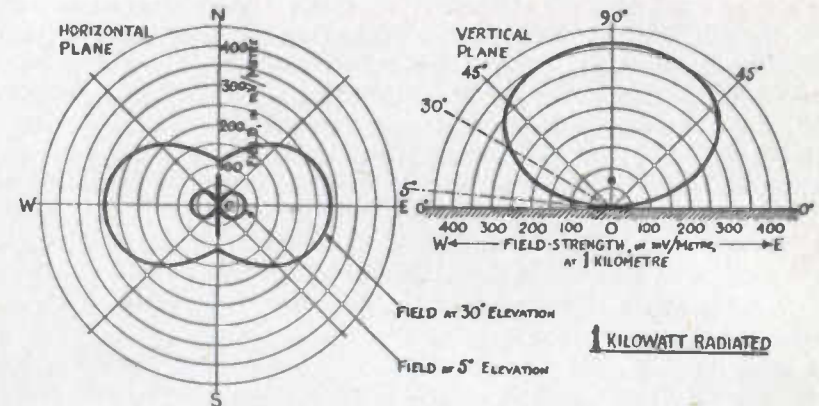

FIG. 126. POLAR DIAGRAM OF RADIATION AT 1 KILOMETRE FROM A QUARTER-WAVE VERTICAL AERIAL

made of theoretical vertical polar diagrams obtained by calculation, and drawn to some arbitrary scale.

The polar diagrams for half-wave horizontal aerials are a little more complicated, but we shall adopt the same technique as for the vertical aerial and plot polar diagrams in both vertical and horizontal planes for such an aerial a quarter-wave above the ground, and then half a wave above the ground (Figs. 127 (a) and (b)).



(a) HALF-WAVE HORIZONTAL AERIAL, QUARTER-WAVE ABOVE EARTH

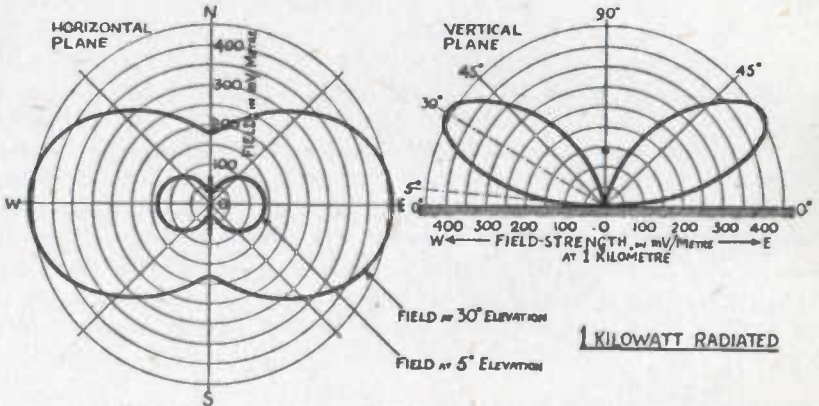

(b) HALF-WAVE HORIZONTAL AERIAL, HALF-WAVE ABOVE EARTH

FIG. 127. POLAR DIAGRAMS OF RADIATION FROM HORIZONTAL AERIALS

Note that the horizontal aerial has no radiation along the ground whether it is a quarter-wave or a half-wavelength above the ground, but that there is more radiation at the lower angles of elevation as the height of the aerial above the ground is increased because the relative phase of the radiation from the aerial and from its image ceases to produce cancellation of radiation at these lower angles. This information is disclosed more readily from the horizontal polar diagram than from the vertical one.

POWER DISTRIBUTION DIAGRAMS

The problem of representing in one plane, i.e. on a flat sheet of paper, a three-dimensional solid polar diagram, has been solved very neatly by the

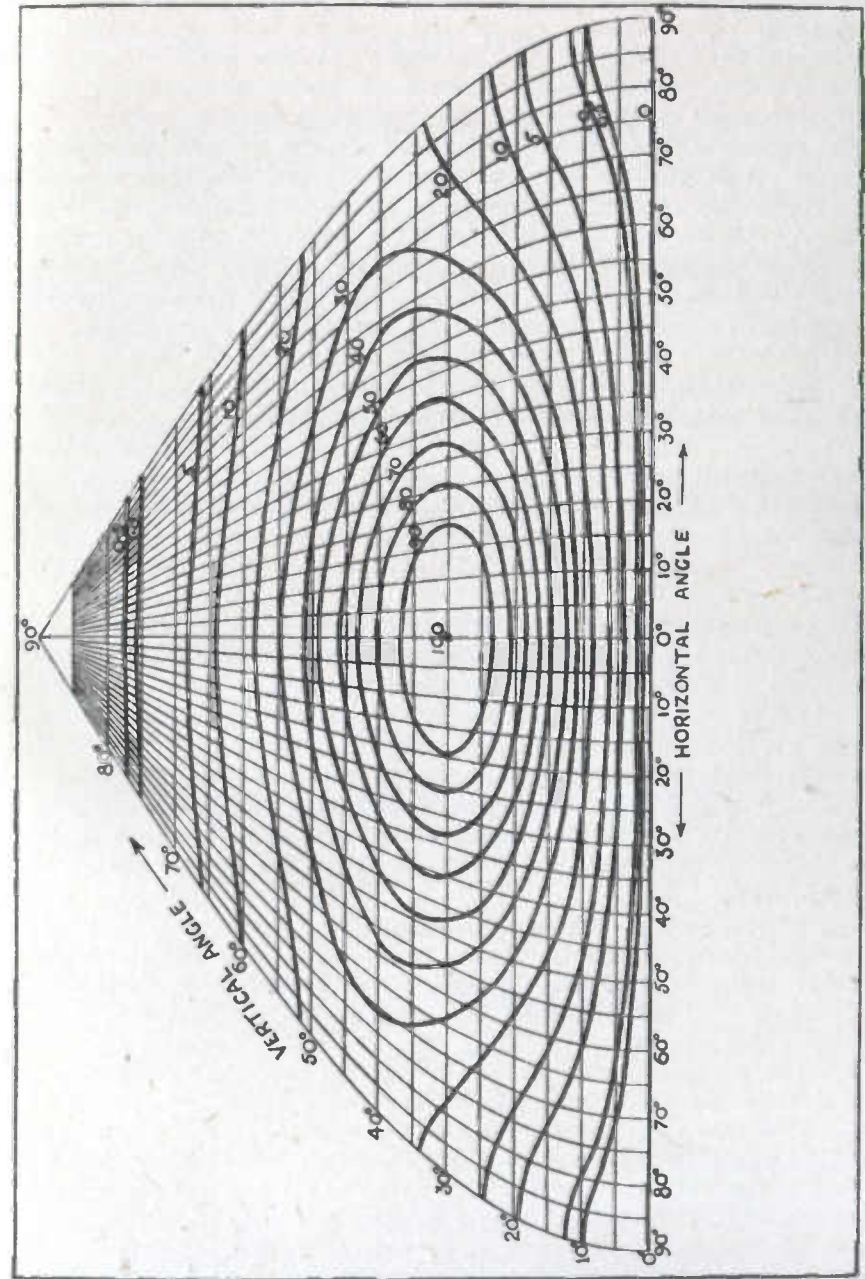

FIG. 128. POWER DISTRIBUTION DIAGRAM FOR HALF-WAVE HORIZONTAL AERIAL, SUSPENDED HALF-WAVE ABOVE GROUND

BBC Research Department in the 'power distribution diagram', which shows in one diagram the complete distribution of field over the inside of a hemisphere of which the transmitting aerial is the centre. The distribution is indicated by a series of contour lines, or lines of equal power, plotted on co-ordinates which represent the projection of the lines of latitude and longitude of the hemisphere on a plane paper. In other words, the field or power is shown in every direction as a percentage of the maximum. An illustration of this method is given in Fig. 128 which shows the power distribution diagram of one of the horizontal aeriels of which the more conventional diagrams are given in Fig. 127b (half-wave dipole, half-wave above ground).

In the diagram (Fig. 128) a horizontal angle of 0° gives the radiation at right angles to the wire, while a horizontal angle of 90° refers to radiation 'end-on' to the wire. In the vertical plane the angles of elevation are also marked. For this aerial the figure for maximum radiation—100 per cent.—corresponds to a field of 458 mV/m for a power of 1 kW at a distance of one kilometre in a direction given by the co-ordinates on the diagram—viz. at 0° horizontal angle (i.e. at right angles to the aerial wire) and at 30° vertical angle (i.e. at an elevation angle of 30° above the horizon).

SHORT-WAVE BROADCASTING

Earlier in this chapter it was stated that it was possible to achieve 'beam' transmission by using aerial arrays several half-waves long and several half-waves high. In practice we use a number of pieces of wire each approximately half a wavelength long, i.e. a number of 'dipoles', which are suspended either horizontally or vertically in rows and in tiers. The radiation from one dipole will then add to that of its neighbours in some directions, and subtract from them in other directions. Each dipole is connected to the transmitter by a 'feeder' line, which generally consists of two or more conductors so arranged as to ensure that the field from one wire exactly neutralizes that from the other and no radiation takes place from the feeder itself (another application of balanced lines). Concentric tube feeders consisting of a central conductor supported inside, but insulated from an outer tube which surrounds it, are also used. The outer conductor is earthed; this is therefore an unbalanced feeder system.

Let us now see in a little more detail how the addition and cancellation of radiation from neighbouring dipoles comes about. Fig. 129 shows how trains of waves leaving two such dipoles either add or subtract from each other in this way. The full diagram, if drawn, would be symmetrical, but might be confusing to follow.

By using a greater number of dipoles than this (for example, by placing four side by side) the beam can be made narrower in the horizontal plane and the radiation along the centre line more intense. It should be noted that with this type of short-wave aerial all the dipoles are fed 'in phase', and the array (as it is called) transmits at right angles to the line of dipoles. It is therefore called a 'broadside' array. Another type of aerial is possible in which the dipoles are connected to the feeder in such a way that the radiation cancels at right angles to the line of dipoles and adds up in line with them. This type of array will transmit 'end-on' to the array, and is called an 'end-on' array. The Corporation's short-wave aeriels are all 'broadside' arrays.

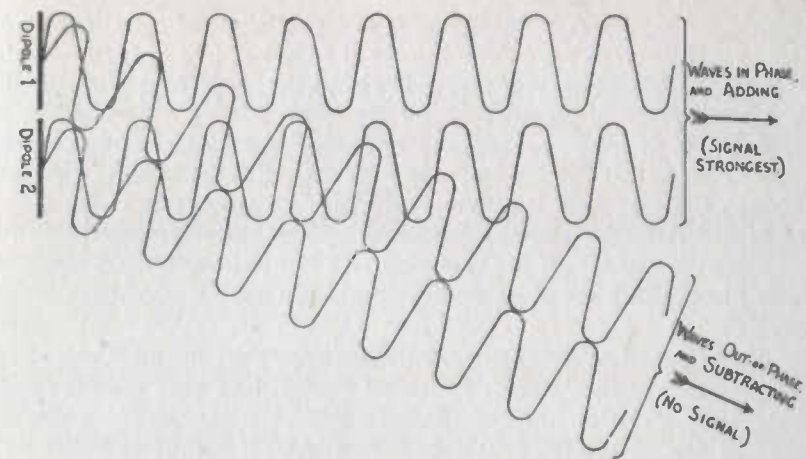

FIG. 129. HOW WAVES FROM TWO AERIALS COMBINE TO GIVE DIRECTIONAL PROPERTIES

The concentration of radiation in the horizontal plane obtained by using four dipoles side by side is such that the resulting 'beam' is approximately 36° wide. By this we mean that the radiation along the centre line at right angles to the line of dipoles is strongest, and weakens gradually to half this strength at about 18° on either side of the centre line. At greater angles than 18° the radiation decreases fairly rapidly, until at 30° on either side it is almost zero, after which it increases somewhat. By using still more dipoles side by side the beam width in the horizontal plane can be still further restricted, and for 'point-to-point' services where only one receiving station is concerned as many as sixteen dipoles are used side by side when the beam width will be about 8° only (4° on either side of the centre line) and the resulting strength along the centre line proportionately greater. Very approximately, we may say that to double the strength on the centre line requires four times the number of dipoles. For broadcasting on short waves—or as it may more accurately be called, 'narrowcasting'—a beam width of 36° is found to be a good compromise, and the Corporation's short-wave aeriels generally give 'beams' of this width.

So much for the concentration of energy in the horizontal plane. Clearly, by using a number of dipoles one above the other in the vertical plane, a concentration of energy can be achieved in this plane, but the beam width and its angle of elevation to the horizontal will be modified by the proximity of the ground, as we saw for the single horizontal dipole (Figs. 127 and 128). By raising or lowering an array we therefore have a method of controlling the elevation of the 'beam'. Although practical difficulties stand in the way of this being done at will after the array has been constructed, the desired (and fixed) elevation angle can be achieved by supporting the array at the appropriate height, and thus the best elevation angle to secure efficient reflection in the ionosphere can be selected according to the number of hops the waves will have to make between transmitter and receiver. The 'beam' is not made too narrow in the vertical plane, and, in practice, arrays which are used contain four rows of dipoles one above the other with half-wave spacing. The main 'lobe', or 'cone', of radiation is then sufficiently wide in the vertical plane to cover the angles of elevation required for different numbers of hops

and different distances (see Fig. 124). The higher angle of elevation should be high enough to cover the greater number of hops, e.g. four to India, and the lower angle low enough to cover the smaller number of hops, e.g. three to India, for which the practical elevation angles are approximately 15.5° and 9.5° respectively. It should be appreciated, however, that the edges of the 'beam' or 'cone' of radiation will not be in the least sharp like the edges of a search-light beam, but that there will be a gradual fall on either side of the centre of the beam. A further reason for not making the 'beam' too narrow in the vertical plane is that we are not conducting a point-to-point service, and have to cover places which are at widely-separated distances from the transmitting station.

The type of array for short-wave transmission used by the Corporation is thus seen to consist of sixteen horizontal dipoles, four wide and four high, with the bottom row of dipoles a distance above the ground which may be as much as one wavelength, but is sometimes less. It will be seen that such an array, which is two wavelengths wide and of which the top row of dipoles may be two and a half wavelengths above earth, can be achieved by the use of masts of reasonable height even for a wavelength of 50 metres, where 500 ft. masts would be required. In practice 325 ft. masts are generally used and the height of the bottom dipole above the ground is reduced for wavelengths above 31 metres.

Fig. 130 shows how the sixteen dipoles are arranged, as well as the method of 'feeding' the power to them so that each radiates in the correct phase. The feeders themselves do not radiate any power.

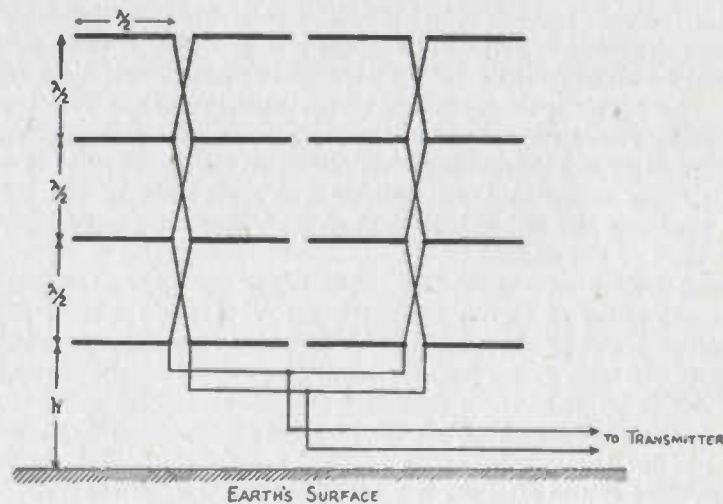

FIG. 130. BASIC DIAGRAM OF A 16 DIPOLE AERIAL ARRAY, SHOWING FEEDER CONNECTIONS

Such an aerial is bi-directional, and radiation takes place in both directions simultaneously. This is often not desirable for several reasons. First, it is a waste of power; for example, there is not a lot of point in having half the power which would be useful to listeners in Africa wasted over the North Pole. The backward radiation could be more usefully employed if we had a means of reversing it so as to radiate all the available power in one direction

only. This can indeed be done by using a reflector in the way described later on in this chapter; but before doing this let us note a second reason why the backward radiation is undesirable. At certain times of day and at certain seasons it is found that ionosphere conditions are suitable for the propagation of a given wavelength right round the world in one or more directions. If one of these directions coincides with the direction of transmission of that wavelength in our short-wave broadcasting service, then the waves sent out in two opposite directions from our broadcasting station will arrive at a receiver over two paths.

To give a practical example, let us consider transmission to India which is about 5,000 miles east of Britain. The waves sent out on 17 metres about 14.00 GMT at equinoctial periods would arrive in India from the west, having travelled 5,000 miles, and could arrive there also from the east having travelled 19,000 miles. If they were of comparable strength, as they might be under certain rather freak conditions, the second signal (which would arrive later than the first) could constitute an 'echo' which could make speech unintelligible. The delay of the echo would be the time taken for the waves to travel $19,000 - 5,000 = 14,000$ miles, at 186,000 miles per second, or about $1/13$ of a second. It is called 'backward' echo, and could, of course, be overcome by sending out the radiation in one direction only. Two methods can be used to cut out this backward radiation—one, the less efficient, is to absorb it; the other, the more efficient, to make it add to the forward radiation by the use of a reflector.

It is well to realize that a reflector cannot do more than reflect all the energy sent out backwards and thus cannot do more than double the effective power in the forward direction. In practice this doubling of power is not generally fully achieved, but the reflector may well be 90 per cent. efficient.

The reflector consists usually of a curtain of dipoles exactly similar to the radiating curtain and placed a quarter of a wavelength behind it. Even if this second curtain of dipoles is not 'fed' with power, it will radiate by virtue of the current induced into it. Due to the quarter-wave spacing, the 'phase' of the re-radiation with respect to the original radiation is such that the two radiations add together in the forward direction but cancel in the backward direction. Fig. 131, showing a single train of waves from a single dipole with the appropriate phase of reflected waves, should make this clearer.

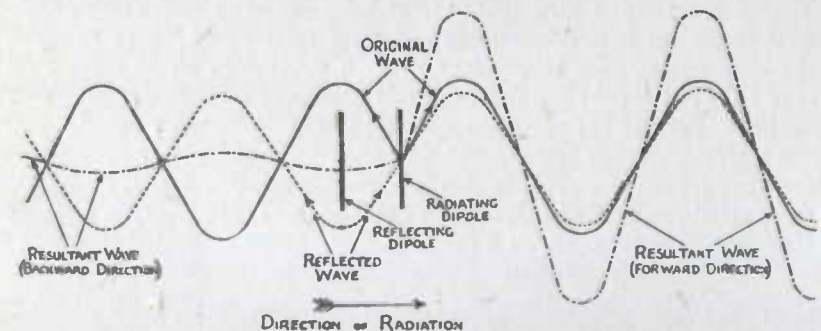

FIG. 131. THE MECHANISM OF AN AERIAL REFLECTOR

The reflector can also be fed with power from the transmitter, so long as the phase is correctly adjusted. The aerial array can also be made reversible

by feeding one 'curtain' or the other by suitable switching. In this way, an aerial array pointing east, say, in the morning can be used to direct a transmission to the west in the evening, and a considerable saving in aerials can therefore be effected. It must not be forgotten that, with the resonant dipole type of aerial used, a different aerial array has to be provided for each short-wave band and for each direction in which it is desired to transmit. Some alleviation is given because it is possible to 'slew' the angle of radiation round up to about 12° from the normal, which we have already said is at right angles to the line of the dipoles. It will be remembered that the effect of feeding two dipoles side by side was to concentrate the radiation in a 'beam' by virtue of addition along the centre line and subtraction at the two edges. This assumes that the two dipoles are fed in exactly the same phase. Were we to feed them so that one dipole received its energy a little later than the other, then the above condition would not be true and the line of maximum strength would be turned away slightly (see Fig. 132).

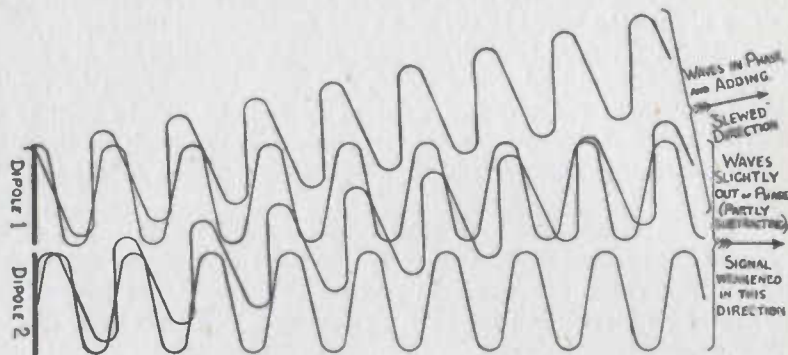

FIG. 132. THE 'SLEWING' EFFECT BROUGHT ABOUT BY FEEDING DIPOLES OUT-OF-PHASE

There are limits to the amount of 'slewing' that can be done in this way, and 12° on either side of the normal centre line is about the desirable maximum with an array fed at two points. It is effected by feeding one set of dipoles a quarter of a wavelength out of phase with the other, as shown above. In this way, an aerial array with a reversible reflector can be made to radiate in one of six possible directions, a useful feature in a world-wide service. Even with its aid it is necessary to use some forty aerial arrays to cover a world-wide service over twenty-four hours a day. Not all of these aerials have to be in use at the same time, and it is uneconomical to have a high power transmitter 'tied' to each one and standing idle much of the time. A smaller number of transmitters is used and switching arrangements are provided to connect any transmitter to any aerial. The photograph (Plate XII) shows a bay of three aerials, one for 17 m. one for 14 m. and one for 19 m., each containing sixteen dipoles and fitted with a reflector. The masts are 325 ft. and 250 ft. high.

A METHOD OF DESIGNATING AERIALS

It is convenient to have a code by which the type of aerial can easily be designated and the one used in the Corporation is as follows:—

The first letter H or V stands for 'Horizontal' or 'Vertical'.

The second letter R stands for 'Reflector'.

The third letter R stands for 'Reversible'.

The fourth letter S stands for 'Slewed'.

The first figure gives the number of dipoles side by side.

The second figure gives the number of dipoles one above the other.

The third figure gives the height in wavelengths above ground of the bottom dipole.

The fourth figure gives the waveband in metres.

The fifth and successive figures gives the azimuthal bearing(s) of the centre of the main lobe of radiation in degrees east of true north.

Letters which do not apply are left out.

Thus HRRS 4/4/0.5/49.6/114°, 126°, 294°, 306° indicates a horizontal array, having a reversible reflector, and capable of being slewed. There are 4 tiers of dipoles side by side and 4 rows of dipoles one above the other with the bottom row 0.5 wavelength above the ground. The aerial is cut for 49.6 metres and, with reversible reflector and slew, can transmit on each of the bearings 114°, 126°, 294°, 306° east of true north.

HR4/2/0.6/16.8/80° indicates a horizontal array, having a reflector. There are 4 tiers of dipoles side by side, and 2 rows of dipoles one above the other, with the bottom row 0.6 wavelength above the ground. The aerial is cut for 16.8 metres and can transmit only on a bearing of 80° east of true north.

QUESTIONS ON CHAPTER IX

- (1) (a) What is meant by a half-wave and a quarter-wave vertical aerial?
(b) Draw a half-wave vertical aerial for a 250-metre station and show the current distribution in this aerial.
(c) Draw a quarter-wave vertical aerial for a 500-metre station and show the current distribution in this aerial.
- (2) What is meant by 'polarization' of a wave? What polarization is normally used for medium wave broadcasting and why?
- (3) What is meant by a 'polar diagram' of a transmitting station or aerial? How does this differ from a 'radio field contour map'? 10 kW is radiated from a half-wave horizontal aerial suspended half a wavelength above ground. From Fig. 128 give the anticipated field (a) along the ground at right angles to the plane of the aerial and at 45° to it, (b) at a vertical angle of 30° , at horizontal angles of 20° , 40° , and 90° , and (c) What would be the field at a vertical angle of 90° ? In all cases work out the answers for a distance of 100 km.
- (4) Show with your own diagram how waves from two aerials combine to give directional properties.
- (5) Make dimensional diagrams of the following arrays:—H2/3/1.0/31 and HR4/4/0.5/49.5.
- (6) Explain with your own diagram the working of a reflector, stressing particularly why the reflected wave is in phase in the required direction of propagation.
- (7) Explain the principle of 'slewing'.

CHAPTER X

SOUND RECORDING APPLIED TO BROADCASTING

MENTION has already been made of the part which recorded material may be required to play in broadcast programmes. By 'recorded programmes' we do not mean simply the playing of commercial records on the gramophone desks in the studios, but the actual recording and subsequent reproduction of a programme which may, or may not, have been broadcast at the time of recording.

GENERAL REQUIREMENTS OF A RECORDING SYSTEM

First of all, why do we need to record a programme? There are many reasons, and because they have a bearing on the systems finally adopted it is as well to enumerate them here.

In the early days of Empire Broadcasting, where the service was divided up into five transmissions, quite a lot of the entertainment material that was suitable for one country could be usefully employed later in the day for another. If, too, the first performance came at an awkward time of day or night for the artists to attend, then they could record the show on 'closed circuit' and some, or even all, transmissions would be reproductions.

Next, there are certain types of programme which occur at times of the day which are unsuitable for immediate inclusion in the programme; for example, an important speech by President Roosevelt which occurs during the early hours of the morning (Greenwich Time), or a sporting event which would have a very small audience if transmitted 'live' in the afternoon, but would interest many listeners in the evening. This brings us to another feature which recordings can provide. The live material may be too long to include in its entirety, but by recording it is possible to broadcast extracts of the 'highlights' in subsequent reproductions.

A fourth reason for recording is to preserve the voices of well-known people or other programme material for archive purposes.

Of the above reasons, all, except the last, demand immediate play-back. The two well-known systems already at a high state of perfection (the ordinary 'gramophone record', and the 'talking-film') were unsuitable, because both of them take many hours to complete their manufacturing processes. So the BBC has had to explore other systems to meet this requirement, in addition to which a system which reproduces the original material as faithfully as possible was required.

In this connection it is well to note that distortion in recording systems may be divided into two classes, viz. inherent distortion of the system in use, and deliberate distortion introduced for some special reason. Both will need correction, of course, and this correction will take the form of appropriate compensation in the reproducing system. When considering any system of recording, we must always remember that the final test can only be made

when the whole chain of events has been completed, i.e. when reproduction has also taken place. So that, with regard to correction of distortion, it is as effective to record to a (known) distorting characteristic and reproduce by a correcting characteristic, as it is to use a machine which records faithfully, and then to use a reproducing system which has a 'linear' response. In both cases it is the overall response which has been taken into account. This will be very evident when we come to disc recording.

There are three systems at present in use, viz. (1) disc, (2) steel tape, and (3) film recording, each of which has its special advantages and limitations, but all have the facility of immediate play-back or reproduction. We will discuss them in the order in which the BBC became interested in them.

THE MARCONI-STILLE STEEL TAPE SYSTEM—HISTORICAL

The steel-tape system is an entirely magnetic one, and in its simplest form dates back to the beginning of this century when 'wireless' was in its infancy. The first man to discover that a magnetic impression could be made on a moving length of wire was one of radio's earliest pioneers, Professor Poulsen. He found it possible to magnetize a spool of steel wire to different degrees along its length, so that these magnetic variations would remain on the wire even after it had been 'rolled up'. Subsequently, it could be passed through a machine which would turn the magnetic record into an electrical one, and thus into sound. In Poulsen's time, this system was used to record only the Morse code, so that the magnetic impression need be of the simplest type, i.e. 'magnetized' or 'not-magnetized'.

It was not until 1924 that the principle was again brought into the limelight, this time in Germany. The Vox Gramophone Company produced a dictating machine for office use, in which a steel wire was used. This instrument, working on the principles outlined by Poulsen, was developed by a Dr. Stille. The BBC's attention was drawn to its possibilities and two engineers went to Berlin in March 1925 to hear a demonstration. As a result, an attempt was made to buy a machine, but in the end nothing came of it and it was not until several years later, in 1931, that the late Mr. Louis Blattner brought a machine to England. This machine, called the 'Blattnerphone', was the outcome of Dr. Stille's further researches; and in it the round wire of Poulsen had been superseded by a flat steel tape, 6 m.m. wide and the whole machine could record for about 20 minutes.

The BBC was still interested in the idea and obtained a machine for test purposes. One of the advantages of the system was that, after the required number of reproductions had been made, the magnetic impression could be 'wiped off' and the tape used again for another recording.

The first machine—the original Blattnerphone—was not very satisfactory, either as regards quality of reproduction or reliability, although tantalizingly good quality was sometimes obtained. The main trouble was the heavy hiss which formed a background to the programme, and this was found to be largely due to the inherent noise of the steel tape itself. Great efforts were made to improve the system, and ultimately Stille Inventions, Ltd., joined forces with Marconi's Wireless Telegraph Co., Ltd., to produce, with the close co-operation of the BBC Research Department, the Marconi-Stille machine which has been in general use since 1934 (Plate XIII). A large measure of its

success is due to the collateral improvement in the manufacture of the tape itself.

The general principle of recording and reproducing is fairly simple, although it must be admitted that some of the finer points of the actual theory are not completely understood. The tape, which is wound on a spool, is 3 mm. wide and 0.08 mm. thick. In order to secure the reproduction of the higher audio frequencies it is necessary to run the tape at a rate of 90 metres per min. past the recording and reproducing 'heads'. This means that the length of tape for a half-hour's programme is about $1\frac{1}{2}$ miles and the machine is arranged to contain this length of tape on one spool.

PRINCIPLES OF MAGNETIC RECORDING

There are five 'heads' on the machine, and their function is as follows. The first one is the 'wiping' head; then come two 'recording' heads (one as a spare to the other); and finally, two 'reproducing' heads (one spare). All the heads look alike, and each consists of two small 'boxes' which are hinged along one edge, and can close together just like a book that has been opened at the centre (see Fig. 133).

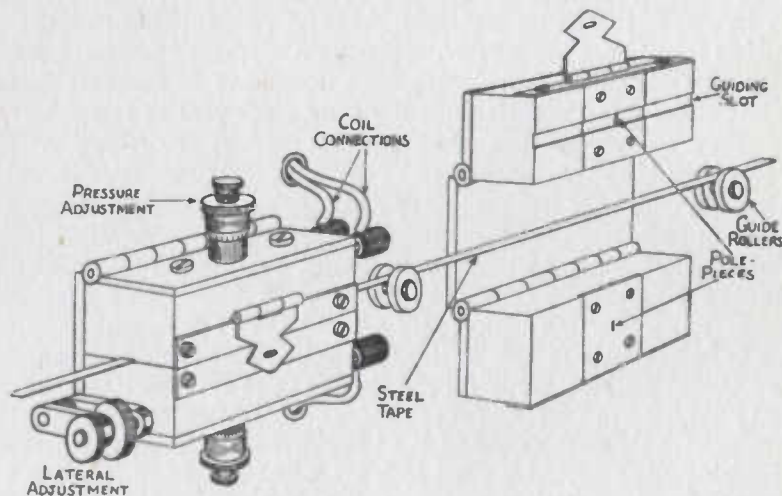

FIG. 133. VIEWS OF RECORDING HEADS IN CLOSED AND OPEN POSITIONS

When closed, a small guiding slot is left for the tape to pass through, so that it passes between the ends of two 'pole pieces' which are held in slots in the heads so that they touch the tape at right angles. Pole pieces are simply small slips of special iron, of the same width as the tape (3 mm.) but thicker (0.4 mm.) and the end which presses on the tape is ground down to a chisel edge, and reduced in width to 1.8 mm., except the 'wiper', which is left flat and of full width. The pressure that they exert on the tape can be adjusted by a screw and spring arrangement. Inside the head, and around the pole piece, is a small coil of wire. Thus, the pole piece can be turned into an 'electromagnet', if so desired, by simply passing a current through the coil.

Fig. 134 is a diagram showing the three types of head, and the arrangement of the coils and pole pieces. The wiping head has a direct current passed through its coils and this causes the pole pieces to become strongly magnetized with a

N. pole on one side, and a S. pole on the other side of the tape. This brings the tape to 'saturation' point, which means that however much more we try to magnetize the tape it will not become any more strongly magnetized. The effect of this is to obliterate any recording previously made on the tape. The

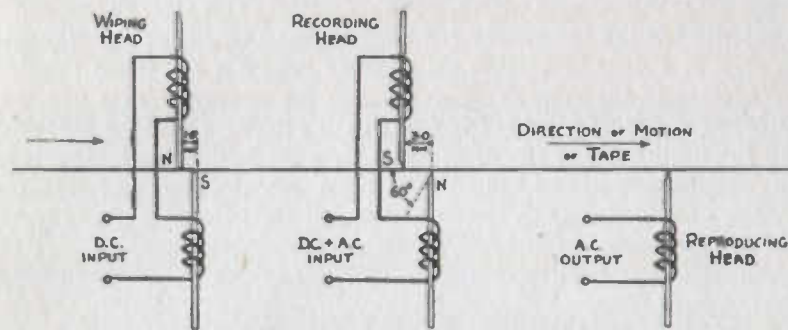

FIG. 134. DIAGRAM OF COIL AND POLE-PIECE ARRANGEMENTS FOR DIFFERENT HEADS

tape then passes through the recording head. This is a little more difficult to understand because the coils carry two currents at the same time. One is a direct current similar to the wiping current, but of less value and in the opposite direction; it has the effect of reducing the degree of magnetization of the tape to about half-saturation value. Superimposed on this direct current is the alternating current of the programme which we wish to record. This can be regarded as the reverse action to that produced by a carbon type microphone. There we had a 'pulsating direct current' which we decided was really composed of two components, one A.C. and the other D.C., and these components were separated by a transformer. In the present example, we have an alternating current and convert it to a 'pulsating direct current' by adding the D.C. The effect of this is to leave a magnetic impression on the tape, so that each little element that emerges from the recording head is magnetized to a certain degree.

It will be noticed from Fig. 134 that the pole pieces for wiping and recording are not placed exactly opposite each other, but are staggered so as to produce a longitudinal gap between them. The best results are found when the wiping pole pieces are staggered by approximately 1.5 mm. and the recording ones by 3.0 mm., and provision for this adjustment is made by the 'lateral adjusting screw' seen at the side of one of the heads in Fig. 133. (In practice, all heads have this adjustment, but it has been left off the second one for simplicity.)

The tape looks the same whether it has been recorded upon or not, and there is no way of telling whether it has been used without actually 'playing' it. This is the very next operation, and is done on the reproducing head. The same sort of double head is used but there is a pole piece on one side only. When the tape passes through it, the different degrees of magnetization of successive elements induce varying strengths of magnetism into the iron pole piece and so cause a varying magnetic field in the coil which surrounds it. As you know, a coil of wire placed in a varying magnetic field will have an alternating current induced into it. These tiny alternating currents are then amplified by valve amplifiers and thus the programme recorded on the tape is reproduced.

One of the interesting points about the system is that we can listen to the recording a fraction of a second after it has been made; in fact, just as long as it takes for the tape to get from the recording head to the reproducing head. It is the general practice to listen by means of a monitor loudspeaker connected to the reproducing output, when recording. This gives an immediate indication whether the programme has been recorded satisfactorily. If a snag occurs, such as a drop in quality, the engineer presses a key which transfers the loudspeaker to the programme as fed into the machine. This will then show whether the recording head is receiving it properly; and the difference between the quality before recording and after reproduction can be estimated by ear. Appropriate action can then be taken, e.g. the recording head can be changed over to the spare, if one or other of the pole pieces has become worn or damaged.

SPEED CONTROL AND OTHER MECHANICAL FEATURES

So much for the principle of recording. We have assumed that the tape has been running through the various heads at constant speed and this is no easy matter to accomplish. If the speed varies it gives rise to a peculiar 'wailing' quality known as 'wow'. The effect can easily be produced on an ordinary gramophone by lightly touching the turn-table while it is running, so as temporarily to reduce the speed. Constant speed of the tape through the heads will not be achieved by rotating the tape spool at a constant number of revolutions per minute. Since the spool changes its effective diameter as each turn of tape is taken off, it would unwind more tape in a given time when the spool was full than when it was nearly empty, and thus the linear speed of the tape through the heads would change throughout the recording.

Instead of attempting an arrangement of constantly varying gears, a system employing three separate motors has been adopted. One is the constant-speed

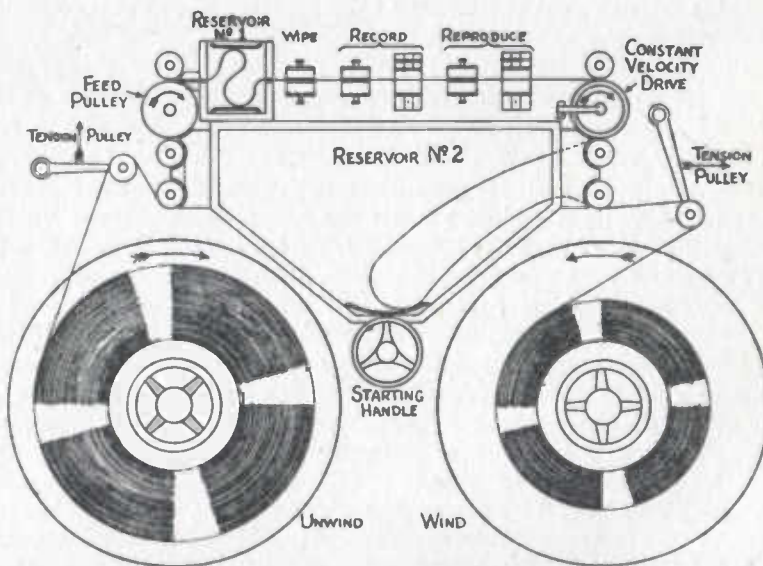

FIG. 135. SCHEMATIC DIAGRAM OF TAPE MACHINE

motor and is used to drive (or rather pull) the tape past the heads at constant speed. The second is to drive the feed pulley which pulls the tape off the discharging spool, and the third is to wind up the tape on the empty receiving spool. Obviously the last two must have speeds which vary throughout the recording. The method of accomplishing this speed control is rather unusual and will be briefly described here.

Fig. 135 shows a general view of the machine from the front. The full spool of tape is placed on the left-hand side of the machine and the motor which pulls it off is always arranged to run a little fast, i.e. it unwinds slightly more tape than the constant speed requires. Next comes the constant-speed motor—placed at the right-hand end of the heads—and this drags the tape through these heads at the required speed. On the left-hand end of the heads is a 'reservoir' (No. 1) which will naturally soon get a loop of tape in it, since we are pushing tape in quicker than we are taking it out. When this loop gets big enough it will touch the edge of the reservoir; along its edges are 'contact' strips, insulated from the rest of the framework, on which the tape will make electrical contact. Because the tape is kept at earth potential this connection can be made to be of use in operating a relay in the usual manner. (Actually, the relay is in the form of a type of valve called a Thyatron, and the relay proper is in the anode circuit of it. The reason for doing it this way is to prevent high operating currents having to pass through any portion of the tape, which would possibly cause 'clicks'.) The relay is made to control the speed of the motor, slowing it down slightly until such time as the loop in the reservoir is reduced. As soon as the tape is pulled clear of the contact, the motor returns to normal (fast) speed, and the whole process starts over again.

A very similar arrangement happens between the constant-speed drive and the winding spool. In this case motor No. 3, rotating the receiving spool, runs slightly slow with the result that the tape is not wound up fast enough and a loop of tape builds up in Reservoir No. 2. A contact at the bottom of this reservoir operates a relay through a Thyatron valve as before, and speeds up the motor, thus increasing the rate of winding till the loop of tape is reduced in size sufficiently to break the contact. The process is then repeated.

The two auxiliary motors are thus kept alternating between their two speeds of 'too fast' and 'too slow', and a loop is maintained on either side of the constant-speed drive. This latter feature is an important one, for it means that the constant-speed motor is relieved of any strain due to drag of the tape that would lead to speed variation. Also, the tape is not subjected to any great strain, another important factor.

When the recording has been completed the tape must, of necessity, be rewound on to the original spool; otherwise it will be 'back-to-front'. As it has taken 30 mins. to record it would mean waiting the same length of time if it were done through the same sequence of speed controls. Special re-winding arrangements are therefore made whereby the machine can be run backwards at approximately double the speed, the left-hand (empty) spool now taking up the winding function and only one reservoir (No. 2) being utilized.

It may be mentioned that the tape is occasionally broken by accident and this is rather a drawback. However, it can be joined by either soldering or welding and, in fact, is in three lengths to start with. When about 12 joints have been made in one spool, it becomes a little risky to play because of the

damage to pole pieces caused by the lapped joint passing under, and so the spool has to be scrapped. Otherwise, the system is entirely reliable and has quite a low running cost. This latter feature is brought about by the fact that, although the original spools are expensive to manufacture, they can be used over and over again.

It is not necessary to wipe off the previous recording first and then rewind before recording. The process of 'saturation' which has been described will wipe off any existing programme a fraction of a second before recording takes place. Obviously, great care must be taken not to leave the wiping current on during the rewinding process !

The quality of reproduction from steel tape is reasonably good. It will, with its associated amplifiers, reproduce faithfully up to nearly 7,000 cycles, its main drawback being a rather noisy (hiss) background. For this reason, it is not an ideal system for the recording of the highest quality musical broadcasts where a large dynamic range is involved. The tapes are not suitable for storage (archive) purposes, partly because of their bulk and partly because of their high initial cost.

To summarize, steel-tape recording is still ideal where a few repeats have to be made of a programme, and where a permanent record is not required. This was one of the main reasons for its adoption. It is cheap, reliable, and has reasonably good quality, except for special orchestral broadcasts. Its failings are amply covered by other systems, and we shall now go on to discuss them.

DISC RECORDING : HISTORICAL

The second type of recording to be used by the BBC employed no drastically new principles. Disc recording does not differ essentially from the ordinary commercial gramophone record as far as principle of operation is concerned, and this dates back to the days of Edison. Perhaps it will help to know a little about the history of the gramophone, and then to see how the BBC has adapted it to meet its own peculiar needs.

Edison, in 1877/8, found a means of 'storing' sound by converting the pressure waves into mechanical motion, and using this motion to cut a varying track in a soft substance. Actually, he used a cylinder of wax and the track was in the form of a fine helical groove around it. The 'modulation' consisted of variations in the depth of the groove. Reproduction was effected by allowing a needle to retrace the path along the groove and in so doing it moved up and down on the 'hills and dales' and this mechanical motion caused a diaphragm to vibrate and so to recreate the sound waves.

The next step was the change-over from the cylinder of the 'phonograph' to the disc of the gramophone as we know it to-day. This was the invention of a man called Berliner (1894) and there was more in it than just a change of shape. Whereas Edison's record was a 'hill-and-dale' cut, the new discs had a groove of *constant depth* but which was 'wavy' in the plane of the disc. It is known as a 'lateral-cut' record, and is the same as is used to-day. There are advantages and disadvantages to both systems. However, it need not be thought that cylinder recording must be done on the hill-and-dale system or that discs are confined to lateral-cut; either type of cut can be made on cylinders or on discs; and in fact 'hill-and-dale' cut discs exist, although they are not so common as lateral cut discs. To effect a general

change-over to hill-and-dale recording on discs would, however, mean making obsolete millions of records and reproducing machines.

The design, both of recording and reproducing equipment, was considerably improved between the date of Berliner's gramophone and the later introduction of the thermionic valve, which made a revolutionary change in recording methods, especially under the developments of two American engineers, Maxwell and Harrison (Bell Telephone Laboratories). Before this time, there was one outstanding drawback to the 'acoustic' system of recording, as it is called, and that was that the energy available for moving the cutter was obtained from the air pressure created by the actual performer. There was no 'amplifier', but merely a horn to 'collect' the sound and a diaphragm to convert the pressure variations into mechanical vibrations. Acoustic methods of recording are now obsolete, but acoustic methods of reproduction are still in use and many mechanical gramophones still exist.

The record, or disc, has not altered a lot in its method of manufacture. It was always the practice to cut the wavy groove on a disc of soft wax, for the very simple reason that the small amount of energy available was insufficient to cut anything harder. Even when electrical means became available for amplifying the energy, it remained the practice to record on wax because the wax remained a very suitable material as a 'master' from which 'copies' could be made.

The method of producing the copies is known as 'processing', and it is done by electro-plating on to the master wax a thick coating of copper. When the plating is finished the copper shell known as the 'master shell' is peeled off the wax. It is of course a reverse copy of the original recording i.e. it has ridges instead of grooves. It is from this master shell that pressings can be made. The material used for making the pressings is plastic when warm but becomes hard when cool. The records are therefore pressed under heat and allowed to cool before removing them from the press. Double-sided records are made by using two copper shells one on either side of the press, the warm plastic material being placed between the two shells.

THE DISC

You will notice that the processing takes a considerable time; it takes at least 12 hours to make even one copy. Obviously, therefore, this system would be no good where the facility of immediate playback was wanted. Surely some material other than wax could be devised which was hard enough to play? After all, means were now available to supply a reasonable amount of energy to the cutting stylus, and the problem was therefore to find some medium which was soft enough to be cut, and yet hard enough to withstand at least some reproduction. In actual fact, several experiments were being made (round about 1930) largely in connection with home-recording outfits, but it was not until 1933/4 that the BBC decided to try out this type of recording.

The medium which proved to be soft enough to cut, and hard enough to play, was a coating of a lacquer sprayed on to a base of some stiff material such as aluminium, zinc, or even glass. It must be clearly understood that the base is purely for holding the lacquer, and is not itself cut into, even though the lacquer coating is only seven-thousandths of an inch thick.

The substance was chosen after many experiments had been made with other materials, such as celluloid, soft metals, etc., which all suffered from the grave

disadvantage of heavy surface noise. The special lacquer was prepared by the manufacturers to have the required consistency. It has to remain in that state for very long periods, and this is accomplished by the addition of lubricants to the mixture to prevent it drying out. Also, great care is taken to ensure that no blemishes in the form of bubbles or any foreign bodies (dust particles, etc.) are present.

The first machines used by the BBC were the product of M.S.S. Co., and since the principles of these machines are the same as in all others we will run over the elements of their operation. The essential parts of any disc-recording machine are these: a motor to drive the turn-table at a constant speed, a blank 'disc' on which the recording is to be cut, a 'cutter head' with its chisel-like cutter to convert the programme currents into mechanical vibrations, and a 'tracking' mechanism to move the cutter head across the record and so produce the familiar spiral groove. Plate XIV shows a view of two of these machines.

MECHANICAL ARRANGEMENTS OF THE DISC MACHINE

Taking these in order, it is essential that the turn-table should have constant speed. Only the very best design of electric motor is suitable and the turn-table is made very heavy to give it a steadying effect. Any variations in speed lead to 'wow' which, as explained under 'Tape Recording', is the result of such variations. The actual speed of the record is made to be 78 revolutions per minute, this being the standard adopted in ordinary commercial records and it is very desirable that BBC discs and commercial gramophone records should be able to be played on the same reproducing machines. (Later, we shall see that there is another standard, viz. $33\frac{1}{3}$ r.p.m., which the BBC has also adopted, but as there are no essential differences in working principles we shall continue our review of the 78 r.p.m. system.) The method of checking the speed is worth while examining. It is worked on the 'stroboscope' principle which, stated briefly, is that if a rotating object which has a uniform pattern is viewed intermittently, it will appear to rotate at a speed dependent on the relation between the frequency of rotation, the frequency of viewing, and the repetitive nature of the pattern. This, of course, is the reason why the wheels of a car on the cinema film sometimes appear to be slipping backwards. Let us look at a simple example. Suppose we view a wheel with 4 spokes, 'A.B.C.D.' as in Fig. 136 (a).

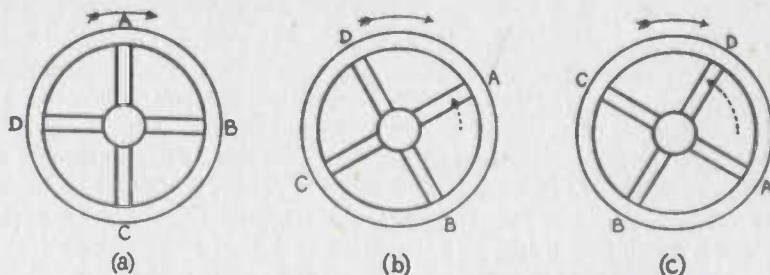

FIG. 136. DIAGRAM TO ILLUSTRATE THE STROBOSCOPE

Imagine that it is rotating in a clockwise direction at a speed of 1 revolution per second. If we view it for a short period of time every $\frac{1}{4}$ sec. then, after the first $\frac{1}{4}$ sec., spoke 'A' will be in the position previously occupied by 'B';

'B' will be at 'C'; 'C' at 'D'; and 'D' will be where 'A' was. In fact, because all the spokes look exactly alike, we shall not realize that the wheel is moving at all.

Now let us view it at a different rate, say at every $\frac{1}{8}$ th sec. Fig. 136 (b) shows where spoke 'A' will be after the first $\frac{1}{8}$ th sec., and this is nearly to the place where 'B' has just left. Our eyes are inclined to deceive us and think that it is much more likely that it is spoke 'B' which has moved the shorter distance back, than it is for 'A' to have moved the greater distance forward. The third figure, (c), shows how spoke 'D' is mistaken for 'A', and so it goes on. The converse is also true: that if the rate of viewing is slower than the time taken for one spoke to 'replace' another, the eye is led into believing that the wheel is creeping slowly forward. It is only when the two rates bear an exact relation to each other (in terms of multiples) that the object appears to be still.

The method of utilizing this phenomenon in turn-table speed measurement is to take advantage of the constant frequency electric light supply of 50 cycles. This provides the 'intermittent viewing', because even filaments of lamps heat up and cool down sufficiently (every $\frac{1}{100}$ th sec., since both positive

and negative cycles are equally responsible for heating) to give a 'flicker' effect. The 'spokes' of the turn-table now have to be arranged. This has to be done mathematically because this time we know the speeds of turn-table and viewing, and the number of spokes has to be calculated from those figures. Actually, we paint the spokes on the periphery of the turn-table in the form of alternate black and white stripes. We have to work out the number of stripes from the consideration that each must move into the position

occupied by the adjacent one in $\frac{1}{100}$ th of a second. Now in $\frac{1}{100}$ th of a

second a turn-table rotates 4.68 degrees, this being therefore the required angular spacing between successive 'spokes'. It follows that there will be $360 \div 4.68$ spokes around the circumference of the turn-table. This gives a quotient of $76.923 \dots$ and as we must obviously have an exact number of spokes we choose the nearest whole number, namely 77. This in turn leads to a spacing between successive spokes of $4.675 \dots$ degrees and thus to a speed of rotation which is not quite 78 r.p.m. The error, however, is only about 0.1 per cent. which is not serious. To make the viewing more definite, a neon lamp is used, because—unlike a heated filament—this type of lamp actually goes right out at each 'zero' point in the alternating cycle. Sometimes, instead of painted stripes, the turn-table has small holes drilled around the edge and the neon light is placed behind them. In addition to running at the chosen constant speed the turn-table must run exactly true and should be mounted so as to be exactly horizontal.

THE CUTTER HEAD

The cutter head is, naturally, a most important part of the machine. It consists, almost invariably, of some form of electromagnetic device for converting the speech currents into a lateral movement of the cutting stylus. Only one type will be described, as the principle in all is roughly the same.

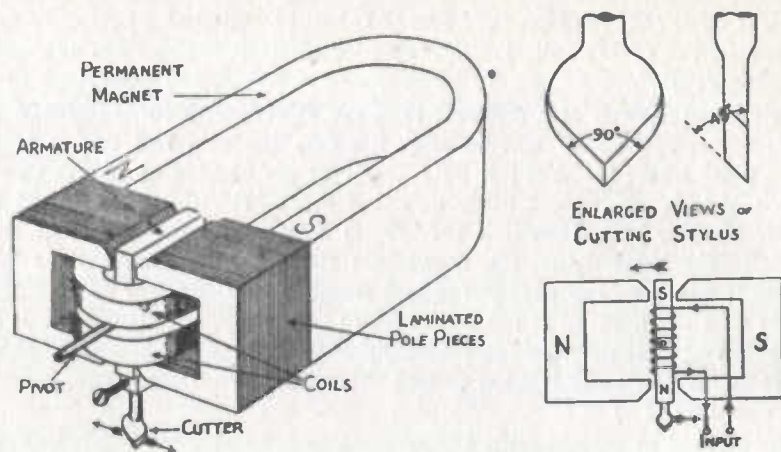
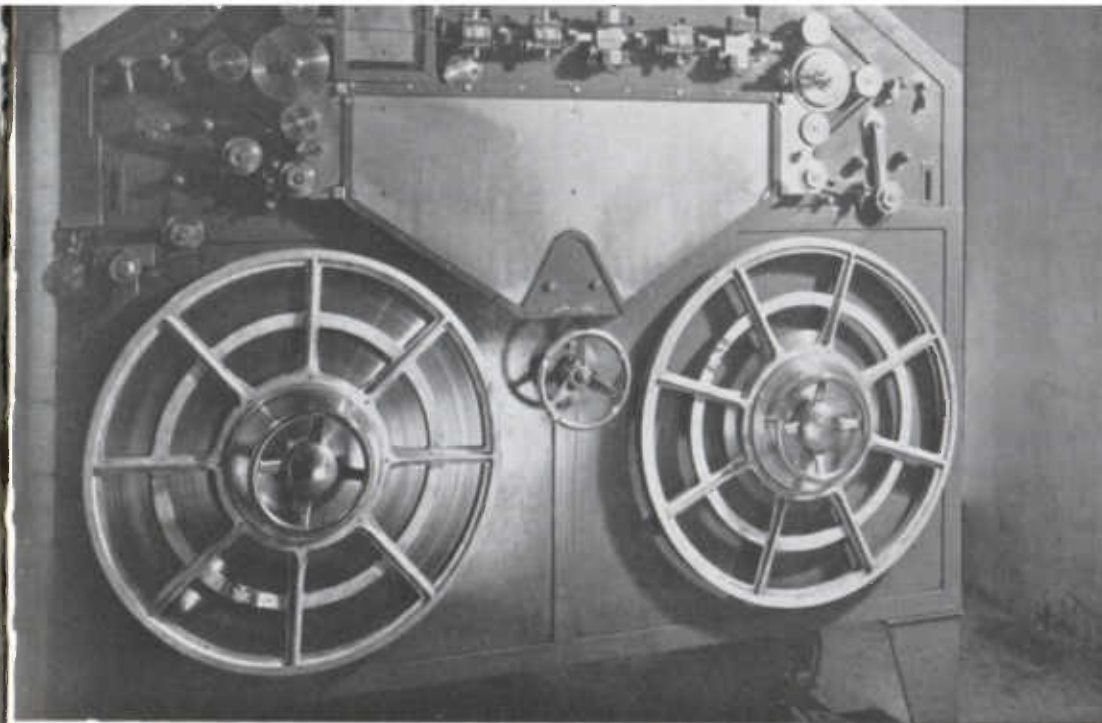

FIG. 137. VIEW OF CUTTER HEAD

A permanent magnet of horse-shoe shape has two pole pieces, of the special design shown, attached to the poles (Fig. 137). They are laminated in order to distribute the field evenly across the gaps, and between these gaps is suspended the soft iron armature. This armature is allowed to move slightly about its centre, which is in the form of a pivot; the latter is securely anchored to the main framework of the cutter head (not shown on diagram). Around the armature (but not touching it) are two small coils, and it is through these that the alternating currents of the programme are passed. When there is no current passing through the coil, the armature is held in the central position by virtue of rubber cushioning in the gaps, known as 'damping'. On passing a current through the coil the armature becomes magnetized to a degree and polarity dependent, respectively, on the strength and direction of the current. The little schematic diagram shows the state of affairs for an instantaneous value of current; the top of the armature being south and therefore attracted to the left (north) whilst the bottom end goes to the right (south). Thus, an alternating current will produce a side-to-side (or 'lateral') movement of the small cutter which is firmly attached to the armature. This cutter used always to be of steel, ground to the angles shown; but recently, sapphire cutters have been tried with considerable success and have the advantage of longer wear.

Now for the actual cutting of the disc. The cutter head is held on a framework so that the cutter rests on the disc with a weight of approx. $3\frac{1}{2}$ ozs., this pressure determining the depth of cut. This framework is arranged to travel across the turn-table, carrying the cutting head from the outside edge towards the centre of the disc. The framework is known as the 'traversing arm'. If, now, we make the turn-table revolve and, at the same time, move the traversing arm slowly across the disc, the cutter will 'plough' a V-track through the cellulose in the form of a spiral groove. Just how close the grooves will be in this spiral will depend entirely on the relation between speed of turn-table and speed of traversing arm. In practice, the movement is carried out by a 'lead screw' (similar to that on a lathe) which is geared to the



Marconi-Stille steel-tape recording machine

Plate XIIIa

Philips-Miller film recording machine

Plate XIIIb



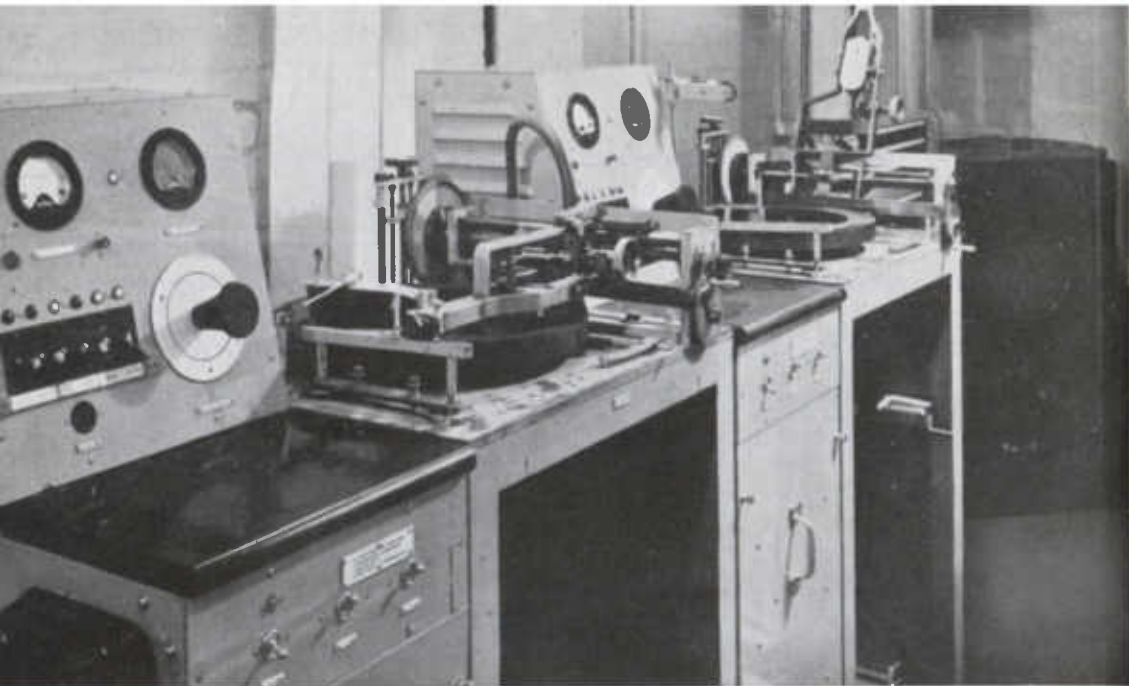

78 r.p.m. disc recording machines

Plate XIVa

The groove locating unit on a gramophone desk, type TD/7

Plate XIVb



turn-table motor. The groove pitch is made $\frac{1}{100}$ th of an inch, i.e. there are 100 grooves made in every inch of record, and the depth of the groove is regulated so as to leave $\frac{4}{1000}$ th of an inch of 'land' between the grooves.

Fig. 138 should make this clear.

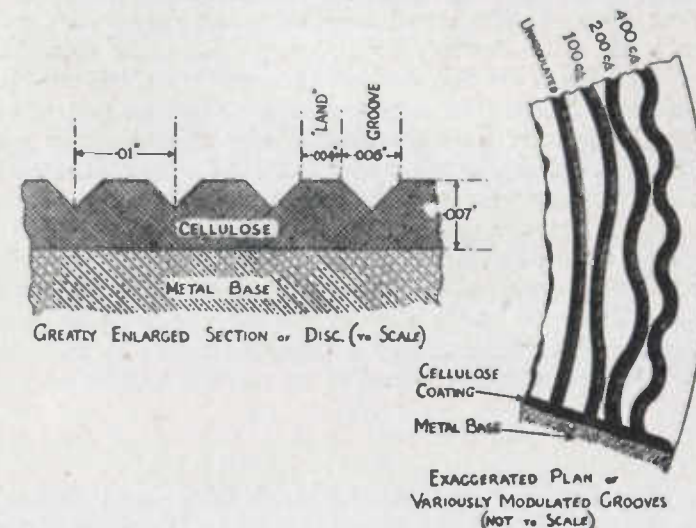

FIG. 138. SECTION AND PLAN OF THE DISC SURFACE

All we have considered so far is cutting a plain spiral. Now let us take a new disc and start the machine up ; but this time, let us feed an alternating current into the cutter head coils. This will make the cutter move from side to side and, instead of cutting a smooth spiral, it will make a corrugated one. A few such wavy traces, grossly exaggerated, are shown in the second sketch.

Just a brief note on the reproduction of the disc. The 'pick-up' is a very similar device to the cutter head, but designed to carry out the inverse function : for whereas in the cutter head electrical energy supplied by the recording amplifier to the cutter head coils causes mechanical motion of the armature and cutter, in the case of the pick-up the mechanical motion imparted to the reproducing needle and armature by the grooves on the disc causes electrical energy in the pick-up coils, which energy is passed to the reproducing amplifiers. Considering the pick-up in more detail, when the needle is placed in the groove the wavy trace causes it to wobble from side to side according to the modulation on the disc. This will cause variations in the number of lines of force passing through the armature in accordance with how near it approaches the pole pieces of the permanent magnet system. A coil of wire placed around the armature, the lines of magnetic force threading through which are varying in the manner now described, will have small alternating currents induced into it, and these may be amplified in the orthodox manner and fed to a loudspeaker, or transmission chain.

QUALITY OF DISC REPRODUCTION

On the normal 12" diameter disc, about $4\frac{1}{2}$ minutes playing time can be obtained with the above standards of 78 r.p.m., and 100 grooves per inch. The system has several advantages, but it has its drawbacks too. Let us start with these first. It will be fairly obvious that since the disc is rotating at a constant number of r.p.m., the linear speed of the groove under the cutter will be greater when the cutter is near the outside of the disc than when it is nearer the centre. For any given recorded frequency, then, the waves will be more cramped when recorded near the centre than when recorded at the edge of the disc. Similarly for a given position of the cutter between the outside and inside of the disc, the higher frequencies will be more cramped than the lower. It follows from these considerations that the greatest amount of 'cramping' will occur when we record a very high frequency near the centre of the disc. How will this cramping affect quality? The answer is that although these cramped waveforms may be accurately recorded by the cutting stylus, the reproducing needle will have great difficulty in following them, and as a result we shall find a gradual falling-off in the reproduction of high notes and overtones as the reproducing needle approaches the centre of the disc. There are methods of overcoming this, such as purposely exaggerating the high frequencies by a correcting circuit in the recording amplifier which is automatically altered as the centre is approached. This is actually done in some cases, particularly on the $33\frac{1}{3}$ r.p.m. disc recording system, which will be dealt with later. It is, in fact, one of those cases of inherent distortion which may be corrected by suitable design.

The frequency response of the recorded disc is quite good; the limitation is generally that of the reproducing pick-up. If we try 'doctoring' the reproducing amplifiers so as to make up for the lack of response at high frequencies, there is a danger of surface noise (which is found to be a mixture of random frequencies in the high-frequency band) becoming very prominent. Because, too, these discs are conveniently mixable with commercial pressings, it is general to use a reproducing system which is a compromise as regards obtaining good high-note response and eliminating noise, and the result is to obtain a reasonably 'flat' response between 50 and 5,000 cycles.

The advantages of the 78 r.p.m. system amply justify its popularity. It is simple in operation, and the machines are so compact that they can even be made up into 'suitcase' models for the purpose of mobile recording, a very useful feature for providing topical News features from normally inaccessible places. Whilst the discs last for only $4\frac{1}{2}$ minutes, there are many short talks, as well as 'effects', which conveniently fall into this duration. If not, then it is a simple matter to extend the time by use of the usual two-machine 'channel' which is invariably provided in a recording room. The discs are fairly easily stored, and can be packed and posted to any BBC centre, where they are suitable for playing on standard BBC disc reproducing equipment; but the most important advantage that it has over all other systems is the extreme ease with which discs may be 'edited'.

THE REPRODUCING TURN-TABLE (TD/7) AND EDITING

By editing is meant the selection of certain parts of a recorded programme, and their fitting-together to make, perhaps a shortened version, or perhaps a composite programme with interlinking speeches from a 'live' (i.e. not

recorded) speaker. With the material recorded on several discs we can literally 'lay the programme out' in front of us, on a few turn-tables, and all that is required is the ability to drop the pick-up needle on to the right groove of the right record at the right time. A device has been developed to do just what has been quoted above, and it is called the 'Groove Locating Unit'. This was touched upon before in the brief mention of the TD/7, the gramophone unit which is found in the listening rooms of studios, and which will now be described in greater detail.

In Fig. 139, we see the essential parts outlined in plan and end view, and Plate XIV shows a general view.

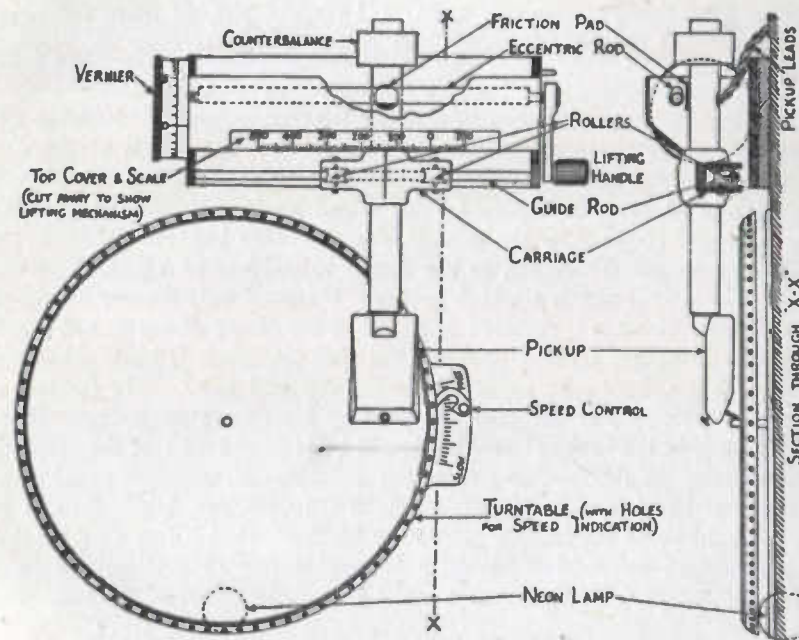

FIG. 139. PLAN AND END VIEW OF GRAMOPHONE TURN-TABLE AND PICK-UP, WITH GROOVE LOCATING UNIT

The turn-table is driven, in the usual way, by an electric motor, and its speed is regulated by a governor control which appears on the right-hand side of each turn-table. The speed of 78 r.p.m. is indicated by a stroboscopic device as already described.

The pick-up is fixed to the end of an arm, the remote end of which is secured to a small 'carriage' running on two small wheels which track along a smooth guide rail. Roller bearings ensure very smooth and easy running because the whole of the pick-up, arm, and carriage (weighing several ounces) has to be dragged along by virtue of the needle pressing against the wall of the groove in the disc. This pressure between needle and groove has to be made as light as possible, both sideways and vertically, and the pick-up arm is counterbalanced to reduce the effective weight of the pick-up to $2\frac{1}{2}$ ozs.

In order to raise the pick-up, we arrange to press down the extension to the arm which is on the other side of the carriage, and to use the guide rollers

as the pivot. A small handle which is seen on the right-hand side of the tracking unit performs this duty by virtue of the fact that it turns a 'cam'-shaped (eccentric) rod. When in the 'raised' position, this cam presses on a small friction pad on top of the carriage and so raises the pick-up. The important point to remember is that the needle comes off the record and is left poised exactly above the groove it has just played. If, therefore, it is lowered again, reproduction will begin where it left off. This may seem so simple that its possibilities are not immediately recognized, but its value in editing discs should now be clear. As an example let us suppose that we wish to pick out a sentence of a long speech and start at that point. We have only to play the record through, make a point of listening to the last word of the previous sentence, play that last sentence again, and lift the pick-up when that word is reached. On the next lowering, the record will start with the required sentence.

But this is not the only way of doing the job. If, instead of 'learning off' the last words of the previous sentence, we let the first words of the next sentence be played and then lift, it might be possible to move the pick-up back slightly so as to incorporate those words again. It may be observed that, as a very rough rule, the average person speaks between 120 and 150 words per minute. Therefore, as the disc is rotating at 78 r.p.m. there will be approximately 2 words on each groove. We need only let our record go past the point where it is required to repeat to the extent of one or two words (enough to recognize it) and then lift the pick-up, move it back about one groove, and it will now be poised above the required point. The method of shifting the pick-up just one groove is done by a vernier arrangement. When the pick-up is in the 'raised' position it will be remembered that the eccentric rod is pressing on the friction pad of the carriage. If, now, we could move the eccentric bar (along its length) by small amounts, say, hundredths of an inch, it would move the carriage with it by friction. That is just what we do; the small wheel on the left having a 'screw' action so that quite a large turning movement will effect only a small lateral movement of the bar. The vernier wheel is marked off in divisions which correspond to $\frac{1}{100}$ th inch movements of the bar.

In order that one turn-table of the TD/7 may be set up for a particular starting point when, perhaps, the other one is actually faded up and reproducing for transmission it is necessary to have some form of 'pre-fade' listening. This is accomplished by a special amplifier incorporated inside the playing desk which has its input connected to the pick-up, in parallel with the input to the fade unit. Headphones may be connected to the output of this pre-fade listening amplifier and so the output of the pick-up will be heard even if the fade unit is not faded up.

33 $\frac{1}{3}$ R.P.M. DISC RECORDING

We come now to a modification which is a comparatively recent (1941) innovation for the BBC. It is the adoption of an alternative speed—33 $\frac{1}{3}$ r.p.m. for the rotation of the disc. Whilst in general terms the same principles are employed as for recording at 78 r.p.m. there are a few points which are

worth mentioning here. The reason for the adoption of the lower speed is the increased playing time—15 minutes—which is brought about by three factors, (a) the slower speed, (b) increasing the size of disc from 12" to 16", and (c) cutting the grooves closer together, 120 grooves instead of 100 grooves per inch. This is naturally a very desirable feature, as many programme items are of only 15 or 30 minutes duration, and it is always better to have as few changes from one disc to another as possible. It means, however, that these discs cannot be played on the standard reproducing desks; but this, in turn, allows us to use special reproducing equipment in order to obtain improved quality.

One of the biggest drawbacks to disc recording is the inherent surface noise. When we try to reduce it by inserting 'scratch filters' it merely means that we have cut out the higher frequencies (which includes those harmonics of lower notes that give tonal quality to the different instruments) and so lose quality. The device that has been introduced on 33 $\frac{1}{3}$ r.p.m. disc recording is the one mentioned at the beginning of the chapter; that of deliberately introducing distortion. We boost up the high frequencies when recording to maintain a good high-note/noise ratio, and then reproduce the records through an amplifier having a 'falling' characteristic with increasing frequency. In this way the programme is maintained at a level response, but noise is kept at a good 'distance' from the high notes. The graphs in Fig. 140 may serve to make this clearer.

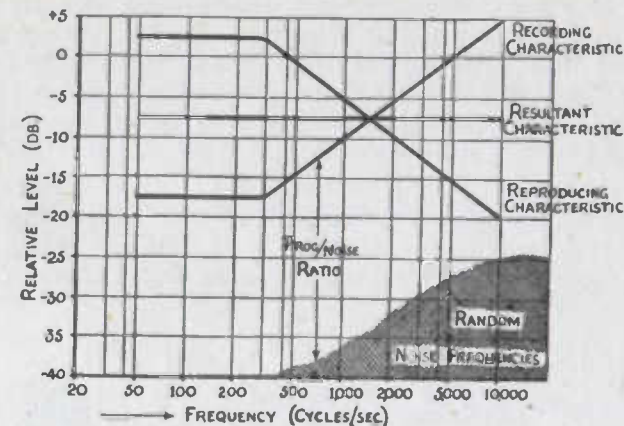

FIG. 140. GRAPHS OF RECORDING AND REPRODUCING CHARACTERISTICS

Another fault from which disc recording suffers has been mentioned earlier in these notes. It is the reduction of quality towards the centre of the disc due to the unavoidable cramping of the waveform at the lower peripheral speed which makes it difficult for the pick-up needle to follow. To compensate for this the tracking device is made to actuate a variable equalizer, which exaggerates the higher frequencies when the cutter is at the smaller radii.

With the above improvement, the final result, as far as quality is concerned, is exceptionally good, being relatively 'flat' from 50 to 8,000 cycles. There are two main disadvantages of the 33 $\frac{1}{3}$ r.p.m. system. The discs need special reproducing apparatus, differing in speed and amplifier characteristics from

the standard equipment. Also they are not easily 'edited'. Because of the greater number of 'words per groove' it is impossible, without further development, to lower the pick-up to the same degree of accuracy in, say, a continuous speech.

There is one feature that is common to both systems that is worthy of mention, and that is the practice employed when several copies of a disc are required. It is found quite satisfactory to process the disc by the ordinary commercial method of copper plating, etc., whence any number of pressings may be stamped from a master stamper. The BBC does not undertake this work, but sends the discs for 'processing' to firms who specialize in it.

If only one or two copies are required, this method would be unnecessarily expensive and the practice of 'dubbing' is resorted to. This simply means taking a record of a record, and must only be done with discrimination if loss of quality is to be avoided.

PHILIPS-MILLER FILM RECORDING : GENERAL PRINCIPLES

Finally we come to the Philips-Miller Film-recording system. The BBC had nothing to do with its development, the first machines being delivered in their fully-developed state in 1937 by their Dutch manufacturers, Messrs. Philips Lamps, Ltd. (Plate XIII).

Because the system embodied the one desirable feature of immediate playback, coupled with such things as reasonably long playing time, negligible deterioration after a very large number of reproductions, very good quality, and possibility of editing, it is little wonder that the BBC became interested in it. Previous 'film' recording had always been accomplished by the photographic method, with its attendant costs and delays in developing and printing; but this new idea had nothing in common with the conventional way of recording sound on film, and was similar only in the method of reproduction.

In a way, this film recording is not unlike disc recording in that the sound track is cut on the medium. The film used is 7 mm. wide, 0.18 mm. thick and consists of 3 layers; the base, which is of celluloid; then a layer of gelatine and, finally, an extremely thin coating of an opaque substance.

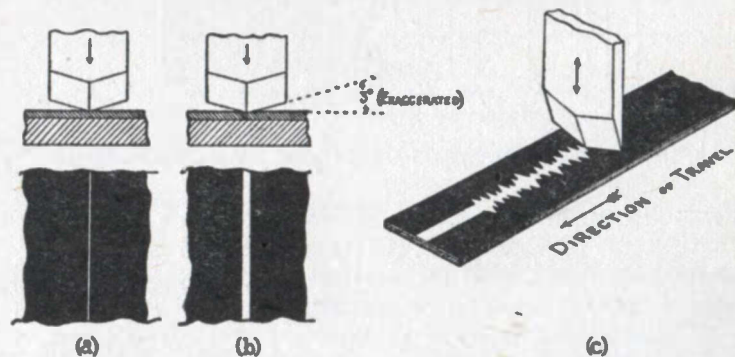

FIG. 141. DIAGRAMS TO ILLUSTRATE THE ACTION OF THE FILM CUTTER

A sapphire cutter is caused to cut the track into the gelatine in the 'hill-and-dale' fashion, never being allowed to penetrate so far that it would enter the celluloid base. The point of the sapphire is ground at a very obtuse

angle (actually 174°) so that small variations in *depth* of groove cause much greater variations in the *width* of the groove. It is in these variations in *width* that we are interested because they are the widths of the opaque substance that have been cut away, leaving a transparent 'variable area' track down the centre of an otherwise opaque film. The sketches (Fig. 141) show a very much-exaggerated picture of the principle of operation. A section and plan of the film is shown in Fig. 141, with (a) the cutter penetrating only a small amount and (b) about five times as much. Actually, the mechanical 'magnification' of $\frac{\text{width}}{\text{depth}}$ is very nearly 40 times, using the 174° cutter.

The third sketch (c) shows the result of moving the cutter rapidly up and down, as the film is drawn underneath it. Quite obviously the clear portion which has been left by cutting away the surface is a symmetrical and variable area, bounded on each side by the 'waveform' of the modulation applied to the electromagnetically driven cutter.

FILM MACHINE MECHANISM

We will leave the method of reproduction until the mechanism of the rest of the recording machine has been dealt with. In this, we have similar problems to the tape-recording system, viz. a full spool of tape has to be unwound, passed at a constant speed through recording and/or reproducing 'heads', and then wound up on the empty spool. We need concentrate only on the constant speed drive, because different models brought out by the manufacturers have varied from a single motor drive (with belt gearing to the film spool drives) to a three-motor system (separate motors for unwind, drive, and wind).

The film is taken from the full spool over guide pulleys until it passes round the recording drum (Fig. 142). This is simply a very accurately made

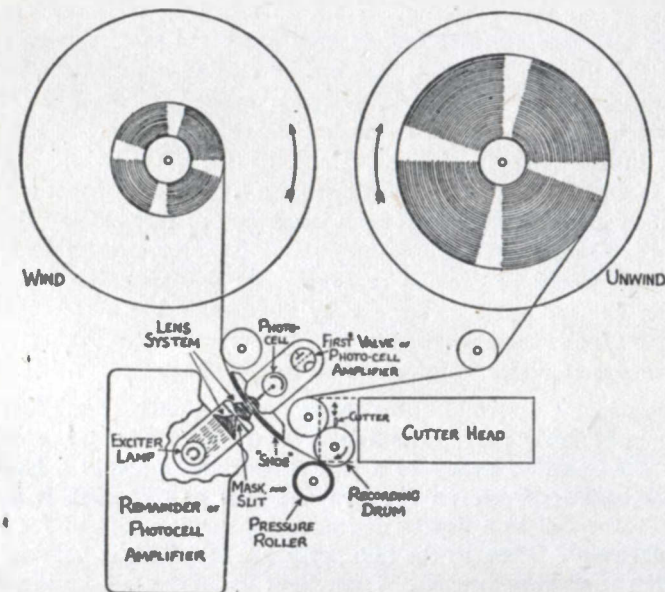

FIG. 142. PLAN OF FILM MACHINE, SHOWING ESSENTIAL PARTS

pulley which acts as an 'anvil' against which the film will be pressed when the sapphire cuts into it. The film would slip on the recording drum were it not for a rubber-faced pressure roller which is brought to bear against the film, pressing it hard against the constant-speed recording drum. After leaving these two rollers, the film is taken on to the winding spool, where arrangements are made to coil it tautly and steadily.

RECORDING AND REPRODUCING HEADS

To return to the recording head, this is an electromagnetic device into which the programme currents are fed, whereupon the cutting sapphire moves in and out. The depth of the cut, and therefore the width of the track, can be initially adjusted (before modulation is applied) by a vernier screw on the cutter head. There is also an automatic device which withdraws the cutter to produce minimum width of cut during 'silent' periods, and so reduces the noise level of the system.

Reproduction has to be performed on the same machine, and is done in this way. In between the recording drum and the winding spool, the film passes over a metal 'shoe' in which a hole is cut away. On one side of the shoe is a small light projector consisting of a lamp, a lens system, and a mask which reduces the light to a very thin beam. This beam plays on the film so that it falls at right angles to the length of the film, passes through the cut-away portion of the shoe, and then on to the photo-electric cell on the other side. This P.E. cell introduces a rather new principle to sound broadcasting technique although it has been the method used in 'Talkies' for many years. Certain substances, notably Caesium and Rubidium, exhibit certain electrical properties in that they contain many free electrons which are released by the action of light. They are said to be 'light-sensitive' and use is made of them in this way. A glass bulb is coated on one half of its inside with, say, Caesium, and then evacuated of air. When light is allowed to fall on the coating, electrons are given off in very much the same way as from the hot filament of a valve: in fact, the caesium coating is called the 'cathode'. These electrons can be collected by a small 'anode' (in the form of a loop of wire) which must, of course, be made positive with respect to the cathode. Variations in the amount of light falling on the cathode will then cause variations in anode current, and the alternating current component is extracted and amplified in the normal way, by a succession of thermionic valves. The output of the photo-electric cell is very small, however, and its impedance is very high. It would be difficult to convey the tiny programme currents to an amplifier situated some distance away without having a considerable loss of programme/noise ratio in the line; so to overcome this difficulty, a small single valve pre-amplifier is incorporated in the photo-electric cell assembly.

This reproducing system is also shown in the sketch (Fig. 142) and its action should be fairly clear. The light from the exciter lamp is concentrated into a narrow beam by means of a lens system and a slit in a mask. This thin slit of light impinges on the film and will pass through it and on to the photoelectric cell to a degree dependent upon the width of the cut-away track at that point. Thus, as the film passes the slit, light in varying amounts will be allowed to pass through. These light variations will be in proportion to the modulation of the film track, and will cause the current passed by the

photo-electric cell to vary in a manner representing the waveform of the original sounds.

It should be noted also that the reproduction may take place while recording is in progress. As in the tape system, this allows a constant check to be kept on the material which is being recorded.

Under ordinary conditions, the film is made to travel at 60 feet per minute, which results in a playing time of 15 minutes for each spool. Continuous recording, or reproduction, is allowed for by building the machines in duplicate, with appropriate change-over arrangements. With reasonable care, excellent quality is obtainable from the film system, the response being practically flat between 40 and 8,000 cycles, with very little surface noise, and a large dynamic range is thus permissible. If, for any reason, we wish to economize in film stock by running the machines at half-speed (and thereby obtaining 30 minutes per spool) we have to be prepared for a corresponding drop in quality. This has been done on certain occasions where quality was not the all-important factor, with the result that the reproduction has been reduced to approximate to that of the 78 r.p.m. disc.

FILM EDITING

As regards the possibility of editing film, it can never be quite so simple as the disc method, for the very simple reason that the required excerpt might be several minutes 'in' the reel, and we should have to wait while the reel unwinds to pick it out. However, editing can be carried out quite simply, 'pre-transmission', by cutting and joining the film. The film is cut with scissors at the places required, and the two new ends are spliced together with a special type of patch and cement. The cut and patch are made on the slant, in order not to create a 'plop' when passing the reproducing system. Instead, just a temporary 'fade' is caused, which is practically unnoticeable.

GENERAL

The above brief descriptions of the three methods of recording should give the reader some idea of its whys and wherefores. Each system has its special advantages and disadvantages, and there is really no single one that could fulfil every requirement set out at the beginning of this chapter. Indeed, a recording is quite often made on one system for one purpose and simultaneously on a different system for another.

To conclude, recording has played, and will continue to play, a very important part in broadcasting. Whether the BBC will introduce new systems to supplement the present ones is a matter which only the future can divulge. At any rate the primary consideration will always be faithful reproduction.

QUESTIONS ON CHAPTER X

(1) Review the uses which a broadcasting organization can make of a recording service. State some of the essential features of such a service.

(2) What are the advantages and disadvantages of the three recording systems used by the Corporation?

(3) Explain with a sketch how a disc cutter-head works. Why is it that the high audio-frequencies are lost, if the speed of the recording medium under the cutter is reduced?

Give a dimensioned sketch of the recorded wave-form of a 1,000 c/s pure note, (a) when the cutter is $5\frac{1}{2}$ " from the centre of a disc running at 78 r.p.m. ;

(b) when the cutter is 2" from the centre of a disc running at 78 r.p.m. ;

(c) when the cutter is 3" from the centre of a disc running at $33\frac{1}{3}$ r.p.m.

(4) Explain the cause of needle scratch and say how it can be reduced.

(5) In a disc recording system the rate of rotation of the disc, the spacing of the grooves, and the diameter of the disc, are all very largely a matter of choice. Describe some of the factors influencing the choice of these dimensions in a practical system.

(6) Describe the construction and operation of a TD/7 desk.

(7) Show with a sketch the position and operation of the wiping, recording, and reproducing heads on a Marconi-Stille tape-recording machine.

Indicate the number and relative positions of the pole pieces in each of these three types of head.

What is the nature of the current in each of these three heads? Is it D.C., A.C., or fluctuating D.C.?

Describe all the steps which are taken to keep constant the speed of the tape through these heads.

(8) Why is the tape first saturated by the wiping head and then reduced in magnetization by the D.C. in the recording head? How would you remove electrically (without cutting the tape) an unwanted announcement in the middle of a tape recording?

(9) Describe the method of working of a Philips-Miller machine. Make a dimensioned sketch of a strip of Philips-Miller film on which a 500 c/s pure note has been recorded. Describe the construction of the film used in the Philips-Miller system.

(10) What is the function of a photo-electric cell? Describe the system for reproducing Philips-Miller film.

(11) In making a film recording the movement of the sapphire is magnified 40 times. How is this done?

APPENDIX I

GENERAL LETTER SYMBOLS OF ELECTRICAL QUANTITIES

I—Current
 E—Voltage, or Electromotive Force (e.m.f.)
 R—Resistance
 P—Power
 Z—Impedance
 C—Capacitance
 L—Inductance
 f—Frequency
 v—Velocity
 λ —Wavelength

Instantaneous values of electrical quantities are indicated by small letters ; thus, the instantaneous value of current is represented by 'i'.

ABBREVIATIONS for names of Units (which must not be confused with the above symbols for Quantities)

A —Ampere (Unit of Current)
 V —Volt (" " Voltage)
 Ω —Ohm (" " Resistance)
 W—Watt (" " Power)
 F —Farad (" " Capacitance)
 H —Henry (" " Inductance)
 c/s—Cycles per second (Unit of Frequency)
 db—Decibel (Unit of Power Ratio, or of Loss or Gain)

The following *Prefixes* :

m —milli- (1 thousandth)
 μ —micro- (1 millionth)
 k —kilo- (1 thousand)
 M—Mega- (1 million) are used to extend the range of

Units, e.g. . . .

M Ω —Megohm (Million Ohms)
 mA —Milliamp (Thousandths of an Ampere)
 μ F —Microfarad (Millionth of a Farad)
 kW —Kilowatt (Thousand Watts) etc., etc.

Special attention should be paid to the fact that the size of the prefix letter is all important, e.g. 'm' = $\frac{1}{1,000}$, but 'M' = 1,000,000.

Thus, 6.25 Mc/s = 6,250,000 Cycles per second
 but 2.54 mW = 0.00254 Watts

APPENDIX II

STANDARD SYMBOLS USED IN DRAWING

NOTE: The following symbols are those most commonly found in BBC drawings and may not all conform to International Standards. In cases where alternative symbols are likely to be met, these are shown . . . but there are many drawings in existence where other variations are to be found.

	Wires crossed, without connection		Wires in contact
	Pairs of wires, or 'Line' (the thickness of the lines shows their relative importance in a circuit)		Twisted pair, often in the form known as 'Flex' (abbreviation for 'flexible cable')
	Fuses. Shown in both wires of a line		Double-pole switch (often of the 'Toggle', or ordinary 'Mains' type)
	Aerial		Press-button switch
	Earth		Plug and socket: Mains type
	General 'Block' symbol for any piece of apparatus. (Designated by appropriate symbol placed within it)		General symbol for any measuring instrument (Designated by appropriate symbol placed in, or near, it)
	Resistance (fixed)		Primary cells
	Variable resistance (adjusted by slider)		Primary batteries (the long thin line is always the positive pole, even when not shown on the drawing)
	Variable resistance (adjusted by studs)		Secondary battery
	H.F. choke, or air-cored inductance		Iron-cored (L.F.) transformer
	L.F. choke, or iron-cored inductance		

	Air-cored (H.F.) transformer		Iron-cored transformers with electrostatic screen
	Symbol for 'Variability' (N.B. An arrow drawn through a component means that its value is variable; or, in the case of transformers, that the 'coupling' is variable)		Thermo-couple
	Fixed condenser		Gramophone pick-up
	Variable condenser		Telephone transmitter
	Electrolytic condenser		Telephone receiver
	Crystal detector, or metal rectifier		Headphones
	Metal rectifiers in 'Bridge' formation		Micro-telephone
	Quartz crystal		Relay (one coil and single 'make' contacts)
	Breakjack (Old type)		Relay (one coil and single 'make' and 'break' contacts)
	Breakjack (New type)		Relay (Slow-acting and double 'make' contacts)
	Plug		Contacts on relays, key-switches, or any other form of switches, may vary as to their complexity, but in all cases are shown in their Normal (i.e. unoperated) position
	2-position lever key (Locking)		OPEN
	3-position lever key (Locking in one direction)		CLOSED

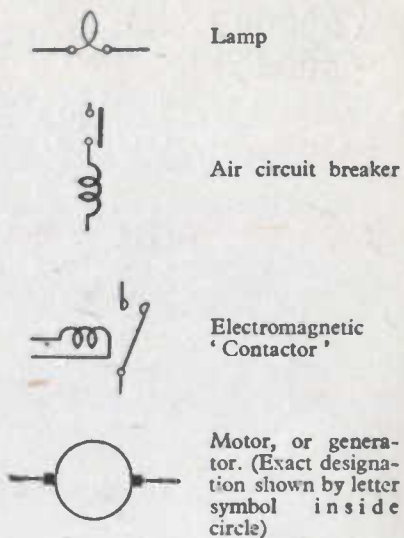
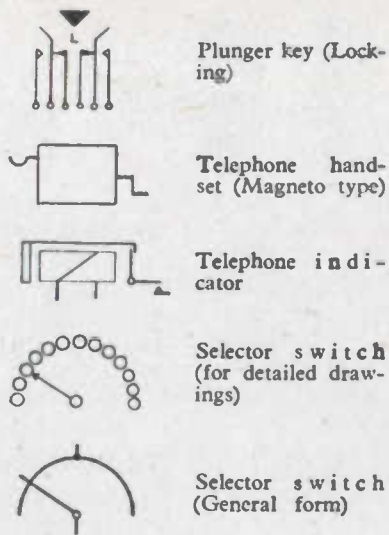

VALVES

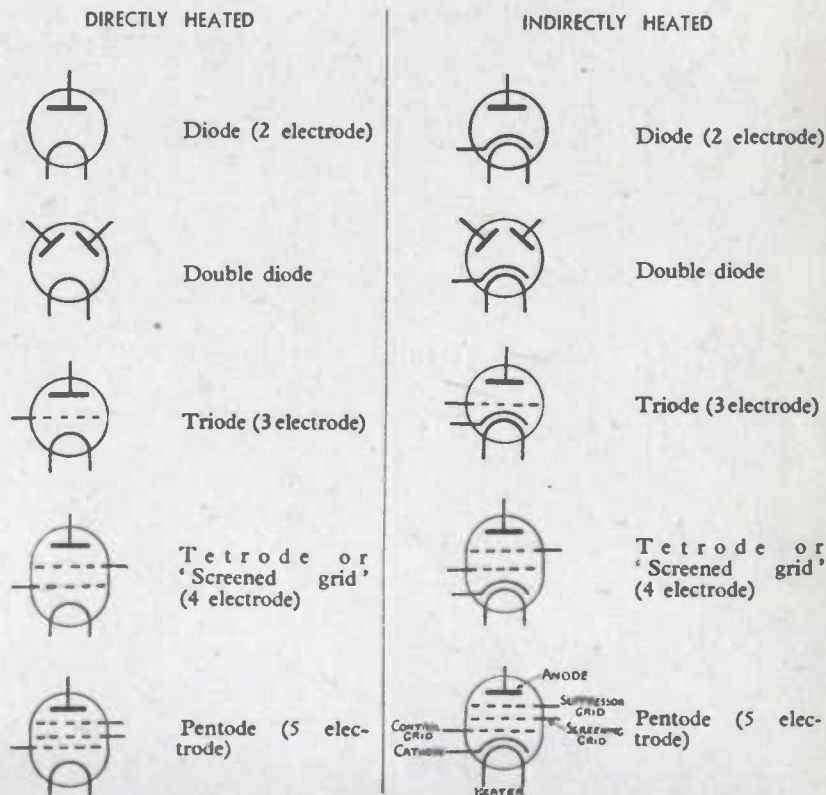

MORE COMPLEX VALVES AND OTHER THERMIONIC DEVICES

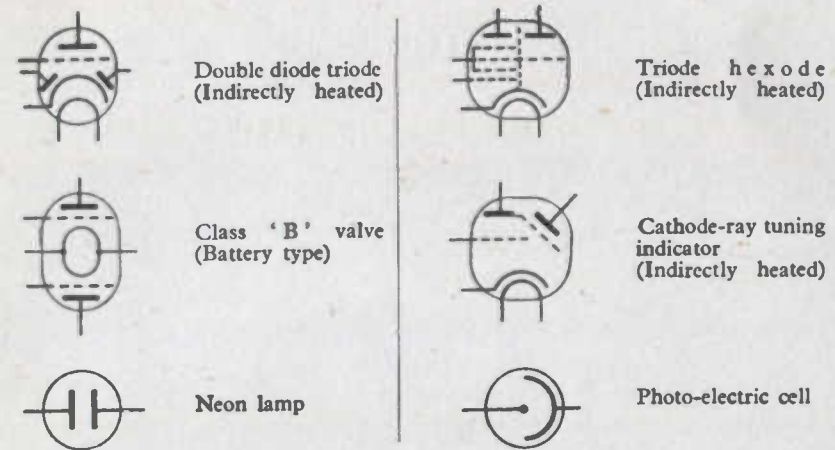

RESISTOR COLOUR CODE

A convenient way to designate the value of a resistor is to use a colour code in which the first figure is given by the colour of the body of the resistor, the second figure by the colour of the tip of the resistor, and the third and any subsequent figures by the colour of a dot (or ring) painted on the centre of the body as shown in the figure below.

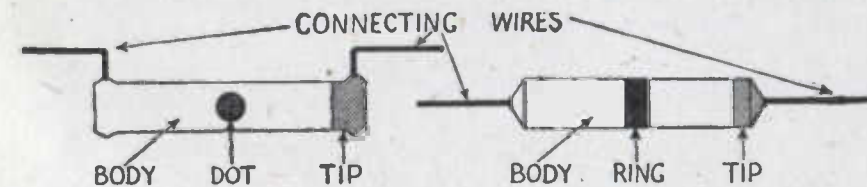

COLOUR	BODY (1st Figure)	TIP (2nd Figure)	DOT, or RING (No. of Noughts)
Black	0	0	-
Brown	1	1	0
Red	2	2	00
Orange	3	3	000
Yellow	4	4	0000
Green	5	5	00000
Blue	6	6	000000
Violet	7	7	-
Grey	8	8	-
White	9	9	-

The order of reading the colours is :—body, tip, dot (or ring). Thus yellow body, black tip and red dot (or ring) means 4,000 ohms.

APPENDIX III

FORMULAE AND TABLES

VOLTAGE, CURRENT, AND RESISTANCE

$$\text{Ohm's law: } I = \frac{E}{R}$$

$$E = I \times R$$

$$R = \frac{E}{I}$$

Where, I = Current (Amperes)
 E = Voltage (Volts)
 R = Resistance (Ohms)

POWER IN A CIRCUIT

$$P = I \times E$$

$$\text{or, } P = I^2 \times R$$

$$\text{or, } P = \frac{E^2}{R}$$

Where, P = Power (Watts)
 I = Current (Amperes)
 E = Voltage (Volts)
 R = Resistance (Ohms)

RESISTANCE CALCULATIONS

Resistances in Series :

$$R_{\text{TOTAL}} = R_1 + R_2 + R_3 + \dots \text{ etc.}$$

Resistances in Parallel :

$$\frac{1}{R_{\text{TOTAL}}} = \frac{1}{R_1} + \frac{1}{R_2} + \frac{1}{R_3} + \dots \text{ etc.}$$

N.B. If calculating the value of two resistances only, the formula becomes :

$$R_{\text{TOTAL}} = \frac{R_1 \times R_2}{R_1 + R_2}$$

INDUCTANCE AND CAPACITY

(Assuming no 'mutual' inductance)

Inductances in Series :

$$L_{\text{TOTAL}} = L_1 + L_2 + L_3 + \dots \text{ etc.}$$

Inductances in Parallel :

$$\frac{1}{L_{\text{TOTAL}}} = \frac{1}{L_1} + \frac{1}{L_2} + \frac{1}{L_3} + \dots \text{ etc.}$$

When inductances are 'coupled', account has to be taken of the mutual inductance which exists between them, and the fact that the inductances may aid or oppose each other in total effect.

If 'M' = mutual inductance, the formulae are modified thus :

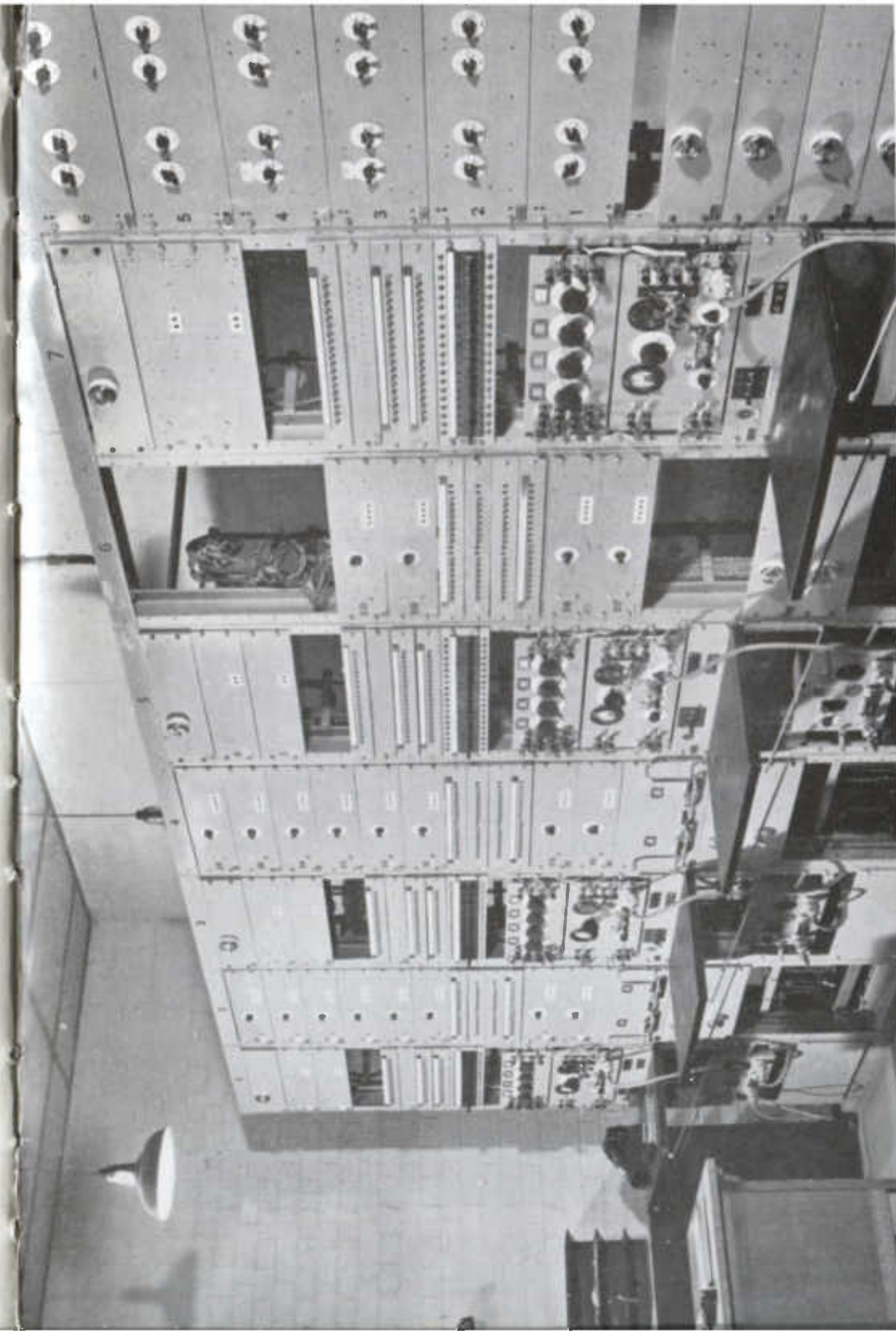

Control position bays in a wartime control room

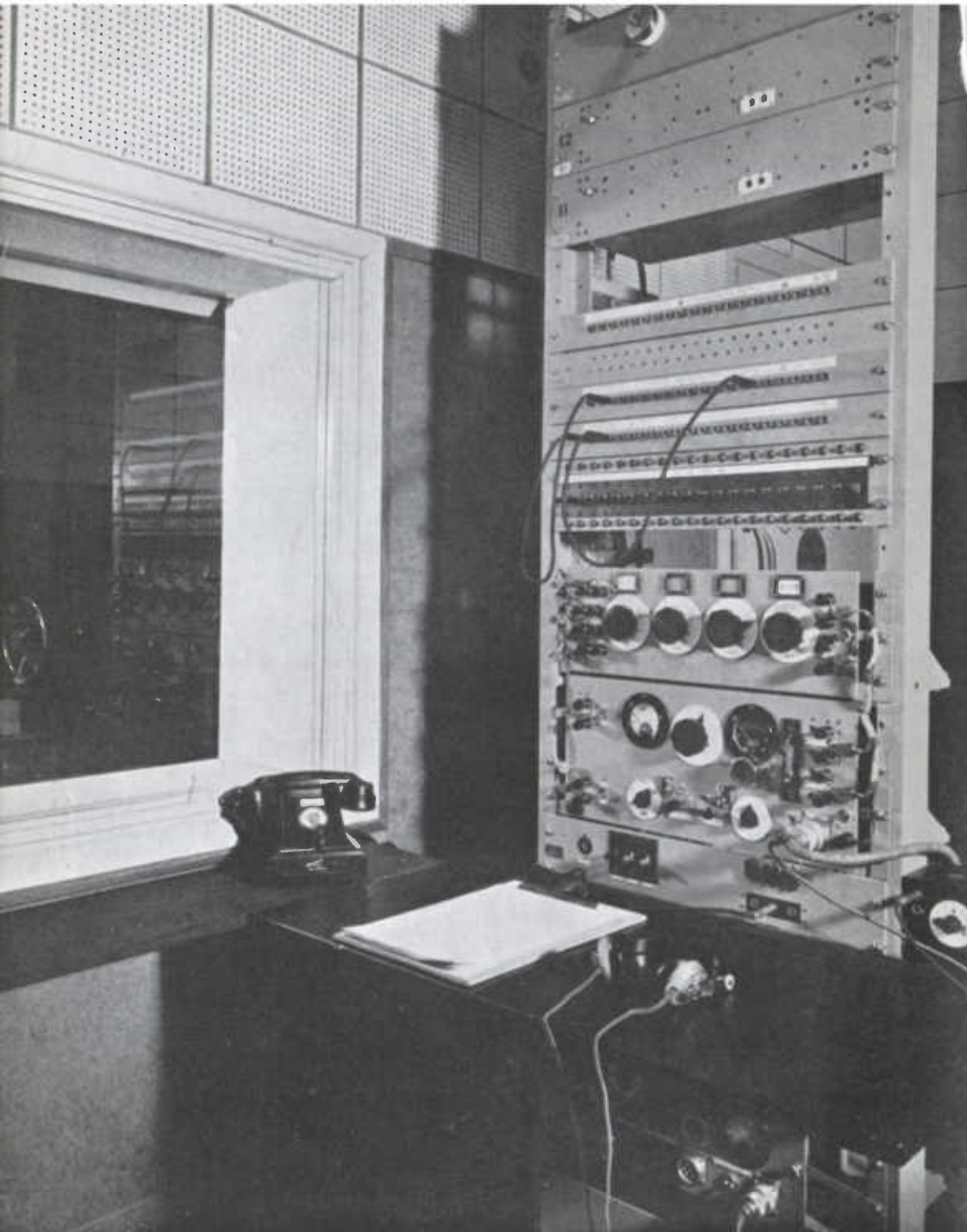

The control position bay in a Continuity suite
Plate XVI

Parallel aiding :

$$L_{TOTAL} = \frac{L_1 L_2 - M^2}{L_1 + L_2 - 2M}$$

Parallel Opposing :

$$L_{TOTAL} = \frac{L_1 L_2 - M^2}{L_1 + L_2 + 2M}$$

Series Aiding :

$$L_{TOTAL} = L_1 + L_2 + 2M$$

Series Opposing :

$$L_{TOTAL} = L_1 + L_2 - 2M$$

Condensers in Series :

$$\frac{1}{C_{TOTAL}} = \frac{1}{C_1} + \frac{1}{C_2} + \frac{1}{C_3} + \dots \text{ etc.}$$

Condensers in Parallel :

$$C_{TOTAL} = C_1 + C_2 + C_3 + \dots \text{ etc.}$$

REACTANCE OF INDUCTANCES AND CONDENSERS

(for Inductance)

$$X_L = 2\pi fL$$

(for Capacity)

$$X_C = \frac{1}{2\pi fC}$$

Where, X = Resistance (Ohms)

L = Inductance (Henrys)

C = Capacity (Farads)

f = Frequency (Cycles/sec.)

$\pi = 3.14159 \dots$

REACTANCE OF A TUNED CIRCUIT

$$X_{LC} = X_L - X_C$$

$$= 2\pi fL - \frac{1}{2\pi fC}$$

IMPEDANCE

Impedance (Z) in Ohms of a circuit containing Inductance, Capacity, and Resistance.

$$Z = \sqrt{R^2 + X^2}$$

$$= \sqrt{R^2 + \left(2\pi fL - \frac{1}{2\pi fC}\right)^2}$$

IMPEDANCE RATIO OF TRANSFORMERS

The impedance ratio of a transformer is proportional to the square of its turns ratio.

Hence, for a repeating coil designed to match 600 ohms to 300 ohms, its turns ratio, 't' will be given by :

$$t = \sqrt{\frac{Z_1}{Z_2}}$$

$$= \sqrt{2}$$

$$= 1.414$$

FREQUENCY OF A TUNED CIRCUIT

Circuit is in 'Resonance' when Reactance (X_{LC}) is a minimum

i.e. when $X_L - X_C = 0$

$$\text{or } 2\pi fL = \frac{1}{2\pi fC}$$

$$\therefore (2\pi f)^2 = \frac{1}{LC}$$

$$\text{and } f = \frac{1}{2\pi\sqrt{LC}}$$

WAVELENGTH AND FREQUENCY

$$\lambda = \frac{v}{f}$$

Where λ = Wavelength (metres)
 v = Velocity of electromagnetic waves in æther (approx. 300,000,000 metres/sec.)

f = Frequency (cycles/sec.)

$$\text{or } \lambda = \frac{3 \times 10^8}{f} \text{ if 'f' is required to be in kilocycles/sec.}$$

$$\text{or } \lambda = \frac{3 \times 10^6}{f} \text{ if 'f' is required to be in Megacycles/sec.}$$

Alternatively, if L and C (in a tuned circuit) are known, the formula becomes :

$$\lambda = 1885\sqrt{LC}$$

Where L = Inductance (microhenrys)

C = Capacity (microfarads)

THE DECIBEL

The number of decibels corresponding to a Power ratio, $\frac{P_2}{P_1}$ is given by

$$\pm N(\text{db}) = 10 \log_{10} \frac{P_2}{P_1}$$

If P_2 (output power) is greater than P_1 (input power), then $\frac{P_2}{P_1}$ is greater than unity and N will have a +ve sign, and is spoken of as a 'gain of N db'.

If P_2 is less than P_1 , then $\frac{P_2}{P_1}$ is less than unity, and N will have a -ve sign, and be spoken of as a 'loss'. When making this latter calculation, it is better to reverse P_2 and P_1 and to find the logarithm of this (greater than unity) number, remembering to put in the -ve sign when N is found.

When calculating the decibel gain or loss for Voltage, or Current ratios, the formula is modified to :

$$\pm N(\text{db}) = 20 \log_{10} \frac{E_2}{E_1}$$

$$\text{or } \pm N(\text{db}) = 20 \log_{10} \frac{I_2}{I_1} \text{ provided that the input and output have equal impedances.}$$

ZERO LEVEL

Zero level is taken as = 1 milliwatt, and absolute power measurements (in decibels) are made with respect to this zero level.

Thus a power of 'P' milliwatts may be expressed in terms of N db above (or below) zero level by the formula :

$$\pm N(\text{db}) = 10 \log_{10} P.$$

If P is greater than 1 milliwatt, N will be +ve; if less than 1 milliwatt, the answer will be -ve.

For absolute voltage measurements in decibels, the zero level of 1 milliwatt is assumed to be dissipated in a 600 ohm load.

$$\text{Since } P = \frac{E^2}{R}$$

$$E^2 = \frac{1}{1,000} \times 600$$

$$= 0.6$$

$$\therefore E = 0.775 \text{ volts}$$

Zero voltage level is therefore defined as being 0.775 volts developed across 600 ohms.

A given voltage, 'E,' may be expressed in terms of 'N db' above (or below) zero level by the formula :

$$\pm N(\text{db}) = 20 \log_{10} \frac{E}{0.775}$$

POWER AND VOLTAGE RATIOS EXPRESSED IN DECIBELS

DECI-BELS	POWER RATIO $\frac{P_2}{P_1}$	VOLTAGE RATIO $\frac{E_2}{E_1}$	DECI-BELS	POWER RATIO $\frac{P_2}{P_1}$	VOLTAGE RATIO $\frac{E_2}{E_1}$
0.1	1.0233	1.0116	38	6,310	79.43
0.2	1.0471	1.0233	40	10,000	100.0
0.3	1.0715	1.0351	42	15,850	125.9
0.4	1.0965	1.0471	44	25,120	158.5
0.5	1.1220	1.0593	46	39,810	199.5
0.6	1.1482	1.0715	48	63,100	251.2
0.7	1.1749	1.0839	50	100,000	316.2
0.8	1.2023	1.0965	52	158,500	398.1
0.9	1.2303	1.1092	54	251,200	501.2
1.0	1.259	1.1220	56	398,100	631.0
2.0	1.585	1.2589	58	631,000	794.3
3.0	1.995	1.4125	60	1,000,000	1,000
4.0	2.512	1.585	62	1.585×10^6	1,259
5.0	3.162	1.778	64	2.512×10^6	1,585
6.0	3.981	1.995	66	3.981×10^6	1,995
7.0	5.012	2.239	68	6.310×10^6	2,512
8.0	6.310	2.512	70	10.0×10^6	3,162
9.0	7.943	2.818	72	15.85×10^6	3,981
10	10.00	3.162	74	25.12×10^6	5,012
12	15.85	3.981	76	39.81×10^6	6,310
14	25.12	5.012	78	63.10×10^6	7,943
16	39.81	6.310	80	100.0×10^6	10,000
18	63.10	7.943	82	158.5×10^6	12,590
20	100.00	10.00	84	251.2×10^6	15,850
22	158.5	12.59	86	398.1×10^6	19,950
24	251.2	15.85	88	631.0×10^6	25,120
26	398.1	19.95	90	$1,000 \times 10^6$	31,620
28	631.0	25.12	92	$1,585 \times 10^6$	39,810
30	1,000.0	31.62	94	$2,512 \times 10^6$	50,120
32	1,585	39.81	96	$3,981 \times 10^6$	63,100
34	2,512	50.12	98	$6,310 \times 10^6$	79,430
36	3,981	63.10	100	$10,000 \times 10^6$	100,000

In using the above table, if the exact value in decibels is not shown, then the result can be interpolated in the following manner. The number to be found,

say 45.5 db, is split up into the nearest component additive parts 44+1+0.5. The ratios corresponding to each of these numbers are found from the table to be (in the case of power ratios) 25,120 ; 1.259 ; and 1.122. These ratios are now multiplied together, the total ratio corresponding to 45.5 db being 35,484.

Ratios which are less than unity are best converted to decibels by first inverting the ratio (i.e. finding the reciprocal) and then using the larger number to find the corresponding number of decibels, which must be prefixed by the -ve sign. Similarly, to convert -N db to a power or voltage ratio, the sign is ignored, whilst the ratio corresponding to 'N' db is found. This ratio is now 'inverted' to get the true answer to -N db.

It should be noted that the power ratio, $\frac{P_2}{P_1}$, corresponding to any given number of decibels is the same as the square of the voltage ratio, $\frac{E_2}{E_1}$. For example, the number of decibels for a power ratio of 10,000 is seen to be 40; the voltage ratio for the same number of decibels is 100 ($=\sqrt{10,000}$).

Use may be made of this fact in ascertaining the power ratio corresponding to an odd number of decibels (not otherwise given in this table), simply by looking up the voltage ratio for twice the number of decibels. As an example, to find the power ratio for 27 db. we look up the voltage ratio for 54 db., given as 501.2.

PERCENTAGE MODULATION IN TERMS OF DECIBELS

Since the depth of modulation is directly proportional to the amplitude (and therefore the voltage) of the carrier, the percentage modulation will be described by a law similar to the voltage/decibel formula, viz.

$$N \text{ (db)} = 20 \log \frac{M_2}{M_1}$$

where M_2 and M_1 are two modulation values in terms of percentage. The following table gives some typical values which (although not absolutely correct) are good approximates for general working. The figures are given relative to 100 per cent. modulation, which is taken as 0 db.

Per cent. Modulation	100	90	80	70	60	50	40	30	20	10	5	1
No. of db. (approx.)	0	-1	-2	-3	-4.5	-6	-8	-10.5	-14	-20	-26	-34

Example

If a transmitter is lined up on tone at 4 db. to give 40 per cent. modulation, what percentage modulation occurs when programme peaks to 10 db ?

This shows an increase of 6 db, which is equivalent to doubling the percentage modulation. (From the table it is seen to be an increase of from 50 per cent. to 100 per cent., or from 10 per cent. to 20 per cent., etc.) Therefore, the programme peaks will modulate the transmitter to 80 per cent.

AN 'ABAC' RELATING WAVELENGTH, FREQUENCY, INDUCTANCE AND CAPACITY

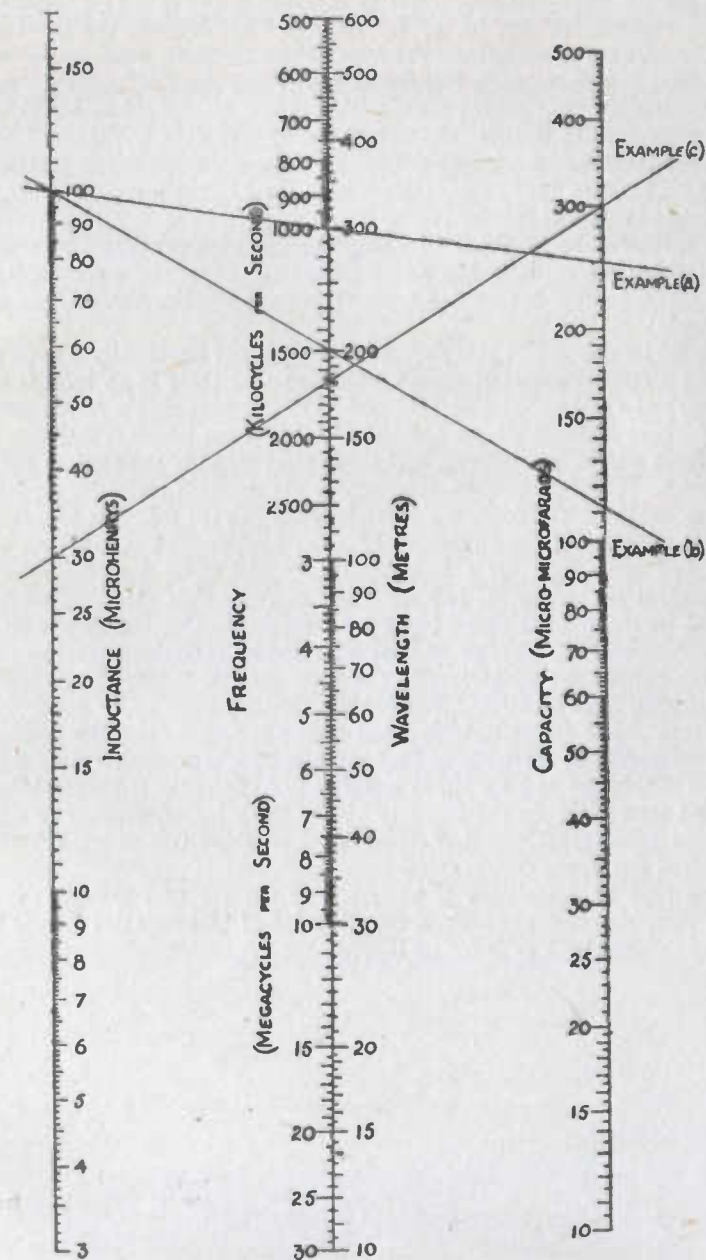

THIS chart is a device which relates wavelength (or frequency) to inductance and capacity by the usual formula $\lambda = 1,885 \sqrt{LC}$.

The centre scale may be used on its own as a simple frequency/wavelength conversion chart ; it being necessary only to read one side of the scale against the other.

The use of the other two scales is as follows. If any two factors of the equation relating 'λ' (or 'f'), 'L' and 'C' are known, the third may be found by placing a straight-edged ruler through those two points, and the place where it intersects the remaining scale gives the third (unknown) factor.

For example, suppose we have a coil of 100 microhenrys and a capacity of .00025 microfarads, to what wavelength would this tune? Placing a straight-edge through these two points (example 'a'), we find that it intersects the wavelength scale at very nearly 300 metres (or 1,000 kilocycles, if the answer is required in terms of frequency).

As a further example (b), let us keep the coil of 100 microhenrys, and find to what value the capacity has to be altered to retune the wavelength to 200 metres. The answer is given at once as 112 micro-microfarads (i.e. .000112 microfarads).

It should be noted that this particular chart is not necessarily a good one for designing circuits because it must be obvious that there is an infinite number (in theory) of combinations of 'L' and 'C' that will give a particular wavelength. There is, however, an optimum 'L/C' ratio which constitutes a good design for a particular purpose, and more knowledge is required to delve into this subject. It really becomes necessary to use separate scales for dealing with the short, medium, and long, wave-bands, owing to the fact that higher 'L/C' ratios are required as the frequency becomes smaller. Thus, whereas we have just worked out a case for a 100-microhenry coil to be used on the medium wave-band, it is more usual to have a coil of twice that value. This example could not be worked out direct from the chart as it only goes up to 180 microhenrys. However, if one has to deal with values of inductance and capacity which are outside the range shown, the scale may be extended by multiplying the inductance scale by 10 and dividing the capacity scale by 10 simultaneously, or vice versa. For example, with a coil of 300 microhenrys and a condenser of .00003 microfarads, we wish to find the wavelength to which they will tune. First, we divide the 300 by 10, in order to accommodate it on the inductance scale, and then multiply the capacity by the same factor, making it .0003, or 300 micro-microfarads. A line drawn through these two points (c) will give the required result, viz. 180 metres.

If this type of calculation is preferred to the use of formulae, the reader may be recommended to obtain a complete set of 'Radio Data Charts' (R.T. Beatty) published by *The Wireless World*.

APPENDIX IV

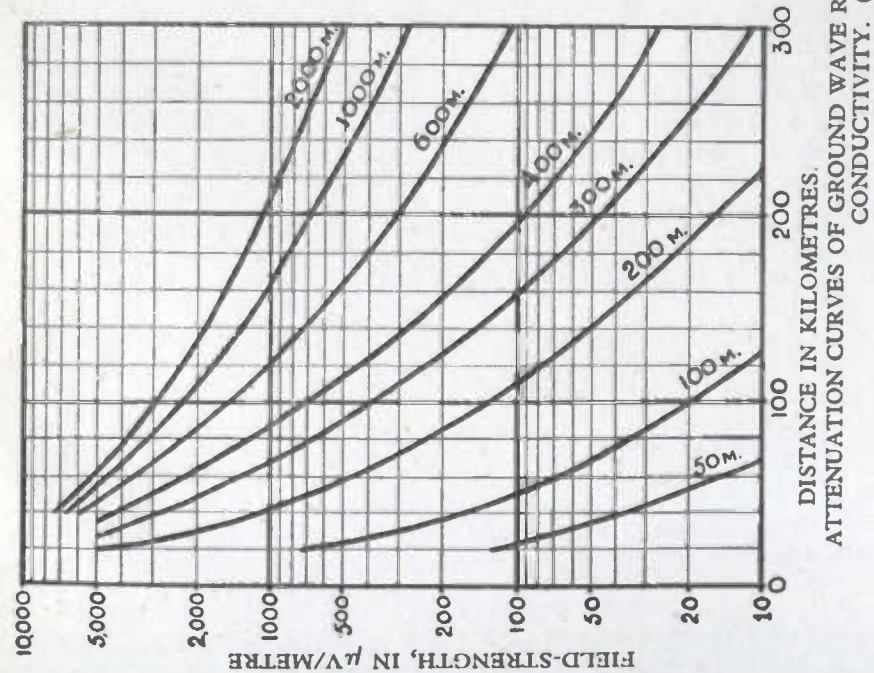
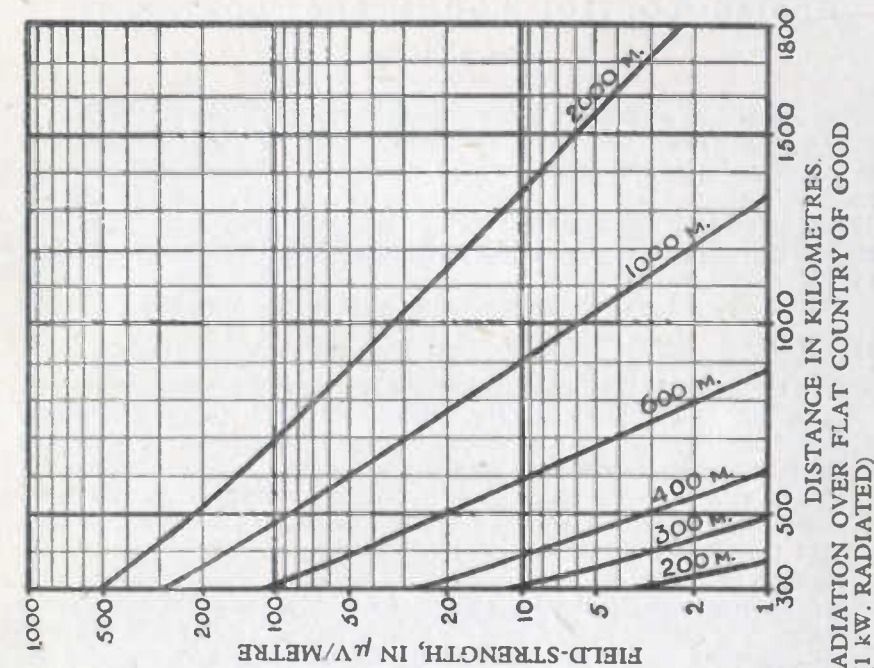

APPENDIX V

MODERN CONTROL ROOMS AND 'CONTINUITY'
WORKING

WITH the advent of the war, and the necessity for the rapid construction of emergency and new control rooms, the modern arrangement differs considerably in layout and principle from the type described in Chapter III. As was mentioned there, the apparatus which was primarily designed for outside broadcast working has filled the breach admirably and, indeed, has now enabled new methods of programme presentation (which were proposed before the war) to be brought into use.

The following extract from an address given by the Assistant Controller (Engineering), Mr. H. Bishop, to the Wireless Section of the Institution of Electrical Engineers, gives a very complete picture of this new equipment.

'The period of two years before the war saw the growth of a new conception in the handling of programme material. New methods of control and switching were proposed and a comparison of the basic differences between the old and the new is of interest.

'The scheme which had been in operation for many years was based on the principle that the studios, artists and producers should be kept apart from the Control Room containing the low-frequency equipment and the engineers operating it. Non-engineering personnel were concerned only with the satisfactory performance before the microphone of the artists in the studio. They were not concerned with the programme as a whole and were not interested except in rare cases in the technical limitations of the apparatus, which might have a profound effect on the programme heard by the listeners.

'Over a long period there was a growing sense that this method of operation was fundamentally wrong. For several years there had been in the BBC a section composed primarily of musicians whose task it was to 'balance' the performers in the studio and to control the dynamic range by means of a potentiometer either in the Control Room or in another room, both of which were some distance from the studio in which the performance was taking place. But these officials were members of the Programme and not of the Engineering Division and, although their value was considerable, the close co-operation so much needed between studio and Control Room was absent.

'It was decided, therefore, to develop control-room equipment operating on an entirely different principle to ensure closer contact between programme presentation and technical operation. A scheme on these lines was worked out in detail and was to be installed in the extension to Broadcasting House which was under construction at the beginning of the war. The carrying out of this major scheme has been delayed, but the essentials of it have been adopted in some of the wartime studio buildings which are now in use.

'The principle of the new scheme is that the control of dynamic range and balance of a studio programme is carried out during both rehearsal and transmission from within the studio's control cubicle, a small room adjacent to the studio. The studio and cubicle are provided with all the necessary technical equipment, to which particular reference is made later, to enable producers to rehearse their programmes both artistically and

technically. Arrangements are made by which any studio can energize its own equipment and hear the output of its microphones in its own cubicle for rehearsal purposes without any manual operation being necessary elsewhere. The control room is not concerned with studio rehearsals, and the producer of the programme is served by a "programme engineer" who is on duty in the studio cubicle during the rehearsal period and who controls the programme during transmission. The programme engineers form the section responsible for balance and control, to which previous reference has been made, but as part of the Engineering Division they are in the closest touch with their colleagues in the control room.

'In the final arrangement of the new scheme (see diagram), the control room becomes mainly an apparatus room, though certain purely technical duties are still performed in it.' (This diagram is not quite the same as that given in A.C.(E)'s address, the Recording Suite having been left out, and a few additions made to the control room.) 'The operational part of the control room under the old scheme is transferred to a number of small rooms known as "continuity suites", each consisting of an operational room and an adjacent studio. The operational room is the main centre for the programme concerned, and the engineer responsible for the continuity of the programme (i.e. fading from one source to another, etc.) is on duty there. With him there is a programme official responsible for the presentation of the programme. The duties of the continuity engineer may be defined as follows:—

- (a) To select the sources of programme;
- (b) To fade and mix these sources as required;
- (c) To distribute the programme to several destinations;
- (d) To maintain aural supervision of the sequence of programmes as a whole.

'Wherever practicable, the dynamic range of the programme is controlled at the point of origin, e.g. in the studio control cubicle as above described or at the outside broadcast point, and the continuity engineer is not required to control except in emergency. The studio adjoining the operational room is provided to enable routine announcements (e.g. the starting and termination of outside broadcasts) to be made without booking a special studio for the purpose. Also gramophone "fill-ups" can be given from the studio, and emergency announcements can be made at short notice.

'To give an example of how a continuity suite is used, let us suppose that a particular programme consists of a studio performance followed by an announcement preceding an outside broadcast. The continuity desk in the operational room allows the engineer to continue transmitting the studio output and at the same time prepare the announcement studio for transmission and listen to the incoming outside broadcast. If the latter is likely to begin late, an interval signal would be required and this would be injected into the programme channel. Channels set up in advance for transmission can be heard on a loudspeaker or headphones by a pre-fade switching arrangement. At the appropriate times the engineer mixes and fades the programme channels. The continuity suite has lamp signalling circuits to local studios and is in telephonic communication with the sources of programme it has selected and with all key points in the engineering chain.

'This brief description illustrates the principles of operation of the new scheme. It has proved very successful in practice in the few places where it has so far been installed, and has been accompanied by the re-design of much of the low-frequency apparatus used in the control room chain.

'There was a tendency in peacetime for broadcasts to become technically over-elaborate. The use of a number of studios for one production was a

growing habit which was catered for to a maximum of 15 channels by a somewhat complicated mixing and control unit known as a "productions panel". With the introduction of local control and the use of larger studios, this multi-studio tendency has largely disappeared and the engineering problems associated with big productions have correspondingly lessened. In any case, the stringencies of wartime broadcasting make such economies essential both as regards accommodation and equipment.

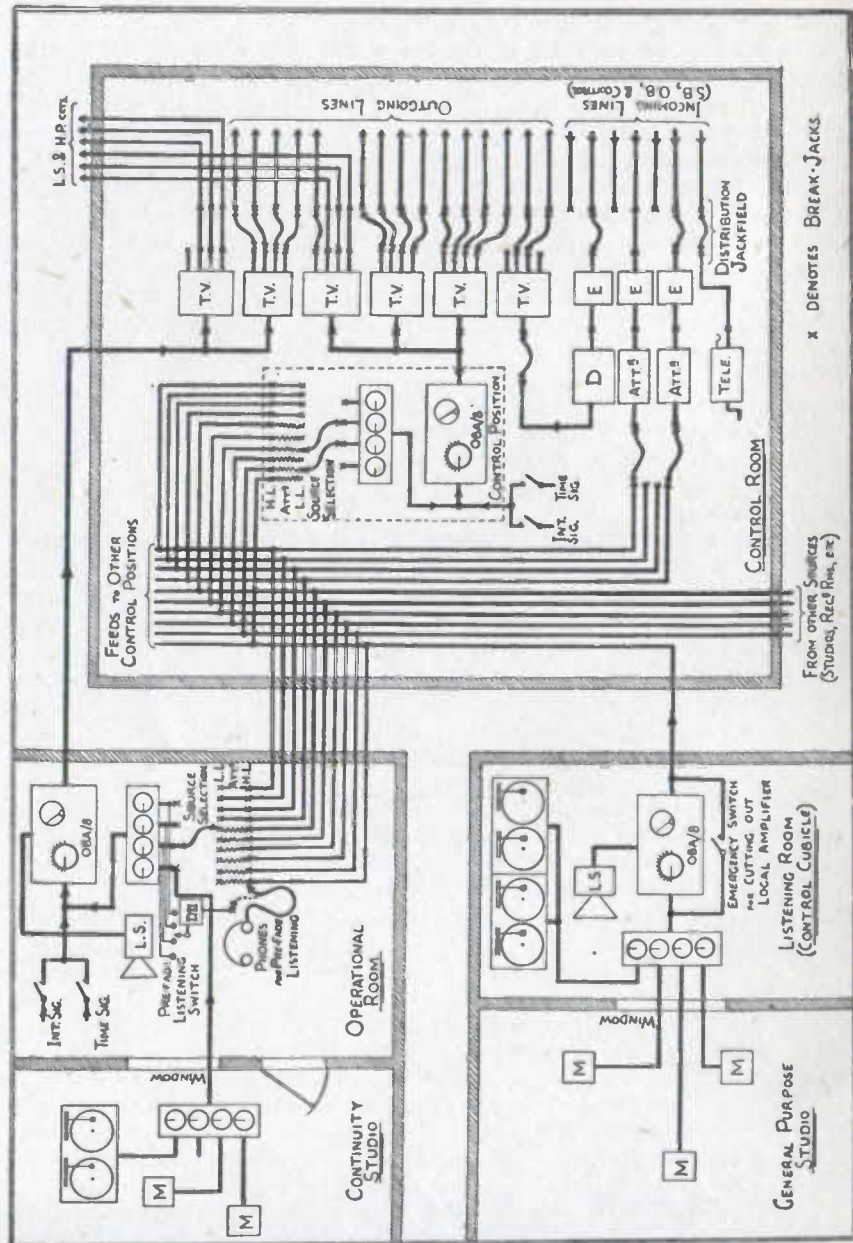

'Pre-war low-frequency equipments were inclined to be elaborate and costly, as they were designed specially to fit the needs of the studio centre concerned. Just recently a considerable measure of standardization has been introduced and has resulted in a reduction of design work and the simplification of manufacture, both urgent necessities in wartime. As a result it is now possible to equip any studio centre with standard bays of apparatus designed to meet almost any likely set of requirements.

'In the bay layout the amplifier bays and control positions are mounted independently of the line termination bays to permit expansion of either section. The layout of the units on the bays is arranged to afford the maximum flexibility, and in many cases space is left for the addition of apparatus if it is desired to increase the operating facilities. A distribution frame is provided through which all circuits, except very low-level circuits, are routed.'

The new method of bay layout mentioned above is worthy of a little attention as it has had a bearing on the development of Continuity working. It has been decided to have a set of 'Standard Bay Assemblies' from which a complete control room can be built up. These bays comprise such arrangements as line termination bays (containing 'U' link panels; repeating coils; fixed equalizers), line distribution jackfields, O.B. termination bays (containing variable equalizers, attenuators, etc.), control line bays, amplifier bays ('D' and 'T.V.' amplifiers), A.C. and other test bays, and a control position bay. This latter bay is the one which particularly interests us, and most of the apparatus on it is shown within the dotted enclosure in the Figure. A complete view of several of these bays is shown in the photograph of part of a modern control room (Plate XV) and a description of one of them will be given in greater detail soon. The main point to notice is that it is one of these control positions that has been taken out of the control room (Plate XVI) and placed in the Continuity Suite. The operator who sits at this control position is supplied with all the usual sources of programme (studio outputs, recording rooms, lines from O.B.'s, and other Studio Centres) and these appear on a row of 20 jacks. The majority of these sources appear at high level ('H.L.' on the diagram) and this provides the additional facility of being able to 'Pre-fade Listen'. This high level has then to be reduced in order to bring it down to the - 75 db. required for the input of the Control O.B.A./8. Attenuators are therefore provided to effect this reduction, and the sources again appear on the strip of low level (L.L.) jacks, whence they may be plugged to any of the four channels of the mixer.

Those sources which do not appear at high level (such as O.B. and S.B. lines) would not normally give the facility of pre-fade listening, so this is accounted for by providing a special pre-fade listening amplifier. Actually it is a 'D.11', which is a 2-stage general purpose amplifier, and is made switchable across any of the four mixer input channels. This is depicted on the diagram in the Continuity Suite only, but in practice it will be incorporated on all standard control positions.

It will be seen that the output from a General Purpose studio will be at + 4 db., this being the output level of its own local amplifier. If this amplifier were to fail (e.g. by reason of a 'mains' failure) then the studio output would also be cut off. Provision is made against this by providing a short-circuiting switch. When this is made the output of the studio now arrives at the H.L. jack at - 75 db. However, the Operator would be aware of this and would now plug the mixer input to this jack. The control of the programme would now pass to the control position instead of being done in the listening room.

In the diagram, only one control position is shown in the control room, but of course there may be more than this—depending on the importance of the studio centre. This is also true of the number of continuity suites, and these may vary in complexity. The one depicted is fairly complicated, as it includes two microphones, a gramophone desk and a separate mixer; but it is quite likely that a more simple arrangement will be found, using only one microphone plus the mixer incorporated in the T.D./7B.

In certain cases provision will be made for the playing of 33 $\frac{1}{2}$ r.p.m. discs, and in this case, the arrangement shown would suffice, as there is a spare channel on the mixer.

BIBLIOGRAPHY

FUNDAMENTAL PRINCIPLES, PHYSICS, MATHEMATICS, GENERAL ELECTRICITY, ETC.

- Communication Engineering (Second edition, 1937).* W. L. Everitt
The Mathematics of Wireless. Ralph Stranger
Mathematics for the Million (Thirteenth edition). L. Hogben
Science for the Citizen. L. Hogben
Elementary Mathematics for Wireless Operators. W. E. Crook
The Admiralty Handbook of Wireless Telegraphy (Vols. 1 and 2, 1938 edition)
Electrical and Radio Notes for Wireless Operators (Air Ministry Publication No. 1762)
Foundations of Technical Electricity. E. Mallett and T. B. Vinycomb
The Outline of Wireless. Ralph Stranger
A Guide to Amateur Radio. Radio Society of Great Britain (yearly)
Radio Handbook Supplement (1942). Radio Society of Great Britain
The Radio Amateur's Handbook. American Radio Relay League (yearly)
The Antenna Book. American Radio Relay League

GENERAL BROADCASTING PRACTICE

- Sir N. Ashbridge: Presidential Address to the Institution of Electrical Engineers.* I.E.E. Journal, Vol. 89. January, 1942
H. Bishop: Chairman's Address to the Wireless Section of the Institution of Electrical Engineers. I.E.E. Journal, Vol. 89. January, 1942
High Quality Radio Broadcast Transmission and Reception (Part I). Stuart Ballantine, Proc. I.R.E., Vol. 22. No. 5. May, 1934
High Quality Radio Broadcast Transmission and Reception (Part II). The Receiving System. Stuart Ballantine, Proc. I.R.E., Vol. 23. No. 6. June, 1935

SOUND AND ACOUSTICS

- Hearing in Man and Animals.* R. J. Beatty
Speech and Hearing. H. Fletcher
Science and Music. Sir J. Jeans
A Fugue in Cycles and Bels. J. Mills
The Acoustical Design of Broadcasting Studios. H. L. Kirke and A. B. Howe, I.E.E. Journal. Vol. 78. April, 1936

Thermionic Valves in Modern Radio Receivers. A. T. Witts

Theory of Thermionic Vacuum Tubes. B. L. Chaffee

(Much useful information on this subject will be found in the books already mentioned under general electrical theory)

TELEPHONY AND LINES

Telegraphy and Telephony (1929). E. Mallett

Telephony (Second edition, 1932). T. E. Herbert and W. S. Procter

The Practical Telephone Handbook (Seventh edition, 1927). J. Poole

Telephonic Transmission. J. G. Hill

TRANSMITTERS AND PROPAGATION

Radio Communication, I and II (Third edition, 1940). J. H. Reyner

Radio Engineering (Second edition, 1937). F. E. Terman

Principles of Radio Communication (Third edition, 1933). J. H. Morecroft

Short Wave Wireless Communication (Fourth edition, 1942). A. W. Ladner and C. R. Stoner

The Design of Transmitting Aerials for Broadcasting Stations. P. P. Eckersley, T. L. Eckersley, and H. L. Kirke, I.E.E. Journal, Vol. 67. April, 1929

A Wireless Broadcasting Transmitting Station for Dual Programme Service. P. P. Eckersley and N. Ashbridge, I.E.E. Journal, Vol. 68. Sept., 1930

The Droitwich Broadcasting Station. Sir N. Ashbridge, H. Bishop, and B. N. MacLarty, I.E.E. Journal, Vol. 77. Oct., 1935

The Empire Service Broadcasting Station at Daventry. L. W. Hayes and B. N. MacLarty, I.E.E. Journal, Vol. 85. Sept., 1939

Direct Ray Broadcast Transmission. T. L. Eckersley, Proc. I.R.E. Vol. 20. No. 10. Oct., 1932

Analysis of the Ionosphere. Karl K. Darrow, Bell System Technical Journal, Vol. 19. July, 1940

The Sun and the Ionosphere (Thirty-second Kelvin Lecture). Prof. S. Chapman, I.E.E. Journal, Vol. 88. Nov., 1941

Ionosphere Measurements at Washington. Proc. I.R.E. (monthly) up to end of 1941

RECORDING SYSTEMS

The Marconi-Stille System. Marconi Review, Jan., 1934

The Philips-Miller Method. Vermeulen (Journal of Society of Motion Picture Engineers, June, 1938)

Some Aspects of Magnetic Recording and its application to Broadcasting. A. E. Barrett and C. J. F. Tweed, I.E.E. Journal, Vol. 82. March, 1938

INDEX

A-A, B-B LOOP, 123
 'A' amplifier, 57, 81, 101
 'ABAC' calculator, 213
 Absorption of electromagnetic waves, 163
 Absorption of sound, 40
 Acoustic method of recording, 189
 Acoustics, 39-41
 A.C., separation from D.C., 52
 Aerial designation, 180
 Aerials, 134, 169-181
 Aerial slewing, 180
 Aerial switching, 180
 Æther, The, 59
 Air blast cooling, 156
 Air pressure, 33
 Alarm circuit, 85
 Alternating current, Definition of, 19
 Ampere, unit of current, 11
 Amplification factor, 97, 98
 Amplifier detector, 128
 Amplifier, Valve, 95
 Amplitude modulation, 139
 Angle of incidence (sky waves), 167
 Anode choke modulation, 140
 Anode current/grid volts graph, 96
 Anode of valve, 92, 155
 Anti-near-fading aerial, 172
 Apparatus bays, 77
 Apparatus jack, 80
 Appleton layer, 167
 Artificial music, 38
 Atoms, 7
 Attenuation of electromagnetic waves, 162, 215
 Attenuator, Gramophone, 77
 Average level, 71, 158
 Average loss of a control potentiometer, 48, 57

BACKWARD ECHO, 179

Balanced line, 59, 74, 116
 'B' amplifier, 57, 102
 Band-pass circuit, 146
 Bandwidth, 145
 Bass correction, 76
 Bathroom acoustics, 39
 Batteries, 9
 Battery bias, 96
 Beam transmission, 177
 Bell, Alexander Graham, 43
 Bel, The, 44
 Berliner gramophone, 188
 Bias, 96
 'B' input switching, 57, 82
 Blasting of microphones, 64, 66
 Blattnerphone, 183
 Block schematic drawing, 54
 Breakjack, 78
 Bridge Megger, 126
 Bridge, Wheatstone, 124
 Broadcasting chain, 54-59

Broadside array, 176
 B.T.H. microphone, 63
 Bunching of loaded lines, 111
 By-pass condenser, 97, 104, 149

CALIBRATION OF AMP. DET., 129

Calibration of P.P.M., 107
 'C' amplifier, 58, 102
 Capacitance, 24, 29, 109, 208
 Capacity, Lumped—of an aerial, 171
 Capacity of line, 109
 Carbon microphone, 50, 63
 Carrier wave, 139
 Cathode bias, 97
 Cathode of valve, 92
 Catswhisker, 150
 C.A.T. valve, 155
 Centre-tapped repeating coil, 118
 Chain, Broadcasting, 54-59
 Channel, Definition of, 61
 Channel, Recording, 194
 Characteristic of line, 110, 114
 Chemical compound, 7
 Chemical method of generating electricity, 9
 Chiffon cover for ribbon microphone, 68
 Choke modulation, 140
 'C' input switching, 58
 Class 'A' amplification, 102, 142
 Class 'B' amplification, 102, 142
 Class 'B' modulation, 142
 Commutator, 153
 Complex waves, 37, 146, 152
 Compounds, 7
 Compression of volume range, 47, 57, 158
 Compressor, 157
 Condenser, 24, 29, 109
 Condenser, By-pass, 97, 104, 149
 Condenser discharge, 24, 135
 Conductivity of earth and sea, 163
 Conductor, Definition of, 8
 Constant impedance equalizer, 115
 Constant impedance potential divider, 74
 Continuity working, 216
 Contour, Radio field—map, 173
 Control of volume, 46, 57
 Control position, 57, 219
 Control potentiometer, 57, 73
 Control room, 56, 217
 Coupled circuits, 146
 Critical frequency, 167
 Cross-talk, 116
 Crystal detector, 150
 Crystal drive, 151
 Crystal oven, 152
 Cue lights, 61, 85
 Current distribution (aerial), 171
 Current, Generating an electric, 9
 Current, Unit of, 11
 Cut-off effect, 110
 Cutter head (disc), 191
 Cutter, Sapphire, 192, 198

DAMPING, MECHANICAL, 192
'D' amplifier, 58, 102
Daylight transmission, 162
D.C. machines, High Voltage, 153
D.C. separation from A.C., 52
Dead side of microphone, 67
Decibel, 44, 68, 210
Decibel; zero level, 69, 210
de Forest, Lee, 94
Designation of aerials, 180
Detection, 150
Detector, Amplifier, 128
Detector, Crystal, 150
Diode, 91
Diode detector, 150
Diode rectification, 150
Dipole, 170
Direct current, Definition of, 19
Directional aerials, 176
Directional properties of microphones, 64, 66, 67
Disc cutter head, 191
Disc editing, 194
Disc recording, 188-198
Disc, 33½ r.p.m.—recording, 196
Distortion, Frequency, 58, 112
Distortion, Harmonic, 115, 143
Distortion on recording systems, 182
Double-diode, 103, 106
Double-diode detector, 150
Double-ended cord, 79
Drives, Crystal, 151

EARTH CONDUCTIVITY, 163

Earth return circuit, 16
Echo room, 60
Echo, Round-the-World, 179
Edison effect, 90
Edison, Thomas (recording), 188
Editing, Disc, 194
Editing, Film, 201
Efficiency, 10
Efficiency of transmitters, 142
E.H.T., 153
'E' Layer, 167
Electric current, Generation of, 9
Electric field, 131
Electrolytic condenser, 104
Electrolytic effect, 10
Electromagnetic generator, 18
Electromagnetic interference, 75
Electromagnetic waves, Production of, 131
Electromagnetism, 18-23
Electromotive force, Definition of, 9, 11
Electron drift, 8
Electron theory, 7, 92
Electrons, Free, 8, 92
Electrostatic field, 131
Electrostatic interference, 75
Elements, 7
Elevation angle, 167
Emergency control room, 62
End-on array, 176
End-on radiation, 170
Energy, 10, 11
Engaged lamp, 84
Equalization, 58, 112
Equalizers, Fixed, 115
Equalizers, Variable, 115
Everyday sounds, Relative levels of, 45

FADE UNIT, 71
Fading of medium waves, 163
Feed-back, 137
Feed-back, Negative, 104, 143
Feeder, 169, 176, 178
Field contour map, 173
Field strength measurements, 161
Fifth, Musical, 37
Filament of valve, 90, 155
Filament seal, 155
Film editing, 201
Film recording, 198-201
Filter, Scratch, 76, 197
Fixed equalizers, 115
'F' layer, 167
Fleming, Ambrose, 91
Forest, Lee de, 94
Formulae, 208
Forward echo, 179
Fourier analysis, 38
Free electrons, 8, 92
Frequency, 20, 22, 209
Frequency, Critical, 167
Frequency, Dependence of current on, 29
Frequency, Dependence of impedance on, 29
Frequency, distortion, 58, 112
Frequency multiplication, 152
Frequency of electromagnetic waves, 133
Frequency of sounds, 35
'Fullness' in music, 39
Fuse alarm, 85

GAIN CONTROL, 100

Gain, expressed in decibels, 68
Galvanometer, 125, 128
Generation of an electric current, 9
Generation of heat, 10
Generator, Electromagnetic, 18
Gramophone unit, 76, 194
Graph of E_g/I_a , 96
Graph of sound pressure wave, 36, 38
Graphs, Practical, 26
Graphs, Use of, 25
Grid bias, 96, 142, 155
Grid current, 96, 142
Grid of valve, 94, 156
'Grid' supply, 155
Groove locating unit, 195
Ground waves, 163

HALF-WAVE AERIAL, 170

Hammond organ, 38
Hard valve, 98
Harmonic analysis, 38
Harmonic distortion, 115, 143
Harmonic generator, 152
Harmonics, 37
Harrison (disc recording), 189
Heads, Recording machine (film), 199
Heads, Recording machine (tape), 184
Hearing, The Sense of, 33
Heat, Generation of, 10
Heaviside, Oliver, 110, 166
High frequency amplification, 151
High frequency, Generation of, 135
High power modulation, 141
High voltage machines, 153
Hill-and-dale recording, 188, 198
Horizontal aerial, 170

Horizontal polar diagram, 173
Horizontal polarization, 134, 169
Horsepower, Definition of, 11

IMAGE AERIAL, 170

Impedance, 23, 209
Impedance matching, 65, 66, 209
Indirectly heated valve, 92, 97
Induced voltage, 20, 75, 117
Inductance, 23
Inductance calculations, 208
Inductance, Lumped, 171
Inductance of line, 110
Induction, Self-, 23
'Inner' contacts of jack, 79
Insulation resistance, 122
Insulator, Definition of, 8
Intensity of sound, 41
Interference on lines, 117
Internal resistance of cells, 15
Interval, Musical, 37
Inverted 'L' aerial, 171
Ionization, 167
Ionosphere, The, 167

JACK, 78

Jumper wiring, 77

KENNELLY, PROF., 166

LACQUER, DISC, 189
Lateral-cut recording, 188, 192
Lead screw, 192
Leakage resistance, 122
Limiter, 156
Line characteristics, 110, 127
Line jack, 80
Listening room, 54
Listen jack, 80
Loaded line, 111
Loading coils, 111
Logarithms, 45
Longitudinal currents, 76
Long wave aerials, 172
Looping of lines, 123
Loop resistance of lines, 12, 126
Loop resistance tests, 123
Loss, Average (of a Potential divider), 48, 57
Loss, expressed in decibels, 68
Loudness, 41
Loudspeaker amplifier, 102
Loudspeaker, General principle of, 22
Low-frequency choke, 140, 144
Low-power modulation, 141
Lubricant, Disc, 190
Lumped capacity of an aerial, 171
Lumped inductance of an aerial, 171

MAGNET, CIRCULAR, 64

Magnetic field, 18, 131
Magnetism, 17
Magnification, Mechanical, 199
Main distribution frame, 77
'Mains' rectification, 103
Manual switching keys, 83
Marconi aerial, 170
Marconi-Stille recording machine, 183-188
Matching transformer, 65, 66
Matter, Structure of, 7
Maxwell (disc recording), 189

Medium wave aerials, 171
Megger, 123
Megohm, Definition of, 12
Mercury arc rectifiers, 154
Microphone, Carbon, 50, 63
Microphone, General principles of, 22
Microphone, Moving coil, 64
Microphone output levels, 71
Microphone, Ribbon, 66
Microphone transformer, 65, 66
Mixers, 71, 86
Mixers, Potential divider type, 73, 76
Mixers, Series type, 71
Modulation, 138-145, 212
Molecule, 7
Motor generator sets, 153
Moving coil microphone, 64
Multi-hop transmission, 167
Multi-stage amplifier, 98

'NARROWCASTING', 177

Near-fading area, 164
Negative charge, 8
Negative feed-back, 104, 143
Network calculations, Resistance, 14
Night transmission, 162
Noise, 46, 116, 165
Noise currents, 75, 117
'Normal' wiring, 79
Novachord, 38

OBA/8, 60, 104

Octave, Musical, 37
Ohm's law, 11, 208
Ohm's law, graph of, 28
Ohm, the unit of resistance, 11
Oscillator, 127, 136
Oscillatory discharge, 135
Oscillograph, 27
'Outer' contacts of jack, 79
Out-of-balance test, 126
Outside broadcasts, 60
Overall response, 183
Overtones, 37

'PACKING' OF CARBON MICROPHONE, 64

Parallel connection of cells, 15
Parallel connection of resistances, 13
Paralleling amplifiers, 14, 80
Partial rectifier, 150
Peak programme meter, 105
Pentode, 98
Permanent wiring, 78, 81
Phantom circuits, 118
Philips-Miller film recording, 198-201
Phon, 46
Phonograph, 188
Photo-electric cell, 200
Pick-up, Reproducing, 193
Piezo-electric effect, 151
Plugs, 78
P.O. 'Clock', 121
Point-to-point transmission, 177
Polar diagrams, 173, 174
Polarization of waves, 134, 169
Polarity of magnet, 17
Pole pieces, 184
Positive charge, 8
Potential, Definition of, 9, 15
Potential difference, 15

Potential divider, 17, 47, 73
Potentiometer, 17, 47, 73
Poulsen, Prof., 183
Power, Definition of, 11
Power distribution diagram, 175
Power, Unit of, 11, 208
Pre-fade listening, 196, 218
Pressure changes of air, 33
Pressure waves, 35
Primary cells, 9
Primary service area, 163
Private wiring, 84
Processed discs, 189, 198
Production panel, 61, 218
Programme meter, 57, 105
Programme meter scale, 48
Propagation of medium and long waves, 161-165
Protective devices, 159
Protons, 8
Pulsating D.C., 52, 95, 185
Push-pull amplifier, 102, 142

QUADS, 119
Quality, 37
Quality of recording systems, 188, 194, 197, 201
Quarter-wave aerial, 170
Quartz crystal, 151

RACK-MOUNTED APPARATUS, 78
Radio field contour map, 173
Ratio arms of bridge, 126
Reactance, 23, 209
Reception of electromagnetic waves, 137, 149
Recording drum (film), 199
Recording head, 184, 191, 199
Rectification, 91, 103
Rectification of R.F. currents, 150
Reflection of electromagnetic waves, 166
Reflection of sound, 39
Reflector, Aerial, 179
Reisz microphone, 63
Relay, 21, 82, 83
Repeaters, 59, 120
Repeaters, Two-way, 120
Repeating coil, 56, 76, 116
Reproducing desk, 194
Reproducing head, Tape, 185
Reproducing mechanism, Film, 200
Resistance, loop, 12, 126
Resistance of cells, Internal, 15
Resistances in parallel, 13, 208
Resistances in series, 12, 208
Resistance, Unit of, 11
Resistance, Variable, 47, 56, 71
Resistor Colour Code, 207
Resonance, Diaphragm, 63
Resonance of tuned circuit, 112, 136, 152, 209
Response of disc system, 194, 197
Response of microphones, 64, 65, 67
Response, Overall, 183
Retentivity, 18
Reverberation, 39
Ribbon microphone, 66

SABINE, PROF. C., 40
Sapphire cutters, 192, 198
Saturation current of valve, 93

Saturation, Magnetic, 185
Scale of loudness, 44
Scratch filter, 76, 197
Screened cable, 56, 65
Screen grid valve, 98
Sea conductivity, 163
Secondary cells, 9
Secondary service area, 163
Selection by tuned circuit, 138
Selectivity, 148
Self-induction, 23
Sending amplifier, 58, 102
Sending circuit, 127
Series commutation, 153
Series connection of cells, 14
Series connection of resistances, 12
Series modulation, 141
Service area, 163
Sharply tuned circuit, 145
Short-wave aerial, 172, 176-181
Short-wave propagation, 165
Side-bands, 147
Side circuits, 119
Side-tone, 53
Signal lights, 61, 85
Signal-to-noise ratio, 46, 116, 165
Simultaneous broadcast, 54
Sine wave, 27, 36, 152
Sky waves, 164
Sleeve circuit, 79
Slewed aerial, 180
Smoothing circuit, 103
Soft valve, 98
Solenoid, 18
Sound, Nature of, 33-38
Speed control, Tape machine, 186
Speed control, Turn-table, 190
Standard bay assemblies, 219
Static electricity, 9
Static, Man-made, 165
Steel tape recording, 183-188
Stille, Dr., 183
Stroboscope, 190
Stud-by-stud potentiometer, 72
Studio centre, 54
Studio equipment, 54
Studios, Acoustic treatment of, 40
Surface noise of records, 47, 197
Switching, Programme, 82
Symbols, Standard, 204-207

'T' AERIALS, 171
Tag-blocks, 77
Talk back arrangement, 60
T.D./7, 194
Telephone, General principle of, 22, 50
Telephone receiver, 51
Telephone, Simple circuit of, 51
Telephone transformer, 52
Telephone, Two-way, 52
Temperature chart, 25
Temperature coefficient, 152
Testing lines, 121-129
Test programme meter, 129
Tetrode, 98
Thermo-couple, 128
Thermo-electric effect, 128, 150
Thermophone, 41
33 $\frac{1}{3}$ r.p.m. disc recording, 196
Thomson, J. J., 90
Threshold of feeling, 42

Thyratron, 187
Timbre, 38
Tone source, 127
Transformer construction, 20
Transformer coupling, 98, 143
Transformer, Matching, 65, 209
Transformer, Microphone, 65
Transformer, principle of working, 20
Transformer, Telephone, 52
Transformer, Voltage ratio of, 20
Trap valve, 58, 102
Trigger action, 98
Triode amplifier, 95
Triode, Development of, 93
Tuned circuit, 112, 136, 138, 152, 209
Tuning fork as source of sound, 35
Tuning fork drive, 152
Turn-table speed, 190

UNBALANCED CIRCUIT, 76
Unbalance test, 126

VACUUM, DEGREE OF—IN A VALVE, 98
Valve amplifier, 95
Valve coupling, Resistance-capacity, 99
Valve coupling, Transformer, 98
Valve detector, 150
Valve, Development of, 90
Valve oscillator, 136
Valve, Transmitting, 155
Variable area recording, 199
Variable equalizers, 115
Variable gain amplifiers, 100

Varley test, 120
Velocity of electromagnetic waves, 133
Velocity of sound, 35
Vertical aerial, 134, 170
Vertical polar diagram, 173
Vertical polarization, 134, 169
Voltage, Definition of, 9, 11
Voltage ratio of transformer, 20
Volume compression, 47, 57, 158
Volume, Control of, 46, 57
Volume measurement, 48
Volume range, 46

WARTIME CONTROL ROOM, 62, 216
Water cooling, 155
Watt, unit of power, 11
Wave-band, 148
Wavelength of electromagnetic waves, 133, 210
Wavelength (sound waves), 35
Wave motion as applied to sound, 34
Wheatstone bridge, 124
Wiping head, 184
Wireless 'waves', 59, 131-135
Wiring, Control room, 77
Wiring, Jumper, 77
Wiring, Permanent, 78
'Wow', 186, 190

ZERO ADJUSTMENT OF P.O. 'CLOCK', 121
Zero adjustment of P.P.M., 107
Zero level, 69, 210
Zero volume, 107