

"Amateur Wireless" Handbooks

CRYSTAL RECEIVING SETS

And How to
Make Them

Fully
Illustrated

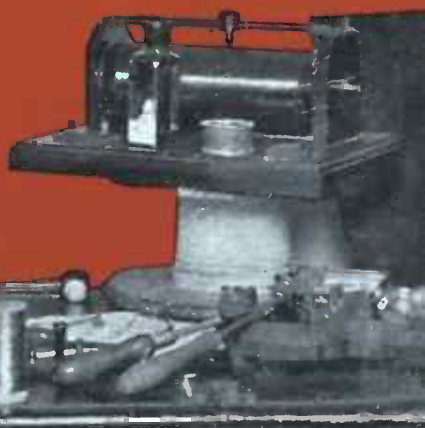

The Best Paper for Wireless Amateurs

Amateur Wireless And Electrics

The Leading Weekly

Devoted exclusively to the interests of Wireless Amateurs; explains the Underlying Principles; Makes the Way Plain to Beginners; Shows them How to Start; What to Do; What to Buy; What to Make, and How to Make It. Gives Expert Replies to Readers' Questions; no matter what the difficulty is, the Reader is helped out of it by Highly Skilled Experts; Wireless Club and Society Fixtures; and the Latest News of Wireless Developments. Fully illustrated by Helpful Diagrams and Photographs. 

Every
Thursday

3^{D.}

ON SALE EVERYWHERE

Cassells, Publishers, London.

SIMPLE CRYSTAL RECEIVING SETS AND HOW TO MAKE THEM

EDITED BY
BERNARD E. JONES

Editor of "Amateur Wireless," etc. etc.

WITH 114 ILLUSTRATIONS

CASELL AND COMPANY, LTD
London, New York, Toronto and Melbourne

PREFACE

THIS Handbook deals, in a simple, straightforward manner, with the making of a number of different kinds of crystal sets representative of those in present-day use. It is uniform in style and price with other members of the "Amateur Wireless" Handbook Series, notably with two of them, namely "Wireless Component Parts and How to Make Them" and "Simple Valve Receiving Sets and How to Make Them," the former containing detailed instructions on the making of the various components forming part of many kinds of wireless receiving apparatus, and the latter treating of valve sets in exactly the same way as crystal sets are dealt with in this present Handbook.

This book has been compiled from the pages of "Amateur Wireless," the well-known weekly journal for wireless amateurs, and the name of the author responsible for each of the various chapters is given in many cases immediately below the chapter heading.

It is believed that the information is presented in such simple fashion as not to cause the reader any trouble when putting it into practice, but should he be in difficulty with regard to any matter dealt with in this book, or to any other subject within the scope of the weekly journal mentioned, he should send a query to "Amateur Wireless," La Belle Sauvage, London, E.C.4, *but should take particular care to accompany his query with a stamped and addressed envelope and a coupon from the current issue of that journal.*

THE EDITOR.

CONTENTS

CHAPTER	PAGE
1. A SIMPLE AND EFFICIENT RECEIVING SET	1
2. A SINGLE-SLIDER SET	16
3. SET WITH SEMICIRCULAR TUNER	25
4. CRYSTAL SET WITH TAPPED SINGLE COIL.	33
5. A LOOSE-COUPLED SET	45
6. SET WITH PLUG-IN BASKET COILS	58
7. COMBINED CRYSTAL AND VALVE RECEIVER	68
8. SOME MINIATURE RECEIVING SETS	73
9. CRYSTAL CIRCUITS	85
10. HOW CRYSTALS WORK	91
11. MAKING A BUZZER	99
12. RECEIVING C.W. SIGNALS ON A CRYSTAL SET	103
13. MAKING A WAVEMETER FROM A CRYSTAL SET	108
14. CONVERTING LOW-RESISTANCE PHONES	111
15. THE MORSE CODE	121
INDEX	124

SIMPLE CRYSTAL RECEIVING SETS AND HOW TO MAKE THEM

CHAPTER I

A Simple and Efficient Receiving Set

As the result of recent experiments conducted in the United States of America to produce an efficient crystal receiving set that at the same time would be reason-

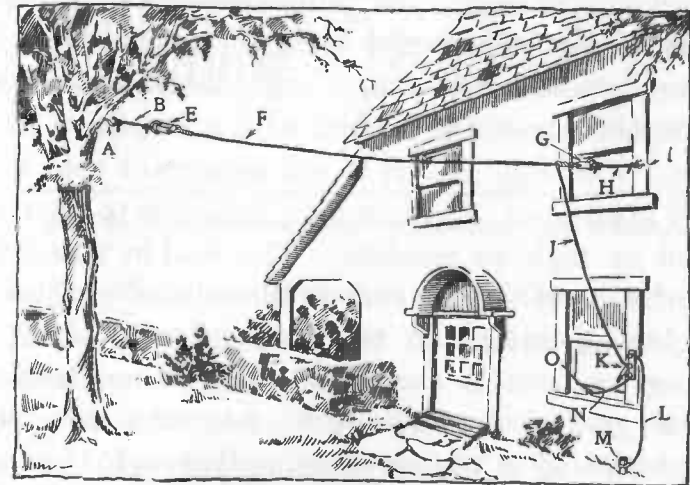

Fig. 1.—General View of the Aerial and its Supports and Connections.

ably simple and inexpensive to make, a circular was issued by the American Bureau of Standards giving constructional details of a set evolved in accordance with the result of those experiments. The set, it is

CRYSTAL RECEIVING SETS

thought, forms a fitting introduction to this book. It has been made by thousands of people, including hundreds of readers of "AMATEUR WIRELESS," and its efficiency is well proved by ample practical experience.

Elements of the Set.—In this receiving set there are five essential parts: the aerial, lightning switch, ground or earth connection, tuner and detector, and telephone receivers, and the construction of each (excluding the last-named, which, of course, must as a rule be purchased) is described under its proper heading.

The details regarding the aerial and earth hold true for any set, but it must be remembered that the aerial, both as regards type and system of erection, is largely dependent upon individual circumstances.

The Aerial.—The aerial is simply a wire suspended between two elevated points, and should not be less than 30 feet above the ground with a length of about 75 feet. (See Fig. 1.) It is not important that it be strictly horizontal. It is, in fact, desirable to have the far end as high as possible. The lead-in wire from the aerial itself should run as directly as possible to the lightning switch. If the position of the adjoining buildings or trees is such that the distance between them is greater than about 85 feet, the aerial can still be held to a 75-foot distance between the insulators by increasing the length of the piece of rope (B) to which the far end is attached. The rope (H) securing the aerial insulator to the house should not be lengthened to overcome this difficulty, because by so doing the lead-in wire (J) would be lengthened.

AN EFFICIENT RECEIVING SET

The parts will be referred to by reference to the letters appearing in Figs. 1 and 2.

A and I are screw eyes sufficiently strong to anchor the aerial at the ends. B and H are pieces of rope $\frac{3}{8}$ in. or $\frac{1}{2}$ in. in diameter, just long enough to allow the aerial to swing clear of the two supports. B is a piece of $\frac{3}{8}$ -in. or $\frac{1}{2}$ -in. rope sufficiently long to

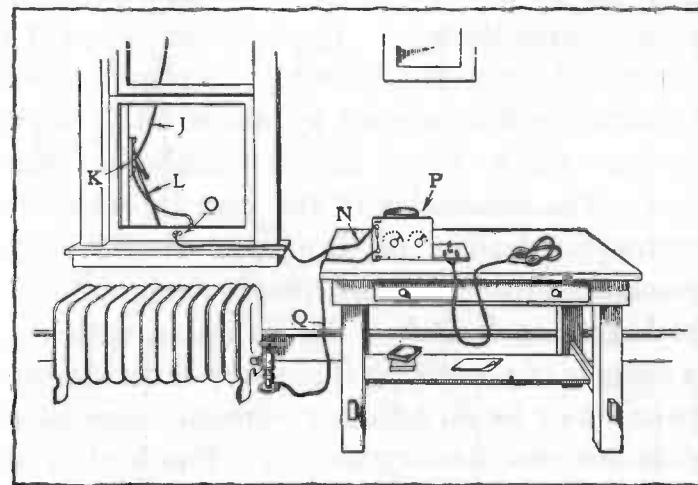

Fig. 2.—The Receiver and its External Connections.

make the distance between E and G about 75 feet. A single-block pulley may be used, but is not really essential.

E and G are two insulators which may be constructed of any dry hardwood of sufficient strength to withstand the strain of the aerial; blocks about $1\frac{1}{2}$ in. \times 2 in. \times 10 in. will serve. The holes should be drilled, as shown in Fig. 1, sufficiently far from the ends to give proper strength. If wood is used the insulators should be boiled in paraffin wax for about

CRYSTAL RECEIVING SETS

an hour. If porcelain wiring cleats are available they may be substituted instead of the wood insulators. If any unglazed porcelain is used as insulators, it should be boiled in paraffin wax in the same way as the wood. The wire for the aerial may be No. 14 or 16 copper wire either bare or insulated. The end farthest from the receiving set may be secured to the insulator (E) by any satisfactory method, care being taken not to kink the wire. Draw the other end of the wire through the other insulator (G) to a point where the two insulators are separated by about 75 ft.; twist the insulator (G) so as to form an anchor as shown in Fig. 1. The remainder of the wire (J) which now constitutes the lead-in or drop-wire should be just long enough to reach the lightning switch.

The Lightning Switch.—The lightning switch κ is for the purpose of protecting the system from lightning. This switch may be an ordinary porcelain-base, single-pole double-throw battery switch. The lead-in wire (J) is attached to this switch at the middle point. The switch blade should always be thrown to the upper clip when the receiving set is not actually being used and to the lower clip when it is desired to receive signals.

The Earth Lead.—L is the earth wire for the lightning switch; it may be a piece of the same wire as used for the aerial, of sufficient length to connect the upper clip of the lightning switch (κ) to the clamp on the earth rod (M), which is a piece of iron pipe or rod driven 3 ft. to 6 ft. into the ground, preferably where the ground is moist, and extending a sufficient

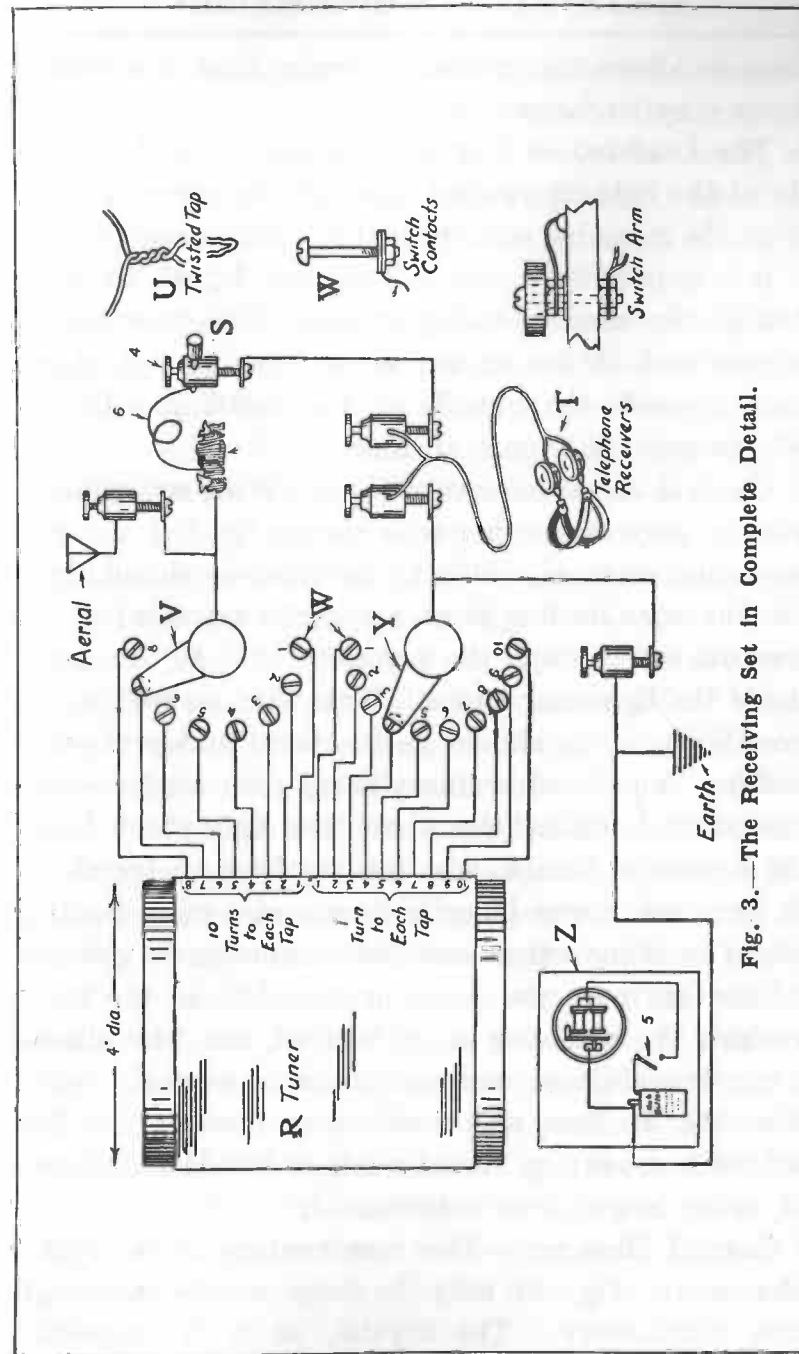

CRYSTAL RECEIVING SETS

distance above the ground in order that the ground clamp may be fastened to it.

The Lead-in.—N is a wire leading from the lower clip of the lightning switch through the porcelain tube (o) to the receiving set terminal marked aerial (Fig. 3).

o is a porcelain tube of sufficient length to reach through the window casing or wall. This tube should be mounted in the casing or wall so that it slopes down towards the outside of the building. This is done to prevent ingress of rain.

General Arrangement.—The receiving set installed in some part of the house is shown by Fig. 2. P is the actual receiver, which is described in detail later. N is the wire leading from the aerial terminal of the receiving set through the porcelain tube to the lower clip of the lightning switch. This wire, as well as the wire shown by Q, should be insulated and preferably flexible. A piece of ordinary hemp cord might be unbraided and utilised for these two important leads. Q is a piece of flexible wire leading from the receiving set terminal marked earth to a water-pipe, heating system or some other metallic conductor to ground. If there are no water-pipes or radiators in the room in which the receiving set is located, the wire should be run out of doors and connected to a special earth below the window, and which may consist of a few yards of wire netting buried a few inches deep in damp soil, or an iron rod as mentioned.

Crystal Detector.—The construction of a crystal detector (s, Fig. 3) may be very simple although quite satisfactory. The crystal, as it is ordinarily

AN EFFICIENT RECEIVING SET

purchased, may be unmounted or mounted in a little block of metal. For mechanical reasons the mounted type may be more satisfactory, but that is of no great consequence. It is very important, however, that a good crystal be used. It is probable also that a galena crystal will be the most satisfactory.

The crystal detector may be made up of a tested crystal, three wood-screws, a short piece of copper wire, a nail, setscrew type of terminal, and a wooden knob or cork. The crystal is held in position on the wooden base by three brass wood-screws, as shown in Fig. 4. A bare copper wire may be wrapped tightly round the three brass screws for contact. The assembling of the rest of the crystal detector is quite clearly shown in Fig. 4. If, however, the reader wishes to adopt any other type of detector, he will find almost every type illustrated and explained in "Wireless Component Parts, and How to Make Them," uniform in style and price with the present volume.

Telephones.—It is desirable to use a pair of telephone receivers connected by a head band, usually called a double telephone head-set (T, Fig. 3). The telephone receiver may be of any of the standard commercial makes having a resistance of between 2,000 and 3,000 ohms. The double telephone receivers will cost more than all the other parts of the station combined, but it is desirable to get them, especially if one intends to improve the receiving set later. A single telephone receiver with a head band may be used, though it gives results somewhat less satisfactory.

CRYSTAL RECEIVING SETS

Accessories.—Under the heading of accessory equipment may be listed terminals, switch-arms, switch-contacts, test-buzzer, dry battery, and boards on which to mount the complete apparatus. The terminals, switch-arms and switch-contacts may all be readily purchased. There is nothing peculiar about the pieces of wood on which the equipment is mounted, except that they should be soaked in melted paraffin wax for an hour or two.

Winding the Tuner.—Having obtained a piece of cardboard tubing 4 in. in diameter and about $\frac{1}{2}$ lb. of No. 24 (or No. 26) d.c.c. copper wire, start the winding of the tuner (see R, Fig. 3). Punch two holes in the tube about $\frac{1}{2}$ in. from one end, not shown in the diagram. Weave the wire through these holes in such a way that the end of the wire will be quite firmly anchored, leaving about 12 in. of the wire free for connections. Start with the remainder of the wire to wrap the several turns in a single layer about the tube, tightly and closely together. After ten complete turns have been wound on the tube, hold those turns snugly while a tap is taken off. This tap is made by forming a 6-in. loop of the wire and twisting it together at such a place that it will be slightly staggered from the first tap. This method of taking off taps is shown quite clearly at U (Fig. 3). Proceed in this manner until seven twisted taps have been taken off at every ten turns. After these first seventy turns have been wound on the tube, then take off a 6-in. twisted tap for every succeeding single turn until ten additional turns have been wound on the tube.

AN EFFICIENT RECEIVING SET

After winding the last turn of wire, anchor the end by weaving it through two holes punched in the tube, much as was done at the start, leaving about 12 in. of wire free for connecting. It is to be understood that each of the eighteen taps is slightly staggered from the one just above, so that the several taps will not be bunched along one line on the cardboard tube.

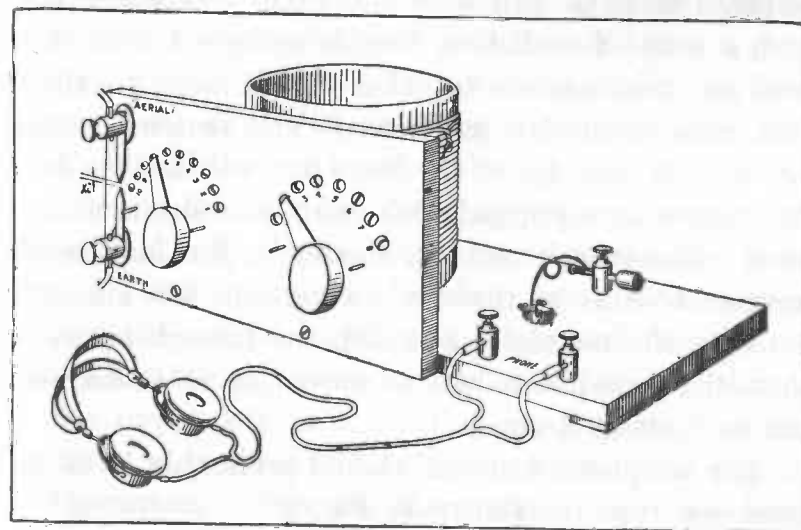

Fig. 4.—View of the Receiver.

It will be advisable, after winding the tuner, to dip it in hot paraffin wax.

Upright Panel and Base.—Having completed the tuner to this point, set it aside and construct the upright panel shown in Fig. 4. This panel may be a piece of wood approximately $\frac{1}{2}$ in. thick. The positions of the several holes for the terminals, switch-arms and switch-contacts may first be laid out and drilled. The aerial and earth terminals may be ordinary $\frac{1}{8}$ -in.

CRYSTAL RECEIVING SETS

brass screws of sufficient length and supplied with three nuts and two washers. The first nut binds the bolt to the panel, the second nut holds one of the short pieces of stiff wire, while the third nut holds the aerial or earth wire, as the case may be. The switch-arm with knob (shown in Fig. 3) may be purchased in the assembled form, or it may be constructed from a thin slice cut from a broom-handle and a bolt of sufficient length equipped with four nuts and two washers together with a narrow strip of thin brass somewhat as shown. The switch contacts (w, Fig. 3) may be of the regular type, or they may be brass bolts equipped with one nut and one washer each. The switch-contacts should be just sufficiently near each other so that the switch-arm will not drop between the contacts, but also far enough apart so that the switch-arm can be set so as to touch only one contact at a time.

The telephone terminal should preferably be of the set-screw type, as shown in Fig. 3.

Wiring.—Having constructed the several parts just mentioned and mounted them on the wood base, the next matter is to connect the several taps to the switch-contacts and attach the other necessary wires. Scrape the cotton insulation from the loop ends of the sixteen twisted taps as well as from the ends of the two single-wire taps coming from the first and last turns. Fasten the bare ends of these wires to the proper switch contacts as shown by the corresponding numbers in Fig. 3. Be careful not to cut or break any of the looped taps. It would be prefer-

AN EFFICIENT RECEIVING SET

able to fasten the connecting wires to the switch-contacts by binding them between the washer and the nut, as shown at w (Fig. 3). A wire is run from the back of the terminal marked earth (Fig. 3) to the back of the left-hand switch-arm bolt (y), thence to underneath the left-hand binding post marked phones in Fig. 4. A wire is then run from underneath the right-hand terminal marked phones to underneath the binding post w (Fig. 3), which forms a part of the crystal detector. Take a piece of No. 24 bare copper wire about $2\frac{1}{2}$ in. long and twist one end tightly round the nail passing through binding post s; its other end will rest gently by its own weight on the crystal. The bare copper wire which has been wrapped tightly round the three brass wood-screws holding the crystal in place is led to and fastened at the rear of the right-hand switch-arm bolt (v), thence to the upper left-hand binding post marked aerial. As much as possible of this wiring is shown in Fig. 3.

Operation.—After all the parts of the set have been constructed and assembled the first essential operation is to adjust the little piece of wire, which rests lightly on the crystal, to a sensitive point. This may be accomplished in several different ways; the use of a miniature buzzer transmitter is very satisfactory. Assuming that the most sensitive point on the crystal has been found by the method described later, the rest of the operation is to get the set in resonance or in tune with the station from which one wishes to hear messages. The tuning is attained by adjusting the inductance of the tuner. That is, one

or both of the switch-arms are rotated until the proper number of turns of wire of the tuner are made a part of the metallic circuit between the aerial and earth, so that, together with the capacity of the aerial, the receiving circuit is in resonance with the particular transmitting station. It will be remembered that there are ten turns of wire between each of the first eight switch contacts and only one turn of wire between each two of the other contacts. The tuning of the receiving set is best accomplished by setting the right-hand arm (v., Fig. 3) on contact (1) and rotating the left-hand switch-arm over all its contacts. If the desired signals are not heard, move the right-hand switch-arm to contact (2) and again rotate the left-hand switch-arm throughout its range. Proceed in this manner until the desired signals are heard.

The Test Buzzer.—As mentioned previously, it is easy to find the most sensitive spot on the crystal by using a test buzzer (z, Fig. 3). The test buzzer is used as a miniature local transmitting set. When connected to the receiving set, as shown at z, Fig. 3, the current produced by the buzzer will be converted into sound by the telephone receivers and the crystal, the loudness of the sound depending on what part of the crystal is in contact with the fine wire.

In order to find the most sensitive spot connect the test buzzer to the receiving set as directed, close the switch 5, Fig. 3, set the right-hand switch-arm on contact point No. 8, fasten the telephone receivers to the binding posts marked phones, loosen the set-screw of the binding post slightly and change the

position of the fine wire (6, Fig. 3) to several positions of contact with the crystal until the loudest sound is heard in the 'phones, then tighten the binding post set-screw (4) slightly.

The illustrations to this chapter were published by "Popular Radio" and prepared by them from the drawings issued by the U.S.A. Government, and the Editor of the present Handbook wishes to express his indebtedness for their use to the American publication named.

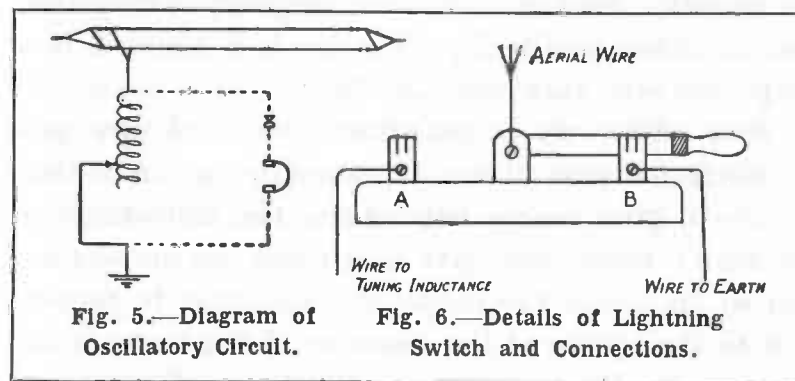

Fig. 5.—Diagram of Oscillatory Circuit.

Fig. 6.—Details of Lightning Switch and Connections.

The Range of the Set.—It is impossible to state offhand what the range of a set will be, for there are different factors that govern the operation. Briefly these are as stated below :

- (1) The distance of the transmitting station and its direction.
- (2) The power used by the station ; this, of course, varies enormously.
- (3) The height and length of the receiving aerial.
- (4) The position of the receiving station. If it is on a hill or a level plain, and is not sheltered by trees

CRYSTAL RECEIVING SETS

or neighbouring houses, these conditions confer great advantages.

(5) The efficiency of the receiving set. This depends on (a) good insulation, (b) proper adjustment of detector, and (c) good telephones.

Hints on Operation.—In order that signals may be received, it must be remembered that the receiving set must be in “tune” with the vibrations in the ether set up by the transmitting station. To tune-in stations of different wave-lengths either the inductance or capacity, or both, of the oscillatory circuit (see Fig. 5) must be altered. The method adopted in a simple set is to vary the inductance.

Now inductance necessitates a length of wire, preferably in the form of turns; two turns, provided they are close, give nearly four times the inductance of one turn; three turns give nine times the inductance, and so on. Also the inductance increases in proportion to the square of the diameter of the turns in the same way. By having, say, 100 turns of wire in a former (each turn being close to its neighbour but well insulated from it), and having a slider, we can vary the inductance over a wide range, increasing by a single turn at a time. The slider has certain disadvantages. It wears the wire by constant rubbing and is liable to short-circuit two or more turns, which will waste some of the energy. In order to overcome these objections, and also to make an inductance suitable for panel mounting, the turns are brought out to two switches, one called the “tens switch” and the other the “units.” Each stud on the tens switch

AN EFFICIENT RECEIVING SET

has ten complete turns connected to it, so that by moving the knob of this switch the inductance is varied by comparatively large amounts at a time. To tune more closely the units switch is used, ten studs being connected to the last ten turns on the coil.

By using both switches together it is possible to include any number of turns varying from one to the greatest number on the coil.

The lightning switch is shown enlarged by Fig. 6. A single-pole change-over switch is used. The aerial wire is connected to the arm. The lead to the tuning inductance is connected to A and the earth wire to B. When the set is in use the switch should be over to the left (A), and when out of use it should be over to the right (B), thus earthing the aerial.

CHAPTER II

A Single-slider Set

By PAUL D. TYERS.

REMEMBERING the statement in the previous chapter that the longer the wave-length the greater is the amount of inductance required to tune it in, it will be obvious that it is impossible to wind up one coil to receive all wave-lengths. The range of the set here described is from about 350 metres to 600 metres.

Construction of the Tuner.—The coil will be wound on a cylinder 6 in. long and 3 in. in diameter. Cardboard postage tubes are very suitable for the purpose if they are previously prepared. A 6-in. length is cut off with a saw and the surface and ends are carefully smoothed with very fine glass-paper. Three small holes are drilled in each end of the tube in the position shown in Fig. 7. The tube is then heated in an oven to drive out any absorbed moisture, and while it is still hot it is given a coat of thick shellac varnish. This is prepared by dissolving shellac in methylated spirit. The tube should be heated and varnished at least three times.

Wooden ends are fixed to the cylinder, which serve as a support for the slider, as follows: Two wooden discs about $\frac{3}{8}$ in. thick are cut out with a fretsaw of such size as tightly to fit into the ends of the tube. This will be understood by reference to Fig. 8, and

it will be seen that they are afterwards secured by small brass screws passed through the sides of the tube. The end pieces are made from any hardwood, and should be about $4\frac{1}{2}$ in. square and $\frac{1}{2}$ in. thick. These are fixed to the discs by brass screws after the coil has been wound.

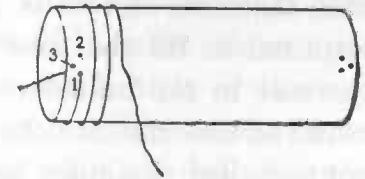

Fig. 7.—Method of Fixing Winding.

Winding the Coil.—When winding a very large coil it is usual to arrange some form of winding apparatus, but it is unnecessary in this case. Referring to Fig. 7, about 6 in. of free end of the wire is passed down hole No. 1, up hole No. 2, and down hole No. 3, the end being put through the loop which has been formed inside the tube between holes No. 1 and No. 2.

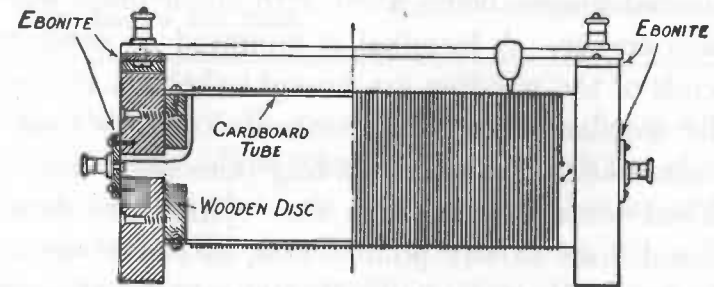

Fig. 8.—Half Section of Tuning Coil.

It will be found that this will fix the end of the wire quite firmly. The winding is then started, making each turn close against the other. It is essential to keep the wire fairly tight, but not so tight as to strain it. When the other end of the coil is reached the wire is fastened off in a similar manner to the first

CRYSTAL RECEIVING SETS

turn. The best wire is double silk-covered, but this, of course, is rather expensive, and cotton- or enamel-covered may be substituted. It should be remembered that enamelled wire is thinner than silk-covered, and therefore if this is employed more turns will be required to fill the winding space, with a consequent increase in the inductance of the coil. It is not very usual to use silk- or cotton-covered wire with a sliding contact, but this may be done if the winding is given a thin coat of shellac.

Mounting the Coil.—Although a connection is only required to one end of the winding, it is useful to bring both ends to terminals for use in other circuits. A hole about $\frac{3}{4}$ in. in diameter is made in the centre of each wooden disc and end piece. Two squares of ebonite about $1\frac{1}{2}$ in. long are placed over the holes in the end pieces, being fixed with small brass screws at each corner. A terminal is mounted on each, and the ends of the winding are brought through the holes in the wooden disc, being connected to the back of the terminals. Thus the winding does not come into electrical contact with either the cylinder or wooden ends and discs at any point; this, of course, ensures the best possible insulation. Having reached this stage the end pieces can be screwed to the wooden discs, thus firmly fixing the coil.

The Sliding Contact.—The slider may be made if desired, but as it is a standard detail it can be purchased cheaply. It consists of a piece of moulded ebonite containing a spring and brass plunger which makes contact on the winding of the coil. Usually

A SINGLE-SLIDER SET

the slider is made to fit a $\frac{1}{4}$ -in.-square brass rod, as shown in the diagram. A piece of square brass rod is cut about 7 in. long (that is, the length of the tube and end pieces), and a hole is drilled in each end to take a small terminal screw. Two pieces of ebonite are next prepared. These should be made about 1 in. long and $\frac{1}{8}$ in. thick. The width is that of the end piece, the ebonite being fixed to this as shown in Fig. 9. It will be noticed that a hole is drilled in the middle of the ebonite, a small part of the end piece

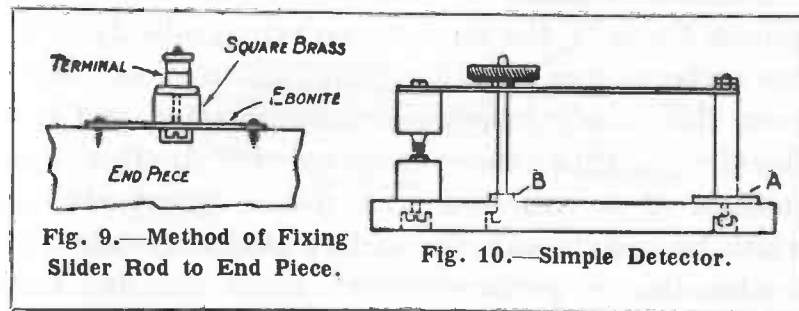

being cut away to accommodate the head of the terminal screw. The screw is put through the ebonite, passed through the hole in the square brass, and the two parts of the terminal are screwed up tightly. The same process is repeated at the other end of the square brass, and the pieces of ebonite are then screwed to the ends.

Two terminals are connected to the slider rod, whereas only one is needed. This makes the appearance of the coil symmetrical, and the additional terminal may sometimes be of use in different circuits.

The Contact Line.—The coil is now complete with

CRYSTAL RECEIVING SETS

the exception of the coil contact line; where the slider touches the winding the insulation must be removed. This is best accomplished by rubbing it with a piece of very fine glass-paper, using the edge of a straight piece of wood as a guide, so that a neat line of bare copper wire appears. Only just sufficient insulation should be removed to ensure the slider making an efficient contact.

The Crystal Detector.—There are a number of different forms of detectors (see Chapter II of the "Amateur Wireless" Handbook "Wireless Component Parts"), the most stable type probably being the carborundum and steel-plate combination. However, this usually requires a potentiometer, and it is therefore a little more complicated. Another type consists of a very fine wire (called a cat-whisker) which bears lightly on the surface of the crystal. This combination is perhaps a little more sensitive than others, but at the same time it is rather erratic in behaviour. The set here described has a perikon detector.

The detector will be understood by reference to Fig. 10. The base may be of ebonite, 4 in. by 3 in. and $\frac{1}{2}$ in. thick. The crystal cups may be drilled or turned from brass rod $\frac{1}{2}$ in. in diameter, or they may be bought for a few pence. The success of the detector depends upon its rigidity; a weak or springy detector will never keep sensitive for more than a few minutes, and it will be found a source of everlasting annoyance. One crystal cup is fixed near the end of the base, as shown in Fig. 10, and the other is screwed

A SINGLE-SLIDER SET

to the end of a piece of brass $2\frac{1}{2}$ in. long, $\frac{1}{2}$ in. wide, and a little less than $\frac{1}{16}$ in. thick.

A thick brass screw about 2 in. long is passed through a hole drilled at the other end of the base. A strong washer (A, Fig. 10) is put on the screw, together with a length of stout brass tube about $\frac{3}{8}$ in. external diameter. This is followed by the brass strip, which is finally secured by two nuts. The length of the brass tube will depend, of course, upon the height of the crystal cups. A similar but longer screw is fixed

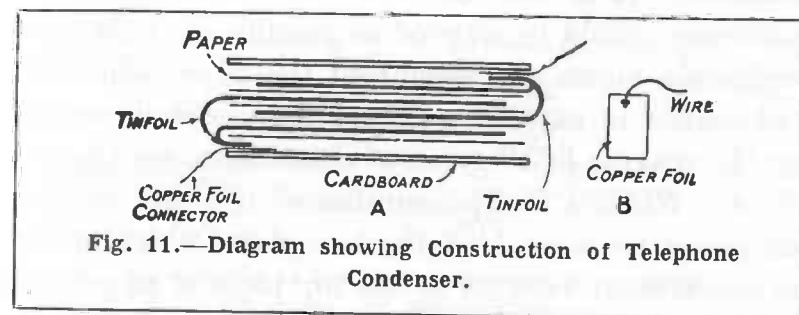

Fig. 11.—Diagram showing Construction of Telephone Condenser.

to the base with a nut B, and the end is allowed to project through a slit in the brass arm. A nut to fit the screw is soldered to a small piece of thin brass, which is then screwed to an ebonite knob. It will be understood that by screwing the knob downwards the two cups will be brought nearer together, thus varying the pressure between the crystals. The crystals are set in the cups with either molten solder or Wood's metal. It is usual to employ a pointed piece of bornite or copper pyrites resting on a flat face of a piece of zincite. Two terminals mounted on the base complete the detector; connection is made, of

CRYSTAL RECEIVING SETS

course, to the fixed cup and the screw holding the upright.

The Telephone Condenser.—This can be made very simply from tinfoil and paper. The actual value of the condenser is not of very great importance, so that the following details need not be adhered to very strictly. Eight pieces of tinfoil 3 in. by $1\frac{1}{2}$ in. and nine pieces of thick writing paper $2\frac{1}{2}$ in. by $2\frac{1}{2}$ in. will be required. Fig. 11 illustrates the method of assembling the condenser, only four plates being shown for clearness. It is essential that the insulation of the condenser should be as good as possible, and therefore before the plates are assembled the paper should be well soaked in paraffin wax. (For full details regarding the making of all types of condensers, see Chapter IV of "Wireless Component Parts.") When the tinfoil plates are assembled, the four plates which project on one side are bent on to the top piece of paper, and the other four are bent on to the bottom piece of paper. The length of the projecting pieces should be a little over half an inch.

Two pieces of waxed cardboard are cut to the same size as the paper to act as a kind of cover. Connection has yet to be made to the plates, and this is best done as follows: Two short lengths of copper wire are soldered to two small pieces of copper foil. These are placed one against each of the bent pieces of tinfoil, being slipped between the top and bottom pieces of paper and the cardboard. This should be quite clear from the diagram. To ensure an efficient contact the condenser is pressed well together, and it is then firmly

A SINGLE-SLIDER SET

bound round with some tough brown paper which is secured with a little gum. To serve as a protection against damp, the finished condenser is painted with hot wax, great care being taken to cover the parts where the copper foil emerges from the paper. If desired, the condenser may be placed in a box, when the wires would be brought to two terminals mounted on a piece of ebonite on the top.

Connecting the Apparatus.—Fig. 12 is divided into

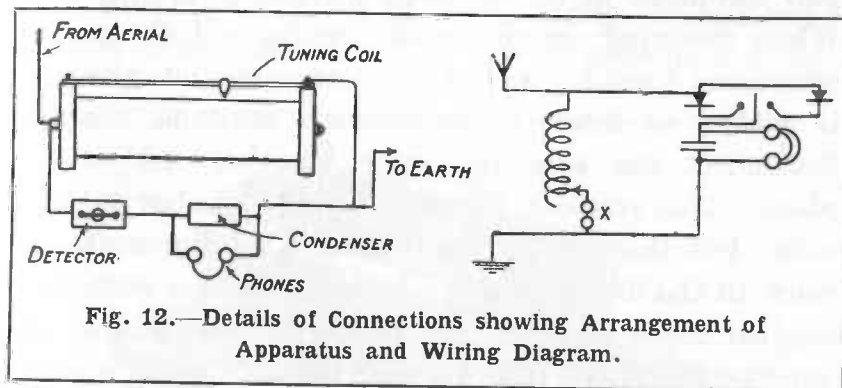

Fig. 12.—Details of Connections showing Arrangement of Apparatus and Wiring Diagram.

two parts. One part shows how the apparatus appears when it is connected up, and the other part shows the standard way of indicating the various components. It will be noticed that a switch has been included between the telephones and the detector. It is so arranged that either of two detectors may be used at will. This is a very convenient method of working, as, should one detector suddenly become insensitive in the middle of an important signal, it is only necessary to put the switch in the other position, thereby connecting up the second detector. As soon as the signal

CRYSTAL RECEIVING SETS

has finished, it is possible immediately to readjust the faulty detector. The switch is also very useful for comparing two different types of detectors, since it is possible to change from one to the other without disconnecting any of the apparatus.

Using Loading Coils.—The tuning coil, as previously stated, is designed to receive wave-lengths up to about 600 metres. However, if it is desired to receive longer waves, all that is necessary is to insert two terminals in the position marked x in Fig. 12. When receiving on the small tuning coil these are connected together with a piece of wire, but when it is wished to listen to longer-wave stations, simply disconnect the wire and insert another coil in its place. This coil can be made exactly similar to the other, but there is no need to fix a sliding contact, since all the fine tuning can be accomplished with the original coil. It is only necessary to tap the coil at varying intervals, bringing the tappings to a multi-point switch.

A coil of this description is usually called a loading coil, since it loads the aerial to the required wave-length.

CHAPTER III

Set With Semicircular Tuner

By O. J. RANKIN.

THE tuning inductance of the set described in this chapter (see Fig. 13) has been specially designed for the efficient reception of broadcasting, "dead-end" effects being obliterated as far as possible by only

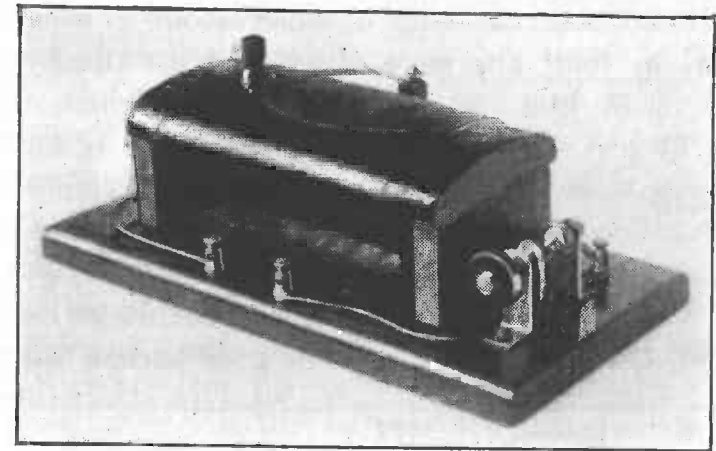

Fig. 13.—Photograph of Set with Semicircular Tuner.

winding on enough wire to just cover the broadcasting wave-lengths.

Materials.—The materials and parts required to build this receiver comprise one cardboard cylinder or "former," 6 in. long by 4 in. diameter, $\frac{1}{2}$ lb. bobbin of No. 24 (or nearest) enamelled copper wire, one

CRYSTAL RECEIVING SETS

baseboard $\frac{1}{2}$ in. thick, 14 in. long and 8 in. wide, one piece of board $\frac{3}{4}$ in. thick, $3\frac{7}{8}$ in. wide and $7\frac{1}{2}$ in. long, two pieces of board each about $\frac{1}{2}$ in. thick, $3\frac{7}{8}$ in. wide

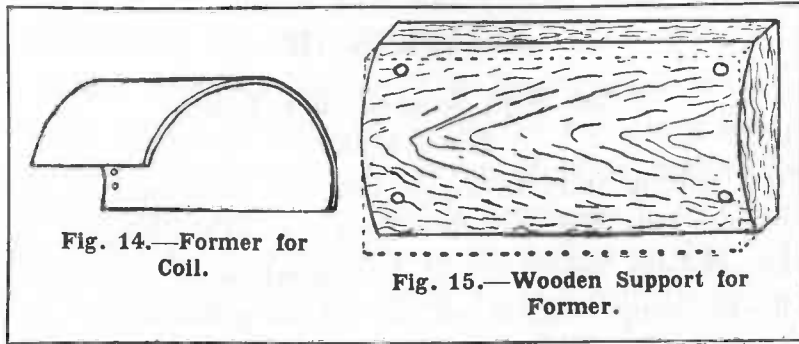

and 3 in. long, one strip of wood about $\frac{1}{2}$ in. square by $3\frac{1}{2}$ in. long, one piece of spring brass (hard-rolled brass) 4 in. long by $\frac{3}{8}$ in. wide, also one piece $1\frac{1}{2}$ in. long by $\frac{1}{2}$ in. wide, two strips of $\frac{1}{8}$ -in. brass $1\frac{3}{4}$ in. long by $\frac{1}{2}$ in. wide, one crystal cup and crystal (preferably hertzite or permanite), one small terminal with nut, four medium-size wood-screw terminals, length of 2 B.A. screwed rod and six nuts, two ebonite or wooden knobs, one spring washer, some good shellac varnish,

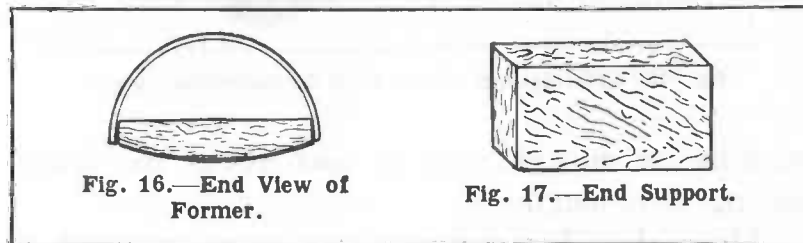

about one yard of connecting wire and systoflex, and a quantity of small nails, screws, and washers and other sundries.

SET WITH SEMICIRCULAR TUNER

Inductance Coil.—Cut the cardboard cylinder lengthwise, as shown by Fig. 14, and put aside the other half, as this will not be required. Take the thick piece of board, $3\frac{7}{8}$ in. wide by $7\frac{1}{2}$ in. long, and shape it as shown in Fig. 15. Fit this to the inside of the semi-cylinder, as shown in Fig. 16, and secure it with a few small brass nails driven in so that the heads are flush with the cardboard. See that the straight edges of the cardboard are flush with the curved edge of board, and that an equal portion of board is left projecting at each end. Give this a coat of shellac varnish inside and out, and when perfectly dry apply a second coat. When this is quite dry screw τ on the two end supports (Fig. 17), which are the two pieces of board $3\frac{7}{8}$ in. wide by

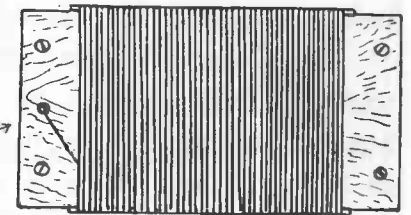
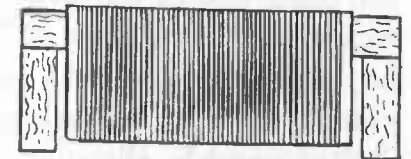

Figs. 18 and 19.—Elevation and Plan of Coil.

3 in. long, as shown in Figs. 18 and 19. Attach the end of the wire from the bobbin to a small screw τ (Fig. 19), apply another coat of shellac, and while this is still "tacky," wind on the wire, taking care that there are no spaces between the layers, particularly where it covers the top curved portion. Having finished it, leave about six or eight inches of wire at the end, and pass it through the holes shown in the cardboard in Fig. 14 to prevent it

CRYSTAL RECEIVING SETS

unwinding. Apply shellac freely over the winding and allow the coil to dry.

Next take the piece of spring brass 4 in. long by $\frac{3}{8}$ in. wide, round off the corners with a smooth file, and drill a hole in each end (see Figs. 20 and 21), one of which must take a length of the 2 B.A. rod and the other a round-headed wood-screw. Cut off about 1 in. of the screwed B.A. rod and fit one end into a suitable wood or ebonite knob, as shown in Fig. 22. Bend the other end of the strip slightly, so that it is parallel to the projecting part of the rod. The latter should be made quite smooth and rounded off to a blunt point. Give the baseboard at least three coats of shellac varnish, allowing each coat to dry thoroughly before applying the next.

The Detector.—The construction of the crystal detector should present no difficulties. The two $\frac{1}{8}$ -in. brass strips should be cut out and drilled as shown in Figs. 23 and 24, and bent at right angles at the dotted lines. The shank of the terminal fitted to one crystal cup (Fig. 25) should slide freely in the slot (Fig. 24). This small terminal should, of course, be fitted before mounting the crystal.

Take the piece of spring brass $1\frac{1}{2}$ in. long by $\frac{1}{2}$ in. wide as shown by Fig. 26, solder the fine wire feeler or "cat's whisker" \cup (Fig. 27) to one end and bend to the shape shown. Solder the other end to the base of the piece of brass (Fig. 23). The hole at the top of the pillar should be tapped 2 B.A. An alternative method is to drill the hole slightly larger than the diameter of the detector screw and solder on a nut

SET WITH SEMICIRCULAR TUNER

previously filled with clay to prevent the solder adhering to the thread. The detector screw (Fig. 28) is self-explanatory. A suitable wood or ebonite knob is clamped tightly to a short length of the 2 B.A. rod with two nuts, as shown, and the end of the rod

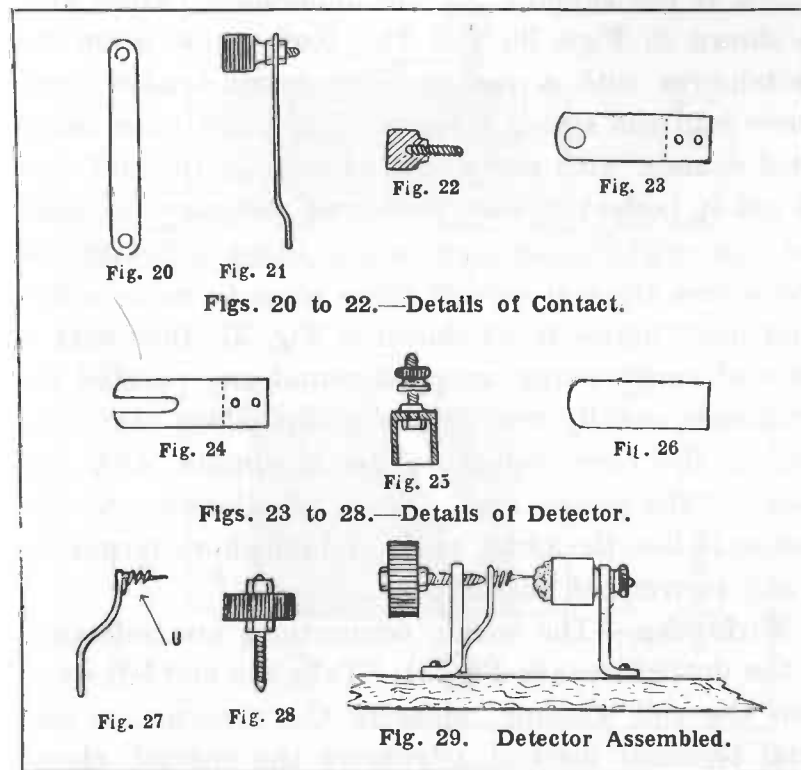

rounded off to a point. The general arrangement of the detector is clearly shown in Fig. 29.

Assembling.—Place the mounted coil on the centre of the baseboard, move it along to the left about $1\frac{1}{2}$ in., see that everything is quite square, and with a pencil mark all round the bases of supports. Drill four holes

CRYSTAL RECEIVING SETS

large enough to take the screws, and screw the two parts firmly together as shown in Fig. 30. Take the strip of $\frac{1}{2}$ -in.-square wood, place it at the back and on a line with the centre of coil, and attach it to the base in a similar way. The correct position of this, which is the support for the inductance switch arm, is shown in Figs. 30 and 31. Now screw down the switch-arm with a medium-size round-headed wood screw and the spring washer. The point must make good contact with every turn of wire on the coil, and to get it perfect it may be found necessary to bend the arm slightly one way or the other. Rotate the arm across the coil several times so as to make a distinct mark across it, as shown in Fig. 31, then with a piece of emery-paper wrapped round any pointed instrument carefully remove the enamel along that line, leaving the bare copper to make contact with the point on the switch arm. Screw the detector to the base and place the aerial, earth and telephone terminals in any convenient position.

Wiring-up.—The wiring connections are indicated by the dotted lines in Fig. 31. Take the end left over from the coil winding, measure the distance to the aerial terminal marked A, remove the enamel, clean thoroughly with emery-paper, and wind it once round the shank of the terminal. Insulating sleeving should be slipped over all connecting wires. Connect another short length of wire from the aerial terminal to the detector pillar which holds the crystal cup, placing the end under one of the screws or soldering it direct to any convenient part of the pillar. This latter

SET WITH SEMICIRCULAR TUNER

method is always preferable. From the detector pillar carrying the detector screw connect a wire to the nearest phone terminal, from the other phone terminal to the earth terminal marked E, and from E to the

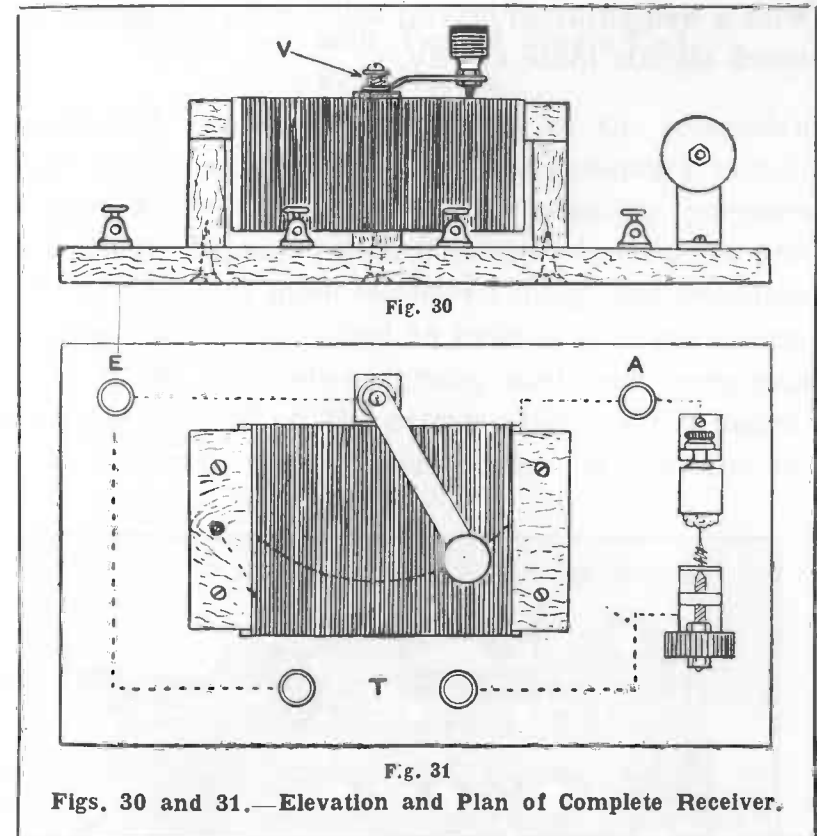

Figs. 30 and 31.—Elevation and Plan of Complete Receiver.

spring washer v (Fig. 30), which, of course, should be soldered. It may be necessary to add that the other end of the coil winding terminates at E.

It will be easily understood that the point on the switch arm represents the end of the winding in the

CRYSTAL RECEIVING SETS

sense that only the turns of wire between the connected end of the coil and the switch-arm contact are actually being used. By rotating the switch-arm the inductance is made variable.

This receiver is extremely simple to operate, and with a well-adjusted crystal will receive telephony and spark signals quite clearly.

CHAPTER IV

Crystal Set with Tapped Single Coil

By A. J. COOPER.

Single-coil Tuner.—A photograph of the completed tuner is shown by Fig. 32. The secondary circuit detailed later is not essential for receiving purposes and can be dispensed with if desired, but its use permits of finer and more selective tuning, and therefore the constructor is advised to include it in his instrument. The bar-switch, studs, and two terminals shown in Fig. 32 on the extreme right of the instrument illustrate that portion of the arrangement re-

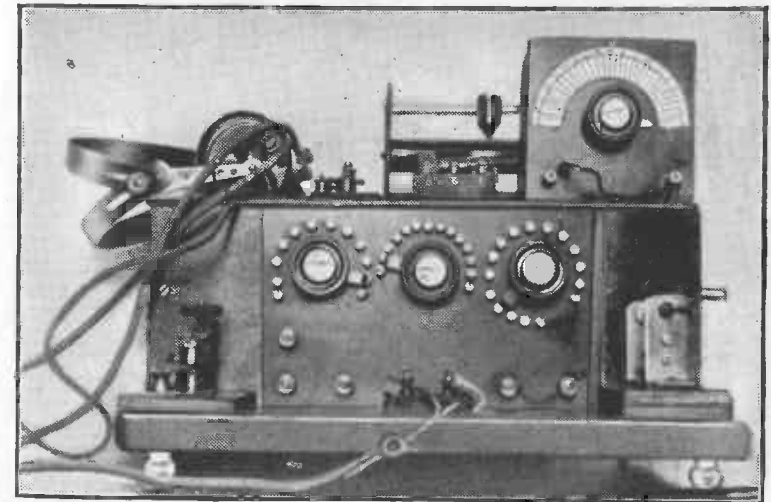

Fig. 32.—Photograph of Complete Tuner.

CRYSTAL RECEIVING SETS

lating to this secondary circuit, and will be dealt with later on.

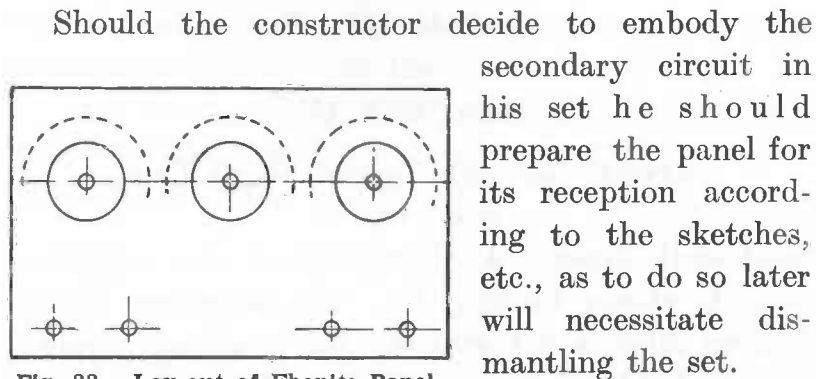

Fig. 33.—Lay-out of Ebonite Panel.

Should the constructor decide to embody the secondary circuit in his set he should prepare the panel for its reception according to the sketches, etc., as to do so later will necessitate dismantling the set. The material detailed does not include the material for the closed circuit, which necessitates an additional 12 studs, 2 terminals and bar-switch.

Panel.—The panel which carries the tuning switches

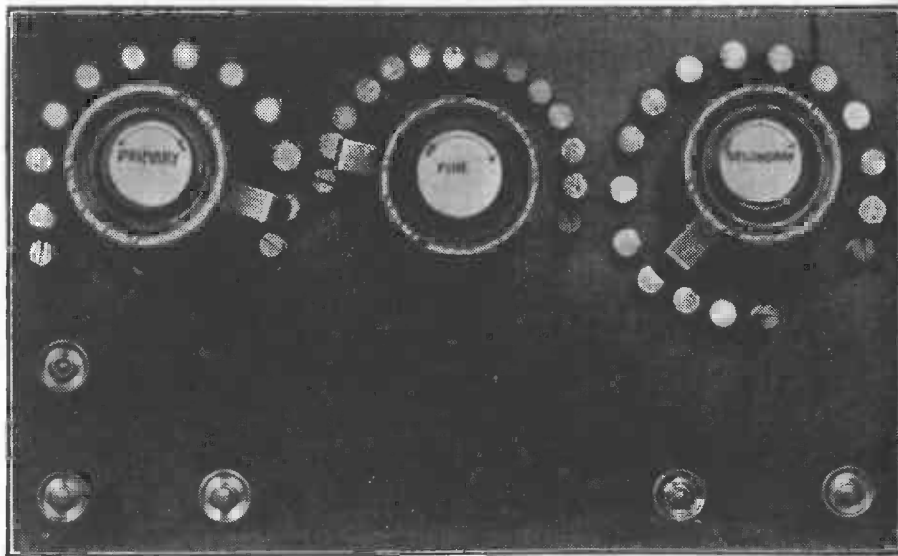

Fig. 34.—Photograph of Panel and Tuning Switches.

SET WITH TAPPED SINGLE COIL

will first be dealt with, and a sketch showing the lay-out is given in Fig. 33.

First take the ebonite and smooth off the rough edges to the dimensions specified, that is, $8\frac{3}{4}$ in. by $5\frac{1}{4}$ in. Prepare a sheet of paper marked with the required dimensions and glue it to the ebonite. The holes required for two sets of 10 contact studs, etc., can now be drilled. The sizes of the holes and dis-

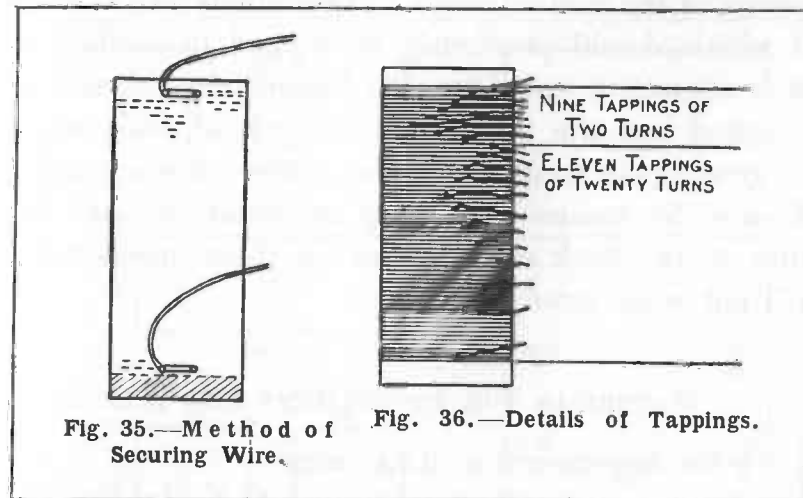

Fig. 35.—Method of Securing Wire.

Fig. 36.—Details of Tappings.

tances apart are not given, as these must be bored to the dimensions of the material obtained. The positions of the contact studs will vary according to the area of their bearing surface, but they should be placed so that the bar-switch cannot fall between them. When boring tapping holes for screw-threads a drill must be put through of the dimension of the inside of the thread for which the hole is intended. Care must be taken when working on ebonite not to exert too much pressure, as the material is very easily broken

CRYSTAL RECEIVING SETS

and also the ebonite might be torn away on the under side, leaving an ugly, uneven edge. When all the holes are drilled, those which are intended for screw-threads should be tapped according to the size for which they are intended.

A photograph of the completed panel is shown in Fig. 34, and this incorporates the bar-switch and studs and terminals for the secondary coil. After the insertion of the contact studs and terminals (the threads of which should previously be dipped in shellac) in their respective positions, the bar-switches should be mounted and the tip of the switches adjusted so as to give equal contact on the centre of each stud. Ensure, by means of pinning or soldering, that the nuts on the back of the panel on these bar-switches will not work loose.

MATERIALS FOR INSTRUMENT AND AERIAL

$\frac{1}{4}$ lb. No. 28 s.w.g. d.c.c. wire.

A cardboard cylindrical former $3\frac{1}{2}$ in. in diameter and 5 in. long. (Should a former of these dimensions not be procurable a Horlick's Malted Milk dummy will meet requirements.)

2 bar-switches with two nuts and spring washer.

Small quantity of shellac varnish.

Crystal cups, crystals, and sundry brass-strip and screws.

2 terminals with large bearing surfaces between the nuts.

2 binding-post terminals (for telephones).

SET WITH TAPPED SINGLE COIL

1 pair of high-resistance phones (total resistance of 4,000 ohms).

1 fixed telephone condenser .003 microfarads.

1 sheet of ebonite $8\frac{3}{4}$ in. by $5\frac{1}{4}$ in.

20 contact studs.

Wood for case, quantity specified in diagram, Fig. 37, $\frac{5}{8}$ in. thick (this wood should be very well seasoned).

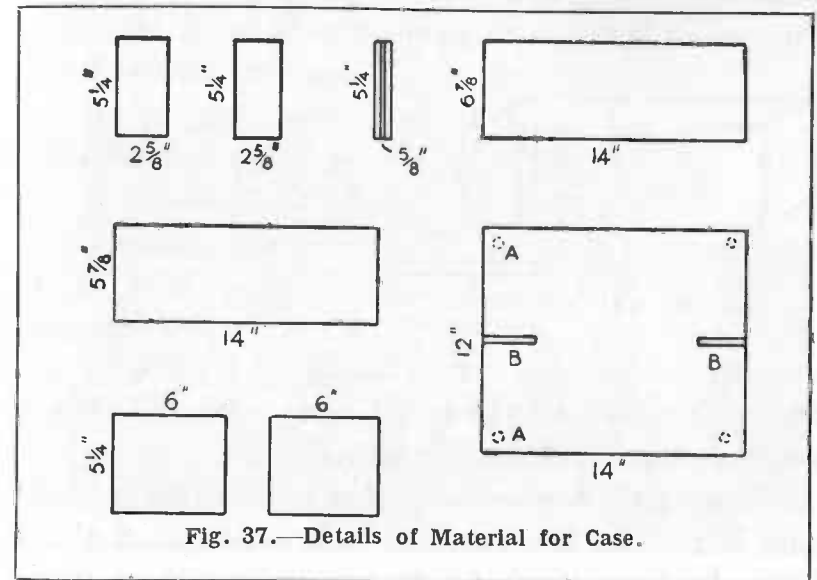

Fig. 37.—Details of Material for Case.

4 small china insulators (feet for instrument).

100 ft. of 7/22 bare or insulated copper wire.

8 2-in. china "reel" insulators with $\frac{1}{2}$ -in. diameter hole in centre.

A pole or poles not shorter than 22 ft. if possible.

Tuning Coil.—Should the coil former be of cardboard it should be put into a moderately hot oven for

CRYSTAL RECEIVING SETS

five minutes and then shellac-varnished. If the former is of ebonite, paxolin or any other specially-prepared material, this process need not be resorted to.

Shellac varnish may be made by dissolving about 4 oz. of shellac in half a pint of methylated spirit.

Now take the former and cut out a disc of wood $\frac{5}{8}$ in. in thickness to fit exactly in one end and glue it in position. Two holes of about $\frac{1}{16}$ in. should be made about $\frac{1}{2}$ in. apart on this end of the former and the end of the No. 28-gauge wire inserted and made

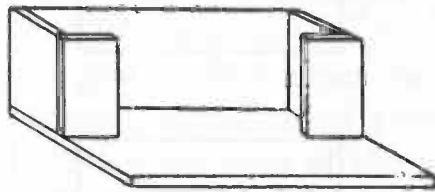

Fig. 38.—Case Assembled.

fast in these holes, being wrapped round as shown in the sketch Fig. 35, leaving a free end protruding from one hole about 12 in. long. Proceed to wrap

the wire round the former, taking off tappings every twenty turns for the first 200 turns, and then every two turns for another 18 turns.

Tapping the Coil.—The method of making the tapping is to take the wire and turn a length of about 12 in. back on itself, twisting it two or three times between the finger and thumb and leaving a loop of 6 in. When the winding of the coil is completed, thoroughly clean the cotton covering from the wire where it is twisted, apply some powdered resin and solder it. When the soldering is completed, one side of the wire loop can be cut, and this will result in a lead of about 12 in. long being left, which is subsequently soldered to the contact stud.

SET WITH TAPPED SINGLE COIL

An alternative method of making the tapping leads is to leave the wire twisted and to bare the end of the loop and solder this to the contact stud, but this method is not so neat or efficient. A loop of 9 in.

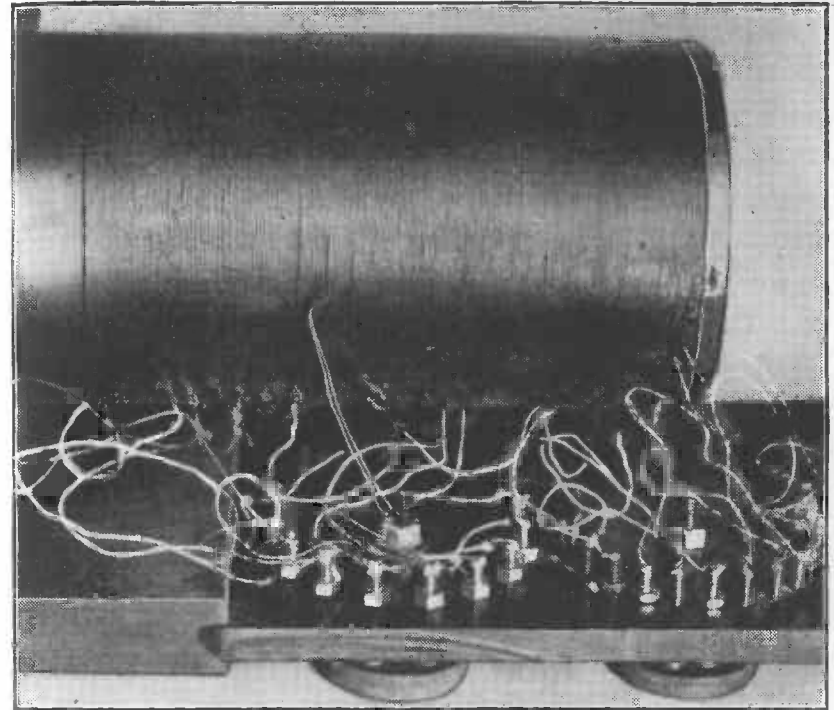

Fig. 39.—Photograph of Coil Connected to Panel.

should be taken if this method is used in order to allow sufficient wire to reach the contact stud.

Finish off the winding in the same manner as it was commenced, leaving a free end of 1 ft. On completion of the winding and the soldering the coil should be given two or three good coats of shellac. The tappings are illustrated in Fig. 36.

CRYSTAL RECEIVING SETS

Case.—The next operation is to prepare the case for the reception of the coil and the panel. This should be of $\frac{5}{8}$ -in. hardwood. Mahogany, teak or oak is to be preferred, but ordinary white wood or pine can be used if it is well seasoned. The case may be french-polished or stained and varnished, according to taste. Prepare the case according to the dimensions and lay-out given in Fig. 37, and use only screws in its construction. The right-hand side and top and bottom should be easily removable, otherwise the constructor can carry out the work according to his skill in joinery, providing the dimensions given are adhered to. The case when finished should appear as in Fig. 38.

A photograph of the coil with wires soldered is given by Fig. 39.

In order to attach the wires of the coil to the panel, as shown in the photograph (Fig. 39), lay the panel on the bench with the bar-switches assembled in position and its top towards the constructor, and place the coil with the end with the wooden end piece to the left and solder the free end to the first contact stud and the loops in rotation to the remaining studs. Keep the leads as short as possible consistent with leaving room to fix the coil and panel in the case and for other wiring. The tappings of twenty turns should now be on the left-hand switch and the two-turn tappings on the right-hand switch, the second free end being soldered to the last right-hand contact stud when completed.

It will now be seen that when the bar-switches are in a position where they point to each other the

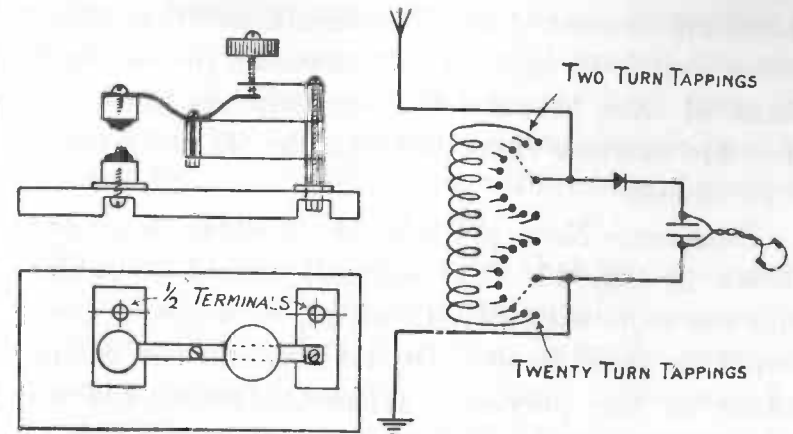

Fig. 40.—Elevation and Plan of Detector.

Fig. 42.—Circuit Diagram of Receiver.

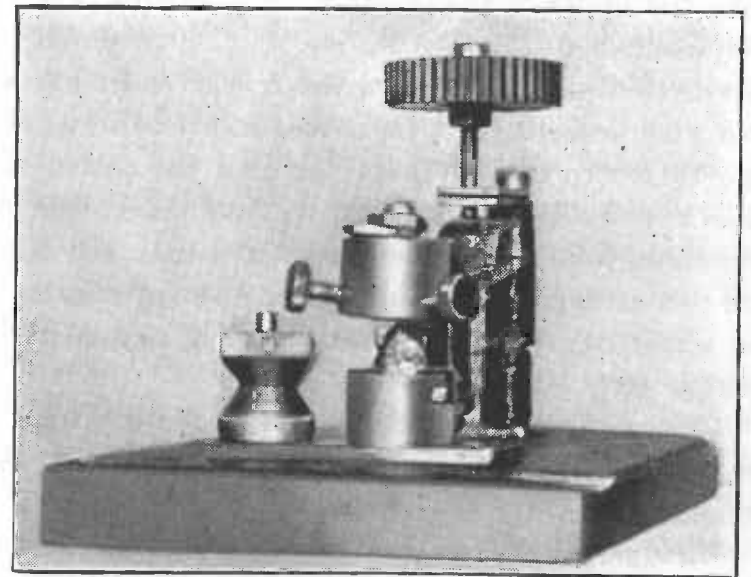

Fig. 41.—Photograph of Detector.

CRYSTAL RECEIVING SETS

minimum amount of coil is in circuit, and that rotating either switch to right or left increases the number of turns of wire between the bar-switches until, when they are extreme right and left, the whole of the coil is in circuit.

Detector.—Now prepare the crystal detector as shown in Fig. 40. The crystals should be soldered into the cups with Wood's metal, with the screws inserted in their bases. On no account use ordinary solder for this purpose. When the screws are withdrawn they will leave a path for their re-entry into the cups when affixing them in position on the detector. Zincite and copper-pyrites or zincite and bornite are recommended, the zincite in each case being the upper of the crystals. A photograph of the completed detector, which should be mounted on ebonite or dry, well-seasoned wood, is given by Fig. 41. Two such detectors can be made, and it is an advantage to incorporate both of them in the instrument with a suitable two-way switch, as one might be sometimes found to be more sensitive than the other, and this arrangement also facilitates the comparing of the sensitivity of one crystal or set of crystals with another set.

The constructor may now complete the wiring of the panel with 18 s.w.g. tinned copper wire (see Fig. 42).

Wiring.—Particular care should be taken that all connections are made fast either by means of nuts or soldering. When applying the soldering-iron to terminals or studs in the panel do not apply it too hot,

SET WITH TAPPED SINGLE COIL

as this is likely to spoil the insulating properties of the panel. A wet rag may be held against the stud being soldered, and this will take the heat from the panel. Ordinary 1/18 rubber-covered electric lighting cable can be used for the wiring with the braid stripped off (not the rubber), or bell wire.

It will be noted by the reader that the number of contact studs on the front of the panel illustrated in the photograph differs from that actually provided for, and also there is an extra terminal. The reason for this is that the writer has used the instrument for certain experimental purposes, such experiments necessitating an additional number of studs, etc., being used, but there is no need for the present construction to embody them.

Assembling.—The crystal detector and phones might be mounted in the position shown in the photograph (Fig. 32), and this has been found to be very convenient, the wiring being under the base and the instrument being kept insulated by the small china insulators. The constructor can, however, use his own discretion as to the position of these accessories. Two detectors are shown in the photograph, one being the perikon and the other a "cat's whisker." A potentiometer, carborundum detector and condenser are also shown on the top of the instrument; these will be described in the next chapter. The wire between the back of the aerial and earth terminals and the bar-switches should be electric-bell flexible wire, as this will allow for rotation of the switch.

Fix the coil by screwing it to the inside of the left-

hand side of the case in a convenient position about midway across the side and about $\frac{1}{2}$ in. from the base of the instrument.

Testing the Set.—To operate the present instrument the crystal detector should be adjusted, and the contact between the two crystals should be light. A buzzer might be sounded near the coil or earth lead, and when the note of this buzzer is heard in the telephones the crystal is in a sensitive condition. Rotate the left-hand switch until signals are heard, and finish by fine tuning on the right-hand switch.

CHAPTER V

A Loose-coupled Set

By A. J. COOPER.

THE apparatus described in this chapter is of a more advanced type than that described in the previous chapter, and includes a tuner with a secondary closed circuit. The general constructional details, however, excluding the loose-coupler, are the same as in the set described in that chapter.

Materials.—The materials required are as follows : A cylindrical former $4\frac{1}{2}$ in. long by $2\frac{3}{4}$ in. in diameter, 1 oz. 36 d.c.c. wire, a length of $\frac{3}{8}$ -in. dowelling, 12 contact studs, 1 bar-switch, 2 terminals, 15 ft. of electric-bell flexible wire.

The Former.—First take the former and prepare two wood or ebonite end pieces exactly to fit in the end, with a hole $\frac{3}{8}$ in. in diameter bored through the centre of both, as illustrated at A in Fig. 43. If wood is used it should be perfectly dry and of a thickness of about $\frac{1}{2}$ in. Should ebonite be used, it need be only $\frac{3}{8}$ in. thick. In one of the end pieces drill ten or twelve small holes, as illustrated at B, Fig. 43.

The former, if of cardboard material, should be prepared with shellac varnish as specified for the primary former. Now draw a straight line down one side, mark off $\frac{1}{2}$ in. from each end, and beginning just inside these marks bore twelve holes right through

the former at equal distances from each other. The positions of these holes should be marked on the former before the commencement of operations. A second hole should now be drilled near the first and last holes for making the end of the wire fast. A diagram of the former prepared to these instructions is given by Fig. 44.

Winding the Former.—Now take the 36-gauge wire and commence winding it on to the former in precisely the same manner as adopted for the primary coil, with the exception that the end of the wire has first of all a length of the flexible electric-bell wire soldered to it and is then pushed through the hole into the former. A slip of paper numbered 1 should now be attached to this flexible lead, which should be about a foot long. Proceed with the winding, and meeting the first hole strip the cotton covering off the twisted wire and solder a flexible lead to this; insert it through the hole and number it 2. Proceed with the winding, and ensure that the next turn of wire bears closely against the one just soldered, and so carry on the soldering and numbering of the leads as the holes are reached until the coil is completed, when twelve flexible leads should be obtained from the end of the former farthest from the starting end. The leads will be numbered 1 to 12. Now insert the end pieces into the former, securing them in position by small brass screws, the one with the small holes being utilised at the end of the coil from which the leads emerge, the leads being passed through the small holes. The numbered tickets should be taken off the leads one at a time whilst they

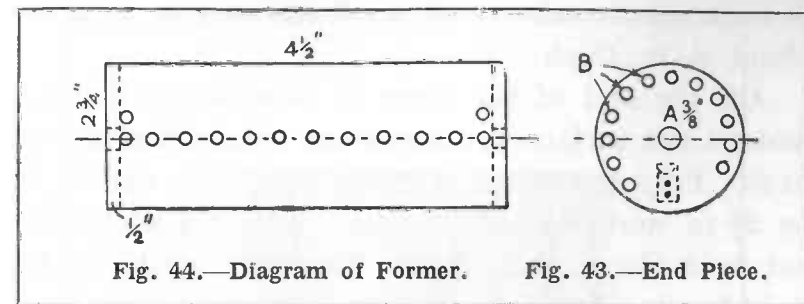

are being pushed through, and then re-attached after the lead is through.

The primary-coil end piece should now have a hole bored through it $\frac{3}{8}$ in. in diameter, and it is preferable that this should be done with the end piece detached from the coil.

The Sliding Arrangement.—Next take the dowelling and cut off a length exactly to fit inside and across the length of the case—that is, $12\frac{1}{2}$ in. long if the case has been made to the specification—and prepare another piece 8 in. long.

Prepare a small brass right-angle bracket 1 in. each way from the apex of the angle, and bore two holes

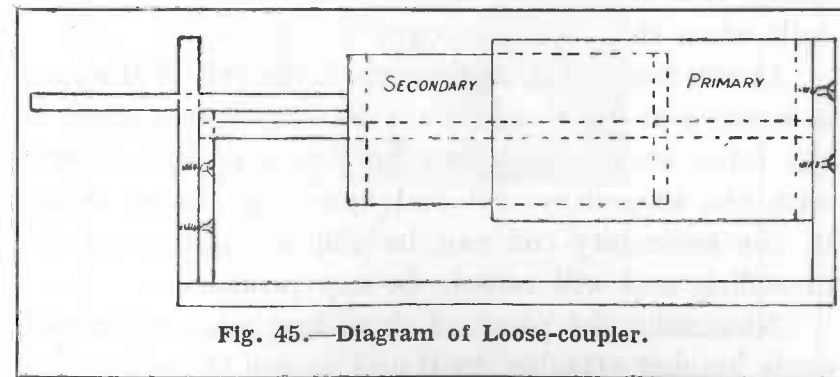

Fig. 45.—Diagram of Loose-coupler.

CRYSTAL RECEIVING SETS

in each side to take small wood screws $\frac{1}{4}$ in. long and about $\frac{1}{16}$ in. thick.

On the end of the piece of dowelling 8 in. long make a flat surface and screw one side of the bracket to it. Prepare a piece of wood $\frac{1}{2}$ in. thick and $2\frac{3}{4}$ in. by $2\frac{3}{4}$ in. and take off the end of the case which does not hold the primary coil. This side would be the right-hand side when the case is facing the constructor. Now pass the piece of dowelling which is to fit exactly into the case through the secondary coil, and see that it slides easily and freely; then place the end in the hole just made in the end piece of the primary. Position the coils and dowelling in the case against the left-hand side about 1 in. clear of the base, and place the piece of wood $2\frac{3}{4}$ in. by $2\frac{3}{4}$ in. against the other end of the dowelling and resting on the base of the case. Adjust the coils and dowelling to a horizontal position, and mark on the piece of wood the centre position of the dowelling and bore a hole $\frac{3}{8}$ in. in diameter at this position. Now screw the wood to the end piece of the case which has been removed, seeing that it is in a line with the centre line of the coils when they are positioned in the case.

It will now be clear that when the end of the case is screwed in position and the primary coil secured to the other end of the case by means of two screws, with the secondary coil and dowelling placed inside it, the secondary coil can be slid up and down the dowelling and will remain in any position.

Now take the piece of dowelling with the right-angle bracket attached to it and secure the other side

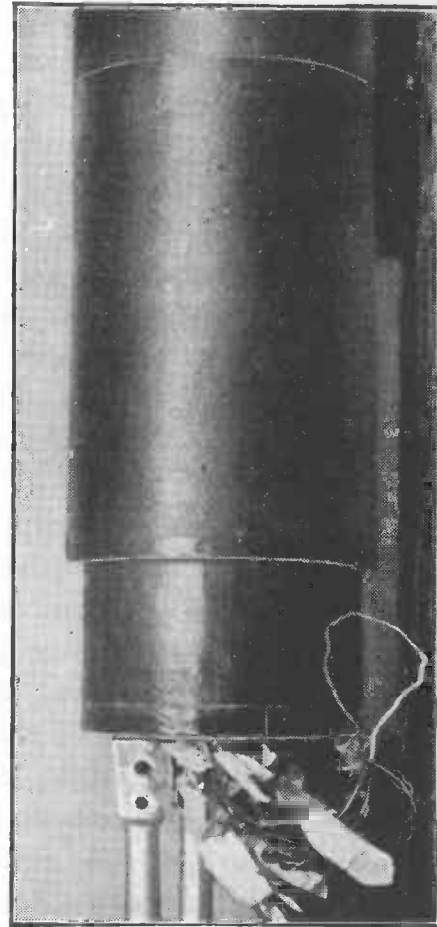

Fig. 46.—Photograph of Loose-coupler.

CRYSTAL RECEIVING SETS

of the right-angle bracket to the secondary-coil end piece through which the flexible leads emerge. A hole must now be bored through the end of the case which has been removed to allow this piece of dowelling to project, and this forms the rod by which the coupling of the coils is varied. The coil when viewed from the back will now appear as in Figs. 45 and 46.

Solder the ends of the flexible leads and the contact studs of the secondary bar-switch, fix the coils in position in the case, and wire up the remainder of the circuit, as in the diagram (Fig. 47). From this diagram it will be seen that the secondary coil, crystal detector, phones and variable condenser are in an entirely self-contained or closed circuit, and the primary coil is in a separate circuit in a position between aerial, and earth.

The Closed Circuit.—There is no apparent connection between the two circuits, but the connection is made by induction between the two coils. To put it simply, the oscillating current passing through the primary coil on its way to earth sets up magnetic lines of force about the primary, and the secondary coil being close enough to intersect these lines of force, a corresponding current is induced in this closed secondary circuit. These high- or radio-frequency oscillations are rectified or filtered out by the crystal "detector," which allows a high percentage of low-frequency current (sometimes termed audio-frequency) to pass and produce an audible note in the telephones.

The Variable Condenser.—Although not essential, it is customary to employ a variable condenser in

A LOOSE-COUPLED SET

conjunction with the close or secondary circuit, as by its means very fine tuning is possible.

Such a condenser can take several forms for practical work (see the companion handbook "Wireless Component Parts," which also explains capacity calculations), the cheapest and possibly easiest to construct being of the sliding type and made from old

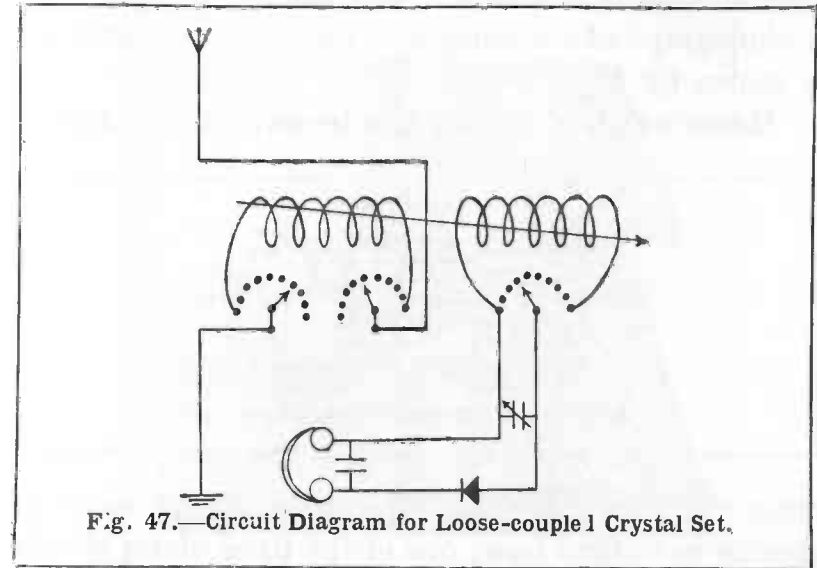

Fig. 47.—Circuit Diagram for Loose-couple 1 Crystal Set.

photographic negatives and sheet zinc. The glass (with the film cleaned off) is interposed and supported between sheets of zinc of a slightly smaller area, and the movable or sliding sheets of zinc are pushed in between the glass sheets and the fixed zinc plates above and below. In this case the glass is the dielectric.

A diagram showing the construction of a variable condenser of this nature is given in Fig. 48.

CRYSTAL RECEIVING SETS

The capacity of a condenser is measured in microfarads, and the size of condenser suitable for the present purpose is .0003 microfarads.

Other forms of condenser are in existence, such as the tubular and rotary-vane type. It is this latter type which is considered by the majority of experimenters as being the most suitable for wireless work generally, as it is compact and smooth in operation. A photograph of a condenser of the capacity prescribed is shown by Fig. 49.

Mounting the Variable Condenser.—When assem-

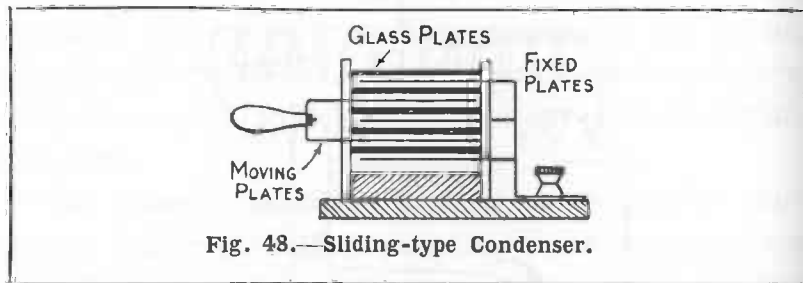

bling the variable condenser, which should have an ebonite panel and base, one of the fixed plates should be placed on the ebonite panel and used as a template for marking off the position of the ties which hold these fixed plates in position. A rotary plate should be placed so that its straight edge is square with the straight edge of the fixed plate but not quite touching it, and the small projecting piece should just fit into the recess cut into the fixed plate for its reception. When the centre of the square hole in the rotating plate has been marked on the ebonite all the holes may be bored with drills of an appropriate size. The

A LOOSE-COUPLED SET

fixed-vane tie rods should be screwed into the ebonite, and for this purpose a tap will be required in order to put a thread in the hole in the panel. The rotary-vane spindle must of course be a close fit to the shoulder on the spindle. When the top panel has been prepared it can be used as a template for the base in which corresponding holes will be required.

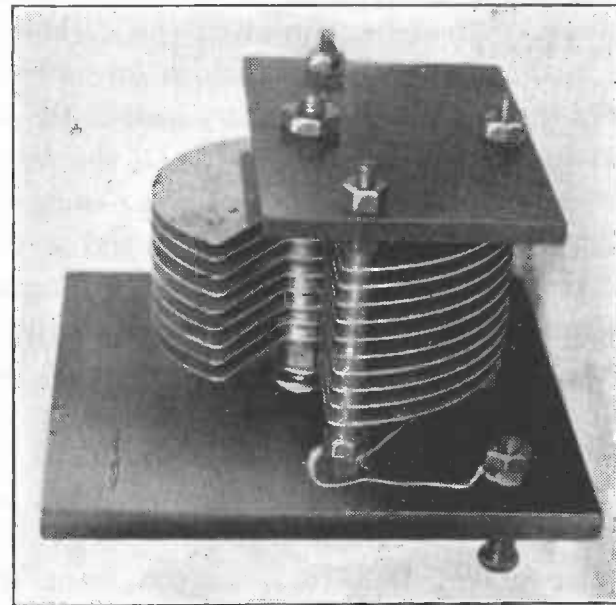

Fig. 49.—Photograph of .0003 mfd. Variable Condenser.

Additional Experimental Instruments.—It is probably known to many readers that a carborundum detector requires a potentiometer and battery for use in conjunction with it, and that these are required in order to create a difference in potential between the carborundum crystal and steel plate. The reader may like to construct a simple type of carborundum

detector, and for this reason dimensions and details are given in Figs. 50 and 51.

Making the Potentiometer.—The potentiometer consists of a piece of wood (broom handle will do) 1 in. in diameter by 4 in. long, wound for $3\frac{1}{8}$ in. of its length with No. 36 d.s.c. Eureka resistance wire and mounted between suitable supports. A slider makes contact on the top surface and runs on a piece of brass rod $\frac{1}{4}$ in. square. When incorporating the carborundum detector in the circuit the wire which formerly led to one side of the perikon detector is joined to the square brass rod by means of a terminal, and the two ends of the resistance wire are connected to each side of a 4-volt dry battery. There is also looped or twisted with one of these battery wires a wire leading to the steel plate on the crystal detector, and another wire runs from the crystal to the telephones. A switch should be incorporated in the potentiometer to cut off the battery current when not in use. The buzzer is used as explained in the previous chapter, and is obtainable for a very small sum.

The Catwhisker Detector.—In the front of the instrument should be placed a simple catwhisker detector, as used in conjunction with certain crystals—for example, galena, rectarite, hertzite, etc. This is simple to construct, and Fig. 52 shows the general arrangement. A photograph is shown by Fig. 53.

The bracket is a piece of brass 3 in. by $\frac{3}{4}$ in. bent to an angle of 90 degrees. A hole is drilled $\frac{1}{2}$ in. from the top of the long side (2 in. long) to take the screw

which secures the crystal cup. A hole is drilled on the other side (1 in. long) to take a terminal.

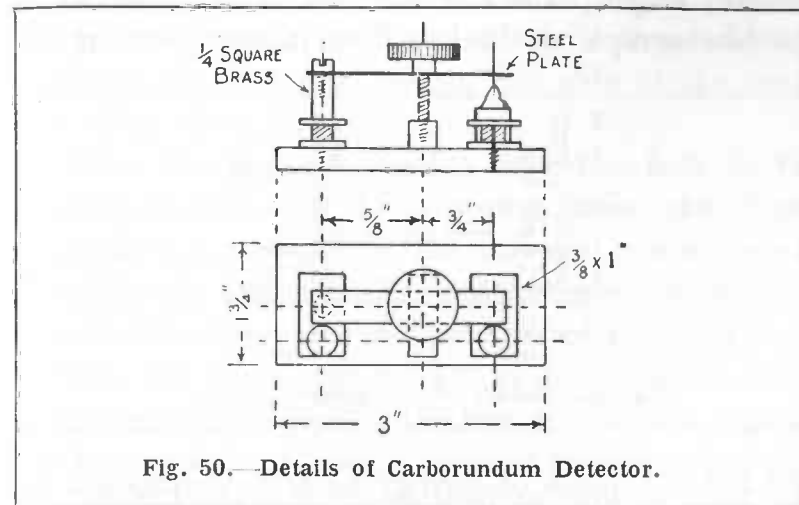

Fig. 50.—Details of Carborundum Detector.

The other bracket is a similar piece of brass bent in the same manner and to exactly the same dimen-

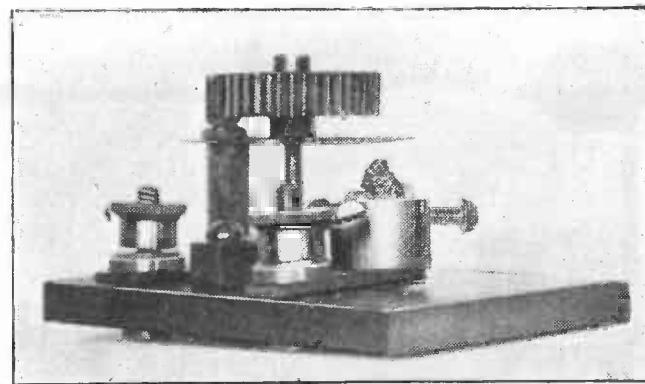

Fig. 51.—Photograph of Carborundum Detector.

sions. A hole is drilled $\frac{1}{2}$ in. from the top of the 2-in. piece, but of a larger diameter—in fact, almost large

CRYSTAL RECEIVING SETS

enough to allow a brass ball to pass through it, but not quite. This brass ball might be $\frac{1}{2}$ in. in diameter, but not larger; the one used on the instrument in the photograph was taken from the top of an old

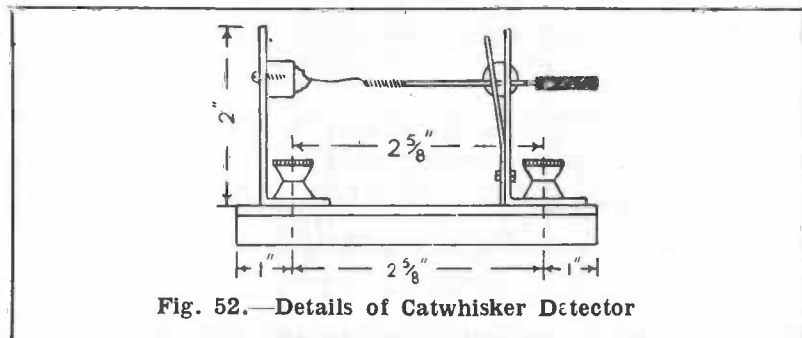

Fig. 52.—Details of Catwhisker Detector

bed rail. A piece of springy brass is prepared 2 in. by $\frac{3}{4}$ in., and has a similar hole drilled in it. The bracket and the spring are then placed together and a hole drilled through the component parts about $\frac{1}{2}$ in.

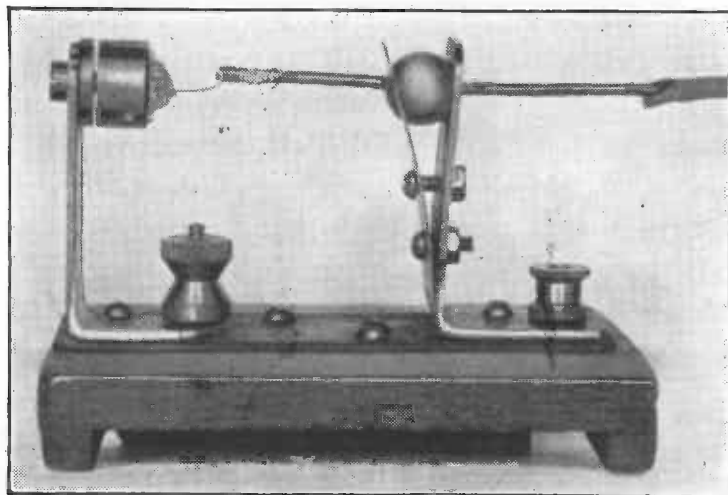

Fig. 53.—Photograph of Catwhisker Detector.

A LOOSE-COUPLED SET

from the foot of the bracket to take a clamping screw, which should be provided with a nut. The brass ball has a hole drilled right through it to take a piece of stout brass wire $3\frac{1}{2}$ in. long, which is then soldered in place, allowing one end on one side of the brass ball to be $1\frac{1}{2}$ in. long.

Place the ball in position over the hole in the bracket and fit over it the spring brass, and clamp in position by means of the nut and screw shown. Solder to the long side of the stout brass wire a spiral of wire 36 s.w.g., and on the other end fit a piece of ebonite rod or rubber to act as an insulator when adjusting the position of the fine wire on the crystal. Fit the crystal cup with a piece of crystal and mount the whole on a suitable base of ebonite or hard, dry wood.

CHAPTER VI

Set with Plug-in Basket Coils

By H. J. TURPIN.

AN unusual type of crystal receiver is described in this chapter, one in which is embodied extreme selectivity. Instead of the orthodox slider and cylindrical inductance coil or the variometer methods, the writer has adopted a system of combined adjustment of the aerial and earth connections, each of which can be independently connected to any particular part of an inductance coil of the "basket" type. It is claimed that by this method (which is explained more fully later) an amount of wire equal to $\frac{1}{2}$ in. can be added to or subtracted from the total quantity in the inductance circuit depending upon the relative position of the aerial and earth tuning plugs. The set is shown photographically in Figs. 53A and B.

In order to ensure that the instrument is as compact as possible it is made in a simple box form, one end of the case being used to carry the crystal detector which is entirely covered in by a suitably designed lid, while the main part contains the ebonite panel and the basket inductance coil.

Case.—The complete case is shown pictorially in Fig. 54, and is made throughout of mahogany $\frac{1}{4}$ in. thick, the overall dimensions being $5\frac{1}{2}$ in. by 4 in. by

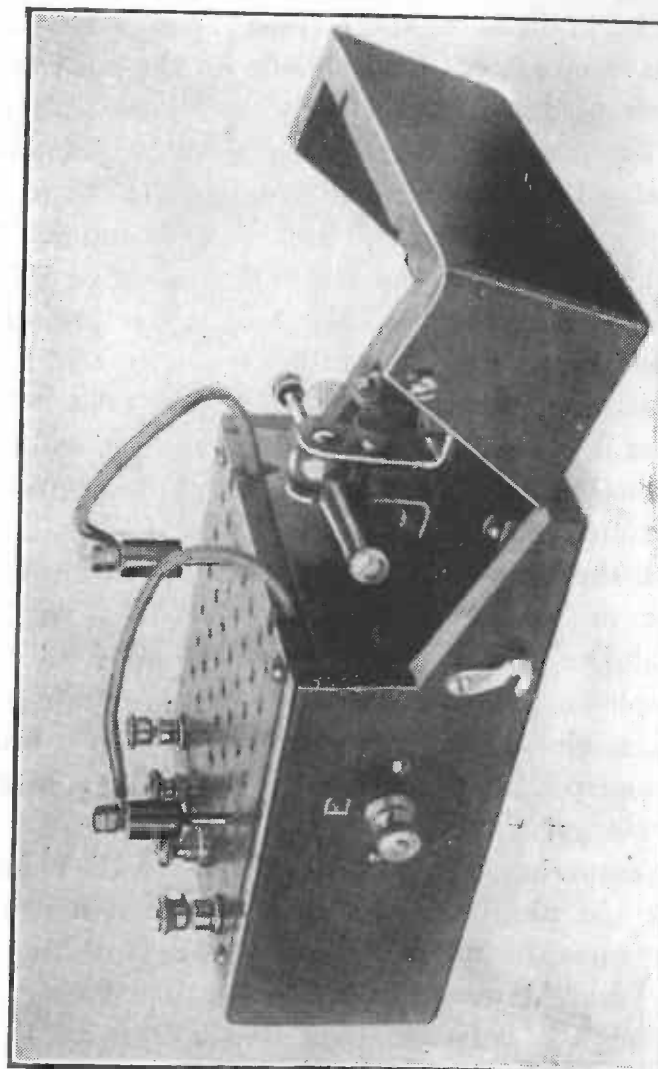

[Fig. 53a.—Photograph of Receiver shown Open.

CRYSTAL RECEIVING SETS

2 in. deep, and the inside dimensions of the chamber containing the "basket" coil are $3\frac{1}{2}$ in. by $3\frac{1}{2}$ in. Holes $\frac{7}{8}$ in. in diameter and recessed $1\frac{1}{4}$ in. in diameter by $\frac{1}{16}$ in. deep are cut on each side for the main aerial and earth terminals respectively, as shown at A and E, Fig. 54. Beyond this the figure is self-explanatory.

Panel.—The panel is made of ebonite $3\frac{3}{4}$ in. by $3\frac{1}{2}$ in. by $\frac{1}{4}$ in. thick arranged as in Figs. 55 and 56. The tuning holes are made by screwing a piece of 2 B.A. rod into the ebonite until the end is just projecting from the other side; the rod is then sawn off almost flush with the panel and roughly filed flat. This operation is repeated for the forty-two plugs and then all are finally filed flush with the panel face, finishing off with medium emery cloth and oil.

Mark the centres of the plugs with a centre punch and then drill each one $\frac{1}{8}$ in. in diameter by $\frac{7}{32}$ in. deep and slightly round off the edges of the holes.

Telephone terminals are fitted in the positions indicated, as also are another pair connected by a bridge of brass strip so that on removing the bridge a loading coil for longer wave-lengths can be fitted.

The slots shown in Fig. 56 are filed in the ebonite, so that the plug leads for aerial and earth can be brought outwards when the instrument is in use, and can be folded downwards and tucked inside the cover containing the detector when the instrument is not required.

Detector.—This is built up entirely of old pieces, the ball being a brass one (from an old bedstead) and plugged and drilled for the wire holder. A simple

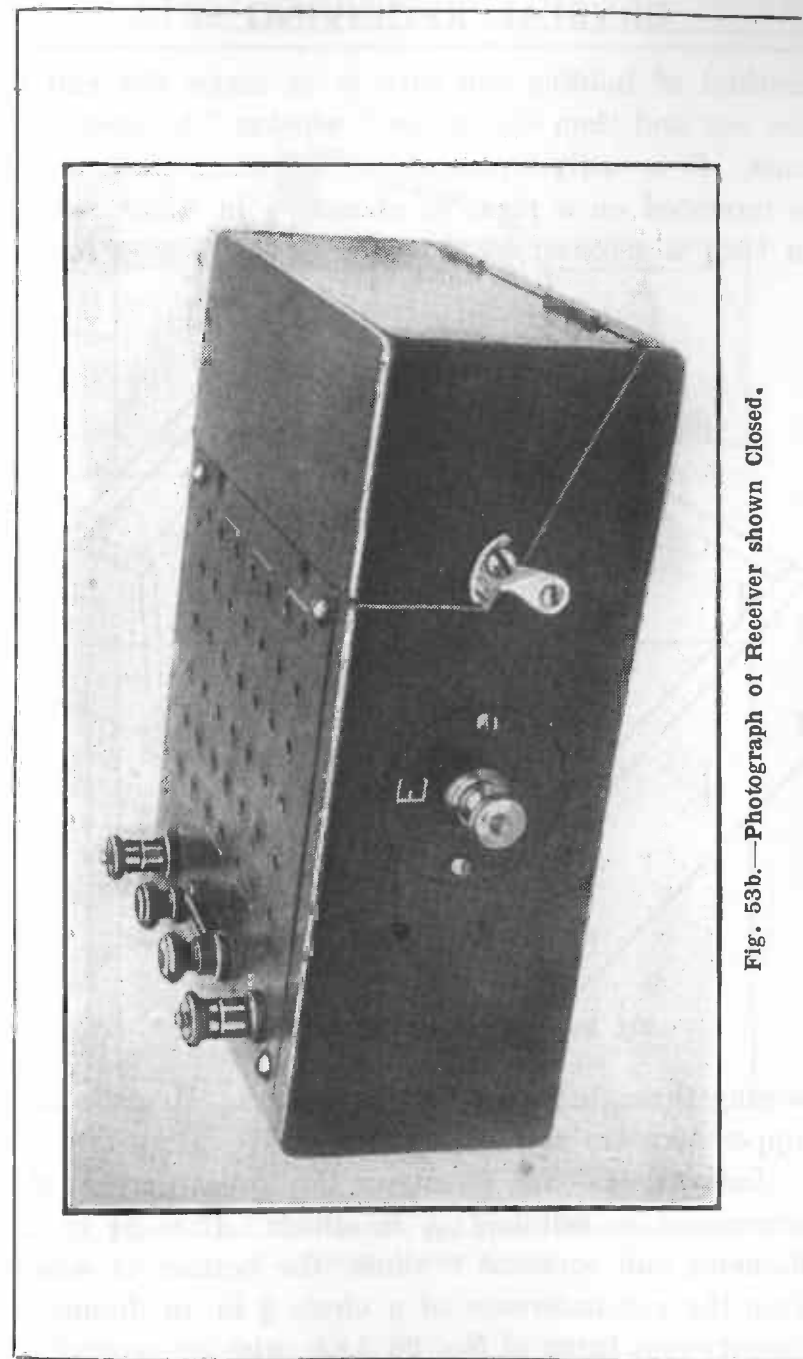

Fig. 53b.—Photograph of Receiver shown Closed.

CRYSTAL RECEIVING SETS

method of holding the wire is to screw the end of the rod and then clamp the "whisker" between two nuts. It is easily replaceable. The complete detector is mounted on a piece of ebonite $\frac{1}{8}$ in. thick, which in turn is screwed to the base by four brass screws

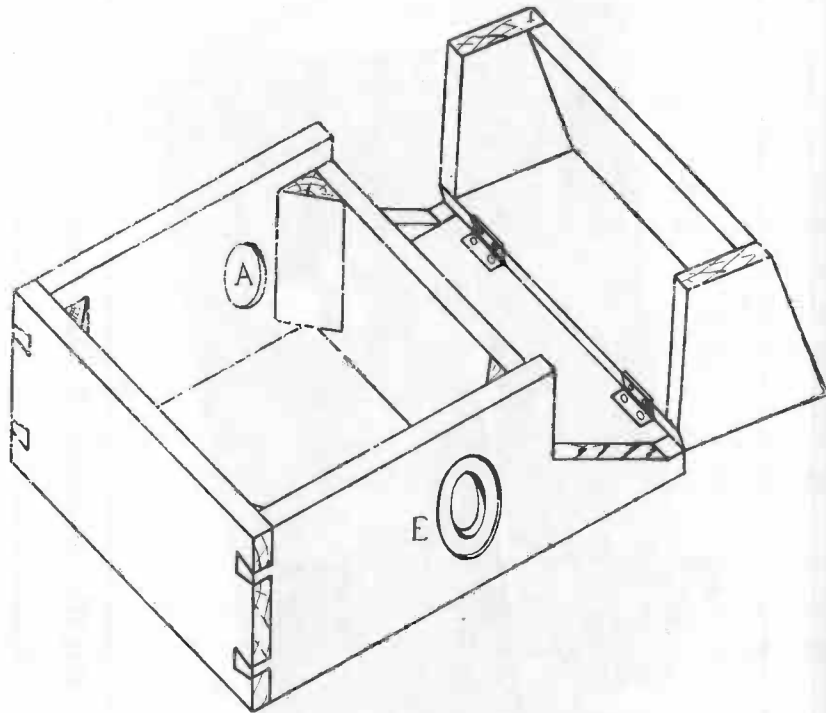

Fig. 54.—Details of Containing Case.

passing through four celluloid washers. Hertzite and copper wire are used as a detector.

Inductance.—Fig. 60 shows the appearance of the former cut in celluloid $\frac{1}{16}$ in. thick. It is $3\frac{1}{2}$ in. in diameter and contains 9 vanes, the bottom of which is on the circumference of a circle $\frac{3}{4}$ in. in diameter. Seventy-two turns of No. 26 d.s.c. wire are wound on

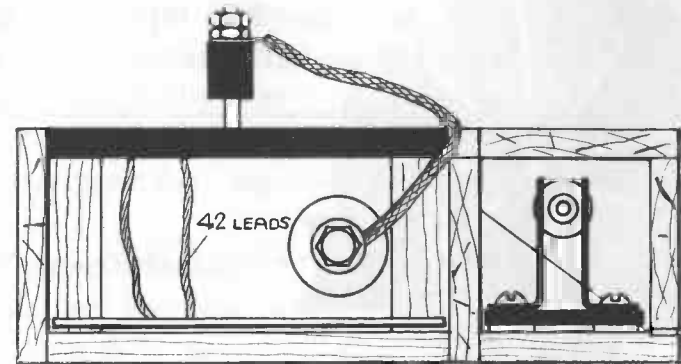

Fig. 55

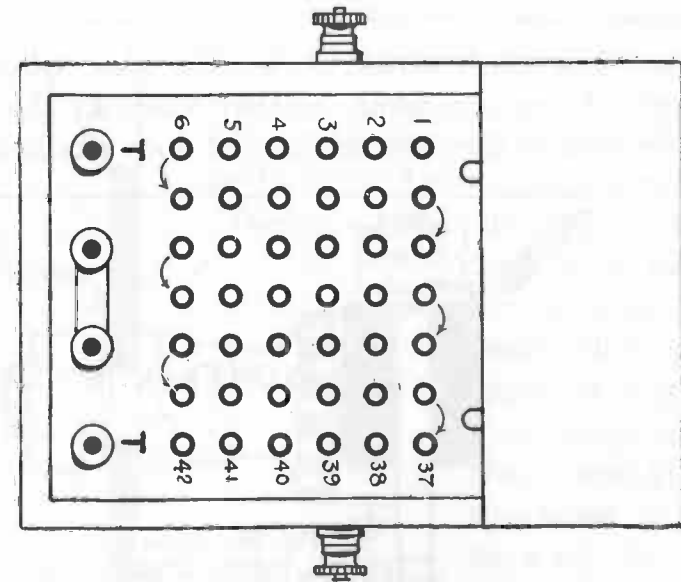

Fig. 56

Figs. 55 and 56.—Section and Plan of Receiver with Plug-in Basket Coils.

CRYSTAL RECEIVING SETS

and tappings taken off in the following manner:— Starting from the inside, the first tapping is taken after the first turn, the second is taken at the next

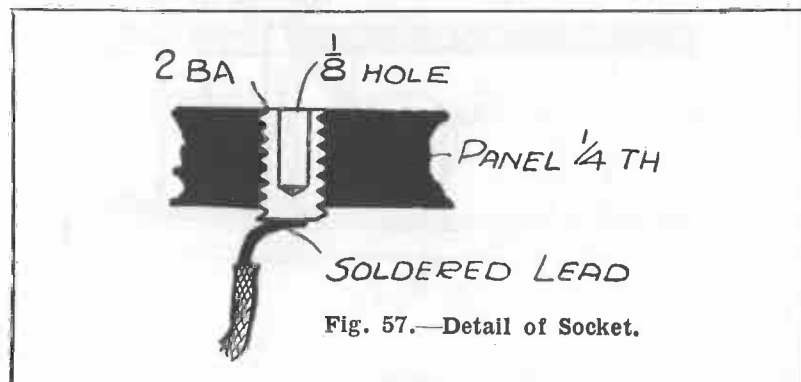

Fig. 57.—Detail of Socket.

one and one-ninth turns, i.e. on the vane following the end of one revolution, so that when all the tap-pings are made they are not heaped upon one another

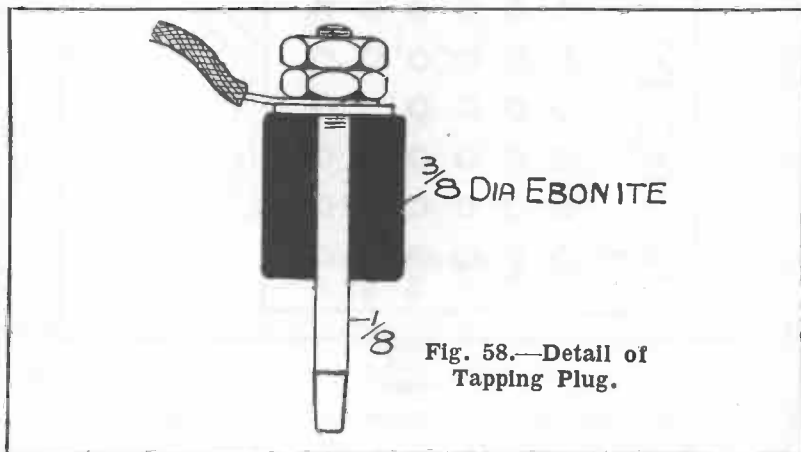

Fig. 58.—Detail of Tapping Plug.

on the same vane. The third tapping is taken after the next one and one-ninth turns, and so on. When completed, 33 tappings should be taken as just

SET WITH PLUG-IN BASKET COILS

described and 9 tap-pings taken at every four and one-ninth turns. The latter are for coarse tuning, and the former for fine tuning.

Connections.— For inductance coil use a five-stranded flexible wire (called "baby" flex) and make each

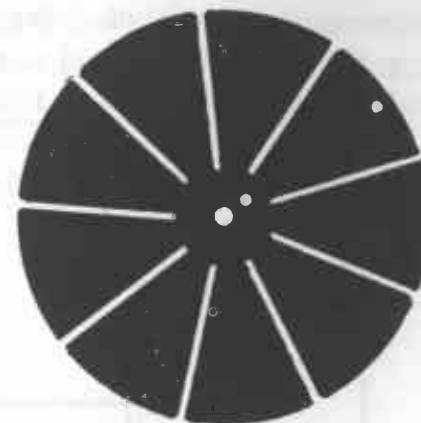

Fig. 60.—Tuning-coil Former.

5 in. long. Solder all connections, and on completion soak the whole in paraffin wax.

The plug numbers in Fig. 56 indicate the order of attaching connections.

Tuning.—As an illustration of the method of tuning, for example, it is found that 2 L O comes in very well when plugs are in Nos. 2 and 41, and also when in Nos. 29 and 42, but there is a very slight difference in the result, as the difference between the length of wire

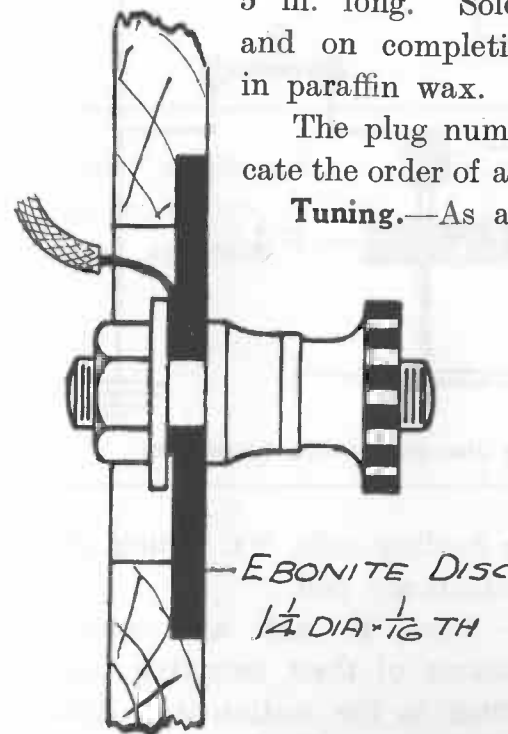

Fig. 59.—Method of Fixing Terminals.

CRYSTAL RECEIVING SETS

between each pair of holes is very small. In this case the final tuning is obtained by moving the aerial and earth plugs together into either pair of holes.

Explanatory details are shown in Figs. 54 to 60 and a wiring diagram in Fig. 61, in which figure B

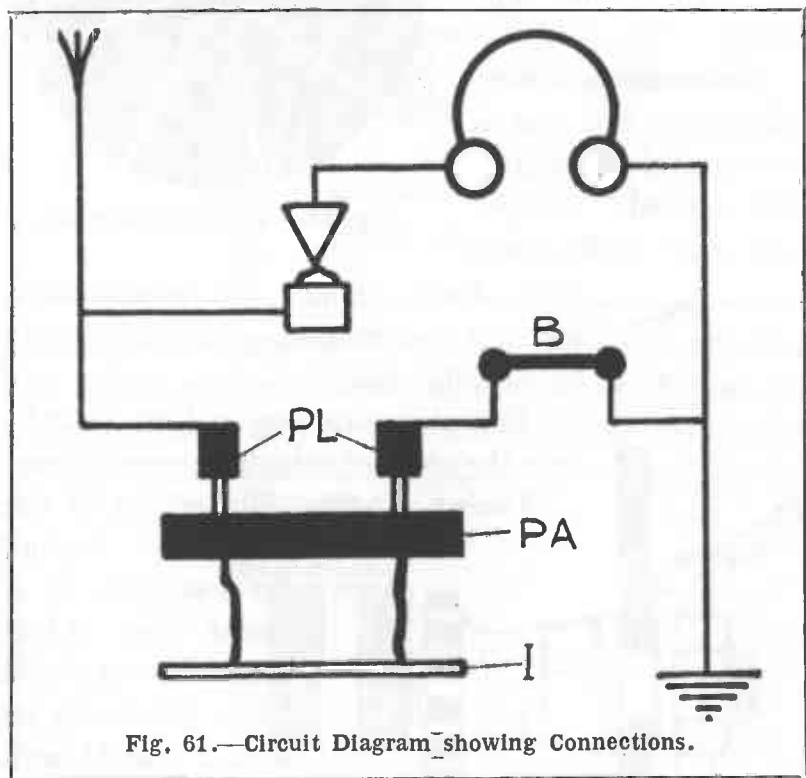

Fig. 61.—Circuit Diagram showing Connections.

represents bridge for loading coils, PL tuning plugs, PA panel, and I inductance coil.

Tuning Cards.—Most, if not all, amateurs memorise the calibrations of their receiving sets or have to tune each time to the station it is desired to hear. It may not be generally known that the

SET WITH PLUG-IN BASKET COILS

use of a tuning card would be of great assistance. These are used in just the same way as a business

STN.	γ	A.T.I.	A.T.C.	C.C.C.	COIL NOS.			COUPLING	H.T. (volts)	STRENGTH	REMARKS
					P	S	R				

man uses a file index. An example of such a card is shown above, though, of course, this may be modified according to individual requirements.

CHAPTER VII

Combined Crystal and Valve Receiver

By P. T. BEARD

THE receiver dealt with in this chapter is not new, but its many advantages are usually unknown to the newcomer in the wireless field. It is as easy to make as a simple one-valve receiver. Briefly the receiver consists of a valve used as an amplifier of radio-frequency oscillations, in conjunction with a crystal used as a detector or rectifier.

The Tuner.—An ebonite or prepared cardboard cylinder 4 in. long by 3 in. in diameter is wound with forty turns of No. 20 d.c.c. copper wire, tapped off to a seven-point switch from the following turns: 6, 12, 18, 24, 30, 36 and 40. Between turns 12 and 13 a space of $\frac{1}{4}$ in. is left as shown in Fig. 62.

Reaction Coil.—This is a basket-wound coil of No. 26 s.c.c. copper wire wound on a cork 1 in. in diameter with thirteen pieces of cycle-wheel spoke or blanket pins spaced equally round its circumference. The wire is simply wound in and out round the spokes (Fig. 63) until the coil is just of sufficient diameter to rotate inside the inductance coil without touching. When the reaction coil is wound, leave about 6 in. of loose wire at each end for connections, and soak the coil in a bath of melted paraffin wax. When the wax is just about to set, remove the coil and allow it to

CRYSTAL AND VALVE RECEIVER

harden. Afterwards the spokes can be withdrawn and the cork taken away.

A piece of brass rod 5 in. long and $\frac{1}{8}$ in. in diameter

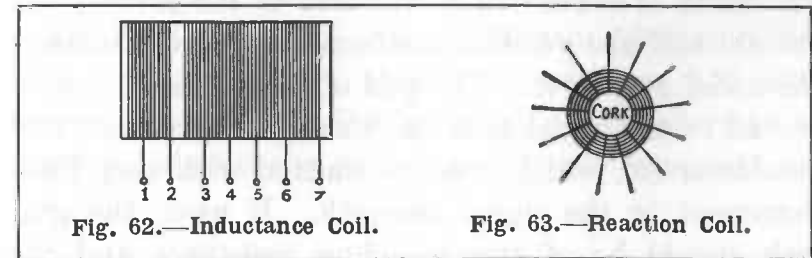

is now passed through the inductance coil in the space left between turns 12 and 13, and the coil lashed securely to the brass rod by means of adhesive tape. A hardwood or ebonite knob is fastened to the end of the brass rod so that the reaction coil can be rotated inside the inductance coil (Fig. 64).

A variable condenser of about .0005 microfarad

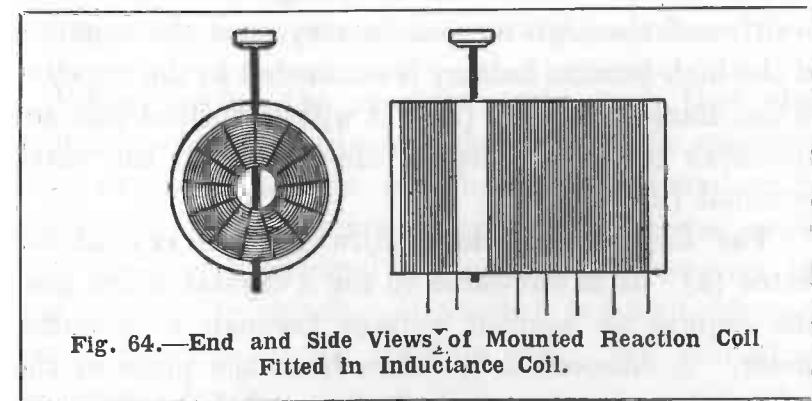

capacity is connected between the aerial end of the inductance (A) and the handle of the seven-point switch, and the tuner is complete (Fig. 65).

CRYSTAL RECEIVING SETS

The complete receiver is shown in the diagram (Fig. 65). It will be seen that the aerial is joined to the inductance coil at the end nearest to No. 1 tapping. The earth is connected to the arm of the seven-point switch, and the variable condenser is placed between the aerial and earth. The grid of the valve (G) is connected to the aerial terminal through a grid leak and condenser (C), which may be omitted with very little detriment to the signal strength. If used, the grid leak should be of two megohms resistance and the grid condenser of $\cdot 0003$ microfarad capacity.

One connection of the reaction coil (which is, of course, inside the inductance coil) is connected to the plate of the valve (P), and the other connection is taken to the telephone terminal which is nearest to the positive terminal of the high-tension battery (M). Take careful note of this part of the circuit. A connection is taken from this telephone terminal to the positive of the high-tension battery, and the negative of the high-tension battery is connected to the negative of the filament battery (H). It will be noticed that the negatives of both batteries are joined to the earth terminal (E).

The Crystal Detector.—Now for the crystal detector (K). It is advisable to use a crystal which does not require an applied voltage through a potentiometer. A connection is taken from the plate of the valve (P) to one terminal of the crystal detector (K). The other terminal of the crystal is joined to the telephone terminal opposite to the one which is connected to the reaction coil. A fixed condenser (N) of

CRYSTAL AND VALVE RECEIVER

about $\cdot 01$ microfarad capacity placed across the phones and high-tension battery as shown will improve results. The valve filament is supplied from a 6-volt accumulator through a variable resistance (J) of 5 ohms.

Operating the Set.—Phones of from 4,000 to 8,000 ohms total resistance should be used, or 120-ohm phones will do as well if a telephone transformer is inserted between the phones and phone terminals.

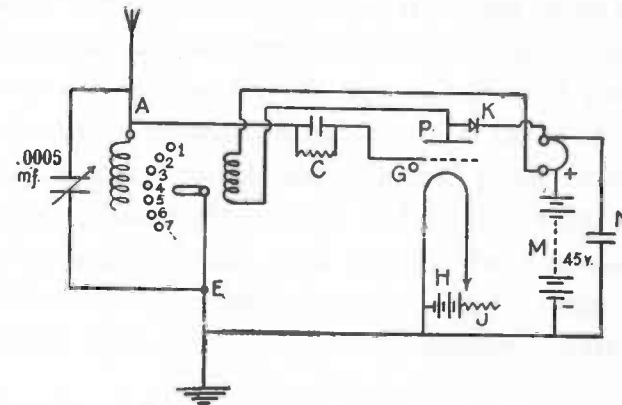

Fig. 65.—Diagram of Connections for Complete Receiver.

When testing the receiver, make sure that the crystal is correctly adjusted, then rotate the reaction coil; at the same time tap the aerial terminal with the finger. If clicks are heard in the phones each time the aerial terminal is touched, the receiver is ready to receive signals. If no click is heard, reverse the connections to the reaction coil; this will give the desired result.

With careful adjustment of the crystal the strength of signals will be from 200 per cent. to 300 per cent. louder than those obtained when using the valve alone.

CRYSTAL RECEIVING SETS

Another advantage of this circuit is that by simply switching off the filament current signals can still be received on the crystal. This is an asset when the filament battery runs down in the middle of an interesting transmission.

CHAPTER VIII

Some Miniature Receiving Sets

WHILST a set carefully built on orthodox lines is a necessity for those living some distance from a broadcasting station, the simplest of sets, even those which may be classed as freaks, are capable of giving excellent results within a range of a few miles of a broadcasting centre. Some have yielded good results over a range of more than 100 miles, but this must be taken as exceptional, and not to be expected as a general rule. The sets described in this chapter are miniature sets of the simplest possible construction.

A BASKET-COIL RECEIVER

This set, as previously intimated, is limited as regards range; that is, it can be described as a single-purpose instrument suitable for broadcast reception only.

An elevation and plan of the instrument is shown by Figs. 66 and 67.

The set consists of an ebonite block supported on four legs, between which are situated inductance coils of the "basket" type. On the top of this block is secured the crystal detector and terminals.

Constructing the Coils.—The construction of the coils is the first operation, as really the size of the base

CRYSTAL RECEIVING SETS

is dependent upon the outside diameter of these, but if the latter are made in accordance with Fig. 68 sufficient wire can be wound on to suit the majority of "broadcast" aerials. Disks $2\frac{3}{4}$ in. in diameter are cut from waxed cardboard, celluloid, or ebonite, and nine slots, each $\frac{3}{32}$ in. wide, cut therein, so that they reach down to the circumference of a circle 1 in. in diameter. A hole $\frac{1}{8}$ in. in diameter is drilled in the centre, and two pairs of holes about $\frac{1}{16}$ in. in diameter are made for the purpose of securing the ends of the wire.

Winding.—The wire is put on as follows: Wind on uniformly 44 turns of No. 26 d.s.c. wire on each disk and secure the ends through the holes just mentioned. It will be necessary to test these coils, the aim being to obtain perfect tuning when they are in the assembled position shown in Fig. 66.

Coupling these coils together and connecting to a crystal detector in the manner shown in the diagram (Fig. 69), it will be possible to determine the best relative position of the coils. (It must be remembered that it is important that the windings should both be in the same direction.) If, for instance, good reception is obtained with the coils 12 in. apart, then some wire must be removed from each coil, taking off one turn at a time, until with the coils about 1 in. apart good results are obtained. In the writer's case the coils each contain 38 turns, in others 36 and 44 turns have been necessary, depending on the natural wave-length of the aerial. This completed, leave 6 in. of wire projecting at each end for connecting purposes, give the

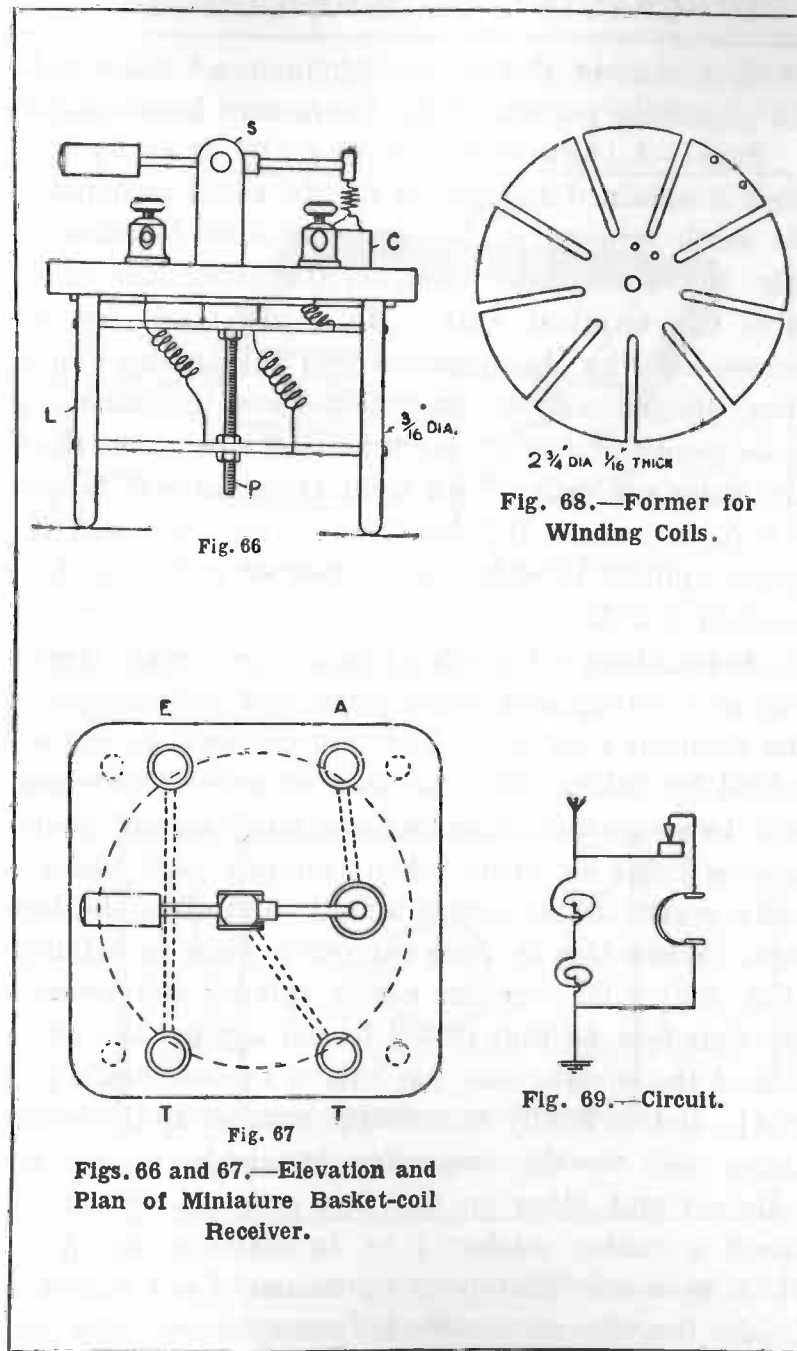

CRYSTAL RECEIVING SETS

whole a coat of shellac varnish, and set aside until the remaining portion of the instrument is completed.

Base.—A block of ebonite $3\frac{1}{4}$ in. by $3\frac{1}{4}$ in. by $\frac{3}{8}$ in. thick is obtained and drilled for the aerial terminal A, the earth terminal E, the two telephone terminals T (Fig. 67), and counterbored on the under side to receive the terminal nuts. Holes are made for the screws securing the stirrup S and the crystal cup C, after which channels are cut underneath connecting these points as shown. On the under side of the block five holes are drilled (not right through) and tapped 4 B.A. to receive the four legs L (Fig. 66), and the centre spindle P, which is a piece of rod 2 in. long screwed 4 B.A.

Assembling.—Assemble the four terminals, crystal cup and stirrup and make permanent connections in the channels provided. The best connections are obtained by taking three or four strands of thin wire and twisting them together, as single-strand coarse wire is liable to break when clamped hard under a nut; screw in the centre spindle and then the four legs. When this is done cut out a piece of celluloid (Fig. 66) to fit over the centre spindle and between the four legs, so that it will lie flat against the under side of the ebonite base (no nuts or screws should project). Before finally assembling, connect up the inductance coils to the respective terminals, replace the celluloid and place on the first coil, taking care to insert a rubber washer $\frac{1}{2}$ in. in diameter by $\frac{3}{16}$ in. thick between. Clamp up by means of a 4 B.A. nut. Solder the wire connection between the two coils, and

SOME MINIATURE RECEIVING SETS

twist the intervening length into a neat coil and assemble the second disk at the predetermined distance by

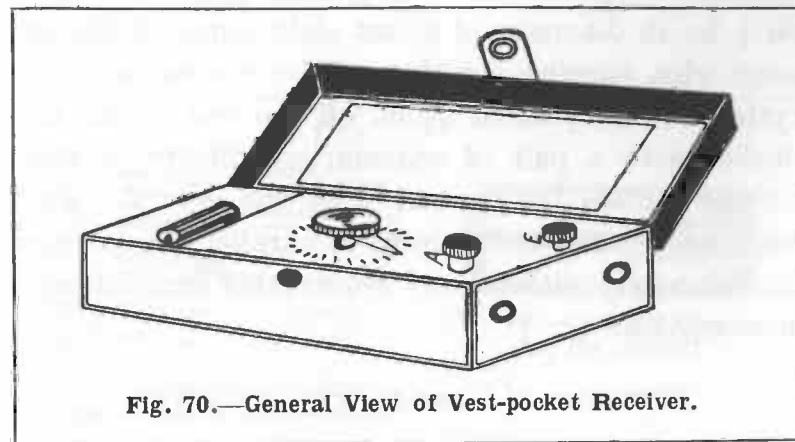

Fig. 70.—General View of Vest-pocket Receiver.

a 4 B.A. nut on each side, at the same time observing the correct direction of the coil winding,

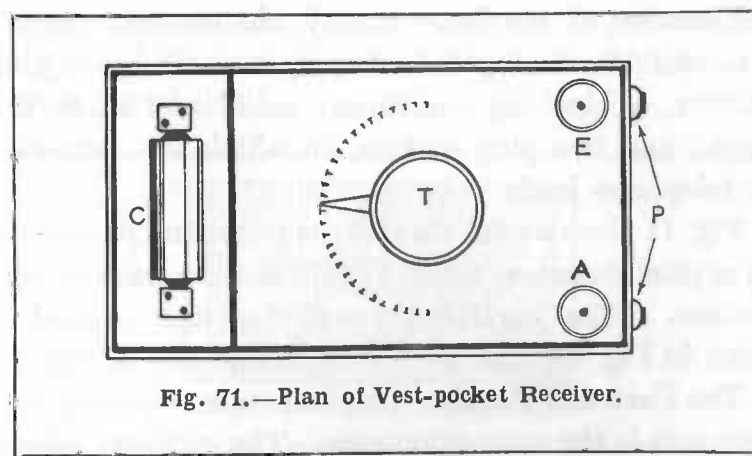

Fig. 71.—Plan of Vest-pocket Receiver.

Check over the connections carefully in accordance with the diagram Fig. 69.

CRYSTAL RECEIVING SETS

The Detector.—Hertzite crystal and copper wire is probably the most satisfactory combination. The copper wire (catwhisker) is preferably made into a coil $\frac{1}{4}$ in. in diameter of about eight turns of No. 36-gauge wire, turning out the end for contact with the crystal. Cutting about $\frac{1}{32}$ in. off the end of the catwhisker with a pair of scissors periodically provides a clean surface for contact with the crystal. Four headphones (each 4,000 ohms) in parallel can be used simultaneously without any appreciable diminution of the reception.

BUILDING A VEST-POCKET RECEIVER

The sketch (Fig. 70) gives a general idea of the appearance of a vest-pocket receiver contained in a safety-razor case. The instrument has only one adjustment, the small tuning knob in the centre of the panel.

Elements of the Set.—Briefly, the receiver consists of a variable tuning inductance, a cartridge crystal detector, a blocking condenser, aerial and earth terminals, and two plug sockets, to which are connected the telephone leads.

Fig. 71 gives a plan view of the panel and position of the crystal detector, while Fig. 72 is a diagram of connections. The cartridge containing the crystal is shown in Fig. 73, and the tuning inductance in Fig. 74.

The Case and Panel.—The first item requiring consideration is the containing case. The ordinary safety-razor case is ideal for this purpose. An ebonite panel is now cut to fit tightly into the case, leaving a small partition in which the crystal is housed.

SOME MINIATURE RECEIVING SETS

panel must be securely supported, either by means of a small strip fixed in the inside of the case or by means of small countersunk screws passing through the sides.

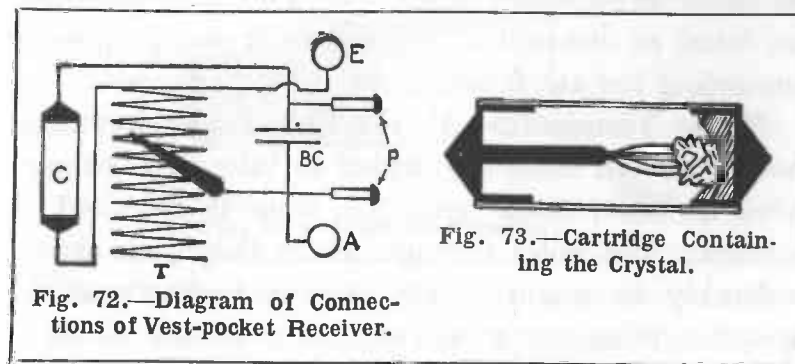

The Tuning Coil.—To the under side of the ebonite panel is fitted the tuning inductance, which consists of No. 32 enamelled wire wound on an ebonite former $\frac{3}{16}$ in. thick, 2 in. deep, and as wide as can be got into the case, that is, a shade smaller than the ebonite panel itself.

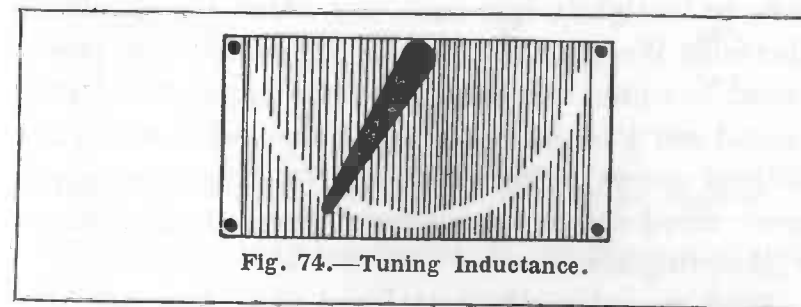

The Contact Finger.—A small contact finger is now made up, soldered to a short spindle, and arranged to make contact on the bared portion of the inductance

CRYSTAL RECEIVING SETS

winding, as shown in Fig. 74. This contact finger is moved by means of the tuning knob *T* on the top of the panel. A pointer may be fitted to enable comparative tests to be made, a scale being engraved on the panel, as indicated in Fig. 71. Two small terminals are fitted at one end of the panel for the purpose of connecting the aerial and earth wires to the set.

Phone Terminals.—At the end of the containing case two small holes are drilled to take two ordinary valve sockets; these must be securely mounted in position. The holes through which they pass should preferably be bushed with ebonite to increase the insulation efficiency of the set.

A pair of valve legs, corresponding to the sockets, should be soldered to the phone, which, for compactness' sake, may consist of a single 4,000-ohm receiver without a head-band.

The Detector.—The cartridge crystal detector is very simple in construction: a short length of ebonite or fibre tube is obtained and two small metal caps made to fit tightly into each end. One cap should be filled with Wood's alloy, and a good sample of a galena crystal mounted therein. The other cap is fitted with a metal rod $\frac{1}{8}$ in. in diameter, to the end of which are soldered several wires of about No. 26-gauge copper wire. Hard-drawn wire should be used on account of its springiness.

With regard to the metal end cap, these are best turned out of solid brass rod, the ends being pointed for the spring-clip holder provided. This holder may consist of two right-angled brass strips screwed to the

SOME MINIATURE RECEIVING SETS

bottom of the containing case. It is, of course, understood that the cartridge is assembled so that the bunch of copper wires makes contact with the crystal in several different places.

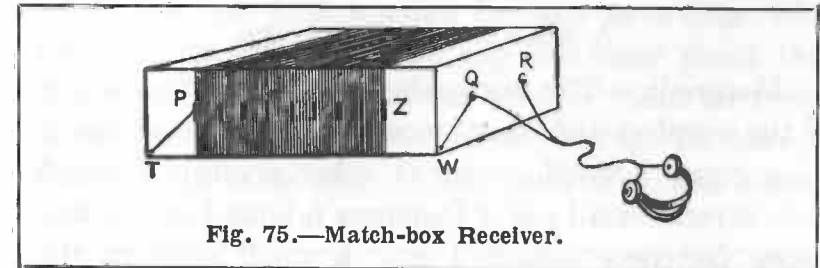

Fig. 75.—Match-box Receiver.

The Condenser.—The blocking condenser consists of eleven sheets of tinfoil, 2 in. by $1\frac{1}{2}$ in., interleaved with wax paper and mounted, underneath the panel on the bottom of the case.

Connections.—The diagram of connections is given in Fig. 72. The telephones are connected to the plug sockets *P*, the aerial and earth to *A* and *E*, *B* *C*

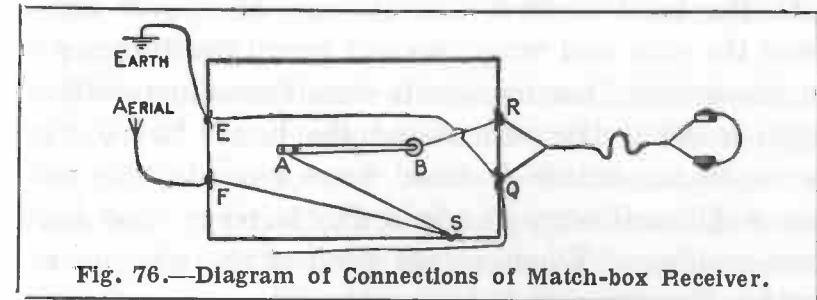

Fig. 76.—Diagram of Connections of Match-box Receiver.

being the blocking condenser, *T* the tuner, and *C* the crystal.

Range of Set.—Using an aerial of the regulation length and height the broadcast concerts should come through very clearly, while a certain amount of Morse

CRYSTAL RECEIVING SETS

and amateurs' transmissions may be picked up under good conditions.

Quite sharp tuning can be obtained with the wiring as given in Fig. 72.

A MATCH-BOX RECEIVER

Materials.—The materials required for this set are of the simplest and merely comprise: $1\frac{1}{2}$ oz. of No. 26 d.c.c. wire, 1 small galena or other crystal, 1 match-box, several small paper fasteners (about $\frac{1}{4}$ in.), 4 large paper fasteners (about $\frac{1}{2}$ in.), a small strip of thin brass, and the screw cap of a metal-polish tin.

Winding the Tuner.—The amount of wire, etc., depends on the size of the match-box used; the best is one of the largest. At each end of the box make two holes about 1 in. apart, and through these holes put the large fasteners. About a $\frac{1}{4}$ in. from the end on one side of the box put a small fastener P (Fig. 75), with the head inwards and through the cover only. Take the wire and wrap the end round the fastener P on the outside, leaving about 6 in. for wiring. Then begin to wind the wire round the box. Every five turns put in another fastener, head inwards, bare the wire a bit and wrap it round the fastener, and continue winding. When within $\frac{1}{4}$ in. of the end put in another fastener, cut the wire, bare the end and wrap it round the last fastener.

Through the inner box part put a fastener S, as shown in Fig. 76, so that its head will touch the head of the fastener Z when the box is closed.

The Detector.—The detector is easily made with

SOME MINIATURE RECEIVING SETS

the piece of galena, the strip of brass, and the screw-cap. Take the screw-cap and cut four slits in the side to about half-way down as in Fig. 77. Bore a hole in the bottom of the cap and fasten it down to the inside part of the box with a small fastener as B (Fig. 76). Then put the crystal in the cap and bend down the edges, thus holding the crystal firmly. Take the strip of brass and cut it into the shape of Fig. 78, boring a hole in the wide end. Then bend it to the shape

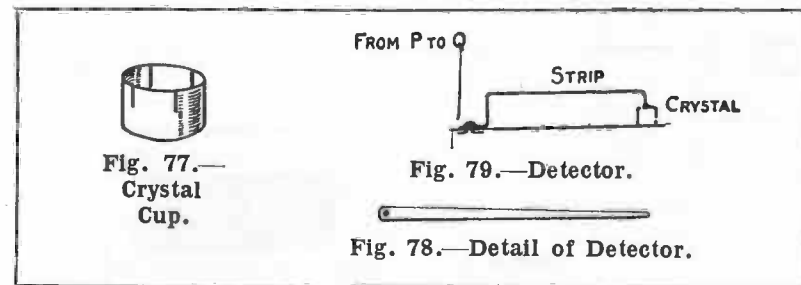

shown in Fig. 79, and fasten it with a fastener at the proper distance from the cup.

Wiring Connections.—Having completed the tuning coil and the detector the next thing is the wiring. Through the outer cover in the bottom corner bore a small hole T (Fig. 75), and through it thread the wire from P. Run wire along the inside of the outer cover so that it comes out at W at the other end, then join it to Q. Next attach a wire to the cup B and connect it to R on the inside. Then attach a wire to the strip A and connect that wire to the fastener S; connect the fastener S to the fastener F, and attach a wire to Q on the inside and join it to E.

CRYSTAL RECEIVING SETS

If desired, a small knob can be glued on to the box between E and F for the purpose of tuning.

The head-phones are attached to the terminals R and Q, the aerial is attached to F and the earth to E.

Operation.—In use the point of the strip A should be moved about until signals are heard. Tuning is then effected by pulling the inner part of the box out.

CHAPTER IX

Crystal Circuits

THE illustrations (Figs. 80 to 85) in this chapter show diagrammatically (as distinct from conventionally) the common circuits used in crystal sets.

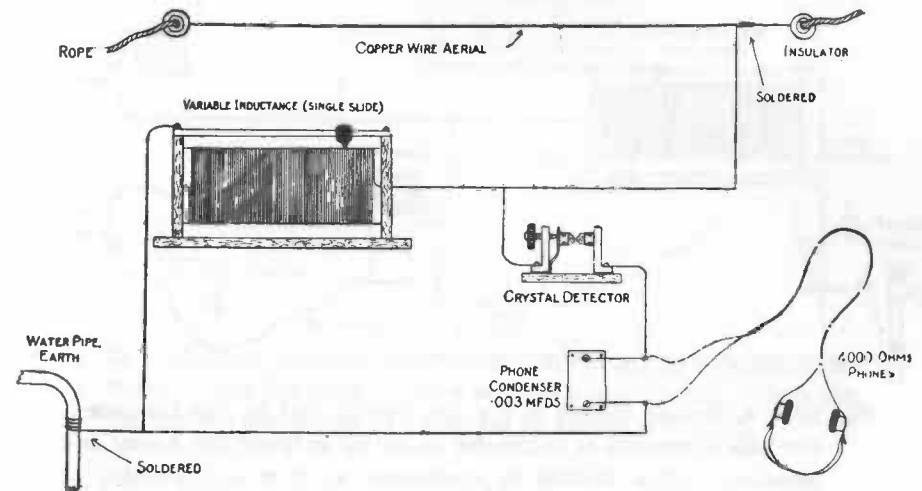

Fig. 80.—Diagram showing the Method of Connecting up a Single-slider Tuning Inductance to a Crystal Detector. This manner of Coupling is termed "Direct-coupling."

There are various types of tuning devices in general use, the more common, perhaps, being the single-layer solenoid type. These may be divided up into two classes—the "tapped" and the sliding contact tuners. Dealing with the single coil direct-coupled

CRYSTAL RECEIVING SETS

tuners, the most effective as regards fine tuning is doubtless the single slider tuning coil as illustrated in Fig. 80. Here it will be seen that tuning is effected by simply sliding a spring contact along the coil. It is possible to obtain fairly accurate tuning to within one complete turn of wire on the coil. For finer tuning a variable condenser is often inserted in the aerial

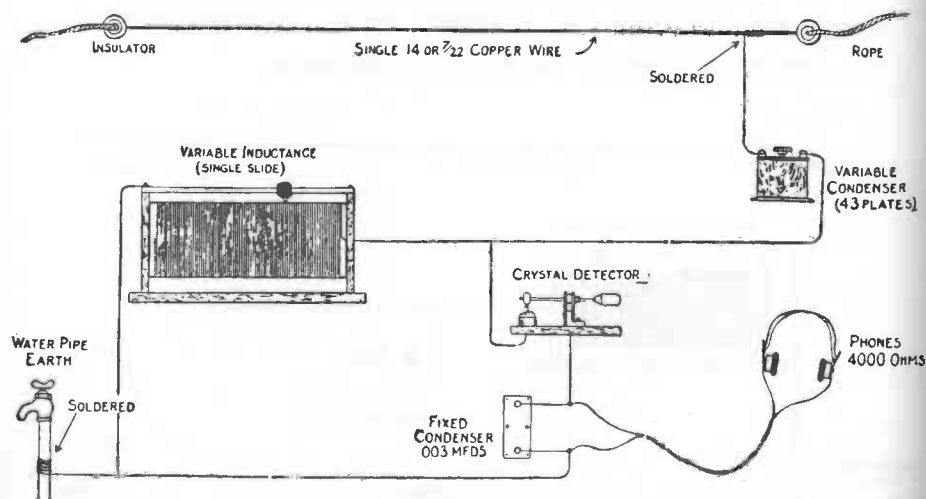

Fig. 81.—A Similar Circuit to Fig. 80, except that in this instance a Variable Condenser is Connected in Series between the Aerial and Receiver. This Method is Inefficient as It is not possible to obtain Correct Tuning.

system, in series with the tuning coil as in Fig. 81. This condenser certainly facilitates short-wave tuning, but is often undesirable owing to its effect in causing unbalanced tuning. Another type of sliding contact tuner is the two-slider. The original object of a two-slider coil was to form an auto-transformer coupling which would give a reasonable transformer step-up in

CRYSTAL CIRCUITS

signal strength without the usual losses attendant to the use of a loose-coupled air-core transformer. The wiring of this two slider is shown by Fig. 82. Here it will be seen that the one coil governs two circuits—the aerial, one portion of the coil and earth being one circuit, and the crystal, phones, one section of the coil and earth, the other circuit. The aerial to earth

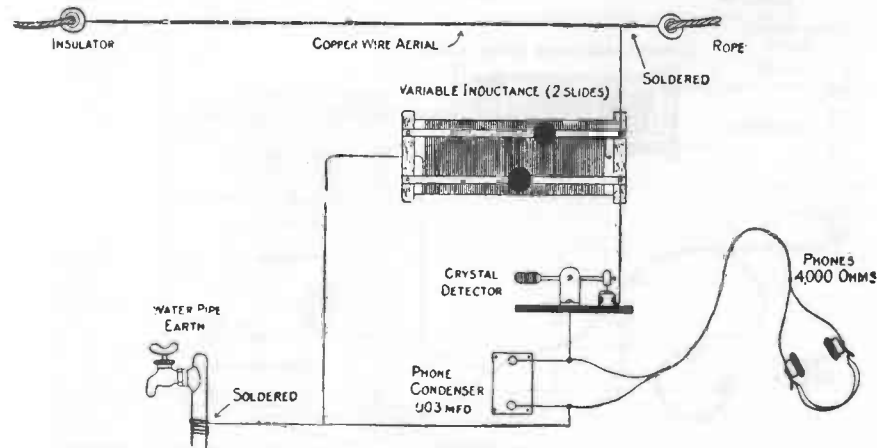

Fig. 82 —Diagram showing One Way of Connecting up a Double-slider Tuner. This Coupling is known as "Auto-transformer" Coupling. The Circuit above may be Improved as shown in Fig. 83.

circuit is the primary, and the crystal, coil, and telephone circuit forms the secondary. Fairly correct tuning is obtained from the primary circuit, but when the secondary circuit is adjusted with a greater number of turns of wire to obtain the necessary transformer step-up, the secondary circuit becomes out of "tune." To obviate this, a variable condenser is inserted in parallel across the secondary section of the coil as in Fig. 83. By means of this condenser, accurate

CRYSTAL RECEIVING SETS

secondary tuning is possible, allowing scope at the same time for any reasonable transformation ratio of turns between the primary and secondary sections of the tuning coil. Provided accurate tuning is employed, this type of tuner is probably the most desirable from the point of view of the crystal user.

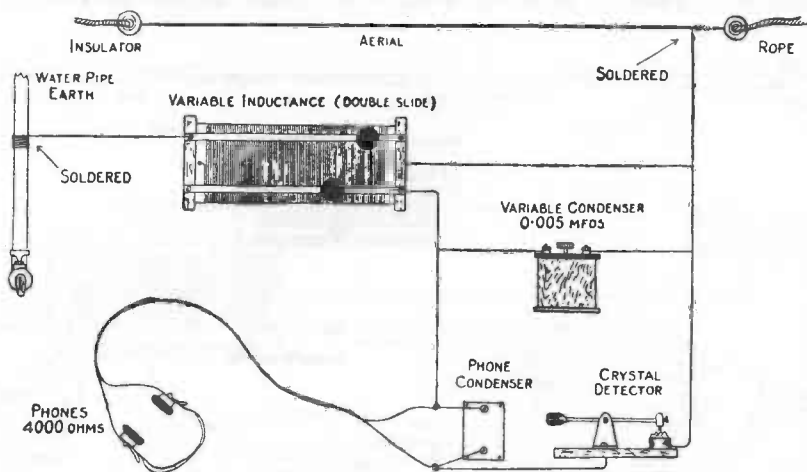

Fig. 83.—A Circuit with a Variable Condenser Connected in Parallel across the "Secondary." A "Transformer Step-up" Effect between Primary and Secondary is Produced which gives Selective Tuning and very Efficient Results.

Another method of tuning is that known as "tapping" the coil. Fig. 84 illustrates the single switch-arm type. Correct tuning, however, is not possible unless the tappings are accurately taken at calibrated points for certain wavelengths. A tuning condenser may, however, be connected between the aerial and earth terminals of the coil to facilitate accurate tuning. A more efficient type of tapped coil is that shown by Fig. 85 where two switch-arms are employed. One

CRYSTAL CIRCUITS

switch-arm is designed to make contact over a portion of the coil which is tapped in units of turns, the other switch-arm making contact over the remainder of the coil which is tapped in sections each equalling the total number of turns covered by the unit switch-arm. Suitably designed, and for short wavelengths, it is possible with this type of tuner to obtain correct

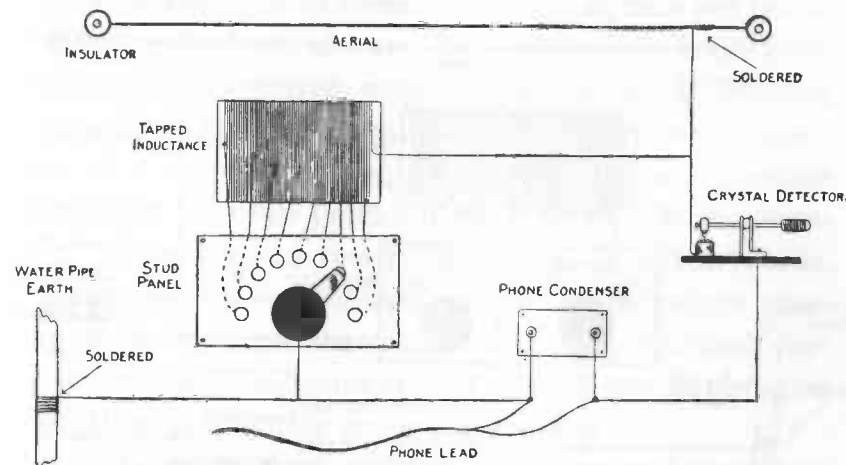

Fig. 84.—Diagram showing the Connections for a Tapped Inductance Employing only One Switch-arm. This Circuit does not allow of very Fine Tuning.

tuning to within one turn of wire on the coil. This type of tuner has one great advantage over the slider method, inasmuch as the wire on the coil is not worn away or cut through by constant use of a slider. These fine particles of copper, worn from the coil by the slider, tend to bridge neighbouring turns of wire on the slider coil. In the tapped coil this trouble is eliminated, but the advantage is lost if the tapping studs are poorly insulated. On each diagram will be

CRYSTAL RECEIVING SETS

seen the necessary crystal detector for detecting and rectifying the signals, and also the telephone condenser and the telephones. The telephone condenser is not absolutely an essential instrument, as the self-capacity of the telephone windings and the telephone leads is often adequate. However, it will generally be found that a fixed condenser of capacity between

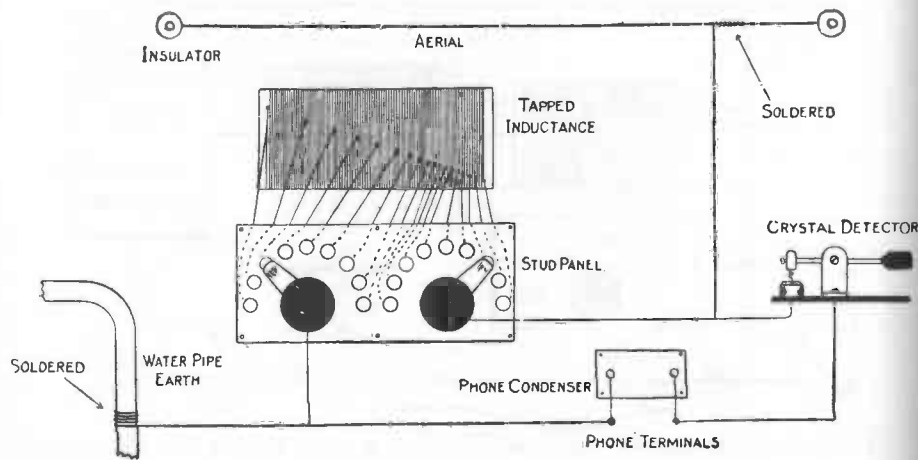

Fig. 85.—An Effective Means of Wiring-up a Tapped Coil to Two Switch-arms which Facilitates Fine Tuning.

.001 and .005 microfarads will considerably improve the note of the signal heard in the telephones. All bare wire connections should be thoroughly clean and soldered, all terminal connections should be clean and tightly bolted. Do not grind or break crystal surfaces unnecessarily and periodically wash the surface of the crystal with methylated spirits by means of a small brush.

CHAPTER X

How Crystals Work

What the Crystal Does.—Wireless signals are transmitted in the form of waves created in the ether, which, striking the receiver aerial, cause small alternating currents to travel up and down it. As these currents are of a very high frequency, the ordinary wireless telephone receiver cannot detect them. It is necessary, therefore, to rectify them, or, in other words, change them into unidirectional currents, before passing them through the telephones. The rectified currents produce a movement of the telephone diaphragms and thus the signals are made audible.

Certain kinds of crystals, such as carborundum, zincite, bornite, silicon, galena, molybdenite and iron pyrites (see Figs. 86 to 93, which show crystals enlarged to about three times normal size), have the peculiar property of being able to rectify small alternating currents. An explanation is given to show how they do this.

How a Crystal Rectifies.—A crystal rectifies because it allows current to flow through it in one direction and does not, to any appreciable extent, allow current to flow through it in the opposite direction. It is practically a uni-directional conductor. The ratio of currents flowing in opposite directions through

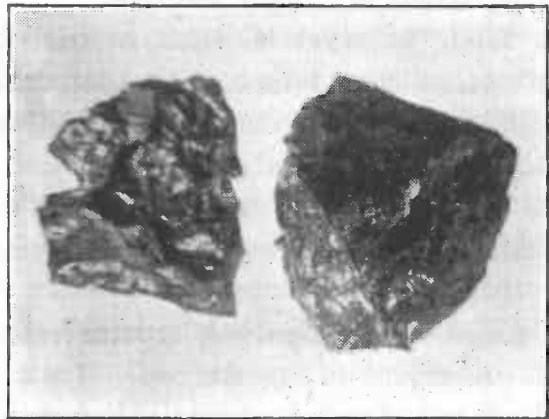

Fig. 86.—Silicon.

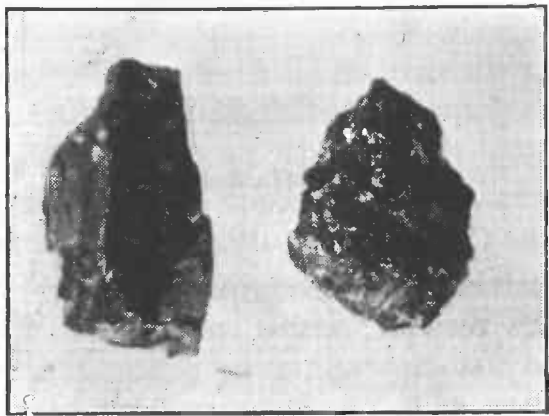

Fig. 87.—Galena and Special Galena.

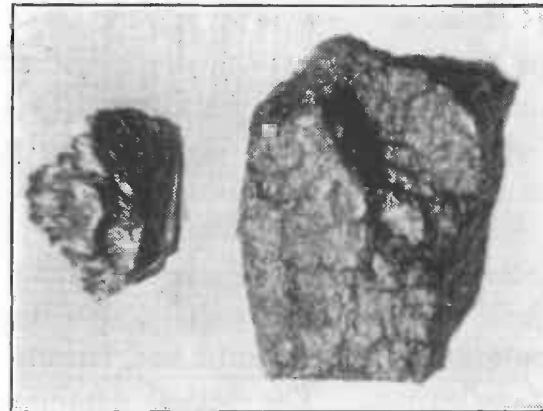

Fig. 88.—Bornite.

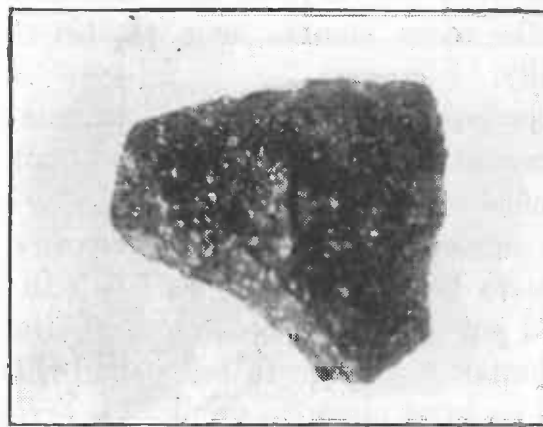

Fig. 89.—Radiocite.

CRYSTAL RECEIVING SETS

a good crystal should be about 40:1. It will be understood that the crystal acts electrically, very much in the same manner as a ratchet-wheel acts mechanically.

Carborundum Crystals.—Carborundum is probably the best crystal for all-round use. It is not affected by mechanical vibration nor by fairly heavy electrical discharges across it, and it is very sensitive. This crystal has to be used in conjunction with a 4-volt battery and potentiometer, because it requires a small initial potential or voltage to be applied across it to bring it to its most sensitive point. Carborundum is used with a flat steel surface, the rectification taking place at the point of contact. This crystal is manufactured by fusing carbon and silicon together in an electric furnace. In practice three kinds of carborundum crystal are met with: (a) a hard dark variety, having great metallic lustre which has poor rectifying properties; (b) a soft crystal of a pale-green colour, a colour due to the presence of copper and iron salts (this type of crystal is a very poor rectifier); (c) a dark grey crystal which will be found to give the best results as regards sensitivity and stability of action.

The Perikon Detector.—The most popular crystal detector is without doubt the perikon detector. This is a combination of either zincite and bornite or else zincite and tellurium. The latter combination is usually found to give the better results. Zincite, a zinc-oxide ore, is dark red in colour; bornite is a compound of copper and iron sulphides, being bluish grey

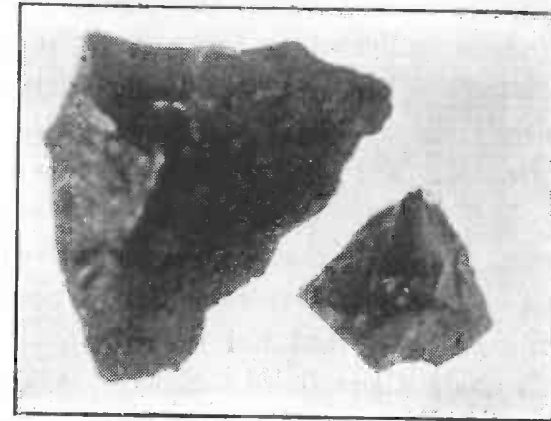

Fig. 91 — Copper Pyrites.

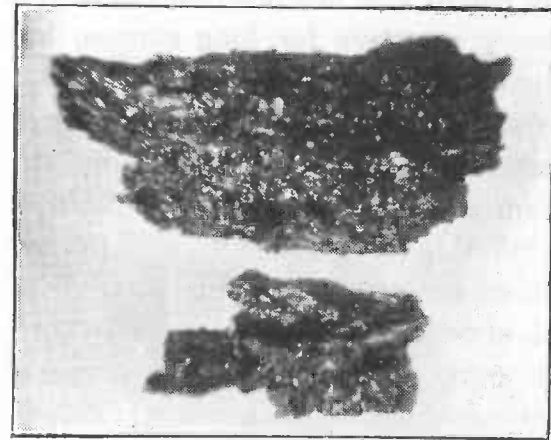

Fig. 90.—Carborundum.

CRYSTAL RECEIVING SETS

in appearance and fairly heavy. Tellurium is a light-coloured metal. The perikon detector does not require a potentiometer because the voltage of the incoming signal is sufficient to bring it to its sensitive point. It has the advantage of being fairly easy to adjust. Also when a crystal becomes slightly insensitive it can be scratched with a knife and a new surface used. To obtain the best results it is usually found that the crystals must make a light contact with each other. This detector is more sensitive in action than the carborundum type, but not so robust.

Other Crystals Considered.—Silicon, galena, molybdenite and iron pyrites, whilst being serviceable for experimental work, do not give such satisfactory general results as either carborundum or the perikon detector. All these crystals are minerals. Silicon is light grey in colour and has not many sensitive points. Galena is very sensitive for long ranges, but strong signals destroy its sensitivity. It is bluish black in colour, has a metallic lustre, and is heavy. When using this crystal it is usual to have a graphite contact in conjunction with it. Molybdenite is dark in appearance and is suitable for the reception of strong signals; it is convenient for use in portable sets. Iron pyrites is a cubical crystal, being very metallic and heavy. It possesses many of the properties of carborundum but is not so sensitive.

Finding the Best Crystal.—The only sure way to obtain a good crystal is to search for sensitive points amongst several specimens. It is wise to remember that sensitivity is not everything; a good crystal

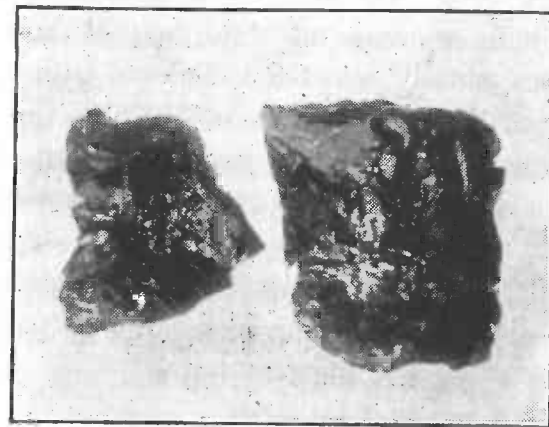

Fig. 93.—Zincite.

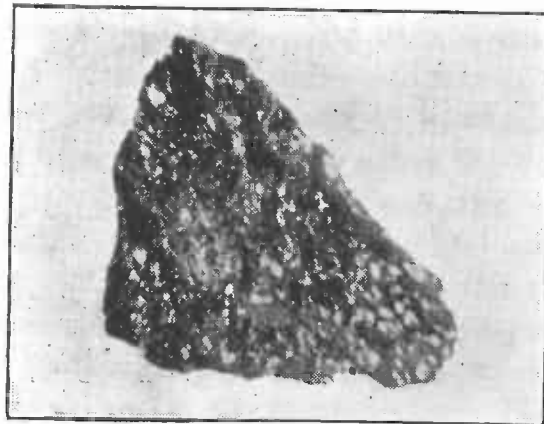

Fig. 92.—Permanite.

CRYSTAL RECEIVING SETS

should have the qualities of being constant in action and of not being affected by atmospheric disturbances. Such crystals as "radiocite" and "permanite" are usually sensitised forms of galena. They are very sensitive but not constant; a fine copper wire contact is used in conjunction with them.

There is plenty of instruction and amusement to be had with a good crystal set. The range of a crystal set is about 300 miles for ordinary ship stations and 20 or 30 miles for high-power telephony.

CHAPTER XI

Making a Buzzer

By A. W. HULBERT

THIS chapter deals with a new type of buzzer, one which utilises a circular armature or diaphragm instead of the usual flat strip of metal. Due to the fact that this diaphragm is supported all round, it is possible to have the magnet almost touching the diaphragm, resulting in a more sensitive instrument and one capable of producing an extremely high-pitched note.

The overall dimensions of the instrument are also considerably less than the standard instrument, and having a minimum of working parts it is very easy to make.

Constructional Details.—Fig. 94 is a section of the instrument. A circular ebonite case B, with a snap-on lid, is fitted with an electro-magnet M, which is wound on a strip of soft iron P which serves the double purpose of a core for the magnet and also a support. The soft iron strip P is bent round and mounted on the bottom of the ebonite case with the aid of two screws, the opposite arm to that carrying the coil M being in contact with the diaphragm D, which rests on a ledge turned in the ebonite case. The distance between the diaphragm and the pole of the magnet M is approximately $\frac{1}{32}$ in.

The lid of the ebonite case B is undercut to enable

the diaphragm to vibrate. Mounted on the top is a contact screw *s* and a terminal *F*. The other terminal (not shown in Fig. 94) is connected to one end of the magnet winding, the other end being earthed to the polepiece *P*. The passage of the current through the instrument is therefore from the battery or accumu-

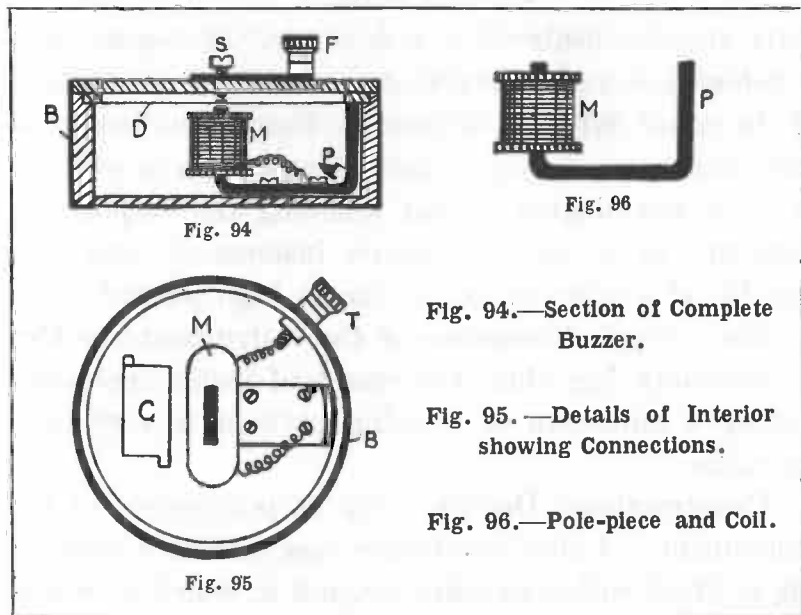

Fig. 94

Fig. 96

Fig. 94.—Section of Complete Buzzer.

Fig. 95.—Details of Interior showing Connections.

Fig. 96.—Pole-piece and Coil.

lator to the terminal *F*, and the metal plate to the contact screw *s*, across the contacts and the diaphragm *D* to the pole-piece *P*, and through the magnet winding to the terminal *T* (Fig. 95), and thence back to the battery.

Due to the fact that the snap-on lid clamps the diaphragm securely all round, it is possible, as mentioned previously, to have the diaphragm very close to the magnet, thereby producing a high-pitched note.

The Magnet.—With regard to the construction of the magnet *M*, this is wound on a metal former made up by soldering two metal cheeks to one arm of the metal strip *P*. This strip should measure $\frac{5}{8}$ in. wide by $1\frac{1}{2}$ in. long, and may be cut from sheet-iron $\frac{1}{2}$ in. thick. This is bent up as shown in Fig. 96; that portion forming the core of the magnet should be insulated by means of waxed silk, which should also be gummed on to the inside of the cheeks. The magnet is wound with No. 36 d.s.c. wire, the last layer but one being covered with a strip of varnished silk. The final layer of wire should be wound on very carefully and secured by looping the last turn under itself, the complete coil then being soaked in melted paraffin wax.

The Pole-pieces.—The complete coil and iron core *P* should now be placed on a surface plate or other flat base and the heights of the two pole-pieces carefully measured. The arm or pole-piece on which the coil is wound must be $\frac{1}{32}$ in. shorter than the other. The height of the other pole-piece must be such that it just reaches a shade higher than the ledge in the ebonite case *B*, so that when the metal diaphragm *D* is in position direct contact is made with the pole-piece *P*.

The Diaphragm.—The diaphragm *D* may be one taken from an old telephone receiver, the only addition being a contact stud soldered in the centre. Both this and the contact on the screw *s* should be of german-silver or other suitable alloy. The actual sparking may be considerably reduced by fitting a

CRYSTAL RECEIVING SETS

small condenser *c* (Fig. 95) in the case and connecting this across the contacts.

The Case.—The ebonite case *B* can easily be turned up by anyone possessing a lathe, or one may be purchased from an electrical dealer. The battery voltage may be anything from 2 to 4 volts, and when the buzzer is used exclusively for testing faults in the circuits the terminals may be dispensed with and a length of twin flexible lead soldered on permanently.

CHAPTER XII

Receiving C.W. Signals on a Crystal Set

By E. H. ROBINSON

It is frequently stated that a simple crystal receiving set will enable the listener only to pick up spark stations and telephony, and that valves will have to be installed before continuous-wave (C.W.) signals can be satisfactorily received. This is true to a certain extent, but this chapter shows how some of the louder C.W. stations can be received by means of a very simple addition.

C.W. Signals.—The reason why C.W. signals cannot be heard on ordinary crystal circuits is that when the key at the transmitting station is pressed down a continuous rectified current passes through the head telephones of the receiver, not an interrupted one as in the case of spark and telephony, with the result that no sound is heard except perhaps a faint click when the key is depressed or raised. If, however, an interrupting device, capable of making and breaking the circuit at a high rate, say 500 times a second, is inserted between the crystal and the phones, then any continuous current in the phones will be broken up into a musical note which is clearly audible.

The "Tikker."—Such an arrangement is shown diagrammatically in Fig. 97. In this figure *T* is a rapidly rotating cog-wheel against which a small metal

CRYSTAL RECEIVING SETS

tongue rests lightly. The use of such an interrupter is the invention of the Danish scientist Pedersen, who used it for reception of signals from the famous arc-transmitting system which bears Poulsen's name. Pedersen called the interrupter a "tikker," and this is the name by which the device is still known.

The cog-wheel τ may conveniently be the fastest-moving wheel in the mechanism of a clock. It will be necessary to remove the escapement so that the wheels rotate freely. If the spring is now wound up and the mechanism allowed to run it will go at a tremendous speed and be run down in a few seconds; a governing device must, therefore, be added, and this can easily be done by soldering, or otherwise fixing, a small vane cut out of thin sheet brass to the most rapidly revolving spindle as shown in Fig. 98. Owing to the friction of the air with this vane the mechanism will not be able to "race," and will run nicely for a considerable time. The actual size of the vane for best working will depend on the nature of the clockwork and will have to be determined in individual cases by trial; the larger the vane the slower the mechanism will run. In the writer's own tikker the vane is only $\frac{3}{4}$ in. across and $\frac{1}{4}$ in. wide, but it is sufficient to ensure a steady run of about twenty minutes. The only other thing that remains to be done is to fix a light tongue which has to make contact with the cogs of the fastest wheel in the train.

The method of mounting is shown in Fig. 99. A is an ebonite strip, sufficiently thick to be rigid, through which a hole has been made at each end. By means

RECEIVING C.W. SIGNALS

of a bolt and fly-nut one end of the ebonite strip is fixed to a point c in the frame, and that at the other end will come near the wheel τ , a hole being made at

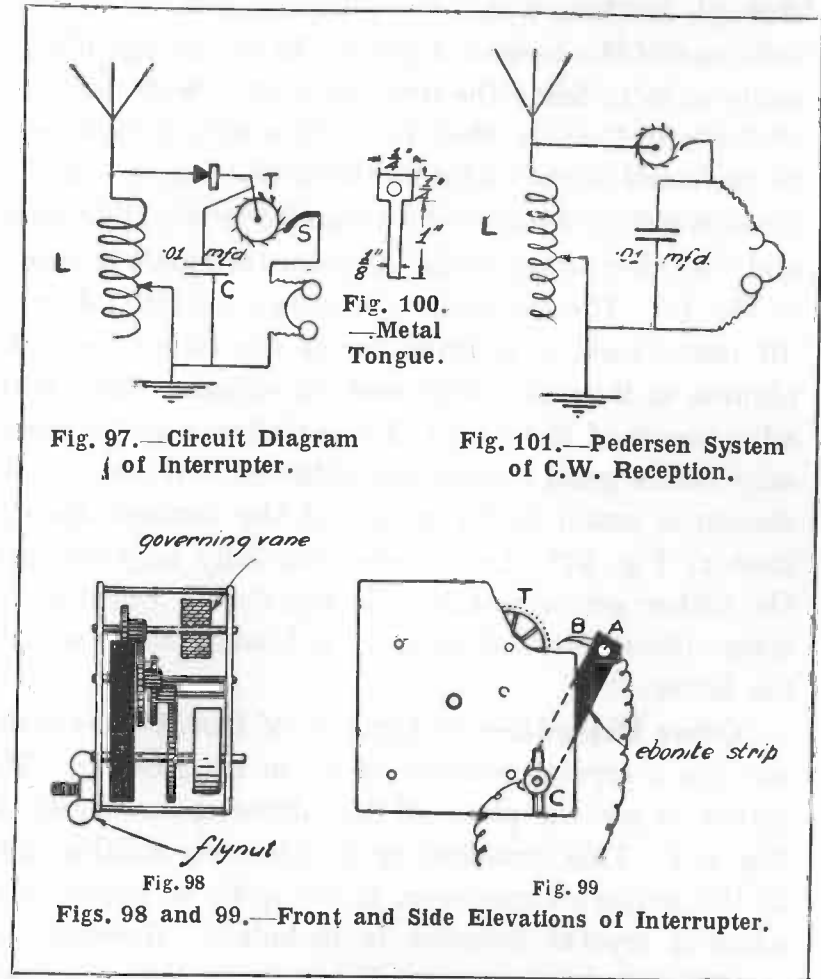

Fig. 97.—Circuit Diagram of Interrupter.

Fig. 101.—Pedersen System of C.W. Reception.

governing vane

Fig. 98

Fig. 99

Figs. 98 and 99.—Front and Side Elevations of Interrupter.

c to accommodate the bolt. The tongue B is cut to the shape shown in Fig. 100 out of springy sheet brass about the thickness of drawing-paper. An ordinary pair of scissors will cut the brass quite easily, and the

hole shown in the wide end may be pushed through by any sharp tool. The tongue is fastened to the upper end of the ebonite strip A by means of a nut and bolt through the hole which has been made there, and the thin part of the tongue is given a twist through a right angle so as to bring the free end square with the teeth of the wheel T. A piece of flexible wire is connected to the clock-frame and another to the tongue; one of these wires is connected to one of the phone leads and the other to one of the detector terminals as shown in Fig. 97. The condenser C, having a capacity of about .01 microfarad, is shunted across the tikker and telephones, as it greatly improves the signals. Some little adjustment of the speed of the tikker may be necessary before good results are obtained. When a C.W. station is tuned in (by means of the variable inductance L, Fig. 97), the detector carefully adjusted and the tikker set in motion, the signals are heard as an intermittent musical note or a hissing note, usually the latter.

Other Methods.—As a matter of fact, Pedersen did not use a crystal detector at all in his receiver. The tikker is put in place of the detector as shown in Fig. 101. This arrangement is extremely reliable, but, in the writer's experience, is not quite so sensitive as when a crystal detector is included. However, as crystal detectors are very liable to go out of adjustment the writer would recommend the method shown by Fig. 101.

Where a crystal detector is to be used, either a good piece of zincite touched by a sharp piece of

bornite or copper pyrites, or a piece of galena touched by a small spiral of 40-gauge copper wire, will be the most suitable. Crystals, like carborundum, which require a battery and potentiometer, cannot be used satisfactorily in conjunction with a tikker. Much depends on getting good specimens of crystal.

A gramophone can be used as a tikker by connecting one wire to the works and allowing the other to rub lightly against the edge of the revolving turntable

CHAPTER XIII

Making a Wavemeter from a Crystal Set

THE components of a crystal set—or some of them—can be assembled to produce a wavemeter that gives approximately truthful results.

With a coil of known inductance, a variable condenser, crystal and phones, a useful wavemeter can be rigged up. The circuit is as shown in Fig. 102.

First calculate from the formula :

$$1,885 \sqrt{L \times C}$$

(which simply means 1,885 multiplied by the square root of the product of the inductance and capacity) the wave-length range the coil and condenser will give. For example, condenser .0001 to .001, and coil, say, 2,000 mhy. = 850 LC to 2,550 LC approx. Next prepare a chart on squared paper (Fig. 103) as follows : Mark off the condenser degrees equidistant on the vertical edge. Start at, say, 900 metres and square the units as follows : 9^2 , 10^2 , 11^2 , 12^2 , etc., = 81, 100, 121, 144. $100 - 81 = 19$; $121 - 100 = 21$. There will be an increase of two in every case after the first number of squares is found ; the others need not be worked out. The wave-length scale starts at 900 metres, therefore count 19 squares and mark 1,000 m. from this mark. If 19 squares is too large and half is taken then the increase will be halved.

MAKING A WAVEMETER

Calibrating.—When the scale is prepared start the calibrating as follows : Set the receiver to a known wave-length adjustment within the scale or get a

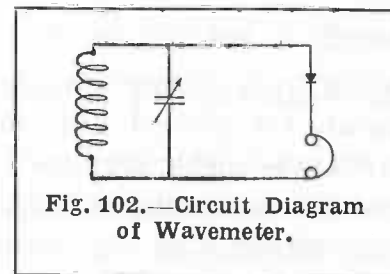

Fig. 102.—Circuit Diagram of Wavemeter.

station on a known wave that can be relied upon, say G.F.A. on calibration waves. Then listen in on the wavemeter circuit, coupling it closely at first to the C.W. receiver and varying the condenser until a rustling noise is heard, which will be very sharp tuning on the shorter waves. This point will be more quickly found

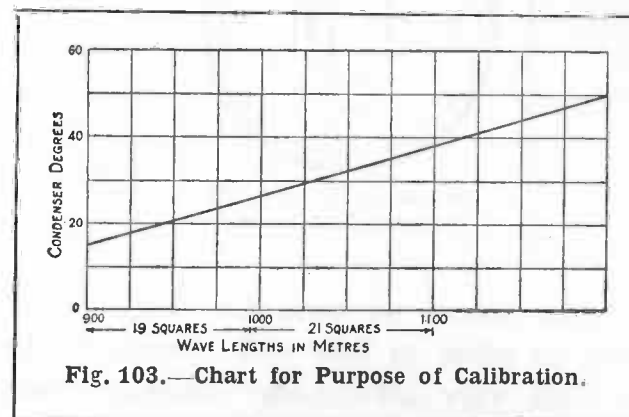

Fig. 103.—Chart for Purpose of Calibration.

if the aerial terminal of the receiver is tapped with a moistened finger. The clicks heard when a set is oscillating will be heard in the wavemeter when it is

CRYSTAL RECEIVING SETS

in tune and sufficiently coupled. The tuning must be completed without the finger or capacity effect will give a false tune, though the difference is usually small.

The wave-length is marked on the chart at the point corresponding with degrees—wave-length. Two or more such points are plotted and joined and produced, when any wave-length between the limits can be found. To use the wavemeter it is set to the wave-length, and while listening in the receiver is tuned until the hiss is heard; then transfer on to the receiver and listen for signals. Different values of coils may be used and scales plotted.

If a calibrated condenser is available the chart can be plotted without the aid of the receiver. A buzzer can be used, when the crystal and phones will not be necessary.

CHAPTER XIV

Converting Low-resistance Phones

Meaning of Resistance.—With a few exceptions, it is necessary that the telephone headgear for wireless work be wound to a high resistance, anything from 60 to 4,000 ohms per receiver being general. The statement "high resistance" is perhaps apt to mislead the reader; what is actually meant, of course, is

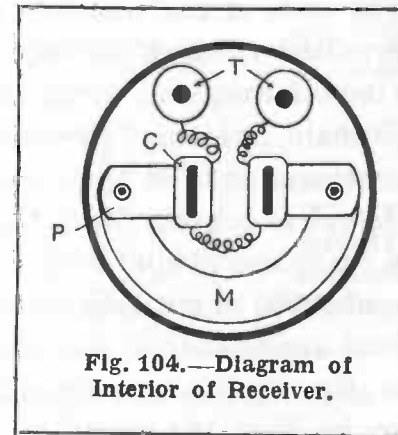

Fig. 104.—Diagram of Interior of Receiver.

that the magnet coils must be wound with a great number of turns of fine wire in order to produce a maximum magnetic effect with very little current. The resultant resistance is, therefore, merely a necessary evil, unavoidable in all magnetic devices which are more or less voltage operated.

Another point about wireless phones is that the

CRYSTAL RECEIVING SETS

diaphragms are much thinner than those used on ordinary commercial telephones. This makes them more sensitive to small variations in the magnetic force from the coils. At the same time, the diaphragms are more easily damaged, an excessive current causing them to buckle.

Construction of Receivers.—The general arrangement of a receiver of the common watch-pattern type is shown in Fig. 104, the ebonite earpiece and diaphragm having been removed. A permanent magnet *M* of semicircular shape is screwed to the outer containing case, and mounted on the poles are two pole-pieces *P*, which are bent at right angles and carry the magnet windings *C*. The ends of the windings are connected direct to the terminals *T*, which pass through insulated bushes in the metal case and serve to connect the coils *C* with the main receiving instruments.

The coils *C* when removed from the ordinary receiver will be found to contain fairly thick wire. The task is to strip them and rewind with much finer wire to a resistance of 2,000 ohms each receiver. Fig. 105 shows the general appearance of the coil when wound, the figures in the sketch corresponding with the reference letters in Figs. 104 and Figs. 106 to 108.

It will be seen that with such a small coil and with only a bent strip of metal *P* to hold, winding the empty bobbin by hand would be an extremely awkward job; in fact, it would be almost an impossibility to wind the wire with sufficient evenness to get anything like the required amount on the coils.

Again, the wire being so fine it is necessary to use

CONVERTING LOW-RESISTANCE PHONES

great care to avoid breakage, which would mean starting all over again, and also the coil being so small, it would be almost impossible to hold it long enough to get all the wire on at once without the hand becoming cramped.

There are several ways of getting over this difficulty, such as with a winding machine.

Device for Winding.—Perhaps the best method is

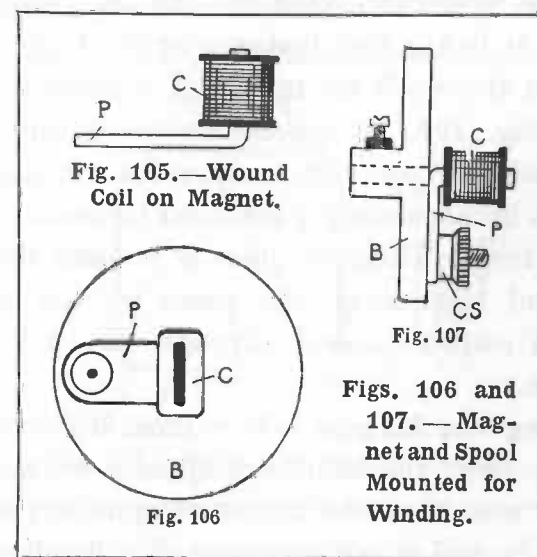

to use a small electric motor. The arrangement is clearly shown in Fig. 108, *E* being a small electric 4- or 6-volt motor, using current from an accumulator and having a variable resistance in the circuit to regulate the speed. Clamped to the end of the armature shaft is a circular block of ebonite or fibre *B* on which the telephone coil *C* is mounted, being secured in position by means of the clamping screw *CS*, which passes through the holes in the pole-piece. It will be

noticed that the coil *c* is arranged to rotate as near as possible in the line of the armature shaft, so that, in spite of the coil itself being rectangular in shape, it will revolve with as little wobble as possible. This is very necessary, as any tendency of the coil to revolve eccentrically will tend to break the very fine wire. The ebonite block *B* is turned up in the lathe and a hole bored through whilst still in the chuck to take the armature spindle; this can either be a good tight fit in the first instance or the block may be clamped on the shaft by means of a small set-screw, shown in Fig. 107. A second clamping screw *cs* is fitted, to hold the coil *c* in position for winding. This screw must be accurately positioned to ensure the coil *c* running true. The best plan is to hold the coil in position and then mark the place for the screw by means of a scriber passed through the hole in the pole-piece *P*.

Revolving the Magnet.—It is most important that the hole to take the armature spindle be accurately bored, and also that the armature spindle runs true, otherwise the coil *c* will wobble and difficulty will be experienced, not only in the wire continually breaking, but also in getting it to fill in close to the cheeks of the coil. If the motor *E* is of the type in which the armature shaft extends at both ends, the opposite end to which the block *B* is mounted may be used to carry a small knurled knob fitted with a short piece of brass wire about $\frac{1}{8}$ in. in diameter to form a handle. This will prove particularly useful for controlling the motor or for winding portions of the coil by hand.

Winding.—The motor should be connected up to the accumulator and regulating-resistance and tested to see that it is in running order. The block *B* is then permanently fixed to the armature shaft and one of the coils to be wound clamped in position and trued up. Some fairly thin shellac varnish should be near at hand, together with a strip of silk ribbon, this latter cut to the width of the inside of the coil.

A single layer of silk ribbon is stuck on the core

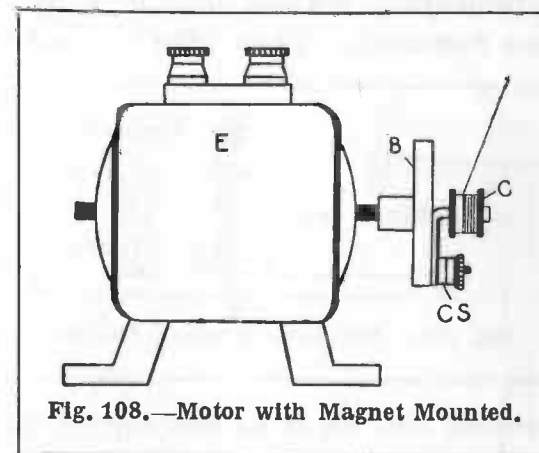

Fig. 108.—Motor with Magnet Mounted.

of the coil with shellac varnish, one layer of wire is then wound on and covered with a second layer of ribbon soaked in shellac. The free end of the wire is then carefully brought outside the coil and secured to the clamping screw *cs* for the time being. It is taken for granted, of course, that the sides of the coil *c* are already insulated with varnished ribbon or paper; at the same time it is a good plan to stick a small piece of varnished ribbon over the free end of the wire, to insulate it from the subsequent layers of wire

CRYSTAL RECEIVING SETS

when these are wound on. The bobbin on which the wire is purchased should be mounted on a small brass rod so that it is free to rotate, and with the wire resting lightly across the second finger of the right hand, the motor should be started on the first speed, gradually increasing the speed of the motor.

If one has access to a gramophone another method of winding is to obtain an empty cotton reel which has a hole through its centre just large enough to fit over the projecting portion of the spindle of the gramophone turntable. Then take the bobbin which

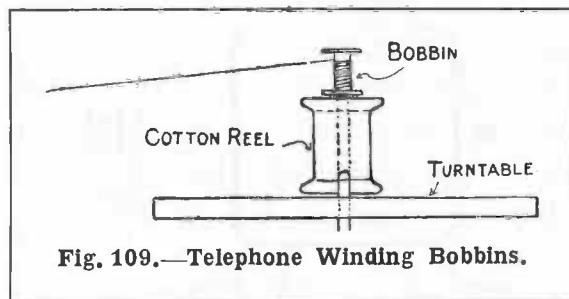

Fig. 109.—Telephone Winding Bobbins.

is to be wound and fix it to the top of the reel by means of a spot of glue or sealing-wax. The wire can then be attached to the bobbin and the turntable allowed to revolve as in Fig. 109. The speed at which it revolves can, of course, be regulated by the controller which is fitted to most gramophones.

When the coil is almost full a single layer of silk ribbon should be put on, the last layer of the wire being wound over this, leaving about six turns from the end empty. The top layer is then held in position with the thumb and finger, while an assistant soft-solders a short length of double silk-covered No. 28

CONVERTING LOW-RESISTANCE PHONES

s.w.g. wire to the winding. The last six turns will consist of thick wire, when the coil should be covered with two layers of ribbon and the whole thoroughly

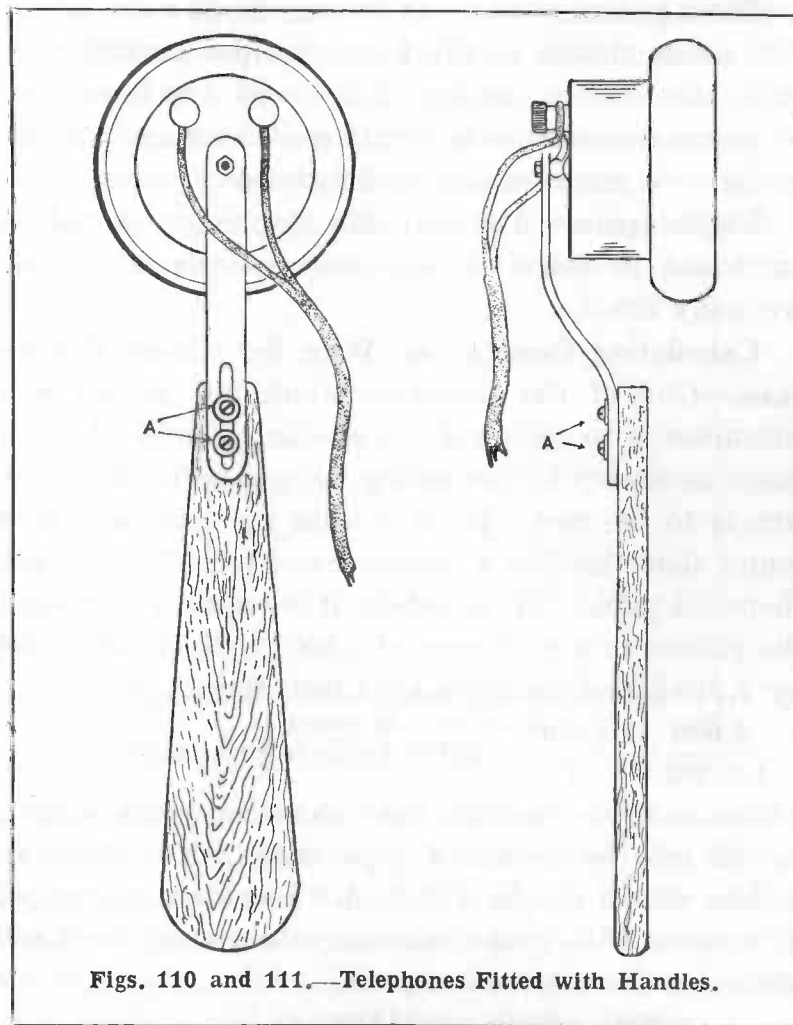

Figs. 110 and 111.—Telephones Fitted with Handles.

soaked in shellac varnish and allowed to dry before touching again. The second coil should be treated in the same way.

CRYSTAL RECEIVING SETS

Assembling.—When both coils are dry they may be remounted on the magnet poles in the receiver case, and the winding connected to the terminals.

Having connected up to the terminals T the whole of the case should be filled with melted paraffin wax up to the level of the top of the coils, the loose connecting wires will thus be firmly embedded and a break in the wire rendered almost impossible.

Diaphragms.—A special thin diaphragm should be purchased in place of the comparatively thick one originally fitted.

Calculating Quantity of Wire for Given Resistance.—One of the problems which the reader will encounter is to calculate the amount of wire of given gauge necessary for rewinding. Suppose No. 42 gauge wire is to be used. From a table of resistances it is found that this has a resistance of 1,910.5 ohms per thousand yards. If, therefore, it is required to rewind the phones to a resistance of 4,000 ohms, divide 4,000 by 1,910.5 and multiply by 1,000, thus :

$$\frac{4,000}{1,910.5} \times \frac{1,000}{1} = 2,093 \text{ yards approximately.}$$

This is a better method than calculating the weight, as will now be shown. Copper wire of No. 42 s.w.g. weighs .14533 lb. per 1,000 yd. To obtain the *weight* of wire of this gauge necessary to rewind to 4,000 ohms the calculation becomes

$$\frac{4,000}{1,910.5} \times \frac{1,000}{1} \times \frac{.14533}{1,000} = .304175 \text{ lb.}$$

The difficulty of gauging this amount of wire is at once apparent, apart from the fact that the weight

CONVERTING LOW-RESISTANCE PHONES

given does not and cannot take the weight of the covering into consideration.

Testing Phones.—The test commonly used for phones was by means of the handiest and weakest of batteries—a penny and a two-shilling piece, between which a bit of moist paper was placed. The end of one wire from the phones was connected to the “copper,” and then the silver coin touched lightly (and repeatedly) with the end of the other wire.

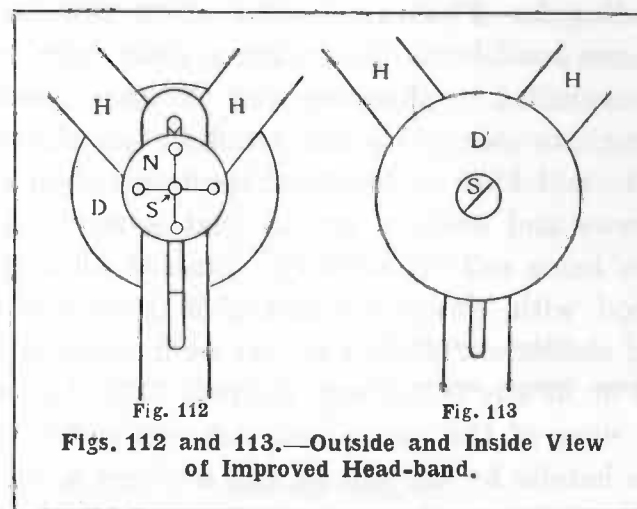

Fig. 112 and 113.—Outside and Inside View of Improved Head-band.

Nowadays a similar test is made with a single piece of sheet aluminium, which should be damp. Simply connect one wire of the phone to one end of the aluminium plate, and then touch the plate with the other wire, when, if the phone is properly adjusted each contact will cause a click in the phones.

Another method of testing phones is less difficult and perhaps more efficient than testing by the “weak battery” or sixpence and penny method.

CRYSTAL RECEIVING SETS

The two leads from the earphones are connected to the two terminals of an ordinary electric bell. No battery whatever is put in circuit. The clapper is pressed forward to the bell and then quickly released. It will vibrate several times before coming to rest. A similar vibration will take place and will be heard plainly in the phones. The explanation of the action is that there is a small amount of magnetism in the magnet of the bell which usually works it.

Handles for Phones.—Ladies often complain of the phone head-band disarranging their hair. This can be remedied by disconnecting the head-band and attaching to short wooden handles, as shown in Figs. 110 and 111. A length of hard dry wood and a few screws and washers are all that is required, the sketches being self-explanatory. Smooth all edges off the wood with glasspaper and give it two or three coats of shellac varnish, or it may be finished in black enamel or in any other way desired. Fig. 110 shows a back view of the phone and link connected to the wooden handle by the screws and washers A, and the side view and general arrangement is clearly shown in Fig. 111. Another method of eliminating the difficulty is to cut out of pasteboard (or other suitable material) two discs 2 in. in diameter. Remove the screws at each side of the head-bands. Pass a screw through the centre of each disc and replace on the head-bands. Fig. 112 shows the outside view, and in this figure D is the disc, H the head-bands, N the nut and S the screw. Fig. 113 (inside view) shows how the attachment shields all moving parts.

CHAPTER XV

The Morse Code

Most owners of crystal receiving sets will be interested in learning the Morse code, for it is interesting to be able to pick up and translate the messages sent between the various ship and shore stations. One excellent method of memorising it is to learn the code in four different groups, the easiest signs being in the first group, which should be learned thoroughly.

FIRST GROUP.

E	■	is opposite	T	—
I	■ ■	„	„	M — —
S	■ ■ ■	„	„	O — — —
H	■ ■ ■ ■			

SECOND GROUP.

A	■ —	is opposite	N	— ■
U	■ ■ —	„	„	D — ■ ■
V	■ ■ ■ —	„	„	B — ■ ■ ■

THIRD GROUP.

W	■ — —	is opposite	G	— — ■
R	■ — ■	„	„	K — ■ —
P	■ — — ■	„	„	X — ■ ■ —
L	■ — ■ ■	„	„	Y — ■ — —
F	■ ■ — ■	„	„	Q — — ■ —

THE MORSE CODE

FOURTH GROUP,

C	—	} No opposites
J	. — — — — .	
Z	— — — . . .	

Fig. 114 shows another method of memorising the Morse code. The code is learnt rapidly simply by visualising the code letters as superimposed upon the alphabetical letters. On thinking of any letter the mind conjures up a mental picture of it and of the dots and dashes of the Morse code lying on it and actually forming part of its shape. The twenty-six letters can be learnt in as many minutes, but only practice, practice, and yet more practice at sending and receiving can make perfect.

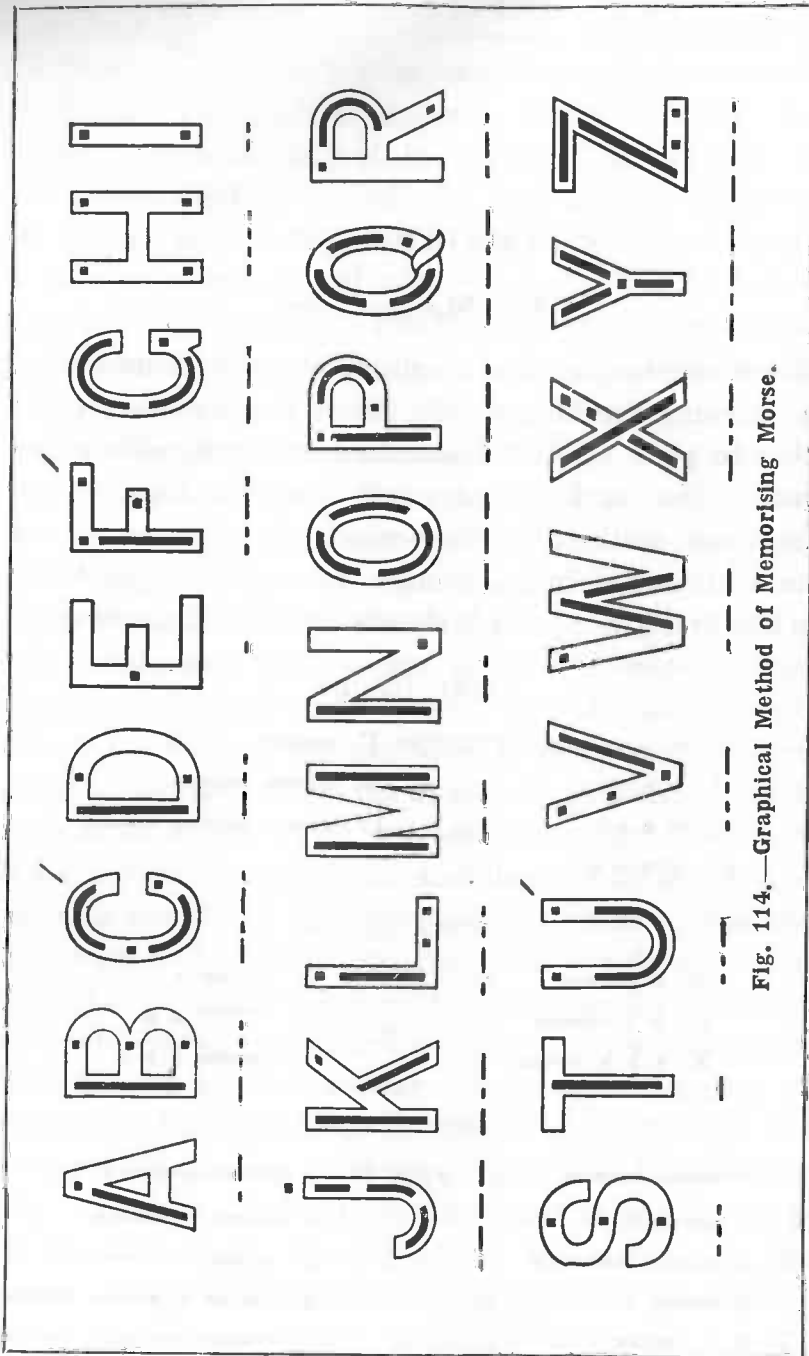

Fig. 114.—Graphical Method of Memorising Morse.

INDEX

- AERIAL erection, 2
Auto-transformer coupling, 87
- BASKET-COIL receiver, miniature, 73
—, tuner, plug-in, 58
Basket coils, winding, 62, 69, 74
Bornite crystal, 93
Buzzer, making, 99
— test, applying, 12
- CARBORUNDUM crystal, 95
Case for set, making, 40, 58
Circuits for crystal sets, 85
Closed circuit explained, 50
Coil, mounting, 18
—, tapping, 38
Condenser, phone, making, 22, 81
Contact, sliding, making, 18
Continuous-wave signals, receiving, 103
Copper pyrites, 95
Coupling, auto-transformer, 87
Crystal and valve receiver, 68
— detector, making, 6, 20, 28, 42, 54, 60, 70, 78, 80, 82
—, finding best, 96
Crystals: how they rectify, 91
—, types of, 91
- DIRECT-COUPLED circuit, 85
- EARTH lead, 4
- GALENA crystal, 92
- HEAD-BANDS for phones, 119
- INDUCTANCE coil (*see* Tuning coil)
Interrupter, 103
- LEAD-IN, connecting to set, 6
Lightning switch, purpose of, 4
Loading coils, use of, 24
Loose-coupled set, 45
— set, sliding arrangement for, 47
- MATCH-BOX receiver, 82
Miniature crystal sets, 73
Morse code, memorising, 121
- OFFICIAL receiving set, 1
Operation of crystal set, 11, 14, 71, 84
- PEDERSEN, 104
Permanite crystal, 97
Phone condenser, making, 22, 81
Phones, calculating quantity of wire for, 118
—, constructional details of, 112
—, converting low-resistance, 111
—, handles for, 120
—, improved head-bands for, 119
—, selecting, 7
—, testing, 119
—, winding device for, 113
Plug-in basket-coil tuner, 58
Pocket receiver, 78
Potentiometer, making, 54
Poulsen, 104
- RADIOCITE crystal, 93
Reaction coil, 68
Rectification by crystal explained, 91
- SETTING of set, recording, 66
Silicon crystal, 92
Single-coil set, tapped, 33
Single-slider set, 16
— with semicircular tuner, 25
Sliding arrangement for loose-coupler, 47
— contact, making, 18
- TAPPED single-coil set, 33
Tapping coils, 38
Testing receiving set, 44
"Tikker," making, 103
Transformer step-up effect, 88
Tuning cards, use of, 66
— coil, basket, winding, 62, 69, 74
— —, cylindrical, tapping, 38
— — —, winding, 8, 16, 27, 37, 46, 79, 82
- VALVE and crystal receiver, 68
Variable condenser, 50, 52
Vest-pocket receiver, 78
- WAVEMETER, calibrating, 109
—, making from crystal set, 108
Winding device for phones, 113
- Zincite crystal, 97

PRINTED BY CASSELL & COMPANY, LIMITED, LA BELLE SAUVAGE, LONDON, E.C.4.
F75.623

There's Money in Knowing How!

Knowing how to do "odd jobs" and repairs, and how to make things for the home, means the saving of expense in many directions. Most men could be "handymen" but lack the necessary knowledge.

"WORK" is a long-established weekly which supplies this knowledge in a simple, straightforward manner. Its articles are full of working details and explanatory diagrams, and are written in simple, non-technical language. Every issue contains several pages devoted to solving, in comprehensive answers, the difficulties of readers.

As a practical guide for the amateur it is unrivalled and unique.

As a mine of information it is inexhaustible.

3^D
Weekly

BUY A COPY TO-DAY



CASSELLS
La Belle Sauvage, E.C.4

ECONOMIC ELECTRIC LTD.

TELEPHONE:

MUSEUM 1055.



**IT'S
A
FACT**

**THAT
OUR
"MAXSIG"**

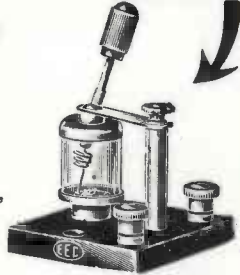

**CRYSTAL
DETECTOR**

**WILL OPERATE A
LOUD SPEAKER
TEN MILES FROM A
BROADCASTING STATION !!**

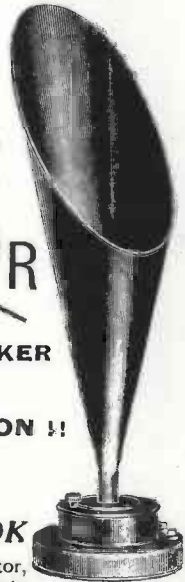

APPLY NOW for the
"E E C" RADIO BOOK

which describes this wonderful Detector, and gives the keenest prices for complete CRYSTAL & VALVE SETS, Component Parts, Material, etc. Undoubtedly the Radio Constructors' *VADE MECUM*. Comprises 40 pages, over 250 illustrations and circuit diagrams for Crystal and Valve Receivers. Send us 4d. in stamps and secure this wonderful publication.



Head Office: 10, FITZROY
SQUARE, LONDON. W.1.

Showrooms:
303, EUSTON RD., N