

UP-TO-DATE IDEAS TO IMPROVE QUALITY

ALSO 8-PAGE  
BEGINNER'S  
SUPPLEMENT

# Amateur Wireless

and  
Radiovision

Every  
Wednesday

3<sup>d</sup>

Vol. XXI. No. 548

Saturday, December 10, 1932

The A-C-  
NEW  
CENTURY  
SUPER

WIRELESS  
MADE EASY  
SUPPLEMENT  
HINTS AND TIPS FOR WIRELESS BEGINNERS

BUILD AS YOU LEARN  
ELEMENTARY WIRELESS  
COURSE  
ABOUT YOUR VALVES

FULL  
DETAILS

The advertisement features a central photograph of various electronic components, including vacuum tubes, capacitors, and resistors, arranged on a metal chassis. To the left, a magazine cover is shown at an angle, displaying the title 'WIRELESS MADE EASY SUPPLEMENT' and several articles with technical diagrams. The background is a dark blue gradient.

# RADIO POWER for $\square$ -NEXT YEAR

## The Ideal Gift for a Battery Set



**"ATLAS"**

*Dear Listener,  
A Happy Radio Xmas and  
many Prosperous Years are  
certain if you insist on  
the Expert's Choice.*

**THE OLYMPIA BALLOT WINNER**

☉ ☉ ☉ An "ATLAS" Unit is the ideal Xmas gift from every point of view—maximum efficiency for your set, better radio for your family and a huge saving for you.

Dry batteries must have cost you at least 50/- this year. Power from the mains the "ATLAS" way will cut running costs to less than a shilling in 1933 and for many years to come.

Ask your dealer for a demonstration now and insist on "ATLAS," the Olympia Ballot Winner. No other can give the same reserve of silent, steady power. Models for every set from 39/6.

# "CLARKE'S ATLAS"

## MAINS

**POST THIS COUPON NOW!**

Messrs. H. Clarke & Co. (M/cr.), Ltd.,  
George Street, Patricroft, Manchester.

Please send me full details of "ATLAS" Mains Units.

Name: .....

Address: .....

20/10/32 .....

## UNITS

H. CLARKE & CO. (M/CR) LTD.  
PATRICROFT. MANCHESTER.

London: Bush House, W.C.2  
Glasgow: G. E. S. Co., Ltd.,  
38, Oswald Street.

To Ensure Speedy Delivery mention "A.W." with Order

# THIS PICK-UP DOES JUSTICE TO THE RECORD

A pick-up which gives the record its due and reproduces every subtle inflexion of harmony at its tone value. Such is the B.T.H. Pick-up, the choice of leading radiogram manufacturers and radio engineers; and the most widely used of any.

Your dealer will be pleased to demonstrate the various models in the B.T.H. range.



**B.T.H. SENIOR PICK-UP (1933 model).** This has been completely re-designed and gives an even better response curve than hitherto. Free coupling of the head to the tone arm reduces pressure on records and facilitates needle changing. Price £2.2.0. (Complete with volume control).



**B.T.H. MINOR PICK-UP** has been re-designed and improved and now includes a special volume control fitted in the base of the tone-arm pillar. This model is constructed in a one-piece moulding of B.T.H. "Fabrolite" and is recommended to those requiring a highly efficient but inexpensive pick-up. Price 25/-.

**B.T.H. SENIOR PICK-UP** complete with four adaptors to fit standard tone arms. Price 27/6.



## PICK-UP and Tone Arm

EDISWAN RADIO—100% BRITISH

THE EDISON SWAN ELECTRIC CO. LTD.



155 CHARING CROSS RD., LONDON, W.C.2  
W.201

Please Mention "A.W." When Corresponding with Advertisers

**For the new  
A.C.  
CENTURY SUPER**

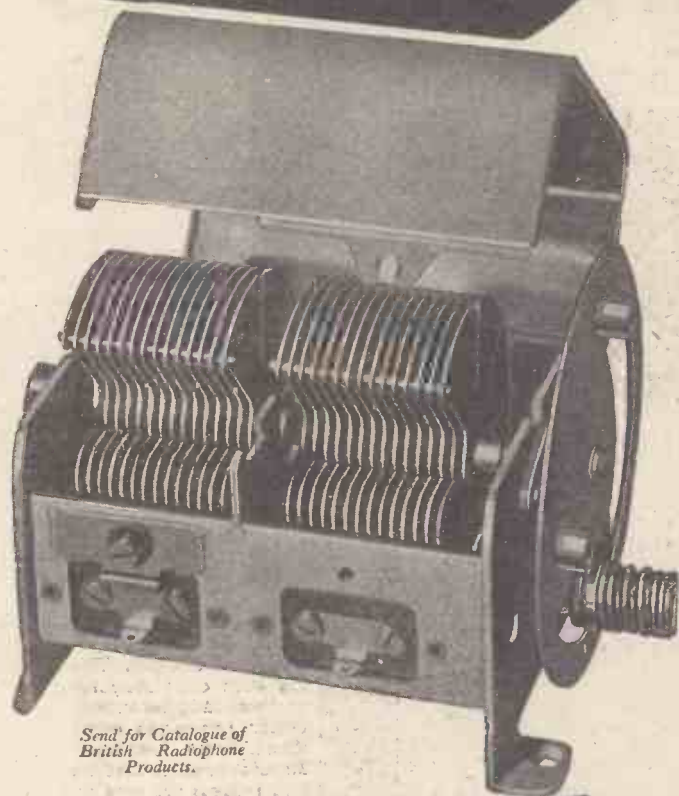

Send for Catalogue of  
British Radiophone  
Products.

**SPECIFIED**

The British Radiophone Uni-control Two-gang Condenser (Type 458) specified for the new A.C. Century Super is designed so that the variable air dielectric trimming condenser belonging to the section nearer the dial can be adjusted from the front of the receiver.

The rotating spindle of this trimmer is brought through the main spindle and its adjusting knob is mounted concentrically with the main operating knob. This permits very accurate trimming and enables maximum signal strength to be obtained with the minimum of trouble.

The other section has a mica dielectric trimmer which can be pre-set in the usual manner. A cover and disc drive are provided with this highly efficient two-gang condenser.

**THE BRITISH RADIOPHONE Ltd.,**  
Aldwych House, Aldwych, W.C.2

Telephone: Holborn 6744

PRICE  
**21/-**

**RADIOPHONE  
GANGED CONDENSERS**

“ . . . how glad I am  
at having bought it! ”

“ I have just purchased one of your Standard Permanent Magnet Speakers, Type S.S.P., and I am very pleased to say how glad I am at having bought it. I tried it out against four other makes and none would handle it like the S.S.P.”

H. E. (Blackburn).



**THE  
Standard  
PERMANENT  
MAGNET  
SPEAKER**

Here's a typical appreciation of the *Standard* Permanent Magnet Speaker! Fit one in your set and you'll be just as satisfied. At the price, there's no speaker to touch it—and remember, it's built by *Standard*—the makers of the first “quality” speakers.

Type S.S.P.

*Standard* Permanent Magnet Speaker Chassis (as illustrated). List Price, including Transformer, 41/6.

Energised Types, from 30/9.

Write now for the *Standard* Loudspeaker Chassis leaflet and particulars of *Standard* sets and Micromesh valves.

*Standard* Telephones  and Cables Limited

(Radio Merchandise Dept.),  
St. Chad's Place, 364, Gray's Inn Rd., London, W.C. 1.  
Telephone: Terminus 6255.

# TELSEN

## H.F. CHOKES, PUSH-PULL SWITCHES & VALVE HOLDERS

### TELSEN TWO-POINT SWITCH

Particularly suitable for use as wave-change switch with the dual-range S.W. Coil unit. Employs electrical "knife" type self-cleaning contact with wedge shaped plunger, and a positive snap action, a series gap reducing self-capacity to a minimum ... 1/-

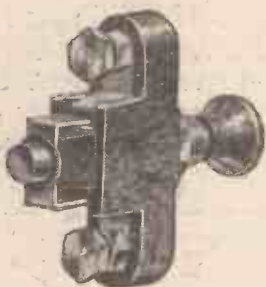

### TELSEN THREE-POINT SWITCH

Soundly constructed on engineering principles, this is the perfect wave-change switch for use with a dual-range aerial coil or for breaking L.T. and H.T. currents simultaneously. Minimum self-capacity ... 1/3

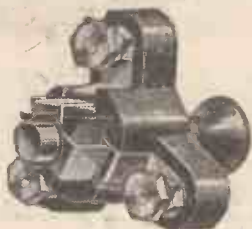

### TELSEN FOUR-POINT SWITCH

Highly suitable for use in wave-changing on two coils or an H.F. Transformer, or for switching pick-up leads or an additional speaker. No possibility of crackling. Minimum self-capacity ... 1/6

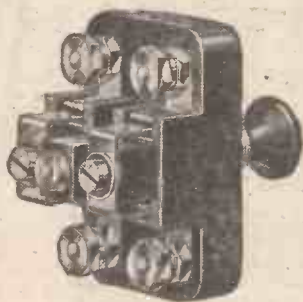

### TELSEN VALVE HOLDERS

An improved range of valve holders in both solid and anti-microphonic types. Employ special contact sockets of one-piece design with neat soldering tag ends and terminals. Extremely low self-capacity.

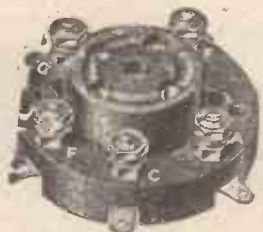

Rigid type 4 pin ... 9d.

Anti-Microphonic 4 pin ... 1/-

Rigid type 5 pin ... 1/-

Anti-Microphonic 5 pin ... 1/3



### TELSEN STANDARD H.F. CHOKE

Covering the entire broadcast band, and occupying only the minimum of baseboard space, the Telsen Standard H.F. Choke has proved deservedly popular ever since its introduction. With an inductance of 150,000 microhenrys, a resistance of 400 ohms, and an extremely low self-capacity, it is highly suitable for use in reaction circuits, and is constantly being specified in this respect by the leading set designers ... 2/-

### TELSEN BINOCULAR H.F. CHOKE

In H.F. amplification, the performance of a choke is of supreme importance. Where the very highest efficiency is the primary requisite, the Telsen Binocular H.F. Choke is the inevitable choice. It has a high inductance of 250,000 microhenrys, with a very low self-capacity and a practically negligible external field (due to its binocular formation). It is from every point of view the ideal choke—and where high-class circuits are concerned definitely the essential choke 5/-

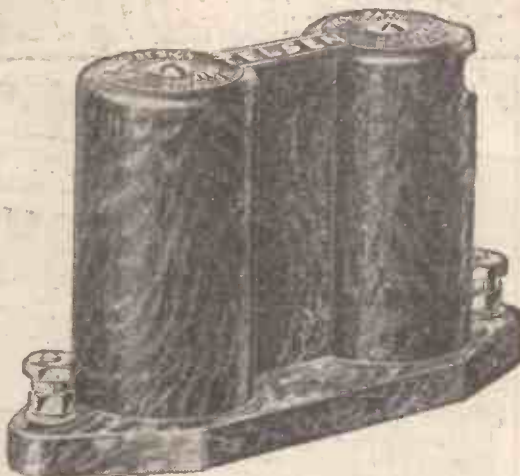

# TELSEN

RADIO COMPONENTS

## TELSEN RADIO COMPONENTS ARE 100% BRITISH

ANNOUNCEMENT OF THE TELSEN ELECTRIC CO., LTD., ASTON, BIRMINGHAM

Please Mention "A.W." When Corresponding with Advertisers

# The Famous WEARITE OT2 INTERMEDIATE COILS are essential to the NEW CENTURY SUPER

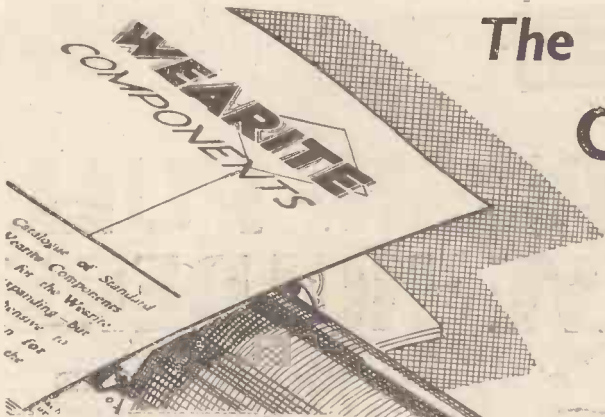

## HERE'S THE IDEAL CHRISTMAS GIFT . . .

Help your radio friend to reception, free from heterodyne whistle—that bugbear with all distant stations. This Wearite Heterodyne Filter permits "clean cut" programmes on a silent background. Ask your dealer or write to us direct.

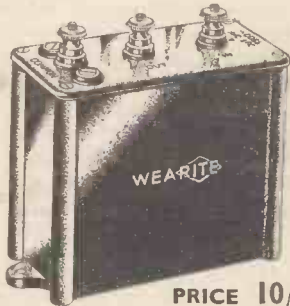

PRICE 10/6

Made in two models, "A" with 3,500-cycle cut-off, and "B" with 5,000-cycle cut-off.

Send for your copy of our latest illustrated booklet (A.1.) dealing with the full range of components.

The heart of a super-het. is in its intermediates—upon them the set's efficiency depends—and the designers have specified Wearite. Prompted by the experience of past triumphs, including the original "Century Super"—the designers pinned their faith in the perfect functioning of their set to these coils. Ensure results as the authors intended—use the Wearite OT2's

## OTHER WEARITE PARTS FOR THE NEW CENTURY SUPER

- One 50,000-ohm Potentiometer (Q.V.C.) combined with switch (Q.40). Price complete . . . . . 6/6
- Eight four-pin and one five-pin Valve Holders (S.1). Price, each 1/3 4/6
- One super-het Choke (H.F.S.). Price . . . . . 2/-
- One 20,000-ohm Resistance (2-watt) (R.D.). Price . . . . . 2/9
- One 50,000-ohm Resistance (4-watt) (R.D.). Price . . . . . 2/9

Add a good Earth Tube, use the Wearite "No Tool" Earth Tube. Price 3/6.

# WEARITE COMPONENTS

Messrs. WRIGHT & WEAIRE, LTD., 740 High Road, Tottenham, N. 17. Telephone: Tottenham 3847, 8/9

1941



## ASK YOUR FRIENDS...

which are the most efficient rectifiers.  
They will tell you that



## METAL RECTIFIERS

meet the needs of constructors most

Send 3d. in stamps for a copy of "The All Metal Way" giving full particulars and circuits

admirably because

CONSTRUCTION IS ROBUST  
EFFICIENCY IS HIGH

The OUTPUT DOES NOT DETERIORATE  
NO RENEWALS ARE NECESSARY  
THERE ARE NO FILAMENT HEATING LOSSES  
TRANSFORMERS COST LESS

THE WESTINGHOUSE BRAKE & SAXBY SIGNAL Co., Ltd.  
82 York Road, King's Cross, London, N.1

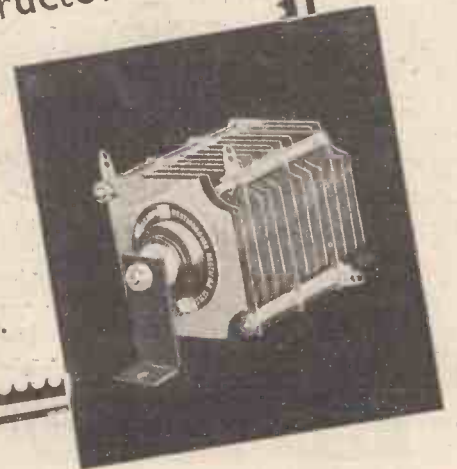

You will Help Yourself and Help Us By Mentioning "A.W." to Advertisers

EVERYTHING **The S.E.C.** ELECTRICAL  
your guarantee

# A TONIC TO ANY SET

## OSRAM 2-VOLT VALVES WITH THE WEMBLEY FILAMENT

The filament with the highest electron emission efficiency of any Battery valve filament in the world.

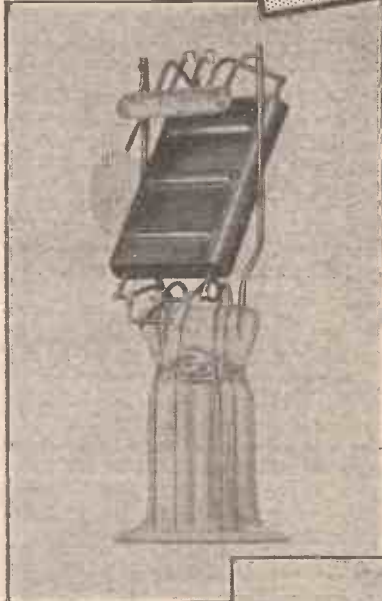

OSRAM LP2  
OSRAM P2

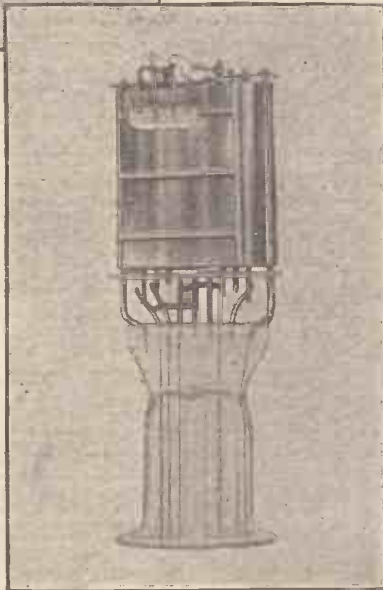

OSRAM PT2

**NOTE**

The large area of Anode for easy heat dissipation — large power output and long life — Osram "Cushion-Springing" & "Safety Lock Construction."

### A CHOICE OF HIGH EFFICIENCY LOUDSPEAKER VALVES

#### OSRAM LP2

The most sensitive and economical 2-volt Power Valve for sets with single stage Low Frequency amplification.

Amplification Factor	15
Impedance	3,900 ohms
Slope	3.85 m.a./v.

Price 8/9.

#### OSRAM P2

The popular 2-volt Super Power Valve for highest Quality Reproduction with economy in HT Current in any 2-volt Battery Set.

Amplification Factor	7.5
Impedance	2,150 ohms.
Slope	3.5 m.a./v

Price 12/-

#### OSRAM PT2

The 2-volt Pentode with amazing sensitivity and high power output for the minimum possible HT current consumption.

Slope	2.5 m.a./v.
-------	-------------

Price 17/6

**Osram**  
2 VOLT BATTERY  
**Valves**

MADE IN ENGLAND  
SOLD BY ALL WIRELESS DEALERS

**FOR EXTRA QUALITY WITHOUT EXTRA COST**

For full technical information WRITE for OSRAM Wireless Guide. Post free on request.

Advt. of The General Electric Co., Ltd., Magnet House, Kingsway, London, W.C.2.

Mention of "Amateur Wireless" to Advertisers will Ensure Prompt Attention

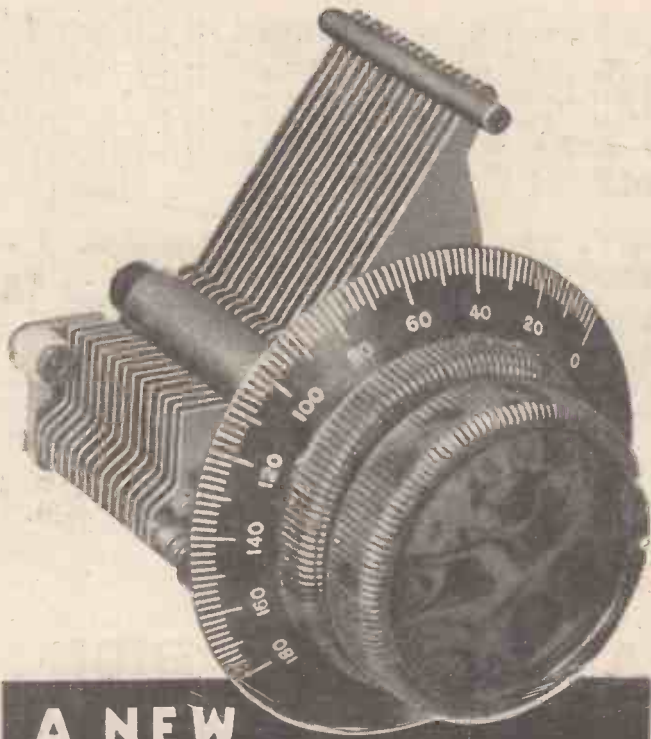

**A NEW**  
**Utility MITE**

Here is the new Utility Mite, with vernier; a better job than ever and that is saying something, because the old Mite was the finest small condenser made.

Its accuracy is of the highest possible order, its geared slow motion drive is as beautiful an action as you could wish for, and its price is no higher than many a cheaper and inferior job.

If your dealer cannot show you the range, write to us for full particulars.

**PRICES**

- W319 .0005 mfd. as illustrated, 6/6.
- Less vernier 4/- W320 .0003 mfd. 6/6.
- Less vernier 4/- W321 .0002 mfd. 6/-.
- Less vernier 3/6.

From your dealer or post free from the makers.

**WILKINS & WRIGHT LTD.**  
UTILITY WORKS, HOLYHEAD RD., BIRMINGHAM

London Agents:  
E. R. Morton, Ltd., 22, Bartlett's Buildings, Holborn Circus, E.C.4.



You will Help Yourself and Help Us by Mentioning "A.W." to Advertisers.

**WHY BUY GANGED CONDENSERS?**

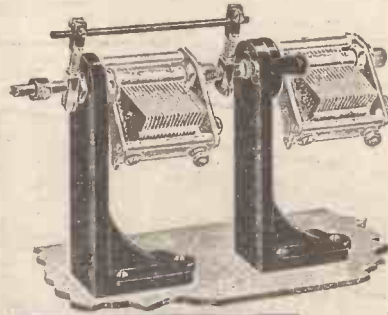

No need to buy expensive ganged condensers. This device enables you to utilize any existing condensers. You can gang them yourself; full instructions supplied. From all dealers, or direct from the manufacturers. **2/6**

**BRITISH GENERAL**

BRITISH GENERAL MANUFACTURING CO., LTD., Brockley Works, LONDON, S.E.4.

**THE UP-TO-DATE CONNECTION**



Lisenin Positive Grip Plugs and Sockets are rapidly replacing the old style screw down terminal. They are many times more efficient and much neater. The special Banana Plug ensures smooth clean contact. The special cone grip holds the lead like a vice and positively protects it from accidental pulling; it cannot work loose. Use Lisenin Plugs and Sockets and you will ensure perfect contacts at all times.

Red, Green or Black.

PRICE 4d. EACH



Plain or engraved.

**LISENIN**

WIRELESS COMPANY  
66, Newman St., London, W.1

**The Super "LANGMORE" No. GI**

RADIO-GRAMOPHONE CABINETS in FIGURED OAK  
Size overall, 3 ft. 6 in. high by 21 in. wide by 15 in. deep.  
THE TOP SECTION. Size, 4½ in. high by 18 in. wide by 14 in. deep.  
THE CENTRE SECTION. Size 10 in. high by 18 in. wide by 14 in. deep, to take a panel either 18 in. by 7 in. or 18 in. by 8 in.  
THE BOTTOM SECTION. Size, 16 in. high by 18 in. wide by 13½ in. deep. With "GALLEON," as illustrated, or "CATHEDRAL" Fret Fronts.

Wooden panels to fit, with oval aperture, 12 in. by 5½ in., 2/- extra.

The whole of the back is enclosed by double doors, so that all parts are easily accessible. ALL are fitted with hinged top, heavy platform to take a 12-in. turntable for the Gramophone, and a substantial base board for the Wireless Set.

Beautifully Finished Jacobean Oak  
NEW ILLUSTRATED CATALOGUE FREE

THE MISCELLANEOUS TRADING CO. LTD.  
13 & 17, NEW OXFORD ST., London, W.C.1.  
Phone: Holborn 4894. Trade Inquiries Invited



PRICE **49/6** each  
Packed FREE and sent Carriage Paid to any address in Great Britain.

**HOW TO ACQUIRE A MODERN SET!**

Present and especially future conditions when Continental stations increase their power enormously in 1933, demand a set giving the utmost selectivity.

**HIGHEST PRICE FOR YOUR OLD SET** (of any description) in part exchange for ANY MAKE OF NEW 1933 RECEIVER.

Terms: Cash or by Instalments.

Our FREE SERVICE includes information and technical advice. Under our scheme you keep your old set until the NEW one is actually in your possession.

**WHY NOT WRITE NOW FOR FULL PARTICULARS?**

MESSRS. K. RAYMOND, Ltd. (Radio Exchange Dept.)  
26/27, D'ARBLAY STREET, WARDOUR STREET, W.1

Without obligation please state your terms

To supply 1933 model.....

Present set.....

I desire to pay by \*Cash Instalments \*(Delete as required) I enclose 1½d. stamp.

NAME.....

ADDRESS..... A.W.



# Telsen

## MICA CONDENSERS AND GRID LEAKS

### MAKE ALL THE DIFFERENCE TO YOUR SET!

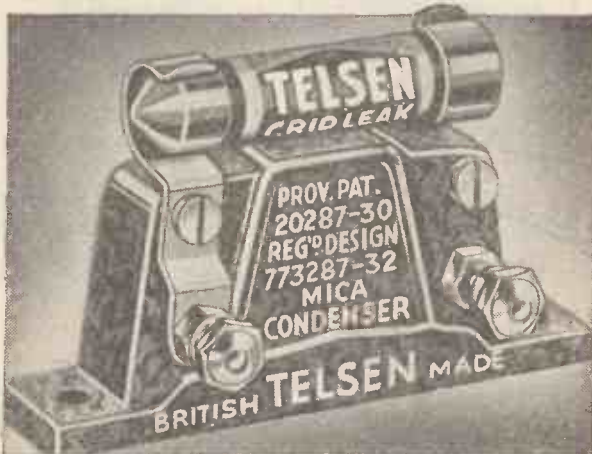

#### TELSEN MICA CONDENSERS

Represent an important advance in technique resulting in the virtual elimination of H.F. losses, even in the larger sizes. In attractive moulded cases, adaptable to flat and vertical mounting. Grid leak clips (for mounting in series or in shunt) are supplied free with the smaller capacities. Made in capacities of from .0001 to .002 mfd. . . . . **1/-**  
Also .006 mfd. . . . . **1/3**



#### TELSEN PRE-SET CONDENSERS

The only pre-set condensers to give so wide a variation between maximum and minimum capacities, providing a correspondingly wide range of selectivity adjustment when used in the aerial circuit. Superbly constructed throughout, for high insulation with low loss. Easily adjusted and provided with locking ring. Made in mfd capacities of from .002 (max) and .00025 (min) to .0001 (max) and .000005 (min) **1/6**

# TELSEN

RADIO COMPONENTS



#### TELSEN GRID LEAKS

This new type of improved efficiency, is absolutely silent and practically unbreakable, the resistance being unaffected by the application of different voltages. They are guaranteed to be completely non-inductive and to produce no capacity effects. Made in capacities of from 5 to 2 megs. **1/-**



#### TELSEN TAG CONDENSERS

Of extremely compact and sturdy construction. May be mounted on either insulated or metal panels by utilising the two base-board screw holes in the neatly designed moulded casing. The tags enable the condensers to be connected to any other components, either directly or by soldering. H.F. losses are negligible. In capacities of .0001 mfd. to .002 mfd. . . . . **6d**

## IT'S THE 'LASTING EFFICIENCY' THAT COUNTS

ANNOUNCEMENT OF THE TELSEN ELECTRIC CO. LTD., ASTON BIRMINGHAM

Mention of "Amateur Wireless", to Advertisers will Ensure Prompt Attention

# WHAT'S THE TROUBLE?

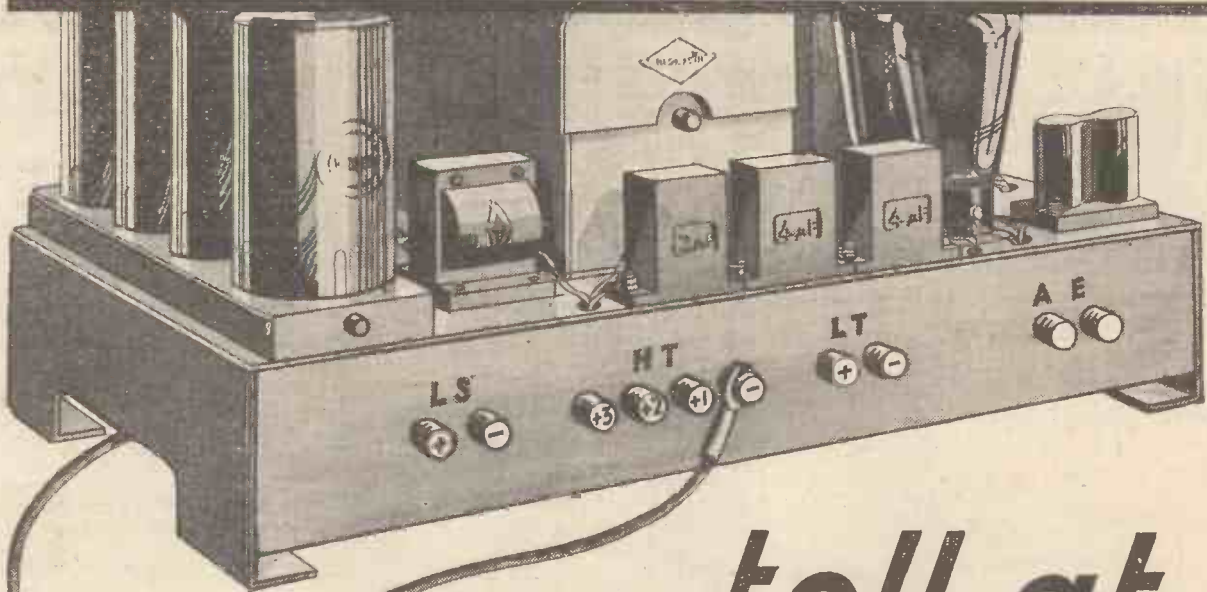

*.. tell at  
a glance!*



When trouble occurs—go over your set with an “All-in-One” Radiometer and quickly trace the true source of any fault.

Wherever it may be—circuit, valves, batteries, transformer, or other components—an “ALL-IN-ONE” Radiometer gets to the root of the matter and registers it at once.

There is no other instrument like it—it is as essential to the radio user as a stethoscope is to the doctor. Ask to see it demonstrated at your radio dealer’s or electrician’s.

If any difficulty, send P.O. to

**PIFCO LTD., High St., MANCHESTER**  
or GRAY HOUSE, 150 CHARING CROSS ROAD LONDON, W.C.2.

Standard Model “All-in-One”  
Radiometer for Battery Sets  
only, as shown here.  
Price **12/6**

De Luxe Model, for Electric  
Receivers, Mains Units and  
Battery Sets.  
Price **£2:2:0**

# PIFCO ALL IN ONE RADIOMETER

Advertisers Appreciate Mention of “A.W.” with Your Order

# PETO-SCOTT RADIO BY MAIL

## ORDER YOUR XMAS RADIO NOW

**TELSEN JUPITER S.G.3.** Complete kit as advertised, less valves and cabinet. Cash Price £3/17/0. Carriage Paid. Balance in 11 monthly payments of 7/-.

Send **7/-** only

**SLEKTUN SCOUT S.G.3.** S.G., Detector and Power. Kit "A," less valves and cabinet. Cash or C.O.D., £3/19/6. Carriage Paid. Balance in 11 monthly payments of 7/3.

Send **7/3** only

**BLUE SPOT SPEAKER UNIT AND CHASSIS. TYPE 100U.** Cash Price £1/12/6. Carriage Paid. Balance in 6 monthly payments of 5/2.

Send **5/2** only

**BLUE SPOT UNIT AND CHASSIS, Type 99 P.M.** Including matched transformer. Cash Price £2/19/6. Balance in 11 monthly payments of 5/6.

Send **5/6** only

**R & A "VICTOR" PERMANENT-MAGNET MOVING-COIL SPEAKER DE LUXE.** With 6-ratio input transformer and protecting grille. Cash Price £3/10/0. Carriage Paid. Balance in 11 monthly payments of 6/5.

Send **6/5** only

**R & A "CHALLENGER" PERMANENT MAGNET MOVING COIL SPEAKER.** With special Ferranti multi-ratio input transformer. Cash Price, Carriage Paid, £1/15/0. Balance in 5 monthly payments of 6/6.

Send **6/6** only

**W.B. PERMANENT-MAGNET MOVING-COIL SPEAKER P.M.2.** With 3-ratio input transformer. Cash Price £4/5/0. Carriage Paid. Balance in 11 monthly payments of 7/9.

Send **7/9** only

**CELESTION P.P.M. PERMANENT MAGNET MOVING-COIL SPEAKER** with impregnated diaphragm and dual-impedance input transformer. Cash Price, Carriage Paid, £2/7/6. Balance in 11 monthly payments of 4/6.

Send **4/6** only

**SONOCHORDE PERMANENT-MAGNET MOVING-COIL SPEAKER,** with universal input transformer. Cash Price £1/12/6. Balance in 5 monthly payments of 6/-.

Send **6/-** only

**BLUE SPOT 66R UNIT AND MAJOR CHASSIS.** Cash or C.O.D. £2/10/0. Carriage paid. Balance in 11 monthly payments of 4/7.

Send **4/7** only

**EKCO H.T. ELIMINATOR A.C.25** for A.C. mains. Tapped S.G. variable, 50/80 volts and 120/150 volts max. at 25 m/a. Cash or C.O.D., Carriage Paid, £3/17/6. Balance in 11 monthly payments of 7/-.

Send **7/-** only

**ULTRA 1933 TIGER.** A.C. or D.C. mains. S.G., S.G. Detector and Pentode. Moving-coil Speaker. Complete with Mazda Valves. Ready for use. Cash Price, Carriage Paid, £15/15/0. Balance in 17 monthly payments of 20/-.

Send **20/-** only

**PYE "G" 3-valve** with Band-pass Tuning. Variable-mu, Power-grid and Pentode. Complete ready to play, with Moving-coil Speaker. Walnut Cabinet. Cash Price, Carriage Paid, £18/18/0. Balance in 17 monthly payments of 24 3.

Send **24 3** only

**LISSEN S.G.3 PENTODE BATTERY SET.** In walnut cabinet complete with speaker, valves and all necessary batteries. Wave-length calibrated. Cash Price, £3/17/6. Carriage Paid. Balance in 14 monthly payments of 13/4.

Send **13/4** only

**A.C. CENTURY SUPER**  
As described last week  
**KIT "A"** Cash or C.O.D., Carriage Paid  
Author's list of components, including eliminator parts and 2 baseboards but excluding panel, valves, speaker and cabinet. Set of specified Valves  
PETO-SCOTT Oak Console Cabinet

£13-5-0  
Or 12 monthly payments of 24/3

£5 16 6  
£1 15 0

**NEW CENTURY SUPER**  
Battery Model, as described October 29.  
**KIT "A"** Cash or C.O.D., Carriage Paid.  
Complete kit of Author's first specified components as listed, excluding panel and foil-covered baseboard.  
Set of Specified Valves  
PETO-SCOTT Oak Console Cabinet

£7.0.0  
or 12 monthly payments of 12/9.

£4 5 6  
£1 5 0

**READY RADIO "METEOR" S.G.3.** Three-valve screened-grid receiver, with valves, cabinet and permanent-magnet moving-coil speaker. Covers short, medium and long waves without coil changing. Cash Price, £8/17/6. Carriage Paid. Balance in 11 monthly payments of 16/3.

Send **16/3** only

**READY RADIO "METEOR" S.G.3.** Three-valve screened-grid receiver. Covers short, medium and long waves without coil changing. Cash Price (less valves and cabinet), £3/15/3. Carriage Paid. Balance in 11 monthly payments of 7/-.

Send **7/-** only

**W.B. PERMANENT MAGNET MOVING-COIL SPEAKER. Type PM4.** Complete with transformer. Cash Price £2/2/0. Carriage Paid. Balance in 7 monthly payments of 5/9.

Send **5/9** only

**ROLA PERMANENT MAGNET MOVING-COIL SPEAKER F.6.** With universal tapped input transformer. Cash Price £2/9/6. Carriage Paid. Balance in 11 monthly payments of 4/6.

Send **4/6** only

**ATLAS ELIMINATOR, Type A.C.244.** Three tappings. S.G., Detector and Power. Output: 120 volts at 20 m/a. Cash Price £2/19/6. Carriage Paid. Balance in 11 monthly payments of 5/6.

Send **5/6** only

**HEAYBERD H.T. UNIT D.150.** Tapped variable 60/120 v., variable 0/150 fixed. Max., 25 m/a. at 150 v., 20 m/a. at 120 v. Cash Price, Carriage Paid, £4/6/0. Balance in 11 monthly payments of 8/10.

Send **8/10** only

**EKCO A.C.18 H.T. ELIMINATOR** for A.C. mains. Tapped S.G. 80 v. 120/150 v. at 12 m/a. Cash Price, Carriage Paid, £3/7/6. Balance in 11 monthly payments of 6/3.

Send **6/3** only

**GARRARD INDUCTION GRAMOPHONE MOTOR.** For A.C. mains. Model 202. Mounted on 12-inch nickel motor plate with fully automatic electric starting and stopping switch. Cash Price £2/10/0. Carriage Paid. Balance in 11 monthly payments of 4/7.

Send **4/7** only

**GARRARD JUNIOR "B" SPRING MOTOR.** Complete with turntable. Cash Price £1/13/0. Carriage Paid. Balance in 5 monthly payments of 6/4.

Send **6/1** only

**REGENTONE W.I.F. H.T. ELIMINATOR** for A.C. mains. Tapped for S.G., Detector and Power, 120/150 volts max. at 12 m/a. Cash or C.O.D., Carriage Paid, £2/15/0. Balance in 11 monthly payments of 5/1.

Send **5/1** only

**PETO-SCOTT WALNUT 1933 ADAPTA-GRAM.** Constructed of walnut with contrasting inlaid walnut veneers. Ready to take your own set and gramophone equipment. Cash or C.O.D. £3/3/0. Balance in 11 monthly payments of 5/9.

Send **5/9** only

**THIS YEAR'S WINNER - LISSSEN "SKYSCRAPER" COMPLETE WITH VALVES S.G.3**

**CHASSIS KIT with (Lissen) S.G., Detector and Pentode Valves. Cash Price, Carriage Paid, £4/9/6. Delivered, carriage paid, on first payment of ... Balance in 11 monthly payments of 8/3.**

**CABINET KIT with (Lissen) Valves, Walnut Cabinet and special Balanced Armature Loudspeaker. Cash Price, Carriage Paid, £6/5/0. Delivered, carriage paid, on first payment of ... Balance in 11 monthly payments of 11/6.**

**ONLY FROM PETO-SCOTT ON GENEROUS EASY TERMS**  
Carriage paid to your door

**BLUE SPOT PICK-UP.** With arm, rotating head and volume control. Cash Price £3/3/0. Carriage Paid. Balance in 11 monthly payments of 5/9.

Send **5/9** only

**MARCONIPHONE PICK-UP K.17.** Send With counter balanced arm and rotating head. Cash Price £2/2/0. Carriage Paid. Balance in 7 monthly payments of 5/9.

Send **5/9** only

**AERODYNE SCREENED GRID 3.** With Variable-Mu. Complete and ready to play with valves, batteries and accumulator with moving-coil speaker. Cash Price, £9/9/0. Carriage Paid. Balance in 14 monthly payments of 14/3.

Send **14/3** only

**AERODYNE ALL-MAINS VARIABLE-MU S.G.3.** Complete and ready to play, with moving-coil speaker. Cash Price, £15/15/0. Carriage Paid. Balance in 17 monthly payments of 20/-.

Send **20/-** only

**IMPORTANT**  
Paris, Kits, Miscellaneous Components, Finished Receivers or Accessories for Cash, C.O.D., or H.P. on our own system of Easy Payments. Send us a list of your wants. We will quote you by return. C.O.D. orders value over 10/- sent carriage and post charges paid.

**PETO-SCOTT CO. LTD. 77 City Rd. London, E.C.1.** Telephone: Clerkenwell 9406/7  
West End Showrooms: 62 High Holborn, London, W.C.2. Telephone: Holborn 3248

Dear Sirs, Please send me CASH/C.O.D./H.P. ....  
for which I enclose £.....s.....d. CASH/H.P. Deposit. Also send your FREE 1933 Radio Catalogue.

NAME .....

ADDRESS .....

..... A.W. 10/12/32.

**STRICT PRIVACY GUARANTEED - WE DEAL WITH YOU DIRECT**

# IGRANIC MAINS COMPONENTS

The increased popularity of all-electric radio has resulted in a demand for mains components of unquestioned reliability. Igranic answer the demand with products that are built to the highest standards of quality and efficiency. The Igranic Mains Transformer is shown on this page. The primary windings are so arranged that it can be connected to any standard 50-cycle A.C. mains supply of from 200 to 250 volts.

The input terminals, mounted upon paxolin boards, are clearly marked in 10 volt steps from 200 to 250 volts.

The output terminals are also mounted upon a paxolin board and marked with their respective outputs as follows:—

- Sec. 1 ... .. 4 volts 3 amps, centre tapped.
- Sec. 2 ... .. 6 volts or 4 volts 1 amp, centre tapped.
- Sec. 3 ... .. 4 volts 2 amps, centre tapped.
- Sec. 4 ... .. 250-0-250 volts.

Price **27/6**

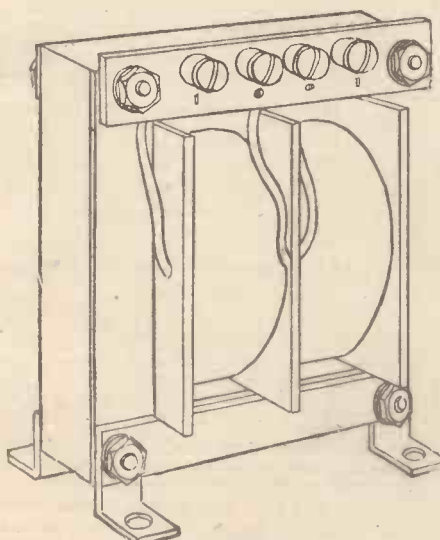
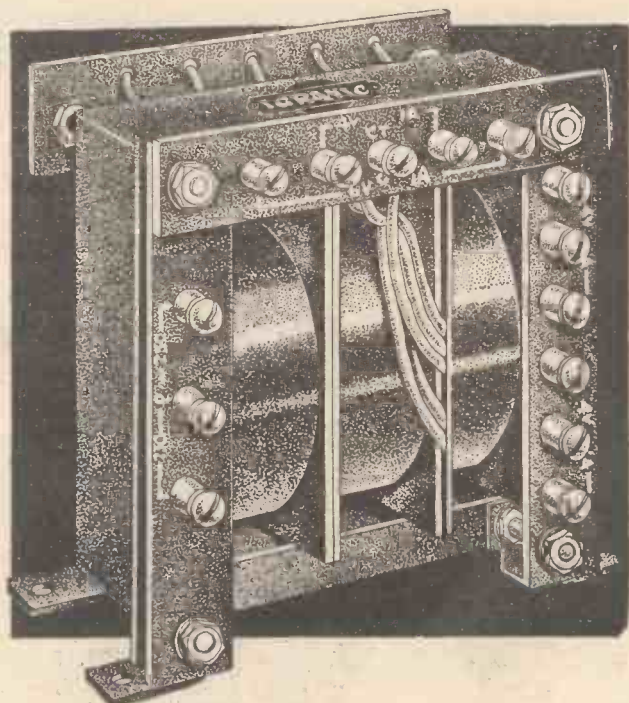

## TYPE C.H.2 CHOKE

40 henries, 40 m/A.

The type C.H.2 constant inductance choke is fitted with four terminals to enable coils to be put in series or parallel. This choke maintains a constant value of inductance up to the maximum current for which it is designed, so that the smoothing remains consistent up to the maximum carrying capacity of the choke.

Price **9/6**

Write to-day for fully illustrated Catalogue No. D.177 of complete new range of Igranic Quality Components:

Igranic Electric Co., Ltd., 149 Queen Victoria Street, London, E.C.4.

**SEND FOR THE 1932 CATALOGUE**

**IGRANIC  
COMPONENTS WILL  
BE THE MAKING  
OF YOUR SET.**





**BRITAIN'S LEADING RADIO WEEKLY  
FOR CONSTRUCTOR, LISTENER & EXPERIMENTER**

**EDITOR:**  
**BERNARD E. JONES.**

**TECHNICAL EDITOR:**  
**J. H. REYNER, B.Sc. A.M.I.E.E.**

**RESEARCH CONSULTANT:**  
**W. JAMES.**

**ASSISTANT EDITOR:**  
**H. CORBISHLEY.**

**NEWS FROM MADRID**

**NEWS FROM MADRID**

**What the Broadcasters Will Gain**

**A**FTER months of acrimonious discussion, the delegates at the Madrid meeting seem to have come to an understanding. It has been a bitter fight between the authorities responsible for the telegraphic services and the broadcasting organisations. So hard has been the fight that it would have been something of an achievement even to have retained our present wavelengths. Inadequate though these are, they were in danger of serious encroach-

ment from the other services. Now that the broadcasters have saved their existing slice of the ether it is creditable to them that the long-wave channel between about 1,200 and 1,500 metres has now been cleared for the exclusive use of broadcasting.

**BEST BRITISH STATION ABROAD?**

**W**HILE the B.B.C. delegates were passing away the tedious hours during the recent discussions at Madrid they took the opportunity to listen to the B.B.C. stations. They found that of all stations in the B.B.C. network North Regional and North National stations came through best. Why these two stations should be so markedly superior to the others is not stated, but probably the very high ground of Moorside Edge may account for it. Then, again, perhaps the distance between Moorside Edge and Madrid is just right for the maximum reflected ray. Whatever the reason, Northerners will be proud to hear that, in Madrid, anyway, their local stations form the "big noise" from the British Isles.

**AN ADDITION TO BROADCASTING HOUSE.**



A huge 10-ft. sculpture portraying Prospero sending Ariel out into the world to discourse unearthly music is being erected above the entrance to Broadcasting House. The work is by Mr. Eric Gill, and is executed in Portland stone

**EMERGENCY AT BROADCASTING HOUSE!**

**W**HEN the electric-light supply failed the other day at Broadcasting House the giant Diesel engine had to be brought into commission. So effectively did this emergency machine take over its job that but for the non-working of the lifts no one would have known anything was wrong. Or rather they would not have known if the Diesel had not emitted rather pungent fumes, which percolated very efficiently from the basement to the rest of the building. We understand that a new exhaust flue is now being fitted!

**NO MORE STUDIO AUDIENCES?**

**A**S an experiment the B.B.C. tells us that it is cutting out studio audiences in all vaudeville shows broadcast from the

Control Tower during the month of December by staff producers. Two other shows during this month, one the pantomime and the other the Ridgeway Parade, will be backed up with the usual audiences, but it is felt that for the normal "inside" shows the hand-clapping brigade has been perhaps a little too prominent of late. No doubt temperamental humorists will complain of the ban, but it is undoubtedly

**FEATURES YOU SHOULD NOT MISS**

- Up-to-date Ideas to improve Quality.
- How to Receive America.
- The Best Aerials—and How to Erect Them.
- Wireless Course for Beginners.
- Radio Dodges.

a fact that the presence in the studio of an audience does tend to make such artistes play to the handful of people they can see rather than to make an effort to amuse the unseen millions, who rightly object to hearing laughter and clapping for "unseen" jokes.

**ANNOUNCERS FOR THE EMPIRE SERVICE**

**M**R. W. G. M. SHOWEN, formerly at the Manchester station, has been appointed as one of the two announcers needed for the new Empire service. The newcomer has successfully passed the critical voice test which was applied with the object of finding a voice "at once refined and robust." Our kinsmen overseas certainly would not like some of the "refained"-voiced gentlemen we resign ourselves to listen to in this country. Owing to their odd hours of service for the Empire programmes the new announcers are having bedrooms fitted up at Broadcasting House. By the way, talking of announcers, there is a new one for London listeners in Mr. De Groot

**NEXT WEEK: 100 WIRELESS QUESTIONS ANSWERED**

# NEWS & GOSSIP OF THE WEEK —Continued

—not the well-known Dutch musician, but an Englishman.

## "MAN VERSUS MICROBE"

**I**N a new series of talks scheduled for Monday evenings, beginning after Christmas, well-known medical authorities will speak to listeners on all the common diseases and ills that man is heir to, including malaria, rheumatism and measles. Why consult a doctor?

## LISTEN FOR THE TEST MATCHES!

**E**YE-WITNESS accounts of the second innings of all the vital matches played by the M.C.C. in Australia will be broadcast by the B.B.C. at 8.30 a.m. The signals will be picked up over the Australian beam telephony service, so reliable contact would be maintained unless conditions are exceptionally bad. It occurs to us that on the mornings when these relays come across many cricket enthusiasts will be late for the office. Discerning "bosses" might just as well forestall trouble and put in a wireless portable.

## WHAT'S IN A NAME?

**Y**OU might think that the names of the regional centres of broadcasting in this country hardly mattered now that every station is either a regional or a national. But down in the West they are anxious to point out that when West Regional comes along in a few months' time the location will be postally known as Washford, not Washford Cross or Watchet.

## TOO MANY BIRTHDAYS

**T**HERE has been a change of policy regarding the reading of birthday greetings from the London station. Recently they had to read no fewer than 570 such greetings, which took about twenty minutes, even at "gabble" speed. Now there is a restriction, and instead of children from birth up to fifteen being eligible, only those from four to fourteen can be greeted.

## RELAYING THE KING'S MESSAGE

**W**HEN the King makes his Christmas afternoon broadcast message to the Empire elaborate precautions will have been taken to ensure that His Majesty's voice is well heard. Two land-lines will be commissioned, one going from Sandringham via King's Lynn and the other from Sandringham via Nottingham. The B.B.C. engineers will use whichever gives the better quality. The royal speech will be recorded on the Blattnerphone apparatus at Broadcasting House and sent to the zones of

Empire as each one's appropriate time arrives after the original speech has been broadcast.

## SPONSORED PROGRAMMES—WHEN?

**O**NCE more the question of the B.B.C. broadcasting programmes paid for by advertising interests has arisen. There seems to be a feeling in certain quarters of the Treasury that listeners would go on paying the present licence fee, from which the B.B.C. derives its revenue, even if that revenue were appropriated for use by the State. What now seems possible is that there will be an inquiry within a year or so to decide the question before the B.B.C.'s charter expires at the end of 1936. It is, of course, essential that the B.B.C. knows years ahead what its future source of revenue is to be, otherwise the technical development of the service would be brought to a standstill.

## B.B.C.'S MOCK LIBEL CASE

**I**N the "Consider Your Verdict" series on December 10 the B.B.C. will stage a mock libel charge against a newspaper, which will be alleged to have stated that "the B.B.C. is biased. It displays political reaction and moral cowardice. It is evident that it is controlled by vested interests." Perhaps this case will be a warning to newspapers.

## KIDDIES' REQUEST WEEK

**R**EGARDING the Request Week for the Children's Hour, to be conducted from January 2 to 7, 1933, the B.B.C. draws attention to the interesting commentary on the modern child's mind in the choice of stories for first place in the requests, with music only second in demand.

## A DEMONSTRATION OF QUALITY

**K**EEN listeners who have followed P. K. Turner's articles on quality reproduction in recent issues of *Wireless Magazine* will be interested to learn that he and Mr. Hartley have promised to give a special demonstration on Friday, December 16, and Saturday, December 17, at the Cathedral Hall, Ambroden Avenue, S.W.1 (near Victoria Station).

Mr. Turner and Mr. Hartley have offered to install a public-address amplifier using the A-P-A radio unit, the A-P-A (both have been fully described in *Wireless Magazine*) and the new Hartley-Turner moving-coil loud-speaker for a bazaar being held on those dates.

## RELAY FROM THE GUILDHALL

**T**HE thirty-ninth annual banquet to Little Londoners, organised by the trustees of the Treloar Crippled Children's Christmas Hamper Fund will provide for National listeners a relay from the Guildhall, London, on December 23.

## MR. TOMPKINS' NIGHTMARE

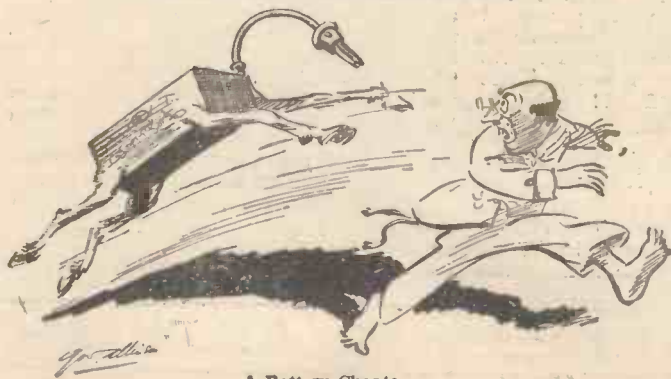

A Battery Charge

## MOZART

**A** DRAMA of a life, for broadcasting" is the label attached to the play entitled *Mozart*, by C. Whitaker-Wilson, author of *Sir Christopher Wren*, which will be broadcast on December 19 (National) and December 20 (Regional).

## GILBERT AND SULLIVAN

**F**OR the first time a Gilbert and Sullivan opera will be broadcast in full on December 24, when *The Yeomen of the Guard* will be relayed from the Savoy Theatre to National Listeners.

## A FAMOUS WIRELESS COMEDIAN



Julian Rose, the favourite Hebrew comedian, photographed during his stay in Harrogate, where he is resting

## THE CHRISTMAS PANTOMIME

**T**HIS year's broadcast pantomime will be entitled *Jack and the Beanstalk*, and Ernest Longstaffe is the author. The broadcasts are on December 26 (National) and December 27 (Regional) at 8 o'clock. Included in the cast will be Leonard Henry, John Armstrong, Miriam Ferris, and Elsie Otley.

A performance of *The Messiah* by the Sheffield Choir will be included in the Regional programme of December 15, being a relay from North Regional.

On December 31 the Children's Hour will be transferred for one afternoon only to a ward in the Princess Louise Hospital for Children, London, and the programme will be relayed to National listeners in the ordinary way.

A novel programme by Dallas Bower, the well-known film personality, is to be produced for broadcasting in a few weeks' time. One of the shortest plays on record, it will run for less than fifteen minutes, and consists of sound effects only. The title is *Working Day*.

The B.B.C. is going to attempt a revival of the "nigger minstrel" idea by organising a troupe of its own, and the first broadcast will probably take place early in the New Year.

Scenes from Offenbach, Sullivan, and Johann Strauss will form the make-up of the programme of comic opera which is to be broadcast Nationally on December 16



# UP-TO-DATE IDEAS TO IMPROVE QUALITY

From the aerial input to the loud-speaker output there are many points in the set's circuit that will affect the quality of the reproduction, as ALAN HUNTER clearly shows in this informative article

ARE you satisfied with the quality you are getting from the loud-speaker of your set? If not, there are many simple and inexpensive circuit improvements that may make all the difference to your reception.

During the past year, every point in

Fig. 1. A band-pass circuit, such as that shown on the right, will improve the selectivity of a set and at the same time give you better quality because high notes will not be cut

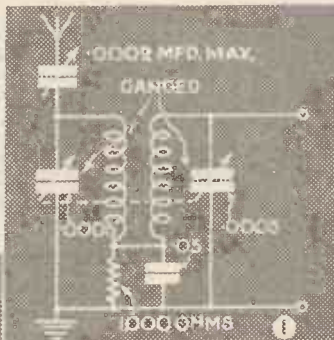

Fig. 2. To use a variable-mu valve in a battery-operated set you must arrange to vary the negative bias on the grid of the valve, as shown by the diagram on the left

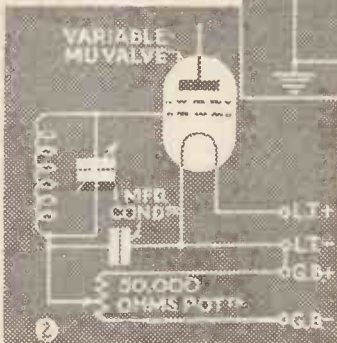

Fig. 3. Good quality can be obtained from the grid leak and condenser method of detection if you carefully choose the values for the components and apply plenty of high-tension voltage to the anode of the valve

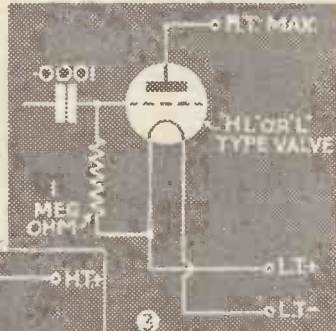

Fig. 4. Unless you make sure the high-frequency current is properly filtered out at the detector stage, as shown by the diagram on the left, you will run the risk of distortion in the low-frequency amplifying part of the receiver

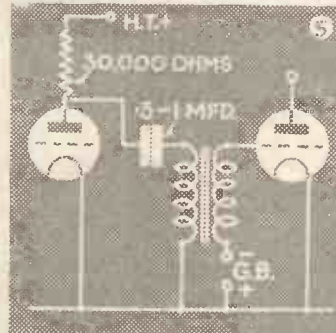
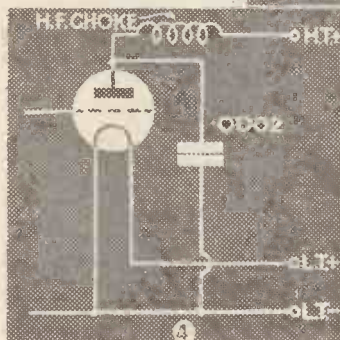
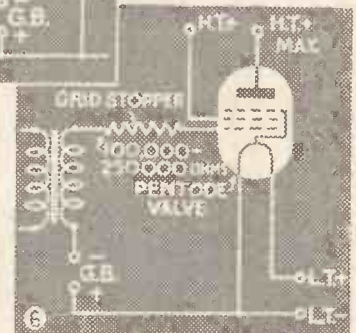

Fig. 5. On the left are the standard connections for parallel-feed low-frequency coupling, as now widely used to prevent distortion due to saturation of the core of the transformer by passing too much current through the primary winding

Fig. 6. A grid stopper, connected as in the diagram on the right, will cut down the high notes if a sufficiently high value of resistance is chosen. This is a useful hint for pentode working



the circuit of the wireless receiver has been attacked to eliminate bad quality, so that to-day there is no reason why anyone equipped with an adequate power supply and a modern loud-speaker should put up with inferior quality of reproduction.

## Where to Look

In the following notes I am attempting to show you the most likely points to look for the causes of bad quality. If your set is old-fashioned it may be lacking most of the ideas mentioned and even if the set is fairly up to date one or more of the ideas suggested will help to improve the quality.

## BAND-PASS AERIAL TUNING

STARTING at the input to the set, we must ask ourselves how far the aerial-tuning system is free from the suspicion of affecting the

quality. If you have a lightly damped aerial-tuning system, that is to say a very selective tuning coil, it is possible that the sharp tuning is cutting down the high-note response, especially when reaction is forced to the limit.

The symptom will be "woofy" speech and "drummy" music. Such signs of bad quality are most noticeable when getting foreign stations. Indeed, it used to be thought that all foreign-station reception must inevitably be inferior in quality to the

locals because it was not realised that to receive these distant stations the set was being forced to cut the high notes.

To-day, we realise that many of the foreign stations can, on a well-designed set, be brought in almost, if not quite, as well as the locals. Band-pass tuning is a great asset not only for selectivity, but for quality. If we make use of the inherently good tuning characteristics of band-passing, we need not force reaction to the limit to get clear separation among the foreigners.

Fig. 1 shows a typical band-pass tuning circuit, as used in the "1932 Ether Searcher." Many excellent commercial types of band-pass tuning coils are now on the market. Most of them involve the use of a two-gang condenser, or a three-gang condenser in sets fitted with a high-frequency valve.

The basic idea of band-passing is a pair of tuning circuits scientifically coupled together so that the maximum amount of selectivity and signal transference is

obtained. The coupling consists of a non-inductive coupling condenser and some form of "link" is provided inside the cans of the two sections of the band-pass.

## THE VARIABLE-MU VALVE

ONE of the most common forms of distortion in a set is "rectification" by the screen-grid valve, a trouble that is particularly prone to occur when the sensitivity of the valve is reduced to get the locals at moderate volume.

To overcome this form of distortion, the variable-mu type of screen-grid valve has been introduced. Its advantage is smooth and distortionless control of the volume. Its disadvantage is reduced amplification.

In a mains set, this is not important, but the constructor must carefully weigh the pros and cons (Continued at foot of next page)

## MICRO-RAYS MAKE FLYING SAFER

*A description of the new transmitters which, working on a wavelength of less than one metre, are to be used for communication between aerodromes in this country and in France*

**A**MAZING progress has been made with the "micro-ray" short-wave gear with which a group of scientists startled the world nearly eighteen months ago.

Using a special type of valve, known as a micro-radio tube, and large bowl reflectors which resulted in a kind of beam transmission, a first demonstration of practical telephony on a wavelength below 1 metre was given by the International Telephone and Telegraph Laboratories of Hendon, working in co-operation with the laboratories of Le Materiel Telephonique, Paris. On that occasion a wavelength of only 18 centimetres was used.

Now the experts have succeeded in going down even lower in the wavelength scale. They are using a wavelength of only 15 centimetres.

A new use for micro-rays has been found. They are helping to make flying safer, and are to be used for cross-channel flying services in this country and in France.

The benefit of these very short wavelengths for air craft use is that they do not add to the congestion of the ether and so the experts at British and French aero-

dromes can get into communication without upsetting any of the normal aircraft 900-metre working.

Transmission and reception on a wavelength of only 15 centimetres is, of course, a rather different proposition from the ordinary 900-metre arrangement, and Standard Telephones & Cables, Ltd., who have done a lot of research work in connection with aviation wireless, are building the new micro-ray transmitters for 15 centimetres.

For communication on this minute wavelength, transmitting and receiving aerials less than 1 in. long are used. Micro-rays oscillating at a rate of about 2,000,000,000 times a second are generated in a special "micro-radion" tube. These oscillations are led to the tiny transmitting aerial and are then concentrated by a combination of mirrors into a fine pencil of rays, which are thrown into space from a circular reflector, about 10 ft. in diameter. This reflector is focused on to a similar reflector at the receiving station.

The equipment ordered by the Air



Ministry will be located at Lympne airport, near Hythe, and will operate in conjunction with a similar equipment ordered by the French Air Ministry to be situated at St. Inglevert aerodrome, nearly seven miles south-west of Calais.

It will be used for announcing the arrival and departure of aeroplanes that are not fitted with radio, and for routine service messages.

An extremely interesting feature of this new service will be the use of teleprinters for both receiving and transmitting messages.

A great advantage of the use of micro-rays is the fact that they are almost entirely unaffected by atmospheric conditions. Another advantage is that on this extremely low waveband there is practically no interference.

### "UP-TO-DATE IDEAS TO IMPROVE QUALITY"

*(Continued from preceding page)*

before deciding to go in for a battery variable-mu. The Fig. 2 diagram shows the circuit modification needed to work this type of valve.

What is wanted is a variable control of the grid bias, the screen-grid voltage being fixed. A 50,000-ohm potentiometer, preferably of the new "graded" type, will be suitable across a 9- or 16-volt grid-bias battery as shown.

As the grid return will be through the pot winding and not direct to earth, it is advisable to fit a 1-microfarad by-pass condenser between the slider of the pot and earth. Another point is that some form of switching must be arranged so that when the set is switched off, the pot winding is removed from the grid bias, otherwise the small current drain, if continual, will soon ruin the bias battery.

### HIGH-QUALITY DETECTORS

**W**E used to fly to "anode-bend" in the old days when we wanted to make sure of distortion-less detection, but now it is widely held that the anode-bend system, besides being inefficient, introduces more distortion than the usual grid-leak and detector system.

The things to watch with grid-leak detection are the grid condenser, the grid leak, and the anode voltage on the anode of the detector valve. The grid condenser should not be too large or it will cut down

the high notes. It must not be too small or it will cut down the signals. A .0001-microfarad condenser seems almost ideal.

With this, a 1-megohm grid leak, or one of a lower value, gives good quality without grid "choking."

As the detector valve in this system of detection is acting as an amplifier of the low-frequency component of the anode current, you must make sure that it is not overloaded in this function or there will be distortion.

Many amateurs used to be deluded into thinking the grid-leak system was at fault when really it was only lack of anode voltage

that accounted for the distortion. Use as high a voltage as possible on the detector anode, but take care not to saturate the low-frequency coupling (see note on parallel feed and Fig. 3).

### FILTERING OUT THE HIGH FREQUENCY

**A**NOTHER very common cause of instability, and therefore of bad quality, for you cannot have an unstable set that gives really good quality, is poor filtering of the high-frequency current at the detector stage.

This is a remarkable state of affairs when we realise how cheap are the components for completely cutting out the high-frequency at the point at which it is no longer wanted—namely, the anode circuit of the detector.

All we need is a high-frequency choke in series with the anode and the low-frequency coupling and a small fixed condenser between the anode of the detector and earth. See Fig. 4.

It is in the value of the "by-pass" condenser that many amateurs make a mistake. If the condenser is made too small it will offer such a high impedance to the high-frequency current, relative to the impedance offered by the choke, that the required by-passing will not take place. If the condenser is made too large, it will by-pass not only the high-frequency we want to eliminate, but also the higher audible frequencies we want for amplification in the low-frequency stages.

*(Concluded on page 1329)*

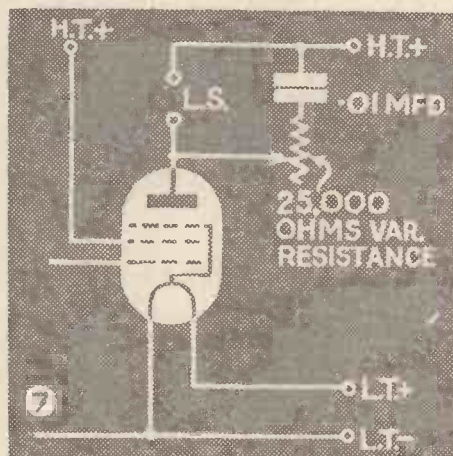

Fig. 7. Here is a good method of cutting the high notes with a pentode



# That Radio Dodge

## STRAIGHTENING WIRE

HOW difficult it is to push round copper wire of about 20 gauge through sleeving! Here's a tip—secure one end of the wire in a vice, or even under the foot. Take hold of the other end with a pair of pliers, and gently pull until you feel the wire "give"—result, perfectly straight wire.

## IMPROVING A CONDENSER

It is sometimes found, particularly on short waves, that a condenser is not rigid enough and that the vanes tend to vibrate. This usually happens on the older forms of condenser where the moving plates are not tied at the end.

If the plates of the condenser are of brass it is a very easy matter to tie the plates. Stretch a piece of fairly thick connecting wire

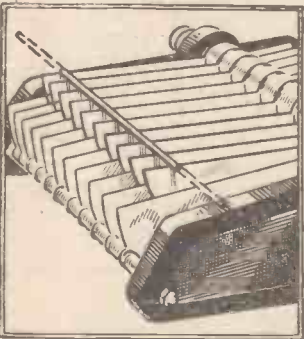

so that it is absolutely straight. Lay this across the top of the moving plates as shown in the diagram and run a small spot of solder along the wire just sufficient to anchor each of the plates. If the iron is hot and the work is clean this operation will be both simple and effective.

## COIL TAPPING

If you require an extra tapping on your home-made single-layer coil, this is how to do it without damaging any turns. With the

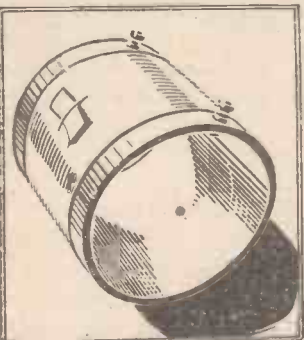

aid of a blunt instrument, such as a screwdriver, gently lever up the required turn until a matchstick or strip of cardboard can be

pushed underneath. Clean the insulation off the wire with a knife or sandpaper, and solder a flex wire to the bared portion.

## A WIRE GRIP

Why not construct for yourself a small grip or vice for wire stretching? A glance at the

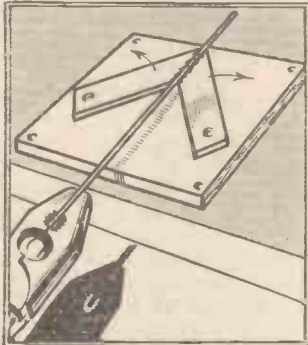

drawing will show two shaped pieces of strip iron 1/2 in. wide and about 1/4 in. thick and 1 in. or 1 1/2 in. long. These are pivoted at the square ends on two stout wood screws driven into a hardwood block. The sloping sides or jaws are serrated with a file to ensure a firm grip. As the wire is pulled the jaws tighten on it.

## SECURING THE HALYARD

What have you done with the halyard after pulling your aerial up into position? Make a neat job of it by driving two stout nails, one above the other, into the pole or tree, 4 in. apart. Then bend one up and the other

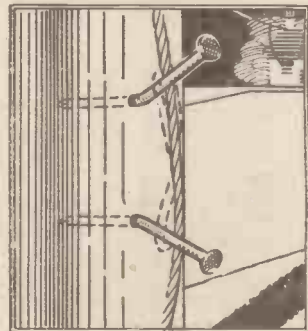

down and wind the rope round the two in figure "8" fashion, commencing close to the pole to avoid pulling on the end of the nails.

## REJUVENATING OLD CONDENSERS

That old condenser can be pulled out and brought up to date without much trouble. First of all clean the condenser thoroughly, using a pipe cleaner to get in between the plates. Clean up the terminals with soft rag. If they are very corroded you will

have to use a little emery cloth. Make sure there is no flux or dust anywhere, particularly on the surface of the insulation, as this will give leakage and losses if it is allowed to remain there. A spot of paraffin on your cleaning rag will help to remove any matter of this sort.

See that everything is tight and that the action is smooth. It is often found that a little machine oil (applied with the pipe cleaner used for cleaning) will ease up the action of an old condenser remarkably and with a little care it will be found quite serviceable for experimental hook-up or even for use in a pukka set.

## A DRILL STAND

To keep your stock of drills always handy obtain a block of hardwood 2 in. square and 8 or 9 in. long. Draw a line down the

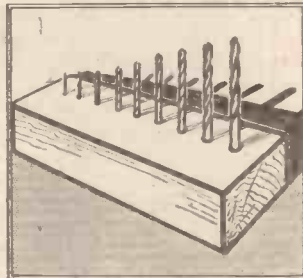

length of one face of the block and locate holes for each drill. Then take each drill in turn and make a hole with it, starting with the smallest size. The most convenient way is to store the drills with shanks inserted in the holes. Two extra holes would enable the stand to be screwed to the table or bench.

## INSERTING SCREWS

Occasions arise when we find our fingers, and even our fine-nosed pliers, too awkward to insert the wood screw into the

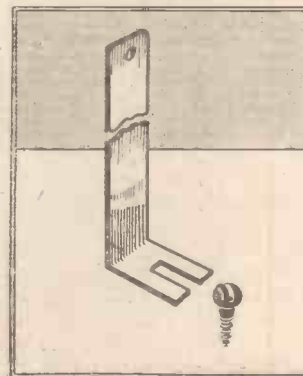

hole of the component to be fixed to the baseboard. This difficulty is easily overcome with the aid of a piece of bent brass strip that is

slotted on the short bent side or end. The screw is rested in the slot and gently lowered into the hole, when the screw can be driven in.

## COIL WINDING

Here is a method for using the hand-drill as a coil-winding

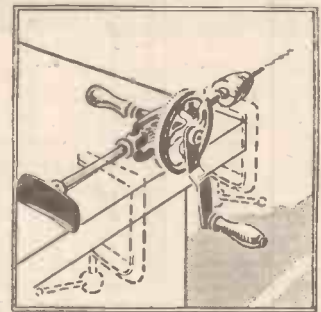

machine. Obtain two ordinary screw clamps, place the drill on one corner of the table, and secure it to the table in such a way that the chuck is free to revolve. Such components as high-frequency chokes can be wound in a very short space of time with this simple device.

## A HOME-MADE CONDENSER

Two razor-blades a piece of mica and two screws, can easily be transformed into an efficient fixed condenser. Procure a small piece of ebonite or wood about 3 in. by 2 in. On this, towards one edge, screw one of the blades through an end hole, then lay a

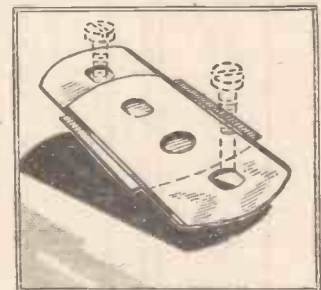

piece of mica on it, and on top of that lay the other blade, screwing down through the end hole, as shown in the drawing. Connections should be made to the two screws.

## STAYING A MAST

When limited for ground space in the erection of an aerial pole which is rather on the thin side and liable to bend, the pole can be "stayed" by fitting an arm two-thirds of the way up. A stay, or guy rope, is then fastened to the top of the pole, down over the end of the arm, and finally secured to a stake or hook driven into the ground.

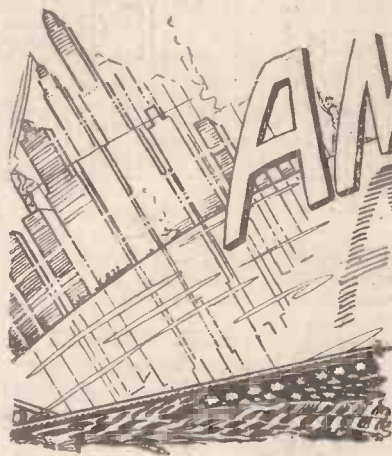

# AMERICA'S CALLING

*There is no need to "sit up" to hear the American stations nowadays. The reception of many is easily possible just after the European stations close down and in this article R. H. HALLOWS explains how they can be logged*

NOT for many years have transatlantic stations been so well heard as they are at the present time. It seems, in fact, not at all unlikely that there will shortly be a return to the marvellous conditions prevailing seven or eight years ago, when it was quite a common feat to receive stations such as KDKA and WGY with sets of the "det. and L.F." type, or even with a single-valver.

As matters are now, a high-frequency stage is required if only for the sake of selectivity, for there are far more big stations at work over there now than there were in those comparatively early years of broadcasting. Any reasonably efficient three-valver should bring in quite a number of stations from the other side of the Herring Pond, provided that a night is chosen when there is freedom from atmospheric interference and from the more violent kind of fading.

The moment the broadcast band begins to be cleared by the closing down of the European stations, you can try for America with every hope of success.

Fortunately, from the point of view of seekers after American stations, the very lowest wavelengths of the broadcast band are the most likely hunting ground just after midnight. These are largely occupied on this side by the Swedish relays and by stations in Central and Eastern Europe, which have generally gone to bed by midnight. Start then at your lowest settings, and the nearer to 200 metres the wavelength represented by these the better.

## An Aid to Tuning

It is a wonderful aid to searching if, at an earlier hour either on the selected night or on previous nights, you make a note of the settings required for various European stations near the bottom of the medium waveband. Csepel, or Budapest No. 2, on 210 metres, Newcastle on 211.3 metres, Aberdeen on 214.3 metres, Fécamp on 223 metres, Nurnberg on 239 metres, Belfast on 242.3 metres, Trieste on 247.7 metres, the London National on 261.6 metres, Turin on 273.7 metres, Heilsberg on 276.5 metres, the Scottish National on 288.5 metres, Hilversum on 296.1 metres and the North National on 301.5 metres are all first-rate milestones. If you know their settings you can be pretty sure of keeping all tuned circuits in resonance whilst you are making your search.

The first station that you are likely to

hear is WAAB of Boston, which operates on 212.6 metres, or just above Newcastle's wavelength. This station has recently increased its power, and on good nights it is heard very strongly.

On 216 metres, just above Aberdeen, you may have something of a surprise, for you will probably find a station whose announcer speaks in Spanish. Don't jump to the conclusion that you have picked up a European station, but wait for the call-sign. Presently it comes: LS.9. of Buenos Aires in the Argentine. This is a 10-kilowatt station, and we may hear some more Argentine stations as we work upwards.

Search carefully the region between 225 and 230 metres, for there you may find WKAQ of Porto Rico coming in strongly and steadily. The wavelength of this station has recently been changed to its present figure, but information regarding the exact wavelength now in use is not yet available. On 230.6 metres you are almost certain to hear that wonderful station WIOD of Miami, which regularly spans the Atlantic with an output power of a single kilowatt.

You will probably hear a good many carriers as you move slowly upwards, but you are not likely to come across anything with much punch behind it until you are just below the settings

of the London National. On 250 metres WOAI, the 50-kilowatt of San Antonio, Texas, is possible, and from this point upwards almost every channel (they use a 10-kilo cycle separation in the U.S.A.) contains a possible station. On 254.1 metres there is KOB of Albuquerque with 20 kilowatts, and just above him on 256.3 metres comes WCAU of Philadelphia with 50 kilowatts. WCAU is very well heard just now. On 260.7 metres WHAM (25 kilowatts) of Rochester is, a transatlantic

"regular," and WJJD (25 kilowatts) of Mooseheart may be found on 265.3 metres.

## A New Station

On 272.6 metres is another wonder station, the 5-kilowatt WPG of Atlantic City. Despite its small power this is one of the best heard of American stations and one of the easiest to find. The wavelength is just below that of Turin.

KMOX on 275.1 metres, WBT on 277.6 and WTAM on 280.2 metres are all probable. Another fine station, WTIC (50 kilowatts) of Hartford, is almost sure to be heard on 282.8 metres.

Turn now to Hilversum's settings and work carefully upwards. The wavelength of 299.8 metres is shared by two 50-kilowatt stations in Iowa, WHO and WOC, only one of which is in action at a time. Above them come two U.S.A. stations which have probably been heard in this country more frequently than any other pair. These are WBZ (25 kilowatts) of Springfield, and KDKA (50 kilowatts) of Pittsburgh. Their

## A NEW U.S.A. STATION YOU MAY HEAR



WCAU—Pennsylvania's new transmitting station which is located at Newton Square, Pa. It has a power of 50 kilowatts

wavelengths are 302.8 and 305.9 metres respectively.

Should you fail to find KDKA you are likely to pick up LR4 of Buenos Aires on 303 metres, and on 316 metres there is LR3, also of Buenos Aires, which is now using a power of 10 kilowatts and has been heard by many listeners in this country.

Stations with wavelengths over about 330 metres generally come in best an hour or more after midnight. This, however, is

(Continued on page 1332)

# 904V

2LO calling! Remember how you listened to that ten years ago on a crystal set. Strained your ears to catch every word, every note — But now what a difference! Mullard have given you A.C. mains valves. No more straining, no more headphones. Sit back at ease and roam the Continent. Use Mullard A.C. mains valves — the 904V and 354V detectors — valves that are built on the Rigid Unit Principle and abolish microphony.

Type 904V

OPERATING DATA	
Heater Voltage	4.0V
Heater Current	1.0A
Max. Anode Voltage	200V

CHARACTERISTICS

(1.) (At Anode Volts 100; Grid Volts Zero)	
Anode Impedance	34,000 ohms.
Amplification Factor	75
Mutual Conductance	2.2 mA/V
(2.) (At Anode Volts 200; Grid Volts Zero)	
Mutual Conductance	3.0 mA/V

Price 13/6

Type 354V

OPERATING DATA	
Heater Voltage	4.0V
Heater Current	1.0A
Max. Anode Voltage	200V

CHARACTERISTICS

(At Anode Volts 100; Grid Volts Zero)	
Anode Impedance	12,000 ohms.
Amplification Factor	36
Mutual Conductance	3.0 mA/V

Price 13/6

Ask T.S.D.—Whenever you want advice about your set or your valves—ask T.S.D.—Mullard Technical Service Department—always at your service. You're under no obligation whatever. We help ourselves by helping you. When writing, whether your problem is big or small, give every detail. Ask T.S.D.

switch over to . . .  
**Mullard**  
THE MASTER VALVE

# FACTS YOU SHOULD KNOW..

# ABOUT THE MAZDA RANGE OF RECTIFIERS



If you are using valve rectification on your A.C. mains receiver, there is a definite advantage to be gained by using Mazda indirectly heated rectifying valves. You are safeguarding the condensers, chokes and valves of your receiver.

When an ordinary rectifying valve is switched on, its operating temperature is reached considerably before that of the receiving valves. This causes a voltage surge and damage is frequently done to components. Mazda filaments are designed to heat up with the receiving valves, the voltage thus being gradually applied.

Full details of Mazda indirectly heated rectifiers will be found in the Mazda catalogue, sent FREE on request.

Mazda valves are fitted by all the leading receiver manufacturers. All good radio dealers stock them.

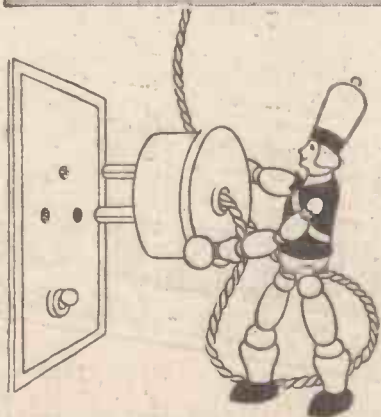

LOOK FOR "EDDY" IN YOUR DEALER'S WINDOW

**EDISWAN RADIO 100% BRITISH — Designed by British Engineers**

# The amazing MAZDA THE BRITISH VALVES

The Edison Swan Electric Co. Ltd.



155 Charing Cross Rd. London. W.C.2

Mazda Radio Valves are manufactured in Great Britain for

The British Thomson-Houston Co. Ltd., London and Rugby.

V170

To Ensure Speedy Delivery, Mention "A.W." to Advertisers

# On Your Wavelength!

## ONE BIG 'UN . . .

**A** GOOD many readers have probably found the new Toulouse station engaged in testing. He has not yet taken over the regular broadcast service, but he has trial trips on a good many nights each week after the old transmitter has closed down. The new apparatus is rated at 60 kilowatts—seven and a half times the power of the old one. He certainly comes across with zip, pep, vim, and punch; and I think that within a short time he may be the most powerfully received European station in this country. The first time I struck him ("struck" is the right word), I was using a very selective super-het which gives no indication that you are approaching a station as you turn the knob. You suddenly find yourself there, so to speak. That is what I did, and as the time was 12.30 a.m., the roar that burst from the loud-speaker made me distinctly unpopular amongst the household. The new Toulouse will be very welcome, for his quality is extraordinarily good, which is much more than you could say of the old transmitter.

## . . . AND ANOTHER

**A** NOTHER fine, healthy voice from the Continent is that of the new 60-kilowatt Munich, who comes in so strongly that it does not need much of a receiving set to obtain full loud-speaker volume even during the afternoon. This plant appears to be now in regular use, and I can assure you that you will not have much difficulty about finding Munich. Both Toulouse and Munich are likely to raise some problems in selectivity. Toulouse has the 120-kilowatt Leipzig as a neighbour on one side and on the other is he only 18 kilocycles from the Scottish Regional. In between Toulouse and the Scottish station comes the 16-kilowatt Lwow. If you can separate Toulouse from Leipzig you can feel pretty proud of yourself, and if you can get Lwow, both it and you deserve full marks. Munich has the 10-kilowatt Sundsvall on one side and the 15-kilowatt Riga on the other. Neither of these is very strongly received in most parts of this country, and in most cases they will now be completely blanketed.

## TIME TO WAKE UP

**Y**OU might have thought that, having received due notice of the coming into action of the Empire station on December 19, our manufacturers would have laid themselves out to evolve special short-wave sets for the Dominion and Colonial markets. Very few of them, unfortunately, appear to have done so; for from all over the Empire come reports that, though there are signs of big trade in short-wave sets, the only apparatus in local markets is of American, German, or some other foreign make. This is rather sad, but it is not yet too late, if our manufacturers will act now, for the boom is sure to last for some little time.

## AN OPPORTUNITY

**I**T seems to me that there is a big opportunity for a special short-wave set of a particularly portable kind. This would make a big appeal, not only to travellers, but also to dwellers in distant places who are far beyond the range of relays from local stations and must receive the Empire broadcasts direct if they are to have them at all. And just what kind of set is required? First of all, it must be battery operated, and dry battery operated at that, for it is likely to be used in places hundreds of miles from the nearest accumulator-charging station. Since only two valves would be required, they could be run, even if they were of the 2-volt 1-ampere type, from a pair of bell cells in series; a filament rheostat, of course, being used. As it would be designed for telephone reception, very little high-tension current would be required and were valves of the original four-electrode type with space-charge grid employed, not more than about 25 volts H.T. would be needed. The H.T.B. would thus be quite small and light.

## THE BATTERY PROBLEM

**I**N many countries, dry batteries of the usual kind would not be found satisfactory, nor would it be possible to store them anywhere for more than six or eight months without serious deterioration on the shelf. Happily, there is another kind of dry battery which exactly fills the bill. This is made up of what are known as inert cells. These are quite literally dry, and no chemical action takes place until they have been filled with water. Refills of inert cells can be stored for years.

## NEW VALVES WANTED

**T**HOUGH we led the way with both the screen-grid valve and the pentode, we are, I am afraid, lagging a little behind the United States in valve developments just now. Apart from the Wunderlich valve, which was specially designed for automatic control volume purposes, there are two admirable types in use

over there with which we could do very well. The first of these is the high-frequency pentode, which is made in both mains and battery types. This is a most efficient and satisfactory valve for use as combined detector oscillator. Another very interesting valve which I have just come across in a set made in America, but soon to be made in this country, is a twin output valve for use in push-pull circuits. It contains a single filament, but there are two separate grids and two separate plates, as it is particularly fitted for push-pull or economy push-pull work. It performs the tasks of two valves, and it is most economical in both high- and low-tension current. The volume, combined with good quality, that can be obtained from one of these twin valves in a push-pull amplifier is nothing short of astonishing.

## A TONE-CORRECTOR POINT

**T**HAT ONE-CORRECTING transformers have become more and more popular since their introduction some months ago. There is no doubt that they deliver the goods if they are properly used, but I have come across one or two cases in which purchasers complained of very poor results after fitting them. The reason was invariably that an anode-bend detector was used in the set instead of one of the leaky-grid condenser or power-grid kind. At one time, as old hands will remember, the anode-bend detector almost ousted the grid-leak-and-condenser type, because everyone told us that it, and it alone, could provide perfect quality. The fact that for quite a long time we revelled in the reproduction of sets using this kind of detector shows how little we knew about quality in those days. The trouble with the anode-bend detector is that it must introduce a good deal of harmonic distortion, because the straight part of a valve curve isn't really straight. If you follow such a detector with a tone-correcting transformer, matters go from bad to worse, for the distortion is emphasised. The grid-leak-and-condenser detector has emerged from the cloud which once threatened to cover it, for it has been shown that, provided that the input is small,

## PERSONALITIES IN THE WEEK'S PROGRAMMES

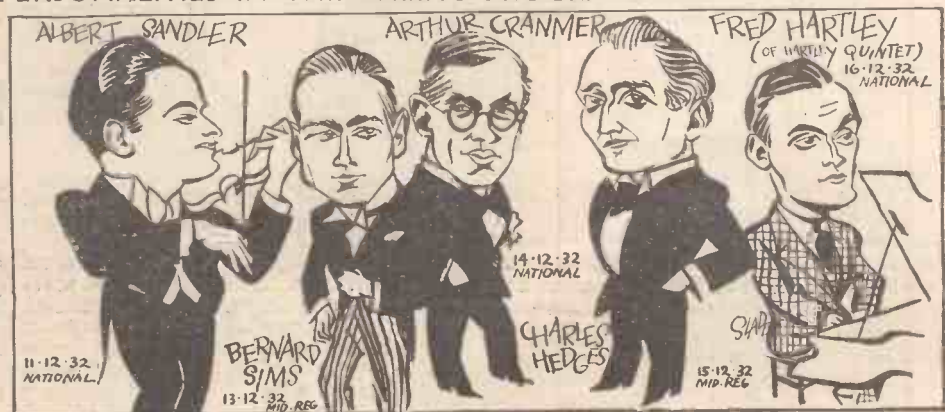

## On Your Wavelength! (continued)

is capable of excellent quality. Power-grid detection is required where there is a large input to the detector. One or the other should always be employed when a tone-control transformer is fitted.

### CRITICISING THE CRITICS

**T**HE "B.B.C. Year Book" is full of interesting reading; but why, oh, why have the authorities chosen that terrible eye-straining type instead of the nice good clear print of former years? One section that particularly takes my fancy is that devoted to critics of the wireless programmes. It is natural, of course, that an institution such as the B.B.C. should come in for a good deal of criticism in both the technical and in the lay papers. Naturally, too, some of the opinions expressed will be diametrically opposed to one another. I am not in the least surprised that one paper should refer to a certain item as clotted nonsense whilst another describes it as one of the best plays the B.B.C. has given us. One man's meat is proverbially another man's poison; and that is that. It is good to see that informed and constructive criticism is given full consideration by the B.B.C. I hope mine is informed, and I have always endeavoured to make it constructive.

### WAITING AND HOPING

**A**S I write, a set of traffic signals is in process of erection at a busy cross-roads about two hundred yards from my abode. I am hoping for the best, but rather fearing the worst. Hoping, I mean, that the local authority has been wise enough to select signals of the non-radiating type, but rather fearing that the point may have been overlooked. Authorities responsible for putting up these signals and other electrical devices should most certainly give a lead by insisting upon a guarantee that they are non-radiating. Pressure brought to bear in this way upon manufacturers of electrical appliances would probably have far-reaching results; and the man in the street can do his bit by making similar stipulations when he (or his better half) invests in a refrigerator, an electric fan, and so on. France, I see, has come into line with other Continental countries by introducing legislation to make it an offence to cause interference with wireless reception by radiation. So far, we have no regulations on the subject, but it is to be hoped that they will be made before it is too late.

### ANOTHER CONFERENCE

**T**HE Madrid Radio Conference, which appears to have been devoted more to "gas" than to wireless problems, will probably break up, having achieved very little indeed. I am relieved to hear that there is to be special broadcasting conference of European authorities at Prague during the spring. The Madrid Conference was badly handicapped by the fact that it was supposed to cover not merely broadcasting, but all kinds of wireless problems. The delegates, therefore, were

numerous; too numerous for much to be done. The Prague Conference should be a nice, compact body, and it will therefore have every chance of achieving results of importance.

### WIRELESS PATENTS IN U.S.A.

**T**HE big wireless patent "pool" in America has just taken a knock-out blow. After a long-drawn-out legal battle, the Department of Justice has succeeded in breaking up an agreement made between three of the big companies under which the control of most of the master radio patents was given to the Radio Corporation of America. Of course, the main idea underlying the grant of any patent is to give the inventor certain monopoly rights, but when hundreds of different patents are concentrated in one pair of hands, so to speak, the effect is rather overpowering, and is likely to lead to serious abuses. At all events, the Federal Court has taken the view that the "pool" is a breach of the Sherman Anti-Trust Law and a menace to the radio industry in general. From now on, each of the companies concerned must handle its own patents as best it can.

### CENTIMETRE WAVES

**W**HEN centimetre waves first came into the limelight, it was generally thought that reception would be limited to the so-called "optical" distance. That is to say, one would not be able to receive micro-waves if the transmitting aerial was beyond visual range. Senator Marconi has, however, recently shown that they can be received at least 30 miles beyond the point where the transmitter dips below the curvature of the earth, though exactly how it is done is more or less wrapped in mystery. Theory indicates that the waves should keep a straight-line path, like light, but practice proves otherwise. We have already got an upper and a lower Heaviside layer, and now it looks as if somebody will have to discover a third.

### WHEN TRIMMING



When two and three-gang condensers are being trimmed, rotate the main knob each time a fresh trimmer adjustment is made. In this way you will make sure that there is no double humping. The trimmers should be adjusted with a long-handled screwdriver, so that there is no hand capacity. The trimmers on the H.F. valve will probably be found to tune sharper than that across the aerial section. Don't adjust the aerial series condenser while altering the ganging, for this will upset the tuning point.

### WIRELESS LICENCES

**I** THINK there must be some error—or omission—in the published account of the recent prosecution in which certain Romford and Ilford residents were fined for using a wireless set without a licence. The P.M.G.'s representative is reported to have said that a separate licence must be taken out for every set actually in use. If this is so, it is new to me. I have always understood that a householder is entitled to have as many sets as he likes, provided they are used either by himself or his family. For instance, he can have one in the living-room, another in his bedroom, and a third in his wireless den, whether or not they are fed from the same or from different aerials. Of course, it is quite another thing if any part of the house is sub-let. In that case, each tenant or lodger must have a separate licence to cover his own set.

### A REACTION PLAINT

**I** HAVE often wondered why some makers are content to send out sets with reaction of the kind that would drive me silly in an hour or two. For good results, reaction must be smooth and without overlap, and nothing is more horrible than the kind which makes the set flop into oscillation just as a signal is building up nicely. But on a good many mains sets, reaction is far too fierce to be pleasant. It is not, as a rule, a difficult business to obtain smooth working reaction control, and I think that some makers will be well advised to pay a good deal more attention than they do to this point.

### POWER OR LIGHT?

**S**OME of the electricity supply authorities, I hear, object to the working of wireless sets from power circuits and contend that they should be run off lighting circuits only. The great point about using a power circuit for the purpose is, of course, that in most localities current obtained in this way is very much cheaper than that supplied for lighting. I confess that I cannot quite understand the attitude of the authorities in question. In the old days of bright emitters, some genius, remember, did design a five-valve set whose valves were arranged so as to form a reading lamp. But you couldn't do much reading by the light of modern valve heaters, and by no stretch of the imagination can you call a wireless set a light appliance. After all, the current is required purely for heating purposes, and this should surely be sufficient reason for classing the wireless set with appliances such as the electric iron and electric radiator, which are regularly operated from power circuits. One consolation, in case the authorities won't give way on the point, is that even when run from a lighting circuit, the all-mains receiving set is a pretty economical piece of apparatus. The average three-valver draws about 50 watts, or the same amount as is required for the kind of lamp that you use in small rooms.

THERMION.



*Graham Farish says*

# YOU CAN'T BE MORE CRITICAL THAN I AM

I don't know what tests you make of the Components you buy, but I do know that every one I sell is tested far more stringently before it leaves my factory. It has to be not only capable of doing the job for which it is designed—but it has to bear electrical stresses greater than will ever be required in practice before I allow it to bear my name. That is why you can trust every Graham Farish product to the limit.

Graham Farish  
**LIT-LOS**  
SOLID DIELECTRIC  
VARIABLE CONDENSERS

**2!**  
EACH

A very carefully constructed instrument, compact in size and efficient in design, with accurately gauged bakelite dielectrics and solid brass pigtail connection to moving vanes. Made in all capacities up to .0005 mfd. in tuning straight line capacity and differential types. Used by many leading manufacturers and specified in sets by famous designers. One hole fixing; supplied complete with terminals.



Graham Farish  
**OHMITE**  
RESISTANCES

**1/6**  
EACH

The popular and efficient resistances for all general purposes. All values 300 ohms to 5 megohms. 1/6d. each.



**BETTER THAN WIRE WOUND**

## GRAHAM FARISH COMPONENTS

GRAHAM FARISH LTD., MASONS HILL, BROMLEY, KENT.

Export Dept. : 11-12 FENCHURCH STREET, LONDON, E.C.3  
Please Mention "A.W." When Corresponding with Advertisers

# CENTURY SUPERS FOR EVERYBODY

## A.C. MODEL

- £ s. d.
- 1 J.B. Unitone 2 type D twin-gang .0005-mfd. variable condenser .. 18 6
  - 1 J.B. Nugang type A1 single .0005-mfd. variable condenser .. 10 6
  - 3 Wearite super-het intermediate coils, type OT2 .. 1 11 6
  - 1 Lisen ganged oscillator and bandpass coils .. 1 10 0
  - 1 R.I. Hypermite low-frequency transformer .. 12 6
  - 1 Ready Radio H.F. choke .. 5 6
  - 1 Sovereign .0003-mfd. max. preset condenser .. 1 3
  - 8 Dubilier 1-mfd. fixed condenser, type 9200 .. 1 2 0
  - 2 Dubilier 2-mfd. fixed condensers, type 9200 .. 7 6
  - 1 Dubilier .02-mfd. fixed condenser, type 9200 .. 2 0
  - 2 T.C.C. .0001-mfd. fixed condensers, type "S" .. 2 6
  - 1 T.C.C. .0005-mfd. fixed condenser, type "B" .. 1 3
  - 1 T.C.C. .002 mfd. fixed condenser, type "B" .. 1 8
  - 2 Erie 1-megohm grid leaks .. 2 0
  - 1 Bulgin 10,000-ohm potentiometer and combined switch, type V833 .. 5 6
  - 1 Telsen Pentode Tone Corrector .. 3 6
  - 4 4-pin valve holders .. 4 0
  - 5 5-pin valve holders .. 4 0
  - 6 Belling-Lee terminals, marked: Aerial, Earth, L.S., L.S., 2 pick-up .. 1 3
  - 2 Erie 50,000-ohm fixed resistances .. 2 0
  - 1 Erie 40,000-ohm fixed resistance .. 1 0
  - 4 Erie 20,000-ohm fixed resistances .. 4 0
  - 2 Erie 5,000-ohm fixed resistances .. 2 0
  - 1 Erie 600-ohm fixed resistance .. 1 0
  - 2 Erie 400-ohm fixed resistances .. 2 0
  - 1 Erie 200-ohm fixed resistance .. 1 0
  - 1 Ready-Radio grammo-radio change-over switch .. 2 9
  - 1 Aluminium bracket .. 3
  - 1 Lewcos connecting wire, screws, sleeve, etc. .. 1 6
  - 1 Piece aluminium foil, 16 in. by 12 in. .. 2 0

## SHORT-WAVE ADAPTOR (BATTERY)

- £ s. d.
- 1 Direct Radio cabinet with baseboard, 10 in. by 9 in. .. 15 0
  - 1 Drilled panel, 10 in. by 8 in. .. 2 0
  - 1 Colvern dual-range screened short-wave coil, type KSW .. 9 6
  - 1 J.B. .00025-mfd. short-wave variable condenser, type 2043, with slow-motion drive No. 1065 .. 10 9
  - 1 Ready Radio .0003-mfd. reaction type bakelite dielectric .. 2 6
  - 1 J.B. neutralising condenser .. 3 8
  - 1 Ready Radio on-off switch .. 10
  - 1 4-pin valve holder .. 6
  - 1 T.C.C. 1-mfd. condenser .. 2 10
  - 1 T.C.C. .0001-mfd. and one .0005-mfd. fixed condensers .. 2 6
  - 1 Ready Radio 400-ohm baseboard mounting potentiometer .. 2 9
  - 1 Erie 1-megohm grid leak .. 1 0
  - 1 Sektun short-wave H.F. choke .. 2 9
  - 1 Sovereign terminal block and 2 Belling-Lee terminals marked Aerial and Earth .. 11
  - 2 Yards thin flex, connecting wire, screws, etc. .. 4
  - 1 Bulgin 4-pin adaptor plug, P.9. .. 2 0
  - 1 Belling-Lee S.G. anode connector, type 1030 .. 4
- £3 0 0

## ACCESSORIES

- £ s. d.
- 1 Siemens H.T. battery .. 13 6
  - 1 Siemens 9-volt G.B. battery .. 1 0
  - 1 Oldham 120-volt H.T. accumulator, 5,500 m/A-hour capacity (H.P. terms, 12 monthly payments of 7/6) .. 4 1 0
  - 1 Oldham L.F. accumulator, type O50 .. 9 0
  - 1 Atlas H.T. unit, type A.C. 244 .. 2 19 6
  - 1 Atlas H.T. unit, type 8K200 (H.P. terms, 12 monthly payments of 8/6) .. 4 0 0
  - 1 Atlas H.T. unit, type A.C. 300 (H.P. terms, 12 monthly payments of 12/-) .. 6 10 0
  - 1 Atlas D.C. 15/25 .. 1 19 6
  - 1 Epoch 20th Century moving-coil loud-speaker .. 1 15 0
  - 1 Epoch Super Junior .. 1 17 6
  - 1 Epoch A3 (H.P. terms, 12 monthly payments of 7/-) .. 3 3 0
  - 1 W.B. PM2 speaker (H.P. terms, 12 monthly payments of 5/-) .. 4 5 0
  - 1 W.B. PM4 speaker .. 2 2 0
  - 1 Aerial .. 5 0
  - 1 Sektanet earth .. 1 6
  - 1 "Cop" lightning arrester and lead-in tube .. 2 6

## TABLE MODEL

- £ s. d.
- 1 Heysberd mains transformer, type 717 .. 1 14 0
  - 1 Heysberd smoothing choke, type 737 .. 1 0 0
  - 2 T.C.C. 4-mfd. fixed condensers, 800-volt test type 80 .. 17 0
  - 1 Dubilier .2-ohm centre-tapped fixed condenser, type BE31, or Peak .. 3 0
  - 1 Belling-Lee twin fuse holder and fuses .. 2 6
  - 1 Easyfix baseboard for set, 18 in. by 12 in., baseboard for mains unit, 14 in. by 8 in. .. 2 0
  - 7 Valves—Mazda AC80, 2 Mullard 2VM4V, 2 Mullard 904V, 1 Mullard Fen4V, 1 Mullard DW2 .. 5 16 6
  - 1 Direct Radio 159 walnut consolette cabinet .. 2 2 0
  - 1 Calibrator Easy Station Finder (No charge) .. 2 2 0
- £21 1 3
- KIT No. 1**  
(less valves and cabinet) £13 : 2 : 9  
Or 12 monthly payments of £1 4 0
- KIT No. 2**  
(with valves, less cabinet) £18 : 19 : 3  
Or 12 monthly payments of £1 15 0
- KIT No. 3**  
(with valves and cabinet) £21 : 1 : 3  
Or 12 monthly payments of £2 0 0
- KIT No. 4**  
(Complete kit with valves, special Consolette cabinet and Epoch A2 permanent-magnet moving-coil speaker with multi-ratio input transformer) £24 : 5 : 0  
Or 12 monthly payments of £2 5 0

## TABLE MODEL

- £ s. d.
- 1 J.B. Unitone twin-gang .0005 variable condenser, fully screened .. 18 6
  - 1 J.B. Unitone single .0003 variable condenser .. 9 6
  - 1 Bulgin 50,000-ohm potentiometer and combined switch, type V836 .. 5 6
  - 3 Wearite super-het intermediates with pistals .. 1 11 6
  - 1 Set Lisen ganged oscillator and bandpass coils and combined on-off switch .. 1 10 0
  - 8 Four-pin and 1 five-pin valve holders .. 5 6
  - 2 Dubilier .02-mfd. fixed condenser, type 9200 .. 2 0
  - 1 T.C.C. .0001-mfd. fixed condenser .. 1 3
  - 1 T.C.C. .002-mfd. fixed condenser .. 1 6
  - 1 T.C.C. .001-mfd. fixed condenser .. 1 6
  - 1 Erie 1-megohm grid leak .. 1 0
  - 1 Erie 2-megohm grid leak .. 1 0
  - 1 R.I. Parafec low-frequency coupling unit .. 11 9
  - 1 Sovereign .0003-mfd. pre-set condenser .. 1 3
  - 1 Ready Radio high-frequency choke .. 5 6
  - 2 Sovereign terminal blocks .. 1 0
  - 4 Belling-Lee terminals, marked: Aerial, Earth, L.S., L.S. .. 10
  - 1 Belling-Lee wander plugs, marked: G.B., G.B.—1, G.B.—2, H.T., H.T.—1, H.T.—2, H.T.—3, H.T.—4 .. 1 2
  - 2 Belling-Lee spade terminals, marked: L.T., L.T.—1 .. 3
  - 1 Sheet aluminium foil, 16 in. by 10 in. .. 1 8
  - 1 Ready Radio fuse and holder .. 1 0
  - 1 Erie 20,000-ohm fixed resistance .. 1 0
  - 1 Erie 50,000-ohm fixed resistance .. 1 0
  - 1 Aluminium bracket .. 3
  - 6 Yards flex .. 4
  - 1 Special Direct Radio "159" cabinet, with Easyfix baseboard and panel drilled to specification .. 1 1 0
  - 6 Mullard valves: PM12 Met., 2 PM12V Met., 2 PM12L Met., 1 PM12A .. 4 0 0
  - 1 Calibrator Easy Station Finder (no charge) .. 2 2 0
- £12 2 0

## KIT MODEL No. 1

(Less Valves and Cabinet) £7:0:0

## KIT MODEL No. 2

With Valves less Cabinet £11:1:0

## KIT MODEL No. 3

With Valves and Cabinet £12:2:0

## KIT MODEL No. 4

(Complete kit as specified with "159" Consolette Cabinet, Valves, and Epoch Twentieth Century Moving Coil Speaker) £15:0:0

Or twelve monthly payments of £17/6

## "Century Super" Short-Wave Adaptor

Complete kit as specified, Price £3, can be purchased on easy terms if included with any "Century Super" Table Model or Radiogram Kit.

Terms: 5/6 per month extra on 12 monthly payments.

## RADIO GRAM

**KIT RG1** Full kit with all radio-gram accessories, as below but excluding valves and cabinet. Price £12:3:6

Or 12 monthly payments of £1 4 0

**KIT RG2** As RG1, but including valves, £16:4:6

Or 12 monthly payments of £1/10/0

**KIT RG3** As RG1, including valves and phone cabinet. Price £19:14:6

Or 12 monthly payments of £1/17/6

**RADIOGRAM ACCESSORIES**  
1 Collaro B.30 clockwork gramophone £ s. d. motor with turntable and automatic stop .. 1 13 0

1 Bowyer-Lowe A.E.D. Mark III gramophone pick-up .. 1 10 0

1 Bulgin radio-gramophone switch .. 1 9

1 Lewcos 50,000-ohm volume control potentiometer .. 3 0

1 Special "159" radio-gramophone cabinet .. 3 10 0

1 Belling-Lee wander plug, marked G.B.—3, 1 length of screened connecting wire and 1 yard thin flex (Lewcos flex) .. 9

1 Epoch Twentieth Century permanent-magnet moving-coil loud-speaker .. 1 15 0

1 Bulgin dual needle cup .. 2 6

## THE ETHER MUSIC TWO

**KIT No. 1** (less valves and cabinet) £3:6:6  
Or 10 monthly payments of 7/6.

**KIT No. 2** (with valves, less cabinet) £4:2:3  
Or 12 monthly payments of 7/6.

**KIT No. 3** with valves and cabinet £4:17:3  
Or 12 monthly payments of 9/-.

**KIT No. 4** (Complete kit with valves, "159" walnut consolette cabinet and R. & A. type 50 loud speaker chassis) £7:14:6  
Or 12 monthly payments of 14/6.

**OFFICIAL DEMONSTRATION**  
150 Borough High Street, London Bridge, S.E.1

"Amateur Wireless" in co-operation with Direct Radio, invite you to a demonstration of the "Century Super" constructed from Direct Radio guaranteed kits. Everyone who hears it is astounded. Before you definitely decide on any new receiver come to 159 Borough High Street and test the remarkable "Century Super" yourself.

## TEST IT FOR YOURSELF

# Direct Radio

159 BORO' HIGH STREET, S.E.1

## CASH, C.O.D. AND EASY PAYMENT EXPRESS ORDER FORM.

To DIRECT RADIO, LTD., 159 Borough High Street, London Bridge, S.E.1.

Please dispatch to me at once the following goods.....

for which (a) I enclose (cross out line) (b) I will pay on delivery (not applicable) £..... (c) I enclose first deposit of

NAME..... ADDRESS..... Amateur Wireless, 10/12/32

## ANY COMPONENT CAN BE SUPPLIED SEPARATELY

You will Help Yourself and Help Us by Mentioning "A.W." to Advertisers

TO CUSTOMERS OVERSEAS. We specialise in Radio for Export. Goods to your exact specification are very carefully packed and insured, all charges forward. Terms: Cash with order, or deposit one-third with order. Balance C.O.D. COMPLETE CATALOGUE OF ALL SETS, ACCESSORIES AND GADGETS PRICE 1/- POST FREE.



# OUR BROADCAST CRITIC ON

## A GREAT 'CELLIST



Paul Casals,  
the famous  
'cellist.

ONE might plagiarise a well-known advertisement in speaking of Paul Casals, thus: "P.C. Plus—plus *what?* Plus a little something most others haven't got," for Casals has got something denied most musicians. One supposes it to be a combination of perfect technique and temperament under perfect control. Those are the chief characteristics of what musicians call a virtuoso. What I have always liked about Casals is the complete absence of showmanship. His playing is nothing but pure tone and pure technique.

It would be hardly fair to omit mention of some other good 'cello-playing in that same concert. During Handel's overture to *Berenice*, Lauri Kennedy played really beautifully.

At last a press critic has noticed the out-of-tune playing of the wood-wind and brass sections of the B.B.C. Symphony Orchestra. The critic of an evening paper has pointed out a "tendency" that way. *Tendency, indeed!*

Now that somebody else has noticed it—I have been the only one for the last year or more—I have no hesitation in saying I was thoroughly disgusted on Wednesday night. The wind intonation was a disgrace to the B.B.C. I want to know why a thorough row is not being made about it.

The performance of Haydn's *Creation* appealed to me as being an attractive finish to the general programme for an evening.

At this point I should like to record my deep regret at the sudden death of Percy Pitt, who conducted that night. The impression he always created on me was that of a kindly man who possessed a vast amount of knowledge and who had a delightful way of imparting it. The B.B.C. loses a friend and counsellor.

Short plays—fifteen or twenty minutes—are suitable for broadcasting. I was very entertained with *The Fourth Man*, which in fifteen minutes proved an admirable working out of a simple theme. Three public school men meet in an hotel and recognise a former school-fellow in the hall porter. They decide to help him to something better, and produce a sum of money between them. They find he is earning £3,000 a year because two hundred people leave every day in this big hotel. They all tip him. A simple play, but very entertaining.

The Dreyfus "Postscript" interested me enormously. Had it only been a little

longer and had the Stranger (who turned out to be Dreyfus) been more closely characterised, this play would have been remarkable. Perhaps it was that, Dreyfus, in concealing his actual identity to the end (or nearly the end; one or two lines gave him away a little too early), concealed himself as a character. The adaptation was cleverly thought out. I admired the adaptor for his pluck in making an attempt to portray French sentiment over something in which we of this generation have never taken a deep interest however much our fathers were stirred by it. That play was concentrated history, and therefore had its value.

I listened with some pleasure to the third-act of Smetana's opera, *The Bartered Bride*, as performed by the Covent Garden Opera Company at the Theatre Royal, Halifax. There is a good deal of "tripe" in that opera—there is in a good many, for that matter—but it made a pleasant entertainment and was extraordinarily well performed.

Did you listen to "Songs You Cannot Buy"? I came to the conclusion that I did not want to buy any of them. I would not have taken any I heard as a gift.

### PROGRAMME POINTERS

*The performance of Haydn's "Creation" was so arranged that the broadcast occupied a few minutes over the hour. Most oratorios last much longer than that—the "Creation" itself is one of them. There are very few forms of serious broadcast that can safely extend over the period of one hour. Perhaps Shakespeare's plays are the only exceptions. Oratorios are not given frequently enough, in my opinion. They are not everyone's type of broadcast, but I feel certain that if suitably cut so that they last an hour they would make far more suitable broadcasting than if done in full. My pointer this week is that the B.B.C. should render a series of oratorios. I add a further suggestion. In the case of well-known works it might be a good plan to indicate in the programmes which movements are to be omitted even to giving the number of the page in the standard edition. Many people are still devoted to oratorio and possess scores. They would take advantage of foreknowledge of the intended cuts.*

Some of them were excellently sung, but that did not obviate the fact that the songs were "wishy-washy."

I was rather interested in the player-piano recital. As I expected, the transmission was satisfactory in every way. It is strange how anything mechanical comes through well by wireless.

I heard a group of songs that I thought well worth buying, but they were not in the show mentioned above. They were by Bernard van Diern and were sung by Megan Foster in the first of the new series of contemporary music concerts at Broadcasting House. By the way, keep an eye on these concerts; they look to me as though they are going to be worth hearing.

I hear very little midday music—probably no more than you do. However, I thought Ernest Parsons and his orchestra, broadcasting from Birmingham, quite worth hearing. Good for Brummagem!

I was disappointed to see that the B.B.C. had engaged Casals to conduct the orchestra on the Sunday evening following his broadcast in the symphony concert. Not that I think he is a bad conductor. On the other hand, he is known to be a very good one. That is not the point. I wanted to hear his 'cello again and so, I imagine, did everyone else. When we have a man like that over here who can play a 'cello (as probably nobody has ever played it in our lifetime), why not get him to play it as often as there is time for him to do so? *We cannot hear him conduct!* Silly, I call it.

The case of the supposed negligent driving was badly handled, in my view, by both counsel. They each dragged in a lot of dramatic nonsense which, unfortunately, is often dragged in during actual court cases. To quote a fifty-year-old law that nobody may legally raise his hand to stop a vehicle unless he be a policeman is sheer nonsense. It may still be a legal fact because nothing has been done to amend the law, but we all do it when necessary. The case was interesting in some respects. Obviously it was an instance of bad driving if true that there was a little space on the left side of the car. Latham could have driven on without hitting Curlew. Legally, I imagine Latham should get off. Even so, if he had a shred of humanity about him he would have offered to compensate the other man.

WHITAKER-WILSON.

# THE NEW A.C. CENTURY SUPER



The "A.C. New Century Super" is shown here complete. It makes a handsome receiver

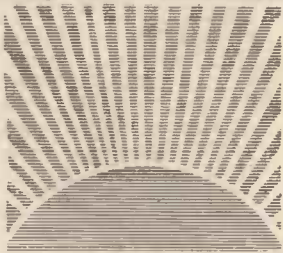

**T**HE mains apparatus is mounted upon a small board and forms a self-contained unit ready to be connected to the receiver and accommodated in the base.

There is first a set of fuses to which the flexible lead from the lighting or power point is joined on one side and the primary of the mains transformer on the other.

It is necessary to connect the fuses to the terminals marked with the voltage of the A.C. supply and a further point is that a special transformer is needed if the frequency is, say, 25 cycles instead of 50.

The power transformer has three windings as well as the primary or input. One of the windings is connected to the heater of the rectifying valve. Another will presently be joined to the heaters of the valves in the set, while the third winding supplies the high-tension to the anodes of the valves.

## RECTIFICATION

Be sure and notice these different windings; the set will not work properly if, for example, the two heater windings by mistake are reversed. This transformer has to handle a fair amount of power and a good make must be used. After the transformer comes the rectifying valve. A full-wave valve is used, and so the high-tension winding of the transformer used to supply it has two parts, or, put in another way, the high-tension winding is centre-tapped.

A small filter condenser is used to stop high-frequency currents from the mains side passing to the set. This condenser must be capable of withstanding a high voltage; therefore do not use one that you may happen to have unless you are sure it will carry the voltage without breaking down.

The other parts used comprise the filter, which turns the pulses of current from the rectifier into a steady uniform current. There are three parts in the filter. There is first a 4-microfarad condenser which is connected across the output from the rectifier.

Then comes the smoothing choke and finally there is another 4-microfarad condenser across the output. The efficiency of the

smoothing depends upon the values of the condensers and the inductance of the choke. If you use a cheap choke having a small inductance when carrying the load current then the smoothing will be poor. The set will probably also hum. A good choke must be used and will, with the pair of condensers, so smooth the supply to the high-tension circuits that there will be absolutely no hum from this source.

The parts should be arranged as shown in the illustrations. This is quite an easy job, and so is the wiring, but personally I always take particular care of the wiring of a mains unit. The voltages are fairly high, so use a good quality of systoflex and arrange the wiring neatly.

It is better not to allow the wiring to touch metal parts such as the case of a condenser, which may be earthed or the core of the choke, as if the insulation should give way there may be a short-circuit. Never run this unit by itself. If you do the voltage developed across the condensers will greatly exceed the normal working pressure and this extra strain does no good.

## TESTING

A pair of good thick leads must be used from the 4-volt 6-ampere winding. Six amperes is a fairly heavy current and thin leads would get hot and drop the voltage applied to the heaters of the valves in the set. If you should notice the connecting wires becoming warm they should be taken out and thicker ones put in or else instead of using two wires two pairs of wires should be connected.

You can hardly test the mains apparatus by itself. The best test is to use it with



The receiver portion of the "A.C. New Century Super" which was fully described in last week's issue

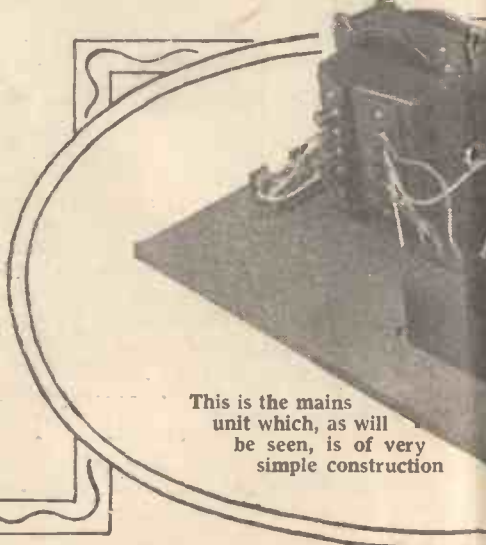

This is the mains unit which, as will be seen, is of very simple construction

**CONSTRUCTIONAL DETAILS OF THIS REMARKABLE SET WERE GIVEN IN LAST WEEK'S ISSUE. IN THIS ARTICLE W. JAMES DESCRIBES THE MAINS UNIT AND GIVES SOME INFORMATION ON USING THE RECEIVER,**

the set and then if necessary to measure the voltages. The unit is so easily constructed that a fault is not likely, but be very careful to check over the wiring. Never forget

I refer to the grid leads going to the radio-gramophone switch in the circuit of the second detector. These two wires pass from the grid circuit to the switch fitted on the back of the set.

There are bound to be a number of people who think that we should have taken advantage of the fairly heavy current taken by the set to make use of an energised type of speaker, and use the field winding as a smoothing choke. What is not generally realised, however, is the fact that the D.C. resistance of the field winding of an energised speaker supplied for the purpose is seldom less than 2,000 ohms. This means that when a current of 50 milliamperes is passing through the field coil, there will be a voltage drop of about 100 volts in this coil. Thus, with a maximum voltage of 250 volts delivered by the rectifier, only 150 will be available for feeding the valves in the set. This will cause loss of efficiency and power. True, we could get over this trouble by using a rectifying system which would deliver 350 volts at 50 milliamperes, but the extra expense incurred by this change would be far greater than the cost of the smoothing choke used in the set.

As they are rather long the wires are shielded, a piece of shielded systoflex being fitted over the actual connecting wires. The metal covering of the systoflex is joined to the earth.

It is necessary to wire the set in a logical manner and the wires shown in the diagram on page 1248 of last week's issue or in the full-size blueprint are numbered.

Follow the numbers carefully. The holes in the baseboard for wires should have been made

**THE HUM PROBLEM**

Another point against using a speaker

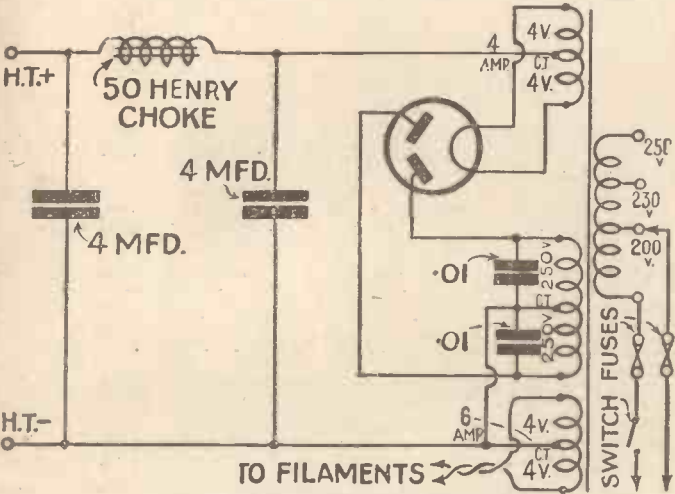

The theoretical circuit of the Mains Unit

when it is working that the voltages are relatively high and do not meddle with it. Always cut the power off by taking the mains plug out of the power point.

Now although the power unit is designed to supply ripple-free current to the anode circuits it is still possible for the output to have a background of hum if the set itself is wired carelessly.

If the wiring is properly carried out there will be no hum. The parts of the set must be so arranged on the baseboard that the correct wiring is easily put in. Thus the heater wiring, always dangerous from the point of view of hum, is carried beneath the baseboard and trouble is therefore definitely cut out.

**GRAMO-RADIO SWITCH**

The important wires are necessarily short because of the placing of the parts, with one exception. This can hardly be avoided.

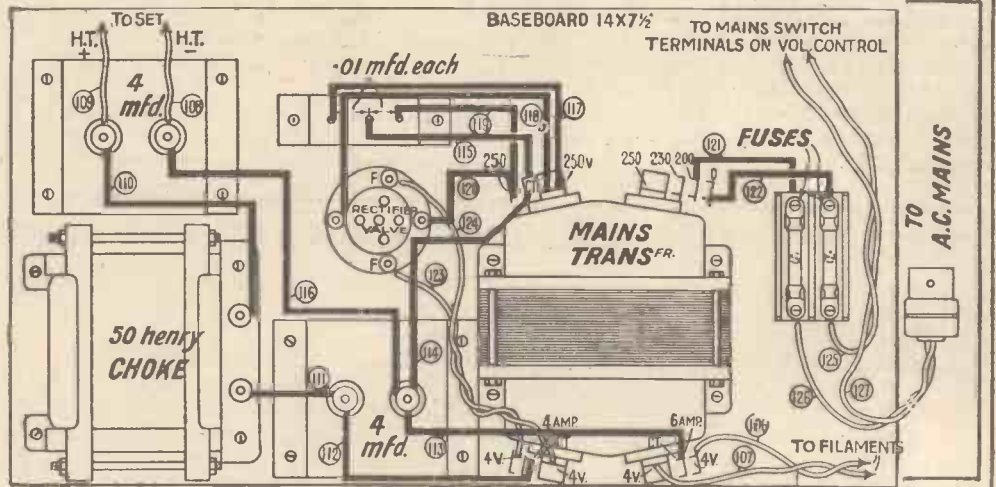

The mains unit is, of course, accessory to the actual receiver, and above is the layout and wiring diagram

before the wiring was started; make the holes of ample size. A point to be noted, as this is where a mistake is sometimes made, is that the right resistance values are connected.

In a circuit of this type where the bias for the valves is obtained from suitable resistances joined to the valves it is obviously essential to have the right values.

**THE SET AND THE SPEAKER**

The moving-coil loud-speaker used with this set must have a suitable transformer. Most types have a "pentode" transformer fitted to them. A permanent-magnet type is recommended unless you have already a field-magnet type and the means for supplying it with power.

winding as the sole smoothing choke of an all-mains set is that hum is very seldom entirely eliminated. The trouble seems to be due to inductance. The ripple voltage which from the mains is flowing in the field winding induces a hum in the actual moving-coil of the speaker which is present in the reproduction whether a station is being received or not and this state of affairs is very unpleasant. Some moving-coil speakers now fit a small "hum-bucking" coil which tends to get over this difficulty, but really hum-free reception is difficult to obtain unless a small choke and condenser is used between the rectifier and the field winding.

Thus, after some consideration, it was deemed best to employ a permanent-

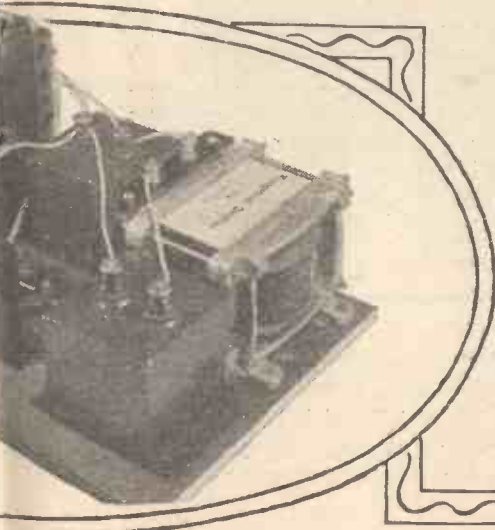

**"THE 'A.C. NEW CENTURY SUPER'"—(Continued from preceding page)**

magnet type of moving-coil speaker in the set.

The permanent-magnet type is connected by a pair of leads from the loud-speaker terminals on the set to the loud-speaker. The power wires are connected as shown in the illustration. There are two wires for the heater circuit and two for high-tension

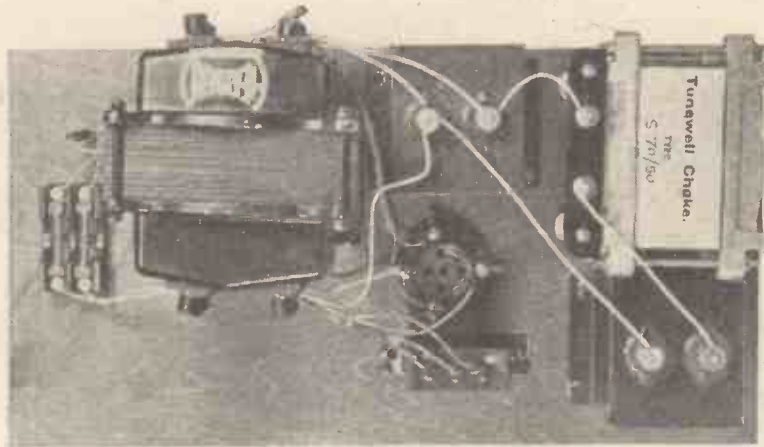

This plan view shows the arrangement of the few parts required to build the "New Century Super" Mains Unit

positive and negative. The valves recommended are a Mazda AC/SG for the first detector, a Mullard 904V for the oscillator, two Mullard VM4V valves (multi-mu screen-grid) for the intermediate-frequency stages, a Mullard 904V for the second detector, and a Mullard Pen 4V for the pentode output stage.

Turn the volume control to practically full on and tune to the local station. Then reduce the volume until the strength is fairly weak. Now the tuning controls can be accurately set.

You will find it is necessary to use the trimming controls as well as the main tuning control of the two-gang condenser, but it is usually not necessary to adjust the back trimming condenser provided it has been unscrewed.

Starting from this point, tuning will be found very easy as the set has plenty of magnification. The quality is excellent and I believe that all worth-while stations will be found to be within range.

I have brought in a large number of stations, clearly and with good quality.

**NEXT WEEK :**  
**A FINE FOUR-VALVER**  
**FOR 65/-**

**TWO-SPEAKER SETS**

THERE is a distinct movement in America towards the use of two separate speakers coupled to the same receiver. At first sight this seems to be rather a costly expedient, but the results are said to more than justify the extra expense, especially when quality is the first consideration. Each speaker is fed through a separate filter circuit, so that one instrument handles only the low notes and the other the high notes. Actually a third speaker may be added to cover the middle ranges. Since each speaker has only to handle a comparatively narrow band of frequencies, it can be made cheaply. In

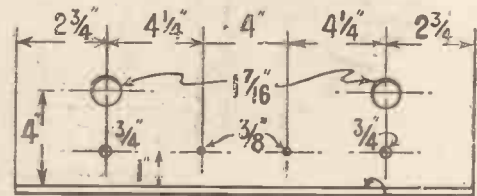

**TOP OF BASEBOARD**

This dimensional diagram shows the positions of the receiver controls on the front of the cabinet

fact, the cost of two such instruments need be little more than that of one high-grade model having a wide frequency response. The great advantage of the "dual speaker" set is that each speaker can be separately adjusted, as required, to secure any desired balance of tone. M. A. L.

**THE PARTS USED IN THE "A.C. NEW CENTURY SUPER"**

**VARIABLE CONDENSERS**

- 1—Twin-gang .0005-microfarad (J.B. Unitune 2 type D, or British Radiophone, Polar, Utility).
- 1—Single .0005-microfarad (J.B. Nugang, type A1, or Polar, Utility).

**COILS**

- 3—Super-het intermediate with pigtail (Wearite, type OT2).
- 1—Ganged oscillator and bandpass (Lissen).

**TRANSFORMERS**

- 1—Low-frequency (Varley Nicore 11, Telsen, Lissen, Lotus, Slektun, Bulgin, Igranic, Ferranti, Goltone, Tunewell, Formo).
- 1—Mains (Heyberd, type 717, R.I., Tunewell).

**CHOKE**

- 1—H.F. (Slektun super-het, Lotus or Ready Radio, Climax, Graham-Farish, Tunewell, Wearite, Telsen, Goltone, Lissen).
- 1—Smoothing (Tunewell, type S30/50, Heyberd, Wearite, R.I., Igranic, Varley).

**PRESET CONDENSER**

- 1—.0003-microfarad maximum (Sovereign, Lissen, Formo; Telsen, Varley, Igranic, Tunewell).

**FIXED CONDENSERS**

- 1—.2 centre-tapped (Dubilier, type BE31).
- 8—1-microfarad (Dubilier, type 9200).
- 2—2-microfarad (Dubilier, type 9200).
- 1—.02-microfarad (Dubilier, type 9200).
- 2—.0001-microfarad, one .0005-microfarad, one .002-microfarad, (Lissen, Dubilier, T.C.C., Telsen, Goltone, Sovereign, Graham-Farish, Franklin).
- 2—4-microfarad fixed condensers, 800 volts test (Dubilier, type LSB, Ferranti, Telsen, T.C.C., Peak).
- 2—1-megohm grid leaks (Eric, Graham-Farish, Lissen, Dubilier).

**VOLUME CONTROL**

- 1—10,000-ohm potentiometer and combined switch (Bulgin, type VS32).

**tone corrector**

- 1—Telsen Pentode tone corrector.

**VALVE HOLDERS**

- 4—4-pin and six 5-pin (Telsen, Lissen, Lotus, W.B., Goltone, Bulgin, Ready Radio, Lotus).

**TERMINALS**

- 6—Marked Aerial, Earth, L.S.+, L.S.—, 2 pick-up (Belling-Lee, Clix, Eelox).

**RESISTANCES**

- 2—50,000, one 40,000, four 20,000, two 5,000, one 600, two 400, one 200-ohm fixed (Graham-Farish, "Ohmite," Lissen, Eric, Telsen; Dubilier, Tunewell).

**RESISTANCE HOLDERS**

- 5—Vertical (Graham-Farish).

**SUNDRIES**

- 1—Gramo-radio changeover switch (Ready, Radio, Bulgin, Tunewell).
- Connecting wire and sleeving (Lewcos or Jifilinox).
- 1—Aluminium bracket (Peto-Scott).
- 1—Piece of aluminium foil 18 in. by 12 in. (Peto-Scott).
- 6—Yards thin flex (Lewcoflex).
- 1—Twin fuse holder and fuses (Bulgin, type F.9, Belling Lee).
- Baseboard for set, 18 in. by 12 in., baseboard for mains unit, 14 in. by 8 in. (Osborn, Peto-Scott).

**ACCESSORIES.**

- Valves (one Mazda AC/SG, two Mullard 2VM4V, two Mullard 904V, one Mullard Pen4V, one Mullard DW2).
- Loud-speaker (W.B., type PM4, Rola, Sonochorde, Epoch, Baker, Celestion, Igranic).
- Cabinet (Stenbac 814).

There is a DW2 full-wave rectifying valve for the power unit. Place the valves in their holders and connect the pigtail ends from the coil units. Put the switch at the back of the set to the radio position. With the aerial and earth joined switch the set on.

A new edition of "Nine-Thirty Novelties" will be given on December 21. The idea is to show English life in the age of super-machines fifty years hence.

The Dutch pianist, Judith de Leeuw, will give a Liszt recital for Midland Regional listeners on December 24. An-

other Christmas Eve item will be a programme of thirteen carols, old and new, by the Midland Studio Chorus.

"Etc. . . . Etc. . . ." a miscellany consisting of "one inconsequential thing after another," is to be broadcast to the Midland region on December 23.

**High  
Tension  
Current for  
1<sup>p</sup> A  
2 WEEK**



**YOURS  
for  
5/-  
DOWN**

**4 MODELS TO SATISFY  
REQUIREMENTS OF ANY SET**

Large smoothing chokes—big condensers—no chance of motor-boating. Decoupling arrangements incorporated in every eliminator—you connect the Lissen Eliminator almost as you would an H.T. battery. Everything has been thought out for you—you simply put the eliminator in. Lissen have made eliminators safe by totally enclosing all the current-carrying parts in high-grade insulating material—see also the thickly insulated “cab-tyre” flex.

From the four types of Lissen Eliminators mentioned on this page you can choose one which exactly suits your set. The type you want is easy to choose. Your dealer will help you, or write direct to factory.

Every Lissen Eliminator is available for a small initial payment and easy gradual purchase terms.

**D.C. MODEL “A”**

100/110, or 200/250 volts. Cash price 27/6. Or 5/- down and 5 monthly payments of 5/6.

**A.C. MODEL “A”**

100/110, or 200/250 volts. Cash price 60/-. Or 5/- down and 10 monthly payments of 6/6.

**D.C. MODEL “B”**

100/110, or 200/250 volts. Cash price 39/6. Or 5/- down and 8 monthly payments of 5/-

**A.C. MODEL “B”**

100/110, or 200/250 volts. Cash price 75/-. Or 5/- down and 10 monthly payments of 8/-

That's all your H.T. current costs from this Lissen H.T. Power Unit

Low first cost is practically your only outlay because the cost of running a lissen Eliminator is so small that your meter will hardly register the current it takes. No current from any eliminator is smoother or more silent than the current of a Lissen Eliminator. No eliminator output is more constant, none is so free from hum. Every Lissen Eliminator will deliver 20 m/A OUTPUT IN PERPETUITY—sufficient H.T. current to feed the largest receiver, with the biggest power valves you are ever likely to use.

**LISSEN**

**AC HIGH TENSION DC  
POWER UNIT**

Please Mention “A.W.” When Corresponding with Advertisers

# HOW TO BUILD THE

# LISSEN



**ABSORBINGLY INTERESTING**  
**AMAZINGLY EASY TO BUILD!**

**GREAT LISSEN CONSTRUCTIONAL**

## CHART

**TELLS YOU EXACTLY WHAT TO DO WITH EVERY SINGLE NUT AND SCREW**



**KIT COMPLETE WITH VALVES 89/6**



Please send me **FREE** copy of your 1<sup>st</sup> Skyscraper Chart.

NAME.....

ADDRESS.....

.....

.....

.....

.....

.....

.....

.....

.....

.....

.....

.....

.....

.....

.....

.....

## Metallised S.G. Economy

Why be satisfied with whispering foreign stations when you can **BUILD WITH YOUR OWN HANDS** this LISSEN SKYSCRAPER that will bring in loudly and clearly distant stations in a profusion that will add largely to your enjoyment of radio?

You can get the Lissen Skyscraper Chart **FREE** from any radio dealer, or by posting the **COUPON** on left direct to factory.

*Mention of "Amateur Wireless" to Advertisers will Ensure Prompt Attention*

# SKYSCRAPER

**The only Kit with such  
HIGH POWER VALVES**

**70 LOUDSPEAKER  
STATIONS**



Lissen have published a 1/- Constructional Chart, giving the most detailed instructions ever printed for the building of a wireless set. You can't go wrong—every part, every wire, every terminal is identified by photographs. Everybody, without any technical knowledge or skill, can safely and with COMPLETE CERTAINTY OF SUCCESS undertake to build this most modern of radio receivers from the instructions given and the parts Lissen have supplied.

This new Lissen SKYSCRAPER Kit set is the only one on the market that you can build yourself employing a Metallised Screened Grid Valve, High-Mu Detector and Economy Power Pentode. Around these three valves Lissen have designed a home constructor's kit the equal of which has never been before.



**GREATEST SET EVER BUILT!**

## *High-Mu Detector and Power Pentode Valves.*

To-day you can buy the LISSEN SKYSCRAPER KIT on Gradual Payment Terms.

Skyscraper Chassis Kit, complete with Valves,  
CASH PRICE 89/6. Or 8/6 down and twelve  
monthly payments of 7/6.

Skyscraper Kit complete with Walnut Cabinet  
and inbuilt Loudspeaker, as illustrated, £6 5s.  
CASH. Or 11/6 down and twelve monthly  
payments of 10/6.

**LISSEN SKYSCRAPER KIT 3**

Please Mention "A.W." When Corresponding with Advertisers

# What Our Readers Think



## A Coil Problem

**SIR**,—In your issue of November 26 you state, in the "50 Hints for Good Reception," that if two ganged coil switches do not open and close together—that is one coil on long and the other on medium waves—poor reception will be experienced.

I made up the "1931 Ether Searcher" and entered it in your competition. I was fortunate enough to obtain a prize of £1. While ganging the set before entering it, I found that the switch was not working correctly. I was using Colvern coils, two TGSC and one TGSR. The switches on the TGSC's did not close, and I found that I obtained more volume and better selectivity than when they did. Thereupon I scrapped the switches and used an ordinary on-off filament switch on the TGSR coil. Thus, two coils are permanently on long waves and only one coil is changing.

This is contrary to expectation. The coils may have been inadvertently wound wrongly, but even so, according to my tests, the set should not behave as it does.

I think AMATEUR WIRELESS is the finest radio weekly, giving its knowledge in an understandable way. E. T. (Salford).

## A Curiosity

**SIR**,—I don't know if this letter will interest you or not. I hope it will.

I have a straight three-valve set, consisting of two L.F. stages and power. For the first stage I use an L.F. valve, then detector and power. Part of the circuit is my own, the rest is taken from other sets.

On the medium waves I can get no lower than 288 metres. On the long, just past Huizen. For a long time I have tried to get Fécamp, without success. This last month I altered my circuit a little more, with the result that when I put the detector valve in the first stage and the L.F. valve in the second stage this is what happened. When the detector valve was in the first stage and the coil switched to long waves it automatically cut the long waves completely out and brought in stations below 261 metres.

Radio Fécamp now comes in at 89 on my dial, so you can see how low I can get down.

I know this may seem perfectly ridiculous to you getting Fécamp when the set is set for long waves, but it is possible.

Several friends have told me it's madness to even suggest the thing, but when they came and heard it they changed their tune.

W. T. (Stafford).

*The Editor does not necessarily agree with the views expressed by readers and does not accept responsibility for the letters published. Letters cannot be published which do not bear the sender's full name and address*



## Mains Transformers

**SIR**,—In connection with mains transformers I think some of your readers would be interested to know of the arrangement which I use to protect the primary winding from the destructive effect of the inductive "flick" when switching off and which is the cause of breakdowns occasionally. I use two ordinary lamps connected in series and connect the primary across one of them, using a tapping equivalent to a mains voltage of half the actual supply being used. I use a 40-watt lamp together with a 30-watt lamp and connect the primary across the 30-watt lamp. The lamps, of course, light up at about half usual brilliancy.

The advantage is that the 30-watt lamp provides a resistance through which the inductive surge can dissipate itself. Also the arrangement limits the current in the event of short circuits on the secondary windings and would no doubt prevent a dangerous burn out. The two lamps can carry quite enough current to feed the average 3-valve set, but, of course, are adjustable in value for any load. Also, it would be possible to utilise the light from the lamps in a number of ways, although in my case they are just accommodated inside the set. I am aware that most mains transformers have not a centre tapping on the primary winding, but hope the matter may be of interest to those readers who may be able to try out the arrangement.

With best wishes for the continued success of your excellent journal.

A. H. S. (London, N.W.).

## Frequency Curves Wanted

**SIR**,—I have looked through the various advertisements of moving-coil speakers advertised in this week's very interesting AMATEUR WIRELESS. In each case the range of frequencies is not given. Why is this? For to me this is, apart from one's opinion on tone, the true test. A moving-coil speaker that could not give from, say, 40 to 8,000 frequencies would not interest me a moment, for I have an amateur-wound speaker that successfully passed the B.B.C. test which was from 50 to 6,000. The 50 was a beautifully strong note, the 6,000 just audible. Many listeners must now know from that interesting test the range of their speakers. It seems strange to me the range of frequencies are not given by the various makers of moving-coil speakers.

W. C. Y. (London, S.W.).

The Editor invites letters from readers on all interesting radio subjects. For the most interesting letter published each week a general-purpose valve or other component to the same value will be given.

## A Suggestion

**SIR**,—As an interested reader of AMATEUR WIRELESS, I was wondering if this would be of interest. A short while ago I purchased a kit set of well-known make and I find that half of the components, such as grid leak, fixed condenser, etc., bear their value, but no manufacturer's name. Now, as a set is tested and tried and found to work with a special make of component, would it not be better if the makers would include a short list in their set so that one could go straight to a dealer and ask for it by name and so be sure of replacing a worn part by the exact component that was in at the beginning, instead of the same value made by another manufacturer.

J. M. (Darwen).

## Daylight Reception

**SIR**,—I am daily noting times and atmospheric conditions on which I obtain "local station" results on medium waves in daylight. One hears so much about daylight reception on medium waves that personal observations are essential. My set is the 1931 "Century Super," a modified aerial (indoor) being employed and it is A.C. mains. It yields excellent results and the tone and power are all I need. Now, my daylight hours are 9 a.m. to 9.30 a.m. and 2.30 to 3 p.m. This morning in bright sunshine, following a hail storm, Prague had a delightful programme by a military band—quality excellent. Volume ample (loud-speaker). Of course, no fading. Yesterday, November 22, between 2.30 and 3 p.m. I had at good loud-speaker strength and without fading or distortion Prague, Langenberg, Katowice, Leipsig, Stuttgart, Breslau, Brno (from 2.40 to 2.55 p.m.) wonderfully. Hilversum, Heilsberg and several others I passed by. On the 18th ult. at 2.50 p.m. Barcelona was coming in at wonderful volume. It is interesting to note that the position of the sun and also temperature have decided effects on daylight reception and fading on medium waves. Other listeners' logs and times and dates would be interesting.

E. G. (Wirral).

## Why?



**SIR**,—Why do valve manufacturers persist in stamping the type of the valve on the top of the bulb? This is, in my opinion, an unsatisfactory procedure, particularly when one is frequently changing the valves. This tends to obliterate the stamping and thus it becomes impossible to decipher the name.

This is overcome by the use of a seal affixed to the bulb. As far as I know this is adopted by only one firm, namely A. C. Cossor, Ltd. If other firms would follow their example less inconvenience would be experienced. G. R. R. (London, S.E.).





# Is your Christmas list complete?

When you've purchased  the turkey,  
 the  nuts,  crackers & cordials,   
 bought the son's car,  & the daughter  
 a house,  collected your array  
 of trifles for friends & relations 

Buy yourself a **LISSEN BATTERY** 

and make sure your radio is right for Christmas



# LISSEN H.T. BATTERY



*Mention of "Amateur Wireless" to Advertisers will Ensure Prompt Attention*

## SETS OF THE SEASON



# CLIMAX BALANCED BAND-PASS 3

LOOKING at the circuit diagram of the Climax set I find a well-designed band-pass aerial tuning system preceding a high-magnification screen-grid valve. This is coupled to the detector valve by an improved form of tuned-anode circuit.

The aerial input to the band-pass is controlled by a variable condenser in the aerial lead and this component is for volume and selectivity variation.

Reaction is applied to the tuned-anode coil from the detector anode circuit. The detector is coupled to the pentode output valve by the popular resistance-fed transformer arrangement.

To cut down the high-note accentuation of the pentode a resistance is inserted in the lead from the transformer to the grid of the pentode, which is transformer coupled to the moving-coil loud-speaker.

The power supply is derived from the A.C. mains by means of a mains transformer and a double-wave rectifying valve. All three valves in the set are indirectly-heated from a secondary on the mains transformer, and are biased by cathode resistances.

### BRIEF SPECIFICATION

**Makers:** Climax Radio Electric Co., Ltd.

**Price:** 16 guineas.

**Valve Combination:** Screen-grid (Mazda AC/SG), detector (Mazda AC/HL), pentode output (Mazda AC/Pen), and mains rectifier (Mazda UU120/350).

**Power Supply:** A.C. mains, 200 to 250 volts, 50 cycles.

**Type:** Table-cabinet set with self-contained moving-coil loud-speaker and mains-aerial attachment.

**Remarks:** An exceptionally selective set very suitable for use near regional broadcasting stations.

All told an excellent circuit, devoid of snags and full of possibilities for good reception, which the makers have exploited to the full.

For example, the three tuned circuits are ganged with a three-gang condenser. Tuning control is therefore one knob. There are no panel trimmers.

Selectivity of the highest possible order with three valves is ensured by the band-pass aerial tuning. The feature is further emphasised by the makers' sensible

inclusion of reaction and aerial-input controls.

Referring to my notes made at the time of the tests I see that I was pleased with the square-shaped cabinet, with its two sides designed for easy transport. The cabinet layout is conventional, with speaker at the top and set chassis below.

### Well-designed Controls

Controls are arranged in line along the bottom, with selectivity control fitted into the left-hand side of the cabinet. The tuning arrangement is outstandingly clear.

It is, of course, an illuminated scale. There are four distinct divisions on the scale. Medium-wave stations are marked at the top and just below are medium wavelengths marked in black in steps of 50 metres. Under these are long wavelengths in red in steps of 100 metres, and at the bottom long-wave stations.

As the tuning knob rotates the moving plates of the gang condenser the scale moves also, and the names and wavelengths of stations appear in turn before a small aperture at the top of the escutcheon.

Great accuracy has been achieved in the wavelength and station markings on this set, presumably due to the band-pass tuning, which effectively prevents the aerial capacity affecting the readings.

The two other knobs on the front are for reaction on the right and a combination wave-change, mains on-off and gramophone switch on the left.

### Excellent Selectivity

Tests soon showed the value of the inclusion of the aerial input control in this set. I got selectivity far above the average for a three-valve set simply by reducing the aerial input and making up the strength with the reaction.

Muhlacker, for example, was tuned in sufficiently clear of London Regional to drown the local station's signals. Foreign stations two channels away from both the London stations were heard at good volume absolutely clear of interference.

These results, which are remarkable, were easily obtained by reducing the setting of the aerial input condenser knob almost to minimum and increasing reaction to maximum.

This is a very easy set to control. Reaction is particularly sweet. It is smooth in action and builds up the strength of foreigners very considerably.

There is a mains-aerial device. On this I got 20 stations on the medium waves at really fine strength and excellent quality.

Talking of the mains reminds me that

this set is fitted with a "safety" back. You cannot take off the back of the cabinet, or rather lift it up, as it is hinged, unless the mains plug is removed from the socket on the set. The adjustment for mains voltage is very conveniently fitted.

There is provision for a pick-up and you can add an external loud-speaker. The self-contained loud-speaker gives plenty of punch without any trace of rattling. Bass reproduction is not pronounced, but the overall tone is pleasing. Speech is clean cut and music has a good "attack."

A practical point is the engraving on ivory tablets on the back of the set of the instructions for working the various controls

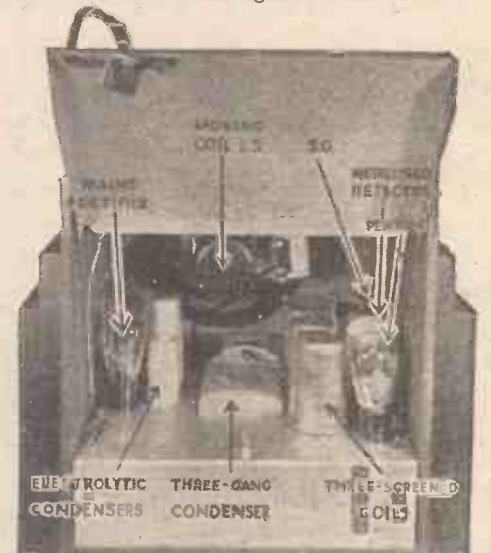

This photograph shows the main features of the Climax set which is built upon modern lines

and for connecting up with the various sockets for aerial, earth and other externals.  
SET TESTER.

### PIEZO PICK-UPS

A PIEZO-ELECTRIC crystal will develop an E.M.F. in response to applied mechanical pressure, or vice versa. The latter property, namely, that of developing mechanical pressure under the action of an applied E.M.F. has already been utilised to produce a piezo-electric loud-speaker, the output from the set being applied to a crystal of Rochelle salt. A still later development is the piezo-electric pick-up in which the mechanical movements of the gramophone needle are converted by the crystal into electrical variations for the grid of the low-frequency amplifier. It is claimed that the new crystal pick-up will deliver an output up to 5 volts. M. B.

# THE S.T. 400—AND TWO FAMOUS THREES

You must build  
One of these sets

## S.T. 400

Complete Kit,

**£4:17:6**

Or deposit of 9/6 and 11 monthly payments of 9/9

### MODEL A

Complete Kit, with four specified valves and beautiful walnut cabinet fitted with moving-coil speaker, £10 . 10 . 0

Or deposit of 20/- and 11 monthly payments of 21/-

### MODEL B

Complete Kit, with four specified valves, £6 . 16 . 9

Or deposit of 12/6 and 11 monthly payments of 13/9



Obtainable from all leading Radio Dealers. In case of difficulty order direct.

## Over 100 STATIONS!

The new four-valve set which will give you over one hundred programmes—more than fifty at "local" strength. Amazing selectivity and sensitivity; wonderful-fascinating to build and operate. You must build it. Insist on the Ready Radio Authorised Kit as approved by Mr. John Scott Taggart, A.M.I.E.E., F.Inst.P.

Full-size blueprint and copy of *Wireless Constructor* and helpful instructions by Mr. G. P. Kendall, free with every kit.

## "THREE-O-THREE"

Complete Kit,

**£2:7:3**

Or deposit of 9/6 and 5 monthly payments of 9/-

### MODEL A

Complete Kit, with set of three Mullard valves and beautiful walnut cabinet fitted with permanent magnet moving-coil speaker, £6 . 17 . 6

Or 10 monthly payments of 16/-

### MODEL B

Complete Kit, with set of three Mullard valves, £3 . 10 . 0

Or 7 monthly payments of 11/9



## "METEOR S.G. 3"

Complete Kit,

**£3:15:3**

Or 9 monthly payments of 9/9

### MODEL A

Complete Kit, with set of three Mullard valves and beautiful walnut cabinet fitted with permanent magnet moving-coil speaker, £8 . 17 . 6

Or 12 monthly payments of 17/-

### MODEL B

Complete Kit, with set of three Mullard valves (metalised screened grid, detector, and power), £5 . 7 . 6

Or 10 monthly payments of 12/6. (A pentode may be used if desired, 8/9 extra.)



## BUILT IN TWENTY MINUTES

The most efficient type of detector-two L.F. set. Remarkably selective and sensitive, giving an excellent choice of home and foreign programmes with superb moving-coil quality. Incorporates the unique Ready Radio dual-range coil, fitted with four-in-one control (on-off, wave-change, selectivity, and volume control all operated by one knob). Only five components to mount and five wires to connect—you will build it in twenty minutes.

Full instructions, diagrams, and photo-plans with every kit.

## SUPER SCREENED GRID SELECTIVITY

The only kit set to give you all the wonderful features of the S.T.300 plus the additional advantage of ultra-short-wave reception of stations in all parts of the world. Super-sharp selectivity; huge volume; a minimum of thirty stations guaranteed. Moving-coil reproduction.

Very easy to build. Full instructions, diagrams, and photo-plans with every kit.

# READY RADIO

To READY RADIO (Book Dept.), Eastnor House, Blackheath, S.E.3.

Please send me full details of your Kits and tell me about your Registered Users' Scheme. I enclose 1½d. stamp to cover postage.

NAME .....

ADDRESS .....

A.W.17



A weekly review of new components and tests of apparatus conducted by J. H. Reyner, B.Sc., A.M.I.E.E.

**NEW BECKER SWITCH**

WE have previously reported in these columns on the Becker quick make-and-break switches. A recent addition to this range is the Kitswitch which has just been introduced. As the name implies, this is intended for use in kit sets, more specifically for those employing an aluminium panel.

The construction of the switch is identical to the ordinary form, except that an insu-



Becker Kitswitch—a useful mains switch for metal-panel mounting

lated sleeve is provided over the operating lever, while in addition a bakelite escutcheon plate is provided engraved with the words "Off" and "On." In this way, no metal parts project through the panel at all and the switch is quite safe in operation.

The switch itself is of the customary standard type rated to control 5 amperes at 250 volts. We found, as in our previous tests, that the switch was well up to its job.

**PHIX CONNECTORS**

SOME interesting connectors which we have received for review are those known under the name of "Phix." These connectors are of the totally shrouded type, the actual connecting surface being in the form of a split and hollow plug, thus permitting a variety of uses. The interesting point in the design of these is that the connecting plug is shrouded by means of a spring-controlled skirt. Thus when the connector is in position the skirt is pushed up into the head, but immediately the connector is removed, the skirt is returned to normal under the action of the spring, and completely shrouds the connecting surface.

The external wires are fixed to the connectors by means of small set screws in the normal way. The insulating material employed is that known as "erinoid," and it may be obtained in various colours. These connectors are retailed at 2½d. each and are manufactured by Messrs. P.

Marks, 6 Garlinge Road, Brondesbury, N.W.

**SERADEX RESISTANCES**

THERE is still a very large number of people whose electric supply is of the direct-current variety. This is now not such a serious drawback as it used to be, as several good makes of D.C. valves are available. We have received for test a breaking-down resistance for D.C. receivers employing the special D.C. valves having ¼-ampere heaters. This resistance, which is made under the name of "Seradex," has an overall resistance of 744 ohms and is rated to carry 250 milliamps. continuously without serious over-heating.

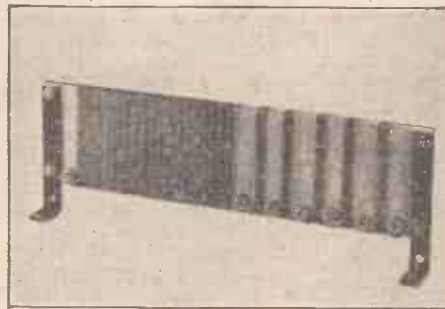

One of the range of Seradex resistances

It is wound on a rectangular slab of heat-resisting insulating material and is tapped at five places, giving a range of resistance from approximately 550 ohms up to the maximum value as above.

This resistance is suitable for use in receivers operating from 200 to 250 volts supply.

**European Broadcasters**

**BRESLAU**

325 metres (923 kilocycles), 60 kilowatts. 743 miles from London. Relayed by Gleiwitz. Transmits at intervals from



5.15 a.m. Announcements in German, the abbreviated call being "Achtung! Hier Breslau." Metronome sometimes given as interval signal.

**W.B. SPEAKER**

AN interesting moving-coil loud-speaker which we have tested this week is the W.B. Mansfield Senior Model manufactured by the Whiteley Electrical Radio Co., Ltd. This speaker employs a special built-up magnetic system which it is claimed allows a very high flux density to be obtained with very little leakage field. Readers will recall that a detailed description of this magnetic system was given recently in "A.W."

On to the base of this magnetic system is bolted a normal type cone chassis from which is suspended the diaphragm. This latter is of the one-piece type having no separate suspension; the diameter being approximately 6 in. The moving coil itself is of the low-resistance type, the necessary input transformer being mounted on the speaker. This transformer is of the multi-ratio type and enables the speaker to be



W.B. Mansfield moving-coil speaker

used satisfactorily with all types of output valve, including pentodes.

The centering device employed is of the normal web type and is mounted behind the diaphragm. A metal stand for the speaker is also included, this being bolted to the bottom of the magnet unit.

On test we found the speaker to give very good overall results. The sensitivity was quite as good as our standard energised model, and at the same time the speaker appeared capable of handling large inputs of the order of at least 2 or 3 watts.

This speaker certainly deserves consideration when the purchase of a new speaker is contemplated.

The concert by the Liverpool Philharmonic Society to be relayed from Liverpool on December 13 is to include Hindemith's overture, "News of the Day."

A Christmas concert by Welsh artistes will be given from the Swansea studio on December 20.

Every day we receive letters like these:

★ Wolverhampton, 7/11/32

Dear Sirs,  
 . . . . . Now I must say a few words about your 337 All-Electric. I think I am right in saying I bought the first in Wolverhampton. I have never heard one to beat it for natural voice and clear tone. I can get as many stations as I want, in fact more than I want. Everybody who has heard it speaks highly of it. One in particular tells me it is better than one he has (Radiogram) which cost 40 guineas. I am wishing your 337 every success as I say anyone requiring a set they can't buy anything better or cheaper.

Yours faithfully,  
 (Signed) . . . . .

★★ Minehead, 17/11/32

Dear Sirs,  
 Before deciding to buy your £9.15 Kit (Model 336) I was able to hear no less than five all-mains sets with self-contained moving coil speakers, all of the latest type by first-class makers and widely advertised, including superhets and your £17.17 four valve model (Model 533A). I found all but the last mentioned perfectly hopeless. In the search for selectivity practically everything else has been sacrificed. The outstanding defect is gross over-accentuation of the bass notes, which involves 'booming' so that the human voice sounds as if it were being projected into a large metal trumpet. Your set alone is free from these defects and reproduces the voice as nearly perfectly as seems possible. Without possessing any special knowledge on the subject, it seems as if every other method of securing selectivity, except your variable-mu valves, is a failure. The success of the last named method is marvellous . . .

Yours faithfully,  
 (Signed) . . . . .

★ " . . . get as many stations as I want . . . "

★★ " .. reproduces the voice as nearly perfectly as seems possible . . . "

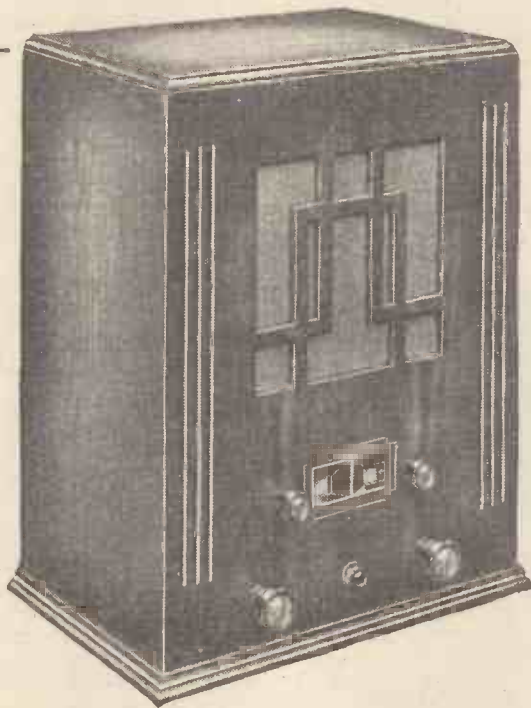

# COSSOR MELODY MAKER

### BATTERY MODEL 335

with Self-Contained Loud Speaker  
 Kit of Parts includes 3 Cossor Valves (220 V.S.G. Variable-Mu Metallised Screened Grid, 210 H.L. Metallised Detector and 220P. Output); Individually Shielded Coils. All-metal Chassis and all parts for assembling the Receiver as illustrated; handsome cabinet 18 1/2 in. x 13 1/2 in. x 10 in. and 10 in. Balanced-Armature Loud Speaker. Provision is made for fitting Gramophone Pick-up Socket and Plug.

Price **£7.17.6**

Hire Purchase Terms: 17/6 deposit and 9 monthly payments of 17/6

### BATTERY MODEL 334

Kit of Parts, similar to Model 335 except that no loud speaker is supplied. Handsome cabinet 9 1/2 in. x 13 1/2 in. x 10 1/2 in.

Price **£6.7.6**

Hire Purchase Terms: 14/- deposit and 9 monthly payments of 14/-

### ALL-ELECTRIC MODEL 337

with Self-Contained Loud Speaker  
 Kit of Parts for All-Electric Melody Maker Model 337 similar to Model 335 (as illustrated) but for all-electric operation. Price, including Cossor Valves, Cabinet, 18 1/2 in. x 17 1/2 in. x 10 1/2 in. Loud Speaker and all parts

Price **£11.15.0**

Hire Purchase Terms: 25/- deposit and 11 monthly payments of 21/-

### ALL-ELECTRIC MODEL 336

Kit of Parts, similar to All-Electric Model 337 except that no loud speaker is supplied. Handsome cabinet 10 1/2 in. x 17 1/2 in. x 10 1/2 in.

Price **£9.15.0**

Hire Purchase Terms: 19/6 deposit and 10 monthly payments of 19/6

### ALL-ELECTRIC MODEL 338

Kit of Parts for All-Electric Melody Maker Model 338 Chassis. Identical with Model 336 except that no cabinet is supplied. Escutcheon and template for drilling your own cabinet is included.

Price **£8.15.0**

Hire Purchase Terms: 32/6 deposit and 8 monthly payments of 20/-

All-Electric Models for A.C. Mains only. 200 to 250 volts (adjustable), 40-100 cycles. Prices do not apply in I.F.S.

To A. C. COSSOR LTD., Melody Dept., Highbury Grove, London, N.5.

Please send me free of charge a full size Constructional Chart, which tells me how to build the Cossor \*All-Electric Melody Maker.

(\* Strike out type not required.)

Name .....

Address .....

A.W. 10/32/32

My usual Retailer is .....

Address .....

A. C. Cossor Ltd., Highbury Grove, London, N.5. Deposits at Birmingham, Bristol, Glasgow, Leeds, Liverpool, Manchester, Newcastle, Sheffield, Belfast, Cardiff and Dublin. 1915 ♡

Advertisers Appreciate Mention of "A.W." with Your Order

# COMPLETING AND USING



# MUSIC TWO

This is one of the best two-valvers ever described in "A.W." It is a very selective set, giving a fine quality output and capable of putting up not only a fine radio performance, but also acting as an efficient gramophone amplifier. Constructional details and a full-size wiring diagram were given last week.

**S**IMPLE to build, easy to tune, economical in running cost; these are the three salient features of the "Ether Music Two."

It is a fascinating set with a performance which is bound to surprise those of you who have never tried a modern two-valver and who do not realise what an amazingly good performance can be put up by a properly designed two-valver.

The "Ether Music Two" has a specially selective coil, in which the degree of selectivity can be readily controlled. It has a radiogram change-over switch. It is adequately decoupled and is provided with an output choke.

## The "Shopping List"

In case you have not yet bought all the parts for the "Ether Music Two," check through your list of components with the accompanying "shopping list," which tells you all the parts you will need.

The list also includes a section of recommended accessories. You cannot expect to get good results with this "A.W." "star" set if the accessories used with it are poor. There must be a good H.T. supply, no matter whether it is from batteries or from the mains. A good aerial and earth are advisable and you must have a good loud-speaker. The quality output of the "Ether Music Two" justifies the use of a good speaker.

## Completing the Construction

If you have any doubt about the component positioning, look at the wiring plan or look at the full-size blueprint. Although the major constructional details are given by the scale wiring plan, you will find it a great help to build the "Ether Music Two" with the aid of the full-size blueprint which has been prepared. Copies of this print can be obtained, price one shilling, post free, from our Blueprint Department, AMATEUR WIRELESS, 58-61 Fetter Lane, London, E.C.4. Get a copy of the print if you are in any doubt about the construction. It shows all the details and gives the wiring in full.

## Useful Hints and Tips

The coil has four sockets and one terminal on one side and four terminals on the other. Mount it as shown, with the sockets facing outwards.

The grid leak has two short wires attached to

A small set but embodying all the newest practice

its end caps. One wire is clamped under a valve-holder terminal, the other is fixed to one terminal of the grid condenser. Take care that these wires are not pulled off. It is a tricky job to re-solder.

The low-frequency transformer should be mounted with its H.T. plus and P. terminals facing to the right of the set, looking from the back.

The main tuning condenser is supported on a small wood block to bring the control shaft up to a suitable height on the panel. Put cardboard or thin plywood packing underneath

the condenser if it is not quite at the right height.

(Continued on page 1328)

## THE COMPONENTS IN THE "ETHER MUSIC TWO"

### PANEL

1—Ebonite, 10 in. by 8 in. (Peto-Scott).

### BASEBOARD

1—10 in. by 8 in. (Peto-Scott).

### VARIABLE CONDENSER

1—Straight-line dial and .0005-microfarad (Utility, type W327).

1—.0003-microfarad reaction (Graham-Farish, Telsen, Ready Radio, Formo, Polar, J.B.).

### SWITCHES

1—3-pole changeover (Wearite, type I.23).

1—Push-pull single-pole changeover (Bulgin, type S.23, Wearite).

### COIL

1—Dual-range screened aerial (Colvern, type TD).

### PRE-SET CONDENSER

1—.0003-microfarad maximum pre-set (Sovereign, Telsen, Formo, Igranic).

### FIXED CONDENSERS

2—.0002-microfarad (Lissen, Telsen, T.C.C., Dubilier).

1—1-microfarad (Telsen, Lissen, Dubilier, T.C.C., Peak, Ferranti, Formo, Sovereign).

1—2-microfarad (Telsen, Lissen, Dubilier, T.C.C., Peak, Ferranti, Formo, Sovereign).

### CHOKES

1—High-frequency (Lotus No. 1, Telsen, Lissen, Igranic, Sovereign, Wearite, Slektun, Bulgin).

1—Low-frequency output (Bulgin, type LF20, Lissen, Telsen, Varley, Ferranti, Igranic, R.I.).

### TRANSFORMER

1—Low-frequency (Lissen Hypernik, Telsen, Igranic, Lotus, Ready Radio, Slektun, R.I., Ferranti, Varley, Sovereign).

### VALVE HOLDERS

2—4-pin (W.B., Telsen, Lissen, Benjamin, Ready Radio, Lotus).

### GRID LEAK

1—2-megohm with wire ends (Dubilier, Lissen, Erie, Claude Lyons).

### RESISTANCE

1—20,000-ohm spaghetti (Tunewell, Lissen, Telsen, Lewcos, Bulgin, Varley, Magnum).

### TERMINAL BLOCK

1—(Sovereign, Junit.)

### TERMINALS

6—Marked 2 LS, Aerial, Earth, 2 pick-up (Clix, Belling Lee, type M, Ealex, Bulgin).

2—Spade marked L.T.+, L.T.— (Belling-Lee, Clix, Ealex).

### SUNDRIES

1—Terminal strip, 4½ in. by 2 in. (Becol, Peto-Scott).

Connecting wire and sleeving (Lewcos, Jiffilix, Quickwire).

Four yards thin flex (Lewcoflex).

5—Wander plugs marked H.T.+, H.T.—, G.B.+, G.B.—1, G.B.—2 (Belling-Lee, Clix, Ealex).

## ACCESSORIES

Cabinet (Direct Radio).

120-volt H.T. battery (Lissen, Drydex, Fuller, Pertrix, Ever Ready, C.A.V.).

9-volt G.B. battery (Lissen, Drydex, Fuller, Pertrix, Ever Ready, C.A.V.).

2-volt accumulator (Lissen, Exide, Fuller, Pertrix, Ever Ready, C.A.V.).

Loud-speaker (Igranic, Kola, type F6, Model PMI, W.B., Sonochorde, Baker, Lissen, Blue Spot, Ormond).

Earthing device (Filt).

Aerial wire (Electron).

Recommended mains unit (Atlas, type A2, Regentone, Ekco, Lissen, Heayherd).

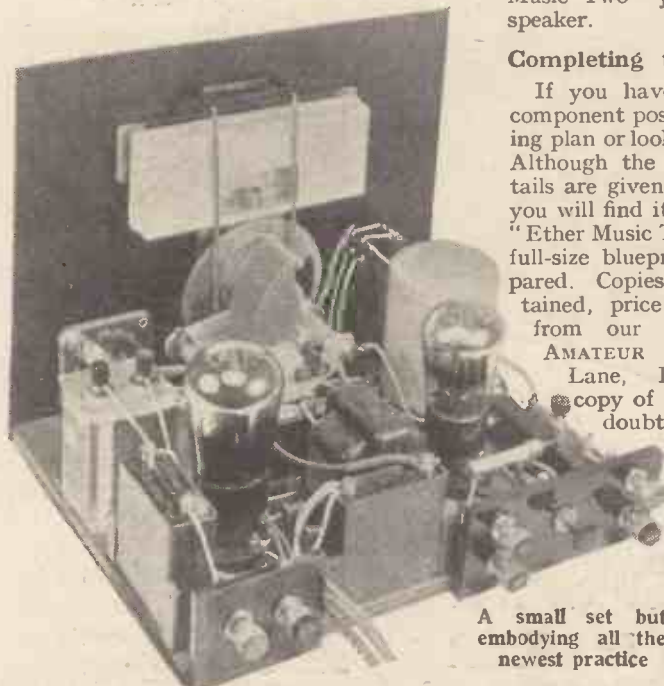

Why is the construction easy? The photograph explains the simplicity of the "Ether Music Two." There is no metal work to be done, the plywood baseboard carrying the major components. A very neat appearance is given to the front of the set by the use of the visible full-scale tuning dial.

In last week's issue the first constructional details were given and readers should refer to these before taking advantage of the additional tips given here.

# PRECISION

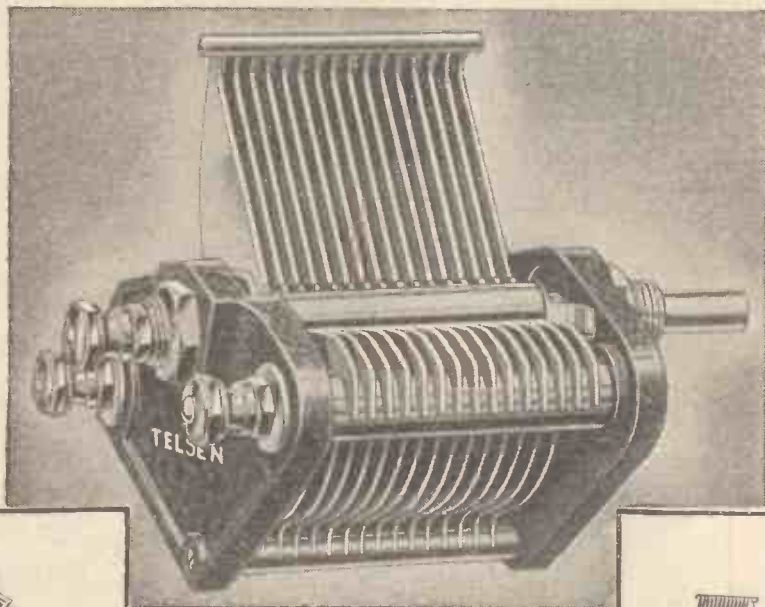

**TELSEN TELORNOR**

An illuminated Disc Drive embodied into an unusually handsome silver oxidised escutcheon plate, complete with artistically grouped Volume, Tuning, On-Off, and Push-Pull controls . . . . . 7/6

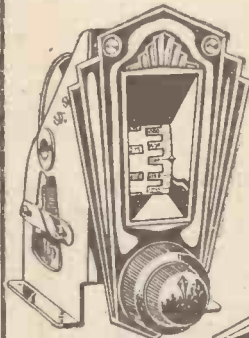

**TELSEN DRUM DRIVE**

Embodies numerous refinements, including cord drive and rocking stator trimmer. An extra scale, graduated for wavelength tuning, is supplied free of charge - 8/6

**TELSEN ILLUMINATED DISC DRIVE.**

Fitted with handsome silver oxidised escutcheon plate and incorporating an improved movement, making for delightfully easy tuning . . . 3/6

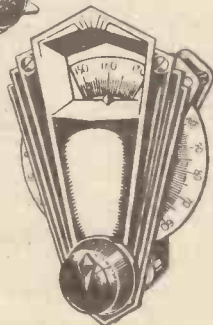

## TELSEN LOGARITHMIC VARIABLE CONDENSER

The Telsen Logarithmic Variable Condenser is a component whose precision, allied to its sturdy construction, ensures years of faithful service. The sturdy frame is braced by three solid pillars, and the vanes clamped at three points, making distortion impossible. The rotor is also built into a rigid unit and the vanes held at both ends, generous bearings preventing backlash or endplay.

Cap. .00025 ... ..	4/6
Cap. .00035 ... ..	4/6
Cap. .0005 ... ..	4/6
Cap. .0005 (left-hand movement with trimmer) ...	5/-
Cap. .0005 (right-hand movement with trimmer) ...	5/-

# TELSEN

**RADIO COMPONENTS**

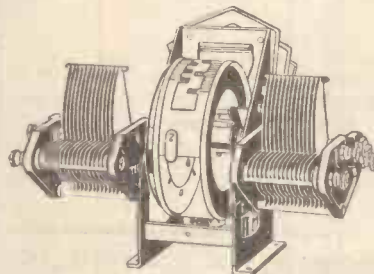

**TELSEN DRUM DRIVE AND CONDENSER ASSEMBLY.**

A complete drum drive and ganged condensers tuning unit, with a handsome escutcheon finished in oxidised silver. An extra scale (marked in wavelengths) is supplied free . . . . . 17/6

**TELSEN SMALL FRICTION DISC DRIVE.**

A low priced disc drive for auxiliary controls. It is extremely robust and may be used for main tuning condensers where considerations of space make it desirable . . . 2/6

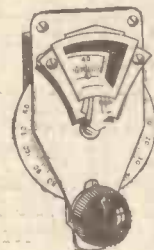

**TELSEN SLOW MOTION DIAL.**  
(Black or Brown Bakelite)

Made with a gear ratio of 8-1, the disc being graduated from 0-100 in both directions. Supplied complete with instructions for mounting on all panels up to 3/16" thick . . . 2/-



**TELSEN RADIO COMPONENTS ARE 100% BRITISH**

ANNOUNCEMENT OF THE TELSEN ELECTRIC CO., LTD., ASTON, BIRMINGHAM

You will Help Yourself and Help Us by Mentioning "A.W." to Advertisers

“THE ETHER MUSIC TWO”

(Continued from page 1326)

If the control spindle of the centre condenser scrapes against the edge of the panel hole, you can safely dismount the condenser and enlarge the panel hole. The hole is hidden by the control knob.

Mount the wave-change switch firmly on the panel, for otherwise it will move sideways when the knob is rotated.

There are two large fixed condensers on the baseboard. The 2-mfd. condenser is mounted near the output choke on the left of the set looking from the back.

The radiogram switch can be wired up before it is clamped to the strip. You may find it easy to do this, especially as two of the terminals are fairly close to the baseboard.

There is only one flexible resistance in the set. The type specified has spade tags. Don't twist these resistances or part of the fine wire may be broken.

The full-scale condenser dial has a holder for a dial illuminating bulb. This need not be connected unless you wish. If used, it should be wired directly across one of the valve-holder filament terminals, so that the indicator bulb is only on when the set is switched on.

The coil screen is painted on the outside and so is insulated, but make sure that no loose wires on any of the coil terminals touch the screen, for they may short-circuit to it.

Watch the two small wires which bridge contacts on the panel switch. If possible, these should be soldered, alternatively, take care to make good twisted connections.

Clamp battery flexes firmly underneath the terminal heads, or they may be pulled loose when the batteries are moved.

Check Your Construction

It only takes a few moments to check over the construction and to make sure

that all the wiring is O.K. It is a worthwhile precaution for it ensures that the batteries are not run down, nor the valves accidentally burnt out through some small snag in the construction. The best plan is to check over the leads one by one, marking off each lead on the blueprint as its



The “Ether Music Two” is neat in appearance and the performance cannot be bettered in a two-valver

counterpart in the set is checked as O.K.

Those Accessories

The next step is to choose suitable valves for use with the Ether Music Two. An ordinary detector and power valve are needed. You will not find the choice difficult, for there are plenty of suitable valves of all makes.

As there is an output circuit in the “Ether

Music Two,” it does not matter which way round the speaker is connected. If extension wires are added to the set it should be remembered that the right-hand terminal, looking at the set from the back is at earth potential.

A gramophone pick-up for use with the “Ether Music Two” should be connected through a volume control, so that the detector valve of the set is not overloaded. Most pick-ups are so fitted. There is no need to disconnect the pick-up from the set when it is not being used as a gramophone amplifier. The switch cuts the pick-up out of circuit.

Selectivity when the “Ether Music Two” is being used as a radio receiver is controlled by the pre-set condenser and by the tappings on the coil. Try adjusting the series aerial condenser in conjunction with each coil tapping to get the best results. The most appropriate final adjustment depends upon the length and type of the aerial used.

Don't forget that the set can be seen in the Radio Department windows of Messrs. Selfridge & Co., Ltd., Oxford Street, London, W.

Two of the usual transmissions of carols will be heard by National listeners on Christmas Eve. In the afternoon a relay takes place of the Carol Service at King's College, Cambridge, and in the evening Cyril Dalmaine conducts carol singing at Whitechapel Parish Church.

A new edition of “Nine-Thirty Novelties” will be given on December 21. The idea is to show some aspects of English life in the age of super-machines fifty years hence.

# WATES Rotary Converter

## TURNING DC CURRENT TO AC

Specially designed for radio by electrical engineers of long experience with broadcast receivers, WATES ROTARY CONVERTER offers a perfect solution to the D.C. problem. A.C. current converted from D.C. by this latest type Wates is actually better than that obtainable from A.C. mains. Ideal for supplying receivers of very high selectivity: public address amplifiers: electric sets attached to private power installations, etc. Will run for many years without attention, apart from oiling and cleaning of brushes, commutator, etc. Special silencing cabinet also makes Wates Rotary Converter quite portable.

MODEL A. For D.C. mains, 200-250 volts. Output, 80 watts A.C., 220-250 volts, 50 cycles. Suitable for most sets up to 9 valves and small radiograms. Complete with Smoothing and Silencing Box **£11:10:0**

Converter, £8:5:0. Smoothing Box, 25/- Silencing Box, 40/-

MODEL B. As above, larger output of 180 watts, suitable for radiograms requiring extra heavy supply. Complete with Smoothing and Silencing Box **£13:5:0**

Converter, £10. Smoothing Box, 25/- Silencing Box, 40/-

Quotations for any output or voltage by return.

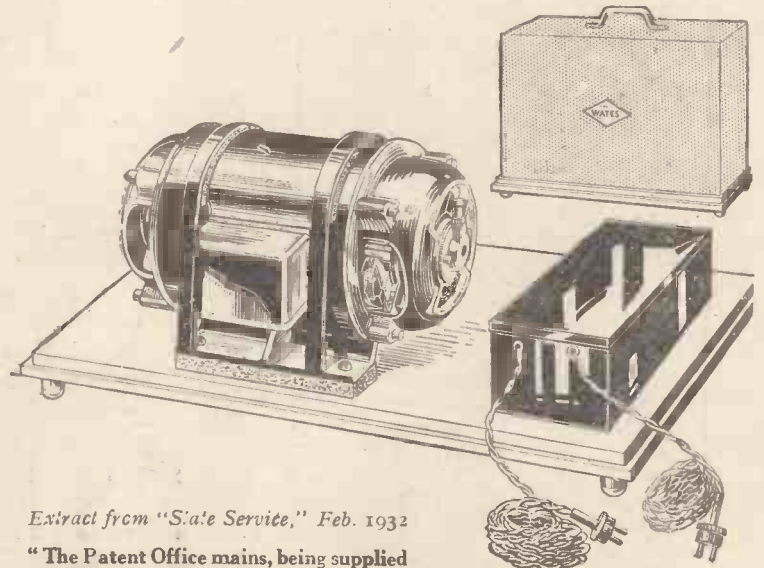

Extract from “State Service,” Feb. 1932

“The Patent Office mains, being supplied with D.C. current, had to be transformed into A.C. for the Amplifier and Radiograms. This important job was undertaken by a Wates Converter and it need only be said that this machine did its work so well and so unobtrusively that the audience were quite unaware of its presence.”

**FURTHER DETAILS AND ADVICE POST FREE**

WATES RADIO LTD., 184-8, Shaftesbury Avenue, London, W.C.2.



**"UP-TO-DATE IDEAS TO IMPROVE QUALITY"**

(Continued from page 1304)

The symptom of an over-size by-pass condenser is "woofiness" in the tone, denoting that high notes are being cut. Usually, with the average impedance of detector valve, a .0002-microfarad fixed condenser will do admirably, though with a high-impedance valve a .0001-microfarad may be large enough, whereas with a fairly low impedance valve, such as a mains detector, you may have to use as large a value as .001 microfarad.

**PARALLEL-FEED COUPLING**

WE come now to a very vulnerable source of distortion in the set—the low-frequency coupling between the detector and power output valves.

With a high anode voltage, the detector anode current may be 4 to 5 milliamperes, which is too much for the average transformer. The result of passing too much current through the winding is to give the effect of a low-inductance primary, and that means very bad reproduction.

To overcome this difficulty, many set designers have now adopted the parallel-feed system. In this, the anode feed is taken through a resistance, and the low-frequency current is led through a fixed coupling condenser to the primary winding of the transformer, as shown by Fig. 5.

Here we are concerned only with the reason for parallel feed and not with all its variations. The main points to watch are the choice of the value of resistance and coupling condenser. If too high a value of resistance is used, the voltage that actually reaches the valve will be very low, and distortion due to overloading the valve in its function of amplifier may easily be produced on loud signals.

Usually a 30,000-ohm resistance is chosen as a good compromise. With this, use a .5- or 1-microfarad coupling condenser.

**HIGH-NOTE ACCENTUATION**

MANY sets, having very carefully avoided cutting the high notes in the earlier parts of the circuit, proceed to overdo their amplification when the power valve stage is reached. This applies especially when a pentode valve is used with a moving-iron type of loud-speaker.

One of the easiest and cheapest ways of cutting down the high notes at the pentode is to insert a grid-stopping resistance between the transformer and the grid. See Fig. 6.

Here again, you must compromise. If you use a large value of grid leak, you will certainly cut down the high notes, but the resulting quality will be anything but pleasing. If you do not use a high enough value, the leak will allow the high notes to pass through. A good value found by experience to give the desired effect is .25-megohm.

A more scientific way of cutting down the high notes, and incidentally a more gradual method, is shown by Fig. 7. Here a fixed condenser is connected in series with a variable resistance across the loud-speaker.

The values depend a good deal on the type of loud-speaker used, but for general experiments you might try a .01 microfarad fixed condenser and a 25,000-ohm resistance.



**Dubilier  
Condensers  
chosen by  
"CLARKE'S  
ATLAS"  
for  
dependability**

Mr. Clarke, of Messrs. H. Clarke & Co. Ltd., the famous manufacturers of ATLAS Radio Products, writes:—"In every case I have found your products to be most satisfactory."

Messrs. Clarke & Co. Ltd. have made certain of obtaining persistent results with their famous "Atlas Receivers" by incorporating Dubilier Condensers. With no other Condensers could they be so sure of getting the same absolute dependability.

Constructors who have used them are equally enthusiastic about their performance. The number of returns is negligible, that is why Dubilier prices are always competitive. In the long run it will cost you far less to get satisfaction if you buy Dubilier Condensers.

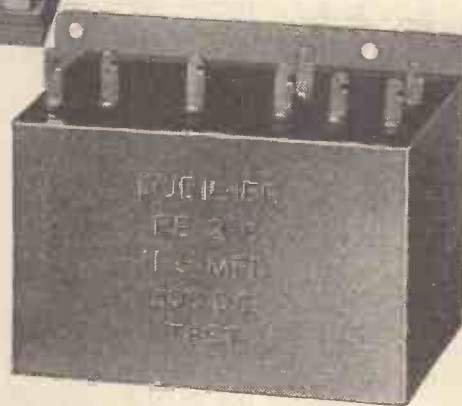

**DUBILIER  
CONDENSERS**

**DUBILIER CONDENSER CO. (1925) LTD.  
Ducon Works, Victoria Road, North Acton, London, W.3**

Distributing Agents for Irish Free State: KELLY & SHIEL LTD., 46/47 Fleet Street, Dublin, C.4

# In My Wireless Den

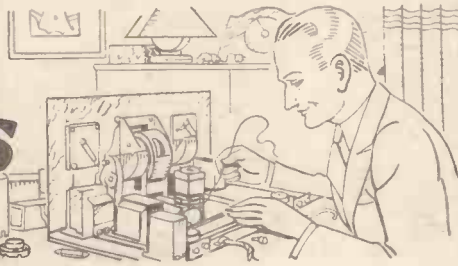

Weekly Notes : Theoretical and Practical

## A NOTE ON GANGING

THERE are one or two points of interest that ought to be remembered when ganging a set and which are not often referred to.

The first is to use the smallest capacity in so doing. This will enable you to tune in the stations working on the lower wavelength.

In the case of a set that I was trying a few days ago the lowest wavelength was a little above 250 metres. The trimmers were adjusted near their maximum capacities, and all I had to do was to unscrew them and to gang the set, using the least possible amount of capacity in the trimmers in order to bring the maximum wavelength down to nearly 200 metres.

I have noticed that the tendency is to use too much capacity in the trimmers. It is usually much better to gang the circuits, remembering that the smaller the capacity added to the circuits of the trimmers, the lower in wavelength will

the set tune. The highest wavelength is, of course, reduced a little, but the range covered is increased.

Another point to note is that the results might be better, on the whole, if the set is ganged at about 300 metres, instead of quite near the bottom of the range. The accuracy of the ganging should be checked at various positions, but rarely can it be said that the tuning is quite accurate at all points.

## CONTROLS AND RESULTS

THE results to be obtained from a three-valve set having a screen-grid stage, a detector, and a pentode output depend very much upon the controls fitted.

Some sets have one knob for the gang condenser, one for the wavelength switch and reaction. Others have, in addition, a volume control fitted to the screen-grid valve and adjustable aerial input condenser.

Now, in skilled hands a set having the

larger number of controls is bound to give the best results. In particular, one is able to obtain the maximum selectivity. To do this the input is reduced, and perhaps the magnification of the screen-grid stage. The amplification is brought up by increasing the reaction.

One of the chief advantages of the variable-mu screen-grid valve is the ease with which its amplification factor can be adjusted by altering the bias. With this control and reaction, very good results can be obtained, but if a series-connected aerial condenser is fitted as well the maximum can be obtained from the valves used. Not everybody could operate a set having so many controls, but there is more fun in trying to manage them than in tuning with a two- or three-knob set.

## MAKE SURE OF GOOD CONTACTS

ONE of the most frequent causes of faults in receivers is bad contacts. A valve contact that is not making a good connection with the socket in the holder may quite spoil the results.

If I find that a valve seems to fit rather loosely I always bend the contact pins a little in order to improve the contacts. The rotors of some condensers do not make good connection with the terminal, and I always suspect contacts that must be made to a fixing screw.

If this is the only way of getting connection, make sure the surface is clean at the place where the wire will touch and scrape the place to make sure. This is a common fault.



"We're Fluxite and Solder—the reliable pair; Famous for soldering—known everywhere!"

When fixing up Wireless—there's no need to fret; Just call US to help you—then perfection you'll get!"

See that Fluxite and Solder are always by you—in the house—garage—workshop—anywhere where simple, speedy soldering is needed.

**ALL MECHANICS WILL HAVE**  
**FLUXITE**  
**IT SIMPLIFIES ALL SOLDERING**

All Ironmongers sell Fluxite in tins: 4d., 8d., 1s. 4d. & 2s. 8d. Ask to see the **FLUXITE POCKET SOLDERING SET**—complete with full instructions—7s. 6d. Ask also for our leaflet on **HARDENING STEEL** with Fluxite.  
**FLUXITE LTD. (Dept. 326), ROTHERHITHE, S.E.16**

**FOR ALL REPAIRS!**





## A SUPER-SELECTIVE AERIAL



THE

**SELECTANET**

Reg. No.  
520797  
Pat. No.  
371534

Super-selective Aerial has a collective surface area of over 800 ft. of pure copper ribbon wire, woven into a tubular net only 9 ft. long. No other aerial has such a ratio. It reduces interference and overlapping to a minimum; and gives sharper tuning. Get one to-day and improve your set. Of all Dealers or direct, postage 3d. extra, from

**2/6 EACH**

**Spong & Co., Ltd., Woodville Grove, London, N.15.**

## "Fiddle, cello, big bass drum, cornet and euphonium"



**30/-**

**MARK III**

Whatever the instrument or combination of instruments, they can be immediately recognised when they are reproduced by means of the Bowyer-Lowe Mark III Pickup. Every fundamental tone, harmonic and overtone is given its correct value without coloration, resulting in a faithful reproduction of the original recording.

**Send for BOWYER-LOWE & A.E.D. LTD.,**  
**Catalogue DIAMOND WORKS, BRIGHTON.**

# TELSEN

# DUAL-RANGE COILS



**TELSEN DUAL-RANGE AERIAL COIL** incorporates a variable selectivity device, making the coil suitable for widely varying reception conditions. This adjustment also acts as an excellent volume control, and is equally effective on long and short waves. The wave-band change is effected by means of a three-point switch and a reaction winding is included ... **7/6**



**TELSEN H.F. COIL** may be used for H.F. amplification with Screened-Grid Valve, either as an H.F. Transformer or, alternatively, as a tuned grid or tuned anode coil. It also makes a highly efficient Aerial Coil where the adjustable selectivity feature is not required **5/6**

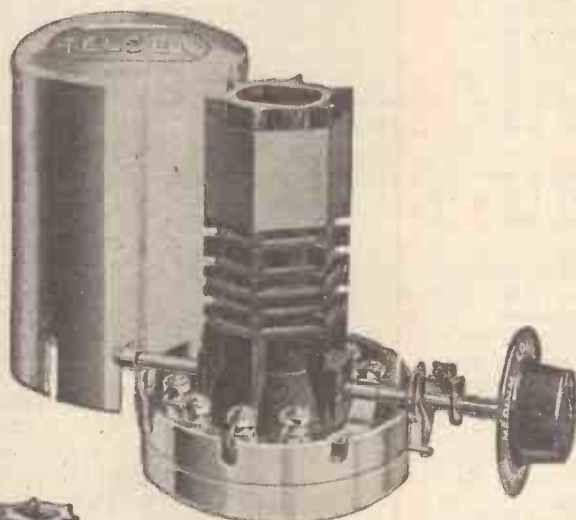

*Twin Matched Screened Coils*  
**17/-**

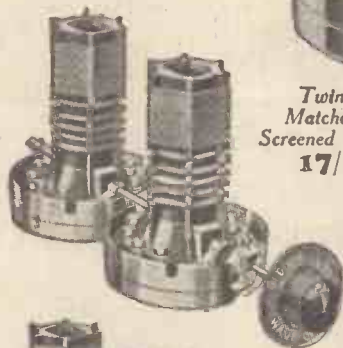

*Triple Matched Screened Coils*  
**25/6**

## TELSEN SCREENED COILS

The result of much research and experiment, these coils embody the ultimate efficiency attainable in a perfectly shielded inductance of moderate dimensions. Provided with separate coupling coils for medium and long waves, they are suitable for use as aerial coils or as anode coils following a screened-grid valve, giving selectivity comparable only with a well-designed band-pass filter. The coils are fitted with cam-operated rotary switches with definite contacts and click mechanism, and are supplied complete with aluminium screening cans, bakelite knob, and handsome "Wave Change" escutcheon plate, finished in oxidised silver **8/6**

*Full instructions are supplied with every Telsens Screened Tuning Coil, showing you the alternative methods of mounting the coils, either singly, or in twin-matched or triple-matched form as required;*

# TELSEN

**RADIO COMPONENTS**

## TELSEN RADIO COMPONENTS ARE 100% BRITISH

ANNOUNCEMENT OF THE TELSEN ELECTRIC CO., LTD., ASTON, BIRMINGHAM

*Please Mention "A.W." When Corresponding with Advertisers*

"AMERICA'S CALLING!"

(Continued from page 1306)

not an invariable rule. Try the shorter wavelengths when you begin your search, and if you don't hear anything of them go up above 300 metres. If, though, the shorter wavelength stations are coming in well you can safely leave those on the longer waves until later.

Chicago has two 50-kilowatt stations, WENR and WLS, which share 345 metres between them, and on this wavelength there is also a good Argentine station, LR2, of 10 kilowatts. A station on 345 metres is easy to find, since this is the wavelength of Strasbourg. Immediately above is WABC (50 kilowatts) of New York City, and almost exactly on Muhlacker's wavelength is the 50-kilowatt KOA of Denver. There are one or two powerful stations on the next wavelengths going upwards, but for some reason these are seldom heard in this country.

The next station worth trying for is WGY on 379.5 metres, just a tick above the settings of the Scottish Regional. WGY occasionally uses as much as 100 kilowatts, but his normal fifty are quite sufficient on a good night to give fine loud-speaker reproduction in this country.

WBBM (25 kilowatts) of Chicago on 389.4 metres and WJZ (30 kilowatts) of New York City are both worth attention. From them you can move up to 416.4 metres, just above Dublin's wavelength, where you may find the 50-kilowatt WGN of Chicago. Proceed carefully now, for you are coming to two first-rate stations. These are WOR (50 kilowatts) of Newark and WLW (50 kilowatts) of Cincinnati on 422.3 and 428.3 metres.

Next turn your dials to about one division below the settings required for Beromunster, and try for the 50-kilowatt WEAJ of New York on 454.3 metres. There are only two U.S.A. giants using wavelengths higher than this. These are WSM of Nashville on 461.4 metres and KFI of Los Angeles on 468.5 metres. Both of these have a rating of 50 kilowatts.

You will see that there are plenty of stations to try for from the far side of the Atlantic. On a good night carriers seem to be sometimes almost as numerous on the medium waveband in the small hours as they are before the European stations have closed down.

BROADCASTING STATIONS

Broadcasting Stations classified in order of wavelengths. For the purpose of better comparison, the power indicated is that of the carrier wave.

Table with columns: Metres, Kilo-cycles, Station and Call Sign, Power (Kw.), Metres, Kilo-cycles, Station and Call Sign, Power (Kw.), Metres, Kilo-cycles, Station and Call Sign, Power (Kw.). Lists various international stations and their technical specifications.

"NEW RADIOS FOR OLD-FOR CHRISTMAS" WE BUY YOUR OLD SET AND SUPPLY YOU WITH ANY NEW SEASON'S MODEL Liberal Allowances and Balance Payable by Cash or Hire Purchase. HUNDREDS OF TESTIMONIALS FROM SATISFIED CLIENTS EVERY MAKE OF KIT, SET OR RADIOGRAM SUPPLIED. It will pay you to write for particulars of our amazing exchange offer, enclosing 1/3d. stamp, naming your old set and the new model you fancy. A FREE QUOTATION WILL FOLLOW. Complete transaction executed by mail. FREE Wireless set to introduce the Radialaddin Club. Please forward this INQUIRY FORM (without obligation) Please quote me free your allowance for the new set: Make..... Model and list price..... My Present Set is: Make..... Batteries or Mains..... Date of Purchase..... Original Cost of Set..... Balance of purchase price would be payable by me as follows: Plan A. Whole of balance in cash. Plan B. Whole of balance over six, nine, twelve \* months. \*Delete unwanted words. NAME (in full)..... (Block letters) ADDRESS..... Visit Our Showrooms RADIALADDIN, Limited THE LARGEST RADIO EXCHANGE IN THE UNITED KINGDOM. (Dept. A.W.), 46 Brewer Street, London, W.1. Phone: Gerrard 4055.

## AROUND THE SHORT-WAVE DIAL—By SHORT-WAVER

VERY little attention has been paid in the past to selectivity on short waves. In view of the general belief that, no matter how simple the apparatus, the selectivity is bound to be knife-edge, it may surprise some listeners to know that the majority of short-wave receivers at present in use would not be sufficiently selective if one or two high-power stations were allocated adjacent wavebands. An example of this is that W2XAF on 31.48 metres and Zeesen on 31.38 metres very often interfere, if conditions for reception are good, but so far this trouble has not been appreciated, as the number of high-power stations transmitting at the present time is strictly limited.

I have been listening during the last few days to the preliminary tests of the Empire broadcasting stations at Daventry. On my normal short-wave receiver, where selectivity is really excellent, no trouble was noticed, but on a commercial four-valver and a commercial plug-in adaptor, GSC completely wiped out Zeesen and W2XAF. The wavelength of GSC is 31.3 metres, which is unpleasantly near to Zeesen.

In my district, which is about thirty miles from Daventry, the strength was R9 without any fading, and with really excellent quality. The programme sent through GSC was simultaneously broadcast through GSA on 49.6 metres, and a harmonic of this was heard slightly below 25 metres.

Tests are being carried out between 8.30 and 10.30 G.M.T. on Monday, Tuesday, and Wednesday for reception in West Africa. It looks, from this, as if we might in the near future have to pay as much attention to selectivity on the short-wavers as to the family set.

### Stations to Log

For new readers who find difficulty with short-wave reception and wish to hear America, with reliability, I should advise you to forget the number of stations that should be "on the air" and concentrate solely on W3XAL on 16.87 metres during the hours of daylight, and W8XK on 48.86 metres after 10 p.m.; this applies all the week round. With the exception of these two stations, conditions are particularly bad at the present time; even when the receiver is carefully calibrated, difficulty is experienced in hearing very much at any rate from the States.

W3XAL has been coming over at about R6 every afternoon for the past week, and after 4 o'clock the strength usually increases to R8 until 5 o'clock, fading off towards 6 p.m.

Saturday morning I tried for Melbourne to see if I could receive any news of the cricket. Admittedly the wavelength is hardly suitable for that time of day, but I managed to hold it for about a quarter of an hour at R3; static and fading interfered so much that it made the reception of little value.

(Continued on page 1334)

# "A definite advance..."



says *Mr. H. J. Barton Chapple* Wh. Sch. B.Sc. (Hons)  
D.I.C. A.M.I.E.E.

*This well-known radio and television authority pays striking tribute to the new W.B. "Mansfield" Speaker Magnetic System.*

"... The ultimate result is a really astonishingly high flux density for the size of the magnet used . . . fidelity of tone of outstanding merit . . . sensitivity very noteworthy, comparable in many respects with externally energised types without the necessity for mains or batteries. The Speaker will handle an input more than sufficient for quite a large room and yet can be worked satisfactorily from a small two-valve set.

"My conclusions . . . this new P.M.4 speaker is a definite advance in the permanent-magnet class."

## The Revolutionary "MANSFIELD" Moving Coil Speakers



Write for copy of Mr. Barton Chapple's full report. The "Mansfield" (patent) Magnetic System is a revolutionary development. It makes possible a magnet 30 per cent. more efficient than a good cobalt steel magnet of same weight and 10 per cent. more efficient than a chrome steel magnet of three times the weight. It enables a steel chassis to be used without magnetic loss. It eliminates the bugbear of loss of magnetism. Ask your dealer for a demonstration—you will be AMAZED.

"Mansfield" Senior (Improved P.M.4), complete with 3-ratio transformer, 42/-.

"Mansfield" Junior (P.M.5), complete with 3-ratio transformer, 27/6.

"Mansfield" Cabinet in well-finished oak (for P.M.4 or 5), 25/- extra (if desired).

Whiteley Electrical Radio Co., Ltd., Dept. A, Radio Works, Mansfield, Notts.

London Office: 109 Kingsway, London, W.C.2. Telephone: Holborn 6714.  
Irish Free State Distributors: Kelly and Shiel, Ltd., 47 Fleet Street, Dublin.

# EXPRESS EASY PAYMENT SERVICE

Prompt Delivery Guaranteed.  
Price List Free on Request.

- MANUFACTURERS' KITS**
- NEW LISSEN "SKYSCRAPER" KIT**, With order including valves  
Cash or C.O.D., £4/9/6. And 11 monthly payments, of 8/3 **8/3**
- "S.T. 400" KIT, COMPLETE SET OF PARTS, EXACTLY TO SPECIFICATION, LESS VALVES AND CABINET.** With order  
Cash or C.O.D., £4/19/6. And 11 monthly payments of 9/1 **9/1**
- "S.T. 400" KIT INCLUDING VALVES.** With order  
Cash or C.O.D., £9/18/6. And 11 monthly payments of 12/9 **12/9**
- READY RADIO "METEOR" S.G.3 KIT,** including cabinet, valves, and moving coil unit  
Cash or C.O.D., £3/17/6. And 11 monthly payments of 16/8 **11/-**  
This Receiver also tunes to Ultra-short Waves.
- TELSEN "JUPITER" S.G.3 KIT,** complete kit less valves. With order  
Cash or C.O.D., £3/17/0. And 11 monthly payments of 7/- **7/-**
- TELSEN "AJAX 3,"** complete kit less valves. With order  
Cash or C.O.D., £3/1/6. And 11 monthly payments of 5/8 **5/8**

- ACCESSORIES**
- NEW BLUE SPOT 99 P.M. MOVING-COIL UNIT.** With order  
Cash or C.O.D., £2/19/8. And 11 monthly payments of 5/8 **5/-**
- ATLAS ELIMINATOR, A.C.244. 3 H.T. Tap.** With order pins. 20 M/A output.  
Cash or C.O.D., £2/19/6. And 11 monthly payments of 5/8 **5/-**
- 12 EXIDE W.H. HIGH TENSION ACCUMULATORS.** (120 Volts, 5,000 M/A). The cheapest and best High Tension Supply With order where Mains are not available.  
Cash or C.O.D., £3/15/-. And 11 monthly payments of 7/- **7/-**
- NEW EPOCH 20c PERMANENT MAGNET MOVING-COIL UNIT.** With order  
Cash or C.O.D., £1/15/-. And 6 monthly payments of 5/8 **5/6**
- Rola Speakers Supplied on Similar Terms.  
All above Carriage Paid.
- To avoid delay, will customers kindly send first payment with order.
- Goods ordered C.O.D. are dispatched by return of post. Post charge paid by us.

The **LONDON RADIO SUPPLY COMPANY** ESTD 1925  
11, Oat Lane, Noble St., LONDON E.C.2  
Phone NATIONAL 1977

**NEW H.T. ECONOMY**  
with the B.M.U. SUPER D.C. mains unit MODEL D.C. 25  
Four tappings 40/100 v. variable, 60 v., 120 v. and 150 v. fixed. Easily convertible to an A.C. Mains Unit **27/6**  
Send for folder FREE

**BRITISH MAINS UNIT CO.,** 17 Edminton Square, Worcester Park, Surrey

Get Your Copy of the **"WIRELESS MAGAZINE"**  
Now on Sale - - - - Price 1/-.

**7 DAYS FREE APPROVAL!**  
H.T. BATTERY ELIMINATORS  
BRITISH THROUGHOUT 2 Years Guarantee  
Westinghouse rectifiers in A.C. Models.

D.C. MODEL	Send for literature to actual manufacturers.	A.C. MODEL
<b>15/-</b>	V.M.C. RADIO COMPANY, Mail Order Dept.	<b>30/-</b>
198 Goswell Road, London, E.C.1		

**OUR BLUEPRINT SERVICE.**  
Constructors of receivers described in this Journal should make full use of our Blueprint Service and avoid all risk of failure.

## "AROUND THE SHORT-WAVE DIAL"

(Continued from page 1333)

On Saturday afternoon I heard a really excellent programme from W3XAL, which was word-perfect for about three hours, consisting of soloists, a cinema-organ recital, and finally a really disturbing talk on the vitamin value of food. So far as I could gather from this, everything that I am at present eating is bound to cause my early demise, and, unfortunately, no mention was made of what food I might eat.

Contrary to this, on Sunday morning Sydney came through quite nicely between 7 and 8; but here again it was of little interest, as the programme consisted mainly of records of English artistes.

An excellent station I have not heard for some time is Madrid EAR110. This station transmits on Tuesday and Saturday evenings after 10.30 on a wavelength of 43 metres. I do not know what power is used, but the volume is really extraordinary. Unfortunately, a number of French amateurs are on a similar waveband, and occasionally they butt in.

### WHEN SUBMITTING QUERIES

Please write concisely, giving essential particulars. A Fee of One Shilling (postal order), a stamped addressed envelope, and the coupon on the last page must accompany all letters. The following points should be noted.

Not more than two questions should be sent with any one letter.

The designing of apparatus or receivers cannot be undertaken.

Modifications of a straightforward nature can be made to blueprints, but we reserve to ourselves the right to determine the extent of an alteration to come within the scope of a query. Modifications to proprietary receivers and designs published by contemporary journals cannot be undertaken.

Readers' sets and components cannot be tested at this office. Readers desiring specific information upon any problem should not ask for it to be published in a forthcoming issue, as only queries of general interest are published and these only at our discretion. Queries cannot be answered by telephone or personally.

Readers ordering blueprints and requiring technical information in addition, should address a separate letter to the Query Department and conform with the rules.

An organ recital by Dr. H. Lowery is to be relayed to Northern listeners from the Manchester College of Technology on December 11.

### THE MOST POPULAR RADIO-GRAM CABINET ON THE MARKET

Reduced to **39/6** Carriage Paid!!!  
Quality Guaranteed Improved  
Soundly constructed in selected oak, etc., and hand polished.  
SPECIFICATION.—3' 3" high, 1'10" wide, 1'6" deep. To take panels up to 18" x 7". Panel opening to suit set. These cabinets allow ample room for the following:—  
Pick-up, Motor, Speaker, Batteries, etc., all for the reduced price of **39/6**.



Catalogue Post Free. From one of the Largest Mail Order Works in England: **W. S. WILKIN, Cabinet Manufacturer, 12-25 Nelson News, Southend-on-Sea, Essex.** Guernsey Depot: Messrs. Leslie Ltd., 7, Bondage, Guernsey.

A wonderful Speaker that needs no introduction

The PPM SOUNDEX

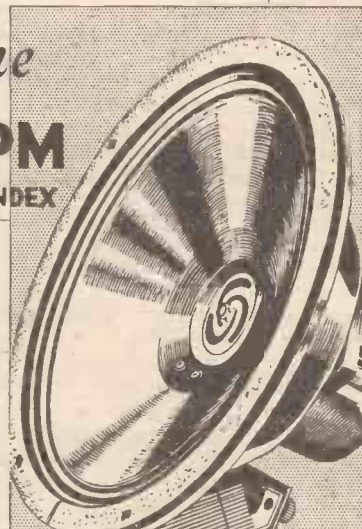

PRICE **27/6**  
Including Transformer

Tonal quality, sensitivity and a remarkable depth of volume has stamped this Speaker as a most outstanding achievement.

The PPM Soundex offers really wonderful value for money. Although only small in size the results obtained are equal to many speakers with much larger diaphragms.

It includes a Hy-flex diaphragm, and a tapped universal transformer. Insist upon your local dealer giving a demonstration—you will be more than surprised at the life-like results.

**CELESTION**  
The Very Soul of Music

Celestion Ltd., London Road, KINGSTON-ON-THAMES  
London Showrooms: 106 Victoria Street, S.W.1

POST CARD

# POSTCARD

## RADIO LITERATURE

**GET THESE CATALOGUES FREE**  
 Here "Observer" reviews the latest booklets and folders issued by well-known manufacturers. If you want copies of any or all of them FREE OF CHARGE, just send a postcard giving the index numbers of the catalogues required (shown at the end of each paragraph) to "Postcard Radio Literature," "AMATEUR WIRELESS," 58/61, Fetter Lane, E.C.4. "Observer" will see that you get all the literature you desire. Please write your name and address in block letters.

**Lissen Tuning Control Unit**

I SEE that many new sets are fitted with the Lissen ganged condenser tuning control unit. It is quite a novel idea. It consists of two 0005-mfd. condensers which can be ganged or independently controlled and the knobs of which are mounted concentrically on a neat bakelite escutcheon. At the base of this escutcheon is a switch for wave-changing and filament switching. Lissen have issued a folder which describes this useful unit. **896**

**New H.T.'s**

I see that some new high-tension and grid-bias batteries are now on the market. These are the Silver Knight batteries made by the Indiarubber Gutta Percha and Telegraph Works Co., Ltd., the firm which, incidentally, was the first to manufacture the Leclanche cell in this country. The Silver Knight batteries are available in the usual standard and triple capacity types of various voltages up to 108. Literature is obtainable through my free catalogue service. **897**

**From H.M.V.**

H.M.V. have just sent me a very handy folder which gives details of everything from the Model 11 pick-up to the de Luxe Super-het. Ten Autoradiogram. It is a very handy catalogue of the high spots of the H.M.V. range, and will interest everybody who is thinking of buying something new in radio, no matter whether it is a loud-speaker or a radio gramophone. Free copies of this folder are obtainable through my catalogue service. **898**

**The Milnes Unit**

I see that the Milnes Radio Co. is so busy in the production of the novel Milnes H.T. supply unit that new premises have had to be taken in Church Street, Bingley. The unit consists of a special type of H.T. accumulator. There is a useful booklet available describing the scheme. **899**

**Matched Speakers**

Matched speakers are all the fashion these days. I see that Epoch moving-coil speakers are now available in matched pairs. The following types are available in this form, 20C, J1, A2, B5, and E8. There is no extra charge for the balancing and full details of these speakers are given in the latest Epoch literature. **OBSERVER. 900**

# WHY

## ROB YOUR SET OF THE H.T. IT DESERVES ?

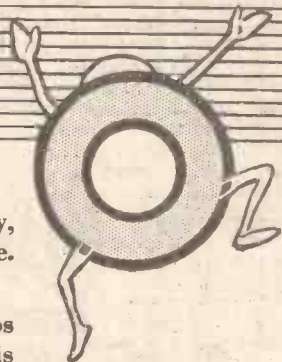

When you throw away an old H.T. Battery, you throw away voltage you cannot use. You are wasting money.

The Lively 'O' H.T. Accumulator stops waste—definitely! From the moment it is charged, up to the time it needs recharging, it is full of power-giving life—full of powerful energy—full of punch! No self-discharge—no leakage—its "Air-Spaced" cells are leakage-proof. The Lively 'O' H.T. Accumulator gives you constant voltage. Smooth, silent current—power that never varies. Isn't that the kind of H.T. supply you've always wanted? Your dealer stocks the Lively 'O' H.T. Accumulator.

Oldham & Son Ltd., Denton, Manchester, Estd. 1865, and at London, Glasgow, Belfast & Dublin

**TWO TYPES**

Standard 10 volt unit capacity 2,750 milliamps - **5/6**  
 Extra large capacity 5,500 milliamps (10 volt unit) - **6/9**

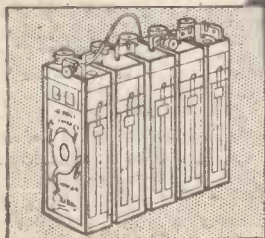

# The Lively 'O'

## H.T. ACCUMULATOR



**CHOSEN for the 'NEW A.C. CENTURY SUPER'**

**HEAYBERD**

Model 717 Transformer was designed to the specification of "Amateur Wireless" experts and exclusively specified by them for the "New A.C. Century Super." It is significant that whenever a really first-class job is required, set designers always enlist the aid of Heayberd—the Mains Specialists. Order your 717 Transformer now and build this set for Christmas. SPECIFICATION: Finest steel and wire. Special metal end-plates protect the core. Strongly clamped laminations. Excellent voltage regulation. Negligible temperature rise. More than adequate insulation.

**SECONDARY OUTPUTS**

- 250 + 250 volts, 60 ma.
- 2 + 2 volts, 1 amp.
- 2 + 2 volts, 6 amps.

Price - 34/-

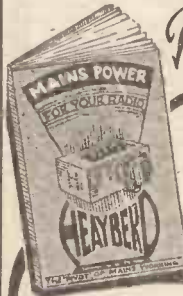

**Post Coupon**

for Heayberd handbook on Mains Working

I enclose 3d stamps for New Handbook of Mains Equipment. Packed with Technical Tips, Service Hints and diagrams

Mr. \_\_\_\_\_  
Address \_\_\_\_\_

**F.C. HEAYBERD & Co.**  
10 FINSBURY STREET, LONDON, E.C.2  
One minute from Moorgate Stn

**VALVES LESS than Half-Price!**



**MANUFACTURER'S FULL GUARANTEE!**

Improve your set with the BRITISH MADE "ION" valves, backed by 10 YEARS Manufacturing Experience. These valves are used by the most prominent set makers. Satisfaction guaranteed or money refunded.

- H.F. & Det. 2 & 4 volts. . . 2/11
- L.F. & Det. . . . . 2/11
- Det. & R.C. . . . . 2/11
- Power . . . . . 3/6
- Super Power . . . . . 4/8
- Screen Grid . . . . . 7/8

Also A.C. MAINS VALVES.  
Postage and packing 4d. C.O.D. Extra.  
**SYNERGY SYNDICATE**  
43 JOHNSON ST., WESTMINSTER, S.W.1

**RADIO SUPPLIES**

Send your list of Radio needs for our quotation. Kits, Parts, Sets, etc. Everything in Radio stocked. Prompt delivery; seven days approval. Catalogue free. Taylor and Standard Wet H.T. replacements stocked.

**A. TAYLOR, 67 STUDLEY ROAD, STOCKWELL, LONDON**

**FULL-SIZE BLUEPRINTS**

When ordering, please send Postal Order, NOT STAMPS.

**CRYSTAL SET (6d.)**

1931 Crystal Set . . . . . AW308

**ONE-VALVE SETS (1s. each)**

- Easy to Build One . . . . . AW304
- Short-wave One-valver . . . . . AW327
- B.B.C. One-valver . . . . . AW344
- Portable Short-wave One . . . . . AW354

**TWO-VALVE SETS (1s. each)**

- 25/- Two (D, Trans) . . . . . AW330
- Ten-Station Two (D, Trans) . . . . . AW336
- Inexpensive A.C.2 (D, Trans) . . . . . AW346
- Midget Two (D, RC) . . . . . AW348
- Mascot Two (D, Trans) . . . . . AW353
- Ideal Regional 2 (D, Trans) . . . . . AW357
- Quality 30s. Two (D, Trans) . . . . . AW361
- Ether Music Two (D, Trans) . . . . . AW364
- Economy A.C. Two (D, Trans) . . . . . WM286
- A Two for 7 Metres (D, Trans) . . . . . WM295
- New-style Radiogram (D, Trans) . . . . . WM299

**THREE-VALVE SETS (1s. each)**

- New Favourite Three (D, RC, Trans) . . . . . AW334
- Home-Lover's All-electric 3 (SG, D, Trans) . . . . . AW335
- P.W.H. ("Mascot" D, RC, Trans) . . . . . AW337
- Home-Lover's Battery 3 (SG, D, Trans) . . . . . AW341
- 18 Radiogram (SG, D, Trans) . . . . . AW343
- New Regional Three (D, RC, Trans) . . . . . AW349
- World-Ranger Short-wave Three (D, RC, Trans) . . . . . AW355
- Wizard (SG, D, Trans) . . . . . AW360
- £2 2s. Family Three (D, 2 Trans) . . . . . AW368
- Percy Harris A.C. Radiogram (D, RC, Trans) . . . . . WM294
- Prosperity Three for Batteries (SG, D, Trans) . . . . . WM296
- 1933 Economy S.G. Taree (SG, D, Trans) . . . . . WM306

**FOUR-VALVE SETS (1s. 6d. each)**

- Four Star 4 (SG, D, RC, Trans) . . . . . AW318
- Up-to-the-Minute Four (2 SG, D, Trans) . . . . . AW356
- Your Home Radiogram, (SG, D, RC, Trans) . . . . . AW358
- Economy Radiogram (SG, D, RC, Trans) . . . . . WM276
- Triple-tune Four (2 SG, D, Trans) . . . . . WM293
- Calibrator (SG, D, RC, Trans) . . . . . WM300
- Table Quad (SG, D, RC, Trans) . . . . . WM303

**FIVE-VALVE SETS (1s. 6d. each)**

- James Short-wave Super (Super-het) . . . . . AW328
- Simple Super (Super-het) . . . . . AW340

**SIX-VALVE SETS (1s. 6d. each)**

- New Century Super (Super-het) with copy of A.W., 4d., post free . . . . . AW363
- New A.C. Century Super (A.C. super-het) . . . . . AW365
- Ideal Home Super (Super-het) . . . . . WM280
- Easytune 60 (Super-het) . . . . . WM284
- 1932 A.C. Super 60 (A.C. Super-het) . . . . . WM272

**SEVEN-VALVE SETS (1s. 6d. each)**

- Super Senior (Super-het) . . . . . WM256
- Seventy-Seven Super (A.C. Super-het) . . . . . WM305

**PORTABLES (1s. 6d. each)**

- Hiker's Two (D, Trans) (1/-) . . . . . AW345
- General-purpose Portable (SG, D, RC, Trans) . . . . . AW311
- Town and Country Four (SG, D, RC, Trans) . . . . . WM282
- Everybody's Portable (5-valve super-het) . . . . . WM291

**AMPLIFIERS (1s. each)**

- Universal Push-pull Amplifier . . . . . AW300
- "A.W." Record Player (L.F. Push-pull) . . . . . AW319
- The Battery-operated Amplifier . . . . . AW362
- A-P-A (Power Amplifier for A.C. Mains) . . . . . WM275
- A-P-A Radio Unit (SG, D.) . . . . . WM281

**MISCELLANEOUS (1s. each)**

- Short-wave Plug-in Adaptor (6d.) . . . . . AW326
- Short-wave Super-het Adaptor (6d.) . . . . . AW329
- Ether Searcher Radio-gramophone Motor Board . . . . . AW333
- "A.W." Short-wave Adaptor . . . . . AW339
- "Mascot" Mains Unit . . . . . AW350
- "A.W." Trickle Charger . . . . . AW352
- Add-on Band-pass Unit . . . . . AW359
- Short-wave Adaptor for New Century Super . . . . . AW367
- A Simple Mains Unit . . . . . WM1385
- Voltage Regulator . . . . . WM287

Copies of the "Wireless Magazine" and of "Amateur Wireless" containing descriptions of most of these sets can be obtained at 1s. 3d. and 4d. respectively, post free. Index letters "A.W." refer to "Amateur Wireless" sets and "W.M." to "Wireless Magazine."

Address letters: **Amateur Wireless Blueprints Dept.,** Ft. St. Fetter Lane 3, London, E.C.4

**"Amateur Wireless and Radiovision." Price Threepence.** Published on Wednesdays and bearing the date of Saturday immediately following. Post free to any part of the world: 3 months, 4s. 6d.; 6 months, 8s. 9d.; 12 months, 17s. 6d. Postal Orders, Post Office Orders, or Cheques should be made payable to "Bernard Jones Publications, Ltd."

General Correspondence is to be brief and written on one side of the paper only. All sketches and drawings to be on separate sheets. Contributions are always welcome, will be promptly considered, and if used will be paid for. Communications should be addressed, according to their nature, to The Editor, The Advertisement Manager, or The Publisher, "Amateur Wireless," 58-61 Fetter Lane, London, E.C.4

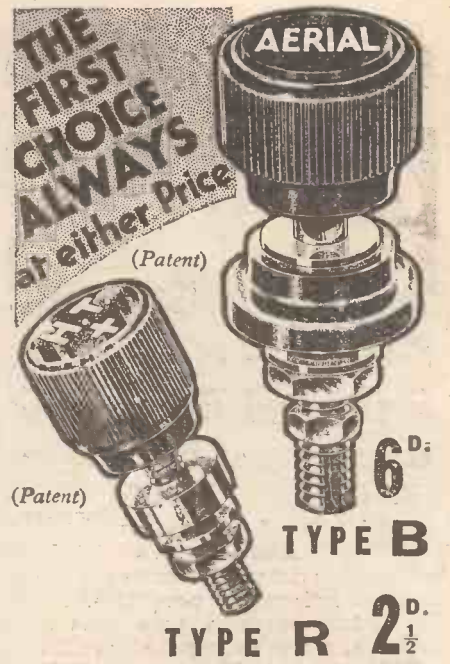

TYPE "B" Non-rotating name. Extra large clamping area. Cross-hole for solid tags or wire. Slot and nut to eliminate soldering. TYPE "R." Rotating name.

Write for "Radio Connections"—FREE

**BELLING-LEE FOR EVERY RADIO CONNECTION**

Advert. of Belling & Lee, Ltd., Cambridge Arterial Road, Enfield, Middlesex.

**EASY PAYMENTS**

"There's no place like HOLMES." The first firm to supply wireless parts on easy payments. Eight years advertiser in "Amateur Wireless." Thousands of satisfied customers.

We unhesitatingly recommend—  
**EPOCH 4/10**  
20th CENTURY P.M. Speaker  
Deposit 7 payments of 4/10

The best in its Class

Any Epoch Speaker supplied on Hire Purchase.

	Deposit	Monthly Payments
LISSEN SKYSCRAPER KIT	89/6 8/3	11 of 8/3
TELSEN AJAX 3 KIT	61/6 6/9	9 of 6/9
R.R. 303 KIT, with Valves	70/- 7/9	9 of 7/9
LOTUS KIT	39/6 5/5	7 of 5/5
COSSOR KIT 334	£67/6 10/-	11 of 11/10
EXIDE H.T. ACCUM. 120 v.	£3 6/-	9 of 6/8
BLUE SPOT 66R and Chassis	£22/8 5/6	9 of 5/6
BLUE SPOT 100U	32/6 4/5	7 of 4/6
CELESTION M.C. SPEAKER	47/6 5/3	9 of 5/3
EPOCH MINOR P.M.	27/6 5/1	5 of 5/1

Parts for any Kit Set. Any make of Speaker. New Goods Obtained for Every Order. Send us a list of the parts you require and the payments that will suit your convenience, and we will send you a definite quotation. Anything Wireless.

**H. W. HOLMES, 29, FOLEY STREET Great Portland Street, London, W.1**  
Phone: Museum 1414.

£5 Radio-Gram CABINET for 65/- 7 DAYS' FREE TRIAL (OR 10/- MONTHLY.)  
Polished Oak and Piano finish! The acoustic Tone brings a fine thrill. Makers to Radio-Press, B.B.C., 8,000 clients. Other Models 35/- to £15. Photographs and List FREE.  
**PICKETTS** Piano-Tone Cabinets, (A.M.) Albion Road, Bexleyheath.

**REPAIRS** to Loudspeakers 4/-. Blue Spots 5/-. Transformers 4/-. Moving Coils, etc. quoted for. Prompt Service. 12 months guarantee. Trade Invited. Streatham 6618.  
**Loud-speaker Repair Co., 2 SHIPKA ROAD, Balham, London**



**THE WORLD'S BEST**

**20** MA AT 20v  
**AC** MAINS 200-250  
**45**

**50% CHEAPER**  
**25% BETTER**  
than any other make

ONE VARIABLE AND 3 FIXED WIRE WOUND RESISTANCES ONLY



ALL BAKELITE CASES

RUNNING COST

1d. PER MONTH

**OTHER MODELS**

- A.C.2 Same as A.C.1, but with Trickle Charger 60/-
- A.C.3 150 v. 30 mA. 4 v. Raw A.C. 60/-
- A.C.4 Same as A.C.3, but with Trickle Charger 75/-
- A.C.5 200 v. 50 mA. 4 v. Raw A.C. 70/-
- D.C.2 140v. 35 mA. One Variable, three fixed 35/-

**WESTINGHOUSE METAL RECTIFIERS**

D.C.1 25 mA. OUT-PUT. For 150v. or 230v. Mains 22/6

10% Deposit and balance monthly, will secure any Bullphone Eliminator. Ask your local dealer for particulars or write direct to address below.

**NIGHTINGALE 3-VALVE RECEIVER**

We have only a limited number of these famous receivers for disposal at this price. All bakelite base, size 18 x 9 x 8. Make sure of being one of the lucky owners of this receiver, undoubtedly the greatest prize at our price ever, offered in radio. Ask your dealer or send cash direct—but don't miss it.

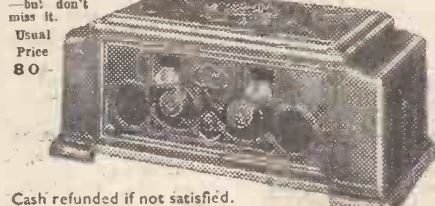

Cash refunded if not satisfied.  
The Technical Staff of "Amateur Wireless" highly recommend Bullphone Eliminators and components for all their circuits. Don't be put off with any other make. There is no other as good, not at double the price. If your dealer cannot supply send direct.

**BULLPHONE RADIO**  
NEW NORTH RD., BARKINGSIDE, ESSEX  
PHONE CHIGWELL 102

**OUR LISTENING POST**

By JAY COOTE

WHAT might have been expected has come to pass: Leipzig's 120-kilowatt broadcasts are causing trouble. Protests have been lodged with the U.I.R. (Union Internationale de Radiodiffusion) at Geneva by Roumania. Listeners, even in Bucharest, complain that the German transmissions completely mar their reception of the local programmes. In addition, France protests that the Breslau and the Poste Parisien stations are far too "neighbourly," and here in Great Britain we are able to witness (orally) the collisions which take place nightly between these two newcomers.

On the Continent suggestions have been put forward to the effect that either Leipzig should exchange wavelengths with Berlin-Witzleben (419 metres), in the hope that the latter's low power would solve the problem, or that the German station should revert to its original channel, namely, 259.3 metres, now taken by Frankfurt-am-Main. I fancy that Great Britain would have something to say to the latter proposal, as Leipzig in that position would cause a bad mix-up with London National. We should then see a recurrence of the Muhlacker-London Regional trouble with more unpleasant results. On the other hand, with Leipzig on 715 kilocycles and Moscow and Madrid only 8 kilocycles away, the position would not be much improved. Tough little nuts for the U.I.R. to crack!

The Soviet authorities are also juggling with radio channels to find suitable seats for their new stations. During the past week or so a general move has taken place. The old Komintern station has adopted the Leningrad wavelength, and the latter may now be heard on 857.1 metres (351 kilocycles), namely, just below Croydon airport and the aviation services; Moscow (T.U.) remains on 1,304 metres, and the 1,481-metre channel is being kept free for the Noghinsk 500-kilowatt. Here, again, bad overcrowding is likely to take place, as already it is a difficult matter to keep Warsaw clear of Eiffel Tower, and another big station at 5 kilocycles from the latter will not make matters more comfortable.

**Christmas Broadcasts**

On Christmas Eve we may be given the opportunity of hearing a very interesting broadcast. It is reported that the National Broadcasting Company of America has concluded arrangements for the relay of a sacred service from the Franciscan Church at Bethlehem (Palestine) through Jerusalem and possibly Cairo. The transmission will be put over the N.B.C. network, which includes the Schenectady, Pittsburgh, and Boundbrook short-wavers. For the benefit of Europe, I understand, there is a strong possibility that Nauen or Zeesen may pick up the broadcast and pass it on to several high-power stations in Germany.

Have you logged the trial tests by the new Munich transmitter? They are strong signals and the station should prove a good channel for the Bavarian programmes. Up to date, satisfactory reception of these entertainments could only be secured through Nurnberg.

If you want to know what the Radio Toulouse 60-kilowatt sounds like in comparison with the plant at present in operation, tune in to St. Agnan on 385 metres after midnight on Sundays or during the week at the end of the day's programmes. Undoubtedly the quality is better than what we have been accustomed to hear, but I do hope that we shall get from this station something different to the everlasting old gramophone records and advertisements.

**New Times Sales Co.**  
EST. 1924



**EVERYTHING CARRIAGE PAID**

- LISSEN SKYSCRAPER S.G.3 CHASSIS KIT. Cash or C.O.D., £4/9/6, or 12 monthly payments 8/3
- LISSEN SKYSCRAPER S.G.3 COMPLETE KIT. Cash or C.O.D., £6/5/-, or 12 monthly payments 11/6
- COSSOR MELODY MAKER MODEL 334. Cash or C.O.D., £6/7/6. First payment balance 11 monthly payments of 11/10 10/-
- COSSOR MELODY MAKER MODEL 335. Cash or C.O.D., £7/17/6. First payment, 11 monthly payments of 14/10 10/-
- SLEKTUN SCOUT S.G.3 CHASSIS KIT. Cash or C.O.D., £3/19/6, or 12 monthly payments 7/3
- STATION MASTER 3-CHASSIS KIT. Cash or C.O.D., £5/11/-, or 12 monthly payments 10/2
- KENDALL-PRICE S.G.4 CHASSIS KIT. Cash or C.O.D., £4/8/6, or 12 monthly payments 8/-
- READY RADIO MELOD S.G.3. Cash or C.O.D., £8/17/6, or 12 monthly payments 16/3
- BLUE SPOT 99 P.M. Cash or C.O.D., £2/19/6, or 12 monthly payments 5/6
- EPOCH 20C PERMANENT-MAGNET MOVING-COIL SPEAKER. Cash or C.O.D., £1/15/-, or 6 monthly payments 6/6
- W.B. PERMANENT-MAGNET MOVING-COIL SPEAKER TYPE P.M.2. Cash or C.O.D., £4/5/-, or 12 monthly payments 7/9
- W.B. PERMANENT-MAGNET MOVING-COIL SPEAKER TYPE P.M.4. Cash or C.O.D., £2/2/-, or 8 monthly payments 5/9
- R. & A. VICTOR PERMANENT-MAGNET MOVING-COIL SPEAKER DE LUXE. Cash or C.O.D., £3/10/-, or 12 monthly payments 6/5
- BLUE SPOT SPEAKER TYPE 100U. Cash or C.O.D., £1/12/6, or 7 monthly payments 5/2
- R. & A. "CHALLENGER" P.M. MOVING-COIL SPEAKER. Cash or C.O.D., £1/15/3, or 6 monthly payments 6/6
- SONOCORDE PERMANENT-MAGNET MOVING-COIL SPEAKER. Cash or C.O.D., £1/12/6, or 6 monthly payments 6/-
- CELESTION P.P.M. MOVING-COIL SPEAKER. Cash or C.O.D., £2/7/6, or 12 monthly payments 4/6
- EOLA PERMANENT-MAGNET MOVING-COIL SPEAKER TYPE F.6. Cash or C.O.D., £2/9/6, or 12 monthly payments 4/6
- ATLAS ELIMINATOR TYPE A.C.244. Cash or C.O.D., £2/19/6, or 12 monthly payments 5/6
- EKCO H.T. ELIMINATOR A.C.18. Cash or C.O.D., £3/7/6, or 12 monthly payments 6/3
- HEAVYBERD H.T. UNIT D.160. Cash or C.O.D., £4/8/-, or 12 monthly payments 8/10
- GARRARD INDUCTION MOTOR MODEL 292. Cash or C.O.D., £2/10/-, or 12 monthly payments 4/7

Miscellaneous Components, Accessories, etc., supplied CASH, C.O.D., or H.P. on our own Private System of Easy Payments. Any items advertised in this journal sent C.O.D. If value over 10/- sent all C.O.D. charges paid.

To NEW TIMES SALES CO., 56 Ludgate Hill, London, E.C.4.  
Please send me (a) Your 1933 Catalogue  
(b)..... for which I enclose  
first payment of £.....d.....  
Name.....  
Address..... A.W.10/12/32

**SAFEST FOR EASY TERMS**

Send FIRST PAYMENT with order and ensure PROMPT DELIVERY

**PREPAID ADVERTISEMENTS**

Advertisements under this head are charged **THREEPENCE PER WORD**, minimum charge **THREE SHILLINGS**. DEPOSIT SYSTEM. As the publishers cannot accept responsibility for the bona fides of advertisers in this publication, they have introduced a system of deposit which it is recommended should be adopted by readers when dealing with persons with whom they are unacquainted.

The amount of the Deposit and Fee must be remitted by Postal Order or Registered Letter (Cheques cannot be accepted), addressed to, "AMATEUR WIRELESS", ADVERTISEMENT DEPARTMENT, 58/61 FETTER LANE, LONDON, E.C.4

**THE RADIO INDUSTRY.**—During the past twenty years I have placed nine hundred students in good permanent posts. I have devised a Home Study course, followed, if desired, by two weeks practical training. Prospectus free.—H. F. Yardley, M.I.R.E., A.I.E.E., Northern Counties Wireless School, Preston.

**COMPLETE KITS** for the "New A.C. Century Super," or separate components supplied on special terms; also Speakers Batteries, Mains Units; cash or C.O.D.—Highbury Supply Stores, 44 Highbury Hill, N.5.

**NEW EDITION RELIABILITY WIRELESS GUIDE.**—Solves Christmas problem—What should I give?

**NEW EDITION RELIABILITY WIRELESS GUIDE.**—Describes on page 23 Stupendous free gift.

**NEW EDITION RELIABILITY WIRELESS GUIDE.**—Complete Constructor's Encyclopedia detailing principal advertised components. Traders supplied.

**NEW EDITION RELIABILITY WIRELESS GUIDE.**—Incorporating Station Log sent post free.—J. H. Taylor and Company, 3 Radio House, Macaulay Street, Hudds.

**MET-VICK A.C. ELIMINATORS.** Guaranteed new. Complete with UU60/250 Mazda valves, suitable for screen-grid three or four-valve receivers. Output, 200 volts 30 m.a. Automatic bias, etc., 47/6. Carriage paid, C.O.D. or cash with order. Send for list of other unused bargains.—Seekamp, 46 Farringdon Street, London, E.C.4.

**B.T.H. R.K. MOVING-COIL SPEAKERS.** Guaranteed new, unused. Manufacturers' surplus. Original price, 6 guineas. Highly sensitive and wonderful tone response. Will handle up to 10 watts output. Available for 6 v., 100 v., 200 v., 30/- . Also A.C. models, £2/10/- . Carriage paid, C.O.D. or cash with order. Send for list of other unused bargains.—Seekamp, 46 Farringdon Street, London, E.C.4.

**EDISWAN POWER PENTODE TWO A.C. Mains Receiver,** £5/10/- . Listed at £12/10/- . Guaranteed brand new. Complete with new Mazda valves, AC/HL, AC/PEN, and UU60/250 rectifier valve. A modern receiver with a high output, suitable for operating a moving-coil speaker on radio or gramophone. Carriage paid, cash with order or C.O.D.—Seekamp, 46 Farringdon Street, London, E.C.4.

**CHARGE YOUR H.T. FROM YOUR L.T. AT HOME.**—Combination trickle. Charges efficiently 1 to 12 H.T. 10-volt accumulators, 10/6. Postage 6d. Diagram only, 1/6.—R. Fox, 188 Camberwell Grove, S.E.5.

**A TONIO** prevents your 2-volt accumulator from becoming "run down." See advert.

**1933 RECEIVERS, KITS, COMPONENTS.** Cash or H.P. Amazingly high part exchange allowance; any type of set or component accepted. Send description, also details of receiver or components required; quotation immediately.—Wood, Fowlcotes Buildings, Holcombe Brook, near Bury, Lancs.

**BUILD SETS FOR FRIENDS** and make money.—Page, 42 Moray Road, London, N.4.

**EVERYBODY KNOWS SIMMONS.**—Sale of Showroom Samples. Ostram 4, £7/10/- . P.M. Speakers, Valves, Components. Stamp for list.—Simmons Radio Supplies, 9 Alfracoop Avenue, Southend-on-Sea.

**CONSTRUCTORS' BARGAINS!** Eliminators, D.C. 25/6; A.C., 42/6. P.M.M.C. speakers, 22/3. Quotations for anything.—Childs, 29 Moray Road, London, N.4.

**PHOTO ELECTRIC CELLS** potassium, guaranteed, for home talkies, light-sensitive relays, etc., 15/- each, postage paid. Sound Installation Services' Ltd., 14 Carlisle Street, W.1.

**"MY SET IS THE BEST,"** so say all designers, but our laboratory tests tell the truth. Unbiased opinion and advice on sets described or manufactured. Write us and save pounds. Fee, 2/6.—Radio Research Laboratories, Austin Friars, Newport, Mon.

**BUILD OWN GRAMO OR RADIO.** Lists of Kits, Cabinets and Parts Free. Terms arranged. Instructions, 3d.—A. W. Burt, 185 High Street, Deptford, S.E.8.

**WIRELESS COMPONENTS.**—All makes supplied. Also Cabinets.—Imperial Radio, 18 Summerhill Street, Birmingham.

**BANKRUPT BARGAINS.**—List free with three-valve diagram. Three-valve kit, 22/6. S.T.400, 50/- . S.T.300, 42/- . Alternative kits: Century Super, 75/- ; Simple Super, 25/10/- ; New Century Super, £4/17/6. Speaker kits from 8/6. Speaker units from 2/6. Transformers from 2/9. 0005 S.M., 3/6. 0005 mica, 10d. H.F.C., from 1/- . Fixed, 5d. Leaks, 5d. Dual coils with switch and base, 3/6. Switches, 4d. Valve holders, 4d. P.M. M.C., 22/6. D.C. Mains, 18/6. S.M. dials from 1/3. 0005, 2/- . All smaller parts in stock. S.T.400 coil, 5/6. Coil, 6d. Screens, 1/- . Diffs., 1/9. 006, 1/- . Panels, 14 by 7 in., 2/3. All goods offered are modern and of good quality. No junk in spite of prices. Old components taken in part exchange. Get my offer. Good A.C. or D.C. mains sets, 3-valve 2 S.G., pentode, with M.C. speaker, walnut cabinet complete £7/10/- . Latest model. Anything radio.—Butlin, 143b Preston Road, Brighton.



No H.T. Batteries needed with a **SUPERSEDER** even if you are *not* on the mains.

Reduced from £3 15s. to:— **37/6** from us only

It gives three voltages of D.C. from your filament battery, and lasts indefinitely. The Superseder is an S. G. Brown boon and blessing to H.T. battery users.

1,000 bargains in our new Sale List. **ELECTRADIX RADIOS** 218, Upper Thames Street E.C. 4.



GET ONE FOR XMAS

ONLY 25/-

A good set needs a good Speaker. Whatever you pay you cannot buy a Speaker of more beautiful tone or handsome appearance than the BURTON here illustrated. In Figured Walnut Cabinet with silk-lined fret.

Obtainable from leading dealers everywhere. Made by C. F. & H. BURTON, PROGRESS WORKS, Walsall.

**LOUD SPEAKER REPAIRS**

Any make Unit, Transformers, etc., from 3/- ; Blue Spots, 5/- ; Moving Coils, Eliminators, etc., from 5/- . Repairs guaranteed laboratory tested and returned C.O.D. post. Special trade terms or by contract.

**WEEDON POWER LINK RADIO CO.**, 185 Earlham Grove, London, E.7. (Phone: Maryland 4344).

**EARN MONEY AT HOME**

Making "Everlast" Leather Matting for us **FINISHED WORK BOUGHT AT FIXED RATES.** EXPERIENCE NOT NECESSARY.

Suitable either sex. Write Dept. D420.

**ARNOLDS (Wellingborough) Ltd., Wellingborough.**

**DESIGNS FOR APPARATUS FOR ANY RADIO PURPOSE, INCLUDING TRANSMISSION. OVERSEAS ENQUIRIES INVITED: ANY APPARATUS SUPPLIED. CONSTRUCTIONAL WORK UNDERTAKEN.**

We undertake to solve your Problems, including obtaining Amateur Transmitting Licence. Whatever your difficulty, write us. Charges: 3/- per query, four or more, 2/6 each, with diagram.

**Radio Technical Agency, (Dept. A.W.), 2, Westgate Chambers, Newport, Mon.**

**TAYLEX WET H.T. BATTERIES**

Give long service, improved volume and tone. Very economical Replacements for Taylex or Standard batteries at low prices; details post free. Also Bargain List; Radio Kits and parts at lowest prices.

**A. TAYLOR, 57 STUDELEY ROAD, STOKEWELL, LONDON.**

**THE "TONIC"** keeps any make 2-volt Accumulator fully charged at home. Electric mains unnecessary. Ideal for remote places. 7/- each, postage 9d. Particulars, copies of testimonials, etc., with pleasure.—Williams, Nethercrod, Cradley, Birmingham.

**SEND FOR COMPLETE RADIO CATALOGUE**, 129 pages, 1/3, post free. Oak Cabinets, beautifully finished, hinged lid, 14 by 7 by 10 in., 7/9; 16 by 7 or 8 by 10 in., 8/- ; 18 by 7 by 10 in., 8/9. Baseboard, 9d., C.P. Hundreds sold. Other sizes made. Cabinet lists free. Speaker Cabinets from 5/6; Stand, 30/- . Radio-gram, in oak, 37/- . State nearest station.—F. S. Gibson, 99 Burnley Road, Ainsdale, Lancs.

**SERADEX RADIO.** Lists of chargers, meters, resistances, condensers, chokes, transformers, etc., for stamp.

**SERADEX BATTERY CHARGER (FOR A.C. MAINS)**—Type M.R.610 Westinghouse rectified. Output variable up to 6 volts at 1 amp., £1 8s. 6d. Ammeter, 7s. 6d. extra.

**SERADEX TYPE B FILTER-CONDENSERS**, 400 v. working. 1 mfd., 1/6; 2 mfd., 2/3; 4 mfd., 4/5; 4x4 mfd., 7/3; 8x8 mfd., 14/6. (Last two specially suitable for Westinghouse Voltage-doubler.)

**SERADEX MOULDED 14-WATT RESISTORS.** Most values 100-ohms to 2 megs, 8d. each, 7s. 6d. dozen.

**SERADEX GLASSWOUND** (all wire-wound) Resistors. Made in most values, in 14, 24, 5 and 8-watt ratings. Prices from 9d.

**CARRIAGE PAID ON ORDERS OVER £2.** Cash or C.O.D. 48 Wakegreen Road, Birmingham, 13.

**MAINS TRANSFORMERS REWOUND**, promptly and efficiently. Satisfaction guaranteed. Keenest terms. The Sturdy Electric Co., Derwent View, Dipton, Newcastle-on-Tyne.

**ENGINEERS** (all grades).—Have you seen the latest edition of "Engineering Opportunities"? In this 250-page book Professor A. M. Low tells of the opportunities Engineers of all descriptions are missing. The book also gives details of A.M.I.Mech.E., I.E.R.E., M.I.M.T., G.P.O. and all other Exams. and outlines Modern Home-study Courses in all branches of Civil, Mech., Elec., Aero., Radio, Motor, and "Talkie" Engineering. We alone guarantee "No Pass—No Fee." You cannot afford to neglect this offer. Send for free handbook now.—British Institute of Engineering Technology, 109 Shakespeare House, 29-31 Oxford Street, London.

**BARGAIN.**—Unused 5-guinea Service Stainless Cutlery. Knives, Forks, Spoons, etc. 60 pieces. 42/- . Particulars, approval.—"Box 4," "Amateur Wireless," 58 Fetter Lane, London, E.C.4.

**TRANSFORMER STAMPINGS, INSTRUMENT WIRES**, etc.—Lumen Electric Co., 9 Scarisbrick Avenue, Litherland, Seaforth, Lancs.

**TRICKLE CHARGERS**, A.C. mains, for 2-volt accumulators, 0.5 amp., no upkeep, 18/6, carriage paid.—A. Benoit, 4 Manor Gardens, Gunnersbury Avenue, London, W.3.

**GILBERT INDUSTRIES** offer following guaranteed bargains, all post paid. Heayberd Chokes, type 757, 50h. 150 m.a., new and boxed, 10/- . Tapped 2-ratio pentode Chokes, heavy, 4/6. 20 h. 10 m.a. Eliminator Chokes, 2/6. Polymet 8-mfd. 435 v. working voltage Electrolytics, 4/- . Special Mains Transformer, input 210, 230, 250; output, 2 v. 4 amp. C.T., 4 v. 2 amp., 325-0-325 at 85 m.a., 15/- .—Gilbert Industries, 519 London Road, Westcliff-on-Sea.

**"UNIVERSAL" RADIO BARGAINS.** All Brand New and Boxed. Switches 6d.; 3-point Wave-change, 10d.; Tumbler, 8d. Valve Holders, 4d.; 6-pin Dual Coils, 2/9; Baseboard Duals with Switch, 2/11. S.T.300 Coils, 5/11; 400, 6/9 pair. Speaker Units, 2/11; Cone Chassis, 3/11. Bakelite Transformers, 2/8. Ebonite Panels from 2/5. Screens, 1/- . Double-reading Voltmeters, 2/11. Disc Chokes, 1/- ; Binoculars, 1/6. Accumulators, 2/6; Unspillable, 6/11. Batteries, 60 volt, 4/3, 90, 6/6; 120, 8/3; Bias, 9d. Geared Dials, 1/- . Volume Controls, 2/6. Illuminated Disc Drives, 2/- . Air-spaced Variable Condenser, 1/11; with Vernier, 3/9; Fixed, 5d.; Leaks, 5d. Differentials, 1/7. Mansbridge Bakelite, 1-mfd., 1/4; 2-mfd., 1/11. Indoor Aerials, 6d. Engraved Terminals, 2d. Walnut Cabinet Speaker, 9/3. P.M. Moving-coil Speakers, with Transformer, 19/11. Pick-ups, 5/11. Earth Tubes, 1/6. Kits: Straight 3, 22/- ; S.T.300, 41/6; S.T.400, 56/6. Selected Kits: New Century Super, £5/12/- ; Wizard, 49/- ; Quotations for any other. Thousands of other Bargains. Lists Free. "Universal," 20 Victoria Road, Peckham, S.E.15. Back of Tower Cinema.

**BUILD SETS FOR FRIENDS** and make money.—Page, 42 Moray Road, London, N.4.

**RADIO BARGAINS.**—1933 New Sets for Old (part exchange). Address full particulars—Radio, 60 Drayton Bridge Rd., London, W.7.

**WALL TELEPHONES**, magneto ringing, 12/6; pedestal telephones 7/6; 50-line tel. phone exchange, large size, 30/- ; telephone magnetos, 4/- ; automatic dial with switching, 2/- ; microphones 1/- , 2/6 and 4/6; transformers 2/6 and 4/6; buzzers, 2/3; morse keys, 4/6.—Below.

**DYNAMOS** for accumulator charging or lighting from a quarter to 4 kilowatts, low prices, also voltmeters, amp-meters, regulators, cut-outs, rheostats, switches, etc.—Below

**TWO-VALVE TRANSMITTERS** with valves, 17/6; two-valve receivers, no valves, 10/- ; 10-inch spark coil, £3 10/6; 2-inch, 17/6.—Below.

**LARGE SWITCH BOARD**, three meters, relays cut-out, all necessary fittings, £5; new transformer, 100v. A.C. to 10,500v., 25/- ; new five-line Fullerphone exchange, 45/- ; battery model, microphone amplifier for public address, 50/- .—Below.

**GALPIN**, 23 Tyrwhitt Rd., Brockley, London, S.E.4. Terms strictly cash with order or C.O.D. (charges extra), three days approval from date of delivery. All goods guaranteed, nearest station. St. Johns, Lewisham.

**Amateur Wireless** INFORMATION BUREAU COUPON Available until Saturday DECEMBER 17, 1932 FEE 1/-



PUBLISHED BY THE TELEGRAPH CONDENSER CO

**This Book will save you money**

WITH electric light in the house—  
—with ample power at your elbow, why use costly and inefficient batteries? From the moment you connect your batteries the power starts to decline—reproduction suffers, and soon—replacement! Get a copy of this book—it will tell you how—if you are on A.C. supply—to cut out battery costs and get better and more powerful radio. There is also an interesting and informative chapter on D.C. apparatus. If you have electric light you need this book.

**Ask your Dealer**

If you have any difficulty in obtaining a copy of this book, fill in the coupon and post to us with six penny stamps. We will send you a copy by return.

**CONTENTS**

- RADIO POWER UNITS—and how to build them.
- NOTES ON A.C. POWER UNITS.
- OPERATING RECEIVERS ON D.C. MAINS.
- ABOUT T.C.C. ELECTROLYTIC CONDENSERS.
- ELIMINATION OF INTERFERENCE.
- FOUR T.C.C. POWER UNITS with full constructional Details.
- ROTATING RESISTANCE CALCULATOR.

**T.C.C.**  
ALL-BRITISH  
**CONDENSERS**

1923

**COUPON**

To Publicity Dept., The Telegraph Condenser Co. Ltd., Wales Farm Rd., N. Acton, London, W.3.

Please send me a copy of your book "The Design and Construction of Radio Power Units," for which I enclose six penny stamps to cover cost and postage.

NAME: \_\_\_\_\_

ADDRESS: \_\_\_\_\_

A.W. 10/17/32

PLEASE WRITE IN BLOCK LETTERS

**BALANCED CAPACITY**



**GIVES LONGER LIFE AND HIGHER AMPERE HOUR**

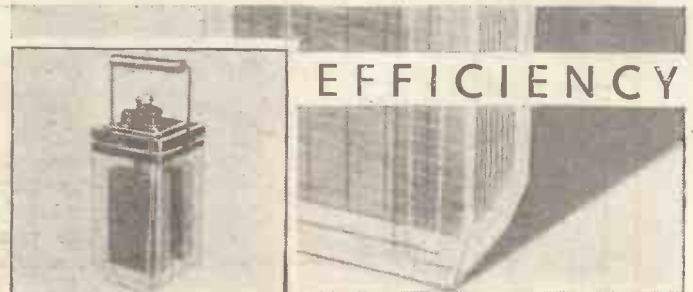

**EFFICIENCY**

- Type E.L.9. 80 a/h capacity **12/3**  
Price - - - - -
- Type E.L.M.4. 45 a/h capacity **8/-**  
Price - - - - -
- Type E.L.S.7. 60 a/h capacity **12/6**  
Price - - - - -

● That's the secret, "balanced capacity," the newest principle in modern accumulator making.

The scientific design of the positive and negative plates which preserves exact electrical "balance" allows this accumulator to be charged more quickly, and to give a longer life per charge. Twenty-five years experience in battery building has gone to produce the Edison Swan "Extra Life" cell. Here are some of the additional refinements incorporated: screwed vents, non-interchangeable and non-corrodible connectors, British made containers of clear glass and metal carriers which fit neatly round the containers.

**EDISWAN**  
*EXTRA LIFE*  
**ACCUMULATORS**



THE EDISON SWAN ELECTRIC CO. LTD.  
155 CHARING CROSS ROAD, LONDON, W.C.2

P.204

Mention of "Amateur Wireless" to Advertisers will Ensure Prompt Attention

# Choose Your Xmas Gifts from the Blue Spot Range!

Naturally you want your Christmas gifts to reflect the esteem you feel for their recipients. That is why you will be certain to give satisfaction if you choose something from the Blue Spot range. Blue Spot products are known and respected throughout the country as the best that money can buy. In spite of their high quality Blue Spot products are not expensive and the range is so wide that you will find an acceptable gift at the price you want to pay.

BRITISH MADE

**100D**  
**52/6**

Here is a speaker that will be prized. Its handsome exterior of first-quality oak is worthy of the movement—the famous 100U—that it shelters. 100D reproduces every word and note to perfection. The whole of the musical range is rendered with clarity and fidelity. It can be used with battery or all-mains sets and with normal or pentode valves. No matching transformer is needed.



**31K**  
**31/6**

Another splendid cabinet in fine quality oak. The movement is the world-famous 66K and its performance is superb. It gives you song and speech and music without a blemish. No better speaker value exists.



**32PM**  
**87/6**

A gift de luxe—from the beautiful cabinet of specially selected walnut to the miraculous 99P.M. movement—the like of which has never been known before. 99P.M. is the last word in moving-coil speakers, giving a purity and richness of reproduction that must be heard to be believed. This wonderful speaker makes broadcast programmes sheer delight.



Ask your dealer to demonstrate these and other products in the Blue Spot range of units, loud-speakers and receivers. If any difficulty send for our Christmas List No. A.W.60S.

*All Blue Spot Products are guaranteed for 12 months and may be purchased by instalments.*

**THE BRITISH BLUE SPOT COMPANY LTD**  
BLUE SPOT HOUSE • 94/96 ROSOMAN STREET • ROSEBERY AVENUE, LONDON E.C.1

Telephone: Clerkenwell 3570. Telegrams: "Bluspot, Isling, London."  
Distributors for Northern England, Scotland and Wales: H. C. RAWSON (Sheffield and London), Ltd., 100 London Road, Sheffield; 22 St. Mary's Parsonage, Manchester; 44-46 High Bridge, Newcastle; 37, 38, 39, Clyde Place, Glasgow.





# WIRELESS

## MADE EASY

### SUPPLEMENT

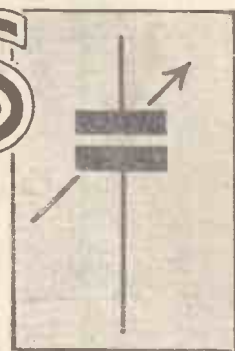

## HINTS AND TIPS FOR WIRELESS BEGINNERS

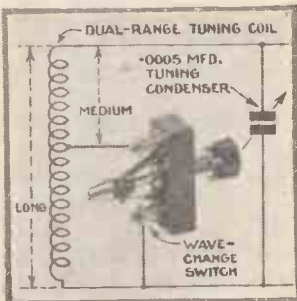

Medium waves are tuned when the larger part of the coil is shorted by the two-way switch

### Dual-range Coils

WITH the aid of a two-point switch, such as is commonly used for battery on-off action, you can easily arrange to switch from medium to long waves with a simple aerial-coil tuning circuit.

The idea is that part of a complete winding is short circuited by means of the switch. When this part is thus removed from action the remaining part acts as a medium-wave tuning coil.

When the switch is opened the short-circuited part comes into action and with the part previously used for medium waves form a large coil suitable for long-wave tuning.

### Keep That Aerial Lead Clear!

EVER so many beginners fall into the trap of running a down lead from the aerial close to the wall of the house. If this is done you will lose signal strength, not because there is any direct current leakage between the insulated lead-in wire and the wall, but because high-frequency current will "jump across" the wire carrying it and the earthed wall.

Wireless signals are oscillating currents of very high frequency and are quite different in behaviour from the direct or alternating currents of, say, a house-lighting system.

The farther you keep the down lead from the wall the less chance is there that the high-frequency current will leak away.

### Getting Better Quality

MANY sets in use to-day could give better quality if the high-tension current flowing through the power valve through the loud-speaker winding, which is normally connected in the anode circuit of the power valve.

It is quite easy for a beginner to make such an alteration. All you need is a low-frequency choke and a 2- or 4-microfarad fixed condenser.

First, it will be necessary to disconnect all the anode leads in the set, which comprise the

are you to get the signal current through the loud-speaker so that it will operate the diaphragm and so produce sounds?

This is also very easy. You connect the loud-speaker in series with the fixed condenser and then connect the two of them between the anode of the valve and low-tension negative.

It is best to connect one terminal of the condenser to the anode and the other terminal of the condenser to one of the loud-speaker terminals. Then the remaining loud-speaker terminal can be connected to low-tension negative.

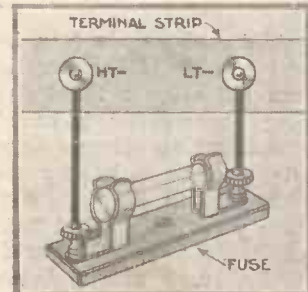

A safe position for the fuse is between the high- and low-tension negative terminals

### Where to Fit Your Fuse

TO save your valve filaments from damage you should fit a fuse. Several questions arise from this advice. First, why do the valve filaments need saving—where is the danger?

Well, if by accident the high-tension battery gets connected across the filaments the high voltage will cause a large current to flow through the filaments and they will be literally burnt out.

How can we stop this current from flowing? Quite easily if, in the high-tension circuit, we fit a device that will carry just the normal amount of current taken from the high-tension battery by the anodes of the valves but that will itself burn out immediately this normal current is exceeded.

A fuse is a kind of very fragile filament, which will burn out long before the current can reach sufficient value to affect the filaments.

The best position for the fuse is in the lead that is common to all the valve anode circuits. Where is that? Why in the connection between the high-tension negative terminals and the low-tension negative terminal.

You will find that these two terminals are joined by a short length of wire. Disconnect this wire and insert the fuse by connecting one of the fuse terminals to the high-tension negative terminal and the other fuse terminal to the low-tension negative terminal.

## CONTENTS OF THIS SUPPLEMENT:

"BUILD AS YOU LEARN" By Percy W. Harris—Pages Two and Three.

ELEMENTARY WIRELESS COURSE for BEGINNERS By J. H. Reyner, B.Sc., (Hons), A.M.I.E.E. and the Staff of "Amateur Wireless"—Pages Four, Five and Seven.

THE BEST AERIALS FOR TO-DAY—Pages Six and Seven.

ABOUT MODERN VALVES—Page Eight.

loud-speaker and the high-tension supply.

The choke replaces the loud-speaker winding. That means

This method of connection will insulate the loud-speaker terminals from the high-tension voltage and will thus prevent

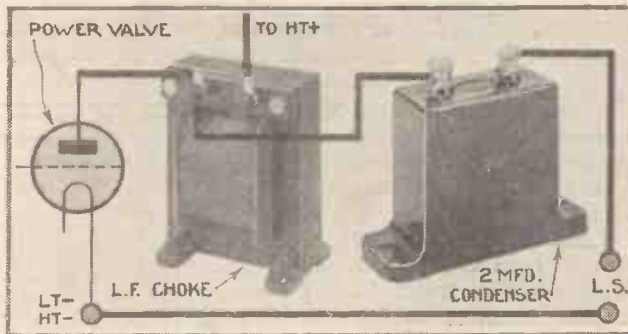

Improved quality is obtained if a choke-capacity filter is fitted to the output of the power valve

one side of the choke winding goes to the anode of the valve, while the other side goes to the high-tension positive terminal.

You now have the anode current flowing through the choke, but how

"shocks" if the power supply goes to the mains. It also enables a loud-speaker extension to be made without carrying the power current round the house.

PERCY W. HARRIS'S

# "BUILD AS YOU LEARN"



*This week Mr. Harris shows you how to make the tuning circuit between the screen-grid and detector valve very selective without losing any power*

Next Week:  
**ALL ABOUT "PARALLEL FEED"**

LAST week we saw how, by providing in the plate connection of the screen-grid valve a tuned circuit consisting of a condenser and an inductance, we could set up voltages across it and apply them to a detector valve in a greatly magnified form. The receiver at the point we reached last week is capable, as you will have found, of receiving very many distant stations on a reasonably good aerial, but the selectivity and stability are by no means good enough for modern conditions.

It would be possible to "trick up" the circuit in such a way as to make it seem stable and by keeping it on the edge of reaction everywhere to obtain sharpness of tuning with a considerable sacrifice of quality. This is not sound radio engineering whatever astonishing results may be obtained.

The low-frequency end of the set is quite stable. What we have to do is to stabilise and improve the high-frequency end. Let us see what happens when we carry out certain experiments.

Firstly we will reduce the coupling between the screen-grid valve and the detector valve.

### What "Tight" Coupling Is

At present you will find, if you have studied the other lessons in this supplement—particularly those which have dealt more with the theory than I have done in this series—that the whole of the tuned circuit is common to both the plate circuit of the screen-grid valve and the grid circuit of the detector valve. The coupling is very "tight," we say.

How can we reduce this "tightness?" A very simple way is to leave the whole of the tuned circuit in the grid circuit of the detector valve and include only a portion of it in the plate circuit of the

screen-grid valve. Fortunately our coil has been so designed that this is very easily done by connecting a crocodile clip to the lead from the plate of the valve and joining it to one or other of

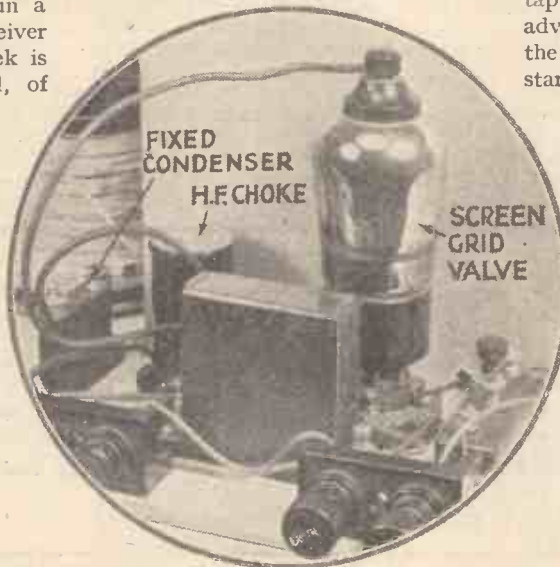

*This "close-up" view of part of the baseboard shows the positions of the high-frequency choke and fixed condenser added for the parallel-feed system of coupling*

the tapings already on the coil.

If you look at the diagrams, you will see a comparison between the method we adopted last week and that I am now suggesting to you. I have purposely drawn the first diagram in a way different from that shown last week so as to make it clearer to you that although one end of the tuned circuit is joined to high-tension positive, it also has an

easy path for high-frequency current to filament via the .006 microfarad condenser shown. The other end of the tuned circuit is, of course, joined to the grid of the detector valve, the filament connection of which is common to both valves, so that whatever voltages are set up across the tuned circuit are detected by the second valve.

### Try This "Tapping Down"

In the second diagram I have redrawn the circuit to show how we can tap down the coil with certain definite advantages. It is very simple to join the clip to the plate lead and you should start by connecting the clip to the end of the coil which is connected to the detector grid condenser.

This is exactly the same connection as we used last week. Now tap down the coil and each time be careful to retune. This re-tuning is very important, otherwise you will get a wrong idea. Although a screen-grid valve has a very small capacity between grid and plate, there is a very large capacity between plate and filament through the screening grid, and this capacity being thrown right across the variable condenser of the next tuned circuit adds to the total capacity.

As you tap down the coil you reduce the effect of this parallel capacity and thereby alter the tuning position for a given station. You also alter the feed-back very appreciably, thereby gaining stability.

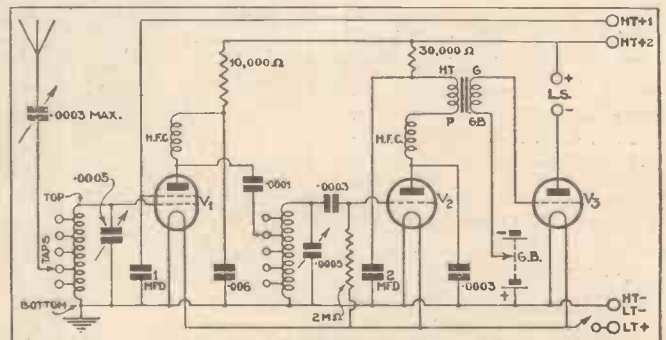

*Complete theoretical circuit diagram of the three-valve set with parallel feed coupling for the screen-grid valve*

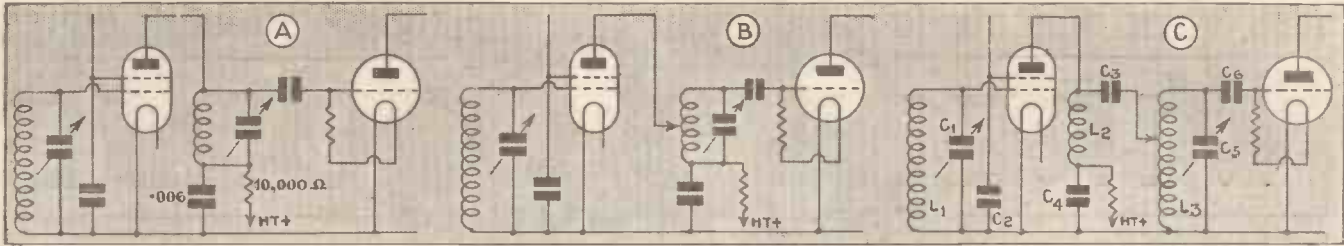

Three simple theoretical diagrams to help you understand all about high-frequency coupling. At A all the tuned circuit is common to grid and plate circuits. At B part of the tuned circuit is in the plate circuit of the screen grid and all the tuned circuit is in the grid circuit of the detector valve, giving looser coupling. At C part of tuned circuit is in plate circuit of screen grid. Note that the high-tension is supplied to the screen grid through a high-frequency choke. Moving plates of both condensers are at earth potential. C3 prevents high tension shorting through L3

Try out every tapping and carefully note the results obtained both in selectivity and stability. Signal strength will drop appreciably as you go down the coil for two reasons.

Firstly, you have a reduced transfer of energy and secondly a reduced reaction effect, or reduced interaction between the two circuits. Reaction in a set like this should be strictly controllable by the user and should not depend, as I am afraid it has done in the past in quite a number of designs, upon a general instability by no means strictly controllable. Later we will see how we can keep reaction in the right place namely the detector circuit.

**Not Convenient**

Now it is not always convenient to use the circuit we have tried and, in fact, it is rarely used in modern designs for the simple reason that the moving plates of the variable condenser are as high potential to earth, or, put in simpler and less technical language, they are connected direct to the positive of our high-tension battery. This does not matter a great deal in the set as we have made it up, for each condenser is insulated on an ebonite panel, or on a bracket. If, however, we were to use a metal panel earthed or connected to L.T. negative, no trouble would arise with the first condenser or in any case, as you will

attempted to join up the batteries with our second condenser in position we should short-circuit the high-tension, for the moving plates would be connected directly to L.T. negative and therefore to H.T. negative.

**The "Parallel Feed" Circuit**

There are several ways of overcoming this difficulty. One of the most popular

a high-frequency choke L2, placing our tuned circuit in the grid of the detector valve as before, but this time with the coil and condenser connected to L.T. negative.

The high-frequency choke so to speak deflects the high-frequency current through the condenser C3, back to earth through the tuned circuit across which high voltages are built up and applied as

before to the grid of the detector valve. The grid condenser C6, performs as explained in our previous lessons and the condenser C3, although offering an easy path to high-frequency currents, effectively prevents the direct current in the high-tension battery flowing straight to filament. We can as a matter of fact get signals on to the detector valve without the tuned circuit consisting of C5 and L3, but as the choke offers a fairly uniform impedance to all frequencies to which we want to tune there will be a negligible selectivity. If we use the tuned circuit C5, L3, it will let most of the frequencies that we don't want go straight to filament and will only build up a voltage to any considerable degree on those we need.

Next week I shall want to tell you more about this parallel-feed circuit and as we have had quite enough experimental work for one lesson I am leaving over the details.

I am giving the practical connections, however, which include just two new parts—the high-frequency choke I asked you to get and a .0001 fixed condenser.

Remove wire No. 25 from .006 condenser and wire No. 24 from twisted coil wires marked B. Join No. 25 wire to twisted coil wires B. Fit .0001 condenser and choke as shown. Detach No. 38 wire from coil and join to one terminal of choke. Fit flex on crocodile clip and join to one terminal of .0001 condenser with new wire No. 41. Join remaining connection of condenser to terminal of choke to which No. 41 wire goes. Join remaining connection of choke to terminal of .006 condenser to which new wire No. 42 goes. 10,000-ohm spaghetti now goes and is wire No. 24. Variable condensers joined with wire No. 43

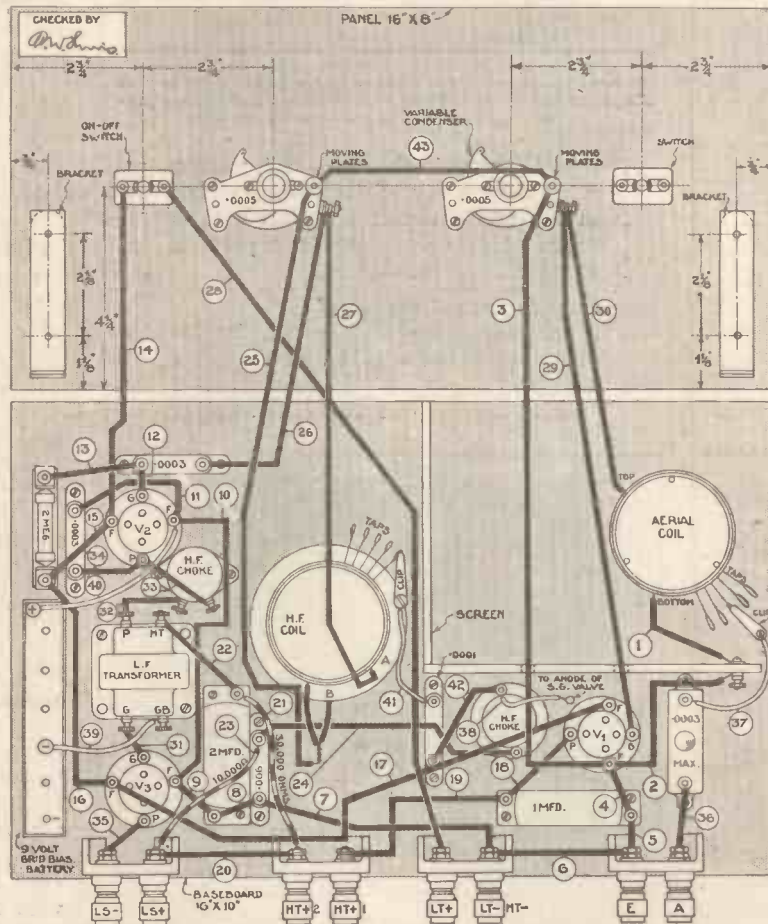

The quarter-scale layout of the three-valve set as fitted with parallel-feed high-frequency coupling. Note addition of fixed condenser and high-frequency choke at back of coil screen

have seen by the diagram, if the moving plates are connected to L.T. negative anyway, but directly we

is to use what is called the "parallel-feed" circuit. In this circuit we use in the plate lead of the screen-grid valve,

ever, which include just two new parts—the high-frequency choke I asked you to get and a .0001 fixed condenser.

THIS WEEK: SCREENING ELEMENTARY NEXT WEEK: All About the Screen-Grid Valve

# WIRELESS COURSE FOR BEGINNERS

**WHY** are the tuning coils of my set encased in metal cans?

To confine the magnetic field of the coil within a limited space. Otherwise there is a danger of interaction between the coils.

**What do you mean by interaction?**

It is an effect somewhat similar to reaction. You remember that in a reaction circuit we pass some of the current in the anode circuit through a coil which is placed near the tuning coil. This induces voltages which add to those already existing in the circuit and so builds up the strength of the oscillations. We say that the anode circuit is *coupled* to the grid circuit and if we increase the coupling beyond a certain point the circuit bursts into self-oscillation.

**I remember. You mean that it won't stop oscillating?**

Yes, the circuit will go on oscillating even if the signal picked up on the aerial ceases, so that it is not under proper control. That is what we call *self-oscillation* and in a receiving circuit we have to avoid it at all costs because we cannot obtain proper reception while the circuit is in this condition.

**So you must keep the reaction under control?**

Exactly, and in those simple words you sum up the whole difficulty of H.F. amplification. To obtain reaction, we deliberately "couple" the anode coil to the grid coil so that the magnetic fields of the two coils interact. It may be, however, that even with the coils several inches apart there is sufficient interaction to cause self-oscillation.

**How can that happen?**

We saw in the last article that with an H.F. valve we often use a coil in the anode circuit, which we tune with a variable condenser. Now when we tune the coil the current in the circuit is increased many times.

The voltage induced into the grid circuit depends partly upon the distance between the coils and partly upon the

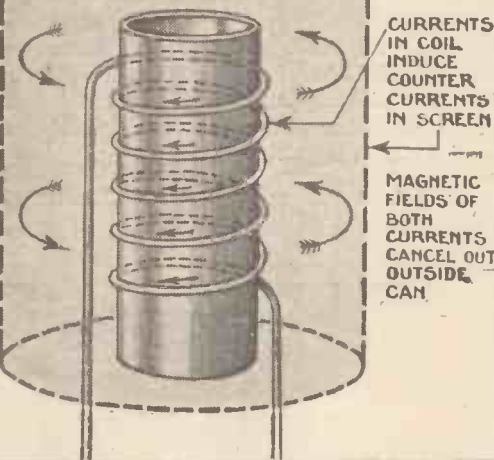

Showing how a metal can surrounding a tuning coil prevents the formation of a magnetic field outside the can, thus preventing inter-action with nearby coils

actual current in the anode coil, so that if we have a strong oscillating current in the anode circuit the coils can be several inches apart and still produce the necessary interaction.

**How do you get over this?**

In various ways. We can, for instance, place the coils in such a position that they do not couple to one another.

If we arrange the two coils at right

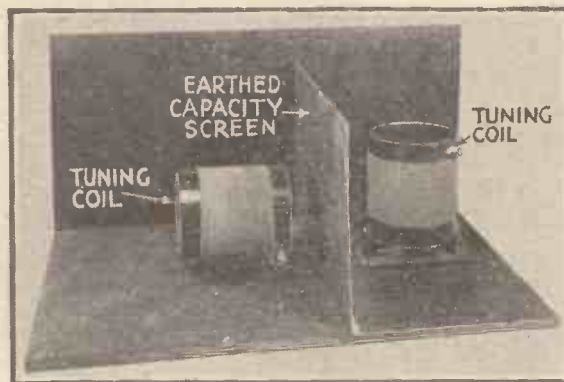

A typical arrangement of two coils, placed with their formers at right angles, with a capacity screen, which is connected to earth, erected between them

angles the magnetic field across the first coil does not pass through the second coil. True, the fringes do spread through the coil a little but if you look at the diagram you will see that they pass through the coil in one direction

at one end and in the opposite direction at the other end, so that the total effect cancels out.

**Are the coils at right angles in my set?**

They may be, but this method is only applied to quite simple sets. The actual point where the coupling between the coils is absolutely zero is critical, added to which there are other forms of coupling due to interaction between the leads and suchlike, which, as you will see later, can be equally troublesome. Consequently we prefer to adopt rather more definite methods by using some form of screening round the coils.

**What is screening?**

A metallic shield placed partially or completely round tuning coils or other parts. There are two principal forms of screening, and as we are dealing with coils we will consider magnetic screening first. Suppose we place the coil inside a "can" of copper or aluminium. We shall then find that the magnetic field outside the can is very small indeed so that we have virtually confined the magnetic field inside the can.

**How does that happen?**

If you think about it you will see that a copper cylinder is really a coil made up of a very large number of very thin turns of wire, all touching one another. You know that the magnetic field of one coil will induce current in any other coil placed near to it, and in the present instance we actually do obtain "eddy currents" in the screen.

These eddy currents produce a magnetic field in opposition to that of the coil, and the two fields wipe each other out, leaving us with no external magnetic field

at all.

In order to obtain this result, we must completely enclose the original coil so that the top and bottom of the tube has to be made of copper as well, leaving small holes for the leads.



BY J. H. REYNER, B.Sc. (Hons), A.M.I.E.E. AND THE "A.W." STAFF

*Does a coil work just as well inside a metal can?*

No. It is obvious that the eddy currents set up in the screen must come from somewhere so that unless we take some steps to supply more energy to the circuit the oscillating current in the coil will be reduced.

We say that the *effective resistance* of the coil has been increased. As you know it is only because of the loss of energy due to the ordinary resistance in the coil that we have to supply voltage to our circuit in order to keep the current flowing.

In this case we have to apply a little more voltage to maintain the current at its original value, because of the extra loss of energy due to the eddy currents in the screen, but we do this quite cheerfully because of the great advantage we derive from the complete confinement of the magnetic field within the can.

*Is that the only effect?*

We also find that for a somewhat similar reason the inductance in the coil is reduced, so that a coil inside a can requires more capacity to tune it to a given frequency than it does outside the can. This, however, is a point which affects the designer more than the user and we need not trouble about it any more just at the moment.

*How large are these screens?*

Usually about twice the diameter of the coil itself and an inch or so longer at each end. The larger the can, the less the losses introduced into the circuit, but if the diameter is increased more than 2 to 2½ times that of the coil the gain in efficiency is not worth the extra size.

transformer, where we are definitely providing a path for the magnetic field. Actually our screening effect depends upon setting up these eddy currents with the smallest possible loss of energy

connected to the condenser. In other words, a condenser behaves just like a conductor as far as oscillating currents are concerned. This is a point you must take care to remember.

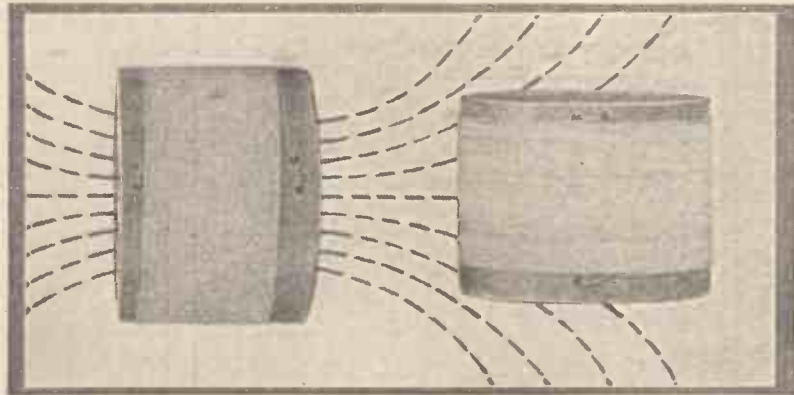

When two tuning coils are arranged at right angles as shown here there is no resultant effect from the mingling of the magnetic fields of the two coils

from the coil and to do this we want material with the lowest electrical resistance. Hence we use copper or aluminium, both of which are excellent electrical conductors.

*Can you place screened coils as close as you like?*

Yes. The screening almost entirely eliminates any magnetic coupling between the circuit. This, however, does not get us entirely out of the wood because there are other ways in which reaction effects can occur.

For example, suppose we connect a condenser between the anode and the grid. Some of the current in the anode circuit will pass through this condenser back into the grid circuit again.

If you have an oscillating voltage applied across the plates of a condenser, the electrons in the dielectric or insula-

*Is that always true?*

Yes, a condenser will not pass a continuous flow of current in one direction, but if the currents are oscillating it is capable of acting just like a conductor. The larger the condenser the greater the number of free electrons capable of being set in motion so that the more easily does it hand on the current, while it is also found that a given size of condenser will pass current more readily if it is of very high frequency than if the vibrations are comparatively slow. This again you will understand, because if we make the vibrations so slow that the current only flows in one direction, the condenser acts as a complete barrier, as we have seen.

*I do not see why we want to connect a condenser between the anode and grid.*

We do not deliberately do so. In actual practice there are small condensers formed by the circuit itself. Any two wires separated from each other act to some extent like two plates of a simple condenser and therefore all the wiring associated with each of the tuning circuits form a sort of network, with quite an appreciable capacity effect between them.

Since one tuning circuit is connected to the grid of the valve and the other is in the anode circuit, we have, in effect, a condenser between anode and grid.

*Surely that is very small?*

Yes. It is perhaps one or two hundredths of the maximum capacity of the ordinary tuning condenser, but owing to the high frequency of the oscillations with which we are dealing, quite an appreciable current is able to leak back

(Continued on page Seven)

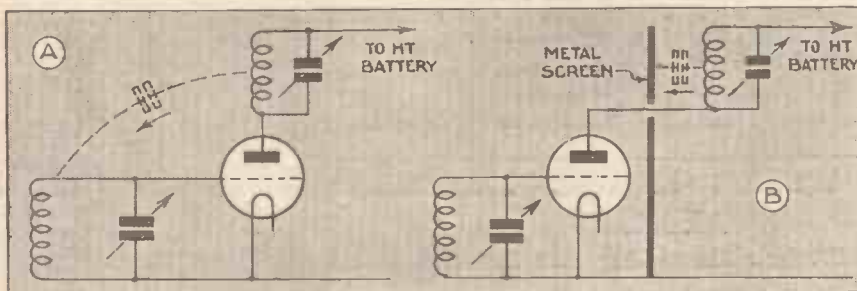

Two simple circuits showing how a capacity screen stops "feed back." For simplicity the batteries have been omitted. A very small capacity between the wires of the two tuning circuits is enough to pass a small quantity of high-frequency current back from the plate circuit to the grid circuit and so causes oscillation as shown by the circuit at A. At B some high-frequency current leaks away as before, but cannot get through the screen

*You said the screens were made of copper. I should have thought iron would be better*

Because iron is magnetic, I suppose? The action here, however, is not quite the same as that of the iron core in a

tion between the plates will move from side to side under the influence of the e.m.f. This will disturb the equilibrium of the system and there will be a corresponding swaying backwards and forwards of the electrons in the circuit con-

# The Best Aerials for To-day—

*In this special article we answer all the most important questions the beginner is likely to ask about the erection of an aerial to suit modern broadcasting conditions. The relative merits of the indoor and outdoor types are clearly explained*

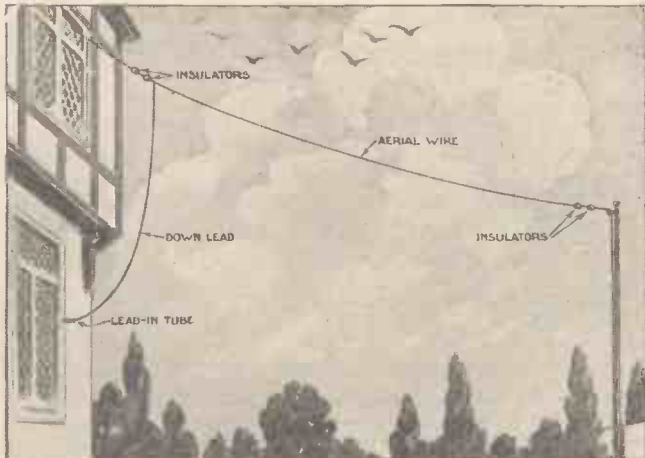

Here you see what might be called the ideal outdoor aerial arrangement, consisting of a single length of wire slung between a pole at the end of the garden (a tree would do almost as well) and the top of the house

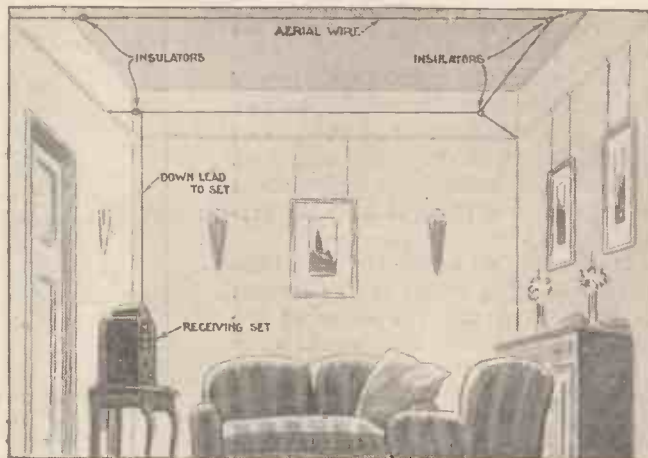

A well-arranged indoor aerial, consisting of a single length of wire slung round three sides of the room and suspended about 1 ft. from the ceiling

**What is an aerial?**

It is an elevated conducting wire insulated and isolated as much as possible from surrounding earthed objects.

**Why do we use aerials?**

To pick up wireless waves, which are vibrations in the ether caused by high-frequency oscillations generated at the broadcasting stations. Whenever an aerial wire is erected, in the ways to be explained, wireless waves will surge up and down the wire. There may be dozens of different signals thus flowing along the length of the wire.

**What wire should be used?**

As we are dealing with high-frequency currents of very minute strength we must offer them the lowest possible resistance, so we use a thick wire.

As a rule, the aerial wire is stranded, because for a given cross-section a wire made up of strands will have a larger surface area than a solid wire. The wireless wave current is of such high frequency that it travels only along the surface of the wire. The larger the surface area we offer, therefore, the easier will it be for the wireless waves to get to the set.

**How long should this aerial wire be?**

A question that can be answered only when your locality is known. If you live close to a powerful station, such as a regional, you will have to make the aerial wire short.

Otherwise it will be so efficient a collector of wireless waves that the local wireless signals will entirely swamp all others. You will have what is called an

"unselective" aerial, because it will not let you select weaker stations in preference to the powerful local.

The total length allowed by the Postmaster-General is 100 feet. This length is measured from the remote point of suspension to the aerial terminal of the set, and therefore includes the down lead and the wire into the house.

In the old days when sets were not very sensitive and stations did not transmit on high power the full length was needed to get good strength in the phones or loud-speaker. To-day there is seldom any need to use a wire with a total length of more than 70 feet.

Within ten miles of a regional station it is important to use a short length of wire. Possibly 50 feet is the maximum with a set of normal selectivity, though this can be proved only by actual test.

If you are living more than twenty miles from a station

foreigners clear of interference.

**Where should this wire be erected?**

In the open if possible. Always remember when thinking of aerial erection that height is more important than length.

A single span is best, stretching from a high point at the end of the garden to the wall of the house and thence down into a lower ground floor window to the set.

**The remote point of suspension?**

That can conveniently be the top of a tree at the bottom of the garden, or if nature is not accommodating you must put up some sort of support, either a well-prepared wooden mast or a tubular steel mast, both of which can now be obtained for a very small cost.

**Why not have the aerial wire indoors?**

There is no objection to an

**What is this isolation?**

Quite different from insulation! We have, as you know, to insulate direct currents flowing through wires in order to confine them to their proper circuits.

With wireless wave current we are not dealing with anything so simple. We may entirely insulate the wires carrying the wireless wave energy and yet much of it can leak away under conditions that would be perfectly satisfactory for direct current.

High-frequency current tends to leak away across any stray capacity that may be formed by the wire carrying it and any adjacent conductor or semi-conductor.

Thus if the aerial wire, no matter how well it is insulated, runs for any length close to a wall or other earthed object, such as a guttering or lead pipe, some of the energy will leak to earth through the condenser formed by the conductor wire and the wall, guttering or pipe.

The only way to stop this waste of energy is to keep the aerial wire well clear of earthed objects. In other words to isolate it. Obviously this is not easy with an indoor aerial wire, which must of necessity be surrounded by the walls of the room and the ceiling.

**Where must an aerial be insulated?**

Although we have stressed the importance of isolation in aerial erection, it is of course very important to see that the wire is well insulated. There are three main points in the aerial system where special care is needed if the complete system

**NEXT WEEK'S SPECIAL BEGINNER ARTICLES**

*Foreign Stations Every Beginner Can Get This Xmas*

*Why and How We Use Grid Bias On First Tuning A New Set*

there is no reason why you should not obtain the benefit of increased signal strength a longer aerial undoubtedly gives. Even so, the total length should not exceed about 70 to 80 feet, or you will have difficulty in getting

indoor aerial. The point is that an outdoor aerial is more efficient. The outdoor aerial enables you to isolate the wire more completely from earthed objects than can possibly be done indoors.

# Special Article for Beginners

is to be well insulated from stray capacity leaks.

Firstly there is the remote point at the bottom of the garden. Down there you must see that the end of the wire does not come into contact with foliage on trees. Further, the end of the wire must be well insulated from the rope or wire that is supporting it. As a rule two insulators in series is enough at the remote end.

The next point to watch is the junction of the horizontal span and the down-lead into the house. Here again two insulators are needed.

It is a good idea to loop the aerial wire through the first insulator so that the down-lead forms a continuous length with the horizontal portion. This also saves making a joint, which would tend to become inefficient in course of time.

The third point needing specially good insulation is the lead into the house. As a rule an ebonite tube driven through the side of the window is used, with a terminal on the outside to which the end of the down-lead is fixed.

This is satisfactory for a time, but if only a pressure contact is made between the wire and the terminal, as it so frequently is, the atmosphere will eventually oxidise the exposed metal and cause an inefficient joint. It is therefore better to solder the end of the wire to the terminal, so as to ensure a lasting good contact.

### What about insulated aerial wire?

By all means! It is just the thing for smoky towns and localities where the atmosphere is apt to contain impurities that quickly attack metal and oxidise. The 7/22 stranded copper wire sold in 100- or 50-foot coils can for little extra cost be obtained with an enamelled covering that will entirely protect the wire from the effect of the atmosphere.

The only point to watch is the scraping of this wire when you are making contact with the lead-in tube. That will be the only point at which electrical contact must be made. At all other points, such as the house and mast suspension points, only mechanical contact is made, so there is no point in scraping the enamel off the wire.

### Is this wire suitable for an indoor aerial?

Yes, but hardly attractive in the living-room! The usual aim in choosing a suitable wire for an indoor aerial is to erect a wire that is unobtrusive and moderately efficient.

It is by no means certain that a thick wire, quite apart from

the question of appearance, is ideal for an indoor aerial.

An indoor aerial has a high capacity, owing to its close proximity to ceiling and walls

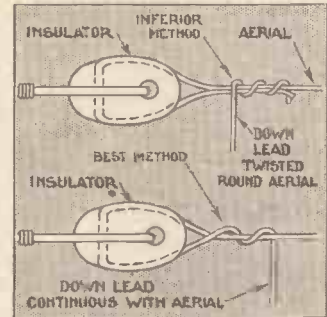

The down lead can form a continuous length with the horizontal portion of the aerial wire if it is arranged as shown

and other earthed objects. The larger the wire the greater will this capacity tend to be.

A very good wire to use for

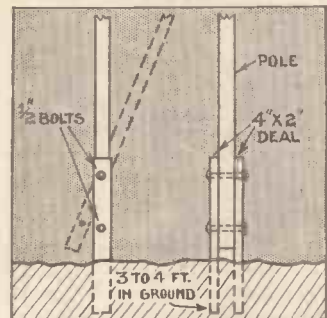

Do not stick the aerial pole straight into the soil, but first fix two wood battens as shown, bolting them to the pole

an indoor aerial is cotton-covered No. 22 gauge. This is thick enough to have a fairly low resistance, is quite un-

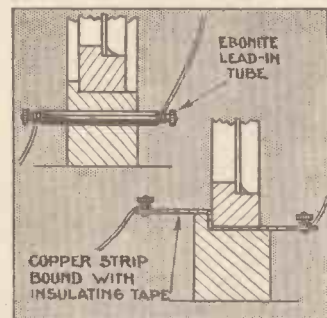

Two good methods of leading in the aerial wire. On the left is the usual tube. On the right is a home-made lead-in

obtrusive owing to its covering of white cotton, and is not likely to add more than is necessary to the capacity losses.

### How long should an indoor aerial be?

That is a good question, because very often amateurs

think that to make up for deficiencies in height and freedom from earthed objects the indoor aerial should be made the full 100 feet length. Nothing

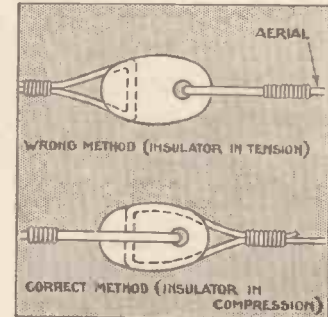

The right and wrong ways to use an insulator. If the insulator cracks, the correct method prevents the aerial falling down!

could be more calculated to produce poor results.

The reason is that by making such a long aerial indoors you

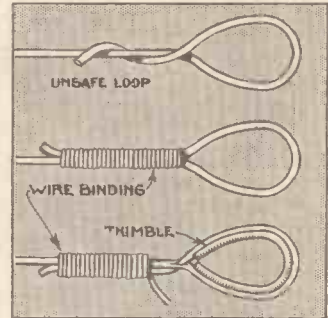

Making loops in rope, cord, or wire is very easy. Note metal thimble as sold for keeping the loops in shape

add very greatly to the capacity losses, and these will more than counteract any possible gain in signal pick-up. For normal use

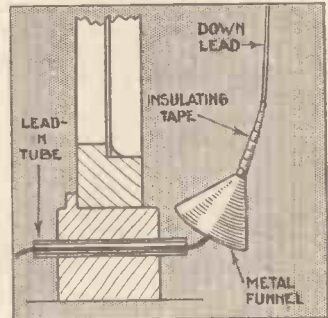

A simple metal cowl or funnel fitted just above the lead-in tube to the down-lead will prevent oxidation inefficiency

about 50 feet is the maximum that should be used for a moderately efficient indoor aerial.

### How can this length be obtained in the ordinary-sized living-room?

Obviously not in one straight length as in the garden. What

we have to do is to make a three-cornered affair, using up three sides of the room.

We start by anchoring the wire at one corner, support it at the next corner by a short piece of string and an insulator, and then anchor it at the third corner, at which point the down-lead to the set is taken.

This type of indoor aerial often gives results comparable with a normal outdoor wire.

### So an indoor aerial is the next best thing to an outdoor aerial?

Not necessarily. You may find that a short vertical wire erected from the top of the house to the bottom gives you a better all-round performance than an indoor aerial.

If you fit up such a vertical wire and keep the wire at least a foot from the wall all the way down you may get ample signal strength on the average sized set, and certainly the selectivity will be very good indeed—better than with an indoor aerial.

### ELEMENTARY WIRELESS COURSE (Continued from page Five)

through this capacity and give us feed-back or reaction.

### How can you overcome this?

By placing a metal screen between the two circuits; if we connect this screen to earth, we break up the capacity effect into two parts. The wiring in the anode circuit now has a capacity to earth and any current which wants to leak away leaks to this screen and never gets as far as the grid wiring on the other side. This is termed a capacity screen.

### Do you have to use this as well as screened coils?

It depends upon the sensitivity of the receiver. The magnetic screen round the coils acts as a capacity screen as well, so that there is only a very small residual capacity coupling left and in many cases this can be neglected.

### Does this screening get over the troubles?

Nearly, but not quite. We have been very careful to avoid coupling in the circuit. We have, however, overlooked the valve itself. Inside the valve we have the grid and immediately surrounding it the anode or plate. Here again we have two elements acting like the plates of a condenser, and there is often more capacity between these two electrodes than the stray capacity.



A typical mains valve with five pins at the base

# WHAT THE BEGINNER SHOULD KNOW ABOUT MODERN VALVES

IN such a short article we cannot hope to tell you about all the modern valves, but we should like you to get some clear ideas about one or two valves used in every wireless set of to-day.

One is the screen-grid valve. This is used for high-frequency amplification. The screen-grid is sub-divided into two varieties—the high-magnification screen-grid and the variable-mu screen-grid.

### For Small Sets

For sets with only one stage of high-frequency amplification the high-magnification screen-grid valve is nearly always used.

In this valve there is a grid coming between the normal or control grid, upon which signals are impressed, and to this extra grid, or screen-grid as it is called, we apply a positive voltage from the battery that supplies the anode of the valve.

With the ordinary type of screen-grid valve this voltage is variable. Up to about 80 volts the amplification of the screen-grid valve increases. We reduce the volume from the set by reducing the screen voltage.

This is all very well until we try to reduce the volume of the local stations, which are very strong signals when they arrive at the input of the valve. If we reduce the screen voltage below a certain point the valve, which is supposed to amplify the signals, begins to detect them, which means that it begins to distort them.

the first screen-grid has amplified them.

This second valve will be "overloaded," and that again will cause distortion unless we reduce the screen voltage of the first screen-grid valve and so reduce the amplification of the signals before, in an amplified form, they reach the second screen-grid.

So the variable-mu type of screen-grid valve has been developed. With this valve the amplification is varied not by altering the screen volts, which are in fact kept constant, but

There are, in addition to the normal or control grid, two other grids in a pentode. One is internally connected to the filament, and the other has a terminal connection that goes to the high-tension battery supply just as with a screen-grid valve.

### Pentode Advantages

What are the advantages of the pentode? The biggest is that its sensitivity ratio is much higher than a simple three-electrode power valve.

What you want from a power

voltage input than an ordinary power valve.

Moreover, it does this with less expenditure of anode current for a given amount of power output. That is to say, you get more power output for a given anode current expenditure with a pentode valve than with an ordinary power valve.

The pentode valve is now made as a power valve that economises the anode current to the minimum expenditure of battery power. For 4 or 5 milliamperes the small pentode valve will give you more power output than a similar amount of anode current will give with an ordinary power valve.

Not everyone needs to economise with anode current, especially when the mains are on tap for the high-tension supply. Then we find the pentode is used to give the maximum power for a given amount of anode current, though this current may be no less than that taken by an ordinary power valve of a similar type.

### Mains Valves for A.C. and D.C.

Another valve we ought just to mention is the A.C. and D.C. mains type. Here there is a radical difference from the battery valve. The filament of the battery valve when heated emits electrons, but the filament of the mains valve is just a heater wire and does not emit, or should not emit, any electrons.

What happens is that the heat from the mains applied to the filament heater through the secondary winding of a transformer is communicated to a cathode which is surrounding the heater element, but insulated from it.

The mains heating varies slightly, but this variation does

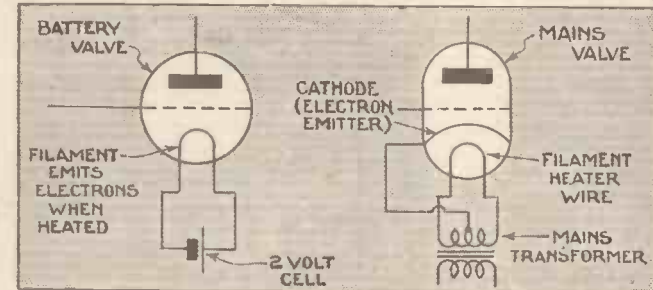

A battery valve, as on the left, has a filament that when heated emits the electrons. A mains valve, as on the right, has separate electrodes for heating and electron emitting

by varying the negative bias on the normal or control grid.

The advantage of this modified screen-grid valve is that it does not detect and does not, therefore, cause distortion when the amplification is greatly reduced to cope with strong local signals.

### No Overloading

It does not overload at all when preceded by another amplifying valve, because it is then biased so much negatively that there is no chance of too great a signal being applied.

Another modern valve that

valve is, quite simply, power. In other words, you want a current variation in the power supply in order to work the loud-speaker, which is a current-operated device.

The more power variation you can create, the more volume you will obtain, up to the limit of the loud-speaker. Up to a point, the greater the voltage you apply to the grid of the power valve, the greater will be the anode current variation, and so the greater will be the volume.

Now it is clear, surely, that if you are assessing the value

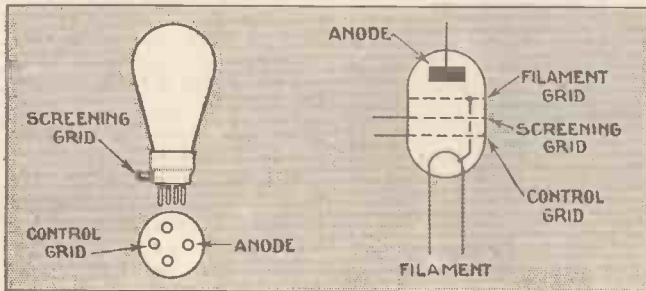

A pentode power valve has three grids. One is the normal or control grid. Then there is the screen grid between the normal grid and the filament grid connected inside the valve to the filament

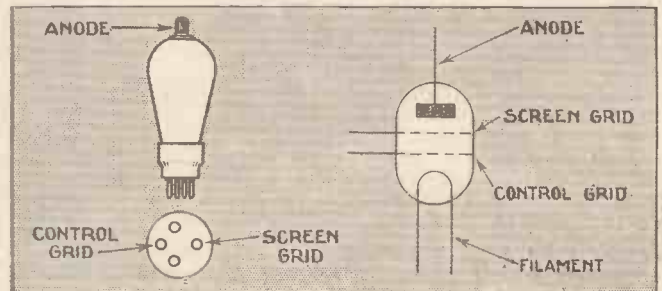

A screen-grid valve consists of a three-electrode valve with the addition of a screening grid between the normal grid and the plate or anode

A similar trouble arises when we use two of these screen-grid valves in a large set. The second screen-grid will have to handle very large signals after

every beginner should know just a little about is the pentode power valve. This is a special form of screen-grid valve used in the output or power stage.

of a power valve you must consider how much power output it gives for a given voltage input. The pentode gives a larger power output for a given

not affect the cathode or electron emitter, whose action is too sluggish to take any notice of the rapid variations in the heating of the filament wire.