

WAVE-CHANGING—AN ENTIRELY NEW METHOD

BUILDING ULTRA-SELECTIVE STRAIGHT THREE

Amateur Wireless

Every
Thursday 3^d

and
Radiovision

Vol. XVIII. No. 460

Saturday, April 4, 1931

The **ULTRA-SELECTIVE
STRAIGHT
THREE**



*Full
Details*

"STRAIGHT" MEANS SIMPLE

WIZARDS OF WIRELESS



Here are two LEWCOS components capable of feats which are magical in effect!

Tests by expert experimenters have shown that the LEWCOS Transformers (References L.F.T.3 and L.F.T.5) are the most efficient of their class owing to special care in design and the high-class materials used in their manufacture.

These transformers are the natural and inevitable link between the high-frequency side of your receiver (tuned with the world-famous Lewcos H.F. Coils) and your loud-speaker.

Write for fully descriptive leaflet Ref. R.61.

LEWCOS LOW FREQUENCY TRANSFORMER (L.F.T.3)

PRICE
Now 12/6

LEWCOS LOW FREQUENCY TRANSFORMER (L.F.T.5)

PRICE
Now 17/6

LEWCOS^{Regd.}

SPAGHETTI RESISTANCES

are now available in nineteen different values.

THE LEWCOS LOW-FREQUENCY TRANSFORMER (REF. L.F.T.5) IS SPECIFIED FOR THE "ULTRA SELECTIVE STRAIGHT 3" RECEIVER DESCRIBED IN THIS ISSUE.

NOTE THE REDUCED PRICES OF EACH OF THESE COMPONENTS.



PRICES
Up to 1,000 ohms - 9d.
Up to 10,000 ohms - 1/-
Up to 100,000 ohms - 1/3

LEWCOS RADIO PRODUCTS FOR BETTER RECEPTION

THE LONDON ELECTRIC WIRE COMPANY AND SMITHS LIMITED, CHURCH ROAD, LEYTON, LONDON, E.10

Mention of "Amateur Wireless" to Advertisers will Ensure Prompt Attention

WHAT THE MIKE TELLS TO TELSEN TELSSEN TELLS TO YOU ...

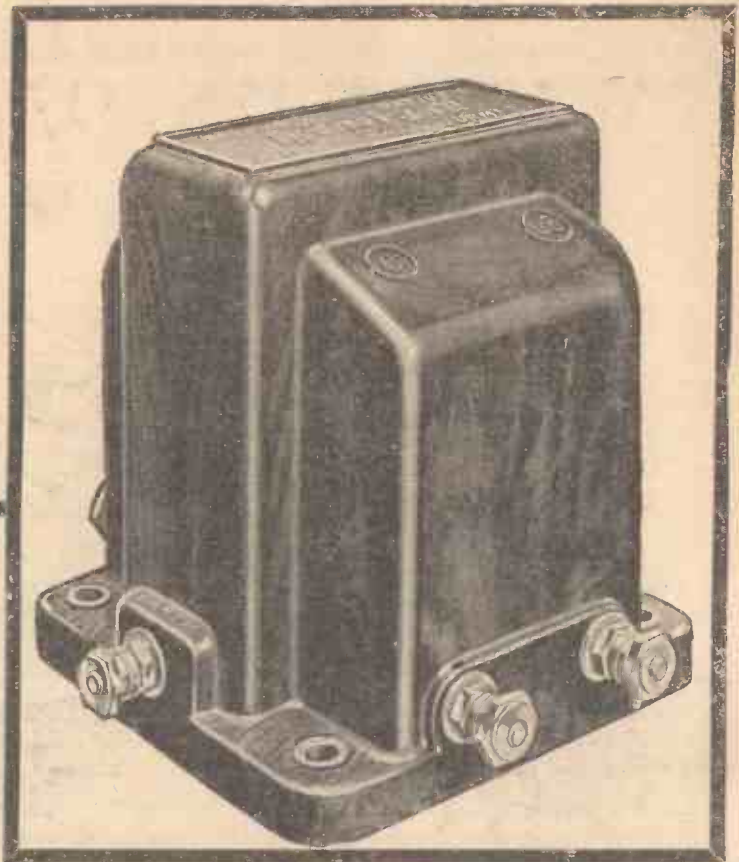

TELSSEN L.F. TRANSFORMERS
 "ACE" - ratios 3-1 and 5-1 8/6
 "RADIOGRAND" - 3-1 and 5-1 12/6
 "RADIOGRAND" - super ratio 7-1 17/6

TELSSEN Components are vital to the efficiency of your set—at all the key positions they pass on the full perfection of the original sound . . . You can take the efficiency of TELSEN Components for granted—all the best radio engineers do . . . Fit TELSEN Components for greater power and truer reproduction.



TELSSEN FOUR-PIN VALVE HOLDERS.
 Price 1/- each.

TELSSEN VALVE HOLDERS.

Pro. Pat. No. 20286/30. An entirely new design in Valve Holders, embodying patent metal spring contacts, which are designed to provide the most efficient contact with the valve legs, whether split or non-split. Low capacity, self locating, supplied with patent soldering tags and hexagon terminal nuts.



TELSSEN FIVE-PIN VALVE HOLDERS.
 Price 1/3 each.

TELSSEN H.F. CHOKES.

Designed to cover the whole wave-band range from 18 to 4,000 metres. Extremely low self-capacity, shrouded in genuine bakelite. Inductance, 150,000 microhenries. Resistance, 400 ohms.

Price 2/6 each.



TELSSEN FIXED (MICA) CONDENSERS.

Shrouded in genuine bakelite, made in capacities up to .002 mfd. Pro. Pat. No. 20287/30. .0003 supplied complete with patent grid-leak clips, to facilitate series or parallel connection. Can be mounted upright or flat. Tested on 500 v.

Price 1/- each.



TELSSEN GRID LEAKS.

Absolutely silent and non-microphonic, practically unbreakable, cannot be burnt out, and are unaffected by atmospheric changes. Not being wire wound, there are no capacity effects. Made in capacities: 1, 2, 3, 4, and 5 megohms.

Price 1/- each.



TELSSEN

COMPONENTS

BIG ROYAL AIR FORCE SALE Bargains straight from Govt. Depot

The Air Ministry clear-up Sale just held is two years since we last offered you some wonderful R.A.F. Bargains then. We have again secured the Radio and Electrical lots below, so do not miss this last chance, but order without delay. Prices this week only.

RECEIVERS. Nice parcel of the famous Mark III*, the most beautiful Crystal Set ever made. Cost £20. Has every refinement, and its Spanish mahogany case would grace a main's transportable. Sale 19/6.

R.A.F. Aero 3-valve Receivers with remote control. All in portable cabinet. 27/6 to clear.

Naval Long-range Tt 3-valve Receivers, 150-2,500 metres, are a fine job. Size, 9 by 9 by 6½ in. Only 30/-. A number of other Receivers, all cheap. Come and see them.

FRAME AERIALS. There are 3 huge Revolving Frame Aerials for ground station direction work. Suit college or lab. 70/-. Vacuum Aerial Lightning-Protectors. Small and neat, fix outside or in. Safe and self-setting. One should be at every receiver 1/- only.

A.C. MOTORS, by Crypto, ½ h.p., 50 cycles, 110 volts, enclosed type, as new, £3 each.

H.T. GENERATORS. Aero model, B.T.H. Mackie, double output, 600 volts, 80 m/a H.T., 8 volts, 2 a.m.p. L.T. Have pulley shaft, but can be run as motor-gen. from L.T. input. Complete with mica smoothing condenser. Cost £40, but during sale to clear 30/- only. Larger H.T. sets, 100 watts, 1,500 volts, £5. 1 k.w., 2,000 volts, a most reliable machine with overload capacity, £20. 2 k.w., 4,000 volts, in a single- or double-unit machine, £30.

L.T. DYNAMOS. 12-volt Lucas for charging 6 to 12 volts, 8 amps., ball-bearing ends. Fitted Auto Cut-out. Cost £10. Sale 17/6. Charging, 6-volt, 40 amps., for 30 cells or plating £4 10s. Few only. 100 volts, 4 amps., £4. 100 volts, 10 amps., £6 10s. 100 volts, 3 kw. 80 amps., £12. Motor Generators, D.C. and A.C., various sizes. Please send inquiries.



METERS. Beautiful 2½ in. Electrostatic, 500 to 2,500 volt dial for H.T. Consume no current. Flush panel, 40/-. A few in portable cases, 50/-.
MOVING-COIL METERS, Weston & Turner, 0-100 m/a, 25/-. B.T.H., 200 m/a, 12/6. Weston, 500 m/a, 27/6; ditto, 0-30 volts, 27/6. Turner and E.E. C. Zero Ammeters, 20-0-20 amps., 25/-.
 Portable Moving-coil Meters with wood case. Need small repairs, 7/6. Complete Meters, 10/- only. Worth 40/-.

THERMO-METERS for A.C. Moving Coil, 1½ amps., 30/-. All above 2½-in. dial flush. Switchboard Meters, as new, 5 in. and 6½ in. dial, A.C. and D.C., 17/6 to 30/-. Cambridge Distant Thermo, 6½ in. Wall Dials, 0-500 deg. C. scale. 40/- each.

HOT WIRE METERS, by G.E.C., ½ amp. Adjustable nickel case, 2½ in. dial. All brand new, 5/-. Altitude meters, baro. pressure, delicate movement. Make pocket aneroids. Bargain, 5/-.
VALVES, LARGE TRANSMITTING. 250 watts for up to 1,500 volts. Make fine power amplifier valves for big volume. Cost £8. Sale 25/-. A few wonderfully made Silica V.T.10.D. Mullard high-power valves, 55/-. 40 watt Osram trans. or power only, 4/6. Cossor Rectifiers, 100 m/a. Snip at 2/6.

MORSE KEYS. Here we can offer you a fine selection of nearly 1,000 new Tappers from as low as Lucas 2/6. R.A.F. 5/ at 6/-. Combination key and 3-way switch, 7/-. Buzzer Practice Sets, with buzzer and key on panel, standard, 8/6. Special heavy type, 10/-. Push keys, 6d.

BUZZERS. Packet of Tiny Townsend Wave-meter Buzzers, high note, 3/6 each. Power Buzzers, 4/6. Cheaper type, 2/-.
TRANSFORMERS. Bargain for home-makers. R.A.F. Interval Trans. Sets, stampings, and 1½ oz. 47 gauge silk cov. wire on bobbin, 1/6 set. L.F. smoothing chokes, ideal for D.C. or A.C. eliminators, 1,000 ohms min. 1/9. Transformers as illustrated, 4 to 1 ratio, 2/9 each.
TELEPHONES. Brown's "A" reed single, 4/-, for speaker units. Single earphones for making Gramo pick-ups, 1/3. Complete 1,500 ohms Brown's Headphones and Cords, 20/-. G.P.O. type Pedestal Receivers, 2/-. Wireless Transmitting Hand Microphones, 15/-.
SUNDRIES. Hand Generators, L.T., 7/6, or H.T. all prices. Switchboards, Charging and Regulating Resistances. Microphones, 5/6. Relays, 1- and 2-valve Transmitters. Battery Hydrometers, 1/-. Polarity Indicators, 4/-. Naval Telescopes, 10/-. Enclosed one-eighth h.p. reduction gear boxes, suit Television discs, 5/-. Electric Drills, medium size, used only, 50/-. Helio mirrors, plane 5½ in. diameter, fine for shaving, office, travelling, camping, etc., 1/6.
WAVEMETERS. In neat polished mahogany case. Cost R.A.F. £10. For correcting your receiver, as Interference Trap or Reception strength tests. A limited number of Service types—Forward, Townsend; Paul & Silvertown offered at 25/6 to clear. Heterodyne 1-valvers, Mark III, 30/-. Special Laboratory Sullivan Het. Wavemeter, as new, with charts, £8 10s.
COMPASSES. Pocket size. Neat. These are just the thing for direction-on frame aerials and portable sets. Sale 2/-. Marching Compasses, 10/- and 15/-.
HIGH-TENSION UNITS. T.V.T. type. For supplying H.T. from 6-volt accu. and stepped up by vibrator transformer to 100,300 volts, and smoothed with mica condensers. All tested. Cost £8. Small number to be cleared at 12/6 each.
ARC LAMPS. 5-movement Searchlight type, 10 to 100 amps., 50/-. A complete Movie Theatre, full-sized Film Projector by Gaumont, for lecture purposes. Bargain, £9 10s.
AUTOMATIC CUT-OUTS. Electromagnetic, for 12 to 100 volts, 10 amps., auto cut-in-out with vibrator volt regulator combined. Cost pounds. To clear at absurdly low price of 7, 6.
TESTING SETS. Elliott Moving Coil 3-range, 45/-. Wireman's set with Hand Gen. Ring and Neon Indicator, 50/-. Evershed Meggers, £6 10s. Silvertown Horizontal Galvos, 7/6. Cell Testers. Record Circule, 3 volts, as illustrated, 22/6 only. Cost treble.
ALTERNATORS. 250 watts, 20 volts, 500 cycles, self-exciting, £3. Will step up transf. to 9,000 volts, £5 10s. Larger models, 400 watts, 100-volt output A.C., £4 10s.
WIRELESS RECORDERS. Morse Inkers in new condition. Magnificent British workmanship. Solid brass case, fine finish on mahogany base, with tape roll drawer. Cost £30. Sale £7 10s.
WHEATSTONE BRIDGES. A fine selection in good order. G.P.O. standard type, £7 10s. Paul Dia model and Galvo, £9. Silvertown Testing Sets, with Galvo, £8. Reflecting Galvos, by Tinsley, £3. Weston Bridge Galvo on stand, 45/-. An assortment of Res. Boxes and Universal Shunts from 15/-.
SWITCHES. 5 amp. Tumbler, 6d. Rocker on-and-off, 6d.; 2-way do., 8d.; 3-way, 10d.; 5-way, 1/-; 6-way, 1/2. Rx. and Lucas 3-way and 5-way, 3/-.; 8-way, 3/6. Extra H.T. 2-pole 2-way, oil filled, 10/6. Also a lot of heavy switch gear, fuses, and resistances. All cheap. Complete Sale List Now Ready.

ELECTRADIX RADIOS, 218 Upper Thames St., London, E.C.4. Phone: City 0191

EXTRACT FROM
 "DAILY EXPRESS"
 REPORT
 MARCH
 10TH.

The "Super 60," as Mr. James calls this new set, employs six valves—oscillator, first detector (anode-cation, second detector (leaky grid) and power valve. "If the set is revolutionary in design, it is no less so in selectivity and power. At four miles from Brookman's Park the London stations have a spread of only one degree on the tuning dial. "All the components for this set can be purchased from any wireless dealer for £12 inclusive of cabinet, frame aerial, and valves. "Under actual test during two evenings the 'Super 60' brought in fifty-six stations on the medium wave and nine on the long-wave band, and even this wonderful record does not exhaust its possibilities. "It seems almost incredible that a super-het of such small a sum, but the specification of parts shows that it can be done without difficulty. "Mr. James is to be congratulated on an extremely noteworthy achievement."

GET
 YOUR COPY
 OF THE APRIL
 ISSUE NOW

The DAILY EXPRESS
 praises the W. James'
 "SUPER 60"

The difficulties of separating stations have now been overcome by a new set of revolutionary design—the "Super 60," by W. James.

Read what the "Daily Express" says about this amazing new receiver. Then read the April issue of WIRELESS MAGAZINE, now on sale, which contains further extensive details of the "Super 60"—the set that has set a new fashion in radio.

OTHER FEATURES OF THE APRIL ISSUE INCLUDE:—

16-pp. LOUD-SPEAKER SUPPLEMENT— Loud-speaker Choosing, Using and Building.

ARE YOU A LISTENER OR A KNOB TWISTER?—by Whitaker Wilson.

POWER NOISES THAT SPOIL RECEPTION —by Alan Hunter.

LATEST L.F. CIRCUITS—by W. James. RADIO MEDLEY—by BM/Press.

WIRELESS MAGAZINE

APRIL ISSUE NOW ON SALE. PRICE 1/-. OF ALL BOOKSTALLS AND NEWSAGENTS

UNDY MULTIPOLE
Super Dynamic '8'
 FAR IN ADVANCE OF ANYTHING EVER
 PREVIOUSLY ATTAINED IN LOUD-SPEAKERS

There is nothing to equal it in the world of radio—an advance in design and capacity which denotes the pinnacle of loud-speaker production. Equally suitable for all from "All Mains" to the smallest "battery" receivers.

Not only is the "Undy" SUPER DYNAMIC fitted with a magnet of unequalled power, but the three tappings on the incorporated auto-transformer enable the perfect adaptation of the A.C. resistance of the speaker to any type of valve, and consequently 100% result in all cases. This means that whether a low-, medium- or high-resistance valve is employed in the final stages, the "Undy" Super Dynamic "8" can be adapted to work in complete unison. No other speaker can claim this.

The provision of the volume switch enables the loud-speaker to stand a constant anode current of 200 milliamperes and anode voltages of over 500 volts without injury.

ON SALE EVERYWHERE.

**Greater Volume!
 Greater Strength!
 Greater Sensitivity!!**

British Patent No. 336,930
PRICE 70/-
 COMPLETE

SAY WEARITE AND YOU CAN'T GO WRONG

W. JAMES' BINOWAVE COILS

Type A. A dual range Aerial Tuner with optional filament switch incorporated in wave-change switch. No reaction is included.
 Type C. Dual range H.F. coupling for S.G. Valves with an alternative Transformation ratio. Reaction winding included. Price EACH
 Ganged Attachment for Binowave Coils, price 3/-

FOR THE FINEST RESULTS From "AMATEUR WIRELESS" SETS, ALWAYS USE WEARITE COILS

W. JAMES' BINOWAVE COILS

Type D. Dual range H.F. transformer coupling for neutralised triodes. Neutralising holds good for both wavebands as well as reaction, which is applied to both broadcast and high wave coil sections.

Type E. Band-pass filter unit to give a flat-topped, sharply tuned resonance curve for high selectivity and good quality. Price EACH

WEARITE COMPONENTS

"CHALLENGE FOUR" COILS (Dual Range) 10/6 each

Always use "Wearite" Components for better results.

WRIGHT & WEAIRE LTD.

740 High Road, Tottenham, London, N.17
 Phone: Tottenham 3847-8

H.F. CHOKE A First-Class Component Price 6/6 each

Illustrated Lists of new Components Post Free.

Send for this interesting leaflet!

A view of the special Dynamic Valve Testing apparatus referred to below. Those technically interested can obtain a complete description of this ingenious instrument by applying to the Publicity Department, The Marconiphone Co. Ltd., Radio House, Tottenham Ct. Road, London, W.1.

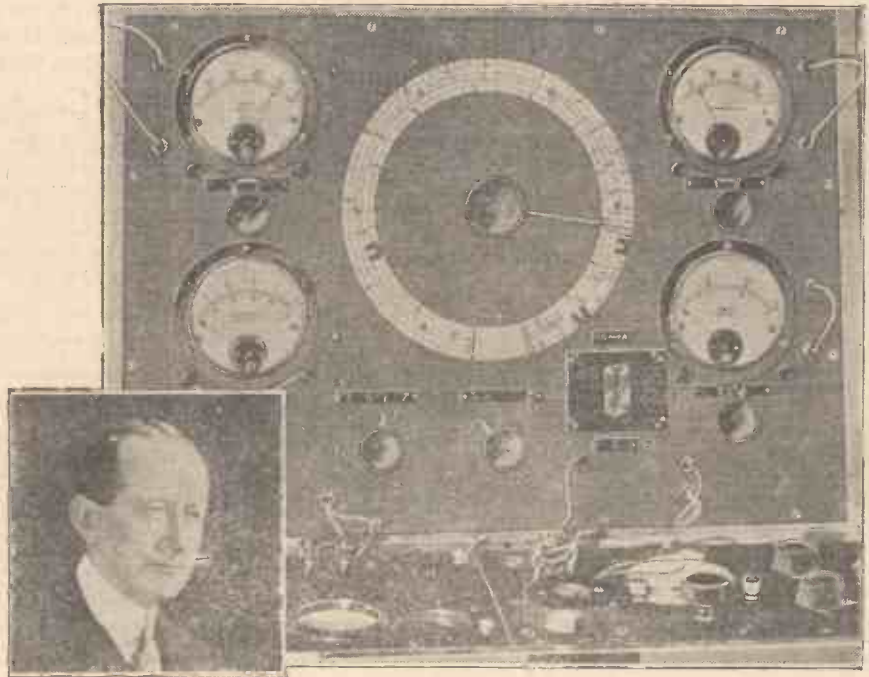

THE MARCHESE MARCONI
—THE GENIUS BEHIND
MARCONIPHONE
ENGINEERS

The traditional consistency in performance of Marconi Valves in the most exacting Radio work throughout the world is of course not a matter of accident. It is due, firstly, to superiorities of design and manufacture and, secondly, to ingenious and exclusive methods of testing, calling for an extraordinarily high test performance. The main element in these exacting tests is the exclusive Dynamic Testing apparatus shown above—an outstanding example of Marconi engineering ingenuity.



FOR DEPENDABLE CONSISTENCY IN ACTUAL PERFORMANCE

MARCONI VALVES

Used by the B.B.C., Metropolitan Police, Imperial Airways, British Trawler and Whaling Fleets, Great Shipping Lines, Trinity House Lightships and Beacon Stations, Empire Wireless Communications, etc., etc.

Mention of "Amateur Wireless" to Advertisers will Ensure Prompt Attention

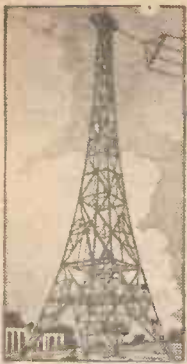

Amateur Wireless

and
Radiovision



EDITOR:
BERNARD E. JONES.

RESEARCH CONSULTANT:
W. JAMES.

TECHNICAL EDITOR:
J.H. REYNER B.Sc., A.M.I.E.E.

ASSISTANT EDITOR:
H. CORBISHLEY.

THE LEADING RADIO WEEKLY FOR THE
CONSTRUCTOR, LISTENER & EXPERIMENTER.

NEWS & GOSSIP OF THE WEEK

SLAITHWAITE

HOW are you faring with reception of Slaithwaite? Tests officially started on March 23, and all readers should take the opportunity of using these preliminary transmissions as a guide. AMATEUR WIRELESS is out to help listeners in every way to get the needed amount of selectivity, and to assist them in increasing the tuning range to cover the 479.2-metre wavelength. An ultra-selective "three" introduced this week will interest regional area listeners who want a sharp-tuning set.

A HOAX!

JOE RAMSBOTHAM, the character impersonated by Philip Ridgeway in the Ridgeway Parade broadcasts, dates back some two years, when a newly arrived impresario from the north got in touch with several London actor-managers by tele-

phone and announced his intention of presenting the pantomime *Goody Two Shoes* if he could find a suitable theatre. A condition which he named was that "trams must pass t'door." The Press took the matter up and the whole of theatreland was soon speculating as to how a personal interview could be obtained with this eccentric magnate, who only conducted negotiations by telephone. Eventually the hoax was revealed. Joe Ramsbotham was none other than Philip Ridgeway himself!

H.M.V. AT ROME

HERE is news that the Gramophone Co., Ltd., has arranged for a series of three broadcast concerts from Rome (441 metres) on Sundays, April 12, 19 and 26, from 7.30 to 8.30 p.m. The programmes will be given by artistes, who record for "His Master's Voice," including records by

PRINCIPAL CONTENTS

News and Gossip	553
A 2-watt A.C. Amplifier	555
Wave-changing—an Entirely New Method	557
Selectivity Need NOT Spoil Quality	558
On Your Wavelength	561
New Views of Slaithwaite	563
The "Ultra-selective Straight Three"	564
How Frame Aerials Work	568
Without Fear or Favour	570
In My Wireless Den	572
The Marconiphone Models 220 and 221	574
We Test for You	576
Radiograms	577
Our Listening Post	578
Readers' Ideas and Questions	579

A NOVEL TALKIE IDEA!

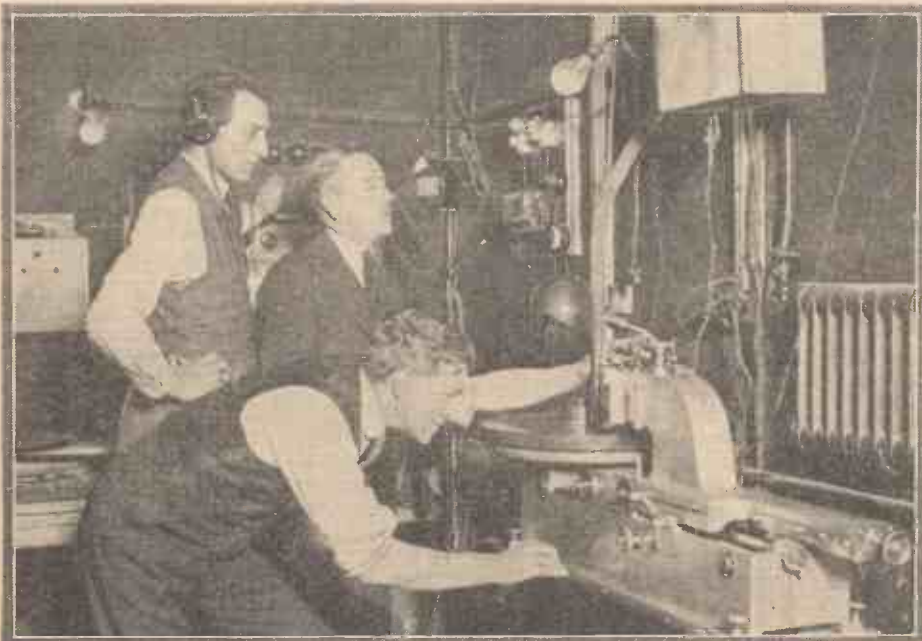

A novel idea was adopted in making a talkie film of the Boat Race this year. The broadcast running commentary was used as the sound portion of the film, and the record is here being made, synchronised with the film camera

Chaliapine, Kreisler, the Philadelphia Symphony Orchestra, John McCormack, Gracie Fields, Jack Hylton's and Ambrose's dance bands. The concerts will be conducted by Christopher Stone of the B.B.C. The programmes will be "all-record" ones, including the preliminary announcements. Major Stone will say a few words before each item, his remarks being recorded at the "His Master's Voice" studios in London.

MOSCOW'S "FIVE-YEARS" RADIO PLAN

THE famous five-years plan of Soviet Russia includes the building of radio stations. A transmitter with a power of 500 kilowatts is now being built in the neighbourhood of Moscow and will be the most powerful station in Europe. Eleven other stations are also being built, each with a power of 100 kilowatts, and twenty-eight stations with a power of 10 kilowatts each.

RADIO AND HEALTH

FOR the man of business whose working hours give full employment to the brain, one of the most unprofitable hobbies is to yield to the fascination of the radio. . . . The wireless undoubtedly tends to lead to lack of exercise. Many valuable minutes or even hours that might be far more profitably spent so far as health is

NEXT WEEK: MORE ABOUT THE NEW WAVE-CHANGING SYSTEM

NEWS · & · GOSSIP · OF THE · WEEK —Continued

concerned are passed in the depths of a comfortable armchair," so says Dr. D. Lechmere Anderson in the *Daily Express*.

MODERN MUSIC

NO matter what you may think of modern music, there is certainly a tendency towards novelties. A work by Arthur Bliss in the National programme of April 7 should appeal to listeners on this account. It is described as "Conversations for flute, bass flute, oboe, cor anglais, violin, viola and violoncello." The movements are entitled "The Committee Meeting," "In the Wood," "In the Ballroom," "Soliloquy," and "In the Tube at Oxford Circus."

ITALY WATCHES HER WAVELENGTHS

THE Italian Broadcasting Company has erected two official receiving stations at Milan and Sesto Colende. The object of the two stations is to check the wavelengths of

Lvov station is being received at great strength over the whole of Poland and the greater part of Europe. In the British Isles alone approximately 1,000 listeners have reported on the excellent quality of the station and the ease with which it is received.

MORE POWER FOR PARIS

AS already reported, the Poste Parisien transmitter will soon start operating on a power of 60 kilowatts. As Radio Paris will soon be operating on an increased power, it is evident that France is anxious to keep up with other countries in the matter of transmitter power. Strasbourg already has a powerful transmitter, and Toulouse is to install a new plant. There is certainly a bright outlook for French listeners!

CECIL LEWIS AND THE FILMS

THE performances of the play, *Krassin Saves Italia*, which were advertised to take place last week had to be postponed.

FOR SOUND EFFECTS!



In order to get sound effects for the train fox-trot "Chor-chou," Reginald Foort the well-known broadcast organist recently went for a foot-plate trip on a Western England express. He listened in with a microphone, amplifier and headphones to pick up the noises of the engine.

the various Italian transmitters to ensure that they keep to their allotted frequencies. In cases of interference from foreign stations the Italian stations will be able to identify the culprits. It is also intended to use the two receivers for picking up distant stations which may be relayed to one or other of the Italian transmitters.

LVOV

A 16-KILOWATT medium-wave station has been completed at Lvov, Poland, and has begun test transmissions. The new station, which is replacing the low-power Marconi broadcaster temporarily erected at Lvov, is the second built under the reorganisation scheme of the Polish Broadcasting Company, the first one being that near Warsaw—the 160 kilowatt long-wave station, which was put into operation in the middle of last month, and which was also supplied and erected by Marconi. The

Red Tabs, a play by Val Gielgud, was broadcast in its place. *Krassin Saves Italia* will be given as soon as its producer, Mr. Cecil Lewis, has completed the production of a film to which he is now committed.

SUNDAY PROGRAMMES

NOW that the Regional programmes are to start at 3 o'clock on Sundays, at the same time as the National programmes, thus offering listeners an alternative of light music to the Bach cantatas, may we hope that this Savoy Hill move is the thin end of the wedge, foreshadowing a general brightening of the present Sunday programme? "During the summer," a B.B.C. official tells us "this question of Sunday timing is to be reviewed from time to time by the Programme Board at Savoy Hill, and it is probable that further concessions will be introduced next winter." The sooner the day the better the deed!

PROGRAMME BOARD'S VIEW

THERE does not seem to be any great support among members of the Programme Board for a contrasted programme vastly different from an alternative programme on Sundays. Unless something unforeseen should occur to revise opinion, any further concessions to Sunday listeners will be confined simply to an extension of hours. There is certainly no indication of any immediate alteration to the character of the B.B.C. programmes sent out on Sundays." This statement was made to us by an official at Savoy Hill.

ARE CRYSTAL SETS DEAD?

WE ask this question in relation to northern listeners particularly, since in its pamphlet recently issued the B.B.C. devotes considerable space to notes on the adaptation of crystal sets to receive alternative programmes. If we may judge by correspondence, there is a very much smaller percentage of crystal set reception in and around Manchester than the B.B.C. implies in its statements.

NORTH REGIONAL TESTS

TESTS with normal power and modulation are now being made daily by Slaithwaite, and every amateur should take the opportunity of tuning in to these transmissions and making the necessary set adjustments.

The public reception test transmissions will be continued daily in accordance with the following schedule: Mornings (Sundays excepted), 11.5 to 11.45 a.m. Nights (Sundays excepted), Mondays, Wednesdays and Fridays, 11.15 p.m. to 12 midnight; Tuesdays, Thursdays and Saturdays, 12.15 to 1 a.m.

This will be continued until there is evidence that the public is ready for an extension, when further announcements will be made and the North Regional transmitter will radiate a portion of the daily programmes.

The object of this gradual introduction of the new transmitter is to enable the public to accustom themselves to its reception before the full programme service is transferred to it.

The B.B.C. is out to assist any listeners who have difficulty in receiving the new station. Listeners are asked to address their letters on technical matters to the Chief Engineer, Savoy Hill, London, W.C.2, and to mark the envelope "N" in the top left-hand corner.

The second transmitter at the North Regional station, which will relay the National programme on 301.5 metres, will not be introduced until the North Regional transmitter has taken over the full service of daily programmes, and until any temporary difficulties in receiving it have been overcome. When the North Regional transmitter is in full operation it will be possible to withdraw at least some of the existing transmitters in the North Region such as those now situated in Manchester, Leeds and Bradford.

GRAMO-RADIO: PUBLIC ADDRESS: HOME RECORDING

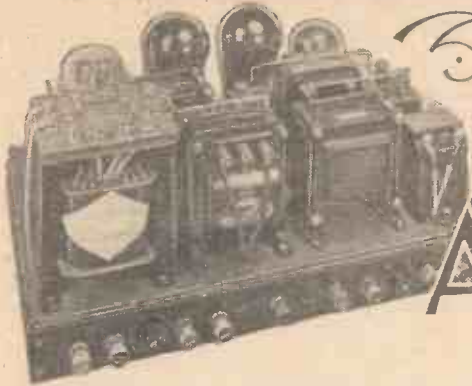

A 2-WATT A.C. AMPLIFIER

By J. H. REYNER, B.Sc., A.M.I.E.E.

THE amplifier described below has been developed as an all-purpose amplifier capable of operating entirely from A.C. mains. It can be put to a variety of uses. In the first place a power output of 2 watts is a very comfortable figure for those who want a good radio-gram. Used with a good moving-coil loud-speaker it is capable of giving sufficient power to deliver ample volume on occasion, and yet if it is kept throttled down it has the necessary reserve

applying 37.5 volts to the grids of the P650 push-pull valves.

The circuit of the amplifier is shown by Fig. 1. It should be noted that there are two input terminals, the connections being changed over from one to the other by means of a switch. The purpose of these two inputs is to enable one to use either a microphone or a pick-up with a rapid change-over from one to the other, or alternatively to change over from pick-up

the two P.650 valves in push-pull. A Ferranti output transformer is fitted in the anode circuit, and as the secondary is provided with a choice of three ratios it is a fairly easy matter to choose the impedance best suited to the valve. There are four types of output transformer giving ratios between 1:1 and 66:1; choose the one you need.

The output circuit is again branched in two directions by means of a change-over switch, and this enables one to change over from a loud-speaker on to a cutter when making records and vice versa, or it may be used for changing from one loud-speaker to another.

Power Supply

The power supply is straightforward in character. A 4-microfarad reservoir condenser is used, the two stages each being separately filtered to avoid any back-coupling. The transformer may either be wired to suit some particular voltage input, or it may have a universal input. In the original amplifier tapings were provided from 200 to 250 volts, which is adequate for the majority of purposes.

The construction of the amplifier is such that all the valves are located along the front, the apparatus itself being housed at the back. This enables a metal cover to be placed over the power transformer, etc., thereby protecting the high-voltage parts from accidental contact although the only danger spot is the 500 volts across the outers of the transformer. At the same time the valves may be removed or replaced without having to remove the cover, and the whole amplifier looks particularly neat

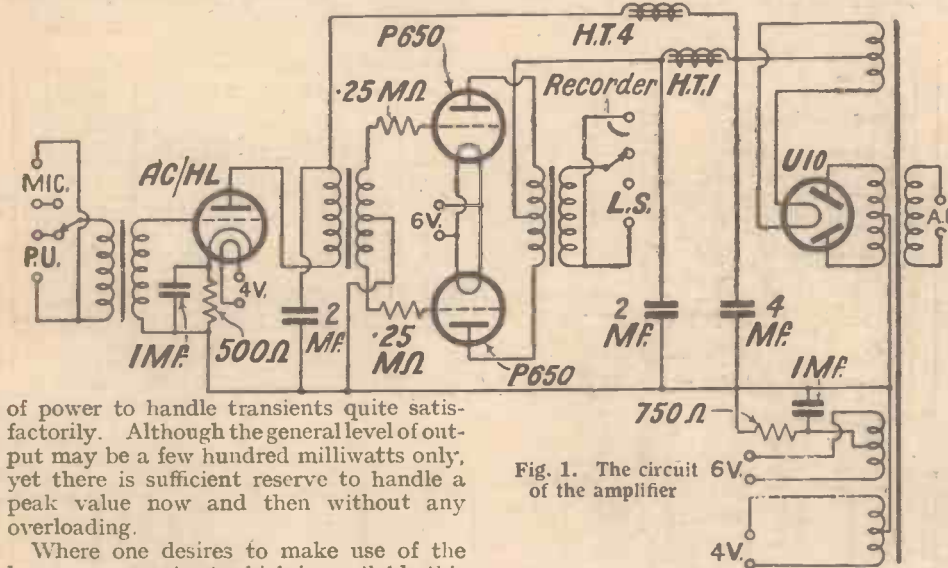

Fig. 1. The circuit of the amplifier

of power to handle transients quite satisfactorily. Although the general level of output may be a few hundred milliwatts only, yet there is sufficient reserve to handle a peak value now and then without any overloading.

Where one desires to make use of the larger power output which is available this may be done. The amplifier will give sufficient volume to dance fifty or sixty couples, while it may also be used for public-address work in connection with a microphone, or for home-recording. It is, in fact, particularly suitable for this latter purpose and I have made a number of very successful records using an amplifier of this class. A particular feature is that only 200 volts are used so that there is little risk of shock in use.

The Input Stage

The input stage of the amplifier is designed to accommodate a normal microphone of the type used for home recording or small public-address work, delivering about 0.1 to 0.2 volt. This is stepped up to about 0.5 volt by the input transformer and applied to an AC/HL. The anode swing is thus about 15 volts and this is stepped up by a 5 to 1 transformer to give 75 volts in the output stage. This output is split,

to radio or radio to microphone as desired. I find, for example, that when making records it is convenient to have a microphone handy with which to make some announcement at the beginning of the record, and then to throw over either to radio or gramophone according to circumstances.

From the input transformer we pass to the first stage valve which is of the HL class. In the anode circuit of this valve is a 5-1 transformer, having a generous iron circuit so that it can carry 5 or 6 milliamps without any danger of saturation. The secondary of this transformer is centre-tapped and feeds

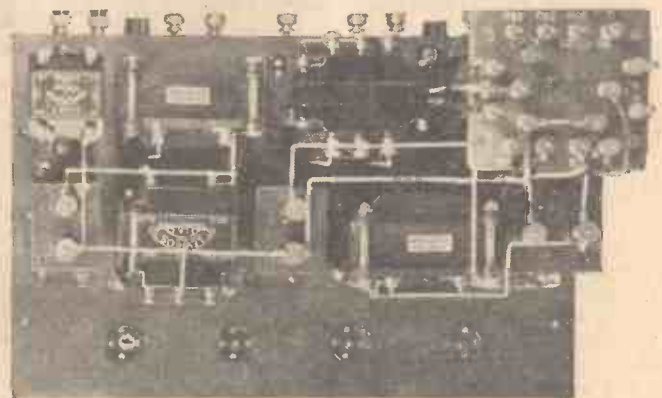

Compare this plan view with the layout and wiring diagram on the next page

if it is boxed in in this manner. Most of the parts have been mounted on the top of the baseboard, and they have been so chosen that the terminals are also at the top of the components so that wiring up is greatly simplified. The grid-bias resistances and condensers, however, have been placed underneath the baseboard for convenience, and a certain amount of the wiring has been carried out underneath.

Suitable Valves

So much for the general design and construction. A few words regarding the valves to be used are desirable. The

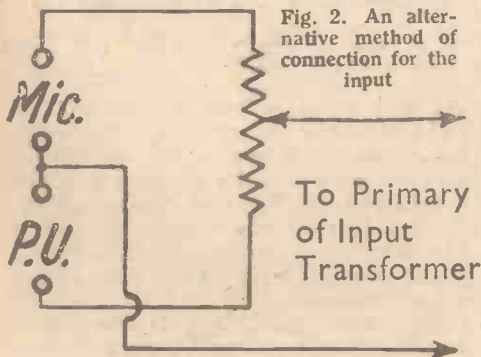

Fig. 2. An alternative method of connection for the input

rectifier valve should be of the U10 or DW2 type capable of giving 60 milliamps output at 250 volts. The voltage actually generated across the reservoir condenser is 240, of which 200 is used for the anode side, the remaining 40 providing the grid bias for the P650 valves. These valves between them take between 45 and 50 milliamps and the first valve takes approximately 5 milliamps more, so that a rectifier valve which is capable of supplying 60 milliamps smoothed is working within its limits quite satisfactorily.

COMPONENTS REQUIRED

- Baseboard 14 in. by 9 in. (Camco, Clarion, Pickett).
- Mains transformer with the following outputs: 250-0-250, 3-0-3 (one ampere) and two 2-0-2 one-ampere sections.
- Two smoothing chokes (Wearite type HT1 and HT4, Varley).
- Low-frequency transformer (Lewcos, Varley, Ferranti).
- Output transformer (Ferranti OPM4C, Varley RL).
- Low-frequency transformer (Varley Nicore II, Telsen, Lissen, Lotus, Burton, R.L., Lewcos).
- Two 2-mfd. fixed condensers 400-volt test (T.C.C., Formo, Dubilier, Lissen, Ferranti).
- 4-mfd. fixed condenser, 400-volt test (T.C.C., Formo, Dubilier, Lissen, Ferranti).
- Four sub-baseboard mounting valve holders (W.B., Lotus).
- Two 1-microfarad, 250-volt test condensers (T.C.C., Formo, Dubilier, Lissen, Ferranti).
- 500-ohm heavy-duty resistance (Bulgin) and 750-ohm ditto (Bulgin).
- Ebonite strip, 14 in. by 1 1/2 in. (Beccel, Peto-Scott, Trelleborg).
- Two single-pole change-over switches (Bulgin, Claude Lyons).
- Two 100,000-ohm resistances (Pye, Graham-Farish, Telsen, Lissen).
- Nine terminals, marked: L.S., +, L.S., - output +, output -, earth, input +, input -, pick-up (2) (Belling and Lee, Clix, Ealex, Burton).
- Connecting wire (Glazite, Peto-Scott).

The P650 valve, as has already been stated, takes 23 to 25 milliamps when biased with 40 volts and this really requires 850 ohms for grid bias. Actually, in order to make use of a standard resistance, the 750-ohm grid-bias resistance has been used. Reference to the curves for P650 valves will show that if we reduce the grid bias slightly the anode current will rise, and at 38 volts bias the anode current is just over 25 milliamps with 200 volts H.T. The anode current consumed by both the valves

therefore, is 50 milliamps, and this across a 750-ohm resistance will produce the 38 volts bias required.

The first valve is of the HL type having an impedance of between 12,000 and 20,000 ohms, and an amplification factor of between 30 and 40. The anode current here varies somewhat with the type of valve, but the 500-ohm resistance chosen will produce between 1 1/2 and 3 volts grid bias in most cases and since the input is less than 1 volt peak this is quite sufficient. In this connection it must be emphasised that many pick-ups deliver more than 0.2 volt and that some volume control should therefore be placed across the pick up external to the amplifier as otherwise overloading will occur.

Home Recording

Where the instrument is to be used for home-recording an extra resistance may

be included as shown dotted on the diagram. This resistance still leaves the loud-speaker connected even when the switch is over to the recorder. Owing to the 50,000-ohm resistance in series, however, the speaker only draws a very small current, so that it is possible to hear what is going on without seriously disturbing the currents going through the cutter.

An alternative connection on the input side is also shown in Fig. 2. Here, instead of actually changing over the connection from the gramophone pick-up to the microphone, a fader is inserted. This consists of a simple high-resistance potentiometer of about 50,000 ohms resistance connected across both pick-up and microphone in series. The input is connected to the slider of this potentiometer, and as it is moved over the scale, so it is possible to fade in the microphone and fade out the gramophone or vice versa.

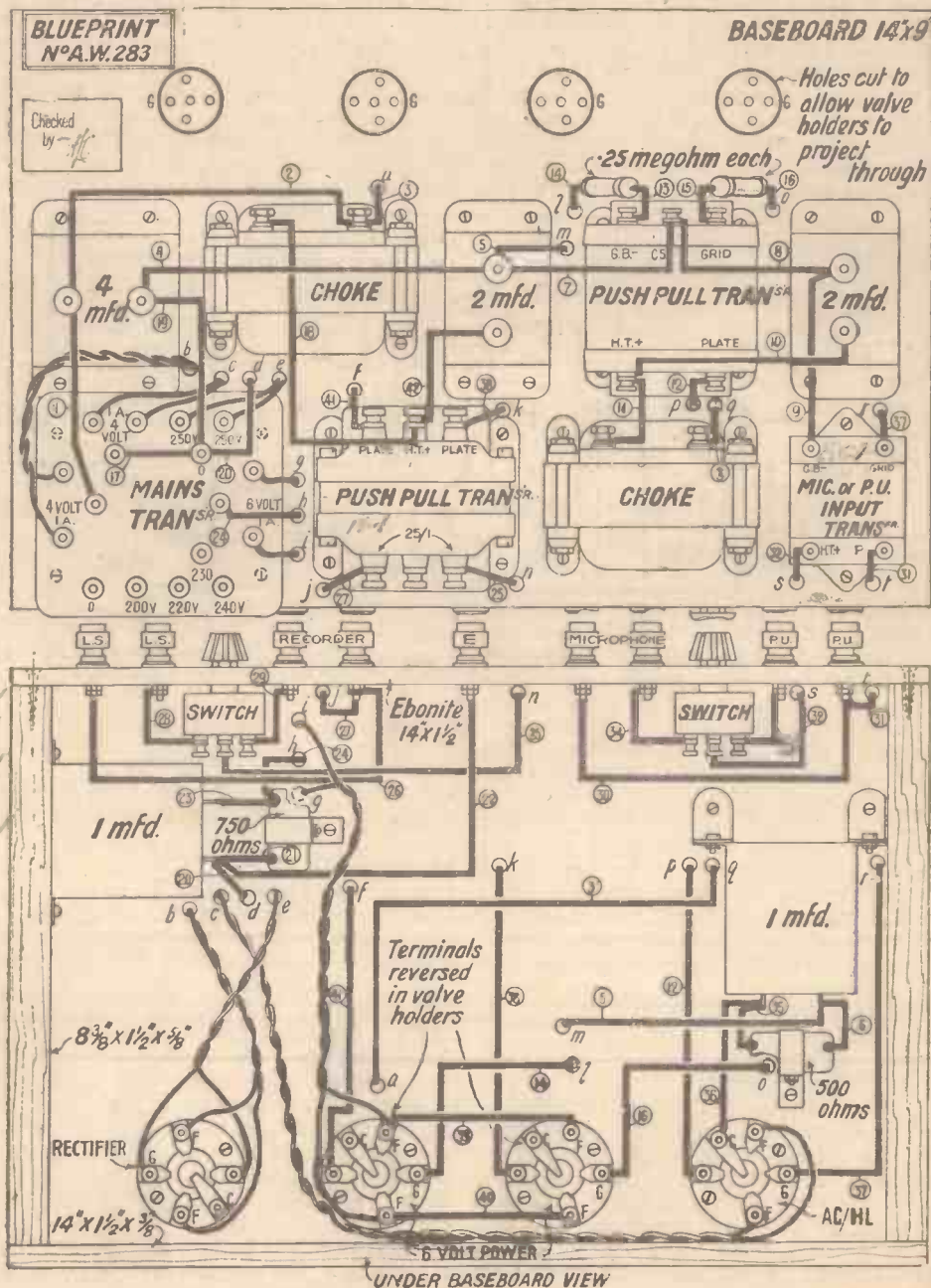

Upper- and under-side plans of the baseboard; the under side is recessed to accommodate the wiring and bases of valve holders, etc. A full-size blueprint is available, price 1/-

WAVE-CHANGING

I—AN ENTIRELY NEW METHOD

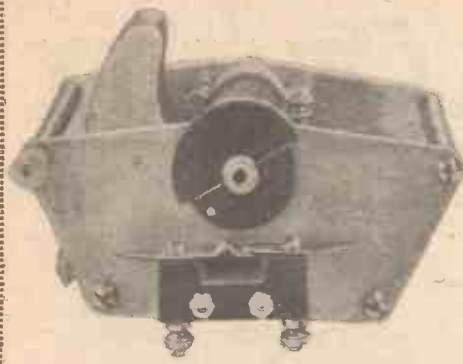

AMATEUR WIRELESS has always led the way in improvements in wireless reception. Readers of even two or three years standing know that this is just the simple truth. We were the first to publish details of mains working by the Johnston system—the “simpler wireless” of four years ago. We also introduced the first dual-range tuning coil, and it may in general be said that our staff is constantly working along new lines for the further simplification and improvement of wireless reception.

Before describing the new device, however, we should like the reader to consider the action of the normal variable tuning condenser.

This varies from zero capacity to its maximum by means of a dial turning through 180 degrees. The increase in capacity from zero, or rather from the minimum, for there is always some capacity even when the plates are fully out, can be made according to several laws. Most present-day condensers increase in capacity according to a logarithmic law, for by this means wavelengths are more evenly distributed over the available 180 degrees.

can, in fact, use a .0005-microfarad variable condenser in the modern set only by using two separate windings, one for the medium waves, and the other for the long waves.

A 360-degree Condenser!

As this state of affairs seems likely to continue for many years, the problem has been, not so much to eliminate the switching, as to overcome the complications arising from its use. It may not be clear to some readers why, apart from the fact that the panel has an extra device, the coil switch is a factor that tends to complicate control. But it will be realised that in the usual set incorporating dual-range coils, tuned by a .0005-microfarad variable condenser, there are two sets of readings, one for the medium waves and the other for the long waves. Thus 30 degrees on the tuning dial might represent 300 metres on the medium waves, but this 30-degree dial point might correspond to 1,300 metres on the long waves. In other words, one given setting of the tuning condenser dial corresponds to two wavelengths.

A simple method of avoiding this duplication of condenser-dial logging may occur to the reader. For, since the variation of the dial for both wavebands involves the turning of the condenser dial twice through 180 degrees, and thus involves certain waste of motion, it follows that if we could have just one complete rotation through 360 degrees we should avoid duplicating
(Continued at foot of next page)

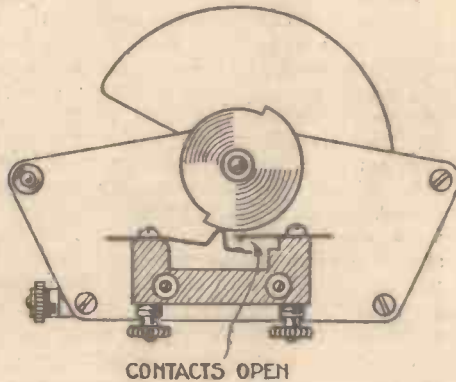
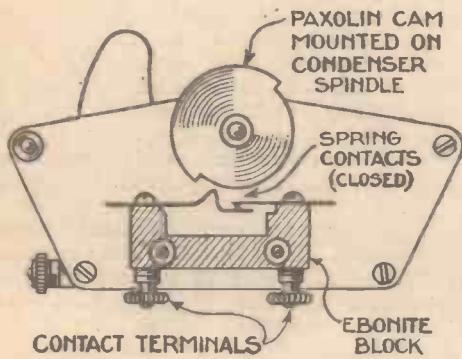

These two drawings show the two positions of the cam-operated switch for the medium and long waves

When the dual-range coils were first brought out we realised that listeners were thereby saved the trouble of changing plug-in coils, but we realised also that this new system introduced certain fresh complications, such as the necessity for a wave-change switch on the panel. We are aware of a number of attempts to work out a system of tuning that would eliminate the wave-change switch.

To cover the present system of broadcasting in Europe we use a medium waveband of wavelengths between 200 and 600 metres and a long waveband between 1,000 and 2,000 metres. It is for this reason, that, some years ago, we had to devise dual-range coils, which, with a .0005-microfarad variation in capacity, would tune between the wide limits of 200 and 2,000 metres. We

Novel Wave-changer

We now announce the introduction of a new type of condenser, which has reached production stage and is here illustrated by photographs and diagrams. Essentially it is a combination of condenser and switching arrangement by means of which the mere turning of the condenser dial will automatically switch over from the medium waveband to the long waveband; in other words, it will obviate the necessity of fitting a separate wavechange switch, thus simplifying construction and rendering the operation of the set still easier. Just how this is accomplished is explained later in this article.

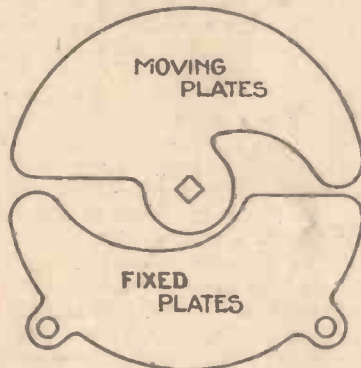

The vanes of the condenser are of special shape in order to obtain an even tuning scale

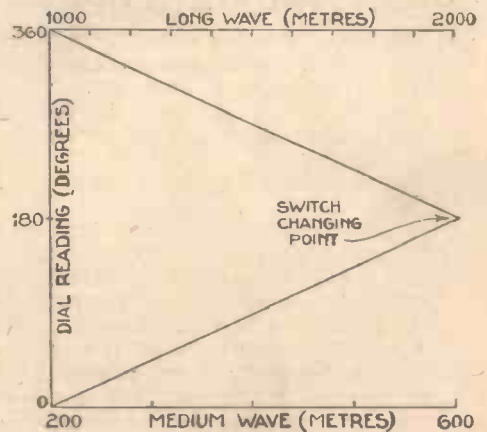

Graph showing the straight line tuning on both wavebands



SELECTIVITY NEED NOT SPOIL QUALITY

—as Alan Hunter explains in this interesting article

BEFORE high power became the watch-word of the chief broadcasters of Europe, very simple tuning arrangements sufficed, at least if the listener wanted only the local station. I wonder whether my readers all appreciate that modern broadcasting conditions have more or less antiquated the local station set of a year ago. It is useless to design any set, whatever its ranging properties, with only one tuned circuit. To-day the problem of tuning is a problem common to every single listener. For while the long-distance listener must obviously be able to cut out the local station in favour of the desired distant station, the local listener must be able to cut out the distant station in favour of the local!

“Local” Sets

I have lately heard a number of these so-called local sets. Their owners are beginning to realise that there must be something in this selectivity business after all. One asks for the London Regional; one certainly gets it on these local sets, but only with a background from Mülacker above and often Graz below. So with the National; at night one can get it only with a foreign station's interfering background.

Granted the need for more selectivity, by which I mean a more generally distributed high standard of selectivity, the question crops up as to whether quality will be spoiled by making the set more selective. The answer needs to be given with caution, for nothing is easier than to ruin quality by wrong methods of sharpening the tuning. So often does this happen that quite a number of readers have been led to believe that good selectivity is

impossible without some loss of quality. Well, provided one is prepared to take sufficient trouble, good selectivity is possible with good quality.

Selectivity and Tuning

Just what happens to the quality when tuning is made sharp, as by unduly increasing the reaction or by making a single tuned circuit low loss? The answer is that the high frequencies are lost. The most common symptom of this fault is “wooliness” in speech and absence of brilliance in music. If the much-sought low notes give depth to the reproduction one must say that the high notes give it brilliance and character.

The loss of high notes is more common in small sets made unduly selective than in big sets. This is because in a small set there are usually not more than two tuned circuits, whereas in a big set there are three or four. If the two tuned circuits are made to give as selective results as the three or four, loss of quality is inevitable. For it so happens that for good quality there is a quite critical *maximum selectivity per tuned circuit*. When we come to co-relate theory with practice we soon find that if the separate circuits are designed not to mutilate high notes at least three and preferably four are required for modern 9-kilocycle separation.

The local station listener will ask me whether I suggest that, to receive the locals clear of foreigners, he must use three or four tuned circuits and, presumably couple them together with two or three high-frequency valves. Such a plan would be extremely wasteful, but fortunately there is a sensible compromise. I am thinking of

the band-pass tuning, where two tuned circuits are coupled together without the inter-position of a high-frequency amplifying valve. The band-pass tuner provides not merely selectivity, but selectivity with good quality.

We shall soon have to consider quite seriously the inclusion of some form of band-passing in local sets, simply to cope with selectivity needs of to-day.

The Super-het the Solution

So much for the stay-at-homes; what of the ether searchers? They have long faced up to the problem of selectivity, but perhaps not until recently has the average amateur worried much about quality tuning. Now I am going to suggest that the long-distance listener need not put up with indifferent quality as the price of his indispensable selectivity. A few days ago I was able to work a new, but at present experimental, super-heterodyne set. Never have I experienced such good quality from distant stations. The designer attributed this excellent quality to the tuning of his intermediate high-frequency amplifier, which incorporates band-pass coils.

That fact seems very significant to me. In the past I have looked slightly askance at the quality side of super-heterodyne reception. While realising that the “peaking” of the intermediate high-frequency amplifier to one particular frequency was an essential part of the scheme, I felt that this type of set would not please the musical ear. But now, good-bye to all that, so to speak, for with a band-pass intermediate the high-note loss is negligible and, of course, the selectivity is positively uncanny.

“WAVE-CHANGING—AN ENTIRELY NEW METHOD” (Continued from preceding page)

the readings. In other words, the capacity would go from minimum to maximum and continue back again to minimum. How? By turning the moving vanes through the fixed vanes 180 degrees and then continuing to rotate the moving vanes in the same direction so that they came out of mesh again.

In this way a continuous rotation of the dial from zero to 360 degrees would be equivalent to two complete variations of the condenser's capacity. But this arrangement is not free from disadvantages; for the variation from zero to 180 degrees (increasing capacity from minimum to maximum) would mean an increase in wavelength, whereas the variation from 180 to 360 degrees (decreasing capacity from maximum to minimum) would mean

a decrease in wavelength. Thus the wavelength changes would be from minimum to maximum on the medium band, but from maximum to minimum on the long-wave band. (See diagram.)

Still, the plan would certainly avoid duplicating the logging points. Another consideration: the arrangement would be satisfactory only so long as one remembered to change the wavelength switch when the dial reached 180 degrees. Now we come to our real object in writing this article. Thanks to the new type of condenser, to which we have already referred, there will be no need in future to remember to change the switch, because the switching from one coil to the other is done perfectly automatically when turning the condenser spindle,

The diagrams show how this object is brought about. A cam is fitted to the end of the spindle of the moving vanes and serves automatically to open and close switch contacts connected to the coils. As the vanes move through the first 180 degrees the cam closes the switch contacts and so shorts out the long-wave coil winding. As soon as the last degree of the 180 degrees is reached the cam opens the switch contacts, thus bringing into play the long-wave coil.

Undoubtedly, one great merit of this condenser is that the cam serves to *open* the contacts during the second half of the zero to 360-degree rotation of the vanes. There is thus a positive make and break and no possibility can arise of poor contact.

No need to wait! You can get

your **Drydex**

to-day!

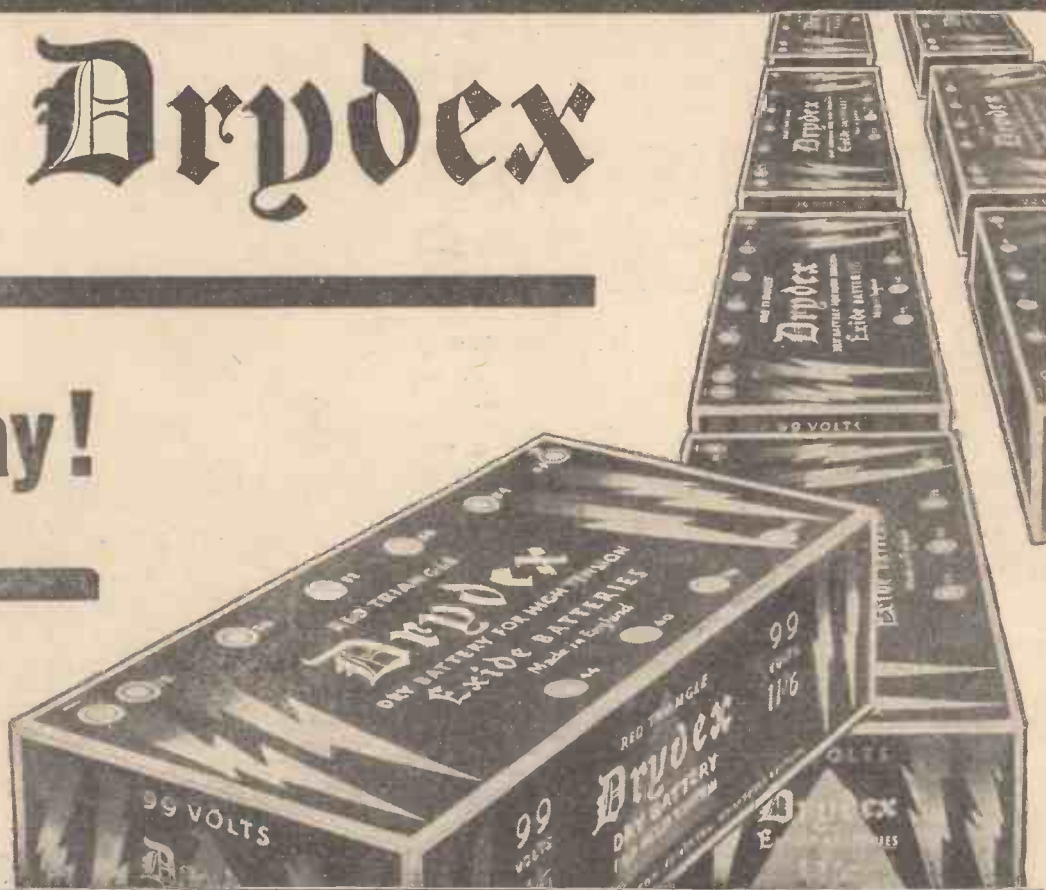

The supreme new dry battery by the makers of the world famous Exide

RED TRIANGLE

60 volts 7/- • 66 volts 7/6
99 volts 11/6 • 120 volts 14/-

GREEN TRIANGLE

60 volts 9/6 • 66 volts 10/6
99 volts 15/6 • 120 volts 18/6

ORANGE TRIANGLE

Triple Capacity • 60 volts 14/-
105 volts 24/6 • 120 volts 27/-

BLUE TRIANGLE

For portable sets • 63 volts 9/-
99 volts - 14/- • 108 volts 15/6

For Grid Bias: *Red Triangle*, 9 volts—1/4, 16.5 volts—2/3. *Green Triangle*, 9 volts—1/9, 16.5 volts—2/9.

Unit Cells for Torches: *Green Triangle*, 1.5 volts—4d. Batteries for Pocket Lamps: *Blue Triangle* 4.5 volts—6d.

Obtainable everywhere from all good dealers.

Exide Batteries, Clifton Junction, near Manchester. Branches at London, Manchester, Birmingham, Bristol and Glasgow.

Dx 16

Don't Forget to Say That You Saw it in "A.W."

For large volume

**WITHOUT HUM
or DISTORTION**

In A.C. mains Sets where the output valve —whether triode or pentode— is directly heated by A.C. mains, hum is difficult to eliminate. A valve using an indirectly heated cathode should therefore be employed.

The Mazda AC/PEN is a high power Pentode capable of an enormous output with only 250 volts H.T. Its characteristics ensure excellent bass response and brilliant high notes and a detector can fully load it without an intermediate stage and complete freedom from hum is assured.

**THE
AMAZING**

**MAZDA
RADIO
VALVES**

CHARACTERISTICS

TYPE	Fil. Volts	Fil. Amps.	Max H.T. Volts	Amp. Factor	Anode Resistance (ohms.)	Mutual cond. m A/V	PRICE
AC/SG	4	1.0 approx.	200	1200	—	—	25/-
AC/HL	4	1.0 "	200	35	11700	3.0	15/6
AC/P	4	1.0 "	200	10	2650	3.75	17/6
AC/P 1	4	1.0 "	200	5	2000	2.5	17/6
AC/Pen	4	1.0 "	250	—	—	2.5	27/6



THE EDISON SWAN ELECTRIC CO., LTD.
*Incorporating the Wiring Supplies, Lighting Engineering
and Radio Business of the British Thomson-Houston Co., Ltd.*

*Radio Division Showrooms:
155 Charing Cross Road, London, W.C.2
Showrooms in all the Principal Towns.*

EDISWAN

V.105

You will Help Yourself and Help Us by Mentioning "A.W." to Advertisers

On Your Wavelength!

RADIATION IN SHORT

IT is rather a curious coincidence that just about the time that Marconi started transmitting the long-wave radiation we now call wireless waves, Becquerel by discovering the radio activity of uranium opened the door to the other end of the frequency spectrum. Very shortly afterwards, Röntgen produced his famous X-rays, which are ether disturbances of such short wavelength that they will penetrate many things quite impervious to light. It is this property, of course, which has made them so useful to the surgeon. But they have proved even more important to the physicist, for they have given him the clue to the complex "make-up" of the atom and the molecule. On the one hand Marconi develops long-wave radiation into a flourishing industry, and on the other there is the physicist revolutionising our ideas on the constitution of matter. And it all springs from radiation of one kind or other.

ELIMINATOR TROUBLE

SEVERAL listeners have been complaining recently of trouble with H.T. eliminators. In each case investigation showed the offending appliances to be early models in which the potentiometer resistances were made of graphite or carbon composition. After being in use for some time, this type of resistance is apt to deteriorate and to increase in resistance value until it practically becomes infinite, whereupon the eliminator naturally goes dead. The only remedy is to have the defaulting elements removed and replaced by wire-wound resistances. In some cases the makers are prepared to make the replacement free of charge if the defect is brought to their attention.

MORE TROUBLE

AMIDST the acrimonious turmoil caused by the Sunday programme policy of the B.B.C., it comes as something of a relief to see that all is not plain sailing in other parts of the world. For instance, there seems to be a spot of trouble brewing up for broadcast listeners in dear old Dixie Land. Recently, the State of South Carolina decided that the owners of radio sets should stump up to the tune of two and a half dollars tax per annum to the local Treasury. The local listeners, however, said "not so!" They pointed out that in other parts of the U.S.A. radio reception was entirely free and appealed to the Federal District Court to remove the proposed tax. The Federal Court has now decided that taxation of this kind is a matter for the Senate and House of Assembly, and cannot be imposed by any individual State. And so, for the moment, the matter rests. After such an episode the Governor of South Carolina will perhaps repeat the invitation made to him on another famous occasion by the Governor of North Carolina.

THE "THOMAS GRAY" PRIZE

I AM glad to see that the Thomas Gray Memorial prize for the most meritorious contribution to the art of navigation has been awarded to Messrs. Charles and David Stevenson, of Edinburgh, for their invention of the Talking Beacon recently installed at the Cumbræ lighthouse. The beacon consists of an ingenious combination of foghorn and wireless transmitter, the latter being operated automatically from a gramophone record. It has been specially designed to help ships in foggy weather. The navigating officer of an approaching ship first hears three warning blasts from the foghorn. Then through a pair of headphones come the name Cumbræ, followed by a series of numbers representing distances in nautical miles, and finally two more blasts from the foghorn. After a short period the whole sequence is repeated. The time intervals are so arranged that the number spoken before the second blast from the foghorn tells the navigating officer his actual distance from the lighthouse. Personally, I think the prize has been well won. It makes one realise what tremendous possibilities there are in wireless—quite outside the field of ordinary broadcasting.

S.G. DETECTORS

IT is surprising how disappointing the screen-grid valve is, when used as a detector. At first sight the high amplification-factor suggests that we should be able to obtain much better results, but in point of fact we are defeated by the high internal resistance of the valve. We can only develop anything like the rated amplification of the valve if the external impedance in the anode circuit is large compared with that of the valve itself, and this unfortunately is not by any means the case in the ordinary detector circuit. Used in conjunction with the ordinary detector valve, the results are not too bad, for here the external impedance is comparable with that of the valve, but the limit occurs in the neighbourhood of 20,000 ohms.

A CASE FOR EXPERIMENT

UNLESS special precautions are taken, little or no improvement can be noted when using a high-resistance valve in the detector stage. Indeed, usually, owing to the slightly better mutual-conductance, the results will probably be the other way round, giving a balance in favour of the lower-impedance valve. At the same time it seems to me that we should endeavour to devise special anode circuits which would enable us to make use of the high amplification factor of the modern S.G. valve. The case is quite different with the pentode, where a distinct improvement in the results may be obtained. Indeed, a pentode used as an anode-bend detector will give results very nearly equal to the average grid detector, yet with the selectivity greatly in excess. Personally, I feel that the extra

cost is very well spent, and I should like to see more sets of this type.

MOORSIDE EDGE AT LAST

AT long last Moorside Edge is regularly at work, and most of you no doubt have heard him by this time. The strength of this station is enormous and it should be able to cover a very large proportion of the entire country. My place is about 180 miles from Moorside Edge, and I have no difficulty in obtaining reception at the fullest loud-speaker strength in broad daylight with a four-valve portable of the S.G. Det.-2 L.F. type. The quality is extremely good at present, and it seems to be likely that a good many of us living in the South and Midlands who find Brookmans Park overpowering will make use of Moorside Edge when real quality in reproduction is needed. This is, of course, all very jolly, but it hardly seems to me to be the function of a regional station to provide a full reception service at ranges of 200 miles or so.

OVERDOING IT

MOORSIDE EDGE is, in fact, a perfect example of a defect in the super-power scheme that I have always been pointing out. In a word, the power is too super. The function of a regional twin station is to serve adequately an area with a radius of about 100 miles. It is quite ridiculous that this area should have a radius at least twice as great. It is generally taken in wireless that to double your effective distance you must increase your power four-fold. It follows that to halve the range you must divide the power by four. This means that the service area could be adequately covered by a transmitter with an output rating of from 10 to 20 kilowatts. Were such transmitters the standard throughout Europe on the medium band we should have far less of the mutual interference troubles, already serious enough, which may well reduce the medium-wave band to chaos within the next couple of years. I spoke a moment ago about receiving Moorside Edge on a portable. I have just made another experiment. I have a tiny two-valver in one room which operates from the simplest of indoor aerials. I am writing at 11.30 a.m., and that two-valver is bringing in M.E. with such vim that you can hear him all over the house—and I am nearly 100 miles outside the service area.

THE CRUX OF THE BUSINESS

THE whole aim of a regional station should be to give perfect service within an area with a radius of 100 miles or so, which means that the total region covered contains some 30,000 square miles. It is a most foolish policy to employ higher power and bigger modulation than is absolutely necessary, for to do so simply means that you swamp all the inlying portions of the area. The area in which reception is difficult owing to swamping effects, when you use a power of

On Your Wavelength! (continued)

70 kilowatts or so and modulate deeply, may be taken as at least 20 miles. Within this area the ordinary set is liable to be over-powered or paralysed, and for real quality you need something more elaborate than the ordinary grid leak and condenser detector for decent reception. Put the point of a pair of compasses on Moorside Edge and draw a circle with a 20-mile radius. It includes, you will find, about the most densely populated area in these islands, taking in towns such as Stockport, Manchester, Rochdale, Burnley, Huddersfield, Halifax, Batley, Bradford, Dewsbury, Leeds, Wakefield, Barnsley, and Oldham. In all these places listeners are going to have a good deal more than they want in order that an area twice as large as it need be may be served by the twin transmitters.

IS IT WISE?

NOR do I think that the policy of fading-in is quite playing the game. I admit that there are points in favour of it, but, to my mind, the objections more than outweigh these. Moorside Edge is to transmit for some time on one wavelength only, namely, 479 metres. People will adjust or alter their sets until they can receive this transmission pretty well, and then will come the next shock—the second transmitter on 301 metres. It is quite absurd to say that you can judge from the 479-metre transmission whether a set will be selective enough on 301 metres. You cannot, for a variety of reasons. Here are two of them. First of all, every set is more selective towards the upper part of its range than down at the lower end, since there is more capacity in parallel with the tuning coils. Secondly, the field strength of a station on a shorter wavelength may be much greater than that of a longer wave transmission at close and medium ranges. In my own case, "Noisy Nat" with 68 kilowatts is very much more powerful than "Raucous Reg" with 70 and has a far greater wipe-out. By far the sounder course would be to let Moorside Edge transmit, to begin with, one day on 479 metres, and the next on 301 metres. Listeners would then have a real chance of seeing just what the wipe-out area from each transmission was likely to be. They could thus make proper preparations for the coming deluge. I think too, that 5GB should be giving us some tests on 398.9 metres, for his change of wavelength is going to be quite a big problem in many parts of the Midlands. There are not a few places where sets that have previously been satisfactory will fail to separate this station from the London Regional.

THE REAL FUN

THE real fun, however—or perhaps one should say the real tragedy—is going to come when the two remaining regional stations come into operation. At present it has been possible to allot to each twin transmitter wavelengths well apart from one another. London has 356.3 metres and 261.3 metres, Daventry 1,554.4 and 398.9 metres, Moorside Edge 479.2 and 301 metres.

But this joyous state of affairs cannot continue, for the remaining wavelengths belonging to the B.B.C. are 376.4, 309.9, 288.5, and 242 metres. The biggest possible separation for the Western and Scottish Regional stations is for one to take 376.4 and 288.5 metres, whilst the other takes 309.9 and 242 metres. There are big objections to any such allocation, for the stations on 309.9 and 242 metres will have two short wavelengths which have an unhappy knack of skipping their own service area. And what proportion of people using simple sets have any chance of receiving on 242 metres whilst "Noisy Nat" is working anywhere within a couple of hundred miles on 261.3 metres?

THE VOICE OF SWITZERLAND

THERE must be few now who have not picked up Sötzens, the new Swiss transmitter, which is using Berne's wavelength. Though rated at not more than 25 kilowatts, this station comes in with enormous power and excellent quality. You will find, by the way, that his experimental transmissions are exceedingly useful when you are testing out the reproduction of your set. He frequently transmits scales played on the piano (a thing which I have long urged our own B.B.C. to do), and these give you a fine chance of seeing whether your set or its loud-speaker have any undesirable resonances and whether there are certain notes or parts of the scale to which they do not respond as well as they should.

A SUGGESTION

IT not infrequently happens that there is an odd quarter of an hour to be filled in by regional transmitters and that the programme experts at Savoy Hill have an easy way out of the difficulty. They just say: "Oh, let the regionals 'take' the National programme." And the regionals duly take it. It fills in the time, I admit, but the regional listener has then no alternative from home stations. Now, if one of these odd quarters of an hour could be filled each

week by the transmission simply of scales by various instruments, it would be of the very greatest value to manufacturers, salesmen, and owners of wireless sets. As it is, when we want to test the response of our sets to musical frequencies we have to fall back on the invaluable "instruments of the orchestra" gramophone records. These are fine, so far as they go, but it must be remembered that the response from the loud-speaker depends to no small degree upon the quality of the pick-up. We can thus test out the "gramo" parts of our sets, but we have no fair opportunity of trying out the purely "radio" stages.

TRY IT OUT

IN a large number of the sets that I look over I find that defects in quality complained of by their owners are due to a cause which is often unsuspected. People find a set incapable of producing anything like big loud-speaker volume because, unless the volume control is made use of, it cracks or sizzles whenever certain notes appear. In an attempt to get rid of the trouble they fit lower and lower impedance output valves, with heftier and heftier plate voltage, and bigger and bigger negative grid bias. But the trouble still remains. In such cases the real culprit is more often than not the first low-frequency valve. It is no good providing an output stage capable of dealing with a big grid-voltage swing if your first L.F. valve is being overloaded. It is quite easy to discover whether this is taking place or not. Wire a milliammeter—you can always beg, borrow or steal one if you don't possess such an instrument—into the plate circuit of this valve and watch its needle. If it kicks whenever certain notes occur you can feel sure either that the G.B. of the valve is not properly adjusted or that it is incapable of handling the grid swings which come its way. Try, first of all, adjusting the grid bias, and if that doesn't keep the needle still then you want a valve of lower impedance in that position.

A GRID-BIAS TIP

WHEN you are watching the milliammeter used to track down the distortion caused by overloading you can learn more from it than the mere fact that distortion is or is not taking place from this cause. Incorrect grid bias means that the working point is either too low or too high on the grid volts plate current curve. Should it be too low bottom bending will take place. This means that you are over-biasing and the milliammeter will record the fact by upward kicks. On the other hand, too high a working point means grid currenting. The grid bias is too low and the milliammeter kicks downwards. You can, therefore, adjust the grid bias carefully, and if the milliammeter won't steady down with any grid bias that you give the valve then you know that the straight portion of the curve is too short and that you want a valve of lower impedance.

THERMION.

A SOLDERING HINT

Use small round-nose pliers when soldering the leads in your set. The



T-joint shown here is being supported in this way while the iron is dropping a small blob of solder on to the junction point.

NEW VIEWS OF SLAITHWAITE

1.—A view of the main transmitter hall with the transmitter panels on each side. 2.—The concrete-lined tank holding many thousands of gallons of water in reserve for cooling. 3.—One of the huge Diesel engines which provide the power for driving the twin transmitters. 4.—One of the control desks for the relay and line apparatus for the transmitters. 5.—The base of one of the huge stayed-type masts resting on an insulating block.

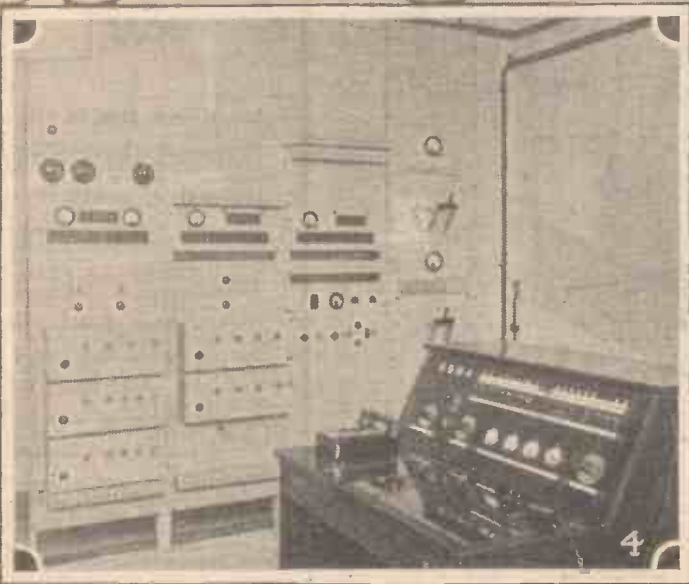
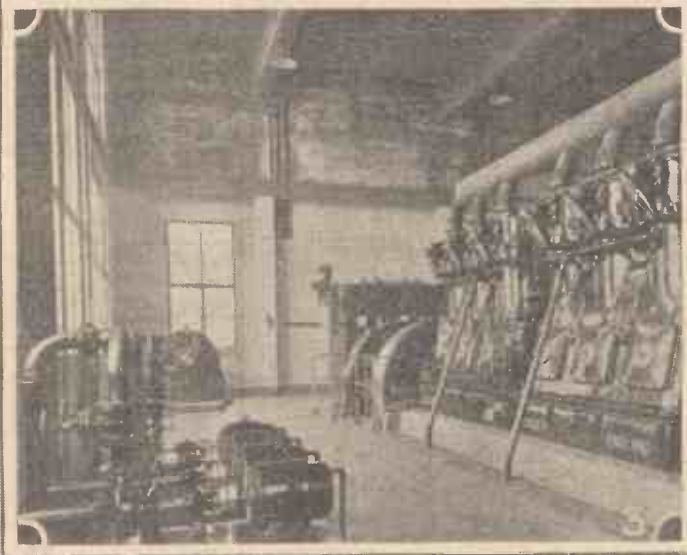

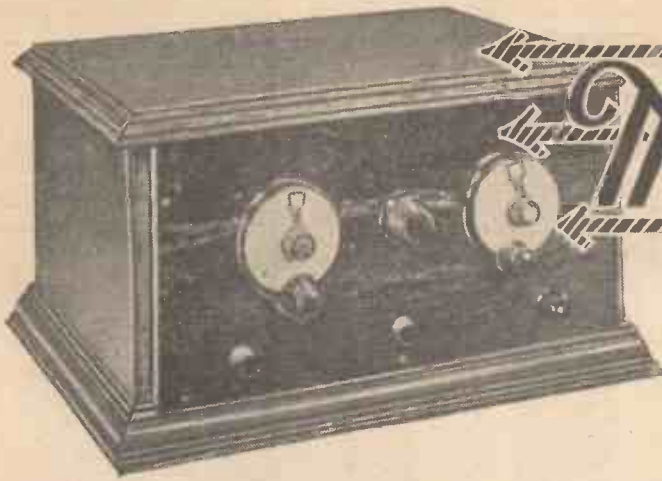

The ULTRA-SELECT - STRAIGHT THREE

A SUPER-SELECTIVE THREE-VALVE SET OF STRAIGHT THREE TYPE
WILL MAKE A PARTICULAR APPEAL TO LISTENERS IN REGIONAL AREAS,
LOCAL STATIONS, AND ALSO WANT TO TUNE IN FOREIGN STATIONS

"I WANT a straightforward three-valver, using ordinary six-pin coils and not having any expensive components, such as ganged condensers or complicated shielding."

A Popular Set

That is a typical request received by the AMATEUR WIRELESS Information Bureau, and it is in response to this that there has been produced this straightforward three-valver which, being inherently super-selective is ideal for use in Regional areas where listeners require not only to get the local programme at good volume, and with reasonable purity but also like to make an occasional tour of the Continental stations;

and when they do so there must not be any background from the adjacent National or Regional transmitters.

Real Simplicity

It is admitted that not everybody wants to make a set which, perhaps at the risk of losing a little simplicity in construction, gives really super performance. There is a large group of listeners who are satisfied by getting a moderate number of foreign stations really well, rather than a large number with indifferent quality. Not every amateur, too, wants ganged tuning which, although simpler once the circuits are set up and properly adjusted, is often a trifle more costly at the outset

because of the expensive parts needed, and is also a little more difficult to adjust because of the initial ganging and perhaps because some small constructional detail, such as the screening and its associated capacity, upset the ganging of the circuits.

For real simplicity, therefore, as demanded by the man who does not want one-knob control because he always adjusts the set himself and does not

leave it to non-technical members of the family, separate tuning of each stage is still the vogue.

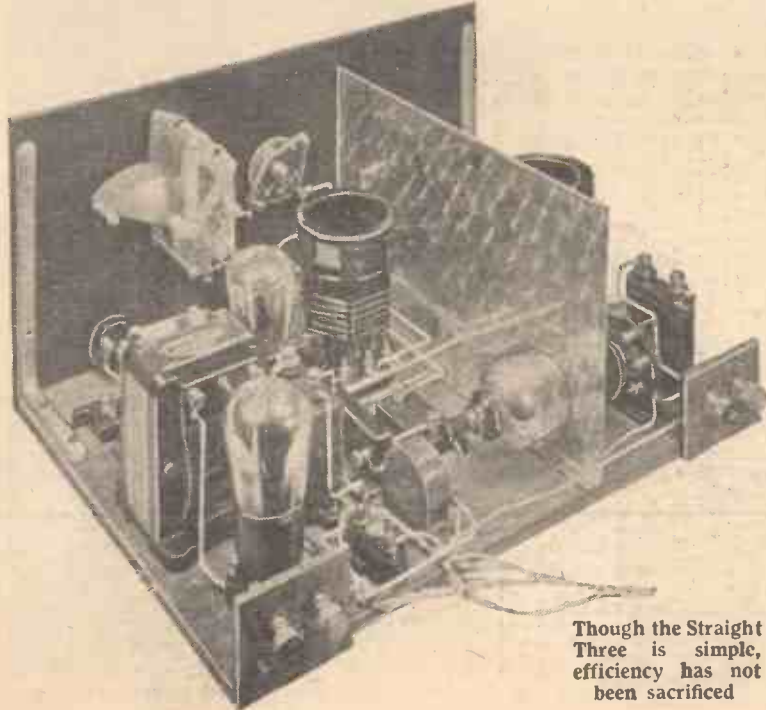

Though the Straight Three is simple, efficiency has not been sacrificed

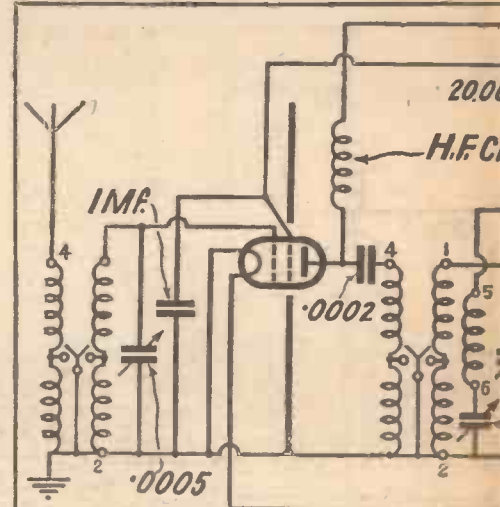

COMPONENTS

- Ebonite panel, 14 in. by 7 in. (Becol, Trelleborg, Peto-Scott).
- Baseboard, 14 in. by 10 in. (Pickett, Camco, Clarion).
- Panel brackets (Bulgin, H. & B., Readi-Rad, Peto-Scott).
- Two .0005-mfd. variable condensers (Lotus, J.B., Lissen, Polar, Cyldon, Formo).
- .0061-mfd. variable reaction condenser (Readi-Rad, Lotus, J.B., Bulgin, Peto-Scott, Lissen, Polar, Cyldon, Formo).
- Two 1931 Clarion coils (Tunewell).
- Two three-point shorting switches (Bulgin, Readi-Rad, Lissen).
- Filament switch (Bulgin, Readi-Rad, Benjamin, Lissen, Junit, Lotus).
- Two slow-motion dials (Astra, Ormond, Formo, Brownie).
- Two valve holders (W.B., Telsen, Lissen, Benjamin, Clix, Lotus).
- Horizontal-mounting valve holder (W.B., Junit, H. & B., Parex).
- Two six-pin coil bases (Tunewell, Lewcos, Formo, Colvern).
- Two .0002-mfd. fixed condensers (Lissen, T.C.C., Dubilier, Telsen, Watmel, Graham-Farish).
- .0001-mfd. fixed condensers (Lissen, T.C.C., Dubilier, Watmel, Telsen, Graham-Farish).
- 1-mfd. fixed condenser (Dubilier, T.C.C., Lissen, Formo).

SELECTIVE THREE-

STRAIGHTFORWARD CONSTRUCTION WHICH
WHO WANT TO GET GOOD RECEPTION OF
STATIONS, FREE FROM REGIONAL WIPE-OUT

If it be taken for granted that our simple set for Regional and foreign station reception is a three-valver, the natural

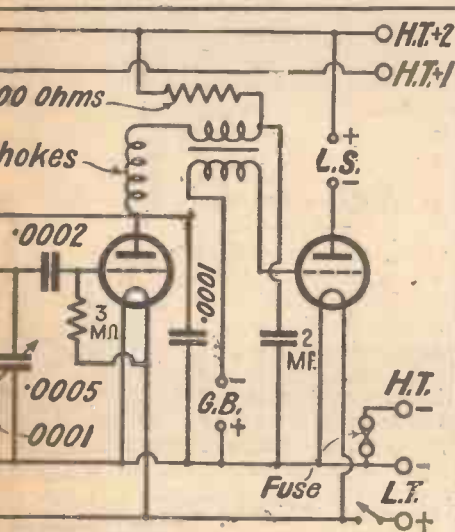

REQUIRED

- 2-mfd. fixed condenser (Dubilier, Ferranti, T.C.C., Lissen, Formo).
- 3-megohm grid leak (Lissen, Dubilier, Telsen, Watmel, Graham-Farish).
- Grid-leak holder (Lissen, Bulgin, Dubilier, Graham-Farish).
- Low-frequency transformer (Lewcos, Telsen, Lissen, Varley, Ferranti, R.L. Burton).
- Two high-frequency chokes (Telsen, Varley, Readi-Rad, Lissen, Bulgin, Sovereign, Tunewell, Lewcos, Burton).
- One 20,000-ohm spaggetti resistance (Bulgin, Graham-Farish, Lewcos).
- Single fuse holder (Bulgin, Readi-Rad, Burne-Jones).
- Aluminium partition screen, 10 in. by 7 in. (Peto-Scott, Parex, Readi-Rad, H. & B.).
- Two terminal blocks (Sovereign, Junit, Belling-Lee, Lissen).
- Four terminals marked: Aerial, Earth, L.S.+, L.S.- (Belling-Lee, Clix, Eelex, Burton).
- Five wander plugs, marked: H.T.-, H.T.+, H.T.+2, G.B.+, G.B.- (Clix, Belling-Lee, Eelex).
- Two spade terminals, marked: L.T.+, L.T.- (Clix, Belling-Lee, Eelex).
- Four yards of thin flex (Lewcoflex).
- Connecting wire (Glazite).

EASY
CON-
TROL

SHARP
TUN-
ING

SIMPLE
TO
BUILD

question arises as to the order in which the valves shall be placed.

Modern Circuits

There is, unfortunately, in certain quarters a reaction towards an unsatisfactory and old-fashioned type of set, the plain detector and two-low-frequency variety of three-valver, with plain tuning. A set of this kind cannot hope to cope with modern conditions, and the AMATEUR WIRELESS Technical Staff most strongly urges its readers to make up a set which represents a progressive policy and which is truly capable of giving the super-selectivity demanded by modern conditions. Three-valvers of this type without a high-frequency stage can still be used in very special circumstances, but the number of cases when they are suitable is so small that for general purposes nothing but a high-frequency set should be considered by the go-ahead amateur.

This new three-valver is yet another of the ever-popular screen-grid H.F., detector and transformer-coupled L.F. sets.

The whole point of its success lies in the special tuning adopted. The layout of the set is straightforward, there being a simple baseboard and right-angle panel, and there is only one screen, which can be bought ready-made if desired and which

serves to screen the high-frequency side of the set from the following detector and low-frequency stages.

On the panel are the two main tuning controls for the aerial and high-frequency stages (the high-frequency stage is particularly critical and so good slow-motion dials are fitted), the reaction condenser, on-off switch and the wave-change switch for each coil.

The coils used fit in ordinary six-pin holders and have standard connections so that not only can you make a small economy by using your existing six-pin coils—although this is not really to be recommended as the recently introduced selective coils used are much more satisfactory—but you can in the same holders fit six-pin short-wave coils and so increase the tuning range of the set and the amount of pleasure you can get.

Dual Range

The three connections to each wave-change switch are taken by means of short lengths of flex. If you are using the plug-in six-pin type of coil in place of these special coils, then it is, of course, unnecessary to fit the wave-change switches. Similarly, when short-wave coils are used, the wave-change arrangements are disregarded.

However, it is urged that the coils specified for the set be used because they contribute in large measure to the natural selectivity of the circuit. The circuit diagram shown here clearly illustrates the manner in which the high-frequency and detector stages are coupled by means of the special tuning circuits and it shows also that the low-frequency stage is arranged on quite straightforward transformer-coupled lines.

Surely nothing could be simpler. You will see that the screen-grid valve is

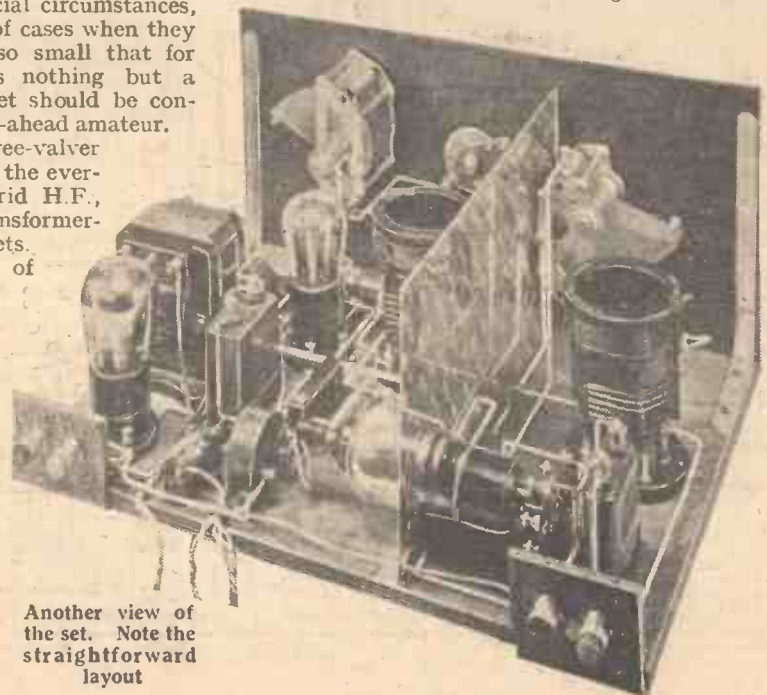

Another view of the set. Note the straightforward layout

"THE ULTRA-SELECTIVE STRAIGHT THREE"

(Continued from preceding page)

coupled to the detector in the shunt-feed manner, a .0003 fixed condenser coupling the anode of the screen-grid valve to the aperiodic winding of the detector grid coil. A 1-microfarad condenser is placed between the screening grid and negative L.T.

Reaction is provided by means of a separate winding on the detector grid coil. This winding acts on both the medium and long wavelengths and a .0001-microfarad reaction condenser in series with it produces oscillation. The grid condenser and leak in the detector stages have the usual values, .0002 microfarad and 2 megohms respectively. As both the H.F. and detector tuning condensers are .0005-microfarad capacity they will, if the circuit is properly set up, move very nearly in step, except at

Comparison of this plan view with the layout diagram below will facilitate the construction

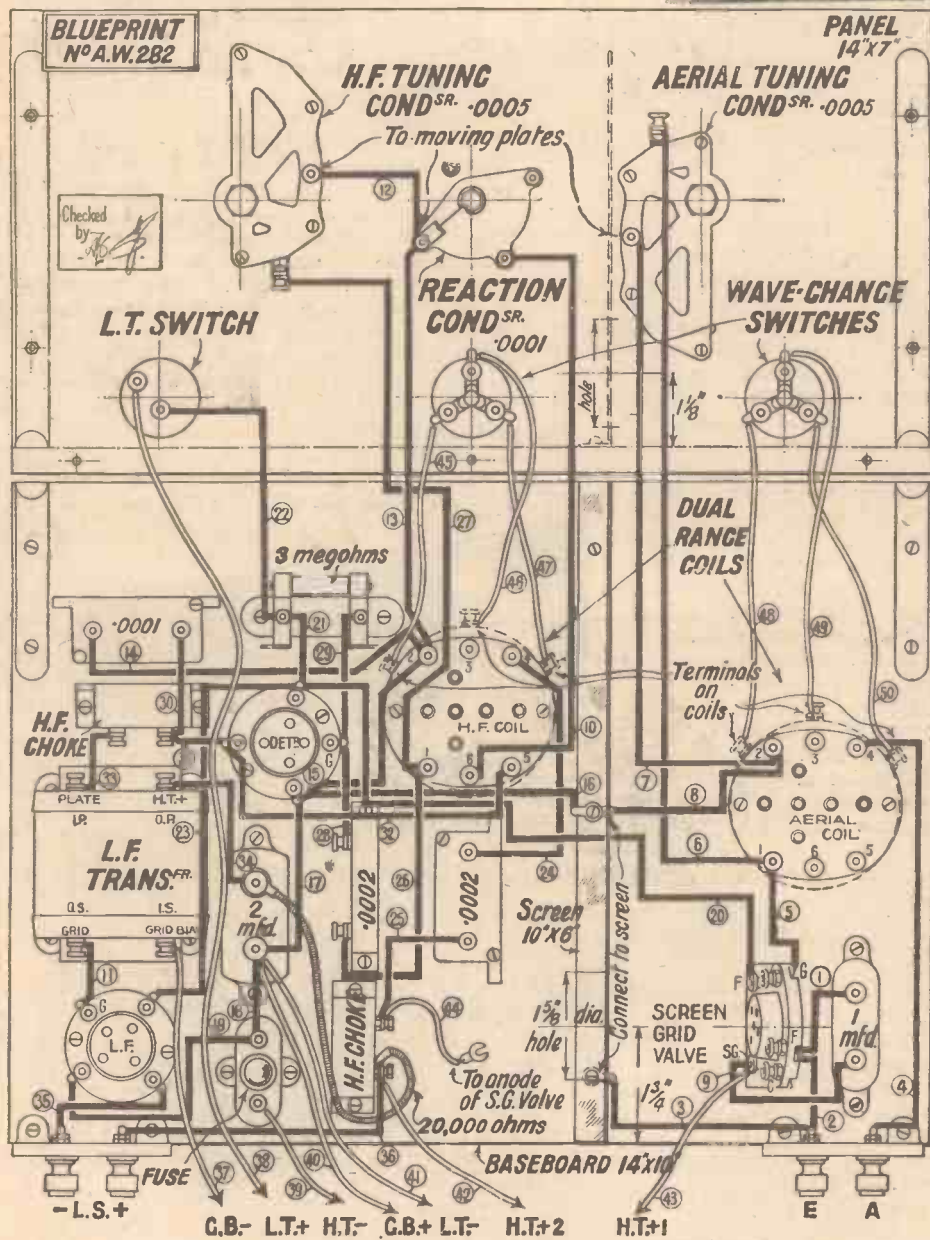
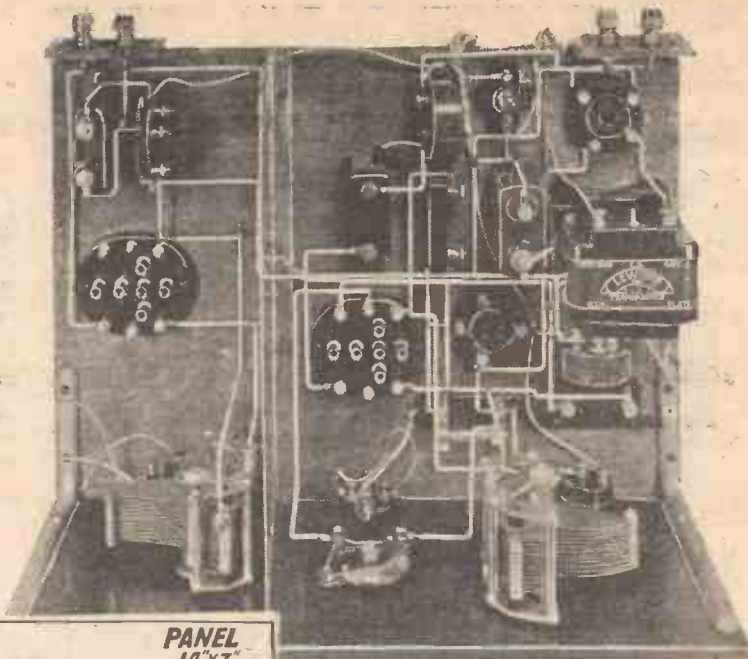

The layout and wiring diagram. A full-size blueprint is available, price 1/-

the extreme ends of the scale and this will be found of great assistance in tuning, making the operation of the separate controls as simple as that of a ganged set.

Note the by-pass condenser between the detector anode and the negative L.T. and also the stopper resistance and by-pass condenser in the anode of the detector, the resistance being in series with the primary of the transformer. A good point is the fuse placed between the high-tension and low-tension negative connections. A special fuse of the screw-in type is used and this is a fine safeguard, not only when the set is wired up and, due to any mistake which may have been made in the connections, the high-tension is short-circuited, but also in ordinary working it prevents a valve being damaged if anything comes loose and short-circuits.

To assist constructors, a full-size blueprint has been prepared and this can be obtained, price 1s. post free, from the Blueprint Department, AMATEUR WIRELESS, 58-61 Fetter Lane, London, E.C.4. Just ask for blueprint No. 282; no correspondence is needed.

In next week's issue, full constructional details will be given, but in the meantime with the aid of the full-size blueprint or of the small reproduction of it given here, the preliminary work, such as panel drilling and mounting of some of the parts may be carried out. If the full-size blueprint is used then it is a very easy matter to drill the panel, for the print can be used as a template, being temporarily attached to the back of the panel on the surface by a spot of adhesive at each corner and the various holes then drilled through. Do not overlook the holes at the lower edge for the wood-screws which attach the panel.

You can see the set this week in the Radio Department windows in Somerset Street of Messrs. Selfridge & Co., Ltd., Oxford Street, London, W.1. Somerset Street is at the back of the main Selfridge building and is parallel with Oxford Street. All London readers should make a point of seeing this fine easy-to-build super-selective three-valver.

TERMS TO SUIT ALL

Order your Kit of Components now. If it is not convenient to send cash with order you can pay on delivery—it costs you no more. Or if you wish, send a small payment with your order and pay the balance by easy monthly instalments. Ready Radio Terms suit all pockets.

CASH or E.P. or C.O.D.

With order (Easy monthly payments) (Pay on delivery)

KITS FOR THE ETHER SEARCHER

(Battery-operated Model)

KIT A

Complete Kit of Matched Components, less valves and cabinet. Cash or C.O.D. **£5.14.6** Or 12 monthly payments of **10/6**

KIT B

Complete Kit of Matched Components, with valves less cabinet. Cash or C.O.D. **£7.13.6** Or 12 monthly payments of **14/-**

KIT C

Complete Kit of Matched Components, with valves and cabinet. Cash or C.O.D. **£8.14.6** Or 12 monthly payments of **16/-**

For full lists of other Kits see previous issues.

ULTRA SELECTIVE STRAIGHT THREE

	£	s.	d.
1 Polished ebonite panel, 14x7x 3/4 drilled to specification	4	6	
1 Hand Polished Oak cabinet with 10 in. baseboard	1	0	0
2 Readi Rad .0005 mfd. variable condensers	9	0	
2 Readi-Rad "Duograph" Slow Motion dials	13	0	
1 Readi-Rad .0001 mfd. Bookman's condenser	2	0	
1 Pair Readi-Rad Panel Brackets	10		
1 Readi-Rad 20,000 ohm Link Resistance	1	3	
2 Readi-Rad 3 pt. shorting switches	3	0	
1 Readi-Rad on off switch	10		
2 Telsen 4-pin valve holders	2	0	
1 Junit H.V. valve holder	1	9	
2 Lewcos 6-pin bases	4	0	
2 Tunewell 1931 Clarion coils	1	1	0
2 Readi-Rad .0002 mfd. fixed condensers	1	8	
1 Readi-Rad .0001 mfd. fixed condenser	10		
1 T.C.C. 1 mfd. fixed condenser	2	10	
1 T.C.C. 2 mfd. fixed condenser	3	10	
1 Readi-Rad 3 meg. Grid leak and holder	1	4	
1 Telsen "Radiogrand" L.F. transformer 5-1	12	6	
1 Telsen H.F. choke	2	6	
1 Readi-Rad "Hilo" H.F. choke	4	6	
1 Readi-Rad single fuse holder with bulb	1	3	
1 Readi-Rad Aluminium screen 10x7 with S.G. hole	2	6	
2 Ebonite terminal strips 14x2x 3/8	1	3	
4 Belling-Lee "R" type terminals	1	0	
5 Belling-Lee wander plugs	10		
2 Clix spade terminals	2	6	
1 Packet "JIFFILINX" for wiring	2	6	
3 Mullard valves to specification, S.G., Det. and Power	1	19	0
4 Yards thin flex, screws, etc.	1	2	

Total (including valves and cabinet) **£8 3 6**

KIT A

Complete Kit of Components as specified less valves and cabinet. Cash or C.O.D.

£5.4.6 Or 12 monthly payments of **9'7**

KIT B

Complete Kit of Components as specified with valves less cabinet. Cash or C.O.D.

£7.3.6 Or 12 monthly payments of **13'2**

KIT C

Complete Kit of Components as specified with valves and cabinet. Cash or C.O.D.

£8.3.6 Or 12 monthly payments of **15'-**

IMMEDIATE DISPATCH

Ready Radio

159, BOROUGH HIGH STREET, LONDON BRIDGE, S.E.1.

Telephone: Hop 5555 (Private Exchange) Telegrams: READIRAD, SEDIST.

TO INLAND CUSTOMERS

Your goods are dispatched post free or carriage paid.

TO OVERSEAS CUSTOMERS

All your goods are very carefully packed for export and insured, all charges forward.

ORDER FORM

To: Ready Radio (R. R. Ltd.), 159 Borough High Street, London Bridge, S.E.1

CASH ORDER FORM

Please dispatch to me at once the goods specified for which I enclose payment in full of

£

Name

C.O.D. ORDER FORM

Please dispatch to me at once the goods specified for which I will pay in full on delivery the sum of

£

Address

HIRE PURCHASE ORDER FORM

Please dispatch my Hire Purchase order for the goods specified for which I enclose first deposit of

£

KIT REQUIRED

THE HOW AND WHY OF RADIO

XXX—HOW FRAME AERIALS WORK

If you are a beginner in wireless, now is your chance to gain a clear conception of its theory and practice. In this series of articles, specially prepared for the beginner, no previous knowledge of wireless is assumed. It is intended to deal with every aspect of the subject and the whole series will endow the beginner with sufficient knowledge to enable him to derive the greatest possible interest from the fascinating hobby of wireless

JUST now we are all devising ways and means of getting selectivity—that valuable property of reception whereby one wanted station can be readily separated from other stations on nearby wavelengths. The frame aerial is certainly one of the most effective selectivity devices available. In most sets it replaces the normal aerial and

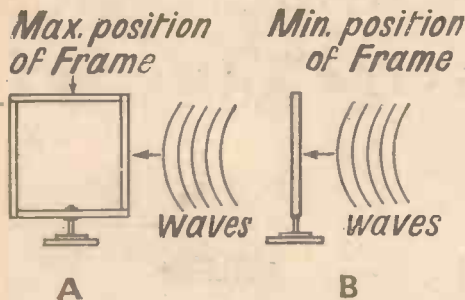

Fig. 1. These diagrams A and B show how a wave travelling along the surface of the earth causes a magnetic field to be developed at right angles

earth wires, as well as the first tuning coil of the set.

First of all let us note the action of the frame. It happens that when a loop of wire is placed in a varying magnetic field, so that the field passes through the loop, a voltage is developed in the wire of the loop. If the loop is closed a current then flows through it. Now it is clear that, since the voltage induced is proportional to the lines of force actually passing through the loop, there will be a maximum amount of current developed when the plane of the loop is at right angles to the direction of the magnetic field. For in this way the maximum number of lines of force pass through the loop. On the other hand, when the plane of the loop is in the same direction as the magnetic field no lines of force will pass through the loop, no voltage will be induced, and therefore no current will flow.

Maximum Pick-up

I have mentioned this theoretical consideration because it has an important bearing on the action of a frame aerial, which is, in fact, a loop in a varying magnetic field. It happens that when a wireless wave is travelling along the surface of the earth it causes a horizontal magnetic field to be developed at right angles to the direction in which the wave is travelling (see Figs. 1A and 1B).

From this it follows that a wireless wave

will develop the maximum amount of current in a frame aerial when the frame is placed in the same plane as the incoming wave, so that the magnetic field, at right angles to the wave, will cut the frame at right angles. If the frame is turned at right angles to this direction the incoming wireless wave will have no effect upon it. It is obvious that wireless waves coming from directions intermediate between the maximum and minimum positions of the frame will have some effect upon it, although not as great an effect as is achieved by pointing the frame in the direction of the station.

In practice we use frame aerials by connecting the two ends of the winding across a variable condenser. In this way the inductance of the frame winding and the capacity of the tuning condenser combine to produce resonance at the frequency of the incoming wave.

Frame-aerial Types

Fig. 2A shows a common form of con-

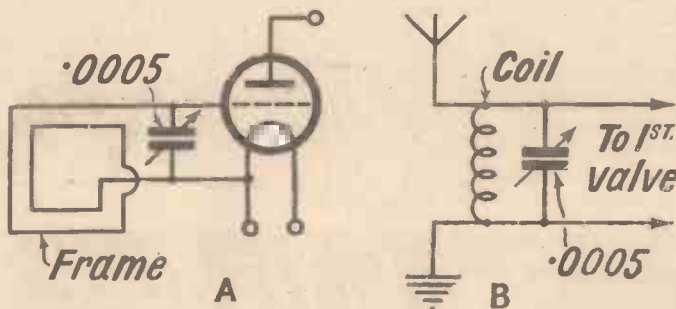

Fig. 3. This is the method of connecting up the frame to the set

struction for a frame aerial whereby the turns of wire are wound in box formation over four corner supports, which should, of course, be made of some insulating material. The larger the area enclosed by the frame winding the better it is able to pick up wireless signals. One large single turn would be ideal, but as this is usually quite impracticable we wind a dozen or so turns side by side. Fig. 2B shows a less efficient, but more compact, construction for a frame aerial, whereby the winding is arranged in pancake fashion. This sort of frame aerial is sometimes very useful in small portable sets.

Fig. 3A shows how the frame winding is connected across a variable condenser and how this tuned circuit is connected to the valve of a receiving set. The corresponding connections for an ordinary aerial and earth system are shown at Fig. 3B.

One hears very frequently of listeners

using frame aerials in an attempt to make inherently unselective sets more selective in order to separate regional programmes. While it is true that the use of a frame aerial, with its very light damping effect, does impart some degree of selectivity, its peculiar directional action cannot be used to advantage. For regional programmes are radiated from the same point: they can be separated by a frame aerial only if it is connected to a set capable of separating them by means of its intermediate tuning circuits.

Dual Direction

Another point to watch, in attempting to use a frame aerial to separate stations that cannot be separated by the inherent selectivity of the set, is that stations coming from diametrically opposite directions have the same effect upon a frame as if they were coming from the same direction.

Sometimes listeners are puzzled by the fact that, although the frame is pointing in what is known to be the direction of the received signal, the maximum signal strength is not being obtained. Screening by steel buildings sometimes completely upsets the action of a frame aerial in this way. Another conflicting factor is the Heaviside layer, which at night-time reflects wireless waves and these strike the frame aerial in such a way that the maximum signal strength is sometimes obtained in a direction quite remote from that of the received station.

HOTSPOT.

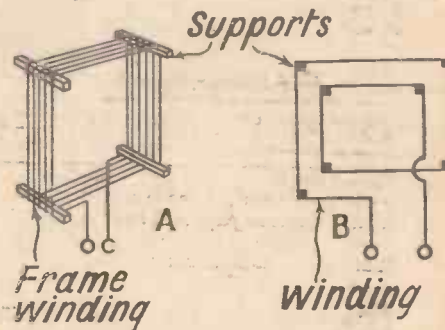
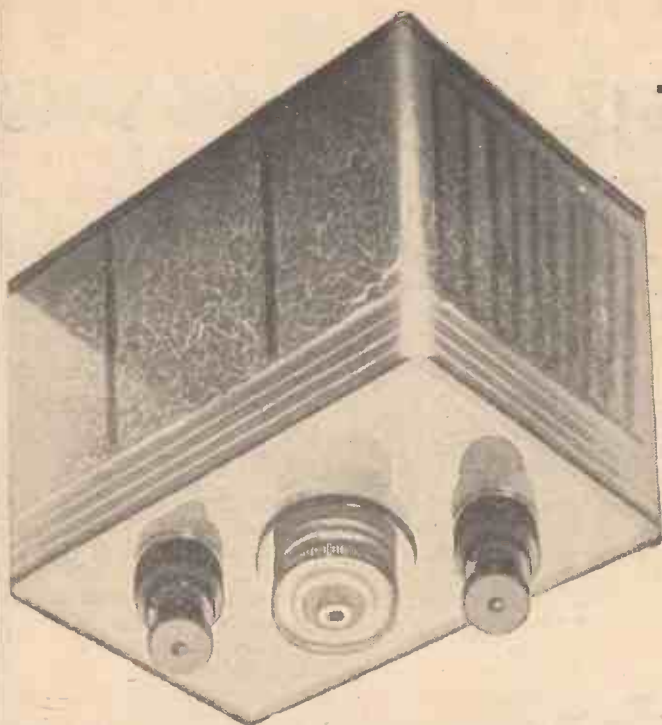

Fig. 2. Here are two arrangements, A and B, for the winding of the frame

Passengers on the Lufthansa's Berlin-Dresden-Prague-Vienna air line can now send radiograms from the air while en route. The messages are transmitted to the ground stations of the Reichpost.



THE FULLER "NON-SPILL"

puts
perfection
into
portables

The secret of the success of Fuller "Non-Spill" L.T. Accumulators lies in the employment of jelly acid with micro-porous plates. Every Fuller "Non-Spill" has micro-porous pasted plates. These unique plates are finer and smoother in texture than the ordinary type, but much stronger in wear. Never crumble or break down. The separators in the 'Sparta' "Non-Spill" are indestructible and there are large non-spill vents.

Fuller 'Sparta' 2-volt "Non-Spill" L.T. Accumulator for Portable Receivers. Standard on well-known Portables. Type JAP II. Price 13/6. Capacity, 22 amp. hours. Overall size, 4 1/8" x 3 1/8" x 3 1/2". Code JEXNA. Also the JUA9: 18 amp. hours, 13/-, and other sizes from 11/6 upwards.

There are 15 different types in all sizes and capacities and suitable for all popular suitcase and transportable receivers.

Write for List, Index No. 269.

FULLER SUPER BATTERIES

Obtainable through Fuller Service Agents or any reputable dealer.

Full list of sizes and types post free.

FULLER ACCUMULATOR CO. (1926), LTD., CHADWELL HEATH, ESSEX

To Ensure Speedy Delivery, Mention "A.W." to Advertisers

L.T. ACCUMULATORS.

Mammoth plates for modern valves; micro-porous paste; patent double grease-cup terminals; patent non-slip metal carrying handle; L D G. 2v. 60 a.h. 9s. 6d. M.S.G. 2v. 22 a.h. 4s. 6d.



FOR MULTI-VALVE SETS.

Accumulators for comparatively heavy discharges. Moulded glass containers. Micro-porous pasted plates. Patent double grease-cup terminals. SWG7.30 A.H. capacity. 11/-



H. T. DRY BATTERIES.

The Fuller W.O.P. 100 gives portables the power they need—guaranteeing up to 20 milliamps, 100 volts (reads 108) 10"x5"x3". 15/- . Complete range of standard, super power and grid bias batteries available.



CAR BATTERIES.

Patent double grease-cup terminals eliminate risk of acid creep. Solid ebonite containers, strong and durable. A type for every car. Ask for lists 104a and 105a.

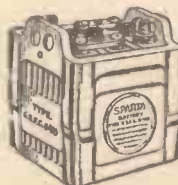

A Weekly Programme Criticism—By SYDNEY MOSELEY.

Without Fear or Favour

Music

Drama

Dance

New
Talks
criticism

Relays
Vaudeville

Television

Debates

Poetry

THE BOAT RACE

BRASS BANDS

TOSCA always moves me, and I put everything else aside in order to hear the last act which was relayed from Birmingham. I have heard a good many Cavaradossis here and abroad, but none who made me feel so unsympathetic. I was very glad that they shot him, after all!

Hats off to the Glasgow Orpheus Choir, who certainly justify all the superlatives that are written about them.

What a clear, beautiful voice Jean Hastings has!

There were two views about the Oxford and Cambridge boat race commentary this year. The younger members of my family thought it was very thrilling and much better than last year. The older people felt it was the reverse—that it lacked thrills and that Mr. Squire last year was much better. As for me, I frankly admit that I did not listen-in!

What a wonderful voice Norman Allin has! At the Popular Celebrity Concert relayed from the Central Hall, Birmingham, he scored a tremendous triumph, and we at dinner knew at once that that voice of purity of tone and immense range could only belong to one man.

The B.B.C. encourages brass bands. It not only broadcasts them, but helps them sometimes materially. I have never heard the Burnhope Silver Colliery Brass Band before, but the relay from Newcastle was very good. Fancy their playing the rare "Norma"!

I like the cool way in which the announcer said, "That concludes the relay from the Prince of Wales' Theatre, Birmingham. It is now twelve minutes to nine. There will, therefore, be an interval till 9 o'clock." Suffering cats!

I have already spoken about the tenor in the opera who had an excellent sob, but little else. Why are tenors so scarce? Particularly in B.B.C. broadcasts? No prize for the answer.

I think, on the whole, it was a pity that the production, *Krassin Saves Italia* was postponed. The B.B.C. lately has been

showing a weakness in regard to criticism, which is unusual. Often it is the other way round. But this play was taken off, if you please, because of the debate in the House of Lords on the alleged socialist tendency of the B.B.C. Inexplicable, isn't it?

Two men who can always rely on a welcome are Albert Whelan and "Stainless Stephen." Both keep up a fairly high level of artistry.

A wonderfully fine relay was that by the Hallé Orchestra, conducted by Sir Hamilton Harty, from the Free Trade Hall, Manchester. Wagnerian music never sounded better.

It is always a delight to listen to Miriam Licette. Even in a list of excellent sopranos, Miriam can always be depended upon to hold her own, both in how she sings and in what she sings. Her songs of the sixteenth and eighteenth centuries were delightful.

Of Jack Payne's new numbers, I like "Shout for Happiness," although this may not be quite so new, and "Ten Cents a Dance" and "Lady of Spain." Now, I suppose the high-brows will tell me what a low-brow I am.



An Impression of OLIVE KAVANN

RADIO HUMORISTS

AT THE QUEEN'S HALL

I went to the Queen's Hall to listen to the eighteenth B.B.C. Symphony Concert, just to show that I am not quite so low-brow, after all. It was a Beethoven night and—listen to this, ye critics of English musical taste—the hall was packed. Years ago when I went to the "Proms" I wondered how people could stick out a whole night of Beethoven. Now I begin to understand, thanks to the B.B.C.

And in this confessional mood, let me admit as a devoted follower of music in all its branches, that the B.B.C. has managed in this department to maintain an excellent balance. Really few listeners have much grouse here.

I heard part of the Worcestershire Association of Musical Societies Festival Concert. The singing was quite good, and I am sorry that the names of the chief characters were not announced. Congratulations, however, to the chorus, who did marvellously well.

One of the best transmissions of opera lately was that of *Aida* by the Covent Garden Opera Company. The transmission was so clear that at first I thought it came from the studio. In the interval Mr. Francis Toye gave an interesting and illuminating talk on Verdi and *Aida*, and although he had a cold he managed to keep up his end quite well. He and other speakers should refrain from speaking of "the latter," which is all-right in print when you can refer back, but not in speech when the previous sentences are soon forgotten.

But my, oh my! Immediately following Verdi's opera came Jack Payne with his low-brow stuff. Now who was responsible for this *faux-pas*? Off with his head!

I am sorry to see that the German conductor, Oskar Fried, had such a bad Press. He is certainly a most vigorous conductor and, like his predecessors, a decent fellow. The concert which he conducted from Studio No. 10 was one of the most enjoyable I have ever heard. Still, these technical musical critics want a lot of satisfying.



ETA Valves have arrived! Quality valves in every respect, they are manufactured with the greatest care and tested again and again before they leave our works.

ETA Valves are sold at a price that will place them high in the esteem of radio-lovers. For purity of tone, dependable efficiency and low current consumption fit ETA Valves. They more than justify their claim of being "the best between aerial and earth." Prices from 7/-.

Ask your Radio dealer for particulars of the ETA Valve to suit your set.

ETA VALVES

THE ELECTRICAL TRADING ASSOCIATION LIMITED,
ALDWYCH HOUSE, ALDWYCH, W.C.2.

Telegrams: Eltradax, Estränd, London.

Telephone: Holborn 8139.

IDEAL for the A.C. ETHER SEARCHER



Model "B.S." Eliminators made by the British Thomson-Houston Co. Ltd. Combined L.T., H.T., Grid Bias and Screen Grid voltages from A.C. mains. All voltages from 100/250, 25 cycle and 40/100 cycle models.

This Eliminator is specially suitable for operating the A.C. Ether Searcher. A heavy smoothing circuit is embodied and hum-free reception is assured.

**SPECIAL
PRICE £5**

from

E. P. ALLAM & CO. LTD.
107/109 GRAY'S INN ROAD
LONDON, W.C.1

W. 134

Advertisers Appreciate Mention of "A.W." with Your Order

IN MY WIRELESS DEN



WEEKLY TIPS—
CONSTRUCTIONAL AND THEORETICAL

By W. JAMES.

A Coil Trouble

A FAIRLY common fault with dual range coils, even in these days, is that the long wavelength part acts to destroy the effectiveness of the medium wavelength part over a portion of its range.

What is happening is that the long wavelength winding, when shorted out or left out of the circuit, as the case may be, is tuning to a medium wavelength. This wavelength is determined chiefly by the inductance of the coil and the self capacity, to which must be added the circuit capacities.

You will find when this fault is present that over a part of the medium wavelength band much more than the normal amount of reaction is needed. Sometimes, in really bad instances, the circuit cannot be made to oscillate at all over part of the tuning range:

The fault is not too easily removed in made-up coils. Shorting out the long wavelength part, when this is not already effected, will often remove the trouble.

In other cases the addition of a fixed condenser across the long wavelength part will so alter the tuning that the trouble disappears. With a faulty coil you get broad tuning, poor signal strength, and the tuning is difficult.

We Need Selectivity

If you were to ask your keen wireless friends what is the chief fault with most sets, they would say, not enough selectivity.

The fact is that most receivers have much too poor a tuning curve. Reaction helps, of course, but not to the extent often thought. Our sets, with their one or two screen-grid stages and three, or perhaps four, tuned circuits, provide not enough selectivity for the magnification available.

The difficulty, in part, is that the coils are made of fairly high resistances in order to help ganging. Then again, the tuning condenser may not tune accurately over the whole range, due, perhaps, to a fault in manufacture or to wrong setting up by the user.

Realising these matters, it is not difficult to understand why designers are turning their attention to the super-heterodyne receiver. I have one now, using six valves, which is as cheap to build and to use as a good-class three-valve set. Tuning is easy. The local London stations are tuned out in one degree. Dozens of distant stations are brought in at full loud-speaker

strength. Quality is good and the construction is so easy that it might well be said to be more easily built than some three-valve sets. This is obviously the set of the future.

A Pick-up Point

There are several ways of connecting a gramophone pick-up to a set, some, of course, being cheaper than others. Results will be obtained if the two wires from the pick-up are connected to the ends of the grid leak which is joined to the detector.

Owing, however, to the varying load of the grid circuit of the valve upon the pick-up the reproduction is usually not considered good enough. The grid circuit of the valve passes current and the value of the current varies with the voltage set up

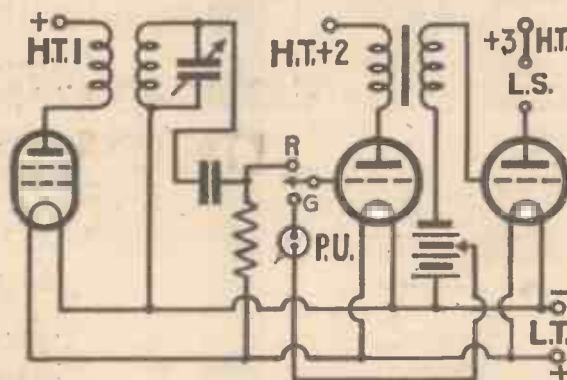

Here is a typical three-valver with pick-up connections. An interesting point in connection with this is raised in the accompanying paragraph

by the pick-up. Thus the effective load is varying all the time and distortion results.

When the grid circuit is connected as in the diagram the valve is used as an amplifier with negative bias when playing a record. One side of the pick-up is joined to the grid of the valve and the other side goes to the grid-bias battery.

A bias of 1.5 volts is usually sufficient and the high tension applied to the valve must be of such a value that the valve is able to work as an amplifier. In some instances the normal voltage used for detection is not quite enough for amplification with grid bias and this point must be watched.

When the switch is put in the alternative position the pick-up is disconnected and the valve works as an ordinary detector. The grid lead to the valve ought to be made as short as possible and a good switch should be used in order to obtain the highest efficiency.

Poor Wander Plugs

Many faults and cases of poor reception are to be traced to the wander plugs. Some of these are so shaped that a good contact with the sockets of batteries is not possible.

Others, again, have the connecting wires fastened to them awkwardly, so that a poor or intermittent contact is obtained. There are good plugs, and they cost but little more than the inferior kinds.

New Dials, Please!

With the super-heterodyne circuit back in favour again, I can see that slow-motion dials with better and slower movements will have to be brought out.

The types now available are perfectly satisfactory in many respects, for standard three- and four-valve sets. But the super-heterodyne set tunes so sharply that we can do with better tuning movements. When a station is in and gone in a part of a degree, something really good in tuning movements is needed for the best results.

High-ratio Transformers

I suppose there must be a number of readers who, like myself, have fitted a high-ratio transformer only to find that the results are no better, if as good, as when the more usual 3 to 1 ratio is used.

It is not surprising that the results are no better with some high-ratio transformers, but there are good transformers with which a noticeable improvement is obtained. In many sets a high-ratio instrument is not needed and the best results are secured with a low-ratio type.

A TERMINAL TIP

NOTHING is more apt to fray one's temper than the task of replacing a screw terminal which has fallen off from some inaccessible component inside the set, where there is no room to insert more than one finger. Or, if by an effort, one can bring a second finger into play, then both get stuck so that it is impossible to screw the wretched nut home. When this occurs it is best to find a piece of spare wire—No. 18 gauge will do—and loop it round the recessed part of the loose terminal head. This will enable you to lower the thing into position from a point outside the congested area, and once in position a single finger will do wonders in screwing it into position.

LOTUS CONDENSERS

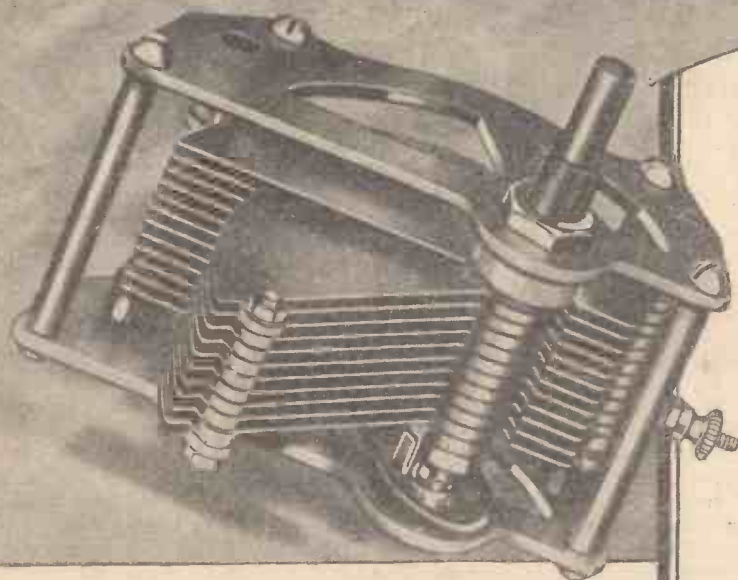

Lotus Radio Ltd., Lotus Works, Mill Lane, Liverpool.

SPECIFIED IN THE "ULTRA SELECTIVE STRAIGHT THREE"

Two '0005 Variable Logarithmic Condensers

PRICE 5/9

In other capacities :-

'0003 ... 5/6 '00035. 5/7
'00025 ... 5/3 '00015 ... 5/-

Consistently specified in leading circuits, these condensers are unequalled for reliability, accuracy and finish.

Also Differential Condensers from 5/3.
Reaction Condensers from 4/9 and Drum Dial for Ganged Condensers—
with one '0005 Condenser, 15/3
with two '0005 Condensers, 22/-
with three '0005 " 28/9
FROM EVERY WIRELESS DEALER.

If results mean anything—this Reproducer means everything

From a wide variety of Loud-speakers you can pick the "R. & A." Type 40, pure and lifelike in its reproduction of speech, song and instrumental music. It possesses all the qualities of a moving coil speaker, without its prohibitive cost. You need nothing better—indeed it is difficult to find a better speaker, and its cost is so low that you can install one in each room.

The "R. & A." is notable for its brilliant reproduction throughout the whole audible range

It is a precision instrument made to finest limits from the best quality materials. The fully floating cone is 12" dia.; the twin magnets are of 35% Cobalt Steel, and the chassis is of enamelled cast Silicon-aluminium.

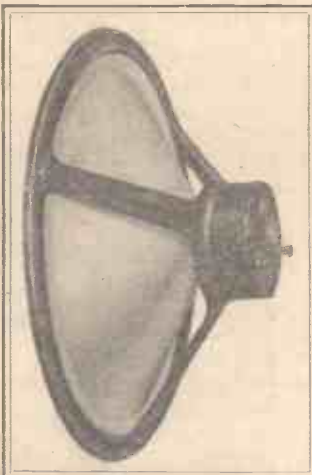

16/6

POST FREE

Send for one to-day, and I enjoy broadcast performances with a new enthusiasm

REPRODUCERS & AMPLIFIERS LTD.
Frederick Street, Wolverhampton



TUNEWELL AGAIN! "THE CLARION COIL"

AERIAL OR ANODE

7/9
EACH

6-p.n base - 2/-



PANEL MOUNTING

10/6
EACH

3-point switch 1/3

Specified year after year for all the popular circuits, and now again for this year's Clarion. For this amazing set Tunewell have produced a new dual-range coil of revolutionary design. Lower resistance, lower self capacity, higher inductance and increased selectivity are only a few of its many features. Add to the efficiency of your set—use Tunewell Coils.

TUNEWELL ALL-BRITISH SPAGHETTI RESISTANCES. 10,000 and 15,000 ohms, 1/-; 20,000, 25,000 and 30,000 ohms, 1/4; 40,000, 50,000 and 60,000 ohms, 1/6.

Send for Lists.

TURNER & CO., 54 Station Road, London, N.11.

Advertisers Appreciate Mention of "A.W." with Your Order

SETS OF DISTINCTION



MARCONIPHONE

MODELS 220 & 221

Makers: Marconiphone Co., Ltd. Prices: A.C. model £11-10-0, Battery model £8

FOR regional reception requirements there is much that could be said—and indeed has been said—in favour of the two-valver. Such a set provides full loud-speaker reproduction of the two alternative programmes, with minimum initial installation cost, small running costs and easy operation. If it is a well-designed two-valver there is no difficulty in getting either station clear of the other.

Operation of two-valvers is usually simple, provided the listener is content with the local station. If he tries to reach out to more distant stations, many of which

have come across for some time.

Actually, two models were sent to me for test. Model 220 is for A.C. mains, of voltages between 100 and 110, or 200 and 250 volts. This set includes two indirectly-heated 4-volt valves, the detector being an MH4 and the output valve an ML4. The high-tension and grid-bias is obtained from a U9 rectifying valve.

The battery model 221 is designed to operate with either 2- or 6-volt battery valves. In the 2-volt range the makers recommend an HL210 detector and a PT240 pentode output valve. If 6-volt valves are used the detector should be an L610 and the output valve a PT625.

These two models are similar in external appearance and in the arrangement of the controls on the front of the cabinets. There is a horizontally-mounted tuning dial in a central position at the top and below this is a vertically-mounted wavelength switch,

the aerial, earth, gramophone pick-up and loud-speaker is admirably simplified and can hardly confuse the veriest tyro.

Having devoted so much space to general considerations I must hasten to record my tests of these sets. Undoubtedly the most remarkable feature common to both of them is selectivity. Tuning in the London National station on my standard 60-foot aerial in south-west London, I was agreeably surprised to find that on model 220 this powerful station could be heard over only seven degrees of the tuning dial. In passing, I must say I like this horizontal mounting of the dial. It enables the degree divisions to be seen without eye strain and adds much to the pleasure of tuning in distant stations.

Good Selectivity

The London Regional was disposed of no less effectively, spreading only 8 degrees on the dial. I found it necessary to work the reaction and selectivity controls one against the other in order to maintain good selectivity with sufficient volume to work the loud-speaker.

Some idea of the distance-getting capabilities of this set can be gained from the fact that I got Kiel 18, London National 21, Heilberg 25, Hilversum 30, Brussels No. 2

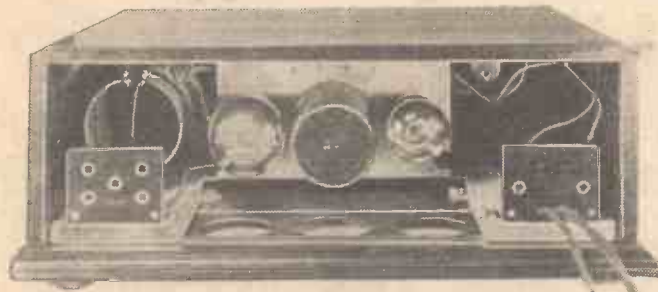

A rear view of the battery model 221—

are certainly strong enough these days to be heard on such simple apparatus, the need arises for a certain expertness in controlling the set, especially the reaction.

It is true to say that all the long-distance reception capabilities of a two-valver can be attributed to the reaction introduced into the detector circuit. If this is really effective—that is to say, capable of being gradually and smoothly increased up to the point when the valve oscillates—there is no limit to the range possibilities. With an average outside aerial of tolerable efficiency an efficient two-valver will receive at least a dozen distant stations.

Two Types

I should like to make it clear that on a two-valver these distant stations are not always, in fact not often, programme alternatives to the locals, for which this type of set is really designed. But their reception is a matter of interest to those who "get a kick," as the Americans would say, in logging distant signals.

These remarks apply with considerable point to a set I have just finished testing, the Marconiphone model 220. Here is one of the best little reaction sets for reliable local and occasional distant reception I

which also brings in the gramophone pick-up as required. To the left is the reaction control and to the right a selectivity control, both operated by handy-sized knobs.

Inside the model 220 one finds accessible valve holders for the two receiving valves and the rectifying valves. In the battery model 221 the centre valve holder is utilised for a plug-in type of grid-bias battery. While this has obviously been done to standardise the stamping of the valve platform it has the effect of considerably reducing the worry of connecting up batteries. For in model 221 there are only two flexible cables coming from the loud-speaker terminal block, one going to the accumulator and the other to the high-tension battery.

The arrangement of the plug-and-socket connections at the back of these sets for

Let "AMATEUR WIRELESS"
solve your wireless problems



—compared with a similar view of the mains model 220

station 35, London Regional 42, Stockholm 57, Rome 58, Langenberg 63, Midland Regional 64, Brussels 70, and Vienna 77. Some of these stations were surprisingly strong, whereas others had merely a logging interest. These results were on the A.C. model, but I found the battery model, thanks to the pentode output valve, very little less sensitive.

Finally, I ought to mention that these sets were tested on the Marconiphone moving-coil loud-speaker, at the request of the makers. I must confess I was very agreeably surprised at the excellent quality and power thus obtained. —SET TESTER.

THIS IS THE DIAL

specified for the
"Ultra Selective Straight 3"



"ASTRA" FAST & SLOW MOTION DIALS

"Astra" dials have a geared action which is precision itself. There is no trace of backlash and action is noiseless and firm. Direct drive is obtained by simply switching up the lower knob. "Astra" Type No. 1 (as specified for the Clarion 3) is 3 in. in diameter and finished in black or brown moulding with aluminium scale or brown with gilt scale. Fits any condenser spindle. Easily mounted.

"Astra" Type No. 1 3/6
"Astra" Type No. 2. 4" diam. 5/-
"Astra" "Popular" 3" diam. 3/-

"Astra" are the only dials manufactured under Ormond licence



"ASTRA" PRODUCTS ARE OBTAINABLE FROM ALL DEALERS

A Fascinating Pastime!

THE KINGSTON HOME RECORDER

brings to all Radio and Gramophone enthusiasts a simple and perfect method of

MAKING RECORDS AT HOME

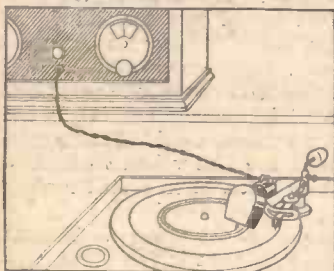

With the aid of your "ETHER SEARCHER" or any multiple valve set you can record all music, speech or song Broadcast as well as recording your own voice.

THE KINGSTON HOME RECORDER

BROADCAST MODEL
Complete. For recording Broadcast and your own voice 76/6

ACOUSTIC MODEL
For recording your own voice 45/-

The Kingston Microphone

Used with either model enables Music, as well as Speech and Song to be recorded in your own home 50/-

The Kingston Home Recorder and Kingston Microphone are obtainable from all high-class Radio and Music Dealers

Free Literature on request. Demonstrations at

RADIO AND GRAMOPHONES

245 Tottenham Court Road, London, W.1. Tel. Museum 0918
Distributors: Kingstophone Co., Ltd., 91, Tottenham Court Road, London, W.1. Tel. Museum 6061-2.

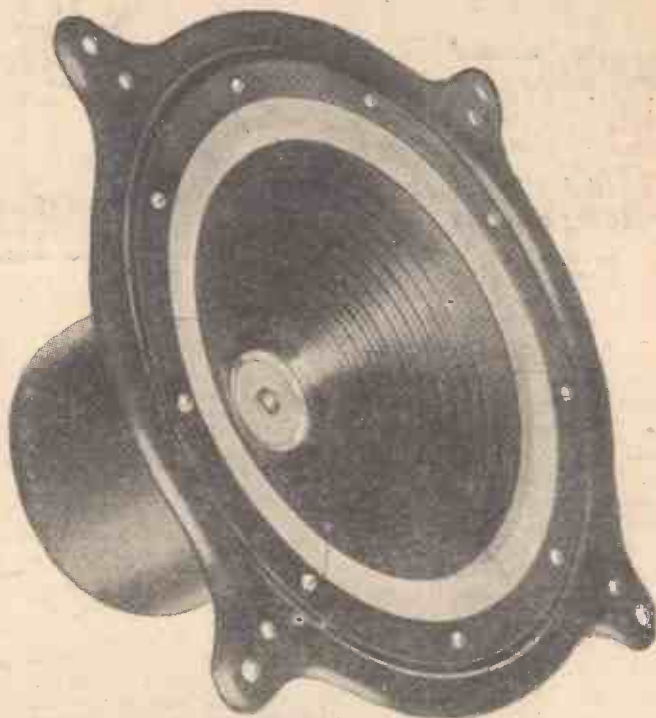

REALITY RECREATED by

B.T.H.



REPRODUCERS

The "R.K." is known all over the world as the best speaker obtainable—it has retained that reputation unchallenged for years.

The permanent magnet needs no battery or mains for its operation—it will work anywhere—off any set which incorporates a small power output valve such as the Mazda P220a class. The price is only £6-15-0 and our hire purchase terms are available.

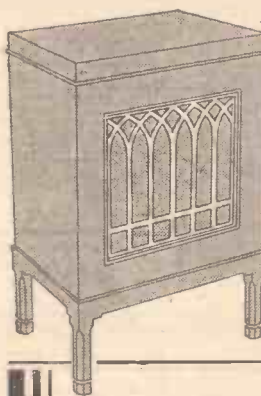

PERMANENT MAGNET R.K.
Complete with Oak Cabinet.
Price £16-16-0

PERMANENT MAGNET R.K. UNIT (as illustrated).
Price £6-15-0



THE EDISON SWAN ELECTRIC CO. LTD.

Radio Division:
155 Charing Cross Road, London, W.C.2
Branches in all the Principal Towns

EDISWAN

W.140

WE TEST FOR YOU

A weekly review of
new components



and tests of
apparatus.

Conducted by J. H. REYNER, B.Sc., A.M.I.E.E.

S.R.S. Adaptor

SOME users of receivers embodying a simple detector followed by one or more low-frequency stages may have wished to try the effect of a screen-grid valve. In particular such a step is to be desired if interference is experienced from nearby stations. The use of a wave-trap will, of course, assist in cutting down the signal from the interfering station, but this is not always sufficient, it being often found that the strength from the distant station has been reduced too much in consequence.

The S.R.S. adaptor provides a means of overcoming this difficulty without any serious modifications to one's set. It consists of a large diameter ebonite tube. Inside the bottom half of this tube are situated a coil, a tuning condenser and a switch. There is also a valve holder mounted on a platform half-way down the tube, and a series of flex leads which are connected respectively to the L.T. and H.T. batteries for the power supply, and a final lead is taken to the aerial terminal of the set. The normal aerial, of course, is removed and is connected to the aerial terminal of the adaptor, thereby effectively adding a stage of H.F. amplification. A screen-grid valve must be inserted in the adaptor, and this must be of the same filament voltage as those already in use in the set.

The connection of the unit to an existing set was found to be a matter of extreme

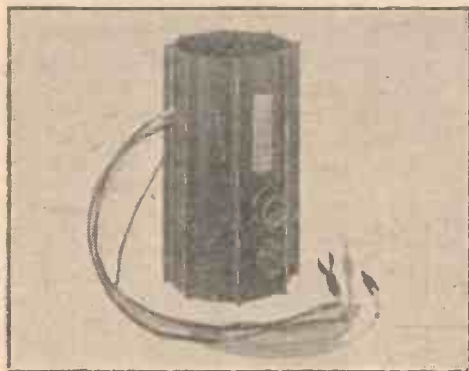

A novel idea, the S.R.S. adaptor

simplicity, and we found on test that there was a noticeable gain in signal strength and distance-getting properties, and the selectivity was improved. While it is clear that an arrangement of this sort cannot be as efficient as a high-frequency stage built in to the receiver, this accessory will form a welcome adjunct to many sets. There is only

one extra tuning control to be operated, and a complete diagram of instructions renders the use of the unit very simple.

New Atlas Eliminator

ATLAS eliminators have established a reputation for themselves for some years past. The latest addition to their range is a small metal rectifier unit, suitable as far as we can judge, for the average three-valve set. This unit which measures 8 in. by 5 in. by 3½ in. high is provided at one end with slightly sloping panel, which is an insert containing the four tapping points. There are no controls on the eliminator, which is thus particularly neat. The case is finished in the well-known olive green which has become associated with this firm's products. An earthing terminal is provided at the back of the case to comply with the regulations.

The three tappings are rated 60/80, 90/100 and 120/150. No indication is given as to the maximum output, but from our preliminary test we deemed it advisable to take not more than 15 milliamps from the output tap, which would enable it to supply an average good class power valve, and the anode of a screen-grid valve. On the other two taps we took at the same time 0.5 milliamps from the 60/80 tap, representing the load taken by the screen-grid, while from the 90/100 tap we took 5 milliamps, as we were advised that the anode of the S.G. valve and the detector stage were both intended to run off this tap.

Under the conditions the voltages were 82, 100 and 150 respectively, which is quite satisfactory. The voltages on the various tappings are affected one by the other, so that it is desirable to use the instrument under the conditions stated to avoid difficulties.

POINTS TO NOTE

A pre-set condenser in the aerial lead is much better than a fixed condenser, for often you need to alter the capacity.

Many of the new balanced-armature and dynamic speakers will not work properly if there is a large steady current flowing through the magnet windings. A filter circuit eliminates this steady current.

Do not overlook the earth. That has a big effect on selectivity. Earth tubes and bowls do not remain satisfactory for years on end. After a time they become corroded and do not make a good low-resistance connection.

Enemains Tapped Resistance

ONE of the difficulties confronting the D.C. enthusiast is the difficulty of obtaining breaking down resistances of known value. He can, of course, wind them himself, but there are variations in the resistances of the same gauge of wire, depending upon the particular batch from which it is drawn, and unless one has an

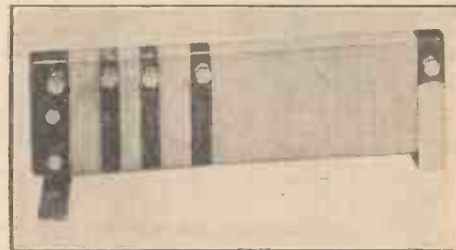

An Enemains tapped wire-wound resistance

ohmmeter or other means of measuring the resistance, a little difficulty may occur.

We have tested this week a convenient gadget known as Enemains tapped resistance. This is intended to be used with valves taking .25 ampere. Thus if all the valves take this current they would be connected in series. If some of the valves take less current a series-parallel arrangement may be adopted. For example, a set having an S.G. valve, a detector and a power valve, might consume filament currents of .15, .1 and .25 amp respectively. The first two valves can be placed in parallel so that their total consumption is .25 amp, and these two valves would then be placed in series with the last valve, so that the total current consumption is still .25 amp.

At this current the resistance will drop the greater part of the voltage. The main body of the resistance is 650 ohms, which will drop 162½ volts. This is intended for use on 200-volt supply, the remaining voltage drop being taken up partly by the valves themselves, which may drop anything up to 12 volts under average circumstances, depending upon, of course, the types of valve, and the combination thereof, while the remaining voltage of between 20 and 30 volts is available for grid bias.

Further tappings are provided at 730, 800, and 900 ohms, for use with 220, 230 and 250 volts.

The resistance is wound on a slab of slate, and silk-covered wire is used so that there is not only ample opportunity to dissipate the heat, but little danger of breakdown of the insulation. The component is well made.



RADIOGRAMS

A PROGRAMME of holiday music will be given by the Midland Studio Orchestra on April 7. The programme describes many ways of holiday-making.

Sunday programmes from London Regional have usually opened at 3.30 p.m. As from Easter Day, April 5, the timing will be put forward half an hour, but the character of the programme will remain unchanged.

A creepy little sketch entitled *Light and Shade*, by L. du Garde Peach, is to be presented in the Midland Regional programme on April 11 by Vera Ashe and Sidney Evans. A young couple returning from the theatre go to switch on the light in their flat, but nothing happens. During the next fifteen minutes of total darkness many strange things take place. Listeners who want to know what really happens before matches are found should tune in to *Light and Shade*.

On April 4 a running commentary will be given for Northern listeners by Mr. F. Stacey Lintott on the second half of the First League Association football match

between Leeds United and Grimsby Town at Leeds.

The National Orchestra of Wales Light Orchestra takes part in a musical comedy programme from Cardiff on April 8. The vocalist will be Florence Smithson.

April 25 is the date of the running commentary on the Final of the F.A. Cup.

From the Shakespeare Birthday Celebrations at the Town Hall, Stratford-on-Avon, on April 23, speeches by John Drinkwater, Sir Nigel Playfair, Miss Lilian Braithwaite, and the Mayor of Stratford-on-Avon will be relayed to National listeners. On the same evening the play *Will Shakespeare*, by Clemence Dane, will be broadcast from the National and will be repeated for Regional listeners on April 24.

A discussion which will be actually an exchange of memories will be broadcast on April 25, the sixteenth anniversary of the landing at Gallipoli. General Sir Ian Hamilton and Mr. Compton Mackenzie are holding the conversation, which is entitled "Gallipoli."

The Ulverscott Singers appear in the Midland Regional ballad concert on April 9, when their programme will include an arrangement of Vaughan Williams' "Linden Lea," and Elgar's "Feasting I Watch."

It is reported that during the month the Vatican (Rome) short-wave transmitter will carry out experiments in picture transmission on the Bélin system.

The French Ministry of Posts and Telegraphs contemplates the installation of a 25-kilowatt broadcasting station at Tunis (N. Africa), as in that colony the Radio Maroc programmes are poorly received.

When the Söttens (Switzerland) high-power station is brought into regular operation, 60 per cent. of the programme material will be supplied by the Geneva studio and roughly 30 per cent. will be relayed from Lausanne. The balance of the entertainments will consist of international relays and of broadcasts provided by other Swiss centres.

Radio Schaerbeek (Brussels) has suspended its evening transmissions, and broadcasts are only made during the lunch-hour and when other Belgian stations are resting.

The German Reichsfunk has decided to install a relay station at Trier (Trèves), but it is not expected to work before 1932; it will take its programmes from Frankfurt-am-Main and Stuttgart.

The private broadcasting station at Strasbourg, which from 1925 supplied wireless entertainments to the Eastern districts of France, has now definitely closed down.

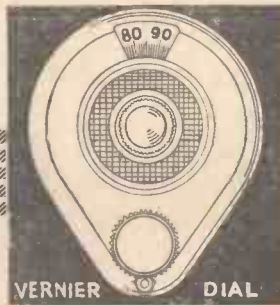

VERNIER DIAL

VERNIER DIAL

Wonderfully smooth action and fractional accuracy makes tuning of close stations a simple operation. Price 3/-.

Build and Replace with FORMO

ARTHUR PREEN & CO. LTD.

—the components specified for performance.

Select Formo Radio components and you are always certain of the best results that yours is designed to give. Sold by all Radio Dealers.

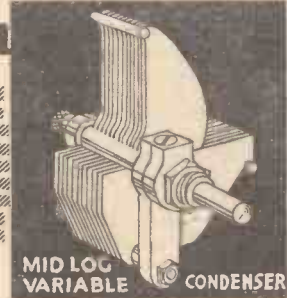

MID LOG VARIABLE CONDENSER

MID-LOG VARIABLE CONDENSER

The enclosed and protected pigtail within the shaft ensures high performance and low loss. In four capacities. Price 4/6.

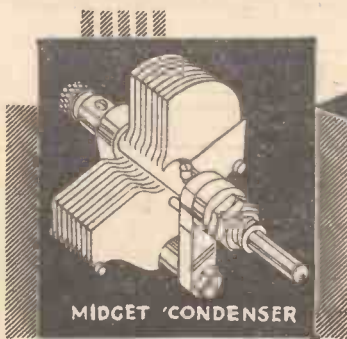

MIDGET CONDENSER

Compact, noiseless and silky action. Concealed internal pigtail. For all reaction circuits. Price 2/9. With knurled knot and pointer, 3/3.



FORMO-DENSOR

This well-known product is the finest on the market. Sold in 10,000 a week. Price 1/6.

Catalogues sent on request from:

ARTHUR PREEN & CO.
Golden Square, Piccadilly Circus, W.1.
FACTORY - Crown Works, SOUTHAMPTON

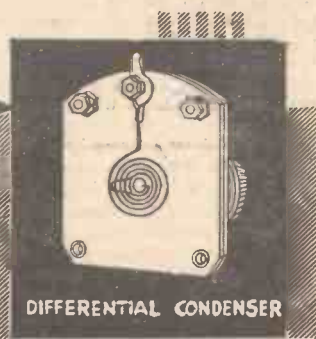

DIFFERENTIAL CONDENSER

Compact, no metal end plates. A perfectly designed condenser with high performance and lasting reliability. Price 3/9.

OUR LISTENING POST

By JAY COOTE

ON Boat Race day I listened to the running commentary broadcast from the launch *Magician*, but I wonder whether any of you picked up the same commentary at about 10 p.m. on that night. It was by sheer accident I happened to tune in to Frankfurt-am-Main and Mühlacker at that time when I found to my surprise that Berlin was relaying to these stations a record taken of the transmission put out by the B.B.C. earlier in the day. This is not the first time I have listened to "belated" speeches or to interesting items which, owing to the time of day at which they occurred I might have missed. The Germans appear to have established a special service for such recording and slip these topical happenings into what might otherwise be the duller portions of their entertainments. Needless to add, the records are excellent reproductions of the real thing.

Söttens

A further reference to the nightly tests carried out by the Söttens 25-kilowatt may be useful to you. During the past week relays have been made of gramophone records played at the Lausanne studio and as the call does not include the name of the transmitter it has puzzled many listeners. On most nights a woman's voice announces: "Ici Radio Suisse Romande, émission d'essai," with a further reference to wavelength and power. Of course, as 403.8 metres is the channel used by Berne, the new station can only come on the air when the former has closed down.

Within a day or so—you may have heard it by now—the second Swiss National station at Beromünster will start its tests on 459.4 metres, with 60 kilowatts in the aerial. It will work in conjunction with the Berne and Zurich studios. As regards Söttens, however, I fear that owners of unselective sets may find that its transmissions have a swamping effect on anything working on a wavelength between 395 and 410 metres. Certainly, it does not facilitate the capture of Katowice and in this case a frame aerial appears the only solution.

Since the advent on the air of the big Warsaw-Raszyn noise, I notice that the Polish authorities are developing an S.B. system and the capital programme may be heard on various settings of the condenser dials. By the way, Katowice still retains its particular metronome as an interval signal. It is a distinctive sound and reminds one of a hammer striking a small anvil; its beats work out at roughly forty to the minute.

B.B.C. Announcements

For what particular reason does the B.B.C. still obstinately refuse to make any but English announcements when it broadcasts a worth-while concert of International interest? Copenhagen, for instance, makes a rule of giving details of its important transmissions in Danish, German, English and French. Many other Continental stations also realise that their broadcasts are heard by foreign listeners who are anxious to know what is being given.

During the past few days I have heard the Prague entertainments at such enormous volume through Brno that I am inclined to believe the new transmitter installed at that station has been brought into operation. Some time ago I was informed that the new plant was nearing completion and that there would be no break in the broadcasts. Usually it is better to get the Prague programmes through Brno or Bratislava, the latter providing a very hefty signal, but on some evenings you may find trouble with Heilsberg, its immediate neighbour. Prague itself is somewhat unreliable and with the advent of North Regional, may disappear temporarily from our logs.

BROADCAST TELEPHONY

Broadcasting Stations classified by country and in order of wavelengths. For the purpose of better comparison, the power indicated is *aerial energy*.

Kilo- Metres	Station and Call Sign	Power (Kw.)	Kilo- Metres	Station and Call Sign	Power (Kw.)	Kilo- Metres	Station and Call Sign	Power (Kw.)
GREAT BRITAIN								
25.53	11,751 Chelmsford (G5SW)	15.0	285.9	1,049.1 Radio Lyons...	0.5	416	721 Radio Maroc (Rabat)	10.0
200	1,500 Leeds.....	0.16	294.6	1,018.1 Limoges (PTT)...	0.5	1,250	240 Tunis Kasbah...	0.6
242	1,238 Belfast.....	1.2	304.3	986 Bordeaux (PTT)...	35.0	NORWAY		
261.3	1,148 London Nat.....	68.0	313.8	956.8 Natan-Vitus (Paris)	0.5	235.5	1,275 Kristianssand...	0.5
288.5	1,040 Newcastle.....	1.2	317.3	945.4 Marseilles (PTT)...	1.5	241	1,244.5 Stavanger.....	0.5
288.5	1,040 Swansea.....	0.16	327.5	916 Grenoble (PTT)...	3.0	364	824 Bergen.....	1.0
288.5	1,040 Stoke-on-Trent.....	0.16	329.5	910.3 Poste Parisien...	1.2	365.1	821.7 Frederiksstad...	0.7
288.5	1,040 Sheffield.....	0.16	345.2	866 Strasbourg (PTT)...	15.0	453.2	662 Porsgrund.....	1.5
288.5	1,040 Plymouth.....	0.16	370	810.5 Radio LL (Paris)...	0.5	493.3	608.1 Nidaros.....	1.2
288.5	1,040 Liverpool.....	0.16	385	779 Radio Toulouse.....	15.0	589.6	508.8 Hamar.....	0.8
288.5	1,040 Hull.....	0.16	447	671 Paris (PTT).....	2.0	1,032	277.2 Oslo.....	75.0
288.5	1,040 Edinburgh.....	0.4	466	644 Lyons (PTT).....	2.3	POLAND		
288.5	1,040 Dundee.....	0.16	1,445.7	207.5 Eiffel Tower.....	15.0	214.2	1,400 Warsaw (2).....	1.0
288.5	1,040 Bournemouth.....	1.2	1,725	174 Radio Paris.....	17.0	234	1,283 Lodz.....	2.2
288.5	1,040 Bradford.....	0.16	GERMANY					
301	995 Aberdeen.....	1.2	31.38	9,560 Zeesen.....	15.0	312.8	959 Cracow.....	1.5
309.9	968 Cardiff.....	1.2	210.3	1,387 Königsberg.....	1.7	330.8	907 Poznan.....	1.9
366.3	843 London Reg.....	45.0	219	1,369.7 Flensburg.....	0.6	381	788 Lvov.....	21.0
376.4	797 Manchester.....	1.2	227	1,319 Cologne.....	1.7	385	779 Wilno.....	0.5
398.9	752 Glasgow.....	1.2	227	1,310 Münster.....	0.6	408	734 Katowice.....	16.0
479.2	626 Midland Reg.....	70.0	227	1,310 Aachen.....	0.3	1,411.8	212.5 Warsaw	—Raszyn 158.0
479.2	626 North Regional testing	60.0	232.2	1,292 Kiel.....	0.31	PORTUGAL		
1,551.4	193 Daventry (Nat.)	35.0	239	1,256 Nürnberg.....	2.3	240	1,250 Oporto (Teatro Apollo)	0.25
AUSTRIA								
219	1,370 Salzburg.....	0.6	246.4	1,217.2 Cassel.....	0.3	284.7	1,053.6 Lisbon (CTIA)	0.25
246	1,220 Linz.....	0.6	253.4	1,184 Gleiwitz.....	5.6	ROMANIA		
284.7	1,053.6 Innsbruck.....	0.6	259.3	1,157 Leipzig.....	2.3	394	761 Bucharest.....	16.0
352	851 Graz.....	9.5	269.8	1,112 Bremen.....	0.3	RUSSIA		
453	666 Klagenfurt.....	0.6	276.5	1,085 Heilsberg.....	75.0	426.3	703.7 Khar'kov.....	4.0
517	581 Vienna.....	20.0	283.0	1,058 Magdeburg.....	0.6	720	416.6 Moscow (PTT)...	20.0
BELGIUM								
206	1,456 Verviers.....	0.3	283.6	1,058 Berlin (E).....	0.8	800	375 Kiev.....	20.0
206	1,456 Antwerp.....	0.4	283.6	1,058 Stettin.....	0.6	824	364 Sverdlovsk.....	25.0
216	1,391 Chatelineau.....	0.25	318.8	941 Dresden.....	0.3	937.5	329 Khar'kov (RV20)	25.0
216	1,391 Radio Conference Brussels	0.25	323.3	927.7 Breslau.....	1.7	1,000	300 Leningrad.....	40.0
244.7	1,226 Ghent.....	0.25	360	837 Mühlacker.....	75.0	1,052.6	285 Tiflis.....	15.0
244.9	1,224.8 Schaerbeek.....	0.5	372	806 Hamburg.....	1.7	1,115	269 Moscow Popoff.....	40.0
338.2	887 Brussels (No. 2)	20.0	390	770 Frankfurt.....	1.7	1,200	250 Khar'kov (RV4)	25.0
509	590 Brussels (No. 1)	20.0	418	716 Berlin.....	1.7	1,804	230 Moscow (Trades Unions)	165.0
BULGARIA								
319	941 Sofia (Rodno Radio)	1.0	452.1	662 Danzig.....	0.2	1,380	217.5 Bakou.....	10.0
CZECHO-SLOVAKIA								
203	1,139 Moravska-Ostrava	11.0	473	635 Langenberg.....	17.0	1,431	202.5 Moscow (Kom)	20.0
270	1,076 Bratislava.....	14.0	533	563 Munich.....	1.7	251	1,193 Barcelona (EAJ15)	1.0
293	1,022 Kosice.....	2.5	559.7	536 Kaiserslautern.....	1.0	268	1,121 Valencia.....	8.0
341.7	878 Brunn (Brno).....	34.0	559.7	536 Augsburg.....	0.3	349	860 Barcelona (EAJ1)	8.0
487	617 Prague (Praha).....	5.5	586	530 Hanover.....	0.3	388	815 Seville (EA15).....	1.5
DENMARK								
281	1,067 Copenhagen.....	1.0	570	527 Freiburg.....	0.85	424	707 Madrid (EA17).....	2.0
1,165	257.5 Kalundborg.....	10.0	1,035	183.5 Zeesen.....	35.0	458	662.2 San Sebastian (EAJ8)	0.5
ESTONIA								
205.9	1,013 Tallinn.....	0.7	1,035	183.5 Norddeich.....	10.0	SWEDEN		
463	648 Tartu.....	0.5	31.28	9,599 Eindhoven (PCJ).....	30.0	230.3	1,304 Malmö.....	0.75
FINLAND								
221	1,355 Helsinki.....	15.0	299	1,004 Huizen.....	8.5	257	1,166 Hörby.....	15.0
453.2	662 Tampere.....	15.0	299	1,004 Radio Idzerda (The Hague)	3.0	307	977 Falun.....	0.65
1,796	167 Lahti.....	54.0	1,071	280 Scheveningen-Haven	5.0	322	932 Göteborg.....	15.0
FRANCE								
219.3	1,368 Béziers.....	0.6	1,875	160 Hilversum.....	8.5	436	689 Stockholm.....	75.0
222.9	1,346 Fécamp.....	1.0	550	545 Budapest.....	23.0	542	554 Sundsvall.....	15.0
235.1	1,275 Nîmes.....	1.0	1,200	250 Reykjavik.....	21.0	770	389 Östersund.....	0.75
237.2	1,263 Bordeaux-Sud-Ouest	2.0	IRISH FREE STATE					
249	1,205 Juan-les-Pins.....	0.5	224.5	1,337 Cork (IFS).....	1.5	1,250	240 Boden.....	0.75
256	1,172 Toulouse (PTT).....	1.0	413	725 Dublin (2RN).....	1.5	1,348	222.5 Motala.....	40.0
265	1,130 Lille (PTT).....	15.0	ITALY					
272	1,103 Rennes.....	1.2	25.4 and 80	Rome (3RO).....	9.0	244.3	1,227 Basle.....	0.5
285.4	1,051 Montpellier.....	2.0	296	1,013.4 Turin (Torino).....	8.5	403.5	743 Berne.....	1.1
HOLLAND								
31.28	9,599 Eindhoven (PCJ).....	30.0	312	951.6 Genoa (Genova)*	1.5	403.5	743 Söttens (testing)	25.0
299	1,004 Huizen.....	8.5	332	905 Naples (Napoli).....	1.7	459	653 Zurich.....	0.75
299	1,004 Radio Idzerda (The Hague)	3.0	441	680 Rome (Roma).....	75.0	459	653 Beromünster (test ng)	0.0
1,071	280 Scheveningen-Haven	5.0	453	662 Bolzano (IBZ).....	0.2	680	442 Lausanne.....	0.6
1,875	160 Hilversum.....	8.5	501	599 Milan (Milano).....	8.5	760	395 Geneva.....	1.5
550	545 Budapest.....	23.0	LATVIA					
1,200	250 Reykjavik.....	21.0	525	572 Riga.....	13.0	1,242	241.5 Istanbul.....	5.0
IRISH FREE STATE								
224.5	1,337 Cork (IFS).....	1.5	LITHUANIA					
413	725 Dublin (2RN).....	1.5	1,935	155 Kaunas.....	7.0	1,538	195 Ankara.....	2.0
NORTH AFRICA								
360.4	832.4 Algiers (PTT).....	13.0	YUGOSLAVIA					
SWITZERLAND								
244.3	1,227 Basle.....	0.5	306.1	980 Zagreb (Agram).....	0.7	431	606 Belgrade.....	3.0
403.5	743 Berne.....	1.1	574.7	522 Ljubljana.....	2.8	TURKEY		
403.5	743 Söttens (testing)	25.0	YUGOSLAVIA					
459	653 Zurich.....	0.75	YUGOSLAVIA					
459	653 Beromünster (test ng)	0.0	YUGOSLAVIA					
680	442 Lausanne.....	0.6	YUGOSLAVIA					
760	395 Geneva.....	1.5	YUGOSLAVIA					
TURKEY								
1,242	241.5 Istanbul.....	5.0	YUGOSLAVIA					
1,538	195 Ankara.....	2.0	YUGOSLAVIA					
YUGOSLAVIA								
306.1	980 Zagreb (Agram).....	0.7	YUGOSLAVIA					
431	606 Belgrade.....	3.0	YUGOSLAVIA					
574.7	522 Ljubljana.....	2.8	YUGOSLAVIA					

WIRELESS MAGAZINE

The Big British Wireless Monthly

1/-

Now that you have made your

1931 ETHER SEARCHER

make a good job of it by housing it in the

CLARION ETHER SEARCHER CABINET

which was designed for and specified by MR. SIEGER. Oak Wax Finish.

21/-

C.O.D. or Carriage Paid.

Full List of Cabinets on request

CLARION

Radio Furniture

28 38 Mansford St., London, E. 2

Telephone: Bishopsgate 6371

Readers' Ideas and Questions

Land Lines

SIR,—There is one aspect of the regional scheme to which neither "Thermion" nor Mr. Moseley have yet given sufficient prominence. I refer to the quality of land-line transmission. Both have mentioned it, but now it occupies so large a part of the alternative scheme it calls for greater stress and more sustained protest if the desired improvement is to be brought about. Of course I am referring to long land-lines, not the short links between Savoy Hill and Brookmans Park. To put it plainly, the quality of the average land-line transmission not merely disappoints the ordinary music-lover, but positively sets his teeth on edge. There are a few exceptions, such as Eastbourne, but unfortunately, while we appreciate Tom Jones and Albert Sandler as exponents of a particular instrument, Oberon with one violin, 'cello, and Mustel organ doesn't cut much ice. Why not Parsifal on a mouth-organ? Seeing that the transmission of music by full orchestras is well-nigh perfect when broadcast direct from Savoy Hill or Queen's Hall, this protest would hardly be justified were it not that land lines are being used more, not less, under the new scheme. Fifty per cent. of the London Regional programme comes via Birmingham and the land line is very far short of the ideal; also it varies greatly. Prove the difference.

C. B. M. (N.W.8).

America on the "Searcher"

SIR,—I built your "1931 Ether Searcher" a few weeks ago. It might interest you to know that just after 12 p.m. last night I received three American stations, one of which I identified quite easily as WTIC, Hartford, Connecticut. This station came in at fair headphone strength, with occasional fading. The other two stations at times came in fairly well, but I was unable to identify them. From their approximate wavelengths, one appeared to be KDKA. The other was between this station and WTIC.

Of the set's range capacity there is no doubt, and I have logged well over the fifty stations you claim for it. It is very selective, and I am able to separate London Regional from Muhlacker.

R. L. N. (Stockton-on-Tees).

SIR,—May I offer a few words in praise of the "1931 Ether Searcher."

I have built and tried many sets of different makes but have never had a set more selective or easy to handle.

Up to the present I have received thirty-five stations on the loud-speaker, the farthest distant being Moscow. I intend to sit up and try for America during the next week.

There are two small difficulties that I find. The first is that I cannot get the set to oscillate between 90 and 100 degrees, and the second, that I get rather a big spread-over from the London National above 30 degrees.

Thanking you for a very fine set which will certainly take some beating.

H. C. (London, E.8).

**Postcard
Radiō
Literature**

GET THESE CATALOGUES FREE

Here "Observer" reviews the latest booklets and folders issued by well-known manufacturers. If you want copies of any or all of them FREE OF CHARGE, just send a postcard giving the index numbers of the catalogues required (shown at the end of each paragraph) to "Postcard Radio Literature," "AMATEUR WIRELESS," 58/61, Fetter Lane, E.C.4. "Observer" will see that you get all the literature you desire. Please write your name and address in block letters.

Ferranti Radio-grams

SHOULD you be in search of a high-class radio-gramophone fitted with an all-mains amplifier, a really up-to-date radio receiver and a Magno-dynamic moving-coil speaker, then you should consider the new Ferranti models. Full details of each are given in a fine folder just issued and I confidently recommend this for your attention. **216**

A New Bulgin Book

I have just received another edition of a fine sixty-page book produced by A. F. Bulgin and Co., Ltd., which is far more than just a catalogue of Deckore and other parts. The manual section, taking up more than half, gives helpful and very practical advice on adding gadgets of all kinds to a set in order to improve the performance. **217**

OBSERVER.

**When Submitting
Queries**

Please write concisely, giving essential particulars. A Fee of One Shilling (postal order), a stamped addressed envelope, and the coupon on the last page must accompany all letters. The following points should be noted.

Not more than two questions should be sent with any one letter.

The designing of apparatus or repairs cannot be undertaken.

Modifications of a straightforward nature can be made to blueprints, but we reserve to ourselves the right to determine the extent of an alteration to come within the scope of a query. Modifications to proprietary receivers and designs published by contemporary journals cannot be undertaken.

Readers' sets and components cannot be tested at this office. Readers desiring specific information upon any problem should not ask for it to be published in a forthcoming issue, as only queries of general interest are published and these only at our discretion. Queries cannot be answered by telephone or personally.

Readers ordering blueprints and requiring technical information in addition, should address a separate letter to the Query Department and conform with the rules.

CLIX

SPECIFIED FOR THE
**"ULTRA SELECTIVE
STRAIGHT THREE"**

"FIT-ALL" SPADE TERMINAL

No. 3 Pat.

Fits all sizes of screw terminals. Lead-coated for L.T., Nickel-plated for general use. Insulators, red or black; Engraved or plain **2d.**



**"SPANSCREW"
WAJBER PLUG**

No. 8. Pat. Pro. Pat. Reg. Des.

Helicically formed leaves, self-cleaning surfaces and solid end. Non-collapse-ible. Red or Black, **2d.** Engraved or plain **2d.**



If unable to obtain CLIX locally order direct, giving names of dealers.

CLIX—Safest for every form of contact

LECTRO LINX LTD., 254, Vauxhall Bridge Rd., S.W.1

**Something
New !!
what is it?—read on**

A Byldurone Cabinet! So easy to construct—only a screw-driver required. Supplied complete, ready to put together. Handsome yet sturdily built—Byldurone—Cabinets will give an added charm to your radio.

Specify BYLDURONE Cabinets

Their distinctive coverings can be supplied in an extensive range to suit individual taste, and to harmonise with furniture style and colour schemes.

Write for L'st J 12.

J. J. EASTICK & SONS, 118, Buxton Row, London, E.C.1

**EPR
4-Valve Screen Grid
Portable Set**

£10 10s. 0d.

Supplied on Easy Terms

WILL DAY LTD

19 LISLE ST. : W.C.2

REGENT 0921-22



**YOU CAN BUILD A
£40 GRAMOPHONE WITH
OUR SCALE DRAWINGS FOR 40/-**

Book of instructions 3d. Catalogue of Motors, Tonearms, Soundboxes, latest internal amplifiers Gramophones and Cabinets Free. Cash or Terms.

W. BURT, 185 High St., Deptford.

**DX THE STANDARD
PLUG-IN COIL**
Sold everywhere from 1/-
DX COILS Ltd, London, E.8

-TAYLEX WET H.T. BATTERIES-
New Prices: Jars 1/3. Sacs 1/2. Zincs 10d. Sample doz. 18 Volts complete with bonds and electrolyte 4/1 post 9d. Sample unit 6d. Illus. booklet free. Bargain list free.
AMPLIFIERS, 37/- 3 VALVE ALL-STATION SET 5s.
A. TAYLOR, 57, Studley Road, Stockwell, LONDON.

FULL-SIZE BLUEPRINTS

When ordering, please send Postal Order, NOT STAMPS.

CRYSTAL SET (6d.)

B.B.C. Crystal Set .. AW281
ONE-VALVE SETS (1s. each)

Monodyne .. AW258
 One Control One .. AW267
 Regional Ultra-selective One .. AW278
 B.B.C. One .. AW280
 Hartley One .. WN193

TWO-VALVE SETS (1s. each)

Talisman Two (D, Trans) .. AW104
 No-battery A.C. Mains Two (D, Trans) .. AW230
 No-battery Gramo-radio 2 (D, Trans) .. AW238
 1930 Talisman 2 (D, Trans) .. AW239
 Searcher Two (D, Trans) .. AW245
 Arrow Two (D, Trans) .. AW249
 Forty-five-shilling Two (D, Trans) .. AW250
 Searcher Short-wave 2 (D, Trans) .. AW259
 Challenge Two (D, Trans) .. AW261
 Loftin-White Two (A.C. Mains) .. AW263
 Everybody's All-in 2 (D, Trans) .. AW273
 Twenty-Shilling Two (D, Trans) .. AW274

THREE-VALVE SETS (1s. each)

Best-by-Ballot Three (SG, D, Trans) Price 4d. free with copy of "A.W." .. AW217
 1930 Clarion Three (SG, D, Trans) .. AW223
 Beginner's Regional Three (D, 2LF) .. AW233
 Britain's Favourite Three 1930 (D, 2 Trans) .. AW243
 "The A.W." Exhibition 3 .. AW247
 Push-Pull "Two" (D, Push-Pull) .. AW270
 1931 Ether Searcher (SG, D, Trans) .. AW271
 1931 Ether Searcher (A.C. model) .. AW276
 Mains Unit .. AW277
 Ultra-Selective Straight Three (SG, D, Trans) .. AW282

FOUR-VALVE SETS (1s. 6d. each)

Horizon Four (SG, D, 2 Trans) .. AW237
 Challenge Four (2SG, D, Trans) with copy of "A.W." .. 4d. post free .. AW251
 Challenge Four (2SG, D, Trans, mains operated) with copy of "A.W." .. 4d. post free .. AW252
 Challenge Radio Gramophone (SG, D, RC, Trans) .. AW265

FIVE-VALVE SETS (1s. 6d. each)

James Quality Five (2SG, D, RC, Trans) .. AW227
 Companion Portable (2HF, D, RC, Trans) .. AW279

PORTABLE SETS

Continental Portable (SG, D, Trans) .. AW241 1/-
 Companion Portable (2HF, D, RC, Trans) .. AW279 1/6
 Pedlar Portable Two (D, Trans) .. WM195 1/-
 Pedlar Portable Three (D, 2 Trans) .. WM197 1/-
 James Portable SG3 (SG, D, Trans) .. WM203 1/-

Copies of the "Wireless Magazine" and of "Amateur Wireless" containing descriptions of any of these sets can be obtained at 1s. 3d. and 4d. respectively, post free. Index letters "A.W." refer to "Amateur Wireless" sets and "W.M." to "Wireless Magazine."

Address letters:

Amateur Wireless Blueprints Dept., 58-61 Fetter Lane, London, E.C.4.

"Amateur Wireless and Radiovision." Price Threepence. Published on Thursdays and bearing the date of Saturday immediately following. Post free to any part of the world: 3 months, 4s. 6d.; 6 months, 8s. 9d.; 12 months, 17s. 6d. Postal Orders, Post Office Orders, or Cheques should be made payable to "Bernard Jones Publications, Ltd."

General Correspondence is to be brief and written on one side of the paper only. All sketches and drawings to be on separate sheets.

Contributions are always welcome, will be promptly considered, and if used will be paid for.

Communications should be addressed, according to their nature, to The Editor, The Advertisement Manager, or The Publisher, "Amateur Wireless," 58-61 Fetter Lane, London, E.C.4.

THE MALL MARK OF BETTER RADIO



MAGNUM

WATKINS-JONES & CO. LTD. 39, BOND STREET, LONDON, W.1.

KONDUCTITE

[Proc. Patent 481731] METALLIC PAPER

Konductite consists of a thin sheet of aluminum mounted on a comparatively stiff backing paper and has all the advantages of sheet metal. It is very easy to work with and infinitely superior to tin or copper foil. It is now specified in all leading circuits.

For Covering Baseboards : Back of Panels : Lining of Cabinets and all Screening purposes

In sheets measuring 30" x 20" 2/- Postage and packing 6d. extra Free sample on receipt of stamped addressed envelope

GRAMO-RADIO AMPLIFIERS LTD., 1a NEW LONDON ST., E.C.3
 Phone: Royal 4303

EASY TERMS

We supply all good quality Radio Receivers, Components and Accessories on deferred terms. We carry adequate stocks and can give prompt delivery

NEW HEAYBERD A.C. ELIMINATOR KIT C.150.—Complete Kit of Parts for building an H.T. Eliminator, including steel case. Output, 25 m.a., 150 volts, 3 H.T. Tappings, one variable.

Cash Price, £3/16/-
 or 7/6 with order and 11 monthly payments of 7/-
12 EXIDE W.H. HIGH-TENSION ACCUMULATORS (120 volts, 5,000 m/h.). Higher voltages if desired.

Cash Price, £3/15/-
 or 6/6 with order and 11 monthly payments of 7/-
Carriage charged on all orders from Scotland.

N.K. FARRAND INDUCTOR LOUD-SPEAKER UNIT.—Quality of reproduction almost equal to a moving-coil speaker.

Cash Price, £3/10/-
 or 5/6 with order and 11 monthly payments of 6/6.
B.T.H. PICK-UP AND TONE ARM.—One of the best pick-ups available.

Cash Price, 45/-
 or 5/- with order and 9 monthly payments of 5/-
NEW BLUE SPOT 66R UNIT.—The finest balanced-armature movement on the market. Complete with large Cone and Chassis.

Cash Price, £2/10/-
 or 5/- with order and 10 monthly payments of 5/-
Send list of requirements and quotation will be sent by return.

LONDON RADIO SUPPLY CO.

11 OAT LANE, NOBLE STREET, LONDON, E.C.2

Telephone: National 1977

ARE YOU BUILDING A SET ?

Compact '0005 mfd. condensers drum-drive, 2 1/2" x 2 1/2" x 2" when full opened

EACH **11/6**

LISTS FREE. POST FREE

O. SMETHURST, Hotel Street, Bolton

ENGINEERS—IMPORTANT NOTICE.—After months of intensive effort and research we are pleased to announce that our new hand-book is now out of the publishers' hands, and ready for distribution. Three times larger than any previous edition, this book is beyond argument the finest and most complete hand-book on Engineering Careers ever compiled. It is a book that will soon be on the bookshelf of every ambitious engineer, whatever his age, position or experience. The book contains, amongst other intensely interesting matter, details of B.Sc., A.M.I.C.E., A.M.I.Mech.E., A.M.I.E.E., A.M.I.A.E., A.M.I.Struct.E., M.B., San.I., L.I.O.B., F.S.I., G.P.O., C. & G., and every other important Engineering Examination, outlines Courses in all branches of Civil, Mechanical, Electrical, Motor, Wireless, Aeronautical, and Talkie Engineering, and explains the unique methods of our Appointments Department. We alone guarantee "NO PASS—NO FEE." The New "ENGINEERING OPPORTUNITIES" is bound to create a mild furore in Engineering circles. See that you get your copy by writing to-day—FREE and POST FREE. (State subject or Exam. of interest).—**BRITISH INSTITUTE OF ENGINEERING TECHNOLOGY, 109 Shakespeare House, 29/31 Oxford Street, W.1.**

WIRELESS PARTS AND SETS taken in part exchange for new, up to 50% or more allowed for modern parts in good condition. Apparatus bought for cash. State lowest price.—**W. Burns, Wireless Factor, 4 Loanda Street, Haggerston, E.8.**

A LIMITED NUMBER of solid oak and mahogany radio gramophone cabinets fitted with B.T.H. 6 gn. electric gramophone motor, A.C. or D.C., and B.T.H. Pick-up and tonearm. Ideal for battery or mains "Ether Searcher" or similar set. Will take any panel up to 18 in. by 8 in. Ample space for loud-speaker, batteries or mains units below. Details and illustrations on request. £11/10/- each, carriage paid.—**James Scott & Co., Inglis Street, Dunfermline.**

WIRELESS BARGAINS.—Three-valve brand new Portable Sets, best makes, from £5 10s. cash or 14/6 with order. Three-valve Sets, complete, 68/- or 7/3 with order.—Below. Send to Posters for latest Bargain List of Wireless Sets, etc.—**Fosters (Highbury), Ltd., 74 Highbury Park, Highbury Barn, London, N.5. Phone: North 4430.**

REAL BARGAINS.—Genuine clearance of unwanted material. Large Horn Speakers, 5/- and 7/6. 5-amp. Tumbler Switches, 6d. Lotus Panel Jacks (new), 1/3. Wearite Wall Jacks, 9d.; Dekorem ditto, 9d. Jack Plugs, 6d. Misc. Panel Jacks, 9d. Detex Push-pull Switches, 6d. Foreign ditto, 3d. Igranic 6-ohm Rheos, 9d.; Foreign ditto, 30 ohm., 6d. Min. Knife Switches, D.P.D.T. (new), 6d. Anti-phonc Valve Holders, 3d. Earthing Clips, 1d. Ferranti 1-1 Output Transformers, 12/6. Telsen Radiogram Transformers, 5-1 (new), 7/6. C.O.D. or carriage forward.—**Tonge, 10 West Crescent, St. Annes-on-Sea.**

PREPAID ADVERTISEMENTS

Advertisements under this head are charged THREEPENCE PER WORD, minimum charge THREE SHILLINGS. DEPOSIT SYSTEM

As the Publishers cannot accept responsibility for the bona fides of advertisers in this publication, they have introduced a system of deposit which if it is recommended should be adopted by readers when dealing with persons with whom they are unacquainted. It is here explained.

Intending purchasers should forward to the Publishers the amount of the purchase money of the article advertised. This will be acknowledged to both the Depositor and the Vendor, whose names and addresses must necessarily be given. The deposit is retained until advice is received of the completion of the purchase, or of the article having been returned to and accepted by the Vendor. In addition to the amount of the Deposit, a Fee of 6d. for sums of £1 and under, and 1s. for amounts in excess of £1, to cover postage, etc., must be remitted at the same time. In cases of persons not resident within the United Kingdom, double fees are charged.

The amount of the Deposit and Fee must be remitted by Postal Order or Registered Letter (Cheques cannot be accepted), addressed to

"AMATEUR WIRELESS" ADVERTISEMENT DEPARTMENT, 58/61 FETTER LANE, LONDON, E.C.4

PHOENIX THREE-VALVE kits complete with cabinet, £1/17/6. Ditto with valves, £2/15/-. Ditto with H.T. and L.T. batteries and speaker, £4/19/6. H.P. terms on kit: 5/- deposit, 2/7 per week.—**Phoenix, 314 High Road, Lee, S.E.13.**

CORRESPONDENCE COURSES OF INSTRUCTION IN WIRELESS.—Particulars from Correspondence Course Department of the R.M. College, 26/27 St. Mary Street, Cardiff.

VERT WIRING CLIP. No soldering. Tested and approved "Amateur Wireless." Samples 3d. and stamped envelope. Half gross, 2/- (sufficient for three-valve set).—**Green & Sons, Redclyffe, Horley, Surrey.**

PATENTS.—Trade Marks, Advice Handbook free.—**B. T. King, Regd. Patent Agent, 140a Queen Victoria Street, London.**

PERSONS WANTED as manufacturing agents, new and interesting industry. Regular work supplied, cash paid weekly. Write E. 87, "Everlast" Leather Matting Co., Wellingborough.

TRICKLE CHARGERS, A.C. mains, for 2- and 4-volt accumulators, 0.5 amp., no upkeep, 18/6, carriage paid.—**A. Benoit, 4 Manor Gardens, Gunnersbury Avenue, London, W.3.**

BRYCE'S MAINS TRANSFORMERS are specially designed to give the highest efficiency. See test report in this issue. Supplied to Corporations and experienced constructors all over the country. Let us supply you. Write for lists.—**Bryce's, Transformer Dept., Dawson Street, Bury, Lancs.**

"UNIVERSAL," the Radio Mail Order House for Components, Kits, and Sets. Send for our Bargain Lists. Traders supplied. Send letter heading or business card.—"Universal," 20 Victoria Road, Peckham, S.E.15.

BANKRUPT BARGAINS.—List with 3-v. diagram free. Note all goods up to date and of good quality. Transformers, 2/9; Telsen Radiogram, 9/6; A.C.E., 6/6; P.W. dual coils, 8/6. '0005 variable, 2/6. Differential, 2/6 S.M. dials, 1/6; geared, 2/-; drum geared, 5/-. Three valve kit with cabinet, 35/-; two, 24/-.—Speaker kits from 12/6. You will not beat my prices for good quality components. No junk sold. Large variety.—**Butlin, 143B Preston Road, Brighton.**

ELECTRICAL ENGINEERS, wiremen, accumulator service men.—The T.E.C. will train you at home for a better job; unsurpassed courses in electrical engineering, wiring, and battery charging; prospectus post free.—**Technical Engineering College, Crown Chambers, Regent St., London, S.W.1. Principal, W. S. Ibbetson, B.Sc., A.M.I.E.E.**

COMET THREE KIT, £2.—Carriage paid. Results guaranteed; send cash or stamp for lists.—**G. Crosbie and Co., 38 Southill Street, Poplar, London, E.14.**

WIRELESS SETS and Parts supplied at red-hot prices. Send list of requirements, quotations by return. Bargains: Famous "Wufa" Speaker Units, 25/-; with Chassis, 35/-; '0005 Drum-drive Condensers, well-known make, 10/-; Differential Condensers, 2/6. Trioform Cone Units, 8/6. H.F. Chokes, 1/9. Spaghetti Resistances, 1/6. All post free.—**Servwell Wireless Supplies (Dept. M.O.), 74 Gough Street, London, E.14.**

"**RADIO TRAINING INSTITUTE,**" Union Buildings, St. John Street, Newcastle-on-Tyne. Our "Certificate of Proficiency" in Radio or Talkie Engineering qualifies you for appointment. Particulars of specialised Correspondence Courses and deferred payments, free.

A MAGNIFICENT SET.—The National and Regional Three, absolutely complete, including Tungram valves, 2-volt accumulator, 100-volt H.T. battery, B.T.H. 45/- loud-speaker. Perfect reception from home and foreign stations. Guaranteed 12 months. Amazing value, £4, inclusive.—**H. Panagakis, Radio Manufacturer, 91 Dale Street, Liverpool.**

COMPLETE KITS AND PARTS as specified in this issue.—**P. R. Co., 34 Buckingham Road, Brighton.**

FOR SALE, 7-valve Superhet, complete with valves; 3-valve Short-wave Receiver, less valves; also 3-valve Reinartz Receiver, less valves; all in first-class condition and constructed with best components, the property of experimenter; for sale, price £25, or nearest offer for lot; also a large number of components of a useful nature included.—**Apply, 43 Calbourne Road, Balham, S.W.12.**

Amateur Wireless Available until Saturday
APRIL 11, 1931

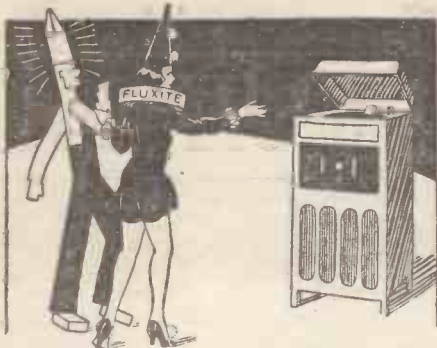

We're Fluxite and Solder.
The reliable pair,
Famous for soldering—
Known everywhere!
You've trouble with wireless
Well, don't get put out—
We'll SOLDER the connections,
That's the trouble, no doubt!

See that Fluxite and Solder are always by you—in the house, garage, workshop—anywhere where simple, speedy, soldering is needed. They cost so little, but will make scores of everyday articles last years longer! For Pots, Pans, Silver, and Brassware; RADIO: odd jobs in the garage—there's always something useful for Fluxite and Solder to do.

ANOTHER USE FOR FLUXITE All Hardware and Ironmongery
Hardening Tools and Case Hardening. Stores set Fluxite in tins, 8d.,
Ask for Leaflet on improved method. 1/4 and 2/8.

FLUXITE SOLDERING SET
Simple to use and lasts for years in constant use. Contains special "small-space" soldering iron with non-heating metal handle; pocket blow-lamp, Fluxite, Solder, etc.; and full instructions.

COMPLETE, 7 or LAMP only, 2/3.

FLUXITE, LTD.

(Dept. 326)
ROTHERHITHE, S.E.16



ALL MECHANICS WILL HAVE

FLUXITE

IT SIMPLIFIES ALL SOLDERING

High-Grade

RADIO GRAMOPHONE CABINET

of exclusive modern design, hand-made and polished on a-carved base.

Figured Oak ... £17: 17: 0

Figured Walnut or Mahogany £21.

Carriage paid.

THE ACME OF CRAFTSMANSHIP.

Sliding doors to set and speaker compartment. Accommodation for records, etc. Photographs and 30-page illustrated catalogue free. Models from £2. Cabinets made-to-order a speciality.

Furniture at Makers' prices.

**GILBERT,
CABINET MAKER,
SWINDON.**

Estimates free

Estd. 1866

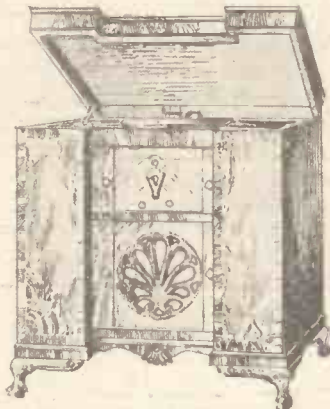

A COMPONENT YOU MUST USE

SOVEREIGN VOLUME CONTROL

50,000, 100,000 and 500,000 ohms, 1 and 2 megohms, each 4/6

If your dealer cannot supply write direct (also for list of full range of Sovereign Components) to the Makers

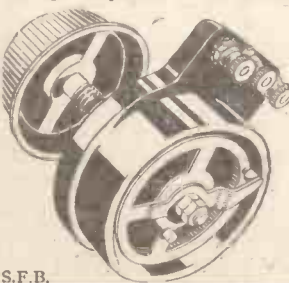

S.F.B.

TO get best results from your set it must be equipped with an efficient volume control, and for this purpose there is nothing to surpass the Sovereign Volume Control (shown here with dust and damp proof cover removed) Smooth silky action; bakelite case and pointer knob; nickelled fittings throughout. Fit Sovereign Components to improve any circuit.

SOVEREIGN PRODUCTS LTD.
52/54 ROSEBERY AV., LONDON, E.C.1



USES

RADIO manufacturers all over the world are using Dubilier Condensers because it is known that their robust construction and high electrical efficiency can make all the difference to the performance of their sets.

You can do no better than follow their lead and make use of Dubilier Condensers for efficiency, accuracy, and reliable Service.

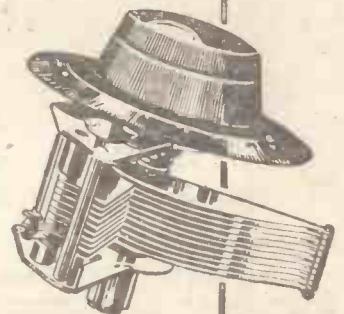

K.C. Variable Condenser

With knob, dial and slow-motion device - - 11/-

Without knob, dial or slow-motion device - - 7/6

DUBILIER

CONDENSERS

DUBILIER CONDENSER CO. (1925) LTD.

DUCON WORKS, VICTORIA RD., NORTH ACTON, LONDON, W.3

You Will Help Yourself and Help Us by Mentioning "A.W." to Advertisers

Switch-on your Radio..



AND NUMBERS OF STURDY CELLS AND PLATES GO TO WORK

Turn the dial of your radio. Out-pours dance music, the martial strains of the military band, speeches direct from the lips of famous people, news but a few minutes old. This marvel of marvels, the radio, owes much of its efficiency to good batteries . . . Pertrix Batteries.

It is because Pertrix Dry Batteries contain NO sal-ammoniac that they are so efficient—that they do not deteriorate when not being used . . . that they are so silent in operation . . . that they do NOT corrode . . . that they last 60 per cent longer. And the Improved Pertrix Accumulator, with the "Kaptive Karrier," will give you the pure filament current that is so necessary for good reception.

Remember, no matter what your set, there is a Pertrix Pair that will fit it—AND improve it. Ask your dealer—he knows.

PERTRIX

SUPER LIFE
DRY BATTERIES
AND ACCUMULATORS

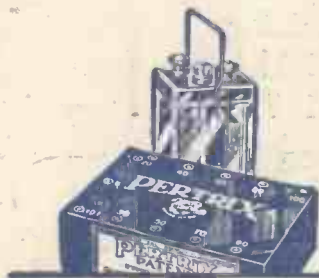

THE PERFECT PAIR FOR PERFECT RADIO

Advt. of PERTRIX, LTD., Britannia House, 233, Shaftesbury Avenue, London, W.C.2. Works: REDDITCH

Telephone: Temple Bar 7971 (5 lines)

Telegrams: Britanicus, Westcent, London, P106

Printed in England. Published by Bernard Jones Publications, Ltd., 58/61 Fetter Lane, London, E.C.4.
Sole Agents for South Africa: CENTRAL NEWS AGENCY, LIMITED. Sole Agents for Australasia: GORDON & GOTCH, LIMITED. Saturday, April 4, 1931