

50 STATIONS WITH THE "1931 ETHER SEARCHER"

DR. ROBINSON ON—WHAT THE "STENODE" DOES

Amateur Wireless

Every Thursday 3^d

and Radiovision

Vol. XVIII. No. 451

Saturday, January 31, 1931

GETTING 50 STATIONS WITH THE "1931 ETHER SEARCHER"

HÖRBY
 RENNES
 HUIZEN
 GÖTEBORG
 STRASBOURG
 TOULOUSE
 KATOWICE
 ROME
 PRAGUE
 VIENNA

LONDON NATIONAL
 BRATISLAVA
 BORDEAUX
 BRESLAU
 HAMBURG
 FRANKFURT
 STOCKHOLM
 LANGENBERG
 MILAN
 BUDAPEST

SEE AUTOMATIC TUNING SCALE (PAGE 194)

Registered at the G.P.O. as a Newspaper

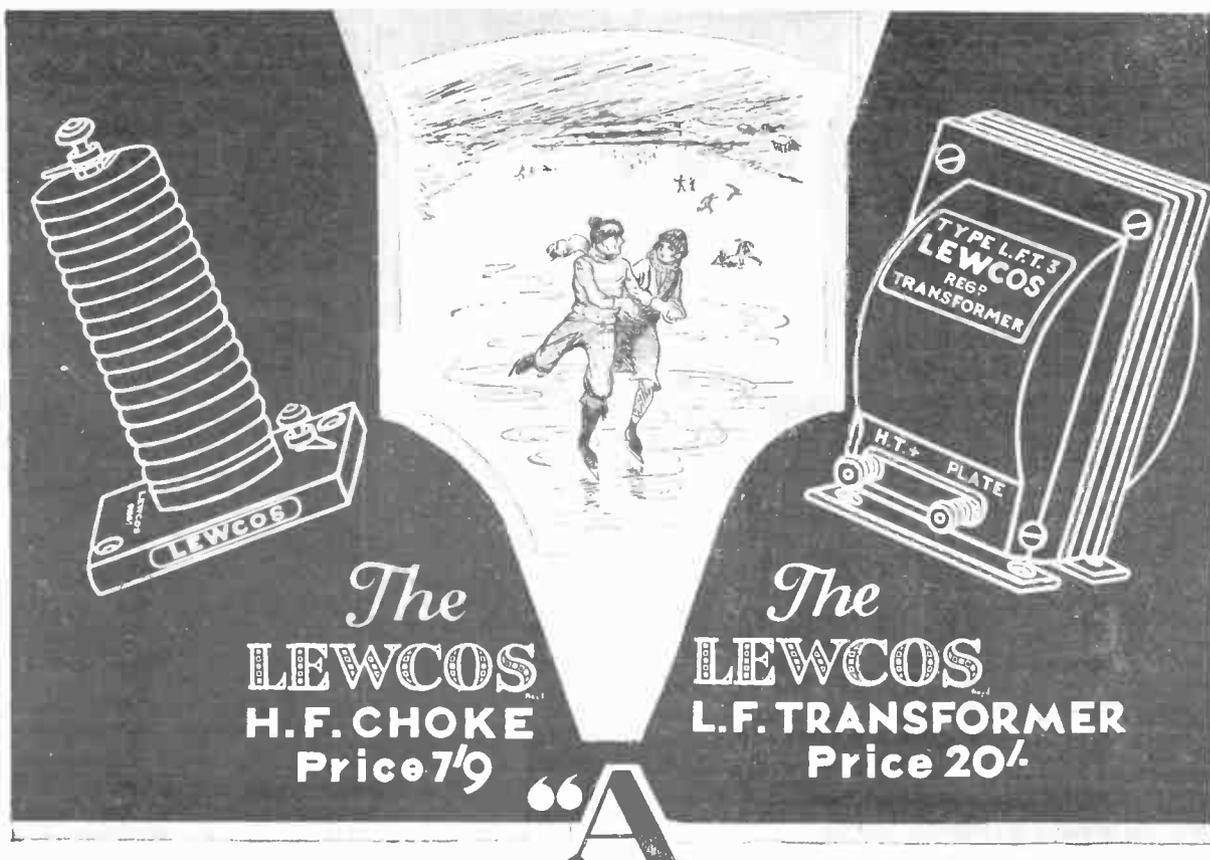

Perfect Combination"

is an extract from the following testimonial recently received from an enthusiastic user of The Lewcos H.F. Choke and L.F. Transformer

READ THIS!

**The
LEWCOS
H.F. CHOKE**

is specially constructed to eliminate self-oscillation.
Write for fully descriptive leaflet Ref. R.53.

"I recently constructed a receiver, and in the first instance employed a High Frequency Choke and L.F. Transformer already in my possession, but after reading your advertisement I decided to incorporate new items of your manufacture, and can assure you that your LFT 3 Constant Inductance Transformer and your well finished H.F. Choke are a *perfect combination*. I was previously troubled with instability in my set, but this has now disappeared and the reproduction is simply wonderful."—(V. J.), C.C., Mitcham.

**The
LEWCOS
L.F.
TRANSFORMER**

has a constant inductance for different values of a.c. current.
Write for fully descriptive leaflet Ref. R.51.

We respectfully request the public to order through their local Radio dealer, as we only supply direct to the trade.



Large Stocks of Lewcos Radio Products are held at all Branches.

LEWCOS RADIO PRODUCTS FOR BETTER RECEPTION
THE LONDON ELECTRIC WIRE COMPANY AND SMITHS LIMITED, CHURCH ROAD, LEYTON, LONDON, E.15
Don't Forget to Say That You Saw it in "A.W."

REPRODUCTION.... THAT MAKES YOU VISUALISE

Pianoforte recitals

GREAT INTERPRETERS



Privileged as we now are to hear the World's greatest pianists broadcast, it would be ungracious of us, to say the least, if we did not make every effort to hear these great masters of music as perfectly as they themselves would wish.

The Piano is acknowledged to be the most difficult of all musical instruments to reproduce faithfully . . . yet Telsen Transformers, scientifically designed and built, and extremely sensitive, reproduce every note, however lightly struck, every variation of touch, without the slightest trace of distortion.

Hear perfectly . . . with absolute purity of tone . . . with ample volume . . . by fitting

TELSEN TRANSFORMERS

- "ACE" - - Ratios 2-1 and 5-1 8/6
- "RADIOGRAND" Ratios 2-1 and 5-1 12/6
- "RADIOGRAND" Super. Ratio 7-1 17/6

The complete range of Telsen Components includes H.F. Chokes, Fixed (Mica) Condensers, Grid Leaks, Four and Five Pin Valve Holders. For complete details and prices of these see advertisements elsewhere in this issue.

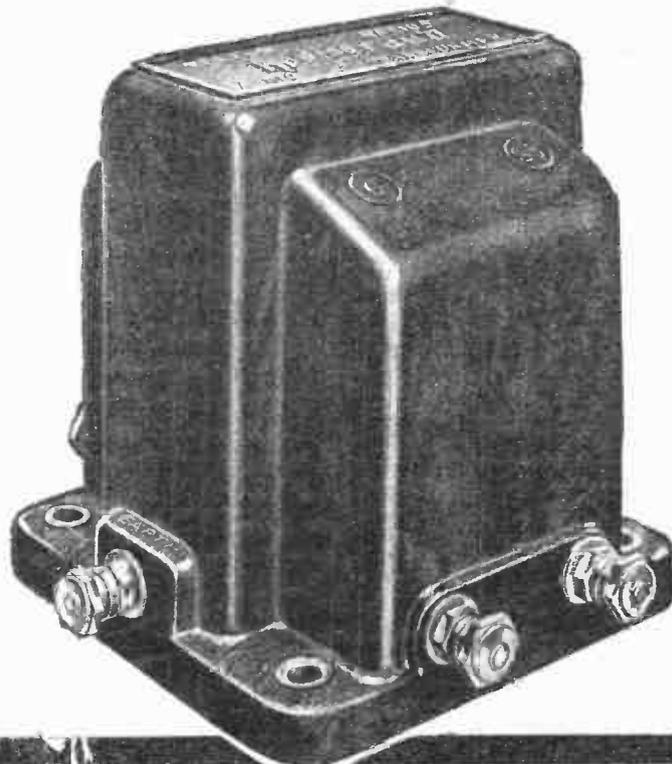

Mfd. of Telsen Electric Co., Ltd., Birmingham.

210

Specially designed for H. F. Amplification

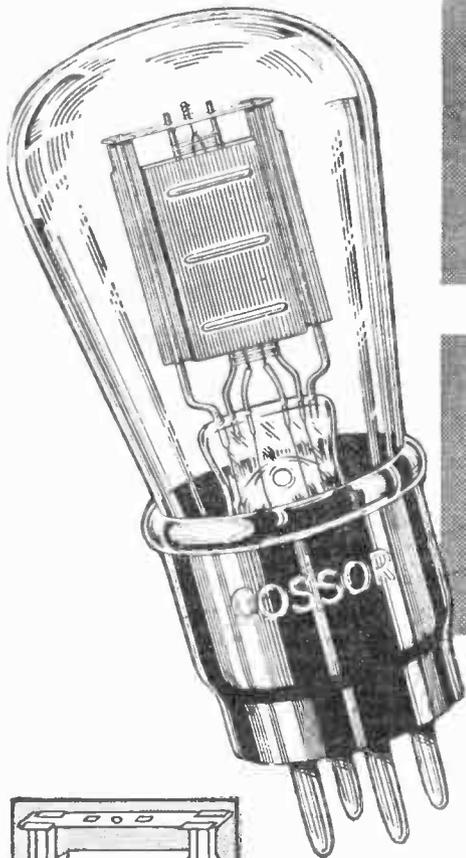

H.L.

Incorporating all the most advanced constructional features the new Cossor 210 H.L. is of exceptional interest to all users of non-screened grid Receivers. To ensure complete freedom from microphonic noises the famous Cossor system of Seven Point Suspension is employed. To permit of greatly increased accuracy in the inter-electrode spacing and, therefore, of an unusually high standard of uniformity, the new Mica Bridge Mounting method of assembly is used. In addition to special grid current characteristics and other important improvements, the base is of an entirely new material on which the "Wireless World" reported, "we find the high frequency losses in the bases of both the two Cossor Valves here tested to be negligible." The use of the new Cossor 210 H.L. in any non-screened grid Receiver will considerably increase its efficiency.

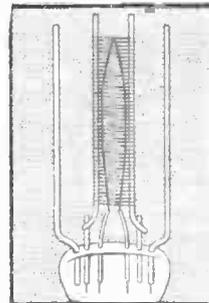

The new Cossor 210 H.L. 2 volts, 1 amp. Impedance 22,000. Amplification Factor 24, Mutual Conductance, 1.1 m.a.v. Anode voltage 75-150. Price **8/6**

SEVEN POINT SUSPENSION

Practical experience has shown that the Cossor 7 point suspension system definitely eliminates microphonic noises. This system is employed in the support of the exceptionally long filament of the Cossor 210 H.L.

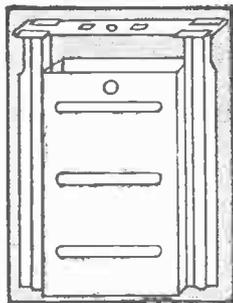

MICA BRIDGE MOUNTING

Permanent alignment of the electrode system is ensured by a stout mica bridge which forms an integral part of the anode assembly. When finally secured in position the whole structure becomes one interlocked unit.

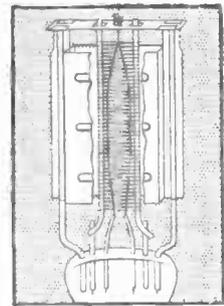

UNIFORM PERFORMANCE

The Cossor mica bridge construction permits no variation of characteristics due to differences in inter-electrode spacing. Complete uniformity of performance is therefore ensured between all valves of the same type.

THE NEW COSSOR 210 H.L.

Be sure to get one of our novel, circular Station Charts, which give identification details of nearly 50 stations with space for entering your own dial readings. Ask your dealer for a copy, price 2d. or send 2d. stamp to us and head your letter "Station Chart .111"

A. C. Cossor Ltd., Highbury Grove, London, N 5

7189

Mention of "Amateur Wireless" to Advertisers will Ensure Prompt Attention



Amateur Wireless

and
Radiovision

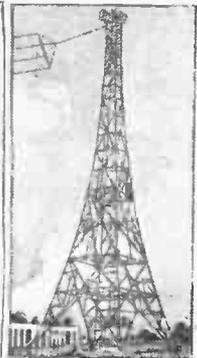

EDITOR:
BERNARD E. JONES.

TECHNICAL EDITOR:
J.H. REYNER, B.Sc., A.M.I.E.E.

RESEARCH CONSULTANT:
W. JAMES.

ASSISTANT EDITOR:
H. CORBISHLEY.

THE LEADING RADIO WEEKLY FOR THE
CONSTRUCTOR, LISTENER & EXPERIMENTER.

NEWS & GOSSIP OF THE WEEK

SEARCHING THE ETHER

A LARGE number of our readers are making the "1931 Ether Searcher," and already we have many reports of the ease and simplicity with which the construction has been carried out. This week, for the benefit of those who want to get the very best out of this set, there are two further guides: one a pictorial diagram of the various connections of the batteries, and so on, to the receiver; the other an

automatic tuning scale which, in conjunction with the simple one-knob tuning control of the set, makes it mere child's play to bring in fifty stations. On page 191 you will find the pictorial diagram of the connections, and the automatic tuning scale is on page 191.

B.B.C. ACTIVITIES

THE B.B.C. engineers are breaking new ground in making use of the "talking tape" machine for recording broadcasts, as is described in detail elsewhere in this issue. This machine has been developed for talkie film work, but the B.B.C. engineers have some ingenious uses in mind for this new recording device. An AMATEUR WIRELESS representative discussed this with a B.B.C. official last week, and while talking of broadcast engineering matters he took the opportunity of mentioning the Stenode. "We are watching developments," said the official. "There is no announcement to make." Rather guarded; but, then, that is B.B.C. policy!

CUTTING OUT STATIC!



In Berlin steps have been taken to cut down the radio interference caused by trams, special arrangements being used for picking up the current from the overhead wires

A CARDINAL'S CRITICISM

CARDINAL MACRORY, the Roman Catholic Primate of All-Ireland, in criticising the modern prophets for expressing their views on present-day religious problems, recently stated that the B.B.C. was to be blamed for broadcasting pagan gospel. We presume the Cardinal refers to the recent series of broadcasts on "Science and Religion," in which the leading thinkers of the day have been allowed by the B.B.C. to express, without reservation, their attitudes towards religion. Most listeners will join with us in saying that this series has probably done much to enlighten religiously-minded people. It has been one of the best talks series.

PRINCIPAL CONTENTS

| | Page |
|---|------|
| News and Gossip | 175 |
| The "A.W." H.T. Unit and Charger | 177 |
| How the Stenode Clears the Ether | 179 |
| On Your Wavelength | 183 |
| Announcers Tell Their Stories | 185 |
| Adding a Coupled Circuit | 186 |
| "Freezing" Broadcasts | 189 |
| Without Fear or Favour | 190 |
| Connecting Up the "1931 Ether Searcher" | 191 |
| Getting the Best From the "1931 Ether Searcher" | 192 |
| The Automatic Tuning Scale | 194 |
| In My Wireless Den | 196 |
| The Gecophone A.C. Four | 198 |
| How a Crystal Set Works | 200 |
| We Test for You | 202 |

THE B.B.C.'s RELIGION

SIR JOHN REITH pointed out at Coventry some time ago that the B.B.C. is very considerably assisting the Church in its work. This help has until now not been acknowledged by the churches nor has it been due to their co-operation. There is no doubt that the B.B.C., through the efforts of Sir John Reith, is a wonderful publicity medium for the Christian religion.

CENSUS TALKS

THROUGHOUT the winter, at 7.25 p.m. on Tuesdays, population problems have been discussed. This series will appropriately culminate with a group of Census talks, starting on February 17 with an introduction by Mr. S. P. Vivian, the Registrar-General. On February 24 Professor M. Greenwood will speak on "Before Census Taking." On March 3 Mr. H. N. Trouncer will speak on "The Actuary Looks at the Census." "A Social Survey of London" will be broadcast on March 10, "How the Census is Taken" on March 17, and a concluding talk by the Registrar-General on March 24. The B.B.C. is publishing a pamphlet dealing with the Census.

THAT INTERVAL SIGNAL

WHAT a poor sort of advertisement for British broadcasting the much-heralded B.B.C. interval signal has turned

NEXT WEEK : "EVERYBODY'S ALL-IN TWO"

NEWS · & · GOSSIP · OF THE · WEEK —Continued

out to be! The strength of the metronome tap has been reduced almost to inaudibility, presumably because some listeners have complained of the irritation caused by this rather ridiculous tapping noise. The signal seems to be reserved mainly for intervals in the National programme, although sometimes the Northern stations have broadcast it. We feel something much more distinctive is needed if the B.B.C. is to continue with an interval signal. At present the engineers are merely playing with the idea while foreign stations are using some imagination.

WHEN JACK PAYNE LISTENS

THE other evening the B.B.C. was besieged with questions as to what had happened to Jack Payne, for, although his band was broadcasting, his familiar voice was not doing the announcements. The reason for this was explained to us by the B.B.C. When there is only a short spell of dance music Jack Payne sometimes asks permission to stay at home in order that he may listen to his band and judge its effectiveness from the listeners' point of view. A good idea!

THE NEW RADIO PARIS

IT has been kept more or less a secret that Radio Paris is to put up its power. Actually, an entirely new transmitter is being built, replacing the existing 17-kilowatt on 1,725 metres, at Clichy. The new gear will, it is expected, be ready by Easter, and will then be pushing a forceful 60 kilowatts on to the already overcrowded long-wave ether. It is not expected that the wavelength will be altered, and some complaints may be made by users of nearly every wavelength neighbour of Paris.

JAMMING 5XX

THERE are plenty of listeners in this country who have sets which are not too selective on the long wavelengths, and which already get a background of Radio Paris on the 5XX transmission. They will get more than a "background" when the 60 kilowatts come along, and it is not so easy to cure lack of selectivity on the long waves as it is on the short. There is nobody to say "No" to Radio Paris, for it is only doing what it is permitted to do under the International ruling.

NOT POPULAR

AN extraordinary thing is that this increase in power is not appreciated even by all French listeners. There is a large section of listeners in and around Paris who already cannot get another programme without jamming from the local station, and because the local station gives English announcements and is partly subsidised by British advertising revenue, it is not wholly liked. And yet the power is being tripled: an extraordinary state of affairs!

FOOTBALL BROADCASTS

WHETHER the B.B.C. is justified in assuming that listeners want as many commentaries on football as can possibly be arranged is a moot point. From advance

information it appears that the Football Association and the B.B.C. have got together in earnest, for no less than fifteen fixtures are due for broadcasting between now and May 2. B.B.C. correspondence shows that these rugby and soccer relays have a wide appeal. It appears that women are gaining an interest in the game as a direct result of the broadcast commentaries.

COMMON REGIONAL WAVELENGTHS

AS was announced last week, the B.B.C. proposes to overcome the difficulty of completing the Regional Scheme with existing wavelength facilities by giving one

The roof is now being put on the B.B.C.'s new Broadcasting House in Portland Place, London. It is now less than a year ago that the building was started



each of the twin transmitters at the Scottish and Welsh Regional centres a common wavelength. The power of the common-wavelength transmitters will be in the region of 50 kilowatts. But the B.B.C. emphasises the fact that neither of the two regional transmitters involved will have as great a range as would be expected with exclusive wavelengths. We imagine there will be a considerable mush area between the two centres, in locations where neither common-wavelength transmitter has a preponderating strength.

A B.B.C. MAN IN CANADA

LISTENERS who can pick up the Canadian stations should make a point of listening to an item to be simultaneously broadcast over the C.N.R. Chain this week, for there is a particular interest in the first broadcast play to be produced by the Canadian National Railways Radio Department under the direction of Tyrone Guthrie, who recently left the B.B.C. to take charge of the production of Canadian historical radio plays.

IN NEXT WEEK'S ISSUE
"EVERYBODY'S ALL-IN TWO"

THE LARGEST STUDIO

WHAT is claimed to be the largest studio in the world comes, need it be said, from America. It is studio A of the National Broadcasting Co.'s new Midwest "Radio City" in the merchandise Mart, Chicago, and it measures 47 ft. by 72 ft. by 23 ft. high. At a rough guess we should say that the public studio at the new Broadcasting House in Portland Place will be far larger than that; and, in addition, it will have a gallery, which the Chicago studio has not.

THESE RADIO CLUBS

ARE you club-by? Or, to be more precise, are you radio-club-by? There

are many amateur radio clubs and societies in various parts of the country and the help and advice you can get from these, apart from the general advantage of being in the company of other radio enthusiasts, are well worth having by every radio man. There is a keen radio society which has its headquarters at the Surrey Drivers' Hotel, Selsdon Road, South Croydon. If you live in the Croydon district you should certainly consider supporting this local radio club.

MÜHLACKER INTERFERENCE

THERE are a few fortunate set owners who can separate Mühlacker from London Regional, and these are in a position to judge the quality of the new German high-power transmission. The officials responsible for the Mühlacker plant are anxious to have as many reports as possible about the strength, programmes, fading, interference, and so on, and listeners in Great Britain are invited to send along reception reports. The address is Süd-deutscher Rundfunk, Charlottenplatz 1, Stuttgart, Germany.

Novelty has been introduced in the special broadcasts for Scottish farmers by the substitution of an interview for the usual talk.

THE "A.W."

H.T. UNIT AND CHARGER

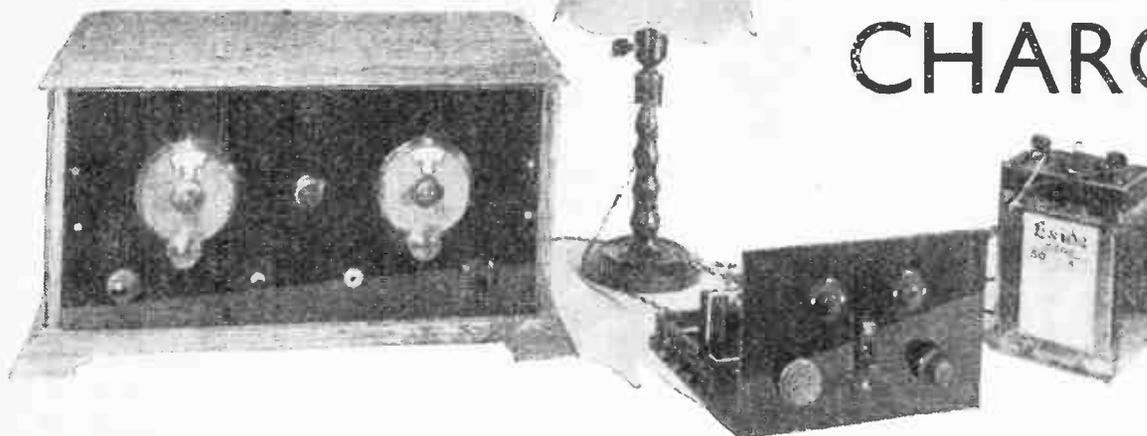

CURRENT SUPPLY AT MINIMUM COST

If you have direct-current mains then it is an easy matter not only to get high-tension but low-tension charging current from the supply. Here are particulars of a handy unit which gives high-tension current and a low-tension charging supply

A GREAT advantage of D.C. mains is that no elaborate apparatus is necessary in order to get a hum-free supply of high-tension current. As readers probably know, with A.C. mains a rectifier of some sort, metal, valve or electrolytic, has to be used and while this does not necessarily increase the difficulty of working, it obviously puts up the cost, and D.C. mains users are fortunate in this respect in that in order to get a good H.T. supply they have only to provide a smoothing circuit and arrange some means for cutting down the voltage.

Staff has arranged for an ordinary standard type table lamp to be used as the charging resistance.

H.T. and L.T.

In this unit, therefore, you have a simple means of getting a steady supply of high-tension current for the set and you also have a ready means of charging the accumulator. The unit does not take the place of the accumulator, of course, but it makes the charging of it almost automatic. Constructionally, this unit is quite a simple job, for it is made up in just the same way as an ordinary receiver with a panel and baseboard. The panel carries two safety fuses, one in each lead, the on-off switch and two variable resistances controlling the high-tension output. Terminals are provided at the back of the unit for H.T. tapplings, negative, positive 1, 2, 3 and 4 and for the low-tension and accumulator connections.

low-frequency choke in circuit with a 4-microfarad smoothing condenser. It is advisable to observe the I.E.E. regulations regarding the safety factor, and working voltages of mains condensers. Each of the dropping resistances is shunted by means of a 2-microfarad condenser which provides an effective by-pass for each tapping.

Straightforward Construction

If you want to make up the unit exactly as described then it is advisable to get the full-size blueprint which can be obtained, price 1s., post free, from the Blueprint Department, AMATEUR WIRELESS, 58-61 Fetter Lane, London, E.C.4. This will assist you in getting the connections quite correct and although the constructional work is just as easy as that of any one- or two-valve set you must bear in mind the fact that a wrong connection might mean blowing the fuses in the unit—not a mistake one likes to make!

(Continued on the next page)

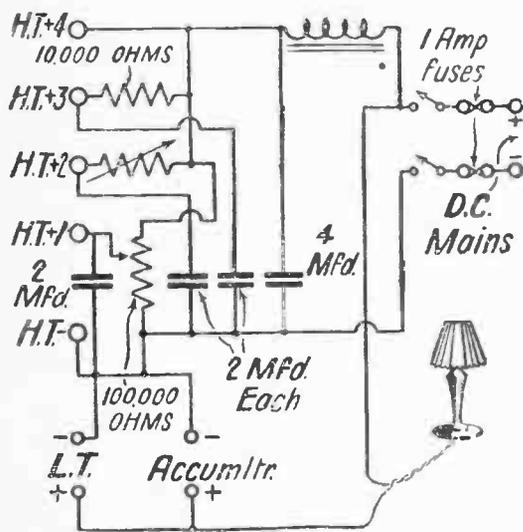

The circuit of the unit

But why stop at high tension? With D.C. mains it is a completely simple matter to get a low-tension charging supply. It is not at all difficult so to arrange the connections of a D.C. high-tension eliminator that the accumulator may be connected up to it for charging purposes, the charging current being passed through a lamp.

There is no need to have a special charging lamp for this purpose and in this new high-tension unit the "A.W." Technical

al. at the back of the unit the polarity is correct and there is no chance of making a mistake in this direction.

The Circuit

The accompanying theoretical circuit diagram shows how the smoothing circuit of the eliminator and the voltage dropping resistances are arranged. The high-tension current is smoothed by means of a large

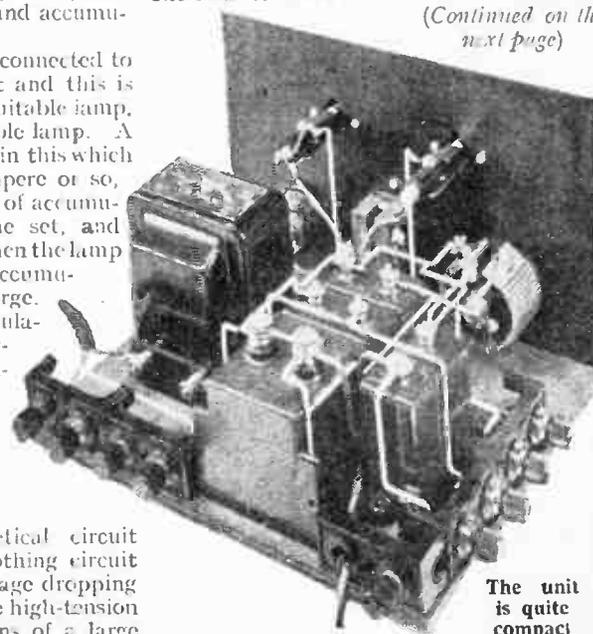

The unit is quite compact

"THE 'A.W.' H.T. UNIT AND CHARGER"

(Continued from preceding page)

When all the parts are screwed down on the baseboard in the positions shown on the blueprint and when the panel has been attached at right angles to the baseboard, then the wiring may be carried out, using

Charging Current Passed by Typical Carbon-filament Lamps

| 200 volt | 50 candle power | 1.0 amp. |
|----------|-----------------|----------|
| " " | 32 " " | .64 " |
| " " | 16 " " | .32 " |
| " " | 8 " " | .16 " |
| 220 " | 50 " " | .9 " |
| " " | 32 " " | .6 " |
| " " | 16 " " | .3 " |
| " " | 8 " " | .15 " |
| 240 " | 50 " " | .83 " |
| " " | 32 " " | .53 " |
| " " | 16 " " | .29 " |
| " " | 8 " " | .13 " |

insulated wire. On no account use bare wire in any mains unit, for this involves the possibility of short circuits. If you do not want to make soldered connections then it is possible to use lengths of wire enclosed in insulated sleeving.

There is a point to note in connecting up the unit to the set.

The earth lead must be disconnected from its terminal on the set and taken to a 2-microfarad condenser capable of standing up to twice the mains voltage. The other terminal of this condenser should then be connected to the earth terminal of the receiver. This is a safety device which prevents the mains being short-circuited and obviates the possibility of shocks while at the controls.

There is really no need to test for polarity when connecting up the unit to the mains, for the set will work only when the positive mains lead is connected to the positive input wire of the unit. In the reverse direction the anodes of the valves will have a negative potential on them, and nothing will be heard. Provided the high-tension section is correctly connected then the polarity of the low-tension charging arrangement will also be correct, but you must take care to connect the accumulator correctly to its charging terminals, negative to negative and positive to positive.

With most mains supplies it will be found possible to charge the accumulator while the set is working without introducing too

much hum. In some cases, though, it is advisable to arrange that the accumulator is charged when the set is not working. There is just a possibility that if the charging lamp is on and, for any reason, the accumulator becomes disconnected, the valves may be burnt out.

If you have never charged accumulators at home you will find it advisable to invest in a hydrometer, which tells exactly when the cells need a freshening charge.

COMPONENTS REQUIRED for the "A.W." H.T. Unit and Charger

- Ebonite panel, 9 in. by 6 in. (Becol, Frelleborg).
- Baseboard, 9 in. by 7 in. (Camco, Clarion, Pickett).
- Two single mains fuses for panel mounting (Bulgin, No. 1).
- Double-pole mains switch (Bulgin, Wearite).
- Variable resistance (Clarke's "Rheograd," Clarostat).
- 120,000-ohm variable wire-wound resistance (Regentstat, Clarostat).
- 4-mfd. fixed condensers (T.C.C., 600 volts test, Dubilier, Filta).
- Three 2-mfd. fixed condensers

- (T.C.C., Dubilier, Filta).
- Low-frequency choke, 20 henries (Varley, Lissen, R.I., Atlas, Wearite, Ferranti).
- Five terminal blocks (Belling-Lee, Lissen, Junit).
- Nine insulated terminals marked H.T.+, H.T.-, H.T.+2, H.T.+3, H.T.-4, L.T.- (2), L.T.+ (2), (Belling-Lee "Junior," Clix, Eelex, Burton).
- 2 yards of lighting flex (Lewcos).
- Complete table-lamp with connecting flex.
- Connecting wire (Glazite).

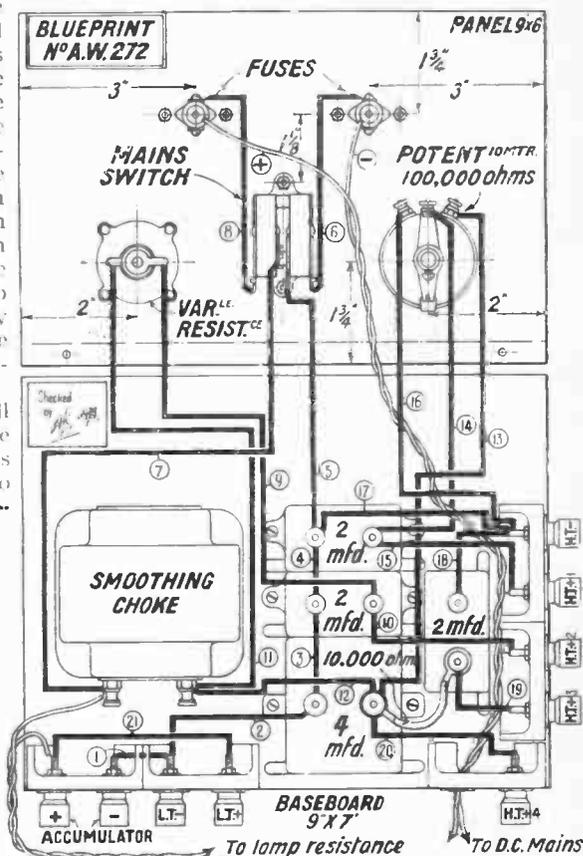

The wiring plan of the unit. A full size blueprint is obtainable, price 1s.

OUR LISTENING POST

By JAY COOTE

POSSIBLY during the last fortnight the rainy, foggy, and generally unpleasant weather may not have been appreciated by the inhabitants of these islands; but from the point of view of the wireless fan, atmospheric conditions during that period have proved ultra-favourable and a positive boon for the testing of that new receiver. Never, in the course of some seven years, have I bagged so large a number of American stations on the broadcast band as during the last fortnight. It was an easy matter on most nights to listen to some eight or ten U.S.A. transmissions, in most instances the signals were too loud for headphones.

Although the netting of these stations spelt wakefulness between 1 and 4 a.m., I have on different occasions heard the Chevrolet programme, the Atwater-Kent hour, Hag Coffee Slumber music, Philco, Pennzoil Pete; entertainments sponsored by Beacon, General Motors, Chesebrough, Palmolive, Mobiloil, O'cedar, Camel cigarettes. I have had samples of funninesses by Phil Cook the Quaker, the Tastyest Jesters, songs by the Ipana Troubadours, and Amos 'n Andy of Pepsodent fame.

Some Easy Catches

The stations which have been the easiest, both to find and to hold, were the following: WTIC, Mount Avon, Hartford, Conn. (283 m.); WGY, Schenectady, N.Y. (380 m.); WPG, Atlantic City, N.J. (272.5 m.); WFAM, Cleveland, Ohio (280 m.); WHAM, Rochester, N.Y. (261 m.); WIOD, Miami Beach, Fla. (242 m.); WBZ, Springfield, Mass. (303 m.); KDKA, E. Pittsburgh, Pa. (306 m.); WABC, Essex County, N.J., the key station of the Columbia system (on 349 m.); WJZ, Boundbrook, N.J. (395 m.); WLWL, Cincinnati, Ohio (428.5 m.); and WEAF, New York, the main station transmitting the National Broadcasting Company's programme.

Well Worth While

A careful search even to-night will be well worth your while. If you take the stations I have enumerated, in many instances you will have logged already a dial reading for some European transmitter near enough to act as a guide. Take WGY (Schenectady) as an example; it is just below Lvov, the reinforced Polish station relaying the Warsaw entertain-

ments. If you have not yet heard Lvov, try Radio Toulouse and gradually work downwards. After 12.30 a.m. there are but few signals on the air, and you will quickly pick up WGY's carrier wave. WTIC (Hartford) is dead on the Berlin common-wave stations; as an alternative, work up from Bratislava (279 m.), or even from the all-powerful Heilsberg (270.5 m.), which now radiates the Königsberg programme.

European Notes

I mentioned Lvov earlier in these notes. You will discover this transmission immediately below Radio Toulouse. On an open aerial it may be swamped by the latter, but with some of the frame variety, as the direction is totally different, you can clear them from each other.

On Sunday, January 11, I heard what I understood was the first relay by Hamburg and its associated stations of the Copenhagen dance music from the Palace Hotel in the Danish capital. It was relayed through the new submarine cable specially laid to link up the German net with the Danish, Swedish, and Norwegian broadcasting systems. In the call from Copenhagen, Lyngby was specially mentioned. These programmes are being simultaneously broadcast on 31.51 metres nightly.

By the way, the Stuttgart station has gone out of action, all its duties having been taken over by Mühlacker on the same wavelength.

Mr. J. SIEGER
(“Amateur Wireless” Engineer)

WHO DESIGNED
THE
“Ether Searcher”
MADE
SURE
AND
CHOSE

Mullard
THE - MASTER - VALVE

Adv.: The Mullard Wireless Service Co., Ltd., Mullard House, Charing Cross Road, London, W.C.2

To Ensure Speedy Delivery, Mention “A.W.” to Advertisers

Arts.

PETO-SCOTT CO. LTD.

IMMEDIATE DELIVERY

1931 ETHER SEARCHER

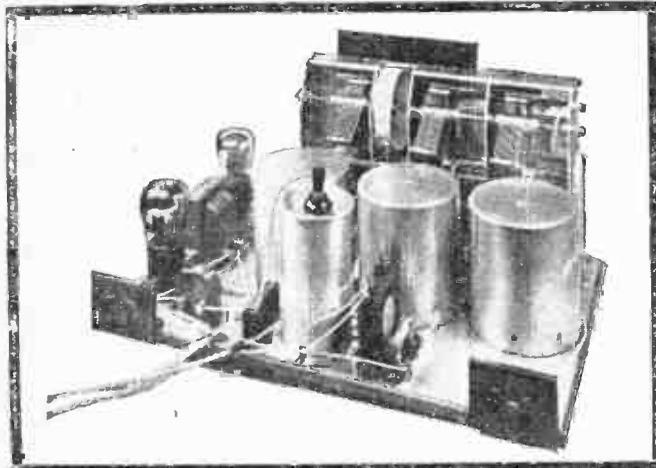

HERE IS DETAILED LIST OF OFFICIALLY APPROVED PARTS

| | £ | s. | d. |
|---|---|----|----|
| 1 Baseboard 16" x 10" | 1 | 6 | |
| 1 R.T. Ebonite Panel 16" x 8" (drilled to specification) | 2 | 0 | |
| J.B. Chassimount 3 gang .0005 mfd. Variable Condenser with drum dial | 1 | 5 | 0 |
| 1 Ready Radio .0003 mfd. variable series aerial cond. Brookman's Type | 3 | 6 | |
| 1 Keystone .0001 mfd. variable reaction condenser | 2 | 6 | |
| Set 3 matched coils with gang switch Colvern type T.G.S.C.2 & T.G.S.R.1 | 1 | 8 | 6 |
| 1 Keystone on-off filament switch | 1 | 9 | |
| 1 Edison Bell .01 mfd. fixed cond. | 1 | 9 | |
| 1 T.C.C. .0002 mfd. S.P. Type | 2 | 4 | |
| 1 Lissen .0003 mfd. fixed condenser | 1 | 0 | |
| 1 " .0002 " " | 2 | 6 | |
| 1 " 1 mfd. " " | 3 | 0 | |
| 3 Telsen Valve Holders | 3 | 0 | |

Any item supplied separately for Cash or H.P.

| | £ | s. | d. |
|--|--------|----|----|
| 1 Telsen Ace Transformer Ratio 5-1 | 8 | 6 | |
| 1 Keystone H.F. Choke | 3 | 6 | |
| 2 Lissen 2-meg. Grid leaks | 2 | 0 | |
| 1 Lissen Grid Leak Clip | 7 | 6 | |
| 3 Coil Screens & 1 S.G. Valve Screen | 1 | 0 | |
| Aluminium foil sheet 16" x 10" | 1 | 0 | |
| 2 Keystone terminal blocks | 6 | 6 | |
| 4 Belling Lee Terminals marked LS-, LS-, A, E | 1 | 0 | |
| 1 S.G. Anode connector | 6 | 6 | |
| 7 Belling Lee Wander Plugs marked HT-3, HT-2, HT-1, HT-, GB-1 and GB-2 | 1 | 9 | |
| 2 Belling Lee spade terminals marked LT-, LT- | 9 | 9 | |
| 6 yards of thin R.C. Flex | 9 | 9 | |
| 1 Packet of screws | 5 | 5 | |
| 1 Set of Beta Links | GRATIS | | |
| | £5 | 14 | 6 |

KIT "B" with Valves but less Cabinet - - - **£7.13.6 14/1**
KIT "C" complete with Valves and Cabinet **£8.14.6 16/-**
FINISHED INSTRUMENT. READY BUILT EXACTLY AS SPECIFIED in French-polished Oak Cabinet; Aerial Tested and fitted with Mullard Valves. Royalties Paid. £9. 9.0 18/-

Avail yourself of our H.P. Terms or C.O.D. for every-thing radio.

POST THIS COUPON NOW →

RECOMMENDED ACCESSORIES FOR THE 1931 ETHER SEARCHER

| | | |
|---|--|---|
| BATTERIES. 120volt Pertrix H.T. Battery 15 6 | ELIMINATORS. A.C. Mains. Regentone W.5. H.T. and L.T. Trickle Charger £5 17 6, or H.T. only Regentone W.I.C £4 7 6. D.C. Mains. Regentone D.C. Combined H.T. and L.T. Trickle Charger £3 19 6, or H.T. only Regentone D.C.1 £2 5 0. | SPEAKER. Pilot Double Air Chrome K Chassis in hand-some Oak Cabinet 57 6 |
|---|--|---|

KIT "A"

C.O.D. - £5:14:6 Pay the Postman

H.P. Terms, deposit 10/11

Balance in 11 monthly payments of 10 11

This Kit is **fully approved.** See what the Editor of "Amateur Wireless" says in his letter published in our announcement dated January 17th and 24th.

READ WHAT THIS SATISFIED USER OF A PILOT RADIO KIT SAYS

St. Paul's Road, London, N.1
January 15th, 1931

Messrs. Peto-Scott Company Limited,
77, City Road, London, E.C.1.

Dear Sirs, Many thanks for the extremely prompt delivery of the kit of parts for the 1931 Ether Searcher which I have now assembled. I am very pleased with its performance, especially as regards selectivity, the degree of which is very high, stations being cut out without any overlapping, even on the strong National and Regional Transmissions. On the first evening I logged 40 stations on the long and short waves and there are dozens more to come. The set took me only three hours to put together, thanks to the drilled and slotted panel and the set of Beta Links. You are welcome to use this letter if it can be of use to you.

Guaranteed Matched Coils and guaranteed accurately matched Ganged Condenser.

FREE Every Pilot Radio Kit includes a Set of "BETTA" No-Soldering Links.

OBTAINABLE FOR CASH. C.O.D. PAY THE POSTMAN. WE PAY ALL POSTAL CHARGES.

PLEASE SEND ME FREE YOUR (a) EASY WAY CATALOGUE (b) PILOT RADIO CHART.

Name.....

Address.....

A.W. 31131

PETO-SCOTT CO. LTD.

77, CITY ROAD, LONDON, E.C.1 Clerkenwell 9406
 62, HIGH HOLBORN, LONDON, W.C.1 Chancery 8266
 MANCHESTER: 33 Whitelaw Road, Chorlton-cum-Hardy. Phone B
 Chorlton-cum-Hardy 2028. NEWCASTLE, STAFFS.: 7 Albany Rd.

Please Mention "A.W." When Corresponding with Advertisers

On Your Wavelength!

A MYSTERY

WHAT exactly is happening about Moorside Edge? Only the B.B.C. appears to know, and it won't or doesn't tell us. We heard in the autumn that the station was to come into operation early in the New Year and that tests might be expected to take place before then. Up to date no transmission—at any rate, at high power—seems to have been recorded from the station, and one gathers that a hitch of some kind has occurred. I may, of course, be wrong, but I have an idea that, having now had some experience of the mutual interference between the London Regional and Stuttgart, the B.B.C. hesitates to bring into operation two more heavily modulated high-power transmissions, especially as the coming of these entails the adoption of Manchester's wavelength by 5GB. Of one thing I am quite certain, and that is this: as soon as 5GB does get to work on that wavelength there will be a chorus of despair from hundreds of thousands of listeners in the Home Counties, and possibly in London as well.

PROPERLY FOR IT

INVESTIGATIONS show that at present it takes a set with two really good high-frequency stages all its time to be able to receive Hamburg completely free from the London Regional. Actually, the majority of such sets that I have tried will not do this. If, then, we plunk 5GB on the channel immediately above Hamburg you can imagine for yourself just what is going to happen. Sets less selective will undoubtedly find had interference between the two home stations, and it is absolutely certain that they will completely lose some of the best foreign transmissions, such as Hamburg, Toulouse and Frankfurt. As for portable sets, of which there are very large numbers in use—well, well, well! And there will be more lit in the fire if and when the second Moorside Edge programme is pushed out on Aberdeen's wavelength of 301 metres. Already owners of smallish sets can only just separate the London National from the London Regional, and the addition of a high-power transmission on 301 metres will probably mean that they cannot receive either of the Brookmans Park programmes without interference. If this insane programme is persevered with thousands upon thousands of sets must automatically become obsolete, and it will be a real hardship to those who scrape together the money for their present receiving sets.

SOME PUNCH

IT is perfectly amazing to notice the distances that some medium-wave station can cover even in daylight. The other morning just after breakfast I thought to myself: "I wonder if by any chance I can hear Stuttgart." I twiddled the knobs

and Stuttgart promptly came in—he was giving a concert at the time—with such strength that the volume control had to be used. No fading, mark you, and excellent quality. "Well," thinks I, "I will see what other sets can do." In the next room was a portable with one screen-grid stage, a detector, and two note-mags. It was not, by the way, attached to any outside aerial. In came Stuttgart again at excellent loud-speaker strength.

ON TWO VALVES!

IN yet another room was a two-valve set specially intended for local-station reception and not designed in any way as a distance getter. This works from a simple indoor aerial consisting of a single wire slung round three sides of a room. I am not going to say that getting Stuttgart was easy: it did, in fact, involve very fine tuning indeed. But I got him all right at such strength that you could hear the music distinctly when you were standing three or four yards from the loud-speaker. Stuttgart often seems to give these breakfast-time concerts, and as the London Regional is not working you can try for yourself whether your set will bring him in.

A DIFFICULT POINT

AMONGST other difficulties introduced by the spread of high-power amongst European broadcasting stations there is one which particularly concerns the long-distance enthusiast. He used to do his searching with headphones, for in this way he could make sure of not annoying his neighbours by letting his set oscillate. Once a powerful station has been tuned in a switch was flicked, and there it was on the loud-speaker. But it is an uncomfortable business nowadays, for, unless you are on the look out the whole time, you may give your eardrums a most uncomfortable shaking up by unexpectedly tuning in an enormously powerful signal from Heilsberg or Strasbourg or Rome. And the trouble is that a station which was quite a docile little fellow on one evening may have blossomed out into a noisy giant on the next. Brussels No. 1, for instance, will give you a shock if you have not tried for him for some weeks. He must have made some far-reaching alterations, for he is now almost as strong as Strasbourg.

ABOUT VALVES

REFERRED not long ago to the rather wide tolerances which valve makers allow nowadays in their test rooms. Of course, one can hardly expect the low-priced valve of to-day to come up to such exacting standards as obtained a few years ago, when prices were double what they now are. Again, in a not very sensitive set it does not matter greatly whether a valve fails to conform exactly with its nominal characteristics. But in sensitive sets—particularly those which require

matched valves in their high-frequency stages or for push-pull purposes—it is most important that one should be able to find without difficulty pairs of valves whose characteristics are like each other's and like those published by the makers.

FACTS AND FIGURES

A TRADE paper of the highest standing decided recently that it would not publish reports on valves unless six of each type were submitted by makers for test. Reports on a good many batches have now appeared, and they all show that valves of the same type and make differ much more than they should from one another and from the makers' figures. Here is a typical case. The test was upon six valves of the small-power type made by a well-known firm. The maker's figure for magnification is 12.5. Here are the actual magnification factors of the six valves: 11.0, 11.5, 13.2, 11.35, 12.05, and 12.8. The published impedance is 3,600 ohms. The actual figures obtained were: 3,180, 4,000, 3,920, 2,980, 4,160, 3,920. The figures for mutual conductance and for the plate current, when tried with the correct anode voltage and grid bias, show divergencies just as great. To sum up, of that batch of six no pair exactly matched could have been found, and there is no valve under any test which shows a figure identical with that of the published data.

SENILE DECAY

AS often as not, when some friend inveigles me round to his house and subsequently suggests that I may be able to tell him what is wrong with his wireless set I find that he is suffering from worn-out valves. Because the filaments of modern dull-emitter valves very seldom burn out, people seem to think that these valves last for ever. I have actually come across heaps of cases in which valves have been regularly in use for three years or more and not a few that have a history of at least from 3,000 to 5,000 working hours. Owners will not believe that their cherished "toobs" are dead or that the distortion, the lack of selectivity, and the falling-off in volume of which they complain can be due to the valves. But the milliammeter tells its own tale when brought into service.

The average working life of a valve is 1,000 hours. After that time it generally begins to "go off," and if your set is not up to the mark you will very likely find that the substitution of a new valve makes all the difference.

A DEAD 'UN

TO show what effects use can produce, let me give you an instance that happened to me. The set was a five-valver with two screen-grid high-frequency stages. Originally it had a very large repertoire of foreign stations on the loud-speaker, but a time came when its erstwhile sharp

:: :: *On Your Wavelength!* (continued) :: ::

tuning seemed to be rather flat and when it was difficult to receive more than a few stations at really good loud-speaker strength. I did not at first suspect any of the valves, since all were comparatively new—none, that is to say had done more than 200 or 300 working hours. Lately, though, it occurred to me to test them out, and I found that the first S.G. H.F. amplifier had so changed its characteristics that it was practically a passenger. Renewing this valve gave the set all its old vitality.

ACCUMULATOR LIFE

HOW long should a well-treated filament accumulator last? I am supposing, of course, that it is of good make and that it never suffers a short-circuit or anything of that kind. My own experience is that from three to four years is the longest life that can be expected, even with small loads and regular recharging. After that time the positives generally look pretty woolly, and one finds that the cells will not hold their charge properly. So long, though, as the case is in good condition an accumulator can be given a new lease of life by being fitted with a fresh set of positive plates at a service station. This is not an expensive business and it is very well worth while. The negative plates should last quite twice as long as the positive.

A WONDERFUL NIGHT

NOT for many years have we had such a wonderful night for foreign reception as that of January 19. There was not a sign of an atmospheric the whole time, there was hardly any fading except for a few brief periods, and interference from commercial stations was almost entirely absent. And, what is better still, stations were coming in at enormous strength. One certainly had a choice with a big set of about fifty alternative programmes, and stations were coming in at almost every division of the dials.

IS IT WORTH WHILE?

FOREIGN listening certainly is worth while if you have the right sort of set or if you confine yourself to stations which are really within the range of whatever set you are using. The two-valve man can never hope, for example, to obtain perfect reproduction from such stations as Riga or Belgrade, for if he can hear them at all he can do so only by pushing reaction up to its very limit. He may, though, be able to bring in pretty well the more powerful fellows, such as Rome, Strasbourg, and Heilsberg. The ideal set for long-distance work is one which has three screen-grid stages and can dispense entirely with reaction. Then the majority of stations require the volume control and you know that the set is always working well within itself.

WIRELESS RAYS

SOONER or later, I suppose, the so-called "death ray," or something like it, will emerge from the realm of fiction and

become an established fact. During the War it was rumoured to exist in various shapes and forms. One heard of a beam of radiation so intense as to be able to destroy life on impact, after the fashion of the lethal "heat ray" employed by the Martians in H. G. Wells' famous story, "The War of the Worlds." In a slightly more credible version, a powerful beam of wireless energy was claimed to throw the magneto of a hostile aeroplane out of action and so put the machine out of action. It is, in fact, quite possible to disable an engine in this fashion, but only at short range—a few yards at most—so that the method hardly provides a practicable weapon of war.

RADIO "LAMPS"

HOWEVER, we are making very rapid strides in short-wave technique nowadays. Wireless waves less than a metre long can be generated and radiated over considerable distances as a sharply-directed beam. For instance, it has recently been found possible to replace the ordinary port and starboard lights of a ship by short-wave generators for use in foggy weather, the radiation being concentrated along sharply-defined sectors in the same way as the red and green lights of the original signal lamps. Instead of "seeing" red or green as the case may be, the navigating officer on one ship "hears" the port signal change to the starboard signal as he crosses the bows of a neighbouring vessel in a thick fog. Short-wave wireless signals of this kind have an effective range of several miles, and are unaffected by a fog thick enough to limit the visibility of ordinary signal lamps to a few feet.

A SUGGESTION

I HAVE often wondered why the radio enthusiast does not fit himself up with a house telephone system. How many of us have to do our serious radio work in a shed at the bottom of the garden. How many times also has "Mrs. Fan" had to come down in the rain because the man has called about the gas meter or some other trivial matter. Only the other day I fitted up for myself an independent line from one part of the house to the other, and the simplicity of the operation started my mind working along the lines I have just described.

QUITE SIMPLE

ACTUALLY, in these days of cheap microphones, and equally cheap telephone receivers, it is the simplest matter in the world to connect up such a system. A microphone at one end and a pair of telephones at the other, and a battery in

between, constitutes the simplest arrangement, of course, but this is not the most satisfactory. The microphone should have its own battery, and should be connected through a transformer to the telephone line. The battery current does not then have to pass through the phones, or through the line, which may have quite an appreciable resistance, and in this way a much more sensitive arrangement is obtained. Of course, this means a battery at both ends, but that is very little trouble because a small flash-lamp battery is quite sufficient. Needless to say, arrangements must be made to switch off the microphone when one is not using it, as otherwise the battery will run down very quickly.

OVERLOADING

AN old friend of mine is a retired engineer, though not of the electrical variety. Wireless to him is just a means of providing entertainment, and he doesn't know the first thing about the inward parts of the set or the way in which they carry out their duties. The other day he told me that he was despairing about his reception because his set overloaded so badly. He seemed to have got hold of that semi-technical term from somewhere and didn't know what it meant, really. So far as he was concerned, it signified that Big Ben striking the hour was apt to sound like someone hitting dish covers with a croquet mallet. Examination of his apparatus disclosed that he possessed a four-valve portable incorporating a standard-capacity battery. This he was using in a big room, where, naturally, a fairly respectable volume of sound was required. I told him that he couldn't expect good volume unless he had a low-impedance output valve with plenty of H.T. volts and ample grid bias. "I expect," I said, "that your H.T. battery is pretty well run down, and certainly it isn't big enough for the job." He told me that the battery was all right, for he had had it tested the other morning.

A LITTLE KNOWLEDGE . . .

ON inquiry I found that the battery hadn't been in use for a couple of days before the test was made. A day or two later I went round with a milliammeter and a voltmeter, just to see what was happening. Before switching on, the battery showed 87 volts. I stuck the milliammeter into circuit, and when the switch was turned over its needle flicked up to the 10 mark. In a quarter of an hour the battery was showing 5.4 volts and at the end of half an hour was down to a little over 40. In case there are still readers who believe that they can get quarts out of pint pots, may I just say that (1) No standard-capacity battery in the world can live for long if you ask it to deliver 10 milliamperes; (2) You cannot expect to fill a big room unless you are giving the output valve a fairly generous amount of H.T. current; (3) Voltmeter tests on the high-tension battery when it is not under load are absolutely and utterly valueless.

THERMION.

NEXT WEEK !
HINTS AND TIPS FOR
"ETHER SEARCHER"
BUILDERS

ANNOUNCERS TELL THEIR STORIES

SOME STUDIO LEG-PULLS

By "RADIOLO,"
of Radio Paris



The main studio at Radio Paris. Note the volume indicator over the control-room door

know! There are authors, critics, doctors, scientists, and so on who, while being serious before the "mike," do not mind cracking a joke with the announcer and being quite jolly while he writes out the cheque—the price of their eloquence!

I recall an incident which happened to an announcer at one of the Paris transmitters. It was at the end of the evening programme, and the announcer had just given out, probably for the thousandth time, the familiar farewell, "Bonsoir, mesdames; bonsoir, mesieurs."

"That's that," he thought, and started to put on his hat and coat preparatory to going out into the deserted streets. It was late. He was very, very tired. He turned to the microphone and addressed it with just one tiny little word—a word expressing his pent-up feelings to the very fullest degree.

And unfortunately the microphone wasn't switched off. That concluding little vulgarity went out to shock the owners of thousands of chaste ears, and the following morning the post was full of letters from indignant listeners.

That announcer was "sacked"!

TO the listener, an announcer is nothing more than the man who speaks into the microphone. He is an anonymous personality.

An announcer's job is not an easy one. He has to work in the silence of the studio with the artistes, surrounded by house phones, indicator lights, light switches and sound-effect machines—those mechanical contraptions which imitate the sound of the sea, the noises of a crowd and the whistling of the wind.

At our station the "silence" light is fixed

announcers under the name of "Radiolo."

The name, by the way, is registered.

Each of the announcers, naturally, is different. One may be a Bourguignon, another a Provençal, and a third a Parisien; but there is a standard pronunciation. You may have noticed the pronunciation of the "r's" and the "s's." That modern little poem which starts "Soixante-six Suisses Assises Sur les Bords du Mississippi" ("Sixty-six Swiss sitting on the banks of the Mississippi"), as properly pronounced by "Radiolo," sounds like Niagara Falls!

There is one thing, and that is that in the studio announcers are treated with respect. Artistes and the station staff pay them due homage; but on the whole the announcer's job cannot be said to be a very happy one, for he lives in a world of lectures, comedians, singers, orchestras and gramophone pick-ups.

What a varied world it is! One time it may be the soprano who, before a frigid microphone, cannot let herself go as she does on a music-hall stage when facing the stalls; or another time it may be a leading Parisien fashion-designer who turns up to give his broadcast in full evening dress (complete with monocle, and he gives his talk interspaced with expressive gestures and much hand-waving.

Then there is the "pathetic" actor who, in his shirt sleeves, declares with vehement gestures (unseen to listeners, of course) his flame of eternal love for the leading lady of the comic opera. She, meanwhile, is nowhere near the microphone but is anxiously studying her wrist watch and wondering how she can get back to the theatre by 10.10 p.m., so as not to miss her entry in Act 1, when it is already 9.40! Eventually, after a frantic rush with her microphone *debut*, and, later, with a taxi, she does it.

Then there is the religion lecturer who talks for so long that the "mike" has to be switched off; but, of course, he doesn't

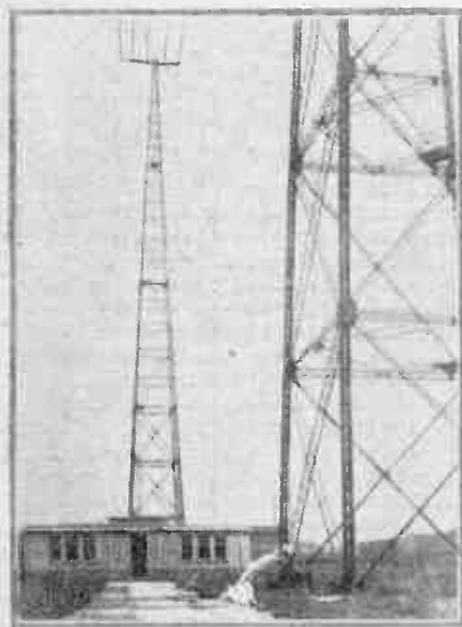

At the base of the transmitter masts

behind the microphones in front of the announcer, and it lights up when the microphone is switched on. When the light comes on, the announcer's duty begins. It seems to be something of a paradox, that "silence" lamp which lights when it is time to speak.

There is, of course, more than one announcer at the station, and the Compagnie Française de Radiophonie hit upon the happy idea of a collective title for the



A corner of the smaller studio at the station

ADDING A COUPLED CIRCUIT

How to Sharpen Tuning with a Band-pass Filter. By J. H. REYNER, B.Sc., A.M.I.E.E.

I HAVE often been asked whether the two halves of a band-pass filter cannot be tuned individually instead of being ganged up together. There is a general feeling that the action is lost in some way if the condensers are not tuned by the same spindle. This is not by any means the case, the use of the ganged control being resorted to merely in the interests of simplicity. It is quite feasible to tune each circuit individually. Some readers like to do this.

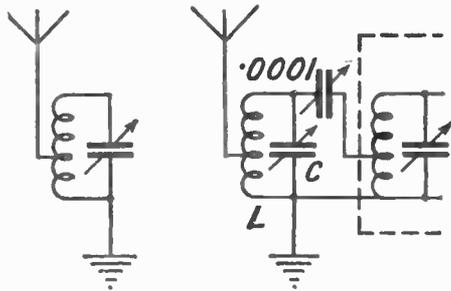

Fig. 1. Simple aerial circuit with tapped coil and (right) coupled circuit

Other readers may wish to add some extra tuning to their existing sets, and, of course, in such cases the use of a ganged control is not desirable nor practicable. Such readers have felt that they could not use a band-pass filter unless they rebuilt the whole set, whereas actually it is quite an easy matter to add an additional tuned circuit and obtain the extra selectivity and still maintain the quality of reproduction.

What a Coupled Circuit Is

The whole subject appears, to my mind, simpler if one refers to coupled circuits instead of band-pass filters. A coupled circuit is exactly what it says it is, namely, another circuit coupled in some convenient manner to the existing circuit. I propose to show in this article how a number of coupled circuits can be arranged, all of which will have band-pass characteristics to a greater or less extent.

Fig. 1 illustrates on the left a simple aerial circuit having a tapped aerial connection, such as is used with an X-tapped coil. On the right of the figure is a coupled circuit added in a convenient manner. The additional circuit is constituted by the coil and condenser LC, the aerial being removed from its original position and connected in a suitable manner to the coil L. In the figure it is shown as tapped towards the bottom of the coil, but a coupled coil or any other of the usual forms of aerial connection may be adopted.

The earth end of the coil is connected to the earth terminal of the set, while the other end of the coil is connected through a .0001 variable condenser on to the aerial terminal of the set. The coupling is varied by adjusting this .0001 condenser. If the condenser is made small, the coupling between the two circuits is weak. This means that the arrangement will be very

selective, but the signal strength will not be large, and there will be a distinct drop in the signal strength in changing from the ordinary single-coil arrangement to the coupled circuit.

As the coupling condenser is increased in value, so the signals become stronger, but the selectivity becomes poorer. The limit is reached where the circuit begins to tune in two distinct places. This shows that the double-hump effect usually associated with coupled circuits has become too pronounced, and this is the practical limit to the increase in the coupling. Fortunately, the signal strength can be worked up to a satisfactory figure before this critical double-humping is reached.

This circuit is quite easy to handle and is one which will make a distinct difference to the selectivity of one's receiver. It can be fitted up quite simply, as can be seen. The same sort of arrangement may be applied if the aerial is coupled by a separate coil instead of a tapping on the secondary, provided that this coupling coil is not too large a value. In the case of the "Q" coil, for example, where one primary was used for both long and short waves, this circuit is not suitable, and one should use the second version shown in Fig. 2.

Double-humping

In the second circuit the aerial is coupled through a .0001 condenser direct to the grid end of the tuned circuit, but the same reasoning applies where we have a large coupling coil, such as has just been discussed. In this instance it is best to take a lead from the inside of the set. A coupled circuit is arranged exactly as before, consisting of a coil L tuned with the condenser C, the

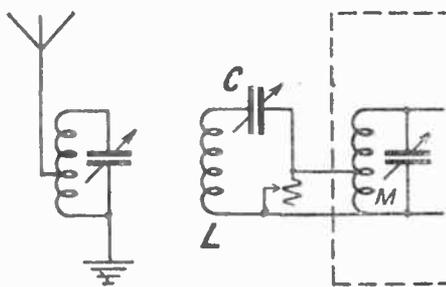

Fig. 3. Inductive coupling is employed in this instance

aerial being coupled in the usual way. As before, the earth ends are connected together, but in this instance the top end of the circuit is not connected to the aerial terminal, but is led through a neutralising condenser on to the grid side of the first tuning circuit inside the receiver. This, of course, is usually connected to the fixed plates of the first tuning condenser, and this is thus a convenient point to which to attach the coupling condenser. A neutralising condenser must be used in this case to keep the coupling weak, because we are now coupling across the whole circuit and not across a small portion; and, therefore, if we use a .0001 condenser the coupling

will be too tight and double-humping will be noticed to a marked degree.

In Fig. 3 a different form of coupling is used. So far the circuits have been coupled to a capacity. It is possible to employ an inductive coupling, and this system has been adopted in this case. Our coupled circuit, as before, is LC, but it will be seen that this circuit is now completed through the small tapped portion of the original aerial inductance. The portion marked M, therefore, is common to both circuits and con-

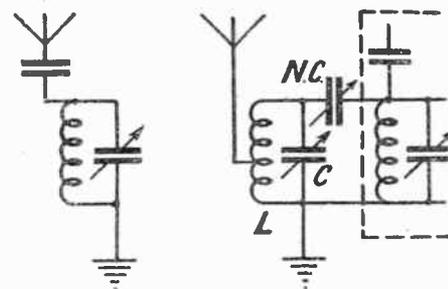

Fig. 2. Another coupled arrangement

stitutes the coupling between one circuit and the other. Unfortunately, this coupling is much too strong for ordinary purposes and will almost certainly give double humping; and, of course, there is no means of varying the coupling at all. The average number of turns across which the aerial is tapped is anything from ten to fifteen with the ordinary coil, whereas the right order of coupling for a coupled circuit is two or three turns only.

Resistance Control

In order to overcome this difficulty, we can connect a variable filament rheostat of 7 ohms or so across the tapped portion of the coil. This will have the effect of shunting some part of the current and reducing the coupling. As we reduce the value of this resistance, so tending more and more to short-circuit the portion M, the coupling becomes weaker and the same effects are noticed as in the reduction of the coupling capacity in the first two circuits. Thus, again, we have a convenient method of varying the coupling, and the degree of signal strength and selectivity required can be balanced nicely one against the other. As in the previous instance, no alteration is required to the receiver, but it must be pointed out that this particular circuit can only be used where one has a tapped or coupled aerial circuit, and cannot be employed where the aerial is coupled direct through a .0001 condenser.

These are three possible circuits, all of which are worth trying. In operation the two tuning condensers must both be in tune with the station, and it is best to work with a fairly strong coupling at first, in order that there shall be no difficulty in finding the stations. Tune in the local station and then gradually reduce the coupling, retuning on both condensers until the selectivity is of the right order.

Remarkable results

OBTAINED WITH THE
**1931
ETHER SEARCHER**
DESIGNED BY
J. SIEGER
OF AMATEUR WIRELESS

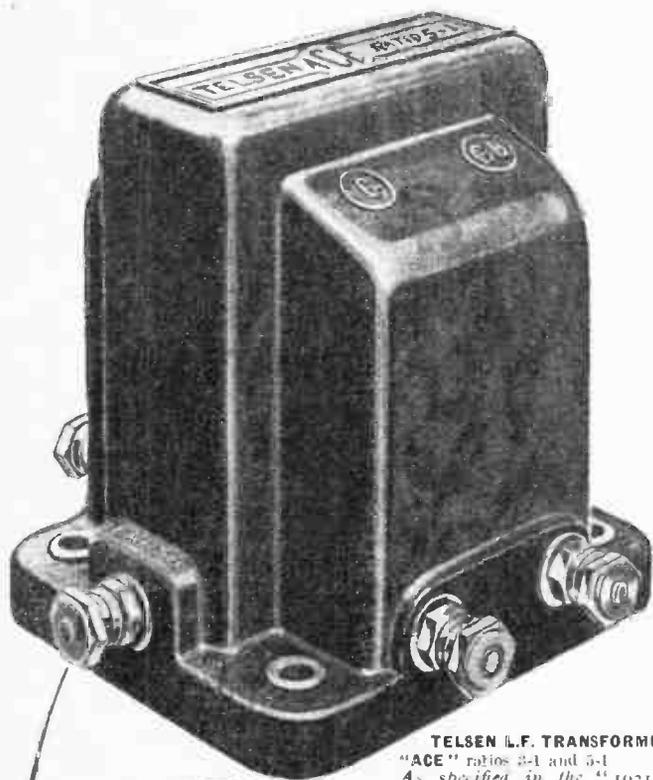

Wonderful power, long range and remarkable quality of tone are the outstanding features of the "1931 Ether Searcher," an outstanding performance due in no small measure to the expert choice of Telsens Components.

Telsens Components are so perfect in every detail of design and manufacture that, individually or collectively, they give uniformly brilliant performance and lasting efficiency throughout their long life!

When building your "1931 Ether Searcher" — or, for that matter, ANY Set — insist on Telsens Components, "Radio's Choice for Better Radio Reception."

TELSEN L.F. TRANSFORMERS
"ACE" ratios 3-1 and 5-1 ... 8/6
As specified in the "1931 Ether Searcher."

"RADIOGRAND" ratios 3-1 and 5-1 12/6
"RADIOGRAND" super, ratio 7-1 17/3

Telsens H.F. Chokes. Designed to cover the whole waveband range from 18 to 4,000 metres. Extremely low self capacity, shrouded in genuine bakelite. Inductance, 150,600 microhenries; resistance, 400 ohms. Price 2/6 each.



Telsens H.F. Chokes
As specified in the "1931 Ether Searcher."

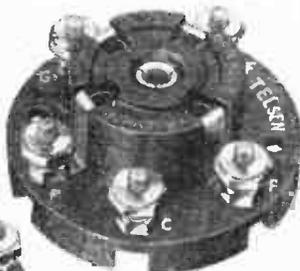

Telsens Five-pin Valve Holders
Price 1/3 each.



Telsens Four-pin Valve Holders.
Price 1/- each.
As specified in the "1931 Ether Searcher."

Telsens Valve Holders. Pro. Pat. No. 20286/30. An entirely new design in Valve Holders, embodying patent metal spring contacts, which are designed to provide the most efficient contact with the valve legs, whether split or non-split. Low capacity, self locating. Supplied with patent soldering tags and hexagon terminal nuts.



Telsens Grid Leaks. Absolutely silent and non-microphonic, practically unbreakable, cannot be burnt out, and are unaffected by atmospheric changes. No being wire wound, there are no capacity effects. Made in capacities: 1, 1/2, 1, 2, 3, 4 and 5 megohms. Price 1/- each.

TELSEN COMPONENTS

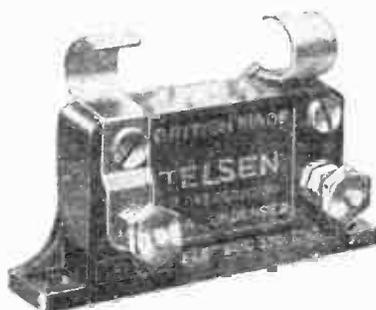

Telsens Fixed (Mica) Condensers. Shrouded in genuine bakelite, made in capacities up to 202 nfd. Pro. Pat. No. 20287/30. .0003 supplied complete with patent grid-leak clips, to facilitate series or parallel connection. Can be mounted upright or flat. Tested on 500 volts. Price 1/- each.

Advt. of Telsens Electric Co., Ltd., Birmingham

Advertisers Appreciate Mention of "A.W." with Your Order

1931 A.W. ETHER SEARCHER — 25% BETTER RESULTS IF YOU USE



THE AMAZING

MAZDA

RADIO VALVES

Used by principal
set makers

A test carried out on this excellent A.W. receiver reveals the fact that much greater sensitivity is obtained by using the Amazing Mazda Valves:

S.G. 215 H.L. 210 P. 220

The "Ether Searcher" is highly selective and it was found possible, by careful tuning, to tune in the London Regional without interference from Muhlacker—an excellent performance. Reaction control was very smooth.

By substituting the Mazda P.220a for the P.220, sufficient volume was obtained from seven stations to operate a permanent magnet R.K. moving coil speaker with ease.

These tests were carried out in a badly shielded district, 40 miles from Brookman's Park, but a very large number of stations were received.

| | |
|--|-------------------|
| S.G. 215 | H.L. 210 |
| Price 20/6 | Price 8/6 |
| P. 220 | P. 220a |
| Price 10/6 | Price 13/6 |
| Permanent Magnet R.K. Price £6.15.0 | |



THE EDISON SWAN ELECTRIC CO. LTD.
*Incorporating the Wiring Supplies, Lighting Engineering and
Radio Business of the British Thomson-Houston Co. Ltd.*
Radio Division Showrooms:
155 Charing Cross Road, London, W.C.2
Showrooms in all the Principal Towns

EDISWAN

197

You will Help Yourself and Help Us by Mentioning "A.W." to Advertisers

“FREEZING” BROADCASTS

“Amateur Wireless” has already been able to give exclusive details of the Stille talking-wire system. This apparatus is now to be used by the B.B.C. for bottled broadcasts and here is an explanation by KENNETH ULLYETT of the way in which it will be used

THE B.B.C. has acquired one of the Stille talking-tape machines, and is experimenting with it with a view to “freezing” broadcasts.

Way back in 1928 I gave a first account in AMATEUR WIRELESS of a private demonstration of the talking-tape machine, given by officials of the Blattner Film Corporation. That was the first information to be published about this new recording system. Shortly afterwards, Captain Bishop, of the B.B.C., saw the apparatus in Berlin and now that certain improvements have been made, an experimental model is now installed at the B.B.C.’s testing depot at Clapham, London.

Briefly, the machine is a very convenient form of home recorder, the recording being done by the impression of magnetic changes on a steel wire or tape, running at a speed of about 360 ft. a minute between two magnet poles.

The speech is “stored” in the wire in this way and is released by simply running the wire past the magnet poles again and connecting the magnet bobbins up to an amplifier and speaker.

In conversation with a B.B.C. official I learnt that there are three salient ideas in mind in trying out the talking-tape machine. The first and most important, of course, is to enable the engineers to “freeze” an item so that it may be re-broadcast later,

on the wire and later use it for re-broadcasting.

There is a second important use for the machine. At present a record is kept of important spoken outside broadcasts, of which there is no manuscript record. This is done, on certain occasions, with a dictating machine using wax cylinders. It is believed that the talking-tape machine will be more suitable, and when a broadcast is taking place of which there is no manuscript record this machine will be switched into circuit with the “mikes,” and will make its own permanent record.

For Auditions

The machine will also be used for rehearsals and for audition tests. It will overcome a trouble which is occasionally experienced in auditions, namely the convincing of an artiste that his or her voice, or method of presentation, is unsuitable for the microphone. At present the audition officials can say only that it is unsuitable. Without making a gramophone record to satisfy would-be artistes, they cannot prove it; but with a talking-tape machine, which will be connected up with one of the microphones used for the audition, a record can be made to which the artiste can listen later and discover the faults.

When the engineers have discovered the most suitable way in which to use the machine with standard microphones and B.B.C. amplifiers, then a finished product may be installed at Savoy Hill.

The talking-tape machine is intriguing because it is so very simple and because at first sight it is almost incredible that it would work.

The machine has two large spools carrying steel wire or steel strip about 1/4 in. wide. These spools are motor driven so that the strip passes from one to the other at a fairly constant speed of between 1 and 2 yards per second. Covering a short length of the tape between the two spools is a

small magnet case carrying two sets of bar magnets, opposing poles facing. One “N” and “S” set is used for impressing the speech on the wire, and the other for “playback.” The windings of each set of magnets are connected in series, and the magnet case opens in halves so that the tape

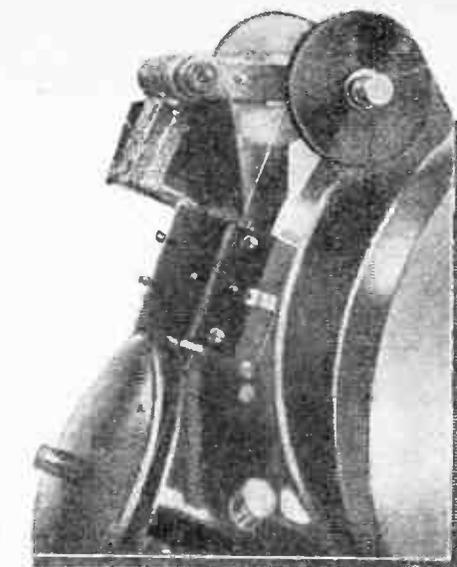

This shows the magnet case, the essential part of the talking-tape machine

can be threaded through. It does not actually touch the magnet poles but is held a minute distance away by means of guides and spacers.

It is possible to impress speech on the wire without any amplification stages, a microphone, battery and microphone transformer being simply connected to one set of magnets. For B.B.C. work, though, at least two stages of low-frequency amplification will generally be used. While the record is being made the speech has to be kept constant. Speech variations have exactly the same effect as they have in a gramophone, that is, they cause a distinct variation in pitch. The first model of the talking-tape machine which I saw at the Blattner sound studios at Elstree had no speed governor, and although the results were good, it is probable that the B.B.C. will take more precise steps to have the wire running at a constant speed.

Running Speed

The strange thing is that the magnetic changes impressed on the wire by the speech currents do not spread appreciably along its length, although it has been found advisable to have a running speed for music twice as great as that necessary to get good recording of speech.

When the speech is to be drawn from the wire, the “playback” set of magnet bobbins is connected to an amplifier—two or three stages generally being needed to give good speaker reproduction.

The recording is not harmed by the bobbins being dropped or knocked about and an advantage is that the tape is very adaptable; for example, the magnetic recording can be wiped off simply by putting on a new impression. There is no elaborate “wax” to prepare as there is with the making of a gramophone record.

The tape machine will probably be installed at Savoy Hill within the next few weeks.

A new series of talks has been begun for Scottish broadcast listeners on the subject of “Highland Folklore.” The lecturer is Dr. Donald Macleod, Inspector of Schools for Inverness-shire.

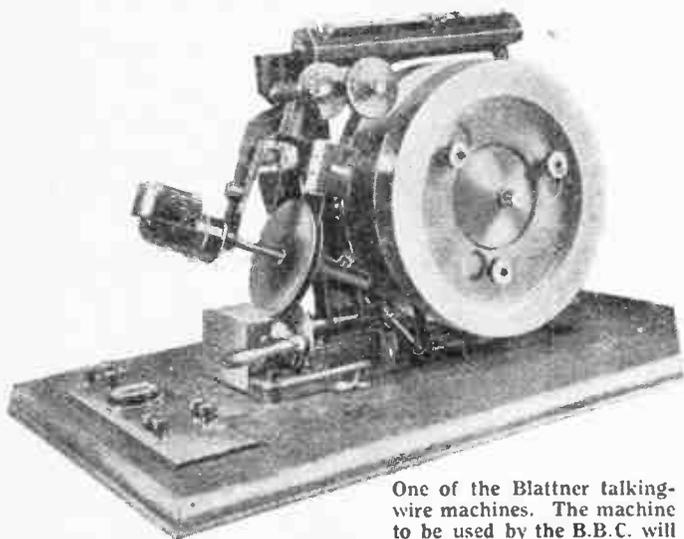

One of the Blattner talking-wire machines. The machine to be used by the B.B.C. will use steel tape instead of wire

At present on rare occasions when important broadcasts are made during the middle part of the day, when not many listeners can conveniently hear, a gramophone record is made (as in the case of a recent speech by H.M. the King), and this is re-broadcast in the evening. This involves the aid of gramophone recording engineers and the B.B.C. engineers are of the opinion that with the Stille talking-tape apparatus they themselves will be able to put the broadcast

NEXT WEEK: A Cheap and Simple All-in Two-valver

A Weekly Programme Criticism—By SYDNEY A. MOSELEY.

Without Fear or Favour



BROADCAST PLAYS

GOOD VARIETY

THESE pages have been a free platform for many-sided views on many different artistes. One is Jack Payne. So that when I was invited to see him—he was near by at the time—I agreed, expecting squalls!

J. P., of course, reads this page, and replied to "Harold's" letter criticising his "symphonising" "Go Home and Tell Your Mother."

Said Jack: "You say you are tired of hearing this tune. Well, in order to make a change I *did* play it with frills on. . . . It was not meant as a tune to be danced to."

In which Jack is quite right. Only a fraction of his multitude of listeners dance in the afternoons. His is more than a dance band, as his comedy shows. I saw his boys at work, and I'll say they work. So does Payne. And on that score, at any rate, I give "three" for Jack!

L. du Garde Peach has reached the foremost rank as a writer of broadcast plays. His latest about *Sir Launcelot*, for the children, and *The Path to Glory*, for the grown-ups, are good types of rugged romantic plays that go over. And in *The Path to Glory* the author had a dig at war-mongering, which made it useful as well as interesting and amusing. Howard Rose produced. Good!

Val Gielgud's talk on broadcasting plays was fine stuff; delivered in the right manner and with the right material. It is not every head of a department at Savoy Hill who can show by example as well as precept. I could name—but I won't.

The vaudeville programme on Saturday evening provided an hour and a half's good variety. Gwladys Stanley rather wasted her opportunities by introducing that much over-worked gag of having left her songs at home and not knowing what to sing.

With two exceptions, the mimicry of Henry Merton was very realistic. If he had not announced each item beforehand and left listeners to guess what he was doing, I should have put down the "dogs fighting over a bone" as the confused noises one hears in a crowded swimming bath; and "starting the car" as some little known animal at the Zoo. His mimicry of

"dogs at various ages" was particularly good.

Jack Payne's B.B.C. orchestra gave a very fine rendering of "Sergeant Quirt and Sergeant Flagg." I saw this performed in the studio, and J.P. proved himself a mimic as well as a musician.

Alexander and Moss were amusing; so much so, in fact, that they frequently had to stop and wait for the studio audience to cease laughing, although, curiously enough, the loudest laughter did not coincide with the funniest jokes—at least, that was the opinion of myself and of others who were listening-in with me.

Tarrant Bailey, jun., in banjo solos, was not good. His playing was mechanised and lacked feeling. It reminded me of a very indifferent theatre-queue entertainer.

I wonder why S.O.S. and police messages which are broadcast with the 9.15 news bulletin are not repeated at 9 o'clock. There must be thousands of people listening



An impression of Arthur Klein

A RECORD INTRODUCTION

TALKS OR LECTURES?

at 9 who had not arrived home in time to hear the 9.15 announcements.

By the way, I noticed in one of those messages, after giving a description of a missing lady, the announcer stated that she was "last seen in Oxford Street, London, on the afternoon of the *above date*." What is the "above date" in a spoken announcement?

He is a discovery to me, if not to a good many readers. Who? Horace Kenny, introduced to me through the medium of a gramophone record, and I took the earliest opportunity of listening to him on the wireless. Whether he was conscious of the studio audience or not, I do not know; but he was a bigger hit, to my mind, on the gramophone record. Nevertheless, his humour—dry, weary, but certainly not depressing—is the sort that might well be developed over the ether. Horace Kenny is one of the few comedians who has made me laugh recently. I should like to hear him oftener. He gives me hopes that we have not yet run dry in pure broad comedy.

I have been listening to more talks, and although admitting their expert nature, I submit they are not talks, but lectures; and in this connection I find that among my correspondents more interest is taken regarding the musical side of broadcasting. Either my readers do not listen to talks or they are not sufficiently interested to write to me about them. Which is it, I should like to know.

The opening of the new season of Symphony Concerts was very well attended, although once more I notice that there were empty seats, due to those who had not the decency to return tickets they could not use. I suggest to the B.B.C. that they should look up, by means of the ticket numbers, those who are persistent offenders and take them off the free list.

I am afraid our friends Flotsam and Jetsam did not quite get away with it in their sketch, *The Wedding of Maud Marie*. It shows, after all, that it is best for the shoemaker to stick to his last. Still, an experiment of this sort is worth while, even if only to show us our limitations.

Connecting up the "1931 Ether Searcher"

A HELPFUL PICTURE

See also pages 192 and 193, and Automatic Tuning Scale, page 194

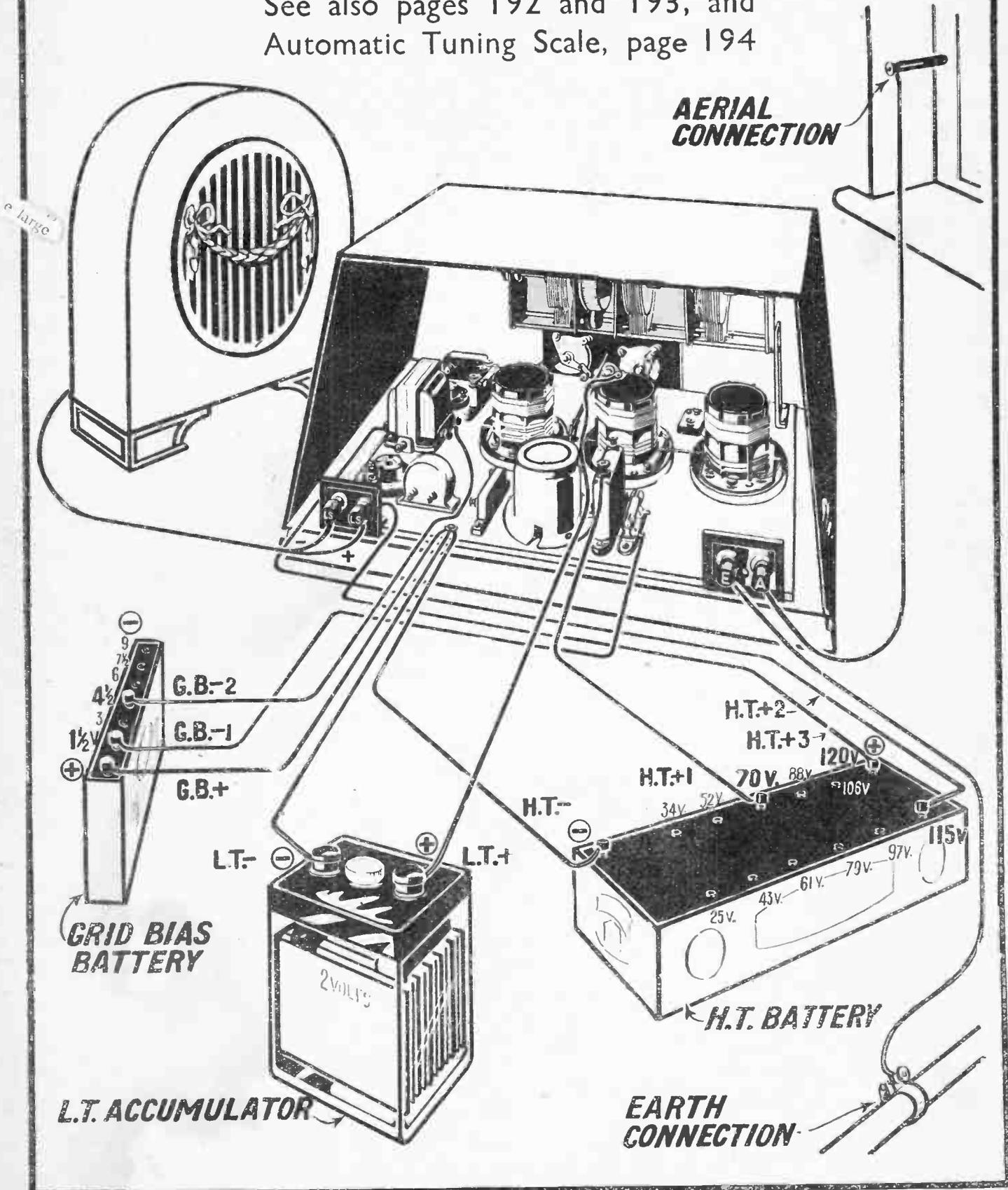

GETTING THE BEST FROM

How to Tune In 50 Stations :: Battery Connections and

By J. SIEGER

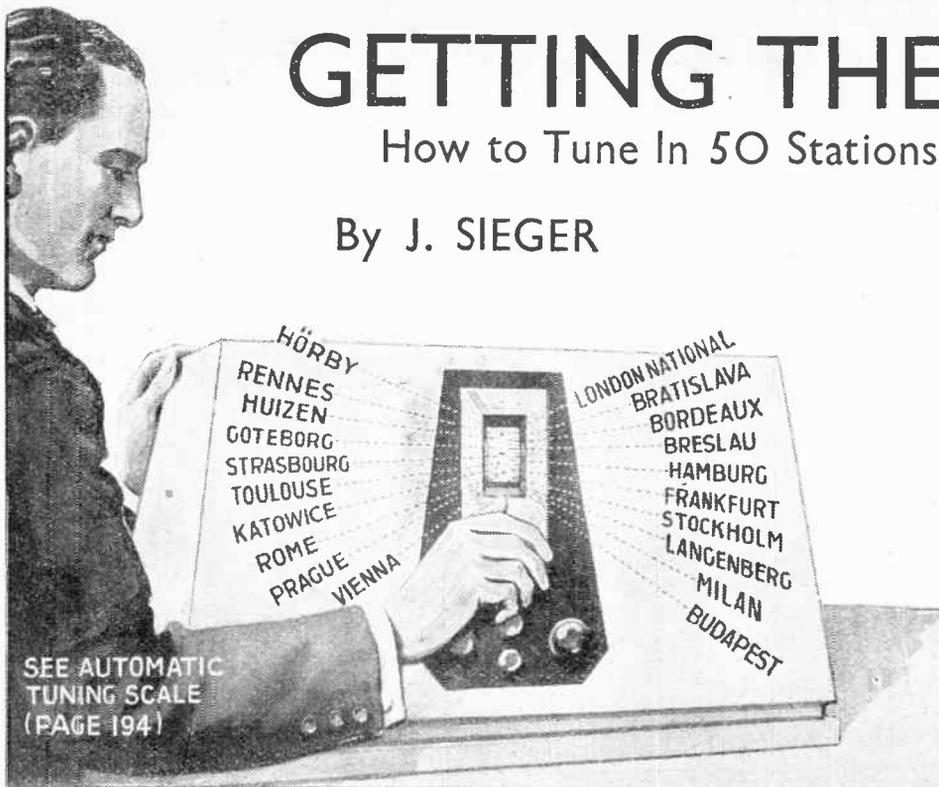

THE successful operation of any set depends largely on the correct valves and voltages applied to the various battery tapplings. This is important with the "1931 Ether Searcher," and for this reason we are giving this week, a special pictorial guide showing correct connections to the batteries, speaker, aerial and earth.

In the past two issues of AMATEUR WIRELESS, we have given two special diagrams to help constructors in the building of the set, and now this pictorial guide to the battery connections is given with every copy of this week's issue, and will be found an invaluable guide (see page 191). The correct voltages necessary, depend largely on the types of valves used, and these will be dealt with first of all.

In the original "Ether Searcher," a PM12 was used in the screen-grid high-frequency stage. Several good makes of screen-grid valve will do here, such as the Ediswan 215SG, Osram or Marconi S215, or Cossor 220SG.

Detector Valves

A number of detector valves were referred to last week, and these should be adhered to as closely as possible. It is possible by using a detector valve of too high an impedance to make the quality of reproduction high pitched and "reedy." Valves such as the Mullard PM2DX, Osram or Marconi L210, Cossor 210Det, and Ediswan L210 are ideal valves for the

detector stage of the "1931 Ether Searcher"

Now we come to the power valve. Various types of low-anode-current-consumption valves have been specified, such as Mullard PM2A, Mazda P220, Marconi or Osram LP2, and Cossor 215P. These valves take a maximum of about 7 milliamps and require between 4 and 6 volts grid bias only.

If a mains unit is used with the set, then large power valves can be used, but it is not recommended that one of these valves should be used with dry batteries, as the H.T. consumption is usually in the neighbourhood of between 12 to 20 milliamps. Suitable super-power valves can be chosen from the following: Mullard PM252, Marconi or Osram P2, Cossor 230Xp and Ediswan P220A. The correct grid bias to be used with these valves can be obtained from the manufacturers' leaflets.

The Batteries

Now for the batteries. Particulars of suitable batteries have already been mentioned, but some care must be taken in connecting them up. There are two leads to go to the low-tension accumulator, these being marked L.T.+ which goes to the red terminal of the accumulator, and L.T.- to the black terminal. Now connect up the grid-bias battery. There are three warden plugs marked G.B.+ , G.B.-1, and G.B.-2. G.B.+ goes to the positive socket of the battery. G.B.-1, is inserted in the first tapping after the positive, that is, 1 1/2 volts. G.B.-2 is now connected to about 4 1/2 volts or 6 volts negative, depending on the type of power valve used. If this is a super power, 16 volts may be required, according to the valve used in this stage. Of course, the grid bias necessary is governed by the high-tension battery voltage.

In the high-tension battery lead, there are four warden plugs. One is black and marked H.T.-, while the others are red and marked H.T.+1, H.T.+2, and H.T.+3. H.T.+1 is the high tension for the screen-grid lead of the screen-grid valve. This can be varied between 60 and 80 volts, and 70 volts will be found about the best for most valves. The best voltage can be gauged from the makers' valve list. The next connection, H.T.+2, is for the detector valve anode. This can be between 100 and 120 volts and is not critical, the most satisfactory tapping being about 115 volts. The last tapping, H.T.+3, is for the power valve and also the anode of the screen-grid valve, and this has the highest voltage, namely 120.

In connecting up the speaker it is necessary that the leads be connected the right way round, otherwise there is a possibility of the speaker unit becoming demagnetised. Connect the lead which usually has a coloured thread running through it to

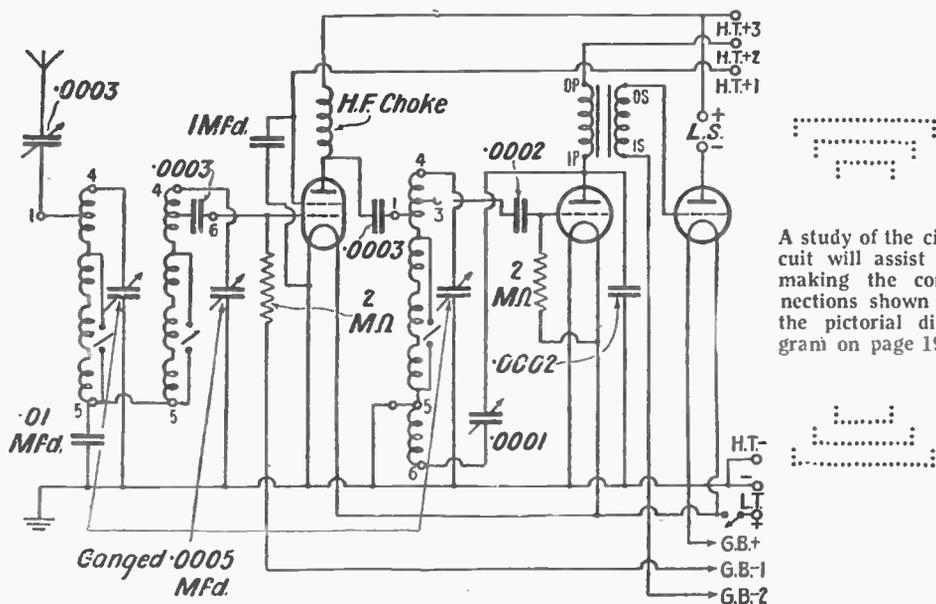

A study of the circuit will assist in making the connections shown in the pictorial diagram on page 191

THE "1931 ETHER SEARCHER"

and Voltages :: Choosing the Valves :: Setting the One-knob Control

the speaker terminal marked L.S. +.
The aerial is connected to the extreme right terminal and earth to the terminal on the left. Finally, don't forget the connection to the S.G. valve.

Switch on the set by pulling out the switch on the front of the panel. Now gently turn the knob of the condenser, when a hissing sound should denote that the set is working. Push in the knob above

the one on the right of the dial. When this is done, turn the dial to another station as denoted by the scale, and by the judicious use of reaction and the aerial condenser, the station should be heard.

The adjustment of the aerial series condenser on the panel is for keeping the aerial circuit in tune, but the selectivity can also be varied by means of this control. If the "1931 Ether Searcher" is to be used near to a powerful broadcast transmitter then the trimming condenser of the aerial tuning condenser should be screwed in so that it will be necessary to have the aerial condenser on the panel at its minimum setting. The correct adjustment here will be found best by trial.

Two points of interest have been raised by constructors who are now making up the "Searcher."

One is that if thin foil is used on the baseboard it may bulge up underneath the valve holders and there is a danger that the valve pins may touch the foil, so short-circuiting the high-tension supply.

To obviate this, a small circle of the foil may be cut away under each valve holder, taking care that the negative connections to the foil from the valve-holder terminals are not rendered imperfect. Alternatively, small discs of bakelite or even of cardboard may be cut and placed between the foil and the underside of the holders. Here again, care must be taken not to derange the negative connections.

It should be noted that most makers of kits of parts for the "Ether Searcher" are supplying these discs.

The second point is that some constructors are puzzled as to the position of the .0003 condenser coupling one of the coils to the screen-grid valve. This condenser, as explained last week, is incorporated in the coil itself.

The "Ether Searcher" may be seen in special display windows of Messrs. Mullard Radio Service and of the Edison Swan Electric Co., Ltd., in Charing Cross Road

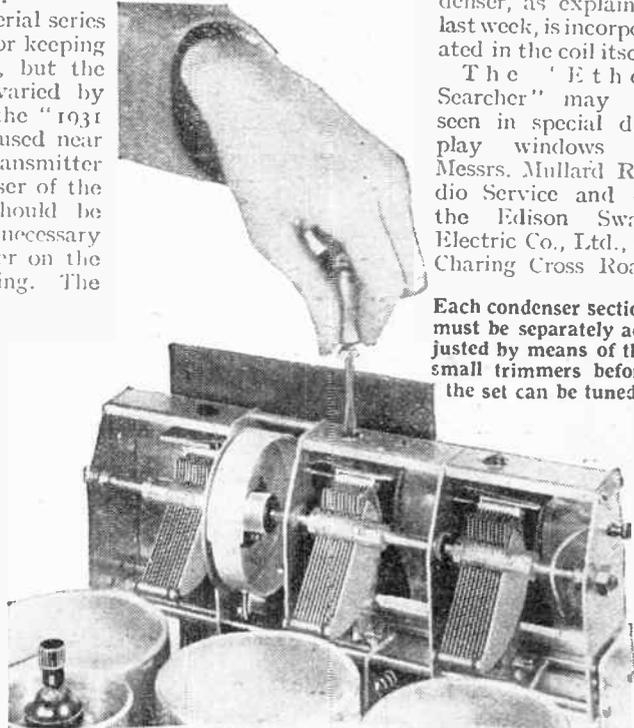

Each condenser section must be separately adjusted by means of the small trimmers before the set can be tuned

the L.T. switch: this should, if you have arranged the coils correctly, switch on to medium-wave working. Set the reaction condenser at zero, that is, turn it to the left as far as possible. Now turn the main condenser to about 60 degrees, this should bring in the London Regional station.

Ganging

In order to gang the set correctly and make the readings coincide with those published in the scale given in this week's issue, the following procedure should be carried out. Pick out from the chart any station which is received strongly, for example, the London Regional. It will be noticed that the dial reading for this is exactly 60 degrees. Set the dial at this reading.

With a screwdriver turn the trimming condenser screw at the top of the condenser, which is on the left of the dial, looking at the pictorial diagram, until the carrier wave is heard. Tune this to the silent point and decrease reaction. If this station is too strong either remove the aerial or make the adjustment on a lower-powered station.

The next condenser should now be adjusted for loudest signal strength, that is,

and in the Somerset Street windows of Messrs. Selfridge & Co., Ltd. "Ether Searchers" may also be seen in the windows of Messrs. Lewis, in Liverpool, Manchester, Birmingham, and at Lewis' Royal Polytechnic, Ltd., Glasgow.

Very many of the manufacturers who are advertising in "A.W." components for the "Ether Searcher" have also arranged demonstrations of the set at their premises.

COMPONENTS REQUIRED TO BUILD THE "1931 ETHER SEARCHER"

Ebonite panel, 8 in. by 6 in. (Becol, Trelleborg).

3-gang .0005-mfd. variable condenser with drum dial (J.B. "Chassimount," Lotus, Polar).

.0003-mfd. variable series aerial condenser (Readi-Rad, Brookmans type, Lotus).

.0001-mfd. variable reaction condenser (Readi-Rad, Brookmans type, Bulgin, Lissen, Lotus, Burton).

Set of three matched coils with ganging switch (two Colvern type TGSC, and one type TGSR).

Low-frequency transformer (Telsen, 5-1 Ace, Lissen, Varley, Ferranti, R.I., Burton, Voltron).

On-off filament switch (Bulgin junior, Junit, Lissen, H. & B., Benjamin, Readi-Rad).

.01-mfd. fixed condenser (T.C.C. flat

type, Lissen, Dubilier, Watmel).

.0002-mfd. fixed condenser (T.C.C. SP type, Lissen, Dubilier, Watmel).

Three valve-holders (Telsen, Junit, Lotus, Benjamin, W.B., Clix).

.0002-mfd. fixed condenser (Lissen, T.C.C., Dubilier, Watmel).

.0003-mfd. fixed condenser (Lissen, T.C.C., Dubilier, Watmel).

1-mfd. fixed condenser (Lissen, T.C.C., Dubilier, Filta).

Two 2-megohm grid leaks (Lissen, Dubilier, Watmel, Ferranti).

Grid-leak clips (Bulgin, Wearite, Ferranti).

Three coil screens (H. & B., Readi-Rad, Colvern).

S.G. valve screen (H. & B.).

High-frequency choke (Telsen, Varley, Readi-Rad, Lissen, Bulgin, Sovereign,

Tunewell, Lewcos, Burton).

Aluminium foil sheet, 15½ in. by 9½ in. (Readi-Rad, H. & B., Parex).

Two terminal blocks (Junit).

Four terminals, marked L.S. +, L.S. -, A., E. (Belling-Lee junior, Clix, Eelex, Burton).

Seven wander plugs, marked H.T. +3, H.T. +2, H.T. +1, H.T. -, G.B. +, G.B. -1, G.B. -2 (Belling-Lee, Eelex, Clix).

Two spade terminals, marked L.T. +, L.T. - (Belling-Lee, Eelex, Clix).

Insulated sleeving (Lewcos, H. & B.).

Cabinet (Clarion, Camco, H. & B. Readi-Rad).

2-volt accumulator (C.A.V. 2AG11).

120-volt high-tension battery (Fuller, "Sparta") and 16-volt grid-bias battery (Fuller, "Sparta").

Loud-speaker unit (Ormond, Blue Spot, Lissen, Hegra).

See the Automatic Tuning Scale on page 194

AUTOMATIC TUNING SCALE

| | |
|---|-------|
| CORK Ireland | 224.4 |
| COLOGNE Germany | 227 |
| NÜRNBERG Germany | 239 |
| BELFAST Ireland | 242 |
| JUAN-LES-PINS France | 248.5 |
| BARCELONA Spain | 251 |
| LEIPZIG Germany | 253.4 |
| HÖRBY Sweden | 257 |
| GLEIWITZ Germany | 259.3 |
| LONDON NATIONAL England | 261.3 |
| BARCELONA Spain | 268.7 |
| AUGSBERG Germany | 269.8 |
| RENNES France | 272 |
| | |
| BRATISLAVA Czechoslovakia | 279 |
| BERLIN Germany | 283.6 |
| RADIO LYONS France | 286.2 |
| BRITISH RELAYS England | 288.5 |
| TURIN Italy | 296.1 |
| HUIZEN Holland | 299 |
| BORDEAUX France | 304 |
| GENOA Italy | 313.2 |
| | |
| GÖTEBORG Sweden | 322 |
| BRESLAU Germany | 325 |
| NAPLES Italy | 332 |
| STRASBOURG France | 345.2 |
| LONDON REGIONAL England | 356.3 |
| MÜHLACKER Germany | 360 |
| ALGIERS North Africa | 363.4 |
| HAMBURG Germany | 372 |
| MANCHESTER England | 376.4 |
| TOULOUSE France | 385 |
| FRANKFURT Germany | 390 |
| GLASGOW England | 398.9 |
| KATOWICE Poland | 409.8 |
| DUBLIN Ireland | 413 |
| BERLIN Germany | 418 |
| | |
| BELGRADE Yugoslavia | 430.5 |
| STOCKHOLM Sweden | 436 |
| ROME Italy | 441 |
| RELAYS | 453 |
| LYON-LA-DOUA France | 466 |
| LANGENBERG Germany | 473 |
| MIDLAND REGIONAL England | 479 |
| | |
| PRAGUE Czechoslovakia | 487 |
| MILAN Italy | 501 |
| BRUSSELS Belgium | 509 |
| VIENNA Austria | 517 |
| | |
| MUNICH Germany | 533 |
| SUNDSVALL Sweden | 542 |
| BUDAPEST Hungary | 550 |

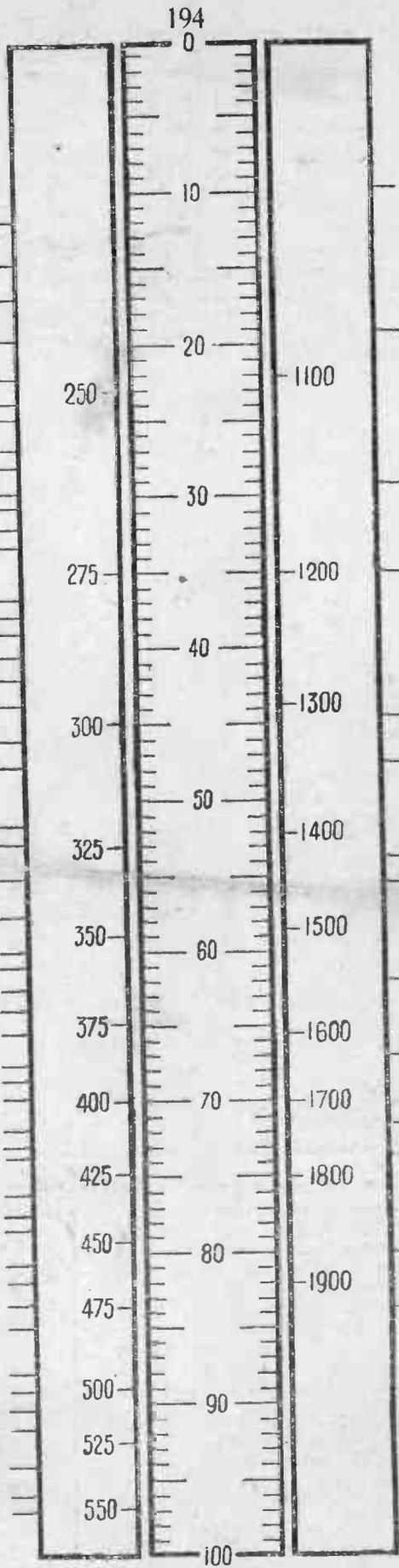

FOR THE "1931 ETHER SEARCHER"

| | |
|-----------------------|------------------|
| 1,000 .. Russia .. | LENINGRAD |
| 1,077 .. Norway .. | OSLO |
| 1,153 .. Denmark .. | KALUNDBORG |
| 1,200 .. Iceland .. | REYKJAVIK |
| 1,304 .. Russia .. | MOSCOW |
| 1,348 .. Sweden .. | MOTALA |
| 1,411 .. Poland .. | WARSAW |
| 1,448 .. France .. | EIFFEL TOWER |
| 1,554 .. England .. | MIDLAND NATIONAL |
| 1,635 .. Germany .. | ZEESEN |
| 1,725 .. France .. | RADIO PARIS |
| 1,796 .. Finland .. | IAHTI |
| 1,875 .. Holland .. | HULVERSUM |
| 1,935 .. Lithuania .. | KAUNAS |

INSTRUCTIONS FOR USING THE SCALE

The centre scale represents the degrees on the tuning dial, and as printed gives the approximate settings required to tune in the stations shown. If, however, with a particular receiver, the settings do not exactly correspond, then tune in a local station and note the dial reading. Cut out the centre portion of the scale and adjust it so that the dial reading obtained corresponds with the wavelength of the station received. Both wavelength scales may need adjustment and the three scales may then be pasted on a card. When this has been done the scales will read approximately correct for all other stations.

READY RADIO *for* MATCHED KITS

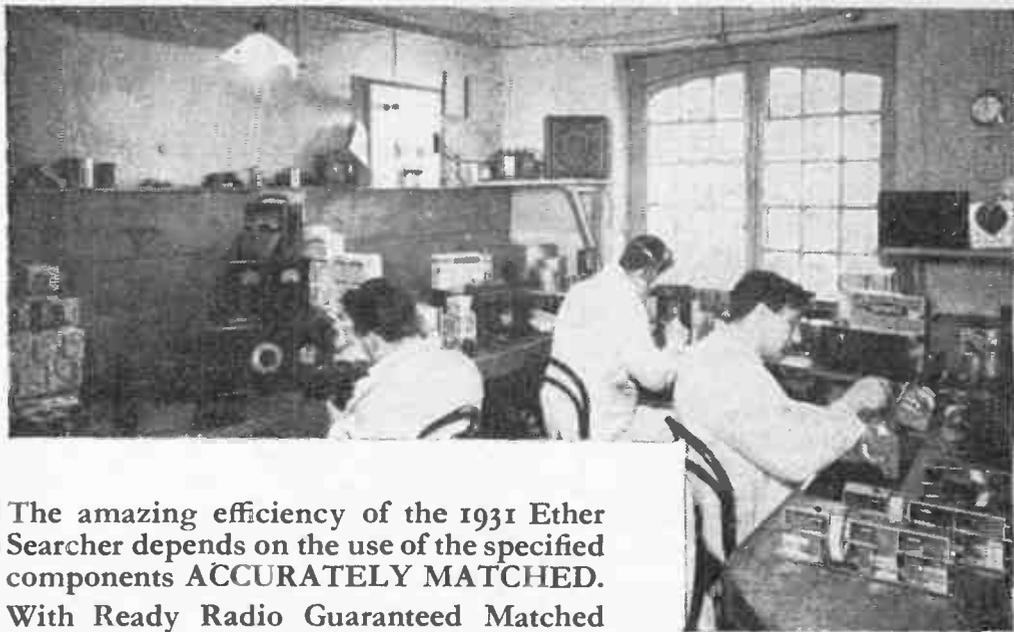

Some of the Ready Radio experts testing and matching "1931 Ether Searcher" Kits

The amazing efficiency of the 1931 Ether Searcher depends on the use of the specified components **ACCURATELY MATCHED**. With Ready Radio Guaranteed Matched Components as many as 50 stations have been received at loud-speaker strength, free from interference. Because all three tuned circuits are controlled by one knob, the accuracy of adjustment necessary for the reception of a large number of stations, combined with the advantages of band-pass tuning, can only be obtained when the circuits are all **ACCURATELY MATCHED**.

Ready Radio has consequently installed a special department where all 1931 Ether Searcher Kits are submitted to electrical laboratory tests and carefully calibrated so that each tuning circuit is identical.

The 1931 Ether Searcher is too good to be spoiled by unreliable components. Guarantee yourself the best possible results by ordering your Kit of Parts from Ready Radio.

Packing and Dispatching some of the hundreds of "1931 Ether Searcher" Kits which have been ordered from Ready Radio



READY RADIO *for* IMMEDIATE DISPATCH

*Full lists of
Ether Searcher
prices on page
197*

Don't Forget to Say That You Saw it in "A.W."



IN MY WIRELESS DEN

WEEKLY TIPS—
CONSTRUCTIONAL AND THEORETICAL

By W. JAMES.

Testing a Few Speakers

IF you take a number of makes of speaker and test them, using a generator of low-frequency oscillations as well as a first-class receiver, you will find distinct differences.

One instrument may respond very well to the higher notes, and have, in fact, a fairly wide range of response. Another may emphasise the top notes and another the lower notes. It therefore follows that a certain amount of correcting may be accomplished by using a speaker with a particular set and so on.

Thus if the set tends to weaken the higher notes, the balance may to an extent be restored by choosing a loud-speaker having a particularly strong high-note response.

It seems quite possible that you would prefer one speaker for speech and another for dance music and a combination suitably arranged might be effective. To fit a speaker to a set without knowing something of the characteristics of both is rather a foolish proceeding, as you might possibly fit a speaker weak in high note response to a set also having this defect.

Tracking Down Distortion

I have lately been looking into the question of distortion in battery-operated sets of popular makes and the results are quite extraordinary.

Some of them provide very little bass or treble and if you drew out the response curve over the usual range of audio frequencies you would find a nice peaked curve. When there is resistance in the high-tension battery circuit the results are affected to a remarkable extent.

Even if the set does not oscillate or motor-boast, certain frequencies are greatly emphasised or reduced in strength. Of course, one could tell by looking at the low-frequency transformer used that even amplification ought not to be expected.

But one part of a circuit often at least partly compensates for another and so we have a result not quite so bad as might be expected. With poor transformers, parts of wrong value, and overloading, the quality is apt to be poor, but too often the range and selectivity of a set are considered before quality of reproduction.

A Coil Arrangement

The accompanying diagram shows a good method of arranging both long and medium wave coils without unnecessary loss in efficiency.

In the aerial circuit you have a two-pole change-over switch. When the switch is in the position S, the aerial is connected to a tap on the medium wave coil and the long-wave section is short-circuited. With the switch in the position marked L, the aerial is joined to the tap on the long-wave coil.

In some circuits the best results on the long wavelengths are not obtained because the coil is not tapped for the aerial. Selectivity may therefore be poor. This is avoided by using the aerial circuit indicated. In the anode circuit of the screen-grid valve a similar type of switching may be used as shown.

Here again, the advantage over the more

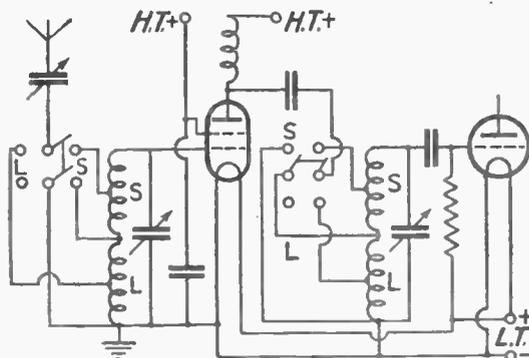

This is the circuit of the simple coil-switching arrangement described in the accompanying paragraph

usual plain circuit is that the best results may be obtained over both long and medium waves.

Rarely does it happen that coils cannot be tapped with advantage, but unless care is taken the expected results will not be obtained.

Troublesome Transformers

A fairly common fault met with in alternating-current sets is hum introduced from the mains transformer.

Some transformers seem more troublesome than others. They appear to have a greater stray field and must, therefore, be placed some little distance from the detector stage of the receiver. When a transformer low-frequency coupling is used between the detector and the next valve, great care must be taken or hum will be introduced.

It will be found that the interference produced by the power transformer is the minimum when it is placed in a certain position with respect to the inter-valve transformer. The power leads, too, are

sometimes a source of trouble and should, therefore, be arranged in the best position.

If hum from the power transformer is suspected and you cannot be sure from simple tests, a good plan is temporarily to wire into circuit a resistance coupling in place of the transformer as this coupling will not pick-up itself. If there is no hum with the resistance coupling, and a hum with a transformer, then the power circuit must be moved.

Curing Mains Hum

When hum is introduced into a set through parts of the mains apparatus being near the components of the receiver, one usually thinks of magnetic couplings. Actually the trouble may not be due to stray magnetic fields at all but to electro-static effects.

Shielding is then likely to prove effective. The circuit attached to the detector valve is the one most likely to pick up hum. Even the valve itself may collect hum and should therefore be seen to. The sensitivity of the detector circuit may be judged by the fact that touching the detector valve often introduces hum.

Clean Joints, Please

One of the points which usually receives too little attention when building a set, is the cleanliness of joints of screens and the contacts made with them. It is definitely a mistake to place pieces of metal together and not to clean them, and to fasten them so well that a good electrical joint is made.

When screens are bolted together they are usually connected quite effectively. Sometimes, however, a wood screw is used for fixing a screen, also a soldering tag is placed below its head and a wire is taken to it. The contact may be good or only fair and the point should be watched.

D.C. Mains

A point to note by those using a direct-current mains high-tension unit having only one smoothing choke is that this will be more effective in one supply lead than the other.

If a hum is heard, therefore, try the effect of transferring the choke to the other side of the circuit. Sometimes a choke in both leads is essential, but as a rule one good choke is enough, provided it is connected in the right side of the circuit.

A Ready Radio Approved Kit is Your Guarantee of Efficiency

COMPLETE KIT OF COMPONENTS

| | |
|---|--------|
| 1 Ebonite panel 8 in. by 6 in. (drilled to specification) ... | 2 6 |
| 1 J.B. 123 chassis 0005-mfd. condensers ... | 1 15 0 |
| 1 Read-Rad 0003-mfd. Bookmans type condenser ... | 3 6 |
| 1 Read-Rad 0001-mfd. Bookmans type condenser ... | 2 6 |
| 1 Set 3 matched C.W. coils with ganging switch ... | 1 10 0 |
| 1 Read-Rad on-off filament switch ... | 1 10 |
| 1 I.C.C. fixed condenser 01 flat type ... | 2 6 |
| 1 I.C.C. fixed condenser 0002 S.F. ... | 2 4 |
| 1 Read-Rad 0002 mfd. fixed condenser ... | 10 |
| 1 Read-Rad 0003 mfd. fixed condenser ... | 19 |
| 1 Hydra I-mfd. bakelite fixed condenser ... | 2 2 |
| 2 Telsens 4-pin sprung valve holders ... | 3 0 |
| 1 Telsen L.F. transformer "Av" 5-1 ... | 8 6 |
| 1 Telsen H.I. choke ... | 2 6 |
| 2 Read-Rad 2-meg. grid leak ... | 1 8 |
| 1 Read-Rad grid leak chip ... | 6 |
| 1 Read-Rad complete set of coil and valve screens for 1931 Ether Searcher ... | 7 6 |
| 1 Aluminium foil base 16 in. by 10 in. ... | 1 6 |
| 2 Terminal blocks 2 terminal type ... | 6 |
| 4 Belling Lee "R" terminals as specified ... | 1 0 |
| 7 Belling Lee wadler plugs (4 H.T. 3 G.B.) ... | 1 2 |
| 2 Spade terminals ... | 3 |
| 1 Packet of Jiffifix for wiring ... | 2 0 |
| 9 Yards ribbon covered wire screws, etc. ... | 11 |
| £5 14 6 | |

The Ready Radio Kit of the "A.W." 1931 Ether Searcher was submitted to lengthy tests by Mr. J. Sieger, the "A.W." designer, and officially approved by "Amateur Wireless"

KIT A .. £5 : 14 : 6

(or 12 monthly payments of 10/6)
Complete Kit of Matched Components, tested and guaranteed, as specified.

KIT B .. £7 : 13 : 4

(or 12 monthly payments of 14/-)
Complete Kit of Matched Components as above with 3 Mullard Valves to specification.

KIT C .. £8 : 14 : 6

(or 12 monthly payments of 16/-)
Complete Kit of Matched Components as above with 3 Mullard Valves to specification and special Cabinet (hand made, weather-d oak finish).

READY RADIO COMPLETE BATTERY-OPERATED EQUIPMENT

Consisting of:—

| | |
|---|--------|
| Complete Kit of Parts with 3 Mullard Valves and Cabinet to specification: ... | 8 14 6 |
| 1 Fuller 100-volt H.T. Battery | 15 10 |
| 1 Fuller 2-volt 30 amp. L.T. accumulator (type SW X7) ... | 11 0 |
| 1 Farrand Inductor-type Loud-speaker Unit ... | 3 10 0 |
| 1 Fuller 9-volt Grid Bias Battery | 1 6 |
| £13 12 10 | |

Or 12 equal monthly instalments of 26/-

READY RADIO MAINS-DRIVE EQUIPMENT

Consisting of:—

| | |
|--|--------|
| Complete Kit of Parts with 3 Mullard Valves, Cabinet to specification: ... | 8 14 6 |
| 1 Atlas Mains Unit with Trickle Charger (A.C.188) ... | 6 0 0 |
| 1 Fuller 2-volt 30 amp. L.T. accumulator (type SW X7) ... | 11 0 |
| 1 Fuller 9-volt Grid Bias Battery | 1 6 |
| £15 7 0 | |

Or 12 equal monthly payments of 34/6

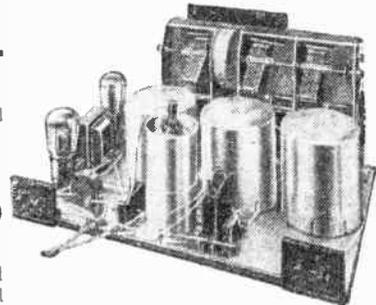

FREE to every purchaser of a Ready Radio 1931 Ether Searcher Kit: A Booklet containing constructional details, full-size wiring diagram, notes on operation, tuning guide and other useful information—
—and 1 Atalanta Radio Screwdriver.

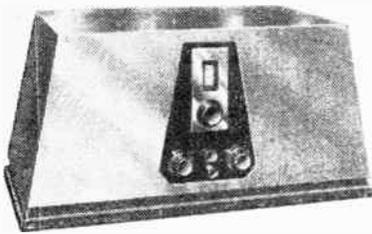

Every Ready Radio 1931 **ETHER SEARCHER** Kit is guaranteed Accurately Matched and Tested.

Send for the Ready Radio Catalogue. A complete Encyclopaedia of all modern Sets, Speakers, Equipment, Components and Accessories including everything needed by the set-builder. Price 1/-, post free.

ANY PART MAY BE PURCHASED SEPARATELY

READY RADIO COMPLETE RECEIVER

£9:17:6 or 12 monthly payments of 18/-

(Royalties included.)
Completely assembled and ready for use, aerial tested. (With Mullard Valves and Cabinet as-specified.)

ORDER FORM

TO READY RADIO (R.R.) LTD., 159 BOROUGH HIGH STREET, LONDON BRIDGE, S.E.1.

Telephone: Hop 5555 (Private Exchange).

Telegrams: Readirad, Sedist.

CASH ORDER FORM

Please dispatch to me at once the item marked for which I enclose payment in full of

£.....

HIRE PURCHASE ORDER FORM

Please dispatch my Hire Purchase Order for the item marked for which I enclose first deposit of

£.....

Please send..... at £.....

Name.....

Address.....

Town..... Nearest Railway Station.....

All goods post free or carriage paid in British Isles.

You will Help Yourself and Help Us by Mentioning "A.W." to Advertisers

SETS OF DISTINCTION

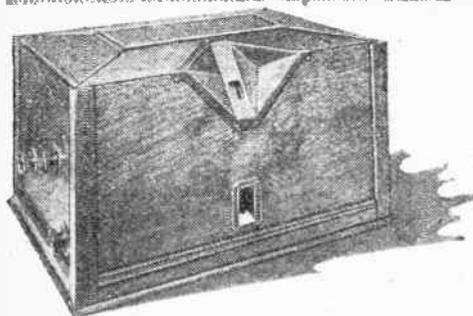

The GECOPHONE ALL-ELECTRIC FOUR

Makers: General Electric Co., Ltd. Price: £30.

ONE of the most powerful sets I have tested this season is undoubtedly the Gecophone four-valver, designed for A.C. mains operation. In front of the detector valve is an enormous amount of high-frequency amplification, achieved by the use of the two MS₄ Osram valves. After the detector is a 10-watt super-power valve, providing enough power to drive a large moving-coil loud-speaker.

Large Amplification

The detector is an Osram MH₄ which, like the two screened-grid high-frequency valves, is indirectly heated at 4 volts. The PX₄ power valve is directly heated. A U10 rectifying valve is employed for the anode-current supply. Those accustomed to battery-operated sets can hardly appreciate the enormous amplification provided by the four valves referred to.

Due to the presence of so much power, special precautions have had to be taken in construction. As can be seen from one of the illustrations, the valves are enclosed in separate screening compartments, readily accessible by lifting up a flap at the back of the set and removing a special metal plate.

Externally, the Gecophone four-valver is striking, due to the unique design of the cabinet. Conforming with modern tendencies, the controls are removed from the front and are fitted in convenient positions at each of the two sides of the cabinet, with the exception of the master switch, mounted below the esentcheon plate of the tuning dial.

Tuning Arrangements

This dial is brightly illuminated when the set is in operation and is rotated by one of the three knobs at the left-hand side of the cabinet. Rotation of this knob varies three tuning circuits, which, by the way, provide an extraordinary degree of selectivity. Tuning this set is a sheer delight, not only because of the smooth action of the knob but also because the dial is calibrated in wavelengths and can be set at any desired station at a moment's notice.

One of the two remaining knobs at the left-hand side of the cabinet is for controlling volume. This is done by means of a series aerial condenser, so that as volume is decreased, by decreasing the value of the condenser, selectivity is increased. The remaining knob at this end of the cabinet is for changing from medium to long wavelengths. The change-over is effected with great precision.

I think the makers have been very wise in their decision to include reaction in this powerful set. Controlled by a knob at the right-hand side of the cabinet, the reaction makes just the difference between good results and really outstanding results. A little more sensitivity and a little more selectivity have been gained by including reaction in a set that, with its two high-frequency stages, could undoubtedly have held its own without this additional boosting effect.

But there is all the difference in the world between reaction in a set such as this and reaction in a set without appreciable high-frequency amplification. Expert manipulation of reaction is not essential with the Gecophone, as I proved by setting the control to zero and tuning in dozens of stations without further reference to reaction.

A Practical Test

On the medium waves I received no less than thirty stations at loud-speaker strength. The notable point about this reception test was the ease with which the stations could be separated from one another. Prague, for example, was clear of the Midland Regional, as was Langenberg. Stockholm and Rome were easily separated. Hamburg was clear of the London Regional.

Long-wave Reception

On the long waves it was a pleasure indeed to be able to log ten powerful stations free of interference and not susceptible to fading. Zeesen was received quite clear of Radio Paris and Daventry, a feat seldom accomplished on a set connected to an outside aerial in London. No appreciable loss of quality could be detected through this excellent selectivity. The London Regional had a spread of about 10 degrees and the London National 9 degrees.

Excellent Quality

I tried this set with a moving-coil loud-speaker and with a good quality lincudiaphragm loud-speaker. Both tests proved the wonderful potentialities of the set, and particularly of the PX₄ output

valve. This excellent quality was particularly appreciated when I used the set as a gramophone amplifier, by plugging in a pick-up to the socket provided at the back.

From my tests, I am very confident in recommending this set to listeners wanting a really de-luxe installation. For those living within a Regional area the selectivity is invaluable. For those desiring good quality above all things this set fills the bill. For those desiring ease of operation I can think of nothing simpler.

It should be remembered that the Gecophone all-electric four is suitable only for A.C. mains. The power consumption is 55 watts, or rather less than the consumption of a bright electric-light bulb.

SET TESTER.

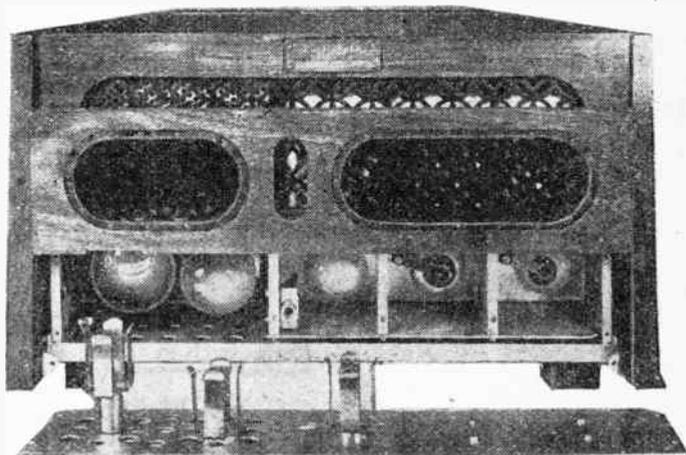

All the valves are enclosed in special compartments in the Gecophone All-electric Four

A STRANGE BROADCAST

WHILE the opera *Rigoletto* was being broadcast from the Prague Opera House and relayed by Prague, listeners heard shrieks of "fire!" interrupt the singing of one of the arias. One of the audience was heard trying to calm his fellows. Then followed a violent stampede, the crackling sound of burning wood mingling horribly with cries of women. Horrified listeners made many phone calls to the station. Long-distance calls came even from as far as Berlin, but enquirers were relieved to hear that it was simply the Czech radio play *The Opera Fire*.

Glasgow listeners are waxing indignant about the transfer of the Scottish headquarters of the B.B.C. to Edinburgh.

PERFECT RADIO RECEPTION IS NOW WITHIN YOUR REACH

"THE STENODE RADIOSTAT"

Registered Trade Mark

Designed around the epoch-making discoveries of Dr. James Robinson, this 7-valve Receiver sets an entirely new standard in selectivity and range.

ELECTRICAL REPRODUCERS Ltd.,
RADIO MANUFACTURERS,
102, West Regent Street, Glasgow, C.2.
Licenses of British Radiostat Corpn.

from
£45

"THE
IDEAL"

H & B

GUARANTEED KIT for the 1931 ETHER SEARCHER

| | £ | s. | d. |
|---|---|----|----|
| 1 Ebonite panel, 8 1/2 by 6 in. (Trillberg) | 2 | 0 | 0 |
| 1 3-gang, .0005-mfd. variable condenser, with drum dial (J.B., Chassimount) | 1 | 15 | 0 |
| 1 .0003-mfd. variable series aerial condenser (Polar) | 3 | 0 | 0 |
| 1 .0001-mfd. variable reaction condenser (Polar) | 3 | 0 | 0 |
| 1 Set of 3 matched coils, with ganging switch (Colvern type, TGSC2 and TGSRI) | 1 | 10 | 0 |
| 1 On-off switch (Pioneer) | 1 | 3 | 0 |
| 1 Low-frequency transformer (Telsen Acc, 5-1) | 8 | 6 | 0 |
| 3 Valve holders (Telsen) | 3 | 0 | 0 |
| 1 .0002-mfd. fixed condenser (Telsen) | 1 | 0 | 0 |
| 1 .0003-mfd. fixed condenser (Telsen) | 1 | 0 | 0 |
| 1 High-frequency choke (Telsen) | 2 | 6 | 0 |
| 1 .01 fixed condenser, flat type (T.C.C.) | 2 | 3 | 0 |
| 1 .0002-mfd. fixed condenser, S.P. type (T.C.C.) | 2 | 3 | 0 |
| 1 1-mfd. fixed condenser (Lissen) | 2 | 6 | 0 |
| 2 2-meg. grid leaks (Lissen) | 2 | 0 | 0 |
| 1 Grid leak holder (Lissen) | 6 | 0 | 0 |
| 1 SET OF H & B SPECIFIED SHIELDS (3 coil shields, 1 S.G. valve shield, ready slotted) | 7 | 0 | 0 |
| Aluminium foil sheet, 16 by 10 in. (H. & B.) | 3 | 0 | 0 |
| 2 Terminal blocks (H & B) | 8 | 0 | 0 |
| 4 Terminals, marked: L.S.+, L.S.-, A, E (Billing-Lee) | 1 | 6 | 0 |
| 7 Wander plugs: H.T.+1, H.T.+2, H.T.+3, H.T.-, G.B.+1, G.B.-1, G.B.-2 (Billing-Lee) | 1 | 9 | 0 |
| 2 Spade ends, L.T.+1, L.T.- (Billing-Lee) | 8 | 0 | 0 |
| Insulated sleeving (H. & B.) | 1 | 0 | 0 |
| 12 ft. wire and 6 ft. rubber flex (Lawcos) | 1 | 0 | 0 |



Mr. Sieger uses only H & B Shields for the perfect screening of S.C. Valve and Coils specified for the 1931 Ether Searcher.

SET COMPLETE - - - 7/-
VALVE SHIELD ONLY - - - 2/9

Order your Kit and Cabinet to-day.
NO DELAY THE H & B WAY

All purchasers of the complete Kit for the 1931 Ether Searcher can have the set BUILT FREE IF DESIRED

TERMS.—Carriage Paid on all orders accompanied by cash. C.O.D. charges paid on orders over £1.

H & B RADIO CO.

34, 36, 38 BEAK ST., REGENT STREET, LONDON, W.1

TELEPHONE: GERRARD 2831

Don't Forget to Say That You Saw it in "A.W."

SUGGESTED ACCESSORIES for the 1931 ETHER SEARCHER

| | | |
|--------------------------------|-------|---------|
| 1 Mullard Valve PM12 | - - - | £1.0.0 |
| 1 " " 2DX | - - - | 8/6 |
| 1 " " 2A | - - - | 10/6 |
| 120 v. Siemens "Full-o-Power" | - - - | 16/3 |
| 9 v. Ever-ready Grid Bias | - - - | 1/3 |
| 2 v. 40 amp. Exide Accumulator | - - - | 8/6 |
| Mullard Model "C" Loudspeaker | - - - | £2.10.0 |
| Ormond Loudspeaker | - - - | £1.9.6 |

H & B CABINET

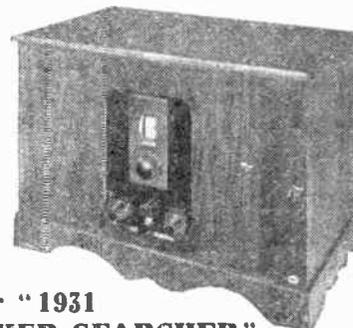

For "1931 ETHER SEARCHER"
Handsome Oak Cabinet - £1:1:0
Walnut Model - - - £1:17:6

THE HOW AND WHY OF RADIO

XXI—HOW A CRYSTAL SET WORKS

If you are a beginner in wireless, now is your chance to gain a clear conception of its theory and practice. In this series of articles, specially prepared for the beginner, no previous knowledge of wireless is assumed. It is intended to deal with every aspect of the subject and the whole series will endow the beginner with sufficient knowledge to enable him to derive the greatest possible interest from the fascinating hobby of wireless

TO a beginner, trying to visualise a simple sequence of events in the conversion of wireless waves into audible sounds, the crystal set has a strong appeal. So this week I am briefly explaining how a crystal set works, adding some practical notes for those wanting to build one.

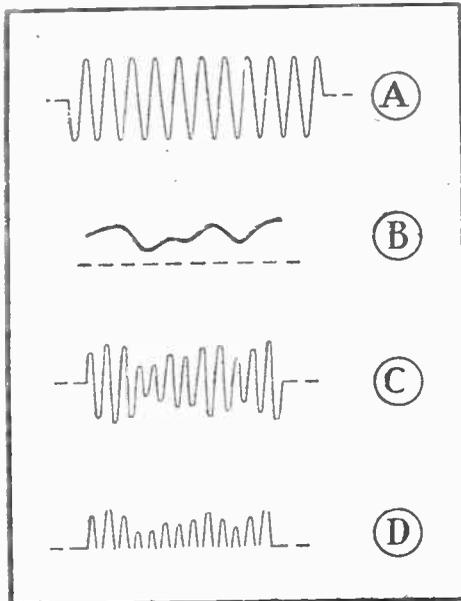

Fig. 1. A is an unmodulated carrier wave, B is a sound wave, C is a modulated carrier wave, and D is a detected modulated wave

Before we can understand the working of the set, some idea of the nature of wireless waves must be grasped. Fig. 1 will help. At A is shown the carrier wave of a transmitting station. Note how it undulates from zero to maximum in one direction, back to zero and then to maximum in the opposite direction. No one can imagine the actual number of these waves that vibrate the ether every second. With a station having a wavelength of say 300 metres the frequency of the waves sent out would be 1,000 kilocycles per second.

The speech and music sent out by broadcasting stations has a much lower frequency. The different sounds our ears can detect have frequencies ranging from 50 to 15,000 cycles. These low frequencies, as they are called, to distinguish them from the high frequencies of wireless transmission, are super-imposed on the carrier wave by the process of modulation. This means that while the transmitted wave consists of millions of vibrations per second, there is a much lower frequency change occurring. I gave an illustration of this dual variation in an early article of this series, showing how a pendulum might be rapidly swinging

from side to side while being slowly lowered to the ground.

Fig. 1B shows the form of a low-frequency wave, as created by the sounds of the voice or a musical instrument. At C is shown what happens when A and B are combined; when the carrier wave of A is modulated by the speech or music of B. Note that the outline of the B curve consists of the high frequency of A.

Now the important point to understand here is that the outline of the B frequency appears *twice* in the modulated carrier. This is because the carrier is an oscillation, alternately positive and negative with respect to zero. It now becomes clear that before we can hear the speech or music represented by the B curve we must eliminate the high frequency of the carrier and one of the two halves—it does not matter which.

Certain mineral crystals, notably galena, exhibit the peculiar property of allowing current to flow more easily in one direction than in the other. Wireless waves applied to a crystal contact are therefore made uni-directional, because the crystal allows the positive half cycle of the oscillation to flow through but acts as a barrier to the negative half cycle.

In effect, the crystal gets rid of the unwanted half of the modulated carrier shown at Fig. 1C. What is left is shown at D, namely a series of high-frequency pulsations varying in amplitude at the modulation frequencies. The crystal itself does not complete the job of detection, for the high-frequency component has still to be eliminated. To understand how this is done turn to Fig. 2, where the simplest possible crystal circuit is shown.

Here we have a tuning coil, across which is connected a variable condenser, with the aerial connected to one of the coil terminals and the earth to the other. Across this oscillatory circuit are developed the incoming signals, which will rise to an appreciable value only when the tuner is brought into resonance with the tuner of the transmitter.

Across the tuner we connect the crystal in series with a pair of headphones. The

high-frequency oscillations surging across the tuner are offered an alternative path. But, as already shown, the crystal will allow current to flow in one direction only, so what flows through the headphones is a uni-directional current and not an oscillation.

It is at the headphones that the high-frequency component is eliminated. The headphones work by the use of electro-magnet coils attracting an iron diaphragm and these electro-magnets are wound with a very great number of turns of fine wire in order to obtain as much inductance as possible. In making the phones of high inductance, to achieve greatest sensitivity, we unavoidably make the resistance of the phones high. When we speak of high-resistance phones we mean high-inductance phones, for the resistance is merely an unavoidable corollary of high inductance.

The high inductance of the headphones offers a considerable impedance to the high-frequency component of the rectified current. So much so that this high-fre-

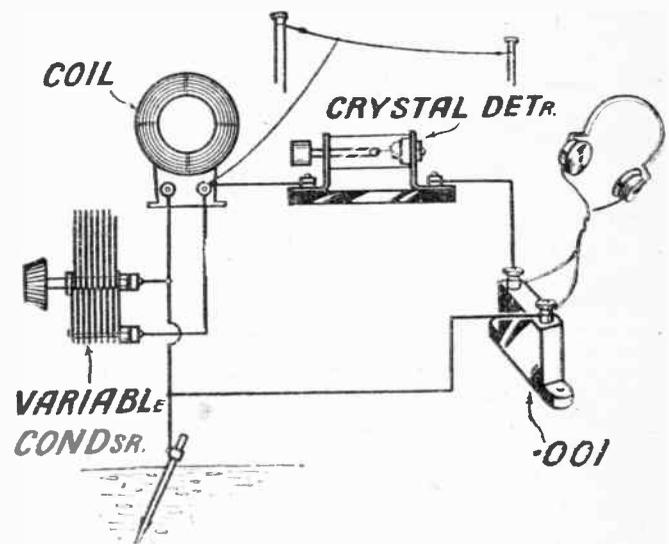

Fig. 2. A crystal circuit shown pictorially

quency current is by-passed through the small fixed condenser shunted across the headphones. What is left is the low-frequency component of the rectified current, corresponding to Fig. 1D. To this low-frequency variation of current the diaphragms of the headphones can readily respond. Sometimes the fixed condenser across the phones is omitted and it may be wondered why the set still works. The answer is that the leads of the headphones have an appreciable capacity, which is

(Continued on page 205.)

RADIO'S NEWEST TUNING DEVICE

The New J.B. "CHASSIMOUNT"

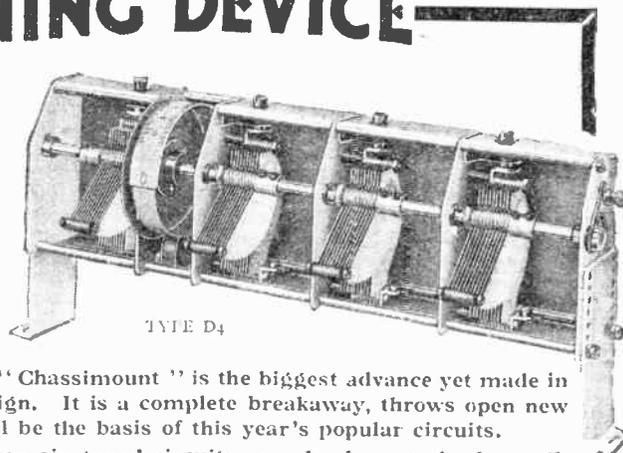

TYPE D4

**J.B. 'CHASSIMOUNT'
TYPE D.3**

SPECIFIED

for

**Mr. J. SIEGER'S
1931 ETHER
SEARCHER**

Your dealer can supply
immediately.



The new J.B. "Chassimount" is the biggest advance yet made in condenser design. It is a complete breakaway, throws open new fields, and will be the basis of this year's popular circuits.

Two, three, even six tuned circuits—one knob controls them all, keeps them perfectly in tune, and brings in station after station.

Once again J.B. lead the way. J.B. precision has made the "Chassimount" possible and ensured the various condenser units matching over the whole range.

The J.B. "Chassimount" is built and designed as a unit. Each stage is adequately screened and has a special device which balances out all stray capacities. AND IT COSTS LESS THAN SEPARATE CONDENSERS:

J.B. "CHASSIMOUNT" GANG CONDENSERS
(With drum drive)

| | | | |
|---------|---------|-------|------|
| Type D2 | 2 stage | .0005 | 26 6 |
| " D3 | 3 " | " | 35 - |
| " D4 | 4 " | " | 42 6 |
| " D5 | 5 " | " | 50 - |
| " D6 | 6 " | " | 57 6 |

PRECISION INSTRUMENTS

Advertisement of Jackson Brothers, 72, St. Thomas' Street, London, S.E.1. Telephone: Hop 1837.

SOVEREIGN SUPREMACY

THE MOST ADVANCED FIXED CONDENSER

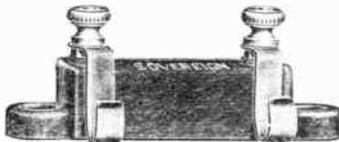

This Sovereign Component (Brit. Pat. No. 261864) is in advance of all other fixed condensers. Made under patent, it is guaranteed within 5% of its stated value. Supplied in Bakelite case with nickelled fittings and clips for Grid Leak where necessary. For this, the Sovereign Grid Leak, also guaranteed (10d. all values), is most suitable. Use Sovereign wherever you can—it improves any circuit.

Do not forget the full range of Spaghetti Resistances. All values. From 9d. to 2 9.

OTHER SOVEREIGN PRODUCTS: Dual Range Coils; Wire-wound Resistances; Volume Controls; Potentiometers; Rheostats; Wave Traps; Screen-grid Coils; H.F. Chokes; Compression-type Condensers, etc.—Write direct to makers if you cannot obtain these lines. Send also for full lists.

FIXED CONDENSERS

| | | | |
|------------------|-------|------------|-----|
| .0001 | 10d. | .001 | 1/3 |
| .0002 with clips | | .002 | |
| .0003 | each. | .003 ca.h. | |

SOVEREIGN PRODUCTS, LTD. 52 54 ROSEBERY AVENUE, LONDON, E.C.4.



Don't Forget to Say That You Saw it in "A.W."

Dr. ROBINSON'S STENODE Radiostat

(Registered Trade Mark)

MADE BY

F. W. SMURTHWAITE, A.M.I.R.E.
IS THE OUTSTANDING WIRELESS PRODUCTION FOR 1931.

THE STENODE RADIOSTAT marks a new era in wireless reception; absolute separation of stations working only 9 k.c. apart. This means, for example, that the London Regional can be cut out in one degree and Mühlacker received free of interference with perfect quality. Very easy to tune. Every set is made up to my well-known high standard of workmanship and is personally tested and guaranteed by me. All A.C. and battery models available. Cabinet work to choice.

PRICES, from £42 - 10 - 0
Demonstrations with pictures.

STENODE RADIOGRAMS to order.
Orders executed in strictest confidence.

F. W. SMURTHWAITE, A.M.I.R.E.
24 Belmont Road, Wallington, SURREY

Phone: Wallington 1982.

Licenses of British Radiostat Corporation.

WE TEST FOR YOU

A weekly review of new components



and tests of apparatus.

Conducted by our Technical Editor: J. H. REYNER, B.Sc., A.M.I.E.E.

New Ferranti Transformer

THE name Ferranti has been associated with low-frequency components for a long time. The latest addition to the Ferranti range, the A.F.S., will appeal to many of our readers in view of the fact that it costs only 11s. 6d.

Needless to say, this transformer is not quite as large as its bigger brothers, but it is nevertheless generously built. Its base-board dimensions are 2 1/4 in. by 3 1/2 in. and it is 2 3/4 in. high. It is different also in appearance, as it is housed in a bakelite moulded casing instead of the metal shroud used hitherto.

We are told that ordinary transformer iron is employed in its construction, for Ferranti's apparently do like "fancy" steels, and its performance is certainly remarkable in view of this fact. The inductance was measured in accordance with our usual practice, and was found to fall from 42 henries, with no polarising current,

to 19 henries with 5 milliamps. As the average valve which this transformer will

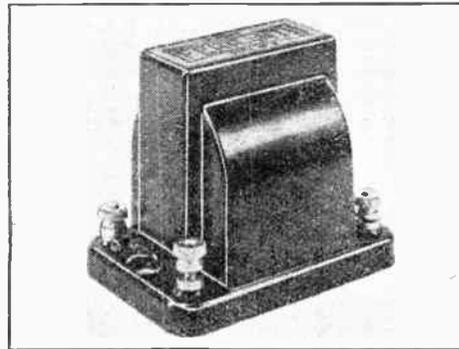

A new Ferranti low-frequency transformer

be called upon to follow will not take more than 3 or 4 milliamps, it can be reckoned as having quite an adequate primary induc-

tance. We checked up its performance and found it excellent. There is a rise in the upper frequencies, but this is a useful characteristic since it compensates for the cut-off which is liable to occur in the tuning arrangements of the set.

Contrary to the usual Ferranti custom, no fixed condenser is included in the instrument itself. Therefore provision should be made to by-pass the high-frequency currents, either by the use of a differential reaction condenser, or by a fixed condenser from the anode of the detector valve to L.T., as is usually done in the modern circuits. If this condenser is made of the order of .0002 or .0003 it will assist the bass reproduction to some extent and will not cause a serious cut-off in the treble, owing to the rising characteristic.

Finally, one may say that the transformer employs the well-known Ferranti sectionalised windings.

(Continued on page 204)

VISIBLE PROOF!

Fig. A. WITHOUT Condenser in Circuit.

Fig. B. WITH Condenser in Circuit.

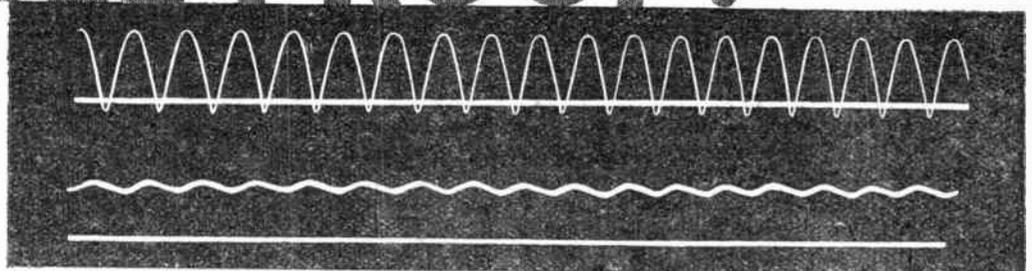

—THAT T.C.C. ELECTROLYTIC CONDENSERS

banish Mains Ripple from Moving Coil Loud Speakers



T.C.C. 2,000 mfd. Electrolytic Condenser. Price 15/-.

STUDY this visible evidence—exact reproductions of two oscillograms which illustrate graphically the way in which the T.C.C. Electrolytic Condenser smooths the output of a moving coil loud speaker. Figure A records the voltage applied to the field windings of a moving coil loud speaker energised from A.C. mains by means of a transformer and metal rectifier. Figure B records the voltage when a 2,000 mfd. T.C.C. Electrolytic Condenser is connected in parallel with the field windings. From this visible proof it will be seen that the annoying mains ripple, so prevalent in moving coil reproduction, is completely banished by T.C.C.—the famous "Condenser in the green case." Get one from your Dealer to-day—and enjoy better reproduction.

TELEGRAPH CONDENSER CO., LTD., NORTH ACTON, W.3.



07449

SURPRISING RESULTS

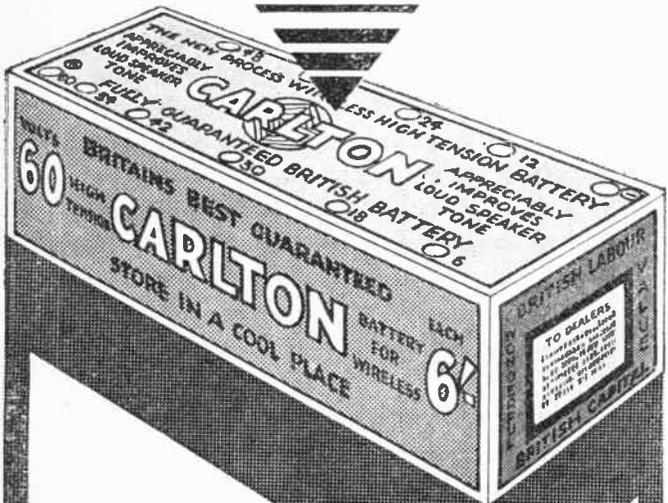

AT LESS COST

Yes, it can be done, battery power just as good at a much lower price. But only with "CARLTON" Batteries.

Try one and be convinced; astonishing results proved on test. Change to "CARLTON" and get smooth power, quick recuperation and long life.

Ask your dealer to-day—if he does not stock send his name and address to:—

VINCE'S DRY BATTERIES LTD., LION WORKS, GARFORD ST., LONDON, E.14

60 VOLTS 6'
BRITISH MADE **100 VOLTS 10'**

CARLTON
LONG LIFE LOW PRICE
RADIO BATTERIES



Now! REPEAT SENSATIONAL SUCCESSES WITH THE SUPER PERFORMANCE CHOKER

WITH BY-PASS CONDENSER

Every superlative feature that has always been aimed at by manufacturers is embraced in this moderately priced unit.

High inductance value, low self capacity, low resistance, free from resonance peaks, and blind spots. Uniform efficiency and in fact, a wonderful product that will improve any set in which it is installed.

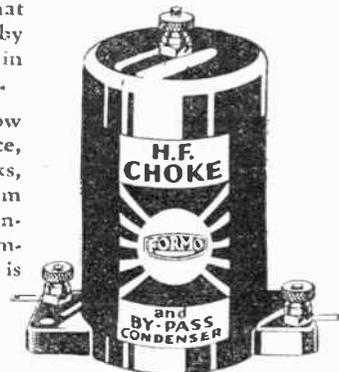

FORMO H.F. CHOKER with By-pass Condenser
Price 7/6d.

Type A. For use in detector anode circuit.
Type B. For use as a coupling device between H.F. and detector valves.

Bring your receiver up-to-date and enjoy increased efficiency by fitting this new choke. From all good dealers. Ask for folder A.11.

ARTHUR PREEN & CO., LIMITED,

Golden Square, Piccadilly Circus, W.1.

There's nothing to beat this!

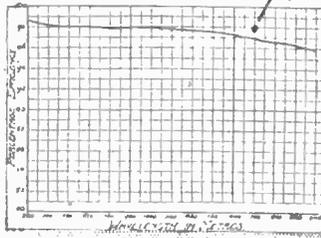

BUY YOUR RADIO WHERE YOU

SEE THESE FORMO Displays



The Sign of the Best Dealer's Inventory

You will Help Yourself and Help Us by Mentioning "A.W." to Advertisers

LOWER PRICE
makes Columbia
even more economical



COLUMBIA
4780, 60 volts,
Triple Capacity.
17/8

The Columbia 4780 (60 volts Triple Capacity) outlasts three ordinary batteries—for ninety nights in every year your H.T. costs you nothing. Throughout its long life Columbia 4780 gives you a constant flow of smooth, even power. And better, purer radio, balanced and entirely trouble-free. Ask your dealer for Columbia 4780.

If your dealer has no Columbia in stock, send to us, giving his name.

For large Sets employing power valves, Columbia "Layerbilt"—truly a battery and a half No. 4486, 45 volts .. 24/-
For 2- or 3-Valve sets, Columbia No. 4721 .. 10/6
For Portables, Columbia No. 4763, 90 volts .. 18/-
Columbia Grid Bias Battery, 9 volts, No. 4756 .. 2/-

**Columbia
RADIO BATTERIES**

J. R. MORRIS, Imperial House, 15, Kingsway,
London, W.C.2

Scotland: J. T. Cartwright, 3, Cadogan St., Glasgow

**TUNEWELL
COILS**

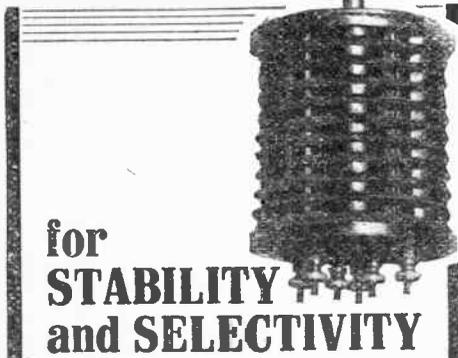

**for
STABILITY
and SELECTIVITY**

Scrupulous attention to detail characterises the entire range of Tunewell Coils. Their careful design, low self-capacity and excellent finish combine to give that performance for which Tunewell are already famous

| | |
|--|------|
| Dual Range Double X Tapped Coils, Panel Mounting | 10/6 |
| 6-pin Dual Range Coil, less switch | 7/8 |
| Separate 6-pin Coils, 20/45, 40 Ω, 200/600 metres | 2/11 |
| 1,000 2,000 metres | 5/3 |
| 2-pin Coils, ultra-short | 1/6 |
| Broadest and High Wavebands from Centre Tapped ditto, each extra | 1/6 |
| X Type ditto, each extra | 9d. |
| Special New H.F. Choke | 6/6 |
| Transformer | 12/6 |
| Speaker Unit | 22/6 |
| Tunewell Portable Turntable | 3/3 |

SEND FOR LIST

TURNER & CO.
54 Station Road, London, N.11

"WE TEST FOR YOU"

(Continued from page 202)

Astra Reaction Condenser

THIS week we have tested a particularly neat Astra reaction condenser. The robust though light construction of this component attracts attention on account of the exceptional smoothness of motion and complete absence of distortion during movement, which might lead to short circuits between the vanes. Two brass end plates carry bushes for the moving spindle, whilst a pig-tail connection is taken to the end plates. The fixed vanes are mounted

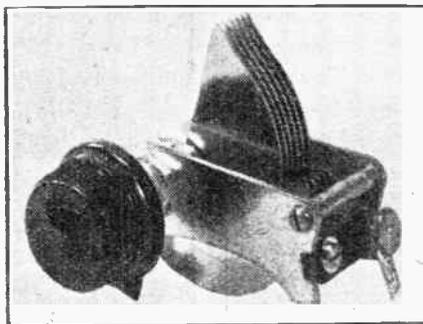

Astra reaction condenser

on a fibre block attached to the end plates. Terminals and soldering tags are supplied as is also a small insulated operating knob.

The capacity range, as measured in our laboratories, extended from .000139 to .00001 microfarads, values particularly suitable for reaction purposes. One-hole fixing, of course, is provided. Smoothness of motion and efficiency of design should make this component an attractive proposition.

Claude Lyons "Humdinger"

WE have just tested a gadget known as a "Humdinger," marketed by Messrs. Claude Lyons & Co. This resistance of about 8 ohms, wound on a strip of fibre, attached to which is a small sliding contact, operated by rotating a small screw. It is thus, in effect, an 8-ohm potentiometer, the purpose of which is to obtain a centre tap on 4-volt windings on A.C. sets, for the connection of cathodes of the independently-heated valves, or for the return of

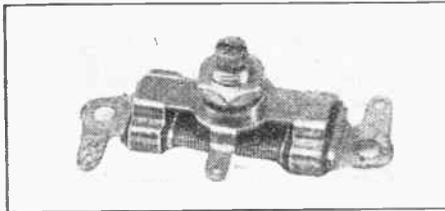

Claude Lyons "Humdinger"

H.T. negative in the case of directly-heated valves. On a 4-volt winding this gadget will, of course, take half an amp, but there is no reason why it should not be used on some of the 7.5-volt filaments which we employ in this country, provided the transformer is capable of supplying the additional current (1 ampere in this case).

**LET "A.W." SOLVE YOUR
WIRELESS PROBLEMS.**

When you
see



specify

OHMITE

Anode Resis-
tances. All values,
100 ohms to
500,000 ohms.

2/3
each



MEGITE

Grid Leak. All
values, 1 megohm
to 5 megohms.

2/-
each

Ohmite and Megite Resistances are constant in value, of negligible self capacity and non inductive. Dead silent and always reliable, they provide the most effective resistance on the market, giving the full range of values required. Supplied with vertical or horizontal holders of superior brown bakelite construction 6d. extra.

Graham Farish components carry a written guarantee of accuracy.

**GRAHAM FARISH
LIMITED. . . . BROMLEY, KENT**

"HOW A CRYSTAL SET WORKS"

(Continued from page 200)

sometimes sufficient to by-pass the high-frequency current to earth.

The simple circuit of Fig. 2 is shown as a theoretical diagram at Fig. 3. Those who do not clearly understand circuit

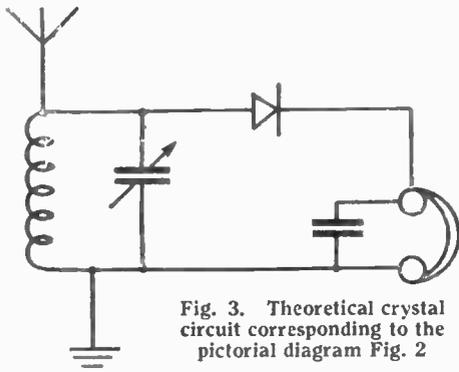

Fig. 3. Theoretical crystal circuit corresponding to the pictorial diagram Fig. 2

diagrams will find a detailed comparison between Figs. 2 and 3 of some assistance.

In these days of high-power regional transmissions, we have to make crystal sets fairly selective, so that the two programmes

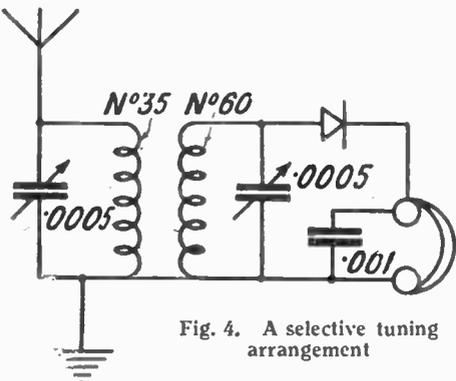

Fig. 4. A selective tuning arrangement

can be heard without interference. Fig. 4 shows the standard two-circuit tuning arrangement for obtaining selectivity. There is a cheaper way of achieving equally satisfactory results, as shown by Fig 5.

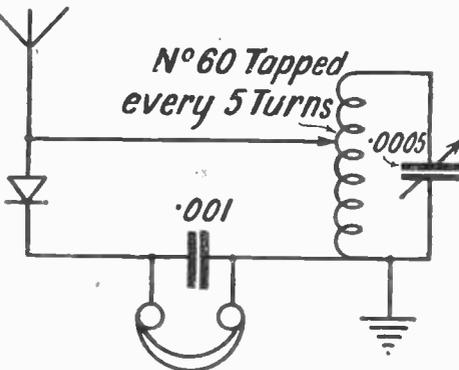

Fig. 5. Another selective tuning system

Here a solenoid coil of say 60 turns, wound with 20-gauge wire on a 2 1/2-inch diameter former, is tapped at every five turns. The aerial is joined to one side of the crystal and this point of connection is taken to one of theappings on the coil. In this way the crystal detector circuit is shunted across only a part of the total tuning circuit. At the same time the aerial and earth are across the same part of the tuner.

The Easy Way TO PERFECT RADIO

CASH or H.P. TERMS

The following list is merely representative and we ask you to fill in the coupon or send us a list of your requirements for a quotation by return.

HERE YOU CAN CHOOSE THAT POPULAR ACCESSORY YOU WANT

Send **11/-** Only **ATLAS H.T. ELIMINATOR AND CHARGER**, Model 188 for A.C. Mains. Cash Price **£3 0 0**. Balance in 11 monthly payments of **11/-**

Send **10/9** Only **REGENTONE W.5 COMBINED H.T. ELIMINATOR AND TRICKLE CHARGER**, One S.G., 1 variable, and 1 fixed tapping for H.T. L.T. charging for 2, 4, and 6 volts. For A.C. mains. Cash Price **£5 17 6**. Balance in 11 monthly payments of **10 9**

Send **8/6** Only **EXIDE 120-VOLT WH. TYPE ACCUMULATOR**, in crates. Cash Price **£4 13 0**. Balance in 11 monthly payments of **8 6**

Send **6/5** Only **LAMPLUGH or FARRAND INDUCTOR SPEAKER**, for perfect reproduction. Unit and chassis complete, ready mounted. Cash Price **£3 10 0**. Balance in 11 monthly payments of **6 5**

Send **7/9** Only **BLUE SPOT MODEL 51R CABINET SPEAKER**. Cash Price **£4 4 0**. Balance in 11 monthly payments of **7 9**

Send **7/9** Only **EPOCH PERMANENT MAGNET SPEAKER** with type B4 unit only. Cash Price **£4 4 0**. Balance in 11 monthly payments of **7 9**

Send **9/2** Only **CELESTION D.12 LOUD-SPEAKER**. An entirely new model in oak. Cash Price **£5 0 0**. Balance in 11 monthly payments of **9 2**

Send **7/6** Only **STANDARD WET H.T. BATTERIES**, 144 volts, 20,000 m/A. Cash Price **£4 2 0**. Balance in 11 monthly payments of **7 6**. Other voltages and capacities available, detailed prices on application.

Send **39/6** Only **THE ADAPTAGRAPH**—the instrument which converts your existing radio receiver into a modern radio-gramophone. Garrard gramophone motor, B.T.H. pick-up and tone arm and Frost volume control included. Takes any set up to a panel size 21 in. by 8 in., or baseboard depth 16 in. Cash Price **£11 19 6**. Balance in 11 monthly payments of **20/-**

Send **9/-** Only **B.T.H. PICK-UP, TONE ARM, and VOLUME CONTROL** complete. Cash Price **£2 9 6**. Balance in 5 monthly payments of **9/-**

MANUFACTURERS' KITS

Send **10/-** Only **COSSOR EMPIRE MELODY MAKER KIT**, 1931 model, S.G., detector and power. Cash Price **£6 17 6**. Balance in 11 monthly payments of **12 9**

Send **23/6** Only **1931 OSRAM MUSIC MAGNET KIT**, two S.G., detector, and power. Cash Price **£11 15 0**. Balance in 12 monthly payments of **18 6**

Send **10/6** Only **DYNAPLUS SCREENED THREE KIT**, S.G., detector, and power. Cash Price **£5 14 6**. Balance in 11 monthly payments of **10 6**

Send **12/9** Only **LISSEN S.G. THREE KIT**, S.G., detector, and power. Cash Price **£6 19 0**. Balance in 11 monthly payments of **12 9**

Send **14 8** Only **MULLARD 1931 ORGOLA THREE-VALVE KIT**, S.G., detector and power. Cash Price **£8 0 0**. Balance in 11 monthly payments of **14/3**

All above Kit Prices include valves and cabinet.

THIS ITEM—C.O.D. SIMPLY PAY POSTMAN

IMMEDIATE DELIVERY

PILOT AIR CHROME SPEAKER
Incorporating the famous Ultra "K"
Chassis Air Chrome, 14 in. by 14 in. Oak **57/6**

ALL ORDERS CARRIAGE PAID

PETO-SCOTT CO. LTD.

LONDON: 77 City Road, E.C.1 Phone: Clerkenwell 0406-7-8. 62 High Holborn, W.C.1 Phone: Chancery 8266. MANCHESTER: 33 Whitelaw Road, Chorlton-cum-Hardy. Phone: Chorlton-cum-Hardy 2028. NEWCASTLE, STAFFS: 7 Albany Road.

SEEN OUR CATALOGUE P describing ALL THE LEADING MAKERS' Receivers, Components, Radio Gramophones, Pick-ups, etc. A veritable guide to Radio. Get your copy to-day.

FREE PLEASE SEND ME YOUR:
(a) EASY WAY CATALOGUE.
(b) PILOT RADIO CHART.

NAME _____
ADDRESS _____

A.W., 11.31

REPAIRS ANY MAKE

of L.F. Transformer, Loudspeaker (except Blue Spot) or Headphones repaired and despatched within **48 HOURS. TWELVE MONTHS' GUARANTEE** with each repair, 4/- Post Free. Cash with Order.

Terms to Trade.
TRANSFORMER REPAIR CO.

Dept. S.953,
GARRATT LANE,
LONDON, S.W.17.

DOES YOUR SWITCH SPINDLE TURN ROUND ?

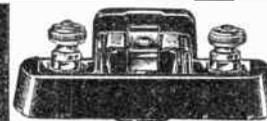

IF SO, YOUR SET "CRACKLES!"

BY FITTING A

"BUSCO" SWITCH

your trouble is ended because there is no contact point to turn round, and when you "switch on" you have contact like a power switch.

WHY NOT FIT ONE?
They are as cheap as the inferior type but far superior in operation. From your local dealer, or

1/3

inch

Patents Pending

BUSBY & CO., LTD. (Patentees)
Dept. A.W., PRICE ST., BIRMINGHAM

"A.W." SOLVES YOUR PROBLEMS

The HEART OF A GOOD SPEAKER

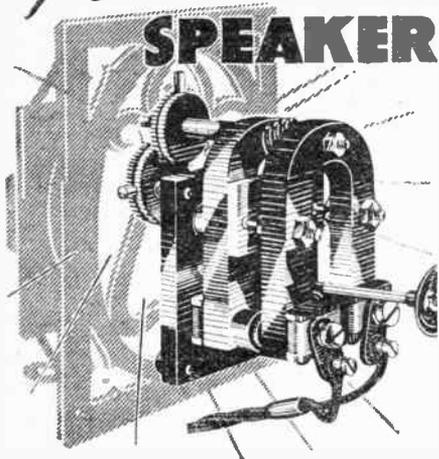

No matter how good your set may be, everything depends upon the reproducing unit. The **Wates Star Unit** fitted in place of any other in your speaker, immediately gives a realism and clear cut definition to music and speech that is a delight to hear. No resonance or boom—cannot be overloaded and fitted with exclusive double adjustment, 2 magnets, four coils and laminated pole pieces.



The Wates is recognised as the finest unit on the market—now available at the reduced price of **25/-**

Fit yours to-day. Obtainable from all Radio Dealers. Leaflets from:

THE STANDARD BATTERY CO., (Engl. A.W.)
194 138 Shaftesbury Avenue, London, W.C.2.



KAY'S CABINETS "THE INVICTA" RADIO GRAMOPHONE CABINET

For Panels 16" x 7". Removable Motor Board for 12" Turntable with 3" clearance for Pick-up, and 12" clearance for Motor. Speaker Chamber 18" square with artistic Grille front, and independent 7-ply inner Baffle; hole cut to requirements. The whole of back of Cabinet is removable. Height 26", width 21", depth 16". Sturdily constructed of Oak, and polished Jacobean shade. A wonderful example of value. Returnable crate 5/- Price **45/-**

Illustrated Lists of 60 Cabinets FREE.

H. KAY, Cabinet Manufacturer, Mount Pleasant Road, LONDON, N.17. Phone: Walthamstow 1626

OUR BLUEPRINT SERVICE

Constructors of receivers described in this Journal should make full use of our Blueprint Service and avoid all risk of failure.



A CAST of some fifty artistes will take part in the broadcast of Christopher Marlowe's play *Edward the Second* on January 29 (Regional) and January 30 (National).

Ernest Longstaffe, the author of *Little Red Riding Hood*, the B.B.C. pantomime which listeners heard last Christmas, has prepared a revue entitled *Bumpkin Pie*, for broadcast on February 4 (Regional) and February 6 (National)

A Welsh play in four acts by J. O. Francis, entitled *The Beuten Track*, will be broadcast from Cardiff on February 12.

Manchester and Leeds listeners are to hear their third and last relay of the present pantomime season on February 7, when excerpts from *Jack and the Beanstalk*, lasting two hours, will be given from the Theatre Royal, Leeds.

The orchestral concert for the Northern Region, which will be broadcast on February 1, will be notable for the appearance of Robert Easton.

The Duke of Gloucester's speech at the British Industries Fair banquet will be relayed from the Guildhall to London Regional listeners on February 16.

Leonard Henry and Ann Penn are in the vaudeville "bill" from London Regional on February 3 and National on February 7. Joseph Fiers will play piano-accordion solos and the Three Ginx are also taking part. A Philip Wade sketch, entitled *Martyrs*, completes the programme.

On February 2 the Glazebury Prize Band will be relayed from Manchester to London Regional; on February 6 the Wallsend United Collieries' Band will also be relayed to the Regional transmitter, this time from Newcastle, while on February 10 the Durham Shakespeare Temperance Silver Prize Band will be heard by London Regional listeners.

Scenes from the hunting novel, *Handley Cross*, by R. S. Surtees, will be broadcast on January 26 from London Regional, under the title of *The Jerrock's arrival at Handley Cross*.

The popular concert given by the National Orchestra of Wales in the Park Hall, Cardiff, on February 8, will be relayed by Cardiff from 9.5 to 10 p.m.

Mr. J. T. Halliday's talk on February 2 deals with "An Old Ship's Log." The ship's logs contain a wealth of adventure and romance for those who are able to interpret them.

On February 2 a running commentary will be broadcast on the contest for the fly-weight championship of Great Britain between Bert Kirby and Jackie Brown. This boxing contest will be staged at Belle Vue, Manchester.

The weekly concert at the City Hall, Cardiff, will be given on February 14 at 7.45 p.m. and relayed until 9 p.m. Joyce Haydon-Bull will play "Nights in the Gardens of Spain," with the orchestra.



THE Watmel Pick-up carrier by its rigidity and accuracy of alignment ensures the electrical pick-up obtaining perfect amplification of the music only.

Reproduction is free from mush and needle scratch.

By use of the tracking template supplied, the Watmel Pick-up Carrier can be set affixed with great accuracy and the wear on the records is largely reduced.

PRICE 7s. 6d.

If you cannot get these Watmel products at your dealers, send remittance and order direct to us and the article will be dispatched by return.

THE WATMEL UNIVERSAL STANDARD ALUMINIUM SCREENING BOX

as specified for many of the popular receivers—

Size 6½" x 6½" x 6" with wooden box.

Price complete with screws etc. **4/6**

Special type with valve screening, **5/-**

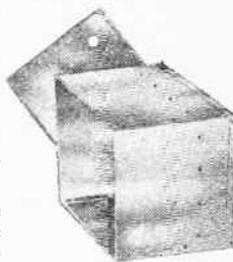

Write for the Blueprints of the T.31 S.G. Imperial Three Receiver. A new highly selective wide-range set. Simple to construct and easy to operate.

FREE TO CONSTRUCTORS.

Watmel

WATMEL WIRELESS CO., LTD., Imperial Works, High Street, Edgware

Telephone: EDGWARE 0323

M.C. 19

MORE RADIOGRAMS

BELFAST listeners will be glad to hear that outside theatre broadcasts will be resumed on February 19 in the shape of a turn by Elsie Griffin and Kingsley Lark, which will be relayed from the stage of the Empire Theatre.

A concert given by the Sutton Coldfield Musical Committee will be relayed from the Sutton Town Hall on February 9, when the City of Birmingham Orchestra will be conducted by Harold Gray.

Victor Hely-Hutchinson will appear in a programme given by the City of Birmingham Orchestra on February 12. Mr. Hutchinson, with Paul Beard and George Barrett, will play Bach's "Fifth Brandenburg Concerto in D major" for piano, violin, and flute.

The prison of the Conciergerie during the Terror is the scene of a little playlet in verse by Louis N. Parker entitled *Le Minuet*, which will be broadcast by the Midland Regional, on February 14.

Radio Maroc is to be transferred from Rabat (Morocco) to Bouznika and the power of the transmissions is to be raised to some 20 kilowatts in the aerial. Programmes, as hitherto, will be relayed from both the Rabat and Casablanca studios.

In a recent census taken in Germany to determine the cause of a loss of 40,000 wireless listeners in the course of some four months, it was found that of the total number who had omitted to renew their licences, 3.2 per cent. declared that they were dissatisfied with the programmes, 8.4 per cent. complained of poor reception in their districts, 3.5 per cent. of local interference and atmospherics, and 38.8 per cent. admitted that they could no longer afford the subscription. The balance was made up of losses due to death, illness, emigration or removal to other parts of Germany.

Russia, in furtherance of the famous Five Year Plan, proposes to build within the next three years eleven 100- and thirty-eight 10-kilowatt radio transmitters. Work has already started on the erection of a 500-kilowatt station at Noghinsk in the neighbourhood of Moscow and plans have been prepared for the installation in its vicinity of a 60-kilowatt (aerial) short-wave transmitter. The new Kolpino 75-kilowatt station destined to broadcast the Leningrad programmes will shortly come into operation.

Leipzig and Gleiwitz have again exchanged wavelengths and the latter is now working on 253 metres, much to the satisfaction of listeners to the London National programme.

It is stated in Paris that Senator Paul Dupuy, the Director of the daily newspaper *Le Petit Parisien*, intends to build a broadcasting station at Pau, in the lower Pyrenees.

A talking beacon—the first of its kind—has now been set up at Little Cumbrae Lighthouse, on the Firth of Clyde, and promises to be of material benefit to navigation during fog. The range of the talking beacon for direction-finding is about 8³/₄ miles, with a wavelength of 1,044 metres and a power of about 40 watts.

It's So Easy

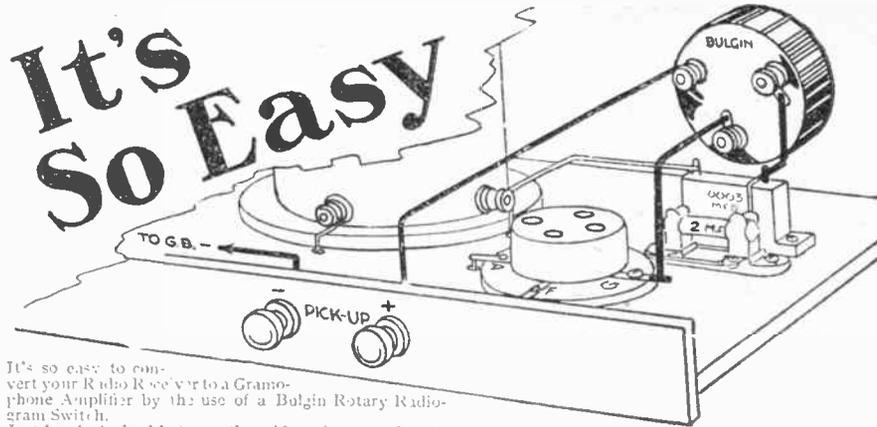

It's so easy to convert your Radio Receiver to a Gramophone Amplifier by the use of a Bulgin Rotary Radiogram Switch. Just break the lead between the grid condenser and grid of valve. Connect centre point of switch to grid connection of valve holder. Then connect one outer switch terminal to grid condenser and the other to the - pick-up terminal. The - pick-up terminal goes to -24 volts on the G.B. battery.

ROTARY RADIOGRAM SWITCH

Fully insulated, snap action, enclosed in bakelite mouldings. Permits pick-up to be permanently connected. With indicating frame, 2/-.



PRICE 2/-



Send now for our 60-page Catalogue. Enclose 2d. postage.

A. F. BULGIN & Co., Ltd.,

9-10-11, CURSITOR STREET, CHANCERY LANE, LONDON, E.C.4
Telephones: Holborn 1072 & 2072

CLARION

and the

"1931 ETHER SEARCHER"

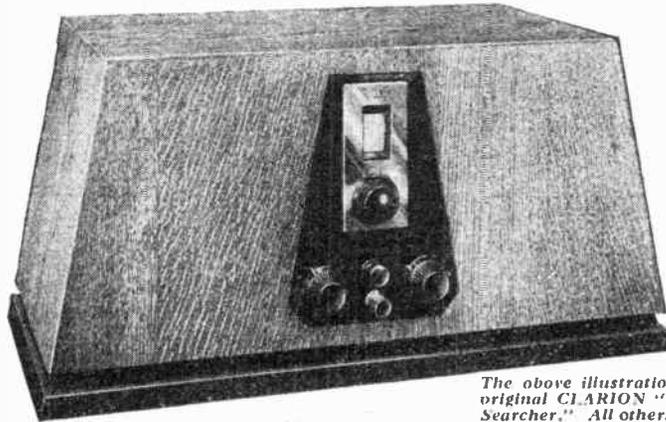

The above illustration is of the original CLARION "1931 Ether Searcher." All others are copies

At the request of Mr. Sieger we specially designed the Specified Cabinet as illustrated above.

A SUPER CABINET FOR A SUPER SET

Insist on Clarion. See the name Clarion on the back of every genuine Clarion Cabinet.

Wax polished Oak with black cellulose base,

TRADE SUPPLIED

CLARION
Radio Furniture

21/-

28-38 Mansford Street, London, E.2
Telephone - - - Bishopsgate 6371

Carriage Paid or sent C.O.D.



ELECTRADIX BARGAINS MICROPHONES

Home and Public Address Transmitters within the reach of all radio users.



Sensitive Solo Pendants in cast metal case with cord 4.6. Pulpit Pedestal 12.6. Ring Pedestal Broadcaster 18.6. Hand W/T Mikes. 15/- and 65/-. Western Electric £28. Transformers, Microphones, Compilers, Valve Amplifiers for Baud Repeats or Field P.A. work.

Switchgear. Our enlarged Switchboard department can now build anything to specification up to 100 ft. long. Send us your enquiries for METERS, Portable, Laboratory or Switchboard, A.C. and D.C. RELAYS for all purposes, battery cut-outs for automatic safety. **Dynamos;** 4 volts to 4,000 volts D.C. **Alternators;** 10 volts to 10,000 volts A.C. **Motor Generators,** and Converters of all sizes.

DIX-ONEMETERS are now 50/- only, a remarkably small price for a meter worth £10 in comparison with others.

Latest Model. Mirror Double Scale, Moulded Base. The finest Precision Multi-Measuring instrument is the DIX-ONEMETER, the acknowledged Radio Standard beloved by Expert and Amateur.

Test Booklet "A" Free.

ELECTRADIX RADIOS
218 Upper Thames Street, E.C.4.
Telephone: City 0191.

1st CLEARERTONE 2/-
2nd FIVE-PIN 1/9
3rd VIBROIDER 1/6

Benjamin Valveholders are sure of a place.
Send for Catalogue No. 1142.

The **BENJAMIN ELECTRIC LTD.**
Tariff Road, Tottenham, N.17.

BENJAMIN

"WIRELESS MAGAZINE"
THE BEST MONTHLY

Postcard Radiō Literature

Electrify Your Transportable

REGENTONE suggest—and rightly, I think—that you get greater economy with your transportable if you work it from the mains. They have just sent me a folder, which you should have, giving details of the way in which you can work your portable or transportable set from any type of lighting mains. **167**

Readi-Rad

I have just received a new illustrated catalogue from Readi-Rad. This is an extraordinarily well got up booklet which should be in the hands of everyone who is on the lookout for a new set or speaker. You can obtain a copy of this free through my Catalogue Service. **168**

A New Mullard Valve

You probably know that the Mullard Wireless Service Co., Ltd., have just brought out a new battery-operated power valve, the PM2A. I have just been looking at a leaflet issued by Mullard giving full particulars of this valve. You should have this for your valve file. **169**

Realism

Bel-Canto Radio have just sent me a good little illustrated catalogue describing the latest radio-gramophones and Bel-Canto speakers. The speakers incorporate the Bel-Canto specially balanced armature unit which can be obtained separately or with a 12-in. or 14-in. cone and chassis. **170**

A New List

You would be well advised to make a point of writing for the new 1931 list of Burton parts. On just casually looking through this I see some favourites such as Burton variable condensers, valve holders and switches, and many new sets and components. The Burton Empire-Two is included, of course. **171**

A.C. Users

Ferranti, Ltd., have just sent me a booklet giving particulars of the two latest mains-driven Ferranti sets, models 31 and 32. These are three-valvers incorporating an S.G. stage, and capable of delivering as much volume as the average man is ever likely to require. **172**

OBSERVER.

GET THESE CATALOGUES FREE.

Here "Observer" reviews the latest booklets and folders issued by well-known manufacturers. If you want copies of any or all of them **FREE OF CHARGE**, just send a postcard giving the index numbers of the catalogues required (shown at the end of each paragraph) to "Postcard Radio Literature," "AMATEUR WIRELESS," 58-61, Fetter Lane, E.C.4. "Observer" will see that you get all the literature you desire.

WIRE AND FORGET WITH CLIX

You have only to wire a "CLIX" Fitment **once** because the **Clix Patent Wiring Device** makes perfect and lasting contact.

Avoid inferior substitutes.

Look at the illustrations below—see how the insulator when screwed down adds—to firmness of contact.

Note how the wire is firmly clamped into the metal by the insulator.

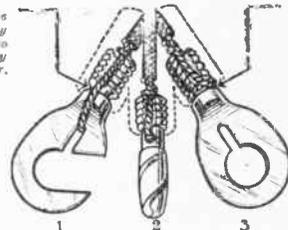

Note the definite grooves or channels giving perfect metal to metal contact.



"SPRING-SCREW" WANDERING PLUG 2d.
No. 8. Pat. Pro. Pat. Reg. Design.

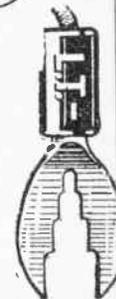

"Fit-all" Spade Terminal 2d.
No. 3 Pat.

Write for Illustrated List of Clix 27 aids to perfect contact.

LECTRO LINX LTD.,
254 Vauxhall Bridge Road, S.W.1

VOXKIT JUNIOR (Reg. Design)

The Console Cabinet shown here takes panels up to 18" x 8". Baseboard up to 12". Speaker chamber 18" x 15" x 12". Height 3 ft.; removable back, lift-up lid and silk-covered fret, best French polished figured oak. Packed and delivered free in England and Wales. Price 45/-. 6 monthly payments of 7/11. Any speaker fitted for cost of speaker only.

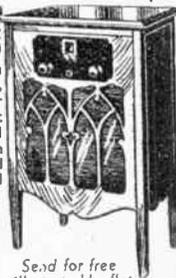

As above fitted with Swiss Single Spring motor and 10 in. Turntable and Water Pick-up and Tone Arm and volume control Cash Price £4.15.0

12 monthly payments of 8/8

Send for free illustrated leaflet

As above but fitted with Garrard Double Spring motor, 12in. Turntable, B.T.H. Pick-up and Tone Arm with Volume Control. Cash Price £6.15.0

12 monthly payments of 12/4

As above but fitted with AIR CHROME type "K" Chassis and Unit. Cash Price £9.7.0

12 monthly payments of 17/11

Supplied ready to take the 1931 **ETHER SEARCHER** at the same price.

VOXKIT RADIOGRAM As above with Motor, Pick-up and Volume Control. Carriage free. From £4.15.0.

PETO SCOTT CO. LTD.
77 CITY ROAD, LONDON, E.C.1
62 HIGH HOLBORN, LONDON, W.C.1

MACNUM
ALL THAT IS BEST IN RADIO COMPONENTS SETS ETC.

BURNE-JONES & CO. LTD.
107, BORO' HIGH ST. LONDON E.C.1

Let "Amateur Wireless" solve your problems

TWO WONDERFUL VALVES

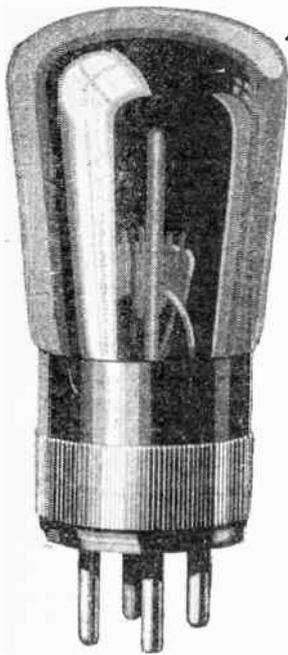

*Highest Efficiency
Lowest Price!*

SUPER-DETECTOR

Slope ... 2 Ma/V
Mag. Factor 15
Fil. Current 0.15 **6/6**

HYPER-POWER

(2-volt)
Slope ... 2.3 Ma/V
Mag. Factor 5
Fil. Current 0.3 **8/-**

*Steep Slope, low impedance,
splendid volume, beautiful tone.
Wonderful reproduction of the
bass notes.*



Best way to all Stations

Ask your dealer or write for
free folder to:—

IMPEX ELECTRICAL LTD.
Dopt. J,
538 High Road, Leytonstone, E.11

W. Barn

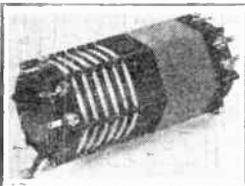

"RECTOR" DUAL WAVE COIL

A well constructed coil covering 180 to 2,000 metres.
Air spaced windings on low-loss ebonite former 12"
long. For horizontal or vertical baseboard mounting.
Terminals or Tags for contacts. PRICE 6/-
AUTO SELECTOR. A wonderful station separator. 2/
WATTS. Non-corrosive Taps. Plates. For L.T. and
H.T. 6d. per pair. All goods Post Free
KINGSGATE SUPPLY CO.,
56, Bromfield Rd., London. S.W.4.

AMATEUR WIRELESS NOTEBOOK DIARY for 1931

This handy and compact reference book, which
will be of assistance on many occasions during
1931, should be kept within easy reach by
every wireless amateur. Here are some of the
contents:—

- Conventional Symbols used in Wireless.
- Technical Contractions.
- Aerials and Earths.
- Frame Aerials.
- Wavelength Frequency Tables.
- Notes on Accumulator Upkeep.
- Coil-winding Data.
- Useful Formula Section.
- Calculating Condenser Capacities.
- List of World's Short-wave Stations.
- Choosing Your Valves.
- Valve Tables.
- Glossary and Definitions of Wireless
Terms.

The "Amateur Wireless" Diary can be obtained at Book-sellers
for 1/6 (cloth) and 2/6 (leather), or by post (2d. extra), from
"Amateur Wireless," 58-61 Fetter Lane, London, E.C.4



Have you got your copy of "The ALL-METAL WAY"?

THIS booklet gives complete
instructions for building high-
and low-tension eliminators; and
there are chapters on Alternating
Current and Rectification, Types
of Electricity Supply, High-
Tension Trickle Charging, Low-
Tension Trickle Charging, Moving
Coil Loud Speakers, General
Principles and Methods of Rectifi-
cation, Smoothing, Transformers
for Eliminators, Voltage Doubler
Circuit, Voltage Dropping, Types
of Rectifiers, etc.

If you are building an all-mains set,
send for this forty-page booklet—
the Coupon, together with 3d. in
stamps, will bring it to you by
return of post. Or if you intend
buying an all-mains receiver, make
sure that it incorporates the



METAL RECTIFIER

**THE WESTINGHOUSE BRAKE & SAXBY
SIGNAL CO., LTD.**

82, York Rd., King's Cross, N.1

Telephone - North 2415

The Westinghouse
Brake & Saxby
Signal Co., Ltd.,
82, York Road,
King's Cross, N. 1

*Please send
me your 40-
page booklet,
"The All-
Metal Way,
1931."*

*I enclose 3d.
in stamps.*

PLEASE WRITE IN BLOCK LETTERS

Name.....

Address.....

A.W. 31.1.31

Please Mention "A.W." When Corresponding with Advertisers



Blueprint Numbers

SIR.—I have often wondered why it is that certain blueprints are periodically omitted from your printed lists. In my case I have one of your older designs of sets which, by the way, is giving entire satisfaction. The blueprint of this set has long been omitted from your lists and I have wondered whether this has been due to the receiver not giving the satisfaction originally professed and anticipated. In my case the receiver is giving me entire satisfaction, possibly because I adhered strictly to specifications, but there must be some concrete reason for omitting this set from your list. Can you enlighten me?

F. R. (Cornwall).

The reason for omitting certain print numbers from our lists is mainly that the issues of our journal describing the actual constructional details of these sets are out of print. For the benefit of those readers who have built certain receivers which have been very popular and who require to replace prints and obtain certain constructional matter, we have instituted a service through our blueprint department which enables readers to obtain the blueprints and a typewritten sheet giving all of the salient points relating to the construction of the receiver. We withdraw the print from our list, however, in order that readers who see the particular title and order the number from this office do not get disappointed with regard to the issue describing it.—Ed.

It is possible on any good two- or three-valve short-wave set to pick up the American station, 2XAF regularly from 11 p.m. onwards on a weekday and from 7 p.m. onwards on Sundays, on the speaker. Reception certainly does vary and fading occurs at times, but at the present time it is even possible to pick up American stations on the ordinary broadcast band. To do so requires rather critical tuning and some interference from European stations is likely to be experienced, but such reception merely goes to prove that ultra-short wave results are definitely to be expected and are not an occasional possibility.—Ed.

Pentodes and Super-power Valves

SIR.—I have a super-power valve in my set and, although volume is good, it has been suggested to me that fitting a pentode will give me more volume. Can you advise me whether this is correct or not?

W. S. (Surrey).

A pentode valve does not give, and is not designed to give, more power output from a given input signal than is possible from a power or super-power valve. The pentode valve is essentially a power amplifying valve which gives a large volume output from a small input signal. If the input signal is large, then it will overload the pentode. A super-power valve would be able to handle this large signal and, what is more, give a greater output energy for working a large speaker. If you have only a weak signal from the detector and you wish to amplify it for working a speaker, then a pentode valve is to be advised. In your case we do not think you will gain any advantage by using a pentode.—Ed.

Good Service

SIR.—At various times I have noticed in the correspondence columns of AMATEUR WIRELESS reference has been made to the prompt manner which reputable firms have dealt with components. Some three weeks ago my Wates Star speaker unit became poor in its reproduction and on examination it was found to have an internal disconnection—not through any fault of construction, but more, I think, through rough usage. However, it was returned to the Standard Battery Co. for repair. A few days ago I received a new unit in place of my old one free of any charge.

F. C. (Dover).

Safety Fuses and L.F. Howling

SIR.—Quite recently I burnt out three valves in an accident and so decided to introduce a flashlamp fuse in my set to reduce the chances of further trouble of this kind. I now find that with the fuse in position, the receiver howls terribly, but as soon as I bridge the terminals of the fuseholder everything is quite in order. Can you explain why this howling should occur and how it can be overcome?

J. A. (Northampton).

The fuse you are using has a high resistance, and owing to being inserted in the common negative H.T. lead it introduces a common resistance in the battery supply circuit. This gives rise to back-coupling between the valves through the H.T. supply. Replace the fuse with another type which has a low resistance.—Ed.

Short-wave Reception

SIR.—I have often wished to listen to American short-wave stations, but have not yet attempted to build a short-wave set owing to the apparent uncertainty of being able to pick up the short-wave transmissions at definite listening periods. Some of my friends tell me they have listened during many evenings and have never heard an American station after hours of searching. Can you tell me whether this is a common experience and whether it is worth while trying for the short waves.

D. R. (Norwood).

Mühlacker Interference

SIR.—Since the new station at Stuttgart has been interfering with the London station's transmission I have noticed a peculiar effect in reception. It takes the form of excessive sibilants in speech and seems not only to be common with the reception from the German station, but also comes over with the London station's transmission. Of course, the trouble is much more pronounced when the set is actually tuned to the German station. Can you account for this and also for the fact that sometimes interference from the German station is not so bad as at other times?

A. G. (Woking).

Preponderance of the sibilants in reception is mainly due to over modulation at the transmitter and, in the case of the new Mühlacker station, it has been proved that this station allows greater modulation than is generally the practice at our own broadcasting stations. We learn on good authority that the authorities at the new German station were recently asked, for experimental purposes, to reduce their modulation to within certain limits. Reports were then received that less interference was experienced with the reception of London station's programme. The fact that the interference, at times, is not so troublesome as at other times seems to be accounted for by the varying of the modulation of the German station by their control engineers.—Ed.

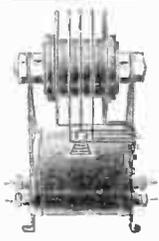

CHARGE YOUR OWN BATTERIES

Eliminate trouble, expense and delay by charging your own batteries, instead of sending them out. You can do it at home cheaply, quickly and efficiently with

HEAYBERD COMPLETE BATTERY CHARGER

Model A.O.2, charging 2-6 volts at 0.5 amp. 32/6
 Model B.O.3, charging 2-6 volts at 1 amp. 52/6
 — Incorporating Westinghouse Rectifiers —

HEAYBERD

10 Finsbury Street, London, E.C.2

WIRELESS IS THE WORLD'S FINEST HOBBY!

MAKE IT A PROFITABLE ONE

Save Money!
 Make Money!
 No Outlay!

JOIN THE ELECTROJET CLUB

EVERY WIRELESS AMATEUR EXPERIMENTER, CONSTRUCTOR,

Should write his name and address in the margin and post this advertisement in a gd. unsealed envelope to:—

THE ELECTROJET CLUB

POPLAR ROAD, SOLIHULL, BIRMINGHAM

(Promoted and controlled by the Electrojet Radio Co.)

BROADCAST TELEPHONY

Broadcasting stations classified by country and in order of wavelengths. For the purpose of better comparison, the power indicated is *aerial energy*.

| Metres | Kilo-cycles | Station and Call Sign | Power (Kw.) | Metres | Kilo-cycles | Station and Call Sign | Power (Kw.) | Metres | Kilo-cycles | Station and Call Sign | Power (Kw.) |
|------------------------|-------------|-------------------------|-------------|------------------|-------------|--------------------------|-------------|-------------------------|-------------|-------------------------|-------------|
| GREAT BRITAIN | | | | | | | | | | | |
| 25.33 | 11,751 | Chelmsford (G5SW) | 15.0 | 204.6 | 1,019 | Limoges (P.T.) | 0.5 | 363.4 | 825.3 | Algiers (P.T.) | 13.0 |
| 200 | 1,500 | Leeds | 0.16 | 304 | 988 | Bordeaux (P.T.) | 35.0 | 410 | 721 | Radhu Marro (Rabat) | 10.0 |
| 242 | 1,238 | Belfast | 1.2 | 315 | 952 | Natan-Vitus (Paris) | 0.5 | 1,250 | 240 | Tunis Kasbah | 0.6 |
| 261.3 | 1,148 | London Nat. | 68.0 | 317.3 | 945 | Marseilles (P.T.) | 1.5 | NORWAY | | | |
| 268.5 | 1,040 | Newcastle | 1.2 | 328.2 | 914 | Grenoble (P.T.) | 1.2 | 235.5 | 1,275 | Kristiansand | 0.5 |
| 268.5 | 1,040 | Swansea | 0.16 | 329.5 | 910.3 | Poste Parisien | 1.2 | 240.6 | 1,247 | Stavanger | 0.5 |
| 268.5 | 1,040 | Stoke-on-Trent | 0.16 | 345.2 | 869 | Strasbourg (P.T.) | 12.0 | 361 | 824 | Bergen | 1.0 |
| 268.5 | 1,040 | Sheffield | 0.16 | 370 | 810.5 | Radio L.L. (Paris) | 0.5 | 367.1 | 817.1 | Frederiksstad | 0.7 |
| 268.5 | 1,040 | Plymouth | 0.16 | 417 | 779 | Radio Toulouse | 15.0 | 453.2 | 662 | Porsgrund | 1.5 |
| 268.5 | 1,040 | Liverpool | 0.16 | 466 | 671 | Paris (P.T.) | 2.0 | 493 | 665 | Nidaros | 1.2 |
| 268.5 | 1,040 | Hull | 0.16 | 1,445.7 | 207.5 | Eiffel Tower | 15.0 | 584.7 | 513.2 | Honm | 0.8 |
| 268.5 | 1,040 | Edinburgh | 0.4 | 1,725 | 171 | Radio Paris | 17.0 | 1,077 | 278.5 | Oslo | 73.0 |
| 268.5 | 1,040 | Dundee | 0.16 | GERMANY | | | | | | | |
| 268.5 | 1,040 | Bournemouth | 1.2 | 31.38 | 0,561 | Zeesen | 15.0 | 231 | 1,283 | Lodz | 2.2 |
| 268.5 | 1,040 | Bradford | 0.16 | 216.3 | 1,387 | Königsberg | 1.7 | 244 | 1,229 | Cracow | 1.5 |
| 301 | 995 | Aberdeen | 1.2 | 219 | 1,399.7 | Flensburg | 0.6 | 312.8 | 959 | Wilno | 0.5 |
| 309.9 | 968 | Cardiff | 1.2 | 227 | 1,319 | Cologne | 1.7 | 338.1 | 887.1 | Poznan | 1.9 |
| 356.3 | 842 | London Reg. | 43.0 | 227 | 1,319 | Munster | 0.6 | 381 | 788 | Lvov | 2.2 |
| 376.4 | 797 | Manchester | 1.2 | 227 | 1,319 | Aachen | 0.3 | 409.8 | 732 | Katowice | 16.0 |
| 398.9 | 752 | Glasgow | 1.2 | 232.2 | 1,292 | Kiel | 0.31 | 1,311 | 212.5 | Warsaw | 14.0 |
| 479.2 | 626 | Midland Reg. | 38.0 | 239 | 1,259 | Nurnberg | 2.3 | PORTUGAL | | | |
| 1,554.1 | 193 | Daventry (Nat.) | 35.0 | 246.4 | 1,217.2 | Cassel | 0.3 | 240 | 1,250 | Oporto (Teatro Apollo) | 0.25 |
| AUSTRIA | | | | | | | | | | | |
| 218.5 | 1,372 | Salzburg | 0.6 | 253.4 | 1,184 | Leipzig | 2.3 | 320 | 937.6 | Lisbon (CTIAA) | 0.25 |
| 246 | 1,220 | Linz | 0.6 | 259.3 | 1,157 | Gleitwiz | 5.6 | ROMANIA | | | |
| 283.0 | 1,053 | Innsbruck | 0.6 | 269.8 | 1,112 | Bremen | 0.3 | 301 | 761 | Bucharest | 16.0 |
| 351.7 | 853 | Graz | 9.5 | 276.5 | 1,085 | Heilsberg | 75.0 | RUSSIA | | | |
| 453 | 666 | Klagenfurt | 0.6 | 283.6 | 1,058 | Magdeburg | 0.6 | 427 | 702 | Kharkov | 4.0 |
| 517 | 581 | Vienna | 20.0 | 283.6 | 1,058 | Berlin (E) | 0.6 | 720 | 416.6 | Moscow (P.T.) | 20.0 |
| BELGIUM | | | | | | | | | | | |
| 206 | 1,456 | Verviers | 0.3 | 283.6 | 1,058 | Stettin | 0.6 | 800 | 375 | Kiev | 20.0 |
| 206 | 1,456 | Antwerp | 0.4 | 318.8 | 941 | Dresden | 0.3 | 824 | 394 | Sverdlovsk | 25.0 |
| 216 | 1,391 | Chateleau | 0.25 | 325 | 923 | Breslau | 1.7 | 870 | 344.8 | Tiflis | 15.0 |
| 243 | 1,235 | Courtrai | 0.1 | 360 | 833 | Muhlacker | 75.0 | 937.5 | 329 | Kharkov (RV20) | 25.0 |
| 244.7 | 1,226 | Ghent | 0.25 | 372 | 806 | Hamburg | 1.7 | 1,000 | 300 | Leningrad | 20.0 |
| 246.2 | 1,218.3 | Schaerbeek | 0.5 | 390 | 770 | Frankfurt | 1.7 | 1,103 | 272 | Moscow Popoff | 40.0 |
| 338.2 | 887 | Velthem (Louvain) | 12.0 | 418 | 716 | Berlin | 1.7 | 1,200 | 259 | Kharkov (RV4) | 25.0 |
| 500 | 590 | Brussels (No. 1) | 1.2 | 452.1 | 662 | Danzig | 0.2 | 1,304 | 230 | Moscow (Trades' Unions) | 165.0 |
| BULGARIA | | | | | | | | | | | |
| 319 | 941 | Sofia (Radio Radio) | 1.0 | 473 | 635 | Langenberg | 17.0 | 1,389 | 217.5 | Bakou | 10.0 |
| CZECHO-SLOVAKIA | | | | | | | | | | | |
| 263 | 1,139 | Moravska-Ostrava | 11.0 | 533 | 593 | Munich | 1.7 | 1,481 | 202.5 | Moscow (Kom) | 20.0 |
| 279 | 1,076 | Bratislava | 14.0 | 550.7 | 536 | Kaiserslautern | 1.0 | SPAIN | | | |
| 294 | 1,020 | Kosice | 2.5 | 559.7 | 519 | Augsburg | 0.3 | 251 | 1,193 | Barcelona (EAJ15) | 1.0 |
| 342 | 878 | Brunn (Brno) | 3.0 | 566 | 510 | Hannover | 0.3 | 268.7 | 1,116 | Barcelona (EAJ13) | 10.0 |
| 487 | 617 | Prague (Prah) | 5.5 | 570 | 527 | Freiburg | 0.33 | 349 | 850 | Barcelona (EAJ11) | 8.0 |
| DENMARK | | | | | | | | | | | |
| 281 | 1,067 | Copenhagen | 1.0 | 1,635 | 183.5 | Zeesen | 35.0 | 368 | 815 | Seville (EAJ5) | 1.5 |
| 1,153 | 260 | Kalundborg | 10.0 | 1,635 | 183.5 | Nordleich | 10.0 | 425.7 | 704.7 | Madrid (EAJ7) | 2.0 |
| ESTONIA | | | | | | | | | | | |
| 401 | 748 | Reval (Tallinn) | 0.7 | HOLLAND | | | | | | | |
| 412.1 | 649 | Tartu | 0.5 | 31.28 | 0,569 | Eindhoven (PCJ) | 30.0 | 299 | 1,004 | Huizen | 8.5 |
| FINLAND | | | | | | | | | | | |
| 221 | 1,355 | Helsinki | 15.0 | 299 | 1,004 | Radio Klerda (The Hague) | 0.6 | 1,071 | 280 | Scheveningen-Haven | 5.0 |
| 260.5 | 1,032.8 | Tampere | 15.0 | 1,875 | 160 | Hilversum | 8.5 | 1,875 | 160 | Hilversum | 8.5 |
| 1,796 | 167 | Lahti | 54.0 | 550 | 545 | Budapest | 23.0 | HUNGARY | | | |
| FRANCE | | | | | | | | | | | |
| 172.5 | 1,739 | St. Quentin | 0.3 | ICELAND | | | | | | | |
| 222.9 | 1,346 | Fecamp | 1.0 | 1,200 | 250 | Reykjavik | 10.0 | IRISH FREE STATE | | | |
| 235.1 | 1,275 | Nimes | 1.0 | 224.5 | 1,317 | Cork (IFS) | 1.5 | 413 | 745 | Dublin (2KN) | 1.5 |
| 237.2 | 1,263 | Bordeaux-sud-Ouest | 2.0 | ITALY | | | | | | | |
| 240.8 | 1,246 | B'ziers | 0.6 | 25.4 and 80 | | Rome (3RO) | 9.0 | 244 | 1,229 | Basle | 0.5 |
| 249 | 1,205 | Juan-les-Pins | 0.5 | 296.1 | 1,013 | Turin (Torino) | 8.5 | 403 | 743 | Berne | 1.1 |
| 256 | 1,171 | Toulouse (P.T.) | 1.0 | 313.2 | 958 | Genoa (Genova) | 1.5 | 459 | 651 | Zurich | 0.75 |
| 265 | 1,139 | Lille (P.T.) | 15.0 | 332 | 905 | Naples (Napoli) | 1.7 | 678.7 | 454.6 | Lausanne | 0.6 |
| 272 | 1,103 | Reims | 1.2 | 441 | 689 | Rome (Roma) | 75.0 | 760 | 395 | Geneva | 1.5 |
| 286 | 1,041 | Montpellier | 2.0 | 453 | 652 | Bolzano (IBZ) | 0.2 | TURKEY | | | |
| 286.2 | 1,047.9 | Radio Lyons | 0.5 | 501 | 599 | Milan (Milano) | 8.5 | 1,225.2 | 244.8 | Istanbul | 5.0 |
| GERMANY | | | | | | | | | | | |
| 231 | 1,283 | Lodz | 2.2 | LATVIA | | | | | | | |
| 244 | 1,229 | Cracow | 1.5 | 525 | 572 | Riga | 12.0 | LITHUANIA | | | |
| 312.8 | 959 | Wilno | 0.5 | 1,935 | 155 | Kaunas | 7.0 | 306.8 | 978 | Zagreb (Agram) | 0.7 |
| 338.1 | 887.1 | Poznan | 1.9 | HUNGARY | | | | | | | |
| 381 | 788 | Lvov | 2.2 | 299 | 1,004 | Radio Klerda (The Hague) | 0.6 | 430.5 | 699.8 | Belgrade | 3.0 |
| 409.8 | 732 | Katowice | 16.0 | 1,071 | 280 | Scheveningen-Haven | 5.0 | 574.7 | 522 | Ljubljana | 2.8 |
| 1,311 | 212.5 | Warsaw | 14.0 | 1,875 | 160 | Hilversum | 8.5 | YUGOSLAVIA | | | |
| PORTUGAL | | | | | | | | | | | |
| 240 | 1,250 | Oporto (Teatro Apollo) | 0.25 | 550 | 545 | Budapest | 23.0 | 231 | 1,283 | Lodz | 2.2 |
| 320 | 937.6 | Lisbon (CTIAA) | 0.25 | ICELAND | | | | | | | |
| ROMANIA | | | | | | | | | | | |
| 301 | 761 | Bucharest | 16.0 | 1,200 | 250 | Reykjavik | 10.0 | 244 | 1,229 | Basle | 0.5 |
| RUSSIA | | | | | | | | | | | |
| 427 | 702 | Kharkov | 4.0 | 224.5 | 1,317 | Cork (IFS) | 1.5 | 403 | 743 | Berne | 1.1 |
| 720 | 416.6 | Moscow (P.T.) | 20.0 | 413 | 745 | Dublin (2KN) | 1.5 | 459 | 651 | Zurich | 0.75 |
| 800 | 375 | Kiev | 20.0 | ITALY | | | | | | | |
| 824 | 394 | Sverdlovsk | 25.0 | 25.4 and 80 | | Rome (3RO) | 9.0 | 678.7 | 454.6 | Lausanne | 0.6 |
| 870 | 344.8 | Tiflis | 15.0 | 296.1 | 1,013 | Turin (Torino) | 8.5 | 760 | 395 | Geneva | 1.5 |
| 937.5 | 329 | Kharkov (RV20) | 25.0 | 313.2 | 958 | Genoa (Genova) | 1.5 | TURKEY | | | |
| 1,000 | 300 | Leningrad | 20.0 | 332 | 905 | Naples (Napoli) | 1.7 | 1,225.2 | 244.8 | Istanbul | 5.0 |
| 1,103 | 272 | Moscow Popoff | 40.0 | 441 | 689 | Rome (Roma) | 75.0 | 1,961 | 253 | Ankara | 7.0 |
| 1,200 | 259 | Kharkov (RV4) | 25.0 | 453 | 652 | Bolzano (IBZ) | 0.2 | YUGOSLAVIA | | | |
| 1,304 | 230 | Moscow (Trades' Unions) | 165.0 | 501 | 599 | Milan (Milano) | 8.5 | 306.8 | 978 | Zagreb (Agram) | 0.7 |
| SPAIN | | | | | | | | | | | |
| 251 | 1,193 | Barcelona (EAJ15) | 1.0 | 525 | 572 | Riga | 12.0 | 430.5 | 699.8 | Belgrade | 3.0 |
| 268.7 | 1,116 | Barcelona (EAJ13) | 10.0 | LATVIA | | | | | | | |
| 349 | 850 | Barcelona (EAJ11) | 8.0 | 525 | 572 | Riga | 12.0 | 574.7 | 522 | Ljubljana | 2.8 |
| 368 | 815 | Seville (EAJ5) | 1.5 | LITHUANIA | | | | 1,935 | 155 | Kaunas | 7.0 |
| 425.7 | 704.7 | Madrid (EAJ7) | 2.0 | HUNGARY | | | | | | | |
| 453 | 662.2 | San Sebastian (EAJ8) | 0.5 | 299 | 1,004 | Radio Klerda (The Hague) | 0.6 | ICELAND | | | |
| SWEDEN | | | | | | | | | | | |
| 230.6 | 1,307 | Malmo | 0.75 | 1,071 | 280 | Scheveningen-Haven | 5.0 | 244 | 1,229 | Basle | 0.5 |
| 257 | 1,166 | Horby | 15.0 | 1,875 | 160 | Hilversum | 8.5 | 403 | 743 | Berne | 1.1 |
| 302 | 990 | Falun | 0.65 | 550 | 545 | Budapest | 23.0 | 459 | 651 | Zurich | 0.75 |
| 322 | 912 | Göteborg | 15.0 | ICELAND | | | | | | | |
| 435 | 689 | Stockholm | 75.0 | 1,200 | 250 | Reykjavik | 10.0 | 678.7 | 454.6 | Lausanne | 0.6 |
| 542 | 554 | Sundsvall | 15.0 | 224.5 | 1,317 | Cork (IFS) | 1.5 | 760 | 395 | Geneva | 1.5 |
| 770 | 389 | Östersund | 0.75 | 413 | 745 | Dublin (2KN) | 1.5 | TURKEY | | | |
| 1,235.6 | 242.75 | Boden | 0.75 | ITALY | | | | | | | |
| 1,348 | 222.5 | Motala | 40.0 | 25.4 and 80 | | Rome (3RO) | 9.0 | 1,225.2 | 244.8 | Istanbul | 5.0 |
| SWITZERLAND | | | | | | | | | | | |
| 244 | 1,229 | Basle | 0.5 | 296.1 | 1,013 | Turin (Torino) | 8.5 | 1,961 | 253 | Ankara | 7.0 |
| 403 | 743 | Berne | 1.1 | 313.2 | 958 | Genoa (Genova) | 1.5 | YUGOSLAVIA | | | |
| 459 | 651 | Zurich | 0.75 | 332 | 905 | Naples (Napoli) | 1.7 | 306.8 | 978 | Zagreb (Agram) | 0.7 |
| 678.7 | 454.6 | Lausanne | 0.6 | 441 | 689 | Rome (Roma) | 75.0 | 430.5 | 699.8 | Belgrade | 3.0 |
| 760 | 395 | Geneva | 1.5 | 453 | 652 | Bolzano (IBZ) | 0.2 | 574.7 | 522 | Ljubljana | 2.8 |
| TURKEY | | | | | | | | | | | |
| 1,225.2 | 244.8 | Istanbul | 5.0 | 501 | 599 | Milan (Milano) | 8.5 | YUGOSLAVIA | | | |
| 1,961 | 253 | Ankara | 7.0 | 525 | 572 | Riga | 12.0 | 306.8 | 978 | Zagreb (Agram) | 0.7 |
| YUGOSLAVIA | | | | | | | | | | | |
| 306.8 | 978 | Zagreb (Agram) | 0.7 | 525 | 572 | Riga | 12.0 | 430.5 | 699.8 | Belgrade | 3.0 |
| 430.5 | 6 | | | | | | | | | | |

High-Grade SET & SPEAKER CABINET
 Constructed of maple finished oak, on casted
 tall wheels, brass hand french polished.
THE ACME OF CRAFTSMANSHIP
 £8 : 8 : 0, carriage paid.
RADIO-GRAMOPHONE CABINET
 £10 : 0 : 0, carriage paid.
 Models from £2 : 2 : 0 to £20.
 Third-price illustrated catalogue, post free.
GILBERT, Cabinet Maker,
 1, Jubilee St., SWINDON.



ELEX
T.14 PLUGS AND SOCKETS
 Rocket Id. Plugs 3d., 6 colour. Name
 plates, 40 kinds, 1d. Write for list J.B.

 J. J. Eastick & Sons
 Plug in parts 118 Bunnhill Row, London, E.C.1

YOU CAN BUILD A £40 GRAMO-PHONE WITH OUR SCALE DRAWINGS FOR 40/-
 Book of instructions 3d. Catalogue of Motors, Tonearms, Soundboxes, latest internal amplifiers Gramophones and Cabinets Free. Cash or Terms.
W. BURT, 185 High St., Deptford.



DX THE STANDARD PLUG-IN COIL
 Sold everywhere from 1/-
DX COILS Ltd, London, E.8

LANCHESTER SPEAKERS
 25 OHM £4:4:0
 7,000 ,, £4:12:6
 "MOVING-COIL PERM. MAG."
 Direct to public only
LANCHESTER'S LABORATORIES Ltd. TYSELEY, BIRMINGHAM



MAKE OR BUY A GRAMOPHONE AT
 a quarter shop prices. Or buy
 cabinets for Wireless. British double
 spring motor, 12 ins. velvet turntable,
 swan arm, metal sound-box, amplifier,
 1 needle cups, for £1-10-0 post, and
 build your own Cabinet. Portable
 Gramophones from 15/6, postage 1/6.
 Motor from 7/6. Late free. 61 pp.
 1931 Catalogue No. 220 with Reduced
 Prices, Drawings and How to Make
 Gramos, 24. 1. published 25. 1930.
Recent Fittings Co., A.W. 120 Old St., London, E.C.1



"BROADCAST" Plug-in Coils
CHEAPEST AND BEST
 25 .. 10d. 51 .. 1- 125 .. 13 25) .. 2-
 35 .. 10d. 61 .. 11 153) .. 14 33) .. 23
 3) .. 10d. 75 .. 12 175) .. 15 43) .. 29
 4) .. 1- 100 .. 13 200) .. 19 53) .. 33
 Centre-Tapped 6d. extra. "A" Coils 9d. extra.
 ALL POST FREE. Trade Supplied.
G. BRICE, 34 Savernake Road, London, N.W. 3

"Amateur Wireless and Radiovision." Price Three-pence. Published on Thursdays and bearing the date of Saturday immediately following. Post free to any part of the world: 3 months, 4s. 6d.; 6 months, 8s. 9d.; 12 months, 17s. 6d. Postal Orders, Post Office Orders, or Cheques should be made payable to "Bernard Jones Publications, Ltd."
General Correspondence is to be brief and written on one side of the paper only. All sketches and drawings to be on separate sheets.
Contributions are always welcome, and if used will be paid for.
Communications should be addressed, according to their nature, to The Editor, The Advertisement Manager, or The Publisher, "Amateur Wireless," 58-61 Fetter Lane, London, E.C.4.

FULL-SIZE BLUEPRINTS

When ordering, please send Postal Order, NOT STAMPS.

CRYSTAL SET (6d. each)

Regional Crystal Set WM176

ONE-VALVE SETS (1s. each)

Monodyne AW258
 One Control One AW267
 Hatley Single-valve WM198

TWO-VALVE SETS (1s. each)

Talisman Two (D, Trans) AW164
 No-battery A.C. Mains Two (D, Trans) AW230
 No-battery Gramo-radio 2 (D, Trans) AW238
 1930 Talisman 2 (D, Trans) AW239
 Searcher Two (D, Trans) AW245
 Arrow Two (D, Trans) AW249
 Forty-five-shilling Two (D, Trans) AW250
 Searcher Short-wave 2 (D, Trans) AW259
 Challenge Two (D, Trans) AW261
 Lotrin-White Two (A.C. Mains) AW263
 Brookman's Two (D, Trans) WM168
 Cleaner Two (D, Trans) WM201
 Music Monitor (D, Trans) WM208
 Merlin Two (A.C. Set) WM213
 Five-Point Two (D, Trans) WM220
 Brookman's A.C. Two (D, Trans) WM225

THREE-VALVE SETS (1s. each)

Best-by-Ballot Three (SG, D, Trans) Price 4d. free with copy of "A.W." AW217
 1930 Clarion Three (SG, D, Trans) AW223
 Beginner's Regional Three (D, 2LF) AW233
 Britain's Favourite Three 1930 (D, 2 Trans) AW243
 The "A.W." Exhibition 3 AW247
 Push-Pull "Two" (D, Push-Pull) AW279
1931 Ether Searcher (SG, D, Trans) AW274
 Brookman's Three (SG, D, Trans) WM161
 Brookman's Push-Pull Three (SG, D, Trans) 1/6 WM170
 Inceptordyne (SG, D, Pentode) WM179
 Brookman's A.C. Three (SG, D, Trans) 1/6 WM184
 Music Marshal (D, 2 Trans) WM199
 Concert Three (D, 2 Trans) WM205
 New Lodestone Three (HF, D, Trans) WM209
 De-Luxe Three (D, RC, Trans) WM212
 Five-Point Three (SG, D, Trans) WM217
 Falcon Three (A.C. Set) WM218
 New Brookman's Three (SG, D, Trans) WM223
 Five-point Short-wave (D, RC, Trans) WM223
 Battle Board Three (D, RC, Trans) WM226

FOUR-VALVE SETS (1s. 6d. each)

Horizon Four (SG, D, 2 Trans) AW237
 Challenge Four (2SG, D, Trans) with copy of "A.W." 4d. post free AW251
 Challenge Four (2SG, D, Trans, mains operated) with copy of "A.W." 4d. post free AW252
 Challenge Radio Gramophone (SG, D, RC, Trans) AW265
 Brookman's Four (2SG, D, Trans) WM174
 Lodestone Four (HF, D, RC, Trans) WM193
 Searcher's Four (SG, D, RC, Trans) WM194
 Invitation Four (SG, D, RC, Trans) WM200
 Regional Band-pass Four (SG, D, RC, Trans) WM211
 Five-Point Four (SG, D, RC, Trans) WM216
 Regional A.C. Four (SG, D, RC, Trans) WM222
 Supertone Four (SG, D, Push-pull) WM227

FIVE-VALVE SETS (1s. 6d. each)

James Quality Five (2SG, D, RC, Trans) AW227
 All-wave Lodestone Five (HF, D, RC, Push-pull) WM146
 1930 Five (HF, D, RC, Trans) WM171
 Dual-screen Five (2SG, D, RC, Trans) WM185
 Radio-Record Five (SG, D, Trans-parallel) WM188
 Overseas Five (SG, D, Trans) WM191
 Regional A.C. Five (3SG, D, Trans) WM224

SIX-VALVE SET (1s. 6d.)
 Hyperdyne Receiver (Super-het) WM221

PORTABLE SETS

Continental Portable (SG, D, Trans) AW241 1/-
 Pedlar Portable Two (D, Trans) WM195 1/-
 Pedlar Portable Three (D, 2 Trans) WM197 1/-
 James Portable SG3 (SG, D, Trans) WM203 1/-
 Touring Portable (SG, D, 2 Trans) WM206 1/6

AMPLIFIERS (1s. each)

"A.W." Gramophone Amplifier AW205
 Two-valve Amplifier AW216
 "Mag" Gramo Unit AW224
 Simple Gramophone Amplifier AW257
 Radio-Record Amplifier (DC Mains) WM183
 Selecto Amplifier (HF, Unit) WM210

MISCELLANEOUS (1s. each)

Simplest H.T. Unit AW167
 By-pass Unit (Wavetrap) with copy "A.W."—4d. AW218
 "Twin" Brookman's By-pass (6d.) AW222
 James H.T. and L.T. Charging Unit AW232
 Simplest H.T. Eliminator for D.C. Mains AW234
 Choke Output Unit AW240
 Simple Tester Unit (6d.) AW246
 "A.W." Improved Lincen-diaphragm Speaker AW248
 Handy L.T. and G.B. Unit for A.C. Mains AW254
 Ohmic-coupled DX Unit AW255
 Novel Lincen-Diaphragm Speaker AW260
 Our H.T. Unit for A.C. Mains AW262
 Gramophone Tone Control AW264
 Challenge Radiogram, Turntable Layout AW266
 Short-wave Super-het Adaptor AW268
 H.T. Unit and Trickle Charger for D.C. Main AW272
 Universal Push-pull Amplifier WM204
 Outspan Short-wave Adaptor WM207
 "W.M." Standard A.C. Unit WM214
 "W.M." Standard D.C. Unit WM215
 Falcon A.C. Unit WM219
 Hyperdyne Short-wave Adaptor WM228

Copies of the "Wireless Magazines" and of "Amateur Wireless" containing descriptions of any of these sets can be obtained at 1s. 3d. and 4d. respectively, post free. Index letters "A.W." refer to "Amateur Wireless" sets and "W.M." to "Wireless Magazines."

AMATEUR WIRELESS 58-61 FETTER LANE LONDON, E.C.4.

PREPAID ADVERTISEMENTS

Advertisements under this head are charged THREEPENCE PER WORD, minimum charge THREE SHILLINGS. DEPOSIT SYSTEM

As the Publishers cannot accept responsibility for the bona fides of advertisers in this publication, they have introduced a system of deposit which it is recommended should be adopted by readers when dealing with persons with whom they are unacquainted. It is here explained.

Intending purchasers should forward to the Publishers the amount of the purchase money of the article advertised. This will be acknowledged to both the Depositor and the Vendor, whose names and addresses must necessarily be given. The deposit is retained until advice is received of the completion of the purchase, or of the article having been returned to and accepted by the Vendor. In addition to the amount of the Deposit, a Fee of 6d. for sums of £1 and under, and 1s. for amounts in excess of £1, to cover postage, etc., must be remitted at the same time. In cases of persons not resident within the United Kingdom double fees are charged.

The amount of the Deposit and Fee must be remitted by Postal Order or Registered Letter (Cheques cannot be accepted), addressed to

"AMATEUR WIRELESS" ADVERTISEMENT DEPARTMENT
 58/61 FETTER LANE, LONDON, E.C.4.

£300, £400, £500 PER YEAR.—You, too, can qualify in your spare time at home for these salaries. Why should you be the one to remain in a dead-end job. Let us show you the way to the highest posts in Mech., Elec., Motor, Wireless, Aero, Talkie Eng., etc. Write to-day for our inspiring volume, "Engineering Opportunities." In this book Prof. A. M. Low throws a new and startling light on the opportunities you are missing. It shows the simplest and most successful way of obtaining B.Sc., A.M.I.Mech.E., A.M.I.E.E., A.M.I.A.E., A.M.I.Street.E., C. & G., G.P.O., etc. Exams. We alone guarantee "No pass—no fee." Take the first step to success to-day. Write for your copy of this eye-opening publication, FREE and POST FREE (state subject of exam).—British Institute of Engineering Technology, 109 Shakespeare House, 29-31 Oxford Street, London.

"CRAFTCASE" CABINETS for Wireless and Gramophones. Ready for assembling or assembled. Write for lists.—Craftcase Works, D Meudip Industries, Wimscombe.

A MAGNIFICENT SET.—The "National Regional Three," absolutely complete, including Tunogram valves, 2-volt accumulator, 100-volt H.T. battery, Ormond cone speaker, fully guaranteed, wonderful value, £4, inclusive; carriage paid. H. Panagakis, A.M.I.R.E., Wireless Specialist, 91 Dale Street, Liverpool, Bank 756.

"HELMAR" Moving-coil Speakers are amazing in quality and price. Sample volume from a good two-valve set. In acoustically-matched cabinets of elegant design. Table and pedestal models. "Helmars" Speakers are musical instruments for the super critical in radio or gramophone reproduction. Prices from £7 15/0.—Particulars from Helmar Radio, 15 Maudsley Street, Bolton.

AGENTS, DEALERS, SET-MAKERS!—Write now for particulars of our unique system of trading. Deliveries on time guaranteed. Thousands of lines catalogued. Brookman Rapid Radio Service, 105 Spencer Street, Birmingham.

WIRELESS BARGAINS.—Three-valve brand new portable sets, best makes, from £5 19s. cash or 14 d. with order. Three-valve sets, complete, 6s/6 or 7s/6 with order.—Hollow Send to Posters for latest Bargain List of Wireless sets, etc.—Fosters (Highbury), Ltd., 71 Highbury Park, Highbury Barn, London, N.5. "Phone": North 4130.

YOUR "ETHER SEARCHER" KIT. We will supply you by return of 2s. cash, including Clarion cabinet, Mullard valves, and Hyperton transformer. The Jupiter Radio Service, 9 Sun-on Street, London, S.E.5.

CORRESPONDENCE COURSES OF INSTRUCTION IN WIRELESS. Write for free particulars to the Correspondence Course Dept., of the R.M. College, 26-27 St. Mary Street, Cardiff.

BIRMINGHAM'S WIRELESS DOCTOR, R. E. Sumnerfield, member R.S.G.E., will call and cure your set: sets overhauled; any component supplied; 20 miles radius. 1 Newhall Street, Birmingham.

WE WILL ACCEPT YOUR SURPLUS APPARATUS (making you a high allowance) in part payment for any new apparatus. Your inquiry will be dealt with promptly. —De-tock & Stonnill, 1 Westbourne Terrace, S.E.26.

WIRELESS PARTS AND SETS exchanged for new, up to 50% or more allowed for modern parts if in good condition. Apparatus can be sent for valuation. W. Burns, Wireless Factor, 4 Loanda Street, Haggerston, E.8.

BANKRUPT STOCK.—Triotron Valves, 2 or 4 volt, 4/3; power, 5.3. Tel-en Acc. 3/4; Grand, 7 1/4. Sutra Double-reading Voltmeters, 3/11. Fuller Trickle Chargers, 18/5 (All as new). Thousands of other bargains. Send for List. —"Universal", 20 Victoria Road, Peckham, S.E.15.

CHARGE YOUR H.T. FROM YOUR L.T. AT HOME. Economy, good reception. Equipment, hydrometer and diagram complete, 60 volts 7.6, 120 volts 10/6. Reliable from (3 to 12) 10. V.T. Units: Diagram with Hydrometer 2/6. —R. Fox, 188 Gamberwell Grove, S.E.5.

TAYLOR WET H.T. BATTERIES
 New Prices: Jars 1 1/3, Sacs 1 1/2, 2 nits 1 0d. Sample doz. 18 Vols complete with b.u.s. and electrolyte 4 1 post 9d. Sample unit 6d. Illus. booklet free. Buy-in list free. AMPLIFIERS, 3/-, 3 VALVE ALL-STATION SET 5s. **A. TAYLOR, 57, Studley Road, Stockwell, LONDON.**

Amateur Wireless **COUPON**
 Available until Saturday
FEBRUARY 7, 1931

MISUNDERSTOOD



MARKER: "Send up some more PLAYERS, please!"

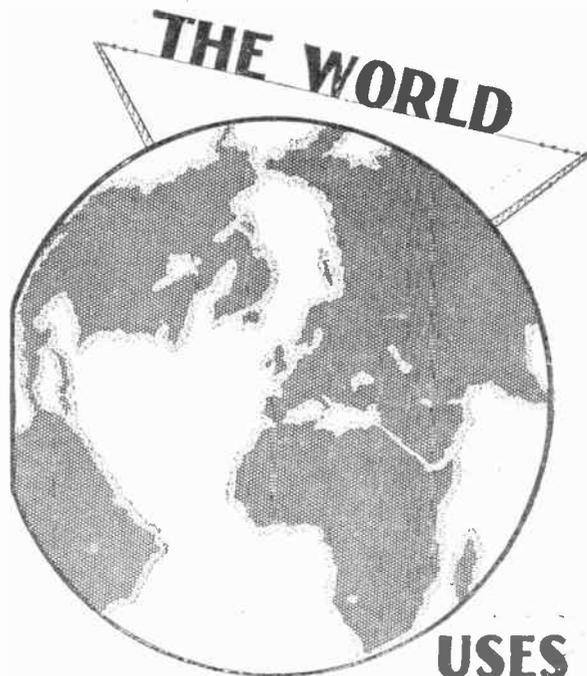

USES

RADIO manufacturers all over the world are using Dubilier Condensers because it is known that their robust construction and high electrical efficiency can make all the difference to the performance of their sets.

You can do no better than follow their lead and make use of Dubilier Condensers for efficiency, accuracy, and reliable Service.

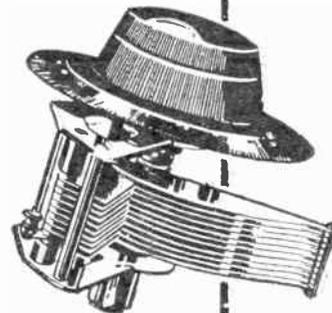

K.C. Variable Condenser
 With knob, dial and slow-motion device - - 11/-
 Without knob, dial or slow-motion device - - 7/6

DUBILIER CONDENSERS

DUBILIER CONDENSER CO. (1925) LTD.,
 Ducon Works, Victoria Road, N. Acton, London, W.3.

NOTICE
BECOL LOW LOSS EBONITE FORMERS

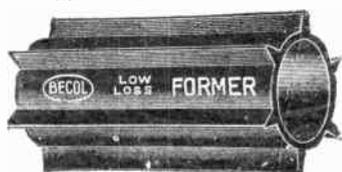

12 SIZES

LOOK FOR TRADE-MARK BRITISH MADE

Sole Makers—

THE BRITISH EBONITE CO., LTD.
 HANWELL, LONDON, W.7

ARE
RELIABLE

Tested before despatch

PANELS, RODS,
 TUBES

FOR ..
ELECTRIC REPRODUCTION

USE A LIMIT

Continental
 Design
 Patents.



Illustration shows
 Pick up arm held.



PICK-UP ARM 15/6

Obtainable through all factors and dealers
 or write

EACH

LIMIT RADIO LIMITED, ALBION ST., LONDON, N.1

To Ensure Speedy Delivery, Mention "A.W." to Advertisers

COLVERN COMPONENTS FOR THE "1931 ETHER SEARCHER"

TWO T.G.S.C.
COILS, 9/6 EACH.
ONE T.G.S.R.
COIL, 9/6.
THREE SCREENS
TYPE C.C.S. 3/6 EACH.
ONE VALVE SCREEN,
2/9.
ONE SWITCH TYPE S1.
1/3.

*Send for the
Colvern Booklet.*

ONE
CRANK
HANDLE
1/6.

COLVERN LTD
MAWNEY S. RD
ROMFORD, ESSEX.

