

RECENT DEVELOPMENTS FOR THE HOME CONSTRUCTOR

Amateur Wireless

Every Thursday 3^d

and
Radiovision

Vol. XVII. No. 425

Saturday, August 2, 1930

The CONTINENTAL PORTABLE

TWO
FINE
SETS

EASY-TUNE
SHORT 2 WAVE





GENERAL PURPOSE VALVES

2v.	4v.	6v.	OLD PRICE	NEW PRICE
PM.1A	PM.3A	PM.5B	10/6	8/6
PM.1HF	PM.3	PM.5D		
PM.1LF	PM.4DX	PM.5X		
PM.2DX		PM.6D		

POWER VALVES

2v.	4v.	6v.	OLD PRICE	NEW PRICE
PM.2	PM.4	PM.6	12/6	10/6

SUPER POWER VALVES

2v.	4v.	6v.	OLD PRICE	NEW PRICE
PM.252	PM.254	PM.256 PM.256A	15/-	13/6

SCREENED GRID VALVES

2v.	4v.	6v.	OLD PRICE	NEW PRICE
PM.12	PM.14	PM.16	22/6	20/-

PENTONES

2v.	4v.	6v.	OLD PRICE	NEW PRICE
PM.22	PM.24	PM.26	25/-	22/6
	PM.24A		30/-	27/6
	PM.24B		35/-	30/-

A.C. DIRECTLY HEATED VALVES

2v.	4v.	6v.	OLD PRICE	NEW PRICE
AC.104	AC.064		17/6	16/-

SPECIAL VALVES

2v.	4v.	6v.	OLD PRICE	NEW PRICE
PM.13	PM.25	AC.084	25/-	22/6

Mullard
THE MASTER VALVE

Advt. The Mullard Wireless Service Co., Ltd., Mullard House, Charing Cross Road, London, W.C.2

Please Mention "A.W." When Corresponding with Advertisers

Amateur Wireless and Radiovision

The Leading Radio Weekly for the Constructor, Listener and Experimenter

Editor:
BERNARD E. JONES

Technical Editor:
J. H. REYNER, B.Sc., A.M.I.E.E.

Research Consultant:
W. JAMES

Assistant Editor:
H. CORBISHLEY

The Ulster T.T. Relay—A Television Idea—The Post Office “Black Maria”— The Winner of WAC—“Mag.” Interference—Mains Matters

The Ulster T.T. Relay—A continuous running commentary, starting at 11 a.m., will be broadcast on the Ulster Tourist Trophy Race, which takes place on the Ards Circuit on August 23. The first part of the commentary will be heard by listeners to Belfast; and from 3.30 to 5.15 p.m., approximately, it will be on the National. The Ards Circuit covers nearly fourteen

through the development of an automatic synchroniser operating by means of a component in the usual television signal. This device is an attachment that fits on the scanning disc shaft. An extra synchronising amplifier is required to supply a 720-cycle current to drive the synchroniser. This sounds as though it is a great deal more complicated than the simple scanning

arrangement used in the Baird system. It would appear to have something in common with the frequency-stabilisers used in talkie-film cinemas.

arrangement used in the Baird system. It would appear to have something in common with the frequency-stabilisers used in talkie-film cinemas.

Mains Matters—Just a word to you mains users. The Information Bureau has had a crop of queries lately relating to eliminators, and in many cases faults and instances of oft-blown fuses have been traced to something outside the eliminator and set, namely, the mains leads and plug. There's so big a temptation to use cheap flex and foreign mains plugs from cut-price bazaars—but really it doesn't pay. There's nothing that puts a man off mains units more than a blown fuse, trivial as this really is.



A peep into a well-known amateur station G5BY. The Philips microphone in the foreground is of the type used at Hilversum and Hulzen. On the bench are the receiver and speech amplifiers

miles and, except that it contains no really severe hills, it embodies almost all the attributes of the ideal course. There are corners of all descriptions, easy bends that can be taken very nearly “all out,” acute bends, right angle turns and hairpin bends demanding skill and iron nerve on the part of the drivers. The race last year was won by Caracciola at an average of 72.82 m.p.h. This should make a good broadcast, and the B.B.C. has by now a deal of experience in relaying events of this kind.

A Television Idea—The engineers of the Jenkins Television Corporation claim to have solved the synchronisation problem

a period of six weeks, the number of new licences taken out in the Newcastle area was 4,256, while for the similar period of 1929 it was only 895. The increase is attributed to a visit paid to this district by the Post Office direction-finding van!

The Winner of WAC—The first English amateur transmitter to gain the coveted “Worked all Continents” (WAC) certificate is Mr. H. L. O’Heffernan, a Philips engineer, who owns and operates the amateur transmitter G5BY, Croydon. This certificate is awarded by the International Amateur Radio Union. Mr. O’Heffernan recently won the silver cup for the best ama-

PRINCIPAL CONTENTS		Page
Current Topics	...	97
Broadcast Artistes in Picture	...	98
Building the “Continental Portable”	...	99
Around the Short-wave Dial	...	100
Fighting Interference	...	101
Be a Globe Trotter...	...	102
On Your Wavelength	...	103
What is Damping?	...	105
Without Fear or Favour	...	106
Recent Developments in Components	...	107
The “Easy-Tune Short-wave 2”	...	108
My Wireless Den	...	112
“A.W.” Tests of Apparatus	...	114

BROADCAST ARTISTES IN PICTURE



ETHEL WILLIAMS.—One of the best-known English contraltos, she was heard most recently in a special concert, singing duets with Miss Marjorie Palmer from the Midland Regional station.



JOAQUIN NIN.—A French artiste of wide repute. His programmes are invariably well chosen, and on this account specially suitable for broadcast purposes.



MILDRED DILLING.—A brilliant harpist and an early discovery of the B.B.C. She has given many recitals and is specially noted for the good taste of her programmes.



WILLIAM PARSONS.—He has long been connected with the musical programme of Cardiff station. A clever artiste, with a wide repertoire.



JEANE PAULE and LEONIE LASCELES.—Two of the cleverest entertainers. Their songs and duets at the piano have given them a place in the variety world as well as in broadcast circles.



GUTHBERT FORD.—Heard on July 23, from the Midland Regional station, Mr. Ford had, as usual, an attractive programme.



MURIEL NORMANSELL.—One of the most popular vocalists in the Regional programmes, Miss Normansell has established herself in the favour of listeners by reason of a wide repertoire of popular and artistic works.



GEORGES HAECK.—Director of one of the most popular restaurant orchestras in London, that of Frascati's. Few players have had wider Continental experience.



KATHLEEN MOORHOUSE.—A member of the great Halle orchestra, this brilliant cellist has broadcast regularly from the Manchester station. She has lately formed her own string quartet.

BUILDING THE "CONTINENTAL PORTABLE"

A Receiver Specially Designed for Long-wave Distant Reception, of which Preliminary Details were Given Last Week

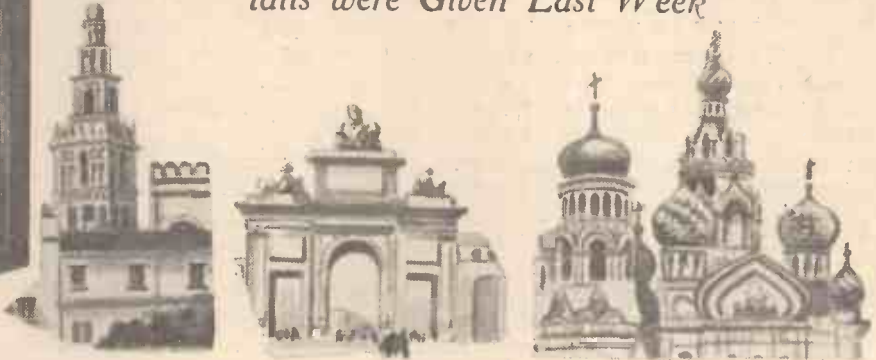

SOME people fight shy of building a portable set for themselves simply because they think that the constructional work is much more difficult than in the case of an ordinary set for the home. This is entirely an incorrect notion.

The blueprint, reproduced in last week's issue, gives details of the cabinet, but there are many firms who will supply this ready made or part finished.

The Cabinet

The outside shell of the cabinet measures 15 3/4 in. by 14 3/4 in. by 7 7/8 in. overall, and it will be seen that beading is placed around the front to a height of 1/2 in., so that the set does not slide out of the front of the box. The correct position for this moulding will be seen in the little sketch on the blueprint. The shell upon which the frame aerial is wound has the outside dimensions of 14 7/8 in. by 13 7/8 in. by 6 1/2 in. and fillets of wood are placed at the outside so that the wire of the frame does not rub against the inside of the cabinet itself.

The baseboard of the receiver, which is a strip of wood measuring 12 7/8 in. by 4 1/4 in., is fixed inside the frame aerial shell, and is supported by two fillets of wood the width of the baseboard, namely, 4 1/4 in., and placed 5 3/4 in. from the top of the frame aerial former.

The Frame Aerial

The frame aerial winding consists of a solenoid layer of 24 d.c.c. wire, and, as no wave-changing arrangements are incorporated, there is only the plain aerial winding of 45 turns and the reaction winding of 8 turns. A very small gap should be left between these two windings, which are, of course, joined together at one end. In the theoretical circuit it will be seen that the section, A, B, is the grid and

aerial circuit, while reaction is provided by the 8 turns of the B.C. section.

Apart from the construction of the receiver unit, the only other work on the front of the receiver is the mounting of the loud-speaker cone and unit. The cone can be made up from a circle of paper 11 3/8 in. in diameter, or it can be bought ready made.

If it is made at home, then it is important to cut out a sector with an apex angle of exactly 30° and to gum firmly an overlap of 7/8 in. Take care in the gumming process not to damage the apex of the cone. The unit is mounted on the loud-speaker fret and the cone is placed on in an inverted position with the edge lightly buried on a felt ring.

Wiring

The wiring-up of the components on the receiver baseboard should present no difficulty, particularly to those who are working direct from the blueprint. Rigid wire is used for the major connections, but all leads to the batteries, the loud-speaker, L.T. switch, and variable condensers are, for convenience, flexible. The small metal screen shielding the S.G. aerial circuit from the H.F. components is best purchased ready made, although full dimensions are given on the blueprint.

When the receiver section is wired up it may be slipped in place, and the leads to the frame aerial, condensers, switch, and loud-speaker completed. For con-

venience the frame aerial flexes, or the actual ends of the winding, are taken to the condenser terminals. The blueprint shows that the join point of the aerial and reaction windings is lettered B, while A is the start of the aerial winding and C is the start of the reaction winding.

There is ample space in the bottom of the cabinet for portable-set size H.T. batteries and an accumulator which should preferably be of the non-spillable type. The grid-bias battery, a 9-volt job, can be tucked away between the H.T. and L.T. batteries. Connections to all the batteries should be made with proper wander plugs and spade tags.

Suitable Valves

A great deal depends on the valves used, which should not only be of the correct type for each respective stage, but should be of a good make, poor valves being a poor economy. The following 2-volt H.F.

(Continued at foot of next page)

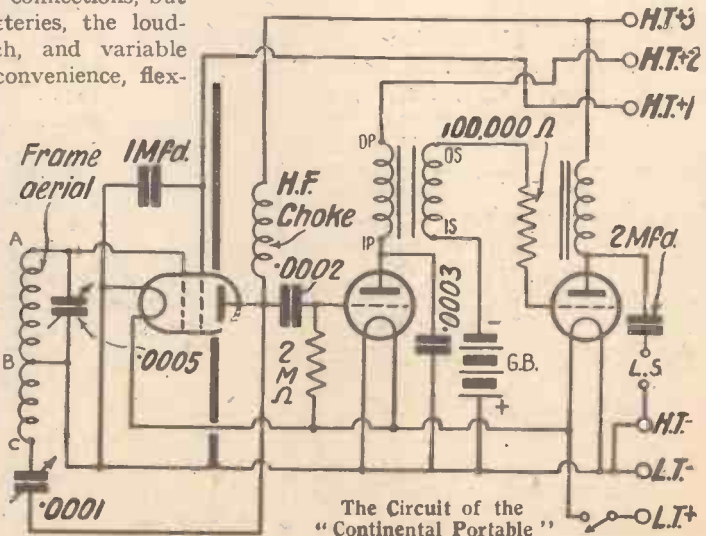

Some Notes on Present-

day Short-wave Conditions

Around the Short-wave Dial



By M.
BARNETT

FOLLOWING the notes on station NRH, given in these columns by the writer a few weeks ago, comes the news that this station is now going to give special transmissions at a more suitable hour for reception in England, and, from the beginning of August will be on the air every Wednesday from 22.00 to 23.00 G.M.T. Note that this is not B.S.T. As stated before, this station has been heard nearly all over the world and its latest report of reception comes from New Zealand. When one remembers that this station only works on telephony transmissions and uses no code its success is all the more remarkable. No one would dream of designing a transmitter with a power of $7\frac{1}{2}$ watts with the intention of getting world-wide phone reception, and yet here is a station which reaches out better than many of its higher-powered neighbours! Another short-wave mystery! Whilst talking of station power, it is rather annoying to have to record the fact that some stations seem very unwilling to make themselves known, either by their announcements over the ether or through

postal correspondence. Of course, experimental work may account for this.

According to the *Listener-In* (New South Wales), a new short-wave station has been erected at Melbourne. The call is 3UZ and it works on 32 metres (crystal-controlled). Reports are welcomed and should be sent to Station 3UZ, 45 Bourke Street, Melbourne. Also, the once popular broadcaster, VK2ME at Sydney, has now dropped broadcasting entertainment altogether and is a commercial station under the call of VLK.

Finding Bearings

Although the new Rome station 3RO is supposed to be working on regular transmissions now, the writer has not heard him on his 25-metre wave for several months. Have any readers heard his transmissions lately on this wave? The lower wave is, of course, useful for world-wide reception, but perhaps this station is concentrating on its 80-metre wave which is useful mainly for reception in near-by countries.

When trying out a new set of short-wave

coils, it is sometimes rather hard to find one's bearings if a wavemeter is not handy. However, after a little experience in handling short-wavers, one comes to recognise various landmarks on the dial. For instance, the stations between 18 and 35 metres are grouped like this:—First on 19.56 metres we have W2XAD, immediately above which will be found a powerful beam station and two American commercials, WMI and WNC. The last three stations are nearly always on after about 5 o'clock, so that if one is searching for W2XAD, these three stations will make a good indication of its whereabouts, as they all operate between 19 and 21 metres.

After these come G5SW and W8XX, close on about 25 metres. The next and fullest group centres around 30 metres and contains such stations as Zeesen, Copenhagen, W2XAF, 7LO and the mighty PCJ, etc. This group is thickly surrounded by code commercials on either side.

Transatlantic conditions are still rather poor and the short-wave ether has remained about the same for the last few weeks.

"BUILDING THE 'CONTINENTAL PORTABLE'"

(Continued from preceding page)

S.G. valves are suitable: Cossor 220SG, Marconi S215, Osram S215, Six-Sixty 220SG, Mullard PM12, Mazda 215SG, Lissen SG215.

Components for the "Continental Portable"

.0005 - microfarad variable condenser (Graham-Farish).

.0001 - microfarad reaction condenser (J.B., Lissen, Dubilier, Ready Radio, Igranic, Lotus, Bulgin, Burton, Formo, Polar).

Push-pull filament switch (Bulgin, Lissen, Ready Radio, Junit, Lotus, Benjamin, Igranic).

Two valve holders (Formo, Lotus, Benjamin, Burton, Wearite, Trix).

Upright valve holder (Junit, W.B., Parex, H. & B.).

.0002-microfarad fixed condenser with series clips (T.C.C., Dubilier, Lissen, Graham-Farish, Atlas).

.0003-microfarad fixed condenser (T.C.C.;

type S, Watmel, Trix, Dubilier, Lissen).

1-microfarad fixed condenser (T.C.C., Lissen, Dubilier, Hydra).

2-microfarad fixed condenser (T.C.C., Lissen, Dubilier, Hydra).

1-megohm grid leak (Lissen, Dubilier, Watmel, Graham-Farish).

High-frequency choke (Varley, Lissen, Lewcos, Wearite, Tunewell, Sovereign, Igranic, Dubilier, Bulgin, R.I., Ready Radio, Polar).

Low-frequency transformer (Telsen "Radiogrand," Varley, Ferranti, Igranic, Burton, Lissen, R.I.).

Output choke (Lissen, Wearite, Lotus, Ferranti, Varley, Bulgin, Atlas, Parmeko).

Aluminium screen, 5 in. by 4 in., with hole for S.G. valve (Parex, Wearite, H. and B., Ready Radio).

Connecting wire (Glazite).

Two yards of thin flex (Lewcoflex).

Six wander plugs, marked: H.T.—, H.T.+1, H.T.+2, H.T.+3, G.B.+ , G.B.— (Belling-Lee, Clix, Eelex, Igranic).

Two spade terminals, marked L.T.+ , L.T.— (Belling-Lee, Clix, Eelex, Igranic).

Loud-speaker unit (Blue Spot type 66K, Tunewell, Watmel, Grassman).

Piece of cone-paper and felt (Six-Sixty).

$\frac{1}{4}$ -lb. reel of 24 d.c.c. wire (Lewcos).

Portable cabinet (Camco "Carrier").

The detector valve can be chosen from the following 2-volters: Cossor 210HF, Dario Univ., Marconi HL210, Osram HL210, Six-Sixty 210HF, Mullard PM1HF, Mazda HL210, Lissen HL210, Fotos BA9, P.R., PR3LF, Triotron HD2.

There is now a wide range of 2-volt power valves, and any of the following will be quite satisfactory and will give an economy of working with regard to L.T. and H.T. consumption: Cossor P2, Dario SP, Marconi P2, Osram P2, Six-Sixty 220P, Mullard PM252, Mazda P220, Lissen P220, Fotos BD9, Tungram P215, P.R. PR120.

Owing to the aperiodic H.F. coupling, tuning is as simple as that of a two-valver, and there is only the frame aerial tuning condenser and the reaction condenser to control. A half-hour's test on practically any evening will suffice to provide a good reception log, with the well-known long-wavers, such as 5XX, Radio Paris, Hilversum, Huizen, the Eiffel Tower, and Zeesen, very prominent.

NEXT WEEK: An old favourite brought up to date—

BRITAIN'S FAVOURITE THREE, 1930.

THE finest music and most perfect transmission, the best receiver with the best loud-speaker—in fact, all the latest developments of broadcasting, are powerless to make up for the trouble caused by the interference of a single motor or high-frequency medical apparatus. The presence of a lift going up and down at frequent intervals is often more troublesome even than a violent thunderstorm, and the smallest piece of electrical apparatus—be it diathermic apparatus, hair-cutting machine, ventilating fan, or a telephone or house bell—is apt to annoy the listener and spoil his pleasure.

The publishers of *Die Sendung*, one of the foremost German wireless weeklies, wished to acquaint the amateur and listener with the various causes of trouble by interference and the best remedies. This is why it organised a large exhibition of a new type which, not content with demonstrating things, is catering for the visitor's active co-operation. Moreover, it appeals to the fairness of all those owning any troublesome piece of apparatus to provide some suitable remedy.

The first thing seen on entering the exhibition hall is a number of plates showing nothing but simple diagrams of connections, some switches; disturbing motor, or the like. If now the visitor, acting upon the suggestion made, operates the light switch, there appears—made visible by illumination from the back—in schematic, though clear and straightforward arrangement, the nature of the disturbing vibrations. By thus switching in practically all models on show himself, the



An Account of a Unique and Instructive Exhibition

visitor has his attention forcibly drawn to the effects produced. Comprehensive and popularly worded descriptions facilitate the understanding of these.

The first plate, for instance, illustrates the way a disturbance takes place, showing how a spark is produced, both on opening and closing a switch, thus giving rise to disturbing vibrations, which travel along the mains, becoming audible in the loud-speaker. The disturbance is seen to last just as long as the spark lasts. Disturbing vibrations are seen also to spread in space concentrically around the spark.

Another plate shows how choking coils are used to check disturbing vibrations. The action of such coils in allowing the line current freely to pass, while stopping any disturbing vibrations, is illustrated by other plates and many different types of choking coils are shown. Another remedy is the use of suitable condensers. Unlike the choke, a condenser will stop the current, though allowing the disturbing vibrations to pass to earth.

The most efficient means of fighting interference is a suitable combination of choking coil and condenser. How the

object is achieved is shown both by diagrams and plastic models and many commercial types of safeguard are exhibited.

A switch-board, shown by the photograph here, comprises twelve switches which enable the various types of disturbing electrical apparatus—high-frequency medical apparatus, hot-air blower, small electric motor, heating cushion, ventilating fan and vacuum cleaner—to be

switched in in succession. Inside the case there is provided a safeguard against interference which can be switched in at will. The luminous board connected with the switchgear, which is visible at the top of the apparatus, shows in each case which apparatus has been switched in, and whether with or without a safeguard. The loud-speaker installed beside the apparatus will reveal the various forms of disturbance acoustically and show that there is a possibility of eliminating even the most violent disturbance by suitable means.

Another interesting exhibit is the gramophone record recently prepared by the German Broadcasting Corporation (*Reichs-Rundfunk-Gesellschaft*) for demonstrating the more frequent types of disturbing noise. The noises thus recorded are reproduced by a large moving-coil loud-speaker and are at the same time demonstrated visually by the curves traced by oscillograph. The curve visible in the photograph corresponds to the disturbing noises characteristic of a high-frequency apparatus.

The model of a tramcar, also shown, is (Cont. on next page)

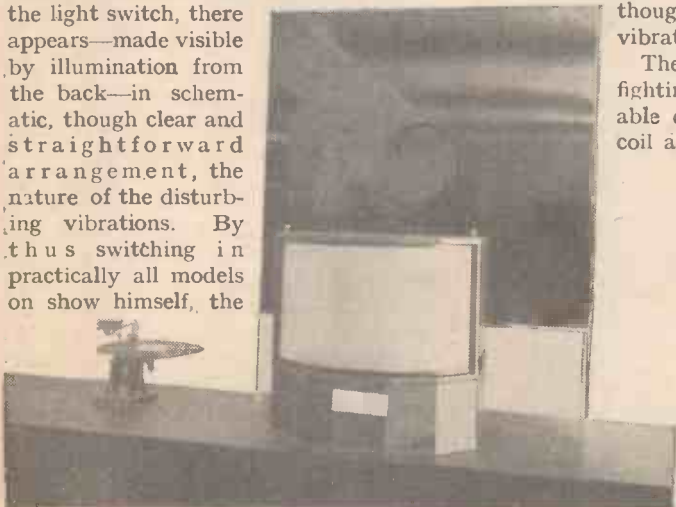

Disturbing noises are reproduced by a loud-speaker and demonstrated visually by an oscillograph

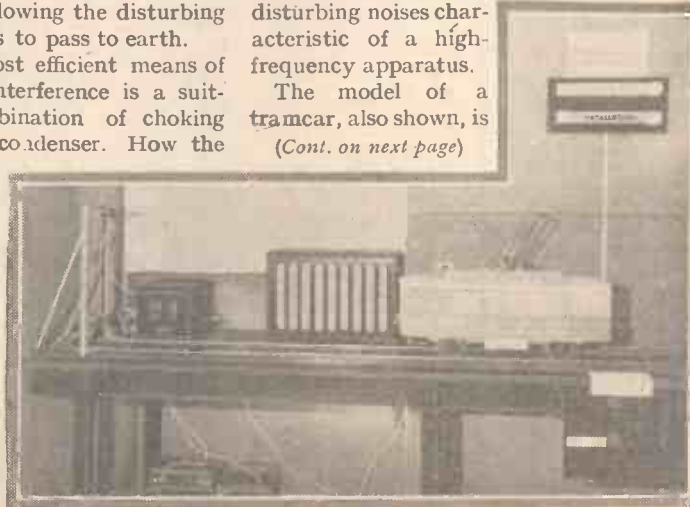

A model of a tramcar fitted with two types of trolley shows how much better one is than the other

BE A GLOBE-TROTTER —ON THE SHORT WAVES

How the world can be tuned in on two valves is explained in this article by "Set Tester" who this week deals with the Stonehouse two-valve set

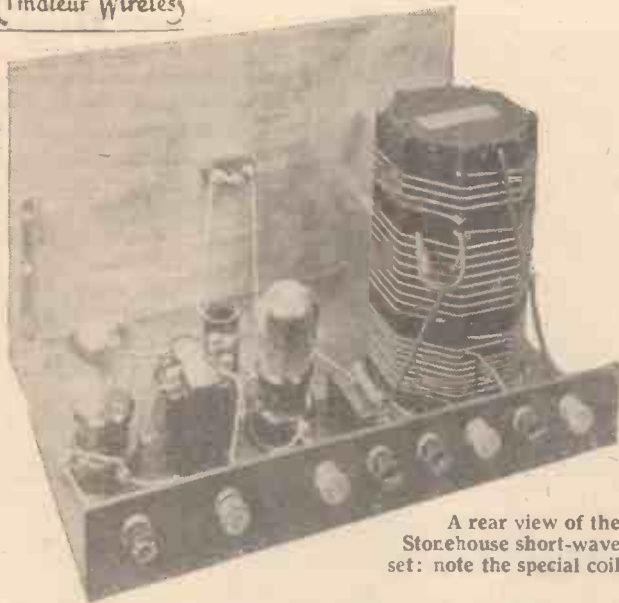

A rear view of the Stonehouse short-wave set: note the special coil

I HAVE just put down the telephones; although my writing desk is some distance from the test bench, voices can be heard, bearing traces of an unmistakably transatlantic accent. The Stonehouse Two is bringing in American telephony at great strength. During the last few days it has brought in signals from most parts of the world.

Testing this set brought home to me, once again, the outstanding appeal of short-wave reception. How else, than by short waves, can one span the world on two valves? If distance lends enchantment, short-wave reception should be universally enchanting. And how cheap is the apparatus for short-wave working; two good valves, a well-designed coil, smoothly acting variable condensers for tuning and reaction—little more is required.

An Interesting Field

While telephony stations in Holland, Germany, Australia, America, Java, and England—to mention a few sources—are quite sufficient inducement to go down below 100 metres, we must not overlook the vast amount of morse signals.

I have mentioned some of the essentials of short-wave reception; the Stonehouse set supplies them in a somewhat unorthodox way. The Stonehouse tuner, which is really the life and soul of the set, is well worth describing. Around a large ribbed

crocodile clip, so that any desired wave-band can be covered with maximum efficiency.

The most interesting part of this short-wave tuner is the mounting of the tuning and reaction condensers inside the coil former. Double-spaced condensers, of low maximum and minimum capacity, are mounted one above the other, with extension rods providing panel control. At first sight, I was a little doubtful of the wisdom of this arrangement, but tests have more than vindicated it. Certainly the design makes for short connections, which are quite a big consideration in a short-wave layout. The absence of slow-motion dials was another point only practice could settle. I find that with the extension rods fitted to the tuner, hand-capacity effects are negligible.

Apart from the tuner, the Stonehouse two-valver is the essence of simplicity. To the right of the tuner, which is mounted at one end of the baseboard, is the detector valve, with its grid condenser and leak, followed by a small high-frequency choke, the low-frequency

transformer, and, finally, the output valve. A neat terminal strip at the back and an aluminium panel at the front, supporting the tuner controls and filament switch, complete a layout carefully planned.

I cannot make too much fuss about the need for good accessories with a set of this type. It is a typical short-waver, ready to do great things if properly equipped. Give it a good detector, such as the HL210, and a good power valve, such as the P215, and the world is at your front door. With these valves and a 120-volt Lissen high-tension battery, I have been able to test the Stonehouse set under fair conditions.

The anode-current consumption is not a big item, being only 7 milliamperes with the accessories mentioned. Short-wave reception does not necessitate a large aerial, so I did my tests on a 50-ft. length of wire erected under the rafters of my home in south-west London. With this modest aerial and a good earth, I got America the first evening, followed by beam telephony from Australia and many other stations.

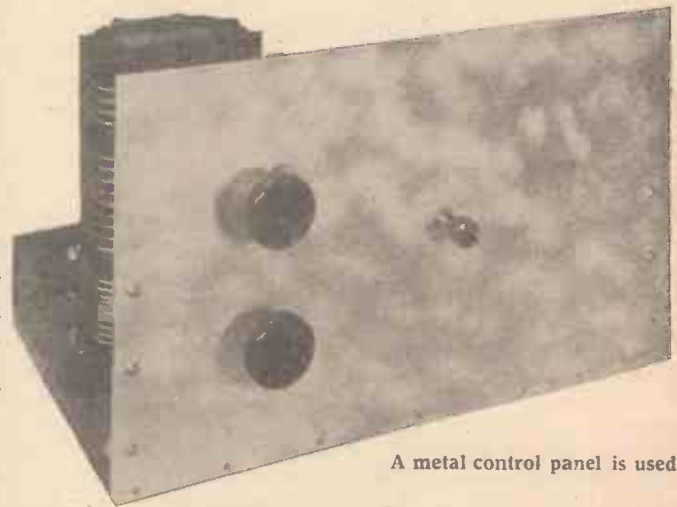

A metal control panel is used

"FIGHTING INTERFERENCE"

(Continued from preceding page)

fitted with two types of trolley and is made to travel in one direction with a carbon, and in the other with a metal contact. The operating switch switches in one of two lamps provided on the right, which bear the inscriptions "Carbon Bow" and "Metal Bow" respectively. The wireless receiver visible on the left strikingly shows that when travelling with the carbon trolley, there are hardly any audible disturbing noises, whereas the familiar crackling is noted in the loud-speaker as soon as the metal trolley is switched in.

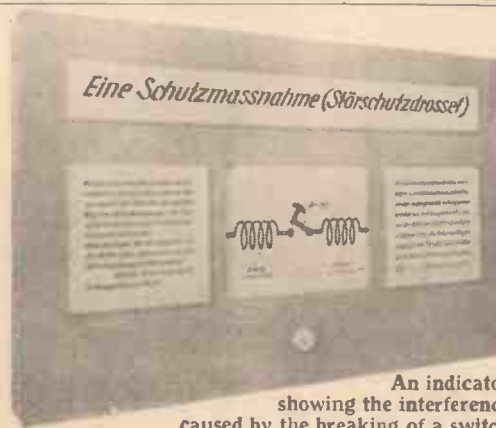

An indicator showing the interference caused by the breaking of a switch

RADIO NEWSPRINT

AS the result of a recent experiment in America, the entire front page of a newspaper was transmitted in facsimile over a distance of 3,000 miles in about three hours. The method used was a development of still-life photographic transmission on the lines of the well-known Fultograph system. If the process can be speeded up, it opens up the possibility of having one's daily paper delivered each morning on a recording apparatus attached to the broadcast set.

B. A. R.

On Your Wavelength!

A Good Quality Test

I WONDER how many readers have had difficulty in maintaining good quality reproduction down to a whisper from their loud-speakers. One is so liable to imagine that the only serious form of curable distortion comes from overloading some part of a set. Yet is this so? My own amplifier and moving-coil speaker is adjusted to operate at comfortable volume for a fairly large room and really gives excellent quality of reproduction. I have noticed, however, that when the volume is turned down this excellent quality is not always maintained. The matter puzzled me for some little time, for, with grid-leak rectification and a pre-detector volume control, distortion in this link of the chain should be highly improbable.

Until recently, in fact, we have been led to believe that the grid-leak detector operated effectively on any strength of signal up to an overloading value, although the anode-bend detector was effective only between definite maximum and minimum limits of input voltages.

Underloading!

Even though I was using power rectification, the symptoms of distortion pointed to underloading the rectifier, for as soon as the input was increased the trouble entirely disappeared. However, this was not all; maximum distortion was experienced on loud passages. How can one underload a detector on loud passages only? After a little bit of research, I discovered that the trouble was most certainly due to underloading the detector valve, but it was most accentuated when the modulation was greatest; this accounts for the seemingly absurd statement that an underloaded detector gives more distortion on a loud passage. The remedy, of course, is simple. Fit a post-detector as well as a pre-detector volume control, and if necessary operate both simultaneously, always keeping the detector loaded between certain limits.

5XX Quality

I returned recently from a holiday in Cornwall. 5XX is the station which is used principally in the more remote parts of the country, and although the quality is good, and one becomes quite used to it, yet the difference between 5XX quality and that obtained from either of the London stations is very striking when one has been away for a short time.

It is not just a matter of the amplifier. The particular receiver I used was the "Sunshine Three," recently described in these columns, and which incidentally gave surprisingly good results for three valves

only. The reproduction was pleasant, but lacking in the essentials at both ends of the scale. It is more particularly the upper frequencies which are missing on the 5XX transmission and not the bass, which tends to emphasise the fact that it is not sufficient to concentrate on bass reproduction in order to obtain good quality.

Effect of Distance

I do not wish to cast any aspersions on the B.B.C. As far as I can see, this loss of quality at a distance is unavoidable, and though I am aware of the handicap under which the outlying districts operate, I have never had the point so forcibly impressed upon me as on this occasion.

B-r-r-r-r

As I write my hands are so cold that they can hardly hold a pen and I am seriously thinking of applying a match to the fire. However, it is an ill wind that blows nobody any good, for the rain-moistened ground overshadowed by cloudy skies has certainly helped considerably to improve conditions for those who indulge in foreign listening. Without looking back into my records, I cannot remember offhand any July in which long-distance reception has been better—if, indeed, as good—than it is at present. There are few atmospherics about and all-round strength of stations is quite remarkable. Suppose that you have one good stage of H.F. amplification, you have at present a round dozen alternative programmes at your disposal on the medium and long waves. With the smaller set of coils you can call on Rome, Toulouse, Turin, Kattowitz, Bratislava, Nuremburg, Cologne, whilst on the long waves there are Radio-Paris, Hilversum, Huizen, Kalundborg, and the Eiffel Tower. All of these are reliable for loud-speaker reproduction, and in addition there are a good many others which will provide it on occasion. Such are Hamburg, Frankfurt, Brussels No. 2, Breslau, Motala, and Warsaw. And that, when you come to think of it, is not too bad a list for the height of summer.

I don't mean that you will receive all of these whenever you try for them, but on any average evening you should have a dozen or so stations at your disposal; and at any time of the day when they are working, four, at any rate, of the long-wave stations should be strong enough to work the loud-speaker.

Let's Hope Not

Someone the other day made the rash suggestion that the B.B.C. should try for another wavelength above 1,000 metres. The idea is that, since 5XX is so successful

as a spanner of distance, it would be well worth while to send out alternative programmes on the higher wavelengths. I view any such suggestion with horror and dismay. The medium band is already swamped for thousands of set owners by Raucous Reg and Noisy Nat and 5GB, and the best chance that the owner of a not very selective set has of hearing good transmissions from abroad is to switch on his long-wave coils. Another 5XX would just about fill the cup of those who are already exasperated by the medium-band 30-kilowattors. One great comfort is that even if the B.B.C. did follow up this mad idea they could hardly hope to succeed in obtaining another wavelength, since the long-wave band is already just about as full as it can hold.

A Broadcast Stenode

In the recently published report of the Stenode people, mention was made of the development of a smaller and cheaper form of apparatus intended for broadcast reception. Though at present my lips are sealed as regards details, I have seen this apparatus working, and I can assure readers that as regards selectivity it is an eye-opener. The system on which it works is based on one of those strokes of genius which are so simple when they are explained to you that you kick yourself for not having thought of them before. There is no reason why, in its simplified form, the Stenode should occupy a cabinet any bigger than that which houses the average multi-valve receiver. It won't be at all difficult to operate, for there are only two tuning controls and it does not require the hair's-breadth adjustment of the laboratory models. Still, it separates comfortably stations which with an ordinary set are right on top of each other, and in many cases eliminates heterodyne whistles heard when a "straight" receiving set is in use.

Welcome News

As I predicted at the beginning of the year, valve prices have come down quite considerably. G.P. valves cost now only 8s. 6d., as against 10s. 6d., whilst there is a drop of 2s. in power valves and 1s. 6d. in super-powers. Both S.G. valves and pentodes are down by half-a-crown. All of these are battery valves, and the only mains "toobs" that have come down in price are one or two types directly heated by A.C. Wireless folk of to-day often don't realise how lucky they are in comparison with the pioneers of pre-broadcasting and early broadcasting days. We used to pay 22s. 6d. at one time for the old bright-emitter R valve, and the first "cheap" valve to come on the market was the Mullard "Ora"

On Your Wavelength! (continued)

at 15s. The earliest dull-emitters were jolly good valves and very long-lived; but heavens, what an amount of good gold had to be spent on them! I had a set in 1923 using four DER valves, which cost £2 10s. apiece. Of the test-tube valves the famous DEQ cost, unless my memory deceives me, £2 15s., and the DEV, £2 10s. I still have some of these old-stagers in very fair working order. Now that G.P. valves are down to 8s. 6d., the days of the crystal set must surely be numbered. Is it too much to hope that the B.B.C. will develop in the near future a valve complex and realise that 30 kilowatts really are not necessary in order to cover a wide service area?

DX Diagnosis

What must be a record in long-distance medical diagnosis was achieved recently. The patients presented themselves at Buenos Aires, in South America, and were examined by physicians and surgeons sitting in Madrid consulting-rooms. This wonder was performed by means of the ordinary commercial telephone service. A special microphone with an amplifying device of its own was used for application to the patients' chests whilst they said "ninety-nine," or whatever Spanish patients do say, and the medicos in Madrid were able to listen both to their breathing apparatus and their hearts. It is stated that the results of the examination were most satisfactory and that this diagnosis at long distance was found to be quite a simple affair, owing to the perfection with which the tiny amplified sounds were conveyed by wireless over thousands of miles.

One More Try

I referred some time ago to the uselessness of some of the data about their valves that manufacturers give us. I mentioned in particular how ridiculous it was to give the amplification factor, impedance, and mutual conductance of any but high-frequency valves for zero grid bias. Though the old evil still remains, I am glad to see that one firm is taking a most sensible line as regards the figures for its screen-grid valves. In their catalogue the Mazda people publish curves which show you exactly what the amplification factor and mutual conductance are with various plate voltages and different positive potentials on the screening grid. And if you know the mutual conductance and amplification factor, you can get the impedance at once. All that you have to do is to divide the amplification factor by the mutual conductance figure, expressing the latter as a fraction of an ampere; thus, if the mutual conductance is 1 milliampere per volt you divide by .001. Despite this good work, though, I cannot make out why in the catalogue the anode-grid capacity of valves should be expressed

in centimetres. All wireless users are familiar with microfarads or micro-microfarads. There is not, in fact, a lot of difference between one centimetre and one "micro-mike"; still the use of a multiplicity of terms is always confusing.

See They're Pierced

The other day a brand new unit came back with my accumulator H.T.B. from the charging station, and a few hours later I was heartily cussing the fellow who had done the job for not cleaning up the battery properly before he delivered it. What I found was that the tops of the cells of this unit were swimming in electrolyte and that there was a large pool of it in the tray on which it stands. "I don't know what's the matter with that unit," he said; "it will throw out electrolyte almost as fast as I put it in." When I came to examine it I didn't wonder. The cells are closed by means of little rubber "corks," each of which is pierced with quite a large hole so as to allow gas to escape. Something had gone wrong with the piercing of two of the stoppers and the holes did not extend right through them. There was, therefore, no vent for the gas and solution was forced out.

How to Do It

If your H.T.B. cells show signs of becoming messy, always have a look at the vent plugs and see that the holes do run right through them. The trouble may easily be caused by one or more of the holes becoming stopped up with some foreign substance. If the holes in the rubber don't go right through from end to end it is rather a difficult business to dig them out satisfactorily with any kind of prodder. The best way that I have found is to make a hole in a piece of wood into which the plug is a pretty tight fit and then to run a twist drill right through. You may have to do this two or three times in order to get a perfectly clear hole.

Not Caught Napping

I often wonder what closing-down time is in Spain; for, really, I think that there is hardly an hour out of the twenty-four when I have not caught the Spanish stations at work on some occasion or other. The other night I couldn't sleep, and at about half-past two, in the morning I decided to get up and sally forth to catch a trout for breakfast. On my way out I naturally switched on the wireless set, to see whether any of the Americans were coming through. They weren't, but both Barcelona and Madrid Union Radio were going strong. So far as I could make out, they were describing an athletic contest or something of the kind; though, really, I cannot conceive what kind of contest could take place at that hour of the morning. It

was good to hear both of these stations so well, for in the ordinary way they suffer a good deal from interference and blotting out by their two near neighbours on the broadcast band. With everything clear in the ether, both were coming through with immense volume and splendid quality.

A Handy Gadget

My wireless table contains one little accessory which some readers may find a boon. They certainly will if their sets are in corners that are not too well lighted. From the filament accumulator a pair of leads runs to a miniature socket fixed below the table and close to its edge. On the table stands a small desk lamp, fitted with a 6-volt bulb. This has a pair of flex leads, which terminate in a twin plug. If I want more light, I don't strike matches and burn my fingers and cuss; nor do I look for the flash lamp that ought to be on the table, but which some member of the family has borrowed and forgotten to return. I simply stick the plug into the socket, and there we are. The whole outfit costs only a matter of a few shillings, and it is a simple business to rig it up. Even if you only have a 2-volt accumulator, you can get 1.5-volt bulbs, which give quite a good light, though, since it is a question of watts, they naturally consume more juice than the 6-volt variety for the same amount of illumination.

Neons for Projection

The normal light that one secures from an ordinary neon lamp with a flat electrode, as used in a television receiver, does not lend itself in that form to projection work whereby the size of the resultant image could be increased. With mirror-drum scanning, however, and a special type of neon, the image size can often be increased quite appreciably. The anode of the glow discharge tube is then made in the shape of a concave or part cylindrical reflector, with the cathode placed at the principal focus. The back of the reflecting electrode is coated with insulating material, such as mica or micanite. By this means a highly concentrated ray is secured, which is focused on to the mirror drum and in turn reflected on to a prepared glass screen, where the image is built up into the usual strip form. What a pity other forms of illumination are so sluggish (in a television sense) in their response to voltage or current fluctuations. If this defect could be overcome, the television images which we now view through magnifying lenses in the vision apparatus could be projected. It is in this connection that further details are awaited of the proposed new projection methods which Mr. Baird states will allow him to show life-sized screen images of living artistes

THERMION.

What is Damping?

By J. H. REYNER, B.Sc., A.M.I.E.E.

I HAVE received an interesting letter from a reader who has obviously been thinking things out for himself. He says: "May I suggest that you write an article on 'Damping.' Information on the following points would be instructive:

- "(1) Explanation of aerial damping on a tuned circuit.
- "(2) The damping effect of a valve on a tuned circuit.
- "(3) Why the damping effect of a grid-leak detector is considerable, whereas the effect of an anode-bend detector is negligible.
- "(4) Does an H.F. valve damp both the grid circuit and the tuned anode?"

The term damping arises from the days when all wireless communication was carried on by spark sets. In a spark transmitter we charge a condenser and then allow it to discharge through an inductance, and the current which flows oscillates backwards and forwards to a gradually decreasing extent, in the manner shown in Fig. 1.

Effect of Resistance

If the circuit contains only inductance or capacity, the oscillations once started would continue indefinitely, but in practice they die away, due to the presence of resistance and losses in the circuit, all of which have the effect of "damping" the oscillation down so that it ultimately dies away. Trains of waves of this character are spoken of as "damped waves." The term damping was, indeed, originally applied to refer to the rate at which the oscillation died away, due to the presence of losses, and used in this sense its meaning is fairly clear.

To-day we are concerned more with continuous oscillations, usually generated by valve transmitters and modulated by speech or music. In this case the term damping has not such a clearly defined physical meaning, but we must bear in mind the following fact. In a spark oscillation we charge the condenser and allow it to discharge. In a continuous wave we set up an oscillation in a somewhat similar manner, but instead of allowing it to die away we feed energy into the circuit the whole time in order to make up the loss which would otherwise take place. Clearly the energy which we supply to the circuit must be equivalent to that which is lost through the damping, and consequently the term damping has come to refer to the losses which are occasioned in a tuning circuit due to the presence of resistance, or

other forms of loss which produce a similar effect.

Let us consider the case of an aerial circuit. First of all we have the resistance of the wire. Next we have the resistance of the earth underneath the aerial, for the oscillating currents actually flow backwards and forwards in the space between

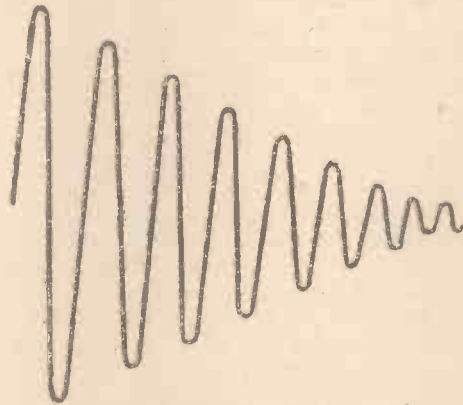

Fig. 1. Diagram showing gradually decreasing oscillation

the aerial and the earth immediately underneath it. This being so, any objects which are in the direct path of these currents will absorb energy and, therefore, introduce extra losses so that we have a further effective resistance (anything which absorbs energy may be considered as an

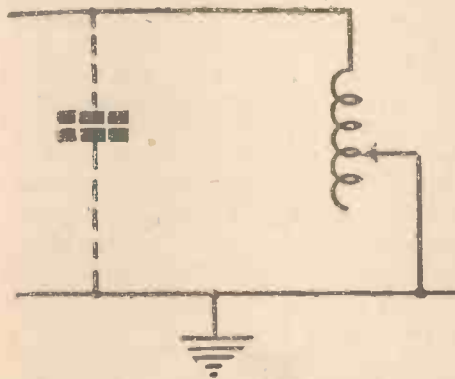

Fig. 2. Circuit in which aerial damping is heavy

imaginary resistance), due to the presence of trees, iron pipes and such things in the immediate vicinity of the aerial.

Finally, we have the radiation resistance of the aerial. In a transmitting aerial the current rushing up and down the wire radiates electrical waves, and this obviously absorbs energy from the system. Indeed, in a transmitter we require this particular form of energy absorption to be

as large as possible, and we write off this loss as being due to what we call "radiation resistance." In a receiving aerial somewhat similar effects take place, for the current induced by the wireless wave in turn re-radiates a small percentage of energy which gives rise to a loss.

Effect of Heavy Damping

Thus we can see that an aerial system contains several quite considerable sources of loss, and indeed the effective high-frequency resistance of the average aerial used for broadcast reception may be anything from 20 to 50 ohms. The extent to which this affects the tuned circuit in the aerial system depends very largely upon the connection. The greatest effect is obtained if we use a circuit such as that shown by Fig. 2.

Here the aerial is tuned by a simple inductance which is made variable. The inductance is adjusted to tune with the effective capacity of the aerial to the wavelength required. The tuned circuit is thus made up of the inductance, the aerial capacity, and in this circuit is the whole of the loss which we have just considered; some 20 ohms or more. This is, of course, added to whatever resistance the inductance itself may possess, so that the whole circuit becomes very flatly tuned.

In practice we do not use a system like this, because it is not convenient. Usually, we connect the tuning condenser across the coil and we connect the aerial by one of the methods shown in Fig. 3. The effect of this is to connect the aerial across a portion of the circuit only.

Reducing Damping Effects

Now, if any oscillating current is set up in this circuit some of the current will flow through the coil and the tuning condenser, and some of it will flow through the aerial. The smaller the tapping of the aerial on the coil (or the smaller the value of the coupling condenser), the less will be the proportion of current flowing in the aerial itself, and consequently the less will be the effect of the aerial on the tuned circuit. In other words, we can minimise the aerial damping by the use of one of the circuits of Fig. 3, and as this arrangement also gives us better tuning properties, the system has come into considerable vogue.

A simple illustration of damping may be obtained by constructing an ordinary pendulum. This is done by taking a length

(Continued at foot of next page)

SYDNEY MOSELEY'S WEEKLY PROGRAMME CRITICISM

Who Are the Judges?

Lupino Lane

A Recruit

The Dance Bands



WHO are the secret critics upon whose secret reports the fate of artistes and speakers are decided? One of those who decides the fate of speakers, I am told, is a man whose own enunciation was so bad that it aroused the whole condemnation of critics. Would not it be far better to permit the public to judge? But I assure you that that is the last thing the Talks Department contrive to do.

Perfectly fifth-rate was Lupino Lane as a broadcaster. Certainly, too, the standard of B.B.C. variety show was not improved by his rubbishy patter. As an acrobat on the films, yes; but he has a cheap music-hall idea of humour, and I am surprised that his patter passed the Savoy Hill sleuths.

Quite a lively lot were those "two pairs" who sang "Good night, Michael; good night, Mike." True, there was a song with that old beautiful, poetical phrase, "feeling blue." But the quartet is of good material, and should do even better with different patter.

In a drowsy state I switched on my portable and heard one of those tinny, halting, nasal band vocalists chirping, "Give me a fair chance," or something like it I did, but soon fled to—the Children's Hour, where, at any rate, a cultured woman's voice was telling of a china cat which lost its tail and helped to repel a burglar. Great stuff when you're drowsy!

Seriously the stupid story was so well written and so delightfully told that I listened to the very end, where the cat was changed into a nice live thing and lived with his mistress happily ever after.

David Wise in violin solos was good. This type of artiste should be encouraged.

Too much banjo is neither good for listeners nor for the banjost. Its range is so limited that Mr. George E. Morris should curtail his turn if he would be successful. Flotsam and Jetsam did not give much for their money.

Colourful stuff is the symphonic suite, "Scheherazade," by Rimsky-Korsakov. I can't see how this can be called high-brow. The names are the most forbidding part of the business. Call it "The Arabian Night Suite" and it would be as popular as "In a Monastery Garden."

The production of *Antony and Cleopatra* left much to be desired. I don't suppose nine listeners out of ten were able to follow the story. I tried to keep in touch with the written play. And even that was difficult. Not the "homeliest" of Shakespeare's plays, either.

Much the better idea of presenting the Bard's work is that adopted by the producer—whatever he is—of the "Scenes from Macbeth."

Sorry Vernon Bartlett is taking a rest from his interesting "Way of the World" talks. But perhaps he is right. The best

moment to retire is when one is on the heights of popularity. I suppose it is really *au revoir*, and not farewell.

Opinions regarding the first television play continue to reach me

Here is one from "Harold" I was one of the lucky ones who saw the first televised play, and I must say it was a fine effort. Apart from the quality of the reception of the images, the players played their parts splendidly. I notice that a newspaper critic said that the sound was badly broadcast. I would advise him to look to his set. I was listening to a moving-coil speaker and was greatly struck by the clear enunciation of every word. My only criticism is that for the first dramatic experiment the Baird Company might have chosen a pleasanter play. Disease was not a happy subject."

A recruit from the stage whom I have just heard for the first time is Billy Milton. His is a pleasant type of turn—just the same as dozens of others. If we are to borrow from the theatre, why not get something new for a change?

Since the departure of Jack Payne and Co. we have had all sorts and types of bands accompanying the variety programmes with varied success. In most cases the result has not been too good. The latest combination at the time of writing, however, while not a dance band, promises to be one of the most successful in this type of work. I refer to De Pietro's Sextet, which has sparkle and tone.

"WHAT IS DAMPING?"

(Continued from preceding page)
of thin cotton and tying a small weight of

released it will swing to and fro approximately once every second. The oscillations will gradually die out due to the air damp-

ultimately come to rest.

Suppose now we fixed a disc of cardboard, say 2 in. in diameter, to the weight and swing the pendulum so that the full force of the air comes against the cardboard disc. It will be found that, although the time of swing is the same as before, the oscillation comes to rest much more quickly. In other words, it is more heavily damped, due to the greater wind resistance, and this gives us a very good analogy to the electrical case. The larger the resistance or the loss from whatever cause, the more rapid the damping in the circuit.

So much for the meaning of the term, and its application to the aerial system. The remaining three points relating to valve damping must be left until next week.

a few ounces on the end. The cotton should be about 3 ft. long, when if it is hung at one end and the weight drawn to one side and

ing. The friction between the air and the weight in each oscillation gradually absorbs the energy from the pendulum, and it will

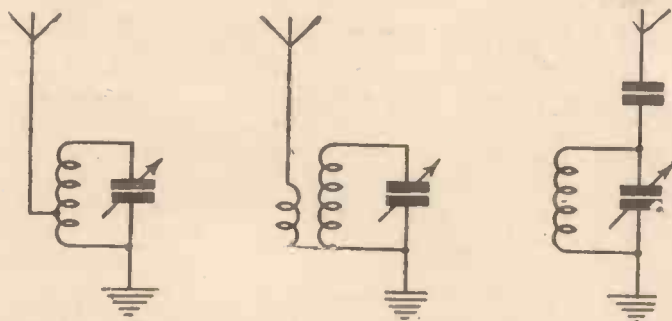

Fig. 3. Three methods of aerial connection to reduce damping

Recent Developments in Components

W. James writes on the trend of detail design of special interest to the home constructor

THE present is a fairly good time to consider the position of the wireless industry and to note the trend of developments, for now next season's sets are being designed and their production is being considered.

The usual procedure is for the designers to produce a set providing the desired results, which may then be modified by the production people, if they have not already taken part in the arrangement of the set; apart from the electrical values of the parts employed, stands the mechanical design.

This really is most important. Switches and other parts subject to continual use must be sound mechanically. A low-loss type switch is of no real value if it is so weak that it will not survive a few months use. Similarly with numerous other parts which are turned or moved by the user.

The mechanical side of a set is one which has, in the past, in this country at least, hardly received the attention which it deserves, with the result, that too large a proportion of sets issued have become faulty after little use.

Some parts are very reliable. Thus fixed condensers seldom give trouble if good ones are used in the first place.

Valve holders are not too good. Some types are faulty owing to the use of poor materials or perhaps the parts are flimsy and not strong enough. A proportion of variable condensers give trouble—plates shorting, contacts loosening and the movement becoming too tight or too loose.

Slow-motion movements are apt to be troublesome. There are good ones, both built into the actual condensers, and in the form of special dials, but quite often the movement is not uniform, slipping occurring at some points.

With switches we know that various troubles occur. The springs of some are soft and eventually fail to provide the necessary good contact. Others are hard to turn and spindles slip.

Speaking generally, faults are usually due

together cannot be considered entirely satisfactory. It is interesting to note, therefore, that at least one firm has a properly constructed ganged job in production. The frame is rigid, large bearings are fitted for a $\frac{3}{8}$ -in. steel shaft and the plates are shaped and held so as to avoid twisting and variation during use.

Without a good ganged condenser the production of the single tuning control set is not a practical proposition, and I for one have hesitated very much because of this condenser question.

For use with ganged condensers we need accurate tuning coils.

Ordinary coils will not do. The mere fact that a maker says that his coils are accurate as to the number of turns and so on, is of no value to me, unless the coils are arranged for accuracy. Thus, moulded formers with slots, and other types, are not acceptable to me for factors such as the tightness of winding and diameter of wire affect the inductance.

If coils were actually measured for their electrical properties all would be well, but the mere checking of turns is of no great value. This matter is one well worthy of the careful consideration of manufacturers.

There seems to be a good supply of well made low-frequency transformers and chokes available. At one time breakdowns were numerous, but to-day this trouble is not met with to any extent. Some of the transformers have a large inductance only when the current passing through the windings is small. These transformers usually have a core of special

steel which must be dealt with carefully. In order to avoid the reduction in inductance which occurs when the current exceeds a certain amount, depending upon the design of the transformer, it is usual to

(Continued at foot of page 118)

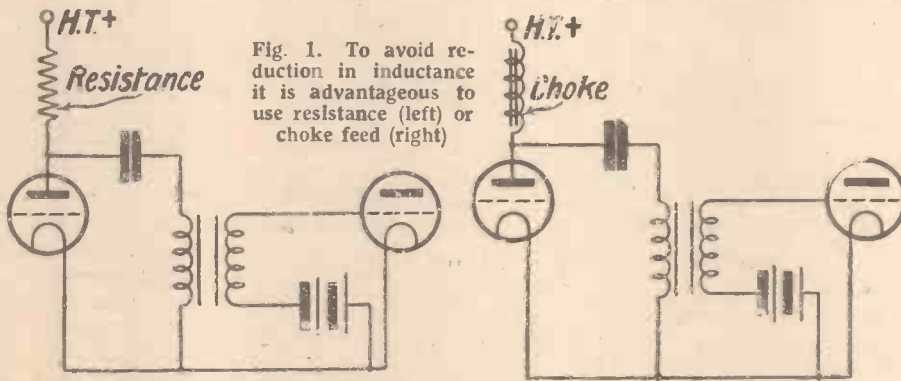

Fig. 1. To avoid reduction in inductance it is advantageous to use resistance (left) or choke feed (right)

to mechanical defects and the question, therefore, arises as to whether the manufacturers are fully aware of this. Those who are closely in touch with the developments going on agree that the new sets will be much better in this respect. The process of cutting down in order to save a few pence has been carried too far.

Take as an example the ganged variable condenser. Some of these cannot by any stretch of the imagination be called satisfactory. The individual condensers may have matched in their capacity values when

first they were issued, but owing to weak bearings and frames, the very act of fitting them may have so twisted them that they are no longer matched.

Obviously the ganged condenser composed of two or three ordinary types bolted

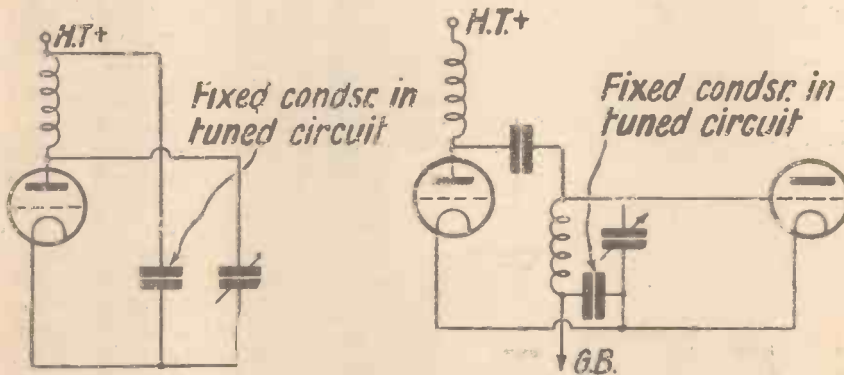

Fig. 2. Examples of arrangement of fixed condensers in tuned circuits

EASY-TUNE S

VISIONS of enthusiasts carrying out tricky operations with highly complicated sets far into the night, and staying up at unconventional hours, phones on head, for the pleasure of hearing stray sounds and heterodynes from across the Atlantic—these and other misunderstandings have done much to dissuade broadcast listeners from participating in the fun of reception below 100 metres.

Most of the tales one hears about hair-line tuning, great technical difficulties of construction, and poor results on the short waves belong to a radio period long dis-

portion of capacity which can be "pre-set" and brought into circuit.

Fine tuning is then carried out with the vernier control on the panel. The total capacity of the condenser is .0001, which is ample for covering the range of most short-wave coils. The subsidiary condenser has a value of .00002 microfarad, and this

gives a fine control. The detector valve is efficient in action because it is connected in a grid-leak-and-potentiometer circuit, the potentiometer being placed on the panel. By this means the grid circuit can be set to its most sensitive condition, and the extreme value of the potentiometer control will best be appreciated when the set is made up and is ready to work. By a proper setting the reaction control can be made as simple and as smooth as it should be in a broadcast-band receiver.

Motorboating

One other difficulty which is sometimes experienced with a very sensitive short-wave set is the tendency to motorboat just as reaction is brought to a critical point. In some receivers this is corrected by the use of an anti-motorboating unit in the detector valve anode circuit—generally a very workable arrangement, but one to be avoided, if possible, because of the cost of parts needed, a resistance or choke and condenser.

In this short-waver, motorboating at the threshold of reaction is obviated partly by the potentiometer control and partly by the correct adjustment of the detector anode voltage. A separate H.T. tapping is provided for the detector and, as will further be explained in the operating notes, care must be taken to get the potential correct, so that the receiver slides easily into reaction without audible plopping.

When phones are worn (which need not

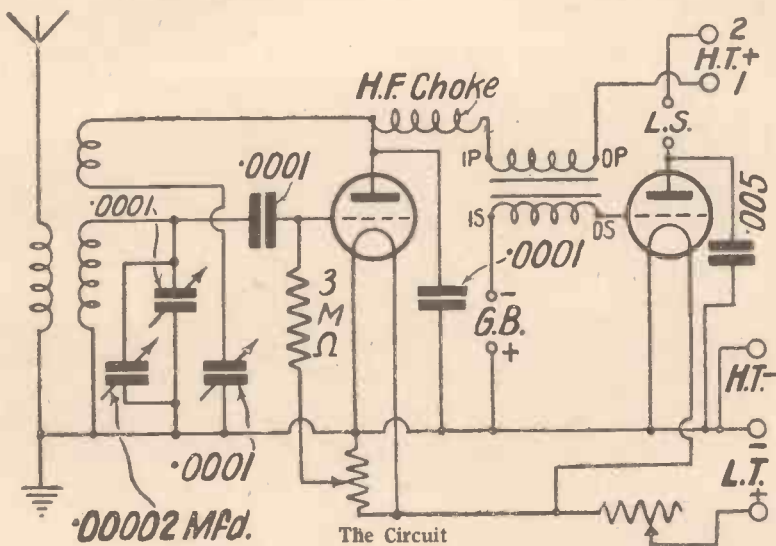

tant, before modern efficient components were introduced.

This easy-to-tune two-valver has been designed with the object in view of inducing broadcast listeners to discover for themselves the pleasure of short-wave reception. A special tuning arrangement is incorporated and the circuit is so designed that the control does not need very delicate adjustment.

The aerial circuit is arranged so that, by means of the special condenser employed, tuning-in of stations is made extremely simple. The condenser is of a new type, and is novel in that the vernier control is mounted on the panel and the main section of the condenser is at the back and has a separate dial showing the exact pro-

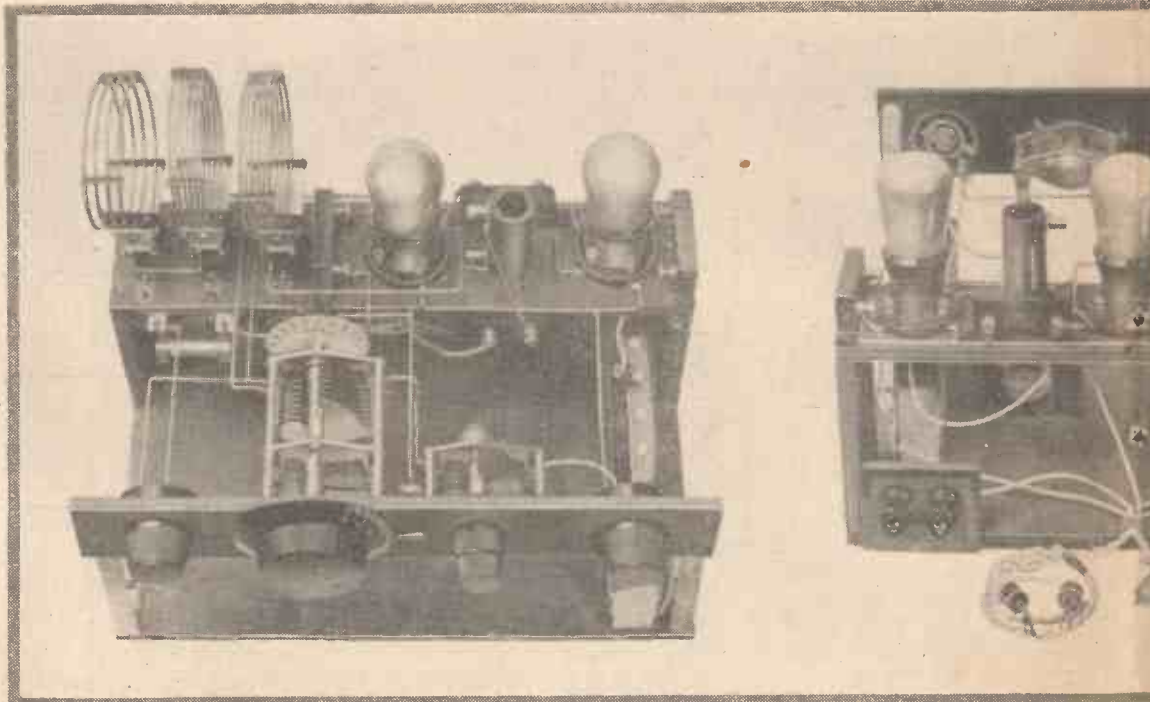

A skeleton construction has been adopted in order to avoid capacity losses and mal-

SHORT-WAVE 2

often be the case with this set) or when the speaker is moved about, stray capacity effects may make themselves manifest if the H.F. filter arrangements are not satisfactory.

A good H.F. choke is connected in the detector anode circuit and, what is equally important, a by-pass condenser is provided so that the H.F. "strays" can go direct to earth without passing through the primary of the L.F. transformer. Transformer coupling is used for the single L.F. stage required, because with modern couplings there should be no trouble on the score of purity, and for short-wave reception one needs every ounce of volume. With R.C. coupling there is generally a marked drop in signal strength as compared with transformer or choke coupling.

Simple Construction

For those amateurs who like to carry out construction with the aid of a blueprint, a full-size blueprint has been prepared and is available, price 1s., post free, from the Blueprint Department, AMATEUR WIRELESS, 58-61 Fetter Lane, London, E.C.4.

There are no points of particular diffi-

culty about the construction of the set, but in this case there is every cause to advise constructors to work with the full-size blueprint, or to work very accurately to the scale drawing given herewith.

The correct positioning of parts is very essential, and while, naturally, a little deviation from the mounting centres given (in order to accommodate an alternative component) will not affect results, it is very unwise to make any drastic alterations to the layout, or to use any other component than those given in the accompanying list of parts needed.

An unconventional layout is adopted, and it will be

noted that the L.F. transformer is mounted underneath the main components strip. There is no real panel, but a small strip of ebonite in front of the set, mounted on "L" brackets, carries the main control, including the condensers and the all-important potentiometer.

Wiring up should be carried out carefully and, in conjunction with the wiring plan shown here, a test should be made when all connections have been put in place. For this test the coils should also be plugged in so that all circuits are complete.

COMPONENTS REQUIRED FOR THE "EASY-TUNE SHORT-WAVE 2"

Ebonite strip, 12 in. by 2 in. (Becol).
Panel brackets (Bulgin, Ready Radio).
Special short-wave tuning condenser (Polar).
.0001-mfd. reaction condenser with slow-motion movement (Polar, Jackson, Lissen, Lotus, Bulgin, Burton, Formo).
400-ohm panel-mounting potentiometer (Wearite, Igranic, Lissen, Varley).
7-ohm rheostat (Wearite, Lissen, Igranic, Varley).
Three single coil holders (Lotus, Lissen, Igranic).
Two valve holders (W.B., Lotus, Benjamin, Formo, Burton, Lissen, Igranic, Trix).
Three fixed condensers, two .0001-mfd. and one .005-mfd. (Lissen, Dubilier, T.C.C., Graham-Farish, Watmel, Atlas).
3-megohm grid leak (Lissen, Watmel, Graham-Farish, Dubilier, Ediswan).

Grid-leak holder (Lissen, Bulgin, Ediswan, Dubilier).
Short-wave high-frequency choke (Igranic, Lissen, Dubilier, Bulgin, Wearite, Polar).
Low-frequency transformer (Voltron, Telsen, Lissen, Igranic, Burton, Varley, Lotus, R.I., Ferranti).
Two terminal blocks (Junit, Lissen).
Four terminals, marked: Aerial Earth, L.S.+ , L.S.— (Belling-Lee, Clix, Eelex, Igranic).
Five winder plugs, marked: G.B.+ , G.B.—, H.T.—, H.T.+1, H.T.+2 (Belling-Lee, Clix, Eelex, Igranic).
Two spade terminals, marked: L.T.+ , L.T.— (Belling-Lee, Clix, Eelex, Igranic).
Four yards of thin flex (Lewcoflex).
Grid-bias battery clips (Bulgin).
Connecting wire (Glazite).

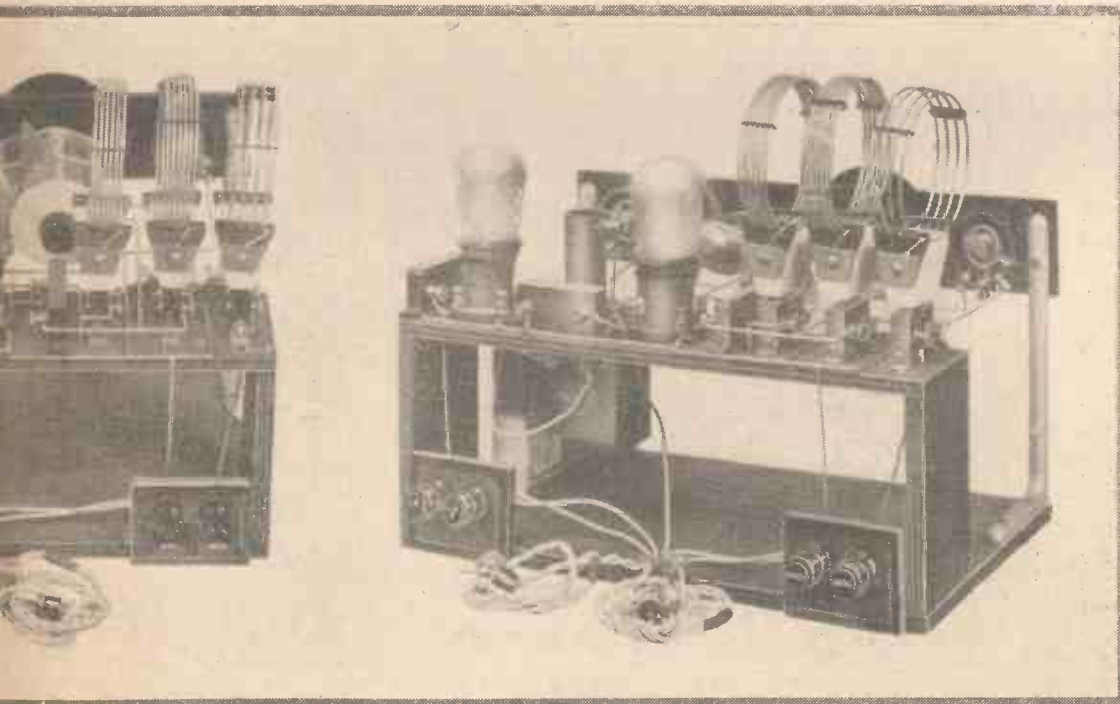

for the greatest efficiency. Note the use of an aperiodic coil in the aerial circuit

The type of plug-in coil used has a standard plug. The smallest coil available in the standard two-pin size is typified by the Clarke's Atlas No. 2, which tunes down to about 15 or 20 metres. There are four coils available in the set, the highest wavelength being about 100 metres.

Suitable Valves

The detector valve should have an impedance of about 20,000 ohms, and the following two-volt valves will serve as a guide: Cossor 210HF, Dario Univ., Marconi HL210, Osram HL210, Six-Sixty 210HF, Mullard PM1HF, Mazda HL210, Lissen HL210, Fotos BA9, P.R. PR3LF, Triotron HD2.

The following two-volt power valves are suitable,

“THE EASY-TUNE SHORT-WAVE 2” (Cont. inued from preceding page)

but four- or six-volt valves can be used if desired: Cossor P2, Dario SP, Marconi P2, Osram P2, Six-Sixty 220P, Mullard PM252, Mazda P220, Lissen P220, Fotos BD9, Tungram P215, P.R. PR120.

H.T. Values

Plenty of H.T. is advisable and at least 120 volts is advised for the L.F. valve, the anode of which is connected to the terminal H.T.+2. Critical adjustment of H.T. should be carried out on the H.T.+1 tapping, which supplies the current to the detector valve.

Generally speaking, the voltage will need to be in the neighbourhood of 60 to 80.

Excellent Results

A test one evening last week produced a gratifying loud-speaker log. Valves selected from the foregoing tables were used both for detector and power, and a medium-capacity dry H.T. battery was used. A potential of 150 volts was applied to the power valve, and the actual anode voltage (measured) was 83. The full 9 volts of the grid-bias battery was necessary, particularly on the louder stations, such as Philips PCJ and our own 5SW, when the best degree of purity was found to be necessary in the interests of intelligibility.

When the set was taken over for test it was fitted with a .0001 grid condenser and a 3-megohm leak. The leak was changed to one of 5 megohms, for this value had, in another set, been found more suitable for the detector valve employed. A high grid-leak value is often an advantage in a DX set.

The potentiometer control rendered the higher value unnecessary, however, for exactly the same results could be obtained with both leaks at a slightly different setting of the potentiometer.

The most useful coils for the main grid circuit were found to be the numbers 4 and 6, on which a large amount of traffic was received on an indoor aerial. The normal outdoor aerial was not used, for 5SW was the only station which could be properly tuned-in on it. Owners of large outside aerials would be particularly well advised to work this set on a short indoor wire.

Thanks to the novel condenser, tuning was found to be very easy, and searching for stations over a wide wave-range could be carried out without the necessity for coil-changing. The capacity of the main section of the condenser was slowly moved step by step, actual searching being effected with the vernier. Just one tip: when manipulating the knob of the main condenser section, take care to keep the hands away from the reaction-coil leads. Even low-voltage shocks are unpleasant!

This set is on view this week in the windows of the Radio Department of Messrs. Selfridge & Co., of Oxford Street, London.

ELECTROSTATIC LOUD-SPEAKER

THE principle of the electrostatic loud-speaker is that of a variable condenser, in which the moving vanes are replaced by a flexible diaphragm, and the fixed vanes by one or more rigid plates. In the Vogt model the flexible diaphragm is arranged between two outer fixed plates both of which carry a positive biasing-potential.

The fluctuating speech voltages are impressed across the two outer plates in push-pull relation, so that as the electro-

static attraction of one plate on the flexible membrane increases, that of the other plate decreases. In this way the centre diaphragm is flexed alternately in each direction, until its mechanical stiffness just counterbalances the electrostatic force. This reproduces the original sounds without harmonics or over-tones.

M. A. L.

As the new Salzburg (Austria) station is nearly complete, October 1 has been provisionally fixed as the date for its preliminary tests.

Work on the 120-kilowatt Warsaw Central station has progressed so quickly that it is hoped to bring it into daily operation by the end of the present year.

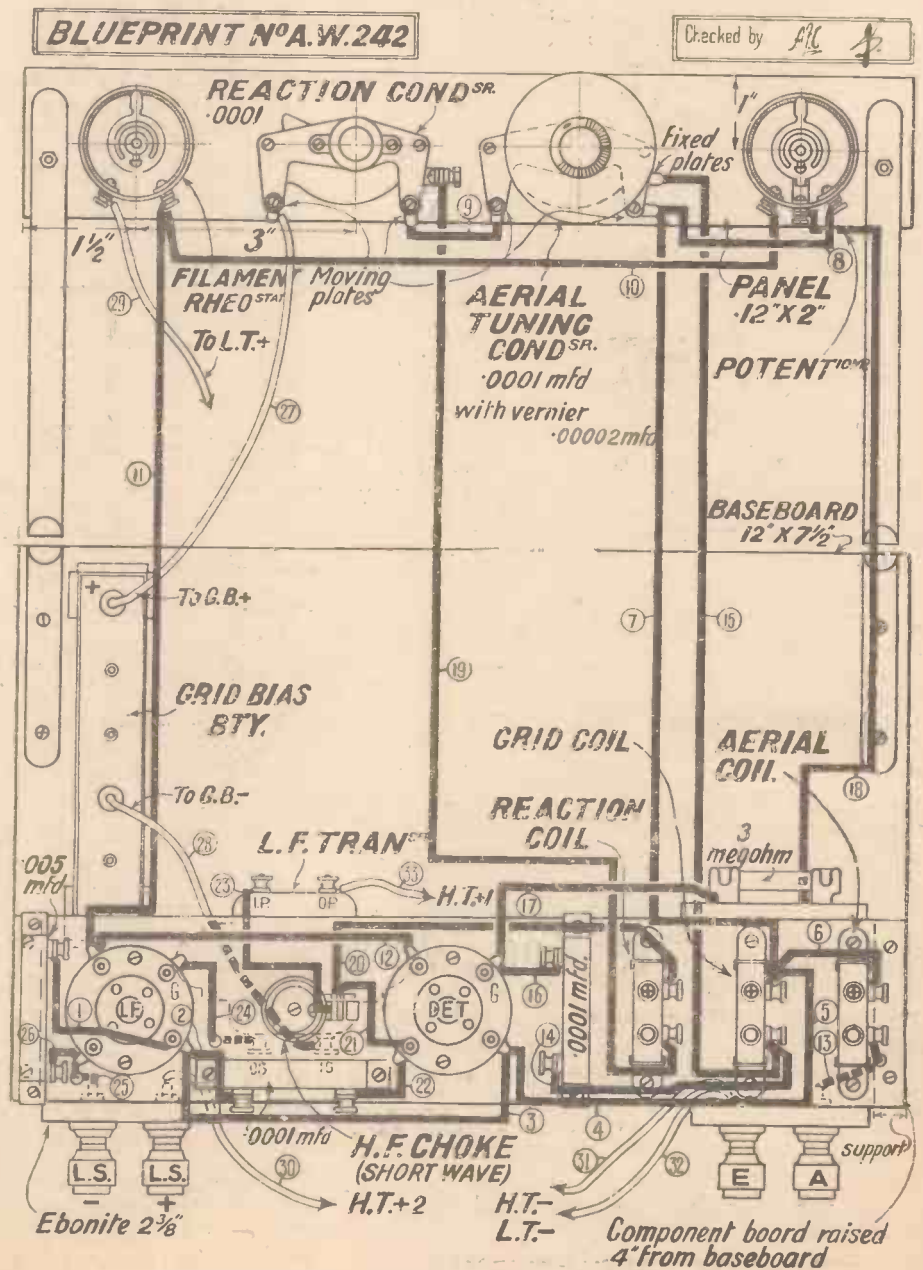

The wiring diagram. A full-size-blueprint is available, price 1/-



SCIENTIFIC RESEARCH USURPS THE THRONE OF MAGIC

Dead and gone are the days of Magic.

In these days the basis of invention is scientific research—definite knowledge of every small detail, every element which ultimately constitutes the finished article.

It is on this basis of scientific research that the work of the Lewcos Laboratories is carried on—hence this firm's world-wide reputation for "perfection in every detail."

The Lewcos Dual Range Binocular Coil, illustrated above, is designed to meet the demand for high efficiency astatic or field-less coils, having wave-length ranges of 235/550 metres and 1000/2000 metres, the wave-length range being selected by a simple push-pull switch which protrudes through the receiver panel. Three types are manufactured, as follows:

Aerial Coil without reaction (Reference D.B.A.).

H.F. Transformer for neutralised 3-electrode valve with Reinartz reaction (Reference D.B.P.).

H.F. Transformer for screened-grid valve with magnetic reaction (Reference D.B.G.). Price 17/6 each.

A special switching mechanism can be supplied so that one or more coils can be mounted on the baseboard of the receiver with switching mechanism parallel with the panel. Price 3/-. (Reference S.M.5).

A fully descriptive leaflet of this marvellously efficient Coil will be sent on request. Please quote Reference No. R.55



STOCKS HELD AT THE FOLLOWING BRANCHES:	
BELFAST:	Mr. H. F. ARPIS, 48 Upper Church Lane.
BIRMINGHAM:	DALTON HOUSE 94 Corporation Street.
CARDIFF:	35 Charles Street.
DUBLIN:	Mr. C. A. JOHNSTON, 38 Upper O'Connell Street.
GLASGOW:	74 York Street.
LEEDS:	2 Cabinet Chambers, Basinghall Street.
LIVERPOOL:	24 Preecons Row, South Castle Street.
LONDON:	7 Playhouse Yard, Golden Lane, E.C.1.
MANCHESTER:	19a Brazennose Street.
NEWCASTLE:	27 Oxford Street.
NOTTINGHAM:	18 George Street.

LEWCOS

(Regd.)

COILS FOR SUPERIORITY

THE LONDON ELECTRIC WIRE COMPANY AND SMITHS LIMITED

Church Road, Leyton
London, E.10.

Advertisers Appreciate Mention of "A.W." with Your Order

MY WIRELESS

Weekly Tips,
Constructional
and
Theoretical—

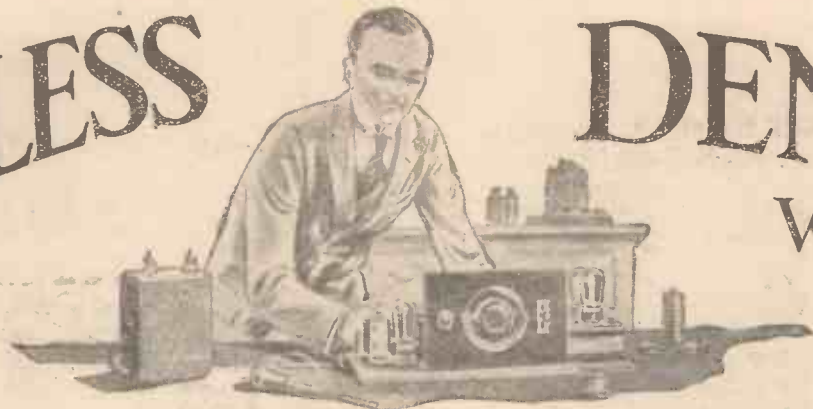

DEN

By
W. JAMES

For the
Wireless
Amateur

H.F. Choke "Strays"

A POINT to remember with high-frequency choking coils is that their characteristics depend to an extent upon where they are fitted in a set. Thus it is possible that the self-capacity and inductance, if it could be measured with the choke in its place in the set, would be very different from the values when the choke is measured by itself.

A choke fitted to a metal base is sure to behave a little differently as compared with a similar choke, but fastened to a wood baseboard. This is likely to affect the results, and when a metal-chassis form of construction is used one should be on the look out, for results may not be as expected, owing to the influence of the metal. When wiring a choke, too, one ought to be careful not to add to the self-capacity, so far as is possible.

The Hum Problem

One still hears the remark that mains sets are all very well when there is no hum. The fact is, of course, that there should be no hum.

In one or two districts it is very difficult to remove hum, but when the supply is a normal one, perfectly quiet operation should be obtained. A hum is often to be traced to a bad arrangement of parts.

A power transformer often has a large stray field, and therefore is likely to set up currents in low-frequency transformers or chokes. Very often a change in the position of the power transformer is all that is needed.

Thumb Dials

I often wonder whether thumb tuning dials will ever be popular. There is much in favour of the ordinary knob, but yet the appearance of a set having drum dials with finger controls is often better.

With a stiff or too loose movement, tuning is really difficult when the finger or thumb control is used. Some types are so made, however, that tuning is easy, and some of the best sets have this form of tuning control.

"R.C." or "Trans."?

Resistance couplings are not nearly so popular nowadays as transformer couplings,

partly, I believe, because good valves of moderate impedance are available and partly because transformers are good and reliable.

Also, one stage of low-frequency is often used, with the result that the slight distortion introduced by the transformer is of no importance. The greater amplification is also a point in the favour of a transformer coupling.

A Good De-coupler

The circuit diagram this week shows a de-coupling resistance and condenser connected to a resistance-fed transformer.

That such a de-coupling circuit is needed is recognised by those who have carefully tested the circuit. Unfortunately, with two resistances included in the anode circuit, the voltage drop is likely to be rather too large a proportion of the total, with the

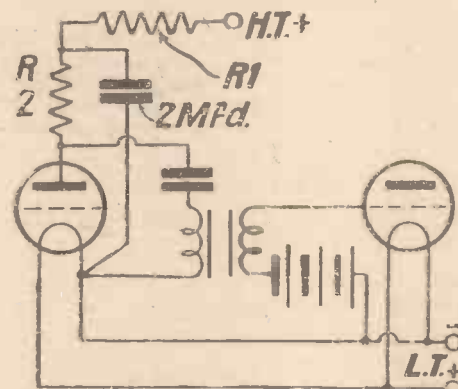

A useful de-coupling arrangement which in many cases will improve results.

result that the actual anode voltage may be too low for satisfactory working.

To avoid this difficulty a choke may be fitted in the place of one of the resistances or two chokes could even be used.

It would, perhaps, be better to retain resistance R2 where possible, and to use a choke in place of R1, this being in the de-coupling circuit. A suitable choke would be one of about 50 henries, having a current-carrying capacity of, say, 10 milliamperes.

Hums Located!

There are many forms of hum, as those who have experimented with mains sets will know. One type is rather puzzling

sometimes. It is the hum which is heard when listening to the local station.

Distant stations, and probably long-wave ones, are heard free from hum, but when the powerful local station is tuned in, the annoying hum is heard. This may usually be cured by connecting a filter between the mains and the supply unit. Often a pair of condensers connected in series across the mains, with their junction earthed, will do the trick.

These condensers must be high-voltage ones. They have to withstand a good A.C. pressure and I, therefore, suggest those having a test voltage of, at least, 500 A.C. I believe a suitable two-part condenser having a capacity of .1 microfarad in each half may be obtained.

Thick Wires for Filaments

A point not to be overlooked by those wiring a set for valves passing a relatively heavy current is that a drop in voltage along the wires is bound to occur.

It can be made negligible by using fairly thick wire. Thin wire ought not to be used as, if the supply is taken to a valve at one end of a row, the last one may be receiving a voltage of from .1 or .2 volt less than the first.

With mains valves, which pass 1 ampere at 4 volts, the drop may exceed this unless thick wire is used. Incidentally, the heater pins of the holder ought to make a good contact with the springs in the valve holder or a further loss will occur.

Atmospherics!

The recent fairly severe atmospheric disturbances once again bring attention to the fact that no method of eliminating them exists.

When using a powerful set, atmospheric disturbances are particularly distressing, the crashes and noises making testing practically hopeless. The disturbances are of such a nature that they appear in the set with the signal, with the result, that no matter how selective the set, the atmospheric disturbances are heard.

They are even heard with the wonderfully selective Stenode Radiostat, which has been described in these pages. Many investigators have tried to reduce the effects of atmospheric disturbances, but no one has succeeded in eliminating them.

THEY'RE

OBTAINABLE
FROM ANY
DEALER

**ALL JUDGED
AGAINST THE
HEGRA**

"It's nearly as good as the Hegra"—that is what hundreds of people say about many fine loud-speakers.

All over the country people are looking upon the New Hegra MAGNET DYNAMIC Loud-speaker as the finest yet produced—a speaker against which all others are judged.

The quality of reproduction is astounding, being equal to that of a moving coil, and yet no field energising current is required. It will handle with ease an input up to 4 watts. It costs no more than the ordinary cone type loud-speaker, but will give sufficient volume to fill a large hall.

CHASSIS FORM (as illustrated) £2 16 0
IN POLISHED WALNUT CABINET £5 10 0

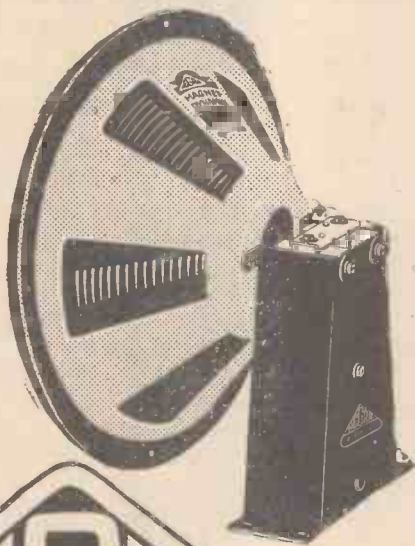

M.C. 8.

**THE WORLD'S FINEST VALVES
REDUCED IN PRICE**



The amazing

**MAZDA
RADIO VALVES**

	NEW PRICE	OLD PRICE
H.210	8/6	10/6
HL.210		
L.210		
H.607		
HL.607	10/6	12/6
P.220		
P.240	13/6	15/-
P.425		
P.625A		
P.625B		
P.650	18/-	20/-
SG.215	20/-	22/6
PEN.230	22/6	25/-
PEN.425		
AC/PEN.	27/6	30/-



THE EDISON SWAN ELECTRIC CO., LTD.
Incorporating the Wiring Supplies, Lighting Engineering, Refrigeration and Radio Business of The British Thomson-Houston Co., Ltd.
Radio Division:
1a Newman Street, Oxford Street, W.1
Showrooms in all the Principal Towns

EDISWAN

V.65

You will Help Yourself and Help Us by Mentioning "A.W." to Advertisers

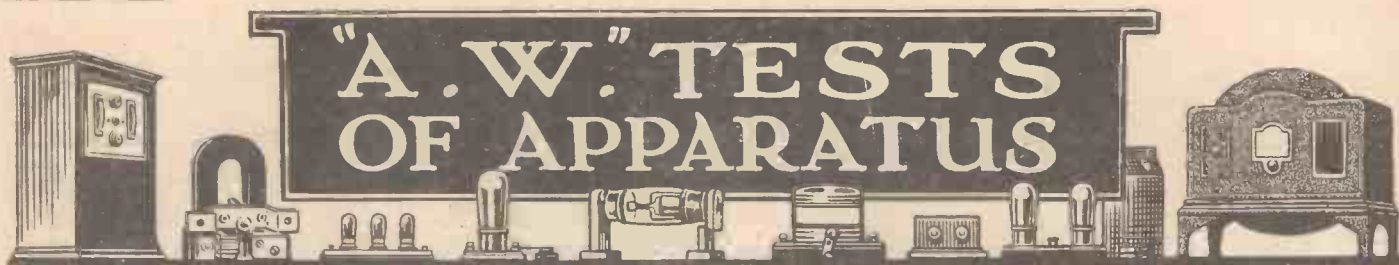

Conducted by our Technical Editor: J. H. REYNER, B.Sc. (Hons.), A.M.I.E.E.

Undy Eight-pole Unit

THE design of speaker units has progressed considerably since the early days of cone speakers. Although there are still excellent examples of speakers operated with a simple type of electro-magnetic unit, the balanced armature has generally emerged triumphant owing to the obvious advantages which the system possesses.

We have recently received for test and report an Undy eight-pole balanced armature unit. This is a well-conceived design, mechanically robust and electrically efficient. The armature, which passes through two magnetic windings, is clamped between four external and four internal poles. These are made up of thin metal laminations clamped securely to a pair of large horse-shoe magnets. The armature is fixed centrally and heavily damped; it operates a dummy armature to which a reed is attached; the latter is supplied with appropriate cone washers and may be readily fixed to any normal type of cone. For mounting to the back of the cabinet or suitable chassis, an aluminium bracket, securely clamped to the magnets, is provided and fitted with four lugs through which the necessary mounting screws may be placed. A 4½-ft. connecting lead is supplied with the unit.

The makers recommend that a cone with a diameter of at least 12 in., and preferably 14 in. to 15 in., should be used, made of a substance not less rigid than a postcard. Full directions are given for mounting the cone in a cabinet.

During our test we attached a suitable

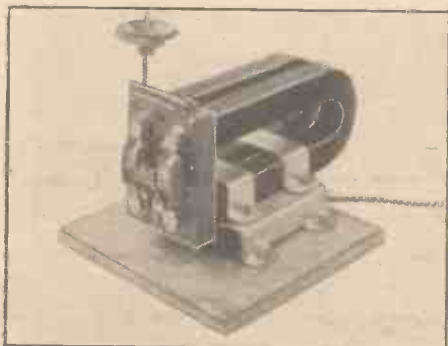

A new eight-pole speaker unit—the Undy

12-in. cone behind a small baffle, and had no difficulty in obtaining good results, with freedom from cone rattle and other forms of distortion. The output appeared reasonably constant throughout the audible

frequency range, both speech and music being reproduced with natural tone. The sensitivity compared very favourably with our standard speaker. A feature of the unit is the absence of any adjustment, and, indeed, we saw no reason why such a robustly constructed armature system should ever need adjustment, even though 10 milliamps were passed through the windings. The makers recommend the use of an output transformer with high anode currents, and, indeed, this is advisable with all balanced-armature units. This speaker can be recommended.

Vatea Valves

AMONGST the apparatus submitted for test this week are a number of Vatea valves made in Hungary, and

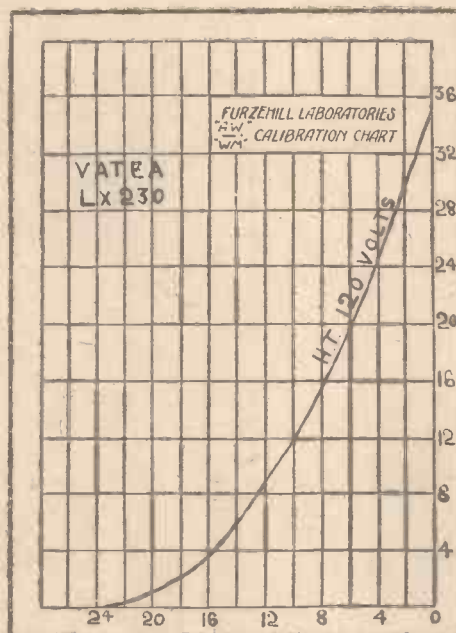

Characteristic of one of the Vatea valves tested

marketed in this country by Abbey Radio, 47 Victoria Street, S.W.1. The two types available for test correspond to our power and super-power valves.

Type U210 is a power valve, having an impedance of 5,700 ohms, and an amplification factor of 8.5, at an H.T. voltage of 120. The filament consumption is 2 volts at .1 amp.

Type LX230 is in the super-power class and has an impedance of 2,500 ohms, with an amplification factor as high as 6.25. The

filament consumption as the nomenclature signifies is .3 amp. at 2 volts.

These figures were obtained in our laboratories, and indicate that a high standard of efficiency has been reached. As regards physical construction the electrodes are mounted horizontally and connections are taken out to the usual four pins on a moulded base. These valves can be recommended to readers.

Burne-Jones Variable Resistance

A VARIABLE wire-wound high resistance is one of those components which, but for its scarcity, would be almost indispensable to the constructor and experi-



A useful variable high resistance

mentor. In many sets a vernier control of voltage is most desirable, particularly when adjusting the grid bias of a detector valve, or varying the bias on the low-frequency valve in A.C. operated sets. In such cases when a current has to be passed through a resistance it should preferably be of the wire-wound type, as it will then be noiseless in use.

A novel and exceptionally serviceable variable high resistance has been sent in for test by Messrs. Burne-Jones. This Magnum component has many excellent features. The resistance is wound on a circular former held firmly in a circular slot cut in an insulated moulding. Contact with this resistance is obtained by means of a rocking metal disc, which is made to bear on different portions of the wire by a rotating lever attached to an external knob. The smoothness of such a mechanism is beyond criticism, whilst at the same time the electrical contact with the resistance is all that could be desired.

The ends of the winding are taken out to terminals, as also is the rotating arm. A metal cover protects all working parts from damage or dust, and the component can be recommended.



COILS specified for the TWO VALVE SHORT WAVE SET

described in this number

RENOWNED for their efficiency and robust construction, "ATLAS" SHORT WAVE COILS are chosen by the discriminating constructor. The turns are rigidly supported by solid ebonite spacing struts and solidly mounted on the famous "ATLAS" anti-capacity porcelain plugs.

They are made in 4 sizes to cover a range of 15 to 100 meters wavelength.

Size 2 2/6 Size 4 2/7 Size 6 2/8 Size 9 2/9
Set of 4 10/-

"X" OR DOUBLE TAPPED COILS

Specially designed for circuits of the Auto-coupled "Reinartz," Split-coil, and Neutrodyne types.

No. 60 tapped at 7th and 12th turns 5/6
No. 250 tapped at 28th and 50th turns 7/6

Obtainable from high-class dealers everywhere.



"CLARKE'S ATLAS" THE KING OF COILS

H. CLARKE & CO. (M/C) LTD., Old Trafford, MANCHESTER

"Britain's leading Valves



-at Lower Prices!"

As from July 18th the undermentioned reductions in the retail prices of certain types of Marconi Valves were brought into effect.

Type						Old Price	New Price
H210	HL210	L210	H410	HL410	L410	10/6	8/6
P215	P410	P610	12/6	10/6
P2	P240	P425	P625	P625A	...	15/-	13/6
S215	S410	S610	22/6	20/-
PX4	PT240	PT425	25/-	22/6
PT625	30/-	27/6

WHEN BUYING VALVES REMEMBER!

Marconi Valves are used by The B.B.C., Imperial Airways, Empire Communications, Metropolitan Police, Passenger Lines, etc., etc. in fact in almost every important British Service. Remember this when you buy Marconi Valves, you buy British and undoubtedly buy the best.

Buy the Valves the Experts use!

MARCONI VALVES



Mention of "Amateur Wireless" to Advertisers will Ensure Prompt Attention



RADIOGRAMS

UNDER the title of "Co-optimistically Yours," listeners to the National transmitter on August 6 will hear the first of a series of concerts to be given by Davy Burnaby, Stanley Holloway, Gilbert Childs, Phyllis Monkman, Betty Chester, and Harry Pepper. The programme will be repeated through the Regional transmitters on August 7.

Impromptu, a new revue by John Watt, will act as a light-hearted prelude to the relay from Queen's Hall, on August 10, the opening night of the Promenade Concert season. This burlesque entertainment includes such skits as *The Bloomer*, a parody of C. K. Munro's more serious play, *The Rumour*, as well as *B.B.C. Exchange*, a travesty of the German war play, *Brigade Exchange*, which was broadcast some little time ago. We are also to be given a colourable imitation of some A. J. Alan stories.

The National vaudeville programme for August 8 will present *Poor Old Snell*, an original sketch by Mabel Constanduros and Michael Hogan; Fred Spencer, in the inimitable Mrs. 'Arris; Nellie O'List, entertainer; "At the Zoo," by P. J. Dewhurst; and Nancy Lovat, the ballad singer. Fred Lewis, another microphone

favourite, will give a series of impersonations on August 2.

In a light variety programme down for broadcast through the Regional stations on August 5, Ray Litvin will provide a Russian's impressions of characters from Dickens. In the same bill will be found Yvette Darnac, Fairchild and Lindholm, and Wilfrid Shine (raconteur).

Radio Vitus (Paris) has temporarily suspended its transmissions in order to overhaul the broadcasting plant which is being transferred to a new site outside Paris city limits.

In connection with a fête on behalf of the Weston-super-Mare Hospital, relays of special vaudeville programmes will be made to the Western and Midland Regional transmitters on August 13 and 14. The variety entertainments will be contributed by such well-known artistes as Patricia Rossborough, Albert Whelan, Mario de Pietro, Tommy Handley, Teddy Brown, Dorothy McBlain, and Ronald Frankau's Cabaret Kittens.

The new Basle broadcasting station is now carrying out its initial tests on 318.8 metres with a power of 500 watts in the aerial. Within the next few weeks the power will be increased.

A realistic scream put 3LO, the Melbourne station, off the air for five minutes recently, and cost the station £40. At the conclusion of the second instalment of radio serial, "The Jazz Spider," the heroine, who makes a get-away in a car which crashes into an express train, screamed so forcefully that one of the transmitting valves was burnt out. The scream set up a rush of power which overloaded the valves.

The B.B.C. is offering a starting salary of £300 to £400 per annum, according to qualifications and experience, in connection with the appointment of an assistant education officer for school broadcasting in Scotland. Candidates, it is stipulated, must be honours graduates, and should have had teaching experience in Scotland or be qualified to teach in Scottish schools. "A good speaking voice," it is naively added, "is essential."

Two of the world's most noted women aviators, Miss Amy Johnson and Miss Elinor Smith, America's woman ace, converged together recently between Sydney, Australia, and New York.

According to anticipation, when the Scottish Regional station is in operation the stations at Glasgow, Edinburgh, and Dundee will be closed down. It is quite likely, however, that the Aberdeen transmitter will be kept in use.

Radio Touraine is the call of yet another small French private broadcasting station which has been launched on the ether; its broadcasts are carried out on 210 metres. On some evenings weekly a relay is also made on 40 metres for the benefit of French experimental amateurs.

UNFORTUNATELY AFTER FLEX SENIOR'S TALK—

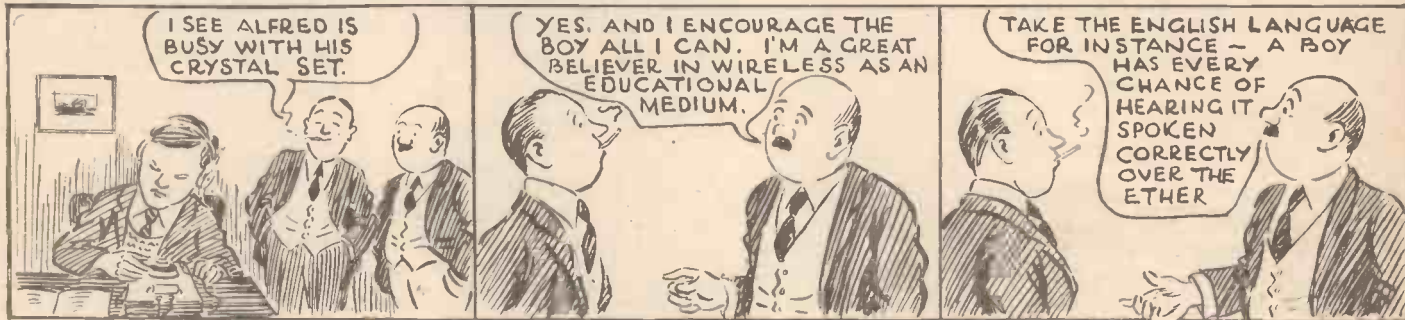

FLEX JUNIOR LETS HIM DOWN WITH A SONG.



DYNAPLUS AND PANASONIC
COVERING THE WHOLE FIELD!

The only British Transformer of merit costing less than 12/6. As used in the famous Dynaplus Screened Three.

As specified by "Amateur Wireless"

One of the first Transformers to employ a Nickel-Iron Core. As used by many of the leading makers of Radio Gramophones.

VOLTRON COMPONENTS

BUILD THE DYNAPLUS 3 SCREENED COMPLETE KIT OF PARTS £3-12-9

In case of difficulty write to the manufacturers:
VOLTRON ELECTRIC LTD., QUEENSWAY, PONDER'S END, Middlesex

GET ALL THE THRILLS OF SHORT WAVE RECEPTION
See that your set has **POLAR CONDENSERS**



SOUTHERN CROSS FLIGHT

Major Kingsford Smith's messages clearly received without a break on 3v. S.G. set using four Polar Condensers, including the S.W. Type "A" as illustrated.

This new Polar Condenser enables a number of Short-Wave Stations to be spread over a large arc of the dial. The larger portion is variable in 10 steps; control is by knob at back. The smaller portion is variable; control by knob on panel. Noiseless. Ideal for use on 15 metres and upwards.

"AMATEUR WIRELESS" SPECIFY AND USE "POLAR"

"EASY-TUNE SHORT-WAVE 2"

See full description in this issue.

POLAR S/W Type "A" - 15/-

POLAR "Q.J." .0001 - 10/-

From all Dealers. Write us for "Catalogue A.W."

WINGROVE & ROGERS, LTD.
188-189 STRAND, LONDON, W.C.2.



Postcard Radio Literature

Mr. Full O'Power

CONVENIENT in size and capable of giving long service is the Siemens Full O'Power 60-volt H.T. battery. I have a folder describing this new battery, and it is very useful because it gives actual discharge curves and technical details. **1**

Cabinets to Suit You

Have you a bright idea for a new radio cabinet? Messrs. J. C. Gilbert specialise in making up cabinets to customers' own designs. There are some very attractive cabinets in the Gilbert range, and these are well illustrated in leaflets available. **2**

New Mains Units

All users of Tannoy H.T. and L.T. mains units are willing to give them praise, and this popularity makes it advisable that you should consider a Tannoy unit for operating your receiver. Get the new Tannoy folder from the Tulsemere Manufacturing Co., Ltd. **3**

Those Coils

Success in short-wave working depends very largely upon the coils used, which must be very efficient. Have you seen the new Duplex short-wave-coil set made by Eddystone? Full technical descriptive matter is to be had. **4**

Choosing a Speaker

Apart from moving-coil jobs, Philips make three very attractive cone speakers. When choosing a new instrument, get the leaflet describing this cone-speaker family. **5**

Non-spill Accumulators

No portable receiver is satisfactory if it has not a non-spill accumulator inside. The Three Star Accumulator Co., Ltd., has sent me a folder showing the right types of Three Star battery to suit practically every portable. Yours is bound to be on this list. **6**

Tunewell Speakers

Turner & Co., the Tunewell coil people, have brought out a series of speakers, both of the cabinet and plaque type, the unit employed having a four-pole differential movement with double magnets. These speakers are well worth investigating and are fully described in an illustrated folder. **7**

GET THESE CATALOGUES FREE.

Here "Observer" reviews the latest booklets and folders issued by well-known manufacturers. If you want copies of any or all of them **FREE OF CHARGE**, just send a postcard giving the index numbers of the catalogues required (shown at the end of each paragraph) to "Postcard Radio Literature," "AMATEUR WIRELESS," 58-61, Fetter Lane, E.C.4. "Observer" will see that you get all the literature you desire.

READ THIS:—

"There is everything in favour of buying a complete kit of parts and nothing against it. You get all the little items, such as screws, etc., and your panel is neatly drilled for you. Moreover, you are certain that every component is suitable for the set—that is if you purchase an approved kit such as is sold by Ready Radio." *vide "Popular Wireless."*

KITS OF PARTS

CONTINENTAL PORTABLE
EASY TUNE SHORT-WAVE 2
MAXIMUM FOUR
1930 TALISMAN TWO
GRAMO-RADIO TWO
ETC., ETC.

Cash or Easy Terms. Lists on Application

Ready Radio

159 BOROUGH HIGH STREET,
LONDON BRIDGE, LONDON, S.E.1
'Phone: HOP 5555 (Private Exchange)

IN THE HIGHEST CLASS



TUNEWELL TRANSFORMERS

NEW POPULAR MODEL

Ratios 3-1 and 5-1

Price 8/9

SUPER TRANSFORMER

Ratios 3-1 and 5-1

Price 12/6

Write for List of Speakers

TURNER & CO.

54 Station Road, New Southgate, N.11

RAYMOND'S

27 & 28a, LISLE ST., LONDON, W.C.2

Come to LEICESTER SQUARE TUBE

This address is at the back of Daly's Theatre

Note New Phone Number: GERRARD 2821

THE TALISMAN TWO

Complete Kit of Parts as specified by "Amateur Wireless," including Cabinet. **£2.10.0** Carriage Paid.

THE CONTINENTAL PORTABLE KIT

Complete Kit of Parts as specified by "Amateur Wireless." Including CABINET. Carriage Paid. **£3.10.0** Blueprint included.

THE STRAIGHT THREE

A Complete Kit of Parts with Blueprint, 2 L.F. Trans., Dual Range Coil, 3 Marconi V.H., '0003 and 2 meg. Leak, '0001, good make H.F. Choke, '0005 and '0003 Var. Con., 2 Slow Motion Dials, Pol. Panel 14x7, Set Leads, Oak Cabinet, Wire, Screws. Usually 70/-. Special Reduced Price until August 30th. **35/-** Pack. and Carr. 3/- extra.

THE STRAIGHT TWO

This Wonderful Offer comprising Kit of Parts and Blueprint. Excellent Circuit. 1 L.F. Trans., Six-pin Coil and Base, H.F. Choke, Panel 12x8, Oak Cabinet, '0003 and 2 meg. Leak, '0001, 2 Marconi V.H., 2 Var. Con., 2 Slow Motion Dials, Term. Strip, Term. Wire, Screws, etc., complete. Postage 2/- extra. **25/-**

Address all Letters:

K. RAYMOND, LTD.

27-28a LISLE STREET, LONDON, W.C.2

BROADCAST TELEPHONY

Broadcasting stations classified by country and in order of wavelengths. For the purpose of better comparison, the power indicated is aerial energy.

Metres	Kilo-cycles	Station and Call Sign	Power (Kw.)	Metres	Kilo-cycles	Station and Call Sign	Power (Kw.)	Metres	Kilo-cycles	Station and Call Sign	Power (Kw.)
GREAT BRITAIN				GERMANY				NORTH AFRICA			
25.53	11,757	Chelmsford (5SW)	15.0	306	080	Bordeaux (PTT)	1.0	365	821	Algiers (PTT)	10.0
*200	1,500	Leeds	0.13	316	950	Marseilles (PTT)	0.5	416	720	Radio Maroc (Rabat)	10.0
*242	1,238	Belfast	1.0	329	914	Grenoble (PTT)	0.5	1,250	240	Tunis Kasbah	0.0
*261	1,148	London Nat.	45.0	345.2	869	Poste Parisien	0.5	NORWAY			
*288.5	1,040	Newcastle	1.0	369	812	Strasbourg (testing shortly)	12.0	364	824	Bergen	1.0
288.5	1,040	Swansea	0.13	385	779	Radio LL (Paris)	0.5	368	815	Frederiksstad	0.0
288.5	1,040	Stoke-on-Trent	0.13	447	671	Radio Toulouse	8.0	453	602	Nidaros	1.0
288.5	1,040	Sheffield	0.13	466	644	Paris (Etat)	0.8	455	650.3	Porsgrund	0.0
288.5	1,040	Plymouth	0.13	*1,446	207	Lyons (PTT)	5.0	*493	608	Oslo	0.0
288.5	1,040	Liverpool	0.13	*1,725	174	Eiffel Tower	12.0	POLAND			
288.5	1,040	Hull	0.13	GERMANY			10.0	214	1,400	Warsaw (2)	2.0
288.5	1,040	Edinburgh	0.35	*218	1,377	Radio Paris	10.0	234	1,283	Lodz	1.0
288.5	1,040	Dundee	0.13	*227	1,319	Flensburg	0.5	*313	959	Cracow	0.0
288.5	1,040	Bournemouth	1.0	*227	1,319	Cologne	4.0	*335	866	Poznan	1.0
288.5	1,040	Bradford	0.13	*227	1,319	Münster	3.0	381	788	Lvov	2.0
*301	995	Aberdeen	1.0	*227	1,319	Aachen	0.35	384	789	Wilno	0.0
*310	968	Cardiff	1.0	232.2	1,290	Kiel	0.35	*408	734	Katowice	10.0
*356	842	London Reg.	30.0	*239	1,256	Nürnberg	2.0	1,411	212.5	Warsaw	8.0
*377	797	Manchester	1.0	244	1,227	Cassel	0.25	PORTUGAL			
*399	753	Glasgow	1.0	*253	1,184	Gleiwitz	2.0	320	937.6	Lisbon (CTIAA)	0.0
*479	626	Midland Reg.	25.0	*259	1,157	Leipzig	2.5	ROUMANIA			
1,551	193	Daventry (Nat.)	25.0	*270	1,112	Kaiserslautern	0.25	*394	761	Bucharest	12.0
AUSTRIA				*275.8	1,087	Königsberg	2.5	RUSSIA			
*246	1,220	Linz	0.5	*283	1,058	Magdeburg	0.5	720	416.6	Moscow (PTT)	20.0
*283	1,058	Innsbruck	0.5	*283	1,058	Berlin (E)	0.5	800	375	Kiev	20.0
*352	851	Graz	9.0	*283	1,058	Stettin	0.5	824	364	Sverdlovsk	25.0
*453	666	Klagenfurt	0.5	*316.8	947	Bremen	0.35	1,000	300	Leningrad	20.0
*517	578.5	Vienna	20.0	*320	937.6	Dresden	0.25	1,080	283	Tiflis	10.0
BELGIUM				*325	923	Breslau	1.5	1,073	279	Rostov (Don)	10.0
206	1,460	Antwerp	0.4	*325	923	Stuttgart	1.5	1,103	272	Moscow Popoff	40.0
216	1,391	Chateaufort	0.25	*372	806	Hamburg	1.5	*1,304	230	Moscow-Stchelkovo (C.C.S.P.)	100.0
216	1,391	Brussels	0.25	*390	770	Frankfurt	1.5	1,380	217.5	Bakou	10.0
		(Conference)	0.25	*418	716	Berlin	1.5	SPAIN			
239	1,256	Binche	0.3	*453	662	Danzig	0.25	251	1,193	Barcelona (EAJ15)	0.5
244.7	1,226	Ghent	0.25	*473	635	Langenberg	15.0	266.7	1,125	Barcelona (EAJ13)	5.0
246	1,218	Schaerbeek	0.5	*533	563	Munich	1.5	368	815	Seville (EAJ5)	1.5
294	1,020	Liège	0.25	560	536	Augsburg	0.25	424	707	Madrid (EAJ7)	2.0
338	887	Forest	3.0	*566	529	Hanover	0.35	462	649	San Sebastian (EAJ8)	0.5
*509	590	Brussels	1.0	570	527	Freiburg	0.35	SWEDEN			
CZECHO-SLOVAKIA				*1,635	183.5	Zeeseen	26.0	135	2,222	Motala	60.0
*263	1,139	Moravska-Ostrava	10.0	1,635	183.5	Norddeich	10.0	291	1,301	Malmö	0.6
*270	1,076	Bratislava	12.5	HOLLAND			31.28	299.0	1,002	Falun	0.5
293	1,022	Kosice	2.0	31.28	9,599	Bindhoven (PCJ)	30.0	*322	938	Göteborg	10.5
*342	878	Brunn (Brno)	12.0	*299	1,004	Huizen (between 11.40 a.m. and 5.40 p.m. B.S.T.)	6.5	*436	689	Stockholm (tests)	60.0
*487	617	Prague (Prahá)	5.0	*1,071	280	Huizen	0.5	*512	554	Sundsvall	1.0
DENMARK				*1,071	280	Scheveningen-Haven	5.0	*770	389	Ostersund	0.6
*281	1,067	Copenhagen	0.75	*1,875	160	Hilversum	6.5	1,251	239.8	Boden	0.6
1,153	260	Kalundborg	7.5	HUNGARY			210	*1,348	222.5	Motala	30.0
ESTONIA				210	1,430	Budapest (Csepel)	1.0	SWITZERLAND			
401	748	Reval (Tallinn)	1.5	550	545	Budapest	20.0	318.8	947	Basle	0.5
FINLAND				*221	1,355	Helsinki	10.0	*403	743	Berne	1.0
*1,796	167	Lahti	40.0	*1,071	280	Scheveningen-Haven	5.0	*459	653	Zurich	0.6
FRANCE				IRISH FREE STATE			25.4 and 80	ITALY			
29.7	10,180	Radio Experimental (Paris)	1.4	*925	1,337	Cork (IFS)	1.0	291	1,030	Turin (Torino)	7.0
175	1,714	St. Quentin	0.1	*413	725	Dublin (2RN)	1.0	332	905	Naples (Napoli)	1.5
210	1,430	Radio Touraine	0.5	ITALY			25.4 and 80	381	788	Genoa (Genova)	1.0
229	1,316	Fécamp	0.7	25.4 and 80	Rome (3RO)	9.0	*441	680	Rome (Roma)	50.0	
237	1,265	Bordeaux (Radio Sud-Ouest)	1.0	291	1,030	Turin (Torino)	7.0	453	662	Bolzano (IBZ)	0.3
259	1,255	Nîmes	0.25	332	905	Naples (Napoli)	1.5	*501	599	Milan (Milano)	7.0
240.6	1,245	Beziers	0.8	381	788	Genoa (Genova)	1.0	LATVIA			
250	1,200	Juan-les-Pins	1.5	*525	572	Kiga	7.0	LITHUANIA			
256	1,171	Toulouse (PTT)	0.7	LITHUANIA			1,035	155	Kaunas	7.0	
265	1,130	Lille (PTT)	0.7	IRISH FREE STATE			25.4 and 80	TURKEY			
*272	1,102	Rennes (PTT)	0.5	*925	1,337	Cork (IFS)	1.0	*1,220	245.9	Istanbul	5.0
286	1,046	Montpellier	0.3	*413	725	Dublin (2RN)	1.0	1,961	153	Ankara	7.0
*287	1,044	Radio Lyons	0.5	ITALY			25.4 and 80	YUGOSLAVIA			
294.8	1,017	Limoges (PTT)	0.5	25.4 and 80	Rome (3RO)	9.0	307	976	Zagreb (Agram)	0.7	

"RECENT DEVELOPMENTS IN COMPONENTS"

(Continued from page 107)

employ a resistance or choke feed as indicated in Fig. 1. A disadvantage of the resistance feed is the fall in voltage over the resistance. Often a higher voltage than usual must be used or the voltage on the anode of the valve itself will be too low for the signals to be handled properly.

When a good choke is used, the loss in voltage is small, but one might well ask why go to the expense of fitting a choke and condenser as well as a transformer when one good transformer will do the work? This point, too, has received attention, for I

know of at least one good unit which will carry a heavy current.

In high-frequency circuits by-pass condensers of good quality are often needed, and sometimes they are also actually in the tuned circuit. A circuit to illustrate this point is shown by Fig. 2. Here condenser C is in the tuned circuit and should, therefore, be a good one. Some manufacturers provide good non-inductive type paper condensers. Having a particularly low radio-frequency resistance, used with short connecting wires, such condensers are valuable, and more makers will be listing them as standard lines during the autumn.

The position of electrolytic condensers is an interesting one, as many types are avail-

All wavelengths marked with an asterisk have been allotted according to the Plan de Prague.

in America and are used fairly extensively in sets as filter condensers in the circuit. We have here, at the moment low-voltage types, but the American to which I am referring are low voltage 20 to 400 and have capacities of 8 or 10 microfarads. Being compact, and practically self-healing in the event of a surge during a breakdown, they have advantages over the more usual paper types and I am looking forward to the production of suitable types by our own manufacturers.

Loud-speakers continue to improve. I have used for some time a permanent-magnet type moving-coil with every satisfaction. It is reasonably sensitive and not too expensive, compared with the electro-magnetic type, and it will deal with adequate power for domestic purposes.

The Farrand inductor-type loud-speaker, no doubt, be issued by various makers. I hear that licences to manufacture are being granted. This loud-speaker was fully described in the *Wireless Magazine* (June) and certainly gives good results.

Then we have some new loud-speaker units, designed expressly to run from large power valves and to deal with considerable volume without shaking to pieces. Very good results are to be obtained from these

units when fitted to a suitable cone, so that good quality is now within the reach of most listeners. The question of suitable loud-speaker windings for various power valves has received attention, but why do British manufacturers appear to lag behind?

New Valves

Some splendid valves are now available, including screen-grids and pentodes. I have not, in the past, thought much of pentodes. Some types were weak, both mechanically and electrically, with the result that breakdowns were of frequent occurrence. But now we have better valves and provided the quality is corrected by the use of a suitable output circuit, the results should be satisfactory.

To conclude then, we now have better parts and valves. Improvements have been effected in those parts subject to wear. Better loud-speakers are being produced and, therefore, much of the trouble which we have had in the past with faulty parts and poor reproduction will disappear with our new sets. Mains units as well are being improved. The adjustable resistances which used to be a nuisance are being replaced by better parts, and design, as a whole, is definitely better.

Letters to the Editor

Correspondence should be brief and to the point and written on one side of the paper. The Editor does not necessarily agree with the views expressed by correspondents.

Faulty Components

SIR,—My sympathies are with A.H. (Thornton Heath) in his experience of faulty components.

Although one may buy a kit of the reputedly best, and highest priced, components for a wireless set, it appears to be a matter of great good luck if they are all undamaged and perfect.

I am much afraid that unless the manufacturers quickly see that none but perfect goods are sent out they will find a heavy tolling off through the enthusiasm of wireless fans being killed.

It is true that one gets a ready exchange and profuse apologies, but this does not remove the feeling that there should not have been the need for either.

A. D. (London, S.W.).

The "James Quality Five"

SIR,—I have much pleasure in sending you a report of the "James Quality Five," which I have at present made up as a four-valver, leaving space to add the fifth valve should occasion arise. I don't think from present results this will ever be necessary. At the outset I must say how charmed I am at the working of this set. The range and power are very great, and

special credit must be given to that genius, Mr. W. James, for another masterpiece. One special feature is the Binovave coils for long and short reception. For long waves I have had to put up an indoor aerial, 50 ft. to 60 ft. long, and the following stations were logged during daytime on a large linen-diaphragm speaker (Blue Spot unit): Huizen, Radio Paris, Koenigs-wusterhausen, Daventry, Eiffel Tower, Motala, Kalundborg, and Hilversum. I have experienced no fading on this wave; in fact, Hilversum has to be tuned down as the volume is so great. For those listeners who get tired of local programmes I would ask them to give this one a trial. Whether it be an orchestra, organ, or even gramophone records, this station is a real treat and must possess one of the finest transmitters in Europe.

In the selection of valves, the following were chosen: Mazda 210, Mazda H210, Osram P2, and Mazda SG215—a formidable four and capable of something good.

On the medium waves, National, London Regional, and Midland are received at great strength. The high-tension of 150 volts is supplied by A.C. through an Atlas AC16 eliminator (H. Clarke & Co., Man-

(Continued on next page)



A WONDERFUL
SHORT-WAVE SET FOR **38/6**

HAVE YOU SEEN

THE TEST REPORT IN THIS ISSUE
OF THE AMAZINGLY EFFICIENT

S.R.S. UNIVERSE

SHORT-WAVE RECEIVER?

This Revolutionary Set sweeps aside all those obstacles which till now have discouraged the would-be listener to the fascinating short-waves—namely
HIGH COST—CRITICAL LAYOUT—HAND CAPACITY, AND COMPLICATED OPERATION

It marks the beginning of a new era in short-wave reception and will undoubtedly be

THE SHORT-WAVE KIT

SET OF THE FUTURE
EXTREMELY SIMPLE TO ASSEMBLE.
COULD YOU JOIN UP 24 WIRES IN 1 HOUR? BECAUSE THAT IS ALL YOU HAVE TO DO, AND MOREOVER
YOUR RESULTS ARE GUARANTEED

EACH KIT COMES TO THE PURCHASER READY FOR IMMEDIATE ASSEMBLY—ALUMINIUM PANEL DRILLED—ALL NECESSARY WIRING—CONSTRUCTIONAL CHART AND OPERATING INSTRUCTIONS—IN FACT YOU HAVE NOTHING MORE TO BUY AND CAN GET RIGHT ON WITH THE JOB AND IN A VERY SHORT SPACE OF TIME BE LISTENING TO RESULTS SUCH AS ARE REPORTED IN THIS ISSUE OF "AMATEUR WIRELESS"

AND IT MAY NOT EVEN COST YOU AS MUCH AS 38/6 BECAUSE YOU PROBABLY HAVE SOME OF THE PARTS ALREADY, SO SEND FOR FREE CONSTRUCTIONAL CHARTS AND LEAFLETS.

THIS FINE SET WAS MADE POSSIBLE BY THE NEW

S.R.S. ULTRA SHORT-WAVE UNIT

which enables ANY SET, even a Portable, to receive the whole Ultra Short-wave band without altering the set in any way or introducing complications. Entirely independent of the tuning or circuit of the set it is used with. Even a set several years old will give as good results as a new up-to-date Receiver.

THE ONLY UNIT OF ITS PRICE
KIND IN THE WORLD 18/6
(Patent No. 329-841) Post 9d. ex.

A WRITTEN GUARANTEE GIVEN OF PERFECT RESULTS ON YOUR SET.

Send for Leaflets and Testimonials.

STONEHOUSE RADIO SUPPLIES

54, UNION STREET
PLYMOUTH :: DEVON
Phone: 2496.

"LETTERS TO THE EDITOR"
(Continued)

chester). It gives complete smoothness and the amount of hum is quite negligible. I can thoroughly recommend it for use with this set where A.C. is available. My best wishes and many thanks. Trusting other readers may have something to say who have built it.

P. L. (Cambridge).

WIRELESS BELLS

SIR.—As I am a regular reader of your most interesting paper, I note in the issue dated July 12 a paragraph, "Bells by Wireless" at Tintagel, Cornwall.

This has been made possible by a specially designed note magnifier, working on 500 volts, I understand. Regarding the volume of this pick-up and amplifier equipment, it is really wonderfully powerful, without the slightest distortion, being quite audible in the middle of Tintagel village, given, of course, suitable weather conditions.

I have been informed that the enterprising firm who has fitted this apparatus are Messrs. Wood & Briggs, Bude. As this is, I think, the first church to be fitted with pick-up and loud-speakers, I really think they must be congratulated for bringing forward this type of instrument to such a degree of perfection.

"INTERESTED" (Stratton, nr. Bude).

FULL-SIZE BLUEPRINTS

When ordering, please send Postal Order, NOT STAMPS
CRYSTAL SETS (6d. each)

B.B.C. Brookman's Park Set AW206
Regional Crystal Set WM176

ONE-VALVE SETS (1s. each)

B.B.C. Official One AW208
Hartley Single-valver WM198

TWO-VALVE SETS (1s. each)

Loud-speaker America Two AW190
Talisman Two (D, Trans) AW194
British Broadcast Two (D, Trans) AW215
Easy-tune Two (D, Trans) AW226
Wavelets Two (D, Trans) AW220
No-battery A.C. Mains Two (D, Trans) AW230
No-battery Gramo-radio 2 (D, Trans) AW238
1930 Talisman 2 (D, Trans) AW239
Easy Tune Short-wave 2 (D, Trans) AW242
Brookman's Two (D, Trans) WM168
Programme Two (D, Trans) WM177
New Crusader (D, Trans) WM182
Radio-Record Two (SG, D) WM187
Gleaner Two (D, Trans) WM201

THREE-VALVE SETS (1s. each)

All-wave High-mag. Three (D, 2 Trans) AW199
Knife-edge Three (D, RC, Trans) AW201
Talisman Two-three (D, RC, Trans) AW203A
Wide World Short-wave Three (HF, D, Trans) AW207
Everybody's Three (SG, D, Trans) AW209
1930 Ether Searcher (SG, D, Trans) AW211
New All-Britain Three (HF, D, Trans) AW214
Best-by-Ballot Three (SG, D, Trans) Price 4d. free with copy of "A.W." AW217
Brookman's By-pass Three (D, 2 Trans) AW220
Everybody's All-electric Three (SG, D, Trans) AW221

FOUR-VALVE SETS (1s. 6d. each)

Clarion All-electric Three (SG, D, Trans)—A.C. Rectifier AW200
Music-Lover's Gramo-radio (SG, D, RC, Trans)—1s. 6d. AW202A
Music-Lover's Gramo-radio (Loud-speaker) 1s. AW202B
Horizon Four (SG, D, 2 Trans) AW237
Standard-coil Four (HF, D, 2 RC) WM122
Dominions Four (2SG, D, Trans) WM134
Arrow (SG, HF, D, Trans) WM154
1930 Monodial (2SG, D, Trans) WM158
Electric Four (All A.C.—SG, D, RC, Trans) WM162
Brookman's Four (2SG, D, Trans) WM174
Transportable Four (SG, D, 2 RC) WM180
Super Q (SG, D, 2 Trans) WM189
Lodestone Four (HF, D, RC, Trans) WM193
Searcher's Four (SG, D, RC, Trans) WM194
Invitation Four (SG, D, RC, Trans) WM200

FIVE-VALVE SETS (1s. 6d. each)

James Quality Five (2SG, D, RC, Trans) AW227
All-wave Lodestone Five (HF, D, RC, Push-pull) WM146
1930 Five (2HF, D, RC, Trans) WM171
Dual-screen Five (2SG, D, RC, Trans) WM185
Radio-Record Five (SG, D, Trans-parallel) WM188
Overseas Five (3SG, D, Trans) WM191

AMPLIFIERS (1s. each)

"A.W." Gramophone Amplifier AW205
Brookman's Separator (HF Unit) AW212
Two-valve Amplifier AW216
"Mag" Gramo Unit AW224
Concentrator H.F. Unit WM169
Radio-Record Amplifier (DC Mains) WM183

MISCELLANEOUS (1s. each)

Short-wave Adaptor (1 v.) AW183
Simplest H.T. Unit AW197
By-pass Unit (Wavetrap) with copy "A.W."—4d. AW218
"Twin" Brookman's By-pass (6d.) AW222
"A.W." Paper Loud-speaker AW231
James H. T. and L.T. Charging Unit AW232
Simplest H.T. Eliminator for D.C. Mains AW234
Simplest H.T. Eliminator for A.C. Mains AW236
Choke Output Unit AW240
Staminator Unit for A.C. Mains WM202
Universal Push-pull Amplifier WM204
Outspan Short-wave Adaptor WM207

PORTABLE SETS

Holiday Portable Three (D, RC, Trans) AW188 1/-
Music Leader (SG, D, RC, Trans) with copy "A.W." AW203 -/4
Merry-maker Portable (D, 2 Trans) AW228 1/-
Sunshine Three (SG, HF, SG, D, Trans) AW235 1/-
Continental Portable (SG, D, Trans) AW241 1/-
Wayfarer Portable (Super Het) WM139 1/6
Pedlar Portable Two (D, Trans) WM195 1/-
Pedlar Portable Three (D, 2 Trans) WM197 1/-
James Portable SG3 (SG, D, Trans) WM203 1/-
Foursome Portable (SG, D, 2 Trans) WM206 1/-
Copies of the "Wireless Magazine" and of "Amateur Wireless" containing descriptions of any of these sets can be obtained at 1s. 3d. and 4d. respectively, post free. Index letters "A.W." refer to "Amateur Wireless" sets and "W.M." to "Wireless Magazine" sets.

AMATEUR WIRELESS 58-61 FETTER LANE LONDON, E.C.4

PREPAID ADVERTISEMENTS

Advertisements under this head are charged **THREEPENCE PER WORD**, minimum charge **THREE SHILLINGS**. **DEPOSIT SYSTEM**

As the Publishers cannot accept responsibility for bona fides of advertisers in this publication, they have introduced a system of deposit which it is recommended should be adopted by readers when dealing with persons with whom they are unacquainted. It is here explained: Intending purchasers should forward to the Publisher the amount of the purchase money of the article advertised. This will be acknowledged to both the Depositor and Vendor, whose names and addresses must necessarily be given. The deposit is retained until advice is received the completion of the purchase, or of the article having been returned to and accepted by the Vendor. In addition to the amount of the Deposit, a Fee of 6d. for sums of 10s. and under, and 1s. for amounts in excess of 10s., to cover postage, etc., must be remitted at the same time. In the case of persons not resident within the United Kingdom, duties are charged.

The amount of the Deposit and Fee must be remitted by Postal Order or Registered Letter (Cheques cannot be accepted), addressed to

"AMATEUR WIRELESS,"
ADVERTISEMENT DEPARTMENT,
58/61 FETTER LANE, LONDON, E.C.4

ENGINEERS—novice or expert—£300, £400, £500 year or more is within your grasp. In our Handbook "ENGINEERING OPPORTUNITIES," Prof. A. M. I. explains where the good posts abound. This handbook shows the way to better things to over 20,000 of your fellows. It contains details of A.M.I.Mech.E., A.M.I.E.E., A.M.I.C.E., A.M.I.A.E., A.M.I.Struct.E., Matric, C. and G.P.O., etc. Examinations, outlines home study course in all branches of Electrical, Mechanical, Motor and Wireless Engineering and shows the unique advantages of the Appointments Department. Why stay in the "Home and File Brigade"? Send for our free Handbook at our stating Branch, Post or Exam, which interests your British Institute of Engineering Technology, 109 Shaftspere House, 29-31 Oxford Street, London, W.1.

SOLDER, specially prepared for radio joints, strip; 6d., post free.—C. O. Pattison, 548, Shields Road, Newcastle-on-Tyne.

COMPLETE KITS—All Circuits. C.O.D. or Terms R.I.B., 33 Maroon Street, London, E.1.

EXPERIMENTAL SURPLUS. Motor Generators, Amplifier components and wireless sundries, cheap, state your requirements or list sent free. Harger, 3 Darnley Road, Hackney, E.9. Amherst 1842.

10 PAGES
Special Bargain List
RADIO AND SCIENTIFIC INSTRUMENTS

Readers of "Amateur Wireless" should apply now. Send 1½d. stamp.

ELECTRADIX RADIO
218, Upper Thames Street, E.C.4
City 0197 Electradix, Genl, London

TAYLEX WET H.T. BATTERIES
New Prices: Jars 1/3. Sacs 1/2. Zincs 10d. Sample doz. 18. Volts complete with bands and electrolyte 4/1 post 9d. Sample unit 6d. Illus. booklet free. Bargain list free.
AMPLIFIERS, 30/- 3 VALVE ALL-STATION SET 2/5
A. TAYLOR, 57, Studley Road, Stockwell, LONDON.

"Amateur Wireless and Radiovision." Price Three-pence. Published on Thursdays and bearing the date of Saturday immediately following. Post-free to any part of the world: 3 months, 4s. 6d.; 6 months, 8s. 9d.; 12 months, 17s. 6d. Postal Orders, Post Office Orders, or Cheques should be made payable to "Bernard Jones Publications, Ltd."

General Correspondence is to be brief and written on one side of the paper only. All sketches and drawings to be on separate sheets. Contributions are always welcome, will be promptly considered, and if used will be paid for. Queries should be addressed to the Editor, and the conditions printed at the head of "Our Information Bureau" should be closely observed. Communications should be addressed, according to their nature, to The Editor, The Advertisement Manager, or The Publisher, "Amateur Wireless," 58-61 Fetter Lane, London, E.C.4.

TANNOY MAIN UNIT

NEED NO ATTENTION
MORE VOLUME
GREATER SELECTIVITY

CHEAPER THAN DRY BATTERIES
H.T. from £2 17 6
L.T. " £1 19 6
TANNOY PRODUCTS
1-7 DALTON ST. S.E. 27

DX THE STANDARD PLUG-IN COIL
Sold everywhere from 1/6
DX COILS Ltd, London, E.8

FAMOUS CRAFTSMANSHIP
For YOUR SET or RADIO GRA Built like a piano, the fine tone and St. brings a thrill no words can convey. (Over 2,000 delighted clients) (Radio Press—leading Experts) DIRECT from makers, APPROVED 7 days FREE. De Luxe, £5 to £10. Cash or EASY PAYMENTS. Photographs FREE.
PICKETTS, Radio Furniture Makers (A.M.) Albion Road, Bexleyheath, Kent (Famed for excellence, honoured in BEST Homes.)

REPAIRS
Any make of L.F. Transformer, Loud-speaker or headphones repaired and dispatched within **48 HOURS—TWELVE MONTHS' GUARANTEE** with each repair: 4/- Post Free.
Terms to Trade
TRANSFORMER REPAIR CO.
"Service" Dept.
214 High Street, Colliers Wood, London, S.W.19

Amateur Wireless **COUPON**
Available until Saturday
AUGUST 9, 1930

WESTINGHOUSE RECTIFIERS



Type A3
D.C. Output 9 v., 1-amp.
23/6



METAL RECTIFIERS FOR LOW TENSION D.C.

Send 2d. Stamp for our 32-page book "The All Metal Way 1930," giving full details of these and other units—high and low tension, and full instructions and circuits for making A.C. mains units of all types.

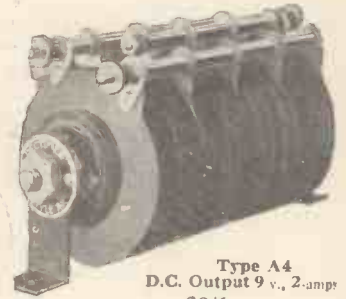

Type A4
D.C. Output 9 v., 2-amp.
39/6

THE WESTINGHOUSE BRAKE & SAXBY SIGNAL CO., LTD.
82, YORK ROAD, KING'S CROSS, LONDON, N.1

Amateur Wireless HANDBOOKS

each 2/6 net.

The Shielded Four-electrode Valve.

The Short-wave Handbook.

The Practical "Super-het" Book.

Wireless - controlled Mechanism for Amateurs.

The Practical Wireless Data Book.

THE BOOK OF THE NEUTRODYNE, by J. H. Reyner, B.Sc. (Hons.), A.M.I.E.E. Price 1/6 net, or post free for 1/9



Of all Newsagents and Booksellers or by post, 3d. extra, from Cassell & Co., La Belle Sauvage, E.C.4.



FOR... ELECTRIC REPRODUCTION

USE A LIMIT

Adjustable Length Tracking Angle Spring Tension

Continental and Bayonet Fittings.



Illustration shows Pick-up attached.

PICK-UP ARM 15/6

Obtainable through all factors and dealers or write

EACH

LIMIT RADIO LIMITED, ALBION ST., LONDON, N.1



The FOURSOME

With this portable, which has been designed for easy construction, alternative programmes at good speaker strength, will be available almost everywhere.

Read, in the August Number of the "Wireless Magazine," now on sale, about this efficient set, which incorporates many of the points you want in a good Portable, one-knob tuning, unusual selectivity, etc.



Other Contents of the

"WIRELESS MAGAZINE"

The Universal Push-pull Amplifier, adaptable for use with any set—Making the 1930 Binowave Coils by W. James—Found, an alternative programme, by W. Hadfield Craven—The New Lodestone Three, with constant H.F. neutralising on all waves—Mains power for your Portable—The Outspan Short-wave Unit, makes ultra-short wave reception possible with almost any set—Tested sets: Philips Portable, Gecophone Battery Three-valver, Gambrell All-electric Two—Give us Better British Sets! by Alan S. Hunter—Around the Turntable, records reviewed by Whitaker Wilson—What is the Pressure from a Pick-up? by J. H. Reyner.

The August WIRELESS MAGAZINE 1/-

Is now on Sale. Get Yours NOW!

EVERYTHING *The* **S. & C.** ELECTRICAL
your guarantee

Osram Valves

Sold by all
Wireless Dealers

MADE ENTIRELY IN ENGLAND.

REDUCED PRICES

The following types of OSRAM VALVES are REDUCED IN PRICE as shown, the reductions becoming operative immediately.

TYPES	OLD PRICES	NEW PRICES	TYPES	OLD PRICES	NEW PRICES
Osram H.L. 210	10/6	8/6	Osram P. 2	15/-	13/6
" H. 210			" P. 240		
" L. 210			" P. 425		
" H.L. 410			" P. 625		
" H. 410			" P. 625A		
" L. 410			Osram S. 215	22/6	20/-
" H.L. 610			" S. 410		
" H. 610			" S. 610		
" L. 610	Osram P.T. 240	25/-	22/6		
Osram P. 215	" P.T. 425				
" P. 410	" P.X. 4				
" P. 610		" P.T. 625	30/-	27/6	

Prices apply only in Great Britain and Northern Ireland

Advt. of The General Electric Co., Ltd., Magnet House, Kingsway, London, W.C.2.

MS
#109666

BUILD THE "FAVOURITE THREE"—1930 MODEL

Every
Thursday 3^d

Amateur Wireless

and
Radiovision

Vol. XVII. No. 426

Saturday, August 9, 1930

The FAVOURITE THREE -1930

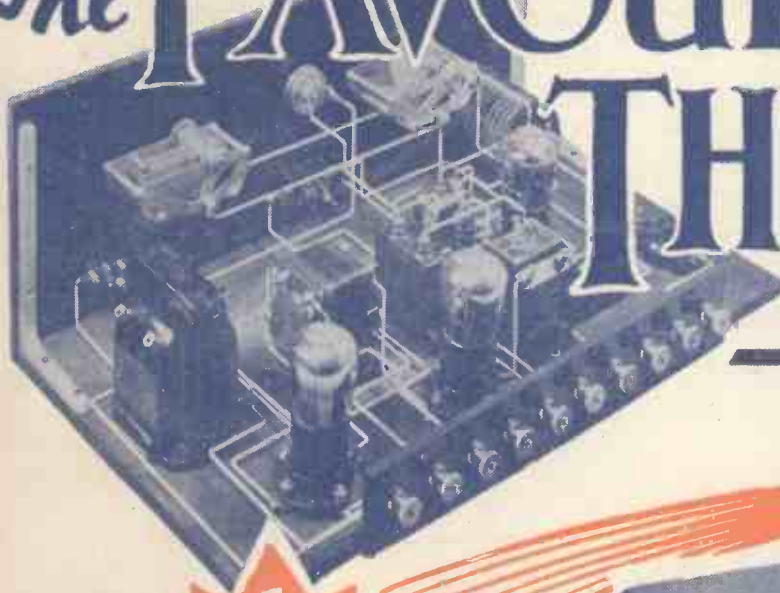

A
STAR
SET



Registered at the G.P.O. as a Newspaper

Volume Control



Another Cossor achievement!

—an entirely new range of A. C. Mains Valves:

incorporating features of vital importance to every All - Electric Set Owner

Entirely new in design, representing an enormous advance in construction, Cossor *New Process* Valves have definitely proved their remarkable capabilities in actual service. They have been used for thousands of hours in every popular type of A.C. Set. Every test, however searching, has only served to demonstrate beyond all possible doubt their exceptional qualities. For pure, trouble-free Radio use Cossor *New Process* Valves in your Receiver.



Cossor *New Process* Battery Valves have been substantially reduced in price. Ask your Dealer for latest lists or write A. C. Cossor Ltd., Highbury Grove, London, N.5.

Mains Valves		Heater Amps.	Anode Volts	Impedance	Amp. Factor	Price
4-volt Indirectly Heated Cathode						
41 M.H.F.	H.F. or Detector	1 amp.	200 max.	14,000	32	15/-
41 M.L.F.	First L.F. Stage	1 amp.	" "	7,900	15	15/-
41 M.R.C.	R.C.C. or Detector	1 amp.	" "	20,000	35	15/-
41 M.P.	Normal Power Use	1 amp.	" "	5,000	13	17/6
41 M.X.P.	Extra Power	1 amp.	" "	2,000	6	22/6
41 M.S.G.	Screened Grid	1 amp.	" "	490,000	1,900	25/-

Rectifying Valves		Filament Amps.	Anode Volts	Output	Price
612 B.U.	Full Wave Rectifier	4 amp.	250	50 m.a.	20/-
412 B.U.	Full Wave Rectifier	1.0 amp.	250	70 m.a.	23/-
412 S.U.	Half Wave Rectifier	1.0 amp.	250	70 m.a.	15/-
£24 B.U.	Full Wave Rectifier	2.0 amp.	550	60 m.a.	20/-
£25 B.U.	Full Wave Rectifier	3.0 amp.	550	120 m.a.	22/6
44 S.U.	Half Wave Rectifier	4 amp.	230	20 m.a.	15/-

COSSOR

NEW PROCESS

A. C. Mains Valves

Amateur Wireless and Radiovision

The Leading Radio Weekly for the Constructor, Listener and Experimenter

Editor:
BERNARD E. JONES

Technical Editor:
J. H. REYNER, B.Sc., A.M.I.E.E.

Research Consultant:
W. JAMES

Assistant Editor:
H. CORBISHLEY

Television on the Stage—A New “Discovery”—The Anthem—The “Reds” —The New Nightingale—Wavelet Vagaries

Television on the Stage—An “A.W.” representative went along to the London Coliseum last week to see the television demonstrations which were given on a 5-ft.-by-2-ft. screen on the stage, the subjects being televised sitting in the Baird studio in Long Acre. This marks a new milestone in television history. An account of the system is given on page 144.

A New “Discovery”—Doubtless you remember the ships *Discovery* and *Discovery II* which set out for the Antarctic at the end of last year, completely equipped with radio gear to assist in Polar explorations. A new expedition has been arranged, and Shackleton's historic ship *Quest* left London last week on an investigation of an all-British air route across the Arctic regions to Canada. Of course, a complete radio outfit is being carried. The transmitting equipment operates on the short waves and will be erected at base camps, one of which it is intended to establish on

the south-eastern coast of Greenland and another, which will serve as a main base, 150 miles inland on the highest part of the plateau. A tough test for radio!

The Anthem—The patriots are at it again. The B.B.C. has been criticised on the ground that the National Anthem is rarely played at the end of the evening broadcasts. While it is not heard every evening, the minimum number of times that it forms the closing item during the week is two. It is always played whenever an orchestra, large or small, a military or brass band, is present in the studio at the conclusion of an evening's programme. It is not played when the concluding items are given by small musical combinations or dance bands, or consist of gramophone records.

The “Reds”—As you may know, a number of the Russian stations transmit a deal of Bolshevik propaganda. This has been causing a bit of a bother lately. The Soviet Government has rejected the protest of the German Government against the transmission of Bolshevik propaganda by wireless into Germany on the ground that its German programmes are intended for Germans living in Russia, and therefore it did not constitute violation of the treaty pledges between the two countries.

PRINCIPAL CONTENTS

	Page
Current Topics	121
Why Not Radio Churches? ...	122
Ornamenting Your Cone Speaker	123
For the Newcomer	124
Valve Damping	125
My Wireless Den	126
On Your Wavelength	127
Why Two-valvers are Still Wanted	129
Life in a Wireless Cabin at Sea ...	130
Without Fear or Favour	131
The “1930 Britain's Favourite Three”	132
“A.W.” Tests of Apparatus ...	136
The Importance of the Output Stage	138

A rather threadbare excuse, it would appear. Broadcast programmes cannot be “intended” for anybody. They can be heard by all.

A New Nightingale—The song of the nightingale has just figured for the first time in the Swedish radio programme. The broadcast was made from Malmö, and owing to the elaborate precautions taken the little performer was not disturbed or frightened, but kept on singing at the top of its form for five minutes. The innovation delighted the listeners, many of whom had not heard a nightingale before, this bird being very rare in most parts of Sweden. Gramophone records have been made of the B.B.C. nightingale broadcasts. Malmö might care to buy a few!

Wavelet Vagaries—How many people are using a short-wave set now? A good idea, you know, for the distant stations are very weak on the medium and long waves just now, unless you have a whole string of H.F. stages—and the average man hasn't! And it is the average man who, therefore, should benefit by trying the “wavelets.” Last week the “A.W.” technical folk were doing a deal of short-wave listening, and conditions are reported O.K.

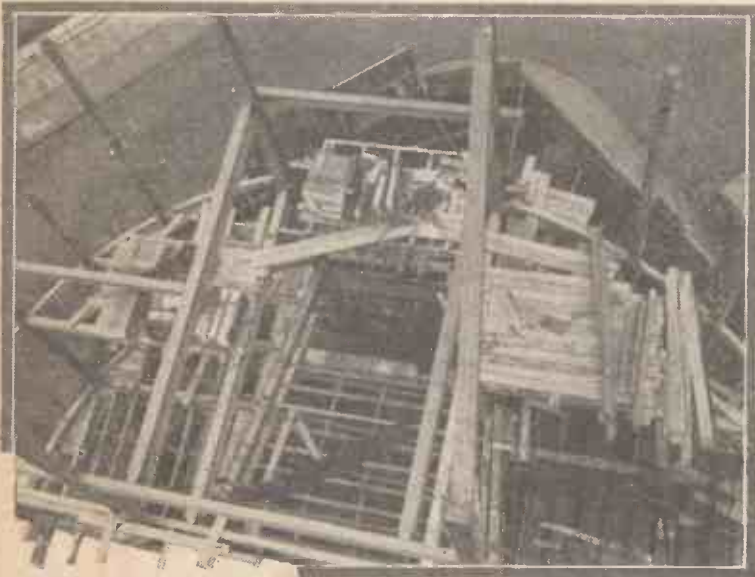

A bird's-eye view of the new Broadcasting House. The main thoroughfare facing down Regent Street can be seen at the top of the picture. This view is taken 100 ft. above where the main entrance will be

NEXT WEEK: A CAR PORTABLE, A NEW THREE-VALVER FOR MOTORISTS

WHY NOT HAVE RADIO CHURCHES?

MILLIONS of people use their sets all over the week-end, but can find time to listen-in for perhaps only half an hour or so during the week. Week-end broadcasting is so important that listeners have a real cause for grumbling if the very best items are not chosen for Saturdays and Sundays.

Now, the suggestion has been made that not only does wireless *not* keep people away from church, but that we should have "radio churches." Many churches could be made more useful if, in addition to the ordinary services, the B.B.C. services could be picked up and re-broadcast in the church through speakers. The existence of a few radio churches would attract larger congregations; and that is the call of the moment.

The B.B.C. has preachers who could never be heard at some of the very small country churches. Cathedral organ music is broadcast which has no comparison with the honest but feeble efforts of much-handicapped country organists.

Some of our national choirs broadcast on Sundays. The leaders of the Church often broadcast. Why should these things be denied the small church, or the poor church?

If the churches took wireless up properly the radio services would be made to blend with the normal church activities. The speakers should be hidden, of course, so that no distracting element is introduced.



How phones are installed in a Berlin church so that the congregation can take part in radio services.

Of General Use

It would be an easy matter to arrange from the technical side. All the B.B.C. main stations provide the right kind of religious material on Sundays, and the new regional scheme conditions make reception very easy for hospitals, churches and other "mass-production" listening bodies.

Some very fine organ recitals are occasionally broadcast, and some good organ records have been produced in which the pedal tones really are heard. A pick-up could be attached to the set so that electric-gramophone organ recitals could be given.

There is nothing unsacred in putting a wireless set, combined with an electric gramophone, in a church. It compares with musical recitals, lantern lectures and

religious plays, and need not be a distraction. It would be creating no precedent. A well-known New York church, St. Bartholomew's in Park Avenue, is often filled to overflowing despite the fact that it is one of the largest buildings. So an elaborate radio and public-address system was installed by a "talkie" film concern, and now the congregation can be accommodated in every available nook and corner and in three entirely separate outside chapels nearby.

Gramophone organ records can also be given over this equipment. Separate 'phones are provided in reserved pews for the use of the deaf, who can thus take an active and much more en-

joyable part in the service and everyone is able to hear. This is a good idea which might be used in the reception of church services.

It should be observed that the B.B.C. does not as a rule broadcast religious services at the same hours as the proper church services; so the ordinary church-goers need not be affected.

The extensive use of radio in churches on Armistice Day is proof of its utility, and there is every reason to hope that a few churches will be sufficiently enterprising to give greater scope to the B.B.C.'s broadcast services. The present Sunday programme scheme, which seems to be displeasing to most people, could thus be turned to good account. K.

DOUBLE DUTCH JOTTINGS FROM MY LOG

By JAY COOTE

IN most European countries the supervision of broadcasting lies in the hands of the Postmaster-General; in Holland the Minister of Waterways is the official responsible for this onerous duty. In that country there exist two private broadcasting stations and five separate associations interested in the transmission of programmes.

Each one in turn would like to possess its own station or, failing this, in view of such an impossibility, the greatest number of hours during which it can monopolise the ether. And all these miniature radio corporations are of different religious or political opinions!

Although on many occasions attempts have been made to reconcile their interests and to effect an amalgamation likely to prove of general benefit to the Dutch listener, no practical means have been found to do this. For this reason the

Ministry of Waterways has stepped in to adjudicate. It had already decreed that the studios should carry out quarterly exchanges of transmitters, that those associations working through Hilversum for three months should broadcast through Huizen during the next quarter; to-day it has apportioned the broadcasting time of each and all the radio organisations, with the result that Holland is more puzzled than ever.

An Involved Business

At present both local and distant listeners are taking pot-luck from either of the Dutch stations; it will be only possible to know who is giving the concert by reference to a published programme, for the rota will not be necessarily the same from week to week. From both transmitters, also, throughout the day we shall pick up different calls, apart from the

ordinary station name, as each individual programme company comes on the air. From Huizen we shall hear entertainments and talks provided by the K.R.O., the N.C.R.V., and the V.P.R.O.; from Hilversum "until further notice" we shall be able to listen to concerts given by the A.V.R.O., the most important of the programme organisers, and by the V.A.R.A., with which are associated the transmissions specially intended for British radio fans. On Mondays and Fridays joint transmissions are to be made from Hilversum; also on Fridays from Huizen two radio clubs will co-operate to provide the wireless fare.

It is evident that with so many different claims to satisfy, the arbitrator's job is a difficult one and his award does not appear to have pleased anybody, the main complaint being that the time is so cut up that it is difficult for the various organisations to fit in the necessary programmes.

THE cone type of loud-speaker is particularly favoured by the constructor, as this type of speaker is not only easy to build, but offers considerable scope for experiment in construction and gives good results. The artistic side, however, is not considered to any appreciable extent, although the cone speaker lends itself admirably to various artistic methods of use and decoration. It may be made to fit into the general scheme of things, and harmonise or blend with the other adornments of the room in which it is used.

This article describes some ways of applying the artistic touch to the cone speaker, and some of the details given will no doubt be quite new to the reader. No great skill is required, and anyone can adopt the ideas given with the assurance of success.

Making Cone Diaphragms

The first consideration is what material to use for the cone. There is lampshade "vellum," but as this material varies much in quality and texture, care should be taken to obtain the best. It can be had in sheets measuring 30 in. by 20 in. at the modest cost of sixpence per sheet. Any of the following colours may be chosen: cream, orange, brick red, buff, blue, yellow, crimson, and green. The cream is also made in sheets measuring 50 in. by 20 in. at one shilling per sheet. The paper, by the way, is greased, and when glueing any section, it is necessary slightly to scrape the contact surfaces with a sharp knife, to ensure



By H. BRAMFORD

off on the inner circle, with the compass already set, and allowing for the half inch gumming overlap, this determines the cut-out for folding. The circumference is then trimmed all round with "V" cuts, this being for the purpose of the ultimate suspension of the cone. Details of the cut-out are shown by Fig. 1.

If you are making a speaker, decoration should be considered before shaping the cut-out, but if you are decorating one already made, then of course you have to work on the shaped article. We will assume, however, that you are making one, as the same procedure applies in either case.

Decorating the Cone

For decoration we require some special materials which are not, however, expensive. First some stencils are needed, and these are to be had for a penny or so each in a great variety of design, and those may be chosen which appeal most. The best are Reeves, which are supplied by most stationers. In addition to this, three stencil brushes of graded sizes should be bought. This leaves the colours to be considered, and they need not be many. For use with the cone material recommended, special colours should be used, and these are also obtainable from the same source as the vellum. They have the advantage of drying almost as soon as they are applied, besides which they are permanent, and can even be washed. The colours

being also transparent, and used on the material suggested, give a splendid effect where a pilot light is used at the back of the speaker, which may also serve to indicate that the set is "on." This suggestion, by the way, is simple to incorporate in any speaker, and is attractive, besides being useful. The colours can be had in sixteen shades, in half-ounce bottles, at sixpence each (Kristal, Messrs. Lechertier Barbe, Ltd., 95 Jermyn Street, S.W.1) and are as follows: red, dark brown, blue, grey, cerise, light brown, light blue, deep yellow, pink, orange, dark green, light yellow, purple, navy blue, light green, and black. For general purposes the following colours are suggested: red, blue, green, yellow, and black.

Stencilling

This procedure is quite simple. The stencil is placed over the work to be treated and held firmly in position. Very little colour is taken on the brush, and applied quickly. The stencil is then removed and placed in another position for further working, and in this manner the entire cone cut-out may be decorated with splendid effect. Different designs, or sections of design, may be used from the stencils to hand, and the sections blended together to form the complete effect. As a rule, simplicity gives the best result, such as simple flower stencils, with effective foliage effect.

The photograph shows, as well as is possible, an example of a formed cone decorated in this manner, using a black colour only on an orange-coloured lampshade vellum. Speakers used for wall hanging or as ceiling pendants, or even fire screens, lend themselves particularly well to this method of treatment. The art, of course, is to choose the right materials, and to get good colour effect with simple arrangement.

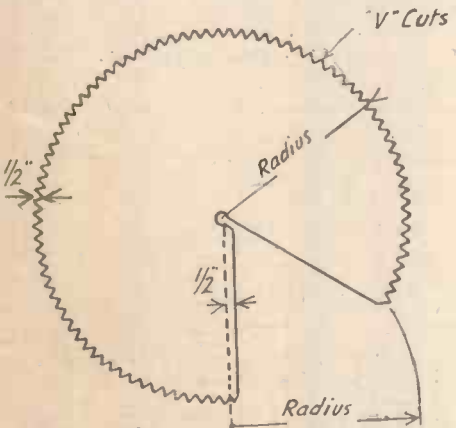

Fig. 1. Method of cutting paper for cone

perfect adhesion, which is, of course, important with cone construction.

Cutting and Suspension Methods

Having considered material, a matter of fundamental importance, we next come to the question of cutting out the paper for shaping. First, draft with a compass a circle according to the size of finished cone required. A good general size is 12 in. Inside this draw another circle, making a 1/2 in. margin all round. This radius is marked

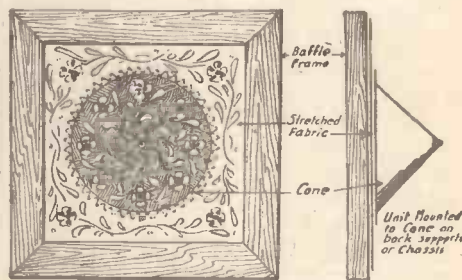

Fig. 2. Suggested method of mounting cone

Suspension

Finally, one of the simplest methods of suspension which is not prone to chatter or rattle when the finished speaker is put together, providing a good unit is used and the reed is centred properly, is as shown

(Continued on next page)

For the Newcomer to Wireless: THE COUNTERPOISE

WHAT exactly is a counterpoise? You know, of course, that the ordinary aerial and earth system forms the two plates of a condenser, which is big in size but small in capacity.

I don't quite follow.

Well, up aloft you have the aerial, consisting of a longish wire well insulated and down below you have the ground itself in electrical contact via the earth plate with the low-potential terminal of the receiving set.

Yes, that's clear.

Between the two is a layer of air, which is, of course, a good insulator. When you have two conductors with a non-conducting layer between them a condenser is formed. So the aerial and earth together form a condenser.

Roughly, what is the capacity?

It varies, of course, according to the height and length of the aerial and the number of wires used in it. Generally speaking, though, the average amateur aerial has a capacity between .00015 and .0003 microfarad.

Then we really receive broadcasting by means of a condenser of big size?

Yes. The condenser is alternatively charged up and discharged and it is parallel with the aerial tuning coil. Thus oscillating potentials are set up across the coil.

That's quite plain now.

You were asking about a counterpoise. Here, instead of using the ground as the low-potential plate of the condenser, you make use of a second insulated wire.

What, a kind of second aerial slung under the first?

Exactly; and it must be just as carefully insulated. With a counterpoise the total capacity is considerably less and reception is often improved. Sometimes one uses a makeshift counterpoise which answers quite well.

Please explain.

If you attach to the earth terminal the end of a length of insulated wire and simply throw the wire in loose coils under the table on which the set stands quite a good counterpoise effect may be obtained.

Do you recommend the counterpoise for broadcast reception?

It is often very good in places where the local station is apt to swamp the receiving set when an ordinary earth is used. By adjusting the length of the counterpoise a nice balance between sensitiveness and selectivity can be obtained. There is, however, one point to notice.

What is that, please?

Some rather old-fashioned sets are

"held down" by the presence of a fairly large aerial-earth capacity. If this capacity is reduced by substituting a counterpoise for the ordinary earth connection, sets of this kind may become unstable. A trial, though, with the makeshift counterpoise that I have mentioned will show whether or not it is likely to be worth while to erect a properly made permanent counterpoise.

What is the effect of the counterpoise upon tuning?

As a rule a rather higher setting is required for the first dial owing to the smaller parallel capacity. That is the first thing.

Anything else?

Yes. There is nearly always a very noticeable increase in selectivity and sometimes signal strength is also improved, though this depends very much upon circumstances.

I have heard that less interference may be experienced; is that so?

Very often when the interference is due to power lines, electrical machinery or flashing signs in the neighbourhood, the counterpoise is distinctly beneficial. In any case, it costs so little to erect that the experiment is always worth making in cases where interference of this kind is bad.

"ORNAMENTING YOUR CONE SPEAKER"

(Continued from page 123)

by Fig. 2. A piece of vellum or silk or suitable material, is first stretched across the frame of the baffle, the cut-out being either square or round. This should be well

stretched and glued, and if paper is used it should be damped before stretching, so that it will shrink when dry, and thus give good tension. The work must be well glued at all contact surfaces. To this, and placed centrally, is glued the cone, by bending out the "V" cuts around the circumference,

and this should be left to set perfectly before assembly to the unit. Finally, the centre is carefully cut out from the baffle mounting, exposing the ornamented cone. If the suspension mounting is square, then this may also be ornamented on similar lines at each corner.

MR. FLEX IS LEFT WONDERING AS TO WHETHER HIS SET—



—COULD BE A LITTLE MORE SELECTIVE.





VALVE DAMPING

In continuation of the article on damping which appeared last week, J. H. Reyner here discusses its effect when associated with a valve

I DEALT last week with the question of damping in general and in the aerial circuit in particular, in response to a request from a correspondent. In this article I propose to consider the extra loss or damping introduced into a tuned circuit when it is associated with a valve. The first and most severe case of this kind occurs in connection with the well-known tuned

is effectively in parallel with the circuit. The high-tension battery may be disregarded as far as any variations of voltage are concerned, since the only purpose of this battery is to supply a steady potential to the valve. Moreover, we know that a valve has a certain internal resistance, so that this circuit is really equivalent to that of the Fig. 1 arrangement, consisting of a circuit with resistance shunted across it.

We overcome this difficulty to some extent by tapping the valve across a part of the tuned circuit only as shown in Fig. 3. It is perhaps fortunate that if we tap the valve across half the circuit, the damping introduced by the valve is reduced to one-quarter. Thus, in the case we have just considered we only introduce a little more

Flat Tuning

Therefore, if the valve resistance constitutes an appreciable leak across the circuit we shall introduce considerable extra damping. A circuit which is heavily damped is equivalent to one which has a large proportion of resistance, and we know that such a circuit will not tune sharply. Consequently, the damping imposed by the valve depends largely upon the relative resistance of the valve and the effective resistance of the tuned circuit, which is given by the expression L/CR .

With the average tuned circuit of 200 microhenries, tuned with a capacity of .002 microfarad, and having a resistance of 5 ohms, this effective resistance works out at 200,000 ohms. It is clear that the average H.F. valve, for example, having a resistance of only 20,000 ohms would constitute a very serious shunt across such a

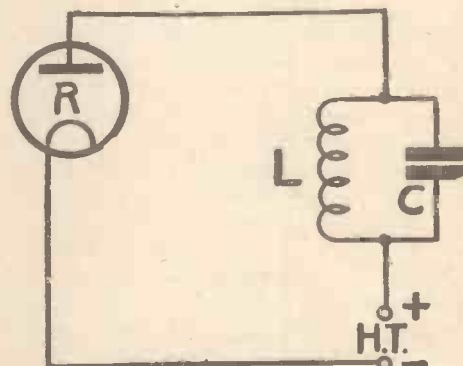

Fig. 2. A tuned-anode circuit is similar to the Fig. 1 arrangement

than 1 ohm extra loss into the circuit by using a centre-tapped tuned anode of the form shown in Fig. 3. Certainly the amplification from the valve would be somewhat reduced because our external anode impedance has been reduced by comparison with the valve, but to offset this we have a 2-to-1 step up due to the auto-transformer action, and in general the loss is not so serious. We can afford to lose a slight amount of amplification in order to obtain the better selectivity.

Grid-circuit Damping

In cases of relatively low-impedance valves, such as the usual three-electrode H.F. valve, we not only gain selectivity, but we definitely gain in signal strength, and we can find an optimum ratio of transformation usually of between 2 and 3 to 1, at which the signal strength is a maximum, and the selectivity has been considerably improved over the simple tuned-anode arrangement. With a screen-grid valve, however, the optimum transformer ratio is in the neighbourhood of 1 to 1, and in some cases it is even a step-down; but we cannot afford to use this because it does not give us sufficient selectivity, and we

(Continued in third col. of next page)

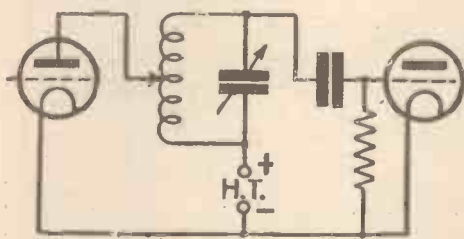

Fig. 3. An auto-transformer arrangement minimises the valve damping

circuit and would introduce heavy damping. In the case of the screen-grid valve the resistance is somewhat higher, being usually of the same order as the circuit. In such a case it is easy to appreciate that the damping in the circuit will be doubled. If we are using a very good tuned circuit, the effect of the valve is much worse or, conversely, if our circuit is only poor to start off with, the effect of the valve will not be so marked.

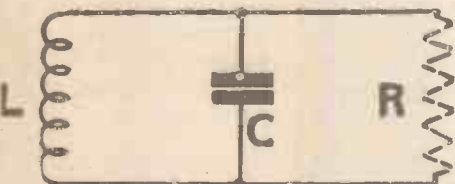

Fig. 1. Resistance across a circuit causes the tuning to be flat

anode circuit. It is immaterial for our purpose whether the valve in question is of the screen-grid type or a simple triode, and we will, therefore, consider the latter as being simpler.

First Considerations

In considering this question of valve damping one must regard the matter from the viewpoint of the tuned circuit under consideration. Consider the simple arrangement shown in Fig. 1. We have seen that if oscillations are set up in a tuned circuit of this character they will gradually die away owing to the damping imposed by the resistance of the circuit. Let us suppose that an extra resistance is connected across the circuit as shown by the dotted line. Obviously, this will absorb energy from the circuit and the oscillations will not persist as long as if this resistance were not present. The resistance acts as a leak across the circuit, so that the smaller the value of resistance, the greater the damping introduced into the circuit. If one carries the matter to the limit the circuit would refuse to oscillate at all if we made the resistance so small as to be a short circuit.

Let us now examine the circuit of Fig. 2. This is the customary tuned-anode circuit. Viewing the matter from the point of view of the tuned circuit we see that the valve

MY WIRELESS

Weekly Tips,
Constructional
and
Theoretical—



DEN

By
W. JAMES

For the
Wireless
Amateur

I SUPPOSE that most people, having once erected an aerial, continue using it until it falls down or needs repairing. The aerial is too often taken for granted, and a little time spent upon it now and again might be very well worth while.

I am not suggesting that the aerial should be lowered and cleaned every few months, but that it should be given reasonable attention. An aerial which has been in use for a long time may very well be a poor collector. An earth, too, should be examined from time to time.

People nowadays seem to use a short tube as an earth, but in the early days of broadcasting we used to dig big holes and bury large plates so as to obtain a really good earth.

Higher and Higher H.T.

The tendency these days is to use higher anode voltages. Better all-round results are sure to be obtained when the high-tension is increased, provided, of course, that the circuit is not an unstable one.

Some portable sets, for example, work very well with 100 volts high-tension, but squeal and howl when this is increased. Normal sets, however, are sure to provide better results. More power is obtained from the last valve, the detector is not so easily overloaded; this also applies to the high-frequency stage.

Where Are the Traps?

I wonder what has happened to all the wavetraps put into use when first the Brookmans Twins commenced working?

No doubt, many users discovered their limitations and eventually decided to be satisfied with fewer stations. The fact is that wavetraps are not of universal value. Sometimes very good results are obtained; but then again, on the other hand, the tuning is tricky and beyond the skill of the less-experienced members of the household who use the receiver.

Modern sets ought not to need a wavetraps, but no doubt when the other regional stations commence working there will be another boom in wavetraps.

The "Life" of Condensers

The question of the life of fixed condensers is an interesting one. It appears that this is determined, in the absence of

abnormal voltages, by the extent to which the elements are sealed.

All condensers are enclosed, but some have a heavy seal of wax. Others appear not to be so fully protected, and may therefore be expected to break down after a period of use. It is certainly foolish to employ cheap condensers for power work, such as in mains units, as a breakdown may lead to extensive damage in the form of destruction of the rectifier and perhaps of the transformer.

A Good Detector Arrangement

The circuit this week shows a detector fed from a tuned-anode circuit and arranged for anode-bend working. A grid condenser and leak are used, as usual, but the bottom end of the leak is taken to a grid battery in order that the detector shall have a negative bias.

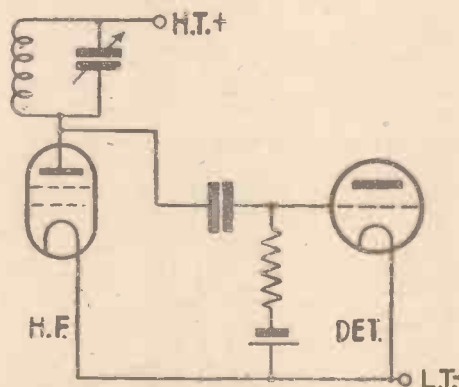

An anode-bend detector with grid condenser and leak

It is not necessary to be so careful in choosing the value of the condenser in comparison with that of the leak in this arrangement, as in ordinary leaky-grid detection. Suitable values are .0003 microfarad and .25 megohm, although, as the values are not critical, there is no need to adhere to these sizes.

Last-stage A.C. Valves

In sets of the A.C. type a power valve of the ordinary battery type is often used, but those who would prefer to fit a mains power valve may easily do so. A five-pin valve holder should be fitted and the cathode terminal be joined to the centre tap of the filament transformer. No other change is necessary.

L.F. Matters

I expect the majority of sets have a low-frequency transformer coupling, but there can be no doubt at all that the resistance coupling, properly used and with adequate high tension, is a better form from the point of view of minimum distortion.

The iron used in transformers is bound to affect the wave form, however cleverly the transformer is designed. Many people prefer transformer coupling because of the greater amplification to be obtained, but I have known of amateurs who maintain that the quality is better than when resistance coupling is used. This can hardly be true if suitable values are used and the set is adjusted correctly.

Fit a Fuse

When a mains unit burns out as the result of a mistake, one realises how well worth while a fuse would have been.

One ought always to be connected in the mains side of the apparatus if one is not included elsewhere in the circuit. Never rely upon the ordinary house-circuit fuse, as this is probably of at least the 5-ampere type.

A special fuse should be connected for the protection of the mains unit. I know that the usual household appliances, such as electric irons and cleaners, are not provided with a fuse. But a wireless receiver is in rather a different class and should be especially protected.

"VALVE DAMPING"

(Continued from preceding page)

sacrifice amplification in order to obtain the sharp tuning required.

While discussing the question of tuned anode damping, we may perhaps refer to the fourth question raised by my correspondent: Does the H.F. valve damp both the grid circuit and the tuned anode? Clearly, from the foregoing simplified theory, no damping will be imposed upon the grid circuit, and in general we may take it that the grid circuit damping is almost negligible. There is a certain loss introduced by virtue of the capacity effect between the electrodes of the valve, but this is either neutralised or (in the case of the screen-grid valve) is so small as to be negligible.

On Your Wavelength!

A Puzzle

OFTEN I wonder who is responsible for the lists of good things in foreign programmes that appear in some of the lay papers. A few of them are obviously prepared by experts who go in for long-distance work and understand summer-time conditions. Others, however, seem to be prepared by the proverbial office-boy. The other day I glanced down a column of selected items for a particular afternoon and evening, which readers were urged to tune in. Twelve stations were mentioned, seven of which, for one reason or another, were not receivable in the ordinary way at this time of year. Of the other five, most were quite good, though only one was a genuine daylight station. It seems to be more than silly to suggest to readers that there is a possibility of tuning in for distant stations at this time of year at three o'clock in the afternoon. I am sure that readers do welcome carefully selected lists as useful guides to reception; equally, I am certain that no good purpose is served simply by picking out especially attractive items from foreign stations and suggesting their reception when it is completely impossible even with the best of sets and the most skilled tuning.

A Portable Point

If you have a portable set whose H.T. current is supplied by a small-capacity dry battery it is just as well to check over the current consumption by means of a milliammeter. Some of the bigger sets require a considerable amount of current—more, in fact, than a little battery can supply economically if rather low-impedance valves are used in them. The consumption can be cut down in several ways. In the first place, it is necessary to pay the most careful attention to grid-biasing. All amplifying valves; whether H.F. or L.F., should be worked with as much negative bias as they will take without distorting. In not a few cases valves of rather higher impedance may be substituted for existing ones without serious detriment to quality if the set is not made to deliver too great a volume of sound. It may be found, too, that the H.T. potential for the high-frequency amplifiers and the rectifier can be reduced a little without detracting from the quality. As the potential is reduced the current falls, and here again we have a useful saving. The best method of all for economising in H.T. with portables is to use the small built-in battery only when the set is operated out of doors. When it is at home, H.T. current can be supplied from a large dry battery and an accumulator or a battery eliminator.

Back to Service—

Not everyone realises what an expert can do with an old loud-speaker that seems to have come to the end of its useful life. Some years ago I acquired one of the cone type which was extraordinarily good when used with suitable valves and a proper output transformer. A time came, however, when it appeared that a replacement was necessary. Its old mellow tone was no longer there; it was apt to "zizz" at times; in fact, it seemed to be completely done for. Then one day I met a friend who belongs to a very excellent firm of wireless manufacturers. "Just send it along to us," he said; "we have a perfect wizard on our staff who can make loud-speakers do almost anything except sit up and beg."

—Better Than Ever

I duly sent it along, and it has come back, if you will believe me, better than it was when it was new. The moral is that if you have an old loud-speaker which is not giving satisfaction—or even a comparatively new one, for that matter—you may find it well worth your while to let a good firm look it over and carry out those tiny adjustments which often make all the difference between very good and very poor reproduction.

A Suggestion

Some of the American wireless manufacturing firms have adopted what to my mind is a very sound scheme. Every Saturday a special programme provided by one firm is put on by a New York station at 1.30 p.m. The programme is especially arranged so that its items shall be of the greatest possible value to those demonstrating receiving sets in the sale-rooms. So successful has this system been that other manufacturing firms are having the programme broadcast simultaneously from stations in different parts of the country. The time which suits America would not be very convenient in all parts of this country. In London, for example, Saturday is early-closing day and most of the big shops put up their shutters at one o'clock. Saturday, though, would be an excellent day in the provinces, where it is very often market day, when the country folk come into the towns.

I should imagine that there are more wireless sets sold in the provinces on Saturday than on all the rest of the days of the week put together. Would it not be possible, then, to have special demonstration programmes on, say, Wednesday and Saturday afternoons?

Some Wiring!

Wiring-up a set is a fairly simple matter these days. Even so, the comparative novice is usually somewhat surprised to observe a set being wired out of one's head; as it were. I usually do this myself, carrying a circuit diagram in my memory and wiring up the various parts as they are required. True, if the set is complex, I generally rough out a circuit diagram for occasional reference; but I have been told by several people that to see the wires being put on, apparently haphazard, without continual reference to a full-size wiring diagram, savours of black magic.

One Better

Whatever pride and swollen head I might have had, however, suffered a rude shock the other day. I happened to see some telephone switchboards being wired up. This, incidentally, was at the G.E.C. works at Coventry. There are a few hundred contacts at the back of these boards, and the girls who do the wiring are provided with plaited cables containing the various wires all bunched up together with the free ends floating about at odd places. They place the cables in the correct position, seize the ends and stick them on to their respective terminals without any reference to a chart at all. Having connected up about six wires to the proper soldering tags, they run over the whole issue with an iron and solder the joints, after which they continue to make a further six or so.

The job does not require a rigid concentration, as one might imagine. They are quite capable of talking to you if you speak to them. When a girl first comes on the job she is given a sample correctly wired, and the first few boards are wired by reference to this sample; but I was informed that it was very remarkable how quickly they learned to disregard it and carry on the wiring entirely from memory.

A Jolly Evening!

We had such a jolly evening from the National stations the other Sunday. It began with a church service in Welsh, lasting for an hour and a half, from 6.30 to 8 p.m. This was followed immediately by a Methodist service relayed from Leeds, which lasted until 8.45 p.m., after which came, of course, "The Week's Good Cause." And before the Welsh service there was a reading from Milton, which occupied the twenty minutes from 6 to 6.20 p.m. These three solid hours of what I presume the B.B.C. call Sunday fare were followed by a delightful brass band concert, which came to an end after but

On Your Wavelength! (continued)

an hour and twenty-five minutes. Now, it does seem to me that if the B.B.C. won't start the entertainment part of its Sunday programmes until 9.5 p.m., it is hardly fair to close down at 10.30 p.m. But that is when both Regional and National transmitters invariably do sign off. Ours is the only country in Europe which concludes its Sunday programmes at such an hour. All of the others go on until midnight, local time, whilst many Continental stations work later.

Yet Another Grouse!

And now I have what I think is a really serious grouse that ought to be taken up hot and strong by all listeners. Under the regional scheme we were promised alternative programmes, and we are not getting them in the evenings. If you will go through the programmes you will find that the Regional stations close down at about 10.30 p.m. on every weekday except Fridays, when they transmit dance music until midnight. The evening entertainment programme of the National transmitters invariably ends at 10.30 p.m., after which time outside dance music is relayed. What it comes to, then, is that, though both a Regional and a National station may be within range of your set, the only thing that you can receive by way of the home transmissions is dance music on any week night after 10.30 p.m. Except on Fridays, the studios just close at that hour and dance music from some hotel is pumped into the ether. There is no question that our broadcasting service is becoming more and more restricted with shorter hours and less variety. Meantime the B.B.C.'s income continues to grow, and it is high time that Savoy Hill came to realise that it is not giving the country the service that it ought to give.

Portable Pinchers

It is quite surprising to find how many portable sets are stolen from wireless shops; there are people who make a business of this kind of thing. Of course, the very fact that it is a portable makes such a receiver exceedingly easy to "lift." One rather neat scheme, which has been extensively worked, is this. A respectably dressed man enters a wireless shop and asks for a piece of ebonite to be cut to a special size. He is in a great hurry and would be much obliged if it could be done at once. Out goes the assistant to put the work in hand, and whilst he is absent off goes the portable! I can, I think, give retailers a tip which they may find worth while. It is not at all difficult to rig up under the portable set a small switch which works in exactly the opposite way to the ordinary push-button. Contact is broken whilst pressure is exerted and made as soon as

the pressure is removed. As soon as the portable set is picked up by the would-be thief a loud bell starts ringing and warns its rightful owner that his presence in the saleroom is rather urgently required.

An Economy!

I ran across a Scottish friend the other day who first took up wireless at the beginning of last February. Observing that he was looking rather gloomy, I asked what the trouble was. He told me that he had just had rather a serious blow, having been told that his high-tension battery required renewal. Since it was a standard-capacity battery and the set a four-valver, my only wonder was that he had made it last so long—or, rather, that he had been able to put up with the appalling distortion that must have been his lot for at least two out of the five months. However, he didn't seem to mind that very much, and told me that he was going to make the battery last at least another month! Some day, I suppose, people will really believe that one is not romancing when one says that a standard-capacity battery will *not* run a four-valve set economically—or even a three-valver, for that matter. One of treble capacity costs about one and a half times as much and gives, as a rule, at least four times the number of service hours. There is no more effective way of banging sixpences than by trying to run big sets off small batteries.

Surprising

The quality of talkie film sound reproduction still leaves very much to be desired. Next time you go to one listen carefully whether you can hear the S's properly. Nearly always I find that they simply aren't there. If a character tries to say "It's so simple," it comes through something like "Ith ho himple." And don't you notice, too, that music has often that quality that we used to call "gramophony" when speaking of wireless sets? I am not saying, mind you, that the general reproduction is bad. I do feel, though, that it would stand a good deal of improvement. And here is a funny point.

The Reason Why

The reason why the talkie reproducers sound rather queer to English ears is that many of the most widely used types were designed originally for American audiences. Now, America, so friends over there tell me, has gone absolutely and completely bass mad as regards wireless and gramophone reproduction, and the same thing applies to its tastes in talkie speech and music. It does not care the proverbial two

hoots about the higher frequencies so long as it gets lashings and lashings of bass. Wireless and gramophone amplifiers are therefore designed to pay particular attention to the low-pitched sounds and rather to skip the higher frequencies. The talkies, too, have had to fall into line since wireless quality and bass are almost synonymous now in the States. That is why talkie speech and music are apt to sound rather boomy and why the S's are conspicuous by their absence. The letter "s" is a high-frequency sound, and the amplifier designed particularly to bring out the bass may give it the cold shoulder.

Room for Improvement

One of the lay papers has recently been conducting an attack upon wireless retailers, depicting in the most lurid language their ignorance and incompetence. Generalisations are proverbially dangerous, and it would be most unjust to state that retailers, as a whole, do not know their job when it comes to installing and maintaining wireless sets. I have come across a good many who are keen wireless men and keep themselves right up to date in every way. Men like these are invaluable from every point of view, for they encourage interest in wireless and help the listener in any little difficulties that may arise. I am not going, though, to deny that there are a good many black sheep in the fold and that the self-styled expert is far too common. The trouble is that in wireless retailing there has been too much dabbling. Lots of little men who were doing a small trade in cycles or gas fittings, or something of that kind, saw an opportunity of raking in the shekels and blossomed out into wireless experts without knowing the difference between a milliammeter and a kilowatt.

The Set Builder

Perhaps the worst bit of disservice they did to wireless in general was to offer to build sets for customers—often without paying any royalties. I have come across a good many of these sets, and anything more appalling than some of them would be hard to find. Nor could one easily come across more dangerous examples of electrical apparatus than some of the eliminators thrown together. Another way in which the incompetent electrician has done harm is by installing an accumulator-charging plant—though really it would often better deserve the name of an accumulator-wrecking plant. No one can stand over such a fellow and see that he uses distilled water and pure brimstone sulphuric acid, or that he does not charge a high-tension accumulator at 5 amps instead of 5.

"A.W." Solves your Wireless Problems

THERMION.

A PAGE FOR THE SET BUYER

WHY TWO-VALVERS ARE STILL WANTED

By "Set Tester," whose weekly accounts of commercial sets are an exclusive "Amateur Wireless" feature



The Cossor 2-valver is particularly compact; note the simplicity of control

MY title is not intended as an apology for two-valvers; the best of the species do not need that. Rather, I want to show how, under modern conditions, two valves exactly fill the bill for a great number of listeners. Firstly, there is the great power of the Regional station at home and of some of the long-wave stations abroad. Signals from these sources are so powerful that very little amplification is needed to produce good loud-speaker strength. Two valves are ample for such conditions.

Secondly, let us remember how simple is a two-valver both to operate and maintain. First cost and running costs are usually very modest. On these two counts alone the two-valver could easily justify its existence. I have just finished testing the Cossor Battery Two, which more than backs up my remarks.

An Efficient Combination

Let me give some details of this great little set. The first valve is, naturally enough, the detector, a Cossor HF210. Its high efficiency is clearly shown by its amplification factor of 22 for an impedance of 20,000 ohms. After this valve is the Cossor low-frequency transformer connecting the HF210 to the output valve, which is a Cossor two-volt pentode. Here again figures speak for themselves: The amplification factor is 40; the impedance, 20,000 ohms.

The whole job is compact; inside a crystalline-finished metal box are the components and the grid-bias battery. The familiar Cossor escutcheon plate on the front carries the three simple controls. The left-hand knob for reaction, the right-hand knob for tuning, and the centre knob for switching; nothing could be more simple. Back of the box are sockets for battery, aerial, and loud-speaker connections; all well arranged.

Internal Details

A look round the Cossor set reveals a dual-range solenoid coil, sturdily built, and designed quite obviously for maximum efficiency. As this set will be on show at Olympia, I need not elaborate upon its appearance. Take my tip and see it there.

The pentode has come up smiling after

a season of very hard knocks. That there is no need to instal an outside battery to run a pentode is quite definitely proved by my test of the Cossor set. Its HF210 detector and PT230 pentode were worked from a standard-capacity battery. The makers must be praised for using their pentode in such a sensible way.

As readers know, this type of power valve has an auxiliary high-tension connection, which is usually taken to the same voltage as the normal anode connection, usually to the maximum available. But by taking the auxiliary high-tension connection to a lower voltage than the anode voltage, a big saving in battery current is

Every set referred to in this regular feature by "Set Tester" has reached a certain standard of efficiency in the "Amateur Wireless" Laboratory. Reports are not given on sets that fail to reach this standard. This will explain why reports that do appear express general satisfaction with the set's performance.

effected, without losing the tremendous amplification of the pentode.

By reducing the voltage to the "H.T.90" lead to 60 volts, I found the total anode-current consumption was only 6 milliamperes. Of course, some loss of amplification was inevitable, but there was quite enough power in hand for both the Brookmans Park stations. With the recommended voltages the anode current was 12 milliamperes. I found a voltage of 72 for the "H.T.90" supply a useful compromise between volume and current consumption.

Good Range and Power

As to results. Well, this is not an ideal time of year for DX work with any set; so I hardly hoped to get much besides the two Brookmans stations and the Midland Regional, with Daventry 5XX on the long waves. But I had hardly got going on a 60-ft. indoor aerial when I had to revise my forecast rather considerably!

On the long waves, Radio Paris was an unmistakable loud-speaker signal, every word and note being heard all over the

room on a new Amplion loud-speaker. Then Eiffel Tower came in, rather more loudly, and soon after that Hilversum. Greatly cheered, I went down to the medium band. There was Rome, surprisingly strong, considering it was not yet dark, and Brussels and Turin and Toulouse, and about ten carrier waves that could have been resolved into signals with a little patience.

Make no mistake, this Cossor two-valver is super-sensitive. Whether it is the new Cossor valves or the well-designed tuning coil, would be hard to say. I imagine it is a combination of several factors contributing to the set's quite exceptional performance.

What pleased me mostly was the way selectivity could be improved without losing volume. The giant voices of Brookmans Park were heard over only a few degrees of their condenser settings, leaving plenty of room for the less stentorian but no less interesting foreign stations already mentioned. The Cossor two-valver is a notable introduction, calculated to enhance the already enviable reputation of its makers.

NEEDLE SCRATCH

THE surface of a gramophone record must be made sufficiently hard, or must contain enough abrasive material, to grind down each new needle to a good fit in a comparatively short time. Even after a full minute's running the pressure between the needle point and record is of the order of 50,000 pounds to the square inch. As the needle wears down to a larger bearing surface, the pressure naturally decreases. It is the initial high pressure and the necessary abrasive qualities of the record which are responsible for the so-called needle-scratch. Even when inaudible on an ordinary gramophone, "scratch" is frequently in evidence on an electric reproducer owing to the amplifying action of the valves.

M. A. L.

THE home wireless enthusiast is apt to envisage the lot of a ship's operator as a continuous spell of his own arm-chair ease, broken at convenient intervals by delightful trips ashore when the vessel berths in a foreign port. Nothing could be a more mistaken notion however, for the life of an operator at sea, although not devoid of technical interest, is a strenuous one and leisure periods are both rare and limited.

What a Wireless Cabin is Like

First, let us take a look at the wireless cabin in which the operator works during his period of duty. Our illustration shows the equipment of the Anchor Liner *Transylvania*. On the left bulkhead are the main distribution panel and the battery charging panel. On the table to the right is the quenched-gap spark transmitter with the aerial tuning inductance on the rear bulkhead centre, while below it are the tuner, receiver, and local oscillator. On the left of the calendar is a wavemeter and above it a throw-over switch for continuous or spark transmission. At the centre of the bench to the right is a "send-receive" switch and transmitting key. The generator



The interior of the wireless cabin of the S.S. *Transylvania*



is contained in the cabinet beneath the bench.

The continuous-wave transmitter is on the bench to the extreme left and the direction-finding receiver is shown in the foreground. Particular notice should be taken of the "gyro repeater"—the clock-like affair above the wheel which swings the direction-finding aerial. This repeater is controlled by the master gyro compass situated on the bridge of the vessel, and gives the correct direction of the ship's head.

Operator's Duties

A ship, such as the *Transylvania*, will carry three qualified operators so that constant watch may be maintained day and night. The usual procedure is for each operator to be on duty for four hours and off duty for eight hours. Let us follow the routine of an operator commencing on watch at, say, 4 a.m. First, his duty will be to assume the headphones, the while discussing with the man he is relieving the batch of traffic on hand. If the position of the ship is in mid-Atlantic there will probably be a number of messages on hand for both England and America. These will be transmitted on continuous wave and should reception at the other end be poor, due to interference or fading, any ship similarly equipped and located between the sending ship and the shore station, will take these messages and pass them on. Very great use is made of this "retransmission," as it is called, because, although apparently some delay occurs, actually time

is saved since the confusion and waste of time due to the repetition of portions of messages is avoided. The average speed of transmission is about 23 to 26 words per minute.

Whatever wave the operator is working on, he must break off and listen in on 600 metres at 15 minutes past and 15 minutes to each hour, for a period of three minutes. This, of course, is for distress messages, which are the only messages allowed to be sent out during these three minutes, thus ensuring that all ships at sea have certain times during which distress messages are free from jamming.

The Variety of Messages

The operator will probably have a bunch of messages for different ships which he will call up at specified times. There will also be press news to be received from both the English and American sides, and all the Stock Market quotations which are of particular interest to business men on the Atlantic route. All "press" is sent down to the printing office of the ship immediately it is received and is available in printed form for the passengers at breakfast.

Private messages which passengers wish transmitted form another large section of the traffic handled by the wireless operators. Because the charges vary with the different routes and coast stations through which messages are sent, as since ship charge, coast station charge and land line or cable charge have to be reckoned separately, these calculations are not always straightforward, especially as calculations have



Diagram showing how the strength of the received signal varies according to the position of the frame aerial

frequently to be made in American and Canadian dollars and in francs as well as in British coinage.

It is, however, in foggy weather or when the ship is approaching the coast, that the wireless operator's duties become more onerous. Bearings must be obtained at frequent intervals by means of the direction-

(Continued on page 142)

"Twelve Thousand" and "Carmen"

The Test Match Broadcasts

Holiday Talks

The News Bulletins

SINCE those early times when the B.B.C. relayed a speech at a dinner, the chairman of which had drunk more than he had eaten, no untoward incidents have occurred. I switched late the other night, however, to a foreign station, the announcer of which was either dead tired or dead—well, he sounded so funny, don't you know.

I wonder what would happen if one of our sober Savoy stalwarts sounded "funny."

There were two productions to which I had looked forward. One was *Twelve Thousand*, a play by Bruno Frank, adapted by John Watt, produced by Cecil Lewis, and acted by—well, we'll come to that. The other was excerpts from *Carmen*.

Now, the story of *Twelve Thousand* held me as an adventurous episode; but why, out of the wealth of stories we have, one hardly complimentary to this country should be chosen I do not know. The Americans remind us in film after film of the wonderful way they broke away from us. If any episode in English history is needed for the special privilege of broadcasting, I suggest we have something more to "uplift our hearts." Good heavens we need it! The acting, too, was mediocre.

As regards the excerpts from *Carmen*, this was a good idea because it is like taking the cream of an opera instead of having to listen to the whole thing which includes padding. Not a bad idea to extend this scheme to other operas. Unfortunately, the production itself was bad. Usually I pay compliments to the Midlands, but on this occasion the Birmingham Grand Opera Society, supported by the Midland Wireless Augmented Orchestra, must have been as disappointed as I was.

The whole production lacked the verve and brightness of Bizet's popular opera, and the production suggested insufficient rehearsing. The gentleman with the vibrato voice would have made a poor showing against a bull—unless he sung to it. I recognised the voice, which was quite good for ordinary ballads—but as a toreador—no.

It was the first time that I have switched off opera. I went over to the National programme and heard Ann Penn in her

WITHOUT FEAR OR FAVOUR

usual items. Extraordinary how the Houston Sisters can be mimicked so successfully and so often.

Major Faulkner knows the game of cricket pretty well, but is he the ideal broadcaster? He lacks the dramatic sense, and although I admire him in many ways, he is not the picturesque narrator needed for the broadcast of an important Test Match.

Why do the announcers read the racing announcements as if they were dictating to a class of school children? They are boring enough in all conscience to those who do not happen to bet. The slow, funereal manner in which they are read sometimes suggests that the announcer has backed a loser.

Gillie Potter is the type of comedian I term "manuscript" comedians. His talk was full of pointed funninesses.

The same evening Captain A. H. D'Egville also gave a talk. But why he was also included under the heading of vaudeville beats me. He was a mixture of A. J. Alan and Clapham or Dwyer (whichever is the silly one). D'Egville (he must excuse my omitting his military title) can be quite funny, but his remark on a question of passion—that he was so hot that his

clothes burst into flames—was neither funny nor in good taste.

It is curious that on most occasions when I have listened to the B.B.C. talks on holiday-making they have been about the beauties of travelling abroad. In these days of British Empire propaganda, why not keep these talks to the untold beauties of our own land? Sometimes, as I mentioned in the paragraph regarding *Twelve Thousand*, one forgets that we are listening to items provided by the British Broadcasting Corporation.

However, we must not forget to pay tributes to the alternative programmes, for, instead of listening-in to the half-hour of holiday-making in the Baltic, I switched over to Cardiff and heard the National Orchestra of Wales, with Mr. Leslie England as solo pianoforte, give us some good stuff.

A singer, truly a newcomer to broadcasting, in whom I was particularly interested, was Aileen D'Orme. If I remember rightly, Miss D'Orme appeared in *Chu Chin Chow*, and sang very nicely, too. She has a voice of purity and obviously likes singing.

John Morel, the baritone, who sang with her, is another artiste with whom I am not familiar, but who also did very well.

Quite the right sort of talk was Colonel G. D. Turner's "Seven Days' Hard Labour," although I recall that when I suggested a series of such talks it was explained by the amazing Talks Department that it was "too sordid."

The News Bulletin is as unbalanced as ever. There seems to be no understanding of what news happens to be of topical national interest, so that I was not surprised when we had to listen to parochial items about a horse show in Dublin or a parson's tea party, before hearing that young Peebles got Bradman out for 16. True, the announcer apologised for giving the news *after* the ordinary cricket items, but one has become so accustomed to the lop-sidedness of the news service that one was not at all surprised.

The announcer at Kosice (Yugoslavia) holds the record for the number of different languages used at the microphone. He speaks Serbian, Czech, Polish, Russian, Rumanian, Magyar, German, and French!



Dorothy Holmes-Gore in Cartoon



BRITAIN'S "FAVOURITE THREE"

FOR BATTERY OR MAINS
SIMPLE CONTROLS

THE history of "Britain's Favourite Three" is doubtless known to every AMATEUR WIRELESS reader, for it was owing to the keenness of readers that the first "Favourite Three" was introduced at the beginning of 1928.

There was at the time a discussion in amateur circles as to the best type of circuit to employ for general-purpose reception, and in order to arrive at a convincing conclusion, a ballot was held in AMATEUR WIRELESS with the object of deciding the favourite circuit for amateur work. "Choose your circuit" was the theme of the competition, which created lively interest and discussion and resulted in what was, at the time, one of the most efficient three-valve circuits possible.

In brief, the circuit was of the "det. and two L.F. type," with one valve resistance-coupled and the power valve transformer-coupled, and with semi-Reinartz type of aerial tuning. But now, in 1930, reception conditions are entirely different and there is a demand for a different type of circuit for general-purpose reception. Anyone who has worked an old-fashioned set, with two or three valves, will realise the shortcomings of circuits designed before the Regional scheme came into being.

The basic work put into the original "Favourite Three," however, has maintained its popularity right up to the present time, and it is only now being felt by owners of

conditions. It was with this idea in view that the AMATEUR WIRELESS Technical Staff decided to produce a new edition of

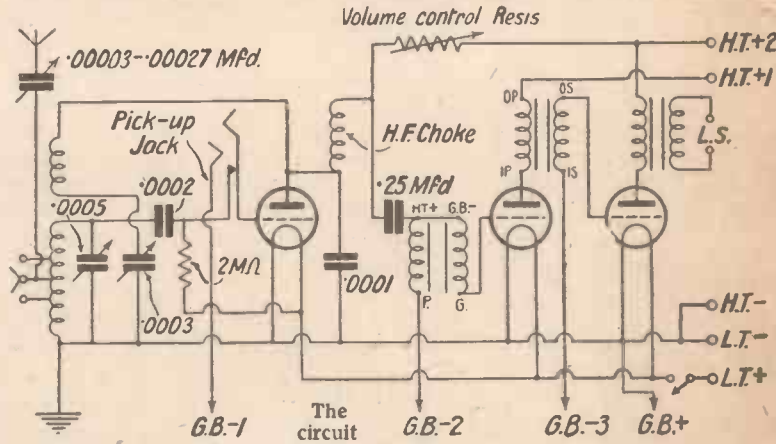

the ever-popular "Britain's Favourite Three."

Up-to-date Features

Not only does this new set constitute a distinct improvement upon the old "Favourite Three," but it embodies features which are not to be found in many other modern sets. This new "Favourite" is essentially a three-valver for the average man who requires, above all, reliable broadcast reception, the ability to get distant stations when required, without very difficult tuning; also the advantage of what may be termed "gadgets"—such as an efficient volume control; and the provision of a plug-and-jack arrangement for the pick-up is a desirable feature of any set.

—And the Old Set

Owners of the original "Britain's Favourite Three" can modify their receivers to conform to the new specification, and it must not be overlooked that this new set can also be made up by owners of any other type of receiver who are on the look out for something which really will give satisfactory results without great expense.

The Circuit

The working of the receiver can best be

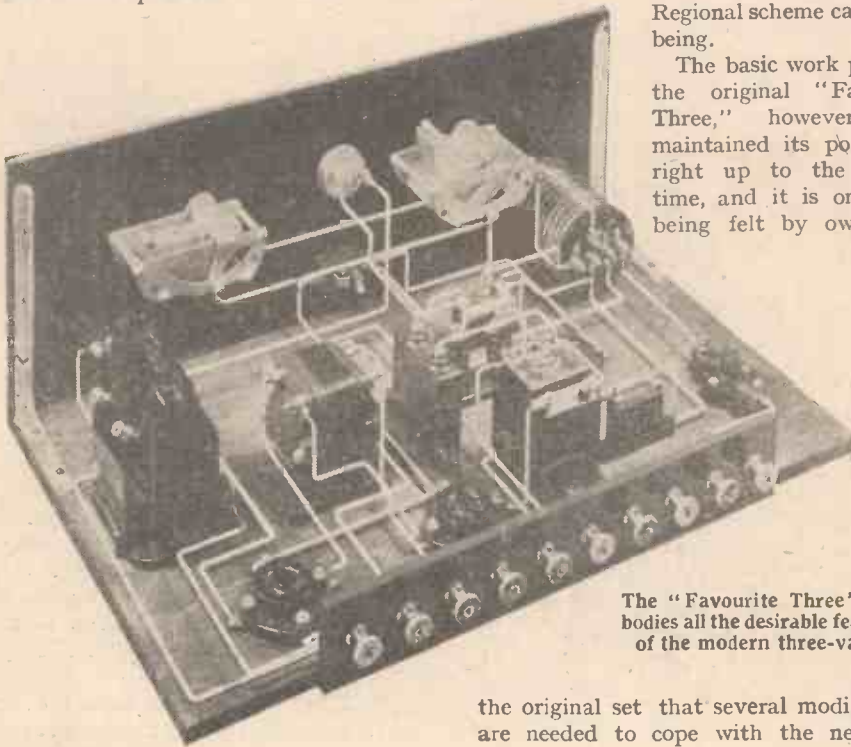

The "Favourite Three" embodies all the desirable features of the modern three-valver

the original set that several modifications are needed to cope with the new con-

"FAVOURITE THREE"

WORKING MODEL 1930 GRAMO-RADIO OUTPUT TRANSFORMER

Understood by examination of the theoretical circuit diagram. There are few people nowadays who cannot read a circuit

Dual Range

Of course, dual-range switching is incorporated and a notable feature is that the tapping of the aerial

to the coil is not disturbed when the wave-changing is brought into action. With some early types of dual-range coil this was the case, the tapping being put out of action on the long waves; but now it has been realised that selectivity is of equal importance, both on the medium and long waves, and the fact that

and a grid leak of the conventional value of 2-megohms. As this is a general-purpose set, it was not deemed advisable to use anode-bend rectification, for the number of instances where there would be risk of the grid circuit being overloaded (when the set is worked very close to a main station) is negligible.

Pick-up Connections

A feature is the connection of a pick-up jack in series with the grid of the detector. This, in itself, is quite an efficient arrangement, and the only point that should be watched is that the wiring to the jack must be well spaced so that there are no capacity losses; but this will be more fully dealt with when the constructional notes are given.

Just a word about the H.F. filtering, which, as has been shown by many set designers, is a most important feature. The H.F. choke is connected in series with the

COMPONENTS REQUIRED

Ebonite or bakelite panel, 18 in. by 7 in. (Becol).

Baseboard, 18 in. by 10 in. (Pickett, Camco).

.0005-mfd. variable condenser (Lotus, Lissen, J.B., Dubilier, Igranic, Burton, Formo, Polar, Ready-Radio).

.0003-mfd. variable condenser (Lotus, Lissen, Ready-Radio, Dubilier, Igranic, Burton, Formo, Polar).

Dual-range coil (Tunewell).

Push-pull filament switch (Junit, Lotus, Benjamin, Bulgin).

Variable resistance (Clorostat, "Volume" type; Atlas, Rheograd).

Pick-up jack (Lotus, type No. 2; Igranic).

Panel brackets (Bulgin).

Three valve holders (Benjamin, Lotus, W.B., Formo, Burton, Wearite, Lissen, Junit, Trix).

.0002-mfd. fixed condenser, with series clips (T.C.C., Lissen, Dubilier, Graham-Farish, Atlas, Watmel).

.0001-mfd. fixed condenser (T.C.C., Lissen, Dubilier, Graham-Farish, Atlas, Watmel).

.25-mfd. fixed condenser (T.C.C., Dubilier, Lissen, Hydra).

Pre-set condenser, capacity .00003 to .00027 mfd. (Igranic, Formo, Sovereign, Lissen, Polar).

Low-frequency transformer, ratio 4 to 1 (B.T.H., Cossor, Lewcos, Telsen, Varley, Ferranti, Igranic, R.I., Lissen).

Output transformer (Lissen, Varley, Igranic).

Special-core transformer (Varley Nicore II, Lotus, Lissen, Igranic, Burton).

2-megohm grid leak (Lissen, Dubilier, Ediswan, Graham-Farish).

Ten terminals marked: Aerial, Earth, L.T.+1, L.T.-1, G.B.+1, G.B.-1, G.B.+2, G.B.-2, H.T.+1, H.T.-1 (Ealex, Chix, Belling-Lee).

Connecting wire (Glazite).

diagram, but if you have any doubts about any of the points mentioned, then they can be allayed by reference to the wiring diagram and layout given on the next page.

One of the first things that the designers had to face was the need for exceptional selectivity, for the Regional scheme is spreading, and when the new Slaithwaite station opens there will be few folk who are not within wipe-out range of either Brookmans Park, 5XX, or the Northern Regional. Therefore, there is a growing vital need for knife-edge tuning, and this is effected in the new "Favourite" by the provision of a pre-set condenser in the aerial lead, and by the arrangement of an intermediate tapping of the aerial connection to the coil.

As was explained in an article on "damping" last week, the damping effect of the aerial is reduced when a connection is made at a point on a coil, and as one need not delve too deeply into technicalities, it may be taken for granted that a reduction of damping means an increase in the sharpness of tuning. With a well-designed coil, such as is used in this set, the tapping does not result in a drop in signal strength concurrent with the sharpening-up of tuning. Indeed, the sensitivity of the detector stage is well above the average.

Reaction is obtained in the conventional manner by means of a small extra winding apart from the aerial turns in series with a .0002-microfarad variable condenser.

Note the arrangement of an intermediate tapping on the aerial coil

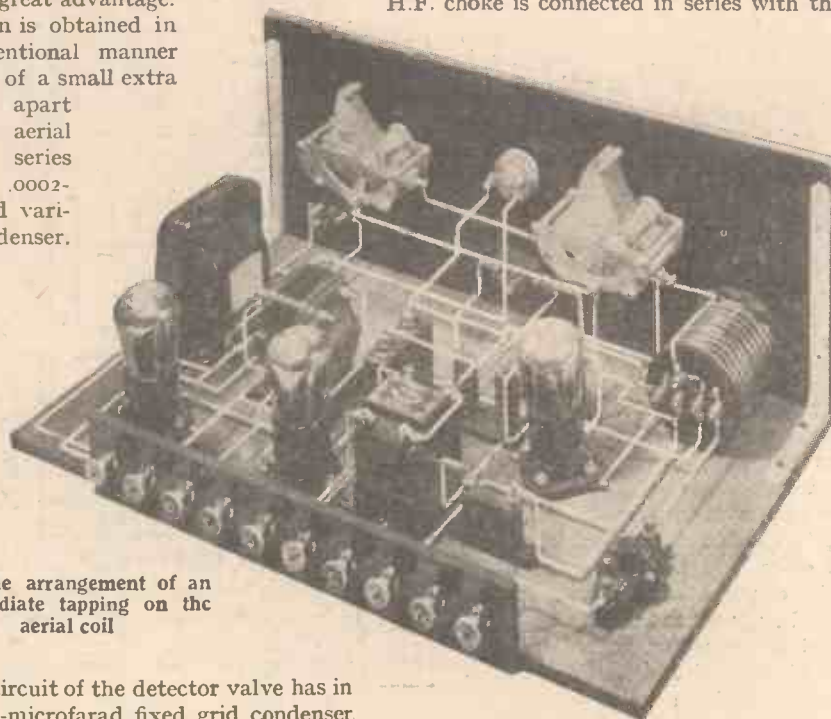

Note the arrangement of an intermediate tapping on the aerial coil

The grid circuit of the detector valve has in it a .0002-microfarad fixed grid condenser

“BRITAIN’S FAVOURITE THREE” (Continued from preceding page)

detector anode circuit (on the H.T. side), as is conventional, but, what is not general in some sets, and is therefore by its omission a mistake, is the provision of a .0001-microfarad by-pass condenser so that the H.F. component, which is stopped by the H.F. choke, can be by-passed to earth. It is unreasonable to provide a choke stopper and not to fit an alternative path for the H.F. currents.

The L.F. Side

The L.F. coupling to the first valve is worthy of special notice. A variable resistance is placed in series with the detector which serves as an L.F. stopper and also as a convenient volume control. From the anode side of this resistance a lead is taken through a .25 microfarad condenser to the L.F. coupler. This is a more efficient arrangement than placing the primary of the transformer in the detector anode circuit, when, of course, it has to pass the steady D.C. current; in this case the D.C. component passes through the variable resistance and the A.C. component has an easy path through the .25-microfarad coupling condenser to the L.F. coupler.

The power valve is, however, coupled to the first L.F. valve with a straightforward L.F. transformer arrangement. A good point is the use of an output transformer to the speaker. The reason for this provision is that so many set users nowadays wish to work an eliminator in conjunction with a set such as the new “Favourite Three,” and it is never advisable to place the speaker direct in the anode circuit when the mains supply is used for the H.T. The reason, naturally, is that when the speaker is directly connected, it is at a high D.C. potential above earth and there is always a possibility of getting a shock if the speaker terminals are accidentally touched. With the provision of an output transformer this is entirely obviated.

Simple Construction

Now, having made this brief survey of the major technical features of the “Favourite Three,” constructional work may be started. The set is arranged on such straightforward lines that no amateur should have any difficulty about making up the set from the photographs and layout plan given here. But as there may be some amateurs who are making up this “Favourite Three” as their first set, and who want to make quite sure that no errors creep into their constructional work, further details will be given next week.

All constructors would be well advised to work with the aid of the full-size blueprint which has been prepared for the “Favourite Three,” and which can be obtained, price 1s., post free, from the Blueprint Department, AMATEUR WIRELESS,

58-61 Fetter Lane, London, E.C.4. The wiring diagram given here is a small reproduction of this print, but the full-size blueprint is invaluable, because not only does it show all the wiring, but it gives all the drilling centres and shows all the components in their correct positions.

The components needed for the “Favourite Three” are not at all expensive, as will be gauged from examination of the components list given in an accompanying panel. It will be seen that in some cases alternative components are stated and these may be safely used, where the first mentioned parts (those used in the original set) are, from any reason, not obtainable, or where one or other of the alternatives is already at hand.

But please take good advice and do not use unspecified parts which, however good they may be in themselves, may not be suitable for the work in hand, and may not match up with the other parts in the receiver. Only set designers realise how essential correct matching is in a receiver, and constructors cannot take better advice than that they should follow the lead of the AMATEUR WIRELESS Technical Department which has spent several weeks in the

development and improvement of the new “Favourite Three.”

Readers who are making up the set from the photographs shown here will be interested in the test report and operating details to be given in next week’s issue.

In the meantime, it should be noted that the “Favourite” is on view in the windows of Messrs. Selfridge, Ltd., of Oxford Street, London, W.1. The Radio Department is in Somerset Street, which is at the back of the main Selfridge building and parallel with Oxford Street. All London readers should avail themselves of this opportunity to see the new edition of one of the most popular receivers that AMATEUR WIRELESS has ever produced.

Some difficulty is being experienced by the herring fleet fishing in northern waters in receiving the information relating to fishing which is broadcast from Aberdeen. The fishermen could receive clearly from Daventry, and it is understood that the Fishery Board for Scotland is in consultation with the B.B.C. as to the possibility of having these bulletins broadcast from Daventry as well as Aberdeen.

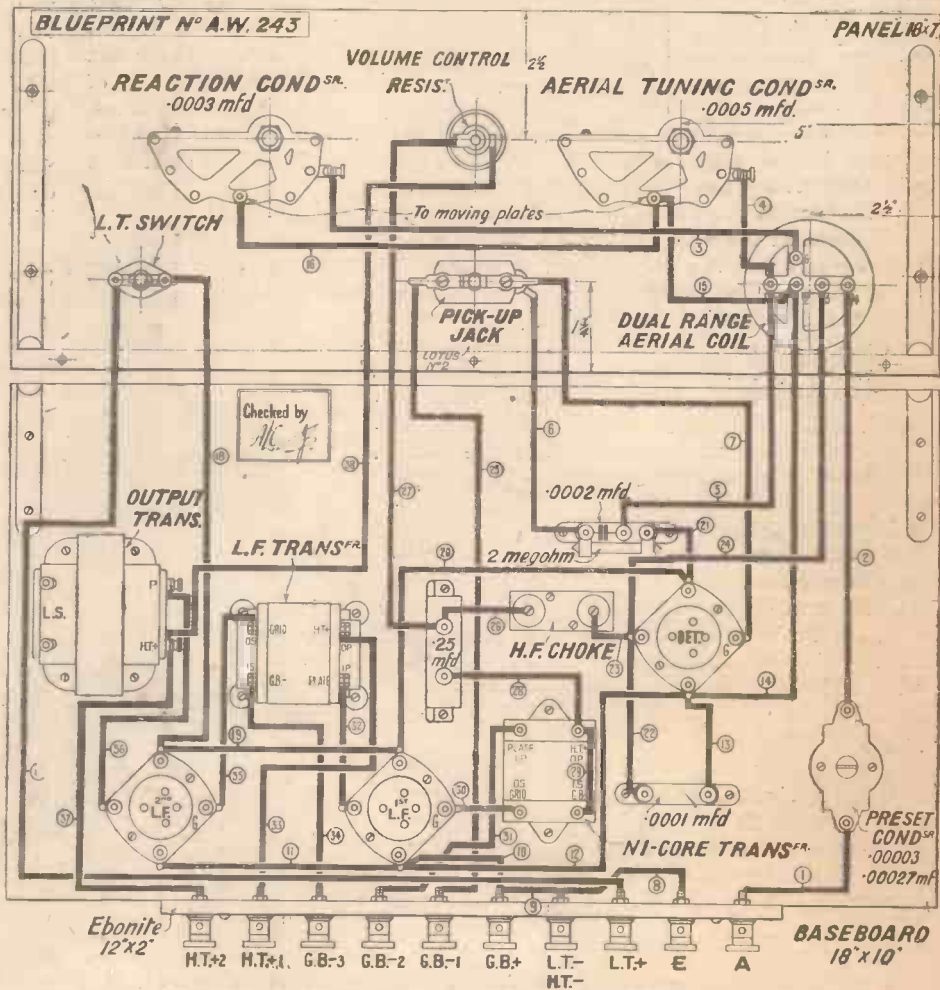

The wiring diagram. A full-size blueprint is available, price 1/-

TESTS OF TIME

That fine old London landmark..

... the Law Courts, has been standing since 1882—for 48 years! It has stood the test of time and is likely to go on standing it for a long, long time. T.C.C. Condensers too, have stood the test of time—and come through with flying colours. If you want your Set to be a success—you cannot disregard the condenser chosen by experts with such astonishing consistency. Ask for T.C.C.—“the condenser in the green case.” The condenser with a guarantee!



The condenser illustrated is 800 volt D.C. test. 400 D.C. working 8/6

THE LAW COURTS

ADVERT. OF THE TELEGRAPH CONDENSER Co. Ltd. N. ACTON W.3

5417

When buying Valves -Remember!

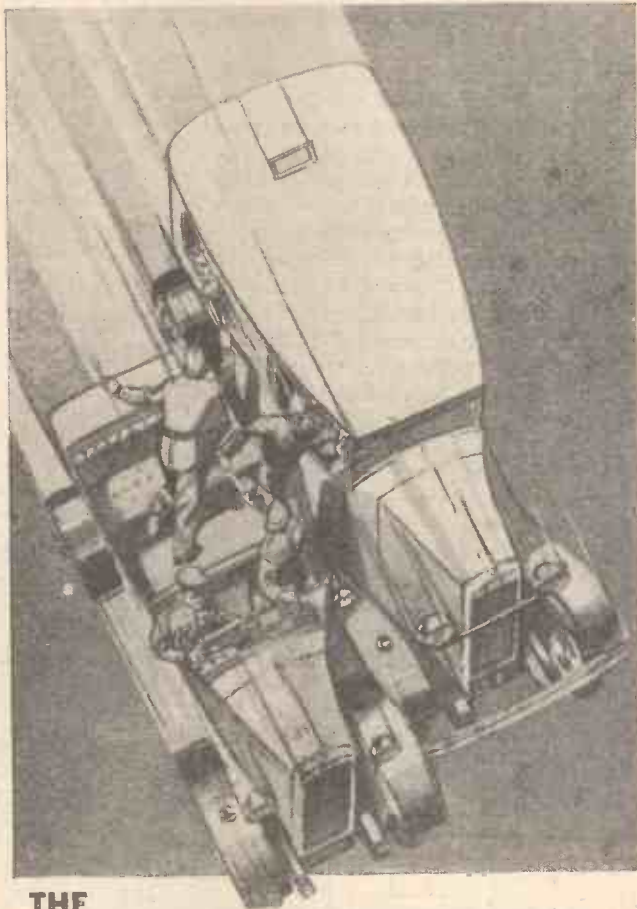

THE METROPOLITAN POLICE Imperial Airways, The B.B.C., Empire Wireless Communications, Trinity House Lightships & Beacon Stations, Croydon Control Tower, and Large Passenger Liners—all

USE

MARCONI VALVES

BUY THE VALVES THE EXPERTS USE



Mention of "Amateur Wireless" to Advertisers will Ensure Prompt Attention



Conducted by our Technical Editor: J. H. REYNER, B.Sc. (Hons.), A.M.I.E.E.

Osram PX4 Valve

TO operate a moving-coil speaker effectively is the aim of many readers who are interested in sound reproduction. Unfortunately, to obtain the best results more power is required from the output stage than can be handled by the average power or super-power valve. It is partly for this reason that the G.E.C. recently introduced a special power valve known as type PX4.

The characteristics of this valve are such that when used in the final stage of an amplifier it will operate a reasonably sensitive moving-coil speaker, whilst if two are placed in parallel or push-pull, sufficient volume is obtainable for use in a small hall. The filament consumption is 0.6 amp. at 4 volts, and the valve can be operated from L.T. accumulators or directly off the mains. The valve has just been improved in its characteristics, the impedance being rated at 1,050 ohms with an amplification factor of 3.5 and a maximum anode voltage of 200.

To ascertain the effectiveness of the valve at lower anode voltages we took the characteristics with a voltage of 120 on the anode. Under these conditions the

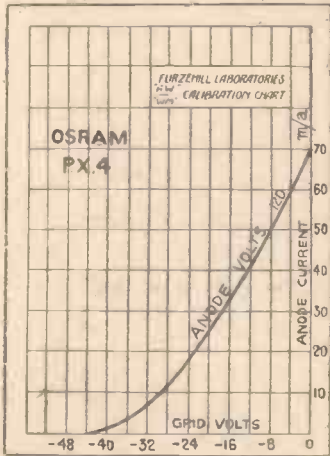

Curve of the Osram PX4 valve

impedance was 1,820 ohms, and the amplification factor 4.5. As can be seen from the curve, the correct value of grid bias lies between 16 and 20 volts, whilst the anode current is approximately 30 milliamps.

We have had previous opportunities of testing this valve in low-frequency amplifiers, operating the filament from accumulators or directly off the A.C.; in the latter case there has been no perceptible hum.

When the anode voltage is raised to 200 and the grid bias correctly readjusted, the undistorted power output is approximately 1,000 milliwatts, sufficient to operate our standard moving-coil loud-speaker at comfortable strength for a medium-sized room.

We have no hesitation in recommending this valve to those who require a high-power output, with moderate H.T. voltages.

Melbourne H.F. Choke

AN H.F. choke has become an indispensable part of a valve detector circuit now that its use is more fully appreciated; indeed, there is little so detrimental to the control and reproduction quality of a set than the unrestricted flow of H.F.

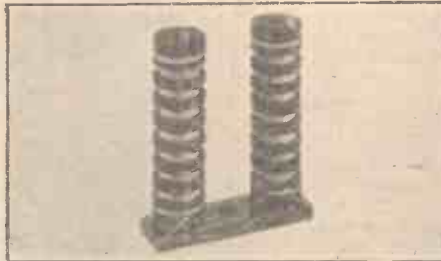

The Melbourne H.F. choke

currents into the low-frequency portions of the set.

The Melbourne H.F. choke, manufactured by Messrs. Melbourne Radio Supplies, is a component of distinctive design, in which attention has been paid to important details. Amongst other features, the external field has been reduced by placing the two halves of the winding in binocular form. A centre tap is provided in case a winding of smaller inductance is required.

Two air-spaced formers are used, in each of which six slots are cut. Such construction is partly responsible for the low self-capacity and the exceptionally good performance on the shorter wavelength band.

The very good performance on the shorter waveband from 200 to 600 metres will be evident, but, unfortunately, this is not maintained on the longer wavelengths, the performance factor at 1,600 metres being only 80 per cent.—a figure which, in our experience, is too low. The choke will work excellently on short and broadcast wavelengths.

Atlas L.F. Choke

MESSRS. CLARKE, manufacturers of Atlas components, have had considerable experience in eliminator work,

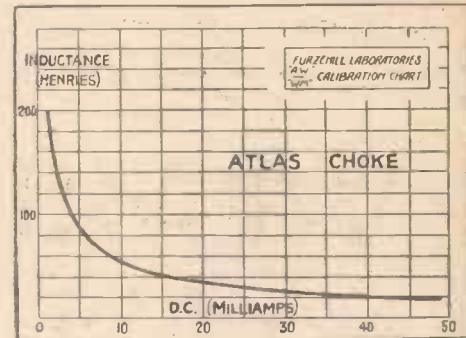

Inductance curve of the Atlas choke

and we were interested to test their latest product—a 50-henry choke.

This component is of generous construction, being clearly intended for heavy duty. It is obvious that no attempt has been made to economise in such details as the winding and the iron core, both of which are of ample dimensions. The ends of the windings are taken out to terminals mounted on a small ebonite strip at the base of the component. The inductance is rated at 50 henries; if, however, only a small D.C. current is handled, such as 1.5 milliamps, the value is actually 191 henries. At 10 milliamps this has fallen to 53 henries, and at 30 milliamps 28.6 henries. The D.C. resistance is 840 ohms.

One should obtain excellent results if this choke is used in such a circuit where the current through the winding does not exceed 5 milliamps, such as a detector circuit. The component is not operated to the best advantage if it carries more than 20 milliamps, and, therefore, for the output stage a different type, rated at a lower inductance value and capable of retaining the figure at high D.C. currents, should be chosen.

Joseph Mercado, a Spanish "radio fan," recently left Casablanca (North Africa) in an attempt to cross the Atlantic and to reach New York in a six-metre sailing boat. This small craft is equipped with transmitting apparatus and messages are sent out nightly in morse on 41.5 metres at 9.30 p.m. B.S.T. and again at 10.30 p.m. and at 5 a.m. on 36.5 metres. The call sign is XCNP.

Let "Amateur Wireless" solve your problems

THE LEADING COIL MANUFACTURERS FOR TEN YEARS—AND STILL THE FOREMOST IN DESIGN & QUALITY

To lead the field of coil manufacturers is an achievement. But to maintain that position for over ten years in face of fierce competition is a performance of which we are justly proud. The use of "Wearite" Coils and components assures the constructor's success in his work, as every "Wearite" product carries our guarantee of perfection. Once again "Wearite" Coils have been specified for the famous Talisman Coils in the "Talisman Two."

Dual Range TALISMAN COILS (Patent applied for)

Aerial	Range	Anode or H.F.
10/6	200-550 1000-1800	7/6

BINOWAVE COILS 1930 (Patent applied for)

A type Unit, Aerial	} 17/-
C or D type Unit, Anode	

Sole manufacturers under licence.

Wearite components are obtainable from all good radio shops.

H.F. BY-PASS UNIT 4/6 EACH

Write for free Illustrated List NOW.

WEARITE

COMPONENTS

WRIGHT & WEARE, LTD.

740, HIGH ROAD, TOTTENHAM, N.17

Telephone: Tottenham 3847/8.

342

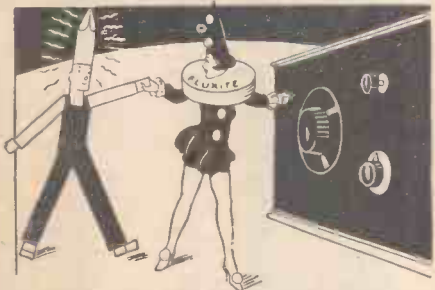

"We're Fluxite and Solder—The reliable pair, Famous for Soldering, Known everywhere! Wherever we go—We're invited to stay, For WE make Soldering Merely child's play!"

See that Fluxite and Solder are always by you—in the house, garage, workshop—anywhere where simple, speedy soldering is needed. They cost so little but will make scores of everyday articles last years longer! For Pots, Pans, Silver and Brassware; RADIO; odd jobs in the garage—there's always something useful for Fluxite and Solder to do.

ANOTHER USE FOR FLUXITE.

Hardening Tools and Case Hardening. A k for Leather on improved method.

FLUXITE SOLDERING SET.

Simple to use and lasts for years in constant use. Contains special 'small-space' soldering iron with non-heating metal handle; pocket blow-lamp, Fluxite, Solder, etc; and full instructions.

COMPLETE 7/6, or LAMP only 2/6.

FLUXITE LTD.,

(Dept. 326)

ROTHERHITHE, S.E.16

All Hardware and Ironmongery Stores sell Fluxite in tins, 8d., 1/4 and 2/8.

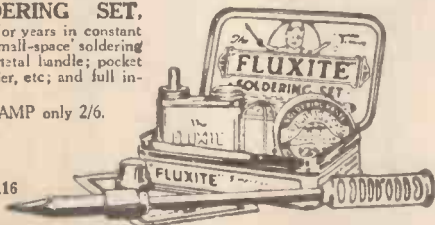

ALL MECHANICS WILL HAVE

FLUXITE

IT SIMPLIFIES ALL SOLDERING

Again Exclusively Specified!

TUNEWELL DUAL X-TAPPED COILS

for this year's

BRITAIN'S FAVOURITE THREE

Range :
190/570
950/2000
metres.



Price :
10/6 EACH
Complete with
3-point switch.

Send for lists describing the whole Tunewell range of Coils, Chokes, Transformers, Condensers, Cut-outs, Speakers, etc.

Remember our Speaker Unit was placed first for quality of reproduction in the recent "Wireless World" Speaker Unit tests.

TUNEWELL 3-VALVE SET

£3-19-6 complete, less valves, Royalty extra. Now ready. Logs 50 stations with ease. Specification includes above coil, Tunewell Choke, Transformer, Condensers, Dials, Cut-out, etc.

TURNER & CO.

54 Station Road, New Southgate, N.11

Advertisers Appreciate Mention of "A.W." with Your Order

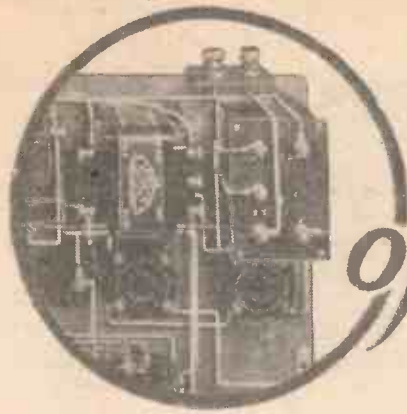

The IMPORTANCE of the OUTPUT STAGE

In this article W. JAMES shows how important is the correct design of the output stage if quality is to be obtained

THE output stage is, perhaps, the most important in a receiver. Its chief purpose is to turn the signals applied to the grid into power for driving the loud-speaker.

Actually, the last valve acts to vary the

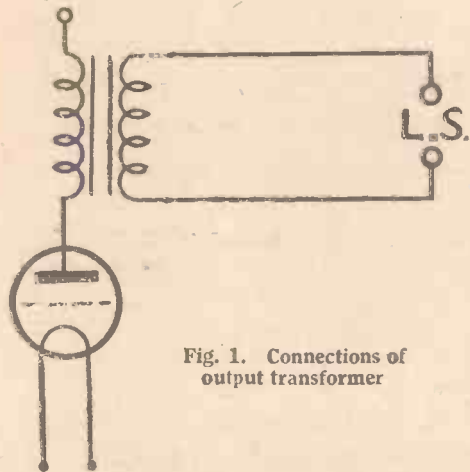

Fig. 1. Connections of output transformer

current flowing in the circuit. Thus, when there is no signal a steady current passes through the output transformer or choke and the valve. This current might be 10 milliamperes and the anode voltage 120, for a grid bias of -9 volts.

The Object of the Power Stage

When a signal is applied to the grid of the valve the bias varies about the normal value of -9 volts, and in a given case it might vary between the limits of zero and -18 volts. This varying grid voltage causes the current to vary with it, the current also changing between a maximum and minimum value. But as the varying current passes through the loud-speaker, the diaphragm is vibrated and sounds are heard.

The sounds will be greater as the driving power is increased. Power is proportional to the product of the change in current and the change in voltage across the loud-speaker.

The object of arranging a power stage is, therefore, to obtain the maximum of power output with the available input and with as little distortion as possible.

Now loud-speakers vary a good deal in their characteristics. One is naturally high-

pitched, whilst another is low-toned. Another type may have a marked resonance near the middle of its frequency range, and so on. Those who test a number of instruments using a nearly perfect set note these wide differences of tone, range of frequencies reproduced, and other peculiarities.

These differences are quite apart from power-handling capacities, one type overloading much before another.

With such a variable it is not to be wondered at that reproduction is seldom really good. Many people are, of course, quite satisfied with the quality of their own reproduction, but those who compare many sets and loud-speakers know only too well that what a user will call good quality is really quite poor, the user apparently not being sufficiently critical to detect even obvious faults.

Constant listening to a given set and loud-speaker, provided the reproduction is not harsh, does tend to make a user satisfied, but direct comparisons with other arrangements would reveal the defects.

Strictly speaking, the last stage ought to be considered as a whole—valve, high-tension supply, and the output circuit.

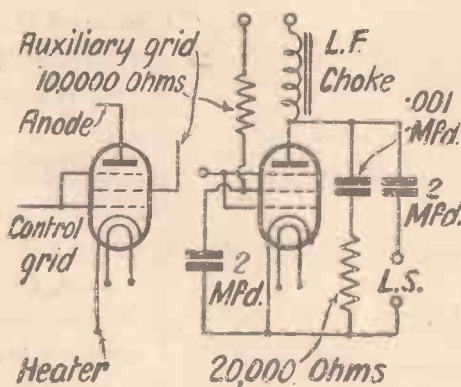

Fig. 3. Output connections of pentode

The maximum power output and minimum distortion is to be obtained when certain conditions are satisfied. One is the value of the impedance of the load compared with that of the valve. The load should usually have an impedance of twice the impedance of the valve at its working point. With a low-impedance output valve

the ordinary so-called high-resistance loud-speaker is suitable without a transformer. This is not true of valves of 8,000 ohms, however, and a transformer having a ratio of 1 to 2 or more may, with advantage, be used (Fig. 1).

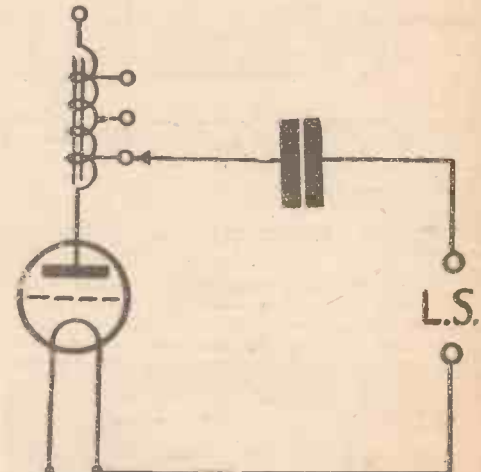

Fig. 2. Connections of tapped-choke output

A tapped choke is also of value here, being equivalent to a transformer in regard to the step-down effect. This component would be joined as indicated in Fig. 2.

Modern power valves are much more sensitive than older types. They have greater amplification factors for a given value of impedance. This means that a given amount of power output is to be obtained from a smaller input.

Less magnification is, therefore, needed elsewhere in the set to produce the full output. The new power valves are better in this respect. Quite large outputs are also to be obtained with not too high values of high tension.

With 200 volts and, say, 20 milliamperes, quite a good output suitable for driving almost any type of loud-speaker at good volume is to be obtained.

The pentode valve, with its peculiar characteristics, presents a more difficult problem for two reasons. One reason is connected with tone and the other with the maximum output to be obtained with safety. A pentode has a high impedance. Its amplification factor is also relatively

(Continued at foot of page 140)

DYNAPLUS AND PANASONIC COVERING THE WHOLE FIELD!

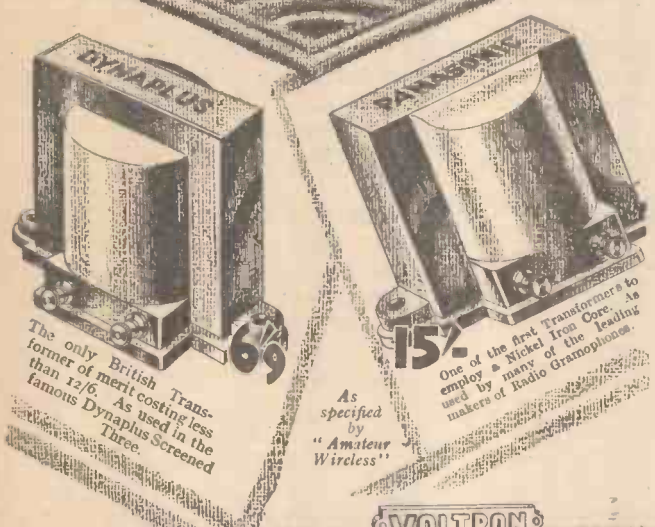

The only British Transformer of merit costing less than 12/6. As used in the famous Dynaplus Screened Three.

As specified by "Amateur Wireless" One of the first Transformers to employ a Nickel Iron Core. As used by many of the leading makers of Radio Gramophones.



BUILD THE DYNAPLUS 3 SCREENED COMPLETE KIT OF PARTS £3-12-9

In case of difficulty write to the manufacturers:
VOLTRON ELECTRIC LTD., QUEENSWAY, PONDER'S END, Middlesex

Find those distant stations

SPECIFIED IN THIS ISSUE

In the Watmel Binocular H.F. Choke, every detail in design has been carefully investigated with a view to obtaining the greatest possible efficiency in high-frequency work.

The Choke is of the inverted "V" windings type, having an extremely restricted field.

It is of very low minimum self-capacity, with special low-loss formers and terminals mounted on top.

Inductance always remains constant.

It is mounted on a moulded Bakelite base, and overall measures only 2 in. long by 2 1/4 in. high.



WATMEL 4/- BINOCULAR H.F. CHOKE Type DX2
Type DX 3 - 6/-

Send for our Folder No. A.85 showing you how to make up a fine loud-speaker; also folder and Blueprint for building a modern 3-valve set.

WATMEL WIRELESS CO., LTD.
Imperial Works, High Street, Edgware
Telephone: Edgware 0323



If you have any difficulty in obtaining Watmel products, write to us.

M.C. 8

H & B

KIT SERVICE FOR YOU

Britain's Favourite Three 1930

Kit contains only specified components together with Trelleborgs panel and strips ready drilled baseboard, wire, and FULL size Blueprint. (Valves, Mullard or Osram, 27/6 extra. Cabinet, 17/6 extra.) **Cash Price £5 0 0**

Easy Tune Short-Wave 2 H & B Full

Kit contains all that is necessary to construct this set together with New Type Polar Condensers and R.I. Hypermite Transformer, all specified parts, panel and strips drilled, baseboard and supports, wire, screws, and FULL size Blueprint. Included in this Kit, Set of Igranic S/W Coils covering 10-100 Metres. (1 Marconi or Osram Detector Valve, 8/6 extra. 1 Osram New Type Power P2, 13/6 extra.) **Cash Price £3 12 0**

Detailed lists sent upon request.

H & B RADIO CO., 34, 36, 38, Beak Street, Regent Street, W.1
GERRARD 2834

You MUST have the

"Wireless Magazine"

Every Month Price 1/-



A good item on any programme

Player's please

It's the Tobacco that Counts

N.C.C.899

SOLVES EVERY RESISTANCE PROBLEM

CLAROSTAT

THE CHOICE OF EXPERTS



VOLUME CONTROL

For many years the most popular volume control. Small. Neat. Inexpensive. Single-hole Fixing. Guaranteed noiseless. Wide resistance range of from 100 to 500,000 ohms, obtained in two-and-a-half turns of the knob, thus giving very gradual and precise adjustment.

7/6

Ample proof of the reliability of ClarOstat volume controls is afforded by the fact that they are specified again and again by technical experts for their "star" receivers. Once again the volume control is specified in AMATEUR WIRELESS.

This time for "Britain's Favourite Three, 1930"

CLAUDE LYONS, LTD.
76 OLD HALL ST., LIVERPOOL

LONDON OFFICES & SHOWROOMS:
40 BUCKINGHAM GATE, S.W.1

Postcard Radio Literature

"The Soul of Music"

"THE very soul of music" is the telling slogan which Celestions have adopted, and it is proved in print by the latest Celestion booklet which describes the whole range of the Celestion speaker family. And, of course, if you are interested in gramio-radio there is the Celestion-Woodruffe pick-up. **8**

"Sound" Advice

A deal of useful information on moving-coil speakers is contained in the "Sound Advice" booklet just produced by Bakers Selhurst Radio. You should have it at hand if you are contemplating making up, or purchasing complete, an M.C. speaker. **9**

A New Portable

Put down the Chakophone "Junior Five" portable receiver, made by the Eagle Engineering Co., Ltd., on the list of portables that you must consider before finally selecting one for outdoor use. The Chakophone set has many convincing points in its favour (low price is one feature) and it is fully described in a leaflet available. **10**

Popular "Juice Boxes"

"Juice box" is an Americanism which has come to be applied particularly to mains eliminators. But don't confuse the term with "power boxes," which are a handy means of combining many mains components in one shielded case, as is done in the new Regentone power boxes. I have just been glancing through the latest Regentone folder dealing with these. **11**

Tungram Valves

Every valve user should have the new Tungram booklet, which gives details of the whole series of Tungram Barium valves. A.C. valve users will be particularly interested, for Tungram's make a good A.C. range. **12**

OBSERVER

GET THESE CATALOGUES FREE.

Here "Observer" reviews the latest booklets and folders issued by well-known manufacturers. If you want copies of any or all of them FREE OF CHARGE, just send a postcard giving the index numbers of the catalogues required (shown at the end of each paragraph) to "Postcard Radio Literature," "AMATEUR WIRELESS," 58-61, Fetter Lane, E.C.4. "Observer" will see that you get all the literature you desire.

"THE IMPORTANCE OF THE OUTPUT STAGE" (Continued from page 138)

high. The valve is, therefore, sensitive, providing a large output for little input. At the same time, owing to the fact that the combined impedance of the anode circuit, including the valve and loud-speaker, is high and fairly constant, there is a tendency for the high notes to be reproduced much too strongly with ordinary loud-speakers.

A pentode cannot, therefore, be considered as an ordinary valve and must, indeed, be carefully treated. For example, the loud-speaker should not be disconnected without first removing the high tension. Neither should the anode circuit be broken whilst the auxiliary grid circuit of the valve is connected.

Failure to observe these points will eventually result in the pentode being destroyed, either through overheating or voltage breakdown. Heavy currents and high voltages are likely to be present when the valve is not properly used. A suitable output load for a pentode is but a fraction of its normal impedance. In the case of the Mazda AC/Pen, for example, a suitable load is of the order of 9,000 to 10,000 ohms. This valve may be used with a high tension of 250 and an auxiliary grid voltage of 200. The grid bias is -10.5, the best load 10,200 ohms, and the maximum undistorted power output is 1.4 watts. At 250 volts H.T., 200 volts auxiliary grid and -10.5 volts grid bias, the anode current is about 28 milliamperes

An output of 1.4 watts is considerable and would usually be considered more than ample for ordinary purposes. The connections are indicated in Fig. 3. Owing to the high efficiency of the valve it is necessary to de-couple the circuits very carefully or howling may occur. A filter, too, is usually needed to reduce the relative strength of the high notes and suitable values are suggested in the figure shown on page 138.

It is a good plan to employ the highest possible voltages with output valves, not over-running them, of course, but keeping within the limits imposed by the makers. Do not overlook the drop in voltage in the output choke, as this may be considerable, and, above all things, use parts well within the necessary rating. An output choke may saturate; therefore use one of ample size and of suitable inductance.

The filter condenser in the output filter should be a high-voltage one, as its working voltages are in excess of the normal value of high tension. A breakdown here would be serious, involving almost a short circuit of the high tension.

It is better as a rule to use a little too much rather than too little bias. This point is fairly easily decided by practical tests. No power valve should ever momentarily be used without grid bias, as the anode current may take up a large value. This may so heat the valve that it is softened and thus rendered useless

RAYMOND'S

27 & 28a, LISLE ST., LONDON, W.C.2

Come to LEICESTER SQUARE TUBE STN.
Note New Phone Number: GERRARD 2821

BRITAIN'S 1930 FAVOURITE THREE SET

Complete Kit of Parts as specified by "Amateur Wireless" in this issue. Packed and sent Carr. Paid, with Blueprint, for **£3.12.6**

STRAIGHT TWO CIRCUIT

Full details of Parts, Etc., see "A.W." 2/8/30. Complete Kit, Carriage 2/6 extra. **25/-**

STRAIGHT THREE KIT

Complete Kit of Parts, full details in "A.W." 2/8/30. Sent to you ready for wiring. Packing and carriage 3/- extra. **35/-**

CONTINENTAL PORTABLE SET

Complete Kit of Parts as specified. With Cabinet of special design. Carriage Paid, for **£3.10.0**

TALISMAN TWO 1930 MODEL

Complete Kit of Parts as specified by "Amateur Wireless." Complete with handsome Oak Cabinet. Sent Carriage Paid, for **£2.10.0**

IMPORTANT. All letters and communications must be addressed to
K. RAYMOND, LTD.
27 & 28a LISLE STREET, LONDON, W.C.2
The name of the street is not sufficient.



BY special permission of the author, *Strife*, one of John Galsworthy's greatest dramas, will be broadcast next October. Other plays to be revived during the autumn will include *R.U.R.*, with its accompaniment of curious mechanical sounds; *Beggar on Horseback*, a clever satire on American habits and customs; Henry Arthur Jones's greatest success, *The Silver King*; and Shakespeare will be represented by *The Winter's Tale*.

Radio Alger (Algiers) has transferred its studio to an art gallery in that city, and it is from the new building that the main musical broadcasts are now heard. The station is installing land-line connections to the principal theatres, music-halls, cabarets, and restaurants of Algiers, and relays from these places of entertainment will be carried out regularly from the end of September next.

A talk by Colonel Charles A. Lindbergh on "International Aviation" will be relayed from New York in the National programme on August 8.

Fireside, an L. du Garde-Peach skit consisting of an "impossibly possible conversation," will be found in the London Regional entertainment down for transmission on August 11. It will be heard by National listeners on August 13.

On August 31 the B.B.C. will relay a concert from the Kursaal at Ostend. The entertainment will also be taken by Brussels No. 1.

The B.B.C. officially states that there is no foundation in the rumour that it is proposed to close down the Daventry National long-wave transmitter when the regional scheme is completed. Such a step has never been contemplated.

Wireless pirates are still being run to earth in Edinburgh. Three offenders who were brought to court there recently each got off, however, with fines of 10s.

A new wireless telephony station destined to connect the island of Sardinia with Italy has been opened at Golfo Aranci. It is the first of its kind to be installed, and will permit two-way communication with any part of the Continent and even with the transatlantic telephony service.

The week of the Radio World's Fair, to be held in New York, September 22 to 27 this year, has been reserved by radio associations as "National Radio Week."

U.S. amateurs, who have in the past

materially aided in the transmission of messages during times of emergency, are now being organised by the Navy Department. Some 2,300 amateurs are now enrolled in the radio division of the Naval Reserve and will receive full instructions on the handling of emergency communications. A plan has been worked out whereby a complete network of amateur stations will be established throughout the United States.

The Fire Department of New York City has just been granted a construction permit to instal a 125-watt transmitter in Brooklyn for emergency fire service with boats in New York Harbour.

About half of the farms in Iowa, U.S.A., are equipped with radio sets, according to a survey by the U.S. State Department of Agriculture. The total is 97,286, and the average is one for each 2.14 farms.

Broadcasting stations owned by religious institutions in the United States are gradually yielding their places to commercial interests. In recent months no less than seven church stations were sold and the transfer of their licences ratified by the Federal Radio Commission.

Broadcasting stations 100 miles from the American coast are exempt from the order to close down at the sound of an SOS.

Contrary to previous reports, it is now officially stated that the Bayreuth Wagner Festival performances in August will not be relayed to any broadcasting station.

A second Italian short-wave station is under construction at Turin; it will take the Milan and Turin programmes. Arrangements are also being carried out for a regular series of picture transmissions. The wavelength will be in the immediate neighbourhood of 80 metres.

It is stated that Roumania has provided an antidote to the Bolshevick wireless propaganda by building a "jamming" station. This is set into operation whenever the Russian station begins to broadcast in the Roumanian language and renders their messages unintelligible.

It is stated that the cost of wirelessing a complete newspaper page to a ship at sea is now about £130. It is recalled that the s.s. *America* successfully received a portion of a newspaper page sent through short-wave station WIZ at New Brunswick, N.J., when 2,310 miles from New York on her recent trip to Bremen.

Success is assured!

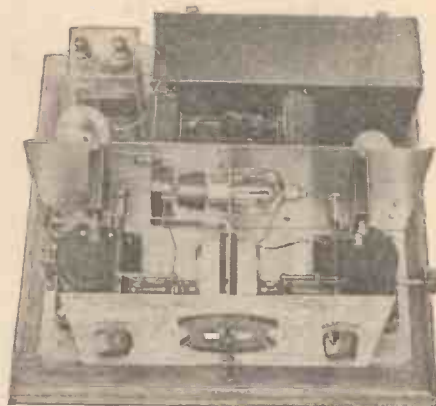

Build the Lotus S.G.P. Battery Set

The success of a set depends on the efficiency of each individual component. The Lotus S.G.P. Battery Kit uses the famous Lotus Components, each one of which works in complete harmony with its neighbours. This remarkably efficient 3-valve set is simple to build: all the main components are already mounted in position to save you time and to ensure success.

Full diagrammatic details supplied with each Kit.

Price: £7-12-6 (excluding valves, cabinet and batteries), or 14/9 down and 11 similar monthly instalments.

Full details on request.

LOTUS

3-VALVE SET KIT

Garnett, Whiteley & Co. Ltd.
(Dept. A.W.9)

Lotus Works, Mill Lane, Liverpool

Caution

Adapt Your Set for A.C. Valves Using Existing Sockets

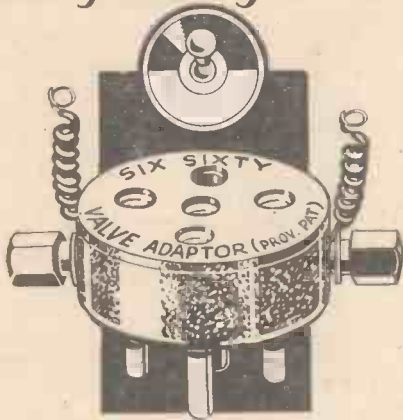

Just plug in SIX-SIXTY 5-4 pin Valve Adaptors into existing sockets, connect up the attached leads to the 4-volt A.C. of your mains drive and your set is converted from D.C. to A.C. Or use our 4-5 pin Adaptor and convert from A.C. to D.C. Modernise your present set this easy way—USE SIX-SIXTY VALVE ADAPTORS. Price 1/6 and 2/- each.

SIX-SIXTY VALVE ADAPTORS

Made by the makers of the famous Six-Sixty Valves Six-Sixty Radio Co., Ltd., Six-Sixty House, 17/18 Rathbone Place, Oxford Street, W.1 Telephone: Museum 6118/7

EVERYMAN'S WIRELESS

By Ernest H. Robinson (5 Y.M.)

A handy book telling in plain, non-technical language all that the average man needs to know about Wireless.

CASELL'S 3/6 net

A WARNING SIGNAL for 2/6

As fitted to all modern receiving sets. No more going to bed and leaving the set on all night, once this useful Gadget is fitted. L.C. Bulbs 6d. extra. A. F. BULGIN & CO., LTD. 9-10-11 Cursitor Street, Chancery Lane. London, E.C.4

BROADCAST TELEPHONY

Broadcasting stations classified by country and in order of wavelengths. For the purpose of better comparison, the power indicated is aerial energy.

Table with columns: Metres, Kilo-cycles, Station and Call Sign, Power (Kw.), and Station and Call Sign. It lists broadcast stations across various countries including Great Britain, Germany, France, and others, with their respective frequencies and powers.

“LIFE IN A WIRELESS CABIN AT SEA”

(Continued from page 130)

finding apparatus and at these times much of the normal traffic working must be suspended.

The procedure when taking bearings is rather interesting and requires a considerable degree of skill. The operator first asks the station from which the bearing is required to send continuously, for three or four minutes, some easily recognisable signal, such as its own call sign. He then tunes this signal to suitable intensity on the direction-finding receiver and then, by swinging the wheel shown in the left of the photograph, revolves the direction-finding

aerial above the cabin. The wheel, of course, is calibrated to 360 degrees. When revolving the aerial, the signals vary in intensity according to the direction of the aerial with respect to the transmitting station and the operator carefully notes the settings of the wheel at which the signal dies completely out and when it can just be heard again. The mid position between these two settings gives the direction of the station sending the signal. It might, of course, indicate also the exact opposite direction as will be made clear from the diagram, but by means of special apparatus, known as the “sense” switch, it can be ascertained on which side the transmitting station lies.

Bearings so obtained are, of course, only relative bearings and the true bearings obtained by instantaneously reading the compass above the instrument and making calculations from these two figures.

It might be thought that the duties already outlined are quite sufficient to keep the wireless operator out of mischief while at sea, but they by no means end here, for the whole of the gear must be kept in good working condition by the operators (the illustration shows that there is plenty to look after), and all breakdowns at sea must be speedily diagnosed and repaired. In addition there is always one and often two life-boat transmitting and receiving sets to be kept in perfect condition for use

at any moment. It will thus be seen that the operator's four hours of duty are very fully occupied in sending and receiving on continuous wave, changing over and working on spark, D.F. working and often nowadays working on the ultra short waves (26 to 32 metres).

We are indebted for permission to publish photographs of the *Transylvania* and her wireless gear to the Anchor Line (Henderson Bros.), Ltd. The *Transylvania* uses Mullard valves, both for the transmitting and receiving equipment. During the recent historic flight of the aeroplane *Southern Cross*, piloted by Major Kingsford Smith, she was able to play an important part in giving the *Southern Cross* her bearings.

Letters to the Editor

Correspondence should be brief and to the point and written on one side of the paper. The Editor does not necessarily agree with the views expressed by correspondents.

The Loftin-White Circuit

SIR,—In your issue of July 12 you publish particulars of the Loftin-White circuit. The basic principle of this circuit as described by you would appear to be the invention not of Messrs. Loftin-White, but of Major C. E. Prince, O.B.E., M.I.E.E. The coupling of valves through a battery and resistance known as Prince's "trigger" circuit was published in the technical press about four years ago, and at that time created a good deal of interest.

The arrangement for providing automatic bias is, so far as I am aware, novel, but has nothing to do with what you call the element of the Loftin-White system, and which is actually Prince's "trigger" circuit.

I think you will agree it is only fair to a distinguished English radio engineer to give credit where it is due.

J. N. B. (Shepperton).

"Without Fear or Favour"

SIR,—Mr. Moseley has earned at least three pats on the back from me. Firstly, for reminding the B.B.C. that listeners expect to hear the B.B.C. Dance Band occasionally instead of the rubbishy makeshifts that we have had of late; secondly, for his little *strafe* of the dreadful dirge-like ballads that spoil the otherwise excellent quintet and sextet programmes; and, thirdly, for pointing out that vaudeville hours are not the place for things like "The Everlasting Club" and high-brow musicians.

If he would only say what the average listener thinks of the high-brow vaudeville and the famous imitation of the Toulouse interval signal I would forgive him even his campaign against the *claque*. But I was forgetting: "A.W." is a respectable

paper, and is not printed on asbestos; so I fear our real feelings about these time- and power-wasting things must remain bottled in our breasts.

A. R. L. P. (Exeter).

"Does Over-biasing Pay?"

SIR,—I am very interested in Mr. Reyner's article in the issue of July 5, "Does Over-biasing Pay?"; but I should be glad if he could enlighten me on one point. He states that, using a Mazda P240, the recommended grid bias is -15 volts when the H.T. anode voltage in use is 120 (giving anode current of about 6 milliamps).

According to the pink paper enclosed with my Mazda P240, the recommended grid bias is as follows:—

A. 125 volts. 150 volts.

Bias -9 to 10.5 . -12 to 13.5 .

The instructions also say that the anode current for working should be steady at between 10 to 15 milliamps—not 6 milliamps, as shown by Fig. 2 at P.

K. M. Q. (Westgate-on-Sea).

[The original article is not quite clear on this point. The bias of -15 volts was recommended by the manufacturers of the particular set, and my point was that this differed considerably from the valve-maker's rating. The normal bias of -10 volts gives the operating point ν in Fig. 2, at which the anode current is 13 milliamps, and, as is pointed out later in the article (page 20), this condition gives us nearly as much power output, despite the reduced grid swing (10 volts as against 15). If one is able to limit the input to 10 volts and is prepared to accept the increased anode current, the valve-maker's figure for grid

(Continued on next page)

READ THIS:—

"There is everything in favour of buying a complete kit of parts and nothing against it. You get all the little items, such as screws, etc., and your panel is neatly drilled for you. Moreover, you are certain that every component is suitable for the set—that is if you purchase an approved kit such as is sold by Ready Radio."

vide "Popular Wireless."

KITS OF PARTS

CONTINENTAL PORTABLE
BRITAIN'S FAVOURITE THREE 1930
MAXIMUM FOUR
1930 TALISMAN TWO
GRAMO-RADIO TWO
ETC., ETC.

Cash or Easy Terms. Lists on Application

Ready Radio

159 BOROUGH HIGH STREET,
LONDON BRIDGE, LONDON, S.E.1

'Phone: HOP 5555 (Private Exchange)

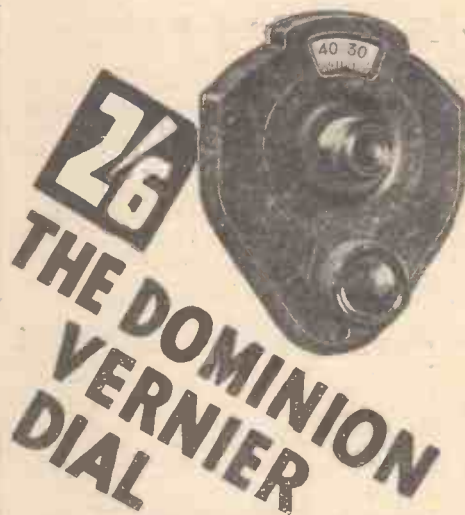

Only Brownie's huge production enables them to offer this really splendid dial for 2/6. The special non-backlash design makes hair-breadth tuning a matter of delightful ease, while its handsome appearance (black or beautifully grained mahogany bakelite) will add to the good looks of that new set you are building.

BROWNIE WIRELESS COMPANY (G.B.) LIMITED,
NELSON STREET WORKS, LONDON, N.W.1.

BROWNIE

WIRELESS

"LETTERS TO THE EDITOR"

(Continued from preceding page)

bias is to be preferred. For economy of operation, the grid bias may be increased to -15 with little loss of quality.—J.H.R.]

The "James Quality Five"

SIR,—While trying out my "solution" of the "James Quality Five" recently I had the unique experience of listening to a thunderstorm being broadcast (unintentionally) from a long-wave station, not yet calibrated. During an interval between band pieces the atmospherics caused by the lightning were very loud, three crashes causing vibration of the furniture; people talking and the cry of a child were also plainly heard.

The set is really a marvel and the results a revelation; power, quality, and distance being just great.

The possibilities of the set are remarkable, too; my aim is to run it as either the five, a straight three only, or with pick-up, and also to put a short-wave first stage in front of the last three.

Please convey my congratulations to Mr. James.—G. A. Y. (Brentwood).

"Amateur Wireless and Radiovision." Price Threepence. Published on Thursdays and bearing the date of Saturday immediately following. Post free to any part of the world: 3 months, 4s. 6d.; 6 months, 8s. 9d.; 12 months, 17s. 6d. Postal Orders, Post Office Orders, or Cheques should be made payable to "Bernard Jones Publications, Ltd."

General Correspondence is to be brief and written on one side of the paper only. All sketches and drawings to be on separate sheets. Contributions are always welcome, will be promptly considered, and if used will be paid for. Queries should be addressed to the Editor, and the conditions printed at the head of "Our Information Bureau" should be closely observed. Communications should be addressed, according to their nature, to The Editor, The Advertisement Manager, or The Publisher, "Amateur Wireless," 58-61 Fetter Lane, London, E.C.4.

The Secret of its PERFECT CONTACT

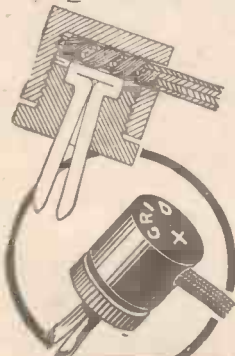

The Powerful grip of the Belling-Lee Wander Plug and its adaptability to any size battery socket are due to the long prongs made of special spring metal.

15 Engravings, side entry. Wire, rubber and braiding firmly gripped.

Write for Belling-Lee Handbook "Radio Connections."

Price 3d.

7-way Battery Cord with Belling-Lee Wander Plugs and Spade Terminals for Orgola and other sets 5/9

BELLING-LEE
FOR EVERY RADIO CONNECTION

Advt. of Belling & Lee, Ltd., Queensway Works, Ponders End, Middlesex

TELEVISION COMES ON THE STAGE

LIFE-SIZE demonstrations of television were given on the stage of the London Coliseum last week, this being the first time that the general public has had the opportunity of seeing Baird television apparatus in action.

A ten-minute programme emanating from the Baird studios in Long Acre, a quarter of a mile from the Coliseum, was presented three times a day on the stage by means of the new "half-tone" lamp screen which is being used by the Baird engineers. An announcer on the stage was in telephone touch with the transmitter, and it was shown how questions asked by the audience could be answered by the subject being televised. There should be great scope for showmanship in this.

From a technical point of view the first demonstration, which was witnessed by an AMATEUR WIRELESS correspondent, was fairly satisfactory, the "wandering" of the image (as when a cinematograph film goes out of frame) being infrequent and the flicker only slightly more pronounced than is the case with standard Baird apparatus.

A Lamp Screen

The screen shown on the stage measured 5 ft. by 2 ft. and was composed of 2,100 small peanut-type lamps capable of being switched on and off by a huge commutator. At a reasonable distance from the apparatus the persistence of vision and the familiar half-tone effect result in a continuous moving picture forming from the switching on and off of the lamps in regular patterns. The individual dots cannot be seen easily, and the greater light intensity of the small bulbs over that of a neon lamp helps to form a satisfactory picture.

It will be recalled that this screen system is similar to that used on occasions by the Bell engineers in America, the difference being that the Bell screen is one continuous length of neon-filled tubing folded to form a plane, and the light spots are caused by varying voltages on 2,500 metal contacts at points along the tube.

At the first demonstration at the London Coliseum our B.B.C. critic, Mr. Sydney Moseley, appeared on the television screen and introduced the artistes, including Miss Irene Vanbrough and Bombardier Billy Wells. Later, questions were put to Mr. Moseley, and he was asked to perform simple movements, such as to shake his head, hold up his hand, and put out his tongue—which latter he reluctantly did after being assured that there really was a medical man in the audience who wished to perform a radio diagnosis!

It remains to be seen whether the public will like television in its present early stage of development. At least one lesson learned is that movement is essential to make a television programme interesting, and that a side-face televises better than a full-face.

PREPAID ADVERTISEMENTS

Advertisements under this head are charged THREEPENCE PER WORD, minimum charge THREE SHILLINGS.

DEPOSIT SYSTEM

As the Publishers cannot accept responsibility for the bona fides of advertisers in this publication, they have introduced a system of deposit which it is recommended should be adopted by readers when dealing with persons with whom they are unacquainted. It is here explained. Intending purchasers should forward to the Publisher the amount of the purchase money of the article advertised. This will be acknowledged to both the Depositor and the Vendor, whose names and addresses must necessarily be given. The deposit is retained until advice is received of the completion of the purchase, or of the article having been returned to and accepted by the Vendor. In addition to the amount of the Deposit, a Fee of 6d. for sums of 1 and under, and 1s. for amounts in excess of 1, to cover postage, etc., must be remitted at the same time. In case of persons not resident within the United Kingdom, double fees are charged.

The amount of the Deposit and Fee must be remitted by Postal Order or Registered Letter (Cheques cannot be accepted), addressed to

"AMATEUR WIRELESS,"
ADVERTISEMENT DEPARTMENT,
58/61 FETTER LANE, LONDON, E.C.

DECORATE YOUR LOUD-SPEAKER YOURSELF! Transfers giving painted effects on Fabric, Wood, Metal etc. Sample and catalogue 1/- A.W., Axon Ltd., Jersey England.

SOLDER, specially prepared for radio joints, 2ft. strip; 6d., post free.—C. O. Pattison, 548, Shields Road Newcastle-on-Tyne.

COMPLETE KITS.—All Circuits. C.O.D. or Terms—R.I.B., 33 Maroon Street, London, E.1.

PHILIPS MODEL 2514 Three Valve Electric Receiver 200 volts, for sale. Nearly new. £15. Refer 8 Eato Square, S.W.1 (Sloane 7182).

TECHNICAL INSPECTORS (spare time) required in every town U.K. to service sets on commission basis. Write qualifications, credentials, present occupation to Service Box 110.

EXPERIMENTAL SURPLUS. Motor Generators, Amplified components and wireless sundries, cheap, state your requirements or list sent free. Harger, 3 Darnley Road Hackney, E.9. Amhurst 1842.

EASY TERMS

We SPECIALISE in the supply of all Good Quality Radio Sets, Components and accessories on Easy Terms. We will give you efficient service. Send us your list of requirements and a quotation will be sent by return.

LONDON RADIO SUPPLY COMPANY
11 Oat Lane, Noble St., London, E.C.2

NATIONAL 1977

DX THE STANDARD PLUG-IN COIL
Sold everywhere from 1/-
DX COILS Ltd, London, E.8

When Asking Technical Queries

PLEASE write briefly

A Fee of One Shilling (postal order or postage stamps) must accompany each question and also a stamped addressed envelope and the coupon which will be found on the last page. Rough sketches and circuit diagrams can be provided for the usual query fee. Any drawings submitted should be sent on a separate sheet of paper. Wiring plans and layouts cannot be supplied. Queries cannot be answered personally or by telephone.

Amateur Wireless

COUPON

Available until Saturday
AUGUST 16, 1930

FULL-SIZE BLUEPRINTS

EACH BLUEPRINT SHOWS THE POSITION OF EVERY COMPONENT AND EVERY WIRE, AND MAKES CONSTRUCTION A SIMPLE MATTER.

WHEN ORDERING, PLEASE SEND A POSTAL ORDER, NOT STAMPS, TO BLUEPRINT DEPT., "AMATEUR WIRELESS," 58/61 FETTER LANE, LONDON, E.C.4

CRYSTAL SETS

All these 6d. each, post free.

B.B.C. Brookman's Park Set	AW206
Regional Crystal Set	WM176

ONE-VALVE SETS

All these 1s. each, post free.

B.B.C. Official One	AW208
A.1	WM153
Hartley Single-valver	WM198

TWO-VALVE SETS

All these 1s. each, post free.

Long Distance Two (HF, D)	AW110
Ace of Twos (D, Pentode)	AW143
All Mains Two (D, Trans)	AW180
Loud-speaker America Two (D, Pentode)	AW192
Talisman Two (D, Trans)	AW194
Hyper-selective Two (D, Pentode)	AW198
Pentector Two (P. det., RC)	AW213
British Broadcast Two (D, Trans)	AW215
Easy-tune Two (D, Trans)	AW226
Wavelets Two (D, Trans)	AW229
No-battery A.C. Mains Two (D, Trans)	AW230
No-battery Gramo-radio 2 (D, Trans)	AW238
1930 Talisman 2 (D, Trans)	AW239
Easy Tune Short-wave 2 (D, Trans)	AW242
Q-coil 2 (D, Trans)	WM63
Crusader (D, Trans)	WM69
Flat-dweller 2 (HF, D)	WM75
Tetrode Short-wave Two (SG, D)	WM99
Key-to-the-Ether Two (D, Pentode)	WM107
Clipper Two (D, Trans)	WM133
Triflex (Reflex)	WM133
Continental Two (D, Trans)	WM143
Stay-put Two (All AC, D, Trans)	WM145
Ether Ranger (D, Trans)	WM155
A.B.C. 2 (D, Trans) with copy "W.M." 1s. 3d.	WM165
Brookman's Two (D, Trans)	WM168
A.C. Two (D, Trans)	WM175
Programme Two (D, Trans)	WM177
New Crusader (D, Trans)	WM182
Radio-Record Two (SG, D)	WM187
Gleaner Two (D, Trans)	WM201

THREE-VALVE SETS

All these 1s. each, post free.

Miniature Hartley Three (D, 2 Trans)	AW109
Three-valve Mains Receiver (HF, D, Trans)	AW109
British Station Three (HF, D, Trans)	AW122
Simplicity Screen-grid Three (HF, D, Trans)	AW132
All-purpose Short-wave Three (D, RC, Trans)	AW147
All-round Three (D, RC, Trans)	AW155
All Britain Three (HF, D, Trans)	AW158
Bantam Three (D, RC, Trans)	AW160
Binowave Three (D, RC, Trans)	AW172
Clarion Three (SG, D, Trans)	AW173
Broadcast Three (SG, D, Trans)	AW192
James dual-range Three (HF, D, Trans)	AW196
All-wave High-Mag Three (Det. 2 Trans)	AW199
Knife-edge Three (D, RC, Trans)	AW201
Talisman Two-three (D, RC, Trans)	AW203a
Wide World Short-wave Three (HF, D, Trans)	AW207
Everybody's Three (SG, D, Trans)	AW209
1930 Ether Searcher (SG, D, Trans)	AW211
New All-Britain Three (HF, D, Trans)	AW214

Best-by-Ballot Three (SG, D, Trans) Price 4d. free with copy of "A.W."	AW217
Brookman's By-pass Three (D, 2 Trans)	AW220
Everybody's All-electric Three (SG, D, Trans-A.C.)	AW221
1930 Clarion Three (SG, D, Trans)	AW223
Auto-Coupler Three (D, 2LF)	AW225
Beginner's Regional Three (D, 2LF)	AW233
Britain's Favourite Three 1930 (D, 2 Trans)	AW243
Britannia (D, RC, Trans)	WM67
All-wave Screened-grid Three (HF, D, Pentode)	WM110
Standard Coil Three (HF, D, Trans)	WM117
Festival Three (D, 2 LF-Dual Imp)	WM118
The Q3 (D, RC, Trans)	WM124
Lodestone Three (HF, D, Trans)	WM129
Simple Screen Three (HF, D, Trans)	WM131
Dynamic Three (A.C.—SG, D, Trans)	WM136
Short Wave Link (D, RC, Trans)	WM142
Binowave S.G. Three (SG, D, Trans)	WM152
Fanfare (D, 2 Trans)	WM157
Brookman's Three (SG, D, Trans)	WM161
Community Three (D, RC, Trans)	WM164
New Q 3 (SG, D, Pentode)	WM167
Brookman's Push-Pull Three (SG, D, Trans) 1/6	WM170
Celerity Three (SG, D, Trans)	WM173
All-nations Three (D, 2 Trans)	WM178
Inceptor-dyne (SG, D, Pentode)	WM179
Brookman's A.C. Three (SG, D, Trans) 1/6	WM184
Music Marshal (D, 2 Trans)	WM190
Gramo-Radio D.C. Three (SG, D, Trans)	WM196
Concert Three (D, 2 Trans)	WM199
New Lodestone Three (HF, D, Trans)	WM205

FOUR-VALVE SETS

All these 1s. 6d. each, post free.

Explorer Four (HF, D, RC, Trans)	AW120
Facility Four (HF, D, 2 RC—Q-coil)	AW154
Broadcast Picture Four (HF, D, 2RC)	AW163
The Orchestra Four (D, RC, Push-pull)	AW167
All Europe Four (2HF, D, Trans)	AW173
Stability Four (HF, D, RC, Trans)	AW182
Clarion All-electric Three (SG, D, Trans A.C. Rectifier)	AW200
Music-lover's Gramo-radio (SG, D, RC, Trans)	AW202a
Horizon Four (SG, D, 2 Trans)	AW237
Q-coil 4 (HF, D, Trans, RC)	WM71
Screened-grid 4 (HF, D, 2RC)	WM77
Touchstone (HF, D, RC, Trans)	WM100
Standard-coil Four (HF, D, 2RC)	WM122
Dominions Four (2SG, D, Trans)	WM134
Drum Major (HF, D, RC, Trans)	WM137
Music Player (HF, D, RC, Trans)	WM144
Arrow (SG, HF, D, Trans)	WM154
1930 Monodial (2SG, D, Trans)	WM158
Electric Four (All AC—SG, D, RC, Trans)	WM162
Outpost Four (SG, D, 2 Trans)	WM165
Brookman's Four (2 SG, D, Trans)	WM174
Transportable Four (SG, D, 2 RC)	WM180
Super Q (SG, D, 2 Trans)	WM180
Lodestone Four (HF, D, RC, Trans)	WM193
Searcher's Four (SG, D, RC, Trans)	WM194
Invitation Four (SG, D, RC, Trans)	WM200

FIVE-VALVE SETS

All these 1s. 6d. each, post free.

James Quality Five (2 SG, D, RC, Trans)	AW227
All-wave Lodestone Five (HF, D, RC, Push-pull)	WM146
1930 Five (2 HF, D, RC, Trans)	WM171
Dual-screen Five (2SG, D, RC, Trans)	WM185
Radio-Record Five (SG, D, Trans-parallel)	WM188
Overseas Five (3SG, D, Trans)	WM191

PORTABLE SETS

Town and Country (HF, D, RC, Trans)	AW111	1/6
House Portable (SG, D, RC, Trans)	AW163	1/6
£5.5.0 Portable (D, Trans)	AW181	1/-
Holiday Portable Three (D, RC, Trans)	AW188	1/-
Music Leader (SG, D, RC, Trans) with copy "A.W."	AW203	-/4
Merry-maker Portable (D, 2 Trans)	AW228	1/-
Sunshine Three (SG, HF, SG, D, Trans)	AW235	1/-
Continental Portable (SG, D, Trans)	AW241	1/-
Wayfarer Portable (Super-her)	WM139	1/6
1929 Chummy (SG, D, Trans, RC)	WM145	1/6
Picnic Portable (D, RC, Trans)	WM148	1/-
Pedlar Portable Two (D, Trans)	WM195	1/-
Pedlar Portable Three (D, 2 Trans)	WM197	1/-
James Portable SG3 (SG, D, Trans)	WM203	1/-
Foursome Portable (SG, D, 2 Trans)	WM206	1/-

AMPLIFIERS

All these 1s. each, post free.

Utility (RC, Trans)	AW68
One-valve LF Unit	AW70
Hook on Short-waver	AW104
Purity Amplifier	AW108
Add-on Distance-getter	AW117
Screened-grid HF Amplifier	AW138
"A.W." Gramophone Amplifier (3RC)	AW162
Searcher Unit (HF)	AW176
"A.W." Gramophone Amplifier	AW205
Beginner's Amplifier (iv.) 9d.	AW210
Brookman's Separator (HF Unit)	AW212
Two-valve Amplifier	AW216
"Mag." Gramo Unit	AW224
Audio Amplifier	WM132
Concentrator (HF, Unit)	WM160
Radio-Record Amplifier (D.C. Mains)	WM183

MISCELLANEOUS

Arcadian Linen-diaphragm Loud-speaker (full-size)	AW177a	1/-
Short-wave Adaptor (r.v.)	AW183	1/-
Gramophone Amplifier (3-v.)	AW187	1/-
High-tension Battery Charger	AW191	1/-
Mains Unit for 8 Valves	AW193	1/-
Simplest H.T. Unit	AW197	1/-
B.P. Wavetrap	AW204	-/6
By-pass Unit (Wave Trap) with copy "A.W."	AW218	-/4
Home-constructor's pleated paper Loud-speaker	AW219	1/-
"Twin" Brookman's By-pass	AW222	-/6
A.W. Paper Loud-speaker	AW231	1/-
James H.T. and L.T. Charging Unit	AW232	1/-
Simplest H.T. Eliminator for D.C. Mains	AW234	1/-
Simplest H.T. Eliminator for A.C. Mains	AW236	1/-
Choke Output Unit	AW240	1/-
James H.T. Unit for D.C. Mains	WM133	1/-
Short-wave Adaptor for Dominions Four	WM149	1/-
Two Ampere Low-tension Unit	WM147	1/-
A.C. Mains Amplifier	WM149	1/-
A.C. Mains Unit for All-wave Lodestone Five	WM151	1/-
H.T. Unit for A.C. Mains	WM159	1/-
"W.M." Linen-diaphragm	WM172	1/-
Trimmer (Selectivity Unity)	WM181	-/6
Brookman's "Wipe-outs"	WM186	1/-
Short-wave adaptor for Overseas Five	WM192	1/-
Staminator Unit for A.C. Mains	WM202	1/-
Universal Push-pull Amplifier	WM204	1/-
Outspan Short-wave Adaptor	WM207	1/-

Copies of "Amateur Wireless" and of "Wireless Magazine" containing descriptions of any of these sets can be obtained at 4d. and 1s. 3d. respectively, post free. Index letters "A.W." refer to "Amateur Wireless" sets and "W.M." to "Wireless Magazine" sets.

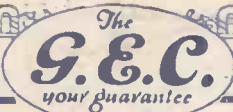
EVERYTHING  ELECTRICAL

Osram Valves

Sold by all
Wireless Dealers

MADE ENTIRELY IN ENGLAND. REDUCED PRICES

The following types of OSRAM VALVES are REDUCED IN PRICE as shown, the reductions becoming operative immediately.

TYPES	OLD PRICES	NEW PRICES	TYPES	OLD PRICES	NEW PRICES
Osram H.L. 210	10/6	8/6	Osram P. 2	15/-	13/6
" H. 210			" P. 240		
" L. 210			" P. 425		
" H.L. 410			" P. 625		
" H. 410			" P. 625A		
" L. 410			Osram S. 215	22/6	20/-
" H.L. 610			" S. 410		
" H. 610			" S. 610		
" L. 610	Osram P.T. 240	25/-	22/6		
Osram P. 215	" P.T. 425				
" P. 410	" P.X. 4				
" P. 610	" P.T. 625	30/-	27/6		

Prices apply only in Great Britain and Northern Ireland

Advt. of The General Electric Co., Ltd., Magnet House, Kingsway, London, W.C.2.

HOW TO IMPROVE AN OLD SET

Amateur Wireless

and
Radiovision

Every
Thursday 3^d

Vol. XVII. No. 427

Saturday, August 16, 1930

Constructing



BRITAIN'S
"FAVOURITE
THREE"-1930

BLUEPRINT
AVAILABLE



2 Valves only —
for Perfect, full Volume Reproduction

Do you appreciate that the Marconiphone Pick-up, followed by a simple 2-valve amplifier and a good speaker, will give you the finest possible reproduction with full volume?

The average output from the Marconiphone Pick-up is $1\frac{1}{2}$ volts R.M.S. — over 2 volts peak. To load a super power valve such as Marconi PX4 or Po25 A, which operate with 30 — 36 volts grid bias, it is only necessary to interpose one stage giving a gain of fifteen to twenty. All you need is a resistance-capacity coupled MH4 (for A.C. Mains) or HL610 (six volts), and you have then enough volume for dancing to, if you wish.

If you are a 2-volt user, have an H210 similarly coupled to one or two Marconi P2 valves, according to the power required, and you will be astonished at the results.

For quality the Marconiphone Pick-up stands alone — a moment's hearing will convince you. The characteristic is level from 250 to 4,500 cycles, with a rise below 250 compensating for the recording loss of low frequencies and a sharp drop at 5,000 which reduces the proportion of scratch without impairing the brilliancy of the upper register. And it is All British.

Complete with carrier arm (ball bearing) and swivelling head — £3.3.0

The Marvellous
MARCONIPHONE PICK-UP
 £3.3.0

THE MARCONIPHONE COMPANY LIMITED
 Radio House, Tottenham Court Road, W.1

CONDENSED CHATS

By
DOCTOR DUCON

Variable Condensers

Three main essentials of a variable condenser are low dielectric loss, low minimum capacity, and positive contact between the moving vanes and their terminals.

If the Condenser is fitted with a slow-motion device there is in addition the need for a positive movement, firm contact of friction surfaces to avoid scraping noises, and a smooth, even movement.

The Dubilier variable condensers combine all these points. You will get easier tuning and lower losses if you fit Dubilier Variable and Fixed Condensers throughout your set.

The Dubilier K.C. Condenser

PRICE, with knob, dial and slow-motion device. **12/-**

PRICE, without knob, dial or slow-motion device. **8/-**

If unobtainable from your dealer write direct to us giving his name and address.



DUBILIER

CONDENSER CO. (1925) Ltd.

DUCON WORKS, VICTORIA ROAD, N. ACTON, LONDON, W.3

B.C.5

You will Help Yourself and Help Us by Mentioning "A.W." to Advertisers

Amateur Wireless and Radiovision

The Leading Radio Weekly for the Constructor, Listener and Experimenter

Editor:
BERNARD E. JONES

Technical Editor:
J. H. REYNER, B.Sc., A.M.I.E.E.

Research Consultant:
W. JAMES

Assistant Editor:
H. CORBISHLEY

A 5XX Rumour—The Manchester Show—Announcers, anonymous!—These Land-line Relays—The New "Diversions"—O.T.C. Radio Practice

A 5XX Rumour.—The rumour is again going the rounds that 5XX will be closed down when the Regional scheme is complete, probably as soon as the Slaithwaite station is in operation. We have heard this rumour before, from readers who write in, in a state of mild panic, to inquire how they can get reception if 5XX shuts down, they being too far away to receive the medium-wave stations. An AMATEUR WIRELESS representative tackled a B.B.C. official on this, to learn, as he had already guessed, that there is no foundation for the rumour. The B.B.C. has never contemplated doing away with 5XX in favour of the medium-wave Regionals.

The Manchester Show.—The Manchester Wireless Exhibition is always one of the big radio features of the North. This year it opens on October 8, and runs, as usual, for ten days. The *Evening Chronicle*

is organising a number of competitions for home-built sets and a sum of £175 is offered in cash awards for the best types of home-made receiver and wavetrap. You can get full information and entry forms from the Radio Editor, *Evening Chronicle*, Withy Grove, Manchester. A stamped envelope should be enclosed. The closing date is September 22, so you will have to get busy on that new set!

Announcers, anonymous!—An American reader says that the listener in the U.S.A. is getting tired of hearing the announcers airing their names at the end of every programme. They ask, how many listeners care who announces the programme? If announcers must be mentioned it is suggested they should be numbered instead of named!

These Land-line Relays.—The B.B.C. is making good use of the new cross-Channel and European lines for linking up with Continental musical centres. A relay from Salzburg over a 1,000-mile circuit was heard last week and further relays over this line will be made on August 20 and August 30. The famous Bruno Walter is conducting at Salzburg on both these occasions.

The New "Diversions."—The series of Surprise Items, which did not prove to be a great success, and which had temporarily been discontinued, has now been started again. The accompanying photograph shows an incident in the first of the latest series of "Diversions"—the start of a relay from a twin-engined air liner cruising in the dark above the Midlands. The Mid-

land Regional studios at Birmingham arranged this aeroplane broadcast. Several days were spent in getting the voice of the announcer free from the noise of the air liner's engines.

O.T.C. Radio Practice.—Radio training which is given to members of the O.T.C. may come in useful in cases of emergency. The public-schoolboys who were recently in camp at Marlborough had their annual tussel with the army-type transmitters and receivers, and had a glorious opportunity for making use of the Morse code which they had laboriously "swotted," for the other fifty weeks in the year. "Camp" days are always jolly days, and the radio section often gets more fun and less hard work than other sections—until it comes to carrying the portable transmitters!

Our Stand Number.—At this year's Radio Exhibition, opening at Olympia next month, AMATEUR WIRELESS will be "on view" at Stand No. 1. Easy to remember!

PRINCIPAL CONTENTS

	Page
Current Topics	145
What Makes a Good Set?	146
Radio Conversations at 60 m.p.h.	147
Around the Short-wave Dial	148
More About the "Favourite Three —1930"	149
Juggling With Frequencies	150
On Your Wavelength	151
The Burndept Super-screened Portable	153
Whistling Tones from the Earth	154
Without Fear or Favour	155
The "Car 3"	156
My Wireless Den	160
"A.W." Tests of Apparatus	162



A scene at the start of the giant air liner, a relay from which featured in a "Diversions" programme last week. The pilot is holding the transmitting aerial of the plane

land Regional studios at Birmingham arranged this aeroplane broadcast. Several days were spent in getting the voice of the announcer free from the noise of the air liner's engines.

O.T.C. Radio Practice.—Radio training which is given to members of the O.T.C. may come in useful in cases of emergency. The public-schoolboys who were recently in camp at Marlborough had their annual tussel with the army-type transmitters and receivers, and had a glorious opportunity for making use of the Morse code which they had laboriously "swotted," for the other fifty weeks in the year. "Camp" days are always jolly days, and the radio section often gets more fun and less hard work than other sections—until it comes to carrying the portable transmitters!

Our Stand Number.—At this year's Radio Exhibition, opening at Olympia next month, AMATEUR WIRELESS will be "on view" at Stand No. 1. Easy to remember!

WHAT MAKES A GOOD SET?



Answering this question, Alan Hunter suggests that batteries and valves have a great deal to do with the making—or marring—of a good set

A WET afternoon is a good time to turn out the radio junk box. So out came parts belonging to a half-forgotten past. A low-frequency transformer that would still put some of the latest ones in the shade; two wonderfully dirty variable condensers with the best slow-motion device I have yet encountered; some X-coils of the plug-in type. I cheered up, for here was the nucleus of the set visualised.

Making a Set

"Do you know anything about radio?" was my first tentative question. "Once I had a crystal set," was the reply. So then I knew how much work was ahead. Down on our knees we laid out the parts, two condensers mounted on an old panel and on an equally old piece of wood the two single coil holders, the transformer, two dusty valve-holders, and a perfectly good grid-leak and condenser. That was all.

Out came some tinned-copper wire, and a two-valver took shape according to the circuit diagram. Nothing startling in the circuit, but wait—we were listening to London exactly fifty minutes after the first exploration of the junk box. Quality—fine; volume—needed toning down; selectivity—Brookmans Twins entirely separated by 20 degrees of intervening silence; range—Midland Regional heard at good loud-speaker strength; control—only one tuning knob and reaction delightfully smooth.

Would not many listeners like to say as much of their pet set? And they will ask how it is done. I think there are three secrets, in this order: (1) the valves; (2) the power supply; (3) the loud-speaker. Although I was prepared to risk whatever reputation I have on the "Junk-box Two," the three "secrets" were very carefully selected.

The detector was a Cossor HF210, well matched to the low-frequency transformer it preceded; sensitive to weak signals and altogether ideal for the job. The power valve was an Osram P215, giving ample output and a useful amount of amplification into the bargain. The high-tension battery was an Ever-Ready 120-volt double-capacity type, and the loud-speaker, a linen diaphragm with a balanced-armature unit.

How did we get the selectivity that everybody wants these days? By using an indoor aerial of 65 ft. total length and a good water-pipe earth. The X-tuning coil was a No. 60, with the aerial taken to the terminal on the side, so that the damping of the aerial and earth was across only a part of the coil. The smooth reaction? No special dodges here; just a .0005-microfarad variable reaction condenser and a No. 25

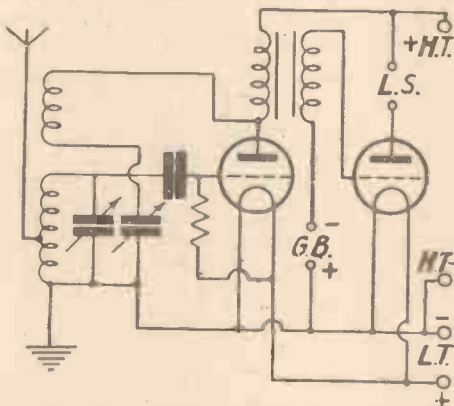

The simple circuit embodied in the two-valver referred to in this article

reaction coil, mounted half an inch away from the tuning coil. This gave a fine control of reaction and cost nothing for extras.

Two interesting sequels to the installation of the "Junk-box Two" must be recorded. A neighbour remarked that he had a very special two-valve circuit up his sleeve, but that, after hearing the "J.B. Two" he had given up the idea. Another neighbour—on the other side of the road—made solicitous inquiries as to what four-valver had been installed. This neighbour proved to have a "four," giving execrable quality, due to (1) a run-down high-tension battery, and (2) old-fashioned valves with practically no emission left.

The more I see of the average wireless set; the more I am convinced that batteries and valves account for the major portion of poor reception. Whenever I hear of a reputedly good set giving poor results, I ask about these accessories. But even when a good set is working with good batteries and valves, the loud-speaker is often found to be an indifferent one, driven by a unit

far too small to cope with the output of a modern power valve.

The set in question serves as a good enough example of my main theme; soon after its installation in the chauffeur's den for which it was designed, trouble began. Now the only difference between the set as tested and the set as installed was an H.T. battery.

Distortion was reported as being very much in evidence; I was not surprised to find the cause—a 100-volt H.T. battery on its last legs. This battery had given a reading of 98 volts the previous day, but the reading had not been taken while the battery was in use. Quality certainly was appalling; but all trace of distortion disappeared when the new 120-volt battery was put in.

"Below Par"

Next time the reader calls on a friend with a bad-quality radio, let him prove my contention by measuring the voltage of the high-tension battery while the set is working. It will more than likely be found very much "below par." The useful life of a standard-capacity battery is much shorter than is generally supposed; the trouble is that there is no distinct sign of extinction, the loss of voltage being a slow malingering decrease that eventually manifests itself as crackling noises in the loud-speaker, together with a general deterioration of quality.

Good components make a good set—obviously. But is it so obvious that bad accessories mar a good set? Answer the question from your own experience.

DETECTING ICEBERGS

WHEN an iceberg drifts into warmer waters (where, of course, it is a constant menace to shipping) the process of melting is accompanied by a peculiar sound, which is sufficiently pronounced to be detected by means of a sensitive microphone. The microphone is mounted on the exterior of the ship's hull and is connected up to a valve amplifier. The characteristic "melting" noise can then be identified, and serves to warn the navigator of the presence of his undesirable neighbour at night or during foggy weather. M. B.

Radio Conversations at 60 m.p.h.

"HULLOH! Is that the long-distance operator? Give me Mr. ———, who left Montreal this afternoon on the International Limited, C.N.R."

A business man in a big town on the outskirts of Montreal waits with the phone to his ear for a few minutes. There is a click and then he hears the voice of the man he is calling, speaking from an express train travelling at full throttle from Montreal to Toronto. That is not a dream of the future, but an actual event which takes place many times a day on the Canadian National Railways.

Phoning to Passengers

Not only can travellers on the bigger C.N.R. "Limiteds" hear broadcasting while *en route*, but it is now possible by means of a new radio-telephone system to call up telephone subscribers from the train while it is in motion, and also, of course, anybody with a telephone can speak to any train passenger.

A Canadian National Railways official in London explained the working of this to me.

This radio service operates on "International Limited," the all-steel daily train of the Canadian National System, operating between Montreal, Toronto, and Chicago.



Inspecting the small generators which supply power for the receiver

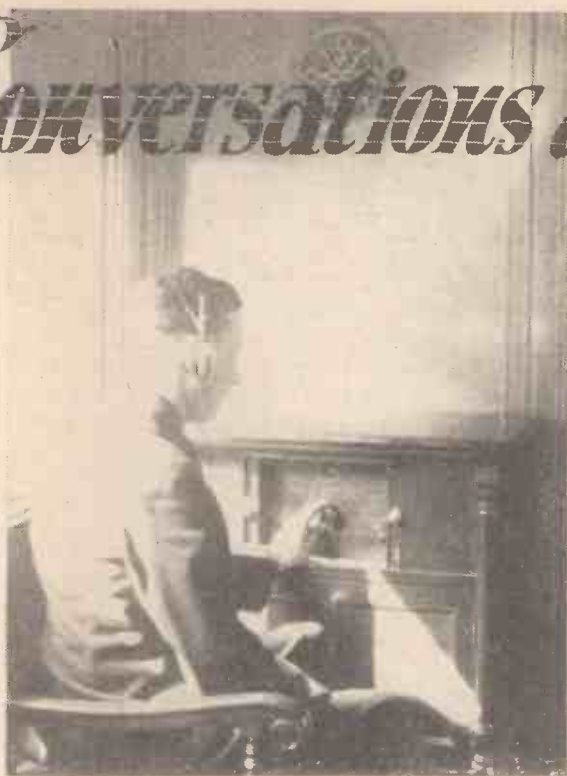

A description by Kenneth Ulyett of the system by which it is possible to telephone to and from Canadian National Railway expresses travelling at full speed

The system works by broadcasting the voice from the train to carrier-current telegraph wires which run parallel to the track. From these wires it is carried to pick-up stations and thence transferred to the Bell Telephone central office at Kingston (Ontario), where it is placed on regular long-distance circuits. Pick-up stations are located at Morrisburg and Cobourg

The Aerials

On the train the aerial consists of two groups of four parallel wires on the roof of the car. It is considered that this is a distinct advantage over the German State Railway system, which has an aerial extended over the tops of several cars, necessitating the use of complicated coupling devices to allow the cars to be separated. Considerable difficulty was experienced, however, in working such a short aerial at the low frequencies used, and special loading coils had to be employed in order to transfer sufficient energy between the car and the telegraph lines. The receiving aerial is also used for the simultaneous reception of broadcast programmes.

Receiving

The receiver consists of a high-frequency amplifier, a demodulator, and a speech amplifier, the output of which operates a telephone receiver.

The circuit employed to connect the ordinary telephone lines is known as the conjugate Wheatstone bridge circuit, and provides a means of connecting the two pairs of wires from the transmitter and

receiver to the single pair of wires constituting a telephone line, without having the transmitter and receiver interfering with each other, yet allowing voice currents from the telephone line to pass to the transmitter and from the receiver to the telephone line. This arrangement is known as a hybrid coil and is in common use in telephone amplifier circuits.

Wired-wireless

At the terminal and pick-up stations, use is made of the telegraph lines running parallel with the railway tracks. Half the wires are used for transmitting and half for receiving. These are connected to the transmitting and receiving sets through special filters, so that there is no interference between this new system and any telegraph or telephone equipment already operating over the wires.

With the low power used and the frequency band employed a considerable degree of privacy is ensured, comparable with the ordinary telephone and probably better than the transatlantic telephone, as it is very unlikely that a radio set covering the wavelength used will be found within 200 ft. of the tele-

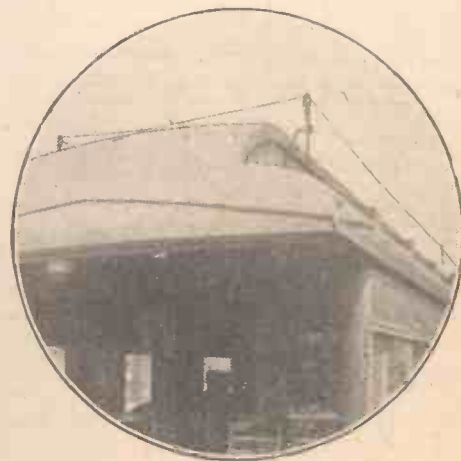

How the aerials are arranged on the carriage roof

graph lines. This is roughly the maximum radio range.

The modulator circuit (at the transmitter end) is a modified form of grid modulation and appears to give a better percentage modulation than the ordinary run of such circuits. Considerable difficulties were encountered, however, in the design of the aerial systems and the determination of the proper carrier frequencies.

The fact that the carriages of the trains

(Continued at foot of next page)

Some Notes on Present-

day Short-wave Conditions

Around the Short-wave Dial

By M:
BARNETT

SO many different short-wave stations have been reported from time to time as having regular transmissions, and so little is heard of the majority of these stations that the average short-wave listener may rightfully begin to wonder if there is not something wrong with his receiver. Many short-wave stations appear in official station lists which, although they may be working as stated, certainly have a very poor chance of being heard in England.

If some stations get across the world with only a very small power, it must not be assumed that any short-wave station can do this because so much depends on the locality of the transmitter. Certainly, some very wonderful records have been made by amateur stations working only on a very small power, indeed, but no one would guarantee to be able to repeat these performances, however good the locality might be.

One popular American magazine, for instance, lists no fewer than 96 stations between 12 and 32 metres and gives the schedules for most of them, yet how many listeners can really say that they have heard even a quarter this number on these

wavelengths? Most of the stations listed stand a very poor chance of being heard here, and quite possibly, in America also, despite the claims made for world-wide reception on low power. Remember that all these stations referred to are regular stations, and do not refer to amateur stations at all.

Short-wave Stand-bys

There are certain stations which can always be regarded as old stand-bys and practically any short-wave receiver has a good chance of receiving them in almost any locality. Among these we find such stations as PLE, PLF, W2XAD, W8XK, G5SW, 7LO, Zeesen, PCJ, Copenhagen, W2XAF, VK3LO, W9XAL, W8XK (on its longer wave) and W2XE. These are the reliable stations and in England the three first-mentioned prove good daylight (afternoon) signals, the next six will be heard well in the early evening and the remainder are heard best late at night, in total darkness.

Practically all short-wave receivers, undoubtedly, can also receive quite a number of other stations, but these cannot be said

to be reliable and their reception is generally in the form of a "fluke." Of course, you can quite truthfully retort that *nothing* is reliable so far as short waves are concerned, but if any stations at all are to be heard, the above-mentioned ones will *certainly* be heard! All the same, reception of very small stations in far-off lands now and then is very entertaining and adds a certain amount of sport to the game!

At present, short-wave conditions have scarcely changed at all since the last of these notes was written and a correspondent in the U.S.A. informs me that they also are not experiencing the good reception that was expected this summer. He also states that reception in the middle States of the U.S.A. is poor compared with that obtained in the Western and Eastern States. Our rule that radio waves are best over water and poorest over long stretches of land does not generally apply to short and ultra short waves, but in this case they appear to do so.

W2XAF still continues to be about the best of the American stations, whilst W8XK comes in a good second, with W2XAD good only occasionally.

"RADIO CONVERSATIONS AT 60 M.P.H."

(Continued from preceding page)

are largely of steel, made matters more difficult. The wavelengths used vary between 1,500 and 3,500 metres.

The power necessary to operate the various parts of the set is obtained from a small motor-generator. At the train end this is driven from the car storage batteries, and at the terminal station from the 110-volt lighting circuits. This generator is a multiple winding machine and supplies the potentials for the plates and filaments of the valves, the telephones and the signal circuits. This provides a complete self-contained set, which, incidentally, has been so designed as to take up a minimum of car space.

In the transmitter the high-frequency carrier current is produced by a valve oscillator, and no frequency-stabilising crystal is needed.

In developing this new train-telephone system, the C.N.R. engineers made use of their special test car. This car is an ingenious laboratory having its own electrical generators run by a petrol engine. Power

can be "tapped" easily at any point in the laboratory, and stepped up or down to convenient voltages.

It is completely equipped with all the

necessary testing equipment for communication work and has also living accommodation for eight men, so that it provides a real workshop for its crew of engineers who can, when necessary, sleep and eat close to their work. It was on this car that most of the preliminary work was done.

Now the train-telephone system is a regular thing, and the C.N.R. is to be congratulated on the experimental ground-work which has had to be covered.

Experiments in the wireless transmission of pictures are to be carried out between Japan and Germany *via* Great Britain and the United States. The transmission will be made *via* Deal Beach and Rugby.

Considerable interest has been aroused in France by the report that a private company has been formed for the construction of a 12-kilowatt broadcasting station at some eighty miles from the French capital. The broadcasts are to be under the sole control of Professor Branly, the well-known radio veteran, and the station is to bear his name. The daily programmes will be supplied from a special studio in Paris to which the public will be admitted.



Cicely Courtenidge in cartoon

Constructing the 1930 BRITAIN'S "FAVOURITE THREE"



Preliminary details of the 1930 "Favourite" were given in last week's issue. Here are some further constructional notes and hints on its operation.

THE reasons, and there are many, for the production of a new edition of "Britain's Favourite Three," were given in last week's issue, when "Britain's Favourite Three, 1930," was introduced to readers.

Constructors of this set should not miss last week's issue, wherein also were detailed many advantages possessed by this new receiver over not only the original "Favourite Three" of 1928, but also other modern sets which are not so efficient as they should be.

The constructional work in connection with this set is quite straightforward. Some readers may care to work only with a small reproduction of the blueprint and with the photographs and constructional notes given herewith, but for the benefit of those who like to work with the aid of a full-size blueprint, which reduces constructional work to Meccano-like simplicity, it may be mentioned that a full-size print, No. 243, is available, price one shilling, post free, from the Blueprint Department, AMATEUR WIRELESS, 58-61 Fetter Lane, London, E.C.4. The print is most convenient in use because it can be used as a template both for drilling the panel and mounting the

parts, both on panel and baseboard.

Assembly

The first job, if the blueprint is to be used as drilling template, is to attach it to the panel temporarily with a spot of adhesive at each corner. The drilling centres for the condensers and for controls can be lightly punched (this is essential in order to give the bit of the drill a good start), and

able to follow the blueprint itself or the small reproduction of it.

On the blueprint the leads are numbered, and if one inserts each lead in turn, there is no possibility of one being left out or wrongly connected. It is advisable to make a check-over of all connections when the job of wiring is complete. If soldering is used, which is advisable, then not only should the leads be tested for their correctness of connection, but they should also be pulled with the fingers to ensure that all the soldered joints are good and not "dry."

Valves

Now comes the all-important choice of valves and H.T. supply.

The detector valve should have an impedance of about 20,000 ohms, and the following 2-volt valves will serve as a guide: Cossor 210HF, Dario Univ., Marconi HL210, Osram HL210, Six-Sixty 210HF, Mullard PM1HF, Mazda HL210, Lissen HL210, Fotos BA9, P.R. PR3LF, and

Triotron HD2.

The first L.F. valve can be chosen from the following 2-volters, or their 4- or 6-volt equivalents: Cossor 210LF, Marconi L210, Osram L210, Six-Sixty 210LF, Mullard PM1LF, Mazda L210, Lissen L210, Dario Univ., Triotron SD2, Tungram LG210, Fotos BA9.

The following 2-volt power valves are suitable, and 4- or 6-volt valves can be used if desired: Cossor P2, Dario SP, Marconi P2, Osram P2, Six-Sixty 220P, Mullard PM252, Mazda P220, Lissen P220, Fotos BD9, Tungram P215, P.R. PR210.

The total H.T. consumption of the "Favourite" with most of the valves specified is fairly heavy, and it is of no use expecting small and standard-capacity high-tension batteries to give good service. Super-capacity batteries should be used, and the man with a good mains eliminator or large H.T. accumulator need have no

(Continued at foot of next page)

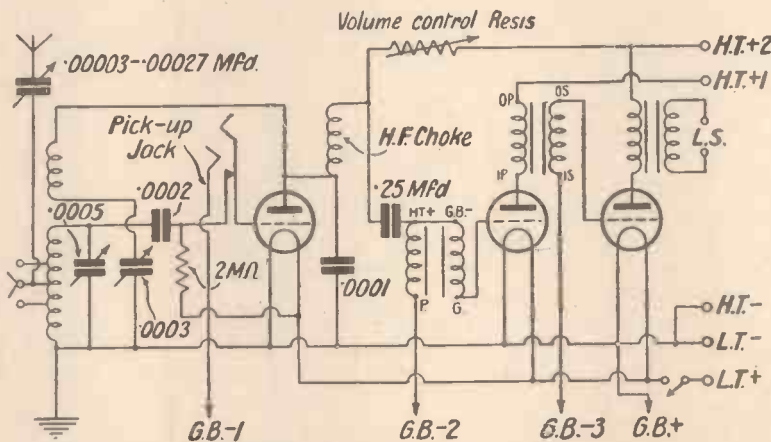

Special features of the circuit are the inclusion of a pick-up jack, volume control and a selective aerial-circuit arrangement

then the holes may be drilled through.

It is not advisable to mount any of the parts until the panel is attached securely at right angles to the baseboard, for the weight of the condensers is apt to make the accurate mounting of the panel a difficult matter. When the panel has been firmly secured, however, all the parts may be put in place, including the dual-range coil, and one may then proceed to mount also the baseboard components.

The blueprint shows exactly how these should be arranged, and better advice cannot be given than to emphasise that all the parts should be mounted exactly as shown, with the least possible deviation being made in the case of alternative parts being used. Rigid insulated wire is best used for making the connections and in order to ensure that all the wiring is done correctly it is advis-

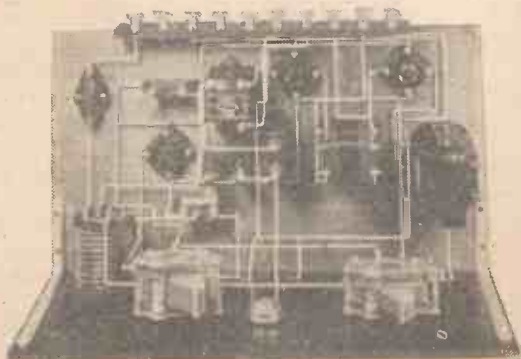

Comparison of this plan view with the wiring diagram shown last week will facilitate construction

JUGGLING WITH FREQUENCIES

By MORTON BARR

IT is a comparatively easy matter to build up a higher frequency from a lower. A thermionic valve operating on the upper or lower bend of its characteristic curve will generate higher harmonics from a given input frequency. One of these harmonics can be separated out by suitably tuning the plate circuit, and then applied in turn to a second thermionic frequency-multiplier and so on.

In this way, starting from a controlled tuning-fork having a standard frequency of, say, 100 cycles, it is possible to build up a carrier-wave frequency suitable for broadcasting or even for short-wave beam transmission, i.e., from one to twenty million cycles per second.

Crystal Frequency Step-up

The same method of stepping-up frequencies is often used when the standard source of oscillations is a piezo-electric crystal. Crystals can, of course, be cut to have a fundamental frequency of several million per second, but their cost increases with the frequency. Moreover, the higher the frequency the smaller the crystal, and the more liable it is to fracture when oscillating under an applied voltage.

Accordingly it is common practice to start with a comparatively large and robust crystal, having a fundamental frequency of, say, 10 to 50 kilocycles, and to use this to feed a series of frequency-doubling valves.

A similar step-up effect can be obtained from a static transformer working on a saturated iron core. Owing to the shape of the magnetisation curve, the currents induced in the secondary windings will contain higher harmonics of the input, which can be separated out as before and used to feed a second static frequency-doubler and so on.

Sometimes the problem arises of reducing a given frequency, i.e., of producing an output having, say, one-half or one-quarter the input frequency. Here the solution is not so simple.

Certain somewhat complex valve circuits will, however, respond in this fashion. The simplest is the so-called multi-vibrator originally designed by Abraham and Bloch.

The Multi-vibrator

As will be seen in the figure, the multi-vibrator consists of two resistance-coupled valves v, v_1 , arranged in rather a curious

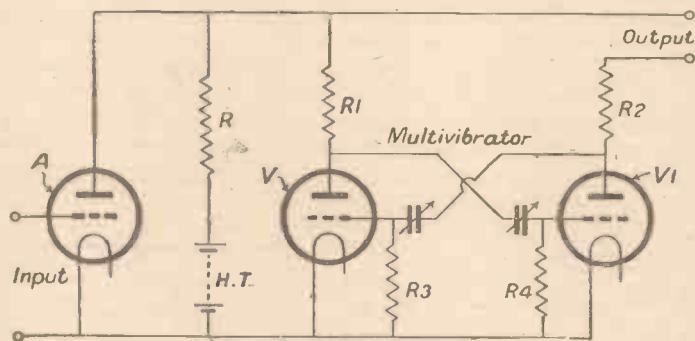

A typical frequency-doubler

manner. The plate of the first valve v is connected to the grid of the second through a resistance R_1 and a condenser in the usual way. The plate of the second valve v_1 is, however, also reciprocally back-coupled through a resistance R_2 and a condenser to the grid of the first. R_3 and R_4 are grid-leaks.

One would naturally expect such a combination to oscillate owing to the back-coupling, but as there is no definite tuning, i.e., no inductance-capacity circuit, there appears to be nothing to stabilise or anchor the output down to any specific frequency.

This is actually what happens in practice. The output is so rich in harmonics that it

may be regarded as a mere complex of frequencies. If the lowest frequency is taken as the "fundamental" it is invariably accompanied by a considerable number of harmonics—sometimes up to the 150th.

By making the value of the coupling resistances sufficiently large the multi-vibrator can be used to generate oscillations having a frequency as low as one per minute.

The Frequency-divider

In order to use the arrangement as a frequency-divider an input valve A is coupled to the first valve v through a resistance R and the various coupling resistances are adjusted so that they "favour" a frequency, say, round about 1,000 cycles per second.

Then if the frequency to be divided, say 10,000 cycles, is applied to the grid of the valve A a series of sub-multiples of this frequency is obtained in the output. The first is the fraction nearest to the "fundamental" whilst others appear in succession as the input voltage is increased.

In other words, for a loose input coupling, the output frequency will be stabilised at exactly 1,000 cycles per second, i.e., one-tenth the input frequency.

Now, if the input coupling is gradually tightened, there will be no effect on the output frequency at first, but when the applied voltage has increased by a certain value the output frequency suddenly jumps from one-tenth to one-ninth that of the input.

At a still tighter coupling, the output frequency makes another sudden and definite jump to one-eighth that of the input, and so on, in clear-cut stages, until the output frequency rises to exactly one-half that of the input.

"CONSTRUCTING THE 1930 BRITAIN'S FAVOURITE THREE"

(Continued from preceding page)

qualms about high-tension.

A brief test made with the "Favourite," with the valves specified, gave a very satisfactory reception log, and a most pleasing feature was the simplicity of operation. The speaker output, with 150 volts on the anode of the last valve, was too great for a small room. The volume control on the panel is a

COMPONENTS REQUIRED

Ebonite or bakelite panel, 18 in. by 7 in. (Becol).
Baseboard, 18 in. by 10 in. (Pickett, Camco).
.0005-mfd. variable condenser (Lotus, Lissen, J.B., Dubilier, Igranic, Burton, Formo, Polar, Ready-Radio).
.0003-mfd. variable condenser (Lotus, Lissen, Ready-Radio, Dubilier, Igranic, Burton, Formo, Polar).
Dual-range coil (Tunewell).
Push-pull filament switch (Junit, Lotus, Benjamin, Bulgin).
Variable resistance (Clarostat, "Volume" type; Atlas, Rheograd).
Pick-up jack (Lotus, type No. 2; Igranic).
Panel brackets (Bulgin).
Three valve holders (Benjamin, Lotus, W.B., Formo, Burton, Wearite, Lissen, Junit, Trix).
.0002-mfd. fixed condenser, with series clips (T.C.C., Lissen, Dubilier, Graham-Farish, Atlas, Watmel).

.0001-mfd. fixed condenser (T.C.C., Lissen, Dubilier, Graham-Farish, Atlas, Watmel).

.25-mfd. fixed condenser (T.C.C., Dubilier, Lissen, Hydra).

Pre-set condenser, capacity .0003 to .0027 mfd. (Igranic, Formo, Sovereign, Lissen, Polar).

Low-frequency transformer, ratio 4 to 1 (B.T.H., Cossor, Lewcos, Telsen, Varley, Ferranti, Igranic, R.I., Lissen).

Output transformer (Lissen, Varley, Igranic).

Special-core transformer (Varley Nicore II, Lotus, Lissen, Igranic, Burton).

2-megohm grid leak (Lissen, Dubilier, Ediswan, Graham-Farish).

Ten terminals marked: Aerial, Earth, L.T.+1, L.T.—, G.B.+1, G.B.—1, G.B.—2, G.B.—3, H.T.+1, H.T.+2 (Ealex, Clix, Belling-Lee).

Connecting wire (Gfazite).

great advantage.

Gramophone working was tried, with an ordinary magnetic-type pick-up connected to the set; and the easy control of strength, the reserve of volume in hand, and the partial elimination of surface noise were deemed to render this method of reproduction well worth while.

In order that all listeners in Hungary may secure alternative programmes, it has been decided to alter the plans of the new Budapest.

On Your Wavelength!

Lightning

ONE never knows when the apparently unnecessary safeguard may prove its usefulness. The other day, following a severe thunderstorm, I had an "S.O.S." from a neighbour. A very near flash of lightning had "done in" his all-mains set. Could I come and see the extent of the damage; whether things could be put right locally or whether the whole set would have to be sent back to the makers?

With visions of fused aerial and burnt-out tuning coils, I went. The aerial was intact and was earthed outside the house. Within the handsome cabinet was no sign of damage. Fuses were fitted between the mains and the input transformer, and the withdrawal of these showed that one had gone. The insertion of a fresh wire sufficed to put the receiver in working order once more.

The owner had happened to have his hand on earthed metal at the moment of the discharge and was sent spinning across the room. I do not doubt that the reflex from the flash had somehow loaded the mains and that the fuse had functioned as it was intended to do and had saved the set from considerable damage. The switch is in the set and not on the wall, which is the safest place for it.

Quaint Microphone Uses

Our friend the "mike" is made to perform some curious tasks. The other day I saw a number in use on a range along which the behaviour of bullets in flight is investigated. The bullets are made to pass through paper screens placed at intervals of 100 yards along the range. Against each screen there is a microphone. The slight sound of the bullet passing through the paper is transmitted along wires to the firing point where it is recorded by a dictaphone. On the dictaphone cylinder an electrically driven tuning fork records each one-hundredth of a second and from these records the time of flight over the whole range, and for each hundred yards of it, can be worked out. Other microphones suspended along the range, and connected to other dictaphones, were recording the sound of the bullet as it passed, so that any irregularities in flight might be detected.

An "O.B." Expression

Talking of ranges, a funny story is told of the recent broadcast of the final for the King's Prize at Bisley, in which a woman, Miss M. E. Foster, won the gold medal and £250 for the first time in the history of this competition to discover the champion marksman of the Empire. Describing the position of the competitors on the firing

point the commentator said that Miss Foster was "half way up the range"; which is an expression commonly used by riflemen in such circumstances, meaning that she was shooting on a target numbered somewhere about 25, out of the 50 in use.

"Of course the young woman won," said an old lady who was listening. "Of course the woman won, if the men gave her a start like that!"

Seeing Distortion

My television receiver has an unexpected use. It is the finest thing I have yet discovered for showing up distortion in an amplifier—H.F. or L.F.—or a detector, for that matter. I have an output stage, permanently connected to the television apparatus, of the necessary power to work it properly. To this can be connected any form of wireless receiver, and undistorted images can only be had from a receiver which will deliver undistorted signals to the output stage. Different forms of distortion produce different effects. In making these tests a curious phenomenon sometimes appears.

The image is completely reversed, appearing as a "negative." This is due to phase reversal in the amplifier. It does not affect speech signals. It can be cured by reversing the output connections, and in several other ways.

Another P.S.A.!

Have you taken the trouble to tot up the total time devoted to entertainment by particular B.B.C. stations on Sunday? If you care to do so you will probably discover that it is something of an eye-opener. August 3 certainly was one to me. That Sunday, coming as it did in the middle of the Bank Holiday week-end, would, one would have thought, contain a generous slice of musical fare for holiday-makers. Church-goers and non-church-goers like to spend such a Sunday afternoon out in the country and any number of portable sets would be taken for an airing if there were anything to listen to. Before you read any further just have a guess at the total number of hours and minutes devoted by the National transmitters to entertainment, not merely during that Sunday afternoon, but in the course of the whole day? Well, what did you guess. Four hours? No. Three and a half hours? Still too much!

The entire entertainment time from the National transmitters was three hours and five minutes. There was a quartet with a couple of soloists from 4.15 to 5.30 p.m., a piano recital from 5.30 to 6 p.m., and a concert from 9.5 p.m. until 10.30 p.m. And what about the London Regional? Here the entertainment time was two hours and

fifty-five minutes—a band concert from 3.30 p.m. to 5 o'clock and an orchestral concert from 9.5 p.m. until 10.30 p.m. On the other hand, without counting the Epilogue, the National transmitters devoted three hours and ten minutes to religious items, including no less than three services.

This is surely overdoing things. My own experience is that there is no more certain way of turning people from religion than to hurl it at their heads in chunks.

Authentic Short-wave News

From an American correspondent who very kindly sends me short-wave information received direct from the U.S.A. stations I have some information to-day which I will pass on now for the benefit of readers. He tells me that he has just been informed direct by the station authorities of WJZ at Boundbrook that their short-wave relay W₃XAL is now working regularly on 49.18 metres with a power of 12 kilowatts. The transmission times are from 10 to 11 p.m. and again from 4 a.m. to 6 a.m. British Summer Time. These transmissions take place on every week-day, but there is no regular transmission on Sundays. Irregular transmissions are also made at various times between 7 p.m. and 10 p.m. on weekdays. I shall be glad to hear from any readers who hear this station at good strength. I think I have mentioned before how exceedingly difficult it is to obtain reliable information about the doings of short-wave stations.

Here is an example. I wrote to one of them in America a few months ago and duly received a schedule of programme times. Trying round with the short-wave set during the period given for the evening transmission I could find absolutely nothing at all on the wavelength stated. On four evenings in succession I went for this station and failed to get him. Then quite by chance I picked him up on a totally different wavelength, heard the call-sign and found the announcer giving out advance programmes for the week which were at utterly different times from those mentioned in the schedule.

Several people, both in this country and America, have had the bright idea of compiling reliable short-wave lists with a view to publication. Much hair has turned grey in the process and no one has yet produced a table that was not out of date before it was printed. If, therefore, you don't find W₃XAL at work on 49.18 metres at 10 o'clock to-night please don't throw bricks at me. Like the pianist in the Klondyke bar, I am doing my best.

It Makes a Difference

If you go in for listening to foreign

:: :: *On Your Wavelength! (continued)* :: ::

stations at all, and have now a plain knob for your reaction control, let me give you a tip that is worth much more than the half-crown or so which you will have to expend to carry it into effect. Remove that plain knob and present it to the first small boy you see, who will be delighted to have it. In its place, instal a miniature slow-motion dial of which there are many good makes on the market. See, though, that you get one which does not "free-wheel" in places and has as little backlash as makes no matter. A "free-wheeling" dial is about the most maddening thing on earth when you are engaged in D. X. work. You won't have had the slow-motion dial fitted to your reaction control for ten minutes before you burst into song in praise of "Thermion." I'll tell 'ee for why.

Fine Tuning—

To begin with, with the plain knob you have only a rough idea of what is the safe setting, the maximum setting, I mean, which will ensure that the set doesn't oscillate. But after a few minutes with the S.M.D. you know that on wavelengths up to 250 metres the safe setting is, say, 20; from 250 to 300, 26; and so on. Thus, when you have a dial of this kind you can search with the set in a sensitive condition, but feel quite sure that you won't annoy your friends and neighbours by howling. And now for point number two. You very soon discover at what reading of the reaction condenser the set *will* oscillate on various bands of wavelengths. Here you have your second safeguard.

—and "Fiddling"

You pick up, let us say, Budapest, who is heard only faintly. You have discovered that in that part of the band the set oscillates with the reaction condenser at, say, 55. Very well then. You know that the biggest strength that you can safely get from Budapest is that produced with the reaction condenser at $54\frac{1}{2}$. There is none of that fiddling about on the edge of oscillation, letting the set occasionally go up in the air to the annoyance of everyone in a big area round you.

You just operate the tuning condensers until the biggest strength that you can get in that way is coming in, then you turn the reaction condenser slowly to $54\frac{1}{2}$ and you know that that is the safe limit. Point number three is that owing to the slow-motion arrangement little reaction adjustments are very much more easily made. With the plain knob you could not possibly make with certainty an adjustment equal to one-half of a dial division. With the S.M.D. it is simplicity itself to do this.

Inventing Inventions

The way of the inventor is a hard one, particularly if other people take a hand in

the game and start inventing things for him. The other day I came across in several places definite statements that Dr. Robinson of Stenode fame had discovered an entirely new principle for sound-proofing buildings and certain details were given. The idea was that by means of a wonderful apparatus upon which he was engaged you could tune in silence just as you can tune in sound. Realising that if this were true it would be of amazing benefit to wireless studios and demonstration rooms as well as for outside broadcasting, I wrote to Dr. Robinson to ask if he could let me have any particulars.

His reply came by return. He had never invented anything of the kind and he wasn't thinking of doing so. What happened apparently was that some interviewer came to him and asked if he couldn't produce something of this sort. His reply was emphatically in the negative and he definitely forbade the mention of his name in connection with anything of the sort. You can gather how electrified he was a few days later to find himself hailed in print as the father of something which was neither his nor anybody else's child. And yet there still are people who believe that if you see a thing in print it must be true.

Broadcast Songsters—

I was glad to see that at a recent musical conference an eminent speaker denounced in the strongest possible terms the horrible habit of wobbling, which is becoming, one fears, commoner and commoner amongst our home-grown sopranos and contraltos. Very justly he blamed some of the singers who broadcast for the spread of this hateful trick. Wobbling in singing is simply a failure to hit the note you want fair and square. It is a vile and horrible fault and no singer who indulges in it should be allowed to make a second appearance before the microphone, at any rate until the fault has been completely eradicated.

Yet I suppose that quite fifty per cent. of the contraltos and sopranos who warble to us via the microphone and the loud-speaker, wobble as though their vocal chords were made of jelly. Mr. Percy Scholes, who is one of the B.B.C.'s big musical men and undertakes a great part of the educational side of that department, has said the most scathing things again and again about wobbling and yet it goes on. Isn't it about time that the wobblers were eliminated? If they cannot find singers that don't wobble, then for heaven's sake let us have less songs.

—and Organs

Mr. Maurice Lane-Norcott in one of his inimitable sketches poked delicate fun, the other day, at the B.B.C.'s astonishing organ complex. According to him, whenever the B.B.C. programme people have a gap to

fill they stick in organ music from somewhere or other. And that I think is just what they do. Personally, I am a great lover of the organ in moderation and in its proper place. But I do think that we get a good deal too much of it on the wireless. The only thing to be said in favour of the spate of organ music to which we are treated is that it comes in jolly useful when you are testing out the low-frequency parts of sets or experimenting with loud-speakers.

No instrument or collection of instruments requires such a high quality amplifier or loud-speaker as the organ if the full beauty of the music is to be brought out. But apart from experimental work I really don't want the organ, except on occasions and then it must be the best of music played by the best of musicians upon the best of organs. I am afraid that these conditions are rarely fulfilled.

Put This in Your Pipe!

Some time ago, when the authorities at Savoy Hill were at the height of their queer campaign against long-distance work, they were wont to point out that no music which came from afar could possibly be so perfectly reproduced as that performed by the local station. They told us, if you remember, that we D. X. fellows didn't care what we heard so long as it came from a range of several hundred miles or more.

The position at the present time is rather curious. If your "Thermion," for example, is to follow out these precepts and to listen only to the stations which give him perfect quality he must never tune in—Brookmans Park. In point of fact he very seldom does, since he receives the National programme infinitely better from 5XX, though 5XX is forty-five miles away from him and Brookmans Park only sixteen. But curiouser and curiouser he can receive many foreign stations with better quality than that obtainable from Brookmans Park. This refers, of course, to reception with an ordinary set, such as employed by ninety-nine per cent. of valve users. Brookmans Park can be well received at this range if one cares to build a special set for the purpose, incorporating something out of the way in detector systems.

For Crystalisers

The deep modulation which gives Brookmans Park such a wide service area is awfully jolly for the crystalisers, but the very dickens for valve-ites. I know that the regional scheme is for the greatest benefit of the greatest number. But somehow it doesn't seem to me very satisfactory that people living at distances up to twenty miles from Brookmans Park should have to complain of rough reception. And don't forget that exactly the same thing is going to happen in other big areas in different parts of the country. THERMION.

A PAGE FOR THE SET BUYER

"Set Tester" on—

THE BURNDIPT
SUPER-SCREENED
PORTABLEA Self-contained Four-valver Worked
Entirely from Batteries

Maker: Burndept Wireless (1928), Ltd.

Price: £23 10s., complete with valves and
batteries.

The Burndept portable is really portable: note the absence of any projections



This picture shows the simple tuning controls and compact internal arrangement

I HAVE just finished an interesting test of a suit-case type of portable, the Burndept Super-Screened Four. As soon as it was handed over to me I was struck with the excellent appearance of the walnut-finished leather-covered case. Except for a small turntable, this container gives no indication that inside is a powerful four-valve set, complete with a high-grade cone loud-speaker, frame aerial, and all batteries.

On opening the lid, the controls are seen at the front of the main compartment; behind is the cover of the batteries, and valves. An ingenious, though simple, method of releasing the cover was noted.

The battery units are a combined high-tension and grid-bias supply (118 volts and 18 volts respectively) and a 2-volt accumulator.

Moderate H.T. Requirements

As I received it, the Burndept portable had the negative grid bias adjusted to 15 volts, whereas the curve of the Mazda P240 output valve used shows that the correct bias with 118 volts high-tension is about 7 volts. But with this small bias voltage the anode-current consumption, as I measured it, was over 10 milliamperes, which is too much for a standard-capacity battery to supply at an economical rate.

By adopting the maker's plan of increasing the grid bias, quite a big reduction in anode-current consumption is effected. With 15 volts negative grid bias, the total anode current of the four valves was only 6 milliamperes, which is very reasonable.

The makers quite conscientiously explain that this economy of high-tension current is at the expense of quality. Of course it is, because the grid swing is reduced by over-biasing. On test, the Burndept set gave very good quality when the P240 valve was over-biased; that is, with 12 volts negative grid bias, at which value the total anode current was reason-

able. With this value of grid bias the high-tension battery will last several months.

The four valves of the Burndept portable are arranged in the sequence of high-frequency amplifier, detector, and two low-

Every set referred to in this regular feature by "Set Tester" has reached a certain standard of efficiency in the "Amateur Wireless" Laboratory. Reports are not given on sets that fail to reach this standard. This will explain why reports that do appear express general satisfaction with the set's performance.

frequency amplifiers, an arrangement admirably suited to our present requirements of selectivity, range, and power. The high-frequency valve is a screen-grid type, a particularly efficient example of the species, the Mazda SG215. The other valves are also Mazdas, including the super-power output valve.

The controls are unusually well arranged. Tuning is done with a thumb-worked dial, calibrated in wavelengths for both medium and long wavebands, together with an auxiliary control marked in degrees. To the left of the tuning is the combined battery and wave-range switch; to the right the reaction knob, which does not masquerade as a volume control, although it certainly has the effect of increasing the strength of distant stations.

The calibrated tuning dial is the biggest simplifying factor in set control. Portable-set makers have an advantage here, in

being able to calibrate on the enclosed frame aerial. With sets connected to outside aerials calibration is, naturally, more difficult, since the aerial affects the tuning. On the Burndept portable the calibrations proved, on test, to be fairly accurate: Midland Regional came in at the 480-metre mark, London Regional at about 358 metres, and the National between the 260 and 270 marks. After logging several well-known distant stations, I am able to say that the calibrations are near enough to help considerably in DX work.

On the long waves, fine results were obtained from all the well-known Continental stations. Radio-Paris and Eiffel Tower were both brought in quite clear of Daventry. I could not get Berlin clear of the home station, but Hilversum, Kalundborg, and Motala were good alternatives.

Although the standard price is £23 10s., a cheaper model at 19 guineas is listed. The internal set is the same.

SHORT-WAVE LIMITS

ALTHOUGH wireless oscillations can now be produced having a wavelength of only a few centimetres, it is not possible to use them for long-distance signalling owing to the fact that they travel, like light, in a straight line and cannot therefore "follow" the curvature of the earth. In fact, waves shorter than 10 metres are usually able to penetrate the Heaviside layer, escaping into inter-stellar space, except in a north and south direction, when reflection sometimes occurs, probably owing to the action of the earth's magnetic field. The transmission range of waves shorter than 3 metres is limited by the height of the transmitting aerial, just as a man's range of vision at sea is limited by his distance above the water. B. M.

French listeners report having picked up test transmissions on 50 metres from the new Vatican station, and that the calls are put out in the English language.

WHISTLING TONES FROM THE EARTH

An Account of a Curious Phenomenon. By J. H. Reyner, B.Sc., A.M.I.E.E.

IN 1919 a curious phenomenon was commented upon by the well-known German physicist, Barkhausen. This effect had been observed during the war-time experiments in tapping the earth for signal currents. Telegraphy, and to some extent telephony, at short ranges is carried out under field service conditions by using one line with an earth return. Though in general the current flows to the earth more or less directly, between the transmitting and receiving point, as shown in Fig. 1, there is a certain spread of the earth current so that minute currents can be found in the earth at considerable distances away.

One of the most important operations of the Signal Services on both sides was the detection and amplification of these very small stray currents, in order to overhear the enemy conversations. For this purpose two plates were driven in the ground some

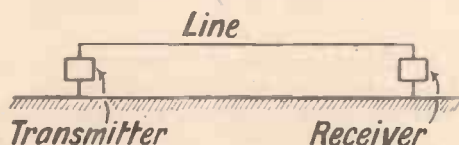

Fig. 1. Normal circuit with earth return

distance apart (three hundred feet or so). Any currents flowing in the earth between these plates set up small voltages which could be amplified and thus rendered audible, by the use of valve amplifiers.

Atmospherics

The success of this method of detection depends upon the relative values of the intercepted signals, and local disturbances or earth atmospherics. We know that atmospherics or X's as encountered in radio consist of electro-magnetic waves of short duration, very often only lasting a wave and a half, so that they are somewhat similar to very rapidly damped sparks. These disturbances may be generated two ways, either by an "X factory" on the ground, such as a desert, where the hot air produces ionisation effects which give rise to electrical discharges, or they may be produced by thunderstorms, either of the violent kind, which are observed on the ground, or the less violent and often unnoticed discharges which are continually taking place in the atmosphere.

The first type will travel along the earth's surface in the ordinary manner with their "feet" on the ground, while the second variety will be transmitted outwards into space from a point some distance above the earth. Some of these waves will strike the earth and a certain portion will be absorbed and the remainder reflected. Thus the earth contains currents of a highly oscillatory

nature, set up by these atmospherics, so producing X's in earth reception just the same as in radio, and the quality or intelligibility of the results obtained depends upon the relative level of the wanted signal and these atmospheric disturbances.

Strange Sounds

Barkhausen called attention at the time to a very peculiar disturbance which is quite separate from the ordinary atmospheric interference. Periodically, a curious whistling effect was heard, which he says can best be described in words as a "peeccou" sound. The note was one starting at a very high or shrill frequency, and rapidly descending until it died away in a rumble. Sometimes, he says, these disturbances were so loud and followed each other so rapidly, as to render reception of the intercepted currents quite impossible. They were found to be affected by atmospheric conditions, being most severe in the warm days of May and June, but they were quite different from the customary atmospheric disturbances.

He has now put forward a possible explanation of these curious effects, based upon our greater knowledge of high-frequency phenomena. He suggests two explanations in the current issue of the *Proceedings of the I.R.E.* The first and, to my mind, the prettier, although he admits that according to our present knowledge it does not strictly fit the data, is that the effect is due to successive reflection from the Heaviside layer. Let us consider Fig. 2. A disturbance at the point A produces a sudden impulse, which can be transmitted to the point B in various ways. First of all it can go direct, and this impulse, having to follow the shortest path, will arrive first. Secondly, it can go up to the Heaviside layer and down again; an impulse of this character would arrive very shortly after the first, because it will not travel very much farther. Following these impulses, however, we have a number of other impulses, which have all arrived after an increasing number of reflections. One impulse some way down the series is also shown in Fig. 2, where the wave is reflected from the Heaviside layer to the earth and back again quite a large number of times.

Delayed Waves

It is quite easy to see that these later waves have to go very much farther and thus arrive after the earlier ones; it can also be shown that the delay in arrival gradually gets longer. Therefore we have the effect at the receiving point B of a number of impulses following one another very rapidly at first and gradually becoming farther and

farther apart. This is shown by the sketch.

But if these pulses arrive sufficiently close upon one another's heels they will blend to form a musical note in our telephone, and this is exactly what happens on this theory. The impulses first arrive very rapidly indeed, giving a high-pitched squeal, which immediately falls in pitch right through the whole gamut of frequencies to the lowest.

So much for theory number one. One of the objections to it is that one never hears this curious whistling sound in ordinary wireless reception, and there seems to be no reason why one should not do so if it is introduced in the manner outlined in the above theory. Theory number two is a little more difficult to explain, but it may prove to be the correct one.

If one drops a weight in a room where there is a piano, practically all the strings of the piano will vibrate, producing a dis-

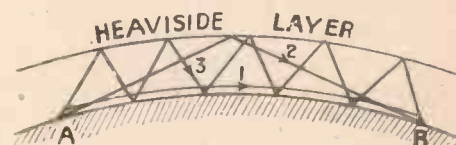

Fig. 2. Diagram showing reflection from the Heaviside layer

cordant jangle. Now an atmospheric disturbance, being a sudden shock like the dropping of a weight, will set up at its point of origin the whole gamut of frequencies, and these will be transmitted to the receiving point. If they all arrive simultaneously they will reproduce a crash corresponding to the initial impulse which set them up.

An Explanation

Barkhausen suggests, however, that they may not arrive simultaneously. It is possible, he points out, that the higher frequencies may be transmitted through space or through the earth more rapidly than the lower frequencies, so that the high notes arrive first. If this is so we have another possible explanation of this whistling. The high notes coming from the distant atmospheric arrive first, and give us the very shrill note on which the whistle starts. Gradually the other and lower frequencies come in turn down the scale, and the note or pitch of the whistle falls rapidly.

Some evidence can be produced so that under certain conditions such as the passage through the earth itself, or in cases of reflection from the Heaviside layer, the higher frequencies are transmitted more rapidly, which is what would be required on the theory, and certainly there are echoes and distortion effects which arise in ordinary radio-telephony when reflection is obtained from the upper atmosphere.

SYDNEY MOSELEY'S WEEKLY PROGRAMME CRITICISM

Sunday Programmes

The "Proms"

Sob Stuff

The New "Diversions"



I THINK we are winning the fight for an alternative Sunday programme. If, after all this time of enforced religious lessons, we are not all converted to the need of listening to two services a day, the fault lies with those who failed to make the most of a wonderful opportunity.

I find that on Sunday, in particular, I want to do something to fill in the hours of broadcasting before London deigns to give us anything. Take a recent Sunday: On the National programme one had to wait until 2.30 before the Church Cantata came on, and, of course, there are many gaps up till the Epilogue time at half-past ten.

On the London Regional one had to wait till 3.30 before an orchestral concert was put on—a programme which was duplicated by the Midland Regional. Therefore, one has to switch over to the many stations abroad for items that, in my view, could very well be given from London. This has made me rather expert in reaching out. I get Rome whenever I want, nearly all the German stations, and other stations in languages I wot not.

It is evident that this campaign for a fuller Sunday programme in this part of the world will have to receive fuller consideration.

Sorry, but the first of the new series of "Diversions" was not promising. All one heard was a monotonous grinding of machinery—a noise that is neither novel nor welcome in an age of nerve-wracking street clamour. Incidentally, the broadcast did not always synchronise and the screeching of the machines was allowed to go on too long.

I have been sent an advance copy of the new Promenade concert programmes. Looking through them one finds music to suit all tastes, and I should think we are in for a jolly nice musical festival.

I liked the idea of the "sob stuff" which was "peptonized" by Gordon McConnel, for it introduced us to some beautiful sentimental gems of the past and present. What I didn't like was the coddling of first-rate ballads and the glorifying of American trash.

For instance, somebody starts off with

the first line of that beautiful ballad, "I Love Thee," by Grieg, one of the older English ballads.

Guying such songs might be excusable if the guying extended to the copyright trash of foreign composers of which so many of us are infernally sick. But when, after the false starts, the singers went on to give a straight rendering of some altogether unknown and unworthy jazz tunes, I felt that the whole purpose as a stunt was lost, and that what might have been genuine fun was merely irritating nonsense.

Also, was it not rather bad showmanship to spoil the finale by quoting some lines of an old doggerel?

I have never heard "Onaway, Awake Beloved" rendered better than did Harold Williams on a recent occasion. Every note was as clear as a bell, and mark ye, every word clearly distinguishable. Thank you, Mr. Williams.

We are having a lot of the two K's lately—Korsakoff and Kreisler. "The Hymn to the Sun" and the airs of K the Second are "so sweet," but remember the fate of "The Londonderry Air."

Bizet's "L'Arlesienne" has come into its own, too, and I don't think I've ever heard this beautiful suite so much before—at home and abroad. "Agnus Dei," one of the themes, simply haunts.

I am right behind with my correspondence, so I will devote some space to the many letters I have received.

L. P. M. (Orpington) writes: "I wish we were given some means of identifying those who take part in the revues and kindred shows. Take a recent show *Bored and Lodging*, for instance. One naturally could not mistake Stainless Stephen, nor could we fail to recognise Patricia Rossborough's clever—if jazzy—piano playing. But as for the rest, I could not tell one from the other. There was a girl who sang in such a horribly affected voice that it irritated one to listen to her. Then, on the other hand, a Cockney fellow, I believe it was the man who took Michael Hogan's place, was extremely funny."

W. Paine (Wolverhampton) does not think that Gershom Parkington has enhanced his reputation by broadcasting his Saxophone Orchestra. "Their attempts to play dance music are creditable but amateurish. I would suggest that our King of Popular Classics would be kinder both to himself and his listeners if he stayed within his kingdom and left dance music to the jazz experts."

I am afraid I have not the space to refer to three letters in support of the point of view I expressed regarding strong language.

As one correspondent puts it, we are all for realism and I am sure that were the bloodthirsty characters made to exchange their brutish words for Oxford English, the radio play would have to pack up.

In one play, for instance, the people who used "bloody" and "lousy" were people who, in real life, do use those words, and very often words far worse. The only fly in the ointment is the fact that in some households the children stay up late and probably listen-in and we cannot have such words as those I have just mentioned bandied about while the youngsters are listening.

What I would suggest is that radio plays should be subjected to a mild form of censorship and granted certificates in the same way as are films. Then the classification of each play could be indicated in the programmes and parents would know when it was wiser to send the children to bed.

It is stated that if Italy can obtain the use of a wavelength above 1,000 metres it will be utilised for the new transmitter to be installed at Florence (Firenze).



An impression of Frederick Burtwell

HERE is a set which fits at the back of the instrument board of your car, and which will work even when the car is in motion.

A unique design has been adopted for this receiver, appropriately known as the "Car 3," because in the average car nowadays there is not much room to spare and it is not always convenient to take up space with a conventional portable in its cabinet. There is a demand for a set which can accurately be built into the car itself and the problem is to find the best place for it.

The "Car 3" has, as will be seen from the photographs, a small vertical panel carrying the controls. This is attached parallel to the fascia board, while the main part of the receiver is at right angles to the panel and is well out of the way, near the dash.

Easy to Fit

The dimensions have been cut down to the smallest possible limit, so that there is no fear of the set being in the way, or fouling the passengers' knees. Most cars nowadays have a cubby hole or a blank panel at the near side of the instrument board, and it is here that the "Car 3" can most conveniently fit.

The set is not entirely self-contained, for several good reasons. L.T. current is taken from the car battery, which obviates the necessity for carrying unnecessary weight in the shape of an accumulator solely for the set. This, however, necessitates a small rubber-covered lead to the starter battery, where connection can be made with any number of cells desired according to whether 2-, 4-, or 6-volt valves are in use.

H.T. is taken from an ordinary dry battery, and rather than attempt to squeeze

a popular-size battery into an integral part of the receiver, it is intended that a large and even triple-capacity battery shall be accommodated in a canvas bag slung down by the passenger's foot, or at any convenient part of the car not far away from the receiver.

If the H.T. battery used is of the type having small voltage graduation tapings at the negative end, then grid bias can be obtained from this without the necessity for an additional battery. In other cases, a separate bias battery will be needed, but this, too,

from the home set and pack it in a satchel for car use when needed. In any case,

sufficient protection should be provided for the battery, which is very apt to be damaged if not



TELLING HOW TO FIT

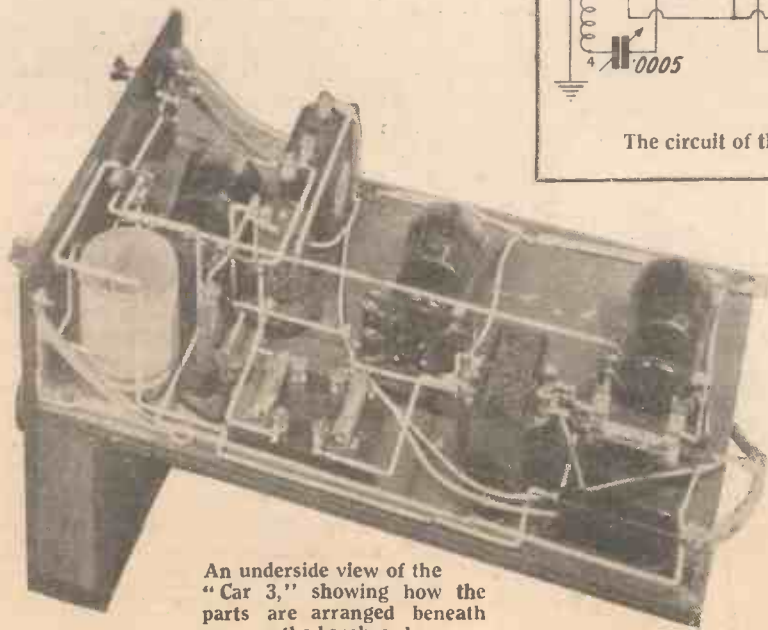
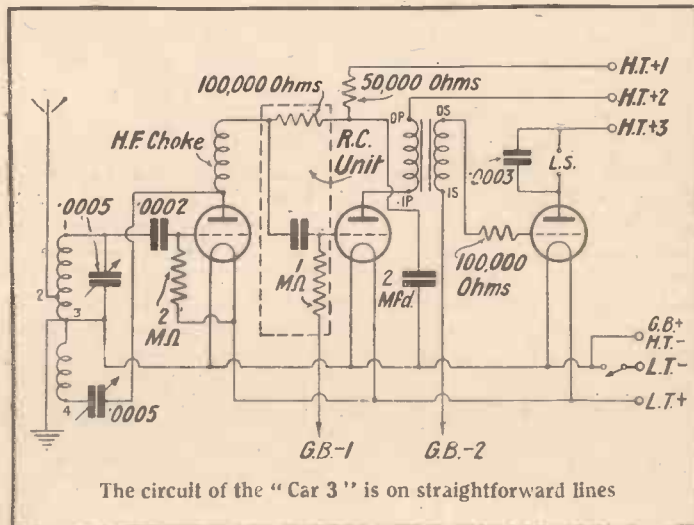

An underside view of the "Car 3," showing how the parts are arranged beneath the baseboard

can be accommodated in the H.T. battery case.

This method of obtaining H.T. will be satisfactory for most amateurs who can keep the "Car 3" receiver itself permanently installed in the car and can take the H.T. battery

put in a case of some kind.

The speaker is external from the set and is connected to it by means of a plug and jack on the panel in front. This is a good idea, because often the best place for a speaker is at the back where sound reflection from the back of the hood or from the saloon roof makes the speaker more audible to all



Compare this plan view given on the



RADIO INTO YOUR CAR

Reproduced by permission from "The Light Car"

the occupants, and on motoring picnics it is very often convenient to have the speaker at some distance from the car, although the set is still working from the car battery and with

these external fittings, however, when the construction of the receiver has been

COMPONENTS REQUIRED

Ebonite panel, 8 in. by 8 in. (H. & B., Becol).

Two .0005-microfarad variable condensers (bakelite dielectric type) (Ready - Radio, Graham - Farish, Harlie).

Filament switch (Bulgin, Lotus, Benjamin, Junit, Wearite, Igranic).

Loud-speaker jack and plug (Bulgin, Lotus, Igranic).

Three valve holders (Junit, Burton, Formo, Benjamin, Lotus, W.B.).

High-frequency choke (Wearite, Watmel, Polar, Dubilier, Sovereign).

.0002-microfarad fixed condenser (Lissen, T.C.C., Dubilier, Watmel, Graham-Farish, Atlas).

.0003-microfarad fixed condenser (Lissen, T.C.C. Dubilier, Watmel, Graham-Farish, Atlas).

2-microfarad, fixed condenser (Lissen, Dubilier, T.C.C., Hydra).

2-megohm grid leak (Dubilier, Lissen, Watmel, Ediswan).

Grid-leak holder (Dubilier, Bulgin, Ediswan, Graham-Farish).

50,000-ohm resistance (Graham-Farish, Lissen).

Resistance-capacity coupling unit, with 100,000-ohm resistance and 1-megohm grid leak (Lissen, Graham-Farish, Dubilier).

Low-frequency transformer, ratio 3 to 1 (Igranic, Lissen, Varley, Telsen, Lotus, Burton, R.I.).

100,000-ohm grid resistance and holder (Lissen, Graham-Farish).

Small panel brackets (Camco, Bulgin, Lissen, H. & B., Ready-Radio).

Aerial terminal (Belling-Lee, Eelex, Clix, Burton).

Coil former, 1½ in. diameter and 2½ in. long (Wearite, "Parohm").

2 oz. of No. 36 d.s.c. wire and 2 oz. of No. 24 d.s.c. wire (Lewcos, H. & B.).

Connecting wire (Glazite).

Six yards of thin flex (Lewcoflex).

Two spade terminals, marked: L.T.+ , L.T.— (Belling-Lee).

Six wander plugs, marked: H.T.—, H.T.+1, H.T.+2, H.T.+3, G.B.—1, G.B.—2 (Belling-Lee, Eelex, Igranic).

Two 3-in. dials (Trolite).

Baseboard, 12 in. by 8 in. (Camco).



with the wiring diagram on the next page

the "Car 3" it is possible to lead the speaker out to almost any distance on a length of flex.

The set incorporates no frame aerial, for frame aerial working in practically every car is at a disadvantage. Frames are directional and as the car changes position on the road it needs accurate manipulation to keep the frame in line with

detailed.

The cost of the "Car 3" is low because, unlike most portable sets, it incorporates only the essentials, and one does not have to consider the expense of a specially fitted speaker or frame aerial, or the cost of batteries for special use in the car.

In the accom-

panying panel will be seen the components needed. Care should be taken when choosing alternatives, if for any reason it is not possible to use the first-mentioned part suggested. The parts used in the original receiver were carefully selected so that the overall dimensions are satisfactory. Some alternatives, although the electrical equivalents of those in the original set, may be too large to fit in conveniently.

panying panel will be seen the components needed. Care should be taken when choosing alternatives, if for any reason it is not possible to use the first-mentioned part suggested. The parts used in the original receiver were carefully selected so that the overall dimensions are satisfactory. Some alternatives, although the electrical equivalents of those in the original set, may be too large to fit in conveniently.

Simple to Build

There are one or two points about the construction of the "Car 3" which may puzzle those who have not had previous experience in set construction, and it is strongly advised that every constructor of this receiver should work from the full-size blueprint, which is available, price 1s., post free, from the Blueprint Department, AMATEUR WIRELESS, 58-61 Fetter Lane, London, E.C.4.

The spacing of the parts in this set is very important, because there is not a great deal of room to spare. The blueprint enables the amateur to follow the original layout very accurately, for it can be used as a drilling diagram and as a mounting template.

There is a small amount of woodwork to be done, but this should present no difficulties, for cigarbox wood or plywood—the best materials to use—are very easily worked. The only essential is that the baseboard of the receiver itself should be very substantial, this having to carry the weight of most of the components, and it forms the "backbone" of the receiver.

At right angles to this at one end is

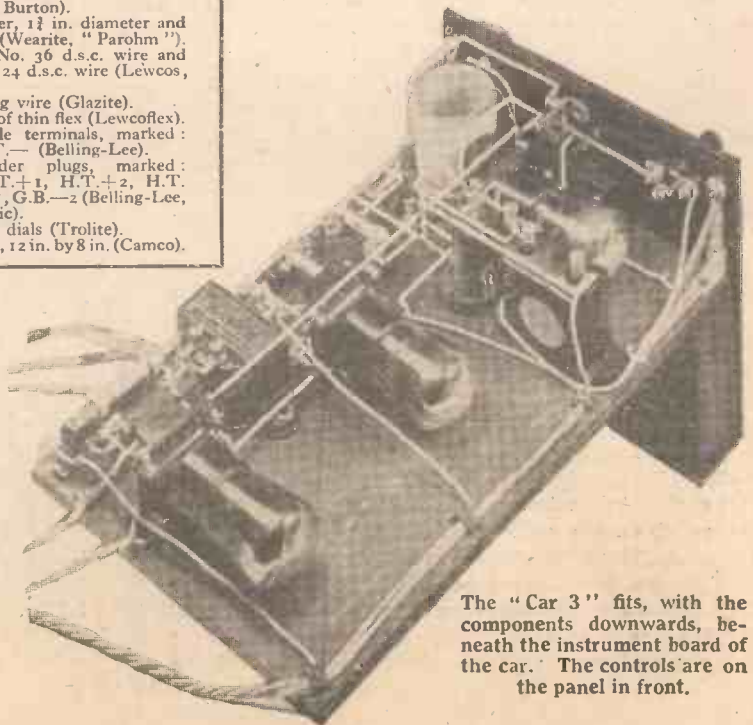

The "Car 3" fits, with the components downwards, beneath the instrument board of the car. The controls are on the panel in front.

THE "CAR 3" (Continued from preceding page)

mounted the panel carrying the few controls, including the tuning condensers and on-off switch. The small wooden casing at the back covers the variable condensers.

The first job when the panel has been cut to size is to drill it (using the blueprint as a guide for the centres), and then to attach it at right

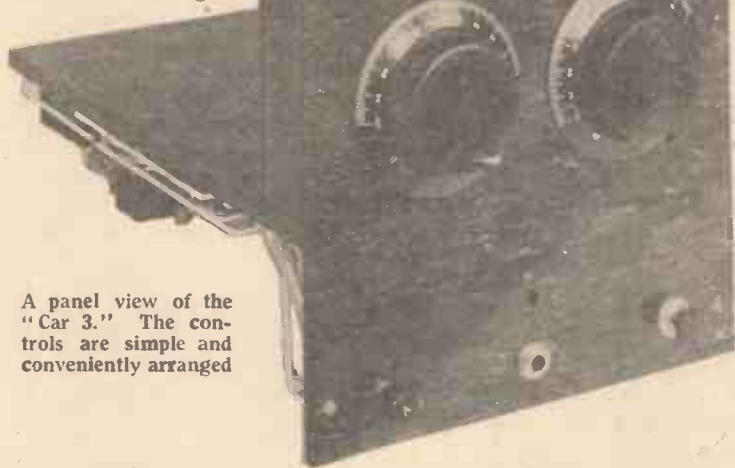

A panel view of the "Car 3." The controls are simple and conveniently arranged

angles to the baseboard. The small panel brackets used should be of a good make, for in rough usage in the car there may be a possibility of the panel being damaged unless it is firmly fixed. When the panel has been attached then the parts may be mounted on it.

Careful Layout

Now the blueprint can be used as a mounting template to show the exact positions of the parts. As has already been said it is advisable to adhere as closely as possible to the layout given. You will see that the tallest component is the condenser in the anti-motorboating circuit and this governs the "thickness" of the receiver below the instrument board. If this is too great, then the receiver may foul the passengers' legs.

Before wiring is undertaken, it would be a good idea for the intending constructor to gain some idea of the circuit employed. He will then have a clearer notion of the scheme of wiring and he should not blindly follow the blueprint without having the satisfaction of knowing what each circuit represents.

The aerial is taken to an intermediate tapping point on the coil. This has the effect of sharpening up the tuning to a great extent. The coil is a single-layer winding working only on the medium waveband; nowadays there is so much to be heard between 200 and 500 metres that it is, in such a set as the "Car 3," hardly worth while going to the trouble of providing dual-range working.

In brief, the circuit is of the type commonly known as "det., R.C., trans.," which

means that a plain grid-leak detector is used, followed by one stage of resistance-capacity coupling and one transformer-coupled power valve. Two features worth noting are the provision of an L.F. filter circuit in series with the R.C. coupler and a stopper resistance in the grid circuit of the L.F. valve. The filter circuit ensures complete stability of the low-frequency side. It consists of a 50,000-ohm resistance in series with the resistance of the R.C. unit and a 2-microfarad by-pass condenser from the join point of these resistances to earth.

The H.F. stopper resistance in the grid circuit is another good point for in many portable sets instability and poor quality are caused by the presence of stray H.F. currents in the low-frequency valve and the fitting of a stopper resistance, as shown here, effectively "kills" the H.F. currents.

A closer examination of the circuit is not really necessary for those who are interested only in the constructional work and who want to have the "Car 3" working as soon as possible; but those who are interested in technicalities can delve farther into the working of the set by comparing the theoretical circuit diagram with the wiring plan given here.

Further notes will be given next week, but in the meantime it should be noted by intending constructors that the "Car 3" will be on view all next week in the Somerset Street windows of Messrs.

Selfridge, Ltd., of Oxford Street, London, W.1.

It would perhaps be advisable to explain here that in cars where, for any reason, it is difficult to make a connection for the L.T. to the car starter battery—though there is usually no difficulty—then an ordinary portable-set type accumulator such as one of the C.A.V. portable series can conveniently be used.

This can be placed in the fascia-board cubby hole of the car, or in a door-pocket, or any handy place, and can be connected to the set by the flex leads. Non-spill types of battery, such as the C.A.V. mentioned, are very suitable for this work, for otherwise there is the danger of spilled acid in the car.

But in most cases it will be found possible to work the "Car 3" from the car battery itself—which is, indeed, the chief point of advantage of this new set.

QUARTZ PECULIARITIES

THE piezo-electric effect of a quartz crystal, which causes it to vibrate mechanically when energised by radio-frequency oscillations, is utilised both for stabilising the frequency of a carrier-wave in transmission and for securing a very high degree of selectivity in reception.

Another peculiar property of quartz, which is not so well known, is that light will flow through it as water flows through a pipe. In other words, a ray of light, in passing through a tube of quartz, does not fall off in intensity according to the inverse square law. This property has been utilised in television receivers.

M. B.

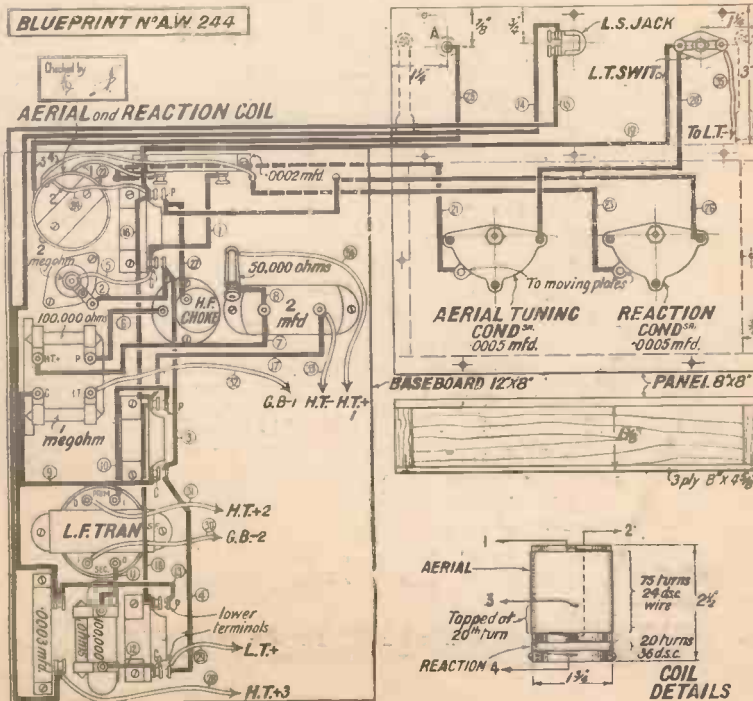

A full-size blueprint can be obtained, price 1/- post free

THE LEWCOS SUPER COIL

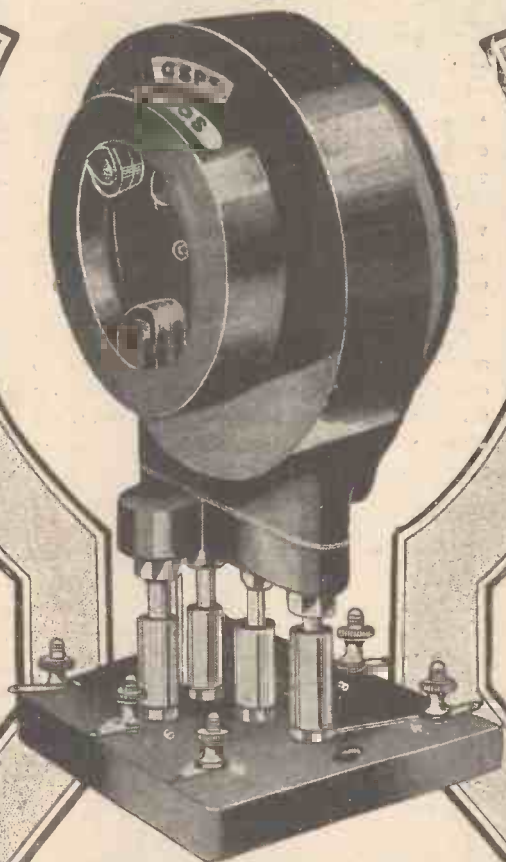

**STANDS ABOVE ALL OTHERS
FOR QUALITY—
AND IT'S A ★ PERFORMER**

Superior to any other make, the Super Coil is one of the greatest "Lewcos" achievements. The following are a few of its advantages:

1. It fits the Standard six-pin base.
2. The Aerial Coil can be used as a Grid Coil followed by one or more H.F. stages, alternately as a Reinartz Aerial Coil with plug-on Reaction winding.
3. The H.F. Transformer, with plug-on primary winding, can be used with three-electrode valves alternating with Screen Grid valves.
4. Range of Primary Coils gives wide choice regarding selectivity and amplification.
5. Litz wound for all wave bands.
6. The Aerial Coil has 3 tapings as similar to the famous Lewcos X Coil.

THE LONDON ELECTRIC WIRE COMPANY
AND SMITHS LIMITED
Church Road, Leyton, E.10

Stocks held at the
following Branches:—

BELFAST
BIRMINGHAM
CARDIFF
DUBLIN
GLASGOW
LEEDS
LIVERPOOL
LONDON
MANCHESTER
NEWCASTLE
NOTTINGHAM



LEWCOS
Radio Products

for
better
reception

Advertisers Appreciate Mention of "A.W." with Your Order

MY WIRELESS

Weekly Tips,
Constructional
and
Theoretical—



DENBY

W. JAMES

For the
Wireless
Amateur

"Anchoring" Transformers

THE point often arises as to whether it is the better plan to earth transformer and choke cases or to leave them not connected

One likes to feel that all parts which can be earthed are earthed. But on the other hand, it must be admitted that earthing may not have the slightest effect.

It all depends upon the particular set. One receiver may howl if the low-frequency transformer is not earthed and this also applies to the output choke. When the low-frequency side is rather cramped earthing may be necessary, and is usually essential when the magnification is considerable. A single earthing wire passing to all the parts is not good practice. Rather should each part be separately earthed.

New Uses for Voltmeters

Low-resistance voltmeters are often condemned as useless, but those who know how to use them recognise their value. Testing a grid-bias battery is a case in point.

If a high-resistance instrument is used the current taken by the meter is small and the voltage indicated is practically the true value. The battery would probably be considered satisfactory if the voltage indicated by the instrument approached the nominal voltage. But this may well be a wrong conclusion.

It is quite possible that the battery, through age, has developed a high resistance. This might greatly affect the working of the set. The low-resistance instrument would show this fault.

Owing to the resistance of the battery the voltage indicated would be much less than normal and no doubt would decrease over a period of a few seconds. A low-resistance instrument is, therefore, of value for a test such as this, the very fact that it takes a fair current being in its favour.

Fewer Knobs

There is a demand to-day for fewer control knobs, and in order to meet this designers may easily go too far. My point is that it is foolish to avoid a knob provided that knob is really useful.

Take volume controls, for instance. Practically all three-valve sets of the high-frequency, detector, and low-frequency

types would be better were two volume controls fitted—one before the detector and the second after it.

With these two controls better quality would certainly be obtained from more stations. One knob controls the amount of the high-frequency amplification and the second controls the low-frequency side.

Therefore the best can be obtained from any station. That few sets have these two controls is due primarily to nervousness on the part of designers, who feel that a set fitted with them looks more complicated than one having fewer knobs.

Fitting Phones

There are occasions when it is desirable to fit a pair of phones to a set without removing the speaker. The diagram shows a simple method.

A stopping condenser is used for safety as indicated, the phones being joined in the detector circuit. Volume from the

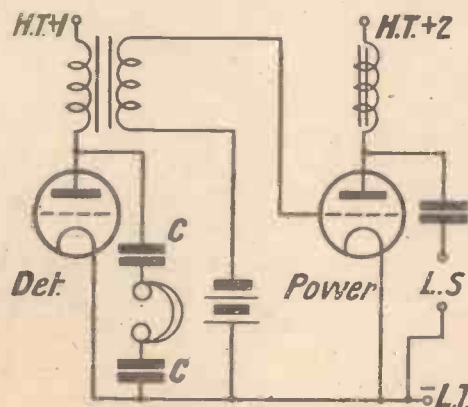

A simple method of working phones with a speaker

loud-speaker will be lost by connecting the phones and the quality is bound to be altered a little if a good loud-speaker is in use.

For simplicity, however, the scheme is a good one and is quite safe. It is as well to use a safety condenser and to connect the phones as indicated for fairly high voltages may be available in the detector circuit when a mains unit is employed. The telephones are, in effect, choke fed, the primary winding of the transformer being the choke.

Adding H.F.

Those who feel that wireless sets comprise merely a number of parts put together anyhow, generally experience a shock when they try to add a second high-frequency stage.

That some sets work at all is due to the effectiveness of modern valves and parts, there being, as a rule, magnification to spare in any fairly well made receiver. When a second high-frequency stage is added, however, lack of real design soon reveals itself.

The high-frequency stages are unstable, magnification is poor and the results are, in many instances not so good as from a smaller set.

Many points that must be watched when building a set having two high-frequency stages can be ignored when there is only the one stage. Screening, decoupling, and other points must be very carefully considered when arranging a 2HF set.

Switch Contacts

I have just had a little experience which shows how careful one must be with even the simplest of circuits. The set was an ordinary two-valver. It had a tuning coil comprising long- and short-wave sections, with a single reaction winding; the long-wave portion of the coil being short-circuited when receiving the short waves.

The set had worked satisfactorily, but when I saw it the reaction circuit appeared to be faulty, as the set could not be made to oscillate over a part of the short-wave range. It had oscillated quite freely over the whole range, but the fault had developed. One naturally suspects first the detector circuit.

This seemed satisfactory, however, both valve and high tension being normal. From past experience I was inclined to suspect the coil. The coil itself was not faulty, so far as the eye could see, and I noticed that the short-circuiting switch was not making a very good contact.

Attention to this cleared the fault. Although the switch was working, its resistance was so high that instead of the long-wave part of the coil being short-circuited, the switch was, in effect, putting a high resistance across it.

EVERY RADIO MYSTERY SOLVED!

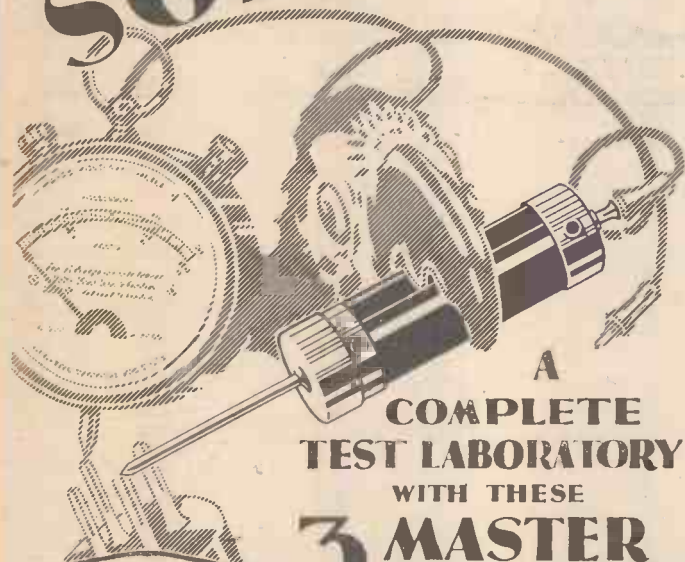

A COMPLETE TEST LABORATORY WITH THESE 3 MASTER INSTRUMENTS

WHAT YOU CAN FIND OUT WITH THESE 3 INSTRUMENTS.

MEASUREMENTS.

L.T. Accumulator Volts, H.T. Battery Volts. Valve consumption in M.A. Resistances between 50 and 2,000 ohms.

TESTS.

For broken valve filament, insulation of condensers. Short circuits, distortion. If valve is working to correct characteristics. Whether circuit is complete.

DATA.

Average depreciation of L.T. and H.T. current, performance of each valve. Milliamps consumed per valve under varying conditions. All information regarding consumption and values of current used.

Write for descriptive leaflets.

THE WATES POLYSCOPE.
An amazingly ingenious device which, containing a small battery, enables you to test and check everything you want to know. It can be used in conjunction with any 3 in 1 meter but for dead accurate work is recommended for use with the genuine 3/- Wates 3 in 1 meter.



THE WATES TEST PLUG FOR VALVES.
Makes the testing of valve consumption, filament faults, distortion and checking of the valves characteristics a simple and accurate operation. Just plug into the valve socket and fit valve into the test plug. A Wates or other milliammeter will give you the readings from the two terminals fitted. For 4 or 5 pin valves.



THE WATES 3 in 1 VOLT AMP METER.
The famous meter has 3 readings: 0-6 and 0-150 Volts and 0-30 M.A. Resistance, 5,000 ohms. The genuine and original patented 3 in 1 meter—guaranteed. 8/6



Obtainable from all Radio dealers

An additional refinement

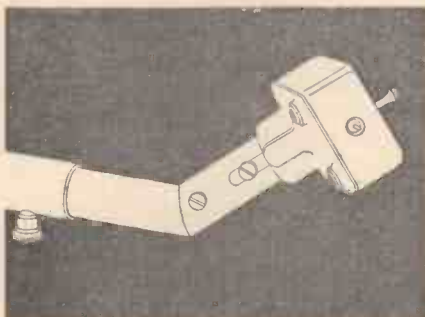
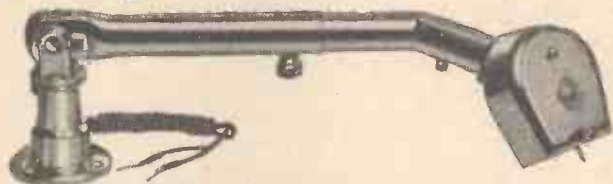

STILL THE SAME PRICE

45/-

The B.T.H. pick-up holds a reputation second to none for excellence and efficiency. Now, with this latest development in the design of the B.T.H. Tone Arm, the complete accessory forms a masterpiece of ingenuity, combining perfect tracking, a feature of B.T.H. pick-ups, with the new arrangement which facilitates the changing of needles. The combination of the B.T.H. pick-up and the B.T.H. Tone Arm ensures a minimum of record wear and excellent tonal quality.



PICK-UP & TONE ARM

From all Radio Dealers



THE EDISON SWAN ELECTRIC CO., LTD.,
Radio Division,
1a Newman Street, Oxford Street, W.1.
Showrooms in all the Principal Towns.

EDISWAN

W.78

M.B.

Please Mention "A.W." When Corresponding with Advertisers

THE STANDARD BATTERY CO. (Dept. A.W.)
184-188, SHAFTESBURY AVENUE,
LONDON, W.C.2.



Conducted by our Technical Editor: J. H. REYNER, B.Sc. (Hons.), A.M.I.E.E.

Chakophone Tuner

ON the question of efficiency there is much to be said for the old pattern all-wave tuner, consisting as it does of a single-layer winding with an internal rotating reaction coil. This form of inductance, owing to the length and diameter of the former, can be made to give a high electrical efficiency. Recently its application has become more limited owing to the difficulty in obtaining sufficient selectivity to meet modern broadcasting conditions. That this difficulty can be overcome is convincingly shown in the Chakophone all-wave tuner, marketed by Messrs. Eagle Engineering, which possesses a commendable degree of selectivity on the shorter broadcasting wavelengths where it is most required.

The windings are placed in six single-layer sections on a 3 in. impregnated cardboard former. The turns of the coil not required in use are short-circuited by a rotary ball selector switch, the position of which is indicated by an external circular oxidised-brass panel plate. Reaction is obtained by the use of an internal swinging coil, the position of which is indicated by a knob moving over a second oxidised panel plate. There are three terminals only, for aerial, grid and earth connection.

Our test was carried out with a conventional two-valve set with a detector and low-frequency stage. In order to obtain efficient reaction control it was necessary to by-pass the primary of the low-frequency transformer with a condenser of not less than .0003 capacity. On a short outside

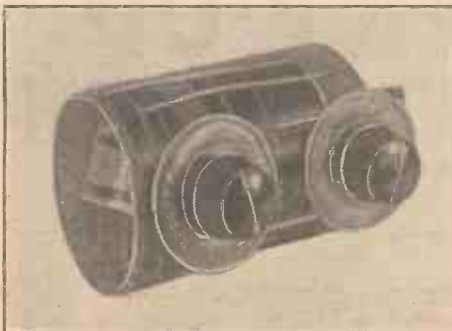

A successful all-wave tuner, the Chakophone

aerial the wavelength range extended from 150 to 1,900 metres approximately. Owing to the ample overlap allowed between consecutive taps it was possible to obtain a station on two different taps, thus in many cases allowing the higher inductance wind-

ing to be selected for optimum results.

The aerial tapping had the greatest effect on the low wavelength where it is most required, and by using an indoor aerial we were able to separate the two Brookmans Park stations at a distance of only six miles. Even with these results signal strength does not appear to be lost unduly.

The coil can be mounted to a panel by drilling two holes for the selector switch and reaction control. It can be recommended as a thoroughly up-to-date tuner.

Imperial Switch

THE Imperial screw switch submitted for test by Messrs. C. Lyons, of 39 Charles Street, London, E.C.1, is a component of the simplest pattern, which should be quite foolproof, if perhaps a little tedious to operate.

The switch consists of two contact strips fixed between two discs, one of metal and the other of ebonite. Reciprocating motion

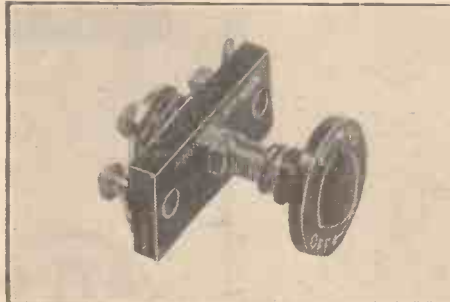

The Imperial screw-down switch

of the discs is obtained by rotating an ebonite knob attached to a screw-threaded spindle. Rotating the knob in a clockwise direction brings the contact strips up against the ebonite disc and in the reverse direction against the metal disc. As these discs rotate, the contact strips are self-cleaning, whilst the constant straining in either direction keeps them in the correct position.

There are no very definite limits to the motion of the knob, although two revolutions are ample to ensure perfect make and break of the contacts.

If readers are ever troubled with bad contact on their normal switches and are prepared to rotate their knobs two revolutions every time they switch their set on or off, then this component will suit them admirably. The finish is good, and the directions "On" and "Off," together with arrows, are engraved in white on the knobs.

Saxa Mercury Contact

AS little operating power is available in remote control relay switches, the contact springs are often of the lightest type and are not always sufficiently self cleaning. There have been experimental types of relay in which the contacts have been dip-

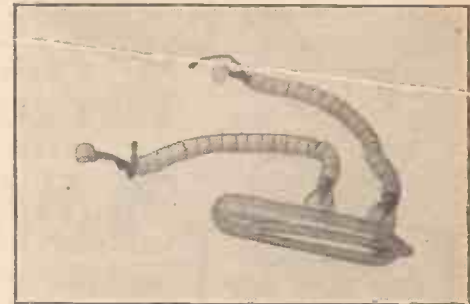

The mercury-contact element of the Saxa tube

ped into mercury cups, thus eliminating any possibilities of contact resistance; but the disadvantage here is that the mercury is liable to spill.

With a knowledge of the problems confronting relays we were particularly interested in a Saxa mercury switch tube sent us by the Saxonia Electrical Wire Co., Ltd. This device consists of a glass tube containing mercury and an inert gas. At one end of the tube there are two metal contacts, sealed into the glass and terminating in short conducting leads. The tube is so arranged that when tipped slightly on one side the mercury runs into the depressions in which the contacts are fitted and closes the circuit. On tilting the tube in the other direction the mercury flows away from the electrodes causing a quick break of contact. Due to the presence of the inert gas arcing is very appreciably reduced.

This particular sample, which is known as pattern 4, is one of many types of tube made in all shapes and dimensions. Its application to wireless switching is quite straightforward, one merely has to arrange a moving armature capable of tilting the tube in either direction. We understand that special electro-magnetic units are made to operate this switch, full details of which can be obtained from the Saxonia Electrical Wire Co., Ltd.

Once the switch is set up there is very little to go wrong, and one is sure of a perfect contact between the two electrodes. This sample is rated to carry two amps.



Camco Cabinets
for your Radiogram
also
**PORTABLES,
TRANSPORTABLES,
LOUD SPEAKER CASES
ETC.**

Send for complete booklet, or call and see full range at our showrooms.

Oak Mahogany
£7 : 10 : 0 £7 : 15 : 0

**CARRINGTON MANUFACTURING
CO., LTD.,**
24, Hatton Garden, London, E.C.1
Phone: Holborn 8302
Factory: Camco Works, Sth. Croydon
5405

Complete with 16 1/2" baseboard and removable baffle board

Eliminate trouble!

TYPE W.14 21/-

Trouble sometimes occurs in a radio battery during a programme that you specially wish to hear. Don't be let down like this. Build an eliminator that will give steady current—free from all trouble—by specifying Heayberd Transformer as the important link-up.



POWER TRANSFORMERS
F. C. HEAYBERD & CO., 10 Finsbury Street, E.C.1
Phone: Clerkenwell 7216

IGRANIC "J" Type TRANSFORMER

AGAIN Specified by Experts in
"THE CAR THREE"

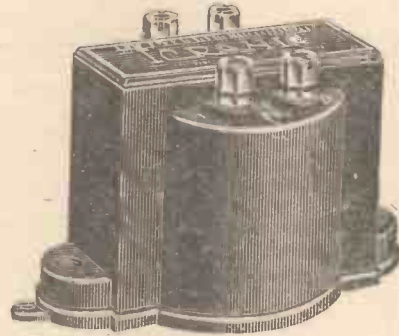

PRICE 17/6

Write to Dept. D.145



Works BEDFORD

FOR...
ELECTRIC REPRODUCTION
USE A LIMIT

Adjustable Length Tracking Angle Spring Tension



Illustration shows Pick-up attached.

PICK-UP ARM 15/6 EACH

Obtainable through all factors and dealers or write

LIMIT RADIO LIMITED, ALBION ST., LONDON, N.1

H & B CAR 3 KIT

Complete kit ready for immediate construction. Panel drilled ready. All components exactly as used in the original. Including special coil ready wound exact to specification, together with wire and **Cash Price £3 12 6**
FULL-SIZE BLUEPRINT with each kit
Write for detailed list. Any parts sold separately. Three Mullard, Cossor or Mazda Valves £1 7 6 extra. The constructed set can be inspected at our showrooms.

BARGAINS IN RADIO

All guaranteed new. But shop soiled.
EKCO All-power Eliminator, model A.C. C.2A. L.T., H.T. and G.B. List Price £10 17 6. Special Price £8.
PYE A.C. Eliminators (6 only). H.T. 4 tappings, 1 variable, in original boxes. List £5 5 0. Our Price £3 each.
EDISWAN Dulcivox Loud-speakers, perfect (8 only). List £2 2 0. Our Price 12/6 each.
CLIMAX CHELLOSET 2-valve Receiver, A.C. model, as new. Perfect condition, complete with 2 Mullard valves. List £9 17 6. Our Price £7 10 0.
Carriage Paid on all cash orders. C.O.D. Charges Paid over £1.

H & B RADIO CO., 34, 36, 38, Beak Street, Regent Street, W.1
GERRARD 2834

A Simple Circuit

for a small eliminator suitable for many of the popular 3-valve radio sets, requiring up to 20 m.a., at 120 volts.

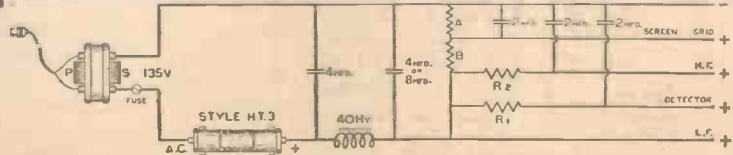

Incorporating the Type H.T.3



METAL RECTIFIER

which has no filaments, chemicals or moving parts

Full details are given in "The All-Metal Way 1930," our new 32-page book, which shows you how to run your set entirely from your A.C. mains. Send 2d. stamp with your name and address to:—

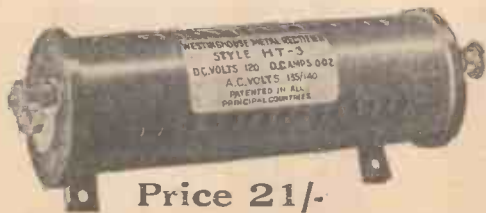

Price 21/-

The Westinghouse Brake & Saxby Signal Co., Ltd., 82 York Road, London, N.1

OUR INFORMATION BUREAU



RULES.—Please write distinctly and keep to the point. We reply promptly by post. Please give all necessary details. Ask one question at a time to ensure a prompt reply, and please put sketches, layouts, diagrams, etc., on separate sheets containing your name and address. See announcement below. Address Queries—AMATEUR WIRELESS Information Bureau, 58/61 Fetter Lane, London, E.C.4

"Hartley DX Three"

Q.—I have made up the above set and get very good results on the ordinary broadcast wavelengths. Not knowing the size of coils required for reception on the Daventry 5XX waveband, I have been unable to receive the long-wave stations. Can you assist me in this respect?—P. D. (London, E.).

A.—For the reception of long-wave stations such as Daventry 5XX, we advise the use of a No. 200 centre-tapped coil. Such a coil should enable you to get very satisfactory results on other long-wave stations also.—C.

Pick-up Distortion

Q.—I use a pick-up in conjunction with my set. In the first L.F. valve grid circuit I have incorporated a volume control, which works quite normally with the wireless receiver in operation. When I connect up the gramophone pick-up and commence to play records I experience terrible distortion. No adjustment of the volume control seems to remedy the distortion. The volume is certainly reduced, but the music is raucous and extremely unpleasant. Can you tell me why this should be so, especially as I get such good reproduction from the wireless part of the set?—F. L. (Bradford).

A.—Evidently you have your pick-up connected between the grid and filament of the

detector valve. As you have the pick-up connected directly in circuit without a volume control across its terminals, you are overloading the grid of the detector, which is now

When Asking Technical Queries

PLEASE write briefly

A Fee of One Shilling (postal order or postage stamps) must accompany each question and also a stamped addressed envelope and the coupon which will be found on the last page. Rough sketches and circuit diagrams can be provided for the usual query fee. Any drawings submitted should be sent on a separate sheet of paper. Wiring plans and layouts cannot be supplied.

Queries cannot be answered personally or by telephone.

operating as the first L.F. valve. The first L.F. valve in the grid circuit of which you have a volume control, is now the second L.F. amplifi-

ing stage, so that no adjustment of this volume control will prevent overloading the actual first L.F. valve when the pick-up is used. Therefore we advise you to connect a volume control in addition to that already in the set, across the terminals of the gramophone pick-up. Then you will be able to avoid overloading the first valve grid and so eliminate the distortion experienced.—L.

Canadian Import Tariff

Q.—Before leaving England I built an "Ether Searcher" receiver, and the results I obtained from this set seem to have made me rather fastidious. As far as I can judge, British three-valvers seem to give as good results as most six-valvers out here. Whether it is the valves or not, I cannot say. In any case I am wanting to build up a set with British components, and wonder if you can tell me whether there is an import tariff on British wireless goods into this country, and if so, what is the fee?—C. M. (East Ontario).

A.—The import tariff on most wireless and electrical goods entering Canada from Great Britain is 15 per cent. of the cost of the goods. If you order a parcel of goods from one of the wireless stores in England, the whole parcel could be paid for either on dispatch or at delivery.—L. C.



THE B.B.C. does not often go outside London nowadays for its dance band music. A change, however, is being made in Scotland, where arrangements are complete for five different dance bands to relay locally during the summer. The first of these to broadcast is the band at the Gleneagles Hotel, under the direction of Mr. Henry R. Hall, director of music of the L.M.S. hotels.

On September 10, when the St. Leger takes place this year, the B.B.C. will broadcast a running commentary on the race from the Town Moor Course at Doncaster, between 2.50 and 3.15 p.m.

Ingredient X, a thriller by L. du Garde Peach, will be revived at the London studio on September 8; it will be re-broadcast on the following evening through the National transmitters.

The first musical programme which was relayed by telephone from Austria to British listeners on August 7 last marks a further advance in international broadcasts. It was made possible by the completion of the new cable from Nürnberg, through Passau (Germany) to Linz (Austria) and thence to Vienna. More than one thousand miles of circuit was used, the route being Salzburg, Linz, Nürnberg, Stuttgart, Frankfurt, Cologne, Aachen, Liège, Ghent, Ostend, Laparine, Canterbury and London. This new cable is specially constructed for the transmission of high quality music. Further relays from the Salzburg Festival will be carried out on August 20, when Gluck's opera *Iphigenia in Aulis* will be conducted at the Feestspielhaus with leading singers and orchestra from Vienna. On August 30, the B.B.C. will give British listeners an orchestral concert of the works of Mozart

and Haydn; both performances are under the direction of the well-known conductor, Bruno Walter.

Although just an hour or so earlier he had been involved in a serious motoring accident, the Rev. Dr. T. Ratcliffe Barnett, a well-known Edinburgh author and clergyman, fulfilled his engagement to broadcast a talk from the local studio. Dr. Barnett was driving a car which came into collision with a van, and, skidding through a hedge, fell nearly 20 feet to a field below. He sustained a cut on the head, while members of his family were also injured. Nevertheless, Dr. Barnett carried out his broadcast successfully.

The Carnegie (United Kingdom) Trustees have approved for subsidy an experimental scheme of adult education by wireless in the counties of Lanark and Dumfries. The experiment is to be conducted under the auspices of a joint committee under the chairmanship of Principal Rait, Glasgow University, and is to have the services of the B.B.C. experts in the area.

F. Morton Howard's sketch entitled *The Brute* will be given by Vera Ashe and Michael Hogan in a National vaudeville entertainment to which Clarice Mayne, Georgie Wood, Tommy Handley, and the Four Fayre Sisters also contribute.

MORE RADIOGRAMS

WHILE officials of the B.B.C. still deny that a site for the new central station in Scotland has been definitely bought at Falkirk, it is understood on good authority that only a few legal formalities remain to be fulfilled before the purchase of the necessary ground may be announced. The station, it is anticipated, will take a year or two to complete.

An interesting story has come to light as to how, through a broadcast S.O.S., a son, whose whereabouts in England were unknown, was summoned to the bedside of his father lying critically ill at Alloa, Scotland. The relatives approached the local police, who got in touch with Scotland Yard and caused an S.O.S. to be broadcast. The son was in employment at Reigate, Surrey, and an electrician employed in the same establishment happened to turn on the household receiver just as the message was being sent out.

The B.B.C. will relay a symphony concert from the Kursaal, Ostend, on August 17. Two prominent Continental artistes to be heard will be Marcel Journet of the Paris Opera House and Henry Gadayne (violinist).

Following the passing of the new wireless laws, a special radio police force is to be organised in Belgium, with a view to stamping out the innumerable "pirates" who persistently refuse to take out the official licences. The new regulations empower this special body of police to enter

the premises of illicit owners and to confiscate their wireless receivers.

It is stated that the Oslo 60 kilowatt transmitter is now devoting its activities to the broadcast of the studio programmes on 135 metres.

Now that the 1½ kilowatt station at Nidaros (Norway) is in regular operation on 453 metres, it is expected that the new relay transmitters at Kristiansand, Bodo and Stavanger will be opened next month.

Almost weekly a new private station is registered in Belgium; the latest addition to the list is Radio Courtrai, working on 243 metres every Sunday from 10.30 a.m. until mid-day. The call is given out in French and Flemish: "Allo ici station experimentale belge L/IH, 39 Esplanade, Courtrai."

So many complaints have been lodged by Parisian listeners regarding the interference caused by the large number of stations operating in the French capital that it is now stated that the majority of the transmitters will be removed by the end of 1930. Radio Paris is at present erecting a high-power station in the neighbourhood of Essarts-le-Roi, Radio Vitus will transfer its broadcasting plant to Romainville, and an early move is also anticipated on the part of the Poste Parisien and Radio L.L. The P.T.T. short-wave transmitter of which the broadcasts are destined to the French Colonies is to be installed on a site between St. Germain and Champbourey.

Postcard Radio Literature

A.C. Sets
ALL-MAINS sets from a simple three-valver to a console radio-gramophone are made by Clarith Reproducers, Ltd., and are well illustrated and described in a folder just issued. You should get this. **13**

Finding the H.T.
There are still many districts lacking a mains supply, and with some sets economical working cannot be obtained with dry H.T. batteries. A solution is the M.L. anode converter which derives H.T. from the L.T. accumulator. Get a folder describing this if you are a "mains-less" listener. **14**

The Battery Problem
People imagine that all dry H.T. batteries operate on the same principle, which is a sorry delusion. Pertrix have just sent me a catalogue which tells in an interesting way how these batteries differ in their action from the ordinary sal-ammoniac battery. Pertrix also make sturdy L.T. accumulators, and this catalogue describes them all. **15**

For Short-wavers
If you want to experience some of the fun of short-wave working without the necessity for making up a special short-wave set, then you will be interested in the Magnum short-wave converter, a new idea of Burne-Jones & Co., Ltd. Literature is available describing this unit, which enables practically any set to be worked on the short waves. **16**

New Panels
Have you seen the new Trolitax panels, the product of F. A. Hughes & Co., Ltd., of Blue-Spot fame? Trolitax is a new panel material available in many modern finishes, and before you make up that new set you should get the illustrated Trolitax leaflet. **17**

OBSERVER.

GET THESE CATALOGUES FREE.
Here "Observer" reviews the latest booklets and folders issued by well-known manufacturers. If you want copies of any or all of them FREE OF CHARGE, just send a postcard giving the index numbers of the catalogues required (shown at the end of each paragraph) to "Postcard Radio Literature," "AMATEUR WIRELESS," 58, 61, Fetter Lane, E.C.4. "Observer" will see that you get all the literature you desire.

READ THIS:—

"There is everything in favour of buying a complete kit of parts and nothing against it. You get all the little items, such as screws, etc., and your panel is neatly drilled for you. Moreover, you are certain that every component is suitable for the set—that is if you purchase an approved kit such as is sold by Ready Radio."
vide "Popular Wireless."

KITS OF PARTS

CONTINENTAL PORTABLE
THE CAR THREE
MAXIMUM FOUR
1930 TALISMAN TWO
GRAMO-RADIO TWO
ETC., ETC.

Cash or Easy Terms. Lists on Application

Ready Radio

159 BOROUGH HIGH STREET,
LONDON BRIDGE, LONDON, S.E.1
'Phone: HOP 5555 (Private Exchange)

Again Exclusively Specified!

TUNEWELL DUAL X-TAPPED COILS

for this year's

BRITAIN'S FAVOURITE THREE



Range :
190/570
950/2000
metres.

Price :
10/6
each.
Complete with
3-point
switch.

Send for lists describing the whole Tunewell range of Coils, Chokes, Transformers, Condensers, Cut-outs, Speakers, etc.

TURNER & CO.

54 Station Road, New Southgate, N.11

Letters to the Editor

Correspondence should be brief and to the point and written on one side of the paper. The Editor does not necessarily agree with the views expressed by correspondents.

Short-wave Outside Broadcasts

SIR,—I was interested to read recently in "A.W." how the B.B.C. arranges its outside broadcasts. So far as I can gather, however, the engineers appear to dislike outside wiring, and they connect up their amplifiers to the first available telephone point.

As a short-wave fan may I be permitted to make the suggestion to the B.B.C. that they should use a short-wave wireless link between the van and Savoy Hill, particularly when the distance is considerable and the cost of the landline might be great. The German Reichsrundfunk engineers have an O.B. van fitted up with a special short-wave transmitter which can be in constant touch with the Berlin control room. Also, I seem to remember that in the early days the B.B.C. carried out a relay from a London theatre by means of a short-wave transmitter; and the boat-race broadcasts are always given in this way.

Some of the landline distortion we get, owing to the long telephone leads, is

terrible. Much of this could be overcome if short-wave transmitters and receivers were used.
B. K. (London).

"Safe" Fixed Condensers

SIR,—In his recent article on developments in components, Mr. W. James says that some parts are very reliable. He instances the fact that fixed condensers seldom give trouble. Perhaps I have had unfortunate experience with fixed condensers, but I must say that I have had condenser trouble in each of the three eliminators I have made up during the past couple of years or so.

True, these were not very expensive jobs having a mica dielectric, but they were "guaranteed" paper condensers, stated to be able to carry twice the voltage that was the working limit in my eliminators. In each of the three cases I had the bother of the condenser insulation breaking down.

Perhaps I should have chosen mica-dielectric condensers for this work, but if the makers' figures had been accurate my paper condensers would still have been working. I know that in eliminators "peak" voltages occur when suddenly switching on and off, but I do not see how these can be estimated or accurately measured, and so many people seem to use paper condensers for mains work. Possibly, I have been unlucky. It would be helpful if Mr. James would give some guiding information for amateurs building up eliminators. I share his view that valve holders are not too good, and that a proportion of variable condensers give trouble. Generally speaking, there is still room for improvement in many components.

J. H. J. (Shrewsbury).

Children's Hour Improvements

SIR,—Why is it that nobody ever complains about the stilted attitude adopted by the new "uncles" and "aunts" who take part in the Children's Hour? As the father of a large family, I do profess to know something of the child mind, and I cannot conceive anything more monotonous for young children than the "highbrow" fairy stories and unsuitable songs which are now given.

As a matter of fact, I was often disengaged at the hour when the children's feature was broadcast and I used to take some interest in it, but of late the style of matter seems to have changed, and I do not listen, nor do the children. Personally, I should like to see a return to the old days when the old familiar stories and simple child songs were often given:

PATERFAMILIAS (London, E.).

HOME CHARGING

WHILST no harm is done by slow charging an accumulator, i.e. supplying current of less amperage than that quoted by the maker, very considerable damage will follow over-charging. The usual result of repeated over-charging is that the positive paste comes away from the plates, in which case the accumulator may as well be written off as a total loss.

The danger of over-charging does not often arise in the home unless a tantalum or other heavy current rectifier is used, or unless the accumulator is left on overnight without attention. Over-charging may occur either by charging for too long a time or by using too heavy a current.

It is frequently stated in makers' catalogues that an accumulator requires recharging as soon as the terminal voltage taken whilst the accumulator is on load has fallen to 1.8 volts. It is not always made clear, however, that this is only true when the cell is discharging at what is called the ten-hour rate.

For instance, in the case of a 20 ampere hour cell, the "ten-hour" rate of discharge is 2 amperes. If this cell happens to be feeding a set where the total filament consumption is only one ampere, it should be recharged as soon as the terminal voltage drops below 2 volts. If it is allowed to fall as far as 1.8 volts, it is being over-charged.

M. L.

RAYMOND'S

27 & 28a, LISLE ST., LONDON, W.C.2

Come to LEICESTER SQUARE TUBE STN.
This address is at the back of Daly's Theatre

NOTE.—NEW PHONE NUMBER—GERRARD 2621

WE ARE OPEN

ALL DAY EVERY DAY. Hours: 9 a.m. to 8 p.m.
ALL DAY SATURDAY. Hours: 9 a.m. to 9 p.m.

BRITAIN'S 1930 FAVOURITE THREE SET

(As described in this issue)

Complete Kit of parts using alternative components,
Packed and sent Carr. Paid, with
Blueprint, for ... **£3.12.6**

THE STRAIGHT THREE

A Complete Kit of Parts with Blueprint, 2 L.F. Trans., Dual Range Coil, 3 Marconi V.H., '0003 and 2 meg. Leak, '0001, good make H.F. Choke, '0005 and '0003 Var. Con., 2 Slow Motion Dials, Pol. Panel 14 by 7. Set Leids, Oak Cabinet, Wire, Screws. Usually 70/- Special Reduced Price until August 30th. ... **35/-**
Packing and Carriage 3/- extra.

<p>THE UNDY DYNAMIC EIGHT-POLE UNIT AND CHASSIS. List 35/- 50/- Carr. free. Or. Unit only, List 25/- 17/6</p>	<p>THE UNDY PICK-UP AND BALANCED TONE ARM. With Volume Control. List 35/- 29/6 Sent post free. Or cheaper model, post free, x9/6.</p>
----------------------------------------------------------------------------------------------------------------------	----------------------------------------------------------------------------------------------------------------------------------------------

IMPORTANT. All letters and communications must be addressed to
K. RAYMOND, LTD.
27 & 28a LISLE STREET, LONDON, W.C.2

The name of the street is not sufficient.



In addition to their own extensive range, PETO SCOTT offer YOU Every Known Radio Receiver or Component on

EASY TERMS

with SERVICE AFTER SALES

The following list is merely representative, and we ask you to fill in the coupon below or send us a list of your requirements.

R-GENTONE		
SEND Model W.5 Portable, E.T. Eliminator for A.C. Mains. Output 120 volts at 15 m.a. 2 variable and 1 power ONLY tappings.	Balance in 11 months by payments of	10/9
FKCO		
SEND Model 1 V.23 Portable, E.T. Eliminator for A.C. Mains. Output 120 volts at 20 m.a. 1 variable, 1 S.G. and 1 Power tapping.	Balance in 11 months by payments of	8/6
EXIDE		
SEND 120 volt W.H. Type, H.T. Accumulator, complete with crates, dry charged.	Balance in 11 months by payments of	8/6
EPOCH		
SEND Model 61 P.M. permanent magnet moving coil loud-speaker. Perfect reproduction without battery or mains for field.	Balance in 11 months by payments of	12/4

KITS & ACCESSORIES, ETC.

We specialise in deferred payments for all KITS, miscellaneous components, accessories, etc.

WE ARE THE "EASY WAY" SPECIALISTS.

PETO SCOTT CO. LTD.

77 City Rd., London, E.C.1. Phone: Clerkenwell 9496.
7-8, 68 High Holborn, London, W.C.1. Phone: Chancery 8266. 4 Manchester St., Liverpool. Phone: Central 2134. 83 Whitlow Rd., Chorlton-cum-Hardy, Manchester. Phone: Chorlton-cum-Hardy 2028.

PLEASE SEND ME YOUR EASY WAY QUOTATION FOR ITEMS MARKED

NAME

BROADCAST TELEPHONY

Broadcasting stations classified by country and in order of wavelengths. For the purpose of better comparison, the power indicated is aerial energy.

Metres	Kilo-cycles	Station and Call Sign	Power (Kw.)	Metres	Kilo-cycles	Station and Call Sign	Power (Kw.)	Metres	Kilo-cycles	Station and Call Sign	Power (Kw.)
GREAT BRITAIN											
25.53	11,751	Chelmsford (5SW)	15.0	306	980	Bordeaux (PTT)	1.0	305	821	Algiers (PTT)	10.0
*200	1,500	Leeds	0.13	316	950	Marseilles (PTT)	0.5	416	821	Radio Maroc (Rabat)	10.0
*242	1,238	Belfast	1.0	326	914	Grenoble (PTT)	0.5	1,250	240	Tunis Kasbah	0.0
*261	1,148	London Nat.	45.0	329	914	Poste Parisien	0.5	364	824	Bergen	1.0
*288.5	1,040	Newcastle	1.0	346.2	869	Strasbourg (testing shortly)	12.0	369	813	Frederiksstad	0.7
288.5	1,040	Swansea	0.13	571	808	Radio LL (Paris)	0.5	453	662	Nidaros	1.2
288.5	1,040	Stoke-on-Trent	0.13	385	779	Radio Toulouse	8.0	455	650,3	Porsgrund	0.7
288.5	1,040	Sheffield	0.13	447	671	Paris (PTT)	0.3	*493	608	Oslo	1.5
288.5	1,040	Plymouth	0.13	406	644	Lyons (PTT)	5.0	135	2,222	Oslo	00.0
288.5	1,040	Liverpool	0.13	1,440	207	Eiffel Tower	12.0	214	1,400	Warsaw (2)	2.0
288.5	1,040	Hull	0.13	*1,725	174	Radio Paris	16.0	234	1,283	Lodz	1.5
288.5	1,040	Edinburgh	0.35	227	1,319	Cologne	4.0	313	959	Cracow	0.5
288.5	1,040	Dundee	0.13	227	1,319	Münster	3.0	335	896	Poznan	1.2
288.5	1,040	Bournemouth	1.0	232.2	1,290	Aachen	0.35	381	788	Lvov	2.0
288.5	1,040	Bradford	0.13	239	1,256	Nürnberg	2.0	385	779	Wilno	0.5
*301	995	Aberdeen	1.0	244	1,227	Cassel	0.25	*408	734	Katowice	10.0
*310	968	Cardiff	1.0	253	1,184	Gleitwitz	2.0	1,411	212.5	Warsaw	8.0
*356	843	London Reg.	30.0	*259	1,157	Leipzig	2.5	320	937.6	Lisbon (CTIAA)	0.25
*377	797	Manchester	1.0	*270	1,112	Kaiserslautern	0.25	394	761	Bucharest	12.0
*399	753	Glasgow	1.0	*275.8	1,087	Königsberg	2.5	720	416.6	Moscow (PTT)	20.0
*479	626	Midland Reg.	25.0	283	1,058	Magdeburg	0.5	800	375	Kiev	20.0
1,554	193	Daventry (Nat.)	25.0	283	1,058	Berlin (E)	0.5	824	364	Sverdlovsk	25.0
AUSTRIA											
*216	1,220	Linz	0.5	283	1,058	Stettin	0.5	1,000	300	Leningrad	20.0
*283	1,058	Innsbruck	0.5	316.0	946.6	Bremen	0.35	1,090	283	Tiflis	10.0
*352	851	Graz	9.0	320	937.6	Dresden	0.25	1,073	279	Rostov (Don)	10.0
*453	666	Klagenfurt	0.5	325	923	Breslau	1.5	1,103	272	Moscow Popoff	40.0
*617	578.5	Vienna	20.0	360	833	Stuttgart	1.5	*1,304	230	Moscow-Stchelkovo (C.C.S.P.)	100.0
BELGIUM											
206	1,460	Antwerp	0.4	372	806	Hamburg	1.5	1,380	217.5	Bakou	10.0
216	1,391	Chatelineau	0.25	390	770	Frankfurt	1.5	1,497	200	Moscow	20.0
216	1,391	Brussels (Conference)	0.25	418	716	Berlin	1.5	251	1,193	Barcelona (EAJ15)	0.5
239	1,256	Binche	0.3	453	662	Danzig	0.25	266.7	1,125	Barcelona (EAJ13)	5.0
243	1,235	Courtrai	0.2	473	635	Langenberg	15.0	349	860	Barcelona (EAJ1)	8.0
244.7	1,226	Ghent	0.25	533	563	Munich	1.5	368	815	Seville (EAJ5)	1.5
247	1,213	Schaerbeek	0.5	560	536	Augsburg	0.25	424	707	Madrid (EAJ7)	2.0
294	1,020	Liège	0.25	566	529	Hanover	0.35	462	649	San Sebastian (EAJ8)	0.5
338	887	Brussels (No. 2)	3.0	570	527	Freiburg	0.35	230.1	1,304	Malmö	0.6
*509	590	Brussels (No. 1)	1.0	*1,635	183.5	Zeelen	26.0	*257	1,160	Hörby	10.0
CZECHO-SLOVAKIA											
*263	1,139	Moravska-Ostrava	10.0	1,635	183.5	Norddeich	10.0	209	1,000	Falun	0.5
*279	1,076	Bratislava	12.5	HOLLAND							
293	1,022	Kosice	2.0	81.28	9,599	Eindhoven (PCJ)	30.0	230.1	1,304	Malmö	0.6
*342	878	Brno	12.0	*299	1,004	Huizen (between 11.40 a.m. and 5.40 p.m. B.S.T.)	0.5	*257	1,160	Hörby	10.0
*387	617	Prague (Praha)	5.0	*1,071	280	Huizen	0.5	209	1,000	Falun	0.5
DENMARK											
*281	1,067	Copenhagen	0.75	*1,071	280	Schevevingen-Haven	5.0	*322	932	Göteborg	10.5
1,153	260	Kalundborg	7.5	*1,875	160	Hilversum	6.5	436	689	Stockholm	1.5
ESTONIA											
401	748	Reval (Tallinn)	1.5	HUNGARY							
FINLAND											
*221	1,355	Helsinki	10.0	210	1,430	Budapest (Csepel)	1.0	542	554	Sundsvall	1.0
*1,796	167	Lahti	40.0	550	545	Budapest	20.0	*770	389	Ostersund	0.6
FRANCE											
20.7	10,180	Radio Experimental (Paris)	1.4	ICELAND							
175	7,714	St. Quentin	0.1	*1,200	250	Reykjavik	16.0	IRISH FREE STATE			
210	1,430	Radio Touraine	0.5	*225	1,337	Cork (IFS)	1.0	*413	725	Dublin (2RN)	1.0
223	1,346	Fécamp	0.7	ITALY							
234.5	1,279	Nîmes	0.3	25.4	and 80	Rome (3RO)	9.0	291	7,030	Turin (Torino)	7.0
237	1,265	Bordeaux (Radio Sud-Ouest)	1.0	332	905	Naples (Napoli)	1.5	381	783	Genoa (Genova)	1.0
240.4	1,248	Béziers	0.3	441	680	Rome (Roma)	50.0	453	662	Bolzano (IBZ)	0.3
250	1,200	Juan-les-Pins	0.5	501	599	Milan (Milano)	7.0	LATVIA			
256	1,171	Toulouse (PTT)	1.5	*525	572	Riga	7.0	LITHUANIA			
265	1,130	Lille (PTT)	0.7	*1,935	155	Kaunas	7.0	TURKEY			
*272	1,102	Rennes (PTT)	0.5	YUGOSLAVIA							
286	1,046	Montpellier	0.3	307	976	Zagreb (Agram)	0.7	307	976	Zagreb (Agram)	0.7
*286.8	1,040	Radio Lyons	0.5	430	696	Belgrade	2.5	430	696	Belgrade	2.5
295	1,016	Limoges (PTT)	0.5	574.7	522	Ljubljana	2.5	SWITZERLAND			



This well-known H.T. Battery recharges itself overnight: and provides unfluctuating trouble-free service for 12 months or more.

STANDARD CARTRIDGE

Four hours a day, thirty hours a week, and more! Smooth power, steady and strong, feeding H.T. to your set, making it give its very best, month after month. Absolutely reliable, the compact Standard Battery is the ideal power supply. For twelve months and even longer the cells do not need recharging, and when they DO, it is quite a simple and inexpensive matter to replenish with the cartridge refills.

For 2- or 3-valve Sets 2 trays (as illustrated) of No. 2 cells, 96 volts, 7/8 down and 5 equal monthly payments of 7/6. Cash £2 2s. 11d. Spare No. 2 cells (complete except chemical), 11 volts each, 5/6 per dozen. Any voltage supplied.

D.6 Battery 108 volts including oil and chemical, but without trays, £1 14s. 9d. All Batteries can be supplied on deferred terms if desired.

Write for full particulars of the complete battery range. THE STANDARD BATTERY CO. (Dept. A.W.), 184-188 Shaftesbury Avenue, London, W.C.2.

AERIAL EQUIPMENT

7/22 Copper, 50 ft. 1/5, Enamelled 1/8. 50 ft. impreg. braided, resists smoke, 2/- 50 ft. 3/20 1/10. 50 ft. V.I.R. 600 meg. 16 gauge, 100 yd. coils, new, 8/6. Frame Aerials, rotary folding, 200/2,000 metres, 15/-, List 30/- Halcyon S.M. Dials 2/3, List, 3/6.
Trans. Keys by Brown, 7/6, cost 45/- Lightning arrestors, vacuum tube, 2/6. Earth Spikes, 1/8. Insulators, 9d. doz. Ironclad Slider Rheos, 2,300 ohms wirewound 110 m/a for direct on mains, 17/6. Violet Ray Sets in case, 27/6, List 70/-
Television Motors. D.C. or A.C., 25/-, List 40/- Combination Mains supply adaptors B.C. with 2-pin plug, 9d., List 1/6. Pye Universal H.T. Eliminators for Portables or Sets, £3 7s. 6d., List £5. Pye 6-1 L.F. Transformers, 13/3, List 22/6. "Blue Spot" Units. Model O, 10/-, List 21/6. Ditto on Cast Chassis, 20/-, List 34/-
ELECTRADIX RADIOS, 218 Upper Thames St., London, Telephone: City 0191 E.C.4

EVERYMAN'S WIRELESS

By ERNEST H. ROBINSON (5 Y.M.) A handy book telling in plain, non-technical language all that the average man needs to know about Wireless. CASSELL'S 3/6 net.

HIGH-RESISTANCE CONNECTIONS

A HIGH-RESISTANCE connection is often one of the most difficult faults to locate in a wireless receiver. It seldom causes a complete breakdown, the symptoms being usually confined to a more or less general "falling off" in efficiency. The trouble often occurs at a soldered junction, particularly when corrosive flux has been used and not properly neutralised, so that in course of time it eats into the metal parts. Telephone jacks or switches with mechanical springs are also liable to give trouble, owing to the springs weakening with constant use until they fail to make firm contact. B. A. R.

TWO-WAY TELEVISION

THE ideal television system in which two persons can both converse with and see each other simultaneously is now being perfected in the Bell Telephone laboratories. Unfortunately, the method seems to be far too expensive to raise any hopes of its being "laid on" to the ordinary public telephone service. No less than seven separate circuits are necessary between transmitter and receiver. Two for the picture signals, two for speech, two for "calling" currents, and one for synchronising. In course of time number of circuits will, no doubt, be reduced, either by "phantoming" or by using wired-wireless methods. M. B.

According to an India Office report for 1929, the beam telegraph service between London and Bombay was considered to have given successful results. A steady increase of traffic was noted, the average number of paid telegrams amounted to 70,000 per month by the end of the year. Interruptions were of very brief duration and were mainly caused by disturbances on the land lines between Bombay and the wireless stations.

The B.B.C. has now officially moved its Scottish headquarters from Glasgow to Edinburgh. So far as listeners are concerned, the reason for the change remains obscure. It is emphasised that, as the two cities are always linked by wire, Scotland can always have the best performance from each. From the programme point of view, therefore, the change-over makes no difference. "Then why change?" is the natural rejoinder. Some people suggest that the B.B.C. considers Edinburgh to be the Scottish centre of "culture," but dare not say so!

"Amateur Wireless and Radiovision." Price Three pence. Published on Thursdays and bearing the date of Saturday immediately following. Post free to any part of the world: 3 months, 4s. 6d.; 6 months, 8s. 9d.; 12 months, 17s. 6d. Postal Orders, Post Office Orders, or Cheques should be made payable to "Bernard Jones Publications, Ltd."

General Correspondence is to be brief and written on one side of the paper only. All sketches and drawings to be on separate sheets. Contributions are always welcome, will be promptly considered, and if used will be paid for. Queries should be addressed to the Editor, and the conditions printed at the head of "Our Information Bureau" should be closely observed. Communications should be addressed, according to their nature, to The Editor, The Advertisement Manager, or The Publisher, "Amateur Wireless," 58-61 Fetter Lane, London, E.C.4.

TWO NEW ASSEMBLY KITS!
Det., 2 L.F., £4 : 12 : 6
S.G., Det., and Pentode, £6 : 6 : 0

Write for free Blueprints to
Currys 24/28 GOSWELL ROAD,
LONDON E.C.1
Or from any of our 185 Branches.

REPAIRS
Any make of L.F. Transformer, Loud-speaker or headphones repaired and dispatched within 48 HOURS—TWELVE MONTHS' GUARANTEE with each repair. 4/- Post Free.
Terms to Trade
TRANSFORMER REPAIR CO.
"Service" Dept.
214 High Street, Colliers Wood, London, S.W.13

DX THE STANDARD PLUG-IN COIL
Sold everywhere from 1/-
DX COILS Ltd, London, E.8

TAYLOR WET H.T. BATTERIES
New Prices: Jars 1/3. Sacs 1/2. Zincs 10d. Sample doz. 18 Volts complete with bands and electrolyte 4/1 post 9d. Sample unit 6d. illus. booklet free. Bargain list free.
AMPLIFIERS, 30/- 3 VALVE ALL-STATION SET 2/5
A. TAYLOR, 57, Studley Road, Stockwell, LONDON.

FULL-SIZE BLUEPRINTS

- When ordering, please send Postal Order, NOT STAMPS
- CRYSTAL SETS (6d. each)**
B.B.C. Brookman's Park Set AW206
Regional Crystal Set WM176
- ONE-VALVE SETS (1s. each)**
B.B.C. Official One AW208
Hartley Single-valver WM198
- TWO-VALVE SETS (1s. each)**
Loud-speaker America Two AW190
Talisman Two (D, Trans) AW194
British Broadcast Two (D, Trans) AW215
Easy-tune Two (D, Trans) AW226
Wavelets Two (D, Trans) AW229
No-battery A.C. Mains Two (D, Trans) AW230
No-battery Gramo-radio 2 (D, Trans) AW238
1930 Talisman 2 (D, Trans) AW239
Easy Tune Short-wave 2 (D, Trans) AW242
Brookman's Two (D, Trans) WM168
New Crusader (D, Trans) WM182
Radio-Record Two (SG, D) WM187
Gleaner Two (D, Trans) WM201

- THREE-VALVE SETS (1s. each)**
All-wave High-mag. Three (D, 2 Trans) AW199
Knife-edge Three (D, RC, Trans) AW201
Talisman Two-three (D, RC, Trans) AW203A
Widely World Short-wave Three (HF, D, Trans) AW207
Everybody's Three (SG, D, Trans) AW209
1930 Ether Searcher (SG, D, Trans) AW211
New All-Britain Three (HF, D, Trans) AW214
Best-by-Ballot Three (SG, D, Trans) Price 4d. free with copy of "A.W." AW217
Brookman's By-pass Three (D, 2 Trans) AW220
Everybody's All-electric Three (SG, D, Trans) AW221
—A.C. AW223
1930 Clarion Three (SG, D, Trans) AW232
Beginner's Regional Three (D, 2LF) AW243
Britann's Favourite Three 1930 (D, 2 Trans) AW244
Car Three (D, RC, Trans) WM161
Standard Coil Three (HF, D, Trans) WM164
Brookman's Three (SG, D, Trans) WM178
Community Three (D, RC, Trans) WM179
Brookman's Push-Pull Three (SG, D, Trans) 1/6 WM184
All-nations Three (D, 2 Trans) WM190
Inceptor-dyne (SG, D, Pentode) WM196
Brookman's A.C. Three (SG, D, Trans) 1/6 WM199
Music Marshal (D, 2 Trans) WM205
Gramo-Radio D.C. Three (SG, D, Trans) WM205
Concert Three (D, 2 Trans) WM205
New Lodestone Three (HF, D, Trans) WM205

- FOUR-VALVE SETS (1s. 6d. each)**
Clarion All-electric Three (SG, D, Trans)—A.C. Rectifier AW200
Music-Lover's Gramo-radio (SG, D, RC, Trans)—1s. 6d. AW202A
Horizon Four (SG, D, 2 Trans) AW237
Arrow (SG, HF, D, Trans) WM154
1930 Monodial (2SG, D, Trans) WM158
Electric Four (All A.C.—SG, D, RC, Trans) WM162
Brookman's Four (2SG, D, Trans) WM174
Transportable Four (SG, D, 2 RC) WM180
Super Q (SG, D, 2 Trans) WM189
Lodestone Four (HF, D, RC, Trans) WM193
Searcher's Four (SG, D, RC, Trans) WM194
Invitation Four (SG, D, RC, Trans) WM200

- FIVE-VALVE SETS (1s. 6d. each)**
James Quality Five (2SG, D, RC, Trans) AW227
All-wave Lodestone Five (HF, D, RC, Push-pull) WM146
1930 Five (2HF, D, RC, Trans) WM171
Dual-screen Five (2SG, D, RC, Trans) WM185
Radio-Record Five (SG, D, Trans-parallel) WM188
Overseas Five (3SG, D, Trans) WM191

- AMPLIFIERS (1s. each)**
"A.W." Gramophone Amplifier AW205
Brookman's Separator (HF Unit) AW212
Two-valve Amplifier AW216
"Mag" Gramo Unit AW224
Radio-Record Amplifier (DC Mains) WM183

- MISCELLANEOUS (1s. each)**
Short-wave Adaptor (1 v.) AW183
Simplest H.T. Unit AW197
By-pass Unit (Wavetrap) with copy "A.W."—4d. AW218
"Twin" Brookman's By-pass (6d.) AW222
"A.W." Paper Loud-speaker AW231
James H. T. and L.T. Charging Unit AW234
Simplest H.T. Eliminator for D.C. Mains AW236
Simplest H.T. Eliminator for A.C. Mains AW236
Choke Output Unit AW240
A.C. Mains Amplifier WM149
H.T. Unit for A.C. Mains WM159
"W.M." Linen-diaphragm WM172
Brookman's "Wipe-outs" WM186
Short-wave adaptor for Overseas Five WM192
Staminator Unit for A.C. Mains WM202
Universal Push-pull Amplifier WM204
Outspan Short-wave Adaptor WM207

- PORTABLE SETS**
Music Leader (SG, D, RC, Trans) with copy "A.W." AW203 /-4
Merry-maker Portable (D, 2 Trans) AW228 1/-
Sunshine Three (SG, HF, SG, D, Trans) AW235 1/-
Continental Portable (SG, D, Trans) AW241 1/-
Pedlar Portable Two (D, Trans) WM195 1/-
Pedlar Portable Three (D, 2 Trans) WM197 1/-
James Portable SG3 (SG, D, Trans) WM203 1/-
Foursome Portable (SG, D, 2 Trans) WM206 1/-
Copies of the "Wireless Magazine" and of "Amateur Wireless" containing descriptions of any of these sets can be obtained at 1s. 3d. and 4d. respectively, post free. Index letters "A.W." refer to "Amateur Wireless" sets and "W.M." to "Wireless Magazine" sets.

AMATEUR WIRELESS 58-61 FETTER LANE LONDON, E.C.4

PREPAID ADVERTISEMENTS

Advertisements under this head are charged THREEPENCE PER WORD, minimum charge THREE SHILLINGS. DEPOSIT SYSTEM

As the Publishers cannot accept responsibility for the bona fides of advertisers in this publication, they have introduced a system of deposit which it is recommended should be adopted by readers when dealing with persons with whom they are unacquainted. It is here explained.

Intending purchasers should forward to the Publishers the amount of the purchase money of the article advertised. This will be acknowledged to both the Depositor and the Vendor, whose names and addresses must necessarily be given. The deposit is retained until advice is received of the completion of the purchase, or of the article having been returned to and accepted by the Vendor. In addition to the amount of the Deposit, a Fee of 6d. for sums of £1 and under, and 1s. for amounts in excess of £1, to cover postage, etc., must be remitted at the same time. In cases of persons not resident within the United Kingdom, double fees are charged.

The amount of the Deposit and Fee must be remitted by Postal Order or Registered Letter (Cheques cannot be accepted), addressed to

"AMATEUR WIRELESS,"
ADVERTISEMENT DEPARTMENT,
58/61 FETTER LANE, LONDON, E.C.4

PATENTS.—Trade Marks, Advice Handbook free.—B. T. King, Regd. Patent Agent, 143a Queen Victoria Street, London.

COMPLETE KITS.—All Circuits. C.O.D. or Terms.—R.I.B., 33 Muroon Street, London, E.1.

EXPERIMENTAL SURPLUS. Motor Generators. Amplifier components and wireless sundries, cheap, state your requirements or list sent free. Harger, 3 Darnley Road, Hackney, E.9. Amhurst 1842.

ENGINEERS—novice or expert—£300, £400, £500 per year or more is within your grasp. In our Handbook, "ENGINEERING OPPORTUNITIES," Prof. A. M. Low explains where the good posts abound. This handbook has shown the way to better things to over 20,000 of your fellows. It contains details of A.M.I.Mech.E., A.M.I.E.E., A.M.I.C.E., A.M.I.A.B., A.M.I.Struct.E., Matric., C and G., G.P.O., etc. Examinations, outlines home study Courses in all branches of Electrical, Mechanical, Motor and Wireless Engineering and shows the unique advantages of our Appointments Department. Why stay in the "Hammer and File Brigade"? Send for our free handbook at once, stating Branch, Post or Examination which interests you.—British Institute of Engineering Technology, 109 Shaftesbury House, 29-31 Oxford Street, London, W.1.

BANKRUPT BARGAINS.—List free. Let me quote for that kit. Faradex transformers 3/3, Polar Ideal S.M. 4/6, S.L.F. 2/6, Polar reaction 2/, Dual coils 8/-. H.F. chokes 1/6, Triotron B.A. 8/6, Blue Spot 60K 19/6, Bullphone 6/6, ditto B.A. 9/-. Gramophone pick-ups 7/6, Butlin, 143B Preston Road, Brighton.

BANKRUPT BARGAINS.—Faradex transformers 2/3, Polar S.M. 4/6, Dual coils 8/-. J.L.F. chokes 1/6, A.J.S. .0002 S.M. 1/9, D.C. eliminators 23/6, Cossor S.W. coils 4d., Cone units Blue Spot 60K 19/6, Triotron 8/6, Bullphone B.A. 9/-. others 6/6. List free. Good stock. Below. Straight 3 kits all parts including cabinet, panel, valves and dual coil £3. Let me quote for any kit. I will certainly be cheaper. Butlin, 143B Preston Road, Brighton.

EASY TERMS

We SPECIALISE in the supply of all Good Quality Radio Sets, Components and accessories on Easy Terms. We will give you efficient service. Send us your list of requirements and a quotation will be sent by return.

LONDON RADIO SUPPLY COMPANY

11 Oat Lane, Noble St., London, E.C.2

NATIONAL 1977

CONSTRUCTING
OR
RE-CONSTRUCTING
Whichever you contemplate, take full advantage of the improved method of contact; use the Clix.

RESILIENT SOCKETS AND SOLID PLUGS
The sockets, being placed behind the panel, are fully protected from damage, their helical slots retain a greater degree of resilience, certain contact and long life are assured. No. 22 Long Uninsulated Resilient Socket for use with insulated panels up to 1 in. thick. Flush mounting. Price 1 1/2d. No. 23 for thin insulated panels Price 1d.
No. 25 Clix Solid Plug. Maximum Tensile strength, 24.

LECTRO LINX LTD., 254 Vauxhall Bridge Rd., S.W.1

Amateur Wireless **COUPON**
Available until Saturday
AUGUST 23, 1930

The New Lodestone Three

ALL
THREE-ELECTRODE
VALVES

CONSTANT
NEUTRALISING
ON ALL WAVES

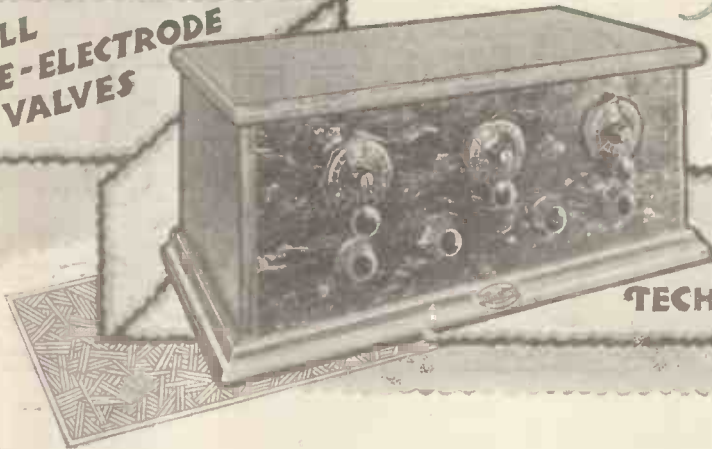

BUILT BY
THE "W.M."
TECHNICAL STAFF

10
REASONS
WHY YOU
SHOULD
BUILD
THIS SET

It is the first three-valver to have constant neutralising on both wavebands.

W. James's famous 1930 Binowave coils are used—a guarantee of good results.

A leaky-grid detector gives maximum sensitivity.

A high-ratio low-frequency transformer gives great volume.

Two separate volume controls are provided.

There is no coil changing for medium- and long-wave reception.

Almost any standard three-electrode valves can be utilised.

Operation is easy and certain.

The layout is clean and all the parts are easily accessible.

It has W. James's full approval!

OTHER CONTENTS OF THE WIRELESS MAGAZINE:

The Foursome, a modern portable with one-knob tuning—The Universal Push-pull Amplifier, adaptable for use with any set—Making the 1930 Binowave Coils, by W. James—Found, an alternative programme, by W. Hadfield Craven—Mains power for your Portable—The Outspan Short-wave Unit, makes ultra-short wave reception possible with almost any set—Tested sets: Philips Portable, Gecophone Battery Three-valver, Gambrell All-electric Two—Give us Better British Sets! by Alan S. Hunter—Around the Turntable, records reviewed by Whitaker Wilson—What is the Pressure from a Pick-up? by J. H. Reyner.

WIRELESS MAGAZINE

for August. Now On Sale Everywhere

GET A COPY TO-DAY

EVERYTHING **The G.E.C.** ELECTRICAL
your guarantee

Osram Valves

Sold by all
Wireless Dealers

MADE ENTIRELY IN ENGLAND.

REDUCED PRICES

The following types of OSRAM VALVES are REDUCED IN PRICE as shown, the reductions becoming operative immediately.

TYPES	OLD PRICES	NEW PRICES	TYPES	OLD PRICES	NEW PRICES
Osram H.L. 210	10/6	8/6	Osram P. 2	15/-	13/6
" H. 210			" P. 240		
" L. 210			" P. 425		
" H.L. 410			" P. 625		
" H. 410			" P. 625A		
" L. 410			Osram S. 215	22/6	20/-
" H.L. 610			" S. 410		
" H. 610			" S. 610		
" L. 610	Osram P.T. 240	25/-	22/6		
Osram P. 215	" P.T. 425				
" P. 410	" P.X. 4				
" P. 610	" P.T. 625	30/-	27/6		

Prices apply only in Great Britain and Northern Ireland

Advt. of The General Electric Co., Ltd., Magnet House, Kingsway, London, W.C.2.

BUILD OUR "TWO"—IT "DELIVERS THE GOODS"

TOMMY HANDLEY'S IDEAL PROGRAMME

Amateur Wireless

Every
Thursday 3^d

and
Radiovision

Vol. XVII. No. 428

Saturday, August 23, 1930

The SEARCHER TWO



DUAL RANGE
EASY TUNING
LOW COST

Full
Details

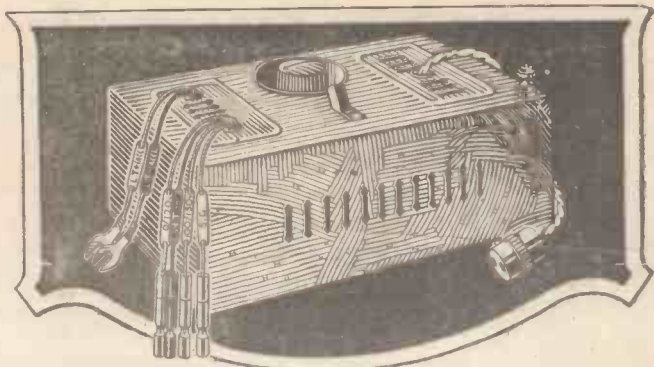

“Ekco” saves you 34/6 every 1,000 hours of use

... on the running costs of your Portable

By fitting an “EKCO” Portable Unit in 3 minutes you can run your Portable for five shillings and sixpence per 1,000 hours as against a battery-operated set which costs two pounds for the same period.

Here’s proof:

A Battery costing twelve shillings lasts three months on a working average of thirty hours per week—or one pound fifteen shillings per 1,000 hours.

Accumulator recharging costs are five shillings, showing a total expenditure of roughly two pounds as against an “EKCO” Portable Unit running cost of five shillings and sixpence. Surely this difference is worth saving at a minimum of trouble!

All you have to do is slip this amazingly efficient Unit into the space previously occupied by your battery—connect your battery and accumulator leads to the “EKCO” Unit terminals—plug the “EKCO” Adaptor into the nearest electric light or power socket, and then, switch on—that’s all.

MODEL C.P.1 for A.C. Mains combines Trick’s Charger and H.T. Unit, eliminating batteries and keeping any 2, 4 or 6 volt accumulator fully charged. Tappings: S.G. (60-80 volts); 0-120; 120/150 (100 volts only, if required) **£6.0.0**

MODEL 1V.20 for A.C. Mains, eliminating H.T. batteries only. Tappings: (S.G. 60 80 volts); 0-120; 120/150 (100 volts only, if required) **£4.12.6**

MODEL 1V.20 for D.C. Mains, eliminating H.T. Battery only. Tappings: S.G. (60 80 volts); 0-120; 120/150 volts **£2.10.0**

Westinghouse Metal Rectifier—flexible output leads and variable tapping in A.C. Models.



Plug-in-that’s-all!

Write for details of the “EKCO-LECTRIC” Receivers, radio’s supreme two and three valve sets

All “Ekco” products are available on Easy Payments. Write for details to E. K. Cole, Ltd., Dept. K., “Ekco” Works, Southend-on-Sea.

“EKCO”

POWER SUPPLY UNITS FOR ALL PORTABLES

378

SURPRISE THEM TONIGHT! WATES

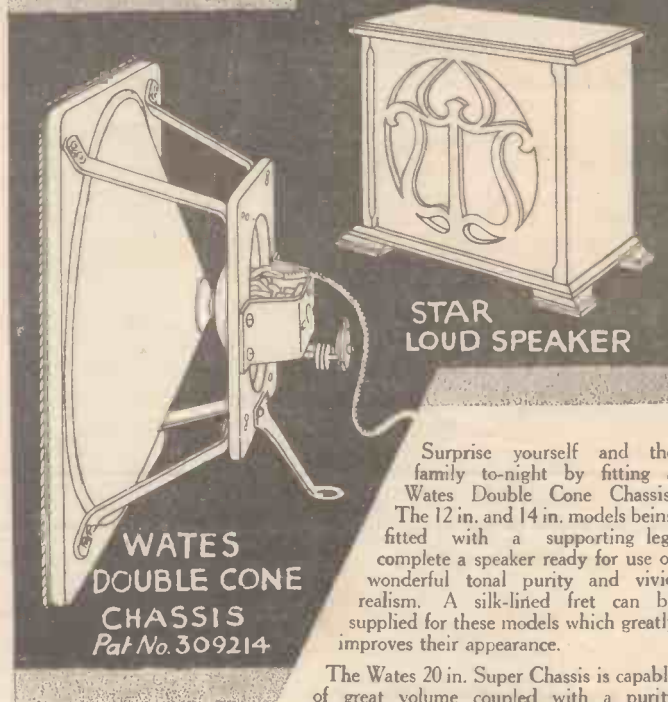

STAR LOUD SPEAKER

WATES DOUBLE CONE CHASSIS Pat No. 309214

Surprise yourself and the family to-night by fitting a Wates Double Cone Chassis. The 12 in. and 14 in. models being fitted with a supporting leg, complete a speaker ready for use of wonderful tonal purity and vivid realism. A silk-lined fret can be supplied for these models which greatly improves their appearance.

The Wates 20 in. Super Chassis is capable of great volume coupled with a purity and realism that surpasses any moving-coil speaker.

PRICES: £ s. d.

Wates Chassis, with Universal Bracket, 12 in.	11 6
14 in.	12 6
20 in.	17 6
Wates Star Unit	1 10 0
Wates 14 in. Star Speakers	
Oak	3 10 0
Mahogany	3 15 0
Wates 20 in. complete Speaker, Oak	4 10 0
Mahogany	4 15 0
Universal bracket (only) for fitting various units to chassis	2 0
Silk-lined fret for 12 in. Chassis	4 0
For 14 in. chassis	5 0

The Wates Star Unit, sold separately at the reduced price of 30/-, is the acknowledged acme of unit perfection.

The man who wants the finest reproduction obtainable will invariably choose the Wates range.

WARNING.—When buying the Wates Patent Chassis beware of imitations with the Cones fixed to the baffles—insist on seeing the name Wates before purchasing

WATES RADIO PRODUCTS

Obtainable from all radio dealers.

Write direct for catalogue to:

THE STANDARD BATTERY CO. (Dept. A.W.),
134-135, SHAFTESBURY AVENUE, LONDON, W.C.2
Telephone: Temple Bar 6195

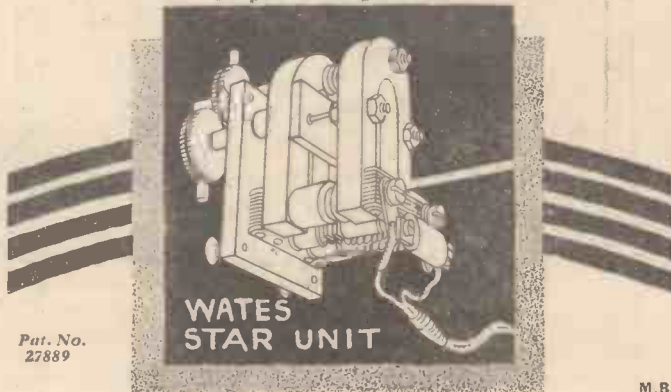

WATES STAR UNIT

Pat. No. 27889

M.B.

Please Mention “A.W.” When Corresponding with Advertisers

Amateur Wireless and Radiovision

The Leading Radio Weekly for the Constructor, Listener and Experimenter

Editor:
BERNARD E. JONES

Technical Editor:
J. H. REYNER, B.Sc., A.M.I.E.E.

Research Consultant:
W. JAMES

Assistant Editor:
H. CORBISHLEY

The First Televised "Talkie"—B.B.C. Musicians—Those Anonymous Announcers —The B.B.C. Criticised—Don't be Caught

The First Televised "Talkie"—An AMATEUR WIRELESS representative was at the London Coliseum last week when, during the Baird demonstration on the stage, the opportunity was taken to televise a talking film of our B.B.C. programme critic, Mr. Sydney Moseley. In view of the fact that this was the first public demonstration of such an experiment—and it was only an experiment—and taking into account the knowledge that, as had been explained, the film had been rushed through, the results were quite good. It is at least a forecast of what can be done. The result, as a whole, was about half as satisfactory as a normal Baird picture on the 2,100-lamp screen.

B.B.C. Musicians—The B.B.C. stations house some brilliant "tame" musicians. They are the backbone of the musical organisation, for there is so much hack-work to be undertaken in the preparation of programmes. Fortunately, however, they are not always "tame," and sometimes they go so far away from their

bondage as to write music of their own! Several members of the B.B.C.'s music department have written compositions of note within the past few years. On September 1 the Belfast programme is devoted to British composers, and listeners will hear two works for orchestra, *Tone Poem No. 2*, "In the Forest of Panchavati," and "Night Among the Lakes," by Reginald Redman, assistant musical director at the Cardiff station.

Those Anonymous Announcers—Last week we had something to say about American listeners' opinions as to whether or not announcers should remain anonymous. The B.B.C. has its own opinion, no matter what America thinks, and there are very few listeners who know anything about the unseen speakers at Savoy Hill. Yet—such is fame—the name of Mr. Stuart Hibberd does seem to have been mentioned in this connection, and—may we whisper it?—Mr. Hibberd is the chief announcer. He has just taken part in the making of one or two descriptive gramophone records and in the recording of one of the B.B.C.'s "Epilogues."

The B.B.C.

Criticised—

The B.B.C. comes in for a good deal of criticism, for every man in the street has something to say about the affairs of broadcasting and the programmes given. One can pay too much attention to criticism of this

PRINCIPAL CONTENTS

	Page
Current Topics	169
Tommy Handley on "My Ideal Programme for Saturday, 1930"	170
A Set to Fit YOUR Car	171
Around the Short-wave Dial	172
A New Valve for H.T.	173
My Wireless Den	174
On Your Wavelength	175
The Voltron Three-valver	177
Without Fear or Favour	178
Mains Power for Your Set... ..	179
The "Searcher Two"	180
"A.W." Tests of Apparatus	184

kind, for many people speak without knowing facts; but when such a distinguished person as Mr. Compton Mackenzie mentions the B.B.C., then one begins to sit up and listen with both ears. "The B.B.C.," says Mr. Compton Mackenzie, in passing, "is, in fact, the perfect expression of English genius and, as such, beyond criticism. The faults of the B.B.C. are inherent in its constitution and in the character of its audience. No change of personnel could do anything to improve it." Such an opinion does, at least, give one "furiously to think," as it is said that a Frenchman once said!

Don't be Caught—Those enterprising gentlemen who go round to wireless fans' homes when *paterfamilias* is out, and, on the pretext that the set wants overhauling, carry it off with them under their arms, never again to return, are once more at this profitable game. "Thermion" had something to say recently about these thieves and their latest dodges. This sort of thing has been done so often under various guises that it is surprising how often it succeeds. Once upon a time it was fashionable to pretend to be a Post Office or B.B.C. "Inspector." Now the game is to produce the catalogue of some respectable firm as credentials and to assure the housewife that arrangements have been made for the set to be tested.



A "close-up" of a radio-controlled motor launch which appeared in Portsmouth Dockyard during Navy Week. The aerial is supported by the posts at the stern.

My Ideal Programme for Saturday 1950

TOMMY HANDLEY recently broadcast a burlesque under this title. Here he describes, in serious vein, his idea of an "ideal" programme

I DON'T want to be my own trumpeter, but I want to know if, some while ago, you heard my little burlesque under the title of "My Ideal B.B.C. Programme for Saturday, 1950"?

Now, after I had arranged the matter for this I talked it over with a friend at the club (which is not a thing I usually do, for my broadcasts are usually "Surprise items"), and he said, "Well, Thomas, that's all right as a burlesque, but what really is your ideal programme for twenty years hence?"

Our Conclusions

We fell at talking about this, and by cock-tail time we arrived at two or three conclusions which the B.B.C. programme people might like to know. As a matter of fact, they weren't all my own conclusions, but the man with whom I was arguing is also a B.B.C. artiste, a musician, and he takes a different aspect.

You must know the usual "guff" about there being no ideal programme because of the diversity of tastes and the impossibility of pleasing everybody. I won't repeat all that.

There are only two things which will make any difference to ideal programmes by 1950. One is *stations*, and the other is the *relative importance of the B.B.C.*

Stations first. I suppose the B.B.C.'s regional scheme will go ahead; I don't quite know what it embraces, but everyone at Savoy Hill is talking about fewer stations and bigger power, and I gather that when the scheme is complete the country will be covered with a number of giant dual stations, so that each big district has a choice of high-pressure broadcasting "on tap."

No Thrills Now

Now I remember the time when the mere reception of any station (even 2LO or the old Birmingham 5IT, for example) on a tinny horn loud speaker gave the family a thrill.

Now there is no thrill. That is inevitable. Listeners are callous in regard to broadcast artistes. You get so many. I should not like the job of having to prepare my own ideal programme for twenty years hence.

When the whole country is covered with

high-power stations, and when the reception of these is easy even in Cornwall and the West of Scotland (where they tell me there are still lucky folk who have never heard a B.B.C. talk!), then there will be no more wonder than in the touch of an electric-light switch. Householders don't marvel at the humming generators miles away at the local power station. Instead, they grumble at the quarterly bills. In ten years time this will be the same with the B.B.C.

It will all be very rough on the broadcast artistes, and the job of picking an ideal programme is therefore getting harder every year. The onus, you see, falls on the artistes, and not on the engineers.

Better Reception

In 1950 reception will be at least 50 per cent. better than it is now, thanks to the new stations, and if other things stay as they are at present, our programmes will have to be correspondingly better, though, knowing the artistes' end, I don't know how to start about improving things.

What will alter, though, is the *relative importance of the B.B.C.* There won't be so frequent cries for "ideal" programmes, *night after night.*

There are some listeners who expect too much for their ten shillings. I know plenty of homes where the set is switched on, morning and evening, every day of the week. And always these listeners expect top-hole programmes. It can't be done, no matter how much L.S.D. is available.

In time, perhaps in ten years, listeners will begin to realise this, and then the B.B.C. will take its place along with other sources of education and amusement. Now everybody wants it to over-ride the theatres and the newspapers, but by 1950 they may realise that it can't.

There is a proper place for radio in everyday life, and I'm afraid at the moment it is the knowledge that so excellent value is provided by a ten-shillings-a-year licence, that tempts people to place too much emphasis on the relative importance of wireless. It is important, of course, and as a wireless artiste I should be the last to deny it; but then so is the theatre important, and so are the newspapers.

What I am trying to drive at is that *my 1950's ideal programme will be a composite one. It won't all come from one station, nor perhaps all from the B.B.C.*

At one o'clock I will switch on to one station and get drowsy music (from what my friend called a "small string orchestral combination") as a background to lunch-time conversation at home.

Just before four I might like an hour of dance music so that the wife's friends who might drop in (I suppose they will still drop in by 1950) could have a *thé dansant*. If they brought their kiddies (will they, in 1950?) they might want a Children's Hour at five o'clock.

Goodness knows what I might want from six till seven. Jack Payne, perhaps, if the saxophones still have any blow left in them; or piano music by the mysterious lady with the soft voice; or I might even feel like a talk, or a cheery weather report.

Vaudeville

I know I'd want vaudeville from seven till eight, so that I could take my mind off dinner. If I wasn't giving a turn myself I would want to hear some solid stuff—the "Proms," perhaps; and I expect I'd have to change over to another wavelength for that.

I have a far-away appreciation, but little knowledge of the Proms; so I would listen only for an hour. Then I'd like to know the final news of the night—stuff too late for the evening papers, and which otherwise wouldn't be in print till the following morning.

Then I'd change to another station for more vaudeville, or dance music till a late hour.

Now, the real catch is this, I can pick a day's ideal programme such as this NOW, in 1930: Not every day of the week, true, but at least two or three times.

Critical self-examination assures me that I am satisfied with this programme scheme, so *what the jumping white elephants will I want and expect in twenty years' time?*

Can you tell me?

Tommy Handley

A SET TO FIT YOUR CAR

How to install the "Car 3," the simple three-valver which was described last week

The "Car 3" fits, with the components downwards, beneath the instrument board on the car. The panel is conveniently in front

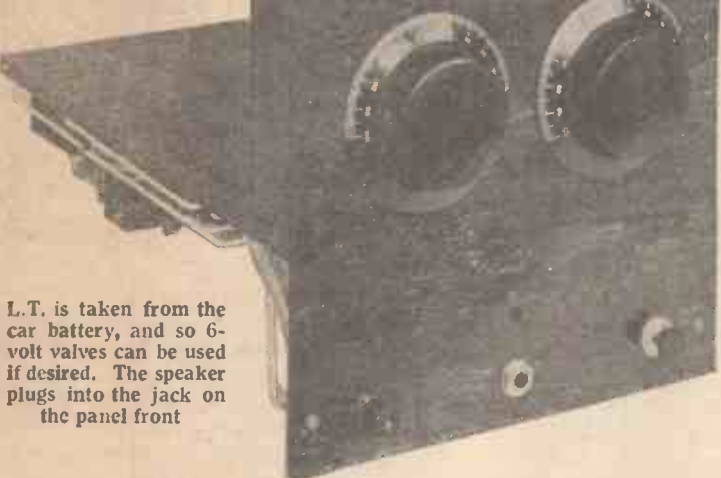

L.T. is taken from the car battery, and so 6-volt valves can be used if desired. The speaker plugs into the jack on the panel front

LAST week the salient facts were given of a simple three-valver which can be fitted into practically every car and which will enable its owner to receive programmes even while the car is in motion.

The particular merit of this set is that it operates from the car-starter battery. In addition, the speaker can be placed anywhere in the car that is convenient—or even outside the car, as may be more suit-

memory. The use of the blueprint entirely obviates mistakes.

Rigid insulated wiring should be used for the connections in the set itself, but rubber-covered flex is best to use for the battery leads.

The coil is very simply made. It consists of solenoid windings on a length of cardboard or paxolin tubing, 1 3/4 in. in diameter and 2 1/2 in. long. The aerial winding consists of 75 turns

of No. 24 d.s.c., a tapping being made at 20 turns from the end, at which point the aerial is connected. The reaction winding consists of 20 turns of No. 36 d.s.c. The ends of the winding can be soldered securely to short lengths of flex, which are convenient for connection, or, alternatively, the wires themselves may be enclosed with Systoflex covering.

When the parts on

which can hang at the back of the car—usually the best place for it—and can be connected to the set by a length of flex. A small speaker-type jack is used for the actual connection to the receiver.

The L.T. supply is, as has been explained, taken from either one, two, or three cells of the starter battery, according to the type of valves it is desired to use. One of the advantages of the scheme is that it is possible to use six-volt valves—not usually a convenient proposition in an ordinary portable, owing to the weight of the accumulator needed.

If you are buying new valves specially for this set, then you should make a careful choice.

Choosing Valves

The detector valve can be chosen from the following, though four- or six-volters may be used: Cossor 210HF, Dario Univ., Marconi HL210, Osram HL210, Six-Sixty 210HF, Mullard PM1HF, Mazda HL210, Lissen HL210, Fotos BA9, P.R. PR3LF, Triotron HD2.

The first L.F. valve can be chosen from these two-volters, or their four- or six-volt equivalents: Cossor 210LF, Marconi L210, Osram L210, Six-Sixty 210LF, Mullard PM1LF, Mazda L210, Lissen L210, Dario Univ., Triotron SD2, Tunggram LG210, Fotos BA9.

The following two-volt power valves
(Continued at foot of next page)

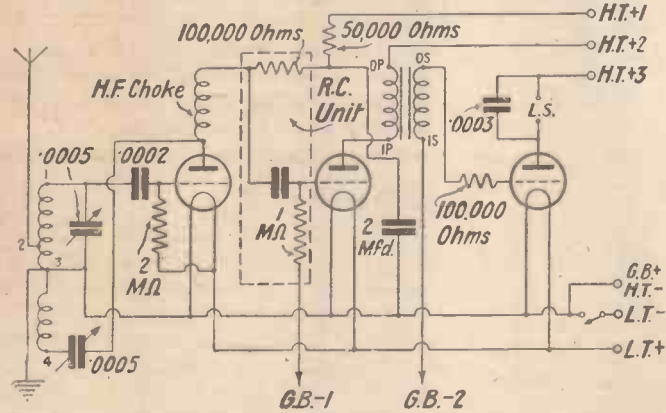

This is the circuit diagram of the easy-to-build car set

able on picnic occasions—and the aerial is slung up from the hood-sticks (or underneath the roof lining in the case of saloons) and is not directional.

It was explained in the preceding article how the "backbone" of the "Car 3" consists of a baseboard measuring 8 in. by 12 in. attached at right angles to a small panel. The main portion of the receiver fits underneath the fascia board of the car, while the panel is conveniently mounted in front and carries the main controls.

From the list of components and the small reproduction of the blueprint given last week, readers were probably able to get well in hand with the constructional work. If the blueprint is used as a mounting template no difficulty should be experienced in fixing the parts in their proper positions on the baseboard and in getting the panel properly drilled.

the panel have been wired, then the top portion of the panel may be cased in This is essential to prevent the condensers short-circuiting to the fascia board, should this be of metal; in any case, it is advisable to protect the condensers

The speaker should preferably be of the wall-plaque type

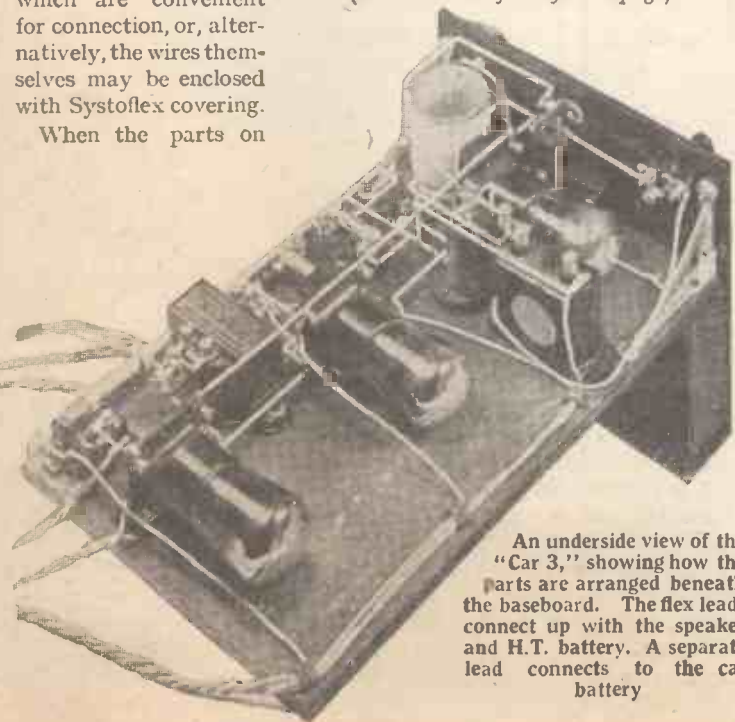

An underside view of the "Car 3," showing how the parts are arranged beneath the baseboard. The flex leads connect up with the speaker and H.T. battery. A separate lead connects to the car battery

Some Notes on Present-

day Short-wave Conditions

Around the Short-wave Dial

By M:
BARNETT

WE are now able to record a distinct all-round improvement in short-wave conditions, as far as the 15 to 35-metre band is concerned, and it is to be hoped that it will continue. The Dutch colonial stations, PLE, PLF, and PMB, are now coming in at really excellent strength and the short musical programmes given by PLE and PMB before their commercial transmissions are coming over splendidly, with excellent quality. PMB is always the fainter of the two and is about the shortest wave of the telephony transmissions to be heard to-day. A Dutch station, presumed to be PCK, is also coming in very well now. A few days ago the writer heard a station giving a musical programme on about 14½ to 15 metres, the announcing being made in Spanish. Perhaps some reader has heard this station, as the writer is unable to identify it? W2XAD has greatly improved, being almost as good as it was at this time last year. From observations of this station's signals, it would appear that he is at his best around 10.30 p.m. and that he fades away rapidly after about midnight. W8XK, on the other hand, appears to increase in strength after about 11 o'clock and is at his best during the small hours

of the morning. This station also has been very good lately and seems to have a higher percentage of modulation than formerly. W2XAF, which is now broadcasting daily, of course, is at its best also in the early hours of the morning and, as it always transmits the same programmes as those of W2XAD (WGY), provides a convenient means of listening to the latter station's programme after the W2XAD transmissions have become too faint to listen to. It is rather interesting to note how these two old-timers still continue to be the most easily-received transatlantic stations.

Well, here we have the good short-wave conditions back again and the writer positively refuses to predict how long they will remain.

Aerial Tuning

The newcomer to short-wave reception probably does not realise how much effect on the tuning, the aerial can have. Different lengths of aerials will completely alter the tuning of a short-wave receiver and it is best, if possible, to have some form of aerial coupling condenser which can be adjusted to the best position and then

screwed tight or locked in some manner so that it cannot be altered. Many a time you have probably tuned in a short-wave station at a certain reading on the dial, made a note of that reading, and then returned some later time to the set only to find that the station has probably moved up another ten degrees, and the fault has been not on the part of the transmitting station, but owing to the fact that the aerial coupling condenser has been altered in the meantime. This, of course, does not apply to receivers which have a screened-grid amplifier, whether tuned or untuned, as any length of aerial can be used or any degree of coupling without hardly any effect on the dial reading. A good method of coupling the aerial is to twist together two pieces of cotton-covered wire and use the two wires as the two electrodes of a condenser, connecting the aerial to one and the set to the other. A certain number of twists can be found by experiment which will allow of easy oscillation on all wavelengths and the remaining ends of wire can be cut off, leaving a small capacity fixed condenser, which cannot easily get out of adjustment, but which can easily be altered if desired.

"A SET TO FIT YOUR CAR"

(Continued from preceding page)

are suitable: Cossor P2, Dario SP, Marconi P2, Osram P2, Six-Sixty 220P, Mullard PM252, Mazda P220, Lissen P220, Fotos BD9, Tungsram P215, P.R. PR120.

The Aerial

The aerial can conveniently consist of 15 ft. or 20 ft. of rubber-covered flex, which can be hidden in the bodywork of the car, preferably at the top. The earth connection is automatically made through the L.T. circuit, and even in cars which have not the electrical wiring completed through the chassis-work (exceptions to this wiring rule are few and far between) there is sufficient wiring to provide an effective capacity earth.

The fact that separate H.T. tapings are provided for each valve is a convenience which will be greatly appreciated by amateurs who like to get the very best out of a set, for critical adjustment of H.T. voltage is needed with some of the new super-efficient detector and L.F. valves.

CRYSTAL "OVENS"

THE frequency of a piezo-electric oscillator varies slightly with temperature. Accordingly the crystals used to

stabilise the frequency of short-wave station GBU (which links this country with America) are carefully housed in a thermostatic oven in which any external temperature variation is automatically compensated. Three wavelengths are used, according to climatic conditions—viz., 16, 24, and 30 metres—the appropriate crystals being switched into the circuit of the master oscillator valve as required. M. B.

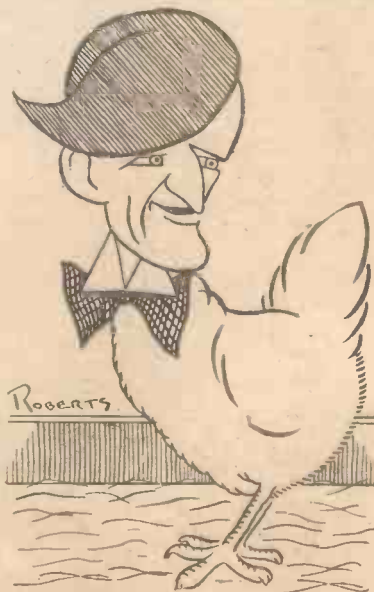

Fercy Merriman—a "Rooster"

MAGNETIC UNITS

A COMMITTEE of the International Electrotechnical Commission has recommended the adoption of the following terms to designate recognised magnetic units: For magnetic flux, the name "Maxwell"; for flux density, "Gauss"; for field intensity, "Oersted"; and for magneto motive force, "Gilbert." The names are those of pioneer workers in the science of magnetism, and the selection offers a well-deserved and lasting tribute to their memory. M. A. L.

The Governor of Rome has decreed that loud-speakers are not to be used outside shops in the streets of the Italian capital.

A NEW VALVE for

Details of a new valve rectifier suit-



This photo shows a Philips

low-voltage gas-filled rectifier

H.T. from the MAINS

able for medium and high-power outputs

NOW that it is recognised that for good quality output high anode potentials on the final amplifier stages are required, any new system of rectification is of interest to the enthusiastic set designer.

A new method is by the use of gas-filled thermionic rectifiers. The gas filling is mercury vapour, the purpose of which is to neutralise the "space charge" effect always to be found in the normal type of thermionic valve.

Space Charge

Any type of thermionic valve functions by virtue of the fact that a heated filament emits electrons which will flow to the anode if a positive potential difference exists between it and the filament. All of the electrons emitted do not reach the anode, but quite a large proportion remain close to the filament. This cloud of electrons acquires a negative charge and tends to impede the flow of electrons newly emitted by the filament, thereby reducing to a certain extent the usefulness of the valve. This effect is known as the "space-charge" effect, and a considerable proportion of the energy applied to any thermionic valve, either two or three electrode, is spent in overcoming it.

Effect of Gas on the Space Charge

There are two known methods by which the space charge effect may be minimised. The first is by the introduction of a positively charged grid near the filament, and the second is by the ionisation of gas in the valve.

If gas, introduced either purposely or accidentally, is present in a valve it is well known that for the same anode voltage a much greater current will flow than would be the case if the valve had been of the normal high-vacuum type.

The phenomenon of "blue glow" in a thermionic valve that has broken down is perhaps the most familiar example of the effect of gas on an electron emission from a heated filament. The anode current, as soon as the glow appears, jumps up to an unduly high figure. Under normal circumstances the blue glow which indicates the presence of ionised gas is always accompanied by destruction of the filament by bombardment of the positive ion of the ionised gas.

Certain gases, particularly argon, neon, and the other inert gases, have the property of preventing this disintegration of the cathode. These gases also protect the cathode against undue wastage by evaporation.

A rectifier having a filling of argon or neon under a fairly high gas pressure is quite satisfactory for even fairly heavy currents. Familiar commercial examples of the successful use of inert gases in this connection are the Tungsar, Ediswan, and Philips rectifiers. All of these are low-voltage rectifiers. Gas-filled rectifiers having output voltages of 500 and 1,000 volts are made, but in general the argon- or neon-filled rectifier is most suited to low voltages of the order of 30 to 120 volts. The actual gas pressure required for satisfactory rectification is very critical in value.

The new type of rectifier employs mer-

cury vapour under very low pressure as the gas filling and is now made possible because of the discovery by Dr. A. W. Hull, of the General Electric Company of America, that there is a certain critical voltage drop of the ionised gas which, if exceeded, will cause the cathode to be disintegrated. If the volt drop across the valve can be kept below this critical figure, which is 22 volts for mercury vapour, the disintegration may be prevented almost entirely. The ionisation voltage for mercury vapour is 10.4 volts, so the mercury-vapour rectifier is therefore possible. A further condition for safe working is the limitation that the maximum current rectified by the valve should not be greater than the electron emission of the filament.

Operation of the Rectifier

Since the rectified current must not exceed the emission current of the filament it follows that a very substantial filament is necessary. The usual heating current is 3 to 4 amps. for even the smallest types of mercury vapour rectifiers, and the voltage may be 2 to 4 volts. Also it is very essential that the filament be fully heated before the high voltage is switched on to the anode. With the low-voltage arc type of gas-filled rectifier once the gas has been ionised and the arc formed the rectifier will work correctly with the filament current cut off, as the positive ion bombardment is sufficient to keep the filament hot.

With the new low-pressure mercury-vapour rectifier the gas does not protect the filament from bombardment, the sole reason for its inclusion being the fact that when ionised it neutralises the space charge. Consequently, if either the high tension is switched on before the filament is heated up, or if the heating current is switched off while the rectifier is in operation, the filament is absolutely knocked to pieces by the subsequent bombardment. With this type of rectifier an oxide-coated filament is always used and if the high voltage is switched on to the anode without the filament current on, large pieces of the oxide coating are immediately observed to fly off. This limitation is rather more serious than might perhaps be imagined as, owing to the fact that the filament current is several

(Continued on page 191)



Miss Angela Maude in cartoon

MY WIRELESS

Weekly Tips,
Constructional
and
Theoretical—



DEN

By
W. JAMES

For the
Wireless
Amateur

DX and Interference

A POINT often noted by those who listen to distant stations with a receiver providing good quality is that muzz and slight interferences may sound relatively louder than when a poorer set is used.

These high-pitched noises are, of course, not magnified by a poor set, with the result that the reception from such a set may sound more clear. A good set, as it magnifies both high and low notes, is capable of providing good quality, but the poor set may actually provide one or two more stations free from interference.

Personally, I would rather have the set providing uniform amplification, as local-station reception, and also that of the majority of distant ones would be better than that from the poor set.

This poor-quality set would be unable to deal properly with any station, but if the object is to hear as many stations as possible, the set with the high-note cut off has its advantages.

Valves Compared

The change from valves of the 4-volt type to others of the 2-volt series will usually not be accompanied by a reduction in the amplification or power-handling capacity.

Good valves are available in both series, and an examination of the valve makers' lists will show that whether the valves compared are of the screen-grid type or power valves, the differences in the characteristics are small. The 2-volt valves take less power for filament heating, with the result that a saving in accumulator-charging costs is to be obtained.

Matched Coils

The coils used in a receiver having ganged tuning ought to be very carefully matched or signal strength will be lost and the tuning will be more broad than it should be.

This is a point that is not given enough attention. It is not satisfactory merely to count the turns. The diameter of the coil and its length are important factors in deciding the inductance, and it must not be forgotten that metal screens placed near a coil will change the inductive value.

For the best results, finished coils ought to be tested, and those which will be used in

a set with screens ought also to be tested in position.

The truth is that coils are too often taken for granted. Poor results are often to be traced to the use of coils of wrong design and construction.

A Novel Coupling System

A convenient method of connecting a transformer when the maximum amount of magnification is required with the resistance feed scheme is illustrated in the accompanying diagram.

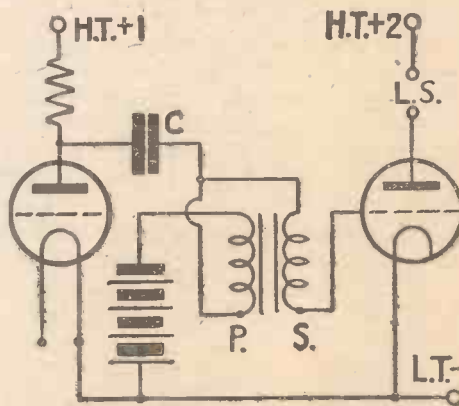

A novel coupling system described in the accompanying paragraph

Here the two windings of the transformer are joined in series. The primary coil P has one of its ends taken to the grid battery and its other end to the coupling condenser C. One end of the secondary S is also joined to the condenser, the other end going to the grid.

With this arrangement the voltage step-up is greater than when the more usual transformer connections are employed. Thus, if the secondary has, for example, three times as many turns as the primary, the step-up is four to one. It would be three with the normal connections.

Naturally, the two windings must be suitably connected, or the desired results will not be obtained. If the primary is reversed relative to the secondary, the amplification will actually be less than with the normal transformer arrangement. Unless the correct connections are specified by the manufacturer, it would be well to try with the primary connected in the alternative directions.

Metal Panel "Snags"

A difficulty met with by those who use metal panels and bases is that of properly insulating the parts. With some components there is only a short distance between the metal panel or base and a "live" contact and, as a consequence, the factor of safety is small.

Sometimes it is best not to rely upon a small clearance by itself, but to fit a piece of insulating material. This will remove the danger.

I have in mind valve holders, the contacts of which are usually not more than one-sixteenth of an inch from the surface of the moulding.

Those Thick Screens

Screens for shielding are often made unnecessarily thick, considered electrically. Quite thin metal is suitable for shielding coils and condensers. Mechanical considerations may, of course, be sufficient to warrant the use of thick metal, but the point ought not to be lost sight of that thin aluminium or copper is suitable electrically.

It is different when dealing with low-frequency circuits or mains equipment. Thick iron should usually be employed for magnetically shielding such parts as are used in these circuits.

It is now possible to obtain switches for coils of such design that ganging may be easily carried out. A neat and effective arrangement has been devised for the Brookman's coils, so that two or three coil units may be switched by moving one knob. Some of the designs which I have seen are very good.

Essential Shielding

The extent to which shielding is employed in some modern commercial sets is probably not fully realised by those who do not have the opportunity of examining examples.

For the best results with a set having two or more high-frequency stages such complete shielding is quite essential; in fact, failure to shield all parts would mean various troubles, such as poor amplification and lack of stable working. Aluminium is often used. Some prefer copper, however, because it is easily soldered, while tinned iron plate has its uses.

Oh Your Wavelength!

An Empire Station at Last!

IT is good news to hear that the Empire Short-wave Station is to come into being, and that right soon. At the recent Colonial Conference delegates were unanimous and most emphatic with regard to its need, and all the money required is to be found by the Government. The station is to be erected at Daventry, close to 5GB and 5XX. I have not seen its power stated, but I hear that it will be something pretty useful.

Readers will remember that AMATEUR WIRELESS has been pressing for years for such a station. The need for it is great, since wireless offers a marvellous means of keeping the Dominions and Colonies in the closest touch with the Mother Country. Though 5SW has done quite useful work, the wavelength has not been suitable for all times and all places, and transmissions have been distinctly limited. The new station, I hear, will probably send out something like a twenty-four hours' programme. I suggested long ago that this could quite easily be done by means of "bottled broadcasting."

The ordinary programmes as they occur are recorded, probably on a wire by means of a system whose name I can't for the moment remember, and then sent out at times likely to suit the various countries. You see, you can hardly expect Australians, for example, to listen-in with any particular enthusiasm to British late evening programmes when they arrive at a very early breakfast time. By means of "bottled wireless" transmissions can easily be made to fit in with the requirements of local time, and it is to be hoped that full use will be made of knowledge about wavelengths that has been gained in the last three or four years through the experiments which have taken place between Chelmsford and Schenectady.

The 25.53-metre wavelength now in use is suitable only for certain periods of the twenty-four hours, and it is one that is particularly liable to atmospheric interference. I expect that something a good deal shorter will be used considerably.

Why—Oh, Why?

There is no doubt about it, components are jolly good nowadays, taking them all round. Electrically they are far more efficient than they were even a year or two ago, and most of them are real sound engineering jobs instead of being merely contraptions. To take one instance, when you were buying a slow-motion dial in, say, 1927 you had to make sure that it did not freewheel or go in jerks.

Nowadays, unless you visit a cheap-jack shop, as no sensible man does, you can feel

pretty sure that any dial that you purchase will have a perfectly good action. What I do want to bring home to makers is that in far too many cases all the gilt is taken off the gingerbread by faulty inspection of components before they are passed out for sale.

During the past week I have been building a small set, which took a good deal of time because I was experimenting with all kinds of circuits. Will you believe me when I say that nearly half the time I spent over it was simply wasted in doing jobs to brand new components which were necessary before they could be brought into use? Some of these jobs were quite simple and could have been done by anyone, and others needed tools which are probably not in the kit of the average home constructor.

Now I do think that makers ought to realise that this kind of thing does them no good at all, individually or collectively. They should certainly make a determined stand and resolve that their inspection departments shall be keyed up to the fullest efficiency. Here are one or two of the jobs that I had to do. I am not making this up—it is the absolute "See this wet, see this dry" truth.

Tinkering and Cussing

The first component that roused your "Thermion's" wrath was a variable condenser of well-known make with a slow-motion dial by the same makers. Having mounted the condenser, I slipped on the dial—and found that the spindle was too long. The panel was $\frac{1}{4}$ in., mark you, but the dial could not be got down to it. It was a choice between taking out the condenser (which meant, incidentally, undoing the whole lot of wiring) and cutting off the end of the spindle with a hacksaw. I chose the latter alternative.

Then I put on the dial again and proceeded to tighten up the setscrew. The setscrew refused to tighten. Investigation showed that it was a B.A. thread, and a tap of the correct size was tried. This proved to be exceedingly tight, showing that the female thread was not properly cut. Having tapped, I tried the setscrew again, and still it would not go home.

Keeping the recording angel busy with his shorthand notebook, I examined the setscrew, and found that the outer end of it was burred. To make it go in it had to be run through a die. Pretty thick, wasn't it? The next thing was a tuner, also brand new, which had a wave-change switch that wouldn't work.

This was, of course, not discovered until the set had been wired up, and it then proved a fiddling, finnick job to put it

right. Then came another new component, a valve holder which had a loose internal connection; and by that time I was really thinking seriously of giving up wireless construction and of taking to spillikins as a spare-time hobby.

Once More

I have said it before, but I am going to say it again, because if I go on saying it, and readers do the same, something will eventually be done. If there is one thing that annoys me more than another, in these days of enlightenment, it is to find a component put together with 5B.A. screws and nuts and provided with terminals of the same size.

What makes it worse than ever is that many of these 5B.A. nuts are not of the standard overall dimensions, so that they look as if they were either 6B.A. or 4B.A. Actually, the odd B.A. sizes are completely unnecessary in wireless work, and their use serves no better purpose than to irritate the constructor. If makers want small stuff, 6B.A. is admirable, and where something larger is needed 4B.A. will answer every requirement.

There is not the slightest rhyme or reason in using 5B.A. for anything. What so often happens is that you lose a terminal nut from a choke, a transformer, or a condenser, and find that you have nothing in stock that will replace it. Your ditty box contains heaps and heaps of 4B.A. and 6B.A. milled nuts, but you haven't a single 5B.A. in your possession. Will makers please read, mark, inwardly digest, and take the necessary action?

Not "Up to Snuff"

Whilst those readers who live near Brookmans Park get all and more than they want from "Raucous Reg" and "Noisy Nat," there is no doubt that the ranges covered by the latter are a real source of disappointment to those responsible for designing the stations. Even at sixteen miles a considerable difference in their signal strength is noticeable with a small set, and I hear from friends living twenty miles or more away that at longer distances "Nat" shows a very poor strength for his size and fades at times to beat the band.

I suppose that the short wavelength has a good deal to do with it, but I am not sure that is the only cause, for I don't remember hearing similar reports about Belfast, which works on a wavelength 21 metres shorter. I can't help thinking that there is some possible connection between high power with deep modulation that may have something to do with it, for

:: :: *On Your Wavelength! (continued)* :: ::

this combination does introduce special problems of its own.

You may remember the awful trouble that Langenberg had when he first came on the air some years ago, using 25 kilowatts. He very soon gained the reputation of being the world's champion fader at medium and long ranges, and his service area in his own country was far below expectations. Meantime, it seems a little hard that those living close to "Noisy Nat" should be swamped out by him, though he doesn't benefit others dwelling further afield. One does not mind suffering in a good cause, but—

Worth Trying

In my time I have done, I suppose, about as much wiring-up of wireless sets and bits and pieces as most people. I have used pretty well every kind of material available—bare wire, square rod, wire in systoflex sleeving, d.c.c., enamelled wire, flex, Glazite, and all the others. All of them have their good points, but there is one trouble common to all if you are in a hurry: baring the ends neatly is a fiddling job that takes up rather a lot of time.

For work that I want to show to my friends (with the ulterior motive of receiving pats on the back) I still swear by Glazite or something similar; but I have just discovered yet another kind of wire which is remarkably handy for ordinary purposes. This is plain tinned wire of about No. 20 gauge, with a single covering of greyish-black rubber; but baring the ends neatly is a lightning business.

Simply take a blunt pair of scissors and nip round the rubber about an inch from the end. Then pull. Off comes all the rubber like a piece of bicycle valve tubing, and there is the wire as pretty as can be! Don't use a sharp pair of scissors, by the way (or, if you insist upon doing so, don't squeeze hard with them), for you may nick the wire and make a weak place in it.

This wire is really very jolly stuff, for it is stiff enough to stay put, and a set containing connections made with it looks very well indeed. It costs only a penny per yard in small quantities, and a good deal less if you buy it in bulk.

A Useful Idea

Absolutely the only way of seeing how transformers of various ratios and makes compare with one another in the results that they produce is to have some means of changing over in a flash from one to another whilst the set is actually working. If it takes you even two or three seconds to make the change, you probably won't get a correct impression, since human memory, particularly for volume and quality, is very unreliable.

The ideal contraption is something which will enable you to go from one to another in a flash. I have just made up a simple and very inexpensive little contrivance that may appeal to readers of an experimental turn of mind, since it allows comparative tests, not only of transformers, but of other components, to be made with the greatest ease and accuracy. It consists of nothing more ambitious than a board, some 10 in. in length, upon which are mounted one pair of double-pole change-over switches.

A four-pole switch could be used with advantage, but I hadn't one in stock when I was making up the gadget; and, anyhow, those of the double-pole variety are much more easily obtainable. Suppose that you are testing out a pair of transformers, here is how you do it. To the four contacts of the arms of the switches bring wires from the appropriate grid, plate, grid-battery, and high-tension positive points in the set.

Connect up one transformer to the fixed contacts on one side of the switch and t'other to those on the other. Then you can flick your switches over as quick as you like and actually make comparisons between the performances of the transformers in their rendering of the same bar of music.

A Telephone Tip

Most sets nowadays use low-impedance output valves and many have output circuits specially designed for low-impedance loud-speakers. For long-distance work it is often desirable to use telephones during searching, for if one works on the loud-speaker direct there is always the chance of interfering with other people by oscillating. Now, the great majority of telephones in use are high-resistance instruments with a very considerable impedance at speech frequencies. For the best results the impedance of loud-speaker or telephones should be in the neighbourhood of twice that of the output valve. The high D.C. resistance of 2,000-ohm phones is also out of place with most modern sets.

You don't want to buy new phones, of course, since the old ones are perfectly good; and here is a tip that will avoid this, besides improving results. Telephone receivers are normally wired in series. Each receiver has a D.C. resistance of, say, 1,000 ohms, which makes 2,000 ohms for the pair. If you wire them in parallel, instead of in series, the D.C. resistance becomes 500 ohms, and the impedance at speech frequencies is also reduced to something reasonable.

A Speed Record, Then—

It is rather amazing to think that it is only just over a hundred years since the installation of lines of semaphores placed

on hilltops enabled messages to be sent between certain places at the then dizzy speed of a hundred miles or so an hour. Previously news travelled very slowly. Amongst the pioneers of rapidity in the transmission and reception of news were the Rothschild family, who are reputed to have made an enormous amount of money by making special arrangements to have the result of the Battle of Waterloo sent from Brussels to London at the quickest approach to lightning speed that had ever been accomplished. Gallopers conveyed the tidings to the coast, a fast-sailing vessel performed the journey across the Channel, and further relays of horsemen completed the stages from Dover to London. Since they had the news many hours before it came to other people, they were able to buy hugely on the Stock Exchange and to reap a rich profit, for prices soared as soon as everyone learnt of the British victory.

—And Now

That was one hundred and fifteen years ago. Just the other day a little experiment was made by a news association which supplies 1,300 American journals. To see how rapidly news could be disseminated they arranged to send a test message from New York. The route of the message was so planned that it encircled the earth, came back to New York, was started on its journey through a different chain of towns, went round the earth again and came back finally to the starting point. Including all delays for transcribing and repeating the message, the first lap was completed in one hour thirty-seven and a half minutes, and the double journey was made in two hours and five minutes. Wireless played an enormous part in this extraordinary feat, and it is undoubtedly destined to play a bigger and bigger rôle in the world's news services.

A Quaint Opinion

I have no sympathy with the man who brags about receiving hopelessly distorted speech and music from Samarkand or Canton on half a valve. Nor have I any use for the kind of DX work that leads to the logging of a hundred and fifty stations in half an hour. I do maintain, though, that the sane long-distance man gets far more pleasure out of his set than the fellow who is content to receive nothing but his local station. The long-distance enthusiast has no gaps in his evening's entertainment. If he doesn't like what the local station is putting out he goes over for the time being to Toulouse or Turin, or Nürnberg, or Rome, or Oslo, or perhaps Budapest, or Vienna, or Radio-Paris, or Motala. With such a wealth of alternatives available he is sure to find something to his liking.

THERMION

A PAGE FOR THE SET BUYER

"Set Tester" on—

THE VOLTRON
DYNAPLUS 3

Makers: Voltron Electric Ltd.

Price: £3.12.9 complete set of parts.

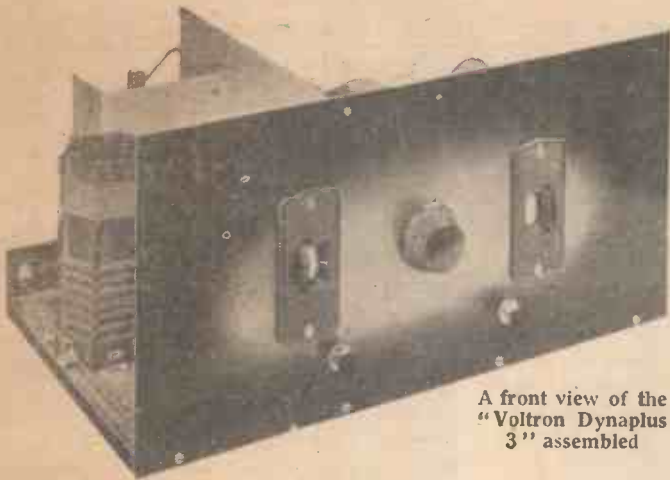

A front view of the "Voltron Dynaplug 3" assembled

"**T**OUR Europe from your armchair" is the slogan applied by Voltron Electric, Ltd., to the Dynaplug Screened Three, a model of which I have been testing this week. The total cost of a kit of parts to make the set is £3 12s. 9d., to which modest total one must add the cost of three valves, batteries, and a cabinet.

As an example of the low price of the components, I quote the low-frequency transformer, which is 6s. 9d. This Voltron product has a core of silicon steel, claimed to give high permeability, which implies good reproduction if a suitable valve precedes it. I am mindful of Alan Hunter's remarks last week on the need for good batteries and valves; they certainly make or mar a set.

A Test

To give the Dynaplug Three a fair chance, I selected a Cossor screen-grid valve for the high-frequency stage, a

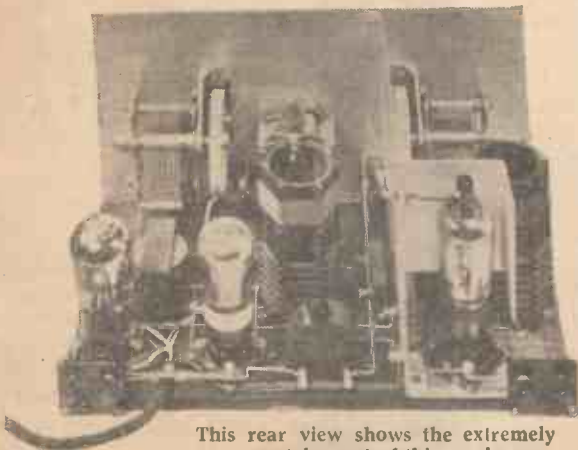

This rear view shows the extremely neat lay-out of this receiver

Mullard PM1HF for the detector, and an Osram P215 for the power stage—rather a mixed batch, but all highly efficient. To work these valves, I hooked up three 45-volt super high-tension blocks.

An indoor aerial, recently put up, having a total length of 50 ft., and a good earth, made all ready for the test; save for the loud-speaker, an Ultra Air-chrome that gives good quality, I find, with anything like a respectable set. Before giving

results, let me explain the illustrations; the front panel is aluminium, suitably finished to harmonise with the normal wireless cabinet.

This panel carries two drum dials—left, for tuning the aerial, and right, for tuning the intervalve coupling coil. Fixed near by these dials are two switches—left, for changing the wavelength ranges (200 to 500 metres and 1,000 to 2,000 metres), and right, for switching the set on and off by making or breaking the filament circuit.

Between the dials is a handy reaction knob—more convenient to operate than the rather small tuning dials. That completes the control layout. The baseboard arrangement of the two dual-wave tuning coils is equally neat, a strong aluminium partition separating one coil from the other. A still neater little shield separates the screen-grid valve from the aerial coil—a necessary precaution, in view of the great sensitivity of the modern screen-grid valve.

The detector valve, power valve, and transformer group themselves with the remaining small parts into an efficient layout that the average constructor should find delightfully easy to follow. I tried a finished model, the wiring of which was exceedingly well done. Connecting up the batteries is simplified by wiring the battery cable directly to the components involved; different colours distinguish the four high-tension leads from the low-tension and grid-bias leads. I suggest to Voltron that some of those neat little tabs marked in volts would be a further aid in the battery-lead identification.

Using a maximum high-tension voltage of 120 volts, the total current was, naturally, not very low, especially as the screen-grid valve is not negatively grid-biased, while the detector works on the leaky-grid-condenser system. The total was 11 milli-

amperes, so a double-capacity high-tension battery would be strongly advisable—as it would with most three-valvers.

With the switch on the left in the "out" position, bringing the medium wavelength band into action, I started out to see whether Europe really could be heard from the armchair. Before "crossing the Channel," I got the home product from the National and Regional stations at Brookmans Park, as well as Midland Regional. Now, I know the man in Wigan or Crewe will get quite different local stations from these; but the reception mentioned does give some general indica-

tion. For one thing, it shows the set is selective. Although I see nothing revolutionary in the Voltron coils, they are extremely selective.

London Regional is not an easy station to get rid of, but turning both dials together I lost it completely in less than 5 degrees. I could hardly find the National, at first; so there was obviously no difficulty in cutting out that station. The Midland Regional station gives the London listener an idea of the ranging properties of a set on test. This set brought in Midland Regional at fine strength.

Tuning is easy because both dials have to be set at similar readings for any given station. For example, London Regional came in at 65 degrees on both dials, Midland Regional at 82 and 80 degrees, on left and right respectively, while the National came in at 28 and 30 degrees.

Now about quality. I am not going to say the "Dynaplug Three" was entirely responsible for the pleasant timbre of the tone, but with the help of the P215 power valve and the Ultra loud-speaker I was able to satisfy a quite fastidious friend. He commented on the crisp top notes, but I was more interested in the bass notes.

The Voltron people are quite justified in their slogan, for as darkness came on I was able to listen to such familiar European stations as Toulouse, Rome, and Vienna at full loud-speaker strength. On the long waves also there was plenty of diversion.

Every set referred to in this regular feature by "Set Tester" has reached a certain standard of efficiency in the "Amateur Wireless" Laboratory. Reports are not given on sets that fail to reach this standard. This will explain why reports that do appear express general satisfaction with the set's performance.

SYDNEY MOSELEY'S WEEKLY PROGRAMME CRITICISM

The "Proms"
 Television Transmissions
 Berlin Talks
 Amy's Broadcast



MUSICAL listeners had their annual treat when the Promenade Concerts opened on Saturday. The enthusiasm of the first night is sufficient answer to any sceptics as to the popularity of music among listeners.

While there is all the difference in the world between difficult chamber music and, say, a Beethoven symphony, there is no doubt that the programmes put over by the B.B.C. at the Queen's Hall have the right appeal.

It was impossible for a good many people to get in the first night. This is where the listener scores. When there is an overflow meeting it is far better to stay at home and listen comfortably through the next best medium

But, nevertheless, I should advise every listener to go to the Queen's Hall and see as well as hear some of the concerts. The prices are popular and it enables you to get into more intimate touch with the other concerts when you are listening-in.

Recently I have become a star turn—three performances daily! I am, of course, referring to the Coliseum transmissions of Baird television. That has interfered somewhat with my listening. Nevertheless, I was able to get into direct touch with many of my readers who have told me what they think of the television programmes.

Despite the kind comments that have been made, I wish to assure readers of AMATEUR WIRELESS that I am by no means satisfied with the kind of programme that has gone out up to the present. The whole thing is still in a state of embryo. I am hoping to do very much better.

I am all in favour of putting over the works of Tchekov. The last two put over had favourable comments in these notes.

In regard to *Wedding*, it was amusing, but I imagine many listeners found difficulty in getting the hang of it. There was a large cast, and the long unpronounceable Russian names must have befogged many an Anglo-Saxon ear. However, let us have more Tchekov.

An artiste who will probably be heard on the wireless as a result of the television

transmissions is Frederick Yule, whose voice came over so well that he has been engaged to sing at the Coliseum.

A duet with Doreen Monte was also so warmly applauded that do not be surprised if you hear it over the wireless, too.

After an exciting week, I arrived home tired. Some music, I thought, will soothe the savage brow. Lying on my bed, I put on the old portable. I "reached out" and found there was a talk from Berlin on "Ventilation." (Horrors!) So I hied back to one of the Dutch stations which, as a rule, offers music even if it is only of the tin variety. But again horror! There was the police news. So I got back to one of the London stations, where I heard one of the best renderings of "Beloved, it is Morn."

The first performance of the much-boomed *Co-optimistically Yours* was rather disappointing, I think. Perhaps all the enthusiastic advance publicity led me to expect something slightly better. Anyhow, the pierrot atmosphere of the "Co-optimists" was lacking.

A singer who always pleases me is Tatiana Makushina. She is a fine artiste and is kind to my loud-speaker—which is saying a lot.

Here is a note from a correspondent:—"I don't know whether I am out of

order in writing the following, but I should like to say how intrigued I was by your recent television show at the Coliseum. Although crude to a certain extent, the broadcast gave one a thrilling foretaste of what is to come. I am willing to bet that 99 per cent. of those who saw it came away ardent followers of the television movement. Congratulations, too, on your ready wit as announcer." (Note by S.A.M.: Does he mean me?)

It appears that the children were pleased with Amy Johnson when she broadcast to them recently. I have had one or two letters from parents, and one expresses regret that Amy is in so much demand. "She would have made an ideal 'auntie,'" he sighs.

Sweeping a Chimney is probably Mabel Constanduros' best sketch. Producers of some of those incredibly dull entertainments to which we are sometimes treated should study the technique of this little sketch. They may get some ideas from it. Amazing, isn't it, how Mabel continues to please us. In this way she undoubtedly holds the record. Even really fine artistes fall down after a while. She lives on as fresh and as popular as ever.

I am glad to see that Joan Revel is broadcasting again. I have always liked her voice. She and Mario de Pietro are a splendid duo.

My experiences as a director of programmes for television leads me to the considered opinion that there is quite a lot of talent. Unfortunately, it is impossible to use even those of our deserving artistes as often as one would like to.

Nevertheless, in order to please both listener and looker-in, I have found it was necessary to choose probably one out of eight with reasonable artistic abilities.

I do not at all envy the work of the Programmes Department of the B.B.C. in this connection, although they have a big organisation and a large sum of money with which to play.

Meanwhile, my intention is to give everybody, with well-known names or not, opportunities, and if any reader of AMATEUR WIRELESS thinks he or she has sufficient talent to have an audition they may write to me c/o the Editor, and I will do my best



A Roberts' impression of Miss Annie Craft

MAINS POWER *for your* SET

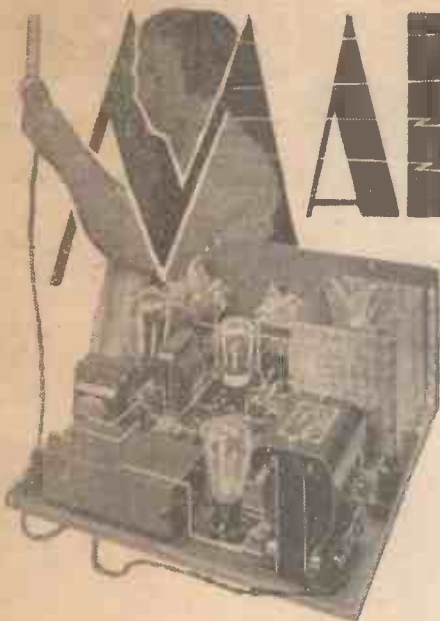

If you have the electric light mains in your house, you should use them for working your receiver

mical ways to take mains power are clearly defined. To scrap the high-tension battery is simple, whether the mains are A.C. or D.C. Plenty of good units at reasonable prices could be quoted from actual experience. For the sake of example, I mention two I have recently tested. The Tannoy type W8 unit, made by Tannoy Products, of 1-7 Dalton Street, West Norwood, S.E., is especially designed to deliver high-tension current to powerful sets. It is worth remembering that powerful sets need a high-tension eliminator more than simple sets, because large anode currents cannot be economically supplied by a battery.

The price of the W8 unit is £5 15s. It can only be used on A.C. mains. It has an ample output, the maximum voltage at 40 milliamperes load being 200 volts. This unit is extremely robust in construction

This unit is most useful for big sets, such as those with a push-pull output stage or super-power paralleled valves. The Atlas makers do a wide range of units, including a medium-power type, AC16, very popular for three-valvers. Its price is only £4 10s. complete.

When we try to eliminate the low-tension battery and grid-bias battery, mains



power is not so easily utilised, unless great structural alterations can be competently undertaken. Normally, my advice is to keep the grid-bias battery because it gives very little trouble, costs practically nothing to replace, and lasts at least six months, however big the set. Some high-tension units provide grid-bias by sacrificing a portion of the available high-tension voltage. This is a good plan that may seem justifiable to some readers.



REPRESENTATIVE UNITS

Left to right, Tannoy, Ekco, Atlas, Regentone

Taps are provided, the voltage descending in ten steps of 20 volts. This firm

Assuming one keeps the grid-bias battery, the problem is to get rid of the accumulator. For those with D.C. mains, the worry of the accumulator can be overcome by charging it through a carbon- or metal-filament lamp passing, say, .2 ampere. This trickle charging can be much more conveniently done if the supply is A.C., for there are many excellent and inexpensive A.C. units for this purpose.

The Ecko trickle charger for A.C. mains, which I recently tested, is an excellent example. Type 500, as it is called, costs £2 12s. 6d., and in my opinion is worth the money. It will charge two-, four-, and six-volt accumulators at a rate of .5 ampere. This charging rate is very convenient, since it corresponds with the rate at which the average set discharges the accumulator.

(Continued on page 189)

make a wide range of mains units, suitable for all output requirements. The good internal workmanship is a notable feature of every Tannoy unit.

Messrs. H. Clarke & Co., Ltd., of Atlas Works, Old Trafford, Manchester, is another pioneering firm producing inexpensive mains units. The Atlas type AC38 is a large unit for A.C. mains inputs of 200 to 250 volts. The price is £9 12s. 6d. Two taps are provided for outputs varying between zero and 150 volts, and the maximum output is 180 volts at 50 milliamperes.

BBETTER than battery power is mains power, so we are told, and the dictum is true, but not always easy to follow. Batteries to-day are efficient, they give long life, and they are not unduly expensive; and, since the day of universal electricity supply is a long way off, batteries must remain for many listeners the only means of operating a radio set. But I find that many listeners who already have a mains supply are by no means sure as to what is the most effective way of making use of it.

D.C. and A.C.

D.C. mains—rapidly being converted to A.C. all over the country—are not so useful for all-electric-set operation. Ordinary valves are generally used in D.C. sets; so one advantage is lost. But many good D.C. sets are available and all abolish batteries entirely. One D.C. set—the Ediswan—employs A.C. mains valves; it is extraordinarily efficient.

Where a set is already installed and working from batteries, the most econo-



NOT everybody wants an expensive set, or one that is going to cost a lot of money to keep in operation on seven nights of every week. At the same time, everybody wants a set which will give good reception from the Brookmans Parks (or their equivalent in parts of England away from London) and 5XX; and, thanks to the increased power which is now available from most B.B.C. stations, it does not need a very elaborate outfit to give this good B.B.C. reception—and also the reception of a few foreigners.

In other words, the coming of the Regional Scheme and the workings of the Prague Plan, by which a number of Continental stations have been able to increase their power, have resulted in a new scope for one of the simplest type of sets, the two-valver.

And yet there is one difficulty, namely, the greater need for sharp tuning. Three-valvers are very popular nowadays because the high-frequency stage which most of them possess makes it easy to get knife-edge tuning without the use of wavetraps or externally fitted series condensers in the aerial lead. The sharp tuning of a good H.F. stage is one of its natural characteristics, and the reason why so many people at an H.F. stage, screen grid or otherwise, is not that they need the extra high-frequency amplification before the detector (in most cases they do not, because of the proximity of high-power stations), but that they appreciate what it means to have one station clear of another on the dial, without fiddling about with a wavetrap.

Provided, however, that one can get satisfactory selectivity with a

plain detector stage (and this is not so difficult as one might think, judging by the scare which was raised at the opening of the Brookmans Parks), then in many districts one low-frequency stage after the detector is sufficient.

The AMATEUR WIRELESS Technical Staff realised this big demand for a two-valver, and so it has produced the "Searcher Two," a receiver which is aptly described by its name.



COMPONENTS REQUIRED

- Ebonite panel, 12 in. by 8 in. (H. & B., Becol, Ready Radio).
- Baseboard, 12 in. by 9 in. (Pickett, Camco).
- Panel bracket (Bulgin, Lissen, Ready Radio).
- .0005-microfarad variable condenser (Igranic, J.B., Lissen, Lotus, Burton, Formo, Polar, Ready Radio).
- .0004-microfarad differential condenser (Lotus).
- Filament switch (Bulgin, Lotus, Benjamin).
- Double-pole double-throw switch (Lissen type LN575, Wearite).
- Slow-motion dial (Brownie, Igranic, Formo).
- Two valve holders (W.B., Lotus, Burton, Lissen, Benjamin, Junit).
- High-frequency choke (Lewcos, Lissen, Bulgin, Tunewell, Wearite, Sovereign).
- Low-frequency transformer (Lissen, Varley, Ferranti, Igranic, Telsen, R.I., Burton).
- .0002-microfarad fixed condenser with series clips (Dubilier, T.C.C., Lissen, Graham-Farish, Watmel, Atlas).
- .0001-microfarad fixed condenser (Dubilier, T.C.C., Lissen, Graham-Farish, Watmel, Atlas).
- Pre-set condenser, .0003 to .000025 microfarad (Formo type J, Lissen, Lewcos, Polar, Sovereign).
- 1-megohm grid-leak (Dubilier, Lissen, Watmel, Ediswan, Atlas).
- Two ebonite terminal strips, 2½ in. by 2 in. (H. & B., Lissen, Ready Radio).
- Four terminals, marked: Aerial, Earth, L.S.+, L.S.— (Ealex, Belling-Lee, Clix, Igranic).
- Five wander plugs, marked: H.T.—, H.T.+1, H.T.+2, G.B.—, G.B.— (Belling-Lee, Ealex, Clix, Igranic).
- Two spade terminals, marked: L.T.—, L.T.— (Belling-Lee, Clix, Ealex).
- Grid-bias battery clips (Bulgin).
- Four yards of thin flex (Lewcoflex).
- Coil former, 1½ in. diameter and 2½ in. long (Wearite, H. & B.).
- Coil former, 2 in. diameter and 2½ in. long (Wearite, H. & B.).
- 4 oz. of No. 36 d.s.c. wire (Lewcos).
- 4 oz. of No. 24 d.s.c. wire (Lewcos).
- Length of Sistoflex (Wearite, H. & B.).

the photographs shown here. The design is very simple and, of course, one would hardly expect anything very complicated in a two-valve set.

Before the constructional work is started, most amateurs who intend making up the "Searcher" will interest themselves in the theoretical circuit diagram and see the general scheme of connections.

The circuit given here shows the coil-

It is a local-station set with a fair turn of volume and with very sharp tuning, and at the same time it is a searcher—a set which really will bring in foreigners. It will bring in enough in the course of an average evening to satisfy any but confirmed DX listeners of the type who never listen to the B.B.C. station!

The Coil

A special home-made coil is built into the "Searcher," and it is largely owing to the good design of this that high performance is obtained. This coil is one which you can wind at home yourself, and it is not difficult to construct or expensive.

A good idea of the general layout of the "Searcher Two" is to be obtained from

switching arrangements; and, really, these are not half so complicated as they may appear. The winding of the coil and its connection in the circuit will be described later, but in the meantime it may be taken for granted that it is on quite straightforward lines.

Built into the set is a variable condenser in series

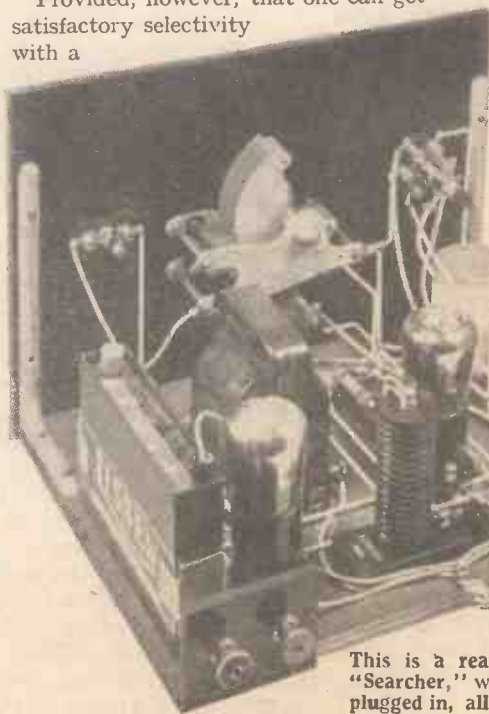

This is a rear view of the "Searcher," with the valves plugged in, all ready for use

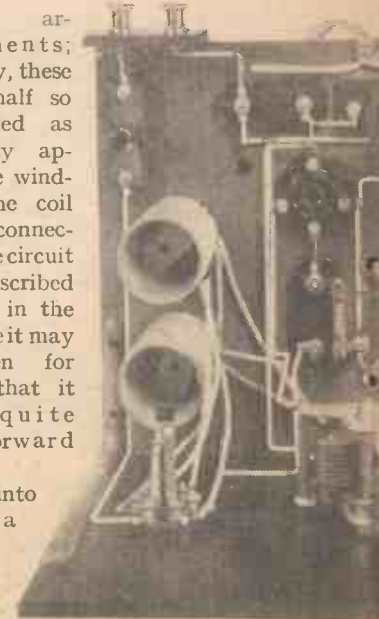

From this plan view a good idea of the

SEARCHER TWO

"It is a local-station set with a fair turn of volume and with very sharp tuning, and at the same time it is a searcher—a set which really will bring in foreigners. . . . A special home-made coil is built into the 'Searcher,' and it is largely owing to the good design of this that high performance is obtained."

between the aerial and the coil. The effect of this is well known and it plays a large part in obtaining the overall selectivity of the "Searcher." Leaky-grid rectification is used, for, although anode-bend rectification can give sharper tuning, if properly set up there is no need to have this extra complication in a set so simple as the "Searcher."

The merit of leaky-grid rectification is

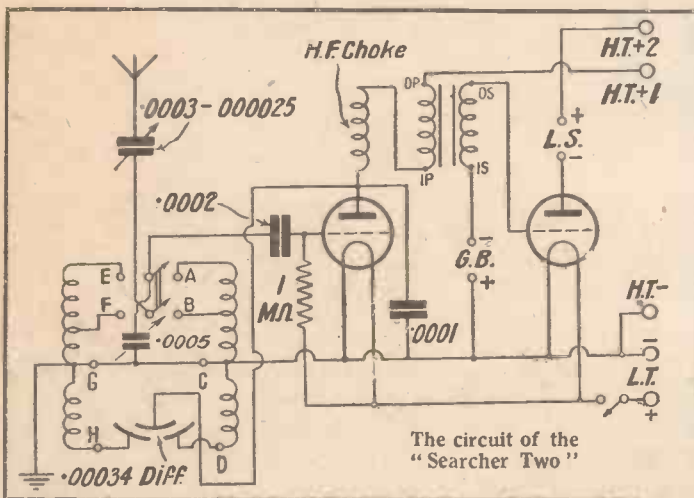

that it is automatic in action, and once the best values have been found for the grid condenser and leak (those specified are most suitable for this set) it does not need any further adjustment, whereas anode-bend rectification needs careful preliminary adjustment of bias value, and there is always the possibility of this

the differential condenser. The moving vanes of the condenser are connected to the anode of the detector valve.

Notable Features

An efficient high-frequency choke combined with a .0001-microfarad bypass condenser forms the H.F. filter circuit, and this, as readers doubtless know, plays a great part in ensuring trouble-free working of any set. The coupling with the power valve is done by means of an L.F. transformer arranged on quite straightforward lines.

Separate high-tension tapings are provided for the detector and power

valves, and this ensures that each valve can be separately adjusted to its best operating action.

A little feature in this set which is commendable is the fact that reaction is obtained with what is known as a "differential" condenser. Just what this means can best be seen by examination of the circuit diagram. In the special coil there is a separate reaction winding for the medium- and long-wave sections, and reaction is properly provided by the two stationary halves of

valves, and this ensures that each valve can be separately adjusted to its best operating point.

Another good thing about this is that when the "Searcher Two" is operated from a mains eliminator (this can be done quite easily) no trouble will be experienced from interference between one valve and another—a fault only too prone to occur with mains-driven sets which are not provided with independent H.T. tapings.

Building the Set

And now one may turn attention to constructional work. The parts needed are neither numerous nor expensive, as will be seen on referring to the list of components given in the accompanying panel. Here, in some cases, will be seen alternatives to the specified makes of components, and these can be used where for any reason the first-mentioned parts (those used in the receiver illustrated) cannot be obtained.

To assist constructors, a blueprint has been prepared for the "Searcher Two," and this can be obtained, price 1s., post free, from the Blueprint Department of AMATEUR WIRELESS, 58-61 Fetter Lane, London, E.C.4. No correspondence is necessary when applying for blueprints. In this instance simply ask for Blueprint No. 245.

The simple job of screwing down the components to the baseboard, of drilling and mounting the panel, and of wiring all the parts should be easy work for one evening with the aid only of the usual set-construction tools—a screwdriver, a pair of pliers, a drill, and a soldering iron.



component layout may be obtained

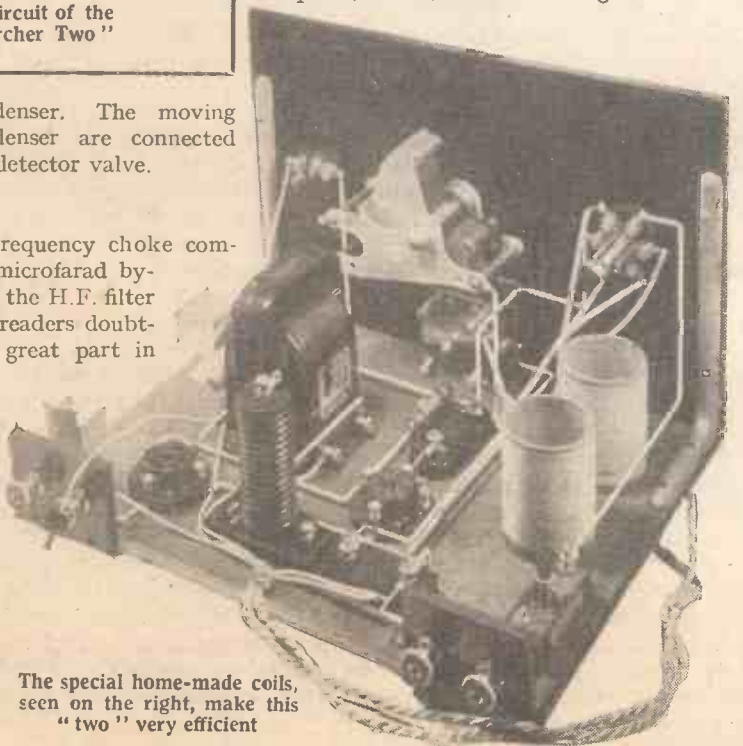

The special home-made coils, seen on the right, make this "two" very efficient

THE "SEARCHER TWO" (Continued from preceding page)

If the work of drilling the panel is shunned, although there is no reason why it should be, for good ebonite does not readily crack, then most wireless dealers will be willing to undertake this small job.

The blueprint, to which reference has

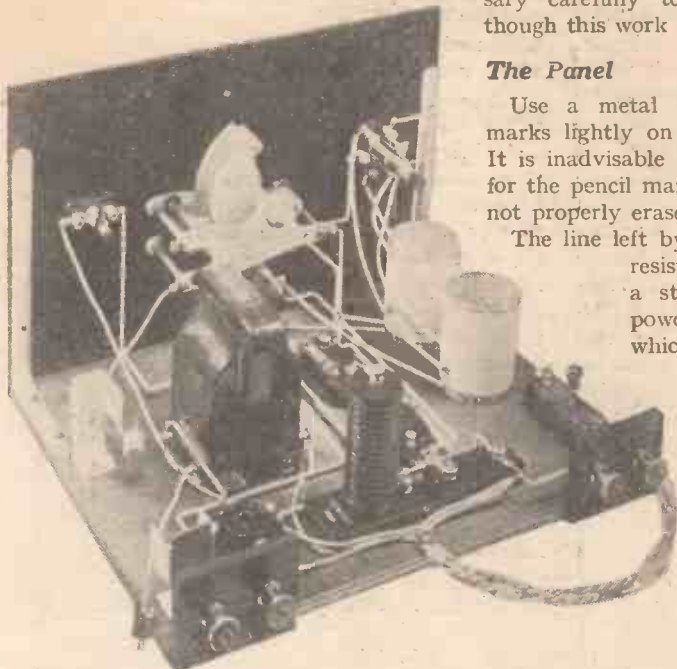

Another view of the "Searcher Two" which will aid constructors

already been made, is invaluable for every part of the constructional work, and the convenience and simplicity of working direct from the print are best appreciated by those who do not consider themselves particularly gifted in the manipulation of ordinary set-construction tools and who are anxious to avoid as much as possible of the more difficult work, and many people still think that the drilling of ebonite is fraught with the constant possibility of the material cracking—which is far from the truth, provided you have good quality ebonite.

Readers who have studied the descriptions given of previous AMATEUR WIRELESS sets will know that we advise that the blueprint itself should be used as the drilling template. This can be done without difficulty, for the print is full-size. It should be attached to the corners of the panel with four spots of adhesive—the back of the panel, of course, is the side from which one drills.

It is then quite easy to see the exact positions of the drilling centres; the mistake must not be made, though, of drilling immediately the template is in position.

The centres should first be marked on the ebonite with a small punch. A light tap is sufficient to make an indentation, and this gives the point of the drill bit a start. If the holes are not punched, then there is a possibility of the bit slipping,

tearing the blueprint and scratching the back of the panel.

Should the blueprint not be used, however, then the small reproduction given herewith can be used for giving the drilling centres, for it is to scale. It will be necessary carefully to mark off each hole, though this work need not take very long.

The Panel

Use a metal scriber for placing the marks lightly on the back of the panel. It is inadvisable to use a pencil for this, for the pencil marks may cause trouble if not properly erased.

The line left by a pencil forms a high-resistance leak (it is, in effect, a streak of graphite-carbon powder), and many sets which have worked in an unsatisfactory manner have, on inspection, been found to have pencil marks still remaining behind the panel.

There is just one further point about drilling. Do not exert too

much pressure on the bit, for it may be bent; and be very careful when a hole is nearly drilled, for a heavy pressure on the drill will cause the last remaining scrap of ebonite to crack the front surface as the bit forces its way through.

And remember that, as you are drilling from the back of the panel, the greatest care must be taken with the front surface. The panel should preferably be worked on a clean, smooth surface, so that the "polish" may not be scratched.

The components are of the one-hole-fixing type, and the only holes which have to be drilled, apart from those for the fixing bolts and screws for the panel, are those for the wave-change and L.T. switches, and the reaction and aerial condensers.

Further Notes

Those who like to have full constructional notes and operating instructions should make sure of getting next week's issue, when final details regarding the mounting and wiring of parts, and the winding of the special coil will be given.

As usual, the "Searcher Two" will be on show in the Radio Department windows of Messrs. Selfridge & Co., Ltd., of Oxford Street, London, W., and London readers who can conveniently do so should make a point of seeing this simple and efficient "two."

Many readers of AMATEUR WIRELESS will learn with deep regret of the death on Saturday, August 9, of Mrs. Kate Raymond, who, until recently, traded for many years in Lisle Street, Leicester Square, London, W.C., under the style of K. Raymond. A character of marked idiosyncracies, and a great personality in her way, she recently had the misfortune to pass through great financial difficulties, as a result of which her business passed into other hands a few months ago, but retained the same trading name. There must be thousands of our readers who were aware of the shrewd, kindly, generous personality hiding itself behind Mrs. Raymond's somewhat brusque exterior.

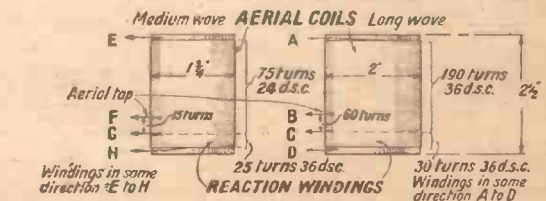
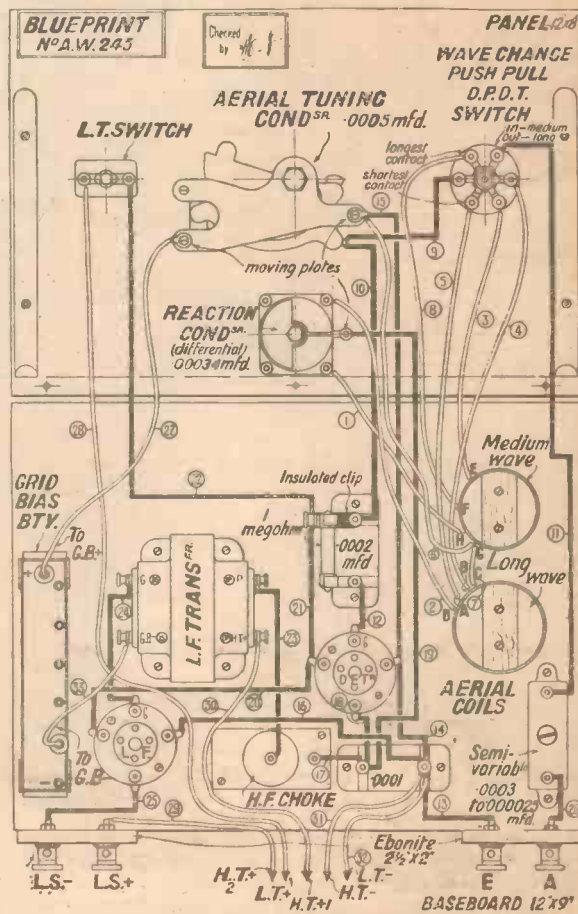

A full-size blueprint can be obtained, price 1/- post free



LONG DISTANCE RADIO
DYNAPLUG SCREENED 3
Tour Europe from your armchair

triumph of the S.G. valve.

No idle boast, but a plain statement of fact This set is proving the most thrilling long-distance station-getter that wireless listeners have ever used.

new, exclusive circuit does the trick.

The circuit is the latest development of the Voltron laboratories and is exclusive to the Dynaplug Screened 3. In no other three-valve set can you get such a choice of programmes at *loud-speaker strength*.

quality without the penalty of high price.

In the past you had to pay fabulous prices if you wanted the best. Now you can get the most wonderful three-valve set on the market using the same Voltron components as are used by the greatest radio-gramophone makers in the industry, at a price within the reach of everyone.

easy to build. no soldering.

The kit is supplied with every component necessary—ready to go together—all holes drilled, and so that you need only a pair of pliers and a screwdriver. Go to your dealer to-day and get a copy of the Voltron catalogue and free blueprint. In case of difficulty write direct.

COMPLETE KIT OF PARTS £3:12:9

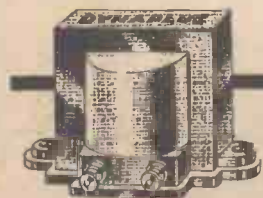

6/9 The Dynaplug Screened 3 is famous not only for its long range and selectivity, but also for its amazing purity of reproduction. The Dynaplug Transformer is the secret. Baritone, soprano, tenor, contralto, drums, fiddle, piano—every one of them comes through clear cut, crystal pure, and with volume in abundance.

VOLTRON ELECTRIC LTD.,
Queensway,
PONDERS END Middlesex



THE MAN WHO TRANSFERRED

When he improved the set with an Ever Ready battery it was as good as a transfer from the pit to the stalls. The Ever Ready gives what listeners want. Gives long life. But not at the cost of efficiency. It works steadily—not in spurts. Silently—not with a crackle. Powerfully—not below the capacity of the set. It lasts but it does not slack. The battery goes on but the loud speaker doesn't go off. You must try the Ever Ready. It is made by an exclusive process—a specially thorough process. It is guaranteed to give satisfactory service by a company which has been making reliable batteries for 28 years.

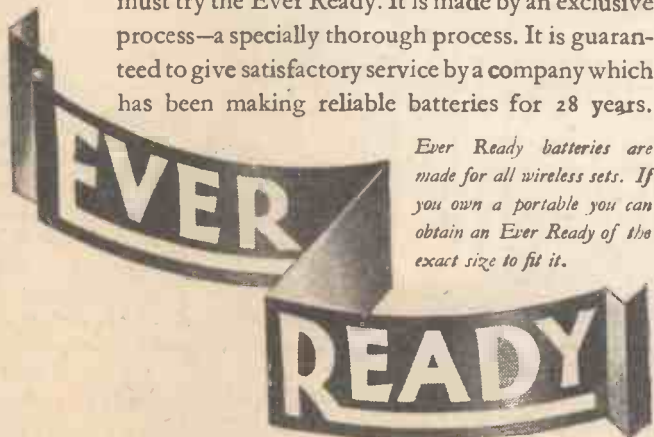

Ever Ready batteries are made for all wireless sets. If you own a portable you can obtain an Ever Ready of the exact size to fit it.

The battery that gives unwavering power

The Ever Ready Co. (Gt. Britain) Ltd., Hercules Place, Holloway, London, N.7

Advertisers Appreciate Mention of "A.W." with Your Order



Conducted by our Technical Editor: J. H. REYNER, B.Sc. (Hons.), A.M.I.E.E.

Dario L.F. Transformer

THE Dario low-frequency transformer, made in France and marketed in this country by Messrs. Impex Electrical, Ltd., is a neat and compact little instrument, having overall dimensions of $2\frac{3}{8}$ in. by $1\frac{5}{8}$ in. by 2 in. high. The windings and iron core are totally enclosed in a metal shroud and the primary and secondary terminals are arranged on the top.

It is hardly to be expected that a transformer selling at such a low figure should have a high primary inductance, but nevertheless, if used following a suitable low-impedance valve the amplification should be reasonably constant down to the lower frequencies reproduced by the average cone loud-speaker. There is no tendency for the iron circuit to saturate at normal D.C. current. With 2 milliamps D.C. through the primary winding, the inductance was found to be 7 henries and approximately 5 henries at 10 milliamps. The step-up ratio is 3 to 1.

This transformer should prove a useful accessory, particularly in cases where space is limited, as in portable sets.



The Dario L.F. transformer

Ever-Ready H.T. Battery

EXPERIENCE in battery making is a factor which cannot be overlooked in these days. There are so many items that count in the service to be obtained from an H.T. battery. It may be run down rapidly in a portable set, or used on a one or two-valve set at infrequent intervals, in which case it should last the best part of a year, while it may be used under varying climatic conditions. All these factors have con-

siderable bearing on the chemical activities of the cells.

There is a feeling of security in the name Ever-Ready, for this company has had long experience in the manufacture of dry cells of all types, and has made a special study of the wireless market with a view to supplying particular types of cell most suited to wireless conditions. The 66-volt Ever-Ready popular battery has been widely used since its inception, and those samples which we have tested in these laboratories have proved their reliability. We recently subjected one of these batteries to a discharge test over a continuous period. The



Ever-Ready H.T. battery

battery being of standard capacity, the rate was commenced at 7 milliamps and continued until the discharge had fallen to $3\frac{1}{2}$ milliamps. This it did after eleven days, or 264 hours of continuous use. The capacity obtained under these conditions is approximately 1,400 milliampere hours, a value well above the lower limit of performance fixed for a standard cell.

The dimensions of the battery are $9\frac{1}{4}$ in. by $3\frac{1}{2}$ in. by $3\frac{1}{8}$ in. high, and tappings are taken at 15 volts and thence at every 3 volts up to the maximum of 66 volts.

Skiwal Aerial Fixing

HOW many readers have not been faced at one time or other with the problem of erecting an aerial on a mast already in position? Sometimes a guy rope or pulley has broken at the top, probably necessitating pulling down the mast.

The Skiwal Manufacturing Co., have produced an ingenious form of aerial clamp which can be readily erected with the mast in position. The device comprises, essentially, a set of metal-tooth jaws capable of automatically gripping the mast when tension is applied to the aerial wire. The jaws are fitted with an extension to which a lifting pole may be fitted.

In erecting the aerial it is only necessary to arrange the wire on the ground with a little spare cable, fix it at one end to the jaws and hoist this end on the lifting pole

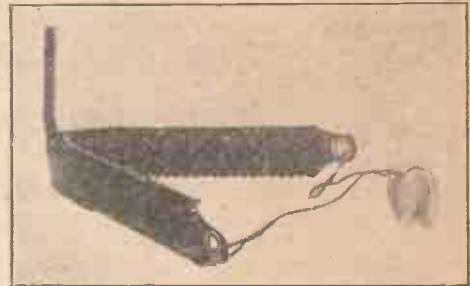

A novel aerial fixing, the Skiwal

to the required height, then, on pulling the other end of the aerial, the jaws will close together and grip the pole with perfect security. Only when the tension of the aerial is reduced considerably will the jaws spring apart and slide down the pole. A slight slackening due to the flexing of the pole should not affect the clamping.

So simple is this device that it can be used with advantage in cases where the pole and the aerial are erected together, in which case one does not trouble about the aerial wire until the pole has been securely grounded.

The test which we carried out showed that the jaws bite well into any wooden mast, even with a moderate tension. The device should prove of practical value.



This is the Melbourne H.F. choke the test report of which was given in "A.W." No. 426



The ORIGINAL Jelly Acid Battery

The popularity of the C.A.V. Jelly Acid Battery is not explained by the mere fact that it contains jelly electrolyte—there are other jelly electrolyte batteries! There are three reasons why the C.A.V. is the most effective non-spillable yet produced.

The Jelly Acid. Its composition is unknown outside our own laboratories. It maintains perfect contact with the whole of the plate surfaces, yet allows unrestricted gassing when on charge. It is chemically pure, and allows maximum conductivity.

The Container. Of special construction, contains a baffle plate and moistening pad, which serves the triple purpose of arresting acid spray during charge, feeding the electrolyte with moisture to maintain an even consistency, and definitely confines the jelly to the plate chamber.

The Plates. These have been specially developed to give the utmost possible capacity when used with C.A.V. Jelly Acid.

The Whole. The C.A.V. is the lightest, cleanest, and most compact non-spillable on the market. By avoiding cumbersome acid traps, the greatest possible capacity for bulk is obtained.

CAYandervell & Co. Ltd.
ACTON, LONDON, W.3.

Obtainable from our Depots and Battery Agents throughout the country and from all Radio Dealers.



Compact, Clean & Non-Spillable

We issue a useful booklet on the care and maintenance of C.A.V. non-spillable batteries. Would you like a copy? Free on request to Dept. C.4.



Hear the new N.K. FARRAND INDUCTOR LOUD-SPEAKER

Moving Coil quality without its drawbacks. **£3:10:0**

This remarkable loud-speaker not only equals the moving coil but improves on its sensitivity, clarity and beauty of tone. Cheaper to buy. Simple to operate. No batteries. Large quantities supplied without delay. Full details free on request.

The Latest Eliminators
and all-mains units specially made for portables and built-in sets from £2 10s. 0d. to £6 0s. 0d.

FOR YOUR HOLIDAY

The New Columbia Cadet Portable Gramophone, exceptionally small, automatic stop, wonderful tone. Only 57s. 6d. Various colours.

Complete range of all H.M.V. and Columbia gramophones and records. Portable wireless of every description.

Ready to take away:—
Charged accumulators and H.T. batteries to fit all portables carried in stock.

WILL DAY LTD.
19 LISLE ST., LEICESTER SQ., W.C.2
Phone: Regent 0921-22

A new, amazing transformer
at an amazing price!

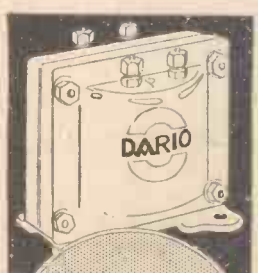

A neat and compact little instrument... particularly useful where space is limited, as in Portable Sets.

(See "Amateur Wireless" Test Report on page 184.)

Gives best results when used with Dario Valves.

DARIO
Best way to all Stations!

IMPEX ELECTRICAL LTD.
(Dept. J.), 538, High Road, Leytonstone, London, E.11

TRANSFORMER

CHOOSING THE RIGHT VALVES

A simple explanation by Mr. W. James of the way in which to make sure of selecting the correct valves for your receiver

THE amount of the amplification obtained from a set depends upon many factors. Most of these are under the control of the user, and it is therefore only a matter of design for the maximum useful magnification to be obtained.

But I do not at the moment propose to discuss very powerful arrangements. Instead, let us consider a typical three-valve receiver and see how we may make certain of getting the greatest practicable amplification.

We have in the first stage a screen-grid valve and in the second a detector. The third stage is the power, a power valve being used here. We can, to commence with, assume the set to be built, this leaving us with the question of the valves only. They will obviously affect the magnification.

With poor valves, distant stations will not be heard; with wrong types they may be heard but faintly, while with the most suitable valves for the receiver many stations will be brought in.

The screen-grid valve will obviously affect the total amplification. It is no exaggeration to state that signals may be ten times as strong with a suitable type as compared with a defective or other type not suited to the circuit.

A defective valve may be one that is passing grid current under normal working conditions. Signals would be much less with such a valve in circuit. The valve might, on the other hand, have too high an impedance for the circuit, or its amplification factor might be relatively low.

It is easy to see that of two valves having equal values of impedance, one having twice the magnification factor of the other, that the actual amplification obtained is likely to be at least twice as much when the better valve is used.

Reaction Effects

Reaction effects would prevent the magnification with one valve being exactly twice that obtained when the other is connected. There is a certain amount of feedback through the valve itself, owing to the capacity of the grid to the anode. Here, then, is a further possibility of the amplification being different with various valves, as the anode grid capacities may be unequal.

It is even possible that the set will be unstable when one valve is used and per-

fectly stable when another is fitted. The different makes of screen-grid valve have not identical characteristics. Some have a lower impedance than others and the amplification factors are different also. Then, again, the capacities are not the same. The result, therefore, is that the amount of the amplification to be obtained from a given set may depend considerably upon the make of screen-grid valve used.

Recommended Types

If we were starting to build we could take advantage of the best possible valve, but when the set is already constructed it is necessary to stick to the type recommended—a better valve might cause the set to be unstable. For this it might be

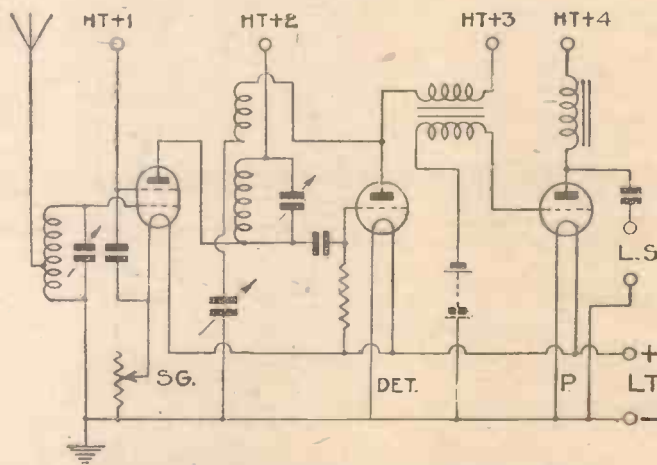

This is the typical three-valver—screen-grid H.F., detector and transformer-coupled power valve—which is referred to here by Mr. James

unfair to blame the valve, as the amount of the high-frequency magnification to be obtained depends largely upon the design of the circuit and in particular upon the shielding and construction of the coils.

It is always advisable to try the effect of different voltages for the screen and anode circuits, as a little experimenting here may make an amount of difference to the performance.

In the second position of the set is a detector valve. We show a leaky-grid detector. This stage may overload and distort. Reaction effects may be poor and the amplification low because of an unsuitable valve.

A valve with too high an impedance ought not to be used for detection and it is foolish to fit a low-impedance valve unless the circumstances are special ones. Normally, a valve of from 10,000 to 20,000 ohms would be used for detection. A quiet valve is essential. Grid current

is also essential, or detection will not be obtained.

Some valves are better detectors than others because their grid current characteristic happens to suit the particular arrangement of grid circuit used. Sometimes a potentiometer is employed for the purpose of giving the user the opportunity of obtaining the best working point. But usually this component is not provided, and the result is that widely different results are to be noticed.

As amplification depends upon both impedance and magnification factor, it is necessary to consider them together, and not merely to judge a valve by its amplification factor. A "steep slope" detector valve is one having a large amplification factor for a relatively low impedance. Valves of this class make good detectors, as they not only provide good amplification, but, having a relatively low impedance, handle fairly strong signals with little distortion. Such valves are equally suitable as anode-bend detectors.

The Detector

An amount of volume may be lost in the detector stage by using a poor valve, more especially if the valve is such that reaction effects are poor. Thus it is necessary for this stage to consider not only the valve and its amplifying properties, but also to select one that will, with the circuit, provide useful reaction.

The characteristics of power valves are fairly well known. That shown in the figure is choke-coupled to the loud-speaker. We can fit here a sensitive valve or one which is not so sensitive, but having a greater power-handling capacity. For a given power output the best valve for many purposes would be one having the greatest amplification factor, but there are limits. Generally, however, a valve of about 3,000 ohms, having the highest magnification factor, would be a first-class power valve for driving an ordinary loud-speaker.

3000 Ohms

A vaudeville programme will be broadcast from the North on August 25, in which all artistes taking part are well known to listeners. They include John Rorke and Phyllis Scott, Stanley Maher and his Merry Men, and John Woods-Smith (entertainer). The music will be provided by the Black Dyke Harmony Quartet.

BROADCAST TELEPHONY

Broadcasting stations classified by country and in order of wavelengths. For the purpose of better comparison, the power indicated is aerial energy.

Metres	Kilo-cycles	Station and Call Sign	Power (Kw.)	Metres	Kilo-cycles	Station and Call Sign	Power (Kw.)	Metres	Kilo-cycles	Station and Call Sign	Power (Kw.)							
GREAT BRITAIN																		
25.53	11,751	Chelmsford	(5SW) 15.0	308	973	Paris (Vitus).....	1.0	NORTH AFRICA										
200	1,500	Leeds.....	0.13	316	955	Marseilles (PTT) 0.5	363.4	825	Algiers (PTT) ...	10.0	416	721	Radio Maroc (Rabat) 10.0					
242	1,238	Belfast.....	1.0	328.2	914	Grenoble (PTT) 0.5	1,250	240	Tunis Kasbah ...	0.6	NORWAY							
261	1,148	London Nat.....	45.0	329	911.8	Poste Parisien ...	0.5	864	824	Bergen.....	1.0	813	Frederiksstad ...	0.7				
288.5	1,040	Newcastle.....	1.0	345.2	869	Strasbourg (testing shortly)	12.0	453	662	Nidaros.....	1.2	455	659.3	Forsgrund.....	0.7			
288.5	1,040	Swansea.....	0.13	568.3	813	Radio LL (Paris) 0.5	364	493	608	Oslo.....	1.5	POLAND						
288.5	1,040	Stoke-on-Trent 0.13	447	571	Paris (PTT).....	0.8	135	2,222	Oslo.....	60.0	214	1,400	Warsaw (2).....	2.0				
288.5	1,040	Sheffield.....	0.13	466	644	Lyons (PTT).....	5.0	234	1,283	Lodz.....	1.5	313	959	Cracow.....	0.5			
288.5	1,040	Plymouth.....	0.13	1,446	207	Eiffel Tower.....	12.0	335	896	Poznan.....	1.2	381	788	Lvov.....	2.0			
288.5	1,040	Liverpool.....	0.13	1,725	174	Radio Paris.....	16.0	385	779	Wilno.....	0.5	408	734	Katowice.....	10.0			
288.5	1,040	Hull.....	0.13	GERMANY								1,411	212.5	Warsaw.....	8.0			
288.5	1,040	Edinburgh.....	0.85	215.8	1,393	Flensburg.....	0.5	PORTUGAL				320	937.6	Lisbon (CTIAA) 0.25				
288.5	1,040	Dundee.....	0.13	227	1,319	Cologne.....	4.0	ROUMANIA				301	761	Bucharest.....	12.0			
288.5	1,040	Bournemouth... 1.0	227	1,319	Munster.....	3.0	RUSSIA				720	416.6	Moscow (PTT) ...	20.0				
288.5	1,040	Bradford.....	0.13	227	1,319	Aachen.....	0.35	800	375	Kiev.....	20.0	824	364	Sverdlovsk.....	25.0			
301	995	Aberdeen.....	1.0	232.7	1,288	Kiel.....	0.35	1,000	300	Leningrad.....	20.0	1,060	283	Tiflis.....	10.0			
310	968	Cardiff.....	1.0	239	1,256	Nürnberg.....	2.0	1,073	279	Rostov (Don) ...	10.0	1,103	272	Moscow Popoff... 40.0				
356	842	London Reg. ...	30.0	246	1,220	Cassel.....	0.25	1,304	230	Moscow-Stchekovo (C.C.S.P.) 100.0								
377	797	Manchester.....	1.0	253	1,184	Gleitwitz.....	2.0	1,380	217.5	Bakou.....	10.0	1,497	200	Moscow.....	20.0			
390	753	Glasgow.....	1.0	259	1,157	Leipzig.....	2.5	SPAIN				251	1,193	Barcelona (EAJ15) 0.5				
479	626	Midland Reg. ...	25.0	270	1,112	Kaiserslautern 0.25	2.5	206.7	1,125	Barcelona (EAJ13) 5.0								
1,551	393	Daventry (Nat.) 25.0	276	1,085	Königsberg.....	2.5	349	860	Barcelona (EAJ1) 8.0									
AUSTRIA												368	815	Seville (EAJ5) ...	1.5			
246	1,220	Linz.....	0.5	283	1,058	Magdeburg.....	0.5	407	737	Madrid (España) 1.0								
283	1,058	Innsbruck.....	0.5	283	1,058	Berlin (E).....	0.5	424	707	Madrid (EAJ7) ...	2.0							
352	851	Graz.....	9.0	283	1,058	Stettin.....	0.5	462	649	San Sebastian (EAJ8) 0.5								
453	666	Klagenfurt.....	0.5	316.9	916.6	Bremen.....	0.35	SWEDEN										
517	578.5	Vienna.....	15.0	320	937.6	Dresden.....	0.25	230.1	1,304	Malmö.....	0.6							
BELGIUM												257	1,160	Hörby.....	10.0			
206	1,460	Antwerp.....	0.4	325	923	Breslau.....	1.5	299.3	1,002	Falun.....	0.5							
210	1,391	Chatelineau.....	0.25	360	833	Stuttgart.....	1.5	322	932	Göteborg.....	10.5							
210	1,391	Brussels (Conference) 0.25	473	635	Hamburg.....	1.5	436	689	Stockholm.....	1.5								
239	1,256	Binche.....	0.3	533	563	Munich.....	1.5	542	554	Sundsvall.....	1.0							
243	1,235	Courtrai.....	0.1	560	536	Augsburg.....	0.25	570	527	Freiburg.....	0.35							
244.7	1,226	Ghent.....	0.25	566	529	Hanover.....	0.35	1,835	183.5	Zeeseen.....	26.0							
247	1,213	Schaerbeek.....	0.5	570	527	Freiburg.....	0.35	1,835	183.5	Norddeich.....	10.0							
294	1,020	Liège.....	0.25	HOLLAND								318.8	943	Basle.....	0.5			
337	890	Forest.....	3.0	31.28	9,599	Eindhoven (PCJ) 30.0	299	1,004	Huizen (between 11.40 a.m. and 5.40 p.m. B.S.T.).....	6.5	403	743	Berne.....	1.0				
509	590	Brussels (No. 1) 1.0	418	776	Berlin.....	1.5	1,071	280	Huizen.....	6.5	459	653	Zurich.....	0.63				
CZECHO-SLOVAKIA												1,071	280	Scheveningen-Haven 5.0	678.7	442	Lausanne.....	0.6
263	1,139	Moravska-Ostrava 10.0	1,875	160	Hilversum.....	6.5	760	395	Geneva.....	0.25	TURKEY							
279	1,076	Bratislava.....	12.5	HUNGARY								1,220	245.9	Istanbul.....	5.0			
293	1,022	Kosice.....	2.0	210	1,430	Budapest (Csepel) 1.0	550	545	Budapest.....	20.0	1,961	153	Ankara.....	7.0				
342	878	Brunn (Brno) ...	12.0	ICELAND								YUGOSLAVIA						
487	617	Prague (Praha) ... 5.0	1,071	280	Scheveningen-Haven 5.0	1,200	250	Reykjavik.....	16.0	306.7	978	Zagreb (Agram) 0.7						
DENMARK												432.3	694	Belgrade.....	2.5			
281	1,067	Copenhagen.....	0.75	IRISH FREE STATE								574.7	522	Ljubljana.....	2.5			
1,153	260	Kalundborg.....	7.5	225	1,337	Cork (IFS).....	1.0	SWITZERLAND										
ESTONIA												413	725	Dublin (2RN) ... 1.0	YUGOSLAVIA			
401	748	Reval (Tallinn) ... 1.5	HUNGARY								YUGOSLAVIA							
FINLAND												25.4 and 80	Rome (3RO).....	9.0	YUGOSLAVIA			
221	1,355	Helsinki.....	10.0	291	1,030	Turin (Torino) ... 7.0	332	905	Naples (Napoli) 1.5	YUGOSLAVIA								
1,796	167	Lahti.....	40.0	381	788	Genoa (Genova) 1.0	441	680	Rome (Roma) ...	50.0	YUGOSLAVIA							
FRANCE												453	662	Bolzano (IBZ) ... 0.3	YUGOSLAVIA			
175	1,714	St. Quentin.....	0.1	501	599	Milan (Milano) ... 7.0	LATVIA											
210	1,430	Radio Touraine 0.5	LITHUANIA								YUGOSLAVIA							
223	1,346	Fécamp.....	0.7	1,935	155	Kaunas.....	7.0	YUGOSLAVIA										
235	1,275	Nimes.....	1.0	LITHUANIA								YUGOSLAVIA						
237	1,265	Bordeaux (Radio Sud-Ouest) 1.0	LITHUANIA								YUGOSLAVIA							
240.4	1,248	Béziers.....	0.3	LITHUANIA								YUGOSLAVIA						
249.5	1,202	Juan-les-Pins ... 0.5	LITHUANIA								YUGOSLAVIA							
256	1,171	Toulouse (PTT) 1.5	LITHUANIA								YUGOSLAVIA							
265	1,130	Lille (PTT).....	0.7	LITHUANIA								YUGOSLAVIA						
272	1,102	Rennes (PTT) ... 0.5	LITHUANIA								YUGOSLAVIA							
286	1,046	Montpellier ... 0.3	LITHUANIA								YUGOSLAVIA							
286.8	1,040	Radio Lyons.....	0.5	LITHUANIA								YUGOSLAVIA						
295.4	1,015	Limoges (PTT) ... 0.5	LITHUANIA								YUGOSLAVIA							
306	980	Bordeaux (PTT) 1.0	LITHUANIA								YUGOSLAVIA							

All wavelengths marked with an asterisk have been allotted according to the Plan de Prague.

What do you look for in a Wireless Set ?



Performance? Appearance? Low Running Costs?

On each of these points the Lotus 3-valve S.G.P. All Electric Receiver scores full marks. Unequalled for width of range, giving perfect trouble-free reception under all conditions—ample volume, highly developed sensitivity and selectivity (enabling unwanted stations to be cut out with ease) and crystal clarity of tone.

In appearance, an elegant piece of furniture of which you can be proud—not merely a cabinet.

Running costs practically nil. No batteries needed—all power being taken direct from the electric-light mains.

Price, £21 cash, or 12 monthly payments of £1:19:9.

Ask your dealer for a free demonstration and full details of this remarkable set.

LOTUS ALL ELECTRIC RECEIVER

Garnett, Whiteley & Co., Ltd. (Dept. A.W. 10) Lotus Works, Mill Lane, Liverpool.

"Handicrafts 1931 Annual"—The new edition of the Handicrafts Annual should be in the hands of every radio home constructor, for it includes the description of many types of radio and gramophone cabinets for home building. The construction of many other useful articles for the home is also described. The Handicrafts Annual can be obtained, price 1s., from Handicrafts, Ltd., Lister Works, Weedington Road, N.W.5.

home-constructer use, and in the pages of this catalogue will be found components for every purpose. Readers can obtain this catalogue free on mention of "A.W."

"Britain's Favourite Three"—Constructors of this popular set, described last week, should note that it is the Watmel DX3 type H.F. choke which is used in the detector anode circuit.

Radio Courtrai (Belgium), a private broadcasting station working on 243 metres with a power of 100 watts, broadcasts every Sunday morning from 9.30 to midday. Announcements are made in French and Flemish.

Constructors will be interested in the new R.I. catalogue, which has been received from Messrs. Radio Instruments, Ltd., of Purley Way, Croydon. This gives full particulars of the whole R.I. range for

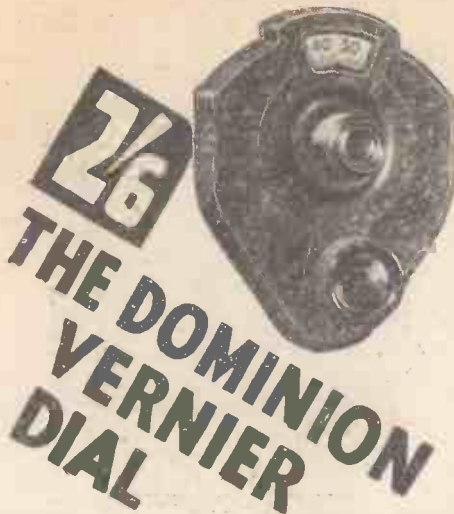

Only Brownie's huge production enables them to offer this really splendid dial for 2/6. The special non-backlash design makes hair-breadth tuning a matter of delightful ease, while its handsome appearance (black or beautifully grained mahogany bakelite) will add to the good looks of that new set you are building.

BROWNIE
WIRELESS

BROWNIE WIRELESS COMPANY (G.B.) LIMITED,
NELSON STREET WORKS, LONDON, N.W.1.

RADIOGRAMS

BOBBY HOWES, Miriello Parray, and Peter Haddon will be heard in excerpts from *Sons o' Guns* when this musical comedy is broadcast regionally on Aug. 25.

In connection with the revival of Lewis Carroll's *Through the Looking Glass* in September, the B.B.C. will introduce an innovation by giving one performance on September 15 at 8 p.m. for adults and an earlier broadcast on the following evening for children.

Listeners to the Regional and National programmes will be given again an opportunity of hearing Nellie Wallace on August 27 and 28. She will appear in a vaudeville hour, which also includes Margaret Bannerman, Joseph Coyne, "Those Four Chaps" (Bobbie Comber, Paul England, Claude Hulbert, and Eddie Childs), and Fairchild and Lindholm.

The Invalid, a Black Country comedy to be broadcast through Midland Regional on September 1, is founded on a true story. The play is by Frank G. Layton, a Staffordshire doctor who has practice among the people about whom he writes.

RAYMOND'S

27 & 28a, LISLE ST., LONDON, W.C.2
Come to LEICESTER SQUARE TUBE STN.
This address is at the back of Daly's Theatre
NOTE.—NEW 'PHONE NUMBER—GFRRARD 2821

BRITAIN'S 1930 FAVOURITE THREE SET
Complete Kit of parts using alternative components,
Packed and sent **£3.12.6**
Carr. Paid, with
Blueprint, for ...

THE STRAIGHT THREE

A Complete Kit of Parts with Blueprint, 2 L.F. Trans., Dual Range Coil, 3 Marconi V.H., '0003 and 2 meg. Leak, '0003, good make H.F. Choke, '0003 and '0003 Var. Con., 2 Slow Motion Dials, Pol. Panel 14 by 7, Set Leads, Oak Cabinet, Wire, Screws. Usually 70/- Special Reduced Price until August 30th. **35/-**
Packing and Carriage 3/- extra.

THE SEARCHER TWO

A complete Kit of Parts, comprising Panel, Baseboard, Panel Brackets, '0005 Formo, '00034 Lotus, Benjamin Switch, Lissen D.P.D.T., Formo Dial, 2 Lotus V.H., Telsen New Type Radiogrand, '0002 and '0001 T.C.C., Formodensar, 1-meg. G.L., Strips, Plugs, Terminals, Wire, etc., 2 Wearite Formers, and **£2.12.6**
Wire. Complete for ...
Carriage 3/- extra.

NEW TYPE TELSEN L.F. TRANSFORMER

Acc, 3-1	...	8/6
Acc, 5-1	...	8/6
Grand, 5-1	...	12/6
Grand, 3-1	...	12/6

SPECIAL FOR CALLERS ONLY

H. T., 60 v.,	3/11;
100 v., 6/11.	S.M. Dials,
1/9.	'0005 S.L.F., 2/9.
7/22 Aerial,	1/9. 2 mfd.,
2/-.	4 mfd., 3/6. D.R.
Coils, 4/11,	and thousand other lines.

IMPORTANT. All letters and communications must be addressed to
K. RAYMOND, LTD.
27 & 28a LISLE STREET, LONDON, W.C.2
The name of the street is not sufficient.

THE LEADING COIL MANUFACTURERS FOR TEN YEARS—AND STILL THE FOREMOST IN DESIGN & QUALITY

To lead the field of coil manufacturers is an achievement. But to maintain that position for over ten years in face of fierce competition is a performance of which we are justly proud. The use of "Wearite" Coils and components assures the constructor's success in his work, as every "Wearite" product carries our guarantee of perfection. Once again "Wearite" Coils have been specified for the famous Talisman Coils in the "Talisman Two."

Dual Range TALISMAN COILS (Patent applied for)

Aerial	Range	Anode or H.F.
10/6	200-550 1000-1800	7/6

BINOWAVE COILS 1930 (Patent applied for)

A type Unit, Aerial	-	-	} 17/-
C or D type Unit, Anode	-	-	

Sole manufacturers under licence.

Wearite components are obtainable from all good radio shops.

H.F. BY-PASS UNIT 4/6 EACH

Write for free Illustrated List NOW.

WEARITE

COMPONENTS

WRIGHT & WEAIRE, LTD.

740, HIGH ROAD, TOTTENHAM, N.17

342

Telephone: Tottenham 3847/8.



A good item on any programme

Player's please

It's the Tobacco that Counts

N.C.C.899

What are the Sound Waves Saying?

SOUNDS of Berlioz came through the other night—from his native France, I think it was; but it does not matter—he is always worth listening to, wherever he comes from. As I listened I found myself conjuring up his hawk-like features in my mind's eye, and I fell to wondering how many of those who were listening have torn through their lives as he tore through his. He was the son of a doctor and, as a child, was not allowed to think much about music; he was to become a doctor like his father before him, but one experience of an operating theatre settled the matter for Berlioz.

In a Chorus

By singing in the chorus at a small theatre Berlioz kept body and soul together while he studied at the Conservatoire in Paris. Old Cherubini was the head in those days; Berlioz loathed the sight of him and consequently defied every rule of the establishment. He managed to win the *Grand Prix de Rome*, all the same, but resisted the conditions regarding it, namely that he must travel for three years and study composition. Before the end of the second he had petitioned the Ministry so piteously that they allowed him to return to Paris.

The following year he met the lovely Irish actress, Henrietta Smithson, with whom he fell violently in love. He wrote an overture to some production in which she was engaged to appear and nearly went mad when he found that she had not even heard it. After that he began to write letters; so strong were they in expression that Miss Smithson was compelled to order her maid not to receive them. But he won her in the end, and married her. She had to earn most of the living for the first few months; not that he was unwilling to do so, but every post he tried for was refused him; pupils were scarce, and concerts did not pay for the giving. In the end he was forced to take up a cheap kind of journalism though he contrived at the same time to write many musical works. A requiem of his was successful, and he sold the rights of two other manuscripts for a considerable sum.

Off for Germany

Having given up the journalism he hated so fervently, Berlioz decided to travel in Germany, knowing that both Liszt and Schumann had written much in his favour. Unfortunately, at the last moment Henrietta refused to go; this caused a dispute that ended in a quarrel and a separation. She was incapacitated through an accident, so he kept her from want but he never lived with her again.

He succeeded well in Germany—in Russia also; in Paris—no. And that was the bitterest blow of all. Many a composer found disdainful Paris hard to please, but none more than Hector Berlioz.

Six months after the death of his first wife, Berlioz married Mademoiselle Recio, a singer of high ambition, but little talent. Unfortunately she insisted on playing lead in his operas, the operas suffered in consequence. If his first marriage had not been a success this was a hell on earth, though in some ways he was devoted to her. Her death, in 1862, left him alone in the world.

I had forgotten, for the moment, his first love—who was also his last. I have just remembered her name—Estelle Gauthier.

After not having seen her for nearly fifty years he sought her out once more. He was, by that time, sixty, and she not far short of seventy. Even so, his love for her seemed to take him by storm. She handled him splendidly, and replied tactfully to all his letters. She was a graceful old lady, widowed, and with a grown-up son.

She sent him her portrait telling him that it might destroy the illusions of the past. They met once, but instead of a ridiculous marriage—which would certainly have occurred had he prevailed—there sprang up a happy friendship which lasted until his death.

WHITAKER-WILSON.

"MAINS POWER FOR YOUR SET"

(Continued from page 179)

Lately we have seen a development in mains units of special interest to owners of portable sets. I refer to the units providing a high-tension supply and a trickle charger for the accumulator, as exemplified by the Regentone model. Made by the Regent Radio Supply Company, this new portable unit is £5 17s. 6d.—by no means expensive, considering its utility. The idea is good; replace the 108-volt high-tension battery and trickle charge the two-volt accumulator, which would be retained. A battery could be kept in reserve so that the portable could on occasion be moved out of doors.

I have tried this Regentone unit in several commercial portables with complete success. Up to loads of 15 milliamperes the maximum high-tension voltage is 120 volts; but there are two subsidiary voltages suitable for high-frequency and detector-valve supplies. The charger works at just under .5 ampere with a two-volt accumulator.

A. S. H.

TUNEWELL



FOR PERFECT TONE

The recent "Wireless World" Speaker Unit Tests proved the Tunewell to be the best for quality of reproduction. Write for details of the full range of Tunewell Loudspeakers from 28/6 (illustrated) to £3 : 3 : 0.

TURNER & CO.

54 Station Road, New Southgate, N.11

1920

1930

Stronger than ever

Our Customers say:—

"I am more than pleased with my set, and must thank you for the prompt way you carried out my order."—J. W. B.

"I am in receipt of the special cabinet . . . it is much better than I ever expected it to be."—W. C.

"I have got one of your Portable Wireless Sets. . . . I think that it is the clearest set that I have heard."—A. H. J.

"May I mention how delighted I am that I have discovered your firm . . . straightforward dealing and courteous, helpful answers to correspondence makes it a real pleasure to deal with you."

"My set has now been installed and I am very pleased with it. I feel that I cannot speak too highly for the excellent services and advice given to me."—W. C.

"You are assured of my again having taken this further opportunity of mentioning to my friends the very fair and straightforward dealings one always obtains at your hands."—G. W. C.

THE EASY WAY

Greater Service for Everything in Radio—Radio-Grams, Mains Sets, Battery-Operated Sets, Mains Units, Kits, Speakers and Components.

PETO SCOTT CO., LTD.

LONDON 77 City Road, E.C.1
 LONDON 62 High Holborn, W.C.1
 LIVERPOOL 4 Manchester Street
 MANCHESTER : 33 Whitelaw Road, Chorlton-cum-Hardy



BULGIN S.W. CHOKES EVERY TIME
 THEY have a reputation unsurpassed for efficiency on all wavelengths from 8 to 80 metres. Ask any keen short-wave enthusiast.
A. F. BULGIN & Co., Ltd. 9-10-11 Currier Street, Chancery Lane, London

"EXCEPTIONALLY GOOD PERFORMANCE . . ."



This is an extract from a most favourable test report made on the Melbourne H.F. Choke published in "A.W." Aug. 9. Specially designed for short and broadcast wavelengths, this efficient choke is obtainable at most good radio dealers at the reasonable price of 4s. 6d.

Write for full details and particulars:—
 MELBOURNE RADIO SUPPLY,
 Norwood Buildings, Roe St.,
 London, E.17. Phone: Walth 1667.

TANNOY Mains Units

INCORPORATING WESTINGHOUSE RECTIFIER

NEED NO ATTENTION
 MORE VOLUME
 GREATER SELECTIVITY
 CHEAPER THAN DRY BATTERIES
 from £3-15-0 (complete)
 A.C. or D.C.

make your **RADIO** "ALL ELECTRIC"

Tannoy Products, 1-7, Dalton Street, S.E.27.

72 PAGE CATALOGUE

Crammed with illustrations and details of all sorts of fascinating and useful gear, at very reasonable prices.

RADIO . . . ELECTRICAL SCIENTIFIC INSTRUMENTS MOTORS . . . GENERATORS

Just send a stamped envelope.

ELECTRADIX RADIOS, 218, Upper Thames Street, E.C.4
 City 0191. Electradix, Cent, London.

AT THE QUEEN'S HALL

ACCORDING to the programme, the "Proms." this year include numerous works by Beethoven, Wagner, Handel, and Mozart. The truth is that three of the Old Masters, including two of those mentioned, have been "dropped" this year. Mozart and Handel are negligibly represented, and on Tuesday, September 23, I shall go to hear the only work to be performed of Haydn—an aria from "The Creation." Why is this composer neglected in London as much as Tchaikowsky is overdone? Why are Tchaikowsky's Fourth and Fifth Symphonies among the most often heard

works in the Queen's Hall?

Sir Henry Wood and the B.B.C. Symphony Orchestra are in good form this year and I return to the regular series of specialised "nights" with joy. The outstanding concert of the first week was the Bach night. There were four concertos, some arias, and a suite. The pianist was Harold Samuel—perhaps the greatest British pianist alive to-day.

L. R. J.

On August 31, after a summer holiday the National Orchestra of Wales will return to the microphone at the Cardiff studio.



W I R E L E S S
 M A G A Z I N E

The Big British Wireless Monthly

1/-

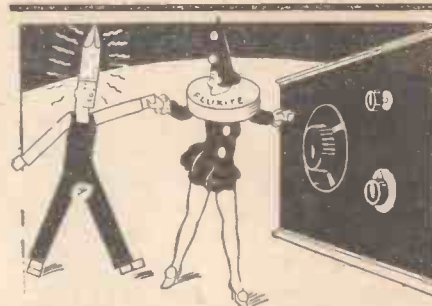

"We're Fluxite and Solder—The reliable pair, Famous for Soldering. Known everywhere! Wherever we go—We're invited to stay. For WE make Soldering Merely child's play!"

See that Fluxite and Solder are always by you—in the house, garage, workshop—anywhere where simple, speedy soldering is needed. They cost so little but will make scores of everyday articles last years longer! For Pots, Pans, Silver and Brassware; RADIO; odd jobs in the garage—there's always something useful for Fluxite and Solder to do.

ANOTHER USE FOR FLUXITE. Hardening Tools and Case Hardening. Ask for Leaflet on improved method.

All Hardware and Ironmongery Stores sell Fluxite in tins, 8d., 1/4 and 2/8.

FLUXITE SOLDERING SET. Simple to use and lasts for years in constant use. Contains special "small-space" soldering iron with non-heating metal handle; pocket blow-lamp, Fluxite Solder, etc; and full instructions.

COMPLETE 7/6, or LAMP only 2/6.

FLUXITE LTD., (Dept. 326) ROTHERHITHE, S.E.16

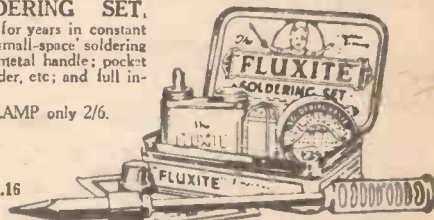

ALL MECHANICS WILL HAVE **FLUXITE** IT SIMPLIFIES ALL SOLDERING

H & B

SEARCHER TWO

Complete Kit of specified parts, together with Trelleborg Panel and Strip ready drilled, Baseboard, Wire, and Screws. FULL-SIZE BLUEPRINT included in each kit **CASH PRICE £3:17:0**

Hand-polished Oak Cabinet, 11/6 extra. Two Mullard Valves, 19/- extra. Write for Detailed List.

H. & B. Special Kit for "Searcher Two." Every part finest quality and guaranteed. Containing all components, Wire, Screws, Panel and Strip drilled **CASH PRICE £2:15:6**

In stock, Cossor Empire 1930 Kit. Cash Price £6 17 6 Easy terms, 30/- down and 6 instalments of £1.

Carriage Paid on all cash orders. C.O.D. Charges Paid over £1.
H & B RADIO CO., 34, 36, 38, Beak Street, Regent Street, W.1
 GERRARD 2884

Postcard Radio Literature

Those Indoor Aerials

OUTDOOR aerials are going out of fashion in many London districts. All kinds of crazy indoor aerials are taking their place, but if you want something better than the average length of flex draped about the room, then you might try the Goltone Nomast aerial which is marketed by Messrs. Ward & Goldstone, Ltd., and described in a new Goltone leaflet. **18**

Those Double Diaphragms

Double-diaphragm speakers are popular at the moment and Messrs. Frederick Squire have sent me a folder telling of the junior double cradle, a very pleasing-looking chassis with twin vellum cones and an ebonised front which should not need hiding behind a cabinet. **19**

A Cheap Portable

If you are on the look-out for a cheap transportable then you should examine the claims of the P.B. "three" which "Set-Tester" described in a recent issue. I have just received a leaflet describing this set

from the P.B. Radio Co., and this should interest prospective portable users. **20**

The Correct Battery

"Use the right battery for the job" is good advice often given. To help non-technical folk, Ever-Ready have just issued a list giving full details of the size, weight, and performance of Ever-Ready H.T., L.T., and G.B. dry batteries. Every battery user should have this list at hand. **21**

For Constructors

Set builders never know when they may be in urgent need of a new component. Therefore, if you are a constructor, get the new Igranic loose-leaf folder, which describes the whole range. **22**

GET THESE CATALOGUES FREE

Here "Observer" reviews the latest booklets and folders issued by well-known manufacturers. If you want copies of any or all of them FREE OF CHARGE, just send a postcard giving the index numbers of the catalogues required (shown at the end of each paragraph) to "Postcard Radio Literature," "AMATEUR WIRELESS," 58 61, Fetter Lane, E.C.4. "Observer" will see that you get all the literature you desire.

"A NEW VALVE FOR H.T. FROM THE MAINS"

(Continued from page 173)

amps, it takes quite twenty to thirty seconds for the filament to reach its correct working temperature.

In the mercury-vapour valves already available the mercury is either contained in the small subsidiary bulb attached to the main glass envelope, or else it is in the form of globules of liquid mercury splashed on the sides of the glass envelope. When the filament current is switched on its heating effect causes some of the mercury to vaporise, and when an alternating voltage is applied between anode and filament during the time that the anode is positive to the filament, electrons emitted from the filament will move towards the anode and in their passage ionise the mercury vapour. During this part of the cycle the rectifier passes current and the valve is filled with the well-known luminous glow of mercury vapour. When the anode is negative the glow disappears and no current is rectified.

The circuits for half-wave and full-wave rectification are absolutely the same for the mercury-vapour rectifier as those normally used with thermionic two-electrode valves. The only exception possibly is in the case where the rectifier is required for charging 6-volt batteries, in which case a ballasting resistance of the barreter type would be required to make up for the difference between the ionisation voltage of the rectifier, approximately 15 volts, and the output voltage for the battery charging, say, 6 to 7 volts. This resistance is, of course, included in the present models of the Philips

low-voltage rectifier.

The most outstanding difference between the old and new types of rectifiers is in the volt drop developed across the valve under load. In an ordinary thermionic valve the volt drop varies with the load, and is such that a normal rectification efficiency is 75 per cent. and an efficiency of, say, 85 per cent. is very good. The volt drop across the mercury-vapour rectifier is constant at approximately 15 volts for all loads, so that an efficiency of 98 per cent. is easily attained. For the larger sizes the filament power is not such a large proportion of the rectified power, so that an efficiency of over 99 per cent. can be obtained. This means also that the heat liberated at the anode is extraordinarily small so that a rectifier having a glass envelope the size of an ordinary 2-volt receiving valve, can have an output of, say, 2,000 volts and 200 to 300 milliamps.

The Future

For the transmitting engineer the new type of rectifier seems likely to supersede entirely the normal type of glass envelope or coiled-anode rectifier, as it has high efficiency and is suitable for both high voltages and high currents. A peculiar fact about the new type of rectifier which must be allowed for in transmitter design is its property of not limiting the current output. In an ordinary rectifier the maximum current is limited by the emission value of the filament, but the mercury-vapour rectifier has no such limiting characteristic. For the broadcast enthusiast the chief usefulness of the new rectifier will be to provide a high voltage for high-power amplifiers.

READ THIS:—

"There is everything in favour of buying a complete kit of parts and nothing against it. You get all the little items, such as screws, etc., and your panel is neatly drilled for you. Moreover, you are certain that every component is suitable for the set—that is if you purchase an approved kit such as is sold by Ready Radio." vide "Popular Wireless."

KITS OF PARTS

SEARCHER TWO
CONTINENTAL PORTABLE
THE CAR THREE
MAXIMUM FOUR
1930 TALISMAN TWO
ETC., ETC.

Cash or Easy Terms. Lists on Application

Ready Radio

159 BOROUGH HIGH STREET,
LONDON BRIDGE, LONDON, S.E.1
'Phone: HOP 5555 (Private Exchange)

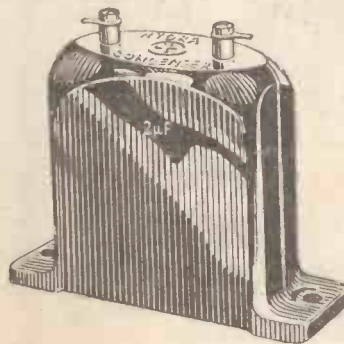

Don't court disaster
... fit Hydra Condensers
in your set to-night
... to-morrow may be
too late!

HYDRA

LOUIS HOLZMAN LTD.

37 Newman Street, W.1
Telephone: Museum 2641

MORE RADIOGRAMS

Free courses in wireless training are being offered by the radio-telegraph branch of the Italian Engineers' Corps to youths likely to be called to the colours later this year or early in 1931. The instruction is being given in Rome and at the radio centres of Naples, Palermo, Cagliari, and Venice.

Construction of a station on a solitary island in the Sea of Japan, at Awashimamura, Iwafune-gun, Niigata Prefecture, was recently finished and will soon be in operation. The wavelength is 171 metres.

IMPROVE THE TONE OF YOUR LINEN OR CONE SPEAKER

Fit the "SELF-CENTRE" device to your cone unit and you will be surprised at the improvement in the tone of your speaker. Designed expressly for use in linen and other speakers. The "SELF-CENTRE" will relieve the driving rod of all undue stress and chatter, allowing for finer adjustment of unit, thus improving tone and volume. Fitted with extra large reversible washers. New Price now 1/6, post free 1/8. Spare washers complete on chuck, 6d.

GOLDEN TAUTENING DOPE

Specially manufactured for use in tautening linen diaphragm speakers. The result of considerable research. NON-INFLAMMABLE, WATERPROOF, and owing to its special qualities a full and rich response to all musical frequencies is constant. It is the dope that counts. Price 1/- per tin, post free 1/3. C.O.D. terms available. Trade inquiries invited. Phone: Grange Wood 1837

WEEDON AND CO.,
80, LONSDALE AVENUE, LONDON, E.6

"Where did that one come from?"

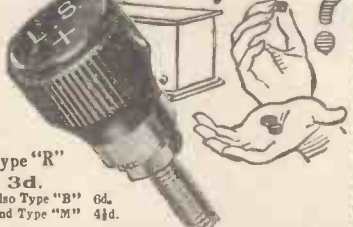

Type "R" 3d, also Type "B" 6d, and Type "M" 4d. Even when their heads are engraved terminals are apt to be very muddling—if the tops come off. The tops of Belling-Lee terminals cannot possibly come off—one of the many advantages to be gained by using these excellent little products. Ask your dealer, or send for FREE Belling-Lee Handbook "Radio Connections."

BELLING-LEE
FOR EVERY RADIO CONNECTION

Advt. of Belling & Lee, Ltd., Queensway Works, Ponders End, Middlesex

"Amateur Wireless and Radiovision." Price Three pence. Published on Thursdays and bearing the date of Saturday immediately following. Post free to any part of the world: 3 months, 4s. 6d.; 6 months, 8s. 9d.; 12 months, 17s. 6d. Postal Orders, Post Office Orders, or Cheques should be made payable to "Bernard Jones Publications, Ltd." General Correspondence is to be brief and written on one side of the paper only. All sketches and drawings to be on separate sheets. Contributions are always welcome, will be promptly considered, and if used will be paid for. Queries should be addressed to the Editor, and the conditions printed at the head of "Our Information Bureau" should be closely observed. Communications should be addressed, according to their nature, to The Editor, The Advertisement Manager, or The Publisher, "Amateur Wireless," 58-61 Fetter Lane, London, E.C.4.

FULL-SIZE BLUEPRINTS

When ordering, please send Postal Order, NOT STAMPS

- CRYSTAL SETS (6d. each)**
B.B.C. Brookman's Park Set AW206
Regional Crystal Set WM176
- ONE-VALVE SETS (1s. each)**
B.B.C. Official One AW208
Hartley Single-valver WM198
- TWO-VALVE SETS (1s. each)**
Loud-speaker America Two AW190
Talisman Two (D, Trans) AW194
Easy-tune Two (D, Trans) AW226
Wavelets Two (D, Trans) AW229
No-battery A.C. Mains Two (D, Trans) AW230
No-battery Gramo-radio 2 (D, Trans) AW238
1930 Talisman 2 (D, Trans) AW239
Easy Tune Short-wave 2 (D, Trans) AW242
Searcher Two (D, Trans) AW245
Brookman's Two (D, Trans) WM168
New Crusader (D, Trans) WM182
Radio-Record Two (SG, D) WM187
Gleaner Two (D, Trans) WM201

- THREE-VALVE SETS (1s. each)**
All-wave High-mag. Three (D, 2 Trans) AW199
Knife-edge Three (D, RC, Trans) AW201
Talisman Two-three (D, RC, Trans) AW203A
Wide World Short-wave Three (HF, D, Trans) AW207
Everybody's Three (SG, D, Trans) AW209
1930 Ether Searcher (SG, D, Trans) AW211
New All-Britain Three (HF, D, Trans) AW214
Best-by-Ballot Three (SG, D, Trans) Price 4d. free with copy of "A.W." AW217
Brookman's By-pass Three (D, 2 Trans) AW220
Everybody's All-electric Three (SG, D, Trans) —A.C. AW221
1930 Clarion Three (SG, D, Trans) AW223
Beginner's Regional Three (D, 21F) AW232
Britain's Favourite Three 1930 (D, 2 Trans) AW243
Car Three (D, R.C. Trans) AW244
Standard Coil Three (HF, D, Trans) WM117
Brookman's Three (SG, D, Trans) WM161
Community Three (D, RC, Trans) WM164
Brookman's Push-Pull Three (SG, D, Trans) 1/6 WM170
All-nations Three (D, 2 Trans) WM178
Inceptordyne (SG, D, Pentode) WM179
Brookman's A.C. Three (SG, D, Trans) 1/6 WM184
Music Marshal (D, 2 Trans) WM190
Gramo-Radio D.C. Three (SG, D, Trans) WM196
Concert Three (D, 2 Trans) WM199
New Lodestone Three (HF, D, Trans) WM205

- FOUR-VALVE SETS (1s. 6d. each)**
Clarion All-electric Three (SG, D, Trans)—A.C. Rectifier AW200
Music-Lover's Gramo-radio (SG, D, RC, Trans)—1s. 6d. AW202A
Music-Lover's Gramo-radio (Loud-speaker) 1s. AW202B
Horizon Four (SG, D, 2 Trans) AW237
Arrow (SG, HF, D, Trans) WM154
1930 Monodial (2SG, D, Trans) WM158
Electric Four (All A.C.—SG, D, RC, Trans) WM162
Brookman's Four (2SG, D, Trans) WM174
Transportable Four (SG, D, 2 RC) WM180
Super Q (SG, D, 2 Trans) WM189
Lodestone Four (HF, D, RC, Trans) WM193
Searcher's Four (SG, D, RC, Trans) WM194
Invitation Four (SG, D, RC, Trans) WM200

- FIVE-VALVE SETS (1s. 6d. each)**
James Quality Five (2SG, D, RC, Trans) AW227
All-wave Lodestone Five (HF, D, RC, Push-pull) WM146
1930 Five (2HF, D, RC, Trans) WM171
Dual-screen Five (2SG, D, RC, Trans) WM185
Radio-Record Five (SG, D, Trans-parallel) WM188
Overseas Five (3SG, D, Trans) WM191

- AMPLIFIERS (1s. each)**
"A.W." Gramophone Amplifier AW205
Brookman's Separator (HF Unit) AW212
Two-valve Amplifier AW216
"Mag" Gramo Unit AW224
Radio-Record Amplifier (DC Mains) WM183

- MISCELLANEOUS (1s. each)**
Short-wave Adaptor (1 v.) AW183
Simplest H.T. Unit AW197
By-pass Unit (Wavetrap) with copy "A.W."—4d. AW218
"Twin" Brookman's By-pass (6d.) AW222
"A.W." Paper Loud-speaker AW231
James H. T. and L.T. Charging Unit AW232
Simplest H.T. Eliminator for D.C. Mains AW234
Simplest H.T. Eliminator for A.C. Mains AW236
Choke Output Unit AW240
A.C. Mains Amplifier WM149
H.T. Unit for A.C. Mains WM159
"W.M." Linnen-diaphragm WM172
Brookman's "Wipe-outs" WM186
Short-wave adaptor for Overseas Five WM192
Staminator Unit for A.C. Mains WM202
Universal Push-pull Amplifier WM204
Outspan Short-wave Adaptor WM207

- PORTABLE SETS**
Music Leader (SG, D, RC, Trans) with copy "A.W." AW203 -/4
Merry-maker Portable (D, 2 Trans) AW228 1/-
Sunshine Three (SG, HF, SG, D, Trans) AW235 1/-
Continental Portable (SG, D, Trans) AW241 1/-
Pedlar Portable Two (D, Trans) WM105 1/-
Pedlar Portable Three (D, 2 Trans) WM107 1/-
James Portable SG3 (SG, D, Trans) WM203 1/-
Foursome Portable (SG, D, 2 Trans) WM206 1/-
Copies of the "Wireless Magazine" and of "Amateur Wireless" containing descriptions of any of these sets can be obtained at 1s. 3d. and 4d. respectively, post free. Index letters "A.W." refer to "Amateur Wireless" sets and "W.M." to "Wireless Magazine" sets.

AMATEUR WIRELESS 58-61 FETTER LANE LONDON, E.C.4

PREPAID ADVERTISEMENTS

Advertisements under this head are charged THREEPENCE PER WORD, minimum charge THREE SHILLINGS. DEPOSIT SYSTEM: As the Publishers cannot accept responsibility for the bona fides of advertisers in this publication, they have introduced a system of deposit which it is recommended should be adopted by readers when dealing with persons with whom they are unacquainted. It is here explained. Intending purchasers should forward to the Publishers the amount of the purchase money of the article advertised. This will be acknowledged to both the Depositor and the Vendor, whose names and addresses must necessarily be given. The deposit is retained until advice is received of the completion of the purchase; or of the article having been returned to and accepted by the Vendor. In addition to the amount of the Deposit, a Fee of 6d. for sums of £1 and under, and 1s. for amounts in excess of £1, to cover postage, etc., must be remitted at the same time. In cases of persons not resident within the United Kingdom, double fees are charged. The amount of the Deposit and Fee must be remitted by Postal Order or Registered Letter (Cheques cannot be accepted), addressed to "AMATEUR WIRELESS, ADVERTISEMENT DEPARTMENT, 58/61 FETTER LANE, LONDON, E.C.4

ELECTRICAL CLEARANCE.—2-valve transmitting sets, 15/-; Morse transmitting sets, 12/6; 11n. spark coils, 6/-; 2in. spark coils, 17/6; super microphones, 2/6; microphone transformers, 2/6; television motors, electric, 110 or 220v., D.C., 10/-; 1/4p. motors, 110v., 30/-; 50v. 5a. dynamos, 35/-; 20v. 6a., 40/-; 100v. 10a., slow speed, 27/-; portable telephones, 17/6; earphones, 1/3; telephone H.T. generators, 6/6; Morse keys, 3/6; buzzers, 2/6; 1 mfd. condensers, 1/6; hand telephones, 5/-; shunt regulators, 10/- to £1, all sizes; 1,000 Ohm chokes, 1/-; magnetic relays, 12/6; P.O. relays, 6/-; Ford ignition coils, 4/-; 1/4p. 220v. motor, shunt wound, 50/-; Mark III Star crystal sets, 40/-; D.III buzzers, platinum contacts, 5/-; Dewar switches, 1/-; 12v. car dynamos, 25/-; 6 or 12v. car starter motors, 12/6; cash with order or c.o.d.; all goods guaranteed; send now, list now ready.—Galpin, Binfield Heath, nr. Henley-on-Thames.

ENGINEERS—novice or expert—£300, £400, £500 per year or more is within your grasp. In our Handbook, "ENGINEERING OPPORTUNITIES," Prof. A. M. Low explains where the good posts abound. This handbook has shown the way to better things to over 20,000 of your fellows. It contains details of A.M.I.Mech.E., A.M.I.E.E., A.M.I.C.E., A.M.I.A.E., A.M.I.Struct.E., Matric., C. and G., G.P.O., etc. Examinations, outlines home study Courses in all branches of Electrical, Mechanical, Motor and Wireless Engineering and shows the unique advantages of our Appointments Department. Why stay in the "Hammer and File Brigade"? Send for our free handbook at once, stating Branch, Post or Examination which interests you.—British Institute of Engineering Technology, 109 Shakespear House, 29-31 Oxford Street, London, W.1.

COMPLETE KITS.—All Circuits. C.O.D. or Terms.—R.I.B., 33 Maroon Street, London, E.1.
BANKRUPT BARGAINS.—Kardex Transformers, 3/3; Tel. en Radiogr. 6/6; Ace, 2/6; Polar variable, 2/6; Rea. tien, 2/-; C.C.O.S. S.L.F., 2/6; 0603 S.M., 3/6; Dual Coils, 8/6; H.F. Chokes, 1/6; Bullphone D.C. Eliminators, 22/6; Triotron Units, 8/6; Bullphone, 6/6; Ditto B.A., 9/-; 66K, 10/3; Kits Parts, 3-valve, 30/-; Cabinets, 18 by 7, 10/6; Speaker Kits, Triotron Unit, Cabinet, Cone, 15/-; with 66K, 25/-; Let me quote for your kit. List free. Easily cheapest.—Butlin, 143b Preston Road, Brighton.

EASY TERMS

We SPECIALISE in the supply of all Good Quality Radio Sets, Components and accessories on Easy Terms. We will give you efficient service. Send us your list of requirements and a quotation will be sent by return.

LONDON RADIO SUPPLY COMPANY
11 Oat Lane, Noble St., London, E.C.2
NATIONAL 1977

FAMOUS CRAFTSMANSHIP

For YOUR SET or RADIO GRAM. Built like a piano, the fine tone and Style brings a thrill no words can convey. (Over 2,000 delighted clients) (Radio Press—leading Experts) DIRECT from makers, APPROVAL 7 days FREE. De Luxe, £5 to £15, Cash or EASY PAYMENTS. Photographs FREE. PICKETS or Radio Furniture Makers (A.M.) Albion Road, Berleyheath, Kent. (Famed for excellence, honoured in BEST Homes.)

DX THE STANDARD PLUG-IN COIL
Sold everywhere from 1/-
DX COILS Ltd, London, E.8

Amateur Wireless

COUPON Available until Saturday AUGUST 30, 1930



Over twenty stations at loud-speaker strength with a simple two-valve may seem too good to be true—but such are the results obtained with this set during a three-hour test one evening. If you build it you can have a choice of programmes from Europe.

WITH the help of the full-size chart contained in the September issue of "Wireless Magazine," now on sale this set can be built by anyone in two hours or so.

All the connections in this set—thirty-one in all—can be made easily with rubber-covered flexible wire without soldering.

Other Contents of the WIRELESS MAGAZINE

The De-luxe Three. A Quality Set with Many Modern Refinements—Megohm Discusses Side-bands—The Selecto-amplifier. To Increase the Range and Selectivity of Existing Sets—What the B.B.C. Does with Your Letters. By Frank Rogers—A Dual Receiver for Television. By H. J. Barton Chapple, Wh.Sc., B.Sc.—Getting the Best from Your Output Valve. By W. James—Plain Facts about Grid Bias. By J. H. Reyner, B.Sc., A.M.I.E.E.—GRAMO-RADIO SECTION. Around the Turntable—Reviews of the Month's Records.

WIRELESS MAGAZINE

FOR SEPTEMBER
On Sale August 22nd.

GET A COPY TO-DAY, 1/-

The Valve with the Long Arm!

CONSISTENT LONG RANGE

MARCONI MS4 GIVES
DEPENDABLE AMPLIFICATION

Whether the station comes in at the top or the bottom of the scale, on the long or medium broadcast wavebands, it will be at its clearest and steadiest with Marconi MS4. So low is the inter-electrode capacity that full advantage can be obtained from the high magnification factor of 550 in any standard circuit. No neutralising or extra screening is called for—Marconi MS4 is the reliable choice for all-round performance.

Note also the generous spacing of the electrodes which allows for rapid radiation of the cathode heat, thus avoiding excessive temperature rise and emission from the grid. This feature is a definite step to longer life and freedom from "backlash."

Marconi MS4 is designed for operation entirely from A.C. Mains. In battery-driven receivers use Marconi S215 two-volt, S410 four-volt, S610 six-volt.

And they are ALL BRITISH.

For the best results in A.C. Mains Circuits use with Marconi MS4:

- Marconi MH4—High magnification.
- " MHL4 — General purpose.
- " ML4 — L.F. and Power.
- " PX4—Super Power.
- " PT425 — Pentode.

CHARACTERISTICS

Mag. factor ...	550
Impedance ...	500,000 ohms
Fil. volts ...	4.0
Fil. amps. ...	1.0



The Amazing
**MARCONI
MS4**

THE MARCONIPHONE COMPANY LIMITED
Radio House, Tottenham Court Road, W. 1

Electrify your Mullard ORGOLA



for the ORGO LA SENIOR
A.C. Mains. Model A.C. 38. Price
£9 12s. 6d. Cash, or 10/- deposit
and nine monthly instalments of
22/- each. D.C. Mains. Model
D.C. 50. Price £7 15s. 0d. Cash,
or 10/- deposit and nine monthly
instalments of 18/- each.



for the ORGO LA III
A.C. Mains. Model A.C. 16. Price
£4 10s. 0d. Cash, or 10/- deposit
and nine monthly instalments of
10/- each. D.C. Mains. Model
D.C. 16. Price £3 15s. 0d. Cash,
or 10/- deposit and eight monthly
instalments of 9/- each.

SEE
SPECIAL REPORT
IN THIS ISSUE
Absolute simplicity and
safety. Delicate voltage
adjustment. No hum.
Ample power. Guarante-
ed for twelve months.
Send for leaflet to-day.

RECOMMENDED BY
"RADIO FOR THE MILLION"

CLARKE'S
"ATLAS"
MAINS UNITS

H. CLARKE & CO., (Mcr.), Ltd., Old Trafford, MANCHESTER

CUTTING YOUR H.T. COSTS

Amateur Wireless

Every
Thursday 3^d

and
Radiovision

Vol. XVII. No. 429

Saturday, August 30, 1930

In this issue



**NOVEL
SET TESTER**

and

The
**"SEARCHER
TWO"**

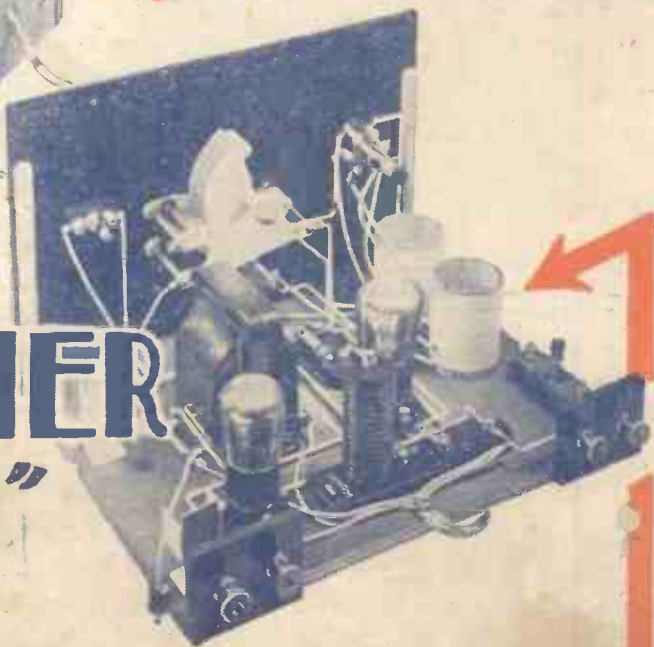

PREDOMINANT IN ITS OWN SPHERE

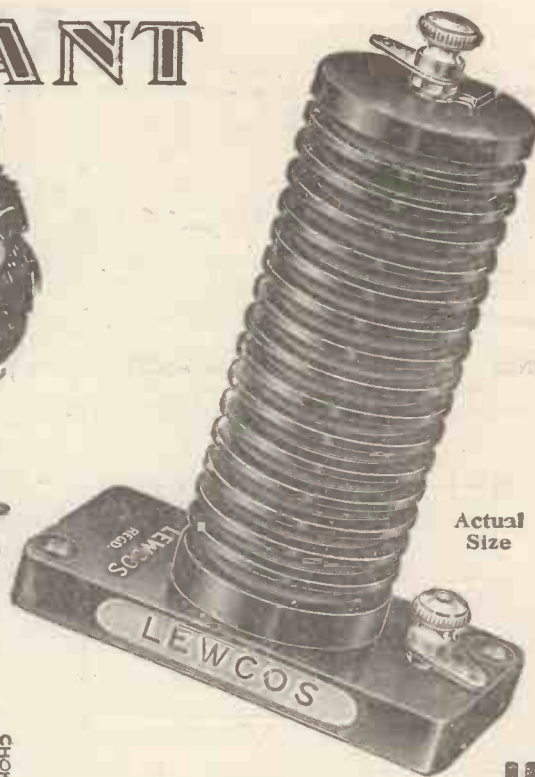

Actual Size

H F CHOKE CURVES
showing the performance of the Lewcos H.F. Choke
compared with other makes

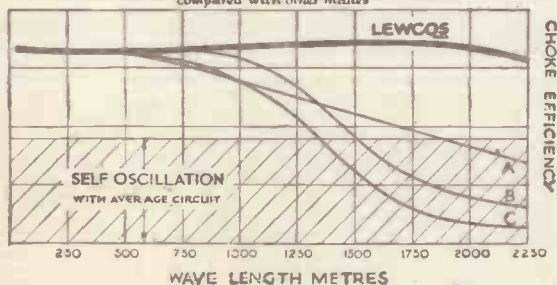

The LEWCOS H.F. CHOKE



The Lewcos L.F. Transformer

"The High-frequency Choke is one of the most important components used in modern radio."

The above is quoted in an article on chokes by Mr. J. H. Reyner, and, being true, it is essential, in order to obtain the most efficient results, to fit in your set a choke of unparalleled success—the Lewcos H.F. Choke.

The Lewcos Choke is "The most efficient choke we have tested" and "Its design places it in the front rank of high-class components," writes Industrial Progress (International) Ltd., of Bristol.

Fully descriptive leaflets, Ref. R.33 and R.61, giving tested values, will be sent on request.

STOCKS HELD AT THE FOLLOWING BRANCHES:

- BELFAST
- BIRMINGHAM
- CARDIFF
- DUBLIN
- GLASGOW
- LEEDS
- LIVERPOOL
- LONDON
- MANCHESTER
- NEWCASTLE
- NOTTINGHAM

THE LEWCOS H.F. CHOKE IS SPECIFIED FOR THE "SEARCHER TWO" RECEIVER DESCRIBED IN THIS ISSUE.



THE LONDON ELECTRIC WIRE COMPANY AND SMITHS LIMITED,
Church Road, Leyton,
London, E.10.

LEWCOS RADIO PRODUCTS FOR BETTER RECEPTION

Please Mention "A.W." When Corresponding with Advertisers

Amateur Wireless and Radiovision

The Leading Radio Weekly for the Constructor, Listener and Experimenter

Editor:
BERNARD E. JONES

Technical Editor:
J. H. REYNER, B.Sc., A.M.I.E.E.

Research Consultant:
W. JAMES

Assistant Editor:
H. CORBISHLEY

A "Pronunciation Bee"—Slaithwaite Progress—Those "Shows"—The British Museum and a Song—Children's Hour Improvements—Bolshevik Jamming

A "Pronunciation Bee"—A recent audition at WABC, a New York station, brought 150 would-be announcers to the microphone for a test. They found many stumbling blocks. One man stumbled over "Bellini," calling it "bologna"; others referred to the Erl King as the "oil king" and Beethoven as "Beet-haven." With the exception of a few, they were nervous. One rattled off the difficult French and Italian composers' names with ease, but when he came to the Russian list he said, "pronunciation unknown to this speaker"; so he did *not* get the job!

Slaithwaite Progress—Reports keep coming to hand of progress which is being made at the new Northern Regional station. Now our northern correspondent says that one of the aerial masts is well on the way to completion. This mast, he says, is of the triangular pillar lattice type, not supported by guy wires and standing on a stone base. The aerials at Slaithwaite will, of course, be much higher than those at Brookmans

Park, for the same aircraft restrictions do not apply. The transmitter to be used is not yet finished, and there is a deal of work yet to be done if the station is to be in going order by the end of the year, as the B.B.C. had planned.

The "Tahiti"—The bravery of the radio operator of the ill-fated *Tahiti* is commendable. It is comforting to know that the old tradition of "sparks" staying to his ship still holds good.

Hospital Wireless—"The craze for fitting hospitals with wireless seems to have died out," writes "M.L.B." (London, E.), "but when I went to see a friend of mine in hospital the other day, he said what a blessing it was to have 'phones at the bedside. I picked up the 'phones, and something was on. I was told that the set was always switched on from lunch-time till the night-time closing down. The reproduction was very clear. In wards where all the patients were well enough to listen, a loud-speaker was sometimes switched on.

Those "Shows"—The German Wireless Exhibition is now in full swing. A photograph on this page gives an idea of the exhibition building, near the Witzleben transmitter. The Bucharest *Expositie Internationala* Officials are also busy, for a radio show opens in the capital on September 7. And, talking of shows, you should see the preparations which are going on in the AMATEUR WIRELESS editorial sanctum for a really "super" series of Radio Exhibition issues. But, for the time being—*hush!*

The British Museum and a Song!—When the B.B.C. arranged to broadcast a song entitled, "Mi vien da ridere," not a single copy could be found among all the publishers in London. As a last resort the British Museum was applied to and was able to oblige. Later, an Australian native song was required, and application to Australian authorities having proved fruitless, the British

PRINCIPAL CONTENTS		Page
Current Topics	...	193
Eliminating Eliminator Troubles...	...	194
A Novel Set Tester...	...	195
For the Newcomer	...	196
My Wireless Den	...	197
Broadcast Artistes in Picture	...	198
On Your Wavelength	...	199
H.T. Battery Economy	...	201
A Super Radio-gramophone	...	202
Without Fear or Favour	...	203
Making Your Own Tuning Coils	...	204
"A.W." Tests of Apparatus	...	205
The "Searcher Two"	...	206
Tele-talkies on a Large Screen	...	208

Museum was called upon and once again came to the rescue. "I hope," said the Philips official who imparted this information, "the British Museum does not collect every new tune that is published, useful as it may have been in this case. I should not like to see the Egyptian room papered solid with fox-trots!"

Children's Hour Improvements—Recently a correspondent had something to say about the present high-brow Children's Hours, which are thought to be not best suited to young children. Some people are unkind enough to suggest that the Children's Hour is an out-of-date feature and might well be scrapped in favour of an extension of the time allocated to Jack Payne. It would be interesting to know what readers think about this.

Bolshevik Jamming—If you tune in to wavelengths about the 1,000-metre region you will hear plenty of Bolshevik propaganda from the Russian stations. This is put out in several languages, but not usually in English, for the Russians are not yet intent on capturing the British "market" in this respect. Other countries are making complaints, though, and a correspondent states that Roumanian politicians are financing a station to jam Russian broadcasters which transmit "Red" propaganda likely to interest Roumanian listeners.

This is the building in which the German Wireless Exhibition is now being held. The tower, a reproduction of the Eiffel Tower, supports one end of the Witzleben station's aerial



Eliminating Eliminator Troubles

THERE is still some prejudice remaining against the use of the mains for driving the H.T. or L.T. side of a set. Much of this is being dispelled by the continued production of reliable commercial units, and by the growing popularity of mains eliminators which are described from time to time in AMATEUR WIRELESS.

Yet there are a few commercial eliminators which are not robust enough inside to give satisfactory working, and there are still some amateurs who do not take the trouble to make up eliminators exactly as described, and who therefore get unsatisfactory working.

Poor Connections

The most common trouble is the fitting of cheap flex and poorly-fitting plugs for connection to the mains point. This is a fault even in some expensive units. It is a fault which tempts many amateurs, because they can pick up at bazaars cheap flex which appears to be stout and of good quality, but which may have defective insulation, a matter difficult to discover without close examination or inspection with an electrical tester.

Therefore, if you are having trouble with your eliminator, home-made or otherwise, be safe at the outset by fitting good-quality flex and a mains plug which makes proper contact with



A well-made countersunk mains socket is a safety measure, while a switch in the mains lead itself is always handy

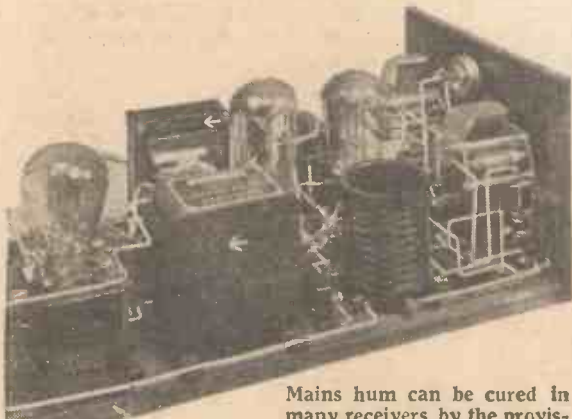

Mains hum can be cured in many receivers by the provision of an efficient smoothing choke and output transformer, shown by the arrows

its socket. Some of the Continental-type plugs do not conform to standard dimensions and a poorly-fitting plug may accidentally pull out and cause a short-circuit. A crackling noise may be set

Some practical advice by Kenneth Ulyett on getting ripple-free results when working a set from the mains

up owing to the bad contact caused.

Hum, which appears to be a common fault with mains users, is often not the fault of the eliminator itself, but is set up in the receiver. Faults which pass unnoticed with battery drive make themselves immediately obvious when the mains supply is used, particularly if it is A.C.

A common trouble is that the grid pin of the detector valve does not make a good contact in its holder. A loosely-fitting grid leak can have the same effect, while some grid leaks have a habit of altering their

resistance values in damp weather and becoming practically non-conductors. All these things make mains hum noticeable, for the detector valve is usually the most sensitive stage to A.C. and L.F. interference.

A common trouble with indirectly-heated mains valves, resulting in a loud hum, is a leak between the cathode and heater. This can only be cured by changing the valve. Sometimes even in a receiver which operates quite satisfactorily with battery drive, a hum may be set up which may be found due to the use of too high a grid leak value. If it is suspected that a high value is accentuating mains hum, then the grid leak should be temporarily short-circuited. If this cuts out the hum, it is possible that a lower value grid leak

may eliminate the hum and still give good results.

In some home-built radio-gramophones, where the receiver, speaker and mains unit are all housed in the same cabinet, an annoying mains ripple is caused by pick-up via the speaker. This is more pronounced if it is a moving-coil speaker, and is also working from the mains. The smoothing

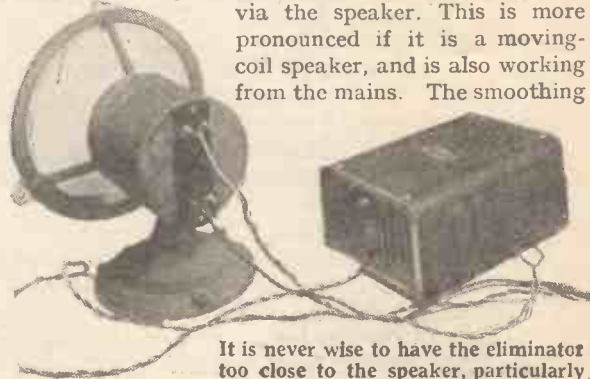

It is never wise to have the eliminator too close to the speaker, particularly if this is a moving coil

of the eliminator circuit for the speaker field winding itself may be insufficient, but this can always be tested by temporarily working the speaker away from the set and seeing if the A.C. interference is still heard. It is generally found that if two or three turns come loose in the pot winding, or if there is a loose joint in the magnetic circuit of the speaker, then a hum may be set up on some frequencies which may accentuate mains hum, or be mistaken for it.

It is a wise thing to keep direct current out of the speaker circuit. With any type of speaker working on a mains set it is advisable to have a choke output circuit, or preferably a transformer, which latter entirely insulates the speaker windings from the high potential existing in the anode circuit of the last stage.

Not only does the D.C. anode current flowing in the speaker windings constitute a danger (in that a shock may be felt if the terminals are touched), but the possibility of hum is increased.

There are so many points in a receiver at which ripple may be introduced that if this trouble is experienced each stage should be checked in turn, starting from the last, for speaker hum pick-up is one of the most likely causes. Take out all the valves excepting the last stage valve and disconnect the primary side of the coupler (transformer or resistance) to this valve so that it

(Continued on page 220)

A Description by L. A. CHAPMAN of

A NOVEL SET TESTER

An easily-made instrument that will enable you to test the receiver for faults, test almost any component and ascertain whether distortion is taking place

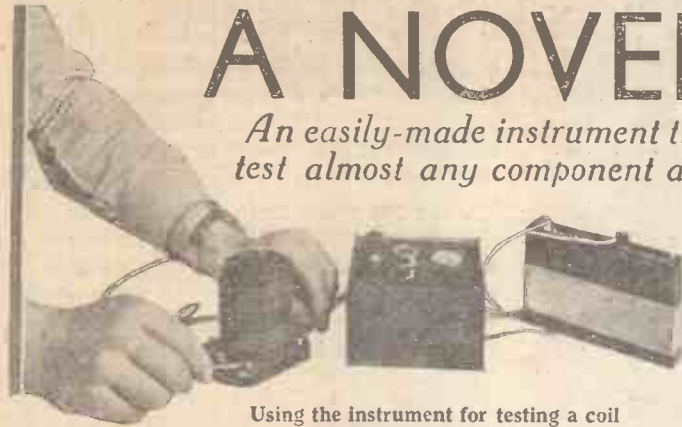

Using the instrument for testing a coil

MANY "gadgets," intended to be of use to the amateur, often repose unobtrusively upon an out-of-the-way shelf when once they have been constructed and tried out. The unit to be described can be adapted to so many uses, however, that there is no excuse for its being put away and treated as a "has been."

Primarily the unit is intended to be used for testing components suspected of being faulty. It can be used as a rough-and-ready means of testing whether valve fila-

ments are broken or not. The method of using the unit is simple. The two flexible leads having battery plugs fitted to their ends are for connection to a suitable battery, such as a tapped G.B. battery. The other two flexible leads connect to the instrument or circuit under test. Before attempting to test a component it is advisable to know what current the component will be likely to consume. The approximate resistance should also be known.

Using the Unit

Assume that a tuning coil is to be tested. We know that a coil is practically useless if it has a high resistance. We also know that coils are usually wound with fairly

thick wire to keep the resistance low. We can, therefore, test a tuning coil for continuity with a 3- to 4½-volt battery and the small lamp. Consequently the knob of the switch on the unit should be pulled up so that the milliammeter is "shorted" out of the testing circuit.

(Continued at foot of next page)

BLUEPRINT
Nº A.W. 246

Checked by *[Signature]*

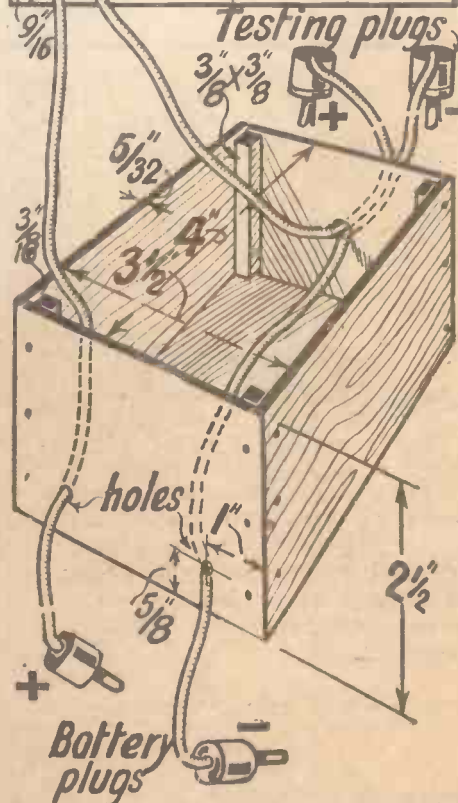
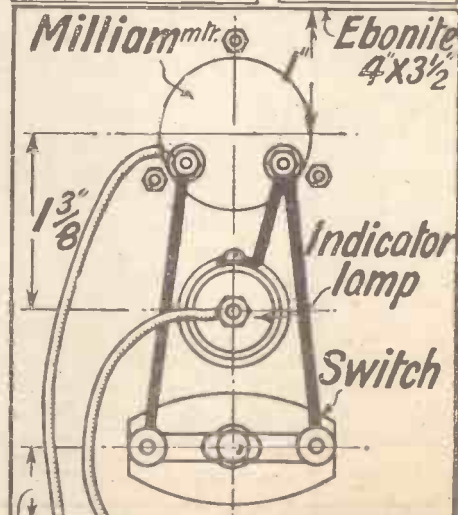

Components Required

- Ebonite panel 4 in. 3½ in. (Becol).
- Indicator lamp (Bulgin).
- Push-pull switch (Lissen, Lotus, Unlimitex, Pioneer).
- Milliammeter (Sifam, Bulgin, Wates).
- Lengths of flex, wander plugs and plywood for containing-box.

If we are testing for "shorting" between the moving and fixed plates of a tuning condenser, we want such short circuits to show readily. Therefore we use the lamp and the maximum voltage—4½ volts—so that the lamp will glow at the least sign of a completed circuit. This also applies in

the case of testing valve filaments. The lamp itself should be of the 60- or 100-milliampere-consumption type. It is only when testing components of high resistance that the milliammeter needs to be brought into use.



Here is the tester in its case, ready for use

ments are broken or not. It has a variety of uses, and later it will be explained exactly how it can be employed for testing through a multi-valve receiver.

When it is not being used for testing components, or for continuity of circuits, it can be employed as a distortion indicator in the plate circuit of the last valve of the receiver. The latter use calls for no alteration to the internal wiring of the unit, it being only a matter of arranging suitable external connections between the flexes and the receiver.

The Cost

If all new components are used, the total cost of the unit will be approximately fifteen shillings. Many amateurs, however, will find certain parts in their junk boxes. The components required are as specified in the accompanying panel. The containing-box was assembled from a few odd pieces

The wiring diagram, of which a full-size blueprint is available, price 6d.

For the Newcomer to Wireless: THE DETECTOR

IN both the crystal set and the valve set there is a detector, isn't there? I'd like to know why it is necessary and what it does.

You'll remember that in previous conversations we have seen how the sounds produced in the studio are converted into electrical impulses at audio frequency and how these impulses are mounted upon the carrier wave by the process known as modulation.

Yes; I am quite clear now on those points.

You'll remember that we discussed the difference between radio frequencies and audio frequencies?

Yes. Audio frequencies are those with which the ear can deal and radio frequencies those whose rate is above this limit.

Well, from the aerial, if there are no high-frequency stages, or from the high-frequency amplifiers if these are present, we receive oscillations at radio frequency corresponding to the modulated carrier. It would be of no use to apply these direct to either telephones or loud-speaker.

Why not exactly?

In the first place the diaphragms of these instruments could not possibly be made to vibrate at speeds such as a million a second or more.

No, I can see that.

And even if they could their vibrations would convey nothing to us for our ears would be unaffected by them.

Is that where the detector comes in?

Yes. The main purpose of the detector is to marshal the groups of radio-frequency impulses into audio-frequency impulses that our ears can hear.

Can you give an analogy?

In music the semibreve can be resolved into two minims, or four crotchets, or eight quavers, or sixteen semiquavers or thirty-two demi-semiquavers. That is to say, you can play a note of the same length either by holding down the key or by striking it thirty-two times with almost lightning rapidity. Every semibreve sounded in the studio is actually resolved not into thirty-two, but into something like a million "taps" when it is mounted upon the carrier wave. The purpose of the detector is to blend this almost incredible number of "taps" back into one smooth note.

That's quite clear. How's it done?

Both the valve and the crystal detector work broadly upon the same principle. Each has the property of passing current in one direction only. Radio-frequency impulses consist of waves which have crests and troughs

just like those that you can see on water. So long as the wave is rising it moves in one direction. Then it changes its direction and falls. The detector can pass only one of these parts.

Then the result is that the detector delivers a stream of impulses in one direction?

Exactly. In the crystal set these charge up a condenser—either a visible fixed condenser in an ebonite case or the "invisible" condenser formed by the telephone leads. The charge in the condenser builds up and then a discharge takes place. Radio-frequency impulses are fed into the condenser, but the discharge is at audio frequency.

And in the valve?

The stream of radio-frequency impulses is applied to the grid, which in the grid-leak-and-condenser detector collects those due to the falling parts of each wavelet. The grid becomes more and more negative whilst the impulse is building up and this produces a fall at audio frequency in the plate current. You will thus see that both crystal and valve do the same thing: they receive radio-frequency impulses, pass only one-half of each rapid wave and so cause audio-frequency impulses to be formed in their output.

"A NOVEL SET TESTER" (Continued from preceding page)

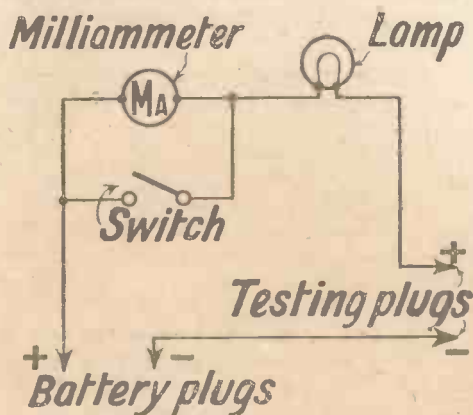

The theoretical circuit of the tester, which incorporates a milliammeter, test lamp and switch

Suppose, for instance, it is wished to test an anode resistance for continuity. The resistance has a value of 100,000 ohms. No anode resistance is called upon, in actual use, to pass more than a couple of milliamperes. One milliampere is usual. Therefore we must regulate our test-unit voltage to suit this current flow. If the voltage is too great, then there is a chance of damaging the meter.

Ohm's Law comes in useful at this stage.

Current (in amps) times the resistance (in ohms) equals the battery voltage required. One milliamperes equals .001 ampere, ten milliamperes equals .01 ampere, and a hundred milliamperes equals .1 ampere. The resistance to test is 100,000 ohms and the current to be passed is 1 milliampere. Therefore 100,000 times .001 equals 100, and this represents the voltage required for our test unit. An ordinary H.T. battery will be satisfactory.

If a stopper resistance of 600 ohms is suspected (and these normally carry not more than 3 milliamperes in actual use), the test voltage required for this can be deduced in the same way. Assume that we wish to get a reading of 3 milliamperes, then 600 times .003 equals 1.8. A tapping at 1½ volts on a grid-bias battery will suffice for this test.

It now remains to see how the unit can be connected up in circuit with the last valve to use it as a distortion detector. If the receiver, with which this unit is to be used, has the speaker connected directly in the anode circuit of the last valve, the inclusion of the unit is a very simple matter.

Disconnect the positive L.S. wire from the positive speaker terminal of the set and

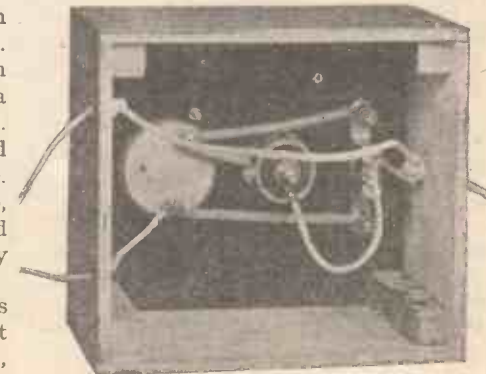

An interior view of the tester showing the wiring of the three components on the panel

connect the positive battery terminal of the unit to the positive speaker terminal of the receiver. Then take the positive testing plug of the unit and connect it to the positive L.S. wire from the speaker itself. The milliammeter and the testing lamp are now in series between the H.T. supply, the speaker, and the anode of the last valve.

Next week it will be shown how the unit can be used to find faults in a multi-valve receiver.

MY WIRELESS

Weekly Tips,
Constructional
and
Theoretical—



DEN By W. JAMES

For the
Wireless
Amateur

Losses in Valve Holders

A VALVE holder may reduce considerably the amount of high-frequency amplification obtained. This may seem a surprising statement, but happens to be one very easily proved.

I came across this when testing some very good coils. What I had noticed was that the amplification was less when a certain detector valve with its holder was connected across the secondary of the high-frequency transformer. Further tests showed that the valve itself produced a certain loss, but that the valve holder was responsible for a by no means negligible loss.

The loss is brought about by the material of the base. The brass or other metal parts are secured to a moulded shell. There is capacity between the grid and filament pins, and this condenser is a poor one, having relatively heavy losses, owing to the bad power factor of the insulating material. With good holders the loss is negligible.

A Bad Set

I have just had to deal with a set having a peculiar fault, one which I think I have described before in this page. The trouble was that reaction effects could be obtained only at the bottom and top of the low-wave range. In the centre of the wave-range the set could not be made to oscillate.

Now when this fault is experienced it is safe to assume at once that the long-wave part of the circuit is tuning to the wavelength at which no reaction is obtained. The effect is due to absorption, the long-wave part absorbing energy from the low-wave tuned circuit.

At about the point where reaction disappears the signals are also weak, so that the effect is, to say the least, quite undesirable. A faulty short-circuiting switch may be the trouble, as it was in the set referred to above, but it is as well so to arrange the long and low-wave parts of a circuit that absorption effects are not present.

Buying Good Batteries

The economy of using dry batteries of ample capacity is obvious to those who have made the necessary tests. But still I find that some people will walk into a shop and accept practically any type of battery offered, if the price is right.

There is a chance that good service will be obtained from a particular battery, but how often do we find that when we purchase a second one of the same type that only a short life is obtained. It seems to me that the best plan is to choose a good make, to get fresh batteries, and to make sure the battery is of the right size for the set.

Automatic Grid Bias

The valve makers usually provide a diagram of connections showing how to arrange the grid bias of a power stage, including a decoupling resistance and condenser.

In the accompanying diagram the fila-

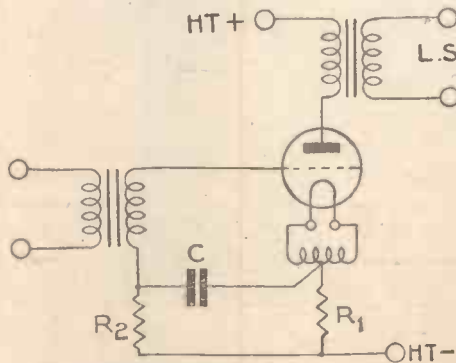

Automatic grid bias can be obtained, when A.C. mains are used, in the manner shown here. The values are given in the accompanying text

ment is shown connected to the heater winding of a transformer, this being centre tapped. To the tapping is joined the bias resistance R_1 . In the anode circuit is a loud-speaker transformer.

The anode current of the valve therefore passes through the bias resistance and the end joined to H.T. — is more negative than the end connected to the centre tap. Actually, the voltage drop in the resistance is proportional to the current, being equal to the product of the current and resistance. Therefore, as the current tends to increase, so the value of the bias tends to become greater, which in turn acts to restrict the steady value of the current.

Resistance R_2 , usually of 100,000 ohms, and condenser C of 2 microfarads form an effective filter between the secondary of the transformer and the filament circuit. The filter stabilizes the set, and should not be omitted in a circuit of this description.

Permanent-magnet M.C. Speakers

Lately I have used a permanent-magnet type moving-coil speaker with good results. Both sensitivity and volume are excellent.

This type should prove popular. A good moving-coil is worth having and when there is no field current to worry about, the relative advantages of this type are considerable.

Is Your Coil Faulty?

I have lately received a few letters from readers dealing with a peculiar fault which has occurred with a few Binowave anode coils.

What has happened in one or two instances is that the set has behaved perfectly for some months and then crackles have been heard from the loud-speaker. After a time the noises have become worse and, finally, no signals at all have been received.

Examination has shown a remarkable thing, which has also been brought to my notice by the makers. The bottom wire in the short-wave section of the coil, just where it passes through the paxolin, has been eaten away. There is a green spot at this point.

Now the winding is the one connected to the anode circuit of the screen-grid valve and what I am wondering is whether the fault is due to damp, the paxolin, or the green silk-covered wire.

Green silk covered wire has, in many respects, a bad name, but I have not before experienced this fault and neither have the makers of the coils. The finest materials are used.

The fact is, that when enamelled wire is used the fault does not occur, neither is it met with when the tube is of ebonite instead of paxolin.

In future the coils will have the primary coil of enamelled covered wire and the tube will be of ebonite. There will be no more breakdowns. The makers repair coils which develop the fault free of charge and are naturally perturbed that the real reason for the fault cannot be found. Readers will remember that until a short time ago it was a common thing for inter-valve transformers to break down—and at the point where the break occurred was usually a green spot showing where the copper was eaten away.

BROADCAST ARTISTES IN PICTURE



WALTER WIDDOP.—This brilliant Yorkshire singer, a member of the late B.N.O.C., will always be remembered for his Wagnerian roles; he was again chosen for the first Wagner night at the present "Promenade" season at Queen's Hall.



OLIVE KAVANN.—One of the finest of English contraltos, with her husband, the noted pianist composer, Percy Kahn, she has broadcast in concerts innumerable. Some of her best performances have been relayed from Eastbourne when singing with Sandler.



LIONEL FALKMAN.—Leader of a fine Cardiff orchestra, Mr. Falkman has been chosen to replace the National Orchestra of Wales while on holiday. With his orchestra, he broadcast again from the Cardiff studio on August 20.



BEATRICE EVELINE.—Another distinguished Welsh artiste is Beatrice Eveline, the violoncellist, one of the earliest of broadcast "stars." Winner of prizes and scholarships brought her to the R.A. and R.C.O.



"STAINLESS STEPHEN."—His humour as unique as his title, Mr. Arthur Clifford has made a name in variety, wireless, and gramophone records. His latest Decca is, indeed, a burlesque of his wireless experiences.



HELEN ALSTON.—How many programmes have been enriched by the singing of Miss Helen Alston, as popular in the Children's Hour as she has been on the classical concert platforms of London and the provinces.



HEDDLE NASH.—A prominent member of the late B.N.O.C., Mr. Nash, has sung also at Covent Garden, and at the principal concerts and halls throughout the kingdom.



ALICE VAUGHAN.—A well-known contralto and pupil of Sir Henry Wood, Miss Vaughan sang for the Birmingham Festival Choral Society, and in London at her own recitals introduced many of Mr. Frederick Nicholl's early songs.



DENNIS NOBLE.—A member of Covent Garden opera, as well as of the B.N.O.C., it is not surprising that Mr. Noble usually includes operatic arias from many of his studio concerts. He sings again at the "Promenade" concert of September 9.

On Your Wavelength!

The Exhibition

TO judge by the advance news that I have had, this year's Wireless Exhibition is going to be a very wonderful show. Makers have now had nearly a whole year of a sample of the regional scheme as given by the two Brookmans Park stations, and they have set themselves to tackle the problems involved with a very great success. Take tuners, for instance. When "Raucous Reg" and "Noisy Nat" first got into their stride there was probably not a tuner on the market that would separate them with a single circuit and an ordinary aerial in use at a range of twelve miles or so. To obtain the required selectivity it was necessary to shorten aërials, to use series condensers, to employ wavetraps, or to add a high-frequency circuit. Recently I have had the opportunity of trying out one of the very latest tuners, which easily effects separation at short range, and that without the slightest loss of quality. I am using it just now in a two-valve detector and L.F. set, and one-knob tuning is as satisfactory as can be.

Other Good Things

Besides selectivity, there is an increasing demand from the wireless public for real quality. This has led to the production of valves, transformers, loud-speakers, and other components specially designed with this end in view. I was trying out the other day a remarkable new transformer which has doubled the step-up ratio that we used to think possible to follow the detector valve without loss of quality. Used in the right kind of circuit, this transformer provides huge magnification and beautiful quality. Output transformers and chokes have also received very special attention, and there are some wonderful new loud-speaker units of both the balanced-armature and the moving-coil types. I don't hear of any great surprises in valves, but some big improvements have been made. Not the least interesting part of the exhibition will be displays of the smaller components, in which there was room for improvement. Readers may expect to find some very good things in the matter of small parts. Here designers have concentrated upon compactness, combined with efficiency as well as upon ease of fitting.

A V.C. Point

One of the most widely used forms of volume control is that in which the filament temperature of the high-frequency valve (or the first of them, if there are two)

is controlled by means of a rheostat. This is most satisfactory, as a rule, and when applied to a powerful set it allows the loud-speaker output to be adjusted readily to anything between a roar and a whisper. It cannot, though, be used satisfactorily with all types of valve. (I am speaking now particularly of battery-operated "toobs.") Some of these require a second or two to warm up when they are first switched on and a like amount of time to respond to any alteration in the filament current. It is, therefore, not too easy to control the volume by means of a rheostat when these are employed on the H.F. side, since the increase or decrease, as the case may be, does not develop fully until a little time has elapsed after a movement of the knob has been made.

No Harm Results

Some readers may be worried by the thought that the use of this type of control may possibly do harm to the filaments, for in the past attention has often been drawn to the damage that might be done by running dull-emitters at too low a temperature. The modern dull-emitter has a much more robust filament than those of the early days and does not seem to worry about temperature variations. I have at present in use a 6-volt screen-grid valve with which a volume control of this type has been employed for six months of pretty hard working. The emission to-day is every bit as good as that of the second S.G. valve in the set, which has been run for the same amount of time with an unvarying filament temperature.

A Useful Gadget

Readers will remember that I have often recommended the use of two loud-speakers, one to take charge of the upper and middle notes, whilst the other deals chiefly with the bass. I find it exceedingly handy when experimenting with loud-speaker combinations to have a simple means of throwing the pair into series or parallel without the bother of disconnecting wires from terminals and connecting them up again. A little contrivance that I use for the purpose is very easily made and costs only a few pence. It consists of a piece of $\frac{1}{4}$ -in. ebonite about 6 in. in length and 3 in. in width. In this are fixed six standard sockets arranged in three rows of two. Connect the top pair of sockets to one another; do the same with the middle pair and with the lower pair. On the panel mount three pairs of terminals. The first pair are for H.T.+ and plate from the output of the set. These are connected respectively to the top and bottom pair of

sockets. The other two pairs are for the attachment of the loud-speakers. Each of these is provided with a wander plug fixed to a short length of flex.

Using the Device

Here is how the gadget is used. Having connected the H.T.+ and plate terminals to the set and the loud-speakers to their terminals, you place the red wander plug belonging to each loud-speaker in a socket of the top row and their black wander plugs each in the bottom row sockets. The two speakers are now in parallel. To bring them into series leave the red wander plug of L.S. No. 1 where it is and put its black plug into one of the middle pair of sockets. Treat plugs of L.S. No. 2 in just the opposite way; that is, leave the black one alone and stick the red one into the second socket of the middle pair. The output current then comes in from the plate, flows round the windings of one loud-speaker into the middle pair of sockets, and then via windings of L.S. No. 2 out to H.T.+.

A Useful Idea

Many readers living in large towns probably avail themselves of the advantages of a regular accumulator-charging service, but in country districts and in the smaller towns it is the exception rather than the rule to find that there is such a service in the ordinary way. To those who, like myself, live in townlets, I have a suggestion to offer. Some time ago I went to the best of the local charging men and told him what I wanted. My requirements were first of all a regular monthly inspection of both low-tension and high-tension accumulators with hydrometer tests and topping up as required; secondly, charging whenever necessary and at regular intervals, even if the batteries were not run down; thirdly, a thorough cleaning and greasing of all terminals, wander plugs, sockets, and so on after each charge; fourthly expert attention should any signs of sulphating or treeing be found, or should there be an undue amount of sludge in the cells.

A Scheme that Answers

Having dealt with my batteries before, he knew the number that I had and their capacities, as well as the approximate amount of charging needed during the average year. I asked him to work out an estimate for this service, and this having proved satisfactory, entrusted the work to him. He now comes in at the beginning of each month, goes over all my batteries, and deals with any that require attention.

:: :: **On Your Wavelength! (continued)** :: ::

The system is satisfactory to both of us, for I know that, no matter how busy I may be, my batteries will be properly looked after and he has regular quarterly payments for doing the work. Readers who are not already making use of a similar service would, I am sure, be well advised to work out a scheme of this kind and to come to an arrangement with a reliable local man.

A Good Investment

Whether you make use of a regular battery service or not, there is one little instrument that you should certainly not be without. This is a hydrometer of decent quality of the three-bead type. It is quicker and handier to use for accumulator-testing purposes than the more elaborate graduated float hydrometer and enables you to see in a matter of moments just what is the condition of any accumulator. Since I went in for the battery service that I have described I have not made a very great deal of use of mine, but it is always there when I want to satisfy myself that the work is being properly done. Even the most reliable of men may make omissions or mistakes at times, and it is just as well to make assurance doubly sure by testing an odd cell or two every now and then. You can purchase a good bead hydrometer for about 3s., and it will soon pay for itself by preventing you from allowing your batteries to get into bad condition.

Musical Feasts

We have had some splendid music from the Regional and National stations of late, and I am sure that listeners must have been thoroughly appreciative. The Promenade Concerts have been fine, on the whole, though I cannot say that I exactly revel in some of the squallier, squawkier, and more cacophonous productions of the ultra-modern composers. To me they are just orgies of hideous noise; but, then, I never did claim to be musical. I do wonder, though, at times, to just what proportion of the vast army of listeners they make any appeal at all. Outside Chelsea, Bloomsbury, and other high-art circles I should think that the proportion must be something so small that it approximates to zero.

Another excellent programme was that given as a relay from the Kursaal at Ostend the other night. All of the performers were stars and the music itself was magnificent. These long-distance relays do vary not a little in quality, and there is at times a certain muzziness which rather spoils one's enjoyment.

Why Not?

One of the little points in wireless that has always puzzled me has nothing to do

with the theory of fading or dynamic valve curves, or anything high-brow of that kind. It is simply and solely this: Why can't the makers of balanced-armature loud-speaker units get together and adopt a standard spacing of the holes which fix the units to the cone chassis? The idea is, I suppose, that they want you to use their own cones with their units.

That is all very well so far as it goes, but in my view they lose more than they gain by adopting all these different dimensions. Mr. X, for example, already possesses a perfectly good cone and chassis, but has heard the performances of a balanced-armature unit which seems rather better than his own. He decides to purchase one and goes into a wireless shop to make inquiries. The price is reasonable and a sale is just going to be effected when it occurs to him to ask, "Oh, by the way, will it fit my chassis?" The man behind the counter has to admit that it won't, and Mr. X, who is hanged if he is going to buy another chassis when he already has a perfectly good one at home, changes his mind and does not buy.

Changing the Unit

Or, again, there are many people who would like to have two or three units for use for different sets or for different purposes. They would do so if these were readily interchangeable, but the fact that they aren't proves a bar. A good many units, of course, are interchangeable with one another or, at all events, adaptable without much difficulty to each other's chassis. But there are, unfortunately, so many really excellent units with fittings unlike those of any others. There should also, I think, be a standard diameter for connecting rods. Some are fat and require a large hole in the cone, whilst others are very thin. You don't get the best results unless the connecting rod is a pretty close fit into the nipple, and a standard diameter would be an advantage all round.

A Chicago Television Studio

A rather ambitious television studio is almost ready for use in Chicago, according to the latest reports received from the U.S.A. Apparently the studio has been made to lend itself to the presentation of television radio plays as well as for the half-length and full-length images of artistes. A double scanning arrangement is to be used, as it is claimed that the operator can then adjust the lenses of his television camera into focus for any number of entertainers. This flexibility is brought about by four projection lenses mounted on a turret on each of the two cameras; contrary to Baird practice, the studio is to be almost dark.

The scanning disc revolves at 900 revolutions per minute, the synchronous speed

of the motor fed from 60-cycle lighting mains. There are 45 apertures in this disc, arranged in three 120-degree spirals, so that scanning is actually accomplished by three explorations for each revolution. There are two large photo-electric cells, some 16 in. in diameter, suspended from the studio ceiling, a track arrangement permitting their position to be adjusted at will, according to the items to be televised. Apparently the announcer has his own "television eye," distinct from the general studio one, and by means of a "mixing panel" the vision signals are sorted out and sent to line as required. Since it is proposed to transmit sound with vision, it will be seen that an effort is being made to meet a popular demand at the moment.

"Three-dimensional" Television

The advantages of stereoscopic relief for television images were demonstrated just two years ago by Mr. Baird, but since that date little has been heard of this development. Mr. Gould, of America, however, has come forward with what he calls a "three-dimensional" television scheme, and it is interesting to see how he proposes to make his system function. Above the subject, or subjects, for transmission is suspended an arm made to revolve at a constant speed by a synchronous motor. Each end of the arm terminates in a scanning drum, in the centre of which is a photo-electric cell complete with a green-light filter in one case and a blue-light filter in the other.

With the subject strongly flood lighted, the arms revolve in a horizontal plane, while each drum scans the subject in a vertical plane. It is this rotary movement of the arm which is claimed to give the "three-dimensional" quality, lenses focusing the entire subject for scanning purposes.

The Receiving Equipment

At the receiving end there are two neon lamps mounted vertically on each end of a horizontal arm, which revolves at 900 revolutions per minute. This arm, supporting the neon lamps, turns within a drum having diagonal slots, and the drum itself revolves, but in the opposite direction to that of the neon lamps. This is to give the illusion of motion, while the "cutting" of the slots across the neons ($\frac{1}{4}$ in. in diameter and several inches in length, according to picture size) is said to build up the image before the eyes of the observer. It is further stated that one of the neons is the general reddish orange colour, while the other is green, although it is not known how this latter condition is brought about. This method is said to portray the image in colours.

THERMION.



H.T. Battery Economy & How to obtain it

A member of our Technical Staff explains how a saving can be effected

MORE confusion surrounds the dry high-tension battery than almost any other part of a wireless set. The peculiar action of the dry cell is itself partly the cause, aggravated by a great reluctance on the part of battery makers to publish life figures.

If we expressly state that a set taking



A battery of this capacity effects a distinct saving

12 milliamperes anode current requires a double-capacity high-tension battery, it does not follow that results cannot be obtained from a single-capacity battery. Therein lies the trouble; for a single-capacity battery is much cheaper than a double-capacity battery, and the temptation to "economise" is very great.

That no economy is, in fact, effected is amply proved by the very short life of the battery, necessitating a further outlay that makes the total cost greater than the cost of a double-capacity battery. Taking a well-known make as an example, we find that a standard-capacity battery gives 320 hours' life when the current is 5 milliamperes, but only 140 hours when the current is doubled to 10 milliamperes.

These figures illustrate an important point; that by taking twice the current from the standard battery, less than half the possible length of life is obtained. Another make gives an equally good proof of this fact. About 550 hours' life can be obtained at 5 milliamperes, but only 225 hours at 10 milliamperes.

The real importance of these figures is only appreciated by knowing the comparative prices of the standard- and double-capacity batteries. Taking the last-named example, the standard-capacity battery is 10s. 6d. for a 60-volt unit, while a double-

capacity 60-volt battery of the same make is 15s. 6d.

At 10 milliamperes this battery gives a life of 475 hours compared with the 225 hours of the standard battery. Reducing figures to a common basis, it will be found that the single-capacity battery costs .6 penny per hour and the double-capacity battery costs only .4 penny per hour. In other words, it is practically 50 per cent. cheaper to buy the double-capacity battery.

From these figures, the economics of high-tension battery buying clearly point to the great advantage of double-capacity batteries. We are assuming that a fairly heavy current is being taken from the battery, and since the average three-valve to-day consists of a screen-grid valve, a leaky-grid detector valve, and a fairly greedy power valve, the assumption has a practical bearing.

Battery-life Figures

Such sets often take between 10 and 12 milliamperes from the high-tension battery, which, for economy's sake alone, should therefore be of double capacity. The reluctance of battery makers to give definite figures on the life of their batteries is not entirely inexcusable. The determination of the hours of useful life possible with any battery is not easy, even in the laboratory. And, as will be mentioned later, laboratory figures often have little relation to actual practice. One of the big difficulties in the way of a straightforward

estimation of life is due to the fact that dry cells recuperate if given a rest.

A high-tension battery worked with long periods of rest usually lasts longer than a battery continually discharged. So a resistance across a battery having a value arranged to pass, say, 10 milliamperes is not a fair test, since it does not allow the cells to exercise their recuperative powers.

As used in the average wireless set, a battery is resting for a much longer period than it is working, so the recuperating properties do affect the life of the battery. But this life will vary according to the recuperation allowed. Thus two similar batteries working two similar sets may not give the same life service owing to a difference in the time periods of reception.

Another difficulty that battery makers have to contend with is wrapped up in the



Another super-capacity battery of a popular make

question: "When is a battery's life said to be ended?" There is no sudden transition from utility to uselessness. A 60-volt battery may still be useful when its total reading has dropped to 50 volts; it may not be discarded by the set owner until the reading has fallen to 30 volts.

Therein we can trace a further incentive to buy cheap batteries, for if they are kept in service beyond the number of hours that might be specified by the makers, the apparent economy of the cheap battery would approach reality. But let us not forget that the prolongation of the span of utility of a standard high-tension battery, by keeping it in use after its initial voltage has greatly diminished, applies with equal force to the double-capacity battery.

(Continued in 3rd col. of next page)

SPARKS

A fire at a wireless dealer's has reduced the stock to a heap of wire, terminals, etc. The survival of the fittings!

* * *

A radio enthusiast says that to get Spain on his set is "up-hill work." A foreign clime!

* * *

Someone asks how to deal with a leaking accumulator. It'll add to his "running" expenses.

* * *

A newspaper writer says it is wonderful for old people to sit at home and focus on foreign stations. The old focus at home!

* * *

A correspondent says that all important tennis fixtures should be broadcast. Too much of a racket.

A Super Radio Gramophone

Details of the Kolster Brandes model, by "Set Tester," who,



in this article, continues his unique service to set buyers

WITH the entry of the "big noises" into the radio-gramophone industry we can assuredly look forward to improvements in radio-gramophones generally. I am always thrilled when a new radiogram appears—there is so much in them to interest a set tester. Unpacking the Kolster Brandes radio-gramophone was a prelude to one of my most interesting tests. Understand, in the first place, that this is a super model, the price is £95, and the volume is enough to fill a big hall, though it can be reduced to a mere whisper.

Two Requirements

There are two things that must be satisfactory before a radio-gramophone meets with my approval. It must give appreciably better quality of reproduction from gramophone records than can be obtained from a mechanical machine. Moreover, the radio side must be capable of reproducing a good selection of home and foreign stations. All this, and more, is adequately fulfilled by the Kolster Brandes model.

I presume that anyone going to purchase a £95 machine will take the elementary precaution of hearing it beforehand. Armed with the following facts, the set buyer can look forward to a gratifying audition. The radio consists of one high-frequency stage utilising a screen-grid valve followed by a detector, with reaction. Both these valves are 4-volt A.C. types, giving more amplification than battery-operated valves.

Detail Arrangements

Following these valves is the power amplifier, which is common to both radio and gramophone-record reproduction. There are two stages of amplification here, an A.C. valve preceding two super-power valves in parallel. When the instrument is being used for reproducing broadcast programmes there is considerable amplification involved; and the gramophone-record amplification, although it does not include the high-frequency or detector valves, is also very great.

Some readers ask why less amplification is needed for gramophone record reproduction than for broadcast reproduction. This is the reason: the voltage developed by the gramophone pick-up is usually much greater than the voltage set up in the aerial by wireless waves.

Two volume controls are employed. One of them controls the low-frequency ampli-

fication and, therefore, works for both forms of reproduction. The other volume control is for radio only.

The whole of the power supply is derived from A.C. mains. A power unit converts this supply into high tension, low tension, and grid bias. A full-wave rectifying valve provides the high-tension current. The A.C. valves are heated with A.C. stepped down to 4 volts. The two output valves, which have .8 ampere filaments, are heated at 6 volts.

So much for the circuit, which, had I more space, could be given more detailed description. Apart from evidence of great care in planning the circuit, Kolster Brandes prove convincingly enough that they understand the need for embodying their circuit in a handsome piece of furniture. Wherever it is housed, the Kolster Brandes radio-gramophone cannot fail to add distinction to the general furnishing scheme.

Electrically Driven

The electrically-driven turntable is a great delight; it works with a silky smoothness, and there is no tedious winding up to be done. The pick-up is a K.B. product, robust in construction and positive in action. Gramophone needles can be changed with great ease.

Playing over some of my favourite records on this machine was a real musical treat. The reproduction of some of Cortot's piano solos and Kreisler's violin solos was achieved with almost concert-hall reality. I purposely kept down the volume to living-room strength. It is a great mistake to try to encompass Queen's Hall volume in a suburban villa.

On the radio side I must explain that an external aerial is required, as there is no enclosed frame aerial; but only a short wire

is needed. Remember, there is an A.C.-heated screen-grid high-frequency valve, an A.C.-heated detector valve, and a super-power amplifier. A short 40-ft. indoor wire and a good earth (necessary to avoid hum from the mains) gave me my favourite home stations at great strength. Such stalwarts of the European ether as Toulouse and Radio Paris had to be reduced considerably, as their full-strength volume was terrific.

A Super Instrument

After my tests, which have extended over a period of ten days, I can say that there is a great reserve of radio amplification in this machine, making it suitable for locations

situated far from broadcasting centres, or for the reception of distant stations under adverse conditions. Altogether, the Kolster Brandes radio-gramophone can be truly described as "super," both in appearance

and in performance. I heartily congratulate the makers on this latest addition to a famous range.

Every set referred to in this regular feature by "Set Tester" has reached a certain standard of efficiency in the "Amateur Wireless" Laboratory. Reports are not given on sets that fail to reach this standard. This will explain why reports that do appear express general satisfaction with the set's performance.

"H.T. BATTERY ECONOMY"

(Continued from preceding page.)

Unfortunately, makers have no standardised percentage drop in voltage on which to base the length of useful life of a battery under any given load. As a result, any figures that may be published are subject to modification by the user, should he decide to sacrifice volume, clarity, and range by continuing to use the battery when it really ought to be scrapped. A 25 per cent. loss of voltage appears to be the absolute limit of tolerance in the interests of quality and stability; so, in urging set owners to use bigger batteries, one must add an important rider: Use them only so long as they give service, otherwise they will give trouble.

We should be glad to hear from readers who have copies of the following issues to spare: 344, 348, 353, 356, 361, 363. These are out of print, and we have received numerous requests from other readers for them.

SYDNEY MOSELEY'S WEEKLY PROGRAMME CRITICISM

The "Proms" and
Popular Music
Poetry Readings
Effects



"Outside Announcers"

WHEN I referred recently to the "popular programmes" of the Promenade Concerts, I may have spoken a bit too soon, for after listening to three concerts I am wondering whether the fare provided is not a wee bit higher-brow than of yore. I must admit that I found even my favourite Wagner a bit wearisome, with the transformation music from *The Twilight of the Gods*, the prelude to *Parsifal*, and more music from the same opera. Well, just a wee bit heavy for one evening. I looked through the season's programmes and found the really popular stuff like *Reinzi* conspicuous by its absence. Is this Savoy Hill influence, is it a more mature Sir Henry Wood, or is it a Henry Wood who feels secure enough not to give the public what it wants?

The reading of poetry presents a praiseworthy but persistent attempt to a middle course. I dare say, like everything else, if they persisted enough in pouring these poems down our unwilling throats we shall get used to them in time. But the way is hard. Yet I love reading poems.

Here is a little thing that has occurred to me recently in listening to plays and revues. Why is wireless sneered at on the wireless? Sounds like the title of one of those catch-penny songs, but it is really serious. Perhaps a reader will oblige.

Fireside, which was described as "an

impossibly possible conversation," turned out to be better than I expected. The dialogue was natural, and although it did not scintillate in the usual manner of the author, it was good enough. So, too, were the actor and actress, who were as natural as the dialogue.

A quite worth-while little play, but, since we are in the pulpit mood, was not there a line which says "Thank you and damn you"? If so, let the author stand forth and be duly rebuked.

Do you notice the usual backgrounds to these plays? They are invariably good, and I must confess that once upon a time I was under the misapprehension that it was really an orchestra in attendance. I have since discovered that it is merely a gramophone record skilfully manipulated. I do not know who is to be thanked for these excellent selections and good stagecraft, but in one play, in which I was able to observe what was going on behind the scenes, it was Mr. Freeman who did the "doings." Holt Marvel, too, has a pretty good taste in musical selection.

Are you not tired, oh reader, of the British Broadcasting Corporation's "outside announcers"? "We will now play a fux-trut"—and this, mark ye, after the solemn announcements of the Advisory Board on English. Fux-truts!

We live and learn. Indeed, there is

hardly a moment when I switch on my set and do not learn something. The latest is a new way of pronouncing Weston-super-Mare. In my ignorance, I pronounced Mare as one pronounces the horse of that gender. Now I gather that the posh way of pronouncing it *a la* Advisory Committee, or perhaps as per the ultra-"refained" announcer—is "Weston-super-Mary."

I do not want to be cont-rary, but is it really "Mary"?

The Glasgow studio some time ago was in a predicament over the presentation of a play in which it was vitally important to have the sound of waves breaking on the shore. The usual "effects" failed to please the producer, and finally the difficulty was met in an elaborate way. A microphone was placed on the shore at Brighton, the sound of the wave was transmitted thereby to Cardiff and thence relayed to the Glasgow studio solely as a background for the action.

Early morning concerts broadcast from Berlin are relayed to Königswusterhausen from 7 to 7.30 a.m. B.S.T., from that hour until 8 a.m. the high power station must make way for the shipping news and weather forecasts sent out by Norddeich on the same wavelength.

In order that all listeners in Hungary may secure the benefit of alternative programmes, it has been decided to alter the plans of the new Budapest transmitter with a view to the broadcast of two separate entertainments at the same time.



Well-known piano duettists in cartoon—Edgar Fairchild and Robert Lindholm, and Ivor Dennis and Patricia Rossborough

Making Your Own Tuning Coils

Some Simple Methods for the Home Constructor

By J. H. REYNER, B.Sc., A.M.I.E.E.

A CORRESPONDENT has written regarding some dual-range coils in his possession. He states that he is quite satisfied with the coils, except that they do not go down to 200 metres. His first thought was to alter the coils, but he subsequently decided that the time was

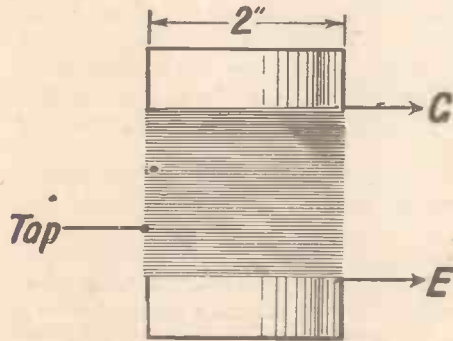

Fig. 1. Details of simple aerial coil

probably not far distant when his own local station (Leeds) would close down under the Regional scheme. He therefore came to the conclusion that the best course would be not to modify the existing coils, which were otherwise giving every satisfaction, but to make up a set of coils for the broadcast band only and to dispense with long-wave reception for the time being.

A Simple Coil

He therefore wrote to ask for some particulars regarding a simple form of coil likely to suit his purpose which he could construct with a minimum of difficulty. It occurred to me that this information would probably be of use to a number of other readers, and I have given the necessary data in the form of an article.

The coil and transformer described are not of a special order of efficiency, but are average coils capable of giving reasonable selectivity and good signal strength. Two-inch paxolin formers have been used in order that the coils shall not have too large an external field. Tubes of paxolin or similar compositions may be obtained fairly readily in standard 3-in. lengths. Cardboard will not be so efficient owing to the losses which are set up in this material, but if this point is not of importance cardboard can be used satisfactorily.

The first coil (Fig. 1) is a simple aerial coil which contains 45 turns of No. 30 d.s.c. wire. This coil will have an inductance of 150 micro-henries, and will tune from about 180 metres up to 500 metres.

A tapping on the coil should be taken at ten turns, the coil being connected in circuit as shown in Fig. 2.

The H.F. Transformer

The next point is the H.F. transformer. The secondary winding here has the same number of turns as the aerial coil, namely, 45 turns of No. 30 d.s.c. We now have to obtain a primary winding for this transformer, and the simplest method of construction, which gives satisfactory results, is shown by Fig. 3. A thin strip of empire cloth about half an inch wide, is obtained, and first of all two layers of this empire cloth are wound round the coil over the bottom end of the winding.

The number of turns of wire on the primary now depends upon the selectivity required. For the greatest signal strength the number of turns should exceed those on the secondary, but this usually gives very flat tuning, and as we reduce the number of turns, so the selectivity becomes greater at the expense of a certain amount of the signal strength. As a good compromise, 30 turns of No. 40 gauge wire should be wound over the layers of empire tape. Double-silk covered wire should be used, the object being to make the winding occupy a very small space—something less than a quarter of an inch—in order to reduce the capacity coupling.

Finally, there is the reaction winding. This should be wound in the same direction as the secondary, but should be separated therefrom by about $\frac{1}{8}$ in. It should be placed at the earth end of the winding, as shown in Fig. 2, and should be wound with 25 turns. The gauge of wire is not important, but the No. 40 d.s.c. wire used

low as 150 metres, but wish to cover the normal broadcast band of 250 to 550 metres. In such circumstances the number of turns requires to be increased.

Wave-Range

On the aerial coil the winding should consist of 62 turns of No. 30 d.s.c. wire

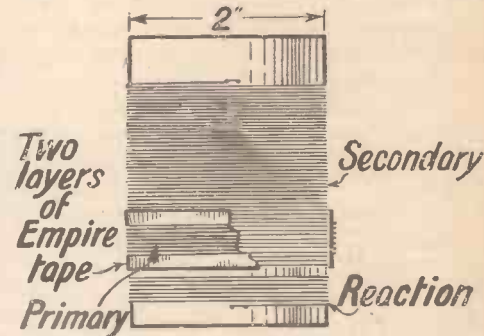

Fig. 3. Winding details of H.F. transformer

with a tapping at 14 turns, while the H.F. transformer should be constructed in the same manner, but again should be provided with rather more turns. The secondary winding will have 62 turns, as with the aerial coil, while the primary should be provided with 40 turns of No. 40 d.s.c. wire. The reaction winding should have 30 turns of No. 40 d.s.c.

The ends of the wires may be brought out in any convenient manner. One method is to drill holes through the ends of the former and thread the wire through. With the fine gauge wire as used on the primary and reaction coils a little care is necessary to avoid breaking the wire. The wire may be held in place on top of the empire tape by a spot of Chatterton's compound or sealing-wax.

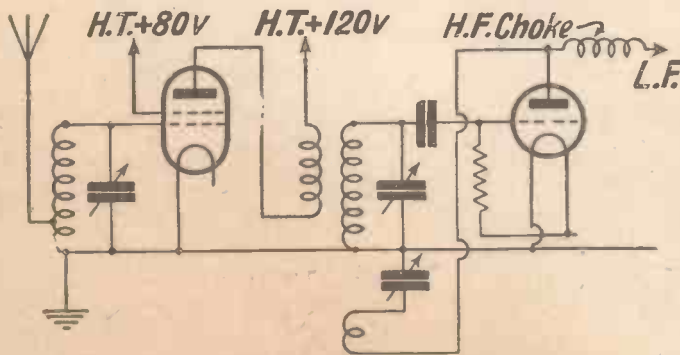

Fig. 2. Circuit incorporating the coils described

for the primary may conveniently be employed. The connections of the transformer are shown in Fig. 3.

It may be that the idea of these home-made transformers will appeal to other readers who do not wish to get down as

A QUESTION OF PITCH

IT is a moot point as to which comes over the ether more agreeably in ordinary speech—a man's voice or a woman's. Some prefer one and some the other, and there, no doubt, the matter must rest. It would, perhaps, be a fair generalisation to say that the best woman announcer is more distinct or clear-cut in enunciation than a man, but is prone to be somewhat flat and monotonous.

In this connection it is interesting to note that the average pitch of a man's voice is about 128 vibrations per second, as compared with 256 per second for a woman, with corresponding overtones in each case.

B. A. R.



Conducted by our Technical Editor: J. H. REYNER, B.Sc. (Hons.), A.M.I.E.E.

Six-Sixty Valve

ALTHOUGH two-volt valves are naturally the most popular type, there is no doubt that much greater filament emission can be obtained with six-volt valves consuming the same current. This is a matter of particular importance in the case of power and super-power valves, where the power output is to some extent governed by filament emission.

The S.S. 625SPA, made by the Six-Sixty Valve Co., is a six-volt.25 amp. super-power valve, capable of giving good results in the final stage of a low-frequency amplifier. Its properties may be judged from the characteristic curve shown on this page, and taken with 120 volts on the anode. It will be seen that the correct grid bias under these conditions should be approximately 23 volts. The valve has an impedance of 1,140, a particularly low figure; and an amplification factor of 2.5, giving a mutual conductance of 2.2 milliamps per volt.

With an H.T. voltage of approximately 150 to 180, the power output is approximately 750 milliwatts, a value sufficiently high to operate a moving-coil loud-speaker in a small room.

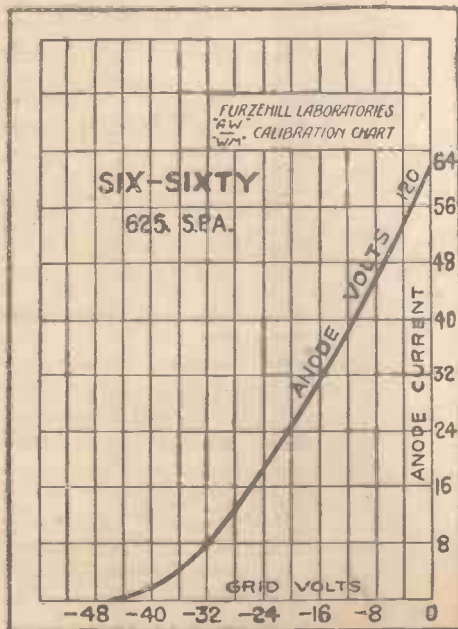

Characteristics of the Six-Sixty 625 SPA valve tested

It would, perhaps, be of interest to mention that this type of valve is particularly suitable for use in the final stage of a D.C.

mains amplifier, when the filament is connected in series with a resistance across the mains.

Beacol Formers

MOST readers will have come in contact with the well-known Beacol extruded ebonite former. It is in the form of a cylinder, having fins or ribs at regular intervals. This former may either be obtained in standard lengths for the reader to make what use he likes thereof, or it may be bought as a complete former fitting a base on which contacts are arranged.

We are advised that the price of these formers with bases has recently been reduced from 10s. 6d. to 7s. 6d., the base being obtainable either with four or six contacts, as desired. The base is provided with a slot, which engages with a pin on the former, so that there is no difficulty in locating the correct position, and it is impossible to insert the former into its base in an incorrect position. The former, indeed, is kept well above the contact strips until the pin engages with the slot at the base, when the former may be pushed down, so that contact is made.

We have also received samples of choke formers. These are suitably ribbed and are approximately 1 in. in diameter. They should prove useful for a variety of purposes.

Eelex Indicators

EELIX indicating terminals are well known to readers. They are of more or less conventional appearance, except that the head carries a small plate having an indication thereon. We have recently received an addition to the Eelex range, consisting of these indicating plates sold separately.

They consist of circular discs with a hole in the centre, and are made in various colours, principally black and red, although other hues are available. A number of standard indications—over forty, so we are informed—can be obtained and the list is continually being added to, while if desired blank discs may be obtained.

These discs will fit round the screw portion of wanderplugs, spade tags, etc., and form a convenient method of marking each particular lead with its appropriate connection.

Any reader who is interested should write to Messrs. Eastick & Sons for a descriptive eight-page leaflet.

The Paillard Induction Motor

THERE is a great deal to be said for a gramophone motor which is in the form of a complete chassis, comprising speed regulator, starting lever, and automatic stop mechanism all in one. The fitting of such a device is carried out in a mere fraction of the time taken to fit the various gadgets separately. Added to this, any little difficulties due to bad fitting are

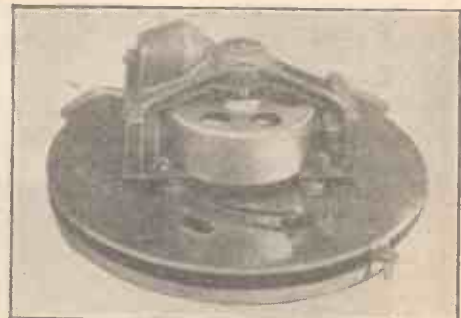

An underside view of the Paillard electric induction gramophone motor

overcome, and when one finds, as in the case of the Paillard gramophone motor, submitted to us for test by the Apollo Gramophone Co., that the automatic stop really does work satisfactorily, one is already kindly disposed towards the instrument.

Our tests on the motor itself, however, strengthened this favourable opinion very considerably. The motor is of the induction type, a large dished plate being carried on robust bearings between the pole pieces of the magnetic system. Application of alternating current to these pole pieces sets up eddy currents in the disc and causes it to rotate. A steady driving torque is thus obtained, and as there is no commutator or brushes at which sparking may occur, the machine is electrically silent and does not cause interference if used with an electrical amplifier.

The construction of this Paillard motor is sturdy, and we found after thorough test that the machine was one of the best we have tried. It runs steadily without fluctuation and there is ample power for the heaviest passages. The motor is, of course, only suitable for alternating current, and to those whose electricity is of this form we commend this machine.

The new Vatican transmitter will shortly carry out tests on 50.26 and 19.84 metres.

MANY readers were, no doubt, interested in the preliminary details given last week of this novel and easy-to-build two-valver, the "Searcher Two."

In introducing this receiver it was explained how, thanks to the higher power put out under the Regional scheme by the B.B.C. stations, a two-valver will now suffice and provide ample speaker volume for reception of stations in this country.

In addition, the changes which have been made under the Prague plan have resulted in many of the bigger Continental stations increasing their power, and so it is an altogether much easier matter, nowadays, to get a good "bag" of foreigners, and with so simple a set as the two-valver provided—and this is most important—that there is sufficient inherent selectivity in the set to get one station free from another, particularly when the high-power Regionals are working.

Constructional Work

The "Searcher Two" is a searcher because it really will bring in the foreign stations; and it has that necessary selec-

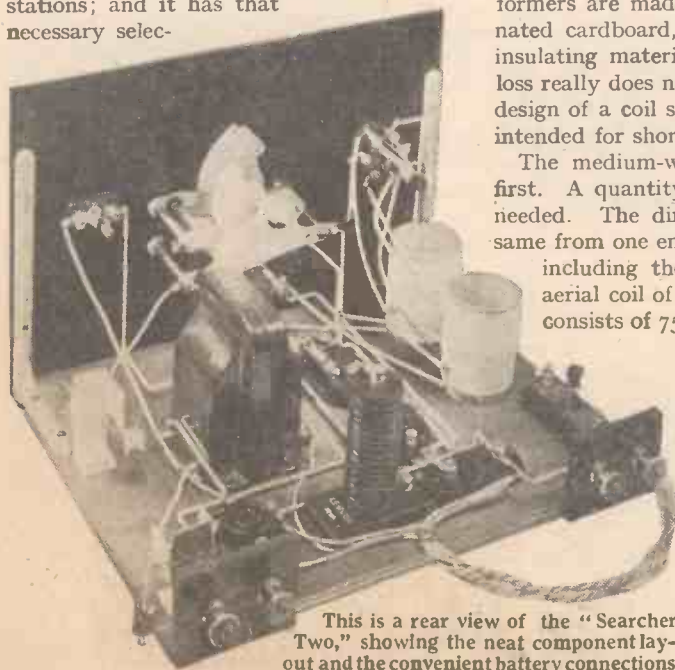

This is a rear view of the "Searcher Two," showing the neat component layout and the convenient battery connections

tivity—thanks to a special home-made coil—which is included in the specification.

The construction of the set can be carried out on straightforward lines with the aid of the photographs given and also by means of the blueprint. A small reproduction of this was given last week, but a full-size blueprint is available, price 1s., post free, from the Blueprint Department, AMATEUR WIRELESS, 58-61 Fetter Lane, London, E.C.4.

Preliminary work, such as the drilling of the panel, has already been described. The

mounting of the parts is also a simple matter, but the coils should be wound before the parts are mounted.

The coil switching arrangements may look rather complicated, but actually there is no difficulty about winding the coil or connecting it up in circuit. The coil is of a new type, which has been developed in the "A.W." Laboratory, and is of the popular binocular type.

The medium-wave winding is on one former, complete with its own reaction winding, while the long-wave coil, with a separate reaction winding, is on an adjacent former.

The formers are each $2\frac{1}{2}$ in. long, the medium-wave former having an outside diameter of $1\frac{3}{4}$ in., and the long-wave former being 2 in. in diameter. These formers are made of thin ebonite, impregnated cardboard, paxolin, or some similar insulating material. The question of low loss really does not seriously enter into the design of a coil such as this, which is not intended for short-wave working.

The medium-wave coil may be wound first. A quantity of No. 24 d.s.c. wire is needed. The direction of winding is the same from one end of the coil to the other, including the reaction winding. The aerial coil of the medium-wave section consists of 75 turns of the No. 24 wire.

This will not take up the whole of the space available on the former. A tapping should be made on the 60th turn, that is, 15 turns from the end remote from the start.

The reaction winding, which is in the same direction to the aerial winding and is adjacent to it, consists of 25 turns of No. 36 d.s.c.

The long-wave coil is wound entirely with the No. 36 d.s.c. wire as used for the medium-wave reaction winding.

Again, the whole of the long-wave section is wound in one direction from the beginning of the aerial winding to the end of the reaction winding. The aerial section consists of 190 turns, with a tapping at 60 turns. The tappings, in the case of both coils, are best made by leaving a small loop in the wire, which can be cut short before and soldered to an extended lead.

The reaction winding for the long-wave

BUILDING THE



A front view of the set in its cabinet

aerial section. The coils are shown on the blueprint and readers should have no difficulty at all in making these up exactly as described.

Wiring

The best method of attaching the formers at right angles to the wooden baseboard is by means of two small pieces of wood cut to fit the diameter of the formers and pressed into them. These small wooden pieces may then be screwed to the wooden baseboard as shown on the blueprint. For convenience, the formers should be mounted in position as shown, that is, with the medium-wave coil nearer to the panel.

On the blueprint each lead is numbered,

WHAT YOU

Ebonite panel, 12 in. by 8 in. (H. & B., Becol, Ready Radio).

Baseboard, 12 in. by 9 in. (Pickett, Camco).

Panel bracket (Bulgin, Lissen, Ready Radio).

.0005-microfarad variable condenser (Igranic, J.B., Lissen, Lotus, Burton, Formo, Polar, Ready Radio).

.00034-microfarad differential condenser (Lotus).

Filament switch (Bulgin, Lotus, Benjamin).

Double - pole double - throw switch (Lissen type LN575, Wearite).

Slow-motion dial (Brownie, Igranic, Formo).

Two valve holders (W.B., Lotus, Burton, Lissen, Benjamin, Junit).

High-frequency choke (Lewcos, Lissen, Bulgin, Tunewell, Wearite, Sovereign).

Low-frequency transformer (Lissen, Varley, Ferranti, Igranic, Telsen, R.I., Burton).

.0002-microfarad fixed condenser with series clips (Dubilier, T.C.C., Lissen, Graham-Farish, Watmel, Atlas).

.0001 - microfarad fixed condenser

SEARCHER TWO

PLETING CONSTRUCTION :: VALVES ND BATTERIES :: OPERATING

and this prevents the possibility of any wire being left out when the job of making connections is in progress. In this case, also, the leads from the wave-change switch on the panel are lettered at their ends as well as numbered, and these letters, from A to H, correspond with those on the diagram of the coils below. It is, thus, easy to connect up the coils to the set. If the switch of the type specified is used, it should be pushed in for medium-wave working and pulled out for long-wave working. The leads connecting the coil to the switch are

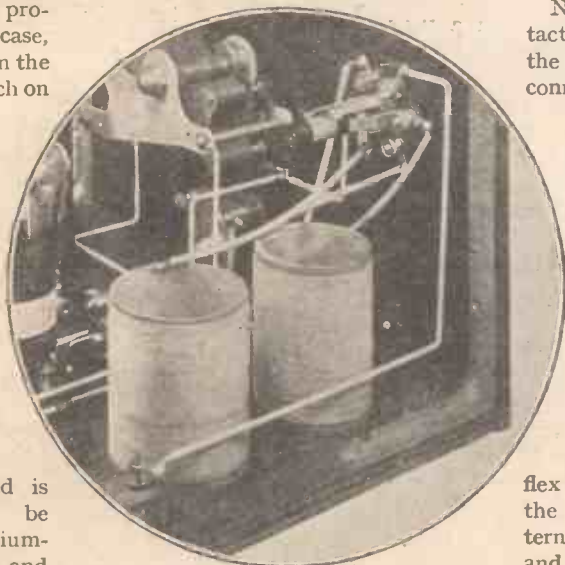

best covered with Systoflex as a precaution to prevent short-circuits.

Note that of the contacts on the switch, the longest contact is connected *via* wire No. 8 to tapping F on the coil and the shortest contact is connected *via* the wire No. 5 to tapping A on the long-wave coil.

Some of the wiring is carried out with rigid insulating wire, such as Glazite, but good-quality

flex should be used for the connections externally to the H.T. and L.T. batteries and for the two short leads to the grid-bias battery in the set. If you do the wiring using the blueprint as a guide, then you really cannot go wrong.

As you complete the various circuits, the connections of the coil will be made clear and it will be seen how reaction is provided by the .00034-microfarad differential condenser on both medium and long waves. Take care to check all connections, for mistakes are often misleading and result in the burning out of valves.

It was pointed out, in a recent issue, how an old, inefficient two-valver can be brought up to date and greatly improved by the provision of new valves and plenty of H.T. The same conditions *must* apply to a modern two-valver, and it is the greatest mistake to work an effi-

cient set with inefficient H.T. and with valves of doubtful characteristics.

The H.T. battery need not be of the super-capacity type, for the "Searcher" is not great in its H.T. demands. Nevertheless, at least 120 volts H.T. is advisable on the H.T. plus 2 tapping supplying the power valve, and it should be remembered that the greatest economical and dry battery H.T. working is to be obtained by using at the outset a very large-capacity battery, which has a long, useful life. Small batteries are a poor economy in the end.

Suitable Valves

The detector valve can be chosen from the following 2-volters, all of which have an impedance approximately suitable for use in this circuit. The equivalent 4- or 6-volt valves can be used, if one has a preference for these types: Cossor 210HF, Dario Univ., Marconi HL210, Osram HL210, Six-Sixty 210HF, Mullard PM1HF, Mazda HL210, Lissen HL210, Fotos BA9, P.R. PR3LF, Triotron HD2.

A good power valve is advisable, although one need not use one of the super-performance low-impedance power valves, which are more suitable for low-frequency work on a large scale. The following 2-volt power valves are quite suitable: Cossor P2, Dario SP, Marconi P2, Osram P2, Six-Sixty 220P, Mullard PM252, Mazda P220, Lissen P220, Fotos BD9, Tungram P215, P.R. PR120.

When operating the "Searcher," you will find that at the outset the semi-variable condenser on the baseboard connected to the aerial terminal should be screwed right in to its greatest capacity of .0003 micro-
(Continued at foot of next page)

WILL NEED

(Dubilier, T.C.C., Lissen, Graham-Farish, Watmel, Atlas).

Pre-set condenser, .0003 to .000025 microfarad (Formo type J, Lissen, Lewcos, Polar, Sovereign).

1-megohm grid-leak (Dubilier, Lissen, Watmel, Ediswan, Atlas).

Two ebonite terminal strips, 2½ in. by 2 in. (H. & B., Lissen, Ready Radio).

Four terminals, marked: Aerial, Earth, L.S.+, L.S.— (Eelex, Belling-Lee, Clix, Igranic).

Five wander plugs, marked: H.T.—, H.T.+1, H.T.+2, G.B.+, G.B.— (Belling-Lee, Eelex, Clix, Igranic).

Two spade terminals, marked: L.T.+, L.T.— (Belling-Lee, Clix, Eelex).

Grid-bias battery clips (Bulgin).

Four yards of thin flex (Lewcoflex).

Coil former, 1½ in. diameter and 2½ in. long (Wearite, H. & B.).

Coil former, 2 in. diameter and 2½ in. long (Wearite, H. & B.).

4 oz. of No. 36 d.s.c. wire (Lewcos).

4 oz. of No. 24 d.s.c. wire (Lewcos).

Length of Systoflex (Wearite, H. & B.).

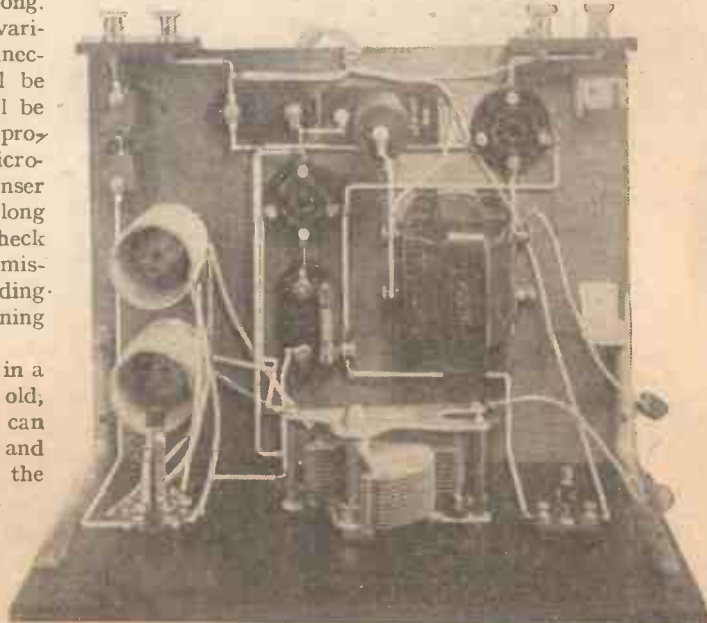

In conjunction with the reproduction of the blueprint given last week, this plan view will facilitate construction

TELE-TALKIES on a LARGE SCREEN

An Account of the Recent Demonstration at the London Coliseum



A view of the receiving screen with (inset) the commutator

mission a film taken at Isleworth showing Mr. Sydney A. Moseley giving a short address was employed, and Mr. Moseley himself appeared on the stage to "show there was no deception."

The effect on a very packed audience was most marked, and although the film, as it appeared on the screen, was far from perfect, it represented a beginning, the ultimate end of which may well be of far-reaching importance.

identical to that used in the standard talking film of this character. There is a sound record running down the side of the film, the varying density of these short horizontal lines being converted into intelligible speech, song or music. A photo-electric cell converts the light into currents and these, after amplification, pass to the line or wireless transmitting station and ultimately reach the loud-speaker.

THE first public demonstration of Tele-talkies or, in other words, a talking film transmitted by television, took place recently at the London Coliseum. This

Transmitting Arrangements

A schematic arrangement of the apparatus used for the transmission of talking films is shown in the accompanying illustration. The projector is one of the type which was popular some years ago and has no Maltese cross or shadow, the film moving continuously:

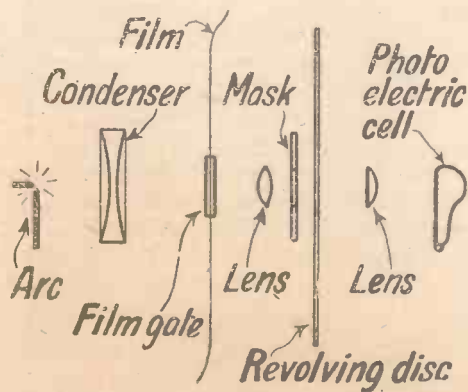

Schematic arrangement of the tele-talkie transmitter

After the rays of light have passed through the condenser they meet the film passing through its own gate or guide and with the aid of the lens an actual image of the film is projected on to the scanning disc. At any one instant that a hole is passing over the picture it will allow a certain light value to pass through, according to the elemental area scanned. This is made to influence the photo-electric cells, an additional lens being called into operation at this point to ensure that the light passing through the disc is spread over the active area of the cells.

theatre was the first in the world to include either television or tele-talkies in its programme. For the purposes of the trans-

For this work, sound-on-film records are employed, the speech equipment being

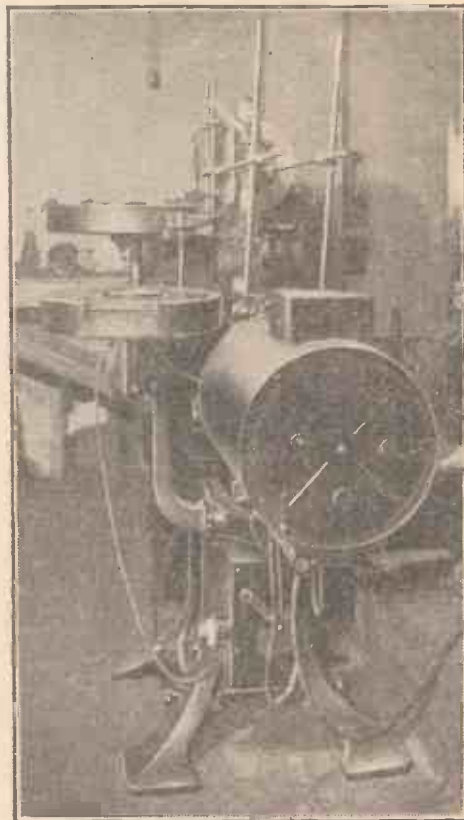

The modified projector used for the transmission of talkie films

"THE 'SEARCHER TWO'"

(Continued from preceding page)

farad. This will not provide the sharpest tuning, but it will give greater signal strength. Later, when one has made a round of the dials, this condenser may be slackened off a little to sharpen up the tuning.

In a test of the "Searcher," which was made by a member of the AMATEUR WIRELESS staff, the most satisfactory results were obtained with valves picked from the foregoing types, with 120 volts on the H.T. +2 tapping and approximately 80 volts on the H.T. +1 detector tapping. The full 9 volts grid bias was found necessary.

THE PROMENADE CONCERTS

IN a press interview, Sir Henry Wood has been congratulating his musicians, justly after their playing of Mahler's First Symphony on Tuesday, August 19, on their skill in rendering modern music, and he says that an element of modern music is to be retained in "Proms." programmes. This is bound to cause disapproval, but modern music has done so at all times, and I should like to ask dissentients at the Queen's Hall whether they think musical development at the death of Brahms cannot be improved upon and whether there is any possible alternative development. For my own part, I

think that all media can be used for artistic expression, and in the infinite complexity of artistic development any medium may be adopted for this purpose.

The first Beethoven night gave me much pleasure. No doubt the First and Eighth Symphonies are in the same programme for convenience, but the effect is to show off the mature Eighth Symphony to great advantage. The first Brahms night was the best concert since I wrote last. There was the "Academic Overture," the Violin Concerto in D, the solo part beautifully played by Miss Isolde Menges, and a great rendering of the Fourth Symphony. This is Brahms in a satisfying quantity. L. R. J.



RADIOGRAMS

A MUSICAL programme entitled *Prunes and Prisms*, by John Watt, is down for broadcast from Regional on August 29 and National on August 30. The story is based on the adventures of a country cousin who breaks into a London night club.

The first of a new series of talks on *Careers* will be broadcast Nationally on September 23. The subject will be *Electrical Engineering*, and the speaker Captain Eckersley, formerly Chief Engineer of the B.B.C.

Edges of the World is the title of another new series which commences on September 6. The speakers will be men whose life work has been carried out in isolated corners of the Empire.

A play entitled *The Invalid*, in which Edgar Lane will take part, will be given in the Birmingham studio on September 1. Midland Regional listeners will remember hearing Edgar Lane in a clever impersonation of Albert Chevalier, in a programme of coster-comedian songs given some time ago.

A concert of the works of Mozart is to be relayed to London from the Salzburg Festival on August 30. It is to be given by the Vienna Philharmonic Orchestra, conducted by Herr Bruno Walter, one of

the most talented and distinguished of German musicians.

The following artistes will take part in the vaudeville programme from National on August 28:—Hetty King (the well-known impersonator), Horace Kenney, comedian, and Elsie Griffin and Kingsley Lark in a musical act.

The lighthouse service of the United States now has seventy-eight radio-beacon stations. The beacons are being established at the more important lighthouses and lightships along both coasts and on the Great Lakes.

The transatlantic telephone was recently opened between Vatican City and the United States. The powerful radio station which Marconi has been constructing for the Vatican, over which the Pope will speak, will soon be in operation.

Parlour Tricks, a revue by Charles Brewer, will be broadcast to Birmingham listeners on September 6. Myles Clifton, who made a great wireless success in *The 'Ole in the Road*, is one of the artistes taking part.

An interesting talk entitled "West Country Writers and their Characters" will be given by Mr. Hedley Goodall from the Cardiff station on September 5. It is the first of a new series to be broadcast

from this station. Mr. Goodall's first subject will be Miss Margaret Kennedy, and he will also deal with the characters of Lewis Dødd and Tessa.

The next of the "Intimate Interviews" series of talks from Cardiff will be heard on September 6. This time it will be given by a Gower lifeboatman.

Amongst other items in a light programme from Belfast on September 9, listeners will hear *The Constant Lover*, a comedy in one act by St. John Hankin.

From the same station on September 11 a repeat performance will be given of Flotow's comic opera, *Martha*. The original cast has been booked in its entirety, and includes Dorothy Bennett, Herbert Thorpe, Harry Brindle, and Albert V. Froggatt.

An Irish comedy in one act, entitled *Hyacinth Helvey*, by Lady Gregory, will be presented in the Belfast studio on September 5 by Arthur Malcolm.

Mr. R. C. Sherriff, the author of *Journey's End*, will broadcast an appeal on behalf of the Invalid Children's Aid Association on August 31.

Although the Queen's Hall concert season opens on October 22, up to the present no permanent conductor has been appointed to direct the performances. The concerts will be arranged in series of two or three under the same baton in order to allow the orchestra to become stabilised under a few of the greatest British and Continental conductors of our time.

On September 6, Belfast will relay a running commentary on the motor cycling race for the International Grand Prix, from the Cladybridge Circuit. The times at which this commentary takes place are approximately 12.45 to 1.30 p.m. and 2.45 to 4 p.m.

MR. FLEX PICKS UP A FOREIGNER—



—AND YOUNG FLEX LETS ONE IN.



The
Easy Way
TO PERFECT RADIO

In addition to their own extensive range, PETO SCOTT offer YOU Every Known Radio Receiver or Component on

EASY TERMS

SERVICE AFTER SALES

NEW OSRAM MAGNET FOUR
SEND 23/6 The very latest kit, incorporating 2 S.O. H.F. stages for great range and extreme selectivity. Single control. Balance in 12 monthly payments of 18/6 ONLY

R-AGENTONE
SEND 10/9 Model W.5 Portable H.T. Eliminator for A.C. Mains. Output 120 volts at 15 m.a. 2 variable and 1 power tapping. Balance in 11 monthly payments of 10/9 ONLY

EXIDE
SEND 8/6 120 volt W.H. Type, H.T. Accumulator, complete with crates, dry charge. Balance in 11 monthly payments of 8/6 ONLY

EPOCH
SEND 12/4 Model 65 P.M. permanent magnet moving coil loud-speaker. Perfect reproduction without battery or mains for field. Balance in 11 monthly payments of 12/4 ONLY

KITS & ACCESSORIES, ETC.
OLYMPIA, Sept. 19th to 27th.
Our Stand will be an exhibition in itself. Do not miss it. STAND No. 110 (Gallery).

PETO SCOTT CO. LTD.
77 City Rd., London, E.C.1. Phone: Clerkenwell 19406-7-8. 62 High Holborn, London, W.C.1. Phone: Chancery 8206. 4 Manchester St., Liverpool. Phone: Central 2134. 83 Whiteley Rd., Chorlton-cum-Hardy, Manchester. Phone: Chorlton-cum-Hardy 2028.

PLEASE SEND ME YOUR EASY WAY QUOTATION FOR ITEMS MARKED NAME.....

AW30P

IN THE HIGHEST CLASS



TUNEWELL TRANSFORMERS

NEW
POPULAR
MODEL

Ratios 3-1 and 5-1

Price 8/9

STAND No. 9 OLYMPIA

Write for List of Speakers

TURNER & CO.

54 Station Road, New Southgate, N.11

LETTERS TO THE EDITOR

The Editor does not necessarily agree with the views expressed by correspondents

Reception on the East Coast

SIR,—In a recent issue of AMATEUR WIRELESS (which journal I always rejoice in, despite my limited knowledge of fundamentals), "Thermion" invited reports as to reception in various parts of the kingdom. Here, I am perched on a cliff about 120 ft. above sea-level, using a 60-ft. mast, and about 50 ft. aerial. Situation absolutely unscreened. Receiver: One S.G., det., and two super-power valves in "push-pull."

I get most of the medium stations at great strength, and, of course, the long waves also; but the National and Regional stations come in so violently that it takes some tuning to cut them out to any extent through three variable condenser controls,

But the chief bogey the past five weeks has been atmospherics, which on this receiver are terrifying. In the town below me, with screening around, reception is as strong and statics greatly reduced. This receiver is also used at Hampstead, near the summit of the Heath, and reception on both wave bands is about the same as here.

I think, however, that in normal conditions one can certainly do better on this coast with German, Swedish, and Dutch stations than in south European countries, although, of course, Toulouse, Rome, Genoa, and Milan can be quite equal to, say, our Midland broadcasts in volume.

The past four years I have sampled many sets, both portables and otherwise, and, despite the limitations, I now incline to frame aerials of some kind or other.

S. L. C. (Sheringham, Norfolk).

The "Easy-Tune Short-wave Two"

SIR,—I have had amazing results with the "Easy-tune Short-wave Two," which was described in "A.W." No. 425, although I have not made it up exactly as described, but have used some old components which I had on hand. However, I have used the valves and coils specified and am working the set from a new H.T. battery.

Experience which I had with a short-wave set some years ago proved that it is impossible to get good results with a run-down H.T. battery which is constantly causing crackling noises, or with valves which have lost their emission. The disappointment I had with that early short-wave receiver caused me to drop short-wave working until I saw the description of the "Easy-tune Short-wave Two."

I am afraid I cannot give a reception log, because I have not been able to identify all the stations I have received—and they number some thirty or forty. There is a

demand for a good short-wave list of stations. Most of those at present available seem to be very inaccurate when one actually starts to tune-in and attempts to log distant stations below 100 metres. Incidentally, how strange it is to find (via 5SW) a B.B.C. programme which can be tuned in and out within a fraction of a degree! It is very much of a change from the conditions which obtain between 250 and 450 metres! J. B. (Ponders End).

Lightning and Atmospherics

SIR,—I was very interested to read in "Thermion's" notes of experiences of atmospherics during thunderstorms. I have had the same thing happen this week, and also once before. We had listened to the London programme all the evening without noticing any crackling going on, but now and again there appeared to be a slight wavering or quivering in the notes of music, only for a second or two, and at others a momentary fading. When switching off and going to bed, I was very surprised to see lightning flashes. Although very bright, they were a long way off and no thunder was heard.

I may be entirely wrong, but it seems to me that the positions of the storms, the powerful transmitters, and the receiving set has got something to do with this. I should say that, roughly speaking, these were in line. Whether the storm was between transmitter and set or the transmitter between storm and set I could not say. I am situated south of London, and if a storm is on in the west, south, or east I notice we get the crackling all right. The next time I see a storm in the London direction, and I am not getting the noises, I intend to try out 5GB and 5XX to see if I get it from them.

A. R. (London, S.).

The Auditions

SIR,—I am not an artiste who has been refused a broadcast by the B.B.C., therefore I hope my opinion on the present audition system will not be considered biased. I ask, with Mr. Sydney Moseley, "who are the secret critics upon whose secret reports the fate of artistes and speakers are decided?" There are so many people who do not grumble so much at the nature of the programmes as the quality of the artistes taking part in them. The general standard is good (I am not a B.B.C. grouser), but there are a few artistes who should never have been allowed to appear before the microphone.

One wonders if these are the oral proof of laxity on the part of the audition officials, or whether—if one may suggest it in a Government department—there was any "influence."

It would be a good thing if some of the spare hours of the day could be taken up by the broadcasting of auditions, so that the public could judge.

H. K. (Manchester).



BARIUM VALVES

Use Tungram Barium Valves in your set. They will give you better performance; long range to bring in distant stations, selectivity, perfect tone. And they are economical. Their first cost is considerably less than any other valve of similar quality. And they make more of your batteries. It pays you to use TUNGSRAM BARIUM VALVES.

Prices: L.F. 5/6, H.F. 5/6, R.C. 5/6, Power 7/3, Super Power 8/-, A.C. Indirectly Heated H.F. and L.F. 9/6 each, A.C. Directly Heated Power 8/6 each, A.C. Directly Heated H.F. and L.F. 8/-, Rectifying Valves 10/- each, Tungram Photo-electric Cells (3 types) Standard £2/10/0, Nava E. £2/17/6, Nava R. £2/17/6.



VP11

TUNGSRAM ELECTRIC LAMP WORKS (GT. BRITAIN) LTD. Radio Dept.: Commerce House, 72 Oxford Street, London, W.1

Makers of the famous electric lamps.

Factories in Austria, Czechoslovakia, Hungary, Italy and Poland.

Branches: Belfast, Birmingham, Bristol, Cardiff, Glasgow, Leeds, Manchester, Newcastle, Nottingham, Southampton.

Postcard Radio Literature

A "Super" Cabinet

DOWN at the works of Clarion Radio Furniture the other day I was introduced to the latest in grammo-radio cabinets—a "super" job some four feet in height, of solid oak and selling at a low figure. The gramophone turntable is concealed in a novel manner. Literature describing this and the other cabinet members of the Clarion family can be had on application; so why be without a good cabinet? **23**

Sets and Speakers

The latest Kolster Brandes three-valvers and cone speakers are described in an illustrated folder just issued. The modest priced Junior cone speaker is particularly interesting. **24**

The P.D. Portable

A pleasing-looking receiver for indoor or outdoor use is the new P.D. "Melody Portable Five." A leaflet describing this can be obtained from Automobile Accessories (Bristol), Ltd. There are also some very efficient table-model sets having two and three valves in the P.D. range. **25**

Artcraft Cabinets

If you want a new set cabinet or a cabinet to contain records or to house the speaker, then you should see the new illustrated Artcraft folder, which gives a good idea of the extensive range of Artcraft cabinets available. **26**

Changing to A.C.

Six-Sixty's are catering for battery-driven set users who wish to change over to A.C. valves, stage by stage. A simple adaptor is available, described in a folder just received, which enables indirectly-heated A.C. valves to be used without extensive wiring alterations. **27**

Testing Meters

There is nothing like a really reliable meter for testing out receivers, and the Weston Electric Instrument Co., Ltd., make handy accurate meters for every radio test purpose. A little booklet, "Radio Control," describes these. **28**

GET THESE CATALOGUES FREE

Here "Observer" reviews the latest booklets and folders issued by well-known manufacturers. If you want copies of any or all of them FREE OF CHARGE, just send a postcard giving the index numbers of the catalogues required (shown at the end of each paragraph) to "Postcard Radio Literature," "AMATEUR WIRELESS," 58/61, Fetter Lane, E.C.4. "Observer" will see that you get all the literature you desire.

BROADCAST TELEPHONY

Broadcasting stations classified by country and in order of wavelengths. For the purpose of better comparison, the power indicated is aerial energy.

Metres	Kilo-cycles	Station and Call Sign	Power (Kw.)	Metres	Kilo-cycles	Station and Call Sign	Power (Kw.)	Metres	Kilo-cycles	Station and Call Sign	Power (Kw.)
GREAT BRITAIN											
25.53	11,751	Chelmsford									
		(5SW)	15.0								
*200	1,500	Leeds	0.13	316	950	Marseilles (PTT)	0.5				
*242	1,238	Belfast	1.0	328.2	914	Grenoble (PTT)	0.5	363.4	825	Algiers (PTT)	16.0
*261	1,148	London Nat.	45.0	329	918	Poste Parisien	0.5	418	721	Radio Maroc	
*288.5	1,040	Newcastle	1.0	345.2	869	Strasbourg	12.0			(Rabat)	10.0
288.5	1,040	Swansea	0.13			(testing shortly)		1,250	240	Tunis Kasbah	0.0
288.5	1,040	Stoke-on-Trent	0.13	368.3	813	Radio LL (Paris)	0.5			NORWAY	
288.5	1,040	Sheffield	0.13	385	779	Radio Toulouse	8.0	364	824	Bergen	1.0
288.5	1,040	Plymouth	0.13	447	671	Paris (PTT)	0.3	369	813	Frederiksstad	0.7
288.5	1,040	Liverpool	0.13	466	644	Lyons (PTT)	5.0	453	662	Nidaros	1.2
288.5	1,040	Hull	0.13	1,446	207	Eiffel Tower	12.0	455	659.3	Porsgrund	0.7
288.5	1,040	Edinburgh	0.35	*1,725	174	Radio Paris	16.0	*493	608	Oslo	1.5
288.5	1,040	Dundee	0.13			GERMANY				POLAND	
288.5	1,040	Bournemouth	1.0	*215.8	1,393	Flensburg	0.5	214	1,400	Warsaw (2)	2.0
288.5	1,040	Bradford	0.13	*227	1,319	Cologne	4.0	*234	1,283	Lodz	1.5
*301	995	Aberdeen	1.0	*227	1,319	Münster	3.0	*313	959	Cracow	0.5
*310	968	Cardiff	1.0	*227	1,319	Aachen	0.35	*335	896	Poznan	1.2
*356	842	London Reg.	30.0	232.7	1,288	Kiel	0.35	381	788	Lvov	2.0
*377	797	Manchester	1.0	*239	1,256	Nürnberg	2.0	385	779	Wlino	0.5
*399	753	Glasgow	1.0	246	1,220	Cassel	0.25	*408	734	Katowice	10.0
*479	626	Midland Reg.	25.0	*253	1,184	Gleiwitz	2.0	1,411	212.5	Warsaw	8.0
4,551	193	Daventry (Nat.)	25.0	*259	1,157	Leipzig	2.5			PORTUGAL	
				*270	1,112	Kaiserslautern	0.25	240	1,247	Oporto	0.25
				*276	1,085	Königsberg	2.5	320	937.6	Lisbon (CTIAA)	0.25
				*283	1,058	Berlin (E)	0.5			ROUMANIA	
				*283	1,058	Stettin	0.5	*304	761	Bucharest	12.0
				*316.9	946.6	Bremen	0.35			RUSSIA	
				*320	937.6	Dresden	0.25	700	416.6	Moscow (PTT)	20.0
				*325	923	Breslau	1.5	820	375	Kiev	20.0
				*360	833	Stuttgart	1.5	824	364	Sverdlovsk	25.0
				*372	806	Hamburg	1.5	1,000	300	Leningrad	20.0
				*390	770	Frankfurt	1.5	1,000	283	Tiflis	10.0
				*418	716	Berlin	1.5	1,103	272	Moscow Popoff	40.0
				*453	662	Danzig	0.25	*1,304	230	Moscow Stchelkovo	
				*473	635	Langenberg	15.0			(C.C.S.P.)	100.0
				*533	563	Munich	1.5	1,380	217.5	Bakou	10.0
				560	536	Augsburg	0.25	1,481	202.5	Moscow	20.0
				*566	529	Hanover	0.35			SPAIN	
				576.1	520.7	Freiburg	0.35	251	1,193	Barcelona	
				*1,035	183.5	Zeessen	26.0			(EAJ15)	0.5
				1,635	183.5	Norddeich	10.0	266.7	1,125	Barcelona	
										(EAJ13)	5.0
								*319	860	Barcelona	
										(EAJ1)	8.0
								368	815	Seville (EAJ5)	1.5
								407	737	Madrid (España)	1.0
								424	707	Madrid (EAJ7)	2.0
								460	652	San Sebastian	
										(EAJ8)	0.5
										SWEDEN	
								135	2,222	Motala	60.0
								230.1	1,304	Malmö	0.6
								*257	1,160	Hörby	10.0
								299.3	1,002	Falun	0.5
								*322	932	Göteborg	10.5
								*435.4	689	Stockholm	1.5
								*542	554	Sundsvall	1.0
								*770	389	Ostersund	0.6
								1,223.5	244	Boden	0.6
								*1,348	222.5	Motala	30.0
										SWITZERLAND	
								318.8	943	Basle	0.5
								*403	743	Berne	1.0
								*459	653	Zurich	0.6
								673.7	442	Lausanne	0.6
								760	395	Geneva	0.25
								1,010	297	Basle	0.25
										TURKEY	
								*1,220	245.0	Istanbul	5.0
								1,595	188	Ankara	7.0
										YUGOSLAVIA	
								306.7	978	Zagreb (Agram)	0.7
								432.3	694	Belgrade	2.5
								579	578.2	Ljubljana	2.5

All wavelengths marked with an asterisk have been allotted according to the Plan de Prague.

NEONS FOR PROJECTION

THE normal light that is secured from an ordinary neon lamp with a flat plate electrode as used in a television receiver does not lend itself in that form to projection work whereby the size of the resultant image can be increased. With mirror drum scanning, however, and a special type of neon, the image size can often be increased quite appreciably. The anode of the glow discharge tube is then made in the shape of a concave or part cylindrical reflector with the cathode placed at the principal focus. The back of the reflecting electrode is then coated with insulating material such as mica or micanite.

By this means a highly concentrated ray is secured which is focused on to the mirror drum and in turn reflected on to a prepared glass screen where the image is built up into the usual strip form. What a pity other types of illumination are so sluggish (in a television sense) in their response to voltage or current fluctuations. If this defect could be overcome the television images which we now view through magnifying lenses in a Televisor could be projected. This would increase the number of "lookers-in" for one machine. However, all the difficulties connected with television are being mastered one by one and no doubt this particular aspect will secure its share of investigation. **B. C.**

Electrify your Mullard **ORGOLA**



for the ORGOLA SENIOR
A.C. Mains. Model A.C. 38. Price £9 12s. 6d. Cash, or 10/- deposit and nine monthly instalments of 22/- each. D.C. Mains. Model D.C. 50. Price £7 15s. 0d. Cash, or 10/- deposit and nine monthly instalments of 18/- each.



for the ORGOLA III
A.C. Mains. Model A.C. 16. Price £4 10s. 0d. Cash, or 10/- deposit and nine monthly instalments of 10/- each. D.C. Mains. Model D.C. 16. Price £3 15s. 0d. Cash, or 10/- deposit and eight monthly instalments of 9/- each.

"ATLAS" MAINS UNITS

Absolute simplicity and safety. Delicate voltage adjustment. No hum. Ample power. Guaranteed for twelve months. Send for leaflet to-day.

RECOMMENDED BY "RADIO FOR THE MILLION"

"CLARKE'S **ATLAS**" MAINS UNITS

H. CLARKE & CO., (Mcr.), Ltd., Old Trafford, MANCHESTER

You will get better results with the **MAZDA P.220A** than with any other 2 volt-2 amp **POWER VALVE**



It will be seen from its figures that the Mazda P220a is by far the best 2-volt .2 amp power valve on the market. It is more sensitive—and has, at the same time, a larger power handling capacity than any other valve of similar type. For a given input its output is nearly half as much again. Tone and power will be immensely improved by this wonderful valve. Its low filament current and low consumption of H.T. make it the ideal power valve for portable sets.

CHARACTERISTICS

Filament volts	- - - -	2.0
" amps	- - - -	0.2
Max. H.T. volts	- - - -	150
Amplification factor	- - - -	6.5
Anode A.C. resistance (ohms)	- - - -	1850
Mutual A.C. conductance (mA/V)	- - - -	3.5

See the amazing Mazda Valves on the Ediswan Stand (No.67) at Olympia.

With Mazda valves in all positions your set will give a performance many times better than before.

The amazing

MAZDA RADIO VALVES

MAZDA P220A PRICE 13/6



THE EDISON SWAN ELECTRIC CO., LTD.
Incorporating the Wiring Supplies, Lighting Engineering, Refrigeration and Radio Business of The British Thomson-Houston Co., Ltd
Radio Division.
1a, Newman Street, Oxford Street, W.1.
Showrooms in all the Principal Towns

EDISWAN

Advertisers Appreciate Mention of "A.W." with Your Order

HOW FACTORY SETS ARE TESTED

ONE of the most elaborate test rooms in the country is a feature of the new Radio Instruments building at Purley Way, Croydon, and last week an AMATEUR WIRELESS Special Representative went along to see how comprehensive factory-built sets are tested before they come into users' hands.

In the Radio Instruments test room



Here are shown a general view of one of the assembling departments and (right) the test laboratory of the new Radio Instruments factory



from complete sets, can be properly put through its paces.

Two testing benches are fitted up for measurement of inductance, and on these everything from an H.F. choke to an L.F. transformer can be tested. Another bench is equipped with an A.C. bridge arrangement for measuring the capacity of condensers, and the tester has so wide a range that it can measure accurately down to a fraction of a micro-microfarad, and up to a maximum of 10 microfarads.

A particularly interesting gadget is an electrostatic

The transformer to be tested is fitted in a jig, and automatic connections are made to the terminals. The speed with which this alone is done is interesting. Then an aural balance of sound is made by means of the operator, wearing phones, and the actual amplification is read from the dial of a Wheatstone bridge. This enables any transformer to be rejected which does not come within the specified limits, and the test is a combination of aural and visual indications.

It is interesting to note that a large section of the Radio Instruments factory is devoted to the testing of apparatus manufactured for the War Office, Admiralty, Air Ministry, Post Office and other Government departments. What to anybody else would have been the "hush-hush" room, wherein is undertaken research work for new developments, is as completely fitted out as the large test room, and the research staff is already busy with several novel developments.

The tests on components are so thorough, that extensive testing of completely-assembled Radio Instruments sets is unnecessary, and trials of new sets take very little time. Mains-operated sets need careful testing, however, under actual operating conditions, measuring instruments by Weston, Eversheds, Nalders, and so on, being used.

The testing department is only one of the many interesting features of the new Radio Instruments "H.Q.," which is one of the new landmarks on the Purley Way, and which, both inside and out, is a model of what a modern, up-to-date radio factory should be.

electrical power of all usual voltages and frequencies can be tapped off from generators and, in the case of D.C., from batteries if necessary. The tappings give 400 volts D.C., 220 volts D.C. from accumulator banks, 230 volts D.C. from a generator, 220 and 230 volts A.C. at 50 cycles, and 230 volts A.C. at 25 cycles. In this way practically every type of apparatus, apart

meter for reading up to 30,000 volts, and this, of course, is in constant use in the testing of high-tension transformers.

A novel idea has been used in the testing of the well-known Radio Instruments transformers for ordinary L.F. work in receivers. The test-bench apparatus includes a special type of bridge and a mutual inductance



Other Contents of the WIRELESS MAGAZINE:

The Music Monitor—a simple 2-valver receiving over 20 stations on loud-speaker—Megohm Discusses Side-bands—The Selecto-amplifier. To Increase the Range and Selectivity of Existing Sets—What the B.B.C. Does with Your Letters. By Frank Rogers—A Dual Receiver for Television. By H. J. Barton Chapple, Wb.Sc., B.Sc.—Getting the Best from Your Output Valve. By W. James—Plain Facts about Grid Bias. By J. H. Reyner, B.Sc., A.M.I.E.E.—GRAMO-RADIO SECTION. Around the Turntable—Reviews of the Month's Records.

DE-LUXE THREE

THIS set is just what its name implies—a three-valver above the average in regard to the quality of components used and in its quality of reproduction.

The actual circuit embodies the best of modern refinements, and altogether the receiving is an outstanding example of what modern practice really is.

The set is ideal for super quality from the local station and will also give a number of Continental transmissions. See the September issue of the "Wireless Magazine" for construction details.

WIRELESS MAGAZINE

NOW ON SALE EVERYWHERE, 1/-

GET YOUR COPY TO-DAY

Always ask your dealer for Dario. It is a guarantee of all that is supreme in Radio Valves, and you are perfectly safe in buying Dario at all times. The following notice to the Trade proves Dario worth.

INDEMNITY BY IMPEX ELECTRICAL LTD.

Messrs. The Mullard Radio Valve Co. Ltd. have recently published notices in the trade press intimating that they intend to take legal proceedings against retailers and others who may infringe certain Letters Patent owned by them, amongst which are Letters Patent No. 283,941.

We are satisfied that the construction of our well-known Dario Valves is not such as to constitute an Infringement of Letters Patent No. 283,941, and we desire to give notice to our trade friends that we undertake hereby to indemnify any person who may be sued for Infringement of Letters Patent No. 283,941 by the sale of our Dario Valve in respect of any costs and damages which may be awarded against him provided that our Solicitors Messrs. Philip Conway, Thomas and Co., of 80 Rochester Row, Westminster, London, S.W.1, shall have the conduct of any action brought to recover such damages.

For the purpose of enabling any retailer conveniently to avail himself of the benefit of this indemnity we are depositing with our Bankers in England in the joint names of ourselves and our Solicitors a large sum of money to be utilised for the purpose of making this indemnity effective.

In future, should any claim be made against any customer of ours for infringement of Letters Patent No. 283,941 by the sale of our Dario Valves, the document containing the claim should be sent immediately unanswered to our Solicitors at the above address in order to obtain the benefit of this indemnity and relief from the trouble of conducting legal proceedings.



Best way to all Stations

Ask your dealer or write for Free Folder to:
IMPEX ELECTRICAL LTD.,
Dept. C, 538 High Road, Leytonstone, E.11.
Telephone: Wanstead 2722.

AMPLION

TWO-GUINEA

CONE

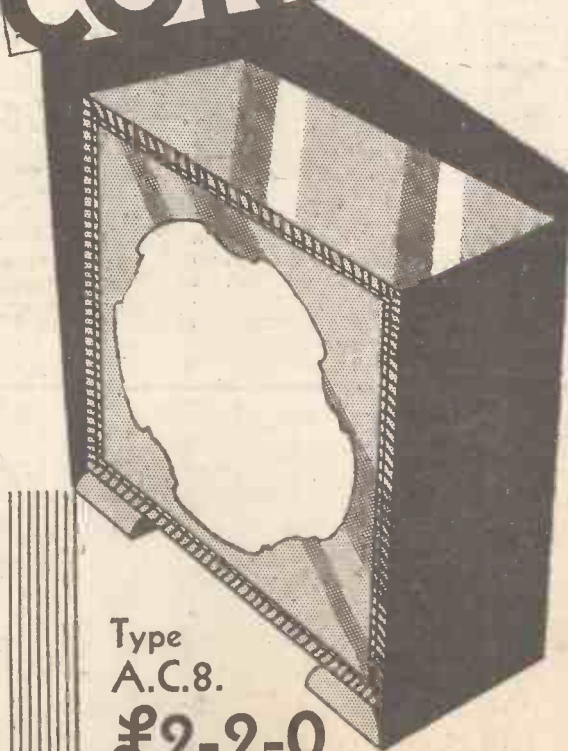

Type
A.C.8.
£2-2-0

One of Amplion's latest models at a really moderate price which brings it within the means of everyone. This sturdy little cone speaker is supplied in a neat cabinet of original design, with an attractive shaded finish. It is capable of giving really excellent reproduction, together with very considerable volume. Size of cabinet $12\frac{3}{4}$ " wide x $13\frac{1}{2}$ " high x $6\frac{5}{8}$ " deep.

Catalogues from Graham Amplion Ltd., 26 Savile Row, London, W.1.

AMPLION

royds

You will Help Yourself and Help Us by Mentioning "A.W." to Advertisers

OUR INFORMATION BUREAU

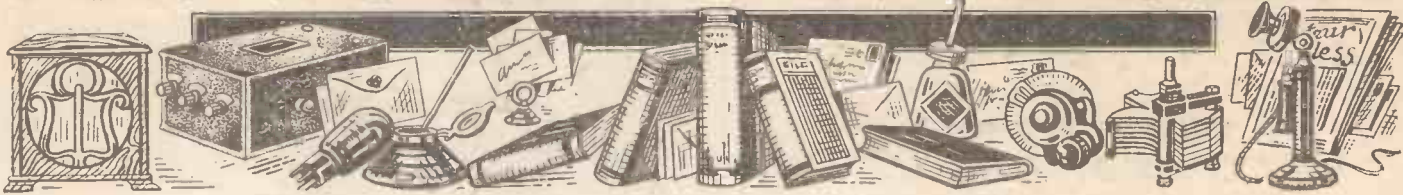

RULES.—Please write distinctly and keep to the point. We reply promptly by post. Please give all necessary details. Ask one question at a time to ensure a prompt reply, and please put sketches, layouts, diagrams, etc., on separate sheets containing your name and address. See announcement below. Address Queries—AMATEUR WIRELESS Information Bureau, 58/61 Fetter Lane, London, E.C.4

Building Portables

Q.—I have now built three portable sets of different design and none seem to come up to the standard as described by the designer. In each case I have used best-quality components, although, I must admit, I have not adhered strictly to the make of component in every case. Why is it that portables do not seem to give the results that one is led to expect?—D. F. (Worcester).

A.—From a glance at the map it appears that you are in rather a poor position for reception with a portable set. You are probably restricted to reception from the Daventry stations in your locality. Apart from this, however, it is very important in the construction of a portable set that you use the actual components as specified by the designer. Take, for instance, an L.F. transformer. With a certain current flowing through its primary there is a certain magnetic and electro-static field set up around that transformer. The designer, in arranging other components around this transformer, considered this magnetic field and its effect on other parts of the set and made suitable allowances. If another transformer is

substituted, the magnetic and electro-static fields differ and interaction possibly takes

When Asking Technical Queries

PLEASE write briefly

A fee of One Shilling (postal order or postage stamps) must accompany each question and also a stamped addressed envelope and the coupon which will be found on the last page. Rough sketches and circuit diagrams can be provided for the usual query fee. Any drawings submitted should be sent on a separate sheet of paper. Wiring plans and layouts cannot be supplied. Queries cannot be answered personally or by telephone.

place. In any case the balance of the receiver is undoubtedly spoilt and reception suffers

accordingly. When building a portable set from a proved design, use only the components specified by the designer, and follow the design exactly.—A. C.

"Everybody's Three"

Q.—I have made up the "Everybody's Three" receiver and, whilst I am very satisfied with results on the long waves, I cannot get any station but the locals on the medium waves. Tuning seems to be sharp on the aerial condenser and anywhere on the H.F. condenser. What is more, the volume is rather poor on the local stations. Can you suggest what might be wrong?—K. L. (Middlesex).

A.—From the details you submit it seems that the primary or reaction winding (medium wave) of the H.F. coil is broken. You are advised to test through the coil with a flash-lamp and battery, for continuity, keeping the wave-change switch to the medium-wave position. If you find that one of the windings is defective, return the coil to the makers with your report. The testing unit described elsewhere in this issue will enable you easily to trace such faults.—A. C.

MAKE YOUR SET—
 ANY SET,
 EVEN A
 PORTABLE

ALL-ELECTRIC
 WITH
REGENTONE
 —the surest way

MAKE SURE YOU GET THIS BOOKLET

— it's **FREE**

—from your Dealer—or in case of difficulty, write direct to the Manufacturers



REGENT RADIO SUPPLY CO.,
 21 Bartlett's Buildings, Holborn Circus,
 LONDON, E.C.4

Telephone: Central 8745 (3 lines)

PUT IT THERE!



NEW BENJAMIN LINE
Supplied complete with indicating knob and dial with or without terminals. Prices 7/8 each with, and 1/6 each without terminals



When the circuit calls for a plain "on"- "off" contact, there is no need to look further than the Benjamin new rotary switch.

It is compact and simple in construction, has self-cleaning contacts due to the action of the ball when the switch is turned, all soldering tags are in one piece with the contacts, and the spindle is thoroughly insulated, enabling it to be used with metal panels, without separate insulating washers. It will also be found very useful for wave-changing and radio-gramophones. This switch can be used for panels from $\frac{1}{16}$ " to $\frac{1}{8}$ " in thickness.

BENJAMIN

The Circuit

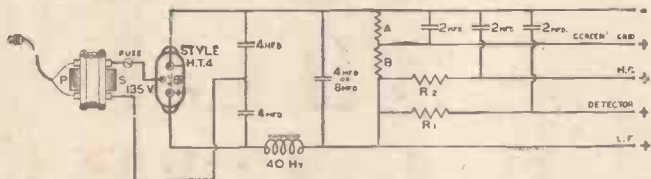

for a high-tension eliminator

which will give 30 milliamps at 180 volts, or 50 milliamps at 150 volts, with full-wave rectification.

It is built up round the

WESTINGHOUSE METAL RECTIFIER STYLE H.T.4

which has been specially designed to obtain full benefit from the valuable "voltage doubler" principle.

The price of this rectifier is only 37/6

Full details of this and other circuits are given in our new 32-page book, "The All-Metal Way, 1930." Send 2d. stamp for a copy to:—

The Westinghouse Brake & Saxby Signal Co., Ltd., 82 York Road, London, N.1.

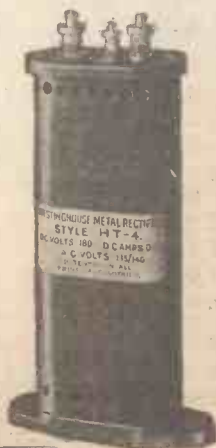

TESTS OF TIME

Built by ..

... Sir Christopher Wren in 1671 — 259 years ago, the Monument certainly has stood the test of time. T.C.C. "the condenser in the green case," too, has stood the test of time — and come through with flying colours.

The Telegraph Condenser Co. have been making condensers for a quarter of a century — so, remember, run no risks when choosing the condensers for your Set, follow the experts' lead: choose T.C.C. the guaranteed condenser and know that you are getting dependability.

Every good Wireless Dealer sells them!

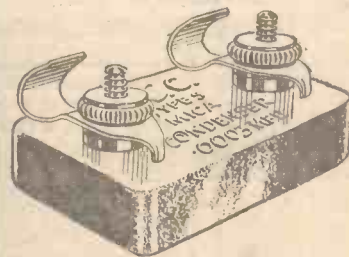

The condenser illustrated is the .0003 mfd. T.C.C. flat mica type 1/3d.

THE MONUMENT

ADVERT. OF THE TELEGRAPH CONDENSER CO. LTD., N. ALTON. W.3.

5648

Don't Forget to Say That You Saw it in "A.W."



AMAZING DELICACY OF TOUCH

That records exact rendering, without scratch, with perfect balance of tone and volume.

Any good record reproduced through the **Wates Pick-up** loses nothing! The perfect balance and exact weight scientifically calculated to exert the correct pressure upon the delicate indentations in the grooves, reproduces all those subtle gradations of tone without which music loses most of its charm.

Actual side-by-side test with other instruments immediately reveals the beautiful quality of reproduction on which the **Wates Pick-up** has earned its popularity amongst music lovers.

Ask your dealer to let you hear it, then try out your favourite records at home. The difference will astonish you. Obtainable from all good-class dealers, or write direct for illustrated literature describing this perfected instrument.

Wates Star Pick-up, oxydised copper finish, complete with adapter to fit any type of tone arm 21/-

Wates Pick-up Arm, finish to match pick-up 7/6



THE STANDARD BATTERY CO.
(Dept. A.W.), 184-188 SHAFTESBURY AVENUE, LONDON, W.C.2

M.B.

TANNOY MAINS UNITS

NEED NO ATTENTION
MORE VOLUME
GREATER SELECTIVITY
CHEAPER THAN DRY BATTERIES
H.T. from £2 17 6
L.T. " £1 19 6
TANNOY PRODUCTS
1-7 DALTON ST.
S.E.27

LET "A.W." SOLVE YOUR WIRELESS PROBLEMS

MORE RADIOGRAMS

PARLIAMENT has resolved to terminate as from January, 1932, the contract with the Great Northern Telegraph Company for cable connection between Iceland and the Shetland Islands. Wireless communication will be used in place.

Gerald Buckley, the announcer at WMBC (Detroit), was shot and killed by unidentified assailants recently in the lobby of his hotel. In talks given from WMBC he made specific references to various alleged gambling resorts, and he had been known to receive threatening letters and telephone messages.

Having contracted with the Telefunken Company for the erection of one of the highest powered broadcasting stations in the world at Nanking, the Chinese Government is sending a group of Chinese engineers on an inspection tour of the German

WE ARE EXHIBITING AT



THE NATIONAL RADIO EXHIBITION OLYMPIA (1930) SEPT 19th-27th 1930

Broadcasting Company's services. The new station is expected to cover the whole area of the Chinese Republic as well as surrounding countries.

Roumania is reported to be combating alleged propaganda from Moscow's new broadcasting station by broadcasting an interfering signal on the same wavelength, which ruins the Moscow broadcasts. Germany is now considering doing the same thing when Moscow broadcasts in German, for the Soviet Government has refused to listen to protests from Germany.

In an effort to determine the most popular time of the week for radio reception, the General Electric Company in America is sending a questionnaire to shareholders in the company. While the questions relate essentially to the company's programme, it is hoped to determine not only the best time of the week for broadcasting, but to find out what type of programme listeners enjoy.

Eight modern wireless stations now serve Iceland, and a new 15,000-watt long-wave Marconi transmitter is now being built near Reykjavik to communicate with the United States and other countries.



LATEST & GREATEST IN CONE SPEAKERS!

The new LOEWE RADIO model EB 85—Radio's greatest advance in Cone Speaker manufacture. Price £2/- complete. Unit only, 12/- Unit and Chassis, 16/3.

Full details from

THE LOEWE RADIO CO., LTD.,
4, Fountayne Road, Tottenham, N.15.
Phone: Tottenham 3911/2.



EASY TERMS

We specialize in the supply of all good quality Radio Sets and components on easy terms. We will give you efficient and prompt service. A few examples below:—

NEW COSSOR EMPIRE MELODY MAKER.

Complete kit of parts including valves and cabinet. Cash price, £6 : 17 : 6 or 10/- with order and 11 monthly payments of 12/6.

EKCO A.C. ELIMINATOR

Model 1, V20. Cash price, £4 : 12 : 6 or 8/- with order and 11 monthly payments of 8/6.

12 EXIDE WH UNITS

(120 V. 5,000 MA) Cash price £3 : 15 : 0 or 5/6 with order and 11 monthly payments of 7/-.

NEW BLUE SPOT 66R UNIT

with large cone chassis. Cash price, £2 : 10 : 0 or 5/- with order and 10 monthly payments of 5/-.

Send us your enquiry and a quotation will be sent by return.

LONDON RADIO SUPPLY COMPANY,
11, Oat Lane, Noble Street,
Phone: National 1977. LONDON, E.C.2

RAYMOND'S

27 & 28a, LISLE ST., LONDON, W.C.2
 Come to LEICESTER SQUARE TUBE STN.
 This address is at the back of Daly's Theatre
 NOTE.—NEW 'PHONE NUMBER—GERRARD 2821

BRITAIN'S 1930 FAVOURITE THREE SET
 Complete Kit of parts using alternative components,
 Packed and sent
 Carr. Paid, with **£3.12.6**
 Blueprint, for ...

THE STRAIGHT THREE
 A Complete Kit of Parts with Blueprint, 2 L.F.
 Trans., Dual Range Coil, 3 Marconi V.H., '0003 and
 2 meg. Leak, '0001, good make H.F. Choke, '0005
 and '0003 Var. Con., 2 Slow Motion Dials, Pol. Panel
 14 by 7, Set Leads, Oak Cabinet, Wire, Screws.
 Usually 70/- Special Reduced Price
 until August 30th. ... **35/-**
 Packing and Carriage 3/- extra.

THE SEARCHER TWO
 A complete Kit of Parts, comprising Ebonite Panel,
 Baseboard, Panel Brackets, '0005 Formo, '00034
 Lotus, Benjamin Switch, Lissen D.P.D.T., Formo
 Dial, 2 Lotus V.H., Telsen New Type Radiogrand,
 '0002 and '0001 T.C.C., Formodenser, 1-meg. G.L.,
 Strips, Plugs, Terminals, Wire,
 etc., 2 Wearite Formers, and **£2.12.6**
 Wire. Complete for ...
 Carriage 3/- extra.

NEW TYPE TELSEN
L.F. TRANSFORMER
 Ace, 3-1 ... 8/6
 Ace, 5-1 ... 8/6
 Grand, 5-1 ... 12/6
 Grand, 3-1 ... 12/6
 Post Free.

SPECIAL FOR
CALLERS ONLY
 H. T., 60 v., 3/11;
 100 v., 6/11. S.M. Dials,
 1/9. '0005 S.L.F., 2/9.
 7/22 Aerial, 1/9. 2 mid.,
 2/- 4 mfd., 3/6. D.R.
 Coils, 4/11, and thou-
 sand other lines.

IMPORTANT. All letters and communications must be addressed to
K. RAYMOND, LTD.
 27 & 28a LISLE STREET, LONDON, W.C.2
 The name of the street is not sufficient.

Just as most towns in the civilised states possess free book libraries, so the city of Cologne has now placed at the disposal of the public a collection of gramophone records. This novel library allows householders to borrow gramophone records at the cost of, roughly, twopence for four days.

Reports that experimental television stations in the United States are selling time in the same fashion as broadcasting stations are being investigated by the Department of Commerce upon request of the Federal Radio Commission. Television licences are issued only for test purposes.

"Amateur Wireless and Radiovision." Price Threepence. Published on Thursdays and bearing the date of Saturday immediately following. Post free to any part of the world: 3 months, 4s. 6d.; 6 months, 8s. 9d.; 12 months, 17s. 6d. Postal Orders, Post Office Orders, or Cheques should be made payable to "Bernard Jones Publications, Ltd."
 General Correspondence is to be brief and written on one side of the paper only. All sketches and drawings to be on separate sheets. Contributions are always welcome, will be promptly considered, and if used will be paid for. Queries should be addressed to the Editor, and the conditions printed at the head of "Our Information Bureau" should be closely observed. Communications should be addressed, according to their nature, to The Editor, The Advertisement Manager, or The Publisher, "Amateur Wireless," 58-61 Fetter Lane, London, E.C.4.

READ THIS:—

"There is everything in favour of buying a complete kit of parts and nothing against it. You get all the little items, such as screws, etc., and your panel is neatly drilled for you. Moreover, you are certain that every component is suitable for the set—that is if you purchase an approved kit such as is sold by Ready Radio."
 vide "Popular Wireless."

KITS OF PARTS

SEARCHER TWO
 CONTINENTAL PORTABLE
 THE CAR THREE
 MAXIMUM FOUR
 1930 TALISMAN TWO
 ETC., ETC.

Cash or Easy Terms. Lists on Application

Ready Radio

159 BOROUGH HIGH STREET,
 LONDON BRIDGE, LONDON, S.E.1
 'Phone: HOP 5555 (Private Exchange)

FOR ... ELECTRIC REPRODUCTION

USE A LIMIT

Adjustable
 Length Tracking
 Angle
 Spring Tension

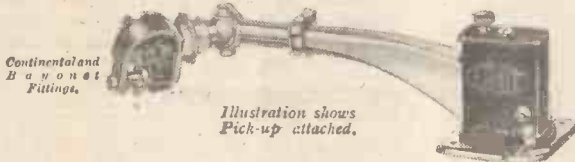

Illustration shows
 Pick-up attached.

PICK-UP ARM 15/6
 Obtainable through all factors and dealers
 or write **EACH**

LIMIT RADIO LIMITED, ALBION ST., LONDON, N.1

IMMENSE SUCCESS

ATTAINED BY

THE "SKIWAL"
AERIAL HOLDER
WHY? ... BECAUSE IT
IS THE MOST

EFFICIENT METHOD OF FIX-
ING OUTDOOR AERIALS.

Attach aerial to insulator shown. Raise Holder with a lifting rod to top of pole. Then pull aerial tight at other end and secure in usual way.

Tested and approved by
 "A.W."

Of all Wireless Dealers, or direct
 from:—

SKIWAL MANUFACTURING CO.,
 32, ELM ROAD, LEIGH-ON-SEA.



Patent applied for.

NO ROPES TO ROT.
NO WIRES TO RUST.
NO LADDER TO CLIMB.
NO POLE TO TAKE DOWN.
NEVER FALLS.
NEVER FAILS. **2/6**

POST
 FREE.

Lifting Rods: 24ft. 2/-;
 28ft. 2/4; 30ft. 2/6.

Trade Enquiries Invited.

"The Shielded Four-Electrode Valve"

Theory and Practice.
 With Numerous Circuits.

By CAPT. H. J. ROUND, M.I.E.E.

Get a copy from any
 Bookseller or Bookstall, 2/6

Cut this out!
 Send CAMCO'S 24 page
 catalogue

NAME
 ADDRESS

To CARRINGTON MANUFACTURING CO. LTD
 24, HATTON GARDEN LONDON, E.C.1 Tel. Ho. 6293

for **Cabinets!**

13'6 DOWN

THE COSSOR EMPIRE KIT

Exactly as specified. Balance in 11 monthly payments of 13/6. CASH PRICE £6:17:6

ALL OTHER COSSOR SETS AT ON PROPORTIONATELY EQUAL EASY TERMS.

NEW OSRAM MUSIC MAGNET 4

23/6 with order. 12 monthly payments of 18/6. CASH PRICE £11:15:0. Exactly as specified.

THE FIRST HOUSE TO SPECIALISE IN RADIO—THE EASY WAY

New Times Sales Co.

77, CITY ROAD, LONDON, E.C.1
62, HIGH HOLBORN, LONDON, W.C.1

"ELIMINATING ELIMINATOR TROUBLES"

(Continued from page 194)

is not in connection with the previous stage in the set. One has thus a good opportunity for discovering if it is the coupler or the speaker which is picking up the stray A.C. currents from the mains circuits.

Some designers have suggested that to rid a set of mains hum the grid and anode circuit wiring should be carried out with thin lead-covered cable. It is not easy to get cable so thin as to be easily workable in wiring the average set, but there is no reason why the speaker output wires, at least, should not be of the smallest diameter lead-covered cable obtainable.

A common trouble is that often what is supposed to be mains hum is actually L.F. oscillation, and this same trouble would be experienced with battery drive if the H.T. voltage were increased. Many set owners are free from trouble of this kind when they are working with only 120 volts from a dry battery, but when the full 180 volts from an eliminator is applied then a ripple is caused which is erroneously put down to the mains.

The cure for this, of course, is the fitting of de-couplers in at least one of the L.F. circuits, and sometimes in the H.F. circuit, particularly if this is a screen-grid valve.

DX THE STANDARD PLUG-IN COIL
Sold everywhere from 1/-
DX COILS Ltd, London, E.8

FULL-SIZE BLUEPRINTS

When ordering, please send Postal Order, NOT STAMPS

CRYSTAL SETS (6d. each)		
B.B.C. Brookman's Park Set	..	AW206
Regional Crystal Set	..	WM176
ONE-VALVE SETS (1s. each)		
B.B.C. Official One	..	AW208
Hartley Single-valver	..	WM198
TWO-VALVE SETS (1s. each)		
Talisman Two (D, Trans)	..	AW194
Wavelets Two (D, Trans)	..	AW229
No-battery A.C. Mains Two (D, Trans)	..	AW230
No-battery Gramo-radio 2 (D, Trans)	..	AW238
1930 Talisman 2 (D, Trans)	..	AW239
Easy Tune Short-wave 2 (D, Trans)	..	AW242
Searcher Two (D, Trans)	..	AW245
Brookman's Two (D, Trans)	..	WM168
New Crusader (D, Trans)	..	WM182
Radio-Record Two (SG, D)	..	WM187
Gleaner Two (D, Trans)	..	WM201
Music Monitor (D, Trans)	..	WM208

THREE-VALVE SETS (1s. each)		
All-wave High-mag. Three (D, 2 Trans)	..	AW199
Knife-edge Three (D, RC, Trans)	..	AW201
Talisman Two-three (D, RC, Trans)	..	AW203A
Wide World Short-wave Three (HF, D, Trans)	..	AW207
Everybody's Three (SG, D, Trans)	..	AW209
1930 Ether Searcher (SG, D, Trans)	..	AW211
New All-Britain Three (HF, D, Trans)	..	AW214
Best-by-Ballot Three (SG, D, Trans) Price 4d. free with copy of "A.W."	..	AW217
Brookman's By-pass Three (D, 2 Trans)	..	AW220
Everybody's All-electric Three (SG, D, Trans) —A.C.	..	AW221
1930 Clarion Three (SG, D, Trans)	..	AW223
Beginner's Regional Three (D, 2LF)	..	AW232
Britain's Favourite Three 1930 (D, 2 Trans)	..	AW243
Car Three (D, RC, Trans)	..	AW244
Standard Coil Three (HF, D, Trans)	..	WM117
Brookman's Three (SG, D, Trans)	..	WM161
Community Three (D, RC, Trans)	..	WM164
Brookman's Push-Pull Three (SG, D, Trans) 1/6	..	WM170
All-nations Three (D, 2 Trans)	..	WM178
Inceptordyne (SG, D, Pentode)	..	WM179
Brookman's A.C. Three (SG, D, Trans) 1/6	..	WM184
Music Marshal (D, 2 Trans)	..	WM190
Gramo-Radio D.C. Three (SG, D, Trans)	..	WM196
Concert Three (D, 2 Trans)	..	WM199
New Lodestone Three (HF, D, Trans)	..	WM205
De-Luxe Three (D, RC, Trans)	..	WM209

FOUR-VALVE SETS (1s. 6d. each)		
Clarion All-electric Three (SG, D, Trans) —A.C. Rectifier	..	AW200
Music-Lover's Gramo-radio (SG, D, RC, Trans) —1s. 6d.	..	AW202A
Music-Lover's Gramo-radio (Loud-speaker) 1s.	..	AW202B
Horizon Four (SG, D, 2 Trans)	..	AW237
1930 Monodial (2SG, D, Trans)	..	WM158
Electric Four (All A.C. —SG, D, RC, Trans)	..	WM162
Brookman's Four (2SG, D, Trans)	..	WM174
Transportable Four (SG, D, 2 RC)	..	WM180
Super Q (SG, D, 2 Trans)	..	WM189
Lodestone Four (HF, D, RC, Trans)	..	WM193
Searcher's Four (SG, D, RC, Trans)	..	WM194
Invitation Four (SG, D, RC, Trans)	..	WM200

FIVE-VALVE SETS (1s. 6d. each)		
James Quality Five (2SG, D, RC, Trans)	..	AW227
All-wave Lodestone Five (HF, D, RC, Push-pull)	..	WM146
1930 Five (HF, D, RC, Trans)	..	WM171
Dual-screen Five (2SG, D, RC, Trans)	..	WM185
Radio-Record Five (SG, D, Trans-parallel)	..	WM188
Overseas Five (3SG, D, Trans)	..	WM191

AMPLIFIERS (1s. each)		
"A.W." Gramophone Amplifier	..	AW205
Brookman's Separator (HF Unit)	..	AW212
Two-valve Amplifier	..	AW216
"Mag" Gramo Unit	..	AW224
Radio-Record Amplifier (DC Mains)	..	WM183
Selecto Amplifier (HF, Unit)	..	WM210

MISCELLANEOUS (1s. each)		
Short-wave Adaptor (1 v.)	..	AW183
Simplest H.T. Unit	..	AW197
By-pass Unit (Wavetrap) with copy "A.W."—4d.	..	AW218
"Twin" Brookman's By-pass (6d.)	..	AW222
"A.W." Paper Loud-speaker	..	AW231
James H. T. and L. T. Charging Unit	..	AW232
Simplest H.T. Eliminator for D.C. Mains	..	AW234
Simplest H.T. Eliminator for A.C. Mains	..	AW236
Choke Output Unit	..	AW240
Simple Tester Unit (6d.)	..	AW246
A.C. Mains Amplifier	..	WM149
H.T. Unit for A.C. Mains	..	WM159
"W.M." Linen-diaphragm	..	WM172
Brookman's "Wipe-outs"	..	WM186
Short-wave adaptor for Overseas Five	..	WM192
Stamator Unit for A.C. Mains	..	WM202
Universal Push-pull Amplifier	..	WM204
Outspan Short-wave Adaptor	..	WM207

PORTABLE SETS		
Music Leader (SG, D, RC, Trans) with copy "A.W."	..	AW203 -/4
Sunshine Three (SG, HF, SG, D, Trans)	..	AW235 1/-
Continental Portable (SG, D, Trans)	..	AW241 1/-
Pedlar Portable Two (D, Trans)	..	WM195 1/-
Pedlar Portable Three (D, 2 Trans)	..	WM197 1/-
James Portable SG3 (SG, D, Trans)	..	WM203 1/-
Foursome Portable (SG, D, 2 Trans)	..	WM206 1/-
Copies of the "Wireless Magazine" and of "Amateur Wireless" containing descriptions of any of these sets can be obtained at 1s. 3d. and 4d. respectively, post free. Index letters "A.W." refer to "Amateur Wireless" sets and "W.M." to "Wireless Magazine" sets.		

AMATEUR WIRELESS 58-61 FETTER LANE LONDON, E.C.4

PREPAID ADVERTISEMENTS

Advertisements under this head are charged **THREEPENCE PER WORD**, minimum charge **THREE SHILLINGS DEPOSIT SYSTEM**

As the Publishers cannot accept responsibility for the bona fides of advertisers in this publication, they have introduced a system of deposit which it is recommended should be adopted by readers when dealing with persons with whom they are unacquainted. It is here explained.

Intending purchasers should forward to the Publishers the amount of the purchase money of the article advertised. This will be acknowledged to both the Depositor and the Vendor, whose names and addresses must necessarily be given. The deposit is retained until advice is received of the completion of the purchase, or of the article having been returned to and accepted by the Vendor. In addition to the amount of the Deposit, a Fee of 6d. for sums of £1 and under, and 1s. for amounts in excess of £1, to cover postage etc., must be remitted at the same time. In cases of persons not resident within the United Kingdom double fees are charged.

The amount of the Deposit and Fee must be remitted by Postal Order or Registered Letter (Cheques cannot be accepted), addressed to

"AMATEUR WIRELESS" ADVERTISEMENT DEPARTMENT 58/61 FETTER LANE, LONDON, E.C.4

YOUTHS REQUIRED age 14—20. Apply W.T. Works, 87a Collingwood Road, Sutton, Surrey.

COMPLETE KITS—All Circuits. C.O.D. or Terms—R.I.B., 33 Maroon Street, London, E.1.

ENGINEERS—novice or expert—£300, £400, £500 per year or more is within your grasp. In our Handbook, "ENGINEERING OPPORTUNITIES" Prof. A. M. Low explains where the good posts abound. This handbook has shown the way to better things to over 20,000 of your fellows. It contains details of A.M.I.Mech.E., A.M.I.E.E., A.M.I.C.E., A.M.I.A.E., A.M.I.Struc.E., Matric., C. and G., G.P.O., etc. Examinations, outlines home study Courses in all branches of Electrical, Mechanical, Motor and Wireless Engineering and shows the unique advantages of our Appointments Department. Why stay in the "Hammer and File Brigade"? Send for our free handbook at once, stating Branch, Post or Examination which interests you.—British Institute of Engineering Technology, 109 Shakespear House, 29-31 Oxford Street, London, W.1.

ELECTRICAL CLEARANCE—2-valve transmitting sets, 15/-; Morse transmitting sets, 12/6; 1in. spark coils, 6/-; 2in. spark coils, 17/6; super microphones, 2/6; microphone transformers, 2/6; television motors, electric, 110 or 220v., D.C., 10/-; 3h.p. motors, 110v., 30/-; 50v. 4a. dynamos, 35/-; 20v. 6a., 40/-; 100v., 10a., slow speed, 47/-; portable telephones, 17/6; earphones, 1/3; telephone H.T. generators, 6/6; Morse keys, 3/6; buzzers, 2/6; 1 mfd. condensers, 1/6; hand telephones, 6/-; shunt regulators, 10/- to £1, all sizes; 1,000 ohms chokes, 1/-; magnetic relays, 12/6; P.O. relays, 6/-; Ford ignition coils, 4/-; 3h.p. 220v. motor, shunt wound, 50/-; Mark III Star crystal sets, 40/-; D.III buzzers, platinum contacts, 5/-; Dewar switches, 1/-; 12v. car dynamo, 25/-; 6 or 12v. car starter motors, 12/6; cash with order or c.o.d.; all goods guaranteed; send now, list now ready.—Galpin, Binfield Heath, nr. Henley-on-Thames.

BANKRUPT BARGAINS. To clear 5-valve suitcase portables complete, guaranteed, £5-15-0. Complete kit parts for 3-valver 30/-. Speaker kits 15/-. Three valve sets, complete valves, batteries, speaker 92/6. Any kit. Cheap component list free. Butlin 143B Preston Road, Brighton.

500 4v. VALVES made in Holland. H.T. required only 30-40 volts. 1/6 each. Drury, 29 Kensal Road, W.10.

72 PAGE CATALOGUE

Crammed with illustrations and details of all sorts of fascinating and useful gear, at very reasonable prices.

RADIO ELECTRICAL SCIENTIFIC INSTRUMENTS MOTORS GENERATORS

Just send a stamped envelope.

ELECTRADIX RADIOS, 218, Upper Thames Street, E.C.4

Phone: City 097. Grams: Electradix, Cent, London.

TAYLOR WET H.T. BATTERIES

New Prices: Jars 1/3. Sacs 1/2. Zincs 10d. Sample doz. 18 Volts complete with bands and electrolyte 4/1 post 9d. Sample unit 6d. Illus. booklet free. Bargain list free. AMPLIFIERS, 30/- 3 VALVE ALL-STATION SET 25 A. TAYLOR, 57, Studley Road, Stockwell, LONDON.

REPAIRS

Any make of L.F. Transformer, Loud-speaker or headphones repaired and dispatched within **48 HOURS—TWELVE MONTHS' GUARANTEE** with each repair. 4/- Post Free.

Terms to Trade **TRANSFORMER REPAIR CO.**

"Service" Dept. 214 High Street, Colliers Wood, London, S.W.19

Amateur Wireless COUPON Available until Saturday SEPTEMBER 6, 1930

MYSTERY

**WHAT
ARE
DUBILIERS
DOING?**

*See next weeks
issue of this
Journal*

DUBILIER CONDENSER CO. (1925), LTD., Ducon Works,
Victoria Road, North Acton, London, W.3.

*When buying Valves
-Remember!*



The Lightship at the Nore.

**Trinity House Lightships
and Beacon Stations**

and such authorities as the Metro-
politan Police—Imperial Airways—
Empiradio Beam Wireless—Croydon
Control Tower—the B.B.C.—all

USE

**MARCONI
VALVES**



Please Mention "A.W." When Corresponding with Advertisers

Have you heard these two Remarkable UNITS?



BLUE SPOT 66R

35/-

Until you have heard these two units you have not heard the best reproduction that is possible to-day.

66P is a development of our famous 66K unit. 66R—the Blue Spot Masterpiece—is acknowledged the finest unit that has yet been produced.

BLUE SPOT 66P



27/6

F. A. HUGHES & CO., LIMITED
204-6 Great Portland Street, London, W.1

Distributors for Northern England, Scotland and North Wales:
H. C. RAWSON (Sheffield and London), Ltd., 100 London Road, Sheffield; 22 St. Mary's Parsonage, Manchester.