

AMERICA ON OUR LOUD-SPEAKER TWO!

Amateur Wireless

Every Thursday 3^d
and
Radiovision

Vol. XV, No. 369

Saturday, July 6, 1929

The LOUD-SPEAKER AMERICA 2

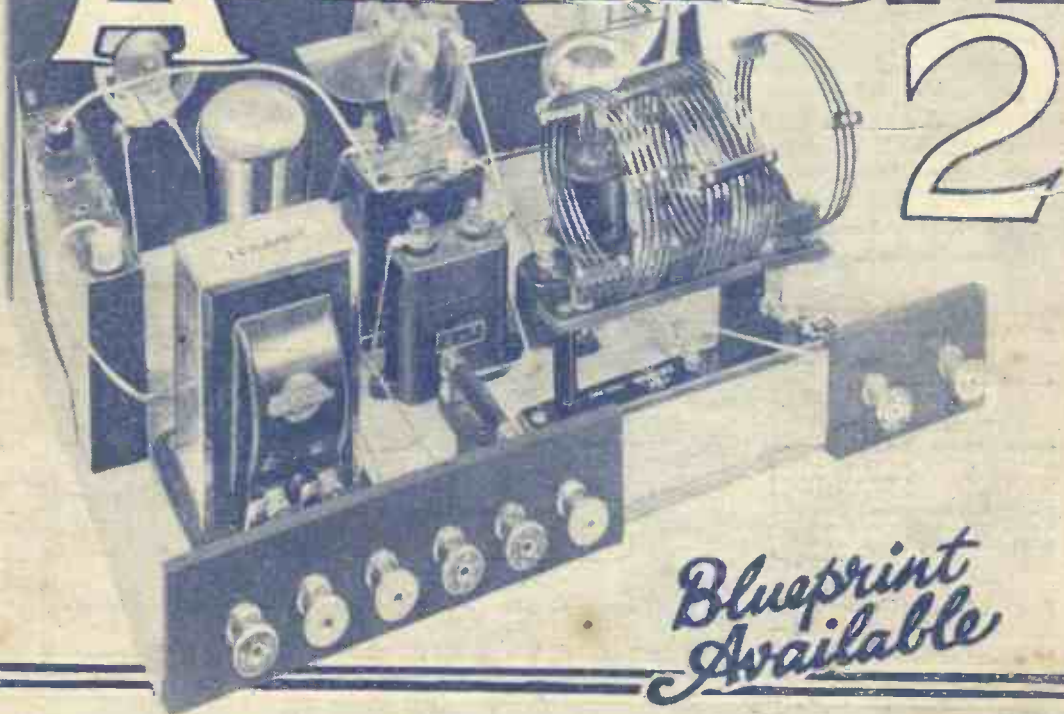

*Blueprint
Available*

FULL CONSTRUCTIONAL DETAILS



**WHY?—
INTERLOCKED
CONSTRUCTION!**

Even the hardest shock cannot upset the wonderful performance of the Cossor Screened Grid Valve. It is built like a bridge, piece-by-piece—all the elements are interlocked—every joint is electrically welded—individual movement is impossible. The hardest blow cannot disturb the perfect alignment of the elements. This wonderful system of Interlocked Construction makes Cossor the world's strongest and most dependable Screened Grid Valve. In any Screened Grid Receiver, use Cossor—there is no substitute for the Cossor system of Interlocked Construction.

Made in three voltages for use with 2, 4 or 6 volt accumulators.

Technical Data.
Cossor 220 S.G. (2 volts, .2 amp.)
410 S.G. (4 volts, .1 amp.)
and 610 S.G. (6 volts, .1 amp.)
Max. Anode Volts—150, Impedance
200,000, Amplification Factor 200,
Grid Bias 1.5 volts at max. anode
volts. Price (any type) **22/6**

Get full details of this wonderful Cossor Valve—write for Leaflet L.10.

**COSSOR
Screened Grid**

**THE ONLY SCREENED GRID VALVE
WITH INTERLOCKED CONSTRUCTION**

A. C. Cossor, Ltd., Highbury Grove, London, N.5.

9337.

Amateur Wireless and Radiovision

The Leading Radio Weekly for the Constructor, Listener and Experimenter

— Editor: BERNARD E. JONES —

Technical Editor: J. H. REYNER, B.Sc., A.M.I.E.E.

Research Consultant: W. JAMES

Assistant Editor: H. CORBISHLEY

Speeches—The Second Tattoo—Marconi's Opinion—Another Loss— Some Battery!—A Loud-speaker Parade—Still Growing

Speeches—In addition to the Prince of Wales's speech at the dinner to Sir Abe and Lady Bailey, on July 8, it is expected that Lord Grey, Sir Austin Chamberlain, and Mr. J. H. Thomas will also be heard by listeners in the relay from the Mansion House. The dinner, of course, is being given to welcome Sir Abe and Lady Bailey on their return from South Africa, and is being given by the Lord Mayor.

The Second Tattoo—The Aldershot tattoo broadcast was undoubtedly a success, and probably 95 per cent. of listeners found their sets in demand on this occasion. The Tidworth tattoo, which ranks next to the Aldershot tattoo, as a spectacular military event, is to be relayed through London on August 3. Make a note of the date.

Marconi's Opinion—Marconi, who has just been created a Marquis by the King of Italy was interviewed recently by the *Sunday Express*. He has much to say about mechanical robots and pilotless aeroplanes, but with wireless he seems to be a little disappointed. He says "Wireless science and technique have made great strides. But they have not reached the standard I anticipated thirty years ago. I expected much more rapid developments." Marconi, of course, still runs his famous yacht, *The Elettra*, and on it conducts many experiments at sea.

Another Loss—The talkie war with the B.B.C. is on several fronts, and a new one is that by which cinemas installing talkie apparatus have to scrap their orchestras. Owing to the installation of talkies at the Rivoli theatre, another regular broadcast of the past two and a half years, namely that of Paul Moulder's Orchestra, is to be discontinued.



War-time radio. The U.S. Signal School recently carried out some field experiments with radio, as a means of communication for army work. A set is here seen being operated during the practices.

originate as from nowhere and turn out to be useless, that one hesitates to cheer at this latest claim. But if there is anything in it then it will be a boon to radio amateurs. A public test is to be carried out on the Gt. Southern Railways in about a month's time. A company has been formed. Mr. Drumm is a science graduate of the National University.

A Loud-speaker Parade—A novel loud-speaker testing arrangement has been installed in the Philips factory. Loud-speakers are carried along on a moving band in a sound-proof room, and for a short distance each makes contact with rods connected to the output of an amplifier. Thus for a few seconds each loud-speaker picks up the tune until the moving band carries the instrument out of circuit. Experts note any defects.

Still Growing—Like Topsy, who "just grewed," the licence figures are increasing. The total number of listeners, according to a census taken at the end of May is 2,760,878. This is an increase of 20,000 over the figure for April. Nobody begrudges the 14,830 free licences issued to blind listeners.

An Epoch-making Speech—Last week some business men in Bush House, London, spoke through an ordinary telephone for twenty minutes, to operators in an aeroplane flying over the State of New Jersey, 3,000 miles away! The plane was flying at 100 m.p.h. at the time. London, Bush House, spoke *via* Rugby by landline, across the Atlantic to Houlton, Houlton to Whippany aerodrome by landline *via* New York, Whippany to the aeroplane by wireless. On the "return journey," the aeroplane was in touch with Bush House through Rocky Point.

Some Battery!—A battery which can store enough energy to drive a train for sixty miles and yet which can be re-charged in six minutes, has been, it is claimed, invented by a Mr. James Drumm, and placed in the control of the Free State Government. So many of these schemes

PRINCIPAL CONTENTS PAGE

Current Topics	1
Broadcasting on 16 Metres	2
Battery Charging from A.C. Mains	3
The Pipe of Peace	4
Are You Troubled with Interference?	5
A Few Portable Set Hints	6
On Your Wavelength	7
Jottings from my Log	9
Grid Leak or Anode Bend?	11
For the Newcomer	12
Without Fear or Favour	13
The "Loud-speaker America 2"	14
"A.W." Tests of Apparatus	18
My Wireless Den	20
Our Information Bureau	23



Broadcasting on 16 Metres!

An Account of the New Huizen Short-wave Broadcasting Station

By KENNETH ULLYETT

PROBABLY one of the first stations you will hear when testing out the "America Short-wave 2," described elsewhere in this issue, is Huizen, the 16.88-metre broadcasting station just opened by Philips in Holland.

In contradistinction to the short-waver at Kootwijk, and our old friend PCJ at Eindhoven, this new PHI (Huizen) station is a proper broadcaster; Kootwijk is a G.P.O. station and Philips' station PCJ is for experimental transmissions only.

In designing Huizen the experience gained by the Philips engineers at PCJ was invaluable; to take just one example, PHI's circuit is similar to that of PCJ, except that in the present case all stages, with the exception of the first two, are arranged in push-pull. In this way it is possible to work with a power as great as 60 kilowatts, and it is claimed that this is the first time on which it has been possible to use such great power on such a short wavelength.

Wavelength Control

Crystal control is, of course, used, and this is followed by ten stages in the oscillator and modulator. The arrangement of the oscillator is as follows. The crystal drives an ordinary Philips receiving valve, and the wavelength is adjusted to be 135 metres. The output of this Philips A415 valve is taken to two 10-watt power valves in push-pull, which act as amplifiers and do not change the frequency. The next three stages are frequency doublers and are screened in a very ingenious manner. The wavelength is first halved to 67.5 metres and again to 33.75 metres; that is, 8,889 kilocycles.

It may interest other transmitters to know that in order to get the frequency doublers working properly, 400 volts are

applied to the plates of the first amplifier and doubler, the 8,889-kilocycle doubler operating with an anode voltage of 2,000.

The seventh stage consists of two 1,500-watt valves connected in push-pull, and this is the final frequency doubling stage. At this point the wavelength is the final one of 16.88 metres, which corresponds to the enormous frequency of 17,778 cycles per second. This frequency doubler is followed by a series of amplifiers to provide the requisite power, and each stage is a separate screened unit. The first consists of two 1,500-watt valves in parallel, with 4,000 volts H.T.; next come

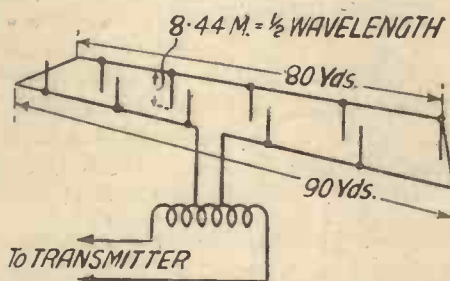

The aerial arrangements at Huizen

two 10-kilowatt valves and, finally, the 60-kilowatt output valve. When the maximum of power is being used these oscillators pass an anode current of 6 amperes! As high a voltage as 12,000 can be applied to the anodes.

All the "juice" is obtained from A.C. mains by means of valve rectifiers; one of the rectifiers is a six-phase job dealing with 14,000 volts.

The control-room is like a small glass cabin in the middle of the station. In this room, by means of a small one-valve receiver and a one-turn frame aerial, the sides of which are 15 in. long, a check is

kept on the modulation of the transmission. By an ingenious remote control system, the six generators in the engine-room can also be regulated from the glass-enclosed operating-room.

The amount of power necessary for driving each portion of the transmitter is considerable. There is, primarily, a large 100-KVA generator for supplying the anode voltage to the final group of valves; a smaller 30-KVA generator supplies the H.T. for the remaining power valves. There are also machines for filament heating and for the provision of grid bias, and also centrifugal pumps for circulating the water in the anode cooling systems.

Huizen boasts an excellently fitted-out studio which is used when the transmissions are not relayed from Amsterdam (which is the general rule), and this is draped in the usual manner.

The Aerial System

The aerial has a strong directional action and is constructed on the beam principle. It is composed of two conductors placed vertically 10 yards apart and about 80 and 90 yards long respectively. There are ten span wires vertically between them, each being 8.44 metres long, corresponding to half the wavelength. The whole aerial is suspended from two iron masts, about 60 yards high. The directional action is at right angles to the plane of the aerial and points towards the Dutch Indies. This directional line passes through Berlin, and it is being proved that the transmitter is heard very well in many parts of Europe and at great distances.

The coming year is to be a great one for Scottish composers. The B.B.C. hopes to be successful in securing a number of performances of their work.

BATTERY CHARGING *from* A.C. MAINS

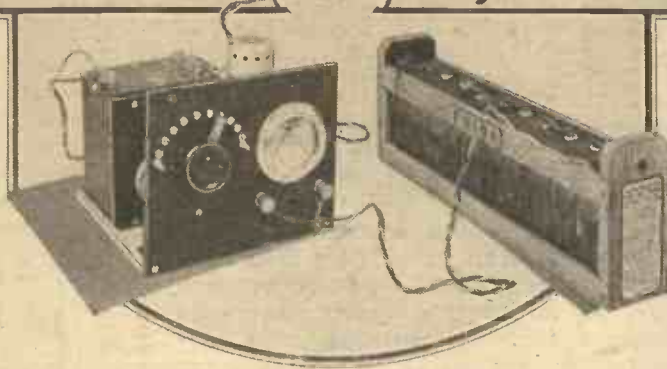

By J. H. REYNER, B.Sc., A.M.I.E.E.

THE difficulty with accumulator high-tension supply is that of charging the accumulator. Although under normal conditions the cells are not discharged for a period of several months, it is necessary to recharge them at definite times, whether they are fully discharged or not, in order to ensure that the cell does not deteriorate. Indeed, in order to obtain the best results, it is desirable to discharge the cells deliberately after a certain period of time and then recharge them again. An accumulator is essentially a device which thrives on work, and the more work it is made to do within reason, the healthier it is.

If alternating current is available, it is possible to construct a charger for the purpose, but here again one is confronted with

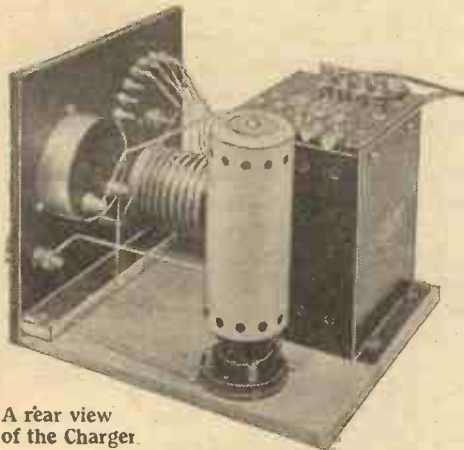

A rear view of the Charger.

a certain amount of difficulty in obtaining sufficient current to charge the battery. The ordinary rectifying valves as used in eliminators which only have to supply some 30 to 50 milliamps D.C. are not adequate for the purpose, for not only would the charging of a battery take a very long time at such a slow rate, but it is somewhat deleterious to the battery itself, and it will usually be found that the makers recommend a charging rate of at least 100 milliamperes (.1 amp.).

The charger about to be described has been constructed to enable batteries up to 120 volts H.T. to be charged at the correct rate of 100 milliamperes. For this purpose no valves at all are employed, but one of the new Igranic-Elkon rectifiers is utilised. This particular rectifier is known as the E.B.H. type, and is capable of handling 15 to 16 watts. From this figure the safe output in D.C. milliamperes can easily be cal-

culated at any given voltage. For example, if we wish to charge 120 volts, then we shall require about 150 volts output from the charger, and this at 100 milliamps represents 15 watts. If batteries of a lower voltage than this are to be charged, the difference in voltage must be made up by a series resistance which is inserted between the charger and the battery, as shown in the circuit diagram (Fig. 1), which indicates the arrangement used.

Batteries of a higher voltage may be charged up to about 200 volts, but in this case the current taken must not be allowed to exceed about 80 milliamps, thus keeping within the limit of the 16 watts already referred to.

Simple Construction

The rectifier has been constructed entirely from standard components, with the exception of the resistance for breaking down the voltage, which is a home-made item. The transformer used is a standard Igranic power transformer, which gives 250 plus 250 volts A.C. output, the primary winding being designed to suit the mains voltage. This particular transformer also has a winding of 4 volts for heating the filament of a rectifying valve, and the high-tension winding of 250 plus 250 volts is rated to carry 75 milliamps. Actually, however, since we are not using the 4 volts filament-heating winding, we can overload the high-tension winding to a small extent with perfect safety, and a prolonged duration test on apparatus described herewith shows that there is no undue rise in the temperature of the components due to the overloading in this particular instance.

The E.B.H. rectifier is a double-wave rectifier arranged in an exactly similar

manner to the standard double-anode rectifying valve of to-day. It is therefore connected in circuit in much the same manner. The outers of the secondary winding are connected across the filament pins of the rectifier. The centre point of the secondary winding becomes the negative pole of the rectified supply, while the positive pole is taken from the plate pin of the rectifier. No smoothing is required, since the apparatus has only to

provide unidirectional currents, and fluctuations in the instantaneous value of this do not concern us.

A moving-coil milliammeter is inserted in the supply lead to show the current at which the accumulator is being charged. It is important to note that this meter must be of the moving-coil type if the correct indication is to be obtained. If a moving iron or a square-law instrument is employed, the fluctuating currents will affect the reading, and the indication obtained will not be the true average current, as will be the case with a moving-coil meter. This point is often overlooked in battery charging equipment, but the discrepancy may be as much as 30 per cent.

Components Required

The components required for the apparatus are:—

- Igranic V208 transformer.
- Igranic-Elkon, type E.B.H. rectifier.
- American valve socket for ditto (Na-ald).
- Moving-coil milliammeter, 0-100 milliamps (Sifam).
- Ebonite panel, 7 in. by 6 in.
- Baseboard, 7 in. by 7½ in.
- Switch arm, with 10 studs and 2 stops.
- Paxolin former, 2 in. diameter 3 in. long,

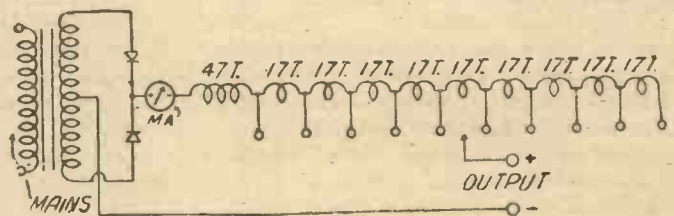

Fig. 1.—The Circuit Diagram

wound with 40-gauge enamelled Eureka wire. The first tap is taken at 47 turns and the remaining nine at every 17 turns.

The construction of the apparatus is straightforward, this being merely an assembly of the different components. The only point which requires any comment is

the matter of making up the resistance.

Take the Paxolin former and first of all drill a number of holes at the various points shown in the diagram. Now wind on a length of enamel-covered Eureka wire as also shown on the diagram.

Having wound up this resistance, it is mounted on the back of the panel as shown and the various tapping points are wired up to the contacts of the first switch on the

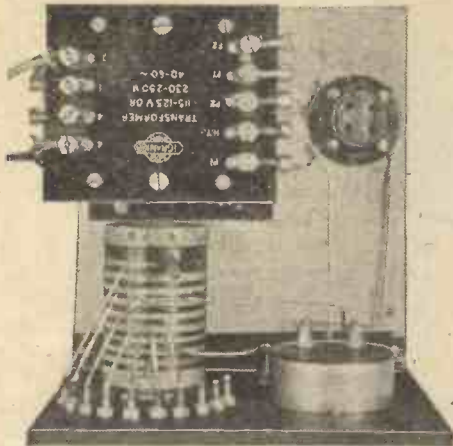

A plan view of the charger

panel. A hole is next cut in the panel for the moving-coil milliammeter, which is then screwed up and wired in circuit.

The remaining components are then placed on the baseboard in the position shown in the photographs and blueprint, and the whole wiring may be completed.

Operation

The operation of the charger is simple

and straightforward. The battery to be charged is connected to the output terminals, the positive terminal of the battery going to the positive terminal of the output. The resistance should then be set at its maximum position; that is to say, with the switch out to the extreme right-hand stud looking from the front of the panel. The adaptor may then be plugged into a suitable electric-light socket and the current switched on. The meter will give a small reading which may be increased to the desired value by reducing the resistance in the circuit by means of the plug and switch.

No further attention is necessary. The instrument may be left on circuit until the accumulator has been fully charged, which may be gauged by any of the usual methods, such as the measurement of voltage, measurement of specific gravity of the acid or both. As a general indication of the duration of a charge, the following rule may be useful.

Take the milliampere-hour capacity of the battery. Divide this by the milliamperes at which the battery is being charged. Add 10 per cent. to the figure thus obtained. This will give approximately the duration of the charge. For example, a battery of 2,000 milliampere-hours capacity being charged at 100 milliamperes should be charged at 20 plus 10 per cent.—equals 22 hours. No serious harm will be done if the battery is left on for 24 hours; that is to say, it may be switched on one night and switched off again the next night at the same time.

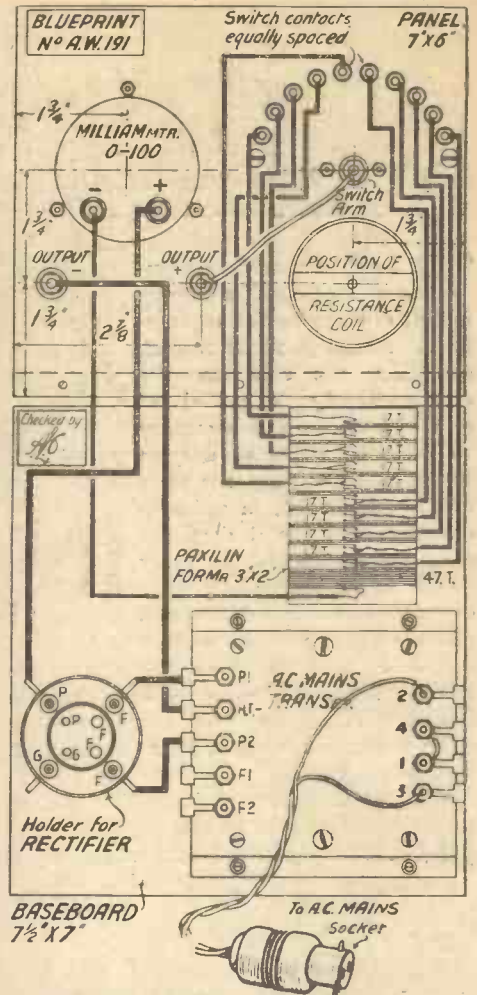

The wiring diagram. Blueprint available, price 9d.

THE PIPE OF PEACE

"LET'S have a moonlight picnic," suggested Lavender.

"Let's," I agreed.

"We'll take cold chicken, lobster mayonnaise, salade, tongue, meringues——"

But I said: "No!" I've been on those sort of picnics with her before. By the time everything is cooked and packed she is all hot, bothered, and peevish, and when we unpack, all the things seem to have got sort of mixed up.

"No!" I said again. It sounds more masterful said twice like that. "You leave the catering to me. I'm not going to sup off mayonnaise of meringue, methylated of lobster, or *compote de fromage*. I'm going to get all sorts of nice things in tins!"

"My dear George!" she snorted. "They're awful muck."

I fetched a catalogue and read out a few samples, and she relented.

"Anyhow, you're certain to forget something," she said.

"There'll be nothing forgotten this trip," I boasted.

"Bet you there is," she snapped.

"Right," I agreed. "The best supper at any hotel you like?"

It was a bet and I got busy.

It was a glorious evening when we packed our tins, together with the portable wireless set into the car.

"Now, look here," said Lavender. "I don't want to take advantage of your young inexperience. No man can possibly arrange a picnic. Sure you've got your pipe? You'll be a perfect misery without that."

"Rather!" I laughed, slapping my pocket. "None of your foul fags for me."

We unpacked in a nicely sequestered dell, miles away from anywhere and gazed hungrily at our pretty tins all laid out in a neat row.

"Just switch on, dear, before we begin," she said. "I hope there is something soothing from Daventry. I'm simply ravenous."

I switched on.

"G-r-r—Brmph—Cluck—Glug—" began the thing. "This is Daventry calling. Our Topical Talk this evening will be by Miss Ida Bounce. She is going to tell you what not to forget when arranging a picnic."

"Whoops!" shouted Lavender. "Now then, sit up and take notice."

The usual complacent tones adopted by

the female of the broadcasting species rent the air.

"I am not going to refer to such obvious things as corkscrews and tin-openers——" she began.

"By the way," I interrupted. "Where did you put the tin-opener?"

"Tin-opener?" said Lavender. "Haven't seen it. Don't mean to say you've forgotten an obvious thing like that?"

"Of course not," I replied. "I distinctly remember putting it out. I expect it's in the basket, or in the car."

But it wasn't, and all my assertions that I remembered putting it somewhere were only greeted with derisive yells. I re-packed the things in silent dignity and drove furiously to the nearest town.

I was feeling slightly more human after we had finished an excellent supper at the hotel and were drinking coffee in the garden.

"Just time to smoke a pipe of peace before we start home," I announced, feeling in my pocket for my pipe.

I didn't pull it out, though. After all, a fellow would look a perfect ass sitting in an hotel garden sucking a silly tin-opener!

HERBERT HAMELIN.



Is your set selective? Can you get Daventry 5GB free from London's interference, and London without a background of 5GB? If not, then your tuning can be improved with one of the simple schemes described below, which can be added to almost any type of receiver. Make sure of selectivity, because the Prague Plan may make matters more difficult.

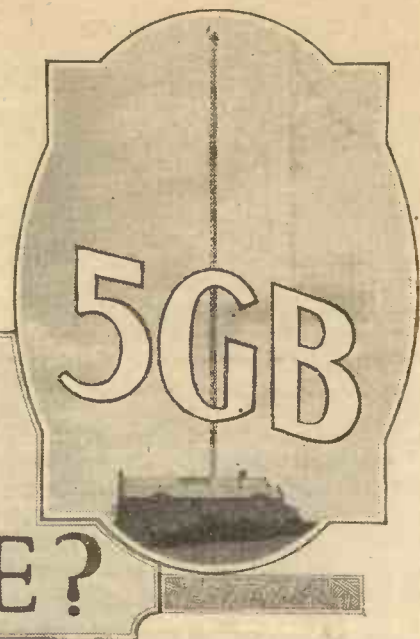

Are You Troubled With ~ INTERFERENCE?

MANY listeners will be thankful that the B.B.C. was able to effect a temporary last-minute alteration in the Prague Plan with regard to the wavelength of 5GB. Until the opening of Brookmans Park it was arranged that 5GB should work on 399 metres and London No. 1 on 356 metres. This gives a separation of only 43 metres—presenting an interference problem not easy of solution to some owners of old-type sets.

Temporarily the change was made and 5GB was raised to 479 metres, and thus, until a further alteration has to be made owing to the opening of London No. 2, there is a separation of 123 metres. Later in the year, night effect may be such as to cause interference between Langenberg

of a receiver without disturbing the tuning arrangement in any way is that shown in Fig. 1.

Here you will see the aerial and earth terminals are joined to a coil consisting of roughly 70 turns of No. 26 d.s.c. copper wire. Across this also is connected a .0005 variable condenser, which serves to tune it. Immediately over the 70-turn winding put six to ten turns of No. 16 or No. 18 d.s.c., and connect this to the actual aerial and earth, as shown. When tuning, the external .0005-microfarad condenser must be adjusted together with the ordinary tuning condenser.

This circuit gives improved selectivity on two counts: first, the aperiodic aerial coupling by means of the 6-10 turn winding to the 70-turn winding; second, by reason of the fact that the ordinary tuning circuit has a further tuned circuit placed in cascade with it. The great advantage is that this can be added to almost any existing type of tuner without having to pull the set about or rewind the coils. However, if the tuner is easily accessible an improvement in selectivity might be obtainable by winding the 6-10 turns of wire immediately round the ordinary coil windings.

In this selectivity improver, and also in the following circuits, the exact value must be found by experiment, which is not at all difficult. So much depends on aerial characteristics and the type of tuner incorporated in the set that it is impossible to give accurate values.

Another Scheme

Here is a second scheme, which can be tried with advantage. The connections are shown in Fig. 2, and it will be seen that it consists of a kind of pre-set wavetrap.

The coil, again, consists of about 70 turns of No. 26 d.c.c. wire on a former roughly 3 in. in diameter. It should be tapped in 10-turn steps at about four places towards

one end of the coil. A simple two-way switch changes over from one .0003-microfarad pre-set condenser to another of a similar maximum value. Either the point *a* or the point *b* can be connected to the aerial terminal on the set, from which the aerial lead should first be taken. Experiment will show whether it is better to connect *a* or *b*.

The aerial lead should be taken to one of theappings on the coil. For preference, and for a first test, connect *a* to the aerial terminal and connect the aerial lead to the bottom or *b* end of the coil. By means of the ordinary tuning control tune in, say, London to the maximum degree of selectivity. Then slowly adjust the pre-set condenser, which is then in circuit, according to the position of the two-way switch, until London is entirely cut out. Then

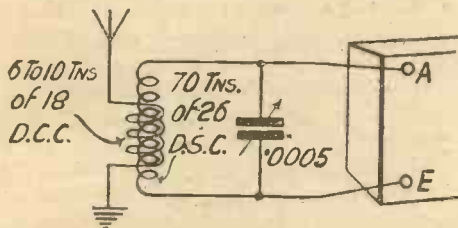

Fig. 1. An easy method of obtaining selectivity and 5GB, and a re-allotment of the wavelengths of 5GB, Manchester, and Glasgow may be necessary.

But, even as things are at present, "ether picking" is no easy matter for a man who owns an unselective set. Indeed, "ether swamping" would be a much better term. Listeners owning sets with bad tuners are having trouble in cutting out a background of 2LO while 5GB is being received or *vice versa*, depending on the locality.

Nowadays a selective set is a real necessity, but it is not necessary radically to alter the tuning arrangements of a receiver in order to get selectivity. A wavetrap is very often a good cure.

An easy way to improve the selectivity

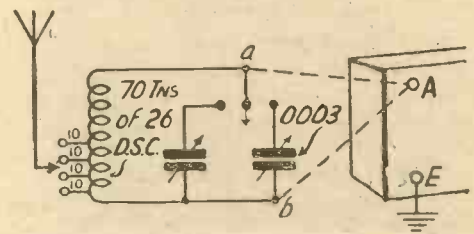
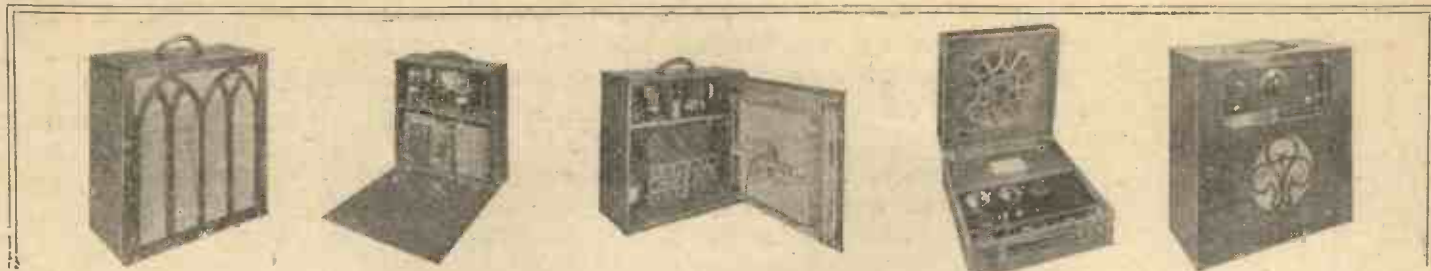

Fig. 2. Here is another simple method of cutting out an interfering station

push the switch in the opposite direction; tune in 5GB, and adjust the other condenser until this station is also cut out. Some experimenting with theappings on the wavetrap coil may be necessary before complete silence is obtained on both settings.

To operate the wavetrap is simplicity itself. When, say, 5GB is required, simply move the two-way switch into the position with which London is not receivable and then tune in 5GB in the ordinary way. The adjustment is, of course, reversed for the reception of 2LO free from 5GB's interference.



A FEW PORTABLE SET HINTS

A Loud-speaker Hint

WHEN a standard commercial unit is utilised for driving the loud-speaker in a portable set it will probably be found that the lead is unnecessarily long, and one has either to cut it short, thus removing the tags, or leave the lead as it is found.

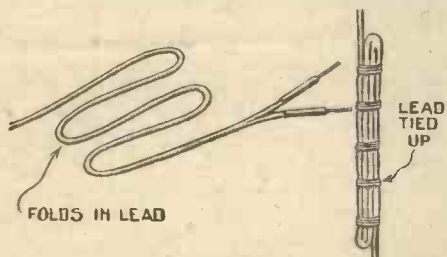

Accommodate long leads in this manner

As these connecting leads are, in most cases, made of very delicate material, so that they will be really flexible, cutting off the tags leaves the wire with very flimsy ends to which it is exceedingly difficult to make a sound connection.

The best method is to leave the tags in position and fold up the lead as shown above until the length of free lead is of the required measurement. The folded portion can then be neatly tied up with thin string or insulating tape as shown. D. N.

A Log Chart

MOST present-day portable sets are fitted with a station log chart. A useful tip which the writer employs on a

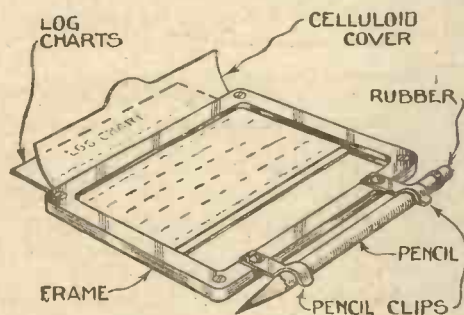

Protecting the Log Chart

portable receiver is shown in the illustration and consists of a sheet of transparent celluloid cut the same size as the cards placed in the log chart frame, except that a small tag is left on the top edge of the celluloid to enable the latter to be easily withdrawn from the frame.

The celluloid cover is normally kept in

position over the card or cards in the frame and is withdrawn when additions or alterations are to be made. Dust and dampness are thus prevented from spoiling the log cards.

A further refinement which may be fitted is a pair of aluminium clips for the purpose of holding a small lead pencil, so that means will be always at hand for making quick additions or alterations to the log. A small pencil, such as those supplied for

time, a good temporary repair can be made by fixing small metal angle brackets inside the corners as shown.

It will generally be found possible to

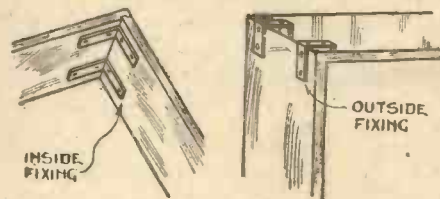

How to strengthen the Cabinet

locate the brackets where they will be unobtrusive, but care should be taken when fixing that the screw points do not project outside the cabinet.

Brackets of the angle type may, of course, be fitted on the outside of the case, providing appearance is not of consequence; in this case small bolts and nuts can be employed for clamping, in place of wood screws. J. H.

Preventing Terminals Slacking Off

THE annoyance of a terminal head working loose inside a portable receiver (which may easily occur when the set is transported by car or train) may be obviated by cutting a small slot with a jeweller's round file in the head as shown by the sketch, and after tightening up the terminal over the connecting wire, bending the extreme end of the latter upwards so that it rests in the slot.

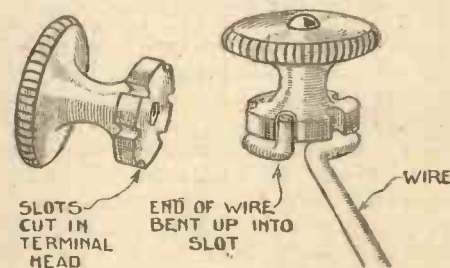

Your terminals can be prevented from becoming loose

In order that no trouble may be experienced in getting the single slot to come into the correct position for bending up the wire end, several slots may be filed in the terminal head so that one of them will be in or near the best position after tightening up. W. K.

—And a Few Don't's

Don't forget that the frame aerial windings must be pointed edgewise towards the transmitting station for best results.

Don't place the receiver on damp ground or keep it in a damp place, or the moisture may condense inside the case and cause high-resistance shorts.

Don't forget to make a note of the positions of the H.T. and G.B. tappings so that when removing or renewing these batteries the original tappings can be adhered to.

Don't forget to adjust the loud-speaker control nut if rattling is heard.

Don't fail to inspect the "works" of the set occasionally; you will be almost sure to "spot" a loose nut or screw.

Don't subject the receiver to rough treatment.

Don't forget that the higher the receiver is placed the better will be the results obtained.

use at whist drives, will be found very suitable for the purpose. T. W.

Strengthening Weak Cabinets

IF the joints of the wood case of a portable receiver weaken or tend to open at any

On Your Wavelength!

A Technical "Poet's Licence"

WE are all familiar with the term "poet's licence," but I am afraid many do not always realise that a similar latitude of expression would appear to exist when the live reporter of the newspaper press prepares "copy" concerning news of a technical character. True facts and important details are either omitted or have only a passing reference; or worse still, in his efforts to interpret technical phraseology he places an entirely different complexion on the whole subject. The non-technical layman is in consequence led to believe something which does not really exist, while the professional engineer is somewhat nonplussed and fails frequently to get an intelligible idea of what is being described. This is unfortunate, but is perhaps inevitable when we realise that if time had to be spent in correctly analysing a piece of technical news then the newspaper would lose any form of "scoop" attaching to the information. I am reminded frequently of this state of affairs, but never more so than when paragraphs dealing with television appear in the press.

Television Misinterpreted

For example, I have in front of me a New Zealand newspaper where a writer has attempted to state the position of television and promptly given himself away as an exponent of the old axiom, "A little knowledge is a dangerous thing." He says that "the serious difficulty with television today is that, at least on a single broadcast channel, we cannot have sound and vision at the same time: The stations that broadcast television have trouble even to switch from aural to visual programmes. Less than a fraction of a second now intervenes during the switching, but this, of course, is not the final solution. It is possible to do it on two or more wavelengths; but, then, again, at the receiving end apparatus is needed to tune into the different wavelengths, and that is evidently very difficult to incorporate into a single set, although not impossible."

You can judge for yourselves from his remarks which I have quoted above that he is getting a trifle mixed. The visual and aural transmissions do take place simultaneously; perfect synchronisation is secured automatically in the latest Baird system, for example; and even if two different wavelengths are employed at present, a double modulation of one carrier wave will, no doubt, be developed in the future by using different types of modulation. In any case, to say that the use of two wavelengths gives trouble at the receiving end is quite erroneous, for with only the

limited television transmissions that have taken place in this country it has been demonstrated successfully that the dual set required is simple to operate and only one aerial is necessary. It is better to leave a thing unsaid or unwritten than to give to the public at large a false impression of technical matters.

By the way, on reading over my notes of last week I notice a small printer's error which puts rather a bad complexion on the point discussed. In the course of the paragraph headed "Is Television Embarrassing?" you will read that "television is more likely to destroy one's privacy." This, of course, is incorrect; and by substituting "not" for "more" the statement will be rectified.

The Way to Cheaper Radio

One might almost think that the valve set had touched its rock-bottom price in view of the very low cost of some of the portables and semi-portables on sale nowadays. In fact, one cannot help feeling that with the present cost of components, the prices of some complete sets are really much lower than they ought to be. How, then, can the wireless valve set be reduced in price, particularly in view of the higher royalties? There are many components the prices of which are probably as low as can, or ever will be unless a miracle happens. Coils, low-frequency transformers, condensers (fixed and variable), resistances and valve holders of the best quality—and it is the biggest mistake in the world to use anything else—all show nowadays the fullest value for money. Nor can we reasonably hope for any reduction worth talking about in the price of good batteries, whether wet or dry.

What About the Valve?

Only one important component remains—the valve itself. And here I think that prices still are at too high a level. When you come to think of it, the general-purpose valve of 1929 is only four shillings and sixpence cheaper than the corresponding valve of 1923. It is true that it has a dull-emitter filament instead of a bright, that it is longer lived, and that it is more constant in operation. But against this we must set various important factors. The fifteen-shilling valve of five or six years ago was very largely hand-made, whereas the valve of to-day is mainly the product of a specialised machine. Mass production is the rule to-day, and factories are now turning out at least a hundred valves for every one that they made six years ago. My own view is that if makers could see their way to reduce prices they themselves, and

the industry in general, would benefit enormously. So long as valves are expensive, one hesitates to throw away old ones which, though their filaments are still intact, are really past their best days. There is no question that British valves are the best in the world; but, owing to their high cost, increasing numbers of cheap foreign valves are being used. I am quite sure that if the G.P. valve came down to, say, eight shillings and sixpence, with a corresponding reduction in other types, an enormously increased turnover would result.

What is the Reason?

I have never quite been able to understand why the wireless trade in general makes so much use of middlemen, or factors as they are called. Comparatively few firms have their own distributing arrangements. When you order a component from a retailer he obtains it, as a rule, not from the makers, but from the particular factor in whose district he is. It is the factor who buys from the actual maker. It follows that two profits—the retailer's and the factor's—have to be added on to the original cost of the component, whatever it may be.

See That You Get It

I have heard many arguments against and for the factor system, but none of them has ever convinced me that it is essential to the wireless industry. One of its supreme drawbacks is this. You may go to your retailer and order a particular make of transformer, which we will call the XYZ. You choose it because you saw it well reported upon by the AMATEUR WIRELESS Laboratories and because friends had found it eminently satisfactory. When you call a couple of days later to ask whether it has come in, the retailer produces one of different make, which he assures you is even better. If you insist upon having the XYZ you will probably have to wait some considerable time before it is delivered. The reason is this. The factor with whom the retailer placed his order either did not stock the XYZ or was out of them at the time. On the other hand, he had a large stock of ABC's. As he did not wish to order a further gross or so of XYZ's he sent down the ABC for you to take—or leave. It hits the retailer hard, for nothing is worse than to acquire a reputation for not being able to get what customers want. It infuriates the home constructor, who objects to being put off with something "just as good," when he particularly wants a special type.

Poor Retailer!

The retailer also gets it in the neck in another way. There is not, and probably

::

::

On Your Wavelength! (continued)

::

::

never has been or will be, any industry which enabled so many people to obtain goods at trade prices as the wireless industry. You cannot obtain a motor-car, a chair, or a saucepan at trade prices, unless you are definitely connected with businesses engaged in the sale of these articles. But all sorts of people, many of them with no right whatever to do so, obtain wireless goods at trade prices. Robinson is thinking of buying a new loud-speaker. He goes round to the retailer, examines various types, and hears them tested out. Then he departs saying that he will think it over. In his own mind he has decided that he will have a Blankophone, and as he has a friend who has a friend whose sister knows a man, etc., he puts his order through this devious channel. The unfortunate retailer is very hard hit, for he has to keep up a big stock; and it is grossly unfair to him and everybody else that such practices should be indulged in by so many purchasers of wireless goods.

A Holiday Reminder

As heaps of readers will be planning their holidays just now, may I suggest that they should make a note of one or two rather important points concerning the wireless set, if it is to be left at home and not to accompany the family on its trip to the country or the seaside? Before leaving, make quite sure that you earth the aerial or, better still, let it down by slacking off the halyards. Cover up dry-cell high-tension batteries and put them away in a cool, dry place. If you use a wet H.T.B., top up the cells before you go, and should it be of the Leclanché type, see that it has an ample layer of oil. Wet H.T.B.'s should also be stored in a cool spot. Accumulators, though, whether H.T. or L.T., are best sent round to the charging station to be examined, attended to if necessary, refilled, and kept safely until one's return. Don't leave the set exposed to the dust which is bound to collect.

Cable and Beam

A short time ago the development which made it possible to make use of the radio beam station for both telegraphic and telephonic communications simultaneously, seems likely to make wireless definitely superior to the cable as a means of long-distance communication. But scientists and research workers are never idle. It is the old story of the projectile and the shell-proof armour plate all over again. As soon as the armour-plate maker makes a shell-proof plate, the shell manufacturer gets down to it and brings out something that will go through it like a red-hot poker through cheese. And then the armour-plate man gets busy again, and so on, and so on. The cable fellows do not mean to take things lying down. They investigated the

properties of permalloy, which has worked such a revolution in wireless L.F. transformers. They produced a permalloy cable which came through all the tests with flying colours.

One of these is shortly to be laid between the United States and Ireland, and we are told that with it telegraphic communication up to five hundred words a minute will become possible, whilst telephone talks at a range of 3,000 miles can be conducted as easily as if one were ringing up a friend just across the road. You may bet your boots or your shirt, or any other article of clothing you like, that before very long the beam people will announce improvements that knock the cable—temporarily, at any rate—into seven different sorts of cocked hats. This kind of competition is a healthy thing, for it benefits you and me and all the rest of the world.

Mains Hum

I have been bothered very much lately by mains hum when endeavouring to use my short-wave set. You know how sometimes you tune in a station which has a very noisy generator. In what ought to be silent intervals, and even sometimes when speech and music are going on, you hear a continuous "woom-woom-woom-woom." Well, I had just the same thing, only forty times as loud, on all wavelengths covered by my short-waver. The trouble was tracked down eventually to some defect or other in the wiring of a neighbour's house, and I live in hopes that I may soon be relieved of this terrible noise and hear the American and other stations once more. All kinds of electrical things can be very noisy when the fit takes them. I have known interference caused by irons, refrigerators, fans, X-ray plants, flashing signs, and electrically-driven sausage machines.

Milliammeters

Do you use a milliammeter in the plate circuit of your anode-bend detector? This meter is, of course, a luxury rather than a necessity, but I am inclined to think that more beneficial results are obtained with an instrument in this position than in the plate lead of the final valve. Most of us are surprised to find how much grid bias is necessary to obtain the optimum anode-bend rectification on powerful signals. If one tries out an anode-bend detector with different values of grid bias it seems to make little difference to the strength and quality of reproduction if, say, three or ten volts negative bias are applied. Here is where the meter helps us, showing us how to adjust the bias until the station, when fully tuned in, causes an increase in anode current equal to about twenty times that of the anode current when no signals are being received. There is also another

advantage. One may set the H.F. amplifier always to give the same meter reading, and therefore ensure that the anode-bend detector is being worked under optimum conditions.

Incidentally, this meter is a form of Moullin voltmeter and definitely reads signal strength so that if we carry out any adjustments, such as altering the tuning coils, we gain some idea of increased or decreased efficiency. One must always remember, however, not to alter the extent of reaction, otherwise the readings will become invalidated.

Gramophone Reproduction

I have of late been listening to a large number of gramo-radio sets, and am beginning to form the opinion that, in the generally accepted form, scratch must be eliminated at all costs. It must have been some early press writer who drilled into the public the fact that electrical reproduction of gramophone records has the great advantage of entirely eliminating scratch; the wireless community have, in consequence, had to live up to this rather untrue statement. Certainly it is possible to eliminate much of the record scratch, but one usually cuts off simultaneously some of the most useful frequencies in our audio spectrum.

With many sets, music and speech seem muffled and extremely mellow in tone, thereby losing much of its charm. On occasion the owner of a set shows me with pride his scratch filter, affirming that it is the crux of the whole set; sometimes, in examining it, I manage to disconnect one of the by-pass condensers in the filter and, like a flood of daylight in a darkened room, the reproduction gains life; but oh, no—the owner rushes up and quickly replaces the component. "My dear man, you've let in all the scratch," he says feelingly, and I retire.

The Origin of Scratch

I learnt the other day that the primary reason for this scratch is due to want of care in making a record blank. The blank is grooved by a special tool, and unless extreme care is taken in this preliminary cutting, surface noise will be very pronounced; unfortunately, it hardly pays record manufacturers to take that last ounce of care. Apparently the cutting tool must do all the work, since a finishing tool only serves to accentuate surface noise. Generally speaking, the best reproduction from a gramophone record is obtained by a carefully planned compromise between needle scratch and high-note reproduction. Some scratch is allowable, provided that it is of insufficient intensity to be noticeable whilst a record is being played.

THERMION.

“WHILE LONDON TAKES A LITTLE PIANO MUSIC”

Jottings from my Log—By JAY COOTE

HOW many times have we heard the words, “While London takes a little piano music,” by the London announcer, for the B.B.C. between two transmissions does not use any kind of interval signal to fill the gap.

That a complete silence may cause anxiety to the public is demonstrated by the fact that should one inadvertently occur, the ether is disturbed by a series of squeaks and howls from a number of con-

denser-twiddlers who fear that their valves have gone “phut”!

Casually, an evening or so ago I tuned in to Hilversum at the end of a concert, and was surprised to hear a series of eight chords, as if played on a musical-box, and in many ways similar to the signal put out by Budapest, although the melody was a different one. It struck me at the time how useful such an harmonious signal could be made were it adopted by a number of home and foreign studios. We could avoid the monotonous ticking of a metronome or the regular striking of a bell, both of which convey but meagre information regarding the identity of the transmitter.

It is true that some French stations put out a gramophone record—e.g., Grenoble, Lille, Petit Parisien, Radio Normandie, and so on—but to tell you that they respectively play “Les Allobroges,” “Le P’tit Quinquin,” does not

help very much. But the musical-box could, in every instance, give us, according to the country, a few notes of a national anthem and follow up the signal with two series of numbers struck on a bell. If, for instance, we heard the start of the “Marseillaise” with two strokes, an interval and one further pong, we should know that we were listening to a French station, No. 21, and on consulting a list could immediately identify that studio.

Haydn’s melody, as played by the German stations, is known to most of us; so is “La Brabanconne” and the Italian “Fascisti Hymn.” In a very short time we should have learnt other foreign anthems.

Moreover, if some difficulty in identifying the interval signals already adopted is anticipated, let a gramophone company show initiative by publishing a double-sided record which would register the principal ones used. In the same way, station calls in the original foreign languages could be made familiar.

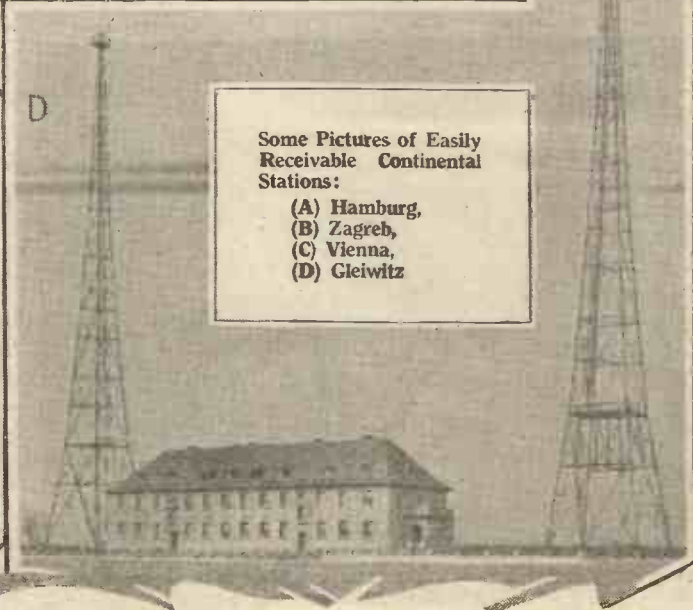
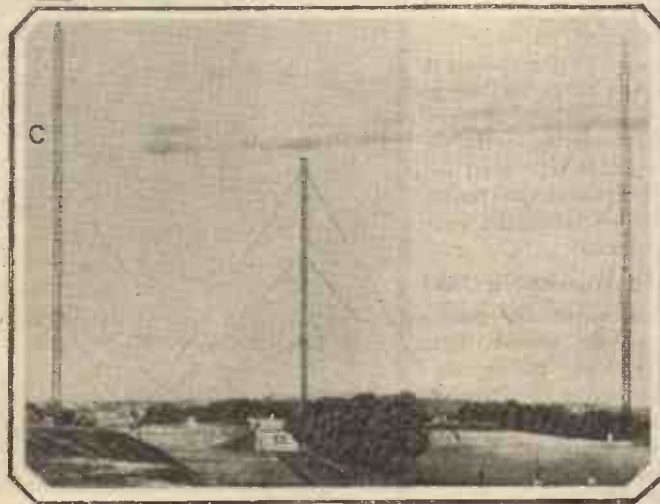
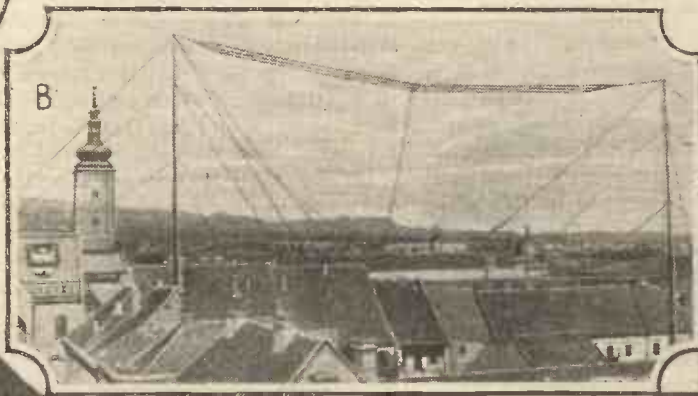
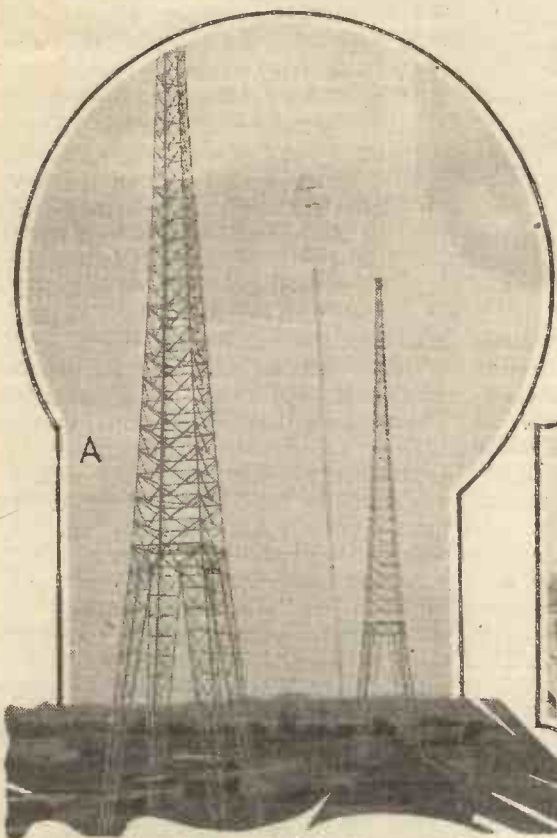

Some Pictures of Easily Receivable Continental Stations:

- (A) Hamburg,
- (B) Zagreb,
- (C) Vienna,
- (D) Gleiwitz

FOR many months past it has been possible on some of the trains of the Canadian National Railways to receive broadcast programmes while travelling at speed. The system was described in AMATEUR WIRELESS, No. 354.

It occurred to a number of German engineers that the utility of train radio would be extended if it could be possible for passengers *en route* to communicate by radio telephony with big centres, and thus to organise a proper wireless telephone service to and from moving trains. They got to work on the problem and devised a carrier telephony system which has worked moderately well, but is a slow process and involves the switching over from "speaking" to "listening" and vice versa.

It has been left again to our Canadian friends to produce a really practical train radio system, and now comes the news that two-way wireless telephone conversation can be carried out on trains travelling at up to about forty miles an hour. All a train traveller has to do is to step into the library coach, pick up a telephone, and be "through" to a number within about half a minute.

The purity of reproduction and reliability of communication are every bit as good as with a normal line telephone.

A considerable amount of money was spent on this radio experiment and it is, of course, well known that the C.N.R. puts great faith in radio and, indeed, runs a chain of broadcasting stations of its own. A special test car was constructed and eight engineers lived and worked in this while the tests were in operation.

Carrier Telephony

A carrier telephony system was devised, the telegraph wires running with the railway tracks being used. Half of the wire is used as the transmitting aerial and half is

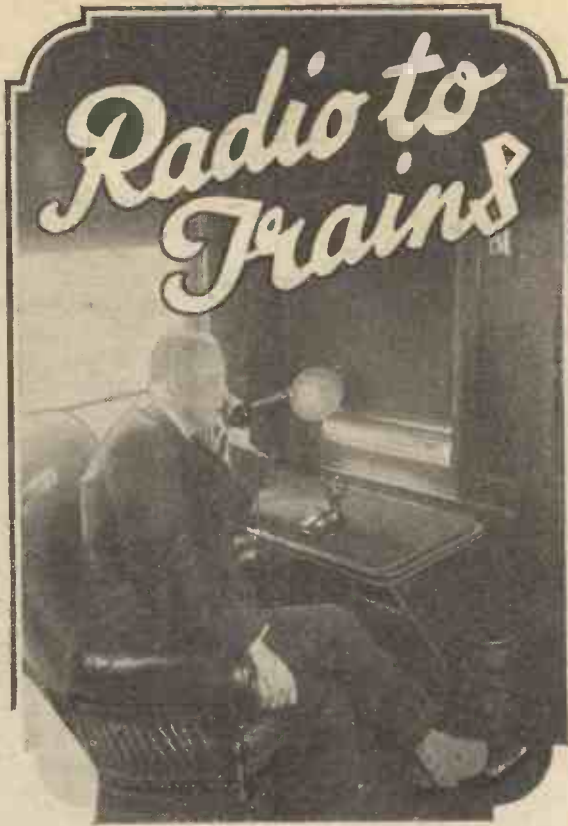

the receiving aerial. Both are in circuit with filters, so that there is no interference between the radio telephone conversations and the telegraph load on the wires. At points along the track are placed small terminal stations, which pick up the signals from the trains and pass them to the normal telephone lines.

On the trains are two aerials, consisting of two groups of parallel wires on the roof of the car. It must be understood, of course, that the system of communication is by high-frequency currents and modulation, just as in ordinary radio reception.

It was desired to have the aerials on one carriage only, and some difficulty was experienced in working such short aerials at the low frequencies used, and special loading coils had to be employed in order to transfer sufficient energy from the car to the telegraph lines. The receiving aerial on the car is also used for the simultaneous reception of broadcast programmes.

The Wavelength Used

A trouble experienced was the choice of a correct carrier frequency, for the attenuation of H.F. currents on wires is opposite to that experienced with ether waves. It was finally decided to employ a

wavelength of between 1,500 and 3,500 metres. To prevent interference the minimum of power is used. The transmitters consume about 20 watts, and with this the maximum distance that can be obtained through the ether is about 200 ft., and this ensures a certain amount of privacy. At the same time it introduces a "snag" in that when the railway runs near towns the telegraph wires are usually carried underground and it is necessary to erect above-ground wires specially for the wireless telephone service. For a number of months it was found possible to work the system very well, provided that a switch was used for changing over from sending to receiving. Duplex telephony is a much more difficult thing, but it has been made possible by putting special H.F. filters at the terminal telephone stations and very sharply tuning the two aerials on the train cars.

Power is obtained, on the train from the car storage batteries, and at the terminal station from the ordinary lighting mains. An ordinary valve oscillator, with grid modulation and with a final H.F. amplifier,

is used for transmission, and the receiver is a simple detector and L.F. combination with filters, but with no H.F. amplification. The first installation of this kind is working between Toronto and Montreal, but work is proceeding rapidly, and in the course of a few months the C.N.R. hopes to have a number of other fast "Limiteds" equipped with two-way wireless telephones.

As was mentioned recently, the C.N.R. engineers are also experimenting with short-wave reception on moving trains, and these tests are being made in conjunction with special C.N.R. short-wave broadcasts.



A typical scene in one of the C.N.R. offices while in communication with a Toronto-Montreal express



View of one of the terminal stations at the track side

Grid Leak or Anode Bend?

Are you wondering which is the better system to use? In this article W. JAMES shows the advantages and disadvantages of both

THE usual broad definition of a detector or rectifier is that it is an arrangement for converting alternating currents into uni-directional currents. This applies to the rectification of high- and low-frequency currents, but the detector of a wireless receiver has, of course, only high-frequency oscillations applied to it, and it converts them into a pulsating uni-directional current.

The function of the detector may be the more readily understood if we consider for a moment what happens at a broadcasting station. We will assume there is a silent period. High-frequency oscillations of constant amplitude or strength are then being generated (Fig. 1), and the station is therefore emitting a continuous wave. This is the carrier wave of the station, and it has a single frequency which, for a wavelength of say 400 metres, would be 750 kilocycles.

A carrier wave is normally not heard, but the well-known whistle is produced when the receiver is allowed to oscillate with a frequency very near that of the carrier. There is also a slight noise produced by a carrier wave, and it may serve to magnify local interferences such as from alternating-current equipment.

When a sound is created before the microphone low-frequency currents are produced, and after magnification they are passed to the circuits of the transmitter.

The effect of creating a simple sound, such as a note having a frequency of 1,000 cycles, is that two side waves are set up, one having the frequency of 751 kilocycles and the other of 749 kilocycles. The net result is that the amplitude of the high-frequency oscillations is varied. This is known as modulation, and when the amplitude of the oscillations changes exactly in accordance with the low-frequency currents (which must, of course, themselves be a faithful copy of the sound waves), there is no distortion. It is therefore important that the circuits of the transmitter be so arranged that low frequencies of all amplitudes and frequencies produce the correct effects.

A wave that is modulated by a low-fre-

quency current of sine form to a depth of about 50 per cent. is shown in the figure. In practice the amount of the modulation is varying all the time, but



Fig. 1. H.F. oscillation of uniform strength and 50 per cent. modulated wave

steps are always taken that the wave be not over-modulated.

Over-modulation produces distortion, and is therefore guarded against. It would

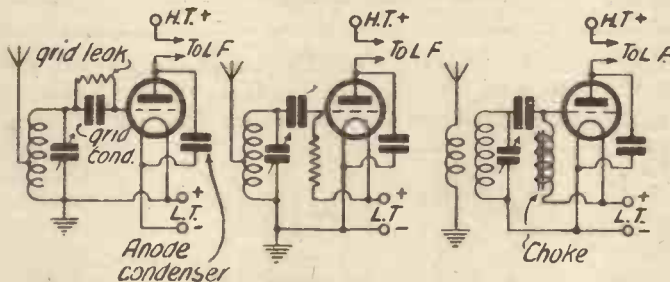

Fig. 2.—A and B, alternative grid-leak connections. C, choke in place of grid leak

appear that the average depth of modulation at the present time of the London

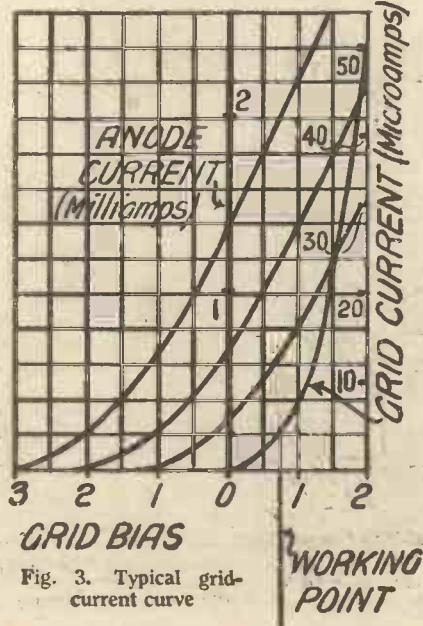

Fig. 3. Typical grid-current curve

transmitter is rather less than 50 per cent., and in the interests of good quality of reproduction it is important that it be not too great.

The range of frequencies of importance in music is a very wide one and extends from about 30 cycles to 10,000, although it is usual to assume that the very highest frequencies in this range are of no great consequence.

From what has been said already, it will be clear that a station which transmits over this range must have a frequency band of 20,000 cycles, comprising 10,000 cycles on each side of the central or carrier frequency. Our receiving circuits should, therefore, be capable of passing this band without distortion to the detector, which in turn should be so arranged that it deals faithfully with the signal.

The detector is coupled on its input side to a high-frequency circuit and on its output side to a low-frequency circuit, and there is usually a little additional apparatus, as will be explained later. Obviously, then, a detector is really a rather complicated

part, for it should deal faithfully with signals of all frequencies and voltages. Ordinary detectors usually distort, but it is possible, by carefully arranging the circuit values and by applying to the detector signals within a certain range of strengths, to minimise the distortion. This is naturally the object of a designer, and we will therefore consider in little detail the two types that are commonly used.

One is generally known as a grid-circuit detector and the other as an anode-bend detector. A fundamental difference between them is that in the first type the rectification occurs in the grid circuit and the valve magnifies the low-frequency currents, whilst in the second type the valve amplifies the high-frequency currents that are rectified in the anode circuit.

For grid-circuit rectification a high impedance to low-frequency currents (but not to the high-frequency currents) is included in the grid circuit, and the valve is so connected that grid current flows.

(Continued at foot of p. 12)

For the Newcomer to Wireless: SAFETY DEVICES

WHAT exactly is a fuse?

A simple little device which prevents electrical apparatus from being damaged by an overload of current.

How do you mean exactly?

Well, suppose you have a valve whose filament is rated at .1 ampere, with a pressure of 6 volts, you know that a higher voltage will drive a bigger current through it.

Yes, that follows.

In a moment of absentmindedness, whilst you are making adjustments in the receiving set, you cause a short circuit, which applies the voltage of the H.T.B. to the valve filament. What happens?

Why, the valve is burnt out.

It certainly is, unless you have—
A fuse?

Yes, a fuse. The fuse is something arranged in series with the filament or in series with the H.T.B. of such a kind that it will break down under a smaller load than would damage the filament.

How is this done?

In household electric-lighting systems fuses are generally made of tin wire. Experiment has shown what gauge of wire will stand a given current.

What exactly does a "2-ampere fuse" mean?

One that will carry 2 amperes, but will "blow" when the load much exceeds this amount.

But that would not be much good in the wireless set.

No.

What do you suggest?

What I use myself are ordinary flashlamp bulbs, designed to consume .2 ampere at 2 volts. I put one of these into each of the high-tension leads. By making tests I found that they blow when the current rises to about .4 ampere.

Then what happens when a short circuit occurs?

The bulb concerned, or it may be more than one, breaks down instantly and the valve filament is not injured by the momentary passage of the rather heavy current through it.

A good way of insuring valves.

It is, since a flashlamp bulb costs only about fourpence, and valves have not come down to that figure yet. There is another kind of fuse, which is even more sensitive than the flashlamp bulb.

What is that?

It is made by depositing a very thin film of gold upon a suitable surface. One drawback to the flashlamp bulb is that its filament resistance is 10 ohms; the gold film fuse has a resistance that is only a fraction of this amount.

Are there any other advantages?

Yes; gold film fuses are made to blow with as small a load as 100 milliamperes. If, therefore, these are used in series with the H.T. leads, there is no possibility of doing the slightest damage to dull emitter valves. Don't forget, too, that fuses serve another useful purpose.

Another?

Yes; they save the high-tension battery from damage. A short, for example, between the screen grid and the plate of an S.G. valve is not unknown.

"GRID LEAK OR ANODE BEND?" (Continued from preceding page)

Grid current is an essential, and the circuit is generally so adjusted that the working point is on the curved part of the grid-voltage grid-current curve.

The impedance usually takes the form of a fixed condenser and a high resistance; they are referred to as the grid condenser and leak, but it will be clear that in place of the high resistance a choking coil offering sufficient impedance throughout the range of audible frequencies could be used.

Usual values for the parts are .002 microfarad and 2 megohms, but the size of the fixed condenser may be from .00005 to .0003 microfarad and of the grid leak from .5 to 5 megohms.

The action of a grid-circuit rectifier is rather complicated, but there are a number of essentially practical points which may be discussed. The first is that a grid-circuit detector must not only be so adjusted that grid current is flowing, but there is ample scope for anode-circuit voltage changes. The high-tension voltage must therefore not be too low, or the necessary length of characteristic for amplification without running into curved portions will not be available. Distortion is, of course, introduced when the curved part of the anode-current anode-voltage characteristic is used. A form of anode-circuit rectification occurs, and this is quite undesirable.

Given an ample anode voltage, distortion

from this source is not likely to arise even when an R.C. type valve is used, and the next point to consider is therefore the

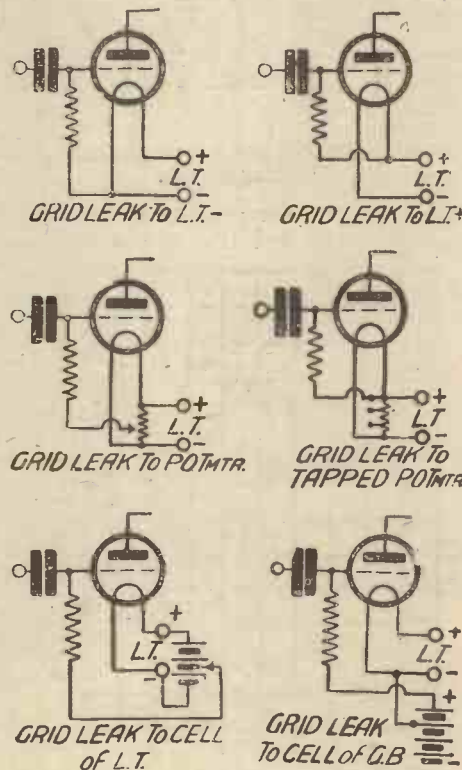

Grid-leak Connections: (1) Grid leak to L.T. —. (2) Grid leak to L.T. +. (3) Grid leak to potentiometer. (4) Grid leak to tapped potentiometer. (5) Grid leak to cell of L.T. (6) Grid leak to cell of G.B.

grid-current curve. The value of the grid leak and the voltage of the point to which its return end is connected have to be so chosen that the working point is on the most sharply curved portion of the grid-current curve. Sometimes it is satisfactory to connect one end of the grid leak to the positive side of the filament, but there are occasions when a voltage of less than this amount is better.

For this reason a potentiometer is sometimes used or one of the other schemes shown in the figures.

A grid rectifier is, then, normally passing grid current which is flowing in the space between the filament and grid of the valve and through the grid leak. When a signal is received the high-frequency oscillations pass to the grid through the grid condenser, which has a low impedance to currents of this frequency. But, owing to the high impedance of the grid leak and to the variations in the grid current produced by the signal, the voltage of the grid varies in accordance with the low-frequency part of the signal.

It should be noted that the grid condenser collects charges which reduce the normal grid voltage, and therefore the normal anode current. If a meter is connected to the anode circuit of a grid rectifier the current will be seen to decrease whilst receiving a signal. There are other factors that have to be considered, but I will discuss them and also anode-bend rectifiers in a further article.

WITHOUT FEAR OR FAVOUR



A Weekly Programme Criticism by Sydney A. Moseley

I WONDER when we are going to have a revue that will be really worth listening to? At present they consist mostly of those milk-and-watery syncopated songs strung together and garnished with a few "chestnuts," the complete product then being adorned with a pretentious title and most fetching descriptions. As an instance of this, take the latest, *Micro-phun*, which had little to recommend it.

On going through the casts of some of the recent revues, it would seem that the B.B.C. has selected the right talent, but are showing little originality in its choice. I should think the average listening public must be getting weary of these over-rated broadcasts.

My comments on "nasal" songs have brought forth some interesting letters from readers. As an example of the extreme diversity of opinion, I quote two of them.

B.K. (Tottenham) writes: "I have always considered you a most capable and unbiased critic of matters musical, but I think you are being unduly severe in your censure of syncopated songs. I like to listen to them, and in my opinion they are a great improvement on the popular ballads of pre-war times. At least, there is life in them."

The other point of view is expressed by A.H.M., of Staines, who rejoices in the fact that I am protesting against "those senseless importations from America. If a friend started making that sort of noise in a private house he would probably be emphatically requested to 'shut up.' The same remark might be applied to a number of so-called 'comedians,' both male and female."

Unfortunately, A.H.M., some people do make those noises in private houses. For instance, I have a neighbour.

Stainless Stephen's latest, "Radio Rastus," was rather disappointing. It was a clever turn; Stephen's quick change from one voice to another was perfect, but we are so accustomed to a flow of original wit from him that his reversion to time-honoured chestnuts came as a shock. In fact, the turn became quite flat after a few

minutes, but the comic song about a nigger up a tree just saved it from completely "flopping."

We shall be missing Mario de Pietro and Joan Revel during the next few weeks or so, owing to a South African tour. Their farewell turns from 5GB were memorable and made the parting all the harder for those listeners who enjoyed their turns.



Bill Browne as our artist sees him

De Pietro's nimble fingers were at their nimblest. Joan's excellent voice was at its best, too. Of course, it was all wrong to label her turn "Italian Folk Songs," and she tended to spoil herself by singing a syncopated number; but, nevertheless, her voice charmed us, and the way she sang the last song—I think it was by Tosti—gave one the impression that she might sound well in opera.

I must pay a tribute to Franz Baumann,

the German radio and gramophone artiste, who sang to us recently. As well as having a magnificent voice, he is a remarkable linguist. I suppose there are many people who speak French, English, and German really fluently, but to sing in any one of those languages without a trace of any other accent is no mean feat.

Baumann's intonation when singing in English was delightful. Didn't you specially like that old German folk song, "Lorelei"?

The excerpt from *Mister Cinders* was, for the most part, highly unintelligible. One missed so much by not seeing the little things which make the audience laugh, and the actors gabbled such a lot that the whole thing seemed meaningless, in spite of the announcer's carefully prepared synopsis.

I suppose most of us who play the piano at all have tried at some time or other to play a duet on one piano with the tutor or the girl from next door. And I have no doubt that most of us have made a mess of it by getting our fingers hopelessly mixed up. Those of us who have had this bitter experience must have felt a twinge of envy when they heard Rae Robertson and Ethel Bartlett playing flawlessly on one piano. And they tackled Rachmaninoff and Arensky—while "Home, Sweet Home" used completely to stump us.

The Savoy Hill gramophone had a temporary lapse the other evening. It went "Yeeweeow!" for a moment and then picked up. Perhaps it was jealous of the animal impersonators.

A word about Jefferson Farjeon's *Up the Stairs*, which is the sort of one-act play we want. It was both brilliantly written and cleverly acted, but I am getting tired of the B.B.C.'s stock of "noises off"—especially the "howling of the wind." Have you noticed what a lot of "howling wind" we're getting? At times it is overpowering.



THE LOUD-AME



addition to this, there are a number of short-wave "giants" on the Continent. Hilversum is the most familiar and, with a power of 25 kilowatts is "easy meat" for even the most inefficient short-waver.

Then there is Huizen, the new 16.8-metre broadcasting station which is described elsewhere in this issue, and this is a regular broadcasting station, and is in no sense of the word an experimental tester.

These short-wave transmitters are mentioned just to give some idea of what can be heard, but the proof of the pudding is in the eating, and it will come as a surprise to the average amateur to find how many carriers can immediately be located on almost the first occasion on which a new short-waver is tried out.

A Loud-speaker Two

There has been one discomfort attached to most previous short-wavers, and that is the necessity to wear phones. The reason for this can best be understood when it is explained that tuning is very critical and there is a fair amount of mush on these very short waves, and these conditions render the use of more than one low-frequency stage inadvisable. At present short-wave high-frequency amplification is not really a practical proposition, unless a super-het. be used, and this means that until the advent of a set such as this about to be described most

short-wave enthusiasts were limited to a receiver of the simple detector and one low-frequency stage type. Apart from the fact that phones have to be worn, a simple two-valver, with one stage of low-frequency amplification, is ideal, because it is easy to work—much more so than with the more complicated professional sets embodying some form of H.F. amplification—and is an inexpensive "second string" to the ordinary broadcast set.

By the use of a pentode and appropriate output arrangements it is possible greatly to increase the scope of the simple two-stage set, and this is what has been done in this "Loud-speaker America 2."

The Circuit

A glance

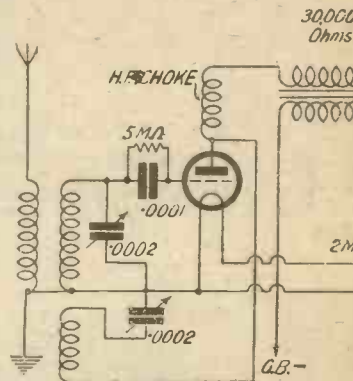

at the theoretical circuit diagram will show that, if the L.F. side is covered over, it does not depart from accepted short-wave practice, and it is not until one "spots" the pentode that the novel feature is obvious. The effect of fitting a pentode in the L.F. stage is simply that with the more easily receivable short-wave stations, such as our own 5SW, Hilversum, Huizen and, on occasions, some of the more favourable American broadcasters, loud-speaker reception is possible. When fading is bad and conditions generally are not ideal

VERY probably until a number of readers read an article entitled "What's on Below 100 Metres" in AMATEUR WIRELESS No. 367 they did not know what a wide gamut of stations is missed if a short-wave receiver is not available for their reception.

It is quite a common fallacy that all the

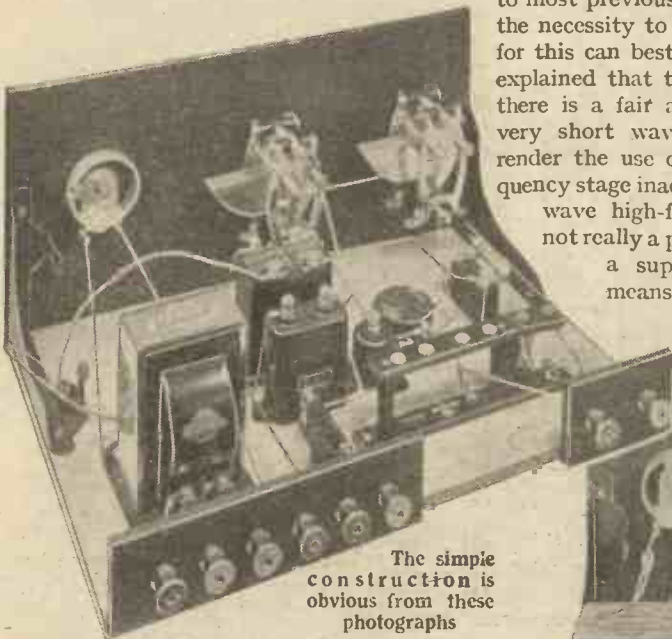

The simple construction is obvious from these photographs

short-wave transmitters are either commercial, and transmit only morse, or else are experimental, and thus cannot be relied upon for enjoyable amateur reception. This is very far from the truth, for all the prominent American broadcasting stations on the medium-wave band have their short-wave counterparts, and very frequently these short-wave *posles* are much easier to receive in this country. In

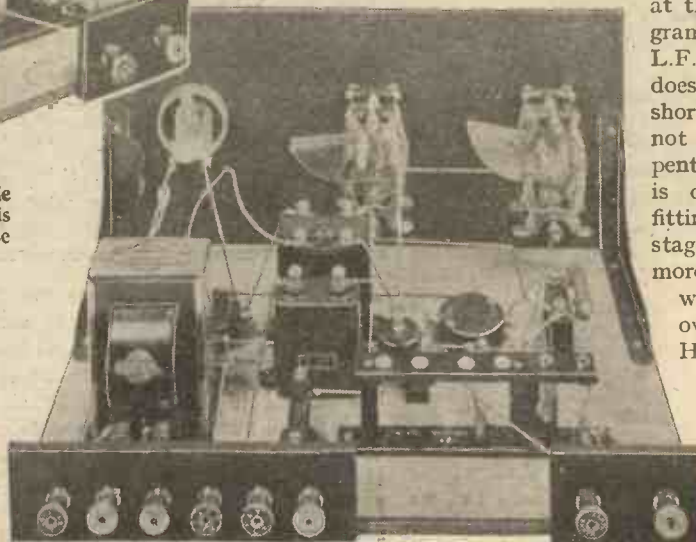

-SPEAKER RICA

the loud-speaker volume may, true, not be very great, but even indifferent loud-speaker reception is preferable to the wearing of phones.

The general construction of the receiver will be obvious from the photographs. Conventional "wound on air" coils are used for the aerial, grid and reaction circuits; the general tuning arrangement is that which has proved so popular in many previous AMATEUR WIRELESS short-wavers and is along Reinartz lines. Leaky grid rectification is employed, this being the only method which is really practicable

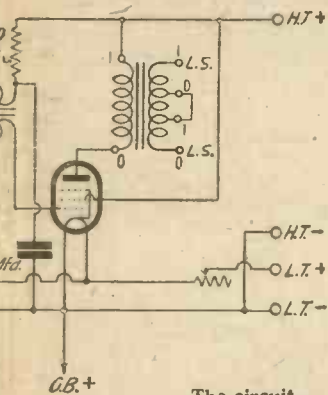

The circuit

detector valve of course, and for this set a short-wave choke is employed, for the distributed capacity and inductance value of a choke for the normal wave length would not be well suited to a short-wave set.

The detector valve is transformer-coupled to the pentode stage, and it is interesting to note that one of the new special core Hypermu transformers is employed. A 30,000-ohm resistance is placed in series with the primary of this transformer.

The pentode necessitates an output transformer for proper working; and this is connected in a true transformer

components should be spaced just as in the original receiver. The best guide to this, of course, is the blueprint, which is obtainable for this set price is., post free, from Blueprint Department, AMATEUR WIRELESS, 58-61 Fetter Lane, London, E.C.4.

Low Cost

The further point which will appeal is that not very many components are needed for making up the set and the total cost is very low. The complete receiver can, of course, be operated from the same batteries as are used for the home broadcast set; but both receivers should not be used at the same time. The following components will be required:—

Ebonite or bakelite panel, 14 in. by 7 in., and two strips, 7 in. by 7 in. and 3 in. by 2 in. (Raymond, Becol, Ebonart, Paxolin).

Baseboard, 14 in. by 9 in. (Pickett).

Two .0001-microfarad variable condensers (Lissen, Ormond, Cyldon, Burndept, Utility).

7-ohm rheostat (Peerless Varley, Igranic).

Two valve holders (Burton W.B., Lissen, Benjamin)

fashion, and not as a choke arrangement; the connections are shown in the circuit diagram.

As with most short-wavers, this is an easy set to construct, but a point which is not immediately obvious is that for successful working the

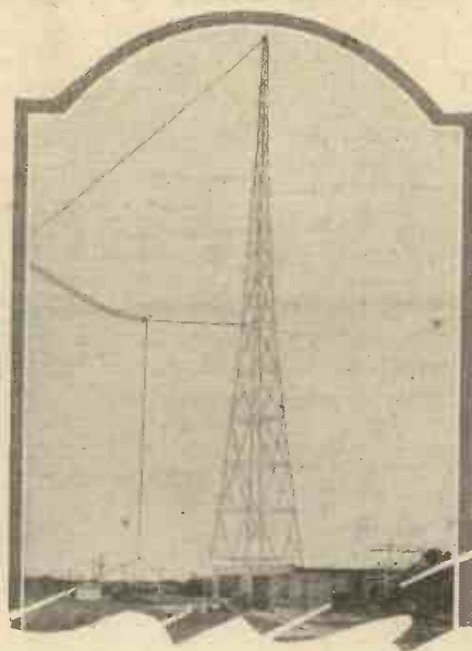

.0001-mfd fixed condenser with series clip (Dubilier, Lissen, T.C.C., Mullard).

5-megohm grid lead (Dubilier, Lissen, T.C.C., Mullard).

Low-frequency transformer (R.I. Hypermu, Lissen, Igranic, B.T.H.).

Set of short-wave coils with base (Eddy-stone or Stonchouse)

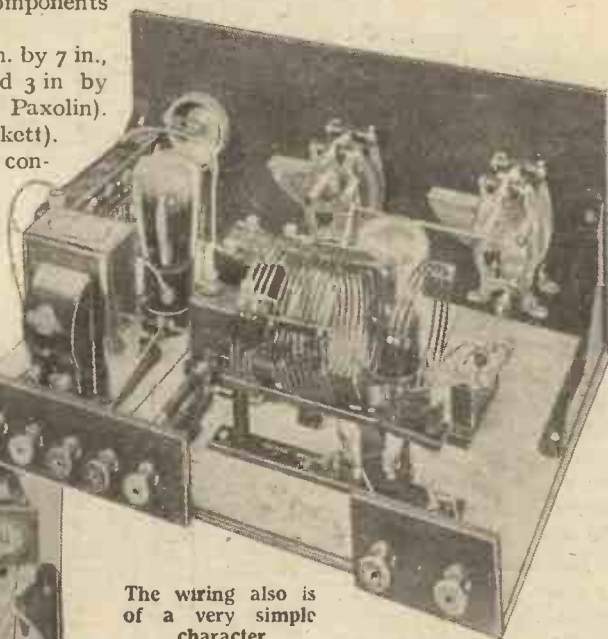

The wiring also is of a very simple character

Short-wave high-frequency choke (Trix, Wearite, Varley).

2-microfarad fixed condenser (Dubilier, Lissen, T.C.C., Mullard).

30,000-ohms resistance with holder (Graham-Farish, Lissen, Dubilier, Varley, Mullard).

Panel brackets (Ready Radio)

Pentode output transformer (Igranic, R.I.)

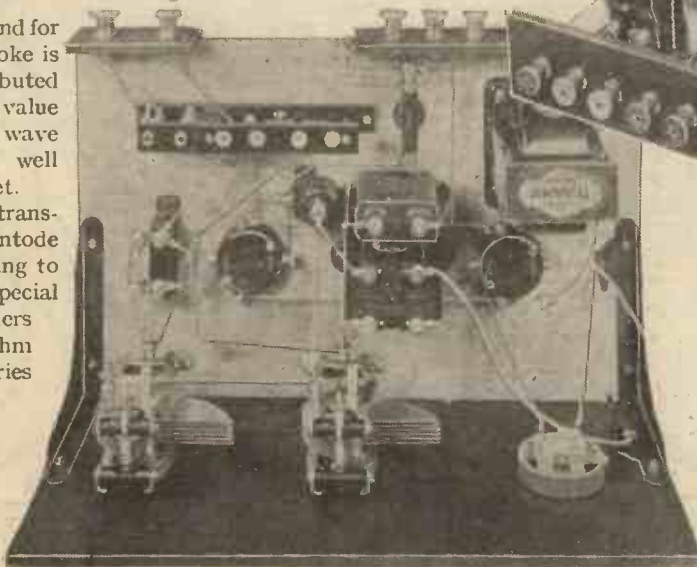

"THE LOUD-SPEAKER AMERICA 2" (Continued from preceding pag.)

Eight terminals, marked: Aerial, Earth, L.T.+, L.T.-, H.T.+, H.T.-, L.S.+, L.S.- (Ealex, Belling-Lee, Igranic).
Connecting wire (Glazite).
Slow-motion dial (Lissen).



The complete receiver

Construction

The panel should be drilled with the aid of the blueprint, and the aerial tuning and reaction condensers and filament rheostat mounted. These are all one-hole fixing components, and the only constructional care needed is in fitting the slow-motion dials to the tuning condenser, for this necessitates a separate small hole in the panel for the spindle of the vernier control.

Substantial L-section panel-brackets are used, for it is imperative that there should be no movement of the panel when the controls are handled, for this would tend to cause an artificial form of hand-capacity. One panel bracket incorporates clips for holding the grid-bias battery

The positions of the components on the baseboard can readily be gauged from the blueprint, and it is a wise plan to follow the original layout as closely as possible. In the original set this has been arranged so that all the wiring is as short, direct, and conveniently placed as possible, and the wise man will follow it if he wants to get the same results as we have obtained.

At the edge of the baseboard remote from the panel are two terminal strips, one carries simply the aerial and earth terminals, and the other the terminals for L.T. positive, L.T. negative, H.T. positive, H.T. negative, L.S. positive, and L.S. negative. The major part of the wiring is carried out with rigid bare wire, but flex leads are used for the grid-bias connections and for the little lead to the additional terminal on the pentode valve.

The connections to the output transformer may present some little difficulty, and the following instructions should be followed. On one side of the transformer will be seen four terminals, the top "O"

is wired to the bottom "I" diagonally; the bottom "I" is taken to L.S. positive, and the top "O" is taken to L.S. negative. On the other side of the transformer are two terminals, "O" being taken to the anode socket of the L.F. valve holder and "I" to the pentode flex lead and to H.T. positive.

The coil connections can easily be followed. Coils are available to cover the range from 18 to 100 metres approximately, and in next week's issue the selection of coils will be described and operating notes given together with some general hints.

PIEZO-SELECTIVITY

THE clear-cut resonance characteristic of a piezo-electric crystal is now being utilised to ensure selective reception, particularly in resistance-coupled circuits where the tuning is normally broad. In one of the Loewe multi-stage valves the ordinary compact coupling resistance is combined, inside the glass bulb, with a quartz crystal calibrated to pass only waves of a given frequency. This particular arrangement is designed for use on a superhet set, between the first detector and the grid of the intermediate-frequency amplifier. The same selective action can, however, be applied to an ordinary inter-valve coupling, though this necessitates the use of a set of interchangeable crystal units, graded according to the particular station to be received.

B. A. R.

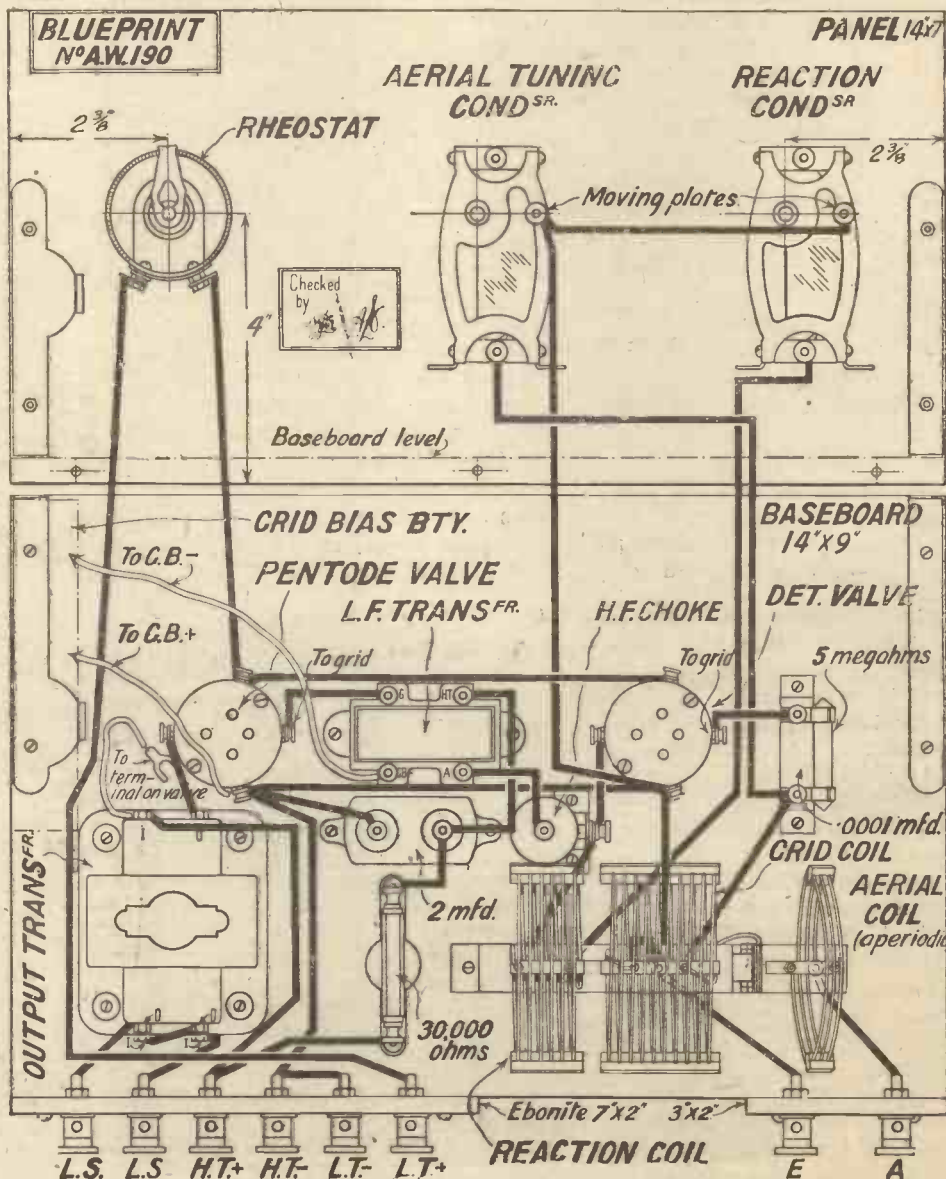

The wiring diagram. Blueprint available, price 1/-

IGRANIC

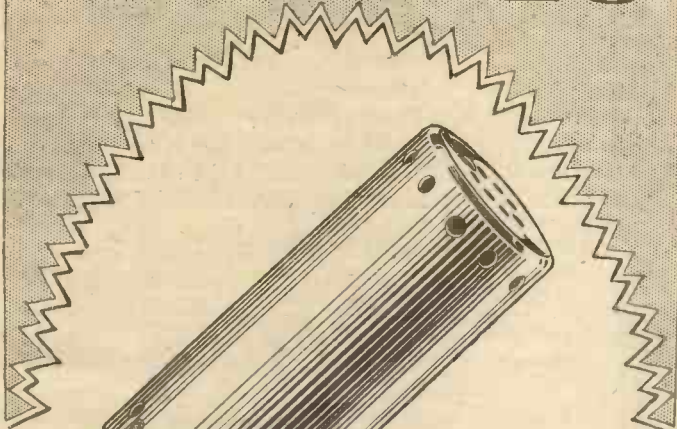

Battery Charging from A.C. Mains

JUST as you know you can place the utmost reliance in the advice of an expert like Mr. J. H. Reyner so you can use the components he uses with the same confidence.

Igranic Components are built by experts for experts. If you are not an expert the use of Igranic Components will give you the same fine results as experts obtain.

Use the Igranic-Elkon Metal Rectifier and the Igranic Power Transformer for "Battery Charging from A.C. Mains" and get experts' results.

Ask your local dealer for full details of the new Igranic-Elkon Metal Rectifier and other equipment for Mains Apparatus, or send to Dept. D. 124 for particulars.

Igranic-Elkon Metal Rectifier (Model E.B.H.) Price **£1.17.6**
Other models from **17/6**

Igranic Power Transformers for H.T. Supply Units **£2.5.0**



Works: BEDFORD

THE SECRET OUT



Here is the Wonderful
NEW

Brown "VEE" UNIT

HERE it is! A wonderful new loud speaker unit that sets an entirely new standard of Radio reproduction. Though it only costs 25/-, it will re create the living artiste in your home as no other loud speaker unit has ever done. But then . . . it's made by Brown! See it at your dealer's soon



PRICE 25/-

(Chassis : 15/-).

"AS BRITISH AS BRITANNIA"

Advt. S. G. Brown, Ltd., Western Avenue, North Acton, W.3

CA 9437

"A.W." TESTS OF APPARATUS

Conducted by our Technical Editor, J. H. REYNER, B.Sc. (Hons.), A.M.I.E.E.

Ekco A.C. Eliminator

FOLLOWING the success obtained with their H.T. eliminators, Messrs. E. K. Cole have recently introduced an all-power eliminator capable of providing high-tension, low tension, and grid-bias. These three D.C. supplies are obtained from Westinghouse metal rectifiers, a type which has proved its worth during the past season.

We recently had an opportunity of testing one of these new A.C. rectifiers, model CIA: this is contained in a metal case measuring 12¼ in. by 12¼ in. by 5½ in. high. The controls are mounted on an insulated panel on the left of which there are five output terminals. The first of these provides the full voltage for the power valve; the second gives a slightly lower voltage, approximating from 120 to 150 volts, according to the current supplied, and is suitable for use with a high-frequency valve, while a third tapping gives a voltage which may be adjusted by rotating the central knob on the panel and is eminently suitable for detector work. There is also a screen-grid tapping varying from approximately 60 to 80 volts.

The L.T. portion of the eliminator includes a voltmeter and resistance control, allowing the exact voltage to be obtained. The five sockets on the right of the panel provide a further adjustment for the voltage. It is important to read the makers' instructions, showing the correct



E. K. Cole A.C. Eliminator

tapping to be used for a given filament current consumption.

At the base of the panel there are 7 grid bias terminals providing voltages varying from 1.5 up to 21 volts negative.

We subjected this unit to a number of fairly stringent tests, all of which it passed satisfactorily. For a test on hum, it was placed on a receiver including a screen-grid H.F. amplifier, detector, and L.F. amplifier. The procedure of changing over from batteries to the eliminator was performed

in approximately ten minutes, which illustrates the simplicity of the connections. The efficiency of the system can be gauged by the fact that hum was almost entirely absent and in fact, could only be heard by listening with one's ear in the horn of a loud speaker.

Utilising 6-volt valves, the filament current could be put up to .75 of an amp, a figure which, in the case of 2-volt valves, increased to 1 amp. The H.T. voltage with 10 milliamps H.T. current was found to be 220 volts; at 20 milliamps, 190 volts; at



Dr. Nesper H.T. Battery

40 milliamps, 150 volts; and at 60 milliamps, 100 volts. These figures show that the eliminator will operate a power amplifier with efficiency enabling sufficient volume to be obtained for using a moving-coil loud-speaker.

Dr. Nesper H.T. Battery

THOSE who use H.T. batteries for fairly powerful sets requiring over 12 milliamps anode current, are certainly advised to employ double-capacity, or preferably triple-capacity sizes. Although the first cost seems considerable, in the end they work out cheaper, since the battery is not being overloaded and in consequence will give a longer life. In brief, a triple-capacity battery delivering from 12 to 20 milliamps will give a better performance than three sets of single-capacity batteries employed consecutively.

We have received for test and report a Dr. Nesper triple-capacity H.T. battery, submitted by Dr. Nesper, Ltd., Colindale Avenue, London, N.W.9.

This battery, with a maximum voltage of 60, has overall dimensions of 14 in. by 6 in. by 3 in. high. It is tapped at every three volts starting from negative up to 60+.

Our test consisted of discharging the battery at a preliminary rate of 18 milliamps. This was continued until the voltage, and consequently the charging rate, fell to half the original voltage. During this time no less than 3,100 milliampere-hours were taken from the battery, the test occupying

approximately 230 hours of continuous discharge.

Under such conditions the results obtained may be taken as entirely satisfactory, indicating that such a battery is suitable for prolonged and heavy work.

W. and B. Five-pin Valve Holder

VALVES deriving their filament current directly off the mains have become so popular recently that it has been found necessary to standardise a holder for their specific use. Since the heater and negative electrode or cathode are separate in an A.C. valve, an additional socket and terminal are required.

This week we have tested a new W.B. five-pin A.C. valve-holder made in accordance with the standard design. Now it is obvious that in order to prevent short circuiting between the five electrodes of the valve, the connections at the back must be made with considerable care. In this W.B. valve holder the sockets are mounted on a brown insulated base, and the central or cathode socket is surrounded entirely by a portion of the moulding, thus preventing any possibility of a short circuit occurring beneath the holder. The extra terminal, marked C, is placed between one of the heater and the anode terminals. A noteworthy feature of this holder is the design of the nickel-silver sockets which are of the expanding type and so shaped that the pins make excellent electrical contact without

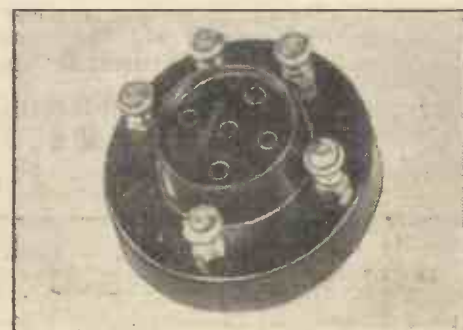

W. and B. A.C. Valve Holder

gripping them too securely.

This component may be recommended. It is manufactured by Whiteley, Boneham and Co., Ltd., of Nottingham Road, Mansfield, Notts.

The Federal Radio Commission of America is being nearly swamped with applications for new stations. These requests are pouring in at the rate of a dozen or more a week at the present time.

AT LAST! WHAT EVERY AMATEUR WANTS
THE S.R.S. ULTRA SHORT-WAVE UNIT

Australia, America, Africa, Amateurs, etc. on YOUR set.

PROV.
PAT.
15639/29

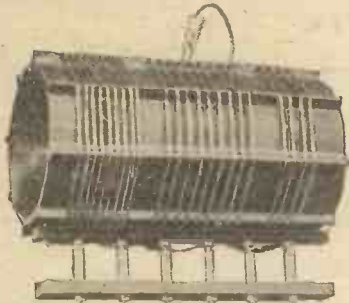

PRICE
12/6

POST 9d.
EXTRA.
C.O.D. or P.O.

AN ENTIRELY NEW AND INGENIOUS way of receiving the ultra short-wave stations on any type of valve set. INSTANTLY APPLIED OR DETACHED. No alterations to set. RECEIVES THE WHOLE ULTRA SHORT-WAVE BAND, 5-100 metres.

Here are only a few of the sets using the unit: Mullard Three Star, Formo S.G.3, All Titan sets, all Detector 1 or 2 L.F. sets, Reinartz sets of all types, Ediswan R.C.3, Everybody's 3, AND YOUR SET, WHATEVER IT IS, 1 or 6 valves; within 2 minutes of receipt you can be listening in on the ultra short waves.

YOUR GUARANTEE - - - S.R.S.

The Firm who have made ultra short-wave reception over the whole ultra short-wave band possible on—

- THE ORIGINAL COSSOR "MELODY MAKER."
- THE LISSEN "S.G.3" RECEIVER.
- THE NEW COSSOR "MELODY MAKER"
- THE CONVERTED ORIGINAL COSSOR "MELODY MAKER."

(Owners of these sets send for special free leaflets.)

For Technical Press Opinion of S.R.S. products, see "Popular Wireless," May 11, 1929 issue.

Now with the S.R.S. Ultra Short-wave Unit, ultra short-wave stations can be received on any and every type of valve set. Full and simple instructions enclosed. Immediate dispatch by return post, or send for free leaflet, ref. U.S.1.

STONEHOUSE RADIO SUPPLIES 54, UNION STREET, PLYMOUTH, DEVON

S.R.S. ULTRA SHORT-WAVE APPARATUS HAS BEEN OFFICIALLY SELECTED FOR GOVERNMENT USE IN NIGERIA.

TRIX
H.F.
CHOKES

make ALL the difference . . .

to your reception. They get the best out of your set. You cannot fail to appreciate their many good features. They function efficiently over a waveband of 5 to 3,000 metres. Mountable horizontally or vertically. Brightly plated nickel parts. Without question the finest value on the market. Send for particulars of the complete TRIX range of components to-day.

5/6
EACH

ERIC J. LEVER (TRIX) LTD.
8/9 Clerkenwell Green, London, E.C.1
Phone: Clerkenwell 3014/5

The TRIX Short-wave H.F. Choke, as used in the "LOUD-SPEAKER AMERICA TWO"—mentioned in this issue. Wavelength of 10-150 metres.

3/- Each



BUILD THE LOUD-SPEAKER AMERICA TWO

Our Kit of Specified parts includes panel drilled, wire cut and looped, screws. Free Blueprint with all orders. **£5.0.0** Cash price Coils included

Two Valves 35/6 extra. Cabinets 14/6. Any part sold separately. Set of Short Wave Coils 20/-

MULLARD S.G.P. Complete Kit of Components; £1 down and 10 monthly payments of 14/-. Write for detailed price list

SPECIAL PURCHASE B.S.A. & Western Electric Headphones. New in original boxes were £1, our price 6/6. Post free. Brown's H. 3. Horn Speakers, Maker's price £3.5.0, our price 30/-. Complete Kits, or any wireless components sent by return of post.

TERMS: Deferred, cash with order or C.O.D. Satisfaction or money returned

H. & B. RADIO CO.

34, 36 & 38, Beak Street, Regent Street, London, W.1 'Phone Ger: 2834

IGRANIC



For the "Loud-speaker America Two"

THE Pentode Valve is a wonderful achievement. It enables you to get loud-speaker results from America with a two-valve set. But, like all valves, it must be used with the correct components. The impedance in its anode circuit must be correct, and as the impedance of the average loud-speaker is not suitable, an Igranic Pentoformer is essential.

In the "Loud-speaker America Two" and in all sets using a Pentode Valve the very definite increase in volume and purity of reproduction obtainable with this remarkable valve can be yours if you use an Igranic Pentoformer.

Price 30/-

If your dealer cannot supply you please write direct to Dept. D125.



WORKS: BEDFORD

MY WIRELESS

Weekly Tips,
Constructional
and
Theoretical—



DEN By W. JAMES

For the
Wireless
Amateur

Our Popular "Threes"

I BELIEVE that one of the reasons why three-valve receivers are manufactured in such large quantities is that the minimum of difficulties are met with. The single high-frequency stage usually provides just sufficient magnification and selectivity for normal purposes, and the one low-frequency stage ensures that the signals are reproduced at fair volume. With three valves the tuning is not difficult and the current consumption is within the capacity of ordinary batteries.

The addition of a fourth valve in the form of a low-frequency amplifier is apt to complicate matters. Anode-circuit filters have usually to be fitted in order to prevent howling or motor-boating, with the result a four-valve receiver is proportionately much more expensive than a three-valver. Further, the high-tension current consumption may be so much greater than ordinary dry batteries are relatively quickly exhausted. The four-valve receiver does, of course, provide one with that factor of safety which is so helpful on occasions, but the three-valve set is deservedly popular.

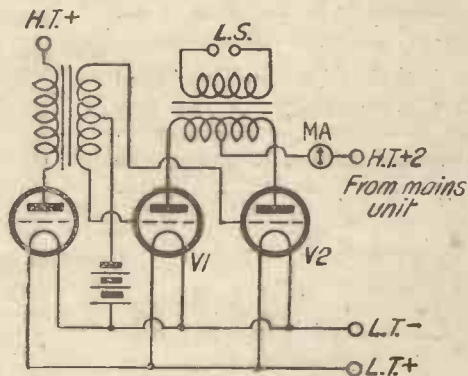

Fig. 1. How to measure the H.T. supply to push-pull valves

Measuring H.T.

In a push-pull amplifier, where the two valves are arranged as in Fig 1, one sometimes wishes to measure the current passed by the individual valves, and one might, without thinking, connect the milliammeter in the main high-tension lead as indicated and then remove one valve while the current taken by the other was noted.

It should be clear, upon consideration that the current taken by one valve only

will increase as compared with the current it takes when both of them are in circuit, because of the resistance of the supply. When this is a battery the difference is very little, but I am thinking of the case where a mains unit is employed for high tension. The correct procedure is, of course, to connect the milliammeter between the anode and transformer of first one valve and then the other.

In this way the true values of the currents flowing will be obtained.

Solder and Grid Leaks

I have written before of the danger of soldering connecting wires to grid leaks, but I feel that a further warning may not be out of place as I recently had an experience where the grid leak of the detector was disconnected. The set naturally was working badly, and the fault was due entirely to wires having been soldered to the grid leak. There are grid leaks fitted with connecting wires which may, of course, be soldered to other parts, but it is advisable with ordinary types to employ holders.

Forgotten Grid Bias

The small dry batteries employed for grid bias usually maintain their voltage for lengthy periods, but, as one would expect, one example may last for a much longer time than another.

Users who do not employ a voltmeter for measuring are, therefore, liable on occasions to be let down. I have had grid batteries that were perfectly good after twelve months' service in a receiver and others have had to be thrown out after six months' use. The amateur should therefore not wait until the quality of the reproduction is noticeably bad before having the grid battery tested. The better plan is to have this battery tested every time the high-tension is renewed.

Metal Matters

The increasing use of metal containers for mains units and receivers is, on the whole, a good sign, particularly when a safety switch is included. All holes through which connecting wires pass should, however, be properly bushed, as there is a danger of the insulation of the wires rubbing through if they rest on the metal.

I had this point brought home to me a

day or two ago when I found a wire actually making contact with the metal case. This wire was carrying alternating current and the contact was sufficient to cause noises and a hum to be set up. Had the hole through which the wire passed been bushed with an insulating material, the fault could not have occurred.

There is one further point. A knot should be tied in the wire or else the wire should

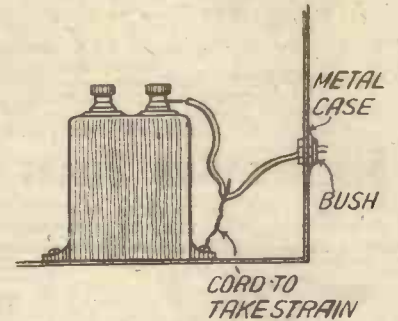

Fig. 2. A metal panel hint

otherwise be fastened in order that when it is strained its connection with a part inside the container shall not be broken. (See Fig. 2.)

Paper for Cones

Those who have experimented with loud-speakers will, I am sure, have realised the importance of using a suitable material for the diaphragm. Unfortunately, there is such a wide range of materials that seem promising that more time than many of us have to spare may be spent in trying them. The mistake most often made is of using a paper which is too thin. It is, of course, a mistake to employ a heavy diaphragm, as the amount of the volume may be disappointing; but when the material is too thin the quality is almost certain to be poor.

For these reasons it is important to follow exactly the instructions given regarding the correct material for building a loud-speaker. The results may be quite poor in comparison with those normally obtained if different materials are used.

I remember testing a moving-coil loud-speaker having an unsuitable diaphragm. It was an easy matter to detect vibrations travelling down the cone, and they were sufficient on occasions to produce a form of chattering or buzzing.



ON the occasion of the dinner given at the Mansion House on July 8, in honour of Sir Abe and Lady Bailey on their return home from South Africa, listeners will hear speeches by the Prince of Wales, Lord Grey, Sir Austen Chamberlain, and Mr. J. H. Thomas.

On July 6 three separate excerpts are to be relayed to 2LO and 5XX from *Hold Everything*, the new revue at the Palace Theatre. Alternately, we are to be taken over to the theatre for Act I at 9.40 p.m. and back to the studio for a special concert. Act II is timed to start at 10.19 p.m., following which dance music will be broadcast until 11.20, when the finale of the performance will be taken from the theatre.

As a military ceremonial the Tidworth Tattoo only ranks second to the Aldershot Tattoo, and, as in previous years, the performance taking place on August 3 will be broadcast from both London and Daventry 5XX.

Gerhardi's play, *Lord Brute*, will not be broadcast from the Savoy Hill studio on July 11, as previously advised; it has been replaced by *Disclosure*, a work from the pen of O. Wyndham and Ivor McClure.

Hunted Down, adapted from a Charles Dickens story, is to be broadcast from 5GB on July 19; the incidents will be linked up by the narrator, Stuart Vinden, who is responsible for its dramatisation.

At the end of May, the number of receiving licences had reached the respect-

able figure of 2,760,878, showing an increase of some 20,000 over the previous month. 14,830 licences have been issued free to blind listeners.

On July 17 Helena Millais, one of the original radio stars, will take part in the vaudeville programme down for broadcast through Daventry 5GB; she appeared among the first dozen entertainments put out from 2LO.

Fifty-Fifty is the title of a new revue for production at the London studio on July 17.

On July 12 the Belfast station will be favoured with a relay of the Irish International Grand Prix from Phoenix Park, Dublin, a running commentary on which is to be given by Mr. F. C. Summerfield. The actual course measures forty-two miles round, the voice being run over three hundred miles. Captain Malcolm Campbell, Kaye Don, Kamponi, and Ivanofsky are amongst the competitors.

On June 4 the new 12-kilowatt broadcasting transmitter erected at Morava-Ostrava (Maehrisch-Ostrau), Czecho-Slovakia started its initial tests; according to the Prague Plan it will eventually work on 263 metres.

During the summer months Cologne and its allied stations will relay daily an early morning concert from one or other of the famous Rhineland watering places; the entertainment is timed to begin at 7.5 a.m.

In Odessa (Russia), the city authorities have linked up the telephone system with

the local broadcasting station in order that some 9,000 subscribers may receive the radio entertainments without being compelled to purchase wireless receivers. A suitable amplifier with loud-speaker may be hired at the reduced rate of 1 rouble per month.

Listeners report having picked up on some recent evenings towards 11 p.m., a French transmission on 570 metres; this is not a new broadcasting station, but a series of tests made by a Paris commercial concern with a transmitter destined to the French colonies.

The Italian authorities have decided to replace the present Milan station by a 20-kilowatt transmitter and to increase the power of the Naples broadcasts to 7 kilowatts.

So great an improvement has been made in the land-line and submarine cable systems during the past twelve months that Anglo-continental telephony now reaches Ceuta (Morocco) in the south, Warsaw in the east and the Arctic circle in the north. Extensions are proceeding rapidly and other European countries are likely to be added to the net before the end of the present year.

From time to time the Reichs Broadcasting Company at Berlin initiates competitions for plays suitable for the microphone. On a recent occasion the sum of 3,000 marks or £150 was paid to a German author, Rudolf Leonhard, for his work *Orypheus*, which captured the first prize. The purchase price is independent of the fees which the studios pay when the play is put over the ether.

An SOS call broadcast from Glasgow to two Buckie steam drifters engaged at the herring fishing on the West and North of Scotland proved successful. Within two days of the message being sent out relatives of a man who was seriously ill had arrived from their vessels in Buckie.

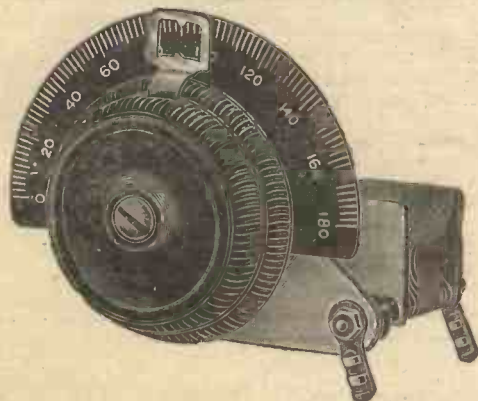

ONE OF "Utility" COMPONENTS

If you need Space— —you need the "MITE"

The principle of the "MITE" Condenser is similar to that of the popular "Utility" standard pattern . . . in other words, it saves valuable space, but at the same time provides maximum tuning efficiency. No backlash—spindle rotates on a ball bearing. A 3" slow-motion Dial with a 12 to 1 ratio is fitted to the Vernier pattern. You may obtain the "MITE" locally or direct from the makers at the following prices:—

Cat. No.	Cap.	With Dial.	Less Dial.	With VERNIER (as illustrated).
W.197	0005	7/6	6/6	10/-
W.198	0003	7/-	6/-	9/6
W.199	0002	6/6	5/6	9/-

WILKINS & WRIGHT, LIMITED
"UTILITY" WORKS, HOLYHEAD ROAD, BIRMINGHAM

JENKINS' TELEVISION EXPERIMENTS

A GLIMMER of what we may expect in the way of television in the near future was given the other day to the Society of Motion Picture Engineers by Mr. Francis Jenkins, whose silhouette pictures are being received three evenings a week in many parts of the United States.

His station, W₃XK broadcasts "movies" every Monday, Wednesday, and Friday with an apparatus giving 48 lines per picture, and 15 pictures per second. With a new 100-kilocycle band which has now been allotted, regular cinematograph films will be used in the transmissions, and specially written picture stories will be broadcast "reminding one of the first film stories of thirty years ago."

Radiovisor kits, including everything necessary, except a motor and baseboard, are being supplied at the extraordinarily low cost of ten shillings, including the 12-in. scanning disc, shaft, and bushings for mounting it, a neon lamp and lamp holder, driving disc and synchronising screw.

It can readily be imagined how a service of this type has stimulated amateur interest in television abroad. It is greatly to be hoped that we shall very soon now see something of the same order from the Baird Company. The co-operation of the wireless amateur is indispensable for the evolution of television, just as it was in the

case of wireless telephony, and television will be none the worse if the apparatus involved is brought down to very low limits in the way of cost.
T. T. B.

CHIEF EVENTS OF THE WEEK

(LONDON AND DAVENTRY (5XX))

- July 7 Drumhead service in connection with the Colchester Hospitals Carnival, from Castle Park, Colchester.
- " 8 Speech by the Prince of Wales at Royal Institute of International Affairs Dinner.
- " 10 A vaudeville programme.
- " 13 Running commentary on the Royal Air Force Display, from Hendon.

DAVENTRY EXPERIMENTAL (5GB)

- July 8 Festival Service of Cathedral and Collegiate Choirs, from Westminster Abbey.
- " 9 "Reminiscences of Chevalier," presented by Edgar Lane.
- " 11 A vaudeville programme.

CARDIFF

- July 12 A Bristol variety programme.

MANCHESTER

- July 13 A special performance of winning band at the Belle Vue Brass Band Contest, relayed from Belle Vue.

GLASGOW

- July 11 A Scottish concert.

ABERDEEN

- July 9 *The Bailie's Nominee*, a comedy by David Martin.
- " 11 A popular concert.
- " 13 A studio concert.

BELFAST

- July 12 A running commentary on the Irish International Grand Prix (motor race).

"THE SERVICE AREA OF BROADCASTING STATIONS"

NOW that the Prague Scheme is being much discussed and amateurs are taking a part in the technical problems which confront B.B.C. engineers, it is particularly interesting to note a paper which has been issued in book form by the B.B.C.: "The Service Area of Broadcasting Stations," by Capt. P. P. Eckersley. Much of the B.B.C. research work in connection with finding the service area of stations is given in a compact form in this paper; information and formulae are given to guide broadcasting engineers in their calculation of effective radiation and service areas in almost all conditions, both for daylight and dark broadcasting on all normal wavelengths. Some idea of the scope covered can be gathered from the contents, which include discussions of attenuation of wireless rays, the calculation of field strength, the design of transmitting aerials and the working of several stations on the same wavelength. There is a section which is of particular interest and that is one which puts forward an argument illustrating the entire unsuitability of the 200-600 waveband for broadcasting.

The new 12-kilowatt broadcaster at Feriby (Czecho-Slovakia), destined to replace the present Bratislava transmitter, will eventually work on 277.8 metres (1,080 khz.).



PICNIC PORTABLE

A three-valver, which even the beginner will have no difficulty in constructing or in operating. With one dial tuning it comprises detector and two L.F. Stages and utilises standard Three Electrode Valves. Full instructions for building this excellent Portable are given in the "Wireless Magazine" for July, now on sale.

OTHER CONTENTS IN THIS ISSUE :

THE ALL-WAVE LODESTONE FIVE, incorporates a push-pull Amplifier and is Reactionless—More "Talkie" Secrets, by Baynham Honri—HOW TO BUILD A TWO-AMPERE LOW-TENSION UNIT, by W. James—What Reaction Really Is, another Half-hour with Professor Megohm—THE A.C. MAINS AMPLIFIER: requires no Batteries and is suitable for Radio or Gramophone Work, by J. H. Reyner, B.Sc., A.M.I.E.E.—Further Notes on the Chummy, by W. James—And over 30 other interesting features, profusely illustrated.

WIRELESS MAGAZINE

for July is now on sale everywhere, 1/-. Get a copy TO-DAY



SUPPLY UNITS HIGH TENSION

For Multi-Valve Receivers
Guaranteed silent! No valves:
No expensive replacements.

Components from
47/6

THE TULSEMER MANFG. CO., Dalton Street, West Norwood, S.E.27.



Guaranteed

7 DAYS' FREE TRIAL AGAINST CASH.

FOR A.C. MAINS LOW TENSION

Incorporating Westinghouse Metal Rectifier.

2, 4 or 6 volts at 1/2 an amp.
No renewals. No attention:

Complete Units from
47/6

'Phone: Streatham 6731.





RULES.—Please write distinctly and keep to the point. We reply promptly by post. Please give all necessary details. Ask one question at a time to ensure a prompt reply, and please put sketches, layouts, diagrams, etc., on separate sheets containing your name and address. See announcement below. **Address Queries**—AMATEUR WIRELESS Information Bureau, 53/61 Fetter Lane, London, E.C.4

Position of Pick-up.

Q.—I have a four-valve set incorporating an H.F., detector, and two L.F. amplifying stages. I wish to use with this set a gramophone pick-up but am undecided whether I should use only the two L.F. valves for gramophone amplifying or whether to use the detector as an extra amplifying stage. Can you advise me on this point? For your guidance I would mention that there is one R.C. and one transformer-coupled stage.—N. D. (Swansea).

A.—We consider it a good plan, when using a gramophone pick-up, to use the detector and two L.F. amplifying valves for the amplifier. The reason for this may not at once be apparent, but can be explained. To get the best possible reproduction from an amplifier it is preferable to use an extra valve and then operate all valves well under their maximum efficiency. In this way not only is the tendency to distortion reduced, but valve noises, which are apparent in the loud-speaker when any valve is forced, are almost entirely eliminated. Therefore, one is not only assured of almost distortionless reproduction or amplification, assuming the amplifier is of good design, but many of the so-called "background noises" are avoided. When using a pick-up, always place a volume control across it. This prevents overloading the grid of the first valve in the amplifier.—A. C.

Milliammeters and Distortion.

Q.—I have been given to understand that if distortion is not taking place in a receiver that a milliammeter needle, when an instrument of this type is connected in the anode circuit of the last valve, should remain perfectly steady. In an endeavour to accomplish this I have been experimenting for several weeks and must admit myself beaten. On no account can I get the needle of the instrument to remain steady. With a certain amount of grid bias the needle "kicks" downwards and increasing bias either causes the

needle to kick both up and down or makes the needle kick upwards. There seems to be no happy medium where the needle remains steady. Can you account for this?—J. P. (Wandsworth).

A.—When very strong signals are being handled by the last valve in a receiver it is quite a common experience to get the milliammeter needle kicking in both directions. This does not denote distortion necessarily, because quite possibly there is no actual overloading of

very nature of construction, lightness of moving parts, and so on, tend to be "dead beat." When a milliammeter needle refuses to remain steady and kicks in both directions and the user is reasonably certain that the valves are not being overloaded and distortion is not apparent, then it may be assumed that the actual signal current is the cause of the movement of the needle.—C. L.

Pick-up Distortion

Q.—I have a set to which I have added a gramophone pick-up. In the first L.F. valve grid circuit I have incorporated a volume control, which works quite normally with the wireless receiver in operation. So soon as I connect up the gramophone pick-up and commence to play records I experience terrible distortion. No adjustment of the volume control seems to remedy the distortion. The volume is certainly reduced, but the music is raucous and extremely unpleasant. Can you tell me why this should be so, especially as I get such good reproduction from the wireless part of the set?—K. S. (Marlow).

A.—From your letter we assume that you have your pick-up connected between the grid and filament of the detector valve. This being the case, and you have the pick-up connected directly in circuit without a volume control across its terminals, it follows that you are overloading the grid of the detector, which is now operating as the first L.F. valve. Your normal first L.F. valve, in the grid circuit of which you have a volume control, is now the second L.F. amplifying stage, so that no adjustment of this volume control will prevent overloading the actual first L.F. valve when the pick-up is used. Therefore we advise you to connect a volume control in addition to that already in the set, across the terminals of the gramophone pick-up. Then you will be able to avoid overloading the first valve grid and so eliminate the distortion experienced.—L. C.

**When Asking
Technical Queries**

**PLEASE write briefly
and to the point**

A Fee of One Shilling (postal order or postage stamps) must accompany each question and also a stamped addressed envelope and the coupon which will be found on the last page. Rough sketches and circuit diagrams can be provided for the usual query fee. Any drawings submitted should be sent on a separate sheet of paper. Wiring plans and layouts cannot be supplied.

the grids of any of the valves in the set. It merely denotes that the energy forming the amplified signal is of such magnitude that the initial surge of current passing through the last valve due to, say, an announcer beginning a sentence or emphasising a certain word, actuates the milliammeter needle. Normally the meter needle will not respond to the fluctuating currents forming the signal, for the simple reason that the fluctuations are of too rapid a nature for instruments which, in their



DR. NESPER H.T. BATTERIES
ARE OF THE HIGHEST QUALITY
RELIABLE & DURABLE

100-v. Treble Cap. 24/6 ea.	100-v. H.T. 14/6 ea.
60-v. " " 15/6 "	9-v. G.B. 1/6 "
60-v. H.T. " 8/6 "	4½-v. P.L.B. 5d. "

100-volt treble capacity
16½ in. x 8 ¼ in. x 3 in.

60-volt treble capacity
14 in. x 5 ¼ in. x 3 in.

ASK YOUR DEALER

Read Mr. J. H. Reyner's report on page 18 of this issue.

DR. NESPER LTD. Colindale Avenue, Hendon, London, N.W.9
Telegrams: "Sedch." Phone: Colindale 6521-2-3

LISTENERS



to the wonderful WATES three-in-one VOLT-AMP RADIO TEST METER

This wonder meter has proved itself the most handy and useful testing instrument in the Radio world. Available from dealers everywhere, including Hulton's and Garry's Stores, or by post direct, with instructions for use and the New Wates Formula which enables accurate Eliminator readings to be taken with this meter. No valve set user should be without it!

Readings
0-150 volts
0-6 volts
0-30 milliamps

Price **8'6**

Case obtainable separately or with meter.

GET THIS EXTREMELY HANDY CASE.

Pleasing appearance. Substantially made with smart mottled black finish. Purple plush base and satinette lined lid, well-made fittings.

2/6

From dealers or by post direct. Get yours NOW.

THE STANDARD WET BATTERY CO., (Dept. A.W.)
184-188 Shaftesbury Avenue, London, W.C.2.



SEND FOR FREE BOOK

Crystallised black finish, fully guaranteed. Can be used as a Poie finder. M.B.

"A.W." Solves Your Wireless Problems

BROADCAST TELEPHONY

(Broadcasting stations classified by country and in order of wavelengths)

Metres	Kilo-cycles	Station and Call Sign	Power (Kw.)	Metres	Kilo-cycles	Station and Call Sign	Power (Kw.)	Metres	Kilo-cycles	Station and Call Sign	Power (Kw.)
GREAT BRITAIN											
25.53	11,731	Chelmsford (6SW)	15.0	*320	914	Montpellier (PTT)	1.5	*307	977	JUGOSLAVIA Zagreb (Agram)	1.21
*200	1,500	Leeds (2LS)	0.13	*345	892	Petit Parisien	0.5	*429	698	Belgrade	4.0
*242	1,238	Belfast (2BE)	1.0	*368	875	Radio LL, Paris	1.0	*572	527	Ljubljana	5.0
*261	1,143	Newcastle (5NO)	1.0	*381	788	Radio Toulouse	0.0	LATVIA			
288.5	1,040	Swansea (5SX)	0.13	413	725	Radio Maroc (Rabat)	2.0	*525	572	Riga	2.0
288.5	1,040	Stoke-on-Trent (6ST)	0.13	436	687	Radio Flandre (Lille)	0.5	LITHUANIA			
288.5	1,040	Sheffield (6LF)	0.13	*447	671	Paris (Ecole Sup. PTT)	0.7	*1,035	155	Kovno	15.0
288.5	1,040	Plymouth (5PY)	0.13	*466	644	Lyons (PTT)	5.0	NORWAY			
288.5	1,040	Liverpool (6LV)	0.13	1,350	222	Tunis (testing)	2.0	*297	1,010	Notodden	0.7
288.5	1,040	Hull (6KH)	0.2	*1,444	207.5	Eiffel Tower	8.0	*364	824	Bergen	1.0
288.5	1,040	Edinburgh (2EH)	0.35	*1,725	174	Radio Paris	8.0	*387	774	Frederiksstad	1.0
288.5	1,040	Dundee (2DE)	0.13	GERMANY							
288.5	1,040	Bournemouth (6BM)	1.0	*218	1,373	Flensburg	1.5	*234	1,283	Muenster	4.0
288.5	1,040	Bradford (2LS)	0.13	*239	1,256	Nurnberg	4.0	*246	1,220	Kiel	0.7
*301	995	Aberdeen (2BD)	1.0	*246	1,220	Cassel	0.7	*253	1,134	Breslau	4.0
*310	968	Cardiff (5WA)	1.0	*259	1,157	Leipzig	4.0	*270	1,112	Kaiserslautern	1.5
*356	842	London (2LO)	2.0	*276	1,085	Koenigsberg	4.0	*283	1,058	Magdeburg	0.7
*377	797	Manchester (2ZY)	1.0	*283	1,058	Berlin (E.)	0.7	*283	1,058	Stettin	0.7
*399	753	Glasgow (5SC)	1.0	*310	941	Dresden	0.75	*325	923	Gleitwitz	6.0
*479	626	Daventry (5GB)	17.0	*339	887	Bremen	0.75	*360	833	Stuttgart	4.0
*1,553	193	Daventry (5XX)	25.0	*372	806	Hamburg	4.0	*390	770	Frankfurt	4.0
AUSTRIA											
*246	1,220	Linz	0.5	*418	716	Berlin	4.0	*453	662	Danzig	0.75
*285.5	1,051	Innsbruck	0.5	*453	666	Aachen	0.75	*473	635	Langenberg	25.0
*352	857	Graz	7.0	*533	503	Munich	4.0	*560	536	Augsburg	0.5
*453	666	Klagenfurt	0.5	*560	536	Hanover	0.7	*572	527	Freiburg	0.7
*517	581	Vienna	20.0	*1,635	183.5	Zezen	20.0	2,100	142	Norddeich	10.0
BELGIUM											
230	1,300	Chatelineau	0.25	2,290	131	GRAND DUCHY					
249	1,203	Schaerbeek	0.5	†223	1,346	Luxembourg	2	HOLLAND			
250	1,200	Ghent	0.5	31.4	9,554	Eindhoven	25.0	IRISH FREE STATE			
280	1,070	Liège	0.5	*208	1,004	Huizen (until 5.40 p.m. B.S.T.)	5.0	*225	1,337	Cork (5CK)	1.5
*509	590	Brussels	10.0	*1,072	280	Hilversum (ANRO)	5.0	*418	725	Dublin (2RN)	1.5
CZECHO-SLOVAKIA											
*263	1,139	Morava-Ostrava	12.0	ITALY							
*279	1,076	Bratislava (Feriby)	12.0	*274	1,094	Turin (Torino)	7.0	ICELAND			
*298	1,022	Kosice	2.0	*332	905	Naples (Napoli)	1.5	*1,200	250	Reykjavik	1.0
*342	878	Brunn (Brno)	2.4	*385	779	Genoa (IGE)	3.0	INDIAN FREE STATE			
*487	617	Prague (Prah)	5.0	*441	680	Rome (Roma)	3.0	*225	1,337	Cork (5CK)	1.5
DENMARK											
*281	1,067	Copenhagen (Kjobenhavn)	1.0	NETHERLANDS							
1,153	260	Kalundborg	7.5	*1,875	160	Huizen (after 5.40 p.m. B.S.T.)	5.0	PORTUGAL			
ESTHONIA											
*295	1,013	Reval (Tallinn)	1.3	*1,875	160	Scheveningen-Haven	5.0	*550	545	Buda-Pest	15.0
FINLAND											
*201	1,031	Helsingfors	0.8	RUSSIA							
*1,800	167	Lahti	20.0	*351	855.5	Leningrad	20.0	*427	702.5	Khar'kov (NKO)	5.0
FRANCE											
170	1,750	St. Quentin	0.25	*483	621.5	Homel	2.5	*825	364	Moscow (PTT)	25.0
212	1,415	Fécamp	0.3	*938	330	Leningrad	20.0	*1,304	230	Khar'kov	15.0
220	1,364	Beziers	0.1	*1,481	202.5	Moscow	30.0	SPAIN			
*237	1,265	Juan-les-Pins	0.4	*268	1,121	Barcelona (EAJ13)	10.0	314	956	Oviedo (EAJ19)	0.5
238	1,260	Bordeaux (Radio Sud-Ouest)	2.0	324	926	Almeria (EAJ18)	1.0	*349	860	Barcelona (EAJ1)	10.0
240	1,250	Radio Nimes	1.0	*368	815	Seville (EAJ5)	5.0	405	750	Madrid (Radio España)	1.0
*255	1,175	Toulouse (PTT)	1.0	405	740	San Sebastian (EAJ8)	0.5	*424	707	Madrid (EAJ7)	3.0
*265	1,130	Lille (PTT)	0.8	456	658	Salamanca (EAJ22)	0.53	SWEDEN			
*273	1,103	Rennes (PTT)	1.0	231	1,301	Malmö	0.5	*257	1,166	Hoerby	10.0
*286	1,049	Grenoble (PTT)	1.5	265	1,130	Trollhattan	0.4	*322	932	Goeteborg	6.0
292	1,028	Radio Lyons	1.5	322	932	Falun	0.5	*436	689	Stockholm	1.5
*293	1,022	Limoges (PTT)	0.5	*542	554	Sundsvall	1.0	*778	385	Ostersund	2.0
*304	986	Bordeaux-Lafayette (PTT)	0.5	1,200	250	Boden	2.0	*1,348	222.5	Motala	30.0
305	982	Agen	0.3	SWITZERLAND							
309	970	Vitus Paris	2.0	*403	743	Berne	1.0	*459	653	Zurich	0.6
*316	950	Marseilles (PTT)	0.5	678.7	442	Lausanne	0.6	760	395	Geneva	0.5
GERMANY											
450	666	Bolzano	0.3	1,010	297	Basle	0.25	TURKEY			
*501	599	Milan (Milano)	7.0	*1,200	250	Stamboul	5.0	YUGOSLAVIA			

Note.—As, on going to press, definite information is still lacking from some countries regarding the distribution of wavelengths allocated to them under the Plan d; Prague, the list could not be completely revised for this issue. All wavelengths marked with an asterisk have been allotted according to the Plan d; Prague. † May continue to transmit on 1.233 m. 251 Kc.

BOOM IN PORTABLE SETS

WYNDHAMS

OFFER A LIMITED NUMBER OF THEIR
5-VALVE PORTABLE SETS
In Leather Case Model at £9.10.0
Royalties included.
3-VALVE PORTABLE SETS
Morocco Rexine Case Model at £7.10.0
Royalties Included.

Carriage paid in U.K. Write or call at our saloon.
123 SHAFTESBURY AVENUE, LONDON, W.C.2

EDDYSTONE SHORT-WAVE APPARATUS

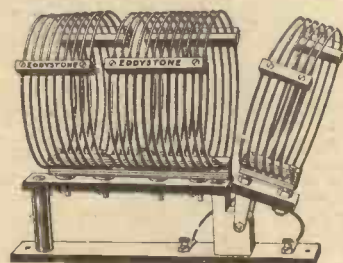

TYPE A.V. INDUCTANCE ASSEMBLY.

This complete inductance unit for short-wave reception consists of five interchangeable coils with mounting stand, the range from 18.90 metres being covered efficiently with a 0.0015 condenser. The arrangement makes use of aerial, grid and reaction coils; the first-named being variable to prevent blind tuning spots. Wound with well-spaced turns, entirely open core and low loss banana type mounting pins, the short wave performance of the coils is unequalled. Full circuit details enclosed. Extra B.C.C. coils can be supplied.

PRICE 20/- WITH STAND

Send for complete list (A) of short-wave apparatus

Sole Manufacturers: STRATTON & CO. LTD., Bromsgrove Street, BIRMINGHAM
London Service Depot: WEBB'S RADIO ELECTRIC STORES, 164, Charing Cross Road, W.C.2.



A MONEY SAVER

The ELECTRADIX NEW SALE LIST contains some wonderful Bargains in Gramo-motors and Panatropo Amplifiers, Scratch Filters, Mains Transformers, Motor Generators, 500 mfd. Condensers, new Light Weight Headphones, 3/6. Accumulators 6/-. House Telephones, 12/6 set. Galvos, Bridges, Telegraph Sets, Microphones, Testing Sets, Cheap Meters, Chokes, Moving-coil Loudspeakers 35/-. Wave Traps 15/-. 3 v. Receivers 27/6. Odd Portables, Cabinet Speakers. W.D. and Liquidator's stock all at under cost.

Send a dressed envelope and we mail you an Illustrated List.

ELECTRADIX RADIOS

218 Upper Thames Street, E.C.4. City 0191

THE ONLY UNIVERSALLY STANDARDISED COMPONENT IN RADIO!

Type "B" 6d.
Type "M" 4d.
Type "L" 3d.

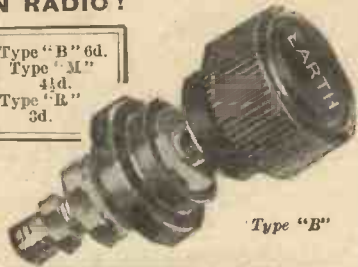

BELLING-LEE
TERMINALS

Elling & Lee Ltd., Queensway Works, Ponders End, Mdx.

CABINETS

PORTABLE - AMERICAN TYPE - PEDESTAL
Stock Sizes and to order.

SEND FOR ILLUSTRATED CATALOGUE

The NEOPHONE SEAMLESS VULCANITE CONE DIAPHRAGM consisting of 70% pure rubber. It affords perfect reproduction, and never breaks down. A perpetual guarantee given with every one. See report in "Amateur Wireless," June 15, 1929.

REWINDING ordinary types headphones, single earpiece, 2/6, per pair, 4/-. Remagnetising free with windings. Loudspeakers reconditioned from 4/-. Transformers from 4/-. Trade enquiries invited, Agents wanted.

THE NEOPHONE ENGINEERING CO.,
9/10, Little St. Andrew Street, LONDON, W.C.2

SPECIAL OFFER to "A.W." READERS

Invaluable information on aerials, earths, coils, accumulators, valves and a host of other subjects is contained in the AMATEUR WIRELESS DIARY, 1929

REDUCED TO Cloth 9d.
HALF-PRICE Leather 1s. 3d.
(Post Free)

Get one and use it as a reference book, only a few left. Send P.O. to-day to Bernard Jones Publications, Ltd., 58/61 Fetter Lane, London, E.C.4.

"WIRELESS MAGAZINE"

The Big British Wireless Monthly

1/-

LETTERS TO THE EDITOR

The Editor does not necessarily agree with the views expressed by correspondents.

The "Chapman Reinartz Two"

SIR,—I was very interested in the letter by W. (Hammersmith) re the "Chapman Reinartz Two." I have made it up also as a three, but transformer coupled, with a potentiometer across the L.T. and a .0002 fixed series aerial condenser. I can endorse everything said by your correspondent about the short-wave side of the set, but on the long-wave side I have had poor success.

In the short-wave coil I kept the discs $1\frac{1}{8}$ in. apart and in the long-wave coil $1\frac{1}{2}$ in. apart. The blueprint shows them much less than that, but the text gives two lengths of 2BA screwed rod, 3 in. long. It seems that the further they are apart, the better the selectivity, as I lose 5SC (seven miles away) on a good, high, outside aerial in two or three degrees, but when correctly tuned the volume is very good; the same applies to German stations, Belfast, and Newcastle. S. (Glasgow).

The "James Special 3"

SIR,—Some months ago I built the "James Special 3," using a pentode in the last stage and Mullard 4-volt valves.

I should like to express my very great appreciation of this set, which is easy to control, selective, and brings in most of the foreign stations at remarkable strength, combined with clarity and purity of tone.

I notice Mr. James states that no appreciable difference was found in completely shielding the valve. But I cannot agree, here in Leicester, with this, as it has made a remarkable difference both in power and stability. I can now tune in station after station without touching the volume control and without fear of squealing or oscillation. S. (Leicester).

5GB in Lancashire

SIR,—My experience of 5GB at Blackburn (twenty-one miles north-west of Manchester) may be of interest to readers. On the "Britain's Favourite Three" 5GB is very poor, fading out completely; but with the addition of a screen-grid unit it comes in splendidly and has to be checked, whilst fading is hardly noticed. 5GB with Dublin and Manchester gives three alternative programmes day and night, whilst on the long waves five good stations are available. W. (Blackburn).

Reception in Manchester

SIR,—Though I am not an amateur, I take AMATEUR WIRELESS to keep in touch with technical developments, and I should like to give those who, like J.R.B., are "wondering" a word of advice.

(Continued on next page)

Brownie



the "DOMINION" Slow Motion Dial

A Vernier Dial at 3/6! Bring your set up-to-date by fitting this slow motion dial. The mechanism is of special non-back-lash construction which makes very fine tuning easy. Finished in smooth black or beautifully grained mahogany bakelite, this unique dial gives high-class finish to every set in which it is included.

Brownie

wireless

NELSON ST. WORKS, LONDON, N.W.1

Easy Terms

YOU CHOOSE
YOUR GOODS
WE PAY FOR THEM

—Immediate delivery—
No troublesome enquiries

ALL ADVERTISED GOODS
IN THIS PAPER SUPPLIED

Let us know your requirements
We will quote you per return
POST COUPON FOR BIG
ILLUSTRATED LIST NOW!

Name

Address

Send to A.W. 6/7
NEW Times SALES CO.,
56 LUDGATE HILL, LONDON, E.C.4
PHONE CENTRAL 2716

OUR BLUEPRINT SERVICE

Constructors of receivers described in this Journal should make full use of our Blueprint Service and avoid all risk of failure.

Tunewell Coils

Special Notice.

An entirely new method of winding **Dual Range Coils** has been **recently provisionally patented**, and every post is bringing us letters of praise from satisfied users.

Coils for the following popular sets are in stock at most dealers:

COSSOR S.G.3	Price 21/- per pair
LISSEN S.G.3	
MULLARD S.G.P.3	
CLARION S.G.3	

—Your Dual Coils, in my Mullard S.G.P.3, are doing wonders, on the high waves especially, they beat the separate coils to a frazzle.

The above is an average sample of letters of appreciation:

Mullard Master 3, Bantam Three, Favourite 3, etc., Coils, Dual Range ... 7/9

H.F. Choke for the Local and Continental Three described in this issue, **5/9**

2-PIN COILS all sizes, from **1/6** each

6-PIN COILS all types, from **3/11** each

TURNER & CO., 54 Station Rd., N.11

WORTH THEIR WEIGHT IN GOLD

HEAYBERD Power TRANSFORMERS

Over 50 types available from stock for all methods of rectification.

The following for H.T. Eliminators—
All Centre Tapped.

200v 20ma, 4v	12/6	500v 100ma, 5v	32/6
400v 20ma, 4v	17/6	440v 120ma, 7.5v	32/6
300v 20ma, 5v	17/6	750v 60ma, 5v	40/-
440v 30ma, 4v	20/-	800v 120ma, 8v	55/-
400v 50ma, 5v	25/-	1000v 120ma, 8v	60/-
500v 50ma, 5v	28/-	2000v 120ma,	85/-
440v 30ma, 4v	and 4 volts 5 amps,		28/6

The following for Westinghouse Rectifiers—

230v 160ma ...	17/6	12v 1.5 amps	15/-
8.5v 1.5 amps	12/6	12v 3.2 amps	20/-
230v 100ma, 12v 1.5 amps.	45v 10ma		32/6

The following for A.C. Valves, etc.—

4 volts 3 amps	8/4	2 volts 3.5 amps	10/-
4 volts 5 amps	12/6	7.5 volts 3 amps	12/6
5 volts 3 amps	12/6	6 volts 3.5 amps	12/6

The following Power Chokes—

50 henrys 25ma	12/6	50 henrys 100ma	20/-
100 henrys 25ma	17/6	100 henrys 100 ma	25/-
30 henrys 50ma	12/6	17 henrys 100ma	15/-

Details with diagrams free on request.

F.C. HEAYBERD & CO
10, FINSBURY ST EC2
One Minute From Moorgate Station.

LETTERS TO THE EDITOR

(Continued from preceding page)

My own set is an unconventional S.G.4, including a switch to give anode or grid rectification, though it is only when searching that I use the grid leak, as I get over forty stations with anode bend.

Anyway, I have found the best all-round coils for an unneutralised S.G.—which is what most people want—are carefully wound basket coils. Heretical as this may seem, they are just so efficient as to set the H.F. valve oscillating when I force reaction.

I will mention here that Manchester is the worst spot I know for reception of Europe. Just under the Pennines, and liable to bursts of ship signals from the Ship Canal, while two miles away I have Manchester doing his worst to blot out everything. To sharpen tuning I use, for medium waves, 8 aerial turns and 60 grid turns. The second circuit is 60 turns in a tuned grid with Hartley reaction.

For long waves I use 220 turns in the aerial coil, with a tap at 90 (from the earth end) for aerial coupling. In the second circuit, 240 turns with 80 reaction (1/3 tap).

If J.R.B. makes up this circuit I think he will have no trouble on the score of weak signals or of flat tuning, and as it is a set which I use both for private and demonstration purposes the quality has to be right.

In closing, let me recommend an R.C. valve, with the grid coil earthed to L.T.—, as an anode detector. It may be used with 1/2-megohm anode resistance with good reaction and excellent quality. The only English station which I (and my friends) cannot get is 5GB, which is the bugbear of every Manchester wireless man. What about an alternative? Well, usually I fall back on Kalundborg.

H. M. (Manchester)

A serious indictment is being brought by certain Scottish listeners against the B.B.C. as to its sins of omission and neglect in both the quality and quantity of the programmes. With regard to the former, special objection is taken to alleged efforts to force English pronunciation upon the people, the frequent deprivation on Sundays of any church service except an English one, and the sending of English commentators to sporting events taking place in Scotland. With regard to the service area of the existing B.B.C. stations it is pointed out that it is almost impossible to find a place in England 100 miles from a broadcasting station, while a large part of the northern kingdom is over 100 miles from the nearest station, and some of it over 200 miles. For approximately similar areas England has twelve stations, using some 56 kilowatts, to Scotland's four stations with 2 1/2 kilowatts.

BLUEPRINTS

Copies of the "Wireless Magazine" and of "Amateur Wireless" containing descriptions of all these sets can be obtained at 1s. 3d. and 4d. respectively, post free, "Amateur Wireless" sets and "W.M." Index letters "A.W." refer to "Wireless Magazine" sets.

All Post Free

CRYSTAL SET (6d. each)

A Daventry-Local Crystal Set ... AW185

ONE-VALVE SETS (1s. each)

Beginner's One-valve ... AW149
Reinartz One ... WM127

TWO-VALVE SETS (1s. each)

East to West Short-wave Two (D, Trans) ... AW159
Beginner's Two (D, Trans) ... AW171
Auto Two (D, Trans) ... AW174
All-Mains Two (D, Trans) ... AW180
1929 Favourite Two (D, Trans) ... AW186
Loud-speaker America Two ... AW190
Key-to-the-Ether Two (D, Trans) ... WM107
Meteor Two (D, Trans) ... WM114
Clipper Two (D, Trans) ... WM125
Twimflex (Reflex) ... WM138
Continental Two (D, Trans) ... WM143

THREE-VALVE SETS (1s. each)

All-purpose Short-wave Three (D, RC, Trans) ... AW147
Screen-grid Q Coil Three (HF, D, Trans) ... AW150
All-Britain Three (HF, D, Trans) ... AW158
Bantam Three (D, RC, Trans) ... AW163
Hartley Dual-range Three (D, RC, Trans) ... AW165
Listener's Three (HF, D, Trans), price 4d. free with copy of "AW" ... AW169
The Binowave Three (D, RC, Trans) ... AW172
Clarion Three (SG, D, Trans) ... AW175
1929 Favourite Three (D, RC, Trans) ... AW179
Local and Continental Three (HF, D, Trans or D, RC, Trans) ... AW 189
Everyday (D, 2 Trans) ... WM51
All-wave Screen-grid Three (HF, D, Trans) ... WM110
Standard Coil Three (HF, D, Trans) ... WM117
Festival Three (D, 2 LF, dual Imp.) ... WM118
Wide-world Short-wave (SG, D, Trans) ... WM120
New Year Three (SG, D, Pentode) ... WM123
The Q3 (D, RC, Trans) ... WM124
Lodestone Three (HF, D, Trans) ... WM129
Simple Screen Three (HF, D, Trans) ... WM131
Dynamic Three (SG, D, Trans) ... WM136
At Home Three (D, 2RC) ... WM141
Short-Wave Link (D, RC, Trans) ... WM142

FOUR-VALVE SETS (1s, 6d. each)

Overseas Short-waver (HF, D, 2 Trans) ... AW133
Stability Four (HF, D, RC, Trans) ... AW182
Five-pounder Four (HF, D, RC, Trans) ... WM80
Touchstone (HF, D, RC, Trans) ... WM109
Reynier's Furzehill Four (SG, D, 2 Trans) ... WM112
Economy Screen-grid Four (SG, D, RC, Trans) ... WM113
Binowave Four (SG, D, RC, Trans) ... WM119
Standard-coil Four (HF, D, 2RC) ... WM122
Dominions Four (2SG, D, Trans) ... WM124
The Drum Major (HF, D, RC, Trans) ... WM137
Music Player (HF, D, RC, Trans) ... WM144

FIVE-VALVE SETS (1s. 6d. each)

"Q" Gang-control Five (2HF, D, 2 Trans) ... AW161
Fidelity Five (HF, D, 2RC) ... WM130
All-wave Lodestone Five (HF, D, RC, Push-pull) ... WM146

SIX-VALVE SETS (1s, 6d. each)

Short-wave Super-6 (Super-het, Trans) ... AW67
Eagle Six (3 HF, D, RC, Trans) ... WM106

AMPLIFIERS (1s. each)

"A.W." Gramophone Amplifier (3RC) ... AW162
Searcher Unit (HF) ... AW176
Gramophone Amplifier (3 v.) ... AW187
Signal Booster (HF Unit) ... WM128
Auditrol Amplifier ... WM134

MISCELLANEOUS (1s. each)

H.T. Eliminator for A.C. (200 v. output) ... AW102
L.T. and H.T. Mains Unit (D.C.) ... AW123
Listener's Speaker, price 4d. free with copy of "AW" ... AW170
Arcadian Linen-diaphragm Loud-speaker (Full-size) ... AW177A
D.C. Unit (HT) ... AW178
Short-wave Adaptor (1 v.) ... AW183
High-tension Battery Charger ... AW191
Universal Short-wave Adaptor ... WM82
Buzzer Wavemeter (6d.) ... WM121
H.T. Unit for A.C. Mains ... WM125
Lodestone Loud-speaker ... WM126
James H.T. Unit for D.C. Mains ... WM133
Short-wave Adaptor for Dominions Five ... WM140
Two Ampere Low-tension Unit ... WM147
A.C. Mains Amplifier ... WM148

PORTABLE SETS

House Portable (SG, D, RC, Trans) ... AW163 1/6
Arcadian Portable (SG, D, 2 Trans) with linen-diaphragm loud-speaker (half scale) ... AW177 1/6
£5.5.0 Portable (D, Trans) ... AW181 1/6
Talisman Portable (SG, D, 2 Trans) ... AW184 1/6
Holiday Portable Three (D, 2 Trans) ... AW183 1/-
Chummy 4 (with modifications for L.S. and H.T.) ... WM80A 1/6
Wayfarer Portable (Super-het) ... WM139 1/6
1929 Chummy (SG, D, Trans, RC) ... WM145 1/6
Picnic Portable (D, RC, Trans) ... WM149 1/-

When ordering Blueprints please send Postal Order NOT STAMPS

AMATEUR WIRELESS 58-61 FETTER LANE LONDON, E.C.4

CELLS THAT BREATHE

By DR. SYDNEY BRYDON

FROM time to time a great deal of consideration has been given to the use of primary cells for valve filament heating. It may, therefore, be of interest to know of tests which have been made with air depolarising cells known as A.D. cells and which are now being made and marketed in this country by Le Carbone.

A Typical Cell

A large-type cell is listed by them, No. 222, and called the Radio Cell of 500 ampere-hour capacity, but seeing that fresh discharges operate by changing the zinc, it really can be called a 1,500 ampere-hour cell over three zinc cycles. When used on sets fitted with D.E. valves, it is quite possible to operate a 3- or 4-valve set twelve months or more without any recharging or maintenance of any kind. It is apparent therefore that in those cases where accumulator charging presents a difficulty such cells should be a great boon.

The complete cell consists of (1) a composition or glass container; (2) a renewable zinc; (3) a carbon electrode.

The whole is set in action by the addition of a saturated solution of salammoniac.

The discharge rate of this large primary cell can be as high as 1½ amperes and at this current the voltage will be about 1; at ½ ampere the voltage would be 1.1.

Performance on Dull-emitter Valves

There are now on the market many D.E. valves operating at 2 volts or less and two of the above cells in series would more than give the required voltage so that with such an installation, a small low-resistance series regulator will adjust the terminal volts perfectly satisfactorily.

In burning hours the results would be somewhat as follows:—

No. of valves.	Total current	A/h per 4-hour day	Life per zinc discharge.
1	100 m.a.	0.4	1,250 days
2	200 m.a.	.8	625 days
3	300 m.a.	1.2	313 days

It is not necessary to limit the output to 300 m.a. for, as was stated above, a current of ¾ ampere to 1 ampere can be discharged for semi-continuous periods of 3 to 4 hours daily so that combinations of valves can be arranged to meet this heavier discharge, the limit of output being about 1 to 1½ amperes.

The great feature of these cells, however, is that the above figures relate to 1 zinc cycle so that the cells can be renewed by putting in a new zinc and fresh salammoniac charge. The carbon electrodes are good for three or more discharges.

What has been said of the large cell mentioned above also applies to two smaller types. No. 229, maximum output 300 m.a. No. 240, maximum output 120 m.a.

(Continued on next pag.)

SPLENDID 3 VALVE LOUD-SPEAKER

SETS READY TO USE In Handsome Cabinet.

Receives London 5GB, 5XX, and many Continental Stations D. & 2 L.F.



NO COILS TO CHANGE JUST SWITCH ON, THAT'S ALL

Complete with 3 Dullemitter Valves, S.M. Dial. All parts on Baseboard. Hinged Lid. Various Panel Designs. CANNOT BE REPEATED. Packing and Carriage 3/6.

65/-

Tunewell Dual

500/2000 5-pin Base, 1/6

PANEL MOUNTING 10/6 PUSH PULL

TUNEWELL COILS or MULLARD S.G.P.3 Aerial or Anode, BBC or Long-wave, 7/10 pair.

DUAL C. TAPPED with reaction

AERIAL ANODE 10/6 each.

FOR CLARION (post extra)

WEST END DEPOT or TUNEWELL COILS TRADE SUPPLIED

Wholesale and Retail

Edison Bell, Lissen, Dubilier, Igranite, Lotus, Ferranti, Celestion, Cossor, Ediswan, McMichael, Watson, Clydon, Climax, Ormond, Pro, J.B., Polymet, T.C.C., W.B., Phillips, Ecko, Amplicon Components, Speakers, Units, wholesale and retail.

SIEMENS H.T. BATTERIES, 60 v., 8/-; 60 v. Power, 13/6; 108 v. 13/-; 100 v. Power, 22/6; 9 and 4 v. G.B. L.T. BATTERIES. Exide D.F.9, 8/6; Exide D.M.G., 11/-; D.H.9, 14/6; Oldham 1V.D., 9/-; U.V.D., 14/-. All with carrier. Carr. extra on Batteries except by arrangement.



HANDSOME OAK POLISHED SPEAKER CABINETS

13x13x6 Similar to sketch

12/11 Post 1/3

BLUE SPOT 25/-

66K (101)

GENUINE ADJUSTABLE

4 POLE BAL. ARMATURE

OR CABINET

BLUESPOT as above 35/-

& 12" CONE

THE LOT POST FREE

With TRIOTRON ADJUSTABLE 4-POLE UNIT AND 12-in. CONE 27/6

TRIOTRON UNIT Adjustable 4-pole Bal. 17/6 Arm. Carriage Paid

ALUMINIUM CRADLE. With fitted 10 in. Floating Cone and 12 in. Square Baffle Board. Takes all Bal. Arm. Units. Post 9d. U.K. 7/11

CONE CHASSIS. Blue Spot (metal) with conedia. 10 1/2 in., depth 2 1/2 in. 12/6. Squire latest, velum Cone on handsome enamelled plate, 15/- Goodman, 12/6 and 16/6.

OSRAM MUSIC MAGNET. Kit of genuine parts by G.E.C. and 3 Osram Valves, as specified. Handsome 25/- Cabinet (Oak or Mahogany) sold with above for 2/6. No Coupon or Voucher allowed on this offer. £8.12.6

SEE FULL PAGE "A.W." JUNE 15, 1929

SETS OF PARTS LEADING HOUR

Space too limited to advertise the many and varied circuits, but if your order is OVER 25/- will give you a reduced inclusive price. All parts in stock for Osram Magnet, Cossor Sealed Kit, Clarion S.G.3, Champion 3, Digger, Radiano 3, Concert 4, Radiano 4. Any circuit (where possible) quoted for. Illustrated Catalogue, 144 pp., 1/- Refunded on first 10/- order.

SPECIAL VOUCHER

A.W. 29-6-29
X MUST NOT be used on same order as COUPON X
THIS VOUCHER IS ONLY AVAILABLE AT RAYMONDS (Retail) AND IS WORTH
On £2 Order (and over) 2/- Cash
On £5 " " " 5/- Cash
On £10 " " " 20/- Cash
PRESENT VOUCHER WITH ORDER
 (Not available Hire Purchase transactions.)
ISSUED AS AN ADVERTISEMENT ONLY.

RAYMOND'S for Wireless

27 & 28a, LISLE ST., LONDON, W.C.2

Come to LEICESTER SQUARE TUBE. This address is at the back of Daly's Theatre Phones Gerrard 4637 and 2821

WE ARE OPEN ALL DAY SATURDAY ALL DAY THURSDAY ALL DAY EVERY DAY Hours 9 a.m. to 8 p.m Sat. 9 a.m. to 9 p.m. Sunday morning 11-1

QUOTATIONS for SETS OF PARTS SPECIAL PRICES on LISTS of 25/- and over CALLERS or POST.

CLARION S.G.3

KIT OF PARTS 2 Polar Units, No. 3 at 9/8. 0001 Reaction, 4/-; 2 Dual range C.T. Coils, with Reaction (Tunewell), Anode, 10/6; Aerial, 10/6. 3 Lotus or W.B. V.H. at 1/3. Formodenser, "J", 2/-; Dubilier 1 mfd., 2/6. 01 Fixed, T.C.C., 1/8. 3-meg. Lissen or Edison Bell, 1/-; S.G. H.F. Choke, Peto-Scott, 5/-; H.F. Choke, Lissen, 5/8. L.F. Transformer, R.I. and Varley, 15/-; Ebonite Strips. 14x7 Ebonite Panel. Screen, 8 1/2 x 3. 8 Engraved Terminals. Push-pull Switch. Flex. Plug, 16-g. Wire. 2 S.M. Dials.

THE LOT 70/-

POST FREE U.K. .0002 Fixed and Series Clips 1/3 16 EXTRA C.O.D.

BRITAIN'S FAV. 2 (UP-TO-DATE.) COMPONENTS

Ormond .0005, 6/-; .00025, 5/6; 7-ohm Ormond, 2/-; 2 W.B. V.H., 2/6; 6 pin Base, 2/-; .0003 and Series Clip, 1/6; 2-meg. leak, 1/-; H.F. Choke, 5/8; L.F. Transformer, Lissen 8/6; Push Pull, 1/3; Tunewell Dual Range Coil, 7/9. PLEASE ADD POSTAGE

WORLD RECEPTION ON YOUR SET

A.W. Short-wave adapter. .00015 Short-wave Condenser with S.M. movement or Dial, 12/- (Ormond or Polar); Reaction, Polan 5/8; 7-ohm Panel Choke, 2/8; 6-pin Base, 2/-; Spring V. Holder, 13/-; 0001 fixed, 3-meg. Leak and Holder 2/6; V. Holder, Plug Clip, 2/-; Total, including Short-wave Choke, Connecting Wire, A. and E. Terminals, Flex, Screws, Baseboard, and Panel. The Lot 30/- Post free U.K. (1/3 C.O.D.) Lewcos AMS4, AMS9, for above 7/6 each.

VALVES

Cossor 210BC, H.F. L.F. Mullard PM1A, H.F. L.F. Six-Sixty RC. H.F. L.F. Marconi DEH210. H.L. DEL. Osram DEH210, H.L. DEL. Ediswan RC, H.F. L.F. 12/6 each. Cossor 220P. Mullard PM2. Six-Sixty 215P. Marconi DEH215. (Osram same). Ediswan PV215. 15/- each. Cossor 230P. Mullard 252, Six-Sixty 230SP. Marconi 240 (Osram same). Ediswan PV235. Screened Grid, 22/6. Pentodes 25/-.

VALVES

DARIO RADIO-MICRO 4-v. 6.4 9/6 Super Power 2/6 Super H.F. 2-v. or 4-v. ea. 7/6 Post 3d. 63 Post 5/- each. TRIOTRON H.F. Det., R.C. 5/2 each; Power 3/8. 2-v. or 4-v. Post 4d. 2 post free. CLEARTRON SCREEN GRID 2-volt, 12/6; usual types, 4/-; R.C. or Power, 6/-. Post 3d.

VALVES for CLARION 3

Screened Grid, Marconi Mullard, Six-Sixty, 22/6 each Detector, 10/6. Power, 12/6 CLEARTRON S.G., 2-v., 12/6. C.T.15, L.F. or H.F., 4/-; C.T.15X, P.6/- DEFINITELY CUTS OUT 2LO AT 1 MILE and obtains 5GB, 5XX and Continental Stations with 2LO working.

REGENTONE MAINS UNIT

H.T. No. W1B £4 : 19 : 6 120 v. at 18 M.A.

A.W., 25th May, 1929 IF YOUR ORDER FOR FAV. 2 PARTS EXCEEDS

32/- YOU CAN BUY for 1/- extra

14x7 Ebonite Panel, Pair Panel Brackets, Baseboard, Battery Clips, 8 Engraved Terminals, Wire, Flex Plugs

LATEST LINES

Postage Paid U.K. for Cash with Order, except where stated. R.I. Hyperion L.F. 21/- Geophone adble. Reed Unit 15/- Lotus L.F. Transformer 12/6 Phillips aerial/Discharger 9/6 Clydon Bebe, 8009 8/- B.T.H. Pick-up Tone Arm 45/- Ultra Short-wave Coils 7/6 1929 Cossor S.G. 3, pair 7/6 B.B.O. Do. 12/6 Longwave 15/- Wates 3 in 1 Meters 8/6 Case for same 2/- All Standard Wet H.T. Parts. All Oldham & Exide L.T. Accumulators. R.T. Batta: Ever-Ready, Siemens, Nipaults, Carnelite and Syverex. Carriage extra on batteries. Amplicon "Guinea" Conc 21/- Ericsson British Phones 12/6 Browns Do. Do. 20/- B.H.T. Do. Do. 15/- All 4000 ohms. Igranite S.M. Dials 6/- Igranite 500 to 1 ratio 9/- Igranite Micro, 4/- Panel Marconi Short-wave Coils, 16 to 50 meters, per set (and base) 32/- Mullard R.C.C. Unit 17/6 R.I. type A, Unit 20/- Mullard Combined Condensers, Leak and Base 7/8 B.T.H. Speaker CT3 (Horn) 45/- B.T.H. Speaker (Cone) 60/- Celestion models from £5 10 6 Engraved Terminals for standard names, 10 for 3/- R.C.C. Units (2 leaks) 4/- (State merolome). Telsen Radiogram L.F. 12/6 Dubilier H.F. Choke 4/6 British General Tuner 18/6 Eight All-wave Tuner 15/- Set 4 shortwave Coils 7/6 Ormond Furntable 6/- R.I. Pentode Transformer 21/- Standard Loading Coils 7/6 Voltmeters for H.T. and L.T. 5/3 Clydon 5005 10/8 Dubilier 6005 Friction do. 12/- J.B. 0005 H.6 Friction do. 14/6

A.W. SPECIAL COUPON (74)

FOR EVERY 25/- you spend retail YOU CAN buy ONE of the following for 3d. each extra (on this Coupon)

H.F. Choke, 51k Loud-speaker Cord, 9-volt Grid Bias, Pair Panel Brackets, 0001 Reaction, 2 mid. Mansbridge, 100 ft. Insulated Aerial, 4- or 5-way Battery Leads, 30 ft. Coloured Connecting Wire, S.M. Dial, 12 yds. Lead-in, Fuse and Holder, 12 Nickel Terminals, 60X Coil, Permanent Detector, Battery Switch, 0003 and 2-meg. Leak, 6-pin Coil Base, 12 yds. Twin Flex, 100 ft. Indoor Aerial, 8005 Variable, Set of 12 Plugs and Sockets (red or black), Set of 3 Coil Plugs with Terminals, Wave Change Switch, 01 Fixed Condenser, 1 mid.

NOT AVAILABLE H.P. OR WITH CASH VOUCHER

"CELLS THAT BREATHE"

(Continued from preceding page)

It will be seen, therefore, that the No. 229 would be suitable for a 3-valve set using, say, two .06 valves plus one .1 valve and that the No. 240 would cope with a small set using, say, two .06 valves.

The operating volts of these cells are clearly seen from the following tabulation. The reading gives the volts at varying discharge rates in milliamperes.

VOLTS AT VARYING DISCHARGE RATES.

Type.	60m.a.	120m.a.	300m.a.	500m.a.	1 amp.
222	1.22 V.	1.15 V.	1.10 V.	1 V.	
229	1.10 V.	1.0 V.			
240	1.10 V.	1.0 V.			

The above readings are good for a normal temperature of 60° F.; there may naturally be slight variations between hot and cold weather, as is well known by all who have made tests of primary cells.

As to the method of setting up and operation of these cells no difficulty presents itself and, of course, they require no charging as is the case with accumulators. The correct charge of salammoniac can be supplied with each cell. The charge is placed in the container, water is added and after being well stirred the zinc and centre electrode are then inserted. The cell is then immediately ready for operation.

If the cells are worked at their maximum output, say 1½ amperes, a certain amount of crystallisation occurs, but this is normal, and cannot be said to be detrimental. It is wise, however, occasionally to examine the cells and if the crystals are noticed they can with advantage be broken or disturbed by shaking the centre electrode, thus freeing and at the same time releasing gases which may be at the bottom of the cell. These crystals are not noticed at lighter current drains.

When the cell is finally exhausted, due to the zinc being consumed, it can be charged a second time by fitting a new zinc and a fresh charge of salammoniac.

Depolarising by Breathing

The continued operation of the carbon electrode is due to what is known as air depolarisation. There is no chemical mixture in the positive element which consists of a coarse-grained carbon, watertight on the surface, but allowing gases to pass so as to depolarise the cell. The formula is as follows:

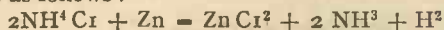

The superiority of this class of primary cell lies in the great porosity of the carbon which renders possible a very rapid circulation of the gases, resulting in quick depolarisation.

There is something almost human in the functioning of A.D. cells, as the action of depolarisation is dependent upon the "breathing" capacity of the carbon. The free circulation of air is advisable when these cells are being used to enable the carbon to be saturated with the correct

quantity of oxygen necessary for efficient operation.

There is no doubt that air depolarisation has now been proved to be a commercial success and with such cells as the above a great advance has been made in primary cell construction.

THE "TALISMAN PORTABLE"

SOME readers have experienced difficulty in obtaining the Marconiphone H.F. by-pass units specified for inclusion in the "Talisman Portable," so we take this opportunity of suggesting a suitable alternative system of connections.

Alternative components required are a Wearite 500-ohms stopper resistance and a .001-microfarad fixed condenser. The latter may be any reliable make having a mica dielectric such as the Dubilier, T.C.C., Lissen, Edison Bell, Mullard, Graham-Farish, etc.

Referring to the wiring plan and the plan drawing of the H.F. by-pass unit in particular, the centre terminal of the unit forms the junction between one side of the fixed condenser and one end of the 500-ohm resistance. The terminal marked "R" represents the other end of the resistance, and the terminal marked "C" is the other terminal of the .001-microfarad condenser.

If constructors will wire up the two separate components, bearing in mind the above sequence of connections, they will have no difficulty in getting satisfactory results with the substituted components.

With the granting of a construction permit to station WTAM (Cleveland) for high power, the list of 50,000-watt stations in the United States grows. The following stations are now using 50,000 watts: WEAF (New York), WGY (Schenectady), WENR (Chicago), WLW (Cincinnati), KDKA (Pittsburgh). Stations which have been granted construction permits to install 50,000-watt transmitters are as follows: WTAM (Cleveland), WCFL (Chicago), WBAP (Fort Worth), KFI (Los Angeles), WOAI (San Antonio), WFAA (Dallas).

"Amateur Wireless and Radiovision." Price Three pence. Published on Thursdays and bearing the date of Saturday immediately following. Post free to any part of the world: 3 months, 4s. 6d.; 6 months, 8s. 9d.; 12 months, 17s. 6d. Postal Orders, Post Office Orders, or Cheques should be made payable to "Bernard Jones Publications, Ltd."

General Correspondence is to be brief and written on one side of the paper only. All sketches and drawings to be on separate sheets. Contributions are always welcome, and will be promptly considered, and if used will be paid for. Queries should be addressed to the Editor, and the conditions printed at the head of "Our Information Bureau" should be closely observed. Communications should be addressed, according to their nature, to the Editor, The Advertisement Manager, or the Publisher, "Amateur Wireless," 58-61 Fetter Lane, London, E.C.4.

PREPAID ADVERTISEMENTS

Advertisements under this head are charged THREEPENCE PER WORD, minimum charge THREE SHILLINGS.

DEPOSIT SYSTEM

As the Publishers cannot accept responsibility for the bona fides of advertisers in this publication, they have introduced a system of deposit which it is recommended should be adopted by readers when dealing with persons with whom they are unacquainted. It is here explained.

Intending purchasers should forward to the Publishers the amount of the purchase money of the article advertised. This will be acknowledged to both the Depositor and the Vendor, whose names and addresses must necessarily be given. The Deposit is retained until advice is received of the completion of the purchase, or of the article having been returned to and accepted by the Vendor. In addition to the amount of the Deposit, a Fee of 6d. for sums of £1 and under, and 1s. for amounts in excess of £1, to cover postage, etc., must be remitted at the same time. In cases of persons not resident within the United Kingdom, double fees are charged.

The amount of the Deposit and Fee must be remitted by Postal Order or Registered Letter (Cheques cannot be accepted), addressed to

"AMATEUR WIRELESS," ADVERTISEMENT DEPARTMENT, 58/61, FETTER LANE, LONDON, E.C.4.

PATENTS.—Trade Marks, Advice Handbook free.—B. T. King, Regd. Patent Agent, 146 Queen Victoria Street, London.

DECORATE YOUR LOUD-SPEAKER YOURSELF. Transfers giving painted effects on Fabric, Wood, Metal, etc. Sample and catalogue 1/- A.W., Axon Ltd., Jersey, England.

FOR SALE—4-Valve wireless set, complete, F.P.F. Circuit. £7. Regal, 128 Bravington Road, Paddington, W.9.

TAYLOR WET H.T. BATTERIES

New Prices: Jars 1.3. Sacs 1/2. Zinc 10/1. Sample 4s., 18 Volts complete with bands and electrolyte 4/1. post 3/1. Sample unit 6d. Illus. booklet free. Bargain list free. AMPLIFIERS, 30/-. 3 VALVE ALL-STATION SET £5. A. TAYLOR, 57 Studley Road, Stockwell, LONDON

SINQUERS

SAVE YOUR ACCUMULATORS

Double the life of your cells! Avoid being let down by a run-out accumulator. Sinquers tell you the exact state of your battery and warn you when it needs recharging. Just drop them in and leave them to it.

1/- per carton from most dealers or 1/3 post free from actual makers. FIDDIAN BAWTREE & CO., Oakhill Road, Sutton.

22 in. LINEN SPEAKER

GREAT SUCCESS. DELIGHTED CUSTOMERS

Complete Kit of the very best. Post Free. Cut price without Unit or Baffle boards. Rubber 2/- extra order. Separate parts supplied. Send With 66K "Blue Spot" Unit 4 1/6 stamp.

Made up complete, less unit and baffle 36/- LOWNE ELECTRIC CLOCK CO. Boones St., Lee, London, S.E.13. Phone: Lee Green 0143

THE LITTLE CELLS THAT SATISFY

Leyton Primary H.T. Battery, Pl Porous Pot Cells, S1. & S2 Sac Cells. All complete for assembly.

	1-cell.	6-cell.	12-cell.	30-cell.
P1	1/6	3/3	5/9	14/-
S1	6d.	3/-	5/3	12/-

"Easeful" Filler: 3-pint 1/-; Pint 1/6. Post 3d extra

Send 1d. stamp for booklet giving full particulars to—
THE LEYTON BATTERY Co.
305 CHURCH ROAD - LEYTON - E.10

REPAIRS

Any make of L.F. Transformer, Loud-speaker or Headphones repaired and dispatched within 48 HOURS—TWELVE MONTHS' GUARANTEE with each repair. 4/- Post Free.

Terms to Trade

TRANSFORMER REPAIR CO.

"Service" Dept.
214 High Street, Colliers Wood, London S.W.13

WIRELESS CABINETS

MAKE YOUR OWN

Send stamp for Free catalogue and price list.

WOODWORK, 199 HIGH ROAD, LEE, LONDON, S.E.13.

OUR BLUEPRINT SERVICE

Constructors of receivers described in this journal should make full use of our Blueprint Service and avoid all risk of failure.

DUBILIER FOR STAUNCH RESISTANCES

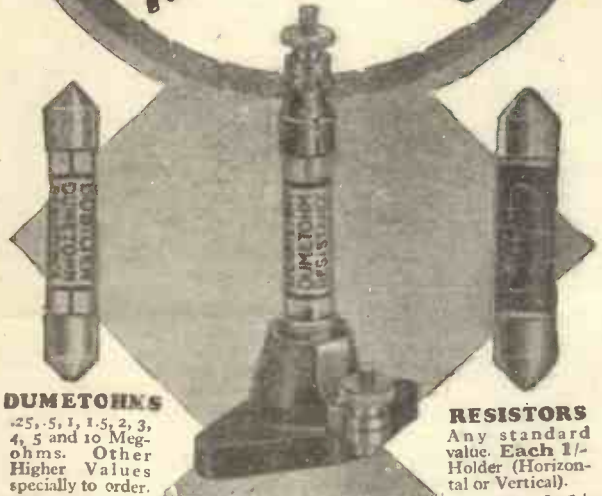

DUMETOHMS

25, 5, 1, 1.5, 2, 3, 4, 5 and 10 Meg-ohms. Other Higher Values specially to order. Each 2/6

RESISTORS

Any standard value. Each 1/- Holder (Horizontal or Vertical). Each 1/-

Vertical Holder
Each 1/-

Horizontal Holder
Each 1/-

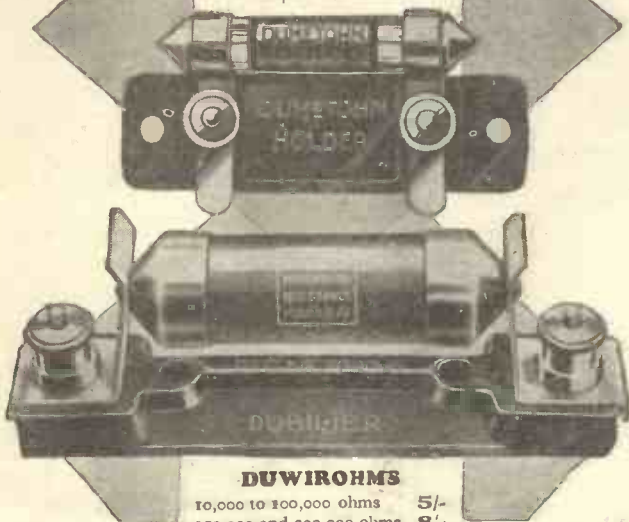

DUWIROHMS

10,000 to 100,000 ohms	5/-
150,000 and 200,000 ohms	8/-
250,000 ohms	9/9
300,000 ohms	11/6
Holder	1/6

"TOREADOR SCREEN-GRID FOUR." This set incorporates the latest developments in Receiver design—full constructional details free on request.

DUBILIER RESISTANCES

If obtainable from your dealer, write direct to us giving his name and address.

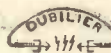

Dubilier Condenser Co. (1925) Ltd., Ducon Works, Victoria Road, N. Acton, London, W.3.

250/R

The new Lotus Transformer gives you an unexcelled performance—

and costs only

12/6



Your set will leap into life when you fit the new Lotus Transformer. For purity, tone and good amplification this transformer is absolutely unexcelled at the price and gives as good a performance as you will get from a transformer at a higher figure.

HAVE YOU SEEN THE NEW LOTUS 5-PIN VALVE HOLDER FOR A.C. VALVES ?

If you are building an All Mains set, this is the valve holder you need. It is rigid—not anti-microphonic, the stronger filament of an A.C. Valve does not demand the anti-microphonic type. Made for 5-pin valves, it will also accept a 4-pin valve and can be used for screened grids and pentodes with equal ease and success. It is only 1 1/8 in. in diameter and is available both with and without nuts.

Price 1/6

Made with all the care, accuracy and handsome finish typical of every Lotus component, this is the transformer you must get for your next set.

From all Radio Dealers.

LOTUS COMPONENTS

GARNETT WHITELEY & CO., LTD., Lotus Works, Liverpool.

Caution

You will Help Yourself and Help Us by Mentioning "A.W." to Advertisers



another triumph

The DUAL ASTATIC H.F. CHOKE

MODERN VALVES NEED MODERN H.F. CHOKES

The Dual Astatic is the first choke absolutely suitable for all receiver circuits, including modern screened grid receivers.

NOTE THE CURVE COMPARISONS

The urgent need for this new Choke is apparent from the curves of existing commercial Chokes shown here. The thick line "A" represents the R.I. Choke, the superiority of which is outstanding, specially on the short wavebands.

NO ENERGY ABSORPTION

Energy loss due to internal resonance is non-existent in this Choke.

COVERS ALL BROADCASTING BANDS

The high impedance absolutely essential for broadcast wavelengths is assured by the use of the Dual Astatic Choke, without the usual reduction associated with Chokes of other makes on the shorter wavebands.

Write for the DUAL ASTATIC CHOKE LEAFLET
Our leaflet will tell you all about H.F. Chokes and the advantages of the Dual Astatic type. It contains valuable and useful information. Write for a copy—it is quite free.

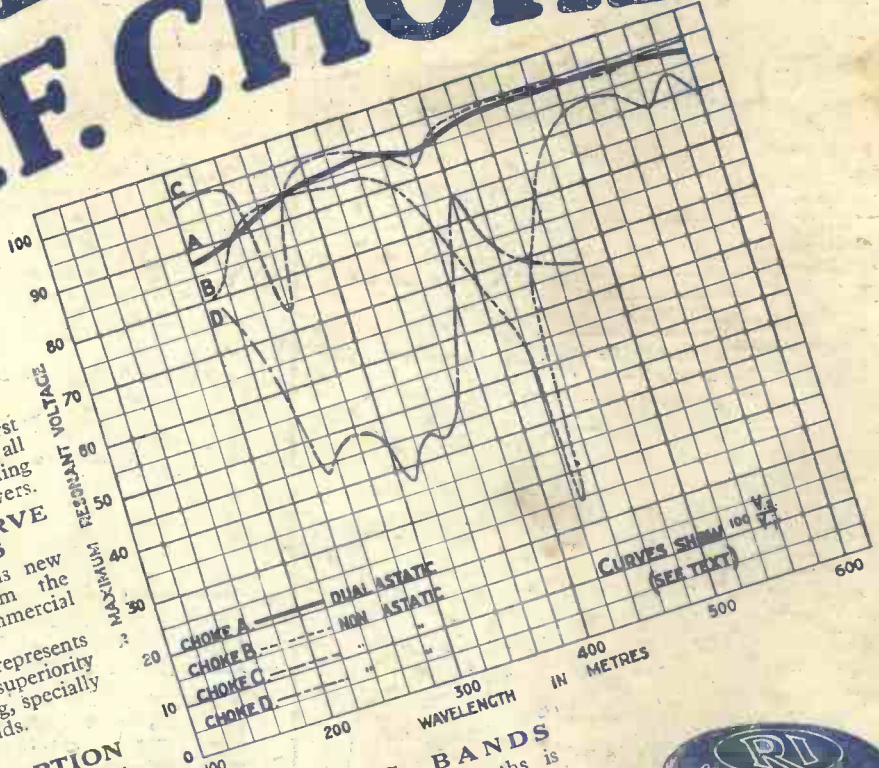

R.I. DUAL ASTATIC CHOKE
The Choke which gives absolutely non-resonant operation and total freedom from blind spots. Overall height 3 1/2 in., base, 2 in. square. PRICE **7/6**

RADIO INSTRUMENTS, LTD., Specialists in Sound Reproduction
Sole Address: Offices, Showrooms & Factories: 12, HYDE ST., NEW OXFORD ST., LONDON, W.C.1

WINDING TUNING COILS :: "JUICE" FOR PORTABLES

Amateur Wireless

Every
Thursday 3^d

and
Radiovision

Vol. XV. No. 370

Saturday, July 13, 1929



**PRACTICAL
COIL
MAKING**

By W. JAMES

for the
HOME CONSTRUCTOR

Carry SILENT POWER to YOUR Set

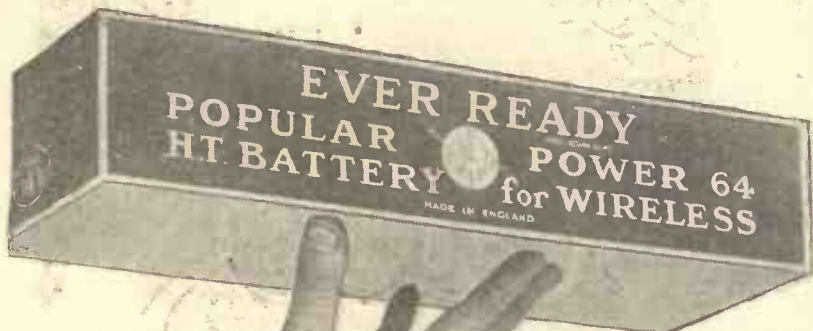

"POPULAR POWER" H.T. BATTERIES

E.M.F. Volts	Price	
60	13/6	
64	14/6	
99	22/-	
105	24/-	
120	27/-	

EVER READY

BRITAIN'S BEST BATTERIES

IN THESE FACTS LIES OF SUPERIORITY

- (1) It fits the standard six-pin Base.
- (2) The Aerial Coil can be used as a Grid Coil followed by one or more H.F. stages, alternatively as a Reinartz Aerial Coil with Plug-on reaction winding.

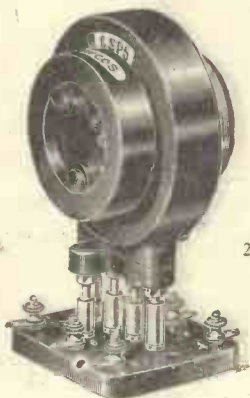

Pat. No. 285723

- (3) The H.F. Transformer, with plug-on Primary winding, can be used with three-electrode valves alternatively with Screened-grid valves.

- (4) Range of Primary Coils gives wide choice regarding selectivity.

Send to-day for full particulars and diagrams.

Lewcos Radio Components are available at 7 Playhouse Yard, Golden Lane, London, E.C.

LEWCOS THE SIX-PIN SUPER COIL



LEWCOS RADIO PRODUCTS FOR BETTER RECEPTION

LEWCOS

SUPER SIX-PIN COIL *Regd.*

LEWCOS COILS are available for the MULLARD S.G.P. MASTER 3

225/550 metres Ref. AM5 10/-
1,000/2,000 .. Ref. AM20 10/-
Six-Pin Bases Ref. SPB 2/9

THE LONDON ELECTRIC WIRE COMPANY AND SMITHS LIMITED, CHURCH ROAD, LEYTON, LONDON, E.10.

Advertisers Appreciate Mention of "A.W." with Your Order

S'easy, now!



Soldering was a hard job before

FLUXITE

came along

FLUXITE is sold in tins, price 8d., 1/4 and 2s. Another use for Fluxite: Hardening Tools and Case Hardening.

Ask for leaflet on improved methods

FLUXITE LTD.,
(Dept. 326)
Rotherhithe, S.E.1

SOLDERING SET Complete
7/6
or LAMP only 2/6

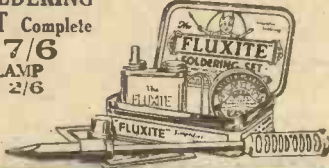

- IT SIMPLIFIES ALL SOLDERING

HELLESEN
DRY BATTERIES

SINCE 1887



In 1887 Helleesen invented his first dry cell.

For over 40 years Helleesens have concentrated exclusively on the manufacture of dry batteries, and to-day three large works and a small army of chemists are devoting their entire energies to maintaining the superiority of the Helleesen Battery.

There are more than 100,000 Helleesen dealers, and they are found carrying on the good work from London to Sydney and from Reykjavik to Valparaiso.

The Helleesen Battery is acknowledged as the standard against which other batteries are compared, and it is a proud position that has been won and maintained by one thing only—sheer merit.

- Standard Capacity.
 - "Wiray" 9-volt Grid Bias Type 2/-
 - "Wirin" 60-volt H.T. Type ... 10/6
 - "Wirup" 99-volt H.T. Type ... 18/-
 - "Wisol" 108-volt H.T. Type ... 20/-
 - Treble Capacity.
 - "Kelin" 60-volt H.T. Type ... 19/-
 - "Kelup" 99-volt H.T. Type ... 32/6
- Your Dealer Sells Them.

HUNTS

HELLESEN DRY BATTERIES,
ELECTRICAL MEASURING INSTRUMENTS,
POLYMET MICA and PAPER CONDENSERS,
HANDLAMPS, TORCHES, ETC.

P. & T.

A. H. HUNT, LTD., CROYDON, SURREY

You will Help Yourself and Help Us by Mentioning "A.W." to Advertisers

BLUE SPOT 49



£2.2.0

We could tell you enough about the Blue Spot 49 to fill a dozen spaces as large as this!

But we will content ourselves with saying this:—

To possess a Blue Spot 49 is almost as good as being in the broadcasting studio. The difference being you can't see the artistes.



Hear it at your nearest dealer's

F. A. HUGHES & CO., LIMITED,
204-6 Great Portland Street, London, W.1.

Distributors for Northern England, Scotland and North Wales:
H. G. RAWSON (SHEFFIELD & LONDON) LTD., 100 LONDON ROAD, SHEFFIELD; 185 PRINCESS STREET, MANCHESTER.

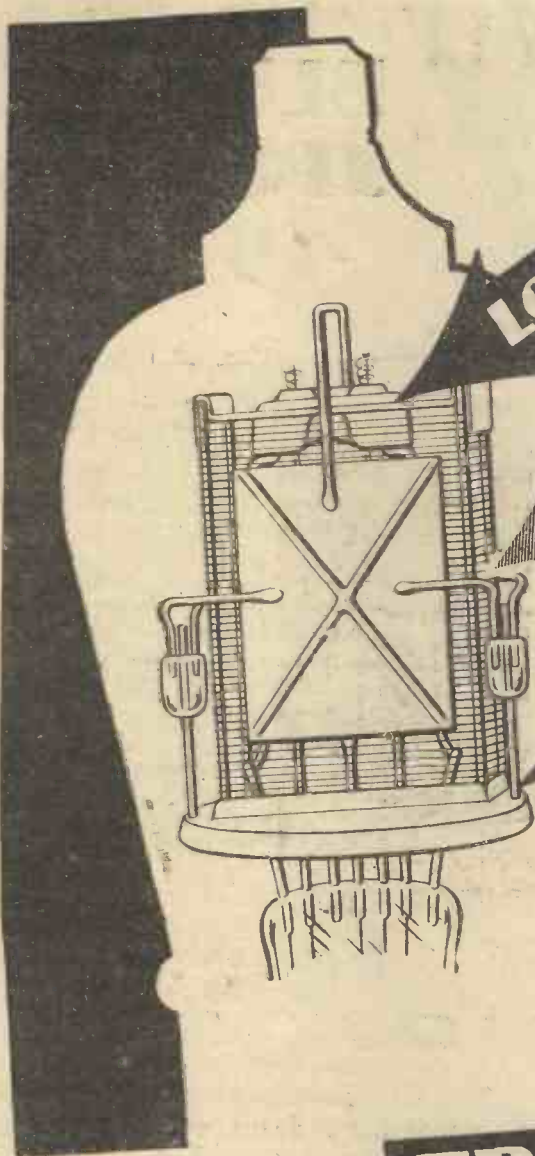

LOCKED HERE!

- AND HERE!

- AND HERE!

In the Cossor Screened Grid Valve all the elements are interlocked. This wonderful new system of construction, developed exclusively by Cossor, ensures a degree of rigidity and strength never before attained in any valve. Piece by piece the Valve is built up—each element supporting and locking the one before it until, finally, the whole assembly becomes a girder-like construction of enormous strength. Even the hardest blow cannot cause individual movement or disturb the perfect alignment of the elements. For performance, for strength and for long life, use Cossor in your Screened Grid Receiver—there is no substitute for the Cossor system of Interlocked Construction.

TRIPLE-LOCKED FOR LONG LIFE!

Made in 3 voltages for use with 2, 4 and 6-volt Accumulators.

Technical Data:

Filament Current 2-volt type .2 amp., 4 and 6-volt types .1 amp.
 Max. Anode Volts 150, Impedance 200,000, Amplification Factor 200, Grid Bias 1.5 volts at max. anode Volts. Price **22/6** (any type)

Get full details of this wonderful Cossor Valve write for leaflet L.10.

Cossor
Screened Grid Valve



A. C. Cossor, Ltd., Highbury Grove, London, N.5.

Advertisers Appreciate Mention of "A.W." with Your Order

Amateur Wireless and Radiovision

The Leading Radio Weekly for the Constructor, Listener and Experimenter

Editor: BERNARD E. JONES

Technical Editor: J. H. REYNER, B.Sc., A.M.I.E.E. :: Research Consultant: W. JAMES :: Assistant Editor: H. CORBISHLEY

Bell Colour Television—The Proms—Honneger Again—Papal Radio— Film-star Inventor—A Mysterious Tester—A Talkie Move

The Bell Colour Television—We receive word, on the point of going to press, that the two members of our staff now on a visit to the United States (see their article on page 34 of this issue) have been favoured with a special demonstration of the Bell system of colour television and will shortly be contributing to AMATEUR WIRELESS an illustrated article—the first of its kind, we believe, to be published in the British Press—explaining the system and giving first-hand impressions of its results.



Here is the studio of Huizen, the new 16.8-metre broadcasting station in Holland. Huizen puts out a regular programme. Can you get it?

The Proms.—Enter the Proms on August 10! This is the third successive year of the B.B.C. control of the Proms at the Queen's Hall, and the majority of the forty-nine concerts which are to be given during the eight-week season will be broadcast. In view of some of the hard things said about modern music, and about British music in particular, it is interesting to note this following important innovation. A British composer's programme will be included on Thursday evenings throughout the season. Some well-known folk, such as Elgar, Vaughan Williams, Gustav Holst, John Ireland, Granville Bantock, and Dame Ethel Smyth will be represented.

Honneger Again—Some of the things the modern composers do with music seem rather humorous to those who have not highbrowish tendencies. For instance, do you remember Honneger's "Pacific 231," which was an orchestral imitation of this giant locomotive in motion?—and the excellence of the imitation must have made the B.B.C. Noise Department rather green. Now we have a new "stunt" by this composer which is to be included in the Proms series—namely, "Rugby." This is not, as you might think, anything to do with

the G.P.O. Rugby! It is an interpretation of the game in musical terms. That Honneger chose Rugby is interesting because he is a Frenchman.

Papal Radio—Marconi's are constructing the wireless station which is to be erected in the Vatican City for the use of the Pope and the Vatican State. The station will rival many commercial jobs and will be able to work both telegraphy

and telephony on all wavelengths, including the "wavelets." It is understood that the equipment will include a beam-type transmitter and receiver. All the apparatus is being installed under the personal supervision of Marconi himself.

Film-star Inventor—A well-known film star, Robert Frazer, who is now being "shot" for a forthcoming film, *The Drake Murder Case*, has had some spare time during the making of the film, and he has put it to use by inventing a remote-control for operating radio sets. Frazer's control is a kind of push-button device with a number of pre-selected tuning circuits, and the object achieved is the same as that in a well-known AMATEUR WIRELESS set, "The Auto Two," described in No. 351.

A Mysterious Tester—Have you located a previously unlogged transmission on about 570 metres towards 11 p.m. on any night during the last week or so? The transmissions are made in French, and a number of reports received seem to indicate that listeners believe this to be a new-comer to the already long list of French broadcasters. Actually, matters are not quite so bad as all that! This new 570-metre *poste* is being tested by a Paris commercial concern before being sent to the French colonies.

A Talkie Move—Here comes news of a giant amalgamation of British and German talkie concerns—namely, British Talking Pictures, Ltd., and the Klangfilm-Tobis group. The apparatus of British Talking Pictures was described some short time ago in AMATEUR WIRELESS. The London director of Klangfilms is Mr. Lawrence Hermies, the well-known pioneer in this country of photo-telegraphy by the Siemens Halske process.

PRINCIPAL CONTENTS PAGE

Current Topics	31
Mistakes That You Can Easily Make	32
More About the "Loud-speaker America 2"	33
U.S.A. Radio	34
"Juice" for the Portable	35
Austria's New High-power Station	36
On Your Wavelength	37
Your Loud-speaker in the Garden	39
For the Newcomer	40
Without Fear or Favour	41
Practical Coil Making for the Home Constructor	42
Grid Leak or Anode Bend?	46
"A.W." Tests of Apparatus	48
My Wireless Den	50
Radiograms	53
Broadcast Telephony	55

Mistakes That You Can Easily Make



The only serious wear to which a plug-in coil is usually subjected is that due to careless plugging in or pulling out. If you wish your coils to last you should always handle them by the base.



Although grid-leak clips can be obtained quite cheaply, many constructors solder the connecting wires directly to the metal caps of a grid leak. This is a risky practice, as the resistance of the leak will probably be considerably altered by the heat.

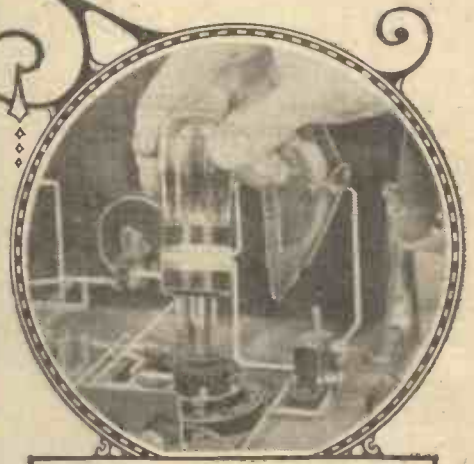

There is usually a great temptation to grasp the glass bulb of a valve when removing it from its holder, but a little thought will show that the bulb may easily come apart from the base by so doing.



Many an H.T. battery has had its life curtailed or cut short altogether by the thoughtless practice of laying a tool or other metal object on top of it and inadvertently making contact between two of the sockets.



Ebonite panels or terminal strips should never be held in the vice without a packing of some soft material, such as thick cardboard, as the polished surface of ebonite is easily spoiled.



The common practice of "testing" an H.T. battery by "sparking"—that is, watching for the spark resulting from short-circuiting the battery and then breaking the current—results in the life of the battery being considerably shortened.



When mixing the acid solution for filling or refilling an accumulator, never pour the distilled water into the strong sulphuric acid, or the latter will be agitated so violently that it will spurt up out of its container.

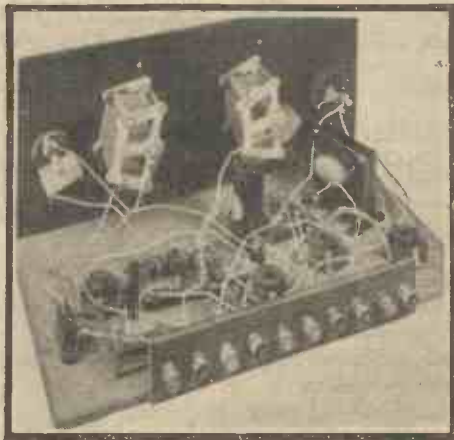

Don't build your set like this. It is impossible to get good results with hurried or careless construction, and a little extra time spent on a careful arrangement of the components and neat wiring is well worth while.



A dangerous practice is to work with metal tools in the set while the batteries are connected up, or if the receiver is of the mains-operated type, while the current is switched on.

MORE ABOUT THE LOUD-SPEAKER AMERICA

2

THE operation of the "Loud-Speaker America 2," constructional details of which were given in the centre pages last week, is very simple, and really, in view of the surprising results that can be obtained, the control is much easier than that of a broadcast receiver.

Coils to cover the whole range of "wavelets" are obtainable and are plugged into the six-socket holder. The correct sizes of

At present, there is only one make of six-volt pentode available to the public, this being the Mullard PM26. The 2-volt pentodes, however, are the following: Cossor 230QT, Osram PT235, Marconi PT235, Dario pentode-type, Mullard PM22, Six-Sixty 230PP, and Ediswan 5E225; there are five 4-volt pentodes available—namely, the Dario pentode-type, Mullard PM24, Six-Sixty 415PP, Cossor 415QT.

most frequently experienced when working on the short-waves. It should not be experienced if the valves and values given here are closely followed. If the trouble should be persistent, however, a change in the value of the 5-megohm grid leak or of the 30,000-ohm anode resistance will effect a cure.

On a first round of the dials it will probably be found that only one or two carriers are heard and some little practice is necessary before a full log can be made. Tuning is very critical, but the slow-motion dial fitted will do much towards making control simple.

Reaction needs to be delicately adjusted:

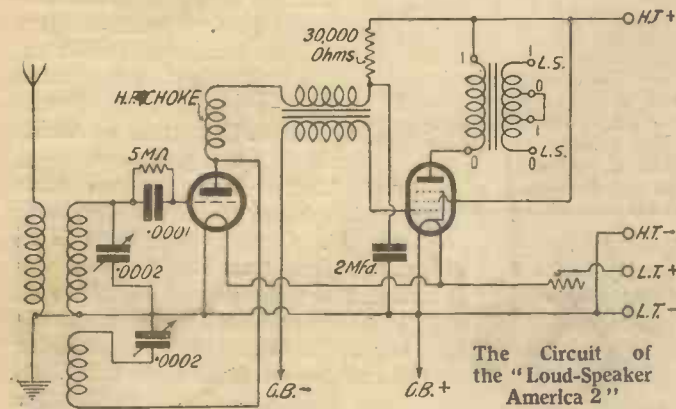

Plenty of H.T. is advisable for the successful operation of the pentode. About 150 volts potential is required for most makes, but the characteristics differ according to the make of five-electrode valve used. Generally speaking, it will be found that not more than 9 volts grid

coils to employ for each waveband are clearly indicated by the instructions given with each set. As a matter of fact, no great trouble will be experienced in locating each waveband, because the range of each coil in a series overlaps to a certain extent. In most cases it will be advisable to use the smallest coil of each set in the aerial socket (that which can be pivoted), the middle coil as the grid coil and the largest coil of each set as the reaction coil.

In the initial tests we used Eddystone coils. We have also used a similar type of tuner, the S.S.R.S. ultra-short-wave unit, manufactured by Messrs. Stonehouse Radio Supplies, and have found it satisfactory.

So far as valves are concerned, the detector should be one having an impedance of approximately 20,000 ohms, such as the Cosmos DE50, Cossor 610HF, Ediswan HF610, Marconi LS5B, Mazda HF607, Mullard PM5X, Osram LS5B, Six-Sixty 6075HF.

bias will be required, but it is advisable to have a 15- or 18-volt grid-bias battery in order to give plenty of room for adjustment. A certain amount of low-frequency oscillation will be experienced if the pentode is not operating properly, but a little adjustment of the grid bias and H.T. voltages will cure this.

Motor-boating just at the point of oscillation (generally referred to as threshold howling) is a minor trouble which is

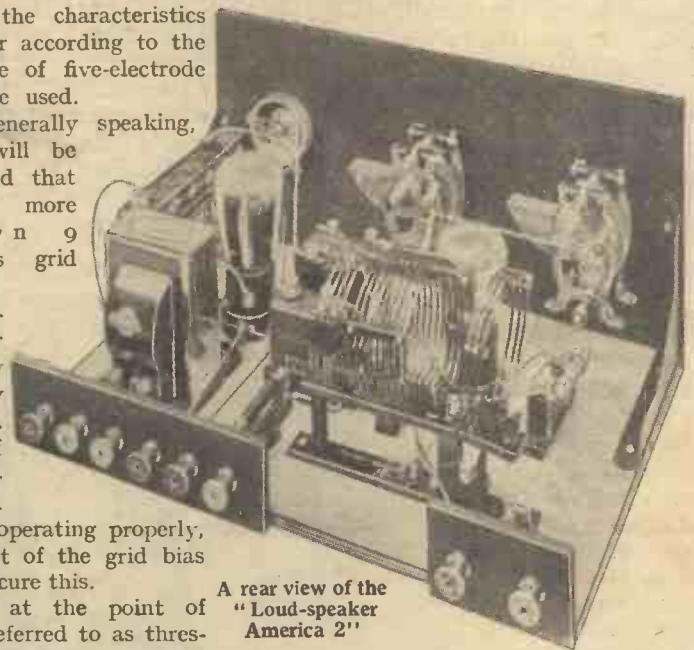

A rear view of the "Loud-speaker America 2"

COMPONENTS FOR THE "LOUD-SPEAKER AMERICA 2"

- Ebonite or bakelite panel, 14 in. by 7 in. and two strips, 7 in. by 7 in. and 3 in. by 2 in. (Raymond, Becol, Ebonart, Paxolin).
- Baseboard, 14 in. by 9 in. (Pickett).
- Two .0002-microfarad variable condensers (Lissen, Ormond, Cydon, Burndept, Utility).
- 7-ohm rheostat (Peerless, Varley, Igranic).
- Two valve holders (Burton, W.B., Lissen, Benjamin).
- .0001-microfarad fixed condenser with series clip (Dubilier, Lissen, T.C.C., Mullard).
- 5-megohm grid leak (Dubilier, Lissen, T.C.C., Mullard).
- Low-frequency transformer (R.I. Hypermu, Lissen, Igranic, B.T.H.).
- Set of short-wave coils with base (Eddystone or Stonehouse).

- Short-wave high-frequency choke (Trix Wearite, Varley).
- 2-microfarad fixed condenser (Dubilier, Lissen, T.C.C., Mullard).
- 30,000-ohms resistance with holder (Graham-Farish, Lissen, Dubilier, Varley, Mullard).
- Panel brackets (Ready Radio).
- Pentode output transformer (Igranic, R.I.).
- Eight terminals, marked—Aerial, Earth, L.T.+, L.T., H.T.+, H.T., L.S.+, L.S.—(Ealex, Belling-Lee, Igranic).
- Connecting wire (Glazite).
- Slow-motion dial (Lissen).

It is hopeless trying to get distant stations if there is "flop" or overlap at the oscillation point.

According to a list published by the Radio Division of the United States Department of Commerce, there are now twenty-six television broadcasting stations operating in the North American Continent.

TWO "A.W." STAFF MEMBERS VISIT THE STATES



With an "A.W." Portable on board the White Star liner "Majestic"

U.S.A. RADIO: Some First Impressions

by ALAN S. HUNTER, of "A.W."

AT a temperature of 93 degrees, an evaporation of radio interest might well be excused, but in spite of the tremendous heat that greeted our arrival in New York, one of our first acts on reaching the Hotel Paramount was to switch on the British portable specially designed by Mr. J. Sieger, of the AMATEUR WIRELESS Technical Staff, for the tour. What we heard was not altogether novel, for when still two days from New York the portable had given us, and a considerable section of the *Majestic* passengers, a foretaste of American radio reception conditions. The dials literally teemed with stations, giving a variety of broadcast entertainment that will prove exceedingly difficult to equal in England, even with a fully-fledged regional scheme.

As English listeners, we came to New York expecting to find considerable chaos in the ether, and we certainly did not expect that our portable would be able to cope with the selectivity problem to the extent it has. Imagine ten stations coming in round the dial with the same intensity as 5GB in London—that gives an approximate idea of the reception con-

Two of the young and zealous members of our staff—Alan S. Hunter and Joshua Sieger—are visiting the United States and inquiring into hosts of matters of interest to "A.W." readers. Already, during the voyage and on their first day ashore (spent in the company of Mr. Eric H. Palmer, of Allied Broadcasting Companies, in the Fada laboratories and plant outside New York), they have had some interesting wireless experiences. Here is the first of Mr. Hunter's articles. Others by him and Mr. Sieger will follow in due course.

ditions in New York. How other American cities are served we are not yet able to say, but the New York listener is certainly well catered for. No wonder radio is such a living thing here—the radio set is alive with interest from morning till night.

be suspended. Consequently, there is no heterodyning and transmissions are sharply tuned. Even the powerful stations do not "spread," as might be expected. In fact, our P.M.G.'s timidity in sanctioning a dual-wavelength station seems a little

amusing in the light of practical working conditions over here. Stations here start their transmissions at 8 a.m. and continue without a break until midnight or later. Possibly we see American radio now in a much more favourable light than we would have done two years ago.

To-day every station must keep dead on its wavelength or be suspended. Consequently, there is no heterodyning and transmissions are sharply tuned. Even the powerful stations do not "spread," as might be expected. In fact, our P.M.G.'s timidity in sanctioning a dual-wavelength station seems a little amusing in the light of practical working conditions over here.

One significant characteristic of the transmissions immediately manifested itself; the quality of the transmissions does seem definitely better here than in England. Piano and soprano items in particular seem more natural.

The National Broadcasting Company, about which we hope to write more fully on our return, now makes considerable use of condenser microphones, which, we believe, are just being tried out in England. The noticeably good quality of the

(Continued on page

56)

FADA RADIO, LONG ISLAND, U.S.A., RECEIVES TWO MEMBERS OF "A.W." STAFF



Alan S. Hunter
"A.W." Staff.

F. A. D. Andrea
President, Fada Radio.

Joe Sieger
"A.W." Construction Staff

F. X. Rettenmeyer
Chief Engineer of Fada Radio.

“JUICE” FOR THE PORTABLE

Considerations of Battery Weight and Efficiency

THERE is one thing which you will not find forgotten in any AMATEUR WIRELESS portable set, and that is a solution to the battery problem. It is no exaggeration to say that in every portable receiver success depends almost entirely on the batteries employed; and these, their weight and bulk, determine the convenience and handiness of the complete receiver.

In some “cut price” ready-made portable receivers of doubtful manufacture there is but the scantiest space left for the accumu-

number of valves, but if the right type is chosen this need not seriously affect working; the grid-bias battery will, generally speaking, be as in an ordinary set.

Filament Current

Consider L.T. matters first of all. Until a first trial is made you will probably have no idea to what vibration a portable is subjected, and how acid can be spilled from an accumulator if not of the non-spillable type. There are several non-spillable accumulators which obviate any such trouble. Portable enthusiasts will remember that the C.A.V. type 2A.N.7 accumulator was used with entire satisfaction in the “Holiday Portable Three,” described a few weeks ago in AMATEUR WIRELESS, No. 365. Accumulators such as this are specially made for use with portable sets, and their dimensions consequently are most suitable. The 2A.N.7 weighs 5½ lb. and, having a jelly electrolyte, can be placed in any position for any length of time. It is a 30 A.H. job, but smaller types are available. The dimensions of accumulators do not vary greatly from type to type, and it will be assumed that in nearly all cases a 2-volt cell is chosen. To take just a few other examples, the Exide U.S.P. 7, which has a capacity of 18 A.H., weighs just over 3½ lb. Then there is the Oldham S.N.V. 7, which has a capacity of 20 A.H. and a useful maximum discharge rate of 1 ampere. This weighs 5½ lb. The non-spillable type, preferably with a jelly electrolyte, such as the C.A.V., is always to be preferred, and there is really not a great deal of difference in actual weights and sizes for any given capacity.

The capacity required depends, of course, entirely on the current drain made by the valves, and should not have any relation to the length of time during which the set will be out of use. The accumulator should, in most cases, be recharged as soon as possible after the receiver is brought back after a trip. It is not wise to fit a large accumulator with the object of making the charging periods infrequent.

Probably the average portable is a four-valver, with one screen-grid stage, and the current consumption will then generally be .15 ampere for the S.G. stage, .1 ampere for the detector and L.F. stages, and probably .15 ampere for the power stage.

The total current consumption will usually be somewhere in the nature of half an ampere, and it does not need a very large accumulator to supply this meagre demand. A 2-volt 20 A.H. job will be found satisfactory for most purposes, but if the receiver has to work for a number of con-

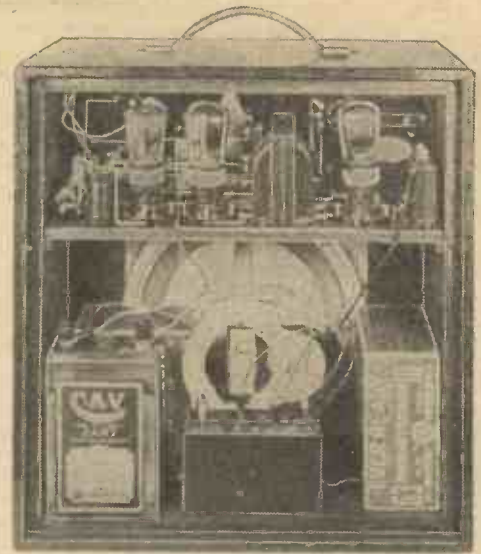

tinuous periods without the accumulator being recharged, then it will be necessary to calculate the A.H. required fairly accurately.

This can be done by dividing the current taken into the actual A.H. capacity of the accumulator, allowing the usual safety margin and taking care that the maximum discharge rate of the accumulator is not

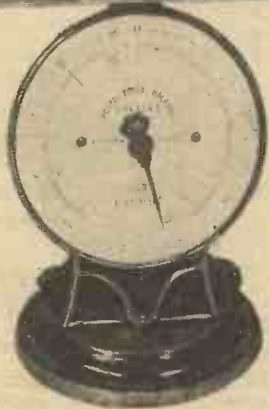

Weight and capacity go hand in hand with accumulators, and this 30 A.H. C.A.V. cell weighs 5½ lb.—not too much for the average portable lator and H.T. battery and, moreover, batteries of very uncertain satisfaction are fitted. The result is that after possibly only a few weeks' working the receiver “goes quiet,” and considerable expense may be entailed in putting it right. A new H.T. battery may have to be fitted, and it may even be necessary to modify the dimensions of the cabinet in order to accommodate an adequate H.T. supply.

When fitting H.T., L.T., and grid bias in a portable set one has to make a discreet compromise between the demands of the circuit, the space which can be allotted, and the maximum weight, which is permissible. Usually the result is that an accumulator, generally of the non-spillable type, is fitted having a slightly less capacity than would normally be used; the H.T. battery is very much smaller than would be employed for a home set having the same

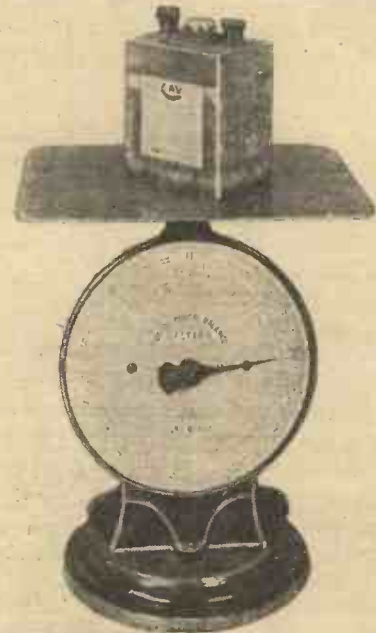

Non-spill light-weight accumulators, such as this C.A.V. 2 N.S.13 cell, are handy. This weighs only 2¾ lb.

exceeded and preferably not even approached.

There is quite a good scheme which a number of mains users utilise, and that is to have a trickle charger available for “topping up” the portable accumulator so that it can be ready at a moment's notice to take out with the set.

Now for H.T. Usually a portable receiver has to be worked with batteries which would not give the most economical working with the same number of valves in a home set. The reason, of course, is that a

(Continued at foot of next page)



The new Austrian station near Graz

THE high-power broadcasting station nearing completion at St. Peter, near Graz, Austria, will be opened officially within the next few weeks. The situation of the new station is all that could be desired, whereas the old transmitter was situated near the Castle Hill in a location hardly suitable for a large power station, because the dimensions of the available ground did not afford room for the necessary aerial stays.

St. Peter is situated about a couple of miles south of Graz, on ground adjoining and level with the aerodrome. The new transmitter has an anode input of about 13 kilowatts for telephony and one of 25 kilowatts for the telegraph service. The L-shaped aerial is carried by two frame-

Austria's New High-power Broadcasting Station

Forthcoming Opening of New Transmitting Station at St. Peter, near Graz

By Dr. ALFRED GRADENWITZ

work masts each of which are about 330 ft. high and 660 ft. apart, a network of copper wires at a depth of 2 ft. being used as an earth.

The transmitter is operated on the direct-current grid-modulation system, comprising three stages, the first of which generates the carrier wave. The second is used for modulation and the third, which has two water-cooled valves each of 20 kilowatts, yields the out-

put to the aerial coupled across an intermediary circuit. A recooling plant was found necessary because of the excessive hardness of the water supply. Rainwater is now collected in a cistern and after circulation is cooled and recovered.

A studio fitted up on the most modern lines is available for the station's own transmissions, adequate provision being made for the accommodation of artistes and rehearsals.

Reports of reception have been very satisfactory, it being inferred from numerous letters that particularly Upper Austria,

the Tyrol, Switzerland, large parts of Germany and Poland, and Jugo-Slavia are receiving under excellent conditions. How far the crystal detector range has been extended by the installation of the new station will not be known exactly until measurements of field intensities have been carried through completely.



Adolphe Kraus, the director of the Graz station

"'JUICE' FOR THE PORTABLE"

(Continued from preceding page)

super-capacity battery of 120 volts takes up far more space probably than the actual receiver portion itself and the weight is excessive.

There are, however, H.T. batteries specially designed for portable use, such as the Ever Ready 63-volt popular portable battery. The 63-volt unit weighs just about 4¾ lb., and usually two will be required to give an adequate potential. The weight of the average "super" battery is 13 to 14 lb., which precludes its use in a portable.

It is not an economical proposition to operate a portable set for any great length of time on midget batteries, because if they are not given time to recuperate they do not give good service.

In the case of transportables, and other sets which are used principally at home and occasionally out of doors, it is advisable to have either a large H.T. battery or mains eliminator for normal working. The smaller light-weight H.T. batteries should

be used only for the out-door trips.

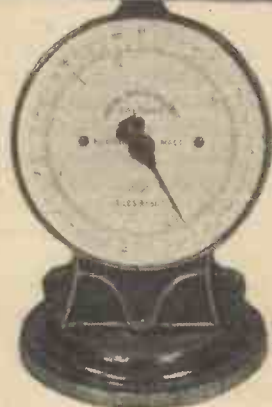

An ordinary small-cell 60-volt unit weighs only about 4¾ lb.

Grid bias is usually not very much of a problem and the only thing is that one has to be content with an ordinary 7½- or 9-volt battery, weighing about ½ lb., instead of a 15- or 24-volt job which may weigh as much as 1½ lb. This does not matter very much, because more than 9 volts grid bias is not usually required unless a large power valve with plenty of H.T. is employed, and this is not usually found in portables.

The type of valve which should be employed in the last stage depends entirely on the circuit used. Many amateurs make the mistake of using a valve which is really too large for the job, and the result is that there is a waste of L.T. and H.T. current, the latter being far more costly. A super-power valve having an impedance of, say, 4,000 or 5,000 ohms is not always needed, because the initial grid swing may not be large enough to justify such a valve. It may, however, use three times the anode current taken by an ordinary L.F. valve, quite suitable for the job in hand.

On Your Wavelength!

A Good Start

AS I write the Prague Plan has been in operation for only a few evenings, and though it is still early to form a definite judgment, it seems as if it was going to be a real success. Each evening since the new order of things started I have made a radio trip round the Continent, finding, rather to my surprise and greatly to my joy, a wonderfully good state of affairs. I was a little afraid that we might be afflicted with almost as many heterodynes as there were when the late Brussels Plan made its bow, for nominally the same 9-kilocycle separation, which then proved unsuccessful, is in use now. I say "nominally" because in many cases the 9-kilocycle separation of the Brussels Plan existed on paper only. Since they were mere voluntary subscribers to the scheme, stations wandered as they listed, with unfortunate results. The official backing of the Prague Plan seems to have produced much better results. Most important of all, every European country has adopted its provisions, so that the wavelength of every station in Europe is now definitely controlled.

A Look Round

An examination of the Prague list of wavelengths and frequencies produced many surprises. Hilversum was found to have dropped from the long waves to a position below 300 metres. Copenhagen, Leipzig, and Breslau have also positions in the lower part of the band. Berlin Witzleben, which for a long time has been blotted out by 5GB, has now a wavelength well clear of the latter's wipe-out effect, except for those living within a few miles of Daventry. And there are many other stations not well heard in the past, either because their wavelengths were in sparky regions or because they were overshadowed by the close neighbourhood of big fellows, that are now much more favourably placed.

Early Trials

A tour round with the wireless set soon showed that the Prague Plan had produced beneficial results. The Sunday was not a particularly good night for reception, strength generally being on the weak side—or perhaps many stations were not using full power at the start. The Monday was a far better night, with wonderfully good strength for the time of year. Starting from the bottom of the band, station after station was logged clearly and well, and with a welcome absence from interference. The only heterodynes noticed were a very slight one on Turin and another in a rather confused area in the neighbourhood of Belfast's wavelength. Amongst the best transmissions received were Toulouse (both

Midi and P.T.T.), Gleiwitz, Hamburg, Frankfurt, Dresden, Leipzig, Koenigsberg, Posen, and Berlin Witzleben. I could not find Hilversum on 298 metres, and I rather wonder whether he was working on either night.

Will it Last?

It must, of course, be remembered that reception at the present time takes place under summer conditions, when the signal strength of stations is always considerably less than it is during the winter. It follows that the wipe-out effect of a station, and therefore its heterodyning propensities, are less just now than they are likely to be in a few months' time. If the 9-kilocycle separation seems to have proved itself sufficient for summer conditions, will it

THAT DISTANT STATION

See how he crouches o'er his set,
His face so tense, his brow so wet,
As frenziedly he tries to get

"That distant station."

Madly he twists the knobs around,
And oft the atmospherics sound,
But what remains still to be found?

"That distant station."

Many a wavelength he has tried,
But still he is not satisfied;
What studio has not replied?

"That distant station."

Again he tries, and yet again,
With tired eyes and buzzing brain,
"Why can't I get," he cries in vain,
"That distant station?"

The night rolls on, and still he sits
Until his head with pain near splits;
What makes him take his set to bits?

"That distant station."

At last, to his intense delight,
He gets the wavelength quite all right;
But who transmits that calm "Good-night"?

"That distant station."

suffice also when autumn brings longer hours of darkness and bigger strength all round? This must remain an open question, for time alone can show. Myself, though, I am rather inclined to think that we shall not have much to complain about after we have changed over from B.S.T. to G.M.T. I have searched round late at night when it was quite dark without finding heterodynes at all prevalent.

The Matter of Time

There is, however, one rather important point to be remembered. Central European time is an hour ahead of ours and Eastern European two hours ahead: At 11 p.m. B.S.T. not a few foreign stations have closed down for the night, and there is

therefore much less crowding on the broadcast band than there is at seven or eight o'clock. It is quite possible that when all the stations are going at full blast during the hours of darkness, as will be the case when the sun sets at seven o'clock or earlier, more interference will be found than at present exists. This may necessitate, not changes in the standard frequencies, but a swop over of wavelengths between stations situated in different parts of Europe. The scheme has been pretty carefully worked out to obtain not only a 9-kilocycle separation between stations, but also as big a geographical separation as possible between stations on neighbouring wavelengths. In a few cases, however, wavelength neighbours do seem rather too close together—not in kilocycles, but in miles.

Maps and Wireless

What I am driving at is this. If you have as wavelength neighbours two stations, both rather powerful, one of which is, say, in South-Eastern France whilst the other is located in Switzerland, each will exercise a certain wipe-out effect upon the other and a heterodyne is likely to result. Let us suppose that there is a third station in Sweden working on a wavelength far apart from either of the other two. If you make the Swiss and the Swede exchange wavelengths, interference becomes unlikely, since long-range heterodynes very seldom occur, except in circumstances which we shall mention in a moment. At first sight, then, the problem looks quite easy. But you must not forget that the new wavelength assigned to the Swiss station may make it now the wavelength neighbour and also the geographical neighbour of a station in Southern Germany or Northern Italy. Also, the Swede, with its new wavelength, may cause trouble with somebody in Norway or Denmark.

Skip Distances

And there is a further consideration which is rather curious. Many stations, especially those working on wavelengths in the lower part of the broadcast band, furnish excellent examples of the skip area. Nuremberg is a case in point. Reception of this station is excellent in his own service area, but not too good for some distance outside it. Beyond this, the skip area comes to an end, and then comes another area in which the station is very powerful indeed. In many places in this country Nuremberg comes in almost as strongly as the local station. Under the Brussels Plan, in fact, he did actually succeed in heterodyning Newcastle, though the latter was separated from him by much more than 9 kilocycles. It will thus be

::

::

On Your Wavelength! (continued)

::

::

seen that, however carefully a frequency separation is worked out with the aid of figures and of the map, actual tests only can show just what will happen in practice.

History as She is Broadcast

I am afraid that I cannot congratulate the B.B.C. upon the Roman news bulletin broadcast some nights ago. The idea was that a news bulletin was being sent out as it might have been at Rome in the time of Julius Cæsar, had broadcasting been known in those days. Quite a good idea, but, unfortunately, whoever was responsible for working it up was not exactly strong in his knowledge of Roman history or Roman customs. An astonishing number of "bloomers" were made, the prize one perhaps being in the date of the death of Julius Cæsar, which according to the B.B.C.'s historian occurred in June, though all the rest of the world knows that it took place upon the Ides of March. The author modestly preferred to remain anonymous. Really, I don't wonder!

A Queer Business

One finds some funny things about wireless in the lay papers from time to time, and here is one of them. I was astonished to read over the toast and marmalade that Paris was to have a radio police corps whose duty would be to comb out a new kind of criminal-(!), "who picks information illegally from the air and uses it for illegal financial dealings." These "criminals," it is stated, possess unlicensed wireless sets by means of which they hear share quotations before the public gets hold of them, and this nefarious practice had led to much wild buying and selling on the Bourse. Well, well, well! Somebody *does* seem to have found a mare's nest. If you want to know the price of any share at any moment all that you have to do is to ring up your stockbroker on the telephone; so that there is not much point in "picking it from the air"—I love that phrase, don't you? Secondly, if anybody is such a fool as to send out secret information by broadcast wireless and then to expect that no one else will pick it from the air, he deserves all he gets and a bit more. All that the business comes to, I believe, is that there exists a certain number of pirates in France, and the French Government is about to take steps to see that they all pay their licence fees!

What Will Happen?

How, I wonder, will listeners in the London area fare when London No. 1 at Brookmans Park, London No. 2 in Oxford Street, 5XX, and 5GB are all at work? Will they get alternative programmes? My own view is that unless they use something rather more selective than the general run of sets nowadays they won't

have a very large choice if the scheme really is carried out on the lines at present indicated. If you draw a straight line from London to Daventry you will find that Brookmans Park is not very far to the east of it. The directional properties of the frame will not, therefore, be of very much help in separating 5GB and the two London stations. In many parts of London 2LO's wipe-out is very big, and Brookmans Park is likely to be pretty hefty in the blotting-out line.

The worst sufferers will, I think, be those who live in Northern London and the northern and north-western suburbs. It isn't much good turning your frame directly towards Brookmans Park if in that position it is pointing directly away from 2LO. It seems to me that the scheme will have to be considerably modified if it is to be as satisfactory as it should, in view of the enormous amount of money that is being spent upon it. I have often wondered why the new big station was not located somewhere on the other side of London, where it would also serve the south coast.

The Royalties Question

I hear on good authority that a settlement on a satisfactory basis of the royalties question is likely to be reached before the end of the month. There is a big difference between twelve shillings and sixpence a valve holder, and five shillings for the first valve and half a crown for each succeeding one that the Comptroller of Patents decided upon last September. Though the Marconi Company are entitled under the decision of the Court of Appeal to receive the full amount of twelve shillings and sixpence per valve holder, it is most likely that a compromise will be made whereby this amount is reduced to a figure acceptable to both sides. There is, I feel, no need to worry about the ruination of the industry, as some of the dismal Jimmies seem to delight in doing.

Television Provides a Fertile Field

The president of the American National Radio Institution gives it as his considered opinion that the development of television will not be the result of true invention, but rather the outcome of sound engineering in the form of wide co-ordination of ideas and the endless refinement of principles already established. At times it is somewhat difficult to discriminate between the finish of true invention and the beginning of development, but undoubtedly the present stage of television affords similar opportunities to the individual as that provided by wireless some years ago. The subject is in no way dependent upon one definite line of thought, for we must bring to bear in its solution the combined problems of wire-

less, electricity, optics, chemistry, physics, and mechanics. Added to that, there is the time factor looming all important in the background when we realise that such a tremendous amount of detail work has to be handled in the minutest fraction of a second.

Steady Progress

The evolution of this wonderful science will call for the close co-ordination of trained engineer and amateur alike, while the interchange of ideas through the columns of the Press and via the medium of television societies cannot fail to be productive of useful information. There are still sceptics who pour scorn on the present-day achievements, but I cannot help feeling that they have failed to keep pace with the rapid progress which materialises daily in the laboratories that are specialising in the work. To quote an example near home, we have only to witness a present-day demonstration at the Baird Company's offices and compare it with that of, say, six months ago, to notice the marked improvements—greater detail, the extension of vision, an almost complete absence of "hunting," etc.

Television Patents

One report that I read recently stated that the A. T. & T. Co., which has been developing a television apparatus, can build a receiver for the purpose of showing good pictures one foot square, the only hitch being that the price of these receivers would be a million dollars. Surely this is stretching the point to the limit of elasticity, and it becomes difficult to place credence in such statements when we think of the proposed twelve-guinea instruments promised in England.

Another point which appears to be overlooked by some writers is that dealing with the priority of patents. No one will deny for a moment that Jenkins and Moore, of America, have contributed an excellent quota to the advancement of television, but to read that the revolving lens disc and the multiple lamp receiver are new inventions of Jenkins is far from true. He must be given credit for effecting certain improvements to these pieces of apparatus, but as far back as 1890 Brillouin patented the lens disc and subsequent to this it was made in a practical form and used by Baird and later by Jenkins. Furthermore, Baird has amongst his "museum" apparatus a multiple lamp receiver, and in June, 1927, lodged a patent dealing with improvements relating to high-speed commutator switches controlling a multiple lamp receiver. When the history of television comes to be written, no doubt all these details will be set out in full, and we shall find our own compatriot well to the fore.

THERMION.

YOUR LOUD-SPEAKER IN THE GARDEN

By J. H. REYNER, B.Sc., A.M.I.E.E.

THIS article deals with a simple subject—that of running a flex lead into one's garden. On some of these glorious summer days one feels positively criminal not to be outdoors, and most of us take every opportunity to be out in the garden if we are not actively engaged in some more strenuous pursuit.

It is a very simple matter to run an extension lead from one's normal set out to a considerable distance, and, as will be seen, this practice has much to commend it. Let me hasten to say at the outset that I do not for one moment recommend the iniquitous practice of letting loose a loud-speaker at full volume on an otherwise peaceful afternoon. Nothing can be more annoying to any neighbours who wish for a quiet relaxation than to have their slumbers disturbed by blasts of brass band, jazz, or perhaps running commentaries hurtling at them from all directions.

The method suggested in this article overcomes this defect, for it is possible, by bringing the loud-speaker to the actual spot where one wishes to listen, to control the volume to something small enough for one's immediate requirements, so that interference some distance away is not possible. This is very simply done, either by adjusting the volume initially to be small or by arranging a suitable volume control at the loud-speaker end.

First of all regarding the extension line

itself. It is essential that the loud-speaker should be isolated from the receiver, either by the use of a transformer or a choke output arrangement, as in Fig. 1. Unless this is done, the high-tension supply to the anode of the last valve in the receiver will have to go out through the extension lead to the loud-speaker and back again. Apart from the voltage drop in the lead, there is a considerable danger of leakage, and if the ground is at all damp it is surprising how much this leakage can be.

If, on the other hand, the loud-speaker is isolated as far as direct current is concerned, then long extension leads can be run, provided suitable precautions are taken, without any difficulty; and indeed, if necessary, these leads can be left permanently in position for the whole of the summer. One finds, for example, that certain spots in the garden prove specially suitable for having tea or for spending a quiet time in the afternoon, and there is not the slightest reason why a semi-permanent wiring should not be taken to these various points. It is desirable to earth one of the loud-speaker leads as shown in the figure. In the case of the choke-output circuit the return should be taken to whichever of the L.T. leads is earthed.

Suitable Leads

The lead for a fairly short distance, up to about 50 ft., can be run with ordinary twisted flex. Such wire has, of course, capacity between the leads, and as the length increases so this capacity becomes quite appreciable. The effect of this capacity is to shunt the upper tones of the loud-speaker, which destroys the balance; and although in some cases it removes a certain shrillness, in other cases, where the speech or music is already correct, it will tend to distort the quality.

It is fairly easy to gauge how serious this effect is going to be, for the self-capacity of ordinary twisted flex is of the order of

.0001 microfarad for every 7 ft. This will be seen to be quite appreciable, but the total capacity is less than .001 microfarad for lengths up to about 70 ft., but beyond this point it is desirable to take certain precautions. One method is to use "Harbros" twin flex, which consists of two wires held in a braided cable at a distance of about $\frac{1}{8}$ in. apart. The wires, therefore, are not twisted together and the self-capacity is appreciably lower, being of the order of

.0001-microfarad for 10 ft., so that a lead of 100 or 120 ft. could be run without serious loss of quality.

Still another method, which is particularly useful on longer extensions, is to use an earth return. In this case a single lead is run from the high-potential end of the circuit out to the particular listening point, the return wire being taken to an earth tube buried at, or near, the particular point. The current then returns through the earth back to the earth on the receiver, to which the other end of the output circuit must be connected. Methods of accomplishing this

(Continued at foot of next page)



The simplest plan is to use overhead wires

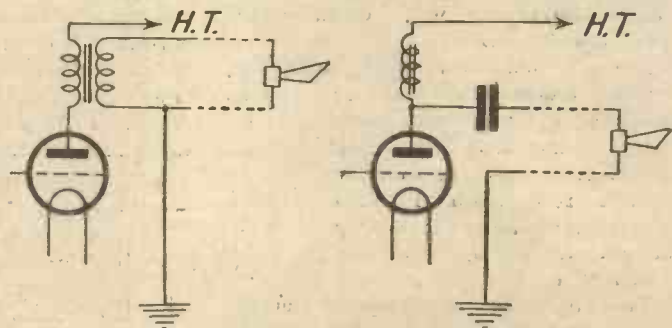

Fig. 1. A transformer or choke output circuit should be used

For the Newcomer to Wireless

MICROPHONIC VALVES

CAN you tell me why the new set that I have just made causes the loud-speaker to make a funny noise whenever any shaking or jarring occurs?

You have in the set, probably as detector, what is known as a microphonic valve.

Just what does that mean?

When a valve is jarred the electrodes within the bulb, and particularly the filament, receive a proportion of the shock and are set vibrating. In bad cases the filament may make quite a big movement, thus, of course, rhythmically changing its position with regard to the grid and plate. If it happens to vibrate strongly at audio-frequency the effect is to produce a ponging or booming noise whenever the valve is shaken.

This kind of thing must surely occur in all valves. Why aren't they all microphonic?

They are to some extent, but the improved methods of to-day of suspending the filament and supporting the electrodes make a valve that is really badly microphonic something of a rarity.

You said just now that I had a microphonic valve that was probably the detector. Why the detector?

Because if a valve has any micro-

phonic tendencies they will be more strongly brought out when it is used in that position than in any other.

Why is that?

That is rather a big question to go into now. I will just mention one important reason. The detector valve has to perform two duties at one and the same time. As a detector pure and simple it converts radio-into-audio-frequencies. That is its first duty.

And the second?

Any valve containing a grid as well as a filament and plate must also amplify. Hence the detector is both a converting and an amplifying valve. Its grid circuit is concerned with small radio-frequency impulses; its plate circuit has to deal with much larger audio-frequency impulses.

Then what shall I do with my detector?

Is it of the same type as your high-frequency valve?

Yes, they are both of the medium-impedance class.

Then change them over. You will often find that a valve which is microphonic and cannot be used as detector is perfectly satisfactory as H.F. amplifier.

I noticed another rather peculiar

effect. When the loud-speaker was near the receiving set it would start sometimes to emit a moaning sound, which was faint at first, but rapidly increased in loudness until it became positively deafening. The only way in which I could stop it was to switch off.

What was happening there is rather interesting. Air waves set up by the loud-speaker reached the bulb of the valve and caused it to vibrate. These vibrations produced a microphonic response from the valve. This was passed on and amplified by the amplifier. Then the loud-speaker began its low moan. Sound waves resulting from this again reached the bulb of the valve, setting up still stronger vibrations. And so the circle continued until the valve was vibrating for all it was worth and the loud-speaker was producing its ear-splitting noise.

The use of a non-microphonic valve as detector will cure this, I suppose?

Yes, it will; but if by any chance you find that when you have changed over the two valves there are still microphonic tendencies I should advise you to keep the loud-speaker well away from the set and to stand the latter on a soft pad.

"YOUR LOUD-SPEAKER IN THE GARDEN"

(Continued from preceding page)

with a transformer and a choke output circuit are shown in Fig. 2.

The wire itself may be run through trees, or in any more or less concealed manner, as is shown in the second photograph. Of course, if the installation is to be at all permanent, then a certain amount more care has to be taken, whereas if it is only for an afternoon, the wire need not be suspended at all, but can simply be run out direct from one point to the other. If the earth return method is adopted it is, of course, advisable to keep the single wire away from the earth to avoid capacity; and this method, indeed, has the advantage of distorting the quality very little, owing to the fact that the self-capacity across the extension lead is very small indeed.

I referred earlier to the possibility of volume control. This may easily be accomplished by connecting across the loud-speaker a variable high-resistance. The set is then adjusted to give the loudest volume that will be required (provided always, of

course, that the receiver is not overloading). The volume may then be cut down by reducing the resistance across the loud-speaker which gradually shunts more and more of the energy. It is possible to obtain table models of such resistances whereby the volume can be adjusted as required. If the programme is musical, then the volume can be cut down to constitute

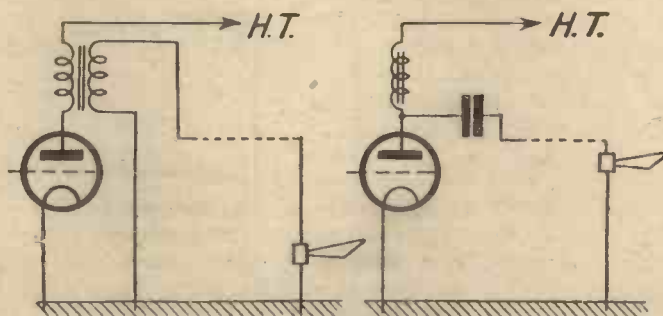

Fig. 2. The earth may be used as one of the leads

a pleasant background to the ordinary conversation, whereas if any announcement is made, or if for any reason a greater strength is required, this can be obtained at a moment's notice.

The resistance should be variable from 2,000 or 3,000 ohms up to about a megohm. Components such as the volume control

Clarostat, marketed by Claude Lyons, or the medium-resistance Volustat, a new British product, manufactured by Harlie Bros., are particularly suitable for loud-speaker control work of this nature. They may both be obtained as table models.

Evidently the B.B.C. begins to realise that Scotland is really disturbed by its broadcasting outlook. Intimation of a programme for all stations north of the Border, in which William Primrose takes part, and which will be composed solely of Scottish music, is prefaced by the hope that it "may help to reassure those anxious listeners who have been misled into thinking that the Scottish flavour was to be lost to Scottish broadcasting."

A new system of conducting radio programmes from a receiving centre to the rooms of hotels or other large buildings through the steel framework of the building instead of by the special wire networks was recently demonstrated at the Hotel Lincoln, New York City, by Dr. F. L. R. Satterlee, a retired New York X-ray experimenter, and his associates.

WITHOUT FEAR OR FAVOUR



A Weekly Programme Criticism by Sydney A. Moseley

A FORTNIGHT ago I warned those who are fond of cinema broadcasts to expect another favourite to be taken off the ether. I had the Shepherd's Bush Pavilion in mind; but Louis Levy's band, under the masterful hand of Arnold Eagle, continues to broadcast.

After leaving me in peace for some little time, "Harold" has popped up again, and his latest epistle is somewhat vitriolic and unreasonable:—

"It's all very well for you to sneer at jazz songs and call them nonsense. But what about those silly students' songs, sea shanties, and olde English songs? Aren't their words sillier than any of the American tunes? And what sense is there in 'Hey nonny no' and 'Blow the man down' and 'I played on my Spanish guitar, tra-la, etc?'"

When I heard the announcer telling us that Percy Honri was going to play on the



Reg. Batton—as Lissenden sees him

concertina I made an involuntary movement towards the switch—and then changed my mind. It was lucky for me that I did, because Honri helped me to modify my aversion to concertina solos—but only a little.

I have just had a complaint about the bridge broadcasts. A correspondent asked

a few friends in to dance to Jay Whidden's band, and half-way through the dance they had to sit down and twiddle their fingers while Mrs. Helen Robinson spoke on bridge.

My correspondent goes on to say that this habit of treating dance music relayed by the best bands in the country as an unimportant feature and fading it out on the slightest provocation to please bridge fiends and nightingale fans is fast becoming a terror to those who like to dance to late band music. "And, anyway, who wants to be told how to play bridge at eleven o'clock at night?" he asks indignantly.

There is a pleasing personal touch about Edna Thomas. When she explains the purport of her delightful negro songs one feels she is not addressing an audience, but individual friends.

I listened to a recent chamber music concert which lasted from 9.40 till nearly 11 o'clock, and could not help thinking of the correspondents who had written to me in the past deploring these broadcasts. That a good percentage of listeners dislike, or even refuse to try to understand, chamber music is evident by the protests which are received. My latest complaint reads like a dirge. I gather that on these occasions 5GB resembles the proverbial oasis.

The other night, in order to escape a particular composer, I turned to 5GB—and was confronted by that from which I fled. In these moments the term "alternative programme" has a rather malicious sound!

Alec McGill and Gwen Vaughan's habit of interrupting one another is effectively funny, but I am inclined to think they carry it too far.

Why does David Hutchinson sound so mournful? I like his voice, but even when he sings a lively song his tone is funereal.

The last act of *La Bohème* made a fitting conclusion to an excellent opera season.

By the way, did you notice that the applause came *after* "The National Anthem," the latter being played immediately the curtain fell?

In a recent issue I quoted a correspondent who objected to his children being treated to songs about Dixie and "oceans of kisses."



Percy Honri—an impression

Now another correspondent, L.V.H., of Whipps Cross, has written to me in a tone of wistful resignation:—

"Although I think it is a great pity that our children should have to listen to such noises as come under the heading of jazz, I suppose that the sooner they get inured to it the better. They have got to go through it some time or another; so why not get it over?"

Further optimism is expressed by a correspondent who says that he infinitely prefers a rhythmic fox-trot to the monotonous waltzes of pre-war times, but agrees that most of the words of these present-day tunes are half-witted and at the best unintelligible—"so that there is really nothing to be afraid of where the very young generation is concerned."

A new 5-kilowatt broadcast transmitter has started testing at Reval (Tallinn); it is temporarily working on 296.2 metres.

PRACTICAL COILS for the Home Co



A Special Article by

medium band of wavelengths. What we should be doing, of course, would be to produce coils having a certain inductive value and the question therefore arises as to the amount of the inductance needed.

A simple calculation shows that a coil having an inductance of 200 microhenries will tune to 600 metres when the condenser has the maximum value of .0005 microfarad. The minimum wavelength would be 190 metres, for a capacity of .00005 microfarad. Inter-

THE subject of tuning coils is a large one. Books have been written about it, but instead of wearying readers with formulæ and exercises in arithmetic I propose giving them the results of my own calculations and experiments.

We will commence by being very practical in order to learn something of the properties of tuning coils. Let us connect one, having, say, 30 turns of No. 24 double-silk-covered wire wound on a tube 3 in. in diameter, in an aerial circuit as in Fig. 1, and then adjust the tuning condenser until the local station is heard.

As this coil is a small one, we shall have to use practically the whole of a .0005-microfarad adjustable condenser in order to tune the circuit to the wavelength of the London station. If now we add a few turns to the coil less capacity will be needed to tune to the same wavelength and by adding further turns, the capacity will again have to be reduced.

We could experiment further with coils of smaller or larger diameters and wound with different gauges of wire, and in every

instance we could produce, by experiment, coils which with a .0005-microfarad adjustable condenser would tune over the

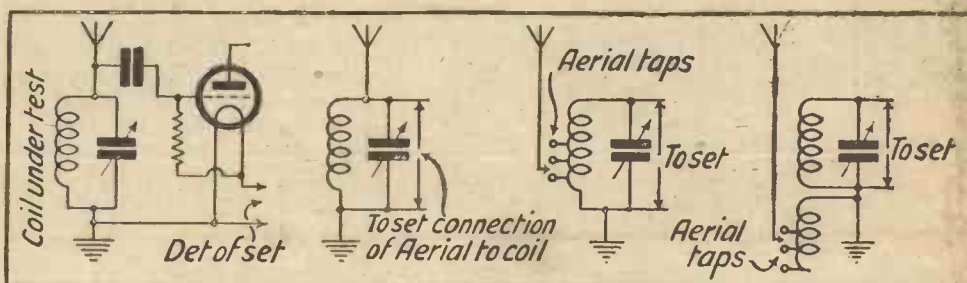

Fig. 1

Fig. 2

Fig. 3a

Fig. 3b

Fig. 1. Circuit for testing coils.
Fig. 2. Aerial connected to top of coil.
Fig. 3a. Aerial connected to tap on coil.
Fig. 3b. Method of connecting aerial to separate coil.

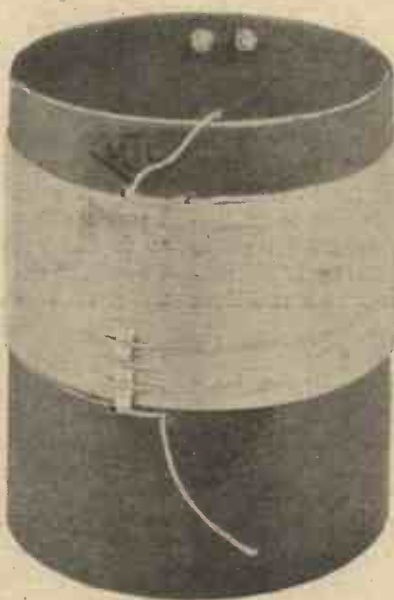

No. 4. Complete Aerial Coil



No. 7. Grid Coil with separate tapped aerial and fine-wire reaction windings



Coils Nos. 1, 2 and 3, 3 in., 2 1/2 in. and 2 in. value—viz., 200, 100, and 50 microhenries

COIL MAKING

Constructor

W. JAMES, Describing How to Make and Use Tuning Coils

mediate values are given in Table 1 (p. 44). Sometimes it is desirable to employ a tuning condenser having the maximum value of .0003 microfarad. A coil having an inductance of 300 microhenries would be tuned by this condenser to the maximum wavelength of 565 metres, and to 230 metres when the capacity is reduced to .00005 microfarad. Other values are given in Table 2 (page 44). It must be understood that the capacity values given are the total of the various capacities across the circuit. Thus, when an aerial is added, the effective capacity is increased, with the result that the wave-

length range is reduced a little, although the maximum is higher. The addition of a fixed condenser in the aerial circuit will once more alter the wavelength range, but it may be taken that an aerial coil having an inductance of about 200 microhenries will tune over the medium band of wavelengths, provided the aerial is properly connected as described below. A coil having an inductance of 300 microhenries is also satisfactory for use in an aerial circuit with a tuning condenser of .0003 microfarad, but it must be used correctly. The wavelength range of a circuit is

always reduced by the addition of a fixed condenser across it, and when it is of importance that the lowest wavelength be of the order of 200 metres, the capacity of the circuit when the tuning condenser is set at its minimum should be as small as possible.

An everyday experience is that one coil is better than another. Thus a tuning circuit having a particular coil included in it may be more selective than when another coil is used, or the signal strength may be greater. What, then, are the factors to receive attention?

The first is the diameter of the former. Up to a point a coil will be better as its diameter is increased. There is, of course, a practical limit to the diameter of a coil, but as a general rule it is advisable to wind coils of large diameter, although here again there may be particular instances when a long-thin coil happens to be better or more suited to one's purpose than a short fat one.

The second factor is the gauge of wire and its covering. A wire having a covering of enamel, silk or cotton may be used. Bare wire is rarely used, but is quite suitable when the turns are held apart by an insulating material.

Enamel-covered wire is relatively inexpensive and silk-covered wire costs more than cotton covered. Yet, from the point of view of electrical efficiency, silk-covered wire is the best to use, but when cost is an important consideration a good quality enamelled wire will be satisfactory. Cotton-covered wire is not greatly used, partly because the cotton may absorb moisture and lower the efficiency of the coil, and partly because the covering is relatively thick, particularly in the case of the finer gauges. The coils illustrated have windings of silk-covered wire.

A most important factor is the diameter of the wire. It is upon the diameter of solid copper wires more than anything else that the efficiency of a coil depends.

A thick wire is not necessarily better than a thin; the diameter of the coil must be taken into consideration. A good rule, however, is to use such a gauge of wire that the length of the finished coil is not greater than its diameter.

A good rule, however, is to use such a gauge of wire that the length of the finished coil is not greater than its diameter.

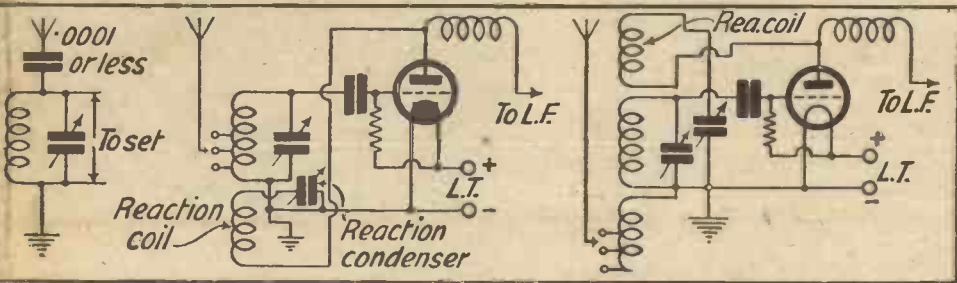

Fig. 3c

Fig. 4a

Fig. 4b

Fig. 3c. Small condenser in aerial lead.
Fig. 4a. Method of applying reaction to circuit of Fig. 3a.
Fig. 4b. Method of applying reaction to circuit of Fig. 3b.



No. 5. Aerial Coil with separately-tapped section



No. 5. Aerial Coil with separately-tapped section



No. 6. Complete tapped Aerial Coil with reaction winding

"PRACTICAL COIL MAKING FOR THE HOME CONSTRUCTOR"

(Continued from preceding page)

The turns of the wire may be wound touching, or they may be spaced a little, depending upon the characteristics required over the working range of wavelengths. For the maximum efficiency the length of a single layer winding may approximate to the radius of the coil, but I have found there is no need rigidly to adhere to this.

An all-important point is that the most efficient coil, as measured by itself in a laboratory, may actually not be so good as another coil when it is included in a receiver and is influenced to an extent by other parts, such as metal screens.

The third factor is the material of which

the former is composed. At one time I employed ebonite tubes, but having found they were not consistently good, commented to use tubes of Paxolin and have continued with them. They have little effect on the losses of coils, retain their shape and look well. First-class ebonite tube is also perfectly satisfactory, but the trouble is, one is not always able to obtain good-quality ebonite.

Formers of skeleton construction have been used in the past, but it is known to-day that the major portion of the total losses of a coil are to be found in the copper wire when the former is a reasonably good one. Cardboard tube is rarely used, because it may contain moisture which would spoil the coil, but there are, no doubt a number of types of coil formers which are satisfactory.

A coil that is composed of a single layer of wire produces a relatively large stray magnetic field in the neighbourhood of the coil and for this reason there are types having windings so arranged that the field is minimised. I will describe these rather special coils in a further article.

The coils described here are suitable for aerial and anode circuits and a number of different sizes are given in the tables. Thus in Table 3 will be found details of a number of coils, all of which have an inductance of 200 microhenries and therefore tune from about 200 to 600 metres with a .0005-microfarad variable condenser.

All coils described in Table 4 are of 300 microhenries and should, therefore, be used with a .0003-microfarad tuning condenser in order to cover the medium band of wavelengths. These coils are wound with the turns side by side and touching, the various wires having a double silk covering. The largest tube used has a diameter of 3 in. and the smallest is 1.5 in. in diameter. Several gauges of wire have been used with the object of providing readers with a variety of coils, from which he may choose according to the materials available.

It is not wise to connect the aerial to the top of a coil, as indicated in Fig. 2, but to join it as in Fig. 3a or 3b. A direct connection, but through a small condenser as in Fig. 3c, may be used when the coil is a very small one or is of fine wire and, there-

fore, not quite as efficient as a larger coil.

When the aerial is connected to a point on the coil, the selectivity of the circuit is much better than when it is joined to the top and, further, the effect of the capacity of the aerial is considerably reduced. The best tapping in a particular instance must be found by trial, because much depends upon the size and effectiveness of the aerial and earth. As a general rule, it will be found that, commencing with the aerial connected to the top of the coil and working downwards, the selectivity and signal strength increase. After a time, depending upon the aerial and the size of

TABLE 1
200-MICROHENRY COIL

Capacity (mfd.)	.0005	.0004	.0003	.0002	.0001	.00005
Wavelength (metres)	600	530	460	375	265	190

TABLE 2
300-MICROHENRY COIL

Capacity (mfd.)	.0003	.00025	.0002	.00015	.0001	.00005
(metres)	565	515	460	400	325	230

TABLE 3
200-MICROHENRY COILS FOR 200 TO 600 METRES USING .0005-MICROFARAD CONDENSER

COIL	DIAMETER.	Approx. length
COIL 3 IN. DIAMETER.	57 turns No. 20 d.s.c.,	2.4 in.
	50 turns No. 22 d.s.c.,	1.6 in.
	47 turns No. 24 d.s.c.,	1.2 in.
	46 turns No. 26 d.s.c.,	1 in.
COIL 2½ IN. DIAMETER.	63 turns No. 22 d.s.c.,	2 in.
	57 turns No. 24 d.s.c.,	1.5 in.
	53 turns No. 26 d.s.c.,	1.2 in.
	50 turns No. 28 d.s.c.,	.9 in.
COIL 2 IN. DIAMETER.	83 turns No. 22 d.s.c.,	2.6 in.
	75 turns No. 24 d.s.c.,	1.9 in.
	69 turns No. 26 d.s.c.,	1.5 in.
	64 turns No. 28 d.s.c.,	1.2 in.
	61 turns No. 30 d.s.c.,	.95 in.
COIL 1½ IN. DIAMETER.	102 turns No. 26 d.s.c.,	2.3 in.
	92 turns No. 28 d.s.c.,	1.7 in.
	85 turns No. 30 d.s.c.,	1.3 in.
	83 turns No. 32 d.s.c.,	1.1 in.

TABLE 4
300-MICROHENRY COILS FOR 200 TO 600 METRES USING .0003-MICROFARAD CONDENSER

COIL	DIAMETER.	Approx. length
COIL 3 IN. DIAMETER.	77 turns No. 20 d.s.c.,	3.2 in.
	67 turns No. 22 d.s.c.,	2.1 in.
	61 turns No. 24 d.s.c.,	1.6 in.
	58 turns No. 26 d.s.c.,	1.2 in.
COILS 2½ IN. DIAMETER.	86 turns No. 22 d.s.c.,	2.75 in.
	78 turns No. 24 d.s.c.,	2 in.
	72 turns No. 26 d.s.c.,	1.55 in.
	67 turns No. 28 d.s.c.,	1.2 in.
COILS 2 IN. DIAMETER	103 turns No. 24 d.s.c.,	2.6 in.
	93 turns No. 26 d.s.c.,	2 in.
	85 turns No. 28 d.s.c.,	1.5 in.
	80 turns No. 30 d.s.c.,	1.25 in.
COILS 1½ IN. DIAMETER.	140 turns No. 26 d.s.c.,	3 in.
	126 turns No. 28 d.s.c.,	2.25 in.
	116 turns No. 30 d.s.c.,	1.8 in.
	108 turns No. 32 d.s.c.,	1.45 in.

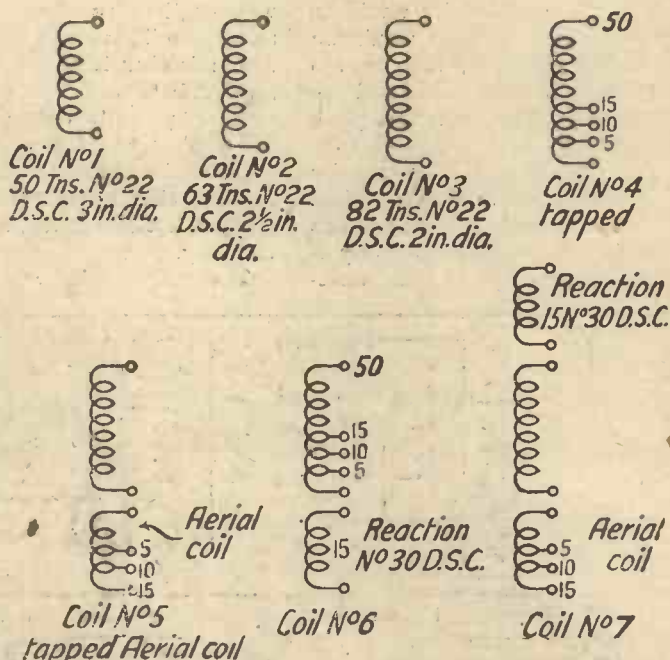

Schematic diagrams of the various coils shown by the photographs

the coil, a tapping point will be reached where the selectivity is satisfactory and the volume is the maximum. By tapping the aerial further towards the bottom of the coil the signal strength will fall off, but the selectivity will improve. Obviously, interesting experiments may be carried out in this direction.

It is better sometimes to employ a separate aerial winding. This winding generally has a small number of turns relative to the number included in the main coil, and is sometimes termed an aperiodic winding, although, actually, it is not. It is tuned by the aerial and may be tapped in order that the selectivity and volume may be adjusted.

There is little to choose between the two methods of connecting or coupling the aerial to the grid circuit coil, but the circuit conditions may be such that in a particular instance one scheme is better than the other.

(Continued on page 54)

SILENT POWERED

FROM BIG CELLS



MADE IN ENGLAND

PRICES:

60-volt (reads 66)	7/11
100-volt (reads 108)	12/11
36-volt	4/6
60 (super power)	13/6
9-volt Grid Bias	1/6
4 1/2-volt Pocket Battery (4/6 a doz.), each	5d.
Single Cell Torch Battery	4 1/2d.

The power of a Lissen Battery flows steadily, smoothly. The big cells are packed with energy. The secret process keeps it pure and sustained. The quality lasts throughout the longest programme—there is never a sign of ripple in the current, never a trace of hum.

Hear how well your own loud-speaker will reproduce a heavy orchestral item when you have the power of a Lissen Secret Process Battery flowing through your set—test it on opera, vaudeville, speech, song, or sports event. Hear how natural and true everything sounds.

Obtainable at every good radio dealer's—ask for Lissen New Process Battery and be sure to take no other.

LISSEN LIMITED, 16-20, Friars Lane, Richmond, Surrey

Managing Director: THOS. N. COLE.

Grid Leak or Anode Bend?

The second instalment of the article by W. JAMES, showing the advantages and disadvantages of the two systems of rectification

THE grid circuit rectifier is essentially a detector of weak signals. As I have explained in the first article, the anode current decreases when a signal is being detected, because the effect of the signal is to charge the grid negatively with respect to its normal voltage.

With too strong a signal the grid-circuit chokes and the anode current may be almost cut off, with the result there is a definite limit to the strength of the signal which may be applied to a rectifier of this type. For weak signals the grid-circuit rectifier is the most sensitive type, and it does not distort too badly.

An examination of the circuit Fig. 1 shows that the grid condenser is in parallel with the grid leak so far as the low-frequency currents are concerned, and as the result there is a tendency for frequency distortion to occur. The impedance of the grid condenser falls off as the frequency is increased and unless precautions are taken to maintain the impedance of the grid circuit at about a certain value the higher frequencies will be weakened.

One should not make the mistake of assuming that only the grid leak is across the grid condenser, there is the grid-to-filament path of the valve, which may be equivalent to quite a low resistance. The actual resistance of this path is dependent upon the working point on the grid-current curve, and may therefore be adjusted by the means already mentioned—that is, by the value of the grid leak and the voltage to which its return end is connected.

When the grid leak is joined between the grid and the negative side of the filament, as it is in certain receivers, the high-note loss may be considerable when the grid condenser is fairly large, such as of .0003 microfarad. A definite and noticeable improvement in the quality may therefore be brought about either by reducing the value of the grid condenser or by fitting a grid leak of lower resistance or, alternatively, by

connecting the grid leak between the grid and the positive side.

It will be seen that the quality may be

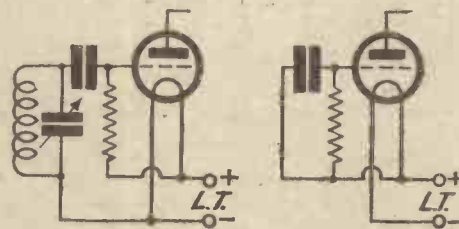

Fig. 1. For the low-frequency part of the signal these two circuits are identical

changed quite easily, and it is a simple matter for an amateur to test the truth of these remarks.

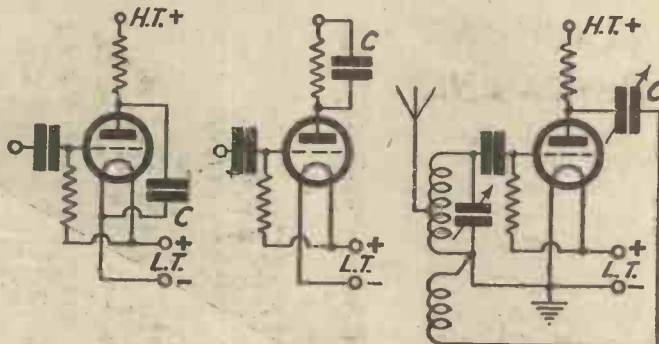

Fig. 2. The condenser C in all circuits is essential

A grid-circuit detector may be coupled to the first low-frequency amplifying valve by means of a resistance, choke or transformer coupling, depending upon the anode

impedance of the valve. This is generally a little greater under working conditions than that specified by the makers at 100 volts high tension and zero grid bias, for it must be remembered that the anode current tends to decrease during reception. Whichever type of coupling is used, however, an anode condenser must be employed. This condenser may be joined directly between the anode and filament of the valve, across the anode resistance or transformer, or it may be included in a reaction circuit. (See Fig. 2.)

The important point to note is that a condenser *must* be used, and my personal preference is for one of at least .0003 microfarad. If the value is too high, therefore having a low impedance relative to the impedance of the valve or of the part connected in its anode circuit, there will be high-note loss.

In order to minimize this a fairly low value of anode resistance should be used, or when a transformer coupling is employed the valve should not have more than a moderate impedance.

I have mentioned only a few of the points that have to be considered when dealing with a grid-circuit detector, but I must pass on to the anode-bend type. When an anode-bend rectifier is used the high-frequency signal is magnified by the valve and the rectification occurs in the anode circuit. The valve is therefore given a negative grid bias in proportion to the anode voltage, which should always be such that the signal does not produce grid current. Fig. 3.

Here, then, is where the anode-bend rectifier differs essentially from the grid-circuit type. The grid is biased to such a negative voltage that the normal anode current is quite small; it is often of the order of 0.1 milliamperes.

(To be concluded next week)

Leningrad, on 1,000 metres, has temporarily closed down for repairs and overhaul; it will resume operations on August 1. Kiev will also be closed during July.

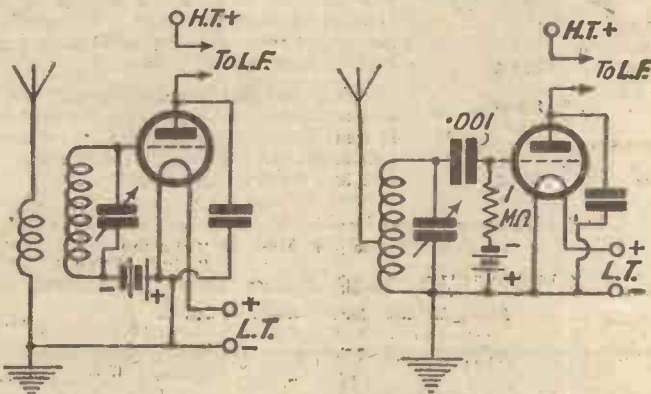

Fig. 3. Anode bend detectors

"ALL POSITION" C.A.V. NON-SPILLABLE



FOR ALL PORTABLE RECEIVERS

The electrolyte in C.A.V. non-spillable batteries differs from all previously known jellied-acid electrolyte, in so far that it is not a solid mass but possesses a cohesive honey-comb-like structure, whereby free distribution of the gases evolved during charge and discharge is ensured.

The introduction of the C.A.V. "All Position" Jellied-Acid Battery has removed, once and for all, the consideration of battery position in Portable Set design. No longer is it necessary to ponder over the various positions in which the set may be placed, for with this battery it may be used in any position, with perfect safety, for any length of time, and with the assurance that no acid will be spilt. All parts of the plates are always surrounded by electrolyte, a condition which is impossible in a battery containing free acid. It is therefore the only class of battery which will give its full rated capacity at any angle.

This class of battery is the result of lengthy and intensive research in our Laboratories; it overcomes the difficulty of total plate immersion in all positions, an essential feature with all portable receivers of the suitcase type.

H.T.3. HIGH TENSION.
The most perfectly designed H.T. Chosen by the most famous Radio Experimenters. 60 volts. 2,500-milliamp hrs. 55/30 & 90 VOLTS. ALSO SUPPLIED



Obtainable from your local dealer and C.A.V. Battery Service Agents
Write for descriptive folder P

C.A.V. Vandervall & Co. Ltd.
ACTON, LONDON, W.3



"ACTON GLASS" L.T.
The most popular L.T. range, of remarkable value and offered in all capacities. Also obtainable in celluloid containers.



CLARION RADIO CABINETS

This illustrates a particularly fine example of Clarion Cabinet work, suitable for housing a complete receiver up to 21" x 7" x 11" deep, and loud speaker.

The price of this model is only £5-2-6 in solid mahogany. Write us for quotations and particulars of all types of Radio Receiver and Loud Speaker Cabinets.

Established over 50 years.

CLARION RADIO FURNITURE
B. Sewell, Jnr
Manford Street, London, E.2
Telephone: Bishopsgate 6371



THIS IS THE NEW PETER GRASSMAN

MOVING-COIL LOUD-SPEAKER
£4-17-6

CONSIDERED the lightest and finest Moving Coil made. Now you can enjoy the advantages of a Moving Coil—the purity and clearness of speech and song—such realistic reproduction that only the Peter Grassman speaker can give you—and at a price which you can afford to pay.

The Peter Grassman A.C. model, according to laboratory tests, has an infinitely superior frequency curve and operates considerably quieter than any other make.

Full particulars from

ROTOR ELECTRIC LTD.
2/3 UPPER RATHBONE PLACE, LONDON, W.1
Telephone: Museum 2642

We want you to hear it. Just send us a postcard, and we will arrange an immediate demonstration in your own district through your own dealer. The following models are available:

PRICES

6-volt, 110-volt, and 220-volt D.C. £4 17s. 6d.
240-volt A.C. models, £8 5s. each

Read the favourable report given in the "Amateur Wireless" June 22 issue.

RADIO from £1:0:0 upwards ON EASY TERMS

Send us a list of your requirements.

"EKCO" ALL POWER UNIT for D.C. MAINS can be yours for first payment of—

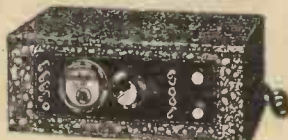

14/9 ONLY

D.C. Model C.2.A.
Get this splendid "EKCO" unit to-day! For a first payment of 14/9 only you can enjoy all the benefits of this excellent D.C. model without delay. Purchase is completed in 11 monthly payments of 10/9. Cash price £5:17:6. Supplies H.T. and L.T. and Grid Bias for anything up to 4-valve sets. A.C. models can also be obtained for a first payment of £1:7:2. Full particulars from:

The LONDON RADIO GRAMOPHONE STORES
Radio Corner, Norton Folgate, Bishopsgate, E.1

Please Mention "A.W." When Corresponding with Advertisers

"A.W." TESTS OF APPARATUS

Conducted by our Technical Editor, J. H. REYNER, B.Sc. (Hons.), A.M.I.E.E.

Berclif Dual Coil

ONE of the recent additions to dual-range coils, tested in our laboratories, is the Berclif Dual Coil, designed for use in aerial or tuned anode circuits.

The windings of this inductance are placed on a hexagonal insulated former in a series of slots. The reaction winding occupies a single slot in between the long and short wave inductances. The primary is coupled to each of these windings, thus ensuring adequate results on both wavelength bands. The change over from one wavelength range to another is accomplished by operating a 3-pole push-pull switch. A knob and extension rod are provided for coupling to the switch spindle.

The inductance we tested is known as type A.N.50, and has a turns ratio secondary-to-primary of 2 to 1. It may also be obtained with a ratio of 1 to 1. The coil is designed primarily for use as a tuned-anode coupling. Tested in a valve circuit, the range on short wavelengths extended from 200 metres to 560, and on the long wavelengths from 750 metres to 2,000. A .0003 reaction condenser gave ample control of oscillation and needed little adjustment throughout the tuning range.

From the results obtained during our tests the efficiency of the coil appears to be high, and it can be recommended to readers. It is made by Messrs. Simmonds Bros., of Shireland Road, Smethwick, Staffs.



Berclif Dual Coil

Lotus Transformer

THE Lotus components made by Messrs. Garnett, Whiteley & Co., Ltd., of Lotus Works, Broadgreen Road, Liverpool, hold a high reputation for workmanship and design, and some of the new lines recently introduced have been no exception to this rule.

We have just tested the new Lotus low-frequency transformer. The windings and the core of this component are housed in a

neat moulded container, with two lettered terminals on each side of the base. The primary and secondary windings are placed in four slots, and these are completely surrounded by a core of special high-permeability steel. The standard step-up ratio is 3 to 1.

We subjected the primary of this transformer to a special inductance test, in which $\frac{1}{4}$ milliamp of A.C. was passed through the windings to represent the actual conditions obtaining in a wireless set. The inductance of the primary without D.C. polarising current was 26 henries, but this rose to 29 with a small polarising current of 1.2 milliamps. In practice, the detector valve passes anode current in the neighbourhood of 1 milliamp, and therefore the transformer will be working under ideal conditions when used following such a valve. Owing to the



Lotus L.F. Transformer

slightly rising inductance for a small polarising current, this component is equivalent to many transformers which have an inductance of approximately 30 to 35 henries without polarising current.

If the instrument is employed in the second low-frequency stage following a power valve passing a current of between 2 or 3 milliamps, the inductance will have decreased to a value between 20 and 15 henries.

We can recommend this moderately priced transformer.

Tangent Coil Base

TANGENT products made by Messrs. Gent & Co., Ltd., of Faraday Works, Leicester, are well known to readers. Recently their range has been increased by a number of distinctive components. One of these, which has been submitted for test, is a six-pin coil base, which has some commendable features. The six-pin terminals are mounted on an attractive brown moulding, rectangular in shape and measuring $2\frac{3}{4}$ in. by $2\frac{3}{8}$ in. Such a compact size is only possible by raising the pin sockets

above the base so that the coil does not foul the terminals. The terminals are arranged three on either side, and connections underneath from the sockets are soldered. The well-known Tangent cup and cone type of terminal is used.

Both the workmanship and finish of this component are beyond criticism. Six-pin



Tangent Six-pin Coil Base

coils fitted into the holder with ease, yet with that feeling of security which means good electrical contact.

This holder can be recommended.

Climax Earth Tube

THE problem of obtaining a good earth connection is one which confronts all users of wireless sets. In many cases, particularly in town, a direct contact with the earth is unobtainable. In other cases, however, a small portion of the ground outside is available for making an earth, and under such circumstances it is undesirable, and sometimes impossible, to bury an earth plate or obtain some other type of efficient earth.

A practical way out of these difficulties is possible by the use of an earth tube, which is driven into the ground with a mallet. We have recently tested a Climax tube, which is made of copper, and so designed that it may be driven into the ground without any difficulty. This is aided by a thin spear point at one end and a thick brass covering at the other. Holes are drilled in the hollow tube, so that water poured into the tube may percolate the surrounding ground and thus give an efficient contact to earth.

Our experience with these tubes, especially with the Climax, is that they will provide a good and reasonably efficient earthing system. In cases where all mains receivers are utilised, a good earth is most important, and we can say that the Climax is up to its job in this way.

The makers are the Climax Radio Electric, Ltd., Quill Works, London, S.W.15.

TWO NEW FEATURES



A—Ball Bearing Swivel Joint, reducing friction to a minimum, thus allowing needle to “track” more easily. By preventing pull on the side of the record groove, this feature adds to the life of the record.

B—Offset Pick-up. By offsetting the pick-up, in respect of the fulcrum of the arm, error in needle tracking is reduced to no more than 3°. The motion of the pick-up armature is always at right angles to the track, also resulting in minimum record wear

With the addition of the two new features mentioned above, the B.T.H. Pick-up and Tone-arm reaches a high stage of mechanical and electrical efficiency. With the new B.T.H. Pick-up and Tone-Arm you get better reproduction with a minimum of wear on the record. In a word, your record is being treated fairly and you hear it at its best.

Price £2. 5. 0.

The above price is applicable in Great Britain and Northern Ireland only.



PICK-UP & TONE-ARM
WITH BALL-BEARINGS AND IMPROVED TRACKING DEVICE

3202

The British Thomson-Houston Co., Ltd., Crown House, Aldwych, W.C.2

AS BRITISH AS BRITANNIA



VERY soon your Wireless Dealer will have stocks of the sensational new BROWN “Vee” Unit. It is the biggest Radio development of recent years. For only £2 (the Unit costs 25/- and the Chassis 15/-) anyone can assemble, in two minutes, a loud speaker that gives fine mellow tone and better volume than you have ever heard before. It recreates the living artiste.

Unit - - Price 25/-
Chassis - Price 15/-

The Wonderful
NEW
Brown
“VEE” UNIT

Advt. S. G. Brown, Ltd., Western Avenue, N. Acton, London. W.3.

9438

MY WIRELESS

Weekly Tips
Constructional
and
Theoretical —



DEN ^{By} W. JAMES

For the
Wireless
Amateur

Condenser Noises!

SOME time ago I mentioned that noises could be set up by the use of tuning condensers having very thin plates, or by the wires of a frame aerial that were not tight. A few days ago when I was testing a simple receiver I once more came across this effect. In this instance the tuning coil itself was not firmly secured, with the result that on occasions it tended to vibrate. When the reaction condenser of the set was so adjusted that a carrier wave could be heard, the vibrations of the coil altered the note, which therefore changed in frequency with the oscillations of the coil. It is a good plan to make certain that coils which may be near tuning condensers or screens are tightly held in position in order to avoid this trouble.

Gramo Control

A volume control is an essential part of a gramophone amplifier and, because it is realised that the input of the amplifier varies over wide ranges, the control is usually connected between the pick-up and the first valve. This arrangement is, of course, correct in the majority of instances, but when the pick-up is connected to a receiver having a low-frequency volume control it is possible on occasions to dispense with the special pick-up control.

The deciding factors are the amount of the grid bias applied to the first valve and the sensitivity of the pick-up. When the pick-up is not very sensitive the maximum

peak value of the voltage set up across its terminals will not exceed much more than one volt, with the result if the first valve has a negative bias of 1.5 volt there will be little fear of grid current flowing.

A more sensitive pick-up may generate so large a voltage as to necessitate a bias of

often of great assistance when receiving broadcast and it may, therefore, just as well be used as described, instead of for controlling the input to the amplifier from the pick-up.

A.C. Detectors

I was particularly interested to receive specimens of a new detector valve having a filament intended to be supplied with alternating current at .8 volt because, whilst numbers of valves of the directly-heated A.C. type have been available for some time, none of them functions satisfactorily as a leaky-grid detector.

The difficulty has been to obtain good detection with the minimum of hum. This is where the new detector valve scores. When used in an ordinary receiver supplied with alternating current, instead of the usual direct for the filaments, there was no trace of hum and, further, magnification appears to be normal. A typical valve has an impedance of about 20,000 ohms for a magnification factor of 15 taking about the usual anode and grid voltages of 100 and zero respectively.

It is, of course, essential to employ either a centre-tapped filament-heating winding on the transformer or a potentiometer. The potentiometer may have a very low resistance, such as 5 ohms, however, and a sliding contact is not necessary, provided one is able to make connection with the centre point. The above circuit shows the connections.

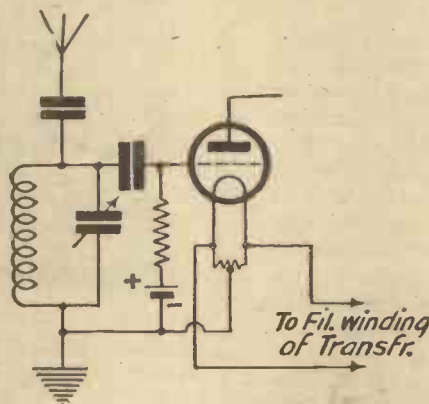

How to connect an indirectly-heated valve as a detector; showing provision of grid bias from a small dry cell

negative three volts for safety. There are many receivers and amplifiers, however, which provide ample magnification when the first valve, which would be used when playing gramophone records, is of such a type that it will take a grid bias of negative three that it would be wise for those about to commence the electrical playing of gramophone records to bear this point in mind. A low-frequency volume control is

THE **100%** Broadcast Receiver
BUILD and OPERATE in ONE EVENING
FORMO
Screened 3 Grid



BRITISH Components Throughout
SEND FOR CATALOGUE.

Famous FORMO COMPONENTS as used in this Set and in all Notable Published Circuits

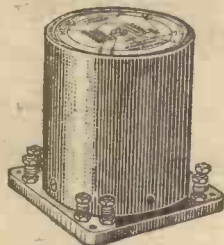

TRANSFORMER-OUTPUT FILTER CHOKE 25/-

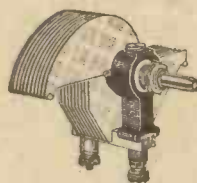

"1928" LOG CONDENSER 5/-
'0005 '00035 '00025

"DE LUXE" MODEL
'0005 6/- '00035 '00015



COILS SG 1 & 2 10/6 each



FORMO-DENSOR 2/- In four variable capacities

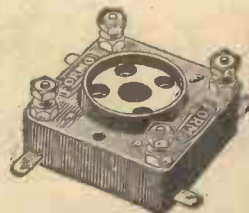

VALVE HOLDER 1/3

THE FORMO CO., CROWN WORKS, CRICKLEWOOD LANE, LONDON, N.W. 2

The **HEART**
of a
Portable
Set
is the *H.T. BATTERY*



To ensure the most satisfactory results, the high-tension battery in a portable set should be the very best obtainable—a Siemens—, specially designed and constructed for the purpose, combining minimum size and weight with maximum efficiency.

Siemens Portable H.T. Batteries are British-made throughout, and are obtainable from your dealer.

**POPULAR TYPE
VALUE FOR MONEY**

No. 1202. 100 volts. Size 10 1/2" x 5 3/4" x 3" high.



**STANDARD TYPE
FOR BEST PERFORMANCE**

No. 830. 99 volts, with grid bias included. Size 9 1/4" x 5" x 3" high.

No. 831. 108 volts. Size 10" x 5" x 3" high.



**HIGH CAPACITY
TYPE**

Provides nearly TWICE the output of current of the ordinary Type.

No. 1075. 126 volts. Size 10" x 6" x 4" high.

No. 1077. 108 volts. Size 10" x 5 1/2" x 4" high.

No. 1088. 126 volts. Size 9 3/4" x 5 1/2" x 4" high.



SIEMENS

PORTABLE RADIO BATTERIES

SIEMENS BROTHERS & CO. LTD., WOOLWICH, S.E.18

**BRING YOUR GRAMOPHONE
INTO LINE WITH
RADIO**

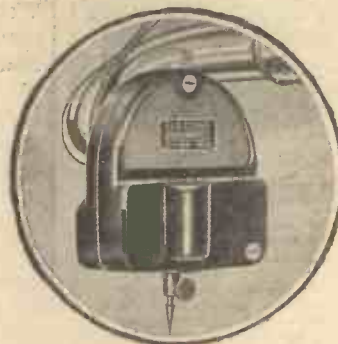

with the **Burndept**

ELECTRIC PICK-UP

Only electric reproduction can do electric recording full justice. With the Burndept Electric Sound-box, however old your gramophone, needle scratch is negligible and reproduction perfect. Volume is controllable, and, as the records are reproduced through the loud-speaker, the greater amplification obtainable gives far better results in the open air than are possible with an ordinary gramophone. It opens up great possibilities for you. Try it for dancing on the lawn at your next tennis party. Fitting is simple, as follows:

Substitute the Burndept Electric pick-up for the ordinary sound-box, connect with flex to the earth and gramophone terminals with which all Burndept receivers are now fitted. With any other model unprovided with terminals the necessary apparatus comprises Sound-box, Volume Control and Adapter



Burndept

ELECTRIC SOUND BOX

Full particulars on request

BURNDIPT WIRELESS (1928) LTD., BLACKHEATH, S.E.3

B.T.19

BROWNIE

WIRELESS



9'6 "POPULAR" TRANSFORMER

When planning your new set ensure perfect amplification by including a Brownie "Popular" Transformer as recommended by AMATEUR WIRELESS for use in a number of their special circuits. The core iron and the windings, which are the very finest obtainable, are assembled in the famous Brownie Factory; while all the delicate parts are protected by an attractive moulded casing which seals the whole transformer against any atmospheric interference. Send P.C. to Dept. 23 at address below for free booklet. "Wireless without Worry."

BROWNIE WIRELESS CO. (G.B.) LTD.

Nelson St. Works, Mornington Crescent,
LONDON, N.W.1

BROWNIE

Tunewell Coils

Special Notice.

An entirely new method of winding *Dual Range Coils* has been recently provisionally patented, and every post is bringing us letters of praise from satisfied users:

Coils for the following popular sets are in stock at most dealers:

COSSOR S.G.3	} Price 21/- per pair
LISSEN S.G.3	
MULLARD S.G.P.3	
CLARION S.G.3	

—Your Dual Coils, in my Mullard S.G.P.3, are doing wonders, on the high waves especially, they beat the separate coils to a frazzle.

The above is an average sample of letters of appreciation:

Mullard Master 3, Bantam Three, Favourite 3, etc., Coils, Dual Range ... 7/9

H.F: Choke for the Local and Continental Three, 5/9

2-PIN COILS all sizes, from 1/6 each

6-PIN COILS all types, from 3/11 each

TURNER & CO., 54 Station Rd., N.11

LETTERS TO THE EDITOR

The Editor does not necessarily agree with the views expressed by correspondents.

Broadcasting The National Anthem

SIR,—I was interested to see a reference in your "Current Topics" (AMATEUR WIRELESS 367, June 22) to a correspondent's suggestion that the B.B.C. should complete each night's broadcast by playing The National Anthem.

At one time, of course, it was the rule at Savoy Hill to end the studio programme in this way, but that was before late relays of dance music became a daily feature from 2LO and other stations.

If the B.B.C. were to revert to this practice, as suggested, they would have to keep an orchestra waiting in the studio from about 10.30 or 11 until midnight (unless a gramophone record were used) or else the anthem would have to be sandwiched in between the end of the studio programme and the commencement of the dance relay, where it would seem rather out of place. Therefore, I think that the suggestion is hardly practicable.

O. (London, S.W.).

"Britain's Favourites"

SIR,—Thank you very much for the remodernising of "Britain's Favourite Two," which I think is one of the best two-valvers I have had yet. I have built "Britain's Favourite Three" (1928); also converted it to the 1929 model. That was a very good set. I have also got the old 1928 "Britain's Favourite Two," still as good as ever, but I think you have beaten the old one.—S. (Stepney).

Scottish Programmes

SIR,—In a recent issue of AMATEUR WIRELESS there was a paragraph which said "Fresh cause for protest has been given West of Scotland listeners by the news that the Glasgow Station Wireless Band is being dismissed." As a West of Scotland listener, please allow me to state that the only complaint about the matter is that this band is not being dismissed before September.

If only you could hear their rendering of good musical pieces you would fully appreciate why the great majority of listeners in this district are looking forward to the time when at least 95 per cent. of the programmes come from London.

All stations are no doubt afflicted by a band of fanatics whose sole desire is for items of purely local interest; but that is no reason why the very large majority of listeners should be deprived of hearing the best of everything; and the best is only obtainable from London.

It is very annoying to sit listening to good songs and musical items being murdered, and all the time know that London

district listeners are enjoying a first-rate programme given by good artistes.

Roll on centralisation!

"GLESCA" (Glasgow).

5GB in Ireland

SIR,—Re letters in your recent issues on the above subject, I was surprised to see that "Kilowatt" (Donegal) is able to get 5GB with greater volume than 5XX. I do not for a moment question the accuracy of "Kilowatt's" statement, as there are some districts where very singular results are obtained. However, I am only three miles from the Birmingham station, yet I get 5XX at 25 per cent. greater volume. I pay frequent visits to Southern Ireland, and find that the same conditions prevail there. This is all the more regrettable, as such excellent programmes are broadcast from 5GB compared with the sob-stuff poured out from 5XX.

There are so many different circuits in use with various coils; dead spots, and aerials, that little reliance can be placed on reports received haphazard.

In order to get a trustworthy insight on the matter under notice, I would suggest that owners of sets of standard design send in reports of their experience. I think that valuable data could be obtained in an experiment of this kind.

A. H. M. (Birmingham).

The "Ranger 4"

SIR,—There must be several of your numerous readers who, like myself, cannot make their minds up regarding the set they require.

The "Ranger 4" appealed to me, so I chanced it. With the help of a friend, we tried it out in Camden Town, St. John's Wood, and near Hyde Park. I should like to compliment the designer on the ease with which it cuts out 2LO. We got 5GB with London full on, also Radio Belgium, Buda Pest, and several others. On the long waves Eiffel Tower, Hilversum, Radio Paris, and Berlin, and could easily cut London out. Kalundborg and Stockholm also trickled in. All these at loud-speaker strength and on 60 volts.

Your splendid paper really helps the amateur.—N. B. (London).

"Amateur Wireless and Radiovision." Price Three pence. Published on Thursdays and bearing the date of Saturday immediately following Post free to any part of the world: 3 months, 4s. 6d.; 6 months, 8s. 9d.; 12 months, 17s. 6d. Postal Orders, Post Office Orders, or Cheques should be made payable to "Bernard Jones Publications, Ltd."

General Correspondence is to be brief and written on one side of the paper only. All sketches and drawings to be on separate sheets. Contributions are always welcome, will be promptly considered, and if used will be paid for. Queries should be addressed to the Editor, and the conditions printed at the head of "Our Information Bureau" should be closely observed. Communications should be addressed, according to their nature, to The Editor, The Advertisement Manager, or The Publisher, "Amateur Wireless," 58-61 Fetter Lane, London, E.C.4.



THE launching of H.M.S. *Exeter*, a new cruiser of 8,550 tons, will take place at Plymouth on July 18 at 3 p.m. A running commentary on the ceremony will be supplied by Commander Stephen King-Hall for the benefit of listeners to Daventry 5GB.

The Posen short-wave station on 30 metres daily relays the local broadcast programmes between 11 p.m. and midnight. Although the energy radiated is barely 300 watts, the transmissions have been heard throughout most of Europe.

Another excerpt from *Love Lies*, the musical play at the Gaiety Theatre, will be relayed to 2LO and 5XX on July 20; the scene enacted includes Stanley Lupino, Laddie Cliff, and Connie Emerald.

In the late evening of July 16 all northern stations and both 2LO and Daventry will broadcast excerpts from the Northern Command Tattoo which is taking place at the Knavesmire, York.

A Tale of Tintern Abbey is the title of a programme which Cardiff will broadcast from these historical ruins at 8 p.m. on July 25.

A chorus of 300 R.N.V.R. men, old blue-jackets, and marines will take part in an entertainment which Daventry 5XX will relay on July 26 from H.M. drill ship *Flying Fox*, the headquarters of the Bristol Division R.N.V.R.

The thirty-fifth season of Promenade Concerts and the third under B.B.C. control will open at Queen's Hall on August 10. During the eight-week season the majority of the forty-nine concerts given will be broadcast through 2LO, 5XX, or 5GB, and other main stations.

According to an Austrian journal, the Zagreb broadcasting station has advised the Jugo-Slavian postal authorities that if financial assistance is not forthcoming the transmitter will be compelled to suspend operations.

Since 1925 two broadcasting stations have been in competition at Barcelona, namely, EAJ1, owned by Union Radio, and EAJ13, operated by an international private company. Agreement has now been reached for the amalgamation of the two concerns.

From July 4 Radio Normandie (France) suspended its daily transmissions, and will not resume them until early or middle August. In the meantime the station is to be transferred to a hill dominating the port of Fécamp, and the power of the transmitter will be increased.

Tests in telephony on 49 metres are carried out daily by the Eiffel Tower (Paris) from 11.30 to 11.45 a.m., 6.15 to 6.30 p.m., and from 10.15 to 10.45 p.m. B.S.T.

The general radio set in America has an average of five and one-quarter valves, according to the National Radio Institute of Washington, D.C. Two-thirds of the radio-owning families have less than five valves, one-twelfth have more than six valves, and less than one-thirtieth still own crystal sets.

Something really ambitious is being tried by the B.B.C. in Scotland. It is an endeavour to transmit the spirit of the inimitable "Wee MacGregor" through the microphone. Every important feature is introduced and the full flavour of the broad comedy preserved.

Player's
please



REGD NO 134011

NCC 207

SMASHING PROOF

"little short of marvellous"

read what power engineer **SAYS** about **STANDARD**

SAC. L. L. LANGRISH

PERMANENT H.T. BATTERIES
Best battery he has had during 7 yrs' experience

Teddington, 6/6/29.

Dear Sirs,

I am a Power Station electrician by trade, so you will appreciate that I have gone pretty fully into the matter. I received the battery on Friday, March 1, and put it into service right away. Since then it has never had less than 6 hours' work per day on a three-valve set, i.e., Det., L.F., and Power, using a well-known type of valve. The average consumption is 7 to 9 m.a. On making a test to-day with an accurate instrument while on discharge after four hours' continuous work, I got an average of 1.23 volts per cell over the 96 cells. Considering the size of the cells, this seems little short of marvellous. In addition to this the quality of reception and tone is increased considerably over any other type of H.T. I have used during seven years' wireless experience. I should think that with the aid of your very complete instruction book the assembly and maintenance of your batteries should be quite simple for the merest novice and I should certainly advise any newcomer to wireless to start right away with your "Trouble free H.T." and save pounds later.

(Signed) N. A. WILLIAMS.

SIMPLE TO INSTALL, LASTS FOR YEARS, IMPROVES RECEPTION

Each battery when delivered consists of strongly made insulated jars assembled in neat, compact "Double" containers, complete with oil and chemicals. All you have to do is to fill the jars with water, add chemicals and battery is ready for use. Gives four times the life of dry batteries and can be recharged cheaply at home.

POPULAR MODEL, 96 v. (up to two valves). Cash £2/3/1, or 7/6 down and five equal monthly payments of **7/6**

SUPER CAPACITY, No. 3 (three to five valves). £2/17/9, or 10/1 down and five equal monthly payments of **10/1**

Obtainable from Halford's Stores, Curry's Stores, and all Radio Dealers, cash or deferred terms.

SEND TO-DAY FOR FREE BOOKLET TO **STANDARD WET BATTERY CO.**
 Dept. A.W.
 184-188 Shaftesbury Avenue,
 London, W.G.2.

M. B.

INSURE YOUR VALVES

USE only "Competa" Fuses. Each guaranteed fuse is branded on the cap and carton. Don't accept substitutes, or ordinary flash lamp bulbs and risk burning out your valves.

6d

TRADE MARK THE WORLD'S SELECTED

COMPETA

Advt. of A. F. BULGIN & Co., 9/10/11 Cursitor Street, London, E.C.4

OUR BLUEPRINT SERVICE

Constructors of receivers described in this Journal should make full use of our Blueprint Service and avoid all risk of failure.

"PRACTICAL COIL MAKING FOR THE HOME CONSTRUCTOR"

(Continued from page 44)

In circuits of the detector and low-frequency types, reaction is generally applied to the grid circuit, and I have, therefore, indicated in Fig. 4 how the reaction winding may be arranged. Remember that a fine wire may be used in the reaction circuit.

In order to illustrate the various points, I have wound a number of coils with No. 22 double-silk covered wire on Paxolin tubes, having diameters of 3, 2½, and 2 in.

The first coil is a plain one having 50 turns of No. 22 d.s.c. wound on a tube 3 in. in diameter. The second one has 63 turns of the same gauge of wire wound on a tube 2½ in. in diameter, whilst the third has 82 turns on a 2-in. tube. These three coils cover the same wavelength range.

Coil No. 4 has 50 turns of No. 22 d.s.c., but is tapped at the fifth, tenth, and fifteenth turns, as illustrated. A piece of systoflex is placed under the wire at the tapping points when winding.

The method of providing a separate aerial winding is illustrated by coil No. 5. This winding has 15 turns tapped at the fifth and tenth. A reaction winding may be added to coil No. 4 as shown by coil No. 6. The winding is of 30-gauge d.s.c. and there are fifteen turns wound in the same direction as the larger coil.

Coil No. 7 is the last and shows how a reaction winding may be provided on a coil having a separate aerial winding.

There is a space of ¼ in. between the aerial and grid windings and of ½ in. between the reaction and grid windings.

In a further article I intend dealing with the construction of long-wave coils.

OLD LODGERS AND NEW "DIGS"

Jottings from my Log—by Jay Coote

WHEN, on Sunday, June 30, some two hundred European stations were called upon to readjust their wavelengths according to the *Plan de Prague*, in view of the fact that all pawns in the game did not possess the standard calibrated wave-meters, it was anticipated that the change-over could not be made without some little trouble. For this reason, special measures were taken to inform the participants in the new scheme whether they had carried out the instructions or not to the general satisfaction. On this occasion the European stations were divided into two groups and were specially watched by Brussels, in co-operation with Keston, on the one hand, and on the other by Prague working with Berlin.

The necessary corrections to be made were advised by both telephone and cable. Daventry 5XX was the mouthpiece for all information concerning stations in the

Western European area and Zeesen for all those lying in the central and eastern regions of the Continent.

On June 30, therefore, at 10.45 p.m., as the British and European stations had already transmitted during the day on the new wavelengths, I listened carefully for the report to be given out by the German and English high-power transmitters. Zeesen, punctual to the minute, came on the air at the conclusion of a dance item, and, both in German and French, addressed its remarks to the "all-buts" who had not succeeded in taking up their exact positions in the ether. Such observations as "Ljubljana, 520.4 kilocycles, you are 9.6 kilocycles too low, and Belgrade, 696 kilocycles, 5.2 kilocycles too high" must have come as a slight shock to the interested parties. Later, at 10.50 p.m. after a preliminary call, Daventry 5XX put out a series of measurements taken at 6 p.m., as supplied by Brussels, and carefully, for the benefit of the foreign nations, repeated them in French—and excellent French, at that.

Until the eleventh hour German listeners had patted themselves on the back over the prospect of 5GB's removal from the neighbourhood of Langenberg; as, however, for the present this is not being done, the disappointment was a severe one.

The Easy Way TO PERFECT RADIO

In addition to their own extensive range, PETO SCOTT offer YOU Every Known Radio Receiver or Component—all on

EASY TERMS

The following list is merely representative, and we ask you to fill in the coupon below or send us a list of your requirements.

- LOCAL AND CONTINENTAL 3. Kit and valves. Send only 12/6. Balance by easy instalments.
- "A.W." HOLIDAY PORTABLE KIT. Send 21/-. Balance by easy instalments.
- MULLARD S.G.P. THREE. Complete kit of components. Send only 15/-. Balance by easy instalments.
- COSSOR MELODY MAKER. Send only 10/-. Balance in 11 monthly instalments of 14/7.
- LEADING MAKES OF H.T. ELIMINATORS from 4/7 down. Balance in 11 monthly instalments of 4/7.
- EXIDE 120-volt H.T. ACCUMULATORS, with crabs. Send only 6/11. Balance in 11 monthly instalments of 6/11.
- PORTABLES. All the leading makes supplied from 21/- first payment.

Build your own set the Easy Way NOW!

Our Catalogue contains all leading makes of Receivers, Accessories, Kits of Components for the Home Constructor.

Mail Coupon in unsealed envelope under ½d. stamp now!

PETO SCOTT CO., LTD.

Please send me your big Illustrated Lists.

NAME

ADDRESS

A.W. 19/7

Free Demonstrations and Advice by Qualified Engineers at our Shops:—
77 City Road, London, E.C.1
 62, HIGH HOLBORN, LONDON, W.C.1.
 4, MANCHESTER STREET, LIVERPOOL.
 33, WHITELOW ROAD, CHORLTON-CUM-HARDY, MANCHESTER.

BROADCAST TELEPHONY

(Broadcasting stations classified by country and in order of wavelengths)

Metres	Kilo-cycles	Station and Call Sign	Power (Kw.)	Metres	Kilo-cycles	Station and Call Sign	Power (Kw.)	Metres	Kilo-cycles	Station and Call Sign	Power (Kw.)				
GREAT BRITAIN															
25.53	11,751	Chelmsford		*329	944	Montpellier (PTT)	1.5	JUGOSLAVIA							
		(5SW)	15.0	336	893	Petit Parisien	0.5	*307	977	Zagreb (Agram)	1.25				
*200	1,500	Leeds (2LS)	0.13	*351	855.5	Algiers	2.0	*429	698	Belgrade	4.0				
*242	1,238	Belfast (2BE)	1.0	368	815	Radio LL, Paris	1.0	*372	527	Ljubljana	5.0				
*261	1,148	Newcastle (5NO)	1.0	*381	788	Radio Toulouse	9.0	LATVIA							
288.5	1,040	Swansea (5SX)	0.13	413	725	Radio Maroc (Rabat)	2.0	*525	572	Riga	2.0				
288.5	1,040	Stoke-on-Trent (6ST)	0.13	436	687	Radio Flandre (Lille)	0.5	LITHUANIA							
288.5	1,040	Sheffield (6LF)	0.13	*447	671	Paris (Ecole Sup. PTT)	0.7	*1,935	155	Kovno	15.0				
288.5	1,040	Plymouth (6PY)	0.13	*406	644	Lyons (PTT)	5.0	NORWAY							
288.5	1,040	Liverpool (6LV)	0.13	1,350	223	Tunis (testing)	2.0	*297	1,070	Notodden	0.7				
288.5	1,040	Hull (6KH)	0.2	*1,444	207.5	Eiffel Tower	8.0	*364	824	Bergen	1.0				
288.5	1,040	Edinburgh (2EH)	0.85	*1,725	174	Radio Paris	8.0	*387	774	Frederiksstad	1.0				
288.5	1,040	Dundee (2DE)	0.13	GERMANY								*450	666.5	Rjukan	1.0
288.5	1,040	Bournemouth (6BM)	1.0	*218	1,373	Flensburg	1.5	*456	657	Tromsøe	1.0				
288.5	1,040	Bradford (2LS)	0.13	*227	1,319	Cologne	4.0	*456	657	Aalesund	1.0				
*301	995	Aberdeen (2BD)	1.0	*234	1,283	Muenster	4.0	*456	657	Porsgrund	1.0				
*310	968	Cardiff (5WA)	1.0	*239	1,256	Nurnberg	4.0	*493	668	Oslo	1.5				
*356	842	London (2LO)	2.0	*246	1,220	Kiel	0.7	POLAND							
*377	797	Manchester (2ZY)	1.0	*246	1,220	Cassel	0.7	*313	959	Cracow	1.5				
*399	753	Glasgow (5SC)	1.0	*253	1,184	Breslau	4.0	*335	896	Posen	1.5				
*479	626	Daventry (5GB)	17.0	*259	1,157	Leipzig	4.0	385	779	Wilno	1.5				
1,553	193	Daventry (5XX)	25.0	*270	1,112	Kaiserslautern	1.5	*408	734	Kattowitz	10.0				
AUSTRIA															
*246	1,220	Linz	0.5	*276	1,085	Koenigsberg	4.0	*1,411	212.5	Warsaw	10.0				
*285.5	1,051	Innsbruck	0.5	*283	1,058	Berlin (E.)	0.7	ROUMANIA							
*352	851	Graz	7.0	*283	1,058	Stettin	0.7	*391	761	Bucharest	4.0				
*453	666	Klagenfurt	0.5	*319	941	Dresden	0.75	RUSSIA							
*517	581	Vienna	20.0	*325	923	Gleiwitz	6.0	*851	855.5	Leningrad	20.0				
BELGIUM															
230	1,300	Charleroy	0.25	*339	887	Bremen	0.75	*427	702.5	Kharkov (NKO)	5.0				
245	1,220	Schaerbeek-Brussels	0.5	*380	853	Stuttgart	4.0	*483	621.5	Homel	2.5				
250	1,200	Ghent	0.5	*372	866	Hamburg	4.0	*825	364	Moscow (PTT)	25.0				
280	1,070	Liège	0.5	*390	770	Frankfurt	4.0	*1,804	230	Kharkov	15.0				
*509	590	Brussels	10.0	*418	776	Berlin	4.0	*1,481	202.5	Moscow	30.0				
CZECHO-SLOVAKIA															
*263	1,139	Morava-Ostrava	12.0	*453	666	Danzig	0.75	SPAIN							
*279	1,076	Bratislava (Feriby)	12.0	*453	666	Danzig	0.75	*208	1,121	Barcelona (EAJ13)	10.0				
*293	1,022	Kosice	2.0	*473	635	Munich	4.0	314	956	Oviedo (EAJ19)	0.5				
*342	878	Brunn (Brno)	2.4	*533	593	Lunenburg	25.0	324	926	Almeria (EAJ18)	1.0				
*487	637	Prague (Praha)	5.0	*569	536	Augsburg	0.5	*349	860	Barcelona (EAJ1)	10.0				
DENMARK															
*281	1,067	Copenhagen (Kjbenhavn)	1.0	*580	536	Hanover	0.7	*368	815	Seville (EAJ5)	0.5				
1,153	260	Kalundborg	7.5	*572	527	Freiburg	0.7	400	759	Madrid (Radio España)	1.0				
ESTHONIA															
*295	1,013	Reval (Tallinn)	1.3	*1,635	183.5	Zeesen	20.0	405	740	San Sebastian (EAJ8)	0.5				
FINLAND															
*221	1,355	Helsingfors	0.8	2,100	142	Norddeich	10.0	*424	707	Madrid (EAJ7)	3.0				
*1,800	167	Lahti	20.0	2,290	131			456	658	Salamanca (EAJ22)	0.55				
FRANCE															
170	1,750	St. Quentin	0.25	GRAND DUCHY											
220	1,304	Béziers	0.1	*223	1,316	Luxembourg	2	SWEDEN							
*237	1,265	Juan-les-Pins	0.4	HOLLAND											
238	1,260	Bordeaux (Radio Sud-Ouest)	2.0	31.4	9,554	Eindhoven (PCJ)	25.0	265	1,130	Trollhattan	0.4				
240	1,250	Radio Nimes	1.0	*293	1,004	Huizen (until 5.40 p.m. B.S.T.)	5.0	*322	932	Goeteborg	6.0				
*255	1,175	Toulouse (PTT)	1.0	*1,072	280	Hilversum (ANRO)	5.0	322	932	Falun	0.5				
*265	1,130	Lille (PTT)	0.8	*1,875	160	Huizen (after 5.40 p.m. B.S.T.)	5.0	*436	689	Stockholm	1.5				
*273	1,103	Rennes (PTT)	1.0	*1,875	160	Scheveningen-Haven	5.0	*542	554	Sundsvall	1.0				
*286	1,049	Grenoble (PTT)	1.5	*350	545	Buda-Pest	15.0	*778	385	Ostersund	2.0				
*292	1,028	Radio Lyons	1.5	ICELAND											
*293	1,022	Limoges (PTT)	0.5	*1,200	250	Reykjavik	1.0	*1,348	222.5	Motala	30.0				
*304	966	Bordeaux-Lafayette (PTT)	0.5	IRISH FREE STATE											
305	982	Agen	0.3	*225	1,337	Cork (5CK)	1.5	SWITZERLAND							
309	970	Vitus Paris	2.0	*413	725	Dublin (2RN)	1.5	*409	743	Berne	1.0				
*316	950	Marseilles (PTT)	0.5	*274	1,094	Turin (Torino)	7.0	*459	633	Zurich	0.6				
GLASGOW															
July 16 A Scottish concert.															
ABERDEEN															
July 18 A Scottish programme.															
BELFAST															
July 19 'Carmen, a opera by 'Bizet.'															

Note.—As, on going to press, definite information is still lacking from some countries regarding the distribution of wavelengths allocated to them under the Plan de Prague, the list could not be completely revised for this issue. All wavelengths marked with an asterisk have been allotted according to the Plan de Prague. † May continue to transmit on 1,283 m. 234 Kc.

CHIEF EVENTS OF THE WEEK

Date	Event
July 16	LONDON AND DAVENTRY (5XX) The Northern Command Searchlight Tattoo. S.B. from Leeds.
17	The Electra, of Euripides.
18	Alhambra ballet music.
19	A symphony concert.
20	Running commentary on the final of King's Prize, relayed from Bisley.
July 15	DAVENTRY EXPERIMENTAL (5GB) Vaudeville programme.
16	The Electra, of Euripides.
17	A vaudeville programme.
18	Launching of H.M.S. Exeter, H.M. Dockyard, Devonport.
20	A popular violin recital.
July 16	MANCHESTER The Northern Searchlight Tattoo, S.B. from Leeds.
July 19	NEWCASTLE An orchestral concert from the North-East Coast Exhibition.

The Mullard Wireless Service Co., Ltd., have now transferred the sales and accounts departments from Nightingale Lane, Balham, to the Company's new premises in Charing Cross Road. All communications to either department should now be made to Mullard House, Charing Cross Road, W.C.2.

Owing to the demands upon our space in this issue we regret that it has been necessary to hold over "Our Information Bureau" feature.

RAYMOND'S FOR WIRELESS

27 & 28a, LISLE ST., LONDON, W.C.2
Come to LEICESTER SQUARE TUBE.

This address is at the back of Daly's Theatre. Phones: Gerrard 4637 and 2821

HOURS OF EVERY DAY 9 to 8
BUSINESS SATURDAY - 9 to 9
SUN. MORN. 11 to 1

MUST BE CLEARED
SPLENDID 3 VALVE LOUD-SPEAKER

SETS READY TO USE
In Handsome Cabinet.



Receives London 5GB, 5XX, and many Continental Stations.
D. & 2 L.F.

NO COILS TO CHANGE JUST SWITCH ON, THAT'S ALL

Complete with 3 Dull-emitter Valves, S.M. Dial. All parts on Baseboard. Hinged Lid. Various Panel Designs. CANNOT BE REPEATED. Packing and Carriage 3/6. NETT

65/-

CAN ALSO SUPPLY (READY TO USE)

CLARION S.G. 3 CIRCUIT, A.W. 9-3-29, (Valves extra) S.M. DIALS, IN CABINET, with TUNEWELL COILS. Nett Cash

79/11

BRITAIN'S FAV. 3 (De Luxe), IN CABINET with TUNEWELL DUAL COIL, S.M. DIALS, Valves extra. Nett Cash

69/6

BRITAIN'S FAV. 2 (up-to-date), A.W. 25-5-29, IN CABINET with 2 DULL-EMITTER VALVES and TUNEWELL DUAL COIL. Nett Cash

70/-

MULLARD MASTER 3 STAR CIRCUIT IN CABINET with TUNEWELL DUAL COIL and 3 DULL-EMITTER VALVES. Nett Cash

84/-

COSSOR (Original) MELODY CIRCUIT IN CABINET with High-class Dual Silkwood Coil, Valves extra. Nett Cash

67/6

If Cabinets NOT required deduct 10/- per set. Above tested ready to use. If to be sent by rail, 3/6 extra.

HANDSOME

PEDESTAL CABINETS



Various Fret Designs for Clarion, Mullard Star, Mullard S.G.P., Cossor Melody (Original), and similar sets. Worth £5.

Takes Receiver Batteries and Loud-speaker. -In Polished Oak. Carriage and packing extra.

47/6

LOUD-SPEAKER AMERICA

(A.W. 6-7-20). Post extra. Lison .001 variable, 6/6, 7-ohm Rheostat, 2/-; V. Holders, W.B., 2 for 2/6; Wearite S.W. Choke, 4/6; R.I. Pentode Output, 2/-; Or Irganic ditto, 3/6; R.I. Hypermu L.F., 2/-; Panel Brackets, Terminals, S.M. Dials, Grid Leaks, Fixed Condensers, Shortwave Coils and Base, at various prices. Quotation if list of requirements sent.

Shortwave Adaptor to Get AMERICA (A.W. 4-5-20) .00015 Shortwave Variable, S.M. Dial, Reaction Condenser, 7-ohm Panel Rheo, 6-pin Base, Spring V. Holder, .001 fixed, Chk. Plug Adaptor, Shortwave Choke, Wire, Screws, Terminals, Baseboard and Panel. The lat 30/- Cash. Post free U.K. Lewoca AMS4, 7/6; AMS9, 7/6 (Ultra Shortwave Coils). Copy A.W. included with order.

SETS OF PARTS LEADING HOUSE: Space too limited to advertise the many and varied circuits, but if your order is OVER 25/- will give you a reduced inclusive price. All parts in stock for Osram Magnet, Cossor Scaled Kit, Clarion S.G. 3, Champion 3, Digger, Radiano 3, Concert 4, Radiano 4. Any circuit (where possible) quoted for. Illustrated Catalogue, 144 pp., 1/- Refunded on first 10/- order.

Please see previous issues for LIST OF SETS, COMPONENTS, VALVES, COUPONS, VOUCHERS, Etc.

BLUEPRINTS

Copies of the "Wireless Magazine" and of "Amateur Wireless" containing descriptions of all these sets can be obtained at 1s. 3d. and 4d. respectively, post free, to "Amateur Wireless" sets and "W.M." to "Wireless Magazine" sets.

Index letters "A.W." refer to "Amateur Wireless" sets and "W.M." to "Wireless Magazine" sets.

All Post Free

CRYSTAL SET (6d. each)
A Daventry-Local Crystal Set AW185

ONE-VALVE SETS (1s. each)
Beginner's One-valver AW140
Reinartz One WM127

TWO-VALVE SETS (1s. each)
East to West Short-wave Two (D, Trans) .. AW159
Beginner's Two (D, Trans) AW171
Auto Two (D, Trans) AW174
All-Mains Two (D, Trans) AW180
1929 Favourite Two (D, Trans) AW186
Loud-speaker America Two AW190
Key-to-the-Ether Two (D, Trans) WM107
Meteor Two (D, Trans) WM114
Clipper Two (D, Trans) WM135
Twinflex (Reflex) WM138
Continental Two (D, Trans) WM143

THREE-VALVE SETS (1s. each)
All-purpose Short-wave Three (D, RC, Trans) .. AW147
Screen-grid Q Coil Three (HF, D, Trans) .. AW150
All-Britain Three (HF, D, Trans) AW158
Bantam Three (D, RC, Trans) AW160
Hartley Dual-range Three (D, RC, Trans) .. AW166
Listener's Three (HF, D, Trans), price 4d. free with copy of "AW" AW169
The Binowave Three (D, RC, Trans) AW172
Clarion Three (SG, D, Trans) AW175
1929 Favourite Three (D, RC, Trans) AW179
Local and Continental Three (HF, D, Trans or D, RC, Trans) AW 189
Everyday (D, 2 Trans) WM52
All-wave Screen-grid Three (HF, D, Trans) .. WM110
Standard Coil Three (HF, D, Trans) WM117
Festival Three (D, 2 LF-dual Imp.) WM118
Wide-world Short-waver (SG, D, Trans) .. WM120
New Year Three (SG, D, Pentode) WM123
The Q3 (D, RC, Trans) WM124
Lodestone Three (HF, D, Trans) WM129
Simple Screen Three (HF, D, Trans) WM131
Dynamic Three (SG, D, Trans) WM136
At Home Three (D, 2RC) WM141
Short-Wave Link (D, RC, Trans) WM142

FOUR-VALVE SETS (1s, 6d. each)
Overseas Short-waver (HF, D, 2 Trans) .. AW133
Stability Four (HF, D, RC, Trans) AW182
Five-pounder Four (HF, D, RC, Trans) .. WM91
Touchstone (HF, D, RC, Trans) WM109
Reynier's Furzehill Four (SG, D, 2 Trans) .. WM112
Economy Screen-grid Four (SG, D, RC, Trans) WM113
Binowave Four (SG, D, RC, Trans) WM119
Standard-coil Four (HF, D, 2RC) WM122
Dominions Four (2SG, D, Trans) WM134
The Drum Major (HF, D, RC, Trans) WM137
Music Player (HF, D, RC, Trans) WM144

FIVE-VALVE SETS (1s, 6d. each)
"Q" Gang-control Five (2HF, D, 2 Trans) .. AW161
Fidelity Five (HF, D, 2RC) WM130
All-wave Lodestone Five (HF, D, RC, Push-pull) WM146

SIX-VALVE SETS (1s, 6d. each)
Short-wave Super-6 (Super-het, Trans) .. AW67
Eagle Six (3 HF, D, RC, Trans) WM106

AMPLIFIERS (1s. each)
"A.W." Gramophone Amplifier (3RC) .. AW162
Searcher Unit (HF) AW176
Gramophone Amplifier (3 v.) AW187
Signal Booster (HF Unit) WM128
Audiotrol Amplifier WM132

MISCELLANEOUS (1s. each)
H.T. Eliminator for A.C. (200 v. output) .. AW102
L.T. and H.T. Mains Unit (D.C.) AW123
Listener's Speaker, price 4d. free with copy of "AW" AW170
Arcadian Linen-diaphragm Loud-speaker (Full-size) AW177A
D.C. Unit (HT) AW178
Short-wave Adaptor (1 v.) AW183
High-tension Battery Charger AW191
Universal Short-wave Adaptor WM82
Buzzer Wavemeter (6d.) WM121
H.T. Unit for A.C. Mains WM125
Lodestone Loud-speaker WM126
James H.T. Unit for D.C. Mains WM133
Short-wave Adaptor for Dominions Five .. WM147
Two Ampere Low-tension Unit WM149
A.C. Mains Amplifier WM148

PORTABLE SETS
House Portable (SG, D, RC Trans) .. AW168 1/6
Arcadian Portable (SG, D, 2 Trans) with linen-diaphragm loud-speaker (half scale) .. AW177 1/6
£5.5.0 Portable (D, Trans) AW181 1/6
Talisman Portable (SG, D, 2 Trans) AW184 1/6
Holiday Portable Three (D, 2 Trans) .. AW188 1/-
Chummy 4 (with modifications for L.S. and H.T.) WM80A 1/6
Wayfarer Portable (Super-het) WM139 1/6
1929 Chummy (SG, D, Trans, RC) WM145 1/6
Picnic Portable (D, RC, Trans) WM149 1/-

When ordering Blueprints please send Postal Order
NOT STAMPS
AMATEUR WIRELESS 56-61 FETTER LANE
LONDON, E.C.4

"U.S.A. RADIO"

(Continued from page 34)

transmissions from this chain may be attributed to this type of microphone.

The notion is fairly general in England that American radio technique is behind in the low-frequency side of the business. We held this notion only until we heard the first American set in action. A whole-hearted adoption of the moving-coil loud-speaker and push-pull amplification, together with the wide use of mains drive, imparts to the latest American receiver a tonal quality such as we in England only produce in the laboratory. The average standard of quality is now very high—much higher than in England.

So much has been written of American superiority in the high-frequency side of radio that we came prepared to be humble in this respect. Experience confirms our pre-conceived ideas, in that the single-dial control of three tuned circuits is a universal feature of American sets.

Having eulogised American radio to this extent, we find some comfort in the thought that the American receiver is, after all, only a product of the conditions it is designed to serve. With such a number of high-powered stations, the problem in receiver design is more related to selectivity than sensitivity. The high-frequency gain need not be great so long as the selectivity is good. In our country the conditions are reversed, and receivers require a greater degree of sensitivity without quite so much selectivity to bring in the available stations.

From the listener's point of view—and that is the main thing after all—the American conditions, we must concede, are very much more favourable than those obtaining in England. The subject matter of the American programmes is not radically different from that in England. Light variety, talks, and good music are just as much in demand here as in England, but, here's the point, the American programmes are served up in a much more palatable way. Here they seem to have the knack of turning the most mediocre item into something that must not be missed on any account! The announcers are very far from anonymous—they take good care to say just who they are every few minutes; the result is that after a very few hours of listening to these announcers they seem to become intimate friends. The whole atmosphere of American broadcasting is friendly to a high degree. Our Civil Servant announcers would be quite shocked at the intimacy of their American prototypes!



MAKE A GRAMOPHONE
Or buy Cabinets for Wireless. At a quarter shop prices. Order Set as shown. British double spring motor 12in. velvet turntable, swan arm, metal soundbox, amplifier, needle cups, for £1. 18. 6 p.p. and build your own Cabinet. Machines sold by others at £10-£20 do not contain better fittings. Motors from 8/6. Repair parts. Lists free. 64 pp. Catalogue drawing and how to make Gramos 8d.
Portables, Gramophones From 2 1/- Post 1/6 Regent Fittings Co., A.W., 128, Old St., London, E.C.1

PREPAID ADVERTISEMENTS

Advertisements under this head are charged **THREEPENCE PER WORD**, minimum charge **THREE SHILLINGS**.

DEPOSIT SYSTEM

As the Publishers cannot accept responsibility for the bona fides of advertisers in this publication, they have introduced a system of deposit which it is recommended should be adopted by readers when dealing with persons with whom they are unacquainted. It is here explained.

Intending purchasers should forward to the Publishers the amount of the purchase money of the article advertised. This will be acknowledged to both the Depositor and the Vendor, whose names and addresses must necessarily be given. The deposit is retained until advice is received of the completion of the purchase, or of the article having been returned to and accepted by the Vendor. In addition to the amount of the Deposit, a Fee of 6d. for sums of £1 and under, and 1s. for amounts in excess of £1, to cover postage, etc., must be remitted at the same time. In cases of persons not resident within the United Kingdom, double fees are charged.

The amount of the Deposit and Fee must be remitted by Postal Order or Registered Letter (Cheques cannot be accepted), addressed to

"AMATEUR WIRELESS," ADVERTISEMENT DEPARTMENT, 58/61, FETTER LANE, LONDON, E.C.4.

A MONEY SAVER

The **ELECTRADIX NEW SALE LIST** contains some wonderful Bargains in Gramo-motors and Panatrop Amplifiers, Scratch Filters, Mains Transformers, Motor Generators, 500 mfd. Condensers, New Headphones, Light Weight, 3/6. Accumulators 6/- House Telephones, 12/6 set. Galvos, Bridges, Telegraph Sets, Microphones, Testing Sets, Cheap Meters, Chokes, Moving-coil Loud-speakers, complete, 35/- Wavetraps 15/- 3 v. Receivers 27/6. Odd Portables, Cabinet Speakers. W.D. and Liquidator's stock all at under cost.

Send addressed envelope and we mail you an Illustrated List.

ELECTRADIX RADIOS

218 Upper Thames Street, E.C.4. City 0191

WIRELESS CABINETS

MAKE YOUR OWN

Send stamp for Free catalogue and price list.

WOODWORK, 199 HIGH ROAD, LEE, LONDON, S.E.13.

For the Best in Radio
WILL DAY LTD.
(THE BEST IN THE WEST)
10 LISLE STREET, LEICESTER SQUARE, LONDON, W.C.2
Telephone: "Hornsey" 4911 and 4912. Daytime: "Trafalgar" 1200
OPEN TILL 7 P.M.
WRITE FOR OUR CATALOGUE
POSTAGE 6d. FREE TO CALLERS

SINQUERS

SAVE YOUR ACCUMULATORS
SET A SINGUER SENTRY!
HE'LL NEVER LET YOU DOWN.



Double the life of your cells! Avoid being let down by a run-out accumulator. Singuers tell you the exact state of your battery and warn you when it needs recharging. Just drop them in and leave them to it.
1/- per carton from most dealers or 1/3 post free from actual makers.
FIDDIAN BAWTREE & CO.,
Oakhill Road, Sutton.

Amateur Wireless

COUPON
Available until Saturday,
JULY 20th, 1929

WEARITE COMPONENTS TALISMAN PORTABLE

Mr. L. A. Chapman has designed this special coil on entirely new lines. Two windings are arranged in parallel for medium wavelength reception, but for long wavelength reception only one winding is used, the two halves of the medium wavelength winding being left "dead" at each end of the long wavelength winding. This introduces just enough damping to offset any tendency to oscillation, when working on the long wavelengths. The arrangement of the switching permits retention of the centre tapping whether switched for medium or long wavelengths, so that the coil can be used in either a tapped tuned-anode circuit or in a plain tuned-anode circuit.

Price 7/6
The Chapman Dual-range Coil is specially designed for use with screen-grid valves

Other WEARITE Components suitable for this Receiver are:

Battery Switch (on and off) G22	1/-
Wave Change Switch (3 way)	1/6
Screen, per pair	6/-

WRITE FOR NEW LIST

WRIGHT & WEARE LTD., 740 HIGH ROAD, TOTTENHAM, N.17 Phone: Tottenham 3847 and 3848

WATCH FOR WEARITE A.C. VALVE HOLDER

THE PANEL WITH A REPUTATION

Registered **BECOL** Trade Mark



The original BECOL Low Loss Former, made in sizes 1" up to 4" outside diameter in lengths up to 36 in. The former that remains rigid when wound.

LOOK FOR TRADE MARK

Have you seen the new BECOL Pinless Former and Base, which is absolutely foolproof? If not send for particulars.

DO NOT BE PUT OFF WITH AN IMITATION.

Write for copy of BECOL Handbook on Wireless Circuits. Full data of windings and illustrations. Price 4d. Post Free.

Sole Makers:

THE BRITISH EBONITE CO., LTD., HANWELL, LONDON, W.7

You MUST have the "Wireless Magazine"

Every Month Price 1/-

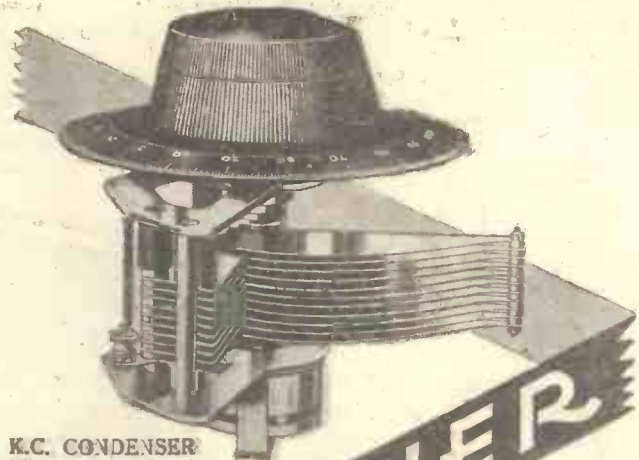

K.C. CONDENSER

With knob, dial and slow-motion device, 12/- .0003 or .0005

Without knob, dial or slow-motion device, .0003 or 8/- .0005

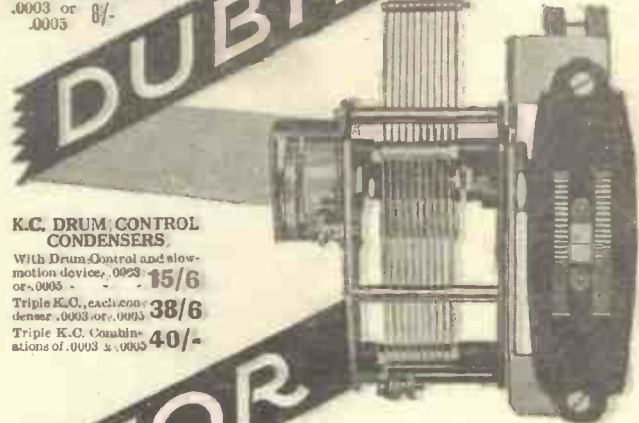

K.C. DRUM CONTROL CONDENSERS

With Drum Control and slow-motion device, .0003 or .0005 15/6

Triple K.C., each condenser .0003 or .0005 38/6

Triple K.C. Combinations of .0003 & .0005 40/-



MIDGET CONDENSER

A small variable condenser for panel mounting. .00005, .0001 or .0002 5/6

DUBILIER VARIABLE CONDENSERS

If unobtainable from your dealer, write direct to us giving his name and address.

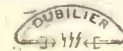

Dubilier Condenser Co. (1925) Ltd., Ducon Works, Victoria Road, N., Acton, London, W.3

© 1929 V

The first of the New Varley Components

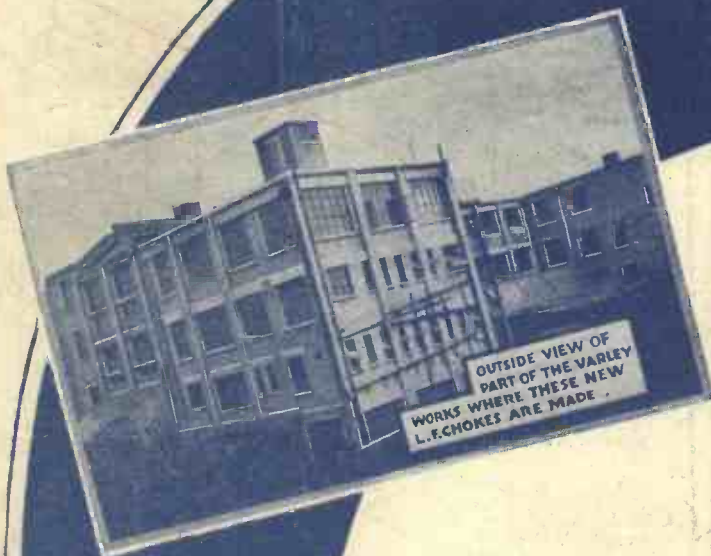

The introduction of an L.F. Choke whose inductance remains constant at all loads will be a real boon to every radio enthusiast.

Hitherto the inductance of a Choke has been measured at no load, which really means that even over the narrow range at which the inductance is stated to be constant there is a definite drop in its value as soon as the D.C. current passes through the choke to feed the valves. This lowering of the inductance has resulted in mutilated reproduction and placed severe limits on the satisfactory performance of many home-constructed receivers.

We have now produced an L.F. Choke whose inductance remains appreciably constant at all loads from 0 to 100 milliamperes, and this new Varley component will be available to the public within the next few days. Advance information has already resulted in some heavy orders, and consequently there may be a slight delay in obtaining supplies in certain districts.

The Varley Constant Inductance L.F. Choke, 20 henries Over the whole range. 0-100 milliamperes.

21/-



Advertisement of Oliver Pell Control Ltd., Kingsway House, 103 Kingsway, London, W.C.2. Telephone: Holborn 5303

89
TROUBLE TRACKING :: SHORT-WAVE STATION LIST

Amateur Wireless

and
Radiovision

Every
Thursday 3^d

Vol. XV. No. 371

Saturday, July 20, 1929

The **BROADCAST
THREE**

WITH NEW MAINS VALVES

ANOTHER LEWCOS ACHIEVEMENT!

The famous "Lewcos" coils have again been specified. This time in the "Broadcast Three with Mains Valves" described in this issue—

LEWCOS

REGD.

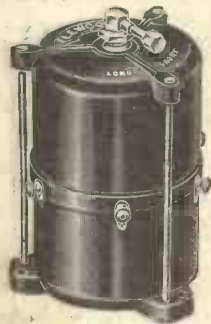

DUA
(Aerial Coil)

DUG
(H.F. Transformer)

Patent No. 285723, and others pending

These coils are Litz-wound and wonderfully selective. Designed for either baseboard or panel mounting with one-hole fixing.

Write to-day for leaflet R.48 which illustrates and fully describes the new LEWCOS Dual Unscreened Coils.

GLAZITE
BRITISH MADE REGD

Always use Glazite coloured connecting wire as specified for the "Broadcast Three with Mains Valves." Reduced Price 8d. per 10-ft. coil. Beware of imitations.

THE LONDON ELECTRIC WIRE COMPANY AND SMITHS LIMITED,
CHURCH ROAD, LEYTON, LONDON, E.10. Trade Counter and Cable Sales: 7, Playhouse Yard, Golden Lane, E.C.1.

You will Help Yourself and Help Us by Mentioning "A.W." to Advertisers

Amateur Wireless and Radiovision

The Leading Radio Weekly for the Constructor, Listener and Experimenter

Editor: BERNARD E. JONES

Technical Editor: J. H. REYNER, B.Sc., A.M.I.E.E. :: Research Consultant: W. JAMES :: Assistant Editor: H. CORBISHLEY

These Surprises—The "Voice of London"—Speaking "Stars"—Police Wireless— Getting Good Radio Pictures—Radio Temptation—Motor Radio Rally

These Surprises—We have just had over a year of the weekly "surprise item" features. Some quaint things have been broadcast: the noises in a main signal box at King's Cross station; an *au revoir* broadcast by members of the Test Team; street singers entertaining a theatre queue; a visit to the Elstree film studios; a tour of London theatres, with curtain, cloak-room, and traffic noises, at the London Hippodrome; gramophone records played backwards; scenes from most popular plays; noises in the fo'c'stle of a steamer; a relay from a night club—all these have successfully been put over the "mike." We are all in favour of the surprise item. It is one of the few things broadcast which do not have to go through the usual mill of the programme department and selection committee, and so the surprise is nearly always fresh.

The "Voice of London"—But what did you think of the surprise item which was given recently as a tribute to the King, expressing joy at his recovery to health? Opinions are bound to differ; some say it was unnecessary, and others that this is just what every serious-minded listener should want. All agree the item was exceptionally well done, the "noises off," music and traffic sounds being particularly good.

Speaking "Stars"—Some well-known film stars will be at the Film Star Regatta on the Thames Riviera, Hampton Court, on July 24 and 25. Most of them are on the silent screen, but Philips are erecting a giant loud-speaker installation, with a sound range of about two miles, and some of the "stars" will make their first appearance before the microphone. Not quite talkies, but the next best thing.

Getting Good Radio Pictures—Though Berlin Witzleben has been transmitting pictures for some



Not quite the last straw for the camel! A Zoo inmate faces the microphone and, if one can judge by his expression, is in the middle of a little speech

time now during the evening programme hours, it has been difficult, if not impossible, to receive them in many parts of this country owing to the wipe-out effect of 5GB. Under the Prague Plan, Witzleben has a wavelength of 418 metres, whilst

5GB works on 479. The German station is now easy to receive and good pictures may be obtained. It should be noted that Witzleben is relayed by a station working on 283 metres. Despite the fact that this is a common wavelength, the transmission is often to be received quite clear of interference. Another good station at the present time for picture reception is Posen, with a wavelength of 335 metres. This station is transmitting pictures every evening at 10.15 p.m. or 10.30 p.m.

Police Wireless—Did you know that Scotland Yard has a radio transmitter with a range of 100 miles? The Metropolitan Police's chief engineer is agitating that the Flying Squad should be linked up with wireless, and that all provincial police centres should have radio receivers and transmitters. He

says that recently a car was reported as having been stolen at 1.5 a.m.; broadcast information enabled it to be found by 1.15 a.m., and the thieves caught. Quick work! He is also concerned with the broadcasting of photographs and finger-prints.

Radio Temptation—And, talking of crime, did you see that a day or so ago some motor bandits took to window-smashing and portable-set "pinching" in South-east London? The raid was made at night time, and all during the night and on the following morning the Flying Squad cars were searching without result for these hyper-enthusiastic listeners!

Motor Radio Rally—Paris recently held a radio motor rally, like those popular in the south of France, and thirty radio-equipped cars took part. They made a run from the centre of the city to the famous forests of Fontainebleau and the portables were used to advantage *en route*. A British amateur obtained the premier award

PRINCIPAL CONTENTS

	PAGE
Current Topics	57
A New Method of Filament Heating	58
Broadcasting on the Screen	59
My Wireless Den	60
"Thermion's" Reminiscences of Trouble Tracking	61
On Your Wavelength	63
Automatic Grid Bias	65
Radio Flies the Atlantic	66
New Developments in Metal Rectifiers	67
Some Reliable Short-wave Transmissions	68
Without Fear or Favour	69
The "Broadcast Three"	70
Grid Leak or Anode Bend?	74
"A.W." Tests of Apparatus	76

A NEW METHOD OF FILAMENT HEATING

An Account of
A Recent Valve
Development.

By
MORTON BARR

UNTIL the appearance of the A.C. valve, working on raw or unrectified current for the filament circuit, the use of current from the mains was in practice chiefly confined to the high-tension side. This may at first sight appear somewhat strange, since the problem of smoothing out a current supplied at 2, 4, or 6 volts seems to be a simpler one than that of maintaining a steady pressure at 100 volts or upwards.

Actually the reverse is the case. The reason, of course, lies in the relative values of the currents consumed. It is a much simpler matter to design a filter circuit capable of smoothing-out fluctuations in a high-tension circuit carrying only a few milliamps than to do the same thing on the low-tension side, where the actual current flow is many times greater. In the latter case the size of the chokes necessary to secure an efficient smoothing effect is such as to make the eliminator unit at once bulky and expensive.

Both A.C. and D.C. plate-filament supply units are available for use with ordinary three-electrode valves, and have proved reasonably efficient in operation, though for the reasons stated most listeners prefer to draw the H.T. supply alone from the mains, depending upon an accumulator and home charger for the filament supply.

Directly-heated Filaments

Attempts have also been made to use raw A.C. (or unrectified) current directly on the filament of the ordinary type of valve, in combination with means for simultaneously applying a compensating voltage to the grid, so as to neutralise the low-frequency hum. The auxiliary grid voltage is tapped off from a potentiometer inserted across the filament, and continuously offsets the effect of the A.C. fluctuations, so that they do not pass through the valve into the output. It is possible that this method may come into wider use in the near future.

Another type of three-electrode valve designed to take raw A.C. current is the so-called "point 8" model. Here the mains voltage is stepped down to .8 of a volt and is then applied to a thick filament wire designed to carry a heavy current of .8 amps. Under these conditions, the A.C. voltage fluctuation is so small that it is effectively absorbed or wiped out by the heavy current and the high heat-inertia of the filament wire. In other words, the filament maintains a steady temperature in spite of the periodic voltage changes, and therefore emits a steady electron stream, so that no low-frequency hum gets through the valve into the output.

The most popular A.C. valve is, however,

the indirectly-heated type, where an extra heating element, forming a fourth electrode, is inserted specially to take the raw current from the mains. Its sole function is to provide a local source of heat from which the true cathode or filament can be heated to the point at which it will produce the necessary stream of electrons.

Fig. 1

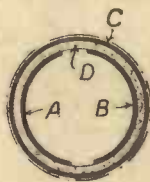

Figs. 1 & 2. Heating the filament by condenser action

Fig. 2

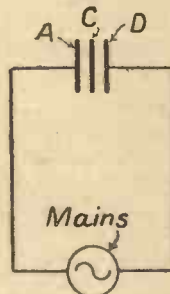

Since the heating element energises the filament by radiation across the space separating the two, it must carry a considerable current which, in turn, means that it must be of robust construction. The actual power dissipated varies from 4 to 8 watts, the usual minimum consumption being 1 ampere at 4 volts.

The presence of the comparatively bulky heating element raises various difficulties to the efficient working of the valve as a whole. In the first place the heavy liberation of heat may affect other parts of the

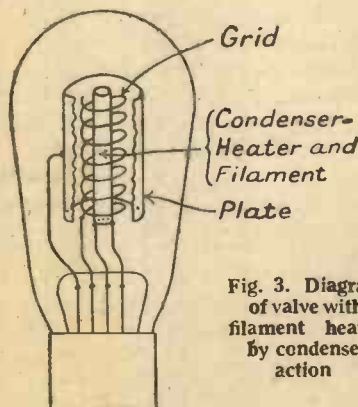

Fig. 3. Diagram of valve with filament heated by condenser action

valve than the filament, and in some cases it tends to raise the temperature of the grid to a point at which it, too, commences to emit electrons.

Again it is difficult to keep the heating-element electrically insulated from the other electrodes of the valve. Direct electronic emission from the heater can, of course, be prevented by suitable shielding, but complete electrical insulation has proved difficult.

Finally, the passage of a heavy current of

1 ampere or more through the heating-wire sets up a strong magnetic field in the space inside the valve, which may adversely affect the electron stream flowing between the filament proper and the plate.

Heating by Condenser Action

In order to avoid some of these difficulties, Graham Amplion, Ltd., have recently invented a type of indirectly-heated valve in which the necessary heat is generated by condenser action, instead of by the direct passage of a current through a wire. If a high alternating voltage is applied across the plates of a condenser separated by a refractory dielectric, such as thoria or silica, displacement currents will flow and will generate sufficient heat to liberate electrons from a sensitised surface of high emissivity.

The arrangement is shown diagrammatically in Figs. 1, 2, and 3, Fig. 1 being a section through the combined heater and filament.

The actual heating condenser consists of two inner plates A, B, and an outer plate C, separated by a cylindrical tube of dielectric D, the voltage from the mains being applied to the two plates AB.

It will be seen that the condenser action takes place say from plate A across the dielectric D to the outer plate C, and then around the latter and across the dielectric to the second inside plate B. As the mains voltage reverses, so does the path taken by the displacement current.

It is important to notice that the arrangement is equivalent to a three-plate condenser, such as shown in Fig. 2, where the middle plate (corresponding to the outer plate C in Fig. 1) is always at the mid-potential point. If, therefore, the outer plate C in Fig. 1 is covered with a thin coating of barium oxide or similar sensitive material, as indicated by the dotted section, it will liberate a stream of electrons when raised to the necessary temperature by the heat losses generated in the dielectric D. At the same time it will maintain a steady and uniform potential relatively to the grid, an important feature which is common to all indirectly-heated valves.

Indignation amongst a proportion of Scottish listeners at the reduction and disbanding of wireless orchestras at the Glasgow and Aberdeen stations is heightened by the belief that no such drastic changes are to be made among such English provincial stations as Birmingham and Manchester, nor in the cases of Cardiff and Belfast.

Broadcasting on the Screen



AN ACCOUNT OF AN INTERESTING GERMAN DEPARTURE BY Dr. Alfred Gradenwitz

LINES of force and electrons a billion-fold enlarged could be seen moving up and down, to and fro, and dancing merrily upon the screen of one of the Berlin picture

ignorant of wireless could master the subject, it was possible to get a first inkling of what it is all about.

The film shows all acoustical and electrical phenomena concerned in a schematic manner and, of course, at greatly reduced speed. After first demonstrating the wave motion by a demonstration of a water wave, the production of sound waves in the human larynx is then illustrated, reference being made to the velocity of sound. The wavelength is shown to depend on the number of vibrations per second and the velocity. The analogy of electric waves and

thermionic valves, the design and functioning of which are likewise illustrated, the part played by the grid being shown very strikingly.

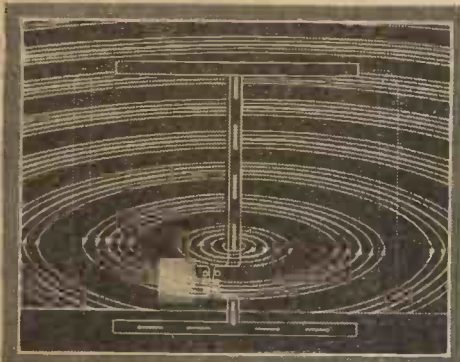

Magnetic Waves

theatres when the German Broadcasting Corporation (Reichsrundfunk-Gesellschaft) recently invited the Press to the first performance of a propaganda film.

The first half of this film was a remarkably vivid manual of radio engineering. It was, of course, no easy task to boil down



Electric Waves

the way these travel through space is then illustrated, it being stated that such waves invariably travel at a speed of 300,000 kilometres per second.

How the Set Works

In demonstrating the production of an electric wave, the flow of negative electric particles—electrons—from the negative to the positive terminal, is shown, and the difference between direct and alternating currents is strikingly illustrated. Nor is there any difficulty in familiarising the looker-on with the meaning of "frequency" and "cycle" and the difference between low- and high-frequency currents. Another section is devoted to the production of oscillations of frequencies between 500,000 and 1,500,000 per second by means of

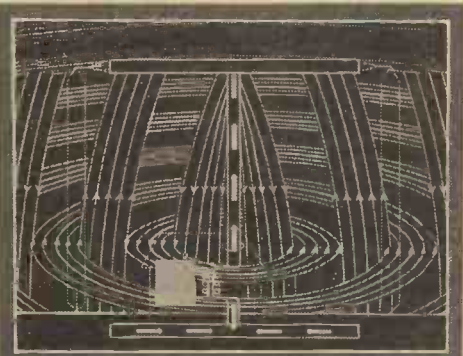

Electro-magnetic Waves

In the second part of the film the working of an oscillatory circuit is dealt with, the radiation of electrical energy into space by means of an open oscillatory circuit coupled to the closed circuit being illustrated. The electro-magnetic waves generated are, of course, quite uniform to begin with and

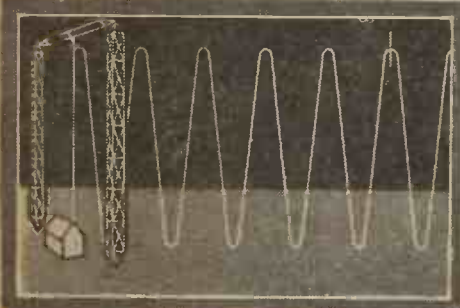

Explaining Wavelength

the essence of radio to what could be shown in about half an hour, and though nobody

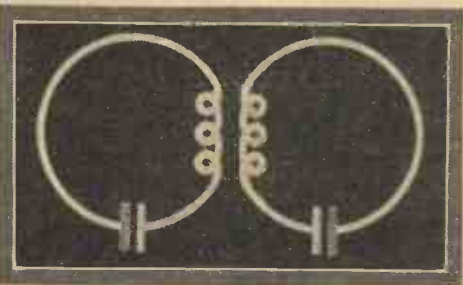

Resonance between two Oscillatory Circuits

later it is shown how they are modulated. (Continued in 3rd col. of next page)

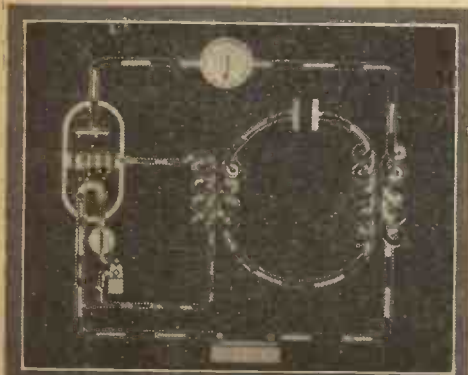

Valve Oscillator and Regenerator

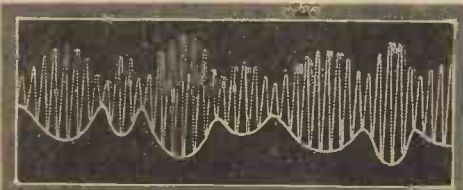

How Waves are Modulated

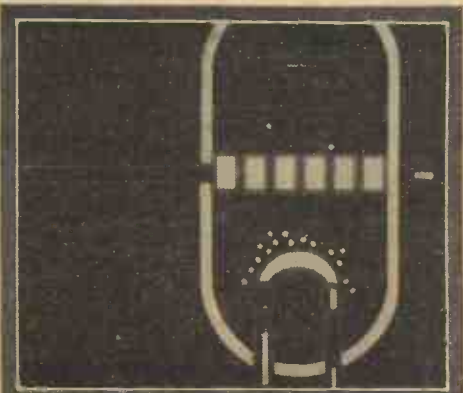

Effect of Negatively-charged Grid

MY WIRELESS

Weekly Tips
Constructional
and
Theoretical—



DEN

By
W. JAMES

For the
Wireless
Amateur

Good H.F. Chokes

I HAVE referred on several occasions to the importance of using properly designed high-frequency choking coils in receivers, and I am glad to notice a few manufacturers have at last realised that a choking coil which may function satisfactorily in the anode circuit of a detector is not necessarily of use in a choke-coupled high-frequency amplifier. Many receiving troubles are to be traced to the use of unsuitable choking coils. This is not surprising when it is remembered that the characteristics of the different circuits are not similar.

A Measuring Hint

One of the first points that should be remembered by those who use measuring instruments is that the condition of the circuit should not be altered at all or else be altered by a known amount when instruments are put into the circuit. If, for example, we were about to measure the current flowing through the filaments of the valves in a receiver we should employ an ammeter whose resistance is so low that the fall in voltage across it is so little that the current indicated is the correct one.

Let us suppose, for example, that we have a three-valve receiver whose filaments are supposed to take .4 ampere from a two-volt accumulator. The resistance of the circuit, ignoring losses in the connecting wires, is 5 ohms.

If, then, the ammeter has a resistance of, say, half an ohm, it will indicate a current of about .36 ampere, whereas when the ammeter is not included in the circuit the current flowing is .4 ampere. One should, therefore, always determine the characteristics of measuring instruments.

Increasing Selectivity

I have mentioned on numerous occasions that the selectivity of a receiver may often be greatly improved by such simple means as the addition of a fixed condenser of small value in the aerial circuit, or by connecting the aerial to a point on the coil instead of to the grid end.

There are, of course, very many schemes that may be adopted, but there is one particularly easy to apply which, I think, I have not mentioned before in these notes.

I refer to the addition of negative grid-bias to the high-frequency valve or valves of a receiver. There must be a large number of sets in which the grid circuits of the H.F. valves are joined to the negative side of the filaments with the result that a strong signal produces grid current. This will spoil the tuning by making it broader.

In many instances the negative grid bias obtained from a filament resistance joined in the negative side of a valve is adequate, but when the receiver is of a type having no bias to the H.F. valve it would be better to use a one-and-a-half volt dry cell. This may be connected as indicated below.

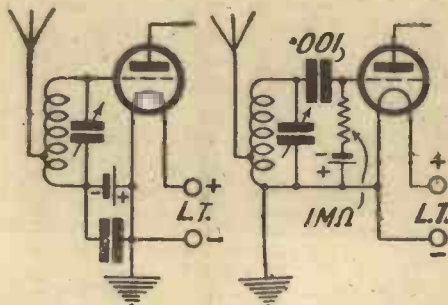

Two methods of adding negative bias to the grid of a screen-grid valve in order to improve selectivity

"Remote" Loud-speakers

It is not uncommon for listeners during the summer months to add a length of twin flex to their loud-speakers in order that their instruments may be taken outdoors. When the flexible wire is new and of good quality there may be little harm in this practice as regards the quality of the reproduction, tuning and safety.

There may be occasions when the receiver will have to be retuned for the best results when the extension wires are connected, but the point to which I wish to draw attention is that leakages may occur, particularly when the high tension applied to the last valve is relatively great.

This may, of course, be prevented by the use of an output transformer or filter circuit, but they will not minimise that lowering of the tone which is often experienced. The extension wires act as a condenser across the loud-speaker and depending upon their length and the way

they are laid, the capacity may be sufficient to lower noticeably the tone. An output transformer or filter circuit will also tend to minimise the effect of the extension leads upon the tuning.

"BROADCASTING ON THE SCREEN"

(Continued from preceding page)

All details of the system, as well as the methods of control, are clearly indicated.

The technicalities of tuning and receiving are shown in the third part of the film. In order to enable a given transmitter to be received the receiver should, of course, be tuned to the same wavelength. This is illustrated by a mechanical system, viz., the tuning of two spring pendulums corresponding to the transmitter and receiver respectively. As soon as the receiving pendulum, by a suitable adjustment of its weight, is tuned to the transmitting pendulum it shares its motion. The same thing occurs with two oscillatory circuits coupled together and which are tuned to one another by alteration of capacity. It is shown how the incoming wave then sets up in the tuned receiving aerial oscillations of the same frequency, how these are rectified, and the principle of reaction effects. All the details and technicalities of radio reception are thus illustrated on the moving-picture screen.

A concluding section of the film illustrates the manifold uses of radio, showing the day's routine of a German broadcasting station. This part of the film, by the way, came in for a good deal of criticism, it being contended that actual programmes are far from being so satisfactory as those responsible for the film would have listeners believe.

Following a petition made by Dutch listeners, the authorities have decided that from July 15 Hilversum will transmit on 1,875 metres, the wavelength utilised by Huizen since June 30. On the other hand, the Huizen broadcasts are to be made on 298 metres until 6 p.m. daily, and from that hour on 1,070 metres. Scheveningen Haven will work on 1,070 metres daily from 10.20 a.m. until 6 p.m.

Thermion's Reminiscences

of

TROUBLE TRACKING

THERE used to be an old rule of thumb to the effect that a set never works right first time. I know that it was true once upon a time and I used to extend it to others, and to myself, as a consolation when a set did not work, despite the effort expended in making it.



A set may work with the wander plug disconnected, but . . . !

But I'm not so sure that it is true nowadays. Sets which are made up to a pattern, just as you might make one from an AMATEUR WIRELESS blueprint, give forth sweet sounds immediately the "juice" is turned on after the last wire has been put in place; and sets continue trouble-free, generally speaking. There are fewer troubles than there were, though some of the same old ones are still with us.

The Most Simple, the Most Puzzling

Most of the little problems which beset us are just the same as those which were *beles noirs* months and years ago. The advent of mains eliminators, screen-grid H.F. amplification, pentodes, moving-coil speakers, and other modern whatnots have not brought in many new possibilities of trouble.

Looking back on some troubles I have traced, it seems that the most puzzling were generally the simplest and most likely to occur.

There is, for example, that old bother of forgetting to change over the lightning

switch at the beginning of listening. Everyone knows the symptoms. The set works and everything seems "live." Dial readings are about the same as normal (though this depends on the tuning arrangements), but the local station is a faint squeak instead of a healthy volume of

purity. Forgetting the lightning switch is silly, but very easy to do; and still sillier are the folk who so constantly forget to move the thing that they very seldom trouble to move it back again when the set is switched off and consequently there is no lightning safeguard.

This is one reason why a lightning arrestor, or a combined arrestor and switch, is better than a simple switch. In the combined job the switch arm is used only when a storm is imminent and a direct connection to earth is safest.

For ordinary working the arrestor gap is a safe protector—and there is no switch to forget! But keep the contacts clean, for many a faulty set which I have come across has been exonerated after examination of the aerial, earth, and lightning arrangements.

Some Puzzles

And now for some puzzlers! I remember a three-valver which, periodically, would set up a low-pitched whistle—I could hardly call it a howl because it did not entirely drown the music. The puzzling part was that it happened only when the accumulator was freshly charged, and not always even then. The whistle might commence immediately the set was switched on, faintly at

first and would then grow to annoying loudness. Once when the noise was very bad I took the set out to examine it, was called away from the job, and on my return put it back untouched and accidentally switched on. The howl had gone! That was a clue.

Finally I traced the trouble to the loud-speaker leads, which on some occasions trailed over the aerial and battery leads. This caused L.F. interaction, which resulted in the annoying whistle. Whether the set whistled or not depended on the position of the loud-speaker; also when the accumulator was well "up," the bigger emission seemed to bring matters nearer to the L.F. oscillation point. In my experience a large number of listeners' sets give impure results simply because careless trailing of the leads results in a tendency towards L.F. howling. The sets may not actually whistle, but purity is destroyed, nevertheless.

There is another loud-speaker-near-the-set trouble with which most people are more familiar. If the speaker is working "all out" and sound waves get back to the set and to the valves, the electrodes may be set vibrating. It seems almost impossible that this could happen, but as a matter of fact it is quite a common occurrence with many powerful sets which are used at full volume on local stations. The result is a

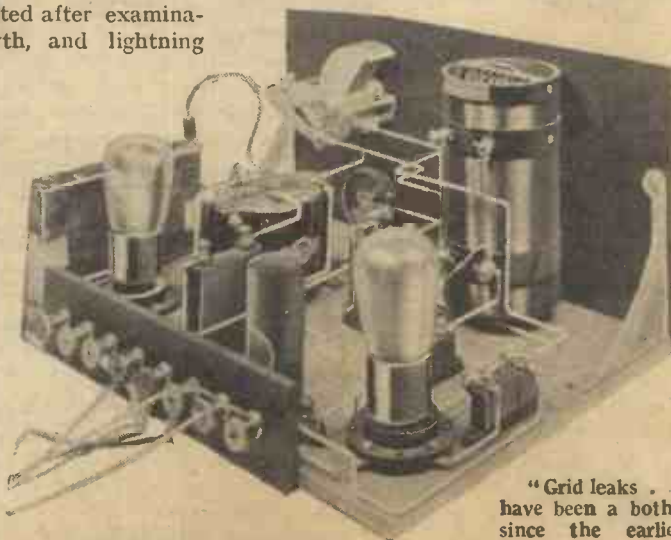

"Grid leaks . . . have been a bother since the earliest days"

"A large number of sets give impure results because of careless trailing of leads"

howl of a more "boomy" nature than an ordinary electrical howl. The cure, of course, is to move the loud-speaker away from the set, or to fit anti-microphonic valve holders. The detector valve is that most likely to be affected.

Mains Problems

I am slowly getting accustomed to the little tricks and fancies of mains-driven receivers, but some of them used to provide sore puzzles. Hard as it is to believe, I have experienced a hum in an A.C. set caused by coupling between the detector and first L.F. valve, via the silver-colour "gettering" on the bulbs. I proved this in practice by screening each valve, and not each stage, and a talk with a well-known valve manufacturer convinced me that my diagnosis was correct.

Another mains receiver which gave trouble was a four-valver with one stage of neutralised H.F. The difficulty was that the set would of its own accord go out of neutralisation. One night it would be working well, but after disconnecting and reconnecting the mains it would require fresh neutralising adjustment. I have heard that one or two mains users have had similar troubles in the way of stray capacity effects. To be frank, I did not have time to go to the bottom of this particular fickleness, but I cured matters entirely by putting an ordinary H.F. choke in each mains lead. The two chokes seemed to cut out all mains capacity effects. I say an "ordinary" H.F. choke, but it needs to be emphasised, I think, that the chokes should be capable of carrying more than the full mains current taken by the set. Some chokes are wound with very thin wire.

Some long while ago, before mains eliminators became so popular as they are now, I operated a set from D.C. mains having the negative lead earthed. No safety condenser was inserted in the earth lead, for such refinements were not known. One evening I went prepared to make a run round the dials, and found nearly every setting altered and a tendency on the part of the set to "hoot" and develop threshold howl. The reason? I won't keep you guessing. The fuse had blown in the negative mains lead (not through any fault in the set), but current was still reaching the negative side of the wiring through the earth lead. This had a much greater resistance, however, than the normal mains lead, and so the normal operating conditions were upset. I can account for the increased resistance causing L.F. instability, but I have never yet quite satisfied myself why the aerial-earth conditions and dial readings should also have been upset.

Finding the Faulty Component

A somewhat similar trouble, but this time presenting simply the symptoms of unmanageable hand-capacity effects, was eventually traced to the normal earth lead having come loose. For some reason—probably because the pick-up of the aerial was good—signals were not noticeably weaker without the earth, but as there was nothing to "anchor" the set, electrically speaking, body capacity was particularly noticeable.

Grid leaks, broken, defective and of poor manufacture, have been a bother since the earliest days. Time was when there was only one leak in a set, and that in the grid circuit of the detector. But now we have

leaks in the grid and anode circuits of R.C. stages, in anti-motor-boating stoppers, and in many other parts of the circuit. Unless of good make, they need watching. Even wire-wound resistances are not above suspicion if the wire is too thin.

I once had to deal with a receiver which had spasms. It would work for periods of about five seconds after first switching on, and would then choke, distort, and finally gurgle itself into silence. If switched off it would promptly come back to life again, and when switched on would work for a further five seconds or so!

The cause was a faulty grid leak in the R.C. stage. Actually there was no connection at all, and after a few seconds working, the grid, being insulated to direct current, became choked with its assumed negative potential.

Grid Bias

Sometimes this does not produce disastrous results. A friend came to me recently and asked why his set worked better when one grid-bias plug was removed from the battery. I tested the battery and found that it was giving practically no voltage at all. The accumulated voltage on the grid, when the bias plug was free, was by chance suitable for the working of the receiver. I have come across several such cases.

I wish that I had kept some notes during past experience of fault-finding in friends' sets: some of the snags encountered have been rather amusing. Write to me if you can recount some interesting fault tracking. I will ask the Editor to publish some of the experiences for the benefit of other readers.

MR. FLEX TUNES IN TO PERFECTION—

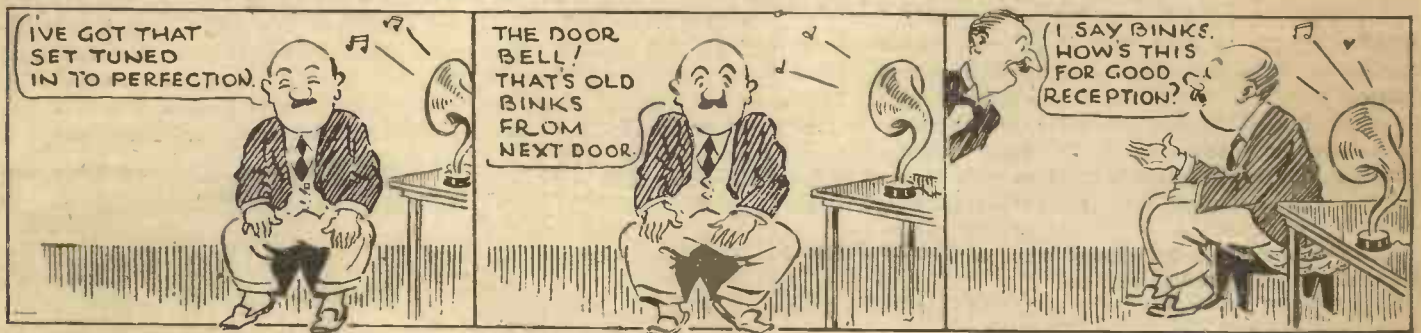

—AND THEN SUFFERS FROM A LITTLE INTERFERENCE



On Your Wavelength!

Working Well

ONE has now had a fairly ample opportunity of surveying the broadcast band under the new condition of affairs. My DX set has been in use on every night since it started—ten days ago at the moment of writing—and I have had all kinds of interesting experiences. The general impression formed is that the Prague Plan is a distinct success so far as summer-time conditions are concerned, but I must confess that I have grave doubts whether it will work in winter without fairly extensive alterations. There seem to be rather too many powerful stations arranged as wavelength neighbours. In my part of the world, for example, a bad heterodyne on 2LO caused by Stuttgart has been noticeable more than once, and if it happens at this time of year, what on earth will it be like when winter comes?

Heterodynes, though, have been, on the whole, remarkably few and far between. Turin was completely jammed for a time on one evening by Rennes, who appeared to be rather off his proper wavelength. The only other heterodynes of importance are those which have affected Leipzig and Cologne on occasion. Readers will see at once that the very fact that one mentions the stations that were heterodyned show what a big improvement there has been; a month or two ago one would have picked out those that weren't!

Some Good Stations

There is no doubt that two Continental stations run dead heat for first place on the "star" list in nearly every part of this country. Curiously enough, one of these is almost at the top of the long waveband, whilst the other is near the bottom of the medium band. The stations are Radio-Paris and Nuremberg. Of the two, the French station scores marks by being easily receivable at any time of the day or night, whilst Nuremberg comes in well only after dusk. Against this we must set the fact that Radio-Paris seldom comes in with such strength as that reached by Nuremberg. Soon after it begins to grow dark I usually find Nuremberg so strong that the volume control must be brought into action to avoid overloading. Other excellent stations at the moment which I can strongly recommend to readers are: Cologne, Flensburg, Toulouse PTT, Leipzig, Breslau, Turin, Lille, Koenigsberg, Ghent, Dresden, Gleiwitz, Posen, Barcelona, Hamburg, Toulouse Midi, Frankfurt (at times), Kattowitz, Berlin Witzleben, and Brussels.

What's the Explanation?

I wonder why it is that Nuremberg

should be so extraordinarily well received over here. The station is rated now at only 2 kilowatts, or the same as that of London. If you ask men well versed in the queer little ways of wireless how it is they will probably answer that there is a skip area in which transmissions are hardly heard at all, after which there comes an area in which they are very strong indeed. This country, they will tell you, falls in the second area. Well and good. But how can you get over the following facts. The distance from Nuremberg to London is roughly 500 miles, that from Nuremberg to Plymouth 700, and from Nuremberg to Edinburgh 750 miles. Yet in all three places the station is amazingly well received. Surely you cannot have in accordance with the theory a "maximum" area that is at least 250 miles wide. And if this explanation holds good for Nuremberg, why does it not also apply to Leipzig, which has the same rating, also uses nowadays a short wavelength (there is only 20 metres between the two), and is no farther away than Nuremberg from some parts of this country? The stations are only about 130 miles apart as the crow flies, yet one is received here loud enough to blow your head off, whilst the other comes in at just comfortable loud-speaker strength. Wireless, as I keep on reminding myself and readers, is full of mysteries.

Other Oddities

Another very queer example of the queer pranks that wireless can play is provided by Flensburg, a station which is rated at only .5 kilowatt. Though this station has its ups and downs he is, on the whole, marvellously well received nearly everywhere with us, and he comes through with a wonderful punch. Queerer still; Flensburg is now working on a common wavelength with two German and one Finnish station as partners, one of which is rated at .8 kilowatt. Yet he is receivable quite free from interference. He simply drowns out his competitors, though some of them are not much farther from us than he is. Curiouser and curiouser, many of the Swedish relays, of which we now hear nothing even after dark, are receivable at full loud-speaker strength on three-valve sets in winter time. Will his partners then lift up their voices and drown Flensburg? There are several other astonishing stations. Posen in far away Poland, is rated at only 1.2 kilowatt, though you could put him on to the loud-speaker quite easily here. Paris PTT, often one of the strongest of Continental transmissions, is only .8 kilowatt and Brussels, who can often be tuned in in broad daylight has only a single kilowatt to his name at present.

At it Again

Our old friend the reporter of the lay paper still appears to be unable to open his inkpot without putting his foot into it. The other day I came across a marvellous account of a new apparatus for producing "talkies" in the home by means of the wireless set. Much intrigued, I read it through six times, endeavouring to make head or tail of it. What really interested me, though, was the statement that "reproduction of speech and music is limited by the power of the loud-speaker, which at present cannot exceed 8,000 sound cycles." Do you know, I had actually never realised before that power was limited by the frequency range! I must really have a go at my loud-speaker to see if I can't make him audible at half a mile by adding another 2,000 sound cycles to his repertoire. If the chappie means that the highest note that the loud-speaker can deal with is one with a frequency in the neighbourhood of 8,000, I more or less agree with him. But, after all, that is pretty well enough for most of us, for it embraces most of the important higher harmonics of both speech and music.

The Old Lady's View

"Push bicycles was bad enough," said the old-lady, as they revived her with a drop of mothers' ruin when she had been knocked down by a motor bike, "but these 'ere motor cycles well deserve the name of killer-cycles that I am always reading in the papers."

"Kilohertz," murmured the B.B.C. man on holiday, who happened to be standing by.

"Urts!" growled the old lady, "they jolly well does, I'll give you my word."

A Simple Insulator

If you want to insulate any bare part inside the set or outside it easily and quickly here is a very effective method. Simply paint it over with a coat or two of quick-drying stove enamel, of which you can purchase a tin for a few pence from any ironmonger. It is not half a bad idea to treat the screens of the receiving set in this way. It does not impair their screening powers in the least, but it does prevent them from offering such splendid opportunities for short circuits as they do when they are left in all their nakedness. Stove enamel makes an excellent dressing for joints made in insulated wires, assurance being made doubly sure if a winding of rubber tape is afterwards put on.

Mihaly in England

Following the announcement that a company has been formed in Germany to

::

::

On Your Wavelength! (continued)

::

::

sponsor the Baird system of television in that country as a result of the successful demonstrations given before an impartial German Government, we have the news that Denes von Mihaly is in this country. During the past three or four months this inventor has been conducting daily transmissions from the Witzleben station with the co-operation of the German Post Office. Now he has brought his apparatus to England and a demonstration is promised at some future date.

The actual receiving apparatus resembles that of the Baird television receiver inasmuch as it contains a rotating disc and a neon lamp, but here similarity ceases. The scanning disc with thirty holes is mounted horizontally and above this is a screen pierced with a hole, above which again are a mirror and a lens, housed in a metal hood, in which the received image appears. The disc itself is driven by a simple electric motor containing ten iron bars which, when rotating, move before the field magnets made by mounting two bobbins on iron cores. To give a phase adjustment, provision is made whereby the motor field can swing bodily about the axis of the armature.

Synchronising Apparently Unsatisfactory

There are two or three models of the receiver, and in the smallest the disc is only about 8 in. in diameter and is made of ebonite. Without attempting to be critical or in any way biased, I cannot help feeling that the apparatus falls far short of the ideal in its scheme for synchronising. It depends upon the motor being in phase with an alternating current supply of 50 cycles and is known as the phonic wheel. This would appear to be all right if transmitter and receiver are working off the same supply where mains fluctuations are common, but since this would occur only in a very limited number of potential users' cases, difficulties are sure to arise. Any phase errors or discrepancies in the supply frequency used at the individual receiving station would produce a cumulative out-of-step effect which would spread the image out into a parallelogram and finally obliterate it in a few revolutions of the disc.

Not True Television

Furthermore, we must not lose sight of the fact that there are still an abundance of direct-current supplies in this country. The inventor had made an effort to cope with this latter case, and those where no mains are available at all, by providing a tuning fork synchroniser, but even with this apparatus the delicacy of adjustment and the driving battery variations still leave the cumulative errors present. The motor is not self-starting and has to be run

up to a speed where it can drop into step by using a mechanical drive mounted on the case cover.

Of course, in the absence of a proper demonstration under normal working conditions it would be unfair to draw conclusions, but it should be pointed out that the received images do not constitute true television as we know it. The system is mainly applicable to the transmission and reception of films where the photo-electric cells are influenced by direct light through the film itself. This is quite distinct from the reflected light operation of the cells as applied to the transmission of actual living artistes sitting before a scanning disc.

A Pick-up Freak

I made a surprising discovery the other day, namely, that it is possible to obtain a distinct tune from the centre portion of a gramophone record! At any rate, my experiments led me to conclude this, for on placing the needle of the pick-up on the centre portion a curious noise resembling a bagpipe was heard. I could not understand where this was coming from, and the funny part was that there appeared to be relatively little scratch. I was very puzzled, and took the record off and examined it very carefully. I thought that perhaps the record was a freak and that in some way a certain amount of note had become impressed upon the large groove which is used to side-track the pick-up when the record has finished playing.

An examination did not show any signs of cut on this groove, however, and I thought I would put the matter to test by trying another record. This appeared to give exactly the same results, although the tune was slightly different.

The Explanation

I ought to explain that the particular turntable and pick-up are in a somewhat dark portion of my workshop, and it is not always possible to see exactly what is happening. I bent down, however, to examine the apparatus and suddenly discovered the reason for the peculiar effect taking place. The pick-up had been mounted in its holder slightly askew, and in addition the needle had been placed in to the fullest extent, so that only a small portion was projecting. The result was that the edge of the pick-up was resting on the record, while the needle itself was apparently playing on the centre groove. The edge of this particular pick-up was rounded so that it slid over the tops of the grooves in the record proper, and in doing so gave rise to the peculiar attempt at a musical note which was reproduced, accompanied by a certain proportion of scratch, in the loud-speaker.

I am afraid this confession, however good for the soul it may be, rather shows how

lax I had become in the matter of my pick-up tracking, because, of course, it is most important to ensure that the needle is truly in a vertical plane. Wear on a record arises largely from transverse strain, and a weight of up to 10 oz. can safely be placed on a record without causing undue wear, provided that it is applied truly vertically, whereas if it is applied at all on the skew, a weight of 2 oz. or 3 oz. is sufficient to cause serious damage. I did not lose much time in re-aligning my pick-up, because I have a number of records which I rather prize and I do not want to wear them out unnecessarily quickly.

The Talker Magnet

A friend of mine who has just returned to England from America tells me of the rush of broadcasting technicians into the talking-picture business. We seem to have heard something about this before, haven't we? But America must do things big or not at all—and figures show that no less than fifty-seven engineers left the service of the National Broadcasting Corporation for the talkies in two "red-letter" weeks. Dozens of young men suddenly decided to throw up their jobs and give up their homes in New York and eastern states and migrate to Hollywood, where, they felt sure, the streets were paved with platinum. Well, for their sakes, let us hope that the talkers are not just a passing fancy.

B.B.C. Leak

Meanwhile there is still a steady leakage of engineers from the B.B.C. to the talkers. Last week six London station engineers joined the talking-film section of the H.M.V. Gramophone Company, which company has also been freely mentioned in connection with the future activities of Captain Eckersley. As a result of this latest exodus, some wag put on a prominent department notice board the following announcement:—

"Demobilisation of B.B.C. Forces

"In view of the unprecedented number of applications for demobilisation, much heavy work has been imposed upon the office-staff section. In order to ease the enormous amount of work entailed in making up pay books and service bonuses, it is suggested that not more than six members of the force apply for discharge at one time. All ranks should kindly note that it is more economical in stationery if two or more (but not more than six) applications be written on one form. Demobilisation forms may be obtained on application to Desk D, Room 54, B.B.C. Experimental Station, Clapham."

THERMION.

IT is becoming increasingly popular to utilise an automatic method of providing the necessary grid bias in a receiver. This is more particularly the case in a mains receiver, or where the H.T. and L.T. are obtained from the power supply it is desirable to provide the grid bias as well in order to eliminate batteries entirely.

Where an eliminator is being used externally to the receiver, it is usually preferable to obtain a separate grid-bias supply. Although this involves the use of a separate rectifier, the smoothing system necessary is only very small, and there are numerous internal connections in a receiver which are liable to give trouble unless the whole circuit has been arranged to allow for automatic bias. Where this is possible, however, grid bias can be obtained by a voltage drop method without serious difficulty.

A Simple Method

This method consists in utilising the voltage drop produced by the high-tension current flowing through a suitable resistance. A skeleton circuit is shown by Fig 1, in which it will be seen that the L.T.— is not connected to H.T.— directly. A resistance is included through which the high-tension current must flow on its way back to the high-tension battery. The passage of the current through this resistance will set up a voltage drop equal to the product of the current in amperes and the resistance in ohms. Thus, for example, if we have a current of 10 milliamps and a resistance of 1,000 ohms we shall obtain a voltage drop of 10 volts which we may use for grid-bias purposes.

The question arises now as to the polarity of this voltage. For grid bias we require the positive end of the biasing voltage to be connected to the filament and the negative end to be connected to the grid return. How is the voltage drop on this resistance arranged? In other words, which end of the resistance will be positive and which negative?

This is a point which may well cause a little confusion at first, for it is customary to regard the filament of the valve as at the

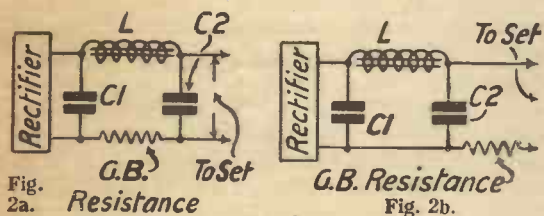

Fig. 2. The resistance should be connected as at b, not as at a

most negative potential in the circuit. This is normally correct, because the H.T.— and the L.T. are customarily connected together. We are considering here, however, the high-tension circuit, for it is H.T. current which is providing us with the necessary voltage drop, and in this circuit the most negative point is the negative pole of the H.T. battery. Inside the battery we build

Automatic Grid Bias

By J. H. REYNER,
B.Sc., A.M.I.E.E.

up a high positive potential and in the external circuit we gradually lose this potential in doing work. Thus the anode on the valve is not quite at such a high potential owing to the voltage drop in the external circuit. The filament of the valve

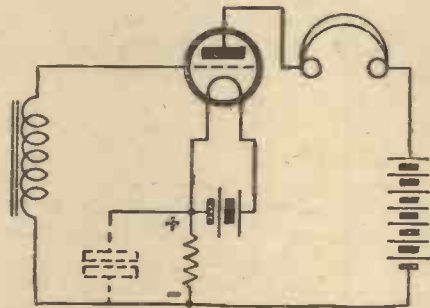

Fig. 1. Method of utilising voltage drop for obtaining grid bias

is at a still lower potential owing to the voltage drop in the valve itself, but in the ordinary circuit the filament of the valve represents the end of the journey, since it is usually connected to H.T.—.

Polarity

In the present circuit, however, we still have some more resistance to cover, so that we have not used up all the potential by the time we reach the filament which is consequently still positive with respect to the negative of the battery. Therefore we can mark the filament end of the grid-bias resistance "positive" and the H.T. battery end "negative." A little reflection shows that this is the direction which we require for proper grid bias and all we have to do is to connect the negative end of the transformer or resistance-coupler, or whatever the device is, to some suitable point on this resistance at which the voltage drop is such as to apply the correct grid bias.

Naturally, one usually chooses the resistance to be just sufficient to give the required value, in which case the whole of the voltage drop is used and the grid bias terminal is connected to H.T.—. It is not economical to utilise more resistance than is necessary, because the high tension actually applied to the anode of the valve is reduced by the amount of the grid bias

voltage. If we have a battery of 100 volts and we use 10 of these volts in the grid-bias resistance, the remaining voltage is only 90, and the actual voltage applied to the valve will be something less than this, depending upon the resistance of the anode circuit proper. It is, indeed, principally this fact that the grid bias can only be obtained at the expense of the H.T. battery that has prevented the system from coming into any extensive use hitherto.

Elimination of Hum

Where we are dealing with mains apparatus, however, this difficulty no longer exists. We can always arrange for the total H.T. voltage to be 10 or 15 volts in excess of what is required for the anode circuit, so that we obtain the necessary grid-bias voltage without any difficulty. In a simple two- or three-valve receiver, having only one stage of low-frequency amplification, no trouble is experienced, and the simple circuit already shown can be used. It is desirable in order to eliminate any trace of hum, to connect a condenser across the grid-bias resistance, as shown dotted. This condenser need only be of 1-microfarad capacity, and need only be of the 150-volt type, as the actual voltage drop, of course, is quite small and there is no danger of breakdown.

On the subject of mains apparatus, it is as well to point out the exact position in which the grid-bias resistance should be inserted. Fig 2a shows the resistance inserted between the reservoir condenser

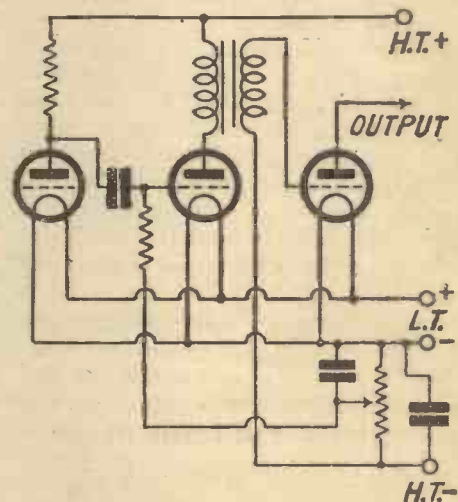
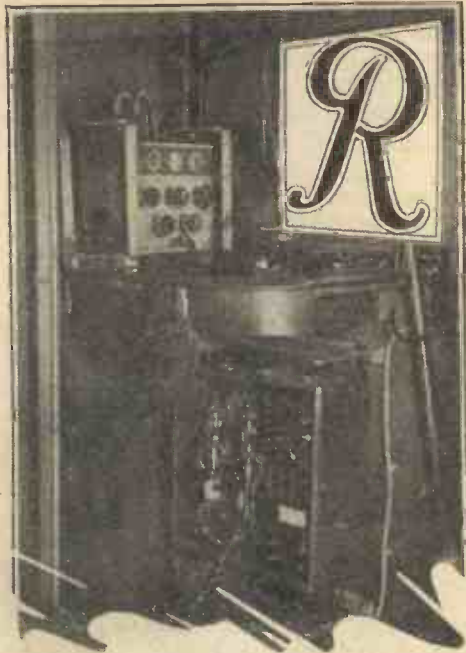

Fig 3. Method of feeding two L.F. stages

and the smoothing condenser, while Fig. 2b shows the resistance inserted after the smoothing circuit. The first of these methods is incorrect, for a certain amount of alternating current passes through the smoothing condenser, through the grid-bias resistance, and back to the transformer, as shown by the arrow. This current will, therefore, set up an alternating voltage in the grid-bias resistance which will be applied to the grid of the valve and will give rise to hum. On the other hand, in the

(Continued at foot of next page)



WIRELESS apparatus on board the monoplane *Yellow Bird* played an important part when, in the hands of three courageous Frenchmen, this diminutive 'plane made a successful crossing of the Atlantic from the United States to Spain, and then on to Paris.

The crew included the wireless operator, Armand Lotti; the pilot, Jean Assolant; and the navigator, Rene Lefevre; and as this is the first Atlantic flight which has been free from alarms and periods of "no news," Lotti had his work cut out to keep touch with the world.

The most important use was made of the radio apparatus when nearing the end of the flight. *Yellow Bird* carried 1,000 gallons of fuel, but it was obvious, after about two-thirds of the distance had been covered, that Paris could not be reached on the allowance. The authorities almost immediately received news that the 'plane would not make direct for Le Bourget, but would land either in the Azores or in Portugal. Actually the landing was made at Santanden, in Spain. Report after report was received concerning the pro-

RADIO FLIES THE ATLANTIC

gress of the flight, and the airmen themselves were equally as well in touch with the world, for *Yellow Bird's* receiver was working whenever the transmitter was silent.

The whole apparatus was installed in one corner of the cabin, both transmitter and receiver being contained in metal screening boxes. The transmitter was a straightforward oscillator with one control valve, and was contained in one cabinet with the tuning and voltage controls. The whole box was slung at six points on aeroplane elastic to insulate it from vibration.

Power was supplied by an air-screw driven generator on the near side of the machine. This was an "extra," and was slung from one of the cabin windows on a triangular frame supported by bracing wires. A heavily armoured cable led to the power resistances and potential dividers in the transmitter cabinet.

On a shelf above was the receiver, a control ammeter for the transmitter current, and a morse-key.

The receiver was a simple three-valve arrangement, using Dario valves, and derived its power from the transmitter resistance voltage-divider. As with the transmitter, a resilient suspension on elastic insulated the set from shock. Phones and a microphone were fitted into the operator's leather flying helmet, and a simple change-over switch enabled him to transmit by key or to listen, as required.

The transmitter was adjusted for wavelength and radiation before the commencement of the flight, and no trouble was experienced. The adjustment of only two tuning controls enabled the receiver to

cover the whole of the commercial wave-band.

An aerial was hung out from the fuselage on pulleys, and the actual framework of the monoplane was used as an earth, both for transmitting and receiving.

The apparatus employed was of French



The power for the wireless installation is obtained by an air-screw driven generator

manufacture, but was very similar in detail to the A.D. 6-type combined transmitters and receiver fitted to many British 'planes. The air-screw driven generator in this case supplies 100 milliamps at 1350 volts for H.T., and 6 amps at 7.5 volts for charging a floating accumulator.

"AUTOMATIC GRID BIAS"

(Continued from preceding page)

Fig. 2b circuit, the current is, or should be, almost steady, all the ripple having been smoothed out by the previous filtering circuits. Thus, no hum will be produced in the grid circuit, and silent working will result.

Different Values

The method may be applied to the production of more than one value of grid bias. In such a case the resistance is chosen to develop the maximum voltage required and a tapping is taken to provide the smaller voltage. The circuit shown in Fig. 3 gives an arrangement feeding two L.F. stages.

The grid-bias voltage is chosen to be sufficient for the second stage, while a tapping is taken for the first stage at an appropriate point. Both grid-bias leads should be condensed to earth in order to avoid hum.

Battery-driven Receivers

There is, of course, no reason why the method may not be used with battery-driven receivers. It certainly has the advantage that as the battery runs down, so the grid bias is automatically reduced and the receiver works as long as possible under satisfactory conditions. Its principal application, however, is to a mains equipment, and provided proper precautions are taken, the method is satisfactory as such.

The calculation of grid-bias resistance can easily be made according to the formula already given. As it is customary, however, to deal in milliamps in a wireless receiver, a more convenient rule will be found to be the following: A resistance of 1,000 ohms drops 1 volt per milliamp. The first thing to do, therefore, is to note the H.T. current. Next decide the maximum value of grid-bias required and divide this by the H.T. current in milliamps. This will give the grid-bias resistance required in thousands of ohms.

For example, if a receiver takes 15 milliamps, and 9 volts grid bias is required, then the grid-bias resistance is

$$\frac{9}{15} \times 1,000 \text{ ohms} = 600 \text{ ohms.}$$

NEW DEVELOPMENTS IN METAL RECTIFIERS

By W. JAMES

THE metal rectifiers issued by the Westinghouse Company have all been of the full-wave bridge-connected pattern (with the single exception of the type GB1 for grid bias), and from time to time descriptions of their uses have appeared in these pages.

There are low-voltage types for charging filament-heating accumulators or for supplying the low-tension circuits directly through filters, and others for high tension. Type HT1 is used extensively in high-tension mains units, and with an input of 230 volts A.C., may be used to supply the

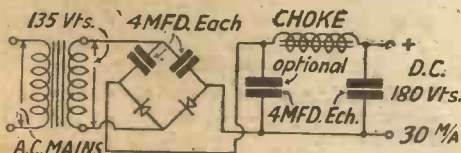

Fig. 1. Method of connecting new rectifier type H.T.3

maximum direct current of 100 milliamperes at 200 volts.

This is a large output, and as it is much greater than the requirements of ordinary receivers, the Westinghouse Company have decided to introduce immediately two new models that are more suited to the needs of those running popular sets.

They are much less costly than type HT1, and there is, of course, the further advantage that the associated equipment, including the transformer and smoothing choke, is cheaper.

The new units are as follows:

Type	A.C. input	D.C. voltage	D.C. current	Remarks
HT3	135/140	120	20 m/a	Half wave.
HT4	135/140	180	30 m/a	Full wave with special circuit.

Type HT3 may be connected as indicated in Fig. 1, and an anode-filter circuit for a three-valve set as in Fig. 2. Any form of anode filter circuit may, of course, be employed, but the one given is typical of those commonly used.

Points to notice are the secondary voltage of the transformer (which must not exceed 140 at no load) and the method of connecting the rectifier according to the labels on the terminals. Being a half-wave rectifier, there will be as many pulses of D.C. per second as the frequency or periodicity of the A.C. supply. The filter will take care of this, however, and with a suitable arrangement of anode filters, such as in Fig. 2, there should be perfectly hum-free reception.

The second new rectifier, type HT4, is intended to be used in a rather special manner, for you will notice that whilst the

A.C. input voltage is no greater than that applied to type HT3, more output D.C. voltage and current are to be obtained. Actually, a voltage-doubling circuit is used and will be understood by referring to Fig. 3. It is merely a bridge circuit, having for two of its arms a pair of condensers of equal values, and metal rectifiers for the other two arms. This arrangement passes to the filter twice as many pulses of current per second as the frequency of the A.C. supply, and therefore resembles the ordinary full-wave rectifier.

In order to follow more closely the operation of the voltage-doubling circuit, let us refer once more to Fig. 3 and assume that wire A is positive with respect to B. Then a current will flow through rectifier R1 and charge C1

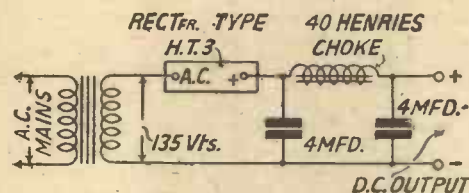

Fig. 4. Complete circuit of H.T. unit and filter

When wire B becomes positive with respect to wire A, condenser C2 receives a charge with the result that the voltage

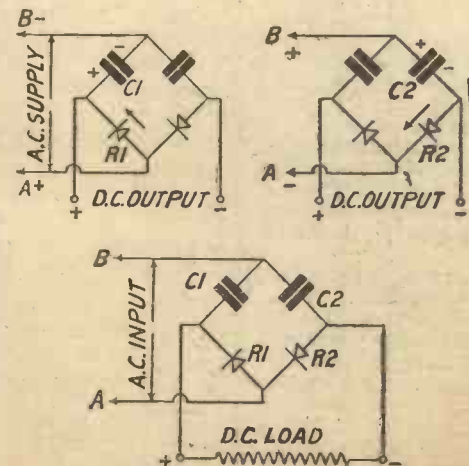

Fig. 3. Diagram explaining the voltage-doubling circuit



across the output circuit is approximately twice that of the applied A.C. The peak value of the voltage of each condenser is, of

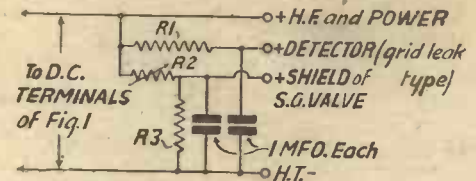

Fig. 2. Anode filter circuit for typical 3-valve set having S.G., det. and power valves

course, $\sqrt{2}$ the RMS alternating voltage, and amounts to 191 volts for 135 volts A.C.

When a load is connected to the output terminals a current will pass through it, discharging one of the condensers whilst the other is being charged. Thus if line A is positive, current flows through rectifier R1 to the positive D.C. terminal, the load circuit and condenser C2, to line B, and the voltages of the supply and condenser C2 are assisting in series. During this period current is also passing through R1 to C1 and is charging it. When the next half wave arrives, making line B positive, condenser C1 discharges through the load and is assisted by the current passed by R2.

The rectifier units carry a double load in each half cycle, one part being due to the output circuit proper and the other to a condenser.

It is interesting to observe that, as one or other of the condensers is in series with the D.C. output circuit, their capacity determines the voltage regulation of the arrangement and also the value of the current in the event of a short-circuit. The manufacturers recommend condensers of 4 microfarads each when the A.C. supply voltage is 135.

The units are not expensive and should last for many years. Type HT3 costs 2rs., and type HT4, 37s. 6d. This last type may, of course, be used as a half-wave rectifier if desired. A transformer giving 230 volts will be required and the terminal marked - (negative) is joined to it.

SOME RELIABLE SHORT-WAVE TRANSMISSIONS

THE average amateur requires information regarding the reliable short-wave stations which he may hope to pick up. Failing definite data of exact wavelengths and times, it is a heartless job to twirl condensers in the hope of tuning-in to some well-known transmitter.

The list published hereunder has been carefully checked, and revised to date and is based on actual "logs" and observations

made by regular listeners to short-wave transmissions. In most instances peculiarities of the broadcasts have been stated as well as comments on the strength at which the signals have been recently received. Strength will, of course, vary according to conditions, time and the location of the receiver, etc.

It is hoped that this data may assist the short-wave fan in identifying a number of his captures.

Metres	Call	Station	Times of Transmissions	Metres	Call	Station	Times of Transmissions
14.83	DGW	Nauen (Germany) 18 kw.	Telephony with Buenos Aires (South America). Daily, 2 to 9 p.m.	31.48	W2XAF	Schenectady (New York). Relays WGY. 10 kw.	Saturdays and Mondays, 11 p.m. to 5 a.m. Tuesdays to 4.30 a.m. Thursdays, 11 p.m. to 5.30 a.m. Signals very clear.
15	W2XAW	Schenectady (N.Y.)	Relays WGY programmes.	31.55	3LO	Melbourne (Australia).	Sundays, 8 to 9 p.m. Usually quite clear and fairly free from atmospherics.
15.03	LP3	Monte Grande (Buenos Aires) 20 kw.	Telephony with Nauen (Germany). See above.	31.6	—	New Copenhagen (Denmark) PTT station	On most afternoons and evenings. Excellent quality and strength.
15.74	PLE	Bandoeng (Java)	1.40 to 3.40 p.m. B.S.T. Wednesdays. Faint, but clear.	33.7	—	Posen (Poland). 300 watts	11 p.m. to midnight (Mondays and Thursdays). Metronome interval signal (240 beats per minute). Announcements in several languages. Has been picked up very clearly in Great Britain.
16.30	PCK	Kootwijk (Holland)	From about 7 a.m. on odd dates (fairly good at times).	37.8	DOA	Doeberitz (Germany)	Usually Mondays and Fridays, 8 a.m. to 12 (mid-day), and from 4 to 8 p.m. Metronome, Gramophone records and speech (news). Good strength.
16.88	PHO	Huizen (Holland)	From 1 p.m. on most weekdays. Clear.	45	CT1AA, Postus Amador Portugal	Lisbon (Portugal)	Irregular. Announcements in French, English, Spanish, German, and Portuguese.
17	PLF	Radio Malabar, Bandoeng, Java. 30 kw.	Daily: 2.30 to 5.30 p.m. B.S.T.	47	CT3AG	Funchal (Madeira Is.) .3 kw.	Saturdays, 10 p.m. to 1 a.m.
18.8	PLG	Bandoeng (Java)	Weekdays, 1 to 5 p.m. B.S.T.	47	8BP, Station Experimentale du Journal des 8	Rugles (France)	Tests daily (except Sundays) from 1.30 to 3 p.m., preceded by strokes on gong.
19.56	W2 XAD	Schenectady (New York). Relays WGY. 6 kw.	Sundays, 7.30 to 10.30 p.m. Tuesdays and Fridays, 7 to 8 p.m. Fair strength and clear at times.	49	—	Eiffel Tower (Paris)	Daily, 11.30 to 11.45 a.m., 6.15 to 6.30 p.m., 10.15 to 10.45 p.m.
21.97 Also on 21.91 and 22.07 22.68	W2XO	Schenectady (New York). Relays WGY.	Mondays and Thursdays from 7 p.m. Excellent strength, good quality, steady signal.	49.02	W2XE	Richmond Hill (New York). Relays WABC. 5 kw.	Daily, 11 p.m. to 5 a.m. B.S.T.; Sundays, 3.50 to 5.30 a.m. B.S.T.
23.35	6XN	Oakland (Cal.). Relays KGO, 5 kw.	Tuesdays, Wednesdays, and Fridays, 5.30 to 9 p.m. Wednesdays, 2 a.m. to 8 a.m.	49.40	Hier Kurzwellensender Ravag, Wien. (UOR2)	Vienna (Austria) experimental	Gramophone records and speech tests. Faint to fair signals. 1 p.m. Tuesdays and Thursdays; at the end of the Vienna evening programme Wednesday and Saturday.
24	PTT	St. Assise (France), 20 kw.	From mid-day to 2 p.m. B.S.T. Experimentally relays the PTT Paris programme.	49.5	W8XAL	Cincinnati (Ohio). Relays WLW. .25 kw.	Daily (except Fridays and Saturdays) from 11.50 p.m. B.S.T.
25.4	W8XK	Pittsburg (Pa.). Relays KDKA	Sundays, 4.30 to 5.30 p.m., and 6 to 8 p.m. B.S.T.	60	Ici Radio Electra, Praha, Tchecho-Slovaquie, Ministère des Postes.	Prague (Czecho-Slovakia). Relays capital programmes,	Daily 5 to 10 p.m. B.S.T.
25.53	5SW	Chelmsford. Relays 2LO and 5XX. 15 kw.	Daily (except Saturdays and Sundays) from 12.30 to 1.30 p.m., and from 7 p.m. to midnight. Weak in most parts of United Kingdom.	84.25	7RL	Copenhagen (Denmark) .25 kw.	Irregular. Announcements in English and Danish. Gramophone records and picture transmissions.
25.6	CJRX	Winnipeg (Canada) 2 kw.	10.30 p.m. to 12.30 a.m., weekdays only; Saturdays, 6 to 8 a.m. Very loud at times, clear, pure quality.				
27.8	PLR	Bandoeng (Java) 25 kw.	Daily, 4 to 7 p.m. B.S.T.				
31	7LO	Nairobi (Kenya)	Daily, 4 p.m. to 7 p.m., and sometimes later. Faint, but clear.				
31.40	PCJ	Hilversum (Holland) 25 kw.	Thursdays, 7 to 9 p.m., and from midnight to 1 a.m. Fridays, 1 to 3 a.m., and from 7 to 9 p.m. Saturdays, 1 to 7 a.m. Metronome, 140 beats per minute. Announcements in several languages. Fairly strong at times.				

WITHOUT FEAR OR FAVOUR



A Weekly Programme Criticism by Sydney A. Moseley

IT has only been by pegging away that we have been able to obtain improvements. Unfortunately, we have not been altogether so successful as regards the Sunday programmes, but I don't despair of getting some change introduced.

Sunday, after all, is the one day on which many have the opportunity of

been novel and instructive to those who have never visited one of these super-auction establishments. But listeners who expected to hear a sort of "Nah, then! Goin'—goin'—gorn!" must have wondered whether the transmission was actually taking place at a real live auction or was a studio affair with nice, well-brought-up actors.

An ardent listener has taken me to task about my criticism of the "noises off" in broadcast plays. He goes to great lengths in explaining to me that these noises play a most important part in giving us an imaginary view of what is supposed to be going on. He holds that the "noises off" form an integral part of a wireless play, and that without them any play would be flat and uninteresting.

True, O friend. I agree that as an aid to the imagination Mr. N. O. is a very useful adjunct to wireless plays. There is no need for these effects to be exaggerated to the extent of spoiling the lines of a play. They should not be rammed down our ears, when they become reminiscent of those blood-curdling, unintelligent melodramas as performed by pre-war barnstormers. After all, *must* the wind howl every time one of the performers gets a fright?

I don't know for sure how long the "Foundations of Music Series" has been running, but I am certain that the Elizabethan madrigals, which comprised a recent week's subject, made the brightest and most entertaining feature we have yet had under the "Foundation" heading. I won't say that the actual madrigals were particularly bright (they weren't!), but the singing of the Wireless Singers was delightful.

The Beggar on Horseback was an ambitious and highly creditable attempt. I am afraid, however, it did not suit all tastes. To many it must have seemed dull and unconvincing. Those designated as "Real People" were totally unreal, and some of the "Dream People" sounded far too practical. Barbara Burnham, the arranger, did her best with a difficult job, but there it is—the best plays are not necessarily suitable for broadcasting purposes.

Moonshine, the revue from Birmingham, bore out the remarks I made in a recent issue about the wireless revues. Once again we were treated to tinkly fox-trot songs and jokes of Stone Age origin. Good sketches with witty dialogue and surprise endings seem to have disappeared almost completely. Ever since *Charlot's Hour* began to become humdrum the broadcast sketch has been neglected by nearly every one.

Patricia Rossborough's "Syncopated Pianisms" struck me as being quite good, but the vaudeville hour during which I heard her play did not enhance her performance, for the simple reason that every artiste in the programme sang or played syncopated music.

It was one of those programmes which set a music-lover's teeth on edge. In addition to Miss Rossborough's playing (which would have been most acceptable by itself), we had two funny gentlemen who sang "do-de-o" stuff between jokes; there were "light songs" which turned out to be vocal fox-trots; a light comedienne based all her comedy upon "cuties" and



An impression of Arthur Rosebury

listening, and I maintain that the B.B.C. should put out good programmes. Well, as you know, it does not; but I understand the matter may seriously be considered before very long.

What about a broadcast holiday—say, for three days? I was thinking the other night, while listening, that one's sense of appreciation might be considerably developed if we were given a little rest from programmes, which, after all, must have a certain kind of sameness about them. You may easily say, "Well, any listener can do that for himself," but, alas! self-discipline is a very difficult matter. The only thing to do is to let the batteries run out! However, this is giving advice which I do not propose to carry out myself. The day on which something goes wrong with the works is a very sad one for me.

Although there may have been nothing very thrilling about the auction sale broadcast from Christie's, it must have



Harry Hemsley in Lissenden's eyes

"sweeties"; and the whole affair was supported by Philip Brown's Dance Band, which gave us fox-trots by way of a change. To what heights does the programme department climb, eh?

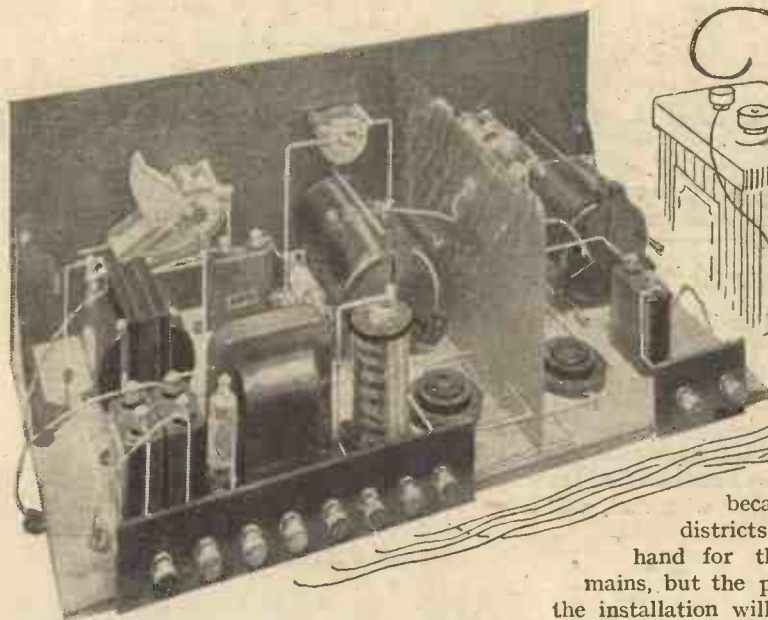

THE BROAD T WITH MAINS

THERE is no doubt whatever that as electric-light mains become more and more general, amateurs will make use of them for radio work.

As things are at present, the developments which have been made even in the last year in A.C. mains components have made it an uneconomical business to use batteries if mains are available. The advent of the directly-heated valve, and the completion of the series of these valves which now covers all purposes, has greatly simplified the task of getting L.T. from alternating-current supply, and quite a simple H.T. eliminator will suffice for the provision of H.T.

Mains or Batteries

In this present three-valver, arrangements are made for working from A.C. mains in this manner, with directly-heated valves and a conventional, straightforward H.T. eliminator, but batteries may be employed if desired. This is a convenience

because a number of districts have plans in hand for the installation of mains, but the probability is that the installation will not be complete for a year or more. Amateurs in that locality wishing to make up a receiver will be wise to keep in mind the possibility of utilizing the mains when the source arrives, and they will want to make up a set which can readily be changed for mains operation when the time comes.

Dual Range

This need is filled in this three-valver. It is a most useful "three" for local or distant-station work, and with ordinary batteries and valves will give results comparable with the best obtainable from almost any ordinary type of receiver. It has advantages, too, in the way of dual-range tuning, necessitating no coil changing, and an efficient motor-boat stopper and choke-output circuit.

When operated from the mains, the new .8-volt A.C. mains valves are used in each stage. The screen-grid valve of this type and the .8-volt detector valve have but recently been put on the market, and it is now possible to build a receiver having directly-heated valves in each stage; as a matter of fact in this present three-valver it has been considered preferable to use an H.L. .8 rather than the special detector valve.

It should perhaps be explained at this point that the directly-heated .8 valves are so designated because they can be connected directly to the secondary of a mains transformer giving raw A.C. at .8 volts. No smoothing or rectifying devices are necessary, the reason being that the filaments are so short and thick that the alternating-current variations do not affect the emission of electrons, and despite the

current fluctuations a steady flow of electrons results between the filament and anode. As a matter of interest it should be noted that in the case of the detector valve the filament is double the thickness of the other valves in the series, in order to give

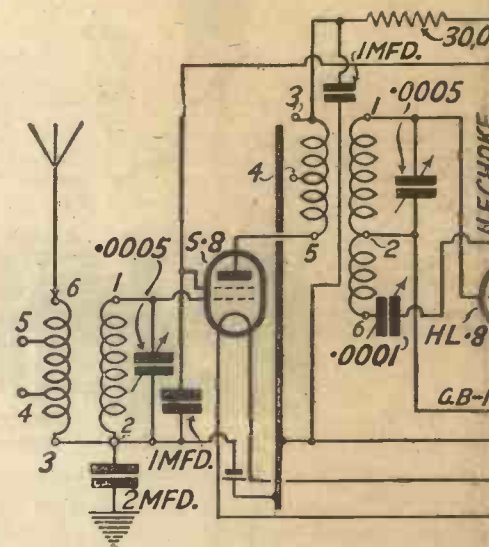

The circuit of the "Bro"

perfect freedom from A.C. ripple, and the current consumption is consequently double. This point will not concern users of the present receiver, however.

It is, of course, possible to use these directly-heated valves from D.C. mains, but in most cases, this will not be found an expedient proposition for the same economy will not result as from their use

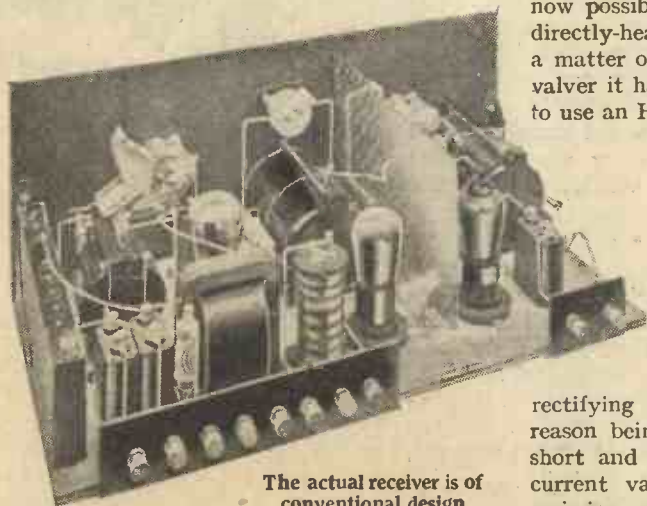

The actual receiver is of conventional design

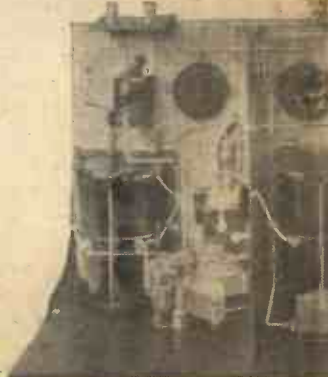

The wiring is simple as

BROADCAST THREE VALVES

with A.C. mains and a step-down transformer.

No alteration needs to be made in the receiver to suit the use of either mains valves or ordinary battery-supplied valves. The eliminator section to be described

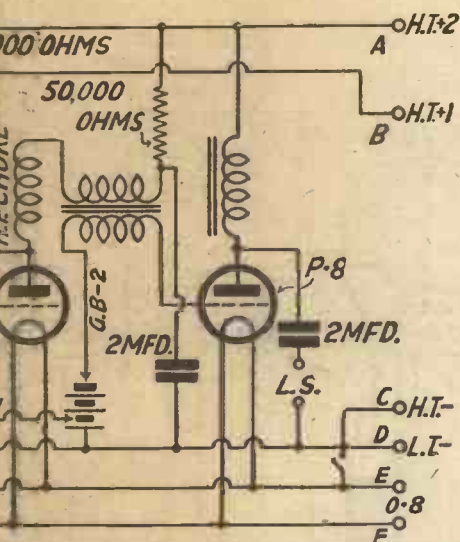

"Broadcast Three" receiver

next week includes a transformer for providing the filament current at .8 volts, and gives two potentials of H.T., one for the anodes of all valves, and a separate variable tapping for the screen grid.

When in use with battery-supplied valves, an accumulator of a voltage of two, four, or six, can be employed, together with the usual 120-volt H.T. battery.

this plan view shows

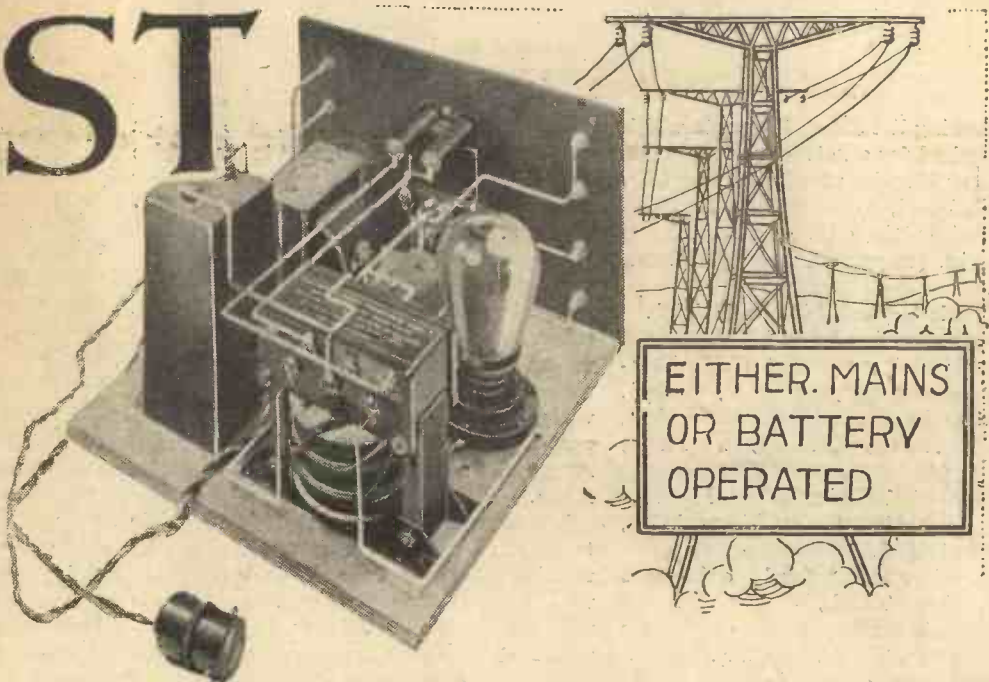

In either case an ordinary dry grid-bias battery is used, for in this instance it is hardly worth complicating the eliminator by having to provide a biasing voltage, and in any case the arrangements would have to be altered, and an ordinary dry battery used where mains are not yet available, and this would cause unnecessary complication

The Circuit

The whole arrangement of the circuit will be obvious from the diagram shown herewith.

Both aerial and H.F. tuning is effected with the dual-range Lewcos tuners, types DUA and DUG. The aerial primary coil gives a choice of three tappings, and this arrangement, with a variable tapping and with an entirely separate primary winding will give exceptional selectivity. This point merits attention by coast dwellers and by all listeners who have trouble in picking programmes from jamming. There are few better "threes" than this for knife-edge tuning, despite the use of a screen-grid valve, and screen-grid valves are still reputed in some quarters to be naturally non-selective, though this half-truth has often been tracked to earth in AMATEUR WIRELESS.

There is a 2-microfarads fixed condenser in the earth lead, to give safety when the mains are employed. It is really an idle component when an ordinary battery supply is provided. A $1\frac{1}{2}$ -volt cell supplies a negative bias

to the H.F. valve grid. This is a useful tip to improve selectivity and results in general, particularly in connection with these screen-grid mains valves.

The circuit shows the H.F. tuning arrangements, though the theory of the matter will not trouble users of the special Lewcos coils, for the dual-range mechanism is totally enclosed. Note the stopping resistance and earthing condenser in the screen-grid anode circuit, a resistance having a value of 30,000 ohms is employed. There is a similar stopper circuit in the detector valve anode circuit, in series with the primary of the L.F. transformer. This ensures complete low-frequency stability and freedom from howling and motor-boating when either the mains or batteries are employed. Some such device is a necessity in almost every good receiver, for most modern sets when worked nearly all out, and with as much "juice" as is usually

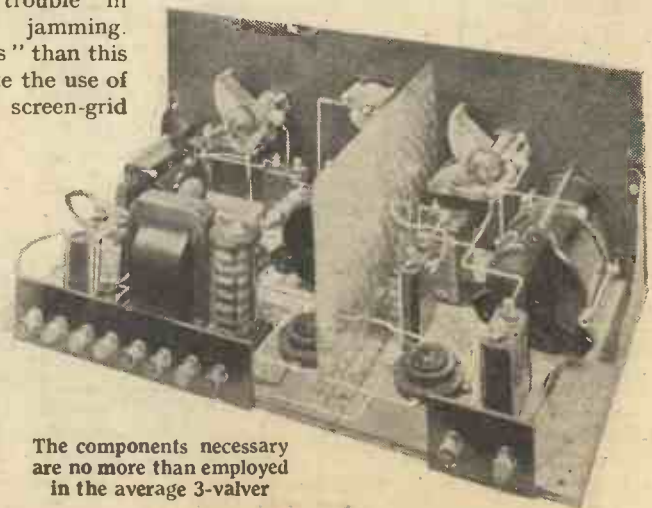

The components necessary are no more than employed in the average 3-valver

"THE BROADCAST THREE" (Continued from preceding page)

recommended, show a tendency towards L.F. instability.

List of Components

The following list shows the parts which will be required for construction:

Ebonite or bakelite panel, 20 in. by 8 in. (Raymond, Becol, Ebonart, Paxolin).

One ebonite strip, 9 in. by 2 in. and one 3 in. by 2 in. (Raymond, Becol, Ebonart, Paxolin).

Panel brackets (Ready-Radio, Bulgin).

Two .0005-microfarad variable condensers with slow-motion movement (J.B., Peto-Scott, Lissen, Ormond, Burndept, Utility).

.0001-microfarad reaction condenser (J.B., Peto-Scott, Lissen, Ormond, Burndept, Utility).

Push-pull switch (Trix, Bulgin, Lissen).

Three valve holders (Lotus, Lissen, W.B., Burton, Benjamin).

Two 1-microfarad fixed condensers (Dubilier, Lissen T.C.C., Mullard).

Three 2-microfarad fixed condensers (Dubilier, Lissen, T.C.C., Mullard).

Two dual-range coils (Lewcos, type DUA and type DUG).

One 30,000-ohm resistance and one 50,000-ohm resistance (Lissen, Graham-Farish, Dubilier, Varley, Mullard).

High-frequency choke (Varley, Trix, Lissen, Wearite).

Low-frequency transformer (Lissen, R.I., Ferranti, Igranic, B.T.H.).

Low-frequency choke (Ferranti, type Br, R.I. Igranic).

Flat screen, 10 in. by 7 in. (Parex).

1½-volt cell (Siemens type G.T., Ever Ready).

Ten terminals marked Aerial, Earth, L.T.-, H.T.-, H.T.+1, H.T.+2, L.S.+ , L.S.- grid bias+, grid bias- (Belling-Lee, Igranic).

Three wander plugs, one + and two - (Belling-Lee, Igranic).

One yard of thin flex (Lewcoflex).

Three sockets and one plug (Clix).

Baseboard, 20 in. by 10 in. (Pickett).

Connecting wire (Glazite).

If an account be kept it will be obvious that the price is not particularly low, though no

unnecessary expense has been incurred. The object has been kept in mind of designing a really good three-valver for the dual purpose, and the constructor can rest assured that if he follows the design exactly, and does not attempt to make false economies, he will get really gratifying results and the greatest economy in the long run.

Construction

Construction presents no special difficulty. A blueprint has been prepared which will greatly assist the constructor in the correct positioning of the parts, and in wiring, and this can be obtained, price 1/- post free, from the Blueprint Dept., of AMATEUR WIRELESS, 58-61 Fetter Lane, E.C.4.

When mounting the parts it is advisable to attach lengths of wire to all the used terminals on the coils, leaving sufficient wire to make connections. If this is not done some difficulty may be experienced in making connection to terminals

placed underneath and near the baseboard.

The only other point which demands attention is that the two wire-wound resistances on the detector and L.F. side of the set are supported simply on their leads, and it is unnecessary to hold them in clips.

Messrs. Selfridge are, as usual, displaying this receiver in the Somerset Street windows. AMATEUR WIRELESS receivers are shown here week by week, and this is a great convenience to London listeners, for they can see for themselves just what the complete receivers are like.

In next week's issue will be given details of operating this set, and constructional particulars of the eliminator section for those who already have A.C. mains.

A new broadcasting station is to be erected at Givors to replace the present Lyon-la-Doua (PTT) transmitter; its power is to be increased.

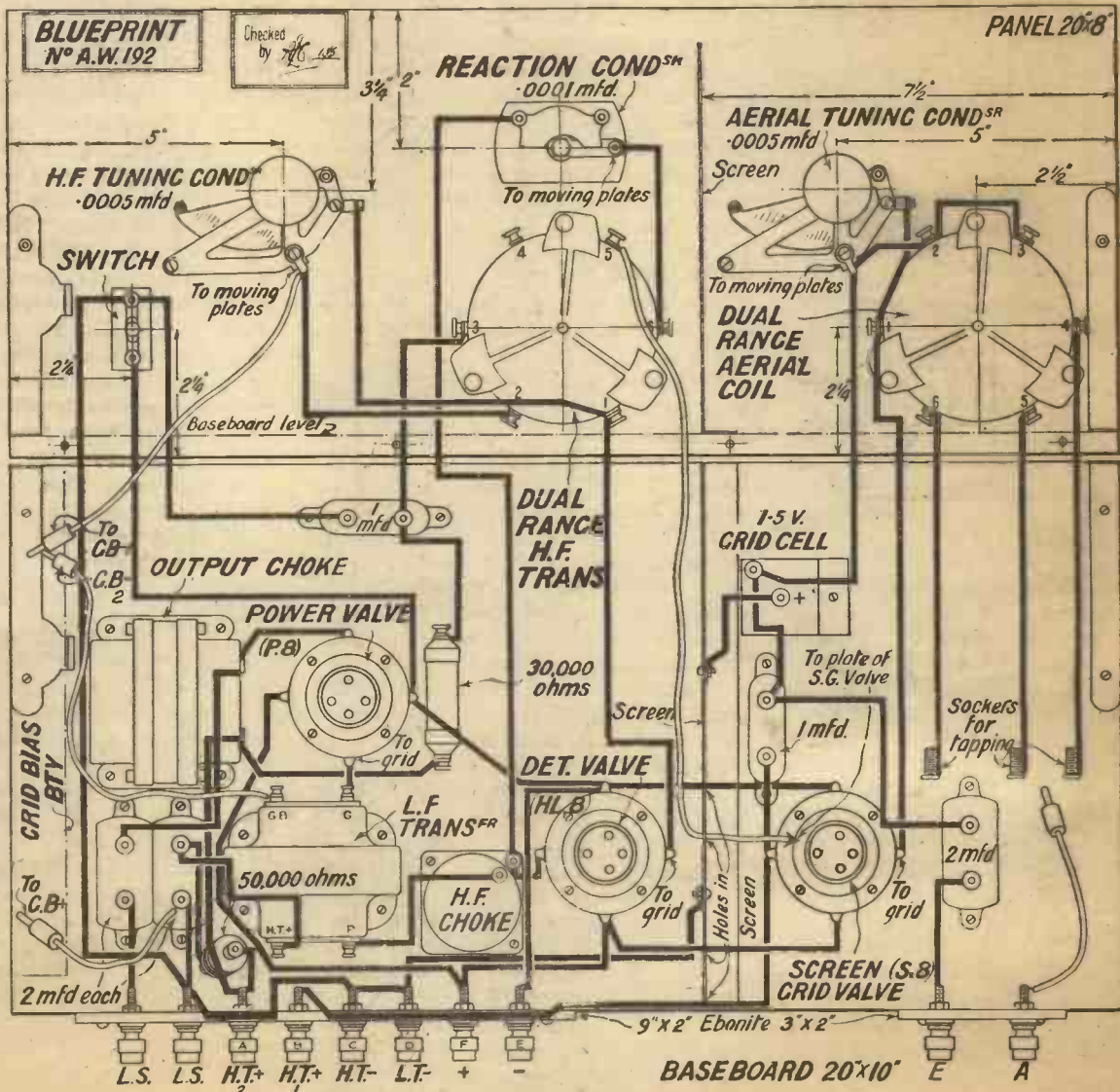

The wiring diagram of the "Broadcast Three." Blueprint available, price 1/-

LOCKED FOR SAFETY!
LOCKED FOR RIGIDITY!
LOCKED FOR STRENGTH!

Strength—Rigidity—Long Life—these three vital features are built-in to the new Cossor Screened Grid Valve. Under the wonderful Cossor system of Interlocked Construction all the elements are locked rigidly in position—they cannot move. Nothing can mar their perfect alignment. And because the elements in the Cossor Screened Grid Valve are rigidly locked micro-phonous noises are definitely eliminated. No other make of valve has Interlocked Construction. Use Cossor in your Screened Grid Receiver, there is no substitute for this new Cossor development.

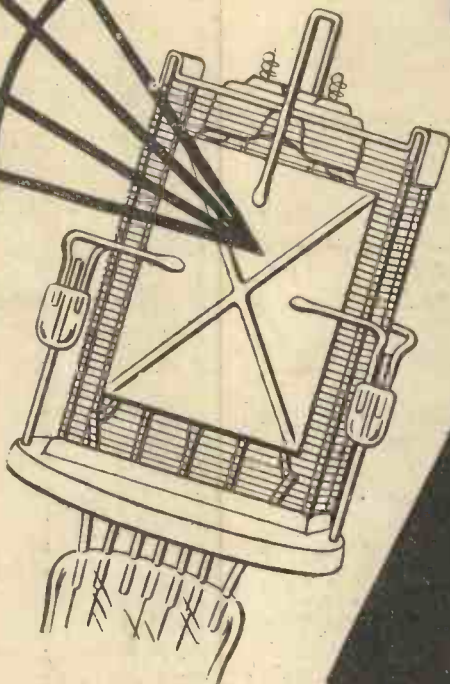

TRIPLE-LOCKED FOR LONG LIFE!

Made in 3 voltages for use with 2, 4 and 6-volt Accumulators.

COSSOR Screened Grid

Technical Data:
 Filament Current 2-volt type .2 amp., 4 and 6-volt types .1 amp.
 Max. Anode Volts 150, Impedance 200,000, Amplification Factor 200, Grid Bias 1.5 volts at max. anode
 Price 22/6 (any type)

A. C. Cossor Ltd., Highbury Grove, London, N.5.

Get full details of this wonderful Cossor Valve, write for leaflet L.10.

BRITAIN'S STRONGEST SCREENED GRID VALVE



Advertisers Appreciate Mention of "A.W." with Your Order

Grid Leak or Anode Bend?

The third and concluding instalment of the article by W. JAMES showing the advantages and disadvantages of the two systems of rectification

WHEN a signal is received the anode current increases as illustrated by Fig. 4a. Thus, the normal anode current has the value shown at A, and it increases to the value B when a carrier wave is received. It further fluctuates about a mean position according to the low-frequency modulation of the signal. In order

The grid-circuit rectifier on the other hand, works under the best conditions when the input is small.

The second point of importance in anode-bend rectification is, therefore, that the input must be so large that with normal values of modulation only the straight part of the characteristic is used. A mistake too often made is that of using too little high tension and grid bias or a valve having too high a magnification factor. Much depends upon the type of low-frequency amplifier and the amount of the volume required, but for ordinary purposes I should use a valve of the moderate - impedance class for anode-bend rectification and follow it by a resistance coupling, which is very satisfactory.

this will tend to weaken the higher audible frequencies. But attention to the values of the coupling between the detector and the next valve will minimise this form of distortion.

The mistake of using too small an anode condenser should not be made, for not only is the effectiveness of the rectifier affected by the construction of the anode circuit, but also the input of the grid circuit. Owing to the anode-grid capacity of a valve the anode circuit is coupled with the grid circuit, and unless the precaution of fitting a fairly large anode circuit condenser is taken, the tuning of the circuit connected to the grid will be broadened.

From these remarks it will be seen that the anode and grid-circuit rectifiers have their relative advantages.

For the detection of weak signals the grid-circuit rectifier should be used, and for strong signals the anode-bend type.

When the best quality of reproduction is required it is better to use the anode-bend type and to provide it with sufficiently strong signals.

A control for regulating the strength of the signals applied to either type of rectifier must be used, as both types will distort if they are overloaded.

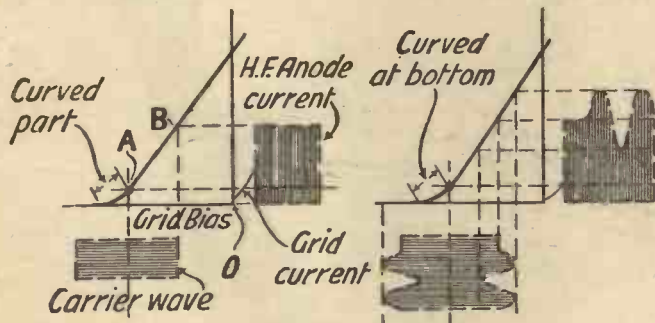

Fig 4a. Anode-bend detector rectifying carrier wave

Fig 4b. Distortionless rectification

to illustrate the essential points quite clearly I have drawn simplified figures.

The first point that will be understood from the figures is that, provided the modulation is not too great, the rectification is practically distortionless, because the actual variations occur on a straight path of the characteristic. (Fig. 4b.)

As the depth of modulation increases, the amount of the distortion will increase, as can be seen from the illustration showing a fully modulated wave. (Fig 5a.) This is because a curved part of the characteristic is used, and there is, of course, the effect of the current changes below the normal zero, which do not matter excepting when the wave is heavily modulated.

It should be noticed that the peak value of the signal may be as much as twice the normal value of the carrier wave. In order to avoid grid current which would introduce distortion, it is therefore necessary either to regulate the amount of the signal applied to the detector or to use such large values of high tension and grid bias that grid current does not flow.

Anode-bend rectification is essentially for strong signals. Distortion occurs when the signals are weak, because the curved part of the characteristic is used. (Fig. 5b.)

When a transformer coupling is to be used the valve may be of the type having a normal impedance of about 10,000 ohms or less, depending upon the characteristics of the transformer.

A further point of importance is that by increasing the high tension and the grid bias it is possible to deal with high-frequency inputs of any magnitude and so to obtain sufficient low-frequency output fully to load a power valve. This point is likely to prove of more importance in the near future, for when the new London transmitters with their great powers commence sending it will be very easy to obtain high-frequency voltages of 20 or 30.

Although the anode-bend detector is much more easily arranged to rectify with very little distortion, it is important that the output circuit be suitable. There must be an anode circuit by-pass condenser, and

An anode-bend detector also distorts when it is used with too little high tension and grid bias, and the signals applied to it must be greater than a certain minimum strength.

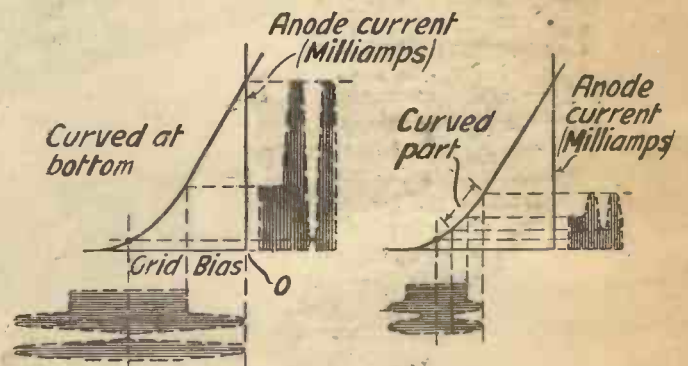
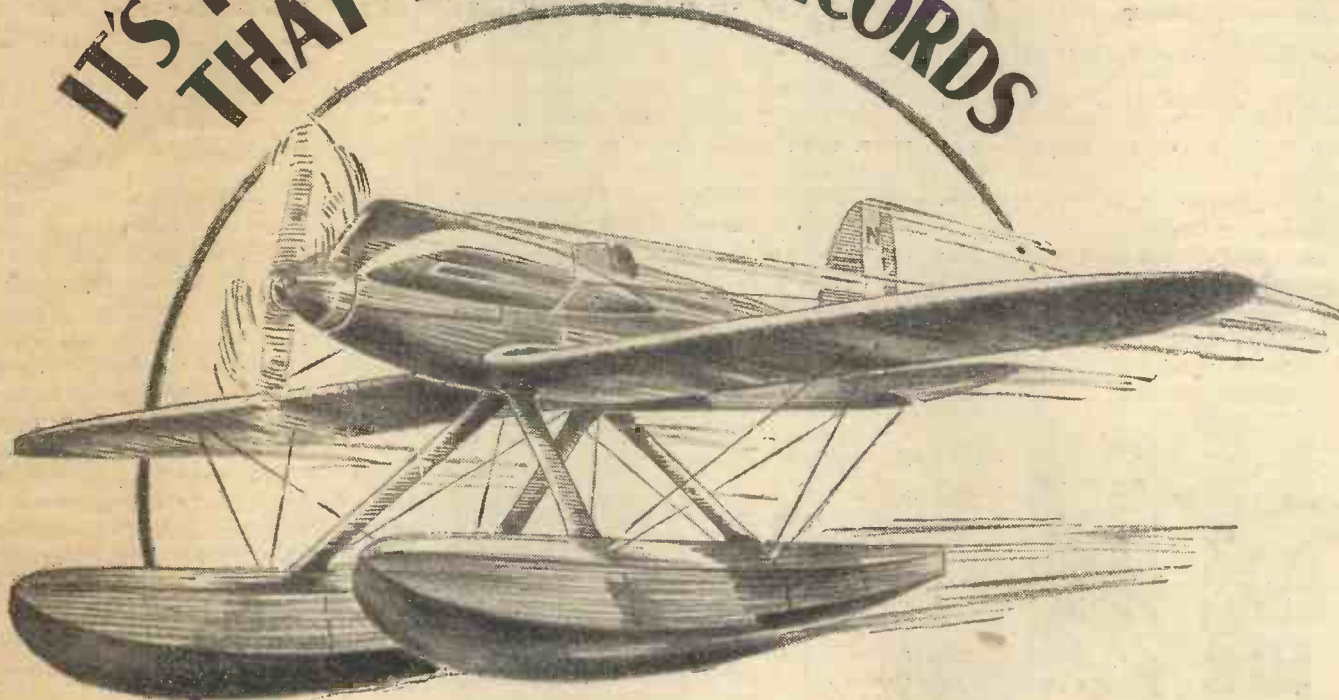

Fig. 5a. Showing distortion when wave is fully modulated

Fig. 5b. Distortion when input is small

IT'S RESEARCH THAT BREAKS RECORDS



Because months of patient research have been devoted to their perfection, Mullard Pentode and Screened Grid valves break all records for super-efficient performance. They have the lowest current consumption combined with the highest efficiency of any valves of their type on the market.

We have never used the public as our research department. We wouldn't risk losing even one of our friends to satisfy an experiment, certainly not after all the years we've been together, up and down every European broadcasting station.

You can take our word for it, Mullard Pentode and Screened Grid Valves are perfect to the last detail, modern to the minute. Otherwise they wouldn't be stamped with the Mullard P.M. monogram.

Mullard

THE MASTER VALVE

Advert:—The Mullard Wireless Service Co., Ltd., Mullard House, Charing Cross Road, London, W.C.2.

Arks.

Advertisers Appreciate Mention of "A.W." with Your Order

"A.W." TESTS OF APPARATUS

Conducted by our Technical Editor, J. H. REYNER, B.Sc. (Hons.), A.M.I.E.E.

Orphean Loud-speaker

THE makers of the Orphean loud-speaker, the London Radio Manufacturing Co., Ltd., of Station Road, Merton Abbey, S.W.12, have recently introduced a cone-type speaker, housed in an attractive wood cabinet, measuring 11 in. by 11 in. by 5½ in. The electro-magnetic unit of this speaker resembles, in appearance, the unit of the Orphean horn loud-speaker, but differs in that a reed is fitted in place of the diaphragm. Attached to the reed by a short metal rod, is a 9½-in. cone made of a reinforced fabric lined

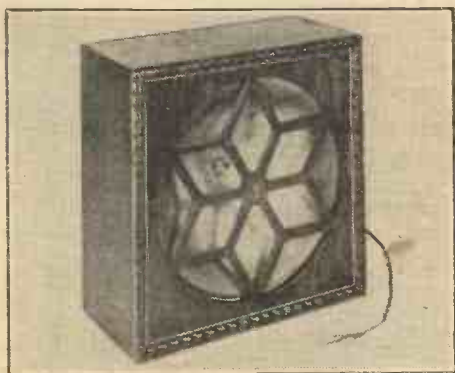

Orphean Cabinet Loud-speaker

round the periphery with a soft rattle-proof material. The normal adjusting knob is provided at the back of the speaker.

We gained a favourable impression of this speaker when trying it out in the laboratory. The tone is pure and mellow, without being too resonant. We were able to pick out the various instruments in an orchestral item without difficulty, whilst speech reproduces clearly.

McMichael Screen-grid Dimic 3 Receiver

WE recently had an opportunity of testing out the McMichael S.G. Dimic Three at our laboratories and, before giving the results of our test, we will describe its chief features. The screen-grid, detector, and pentode stages are combined in a reasonably compact space and housed in a cabinet measuring 27 in. by 11½ in. by 12 in. high, having sufficient spare space for carrying H.T. and L.T. batteries. To obtain the utmost efficiency from the set, the screening between the H.F. and detector circuits is fairly thorough and the screen-grid valve passes through a circular hole cut in a metal partition. Two definite types of screen-grid valve are recommended, the new Cossor double-ended type and the Mullard PM12. Dimic coils are utilised for

tuning purposes, the long-wave coils being fixed permanently inside the set. The short-wave coils are interchangeable and may, in certain cases, be reversed to obtain varying degrees of selectivity. A set of ultra short-wave coils may also be used with excellent results; these are not supplied with the set.

A high-grade low-frequency transformer couples the detector to the pentode. The loud-speaker terminals are connected directly in the plate circuit of the pentode, which practice appears to us to be rather out of keeping with the high standard of the design in general.

Although this set has a stage of high-frequency amplification, the tuning is quite simple, and once the knack has been acquired, it should present no difficulty to the beginner. The left-hand large dial tunes the aerial and the right-hand the H.F. circuit. The central knob controls the reaction. A change-over from long waves to medium or ultra-short is obtained by a rotary switch on the bottom left-hand side of the panel; the corresponding right-hand knob acts as a combined volume control and on-off switch.

Performance leaves little to be desired; the tuning is simple, and with the coils in their normal position, reasonably selective. In cases where greater selectivity is desired a special aerial coil may be used, whilst if greater volume and less selectivity is required this coil can be reversed in its socket. The reception on an indoor aerial is good, provided that the maker's instructions are carried out with regard to changing the series aerial capacity for a larger value. The local and high-power stations were received at ample loud-speaker strength, whilst after dark quite an assortment of foreigners were logged. In daylight with an outside aerial, such stations as Langenberg, Bournemouth, and one or two others were tuned in on the loud-speaker without difficulty. Naturally at night stations are received at most positions of the dial.

Although the performance of this set on the high and medium broadcast wavelengths is commendable, it seems to earn the greatest distinction from reception on the ultra-short waves: the liveliness on these wavelengths and the ease of tuning are most marked.

We feel that this Dimic "three" receiver should make a distinct appeal to readers owing to the ease with which it may be adapted to varying conditions. The control of selectivity is a valuable asset, especially in view of the changes to be made in wave-

lengths. The makers are Messrs. L. McMichael, Ltd., Wexham Road, Slough.

Talisman Coil

FOR the Talisman portable, described in AMATEUR WIRELESS, No. 361, a set of special dual-range coils were designed which are suitable not only for the Talisman screen-grid portable, but for other sets of the same type.

The inclusion of a screen-grid circuit in a portable receiver requires particular care in design if maximum results are to be obtained. It is well-known that on the higher wavelengths, from 1,000 and upwards, the screen-grid valve is naturally more efficient, and therefore the coil has been designed to have a lower efficiency on these wavelengths. In consequence a set can be made to give uniform results on both wavelength bands.

This carefully-worked-out design has been obtained in practice by a particular method of coil winding, entrusted to Messrs. Wright & Weaire, the makers of



The Talisman Dual-range Coil

Wearite components. The windings are placed in opposite directions on two 1-in. formers mounted approximately 1½ in. apart, and are therefore astatic. A three-point short-circuiting switch provides a change-over from short to long waves. A reaction winding serves on both wavelengths. The complete unit, including terminal switch, is mounted on a 2¾-in. square piece of ebonite and is arranged for one-hole fixing on a panel.

The coil which we tested is one of the standard Wearite components for the Talisman portable and functioned satisfactorily in practice. The range on the low wavelengths extended from approximately 200 to 600 metres, and on the high wavelengths from 800 to 2,200 metres.

It may be recommended for use in the Talisman and other portables.

**THE WONDERFUL
NEW**

**Brown
"VEE"
UNIT**

HERE is the sensational new BROWN VEE Unit! Its tone is amazingly pure and mellow. Its volume is astoundingly rich and full. Anyone can assemble the Vee Unit to to the Brown Chassis and have a complete and better loud speaker in 2 minutes. See and hear it at your Dealer's soon.

Unit costs only **25/-**

Chassis 15/-



**AS BRITISH AS
BRITANNIA**

Agents: S. G. Brown, Ltd., 19, Mortimer Street, W.1. 67, High Street, Southampton. 15, Moorfields, Liverpool. 2, Lansdown Place West, Bath. 29, Constitution Hill, Birmingham. Gibbon Buildings, Castle Street, Belfast. 5 & 7, Godwin Street, Bradford. 200, St. Vincent Street, Glasgow. Gibb Chambers, Westgate Road, Newcastle-on-Tyne. 39, Beverley Road, Hull.

9573

IGRANIC



AS a technical man you appreciate the advantages of an output filter circuit.

It protects your loud-speaker windings, gives better quality and often is the remedy for L.F. howls and "motor-boating."

The Igranic Tapped "C.C." Output Unit contains a choke and condenser of the correct proportions and is provided with tappings so that a step-up or step-down auto transformer effect can be obtained.

Price **21/6**



**IGRANIC G TYPE
L.F. TRANSFORMER**
For superlative quality. **30/-**

Send to Dept. D123 for fully descriptive leaflet. You will find it interesting and helpful.



IGRANIC L.F. CHOKES
Type G. For intervalve coupling and output circuits. **27/-**



WORKS BEDFORD

To Ensure Speedy Delivery, Mention "A.W." to Advertisers



ON August 1, 5GB will give listeners a new revue, in which the humorous side of astronomy is well illustrated; the cast includes a Fallen Star, supported by the Pleiades and a number of constellations, with a syncopating satellite at the piano.

In future a regularly weekly organ recital is to be given by Reginald Foort from the Regent Cinema, Bournemouth; it will be relayed to 2LO and 5XX.

The Band of H.M. Royal Horse Guards (The Blues), which is now on a visit to the North-East Coast Exhibition, will be heard by listeners to the Newcastle and London stations on July 25.

On July 28 the National Orchestra of Wales gives a concert in the Pavilion, Llandaff Fields, to be broadcast from Cardiff between 9.5 and 10 p.m. The vocalist on this occasion will be Francis Russell (tenor).

The concert forming part of the opening ceremonies of the British Medical Association's ninety-seventh annual meeting, held at the Free Trade Hall, Manchester, on July 22, will be broadcast from all northern stations.

On July 24 part of the Festival of British Music taking place at the Royal Hall, Harrogate, will also be transmitted from the Manchester group.

A running commentary on the day's play in the Test Match, England v. South Africa, at Old Trafford on July 27 will be given by Mr. A. E. Lawton, the former captain of Derbyshire, for the benefit of all northern regional stations, as well as London and Daventry.

Entertaining America is the title of a programme arranged for broadcast from the Cardiff studio on July 30; it has been specially prepared by Mr. J. Eddie Perry, the writer and entertainer, and owes its inception to a casual meeting with a party of Americans who were re-visiting Wales after nearly forty years' absence.

The station XFX, of the Mexican Department of Education at Mexico, is now broadcasting a daily news report in both English and Spanish every night at 11 o'clock. At midnight the government station XDA, using high power on a 32-metre wave, is broadcasting another news report by morse code, also in English and Spanish.

The belief that a faith in the possibilities of television were partly responsible for the purchase of half interest in the Columbia Broadcasting System in America by the Paramount-Famous-Lasky Corpn., was confirmed in an interview recently with William S. Paley, president of the C.B.S.

Out of a total of 11,000 merchant steamships of 1,600 tons gross and upwards owned by the maritime countries of the world, no less than 10,000 are equipped with radio installations.

Successful broadcasts are periodically carried out by the Silver Band of the Royal Glasgow Asylum for the Blind. Each of the twenty-four blind musicians forming the combination has a piece of cord attached either to his arm or leg (like the reins of a four-in-hand coach) which converge into two cords held by the conductor, who taps them with his baton, and is thus able to convey his directions to each player through the vibrations which he feels. Of course, each player has to memorise every piece played.

Musical works by royal composers are sufficiently numerous to serve as a broadcast programme. Belfast has realised the fact, and the Irish station's selections include compositions by Frederick the Great and Prince Henry of Prussia.

According to a Paris journal, within the next few days the Eiffel Tower will carry out test transmissions of photographs on the Belin system, both by wired and wireless telegraphy. It is stated that an arrangement has been made with both Berlin and London for the exchange, in this manner, of photographs of wanted criminals.

IF wireless amateurs could know even a little of the developments which are taking place in sound reproduction horns in the gramophone industry, they would not imagine that horn loud-speakers for radio are as dead as the proverbial dodo.

There seems to be a widespread opinion that no horn-type reproducer can compare with a cone or coil-driven instrument; this is quite untrue, for while the horn has its limitations, it can be made entirely satisfactory for amateur use.

A notable development in the gramophone type of horn, which is equally suitable for use with a loud-speaker attachment, is the Bifeca, made by F. A. Boyd of 142 Grays Inn Road, W.C.1, and illustrated in the accompanying photograph.

It is claimed for this that it gives full-scale reproduction; the method in which it works should be obvious. The horn is divided into two sections, one half allowing of expansion in a true exponential ratio, and the other being carried for half its length without expansion in order to retain the higher tones.



The Console-type Bifeca Horn

Plane Reflecting Surfaces

There are no curves in the horns, which are of metal, all reflecting surfaces being flat and the angles arranged so that there is the most free path from the loud-speaker movement or soundbox to the open ends of the horns. The flat reflecting surface is,

Sound Reproduction and Horn Design

indeed, an essential feature of the Bifeca. Results certainly seem to confirm the theory. On test with a well-known make of gramophone tone-arm and sound-box the tonal quality is well up to the very best commercial standards; indeed, the quality of reproduction would come as a surprise to many radio enthusiasts who affirm that no "canned" music can compare, so far as purity is concerned, with radio at its best.

With a commercial type of gramophone loud-speaker attachment very similar results were obtained, and undoubtedly the fact that purity equal to the best cone-type speakers did not result was simply due to the attachment itself not being ideal. The design of these components have been allowed to lapse in recent years. Results certainly indicate that with a horn of the Bifeca type it is worth manufacturers' while to bring gramophone attachments up to the present high standard of reed movements—not at all a difficult matter. Both vertical and horizontal type Bifecas are obtainable.

THE MOST FAMOUS OF ALL LOUD-SPEAKERS CELESTION

Now obtainable at big price reductions

MODEL	OLD PRICE	NEW PRICE
C 10 ...	£ 5 10 0 ...	£ 3 15 0
C 12 ...	£ 7 5 0 ...	£ 5 12 6
C 14 ...	£ 13 10 0 ...	£ 11 0 0
C 24 ...	£ 24 0 0 ...	£ 20 0 0

These substantial reductions are made possible only by reason of the greatly improved production facilities, made available in the new and extensive Celestion factory.

Obtainable from any high-class Radio Dealer

Write for free Booklet to:
CELESTION, LTD., Dept. J, KINGSTON-ON-THAMES

THE VERY SOUL OF MUSIC



THIS IS THE CABINET
specified and used by
MR. L. A. CHAPMAN
for the
"TALISMAN"

Price complete - 45/-

Carrington Mfg. Co., Ltd., Camco Works,
Senderstead Road - South Croydon
Telephone: Croydon 0623

THE High Frequency Choke



FIT your receiver with a Watmel H.F. choke and obtain greater stability, range, selectivity and purity of tone. It makes an all-round improvement to the performance of your set, and has been fitted with outstanding success to the Cossor Melody Maker. Of all good Radio Dealers or direct from us in case of difficulty **5/-**

You **MUST** have the

"Wireless Magazine"

Every Month Price 1/-

Have you had your copy of this blueprint and assembly chart? It tells you both how to build a really modern, inexpensive three-valve receiver (1929 Imperial 3) and also how you can bring many old-fashioned sets up to date by incorporating a few Watmel components.



WatMel

THE WATMEL WIRELESS Co., Ltd.
Imperial Works, High St., Edgware, Middx.
Telephone: Edgware 0323

Send for your copy: a post card will do.

R&Y

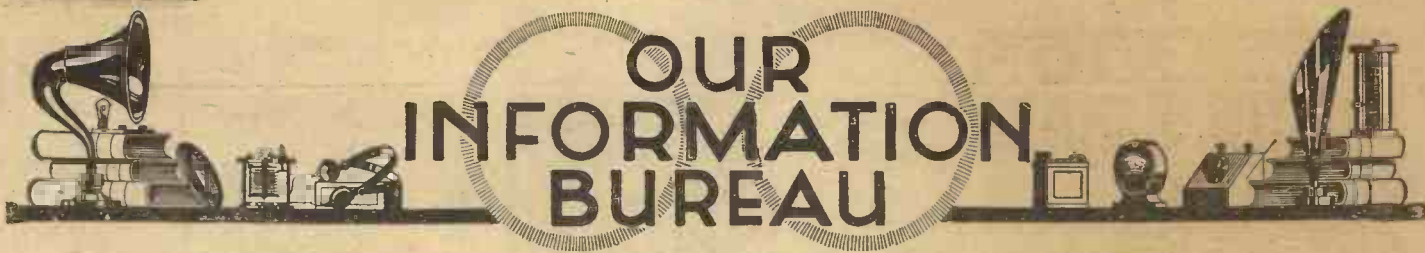

RULES.—Please write distinctly and keep to the point. We reply promptly by post. Please give all necessary details. Ask one question at a time to ensure a prompt reply, and please put sketches, layouts, diagrams, etc., on separate sheets containing your name and address. See announcement below. Address Queries—AMATEUR WIRELESS Information Bureau, 58/61 Fetter Lane, London, E.C.4

Purity and Sensitivity

Q.—As I am considering, from a theoretical point of view, the design of a new set for the coming season and what I want above all is purity of reproduction, and receiving range second, I would be glad to know what are the relative merits of grid-leak and anode-bend rectification.—H. S. (Pulney).

A.—To get a full understanding of this rather interesting question it is really necessary to become acquainted with valve characteristics and also the fundamental principles of valve rectification as a whole. First of all it should be realised that when grid-leak rectification is employed, it is usual to apply a slight positive bias to the grid of the detector valve. Now when a positive bias is applied to the grid of a valve and a signal voltage is superimposed on the grid, the positive half cycle of the signal causes a minute current, in the order of micro-amps, to flow between the grid and the filament inside the valve. This current is known as grid current, and is a common source of distortion in a valve detector.

The nature of the detector valve characteristic curve, when the grid is given a slightly positive bias, tends to cause the valve to amplify as well as to detect. Rectification

occurs because the grid condenser isolates the grid from the filament of the valve, so that any electrons which become attached to the grid

**When Asking
Technical Queries**

*PLEASE write briefly
and to the point*

A Fee of One Shilling (postal order or postage stamps) must accompany each question and also a stamped addressed envelope and the coupon which will be found on the last page. Rough sketches and circuit diagrams can be provided for the usual query fee. Any drawings submitted should be sent on a separate sheet of paper. Wiring plans and layouts cannot be supplied.

must necessarily remain there until the grid becomes so heavily charged that the energy so stored up suddenly discharges itself across the

high-resistance grid leak to the filament. This cycle of events continues all the time a signal is being received on the grid of the valve. The values of the grid condenser and grid leak are chosen so that the charges are only allowed to store up to a certain point and then discharge themselves. In this way a fairly regular charge and discharge takes place, or, in other words, the radio-frequency currents are split up or broken up into audible frequency trains of waves. From the foregoing it can be deduced that grid-leak rectification is to be preferred where sensitivity and amplification are the main essentials. Anode-bend rectification, however, is somewhat different. The valve grid is given a negative potential (usually) with respect to the filament. This means that on no occasion, with a normally powerful signal, will the grid of the valve become positive with respect to the filament, and therefore no grid current can flow. Anode-bend rectification, therefore, eliminates one cause of distortion, namely, that due to grid-current flow. A reference to a text-book on the subject of rectification, more especially a glance at the characteristic of an anode-bend detector valve, will serve to show that, although much more perfect rectification is permissible, due to the cutting off of the amplified negative half cycles of current, there is little or no actual amplification taking place inside the valve, apart from that necessary in the relay action.—C.A.



PHILIPS MODERN LOUD-SPEAKERS

ON
**MODERN
TERMS**

5/-

**FIRST
PAYMENT**

Philips Type 2016. In mottled red or grey. The best for 2- or 3-valve sets. 5/- down and 6 payments of 8/-

Build your own set the Easy Way NOW!

Our Catalogue contains all leading makes of Receivers, Accessories, Kits of Components for the Home Constructor

Mail Coupon in unsealed envelope under 1/2d. stamp now!

PETO SCOTT CO. LTD.

Please send me your big Illustrated Lists.

NAME

ADDRESS

.....A.W. 20/7

Free Demonstrations and Advice by Qualified Engineers at our Shops—

77 City Road, London, E.C.1
62 HIGH HOLBORN, LONDON, W.C.1.
4 MANCHESTER STREET, LIVERPOOL,
33 WHITELOW ROAD, Chorlton-cum-Hardy, MANCHESTER.



Philips Type 2007. In 3 colour schemes.
10/- down and 11 payments of 9/6.

The
Easy Way
TO PERFECT RADIO

LETTERS TO THE EDITOR

*The Editor does not necessarily agree with
the views expressed by correspondents.*

A Terminal Hint

SIR,—This is the first time I have dared to criticise any article contained in a technical journal, but I must point out an error in the illustration *re* terminals slacking off by W.K.

Every wireman, wireless expert or experimenter, surely knows the elementary rule of looping the wire round the screw in a *clockwise* direction (except where a left-handed thread is used). If this is not done the loop tends to slacken out when the terminal is tightened up.

Many years' wireless experience has taught me the truth of this.

E. L. (Horley).

5GB in Manchester

SIR,—In a recent issue of AMATEUR WIRELESS I noticed a letter from a reader (H.M., Manchester) saying he could not get 5GB on four valves, including one of the S.G. type.

Well, unlike H.M., I am only an amateur, and my set is the "Inceptor Three,"

(Continued on next page)

DOMINION VERNIER DIALS



BBROWNE are now producing 2,000 Dominion Vernier Dials a day. That is why it is possible to offer this high-grade dial at the wonderful price of 3/6.

The mechanism is a special non-backlash design with a reduction ratio which makes fine tuning easy without becoming tedious.

Obtainable from all wireless dealers in beautifully finished plain black or lovely grained mahogany bakelite.

BROWNE ♦♦ WIRELESS

NELSON ST. WORKS LONDON, N.W.

TUNEWELL COILS

Special Notice

Our newly designed and provisionally patented **DUAL RANGE COILS** set a new standard of efficiency.

The leading Scandinavian Wireless Technical Journal "Hallo, Hallo," is full of praise. They have even gone so far as to print a special paragraph in English (issue No. 27, June 28th, 1929). Mr. S. W. Flood, their chief technical expert writes as follows:

"They are without doubt and by far the best Dual Range Coils I have ever tested. They are altogether wonder coils and I have immediately specified them for my receivers to be published."

Praise from such a quarter is praise indeed. It is your guarantee of super efficiency. Coils for the following popular sets are in stock at most dealers:

Dominion 4, Cossor S.G.3, Mullard S.G.P.3, Clarion S.G.P.3, Broadcast Picture 4 Aerial or Anode **PRICE, each 10/6**
Mullard Master 3, Bantam 3, Favourite 3, etc. Dual Coils: **7/9 each**

Always fit our **H.F. Choke** on above circuits to ensure success. **Price 5/9**

2-pin coils, all types, from **1/6**
6-pin coils, most types, from **3/11**

Separate pins for converting Panel mounting coils to six-pin base type, **1/- per doz.**

TURNER & CO.,

54 Station Rd., London, N.11

Stand 95 at forthcoming Olympia Exhibition

"LETTERS TO THE EDITOR"

(Continued from preceding page)

described in the *Wireless Magazine* for October, 1928. It is a S.G., det., pentode, and I can get 5GB on an indoor aerial, using these valves, as loud as I get the local (which is only 1½ miles away) when I use an ordinary power valve.

I may mention that I get 5GB without a trace of Manchester, and the coils used are as specified, i.e., 60 aerial centre-tapped, 60 anode centre-tapped, and reaction (which I have no need to use) 25 turns.

I should like you to publish this letter with a view to getting into communication with H.M., as I would like to demonstrate this receiver to him. H. (Manchester).

The "Chapman Reinartz Two"

SIR,—I notice in your issue of July 6 a letter by S. (Glasgow) in which he states that he has experienced poor success on the long-wave side of the above set.

The discs of my short-wave coil are 1½ in. apart, and those of the long wave 2 in. I have not found that varying these distances makes any appreciable difference to selectivity. By reducing the flex of the long-wave coil by 10 ft. and increasing the length of the d.c.c. wire 10 ft., I obtain better results than by keeping to the specified lengths. But this, of course, may have something to do with locality, aerial, and other such matters. Another thing which I found increased the efficiency of the long-wave coil was winding it single-basket instead of double in the same way as the short-wave coil is wound. Why this should be so I do not know. Perhaps Dr. Chapman can supply the solution!

Your correspondent will probably find that he will get better results on the long waves without the series aerial condenser in circuit. W. (Hammersmith).

Empire Service

SIR,—Thermion's note in the issue dated June 8 on "An Empire Broadcast" was excellent. Please keep it up. We rely on the Americans for news here, and what we get about England is very little. So please agitate until 5SW send us some news. F.G.C. (Ashanti, W. Africa).

"Amateur Wireless and Radiovision."

Price Three pence. Published on Thursdays and bearing the date of Saturday immediately following Post free to any part of the world: 3 months, 4s. 6d.; 6 months, 8s. 9d.; 12 months, 17s. 6d. Postal Orders, Post Office Orders, or Cheques should be made payable to "Bernard Jones Publications, Ltd."

General Correspondence is to be brief and written on one side of the paper only. All sketches and drawings to be on separate sheets. Contributions are always welcome, will be promptly considered, and if used will be paid for. Queries should be addressed to the Editor, and the conditions printed at the head of "Our Information Bureau" should be closely observed. Communications should be addressed, according to their nature, to The Editor, The Advertisement Manager, or The Publisher, "Amateur Wireless," 58-61 Fetter Lane, London, E.C.4.



The Great Aranyani Dam, part of New Zealand's new hydro-electric scheme.

ENGINEERING PRECISION

Imagine the genius, the inspiration, the tireless labour expended on this vast dam—a supreme achievement of modern engineering. One slip in design, one slip in workmanship, might cause untold disaster. With wireless instruments such inaccuracies would lead to a defective set—surely damage enough—damage, however, that can be prevented by using J.B. precision instruments.

The J.B. New Type Slow Motion Condenser (Ratio 40-1)—is really a wonderful job. The height of the Vernier Knob and Dial is less than that of last year's model, but the new arrangement provides remarkably convenient control, and is vastly improved in appearance.

Completely enclosed—dustproof mechanism—a real protection from accidental damage. Tension of friction mechanism adjustable. Absolutely silent on short waves. Every possible precaution has been taken to prevent wear.

PRICES: S.L.F.		PRICES: LOG.	
.0005	... 14/6	.0005	... 14/6
.00035	... 13/6	.0003	... 13/6
.00025	... 13/-	.00025	... 13/-
.00015	... 13/-	.00015	... 13/-

Two .0005 J.B. Condensers are used in the "Broadcast Three" described on page 70 of this issue.



PRECISION INSTRUMENTS

Advt. of Jackson Brothers, 72, St. Thomas' Street, London. S.E.1. Telephone: Hob 1837.

SOUNDING PROOF

"little short of marvellous"

read what **power engineer** **SAYS** about **STANDARD**

SAC LÉLANCHE

PERMANENT H.T. BATTERIES
Best battery he has had during 7 yrs.' experience

Teddington, 6/6/29.

Dear Sirs,

I am a Power Station electrician by trade, so you will appreciate that I have gone pretty fully into the matter. I received the battery on Friday, March 1, and put it into service right away. Since then it has never had less than 6 hours' work per day on a three-valve set, i.e., Det., L.F., and Power, using a well-known type of valve. The average consumption is 7 to 9 m.a. On making a test to-day with an accurate instrument while on discharge after four hours' continuous work, I got an average of 1.21 volts per cell over the 96 cells. Considering the size of the cells, this seems little short of marvellous. In addition to this the quality of reception and tone is increased considerably over any other type of H.T. I have used during seven years' wireless experience. I should think that with the aid of your very complete instruction book the assembly and maintenance of your batteries should be quite simple for the merest novice and I should certainly advise any newcomer to wireless to start right away with your "Trouble free H.T." and save pounds later.

(Signed) N. A. WILLIAMS.

SIMPLE TO INSTALL, LASTS FOR YEARS, IMPROVES RECEPTION

Each battery when delivered consists of strongly made insulated cells assembled in neat, compact "Unibloc" containers, complete with oil and chemical solution provided. All you have to do is to fill the jars with chemicals and battery is ready for use. Gives up to ten times the life of dry batteries and can be recharged cheaply at home.

POPULAR MODEL, 96 v. (up to two valves). Cash £2/3/1, or 7/6 down and five equal monthly payments of **7/6**

SUPER CAPACITY, No. 3 (three to five valves). £2/17/9, or 10/1 down and five equal monthly payments of **10/1**

Obtainable from Halford's Stores, Curry's Stores, and all Radio Dealers, cash or deferred terms.

SEND TO-DAY FOR FREE BOOKLET giving full details of all models to,

STANDARD WET BATTERY CO.
 Dept. A.W.
 184-188 Shaftesbury Avenue,
 London, W.C.2.

M.B.

SPECIAL OFFER to "A.W." READERS

Invaluable information on aerials, earths, coils, accumulators, valves and a host of other subjects is contained in the **AMATEUR WIRELESS DIARY, 1929**

REDUCED TO Cloth 9d.

HALF-PRICE Leather 1s. 3d.

(Post Free)

Get one and use it as a reference book, only a few left. Send P.O. to-day to Bernard Jones Publications, Ltd., 58/61 Fetter Lane, London, E.C.4.

The Neutrodyne from A to Z

"The Book of the Neutrodyne"

By **J. H. REYNER**

1/6 net

Cassell & Co. Ltd., La Felle Sauvage, E.C.4

AN ORCHESTRA IN A CABINET

REMARKABLE progress has been made of late in the combination of gramophone principles with those associated with wireless practice. This was exemplified recently at a demonstration given in London of the Orchestrope, an entirely electric automatic gramophone, an American production which is handled in this country by the Rothermel Corporation, Ltd., of Maddox Street, W.

The Orchestrope is entirely operated from the lighting mains and is almost human in its performance, for it will play both sides of twenty-eight records, remove each as it is finished, and, with but a few seconds' interval, place another in position. The total playing time is approximately three hours, when the records can either be repeated or a fresh batch placed in the instrument; furthermore, should any record not be desired, the touch of a switch will cause it to be passed over or rejected when partly played.

Two photographs of the instrument are shown here, the lower one showing the chassis of the mechanical part of the instrument.

A pick-up is, of course, used, and the amplifier has two L.F. stages with a super-power output stage with two valves in parallel.

The loud-speaker is a Magnavox moving-coil instrument, and will give sufficient undistorted volume to fill a cinema or dance-hall, though this volume can be reduced to meet the needs of a small room.

Quality left nothing to be desired, and it was evident that the amplifier had been developed to a high degree of perfection. It was noteworthy that the records used were mostly of the low-priced type, and the resulting reproduction was proof of the quality obtainable from these under suitable conditions.



A view of the Orchestrope and (below) the chassis of the record-changing device

sentations had been received as to the effect of a recent decision of the Court on the manufacture of wireless receiving sets. As to the second part of the question, a committee was recently appointed by the Board of Trade to inquire whether any amendments in the Patents and Designs Acts were desirable.

Easy Terms

YOU CHOOSE YOUR GOODS WE PAY FOR THEM

—Immediate delivery—
 No troublesome enquiries

ALL ADVERTISED GOODS IN THIS PAPER SUPPLIED

Let us know your requirements
 We will quote you per return

POST COUPON FOR BIG ILLUSTRATED LIST NOW!

Name
 Address.....

Send to A.W.20/7
NEW Times SALES CO.,
 56 LUDGATE HILL, LONDON, E.C.4
 'PHONE - CENTRAL 2716

WIRELESS IN PARLIAMENT



From Our Own Correspondent

DR. SPERO asked the President of the Board of Trade whether he was aware that the increased royalties on wireless receivers had placed the wireless industry in a serious position; and whether he would make an inquiry with a view to amending legislation.

Mr. W. Graham said that some repre-

BLUEPRINTS

Copies of the "Wireless Magazine" and of "Amateur Wireless" containing descriptions of all these sets can be obtained at 1s. 3d. and 4d. respectively, post free, to "Amateur Wireless" sets and "W.M." to "Wireless Magazine" sets.

All Post Free

CRYSTAL SET (6d. each)
A Daventry-Local Crystal Set AW185

ONE-VALVE SETS (1s. each)
Beginner's One-valver AW140
Reinartz One WM127

TWO-VALVE SETS (1s. each)
East to West Short-wave Two (D, Trans) .. AW159
Beginner's Two (D, Trans) AW171
Auto Two (D, Trans) AW174
All-Mains Two (D, Trans) AW180
1929 Favourite Two (D, Trans) AW186
Loud-speaker America Two AW190
Key-to-the-Ether Two (D, Trans) .. WM107
Meteor Two (D, Trans) WM114
Clipper Two (D, Trans) WM135
Twinflex (Reflex) WM138
Continental Two (D, Trans) WM143

THREE-VALVE SETS (1s. each)
All-purpose Short-wave Three (D, RC, Trans) AW147
Screen-grid Q Coil Three (HF, D, Trans) .. AW150
All-Britain Three (HF, D, Trans) AW158
Bantam Three (D, RC, Trans) AW160
Hartley Dual-range Three (D, RC, Trans) .. AW166
Listener's Three (HF, D, Trans), price 4d. free with copy of "AW" AW169
The Binowave Three (D, RC, Trans) AW172
Clarion Three (SG, D, Trans) AW175
1929 Favourite Three (D, RC, Trans) AW179
Local and Continental Three (HF, D, Trans or D, RC, Trans) AW 189
Broadcast Three (SG, D, Trans) AW 192
Everyday (D, 2 Trans) WM 52
All-wave Screen-grid Three (HF, D, Trans) .. WM110
Standard Coil Three (HF, D, Trans) WM117
Festival Three (D, 2 LF-dual Imp.) WM118
Wide-world Short-waver (SG, D, Trans) .. WM120
New Year Three (SG, D, Pentode) WM123
The Q3 (D, RC, Trans) WM124
Lodestone Three (HF, D, Trans) WM129
Simple Screen Three (HF, D, Trans) WM131
Dynamic Three (SG, D, Trans) WM136
At Home Three (D, 2RC) WM141
Short-Wave Link (D, RC, Trans) WM142

FOUR-VALVE SETS (1s. 6d. each)
Overseas Short-waver (HF, D, 2 Trans) .. AW133
Stability Four (HF, D, RC, Trans) AW182
Five-pounder Four (HF, D, RC, Trans) .. WM91
Touchstone (HF, D, RC, Trans) WM109
Reynier's Furzehill Four (SG, D, 2 Trans) .. WM112
Economy Screen-grid Four (SG, D, RC, Trans) WM113
Binowave Four (SG, D, RC Trans) WM119
Standard-coil Four (HF, D, 2RC) WM122
Dominions Four (2SG, D, Trans) WM134
The Drum Major (HF, D, RC, Trans) .. WM137
Music Player (HF, D, RC, Trans) WM144

FIVE-VALVE SETS (1s. 6d. each)
"Q" Gang-control Five (2HF, D, 2 Trans) .. AW161
Fidelity Five (HF, D, 2RC) WM130
All-wave Lodestone Five (HF, D, RC, Push-pull) WM146

SIX-VALVE SETS (1s. 6d. each)
Short-wave Super-6 (Super-het, Trans) .. AW67
Eagle Six (3 HF, D, RC, Trans) WM106

AMPLIFIERS (1s. each)
"A.W." Gramophone Amplifier (3RC) .. AW162
Searcher Unit (HF) AW176
Gramophone Amplifier (3 v.) AW187
Signal Booster (HF Unit) WM128
Auditor Amplifier WM132

MISCELLANEOUS (1s. each)
H.T. Eliminator for A.C. (200 v. output) .. AW102
L.T. and H.T. Mains Unit (D.C.) AW123
Listener's Speaker, price 4d. free with copy of "AW" AW170
Arcadian Linen-diaphragm Loud-speaker (Full-size) AW177A
D.C. Unit (HT) AW178
Short-wave Adaptor (1 v.) AW183
High-tension Battery Charger AW191
Universal Short-wave Adaptor WM82
Buzzer Wavemeter (6d.) WM121
H.T. Unit for A.C. Mains WM125
Lodestone Loud-speaker WM126
James H.T. Unit for D.C. Mains WM133
Short-wave Adaptor for Dominions Five Two Ampere Low-tension Unit WM147
A.C. Mains Amplifier WM148

PORTABLE SETS
House Portable (SG, D, RC Trans) .. AW168 1/6
Arcadian Portable (SG, D, 2 Trans) with linen-diaphragm loud-speaker (half scale) AW177 1/6
£5.5.0 Portable (D, Trans) AW181 1/6
Talisman Portable (SG, D, 2 Trans) .. AW184 1/6
Holiday Portable Three (D, 2 Trans) .. AW188 1/-
Chummy 4 (with modifications for L.S. and H.T.) WM80A 1/6
Wayfarer Portable (Super-het) .. WM139 1/6
1929 Chummy (SG, D, Trans, RC) .. WM145 1/6
Picnic Portable (D, RC, Trans) WM149 1/-

When ordering Blueprints please send Postal Order NOT STAMPS
AMATEUR WIRELESS 55-61 FETTER LANE LONDON. E.C.4

UNREHEARSED EFFECTS

Jottings from my Log

By JAY COOTE

AS most regular listeners know, Continental broadcasts are not always as advertised in their programmes; they are not necessarily of a stereotyped character, neither do the same items recur at regular intervals, for, especially in Germany and Austria, every effort is made to secure novelty and to present unexpected items in the radio entertainments.

On the evening of Thursday, July 4, however, weird sounds emanated from the Berlin studio. At the outset I was under the impression that I had struck an outside broadcast of which I could not fathom the character, and I waited patiently for some explanation. It came; the studio was on fire and the weird noises were contributed by the fire brigade which had been called in to deal with the matter, one evidently outside the announcer's daily duties! But the latter proved worthy of the occasion, for, having left the "mike" open, he realised that his listeners would want to know the cause of the trouble and, acting on his own initiative, he supplied a running commentary on this unrehearsed incident.

Previously, on June 27, again quite by chance, I had connected up at a late hour with Cologne and discovered that, in view of the fact that a German pugilist, one Mueller, was defending his title at Turin in the European welter-weight boxing championship, that station, through the medium of Munich, was relaying their favourite's match against the Italian, Bonaglia.

Apparently the eleventh-hour relay by Cologne was but the preliminary to greater things, for long past their advertised closing-down times I found all German studios merrily extending their entertainments by additional cabaret performances, short talks, transmission of dance music, or impromptu concerts in which gramophone records played an important part. Later, at 1.55 a.m., the explanation came; the Reichsfunk was taking through Schenectady a relay of the Schmeling-Paolino fight, Schmeling having been termed by his admirers "the German Dempsey." As the eye-witness account from the ring, in English, reached Schenectady, it was translated into German and picked up by the Trans-Radio short-wave station at Geltow and passed through Zehlendorf to the Berlin central switchboard for distribution to some twenty-seven broadcast transmitters. Both by day and night there are unexpected items to be captured in the ether.

Unofficial news from Spain states that it is proposed to install a short-wave transmitter on Mount Tibidabo, in close proximity to the EAJI station, with a view to the simultaneous broadcast of the Barcelona radio programmes.

RAYMOND'S FOR WIRELESS

27 & 28a, LISLE ST., LONDON, W.C.2
Come to LEICESTER SQUARE TUBE.

This address is at the back of Daly's Theatre Phones: Gerrard 4637 and 2821

WE ARE OPEN
ALL DAY SATURDAY
ALL DAY THURSDAY
ALL DAY EVERY DAY
Hours 9 a.m. to 8 p.m.
Sat. 9 a.m. to 9 p.m.
Sunday morning 11-1

H.T. BATTERIES
Lissen, Hellesen, Siemens, Pertrix, Ripaults, Eveready, Carnalito. L.T., Exide, Oldham.

144-pp. Catalogue 1/- Refunded first 10/- order.

CLARION S.G.3 VALVES

A.W. 9-3-29
KIT OF PARTS
3 .0005, No. 3 at 5/9. .0001 Reaction, 4/- 2 Dual range C.T. Coils, with Reaction (Tunewell), Anode, 10/6; Aerial, 10/6; 3 Lenses or W.B. V.H. at 1/3; Formidenser, "J," 2/-; Dubilier, 1/6; 2/6; .01 Fixed, T.C.C., 1/6. 3-meg. Lissen or Edison Bell, 1/- S.G. H.F. Choke, 5/- H.F. Choke, Lissen, 1/6 L.F. Dyn former, R.I. and variety 15/6; Ebonite Strips. 14x7 Ebonite Panel screen, 5/6; 8 Engraved Terminals, Push-pull Switch, Flex, Plugs, 16-g. Wire, 2 S.M. Dials.

THE LOT 70/-

Post Free U.K. CASH
-0002 Fixed and Series Clips 1/6 extra.

IMPORTANT!
The Clarion S.G. 3 in Handsome American Type OAK CABINET, with S.G., H.F. and Power Valves, large capacity H.T. Battery, L.T. ditto, 4-pole Bal. Armature Cone Speaker (adjustable), Aerial Equipment ready to use. Supplied to approved accounts.
SENT FOR 16/8 FIRST PAYMENT 11 MONTHLY PAYMENTS OF 16/8 SET IN WINDOW.

It is obviously impossible to advertise every Component or Set on the market. Will you therefore kindly make out a list of your requirements if

OVER 25/-
and I will give you an inclusive Cash Price (without obligation to you). Further, any Portable Set, Loud-speaker, complete sets, etc., at makers' list prices supplied on deferred payments.

VALVES	VALVES
DARIO RADIO-MICRO 2-v. or 4-v. G.2 5/6 Super Power 2/6 Super H.F., 2-v. or 4-v. ca. 7/6 Post 3d. (3 Post Free).	10/6 each. Coscor 210RC, HF, LF, Mullard PM1A, HF, LF, Six-Sixty RC, HF, LF, Marconi DEH210, HL, DEL, Osram DEH210, HL, DEL, Ediswan RC, HF, L.F. 12/6 each.
TRIOTRON H.F. Det., R.G., 5/2 each; Power 6/9. 2-v. or 4-v. Post 4d. 3 post (free).	Coscor 220E, Mullard PM2, Six-Sixty 215P, Marconi DEP215 (Osram same), Ediswan PV213. 15/- each.
CLEARTRON SCREEN GRID 2-volt, 12/6; usual types, 4/-; R.C. or Power, etc. Post 2d.	Coscor 230P, Mullard 252, Six-Sixty 230SP, Marconi 240 (Osram same), Ediswan PV225. Screened Grid, 22/6. Pentode, 24/- Most 4 and 6 volts also stocked.

BRITAIN'S FAV. 2 (UP-TO-DATE) COMPONENTS
Ormond .0005, 6/-; .00025, 5/6; 7-ohm Ormond, 2/-; 2 W.B. V.H., 2/6; 6-pin Base, 2/-; .0003 and Series Clip, 1/6; 2-meg. leak, 1/-; H.F. Choke, 5/6; L.F. Transformer, Lissen, 8/6; Push Pull, 1/3; Tunewell Dual Range Coil, 7/9.
PLEASE ADD POSTAGE
OR READY TO USE INCLUDING DUAL RANGE COIL, POWER & DET. VALVES IN Handsome CABINET. All parts enclosed on Baseboard. (SET IN WINDOW).

TUNEWELL Dual 250/2000 6-pin Base 1/6 7/9
PANEL MOUNTING 10/6
PUSH PULL
TUNEWELL COILS for MULLARD S.G.P.2 Aerial or Anode, BBC or Long-wave, 7/10 pair.
TUNEWELL DUAL C. TAPPED with reaction
AERIAL ANODE 10/6 each. FOR CLARION (post extra)
WEST END DEPOT for TUNEWELL COILS
TRADE SUPPLIED

BROADCAST TELEPHONY

(Broadcasting stations classified by country and in order of wavelengths)

Metres	Kilo-cycles	Station and Call Sign	Power (Kw.)	Metres	Kilo-cycles	Station and Call Sign	Power (Kw.)	Metres	Kilo-cycles	Station and Call Sign	Power (Kw.)
GREAT BRITAIN											
25.53	11,751	Chelmsford		*329	974	Montpellier (PTT)	1.5	JUGOSLAVIA			
		(5SW) 15.0		338	892	Petit Parisien...	0.5	*307	977	Zagreb (Agram)	1.25
*200	1,500	Leeds (2LS) ...	0.13	*351	855.5	Algiers	2.0	*429	698	Belgrade	4.0
*242	1,238	Belfast (2BE) ...	1.0	*381	738	Radio Toulouse	9.0	*566	530	Ljubljana	5.0
*261	1,148	Newcastle (5NO) 1.0		413	725	Radio Maroc (Rabat)	2.0	LATVIA			
288.5	1,040	Swansea (5SX) 0.13		436	687	Radio Flandre (Lille)	0.5	*525	572	Riga	2.0
288.5	1,040	Stoke-on-Trent (6ST) 0.13		*447	671	Paris (Ecole Sup. PTT)	0.7	LITHUANIA			
288.5	1,040	Sheffield (6LF) 0.13		*466	644	Lyons (PTT) ...	5.0	*1,935	155	Kovno	15.0
288.5	1,040	Plymouth (5PY) 0.13		1,350	222	Tunis (testing)	2.0	NORWAY			
288.5	1,040	Liverpool (6LV) 0.13		*1,444	207.5	Eiffel Tower ...	8.0	*297	1,070	Norodden	0.7
288.5	1,040	Hull (6KH) ...	0.2	*1,725	174	Radio Paris ...	8.0	*364	824	Bergen	1.0
288.5	1,040	Edinburgh (2EH) 0.35		GERMANY							
288.5	1,040	Dundee (2DE) 0.13		*213	1,373	Flensburg ...	1.5	*227	1,319	Cologne	4.0
288.5	1,040	Bournemouth (8BM) 1.0		*234	1,283	Muenster	4.0	*239	1,256	Nurnberg	4.0
288.5	1,040	Bradford (2LS) 0.13		*246	1,220	Kiel	0.7	*246	1,220	Cassel	0.7
*301	995	Aberdeen (2BD) 1.0		*253	1,184	Breslau	4.0	*259	1,157	Leipzig	4.0
*310	968	Cardiff (5WA) ...	1.0	*270	1,112	Kaiserslautern 1.5		*276	1,085	Koenigsberg ...	4.0
*356	842	London (2LO) 2.0		*283	1,058	Magdeburg	0.7	*283	1,058	Berlin (E.)	0.7
*377	797	Manchester (2ZY) 1.0		*283	1,058	Berlin (E.)	0.7	*283	1,058	Stettin	0.7
*399	753	Glasgow (5GC) 1.0		*319	941	Dresden	0.75	*319	941	Dresden	0.75
*479	626	Daventry (5GB) 17.0		*325	923	Gleitwitz	0.0	*325	923	Gleitwitz	0.0
*1,554	193	Daventry (5XX) 25.0		*339	887	Bremen	0.75	*339	887	Bremen	0.75
AUSTRIA											
*246	1,220	Linz	0.5	*360	833	Stuttgart	4.0	*372	806	Hamburg	4.0
*285.5	1,051	Innsbruck	0.5	*372	806	Hamburg	4.0	*390	770	Frankfurt	4.0
*352	851	Graz	5.0	*418	716	Berlin	4.0	*453	662	Danzig	0.75
*453	666	Klagenfurt	0.5	*453	662	Danzig	0.75	*453	666	Aachen	0.75
*517	581	Vienna	15.0	*473	635	Langenberg ...	25.0	*533	563	Munich	4.0
BELGIUM											
230	1,300	Charleroy	0.25	*560	536	Augsburg	0.5	*560	536	Hanover	0.7
245	1,220	Schaerbeek		*560.2	527	Freiburg	0.7	*560.2	527	Freiburg	0.7
250	1,200	Ghent	0.5	*1,635	183.5	Zeesen	20.0	*1,635	183.5	Zeesen	20.0
280	1,071	Liège	0.5	2,100	142	Norddeich	10.0	2,100	142	Norddeich	10.0
*509	590	Brussels	10.0	2,290	131	Norddeich	10.0	2,290	131	Norddeich	10.0
CZECHO-SLOVAKIA											
*203	1,139	Morava-Ostrava 12.0		GRAND DUCHY							
*279	1,076	Bratislava (Feriby) 12.0		1,283	234	Luxembourg ...	2	HOLLAND			
*293	1,022	Kosice	2.0	31.4	9,554	Eindhoven (PCJ) 25.0		SWEDEN			
*342	878	Brunn (Brno) 2.4		*293	1,004	Huizen (until 6.0 p.m. B.S.T.) 5.0		231	1,301	Malmö	0.5
*487	617	Prague (Praba) 5.0		*1,875	160	Hilversum (ANRO) 5.0		*257	1,160	Höerby	10.0
DENMARK											
*231	1,067	Copenhagen (Kjbenhavn) 1.0		*1,070	280	Huizen (after 6.0 p.m. B.S.T.) 5.0		265	1,130	Trollhattan	0.4
1,153	260	Kalundborg ...	7.5	*1,070	280	Scheveningen-Haven 5.0		*322	932	Goeteborg	6.0
ESTHONIA											
*295	1,013	Reval (Tallinn) 1.3		(from 10.30 a.m. to 6.0 p.m. B.S.T.)				322	932	Falun	0.5
FINLAND											
*221	1,355	Helsingfors ...	0.8	HUNGARY							
*1,800	167	Lahti	20.0	*550	545	Budapest	15.0	ICELAND			
FRANCE											
170	1,750	St. Quentin ...	0.25	*1,200	250	Reykjavik	1.0	IRISH FREE STATE			
220	1,364	Béziers	0.1	*225	1,337	Cork (5CK) ...	1.5	ITALY			
*237	1,265	Juan-les-Pins ...	0.4	*413	725	Dublin (2RN) 1.5		*274	1,094	Turin (Torino) 7.0	
238	1,260	Bordeaux (Radio Sud-Ouest) 2.0		MANCHESTER							
240	1,250	Radio Nîmes ...	1.0	July 26	A request performance of <i>The King of Zenoa</i> , by Edwin Lewis.						
*255	1,175	Toulouse (PTT) 1.0		"	27	An eye-witness account of test match, England v. South Africa.					
*265	1,130	Lille (PTT) ...	0.8	GLASGOW							
*272	1,103	Rennes (PTT) 1.0		July 23	A Scottish concert.						
*286	1,049	Grenoble (PTT) 1.5		ABERDEEN							
292	1,028	Radio Lyons ...	1.5	July 23	"Treasures of the West," an instrumental and vocal programme, with a one-act play.						
*293	1,022	Limoges (PTT) 0.5		"	26	A Scottish programme.					
*304	986	Bordeaux-Lafayette (PTT) 0.5		REPAIRS							
305	982	Agen	0.3	Any make of L.F. Transformer, Loud-speaker or Headphones repaired and dispatched within 48 HOURS—TWELVE MONTHS' GUARANTEE with each repair. 4/- Post Free. Terms to Trade.							
*316	950	Marseilles (PTT) 0.5		TRANSFORMER REPAIR CO. "Service" Dept. 214 High Street, Colliers Wood, London S.W.13							

CHIEF EVENTS OF THE WEEK

- LONDON AND DAVENTRY (5XX)**
 July 21 Massed bands concert, S.B. from Leeds.
 " 25 A vaudeville programme.
DAVENTRY EXPERIMENTAL (5GB)
 July 24 "X Radiants," a programme arranged by Dorothy Evans.
 " 26 Mrs. Buggins Again Sees It Through, a revue by Mabel Constanduros and Stanford Robinson.
 " 27 "Our Mr. Phillicoek" presents *The Gentle Shade*, a radio illusion by Walter Pitchford.

- MANCHESTER**
 July 26 A request performance of *The King of Zenoa*, by Edwin Lewis.
 " 27 An eye-witness account of test match, England v. South Africa.
GLASGOW
 July 23 A Scottish concert.
ABERDEEN
 July 23 "Treasures of the West," an instrumental and vocal programme, with a one-act play.
 " 26 A Scottish programme.

PREPAID ADVERTISEMENTS

Advertisements under this head are charged **THREEPENCE PER WORD**, minimum charge **THREE SHILLINGS**.

DEPOSIT SYSTEM

As the Publishers cannot accept responsibility for the bona fides of advertisers in this publication, they have introduced a system of deposit which it is recommended should be adopted by readers when dealing with persons with whom they are unacquainted. It is here explained. Intending purchasers should forward to the Publishers the amount of the purchase money of the article advertised. This will be acknowledged to both the Depositor and the Vendor, whose names and addresses must necessarily be given. The deposit is retained until advice is received of the completion of the purchase, or of the article having been returned to and accepted by the Vendor. In addition to the amount of the Deposit, a Fee of 6d. for sums of £1 and under, and 1s. for amounts in excess of £1, to cover postage, etc., must be remitted at the same time. In cases of persons not resident within the United Kingdom, double fees are charged.

The amount of the Deposit and Fee must be remitted by Postal Order or Registered Letter (Cheques cannot be accepted), addressed to

"AMATEUR WIRELESS," ADVERTISEMENT DEPARTMENT, 58/61 FETTER LANE, LONDON, E.C.4.

PATENTS.—Trade Marks, Advice Handbook (free).—B. T. King, Regd. Patent Agent, 146 Queen Victoria Street, London.

DECORATE YOUR LOUD-SPEAKER YOURSELF. Transfers giving painted effects on Fabric, Wood, Metal, etc. Sample and catalogue 1/- A.W., Axon Ltd., Jersey, England.

ELECTRADIX

The accepted Rolls-Royce of Radio is the great success

DIX-ONEMETER

Highest Possible Grade. Used in Admiralty, L.C.C., G.P.O., and the "Varsities."

Price: "DIX-ONEMETER," in case, reading 0.2 m/a, 40 micro-amps. per div., .. 55/-



Send Stamped Addressed Envelope for large sale list.

ELECTRADIX RADIOS
 218 Upper Thames Street, London, E.C.4.
 Telephones City: 0191

SINQUERS

SAVE YOUR ACCUMULATORS SET A SINKER SENTRY! HE'LL NEVER LET YOU DOWN.



Double the life of your cells! Avoid being let down by a run-out accumulator. Sinquers tell you the exact state of your battery and warn you when it needs recharging. Just drop them in and leave them to it. 1/- per carton from most dealers or 1/3 post free from actual makers. FIDDIAN BAWTREE & CO., Oakhill Road, Sutton.

REPAIRS

Any make of L.F. Transformer, Loud-speaker or Headphones repaired and dispatched within 48 HOURS—TWELVE MONTHS' GUARANTEE with each repair. 4/- Post Free. Terms to Trade.

TRANSFORMER REPAIR CO.
 "Service" Dept.
 214 High Street, Colliers Wood, London S.W.13

TAYLEX WET H.T. BATTERIES

New Prices: Jurs 1/3, Bas 1/2, Zincs 10s. 6d. 18 Volta complete with bands and electrolyte 4/1, post 1/1. Sample unit 6d. Illus. booklet free. Bargain list free. AMPLIFIERS, 30". 3 VALVE ALL-STATION SET 5s. A. TAYLOR, 57 Studley Road, Stockwell, LONDON

STANDARD HIGH TENSION BATTERIES with GRID BIAS

No. 16217 "Daimon" Battery 60 volts with Grid Bias 7/3 each
 No. 16219 "Daimon" Battery 100 volts with Grid Bias 12/3 each

From all good dealers

Issued by The Mandaw Company, Ltd., 9-15 Whitecross Street, London, E.C.1

Amateur Wireless

COUPON Available until Saturday, JULY 27th, 1929



DUBILIER FOR DURABILITY

R.C. COUPLING UNIT. Complete with Dumet-ohms. ... 7/6



COMBINED R.C. COUPLING UNIT AND VALVE HOLDER. Complete with Dumetohms: 8/6



H.F. CHOKE. Four Types to meet all uses! Each 4/6



"TOREADOR SCREEN-GRID FOUR." This set incorporates the latest developments in Receiver design—full constructional details free on request.

DUBILIER RADIO PRODUCTS

If unobtainable from your dealer, write direct to us giving his name and address.

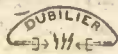

Dubilier Condenser Co. (1025), Ltd., Ducon Works, Victoria Road, N. Acton, London. W.2
©251/C

Please Mention "A.W." When Corresponding with Advertisers

Are you making an All Mains Set ?



Use the new **LOTUS** 5-pin Valve Holder for A.C. valves

IF you are building an All Mains set, this is the valve holder you need. It is rigid—not anti-microphonic; the stronger filament of an A.C. Valve does not demand the anti-microphonic type. Made for 5-pin valves, it will also accept a 4-pin valve and can be used for screened grids and pentodes with equal ease and success. You will find this new Lotus valve holder in every detail as well constructed as the famous Lotus buoyancy type. It is only 1 5/8 in. in diameter and is available both with and without terminal nuts.

Price 1/6

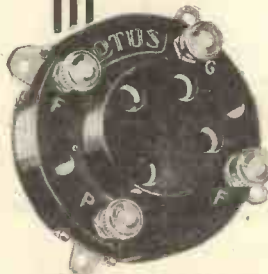

And for other sets — the **LOTUS** Buoyancy Anti-microphonic Valve Holder

THIS famous little valve holder is still supreme for ordinary valves. It is anti-microphonic, absorbs shock and protects the most delicate valve. Made in the very best of materials and most carefully constructed, it is only 1 5/8 in. in diameter and for everyday use is the best valve holder you can buy.

Price 1/3

LOTUS VALVE HOLDERS

Made by the makers of Lotus Components and sold by wireless dealers everywhere.

Garnett, Whiteley & Co., Ltd.,
Lotus Works Liverpool

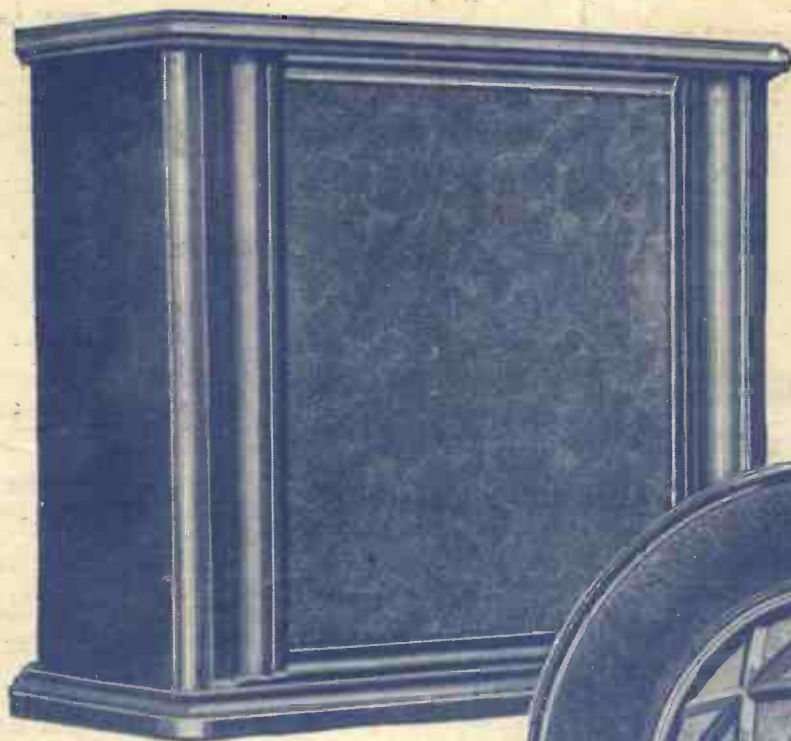

BLUE SPOT

49

PRICE - 42/-

Attractive Efficiency

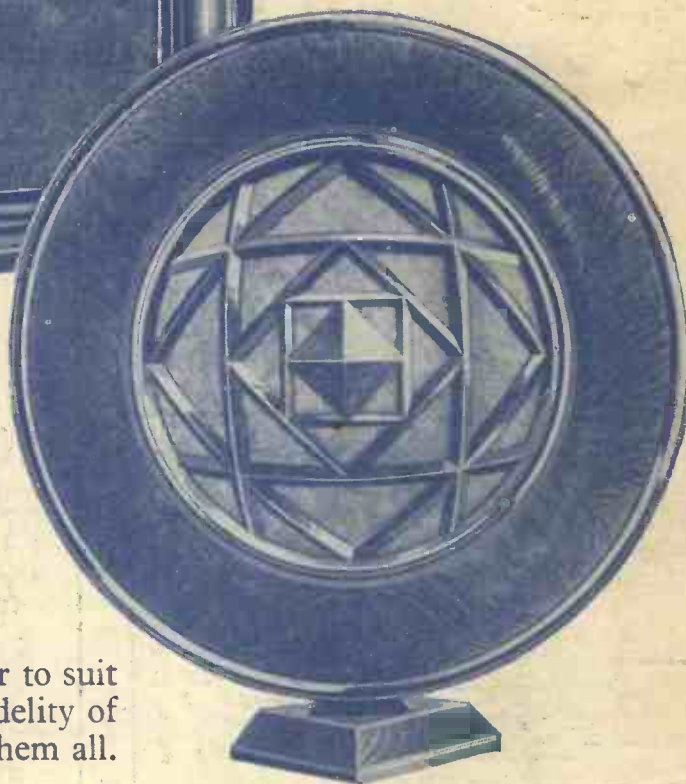

There is a Blue Spot Speaker to suit each individual taste, but fidelity of reproduction characterises them all.

Here are two popular models, each a masterpiece in its own class. The 49 is driven by the Blue Spot 66Z unit. The 101 is driven by the Blue Spot 66K unit

BLUE SPOT

101

PRICE - 73/6

On and after August 1st the price of the Blue Spot 101 will be £4 : 4 : 0

F. A. HUGHES & CO., LIMITED, 204-6 Great Portland Street, London, W.1

Distributors for Northern England, Scotland and North Wales: H. C. RAWSON (SHEFFIELD & LONDON) LTD., 100 LONDON ROAD, SHEFFIELD; 185, PRINCES STREET, MANCHESTER.

1929 1

WINDING ULTRA-EFFICIENT TUNING COILS

Amateur Wireless

Every Thursday 3^d
and
Radiovision

Vol. XV. No. 372

Saturday, July 27, 1929

FOR MAINS OR BATTERIES!

The UNIT FOR
The "BROADCAST 3"

FULL
WORKING
DETAILS

FIRM AS A ROCK!

RIGID AS A BRIDGE!

**INTERLOCKED
CONSTRUCTION
MAKES COSSOR
THE STRONGEST
AND MOST
DEPENDABLE SCREENED
GRID VALVE EVER
PRODUCED**

This wonderful new Cossor development—Interlocked Construction—eliminates all the inherent weaknesses of valve design. In the Cossor Screened Grid Valve the elements are rigidly locked in position. All through their abnormally long life they retain their perfect alignment. Even the hardest blow cannot upset the performance of this wonderful valve. Use Cossor in your Screened Grid Receiver—no other Screened Grid Valve has such strength or dependability.



Get full details of this wonderful Cossor Valve—write for leaflet L.10.

Made in three voltages for use with 2, 4 or 6 volt accumulators.

Technical Data.

Cossor 220 S.G. (2 volts, .2 amp.)
410 S.G. (4 volts, .1 amp.)
and 610 S.G. (6 volts, .1 amp.)
Max Anode Volts 150, Impedance
200,000, Amplification Factor 200
Grid Bias 1.5 volts at max anode
volts. Price (any type) **22/6**

COSSOR
Screened Grid
Valve

A. C. Cossor, Ltd., Highbury Grove, London, N.5

CA 9602

Advertisers Appreciate Mention of "A.W." with Your Order

Amateur Wireless and Radiovision

The Leading Radio Weekly for the Constructor, Listener and Experimenter

— Editor: BERNARD E. JONES —

Technical Editor: J. H. REYNER, B.Sc., A.M.I.E.E.

Research Consultant: W. JAMES

Assistant Editor: H. CORBISHLEY

Still More Going!—The Aero Show—The Second Tattoo—A Gigantic Relay—Be Prepared!—To Nauen from the States

Still More Going!—Apologies for bringing up a stale subject, but according to recent accounts—which were more than adequately dealt with in the daily Press—the exodus of engineers from the B.B.C. is not yet at an end. “Thermion” had some very effective remarks to make about these staff resignations last week. The B.B.C.’s attitude seems to be that the more recent departures are those of routine staff men who can easily be replaced if necessary. Two points arise. Were these men necessary while in the employ of the B.B.C., or were they “extras”; and if their work was important, why do the talkie companies find it necessary to “steal” B.B.C. men? There cannot be an unlimited number of trained engineers.

The Aero Show—Having had the R.A.F. display, which (or, rather, the wireless side of which) is recorded on another page, we have the Aero Exhibition at Olympia; this, too, contains many things of radio interest. Much is commercial apparatus which is interesting to the amateur only inasmuch as he can stand and gaze at it and wonder at the progress in radio D.F. But there is the Marconi anti-noise helmet, which many DX enthusiasts would like to wear when they want absolute quiet for the reception of the foreigners, and domestic affairs are rather noisy!

The Second Tattoo—If you cared for the Aldershot Tattoo, make a note of Saturday, August 3, which is the occasion of the Southern Command Tattoo at Tidworth. The B.B.C. is using for the relay practically the same apparatus as at Aldershot, including the new O.B. van, which incorporates all the heavy amplifying gear, and a complete studio! The relay will be from approximately 9.30



A lively scene during the R.A.F. Display at Hendon. Loud-speakers and a film-man feature in this picture, and a full story of the part which radio played in the Pageant is given on page 87

And To Australia!—AS though not content with that, the Canadian Marconi Company linked up by beam with La Perouse Sydney, and the service was re-broadcast throughout Australia by the numerous stations of Amalgamated Wireless (Australia), Ltd. This gigantic re-broadcast is a unique one in the history of broadcasting, and doubtless few of those who were actually at the service in the Abbey had little idea that millions upon millions of people in the Dominions were listening, too. Listeners to CNRM,

will 11.50, with an interval at 10 p.m..

A Gigantic Relay—One of the most successful re-broadcasts of a B.B.C. station ever carried out was that for which a number of prominent firms were responsible, on the occasion of the Westminster Abbey service of thanksgiving for the King’s recovery. The service was sent to Canada from Bodmin by means of the Marconi-Mathieu multiplex system and sent to the chain of C.N.R. stations in all parts of Canada.

Montreal, wrote to the station and said that they could even hear coughing and other incidental noises in the Abbey.

Be Prepared!—Almost everybody is interested in the Scout movement in one way or another, and so the relay of speeches at the International Jamboree is of note, particularly so as the Prince of Wales and Sir Robert Baden-Powell are speaking. The Jamboree is being held at Arrowe Park, Birkenhead, and the speeches will be given through 2LO and 5XX on Friday, August 2.

To Nauen from the States—Engineers at KDKA (Pittsburgh) have been attempting to establish two-way conversations between America and Nauen. On several successive evenings, usually between 7 and 8 o’clock, the short-wave broadcast from W8XK has been momentarily interrupted while the engineers went “on the air” with a repetition of “Hello, Nauen,” and with requests in German that the engineers in Nauen should stop their programme and exchange verbal messages. Pittsburgh has reported strong signals from Germany with the aid of a new short-wave transmitter. The Herring Pond is conquered by airmen and wireless waves.

PRINCIPAL CONTENTS

	PAGE
Current Topics	85
The Real Problem of Television	86
Radio and the Air Pageant	87
Experiments with Neon Lamps	88
Practical Coil Making	89
On Your Wavelength	91
Some Sensitive Single-valve Circuits	93
My Wireless Den	94
Broadcast Artistes in Picture	95
How the Prague Plan is Working	96
Without Fear or Favour	97
The “Broadcast Three”	98
Those Interval Signals	100
“A.W.” Tests of Apparatus	102
Radiograms	104

A STEADY improvement in the quality of images transmitted instantaneously by electricity is resulting from the amount of labour and thought that is being concentrated on the problem, but, in view of the almost incredible speed with which scientific things are developed in these days, many of us perhaps wonder why television does not become perfected more quickly.

The transmission of still photographs has reached so high a state of perfection that newspapers have almost ceased to mention the fact of their having been telegraphed. The whole thing seems to have crystallised into an everyday matter during the last year or two. But how many of us realise that experiments have been going on almost ceaselessly for twenty-four years and that it has taken a quarter of a century to make the telegraphy of pictures really practicable?

Probably nothing like this time will be taken to make television as simple and certain as the ordinary telephone. But, reviewing the past two or three years' progress in the light of other problems, one is led to wonder whether even yet the germ of finality has been conceived.

It certainly has not in the case of colour photography. Many admirable processes of taking pictures in natural colours exist, yet none of those closely associated with the work believes that the colour photography of the ultimate future has so far been discovered.

Television is of necessity a very laborious process because we have so far to deal with the image piecemeal. The image must be split up into hundreds or thousands of minute areas, each one of which has to be telegraphed with lightning rapidity in correct sequence and thrown upon the viewing screen in exactly the right spot. The process has to be repeated from beginning to end sixteen times a second in order that a continuous image may be seen upon the screen by the eye.

Contrast with this the reproduction of twenty different musical instruments making a highly complex sound, yet one tiny spot of a gramophone record will reproduce the entire range of sounds with all their delicate characteristics.

Sound and light both depend on wave motion, and musical and electro-magnetic wave motions follow very similar laws as regards their propagation. Yet so different is the eye from the ear that the former is entirely unable to reconstruct a whole image from one complex electrical impulse, while the ear can reconstruct the complicated music of an entire orchestra from one

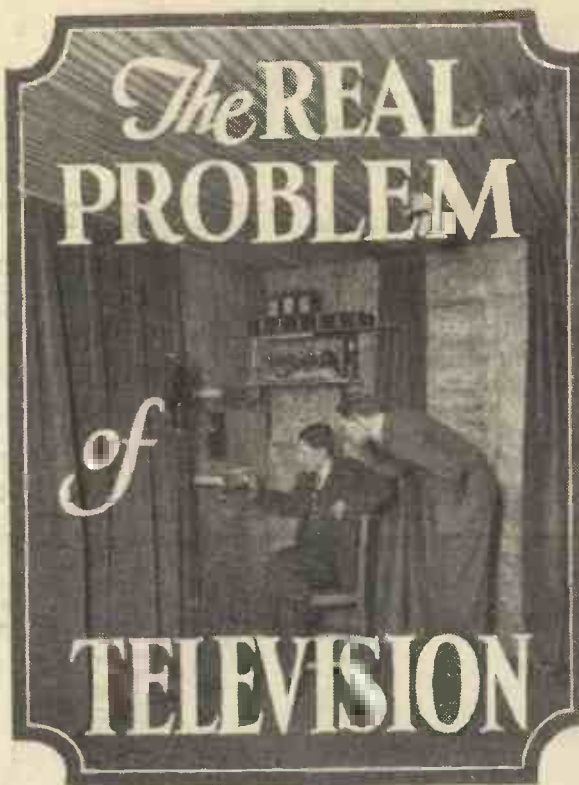

By T. THORNE BAKER,
F. INST. P., A. M. I. E. E.

complex wave motion sent out from the drum of the telephone.

Although there is no way at present thinkable in which the light rays from a subject could be all concentrated by a lens on one spot and made to give a "record," it seems incredible that such a solution will not ultimately be found. Each such spot of the record would be made to actuate some form of reproducing apparatus, which



Violin, pizzicato, G, D, A and E sounded simultaneously
(This figure is reproduced by permission of Adam Hilger Ltd., and represents a wave form recorded on the Low-Hilger Audiometer made by the above company.)

would resolve the record into the various lights and shades of the original and would place all the tiny units of the picture in their correct position on the viewing screen.

The Parallel in Sound

The real problem of television is to find a means of imposing on one carrier wave all the characteristics of the image that one wishes to telegraph. Glance at the photograph, where are seen several musical sounds recorded by a wave motion by

means of the Low-Hilger Audiometer. Each complete wave is distorted by numerous partial sounds, and the electric current which will actuate an oscillograph in sound reproduction, if passed through a loud-speaker, will reproduce all the musical notes that were originally recorded.

Now suppose that on some carrier wave all the characteristics that go to make up a photographic picture could be imposed, and that some form of reproducer could not only detect the various characteristics, but could convert them into light patches of corresponding strength and place the patches in exactly correct order on the viewing screen. Except that the ear does not have to place musical sounds in any space order, it does separate out, as far as the brain is concerned, each individual sound from its fellows; sorts them all out from one carrier wave, as it were, in which the musical characteristics were imposed, and thus performs a somewhat parallel function.

In the cathode ray oscillograph we have an instrument that will record the most complicated characteristics, but there is no means of sorting these out and spacing them on the viewing screen. The result is that, no matter how fast the light "pencil" which draws the new picture can work, it must work one spot at a time, record one dot at a time, and some mechanical or electrostatic device must be employed to space out the flashes in correct position on the viewing screen.

The effect of this necessity for moving parts must impose a limit on any of the present successful systems of television, and it also makes the excellent results recently achieved by Baird the more noteworthy. The Baird and the Bell systems, with others such as that of Mihaly, will undoubtedly carry us on for the present, and will be improved out of recognition; but the real problem, that of instantaneous and automatic spacing of thousands of tiny light patches on the viewing screen, sorted out from a single carrier impulse, has yet to be solved.

Some further evolution of electrical science will have to take place before such a delightful state of things can be realised, but it will eventually be done.

In Medan, Sumatra, two commercial wireless stations are in use, one for transmitting and the other for receiving; little or no attention has yet been given to broadcasting. A few receiving sets are in use, but the lack of a broadcasting station in Sumatra has prevented them from becoming popular.

RADIO AND THE AIR PAGEANT

By KENNETH ULLYETT

"THREE of our bombers are now approaching from the left . . . the formation of fighters is on their tail . . . one bomber has been hit and is coming down in flames. . . ."

The noise of a 'plane immediately overhead drowns the loud-speakers for a minute, but nobody minds. It is the R.A.F. display at Hendon and thrills are coming thick and fast. To aid the public in following the mock battles and stunts a battery of loud-speakers has been placed at sixty points around the aerodrome, and the veriest novice can follow the whole display without reference to the programme. From a control tower above the gigantic crowd of 100,000 or more an announcer gives a running commentary on the display, and every spectator, including those in the Royal enclosure, who have a special moving-coil speaker to themselves, can follow the events.

Giant Loud-speaking Plant

This, true, is hardly wireless, but it is loud-speaker equipment and low-frequency amplification on a giant scale. It is the biggest public address venture ever made in this country, and is a great deal larger even than at last year's pageant.

And then there is *real* wireless! A click shows that the commentator's "mike" has been switched off. A low moaning sound is heard in the loud-speakers all round the ground, with the occasional "pee-e-eep" of a carrier wave. A voice is heard, distorted at first, but soon resolving into a



Above: View of the interior of the control room. Right: The loud-speaker used in front of the Royal enclosure



tors can see from the ground. All wireless enthusiasts marvel at the way in which the signals are picked up from the 'plane, amplified sufficiently to be put out through sixty loud-speakers, and yet are of reasonable purity. The only distortion was at the 'plane end.

Morse and Field Phones

Then there is radio telegraphy, used extensively during the morning and afternoon to time the arrival of air units over the display ground, and a comprehensive system of field telephones all over the aerodrome and at Hendon Training Camp.

Not a few of the interested spectator-listeners must have wondered where was the headquarters of the radio section, and where was the man who could see every happening to advantage. Actually the apparatus, most of it, was installed in an army hut near the grand stand, and a kind of tower erected at one end gave the announcer a vantage point. The apparatus in the hut below is illustrated in the photograph which forms part of the heading to this article; there is a gramophone with electric pick-up (right to the left, and out of the picture), an A-type amplifier, incorporating three L.F. stages and special volume controls, two B-type amplifiers in duplicate, and a final giant amplifier, including a power bank of 32 valves. The total number of valves used was 180!

6,000 m.a. H.T.!

A brief inspection of the gear revealed other interesting figures. High tension was derived from a 350-volt motor generator and a bank of Exide accumulators, giving

2,000 volts in all; the total H.T. consumption was 6,000 milliamps, a figure which would put the average amateur H.T. battery to shame! More than twelve miles of armoured cable were used for connecting up the loud-speakers on the ground (this for the input to the windings alone), so the Marconiphone Co. can be justly proud of their effort!

Loud-speakers

The loud-speakers used at most points were the familiar horn-type 2 in. moving coil Marconiphone jobs, and were supported on poles with the horns facing the enclosures. The sound distribution was reasonably good. Each group of speakers was separately supplied with field current from 6-volt accumulators in cases at the pole bases. A complete speaker group with field current accumulator is shown on this page. Trenches

were dug from one group to the next to take the armoured cable which carried the A.C. anode current only.

For reception from the 'planes, two receiving posts were used; one was situated at the back of the "seaport" which was bombed while the relay was in progress, and the other on the further side of the ground, nearer to the grand stand. The apparatus employed utilised a short wavelength in the neighbourhood of 110 metres, and, being different from standard R.A.F. practice, is placed on the Air Ministry's secret list. It may be explained, however, that the transmitters were simply modified sets somewhat similar to the commercial A.D. 6h type used on most cross-Channel 'planes. Choke control modulation was employed, and power was supplied by small generators driven, in most cases, by the slip stream of the propeller, and not by the wind set up by the motion of the machine.

Aerials which were let down on small cane poles from the underside of the fuselage, and not the usual drum-and-cable aerials, were the order of the day.

The B.B.C. Relay

All B.B.C. stations, except 5CB, relayed a running commentary on the display, the microphone being placed on the top of the B.B.C. van and partly shielded off with canvas screens on three sides. In the van were duplicate A and B amplifiers, similar to those in the control room used for the loud-speaker installation.

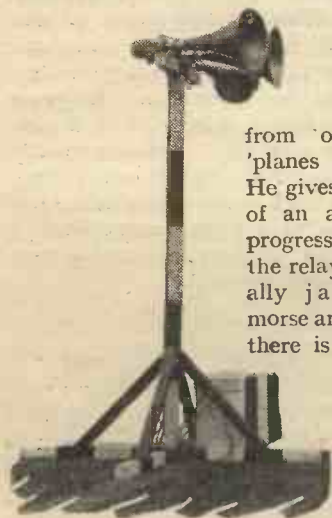

A loud-speaker unit of the Marconiphone public-address system

reasonable degree of purity. It is a pilot speaking from one of the 'planes in flight. He gives his account of an air battle in progress and, though the relay is occasionally jammed by morse and static, and there is all the time the moaning background of sound, his account forms an interesting aid to what the specta-

EXPERIMENTS WITH NEON LAMPS

Good entertainment and some instruction may be obtained by experimenting with Neon Lamps. Below are some interesting suggestions.

WIRELESS users know that a sensitive set, tuned to just below oscillation point, gives an audible growl when the hand approaches the coils. The neon-

in series with the mains. The rheostat in the set shown in the drawing Fig. 1, is a Singer foot-control, and when this is adjusted to just below the lighting point of the neon lamp the latter may be caused to glow by approaching the hand to six inches from bulb centre.

place of the bee-hive, the hand capacity effects described show a unidirectional bias.

Thus, the small electrode is caused to

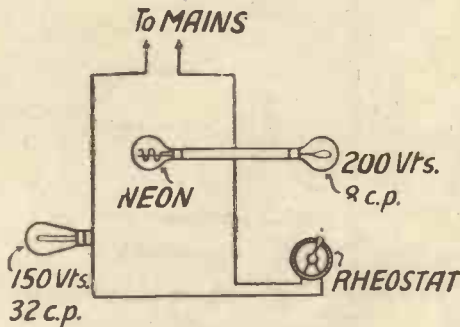

Fig. 1. A balanced neon-lamp circuit

lamp set, described here, gives a visual indication of body capacity.

For a 200-volt circuit an ordinary bee-

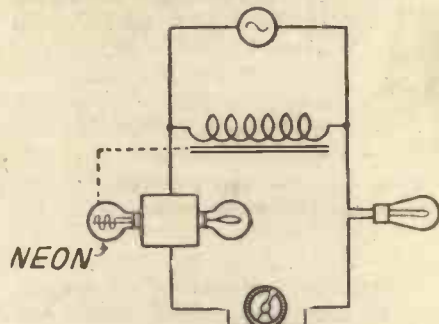

Fig. 3. Effect of transformer

hive neon lamp is connected in parallel with a 200-volt, 8 c.p. carbon lamp, a rheostat and a 150-volt, 32 c.p. lamp being placed

The neon lamp may be mounted on a square box which contains the control and the two other lamps, a screw down rod serving to adjust the rheostat (see Fig. 2).

The neon lighting voltage is about 115 and the carbon lamp in parallel balances this, the 150-volt lamp serving to take current strain from control.

A further effect of an opposite nature is provided by placing a transformer primary across the mains (Fig. 3).

If the neon lamp is caused to glow with one hand it may be extinguished by placing the other hand on the transformer core.

Evidently the magnetic component of the neon capacity is off-set by the induction magnetism.

Aerial Effect

Another interesting effect is seen when an aerial is looped round, and in contact with, the neon bulb. The lamp will then glow as long as the aerial remains in contact (Fig. 4).

Various body-capacity effects may be tested with the circuit as described, for instance, one person may hold the lamp without affecting it, but when another person with more self-capacity takes hold of the first person's hand the lamp may be lit.

When a letter type neon lamp is used in

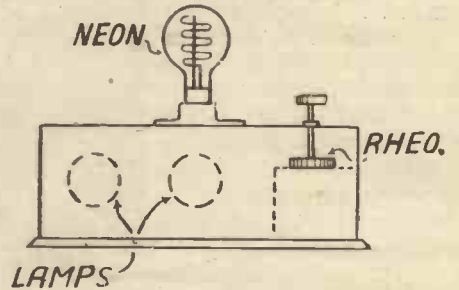
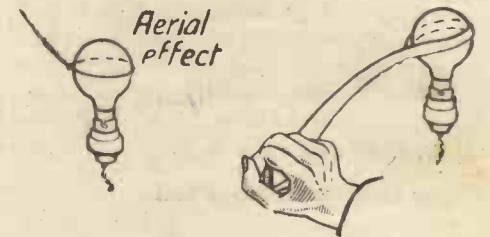

Fig. 2. Arrangement of lamps and rheostat

glow with the lamp in one position in the socket and caused to fade out (if alight) with lamp in reversed socket position. The



Figs. 4 and 5. Aerial and body capacity effects

magnetic effect behaves correspondingly. The hand capacity effect may be obtained at a distance from bulb by looping an insulated wire once round and touching the wire end (Fig. 5).

C. M.

TRANSFORMER MAGNETISATION

ONE of the many advantages of using push-pull amplification lies in the fact that the direct-current component through the primary of the output transformer is automatically cancelled out. In the case of the single-valve L.F. amplifier this is not the case; a steady direct current flows through the primary windings in addition to the fluctuating signal voltages. In a push-pull arrangement, the D.C. component from one valve opposes that from the other, so that the resultant current is zero.

The presence of a D.C. component is undesirable for two reasons. In the first place it affects the magnetisation of the transformer core and may so cause distortion. In the second place, if a mains eliminator unit is used, any ripple in the H.T. supply will flow through the primary of the transformer, from which it is trans-

ferred to the secondary and so gets through to the loud-speaker. In a push-pull circuit the H.T. supply is taken to a centre tapping on the primary winding and flows through both halves of the winding in opposite directions. There is, accordingly, no resultant inductive effect on the secondary.

M. A. L.

Concerts from the Atholl Palace Hotel at Pitlochry, Perthshire, have been a feature of recent summers in Scotland. They are again being broadcast this year, with the added attraction of a short Scottish play performed by the Scottish National Players.

At the present time the B.B.C. Scottish regional director is in negotiation with both the Glasgow Choral and Orchestral Union and the Reid Orchestra of Edinburgh regarding broadcasting from their concerts next season.

LIGHTNING

A FLASH of lightning consists principally of a unidirectional current starting at zero, rising to a maximum, and then decreasing to zero. During this period the discharge is not oscillatory. Clouds are almost perfect non-conductors, but once the discharge path has been formed it will have both capacity and inductance. Accordingly if the resistance is not too high, subsequent oscillatory discharges will occur, as in the case of the spark-transmitting aerial.

A lightning flash discharges anything from 10 to 50 coulombs of electricity. For an average discharge, passing, say, 20 coulombs, the pressure is approximately one million volts, whilst the duration is about the one-thousandth part of a second. The mean current over this period of time is of the order of 20,000 amperes.

B. A. R.

PRactical COIL MAKING

for the Home Constructor



Litz Coils, and Types having Small Stray Fields

By W. JAMES

ALTHOUGH very good coils may be constructed from covered solid wire and suitable supports or formers, it is possible by using a stranded conductor to obtain a greater efficiency in a given size or bulk of coil.

Anyone who carefully untwisted a twenty-seven wire cable would, therefore, first distinguish three groups of nine wires; the groups of nine wires would in turn be divisible into three groups of three wires, and finally, the individual wires of the three-wire twist would be seen.

Properly woven or twisted wire is usually referred to as Litzendraht or, briefly, as "litz." A word of warning is necessary here. The right size of litz must be used or the coil may be definitely inferior to one wound of solid wire. Litz is expensive. Fine wires always cost more per pound than the thick and, as litz is composed of a number of strands of fine wire, it is naturally relatively costly.

If I remember rightly, a small reel of litz having twenty-seven strands of silk-covered No. 42 wire and containing sufficient for two 300 micro-henry coils costs ten shillings.

I have wound coils of litz wire that had a greater resistance than coils of equivalent

size, but of solid wire. What then is a suitable size of conductor? For 200- or 300-micro-henry coils (i.e., medium wavelength coils) of three or four inches in diameter, the twenty-seven strands of No. 42 silk-covered litz is very suitable.

An excellent coil results when a cable having an even greater number of strands is used. Such litz would have 81 strands of

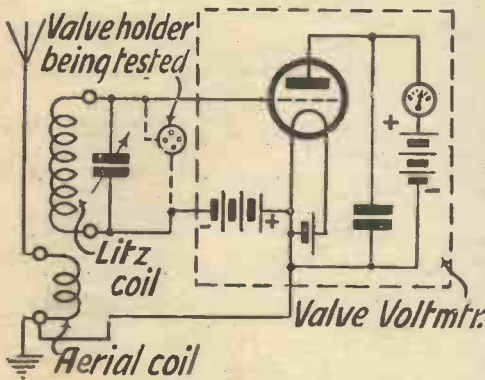

Fig. 1. Method of testing components

The stranded wire to which I am referring does *not* comprise a number of bare fine copper wires twisted together, such as the standard flexible conductors as commonly used with electric-light fittings. This wire may be a little better or a great deal worse than a solid wire of equivalent gauge and is,

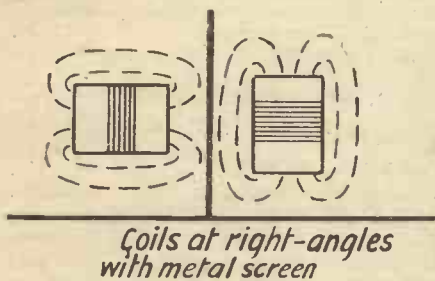

Fig. 2. Further method of avoiding coupling

therefore, not used to any extent in coil construction.

A suitable conductor is composed of a number of separately insulated fine wires properly twisted to form a cable which, in turn, may have a covering—usually of silk. Each wire of the cable may be covered with enamel or silk and a usual method of construction is to twist three of the wires and then, to combine three of these groups of three to form a nine-wire cable. A twenty-seven wire cable would have three groups of nine wires.

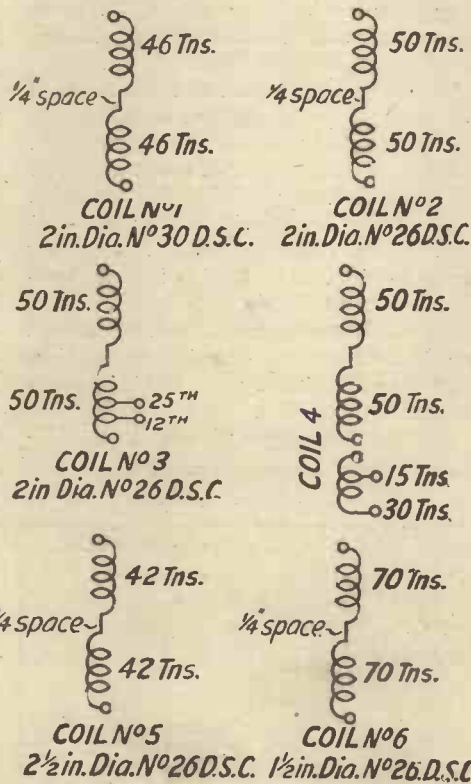

Fig. 3. Details of astatic coils for 200-600 metres with .0005 condenser

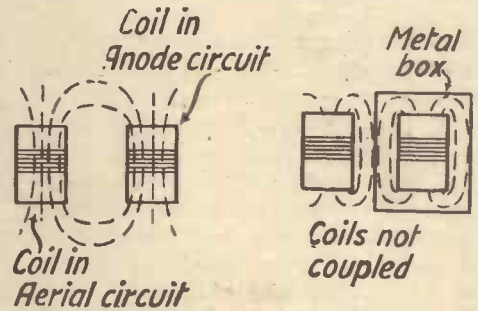

Fig. 2a. These coils are coupled
Fig. 2b. Coils not coupled

No. 44 or 45 silk-covered wire, but because it is so expensive and because the coil has so low a resistance, it is only used for special purposes.

I have a few coils wound with this wire, but they tune so sharply that the quality of the reproduction is bad. Coils having windings of No. 27/42 litz have been used in several of my receivers, and they

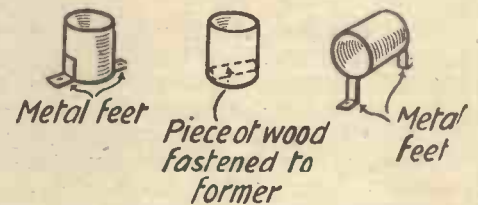

Fig. 4. Method of fixing cylindrical coils

have contributed materially to the great magnification and selectivity for which they are famous. (Examples are the "Touchstone 4" and the "Lodestone 3.")

Coils having litz windings have to be properly connected, or the results may be no better than when ordinary solid wire coils are used. Further, care must always be taken that such parts as valve holders, switches, terminal connections and tuning condensers, that may be used with a litz coil, are of the highest quality. Tuning

MAKING AND USING ULTRA-EFFICIENT TUNING COILS *(Continued)*

condensers are usually of a sufficiently high standard, but valve holders and switches are on occasions not satisfactory.

Those having a valve voltmeter of the anode-bend type may easily check these remarks. A good litz coil should be coupled to an aerial by two or three turns (Fig. 1), and the voltmeter be joined across the tuning condenser. An oscillator may, of course, be used, but it should be loosely coupled, i.e., be placed a distance from the coil.

Valve holders and other parts to be tested should be connected across the tuning condenser and the circuit retuned.

In many instances, the deflection of the valve voltmeter will fall off by a serious amount and the equivalent resistance of the particular part being tested may be judged by substituting grid leaks of the metalised pattern.

Stray Couplings

The coils so far described have been of the plain single-layer type and for the medium wavelengths. If two of these coils are fitted in a receiver—in the aerial and anode circuits, for example—the magnetic field created by one coil during reception may link with the turns of wire of the second coil. These two coils are therefore coupled and the effect may be to strengthen or weaken the signals.

In many instances the circuits will oscillate and orderly reception become impossible. This state of affairs should never be allowed to exist. One circuit should not be coupled with another as the result of stray fields. Correct operation is in fact, not possible when two or more circuits have unintentional couplings.

It is therefore necessary so to arrange circuits that stray couplings are the minimum and when ordinary coils are used one of two precautions, or both, are adopted.

First, the coil of one circuit may be totally enclosed in a metal box, or it may be more convenient to include the complete stage inside the metal box. Copper or aluminium is generally used, as the function of the metal is to confine the magnetic and electrostatic fields without, however, un-

duly adding to the losses of the circuit.

Iron or tin plate may not be used, and even when copper or aluminium is employed, it is necessary carefully to position the coil in the shielding container and to use one of adequate size.

Are You Interested in Long-distance Reception? If so—

Remember that the use of too much reaction will not only spoil your reception, but probably that of neighbouring listeners also.

Remember that a pentode in the last valve holder will bring up the volume of foreign transmissions.

Remember that a low-resistance earth is a desirable part of the equipment of a good receiving station as well as an efficient aerial.

Remember that valves do not last indefinitely and one valve which has partly lost its emission will spoil the reception of even the best set.

Remember that contacts such as those of switches, jacks, valve legs, coil legs, terminals, and wander plugs become oxidised in time and unless kept clean will mar the performance of the receiver.

Secondly, the axis of one coil may be placed at right angles to that of the other and a simple shield, in the form of a sheet of metal, placed between them (Fig. 2).

The adoption of either of these methods will prevent one circuit from coupling with the other. Direct pick-up is not prevented, however, unless both coils are shielded, or one is shielded and the other fitted upright.

Those who live relatively near a broadcasting station will know what is meant by direct pick-up. A coil with its axis horizontal, such as the left-hand one of Fig. 2, is a miniature frame aerial and will collect sufficient energy on occasion to provide, after magnification by the receiver, loud-speaker reproduction.

Whether the direct pick-up is trouble-

some or not is dependent upon the power of the receiver and the transmitter. It is, of course, best reduced to the minimum.

In order to minimise the stray magnetic couplings without complete shielding, coils of special construction may be used. In one form the coil is wound in two equal parts upon formers fastened side by side with a separation of a fraction of an inch.

Astatic Coils

The illustrations show a different type of coil of the so-called astatic pattern. They will be seen to comprise a continuous winding, one half being wound in one direction, and the other half in the reverse direction.

There is a small space between the two parts of the coil; this affects not only the inductance, but the resistance and stray field. By reducing the space, the inductance, and stray field are decreased, but it is usually not necessary so to wind that the inner turns touch.

Details are given in the figures and tables where the space is about one-quarter inch.

These coils naturally have a greater resistance than coils of equivalent size, wound with a plain winding. But allowance must be made for the effects of shielding and the influence of other metal parts. The net result is that the split coils are not greatly inferior as regards losses and have the immense advantages of a small stray field.

DETAILS OF COILS FOR 200-600 METRES WITH .0005-MICROFARAD TUNING CONDENSER

		DIAMETER, 1 1/2 IN.	
Turns		Approx. Length	
62 each half	No. 30 d.s.c.,	.95 + .95 + .25 in.	
66 " "	No. 28 d.s.c.,	1.2 + 1.2 + .25 in.	
70 " "	No. 26 d.s.c.,	1.5 + 1.5 + .25 in.	
		DIAMETER, 2 IN.	
Turns		Approx. Length	
46 each half	No. 30 d.s.c.,	.7 + .7 + .25 in.	
48 " "	No. 28 d.s.c.,	.85 + .85 + .25 in.	
51 " "	No. 26 d.s.c.,	1.1 + 1.1 + .25 in.	
54 " "	No. 24 d.s.c.,	1.4 + 1.4 + .25 in.	
		DIAMETER, 2 1/2 IN.	
Turns		Approx. Length	
37 each half	No. 30 d.s.c.,	.6 + .6 + .25 in.	
39 " "	No. 28 d.s.c.,	.7 + .7 + .25 in.	
41 " "	No. 26 d.s.c.,	.85 + .85 + .25 in.	
42 " "	No. 24 d.s.c.,	1.1 + 1.1 + .25 in.	

All coils have one half wound clockwise and the other anti-clockwise with a 1/4 in. space.

MR. FLEX DISCOVERS SOMETHING'S WRONG—

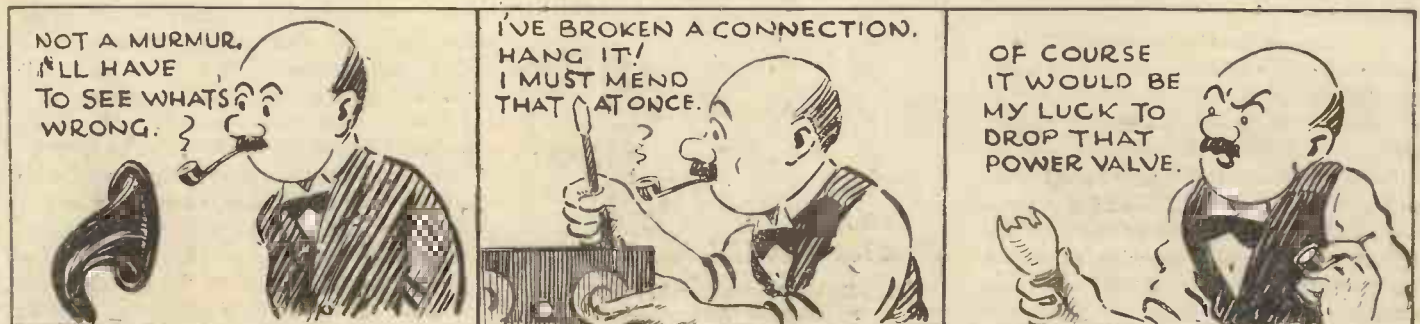

On Your Wavelength!

American Receivers

AMERICAN receivers are of a higher standard than those generally used in England. Moving-coil loud-speakers, super-power output valves, multi H.F. stages, and single-knob control are the rule rather than the exception, and the prices are considerably less than those prevailing in England. For quite a modest sum an American can buy a most efficient set working from the house mains and giving excellent quality. The cheapness is due largely to mass production and keen competition, and at the same time everyone can buy a good set, for it must be remembered that wages are high and everybody can afford luxuries. But what happens when the average listener has installed his "radio"? He switches it on and, for the most part, the music he hears makes no impression on him, for he is in the meantime occupying himself with something else which demands all his attention.

A National Trait

A large proportion of the American programmes are devoted to what we would call inferior imitations of a "Charlot's Hour," requiring no concentration. Radio plays, as they are known in England, are non-existent, and big musical and dramatic productions, such as we occasionally hear, are never attempted. Dance bands are broadcast *ad nauseum* from all stations, with plentiful slices of advertising inserted, and the multi-alternative programmes apparently give no real alternative at all. On the other hand; a moderately good receiver in England should be able to pick up at least two real alternative British programmes, in addition to the widely contrasted programmes of European countries.

British Developments

There is no doubt that the B.B.C. single-programme system retarded progress in British receiver design. And when an alternative programme became available, few people of the "popular" listening public troubled to improve the selectivity of their

sets in order to receive the two programmes perfectly. The B.B.C. are already getting nervous about the effect the powerful Brookmans Park station will have on thousands of old-fashioned unselective receivers. It is feared that this station will make its mark so heavily, that nothing else will be received without considerable interference. If the B.B.C. had had at least three powerful stations for the London area from the very commencement of broadcasting, the selectivity problem would have solved itself. It should be remembered that the least interference between broadcasting stations in one "region" occurs when the stations are located on one site and are as widely separated in wavelength as possible. Only the most selective receivers, such as are ordinarily used in America, will cut through the three or more local programmes and "get" distant stations. The B.B.C. must force the wide listening public to use selective sets, and must educate it to abandon the obsolete receivers of their forefathers. Brookmans Park, with three programmes instead of two, and with 50 kilowatts of each programme in the air, would be the remedy for the unselective set evil. If the three alternative programmes were widely contrasted, and all good in their own particular "line," the selectivity problem would lose its fearsome aspect. British broadcasting would then lead the world by many "lengths."

From Radio Plays to Films

Talking about radio plays reminds me of R. E. Jeffrey, the man who was largely responsible for the development of this phase of broadcasting. Mr. Jeffrey left the B.B.C. to take up the sound side of talking-film work. Tired of continual arguments with American engineers, who refused to believe in the possibilities of artificial echo, special acoustics or dramatic control boards, he has taken up film producing. His first production, *Chelsea Nights*, a short singing and talking picture, in which Carl Brisson appears, has been well received by the cinema trade and will shortly be seen in

all "wired" cinemas. The B.B.C. lost a good man in "R. E. J."

Colour Television

Did you see that the famous Bell Laboratories in New York have just given a demonstration of television in natural colours? The Union Jack fluttering in a breeze was flashed on a screen in all its colour brilliance, and following this was seen a man eating a water melon, the red of the fruit, the black seeds, and the green rind appearing true to nature. Geraniums, a bouquet of roses, and, finally, a girl in a coloured frock, were also shown. The Bell Laboratories are to be congratulated on this achievement, for it is a mark of real progress, but in honesty to Mr. Baird it must be pointed out that just over a year ago, July 3, 1928, to be precise, he gave the first colour television demonstration.

This was achieved in a most ingenious fashion. Essentially the system bears a strong resemblance to one of the forms of colour cinematography, since it consists in presenting to the eye in rapid succession first a green image, then a blue, and then a red. It is these three colours which form the well-known primary colours from combinations of which any other colour or tint may be obtained. Using the familiar spotlight system, the single spiral disc is replaced by one of three spirals, the three sets of perforations being covered respectively with red, blue, and green filters. When the disc is rotating, therefore, we have transmitted at each revolution three images consisting of red, green, and blue parts respectively.

Two Light Sources Used

At the receiving end a similar triple spiral disc is employed, the colour filters, of course, being included. To overcome the difficulty of a light source capable of generating red, green, and blue rays, a composite arrangement was used by mounting double tubes, one a neon, to give the red light, and a specially designed helium and mercury vapour tube, to produce the blue

-AT THE LOCAL STATION

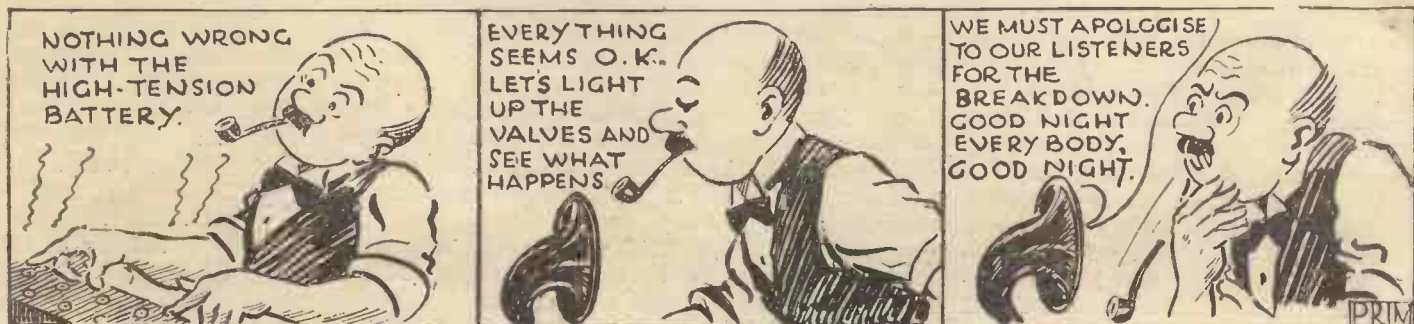

::

::

On Your Wavelength! (continued)

::

::

and green. The incorporation of a commutator ensured that while the red viewing disc holes of the receiver were in front of the viewing screen, only the neon lamp was illuminated, while for the green and blue holes the helium and mercury lamp was brought into circuit. In spite of the fact that there are three separate images, only one common channel is required for transmission, and although it would appear necessary to increase the disc speed to three times normal working, this did not prove to be the case in actual practice.

Loud-speaker Patents

The ups and downs of patent law are strikingly illustrated in the recent Marconi v. Brownie case, where, as the result of a reversal of the first judgment, considerable readjustments in the scale of royalty payments on valve receiving sets will have to be made, either directly or by way of compromise. Last week another important patent judgment came under review. This time, however, the Court of Appeal has upheld the decision of the Court below.

It will be remembered that in the original action the Lektophone Corporation sued Messrs. S. G. Brown, Ltd., for infringement of patent rights which they claimed covered the use of any cone or similar large diaphragm capable of reproducing sounds when freely exposed to the air, without the aid of a horn. Had this claim been upheld by the Court most modern loud-speakers would have had to pay tribute.

In the first instance, however, Mr. Justice Tomlin decided that, although the Lektophone patent did cover a large conical diaphragm with rigidly-clamped edges, the diaphragm was designed solely for use with a gramophone. In other words, the invention was intended only for sound reproduction by means of a stylus and record, and did not cover the modern loud-speaker, which was energised by the comparatively powerful valve amplifier. This decision the Court of Appeal has now confirmed.

Drought and Wireless

The prolonged drought, which at the moment of writing shows no signs of giving way, is having its effects upon wireless reception. If any reader has noticed an undue falling off in the range of his set or in the signal strength of stations, he may find something to interest him in the experience that came my way the other day. A friend remarked when we were chatting together at his house that it was a phenomenally bad summer for long-distance work. This was astonishing, for, with the exception of one bad patch in May, the present summer has, on the whole, been much above the average for medium- and long-wave work. The friend in question could hardly believe it when I told

him what my experience had been and went on to say that not only he himself but also several of his neighbours found it difficult to get even the local station at decent strength and could make nothing at all of foreign transmissions. He switched on to show me what his set would do on the local. Though the set is a particularly good AMATEUR WIRELESS design and normally has to be toned down when the local is coming through, I was surprised to find that 2LO's sturdy voice was now distinctly *piano*. My own house is a bare quarter of a mile from his, yet I have been obtaining excellent reception all along.

The Cause

When a set is known to be in thoroughly good order, as this one was, and when all the valves and the batteries are proved to be up to the mark, the first thing to suspect if results are bad is the earth connection. I suggested taking up the earth and offered to help. Since it was a hot day the "help" took the form of looking on and making encouraging noises from time to time when my friend's energy appeared to be flagging. It wasn't really very hard work, though, for the soil was light. When, in fact, we got down to the earth plate, we found that its surroundings were as dry as the proverbial bone!

Other Effects, Too

The earth connection is not the only part of the receiving gear, though, that may be suffering from the hot, dry spell. I have lately come across several accumulators, both L.T. and H.T., which have been damaged by unnoticed evaporation of the electrolyte. As soon as the solution sinks below the tops of the plates sulphation sets in, doing irreparable harm. Keep an eye, therefore, on your secondary batteries. And don't forget your dry batteries either. It is astonishing what a touch of sun can do to these. There is always a certain amount of gas in the cells, and if the battery is left exposed to the hot sun this expands, setting up a pressure which may burst the cell cases and sometimes cause the top sealing of the battery to assume all kinds of queer shapes. Keep dry batteries in the coolest place that you can find.

An Interesting Relay

Those who tune in the big German stations must have found the relays from the giant liner *Bremen* very interesting. Her actual start on her maiden voyage was relayed from Hamburg and other stations, but this, unfortunately, took place too early in the evening for there to be much hope of receiving it over here. On subsequent nights, though, a relay was given at 9.30 p.m. each night, and this proved very successful. Messages and music broadcast from the land station were received and

reproduced on board the ship, whilst similar transmissions from the *Bremen* were sent out to broadcast listeners. So far as I know this was the first time that a big liner has kept in touch with the general public ashore during the whole of her voyage, though odd concerts have been relayed on occasion from several other ships.

A Difficult Voice

Mr. H. G. Wells's broadcast talk the other night was interesting in more ways than one. Quite apart from its subject matter (who said that controversial subjects weren't allowed, by the way?), its delivery provided some interesting technical problems. The easiest of all voices to transmit or to receive well is that which does not vary very greatly in pitch or in strength. Mr. Wells's, however, runs nimbly up and down the scale, being sometimes high pitched, sometimes low pitched, and sometimes medium pitched. His signal strength also, if one may put it that way, varies from *fff* to *ppp*.

News of Hilversum

When the Prague Plan came along with its wavelength lists showing Hilversum on 298 metres, everybody said: "Now for something that really will roar in." And we twiddled our condensers and consulted our calibration charts and found nothing but a lot of silence, and said that Hilversum wasn't working. And then we met a friend, who said that he was still using his old wavelength of 1,071 metres. So a night or two later we put on the long-wave coils and tried to tune in Hilversum on 1,071 metres and found that we had got Huizen instead. And then we looked at the lists and found that Huizen was put down for 1,875 metres and wondered what had happened to our tuning and gave it up as a bad job.

A Change Over

And then came some fresh news. Hilversum and Huizen had swapped over. So we tried for Huizen on 298 metres and found that he wasn't there, and began to wonder what on earth was happening. And then we discovered that Huizen only worked on this wavelength till 5.40 p.m., and then went up to 1,071 metres. And we cursed like anything because 298 metres is no good at all until after dark and Huizen doesn't seem to come in very strongly on 1,071 metres. And our coils probably won't tune up to 1,875 metres to get Hilversum. And then came some more news. These stations have come to an arrangement whereby they have swapped wavelengths for the present, and in three months' time they are going to do it all over again, and three months after that there will be another swop. And there you are. And if you know exactly where to find Hilversum and Huizen now I congratulate you!

THERMION.

CIRCUITS FOR YOU TO TRY

From time to time our Technical Editor has described various circuits of particular interest to

THE single-valve detector circuit is not employed to anything like the extent that it used to be some years ago. The price at which good loud-speaking equipment can be obtained to-day has led to the development of the two- and three-valve sets for ordinary use in preference to the single-

Such an impedance, however, is not necessarily the best at high frequencies. The self-capacity is at once too large and too small; too large to enable us to obtain sufficient amplification and too small to afford adequate by-passing.

Effective Rectification

As I pointed out in a recent article, it is essential in order to obtain proper rectifying action, that the high-frequency currents shall be drained away after they had finished their work, and for this reason a capacity from anode to filament of the detector of at least .0001 is desirable. The first circuit, Fig. 1, is a straightforward Reinartz detector, in which this parallel capacity has been added. The improvement in rectification is so marked as to be audible in the majority of cases. L1 is a 60-turn coil, while L2 is a centre-tapped coil of anything from 30 to 50 turns. The aerial is connected to the centre tap to obtain greater selectivity.

We have to combine with this provision for efficient rectification some arrangement which will give us a high impedance to the high-frequency currents, so that the valve can amplify well at these frequencies. One way of doing this is to put an additional tuned circuit in the anode circuit of the valve as shown in Fig. 2. Here we have the necessary high impedance at the frequencies on which we are working, for the impedance

those who are experimentally inclined; on this page are some sensitive single-valve circuits

needed to a potentiometer across the filament of the valve. Generally it will be found that when the leak is to the negative, the circuit oscillates. As the slider is moved over towards the positive, damping is introduced and the circuit ceases to oscillate. The coils L1 and L2 should both be 60-turn coils and should be kept well apart.

With a little experience a point can be

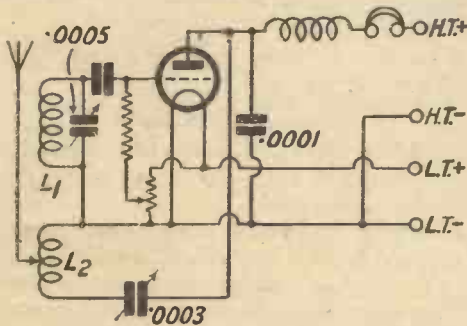

Fig. 1. A Reinartz detector circuit

valve-with-telephones type of set. A great deal of amusement, however, can still be obtained from the old single-valve hook-up, and the present article contains one or two suggestions regarding sensitive circuits which can be tried out in this manner.

Headphones, of course, are employed in the majority of cases, and it is surprising how many different stations can be received on an arrangement of this sort. The average loud-speaker efficiency increases rapidly as the signal strength increases. Consequently, relatively weak stations are often missed, while in addition the swamping effect of the local transmission is relatively larger than with headphones. I must admit that I myself very rarely use headphones, but I have often been surprised at the increase in reception which results from their use.

The single-valve circuit must, of necessity, be a detector if we exclude such arrangements as reflex circuits. For efficient operation of a detector, we have to allow the valve to function both as a high-frequency and a low-frequency amplifier. The principal requirement for good amplification in any triode valve circuit is that the external impedance in the anode circuit shall be high relative to that of the valve. As far as the low-frequency component of the current is concerned, we achieve this by using high-resistance telephones, the impedance of which is many times that of the valve under normal working conditions.

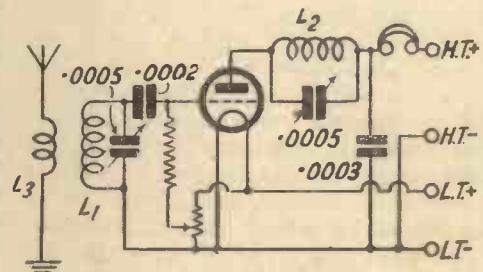

Fig. 2. Here there is an extra tuned circuit in the anode circuit

found where the circuit is in a sensitive condition and remains so throughout the tuning range. If desired the effect of tapping the coils may be noted, as it is possible, by matching the impedances to some extent, to obtain a form of constant reaction, in which case a very sensitive and satisfactory circuit results. The effect of coupling L1 and L2 together to varying extents is very interesting.

The circuit shown by Fig. 3 is at once a development and a simplification of the Fig. 2 circuit. Here the same circuit is made to lie in both anode and grid circuits. We thus obtain the well-known Hartley arrangement. High tension is applied to the anode of the valve through an H.F. choke, while the high frequency currents are by-passed through a condenser on to the tuned circuit. If this condenser is large, continuous oscillation results, and by making it variable we can obtain a suitable control. This is the usual method.

The value of condenser necessary to control the oscillation, however, is usually too small for efficient rectification, so that once again we have to connect a by-pass condenser from anode to earth. This is shown at C4, and in the present circuit it is shown variable. It may then be used as the reaction control by by-passing an increasing quantity of the current from the actual
(Concluded in 3rd column of next page)

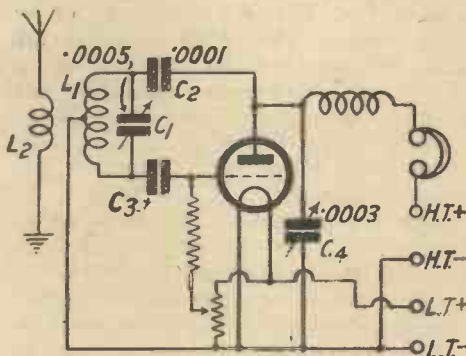

Fig. 3. A modification of the circuit shown by Fig. 2

is a maximum when the circuit is tuned. The high-frequency energy, having done its work, is by-passed direct to earth by the batteries shown across the telephones. The grid leak in this circuit is also shown con-

MY WIRELESS

Weekly Tips
Constructional
and
Theoretical—



DEN

By
W. JAMES

For the
Wireless
Amateur

Safety—and Terminals

POWER transformers that are fitted with terminals should always have a covering in order that an accidental contact will not be made with them whilst the current is on. Those employed with a valve rectifier may, for example, have a secondary winding giving 500 volts across each half, or 1,000 over the ends, and it is obvious that this voltage is a dangerous one.

A form of safety-box having a switch incorporated in its lid may be recommended, as then the circuit is broken by opening the lid. One should remember however, that the various condensers employed in the smoothing circuit may retain a charge and they should, therefore, be short-circuited or discharged by other means before being handled.

New Speakers for Old!

There must be a large number of loud-speakers that have been working almost daily for the past two or three years. Some of them, we are told, improve with use, but yet I wonder how many of those who complain that the quality or the volume of the reproduction is not what it was, consider returning their loud-speakers to the manufacturers for overhauling or modernising?

The permanent magnets that are used in many types undoubtedly become weaker with age; diaphragms change their shape or are bent and various parts work loose, with the result that reproduction is not as clear as it used to be. For an expenditure of a few shillings on an overhaul, the amateur may obtain practically a new instrument as regards performance, and I would therefore suggest the money to be well spent.

Phones

Phones are, I find, still used by numbers of listeners having small valve receivers, and the reason in many instances is because the quality of the reproduction obtained is preferred to that from a small or even a reasonably good loud-speaker.

But users of phones should remember that the metal band may be connected to earth through the receiver owing to a faulty winding and that, as a result, a certain amount of care is necessary. Occasionally, one hears of listeners who

have received a shock because they touched a faulty piece of apparatus connected to the supply mains. Others experienced a mild electric shock through adjusting the high-tension whilst wearing the headphones.

Fortunately, accidents have been rare, but those who employ telephones when testing eliminators or receivers connected to mains units should protect themselves by using a telephone transformer or a choke-condenser filter circuit, such as is so often used with a loud-speaker. Phones are not constructed to withstand high voltages and it is therefore to be expected they will break down when used with relatively high voltages.

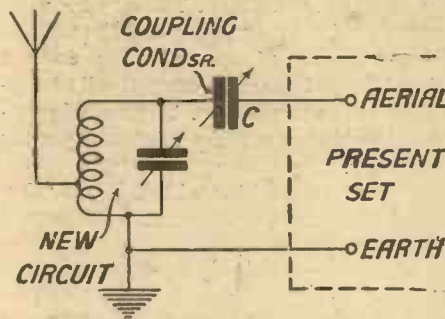

A useful external circuit as an aid to getting selectivity

Improving Selectivity

A method of improving the selectivity of a receiver which, whilst not being new by any means, is not widely known consists in coupling a further tuned circuit through a very small condenser to the receiver. The circuit is shown above.

I was trying this simple arrangement only a few days ago when Daventry 5GB was transmitting for a few hours on a wavelength of about 400 metres whilst London was working and I found that, provided the coupling condenser was set to a sufficiently low value, the selectivity was adequate when using a detector and low-frequency receiver with an outdoor aerial about 3 miles from the London station.

The additional tuned circuit may comprise an adjustable condenser of .0005-microfarad and any reasonably good coil of the usual size for the wavelength band to be covered. Condenser c may be of the neutralising pattern, as its capacity must

be small if the selectivity is to be greatly improved.

Those who try this arrangement will find that as the capacity of the coupling condenser c is reduced in value, the tuning becomes sharper and they will also notice that for the best results there should be no magnetic coupling of the coils.

The coil of the new circuit should therefore be placed at right angles to that included in the receiver, or alternatively be so placed that little is heard when the coupling condenser is temporarily disconnected. A few experiments will soon reveal the tuning properties of the circuit.

Home-made Transformers

Small power transformers for mains units or for lighting the filaments of valves are easily built at home and the materials are not expensive. It is very important however for the amateur to realize how necessary it is to insulate the primary winding from the others and from the core.

When once a transformer has been fitted, one is apt to forget all about it, as they have a reputation for reliability and it is, therefore, quite possible that a poorly constructed component may develop a fault which will pass unnoticed until damage which may be serious is caused.

The insulating material may be empire cloth or tape or something similar. Several layers should be used and great care taken when assembling the core that the covering be not cut. It is better to use a suitable former of Paxolin or even of fibre, and to wind the different parts of the transformer separately.

"CIRCUITS FOR YOU TO TRY"

(Continued from preceding page)

tuned circuit. L1 is a centre-tapped 60 coil. L2 is a 20 or 30 coil.

The aerial circuit has been shown as a tight-coupled arrangement throughout. Various modifications of this are possible, of course, if necessary. Thus, for example, a tapped aerial arrangement may be used or the aerial may be coupled directly to the grid of the valve through a .0001 condenser. This latter practice, however, is not as good as the others, as it does not give such selective results.

BROADCAST ARTISTES IN PICTURE



ARTHUR CATERALL.—Head of his own quartet and late leader of the Hallé Orchestra, for many years Mr. Catterall was also leader of the Queen's Hall Orchestra. Both as orchestral and solo violinist, he has made his name all over the world.



HELENA MILLAIS.—In the early days of broadcasting we looked weekly for two names in the field of humour, and one of them was "Our Lizzie," who was one of the bright stars of entertainment. Few realise that she is also a great Shakespearean actress.



BERTRAM AYRTON.—One of the most popular of broadcasters, he is famous also for his classical recitals at Wigmore and Aeolian Halls. He has a baritone voice of wonderful range and expression, and is as at home in oratorio work as on the concert platform.



LILLAS MACKINNON.—This classical pianist has rapidly become as familiar to the general public as the violinist, and Miss Mackinnon is widely known for her interpretations of the old masters. She has broadcast from many stations.



CONSTANCE WILLIS.—One of the best known of all the B.N.O.C. stars, she has figured in every one of the standard operas from "Rigoletto" to "Gianni Schicchi"; as a broadcaster she is always a success by reason of her wonderful diction.



SIDONIE GOOSSENS.—Very early it was found how finely the harp broadcast, especially in the safe hands of Miss Goossens, late of the Queen's Hall Orchestra; she has long been recognised as one of the foremost harpists in the country.



EDWARD CLARKE.—A very popular B.B.C. conductor, he has made his orchestra at the Newcastle station an outstanding one. Mr. Clarke has had wide Continental experience, and was connected at one time with the famous Russian Ballet.



FRANK CANTELL.—The leader and soloist of Birmingham station, he is a violinist with a wide repertoire. Mr. Cantell not only has won his spurs as a soloist, but is also an able conductor.



DUFTON SCOTT.—There is an undeniable attraction in Scottish humour when it is well delivered. In Mr. Dufton Scott we have an entertainer with a decided penchant for broadcasting and a repertoire which allows him a broad field of literary wit.

THERMION on How the Prague Plan is Working

ALL long-distance enthusiasts who have spent much time during the last few weeks in exploring the broadcast waveband under the new conditions must have come to the conclusion that the Prague Plan, so far as it has gone, is a very distinct success. There is every reason why it should be, for since it is the third wavelength scheme evolved since the problem of clearing up the European ether became acute, those responsible for it had much valuable data upon which to work. Most important of all, perhaps, the Prague Plan is definitely official and includes all European countries.

The other schemes were handicapped from the very outset in three ways: they were not official, individual broadcasting authorities subscribing to them or not, according to their inclination; secondly, certain countries refused to adopt both the Geneva and Brussels Plans from the very beginning; thirdly, there was nothing to compel even those who had subscribed to the conditions to abide by them if they found them at all irksome.

Many stations, which did not like their new wavelengths for one reason or another, adopted the plan of wandering about until they discovered something which suited them. During their wanderings they caused an immense amount of interference. Since the Governments have undertaken to see that the provisions of the Prague Plan are carried out by their broadcasting authorities, and since the laboratory at Brussels has been appointed as a kind of ether

policeman to check wavelengths, nothing of the kind should occur in future.

The Start

On the night of June 30, when the scheme came into operation, conditions for reception were very bad indeed, it being quite difficult to tune in many of the stations that are ordinarily well heard. Not a few, I believe, were using reduced power, taking things gently until they had got into their stride. One did, however, obtain the impression at the very outset that there was going to be much less heterodyning. From then onwards conditions improved enormously, and ever since signal strength has continued to be very good indeed for the time of year. Though a few stations are disappointing, the great majority are coming through with plenty of volume behind them and one has therefore had a good chance of making an extensive survey of the band.

5GB and Others

Up at the top of the band 5GB's drop to 479 metres has, on the whole, been beneficial, though his wipe-out effect at rather short range is sufficient to make Prague, Langenberg, Lyons Doua, and sometimes Milan, difficult to receive with a set which is selective enough for all ordinary purposes. Brussels has been coming in extraordinarily well; in fact I have more than once been able to receive him on the loud-speaker as early as 6 p.m. Curiously enough, though

Langenberg is often audible (but without great strength) in daylight, and most of the other German stations are not; he generally shows much less strength than they do after dusk. Vienna and Budapest vary a good deal as regards their strength, but neither is suffering from interference.

Prague?

If the Prague Plan, by a curious piece of irony on the part of Fate, has deprived us the pleasure of hearing Prague himself, it has given us in return many stations of which previously we heard nothing for various reasons. Amongst these is Berlin Witzleben, which used to be much too close to 5GB for good reception. With his drop to 418 metres he has, however, somewhat reduced his power for the present, so that he does not produce great volume, though his signals are perfectly clear. This station should provide good entertainment a little later in the year. Kattowitz is coming through very well just now, and on favourable evenings after dark Rabat may be heard. Frankfurt is suffering from summer weakness, but there is no interference, and he should be great in the autumn and winter. Toulouse Midi continues to be one of the best of foreign stations, and it really seems as if his troubles are ended, for there is none of the interference that used so often to accompany his transmissions. Another station which in the past suffered very badly from interference is Hamburg, who can now be heard to perfection.

Many Improvements

Stuttgart must remain a closed book to all those who are within moderate range of 2LO, except at times when the latter station is not working. A heterodyne occurred on one or two nights in the early days of the new order of things between these two stations, but it has not been noticeable since. Barcelona is well heard on almost any night of the week, and Posen, though rated at only 1.2 kilowatts, is now well worth trying for; he has provided me with good reception on many evenings. Gleiwitz comes in well as a rule, and Dresden—a tiny .25 kilowatt—is sometimes to be picked up at good strength. Hilversum was originally announced as dropping down to 298 metres, but it has now been arranged that this station shall work all the time on 1,875 metres, whilst Huizen works on 298 metres until 5.40 p.m., and then goes up to 1,071 metres.

Down below 300 metres things were
(Concluded on page 110)



The
Zitenfeld
Twins
broadcasting
recently
from 2LO
a talk on
swimming



WITHOUT FEAR OR FAVOUR



A Weekly Programme Criticism by Sydney A. Moseley

I WONDER what is the extent of the repertoire of Sandler's band? Personally, I am all for old favourites. Well, it would be instructive to know what the repertoire is. Same with certain singers. I like Leonard Gowings' voice and I have always said so. What is the extent of his repertoire? It was amusing; I don't know whether it was done purposely, but the orchestra rather forestalled him by playing

thing of beauty. The programme was well chosen and must have pleased the majority of listeners. After all, that is the B.B.C.'s job.

Sorry, dear Mr. Surprise Item, but the "special effort made to please listeners on the first anniversary" was like so many special efforts we make—not even up to the normal. The "Cod" sonata was so much like the real thing that—perhaps it might have been. Then, of course, as a "special effort to please listeners" we have a lady who sang one more sloppy American ditty, and I asked myself whether the "cod" was being continued.

Then we had something "by kind permission of the Cafe de Paris." But was it so kind, after all? The best and only item was the elocution class at Hollywood. It hit off the situation very well and made up for quite a good deal of disappointment in other directions. And, oh! of course, I must throw a flower or two to Ann Penn, who hit off the Houston Sisters admirably.

Re Piccadilly Players, directed by Al. Starita, and the Piccadilly Grill Band, directed by Jerry Hoey from the Piccadilly Hotel. A correspondent, evidently preferring to be more facetious than veracious (that is the result of listening to some of the B.B.C. talks), says he prefers the grill to the band. Voracious!

Pray, believe me when I say I am the last person in the world to be interested in tittle-tattle or in listening to what the other fellow is saying. I would rather listen to myself all the time! But when a transmission is taking place from a public dinner I try—oh, so hard—to eavesdrop before the auctioneer's hammer comes down and bids us to be silent. In the Snowden transmission there was the inevitable lady whose voice was heard now and again over all the others:—

"But how do you know? I shouldn't wonder..." But all the spicy bits, I am afraid, I could not quite catch. I really do think the B.B.C. engineers ought to make better arrangements for enabling us to eavesdrop to better effect. Now, what do you say about it?

Congratulations, belated as they are, to

Noel Ashbridge. I found abroad that they regard the new regime as timely. The technicians I met in Germany and France do not give us the same credit for possessing the technical knowledge of broadcasting which I always believed we possessed.

The Wells talk was, of course, historic; for, whether listeners agree with his views or not, he must be considered as one of the foremost thinkers of to-day and should be listened to with respect in any case. The time will come when we shall be able to boast of having heard such men as Wells and Shaw.

Well, here are the dog days and hardly a real grouse. Come, come, and again, come!

Evergreen Sir Walter Davies! But fancy switching over from Handel to "Ol' Man River." That, of course, shows the catholicity of his taste. Attaboy, Wallie!

A point of criticism from the wife of



George Carney as Lissenden sees him

"Songs that Mother Taught Me" before he had a chance to sing it. I wonder whether this was done intentionally? If so, the joke was quite good.

As a matter of fact, this idea of repertoire opens up a subject on which one could write at great length. I don't appear to have seen the theme developed before. What is the usual number of pieces a band plays over? I think the B.B.C. might publish a list.

My recent experience of German broadcasting has not made me any more enamoured of the senseless nasal songs we get over here. If the B.B.C. persists in putting over this type of song we shall begin to wonder whether undue American influence is being exercised.

The concert given by "The Masks" and the Gershom Parkington Quintet was a



A. W. Baskcomb, an impression

a medical friend of mine. She declares she is musical, but cannot stand the chamber music, a sentiment with which many readers of these notes will concur. But you notice how persistent they are at Savoy Hill in giving us this kind of study music. I cannot think why.

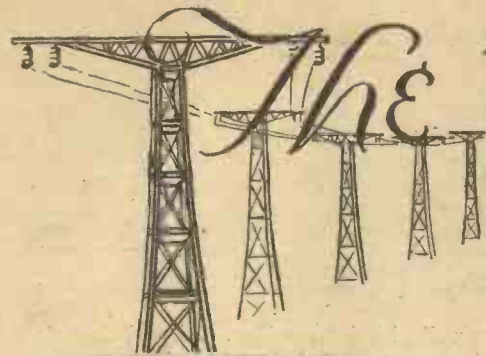

THE BROADCASTS

PART II—BUILDING THE MAINS

**EITHER MAINS
OR BATTERY
OPERATED**

LET us explain just what is the purpose of the mains unit for the "Broadcast Three," a receiver which was described in the centre pages last week, and how the receiver itself can be used either with the unit, and mains valves, or with ordinary batteries and valves.

The "Broadcast Three" is a set which has been designed as a high-class three-valver to give really good reception of the local and distant stations, and to possess

all the advantages of dual-range working (which means no coil changing), extreme selectivity, and comparative ease of operation. It is a receiver which will give most satisfactory results if used with normal batteries and valves, while if it is desired to obtain the current supply, both H.T. and L.T., from the alternating-current mains, then it is necessary only to use the new .8-volt valves, directly heated, and the simple eliminator now to be described.

The eliminator serves the following purposes: it includes a transformer which gives current at .8 volt on the secondary, which is taken direct to the valve filaments without any smoothing devices being necessary; also it includes a rectifier, of the double-wave type, for converting the A.C. mains supply to smooth direct current for H.T. In this way the need for any batteries other than the ordinary grid-bias dry battery included in the set is obviated.

marked: -, +, L.T., H.T., H.T.+1, H.T.+2 (Belling-Lee, Eelex, Igranic, Burton).

Baseboard, 9 in. by 9 in. (Pickett).

Power transformer (Marconiphone, model "L" or "M").

Smoothing choke (Igranic, Varley, Parmeco, R.I., Ferranti).

4-microfarad condenser (400 volts, D.C. working) (T.C.C., Lissen, Dubilier, Hydra).

2-microfarad condenser (250 volts, D.C. working) (T.C.C., Lissen, Dubilier, Hydra).

Valve holder (Lotus, W.B., Lissen,

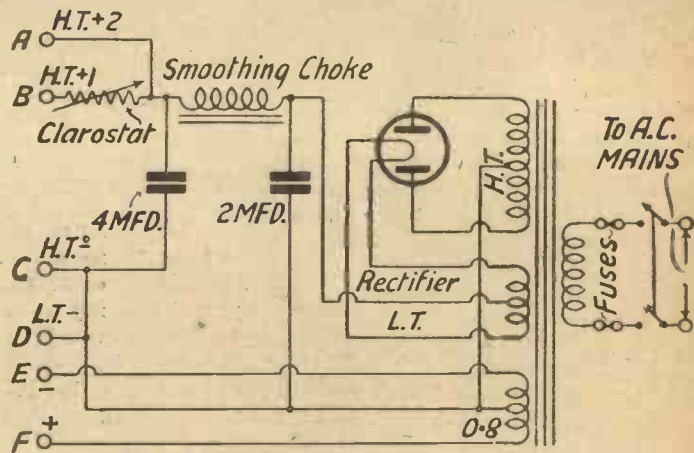

The Circuit of the Broadcast Three Mains Unit

Constructional details of the "Broadcast Three" receiver itself were given last week, and, for the benefit of those who intend using it with ordinary valves, operating notes will be given. First, however, it is intended to describe the eliminator unit so that those who have alternating-current mains can connect up the set and operate it immediately the eliminator is complete.

The following few parts will be required for the construction of the unit:

List of Components

- Ebonite panel, 9 in by 6 in. (Raymond, Becol, Ebonart).
- Double-pole mains switch (Marconiphone, Bulgin).
- Twin-fuse unit (Gambrell).
- Universal-type Clarostat.
- Six insulated terminals

Benjamin, Wearite).

Two yards twin flex (Lewcos).

Connecting wire (Glazite).

Cheap to Run

At this point it is opportune to say something of the economic operation of the set. Probably some listeners are deterred from using the mains on account of the seeming greater cost of the eliminator over that of an H.T. dry battery. True, the total cost of the parts for the eliminator in this instance, including the relatively expensive mains transformer, smoothing choke, mains condensers, and rectifying valve, may seem high.

Against this must be set the fact that these components are almost everlasting, except the rectifying valve, which will need replacing only at very infrequent intervals. The total cost is not so much greater if compared with the expense of an accumulator and H.T. battery; and the accumulator has periodically to be recharged and

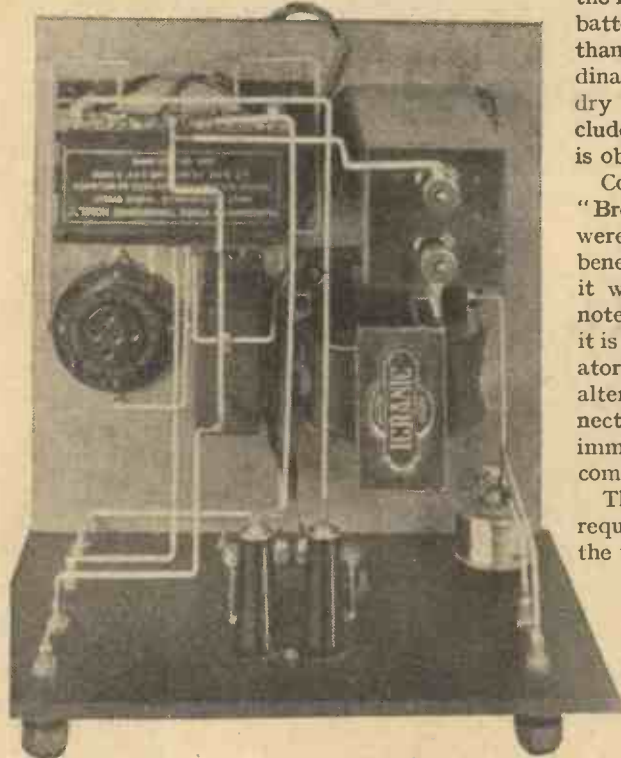

This plan view of the Mains Unit shows how simple is the construction

BROADCAST THREE

UNIT :: OPERATING NOTES

the H.T. battery has to be replaced at all too frequent periods, particularly if a large power valve taking heavy H.T. current is used in the last stage.

Constructional Features

Obviously, if A.C. mains are available, and it is intended to use this receiver for a period of two years or more, it is like putting money in the pocket to make up the eliminator, which takes very little current indeed from the mains, rather than to keep buying high-tension batteries and making those tiring trots to the accumulator charging station. There is no danger whatever attached to the eliminator (this is a point which frequently worries those unaccustomed to public mains supplies), for it is adequately protected with fuses.

It is made up in the conventional "American" manner, and matches the receiver. The heavier components are mounted on the baseboard, and the panel carries simply the main switch, fuses, and terminals.

A blueprint, No. 193, has been prepared showing the construction and wiring of the unit, and every constructor should obtain one in order to prevent the chance of error. The print shows the wiring and connecting points, and is a full-size template and construction guide. It can be obtained, price 9d., from the Blueprint Department of AMATEUR WIRELESS, 58-61 Fetter Lane, London, E.C.4. Readers who are also making up the "Broadcast Three" should note that the blueprint of the receiver and of the mains unit can both be obtained for a total cost of 1/6. Either print can, however, be supplied separately.

There is not very much which needs to be said regarding the construction of the unit, for it is quite straightforward, and the accompanying photographs are almost self-explanatory.

Great care, however, should be taken with the transformer connections. The transformer employed in the original unit is a Marconiphone type L. This can be used with 200-240-volt mains, at any

periodicity from 50 to 100 cycles; it gives an H.T. output from the rectifier of 150 volts at 40 milliamps, 2.5 amps at .8 volt for filament heating, and also other filaments for other types of A.C. valves, not directly heated.

The terminal marked "com" is the common mains input terminal for any voltage from 200 to 240, and is connected to the end of one fuse holder. The back of the other fuse holder is connected to one of the other three input terminals marked 200, 220, or 240, according to the mains voltage. This should be verified by inspection of the plate on the

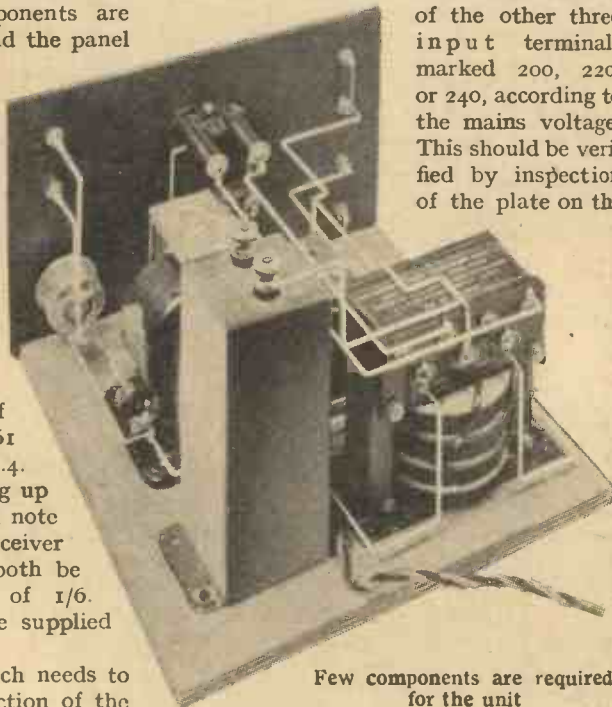

Few components are required for the unit

supply meter. One of the terminals marked H.T. is connected to the anode socket of the valve holder (or to what would be the anode socket were an ordinary three-electrode valve employed), and the other to the grid socket. The centre terminal, between the H.T. terminals, is connected



to one side of each of the mains condensers, and to the centre L.T. terminal on the other side of the transformer. The outside terminals on this side, also, are taken to the positive and negative terminals on the panel.

Filament Supply

Below the .8-volt filament terminals are three terminals which give filament current for the rectifying valve. The centre terminal is connected to one side of the 2-microfarads mains condenser, and to the terminal marked I on the smoothing choke. The outside terminals are taken to the filament sockets of the rectifier valve holder.

The mains supply is taken to the unit via a convenient length of flex, and thence through the mains switch and fuses, to the transformer primary. It should be mentioned that the switch on the receiver should be used only when batteries are employed. The mains switch is the only control to be used when the eliminator is hooked up to the receiver.

Before putting the eliminator on the mains, make certain that all connections are absolutely correct. Check each wire over with the blueprint as a guide; the work will only take a few minutes, and the print is an immense help.

If the receiver is to be employed with the mains, then it should be provided with the special directly-heated valves. The new S8 is used in the screen-grid stage, the HL8 as a detector, and the P:8 as a power

THE MAINS UNIT FOR THE "BROADCAST THREE" *(Continued)*

valve. An important point is that the connections from the L.T. terminals on the eliminator to the L.T. terminals on the set should not be too long, for otherwise a voltage drop will occur which will affect the resulting voltage applied to the filaments. Actually, if the lead is not more than one yard in length, then a cable composed of the standard of 40 strands of .0076 wire (designated 40/.0076) is suitable. If the total length is greater than one yard, then a 70-strand cable (70/.0076) should be used.

The H.T. terminals are connected up just as though the eliminator were an ordinary high-tension battery. The H.T.+1 terminal has a variable resistance in series with it, and this is the terminal which is connected to the screening grid. The potential on this electrode can be controlled

to a nicety, and, indeed, much better than with an ordinary H.T. battery, simply by the resistance on the eliminator panel.

Valves

When the "Broadcast Three" is being used with ordinary batteries and valves, the following valves should be employed: screen-grid valve, impedance 100,000-200,000 ohms; detector valve of the HL type, impedance 20,000-30,000 ohms; power valve of the DEP type, impedance 4,000-7,000 ohms.

About 120 volts high tension is suitable, though H.T. up to 150 volts can be used with advantage. Generally, a 9-volt grid-bias battery will be sufficient, but a 15-volt battery may be necessary with the higher values of H.T.

Last week a great point was made of the selectivity of the "Broadcast Three,"

and it was explained that this is due largely to the fact that the aerial coil has an independent primary winding for the aerial, and this carries threeappings. Tapping No. 4 will give the best selectivity, but, depending on conditions, sometimes at the loss of a little signal strength. Tapping No. 5 is an intermediate point which, with most aeri- als, will give a very satisfactory degree of sharp tuning combined with no noticeable loss of strength. Tapping No. 6 is best used when loud local-station reception is desired and selectivity is of no great moment.

With the exception of the daily transmissions of time signals and weather forecasts, the Kovno (Lithuania) station suspended its broadcasts during the period July 1 to 15.

In view of the inefficient service given by the French P.T.T. station at Rennes, a proposal has been made for its transfer to Chateaubriant or Pouancé, a site in the centre of a triangle formed by the cities of Angers, Nantes, and Rennes.

THOSE INTERVAL SIGNALS

Jottings from my Log
By JAY COOTE

A WEEK or so ago I mentioned in these notes that Hilversum was testing out a new interval signal, namely, a short melody automatically played by a musical box in a similar fashion to the now well-known Budapest call. Apparently this gadget is also appealing to other studios, for on recent evenings I found that, between items, Posen also broadcast a tune composed of five notes, which seemed to be produced in the same way. The cuckoo, which for some months has been Ljubljana's monopoly, has found imitators in other cities, for you will hear its call from both Wilno (Poland) and from Strasbourg (France).

But the cuckoo is not the only bird on the air; he possesses a healthy competitor at Lille in the form of a live canary, whose song you may pick up on occasion. The broadcasts are irregular, as the new artiste cannot always be made to perform as and when required. Radio Montpellier (France) for some time back has opened its programmes by playing a record illustrating the trilling of the nightingale.

After having secured the opinions of their listeners, the Italian stations decided to try out original interval signals, and you must now be familiar with the flute-like dash (morse letter T) put out by Milan, as well as with the high-pitched dot (morse E) adopted by Naples. Listening to Turin during the past week, I heard this station give out what I took to be another record of a nightingale in full song.

Munich, by the way, since its removal to new premises has discarded the Harlequin slap-stick and has replaced it by a more melodious tune electrically played on six bells which as they come over crystal clear will be easily memorised. Cracow, also, has abandoned its sleigh bells for three pizzicato notes (F D and A flat), similar in tone to those of a violin; they are repeated every two minutes. Zagreb (Yugoslavia) seems to have copied Munich, inasmuch as from that studio, on favourable nights, you will capture a short toot, followed by a metronome beating some sixty to sixty-five times to the minute, rather low in tone, and resembling, as did the signal from the Bavarian stations, the striking of a hammer on a wooden slat.

It is to be hoped that even if the stations change their wavelength they will still maintain their individual signals; any alteration is liable to cause confusion. When you do hear one distinctly, make a note of it without delay, for it will prove of considerable assistance to you at a future date.

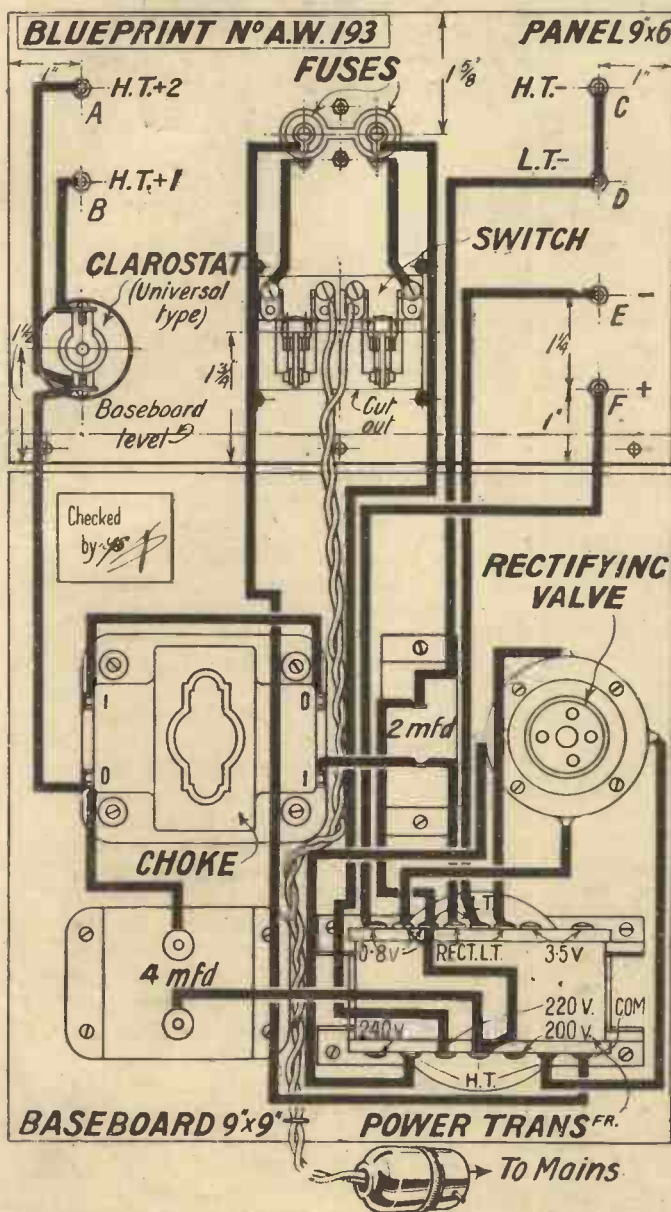

The wiring diagram of the mains unit. Blueprint available, price 9d.

WATMEL IMPERIAL



WIRELESS PRODUCTS

A True
 ★ Balanced
 Armature
 Unit
 at Last!

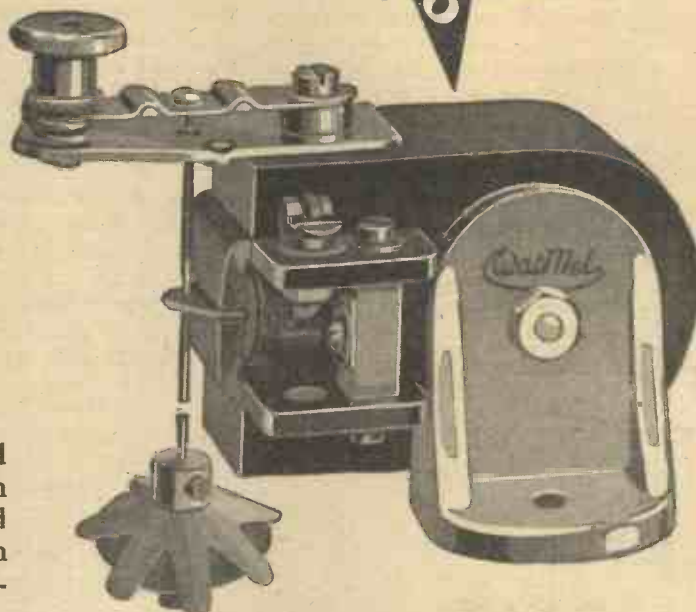

HERE at last is the real four-pole balanced armature unit for which you have been waiting. A well-designed, hyper-sensitive and beautifully finished instrument, abounding in excellent features and selling at a most attractive price.

The permanent magnet is of cobalt steel, giving the highest possible magnetic flux density across the pole pieces, which are themselves of turbo stalloy.

The specially chosen armature rides balanced on a knife edge between the pole pieces, and is energised by two carefully insulated coils.

Sensitive and positive armature adjustment is provided, and a special feature is the pair of aluminium clamps which allow the unit to be mounted horizontally, vertically, or at any desired angle.

With a good cone, cradle and baffle, you will get purity and volume equal to that of the best loud-speaker money can buy.

Ask your dealer for a Watmel Imperial Balanced Armature Unit, and accept no other.

The term "balanced armature unit" has become loosely applied to many instruments whose sealed dust cover prevents a proof of the claim. In the Watmel Imperial Unit the armature is balanced on a knife edge in the powerful field between the four pole shoes as shown here.

Under the influence of even minute currents from the receiver, the armature becomes itself a magnet, and is attracted or repelled simultaneously by all four of the pole pieces.

It is this arrangement which makes the Watmel Unit so highly sensitive, and enables you to get the equivalent of four-valve volume from a two-valve set.

When you order a balanced armature unit, it will pay you to make sure you are getting one, and the surest way of doing this is to insist on a Watmel Unit.

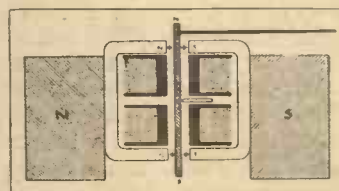

WatMel

Write to us for a free leaflet describing this Unit in detail

WATMEL WIRELESS CO., LTD., Imperial Works, HIGH ST., EDGWARE, MIDDLESEX
 Telephone: Edgware 0323

P & T

Don't Forget to Say That You Saw it in "A.W."

"A.W." TESTS OF APPARATUS

Conducted by our Technical Editor, J. H. REYNER, B.Sc. (Hons.), A.M.I.E.E.

Burne-Jones Safety Fuse

IN these days of mechanical and electrical machines it is customary to ensure against accidental damage to vulnerable articles. Perhaps the most vulnerable articles in a wireless set are the valves, and since these articles are very liable to accidental damage, some form of safeguarding switch is particularly desirable. When one considers that the premium for such an insurance is only a fuse costing 6d. or less, it is surprising that such devices are not in more general use.

We have received for test and report a Magnum H.T. fuse, made by Messrs. Burne-Jones & Co., Ltd., of Magnum House, 288 Borough High Street, S.E.1,



Burne-Jones Fuse

London. This device is intended for use in the H.T. circuit of a valve receiver, so that in the event of an accidental short circuiting of the H.T. supply across the valve filaments, the fuse will blow first and leave the filaments intact with their full emission.

The component consists of a black circular moulded base with a central hole into which a flash lamp bulb may be screwed. It is so arranged that as the bulb is removed, a spring contact comes into operation and short circuits the two terminals, thus allowing the set to function without the fuse in place. In the event of a short circuit taking place and the flash lamp blowing, it is most important to ascertain the cause of the accident before withdrawing the lamp, otherwise the valves may be damaged. It may be emphasised that the lamps used in the device should not consume more than .15 or .2 amp, and should preferably take less.

Reliance Grid Bias Battery

A GRID BIAS battery is an almost essential component in every valve receiver, and amateurs should prefer to buy the best, because the initial cost is low and a good-quality bias battery, as correctly adjusted, will save unnecessary H.T. consumption.

An essential is, that the bias battery should be able to maintain a reasonable voltage over a long period.

We have received for test, a Reliance grid bias battery from Emanee Ltd., 29 High Street, S.W.4.

This is a 9-volt grid bias battery of conventional appearance measuring 5 in. by 1 in. by 2 3/4 in. in height. The total voltage is nine and the battery is tapped at every 1 1/2 volts in the conventional manner. The negative and positive signs are marked clearly at the ends.

The proper test for a grid bias battery would undoubtedly be a "shelf-life" test which would probably take the best part of a year to perform. Suffice to say that the Reliance battery has given excellent service during the time it has been in our possession.

This component can be thoroughly recommended.

Aptus Linen Loud-speaker

ONE of the most interesting loud-speakers evolved in recent times is the linen-diaphragm speaker which, by nature of the material used for the diaphragm, is particularly free from undesirable resonance. The deep substantial tone on the bass frequencies and a refinement in tone on the middle and upper audio registers are outstanding features of this loud-speaker, and in many respects bring it up to a standard not far short of the moving-coil loud-speaker.

In order to obtain rigidity of the linen diaphragm, the ingenious scheme was evolved of using two diaphragms with their apexes clamped together on the armature of an electro-magnetic movement. In consequence, the necessary pressure between the periphery and the apex of the cones to obtain rigidity balances out between the two diaphragms and therefore does not place any strain on the armature of the operating unit. To obtain maximum stretching of this material a special type of dope is employed, which causes the diaphragm to shrink and automatically stretch.

Messrs. Moore & Co., of 101 and 103 Dale Street, Liverpool, have supplied us with an Aptus linen-diaphragm speaker. The two cones of this speaker have a diameter of 20 in. by 15 in., and are held externally by a particularly strong wooden framework to ensure freedom against buckling. A Hegra four-pole balanced armature unit is fitted as standard, the combination proving thoroughly efficient in practice.

Our tests of this speaker confirmed our

belief in its capabilities of giving faithful reproduction. Speech is clear and intelligible; music is reproduced with a noticeably good tonal balance and absence of resonance. The slight "tubbiness" which one gets at some of the very lowest frequencies is no disadvantage, since it tends to boost up the reproduction at the lower end of the musical range where it is beginning to fall off in the majority of amplifiers.

The plain chassis fitted with a Hegra unit sells at the reasonable price of £3, whilst the speaker may be obtained in an oak cabinet from £4 10s.

Bulgin Fuse

MOST readers have proved the advantage of incorporating a fuse in their H.T. circuit, thereby ensuring against accidentally burning out valves. Even those who are abnormally careful in making adjustments to their sets with the high tension connected will feel an added sense of security with a fuse in circuit.

Messrs. Bulgin & Co., of 9-11 Cursitor Street, London, W., have long been noted for their radio fuses, which from time to time have been improved. In one of their latest gadgets a flash lamp is incorporated in a special holder having spring contacts. A further holder is mounted on the same base and carries a spare flash lamp. Many



Aptus Linen-diaphragm Loud-speaker

of us have avoided the use of such fuses in the past owing to the fact that when one burns out, there is seldom another to replace it: the provision of a spare holder is certainly a good idea.

This component is mounted on a neat insulated base and sells at the modest price of 1s. 3d. Flash-lamp fuses may be obtained for 6d., and are especially suitable for wireless work, for they are rated at 60 milliamps, and will therefore blow at a current value considerably less than in the case of the normal flash lamps.

MORE POWER TO YOUR RADIO RECEIVER

with these three
BURNDIPT
Accessories for
use with Mains



Burndept Ethopower H.T. Unit
£6:18:3. Plus royalty, 12/6.

Your modern super-power valve needs a Burndept Ethopower H.T. Unit to bear heavy currents at a high voltage; to eliminate hum, shrillness, and "motor-boating"; to overcome variable voltage; and to do it efficiently and economically, consuming only 1 unit of electricity per 60 hours.



Burndept L.T. Battery
Charger £2:9:6

Let the Burndept L.T. Battery Charger renew your accumulator after every performance without removing it from its position. Economical, too—it uses only 1/7th the electricity of an ordinary light, and necessitates only a single small accumulator instead of two large ones.



Burndept Automatic Power
Control £1:5:0

Connect your receiver to the nearest lighting socket with the Burndept Automatic Power Control. With this labour-saving device the H.T. Unit is automatically started when the set is switched on, and the L.T. charger is brought into operation when the set is switched off.

Burndept MAINS ACCESSORIES

Write for full particulars of these components.

BURNDIPT WIRELESS
[1928] LTD.,
BLACKHEATH, S.E.3.

B. 22



The Wonderful NEW Brown "VEE" UNIT



HERE is the sensational new Brown "Vee" Unit. It is the biggest Radio development of recent years. For only £2 (the Unit costs 25/- and the Chassis 15/-) anyone can assemble, in two minutes, a loud speaker that gives fine mellow tone and better volume than you have ever heard before. It recreates the living artiste—in a degree that is positively uncanny. Soon your Dealer will have stocks. Make sure to hear the "Vee" Unit before you buy your loud speaker.

The Unit Costs	Chassis with Cone
25/-	15/-
S. G. BROWN, Ltd.,	
Western Avenue, N. Acton, W.3.	

"AS BRITISH AS BRITANNIA"

Advertisers Appreciate Mention of "A.W." with Your Order



ON August 2 speeches delivered by the Prince of Wales and the Chief Scout, Sir Robert Baden-Powell, at the International Jamboree, which is being held at Arrowe Park, Birkenhead, will be relayed to both 2LO and 5XX.

Sir Henry Wood will conduct the Symphony Orchestra on the occasion of the opening night of the Promenade Concert Season at Queen's Hall on August 10. The concert will be relayed to the London station.

Another entertainment for listeners this year will be provided by the New Romney Holiday Camp for public-school boys and working lads when on August 7 a sing-song will be broadcast by the London and Daventry stations.

Up the Stairs, by J. Jefferson Farjeon, a thriller "with an explanation," is to be revived in the programme arranged for transmission from the London Studio on August 7.

In the libretto series of operas to be broadcast, *Le Roi l'a Dit*, by Delibes, is to be given by 5GB on July 29. It will also be taken by 2LO and 5XX.

A. A. Milne's well-known comedy *Wurzel-Flummery* is down for broadcast from the Birmingham studio on August 6. It will be relayed to 5GB.

In view of the fact that France now possesses some twenty-four broadcasting stations and has only been granted sixteen wavelengths according to the *Plan de Prague*, a referendum was recently taken by a Paris wireless journal to ascertain which transmitters, in the opinion of the listening public, should be retained. As a result of the votes cast, Radio-Paris and Radio Toulouse proved to be favourites. Generally speaking, French radio fans considered that Bordeaux Sud Ouest, Béziers, Vitus, Fécamp, Limoges, Nimes, Toulouse PTT and the proposed station at Rheims barely justified their existence.

The new 20-kilowatt Leningrad (Russia) high-power station will resume its broadcasts on 1,000 metres on August 1 next. On this date five other new transmitters are also to be brought into operation.

The new 10-kilowatt broadcasting station erected for the Czech-Slovakian authorities at Moravska-Ostrava has started its test transmissions on 263 metres. Announcements made in Czech, German, English, and French have been clearly picked up in the United Kingdom.

Listeners report the reception of transmissions from KYMI (Manila, Philippine Islands) on a wavelength of 24.5 metres. The broadcasts are to be heard on almost every weekday evening between 7.30 and 9 B.S.T.

In connection with the reorganisation of the Swiss broadcasting system undertaken by the Ministry of Posts and Telegraphs in that country a site has now been found for one of the two high-power stations to be erected in the western district in the neighbourhood of Moudon. Work on the station is to begin at once.

The general manager of the North German Broadcasting Co., Mr. H. Bodenstedt, and the representative of the Reich Broadcasting Company, Dr. Magnus, will sail shortly for the United States in the *Bremen*. As representatives of the German Ministry of Posts and their respective companies they will make an extensive tour through the States with the object of inspecting the principal American broadcasting stations. During the trip experiments will be made on board the *Bremen* with a new low-wave transmission apparatus.

A new wireless service from Chapultepec station has just been opened with high-power short-wave installation, and is capable of communicating with South America, Europe, and Asia.

Listeners should bear in mind that until October next the Hilversum concerts will be broadcast on 1,875 metres instead of 1,071 metres, as hitherto.

Both Stuttgart and Leipzig advertise night transmissions starting at 12.30 a.m.; the former on July 27, the latter on the last day of the month.

Germany is extending her service of broadcast reception on the railways by the equipment of all express trains between Cologne, Frankfurt and Munich. Travellers on this route, similarly to those using the Berlin-Hamburg lines, may send or receive telephone messages during the journey on payment of a slight increase over the ordinary tariff.

Many of the older Scottish royal burghs have very interesting histories, and there should be ample scope for the various speakers who are to give the B.B.C.'s new series of talks on "Smaller Royal and Ancient Burghs of Scotland." The series has been opened with a talk about Linlithgow.

One of the latest Aberdeen ideas is an entertainment showing how wireless critics would themselves take up the task of programme building. Some twelve enthusiastic, but quite imaginary, "radio fans" let loose in the studio, and allowed each to sponsor a short programme of his own construction, provide illumination and a "home brew" not to be taken too seriously.

An historic Ulster broadcast is taking place on July 25, when the ceremony of the dedication of the bells of Derry Cathedral will be heard. The original bells, to which five new ones have been added, are the oldest peal in Ireland. The whole peal has been recast and rehung.

Ship-to-shore telephone service, which will permit passengers to talk over a radius of 300 miles, has been inaugurated by the Cunard liner *Berengaria*.

Radio-Vitus, Paris, which suspended its transmissions on July 14, will remain closed during the months of August and September; if authority can be obtained, the station will re-open at the beginning of October and will transmit on higher power.

The construction of the German short-wave high-power transmitter at Zeesen is nearing completion. Although no official announcement has yet been made regarding the wavelength to be adopted, it is understood that the broadcasts will be carried out on 13.38 or 25.1 metres. The preliminary tests are expected to take place shortly.

Made by Mr. Paul Askew, musical director and assistant at the Aberdeen B.B.C. station, the suggestion is before the local Town Council that a municipal orchestra be formed, consisting of twelve first-class performers with Mr. Askew as musical director. It is understood that the B.B.C. may interest itself in the scheme.



A. Ponsonby—A caricature

S'easy, now!



Soldering was a hard job before
FLUXITE
came along

FLUXITE is sold in tins, price 8d., 1/4 and 2/8. Another use for Fluxite: Hardening Tools and Case Hardening.

Ask for leaflet on improved methods

FLUXITE LTD.,
(Dept. 326)
Rotherhithe, S.E.1

SOLDERING SET Complete
7/6
or LAMP only 2/6



- IT SIMPLIFIES ALL SOLDERING

Every other type of Speaker Beaten & MUCH CHEAPER TOO!

"APTUS"

(Improved model)

DOUBLE LINEN DIAPHRAGM PREMIER SPEAKER

Performance never before equalled. Astounding realism, with amazing volume. Unaffected by climatic conditions.

Why pay expensive prices for moving-coil speakers? This wonder speaker puts all other types of cone or horn speakers out of date. Ask your dealer to demonstrate this speaker against the best speaker in his shop. Comparison is the best test. See "Amateur Wireless" test report in this issue.

Specification:

Pure Irish Linen treated and strained by a special process. "Hegra" adjustable four-pole unit fitted as standard (other units to order). The larger diaphragm gives perfection in the base and medium register, while the smaller one ensures the high register in correct relationship. A special acoustic baffle is supplied for those who already have a cabinet.

Supplies through your dealer or direct. From sole makers of "Aptus" specialities:

Phone: CENTRAL 5294

MOORE & CO.
(Est. 50 years)

'Grams: "SOLUTIONS," LIVERPOOL.

101 and 103, Dale Street, Liverpool.



In special acoustic baffle, 4 sizes:
22 in. sq. - £3 : 10 : 0
20 in. sq. - £3 : 5 : 0
18 in. sq. - £3 : 2 : 6
16 in. sq. - £2 : 17 : 6
Complete speakers in choice cabinets from - £4 : 5 : 0

AMAZING SUCCESS OF THE C2



PRICE £2-5-0

ARE YOU BUYING A HORN LOUD SPEAKER?

If so, ask your dealer about the wonderful C2. You cannot purchase a better horn speaker. Ahead in 1925 and still ahead both in quality of performance and manufacture



LOUD SPEAKER

The British Thomson-Houston Co. Ltd., Crown House, Aldwych, W.C.2

Mention of "Amateur Wireless" to Advertisers will Ensure Prompt Attention

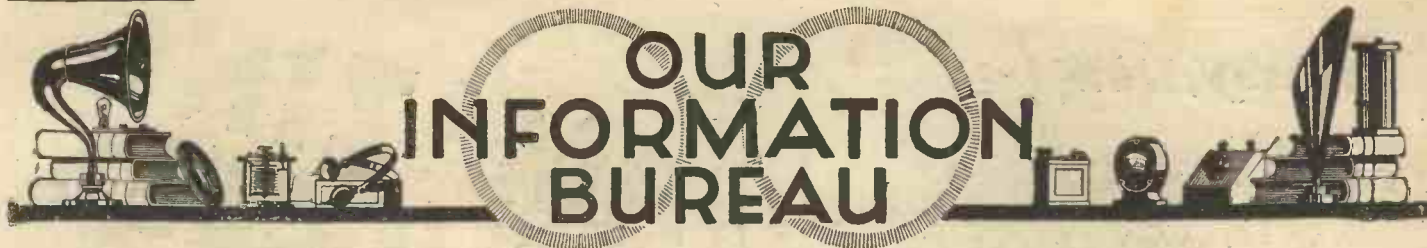

OUR INFORMATION BUREAU

RULES.—Please write distinctly and keep to the point. We reply promptly by post. Please give all necessary details. Ask one question at a time to ensure a prompt reply, and please put sketches, layouts, diagrams, etc., on separate sheets containing your name and address. See announcement below. Address Queries—AMATEUR WIRELESS Information Bureau, 58/61 Fetter Lane, London, E.C.4

Getting a Good Earth.

Q.—The nearest main water pipe is roughly 25 ft. away, and I am afraid that this will be no good as an earth. Do you think it would be better to use the water-pipe which runs to the cistern and so keep the earth lead not more than 5 ft. or so in length?—P. K. (Chiswick).

A.—It is no use having the earth lead short when the actual earth connection is likely to be very inefficient. By far your best plan will be to take a long lead to the main water-pipe, or to a sheet of copper 2 ft. square buried 3 ft. in the ground. In order to minimise the bad effect of the long lead, we suggest that you strand together four or five lengths of enamelled 7/22 aerial wire and use these for the lead to earth. In this way the resistance of the earth lead with be kept low and at the same time a fairly efficient earth obtained.—L. C.

A Strange Fault.

Q.—Signals from the local station are received at normal strength on my receiver, but at regular intervals a crackling sound is heard, and the signals cease for a moment and then come on again. Can you explain this?—R. H. B. (Leyton).

A.—Without actually inspecting your set it

is difficult to say just what is the cause of the trouble. But it is most likely to suspect that

When Asking Technical Queries

PLEASE write briefly and to the point

A Fee of One Shilling (postal order or postage stamps) must accompany each question and also a stamped addressed envelope and the coupon which will be found on the last page. Rough sketches and circuit diagrams can be provided for the usual query fee. Any drawings submitted should be sent on a separate sheet of paper. Wiring plans and layouts cannot be supplied.

the grid of one of the valves is becoming choked. You are advised to look to the connections to the grid leak and condenser. If the

connections appear to be sound, you might try the use of a different grid leak, as the one you are using may be defective. Breaks in the secondary winding of the L.F. transformer, between the transformer and the valve grid or grid battery would also cause the trouble.—W.S.

Mains Hum and Extension Leads.

Q.—I have recently wired my house for loud-speaker extensions to several rooms and now find a decided hum from the mains. This did not happen before running the extension leads—L. R. J. (St. Ives).

A.—The use of a choke filter circuit between the receiver and the loud-speaker extension leads may obviate some of the trouble, but this cannot be guaranteed to overcome the difficulty entirely. You should try re-wiring the extension leads so that they do not run parallel to any of the electric-light wiring in the house. At the same time, if the extension leads have to cross or run near to the house wiring, then they should cross at right angles or run at as large an angle as possible. Failing this, we are afraid that the only complete remedy is to do away with the extension leads or move the receiver and extend the aerial lead-in and earth wires as required.—C. A.

IMPOSSIBLE TO BURN OUT VALVES

This new Belling-Lee product is the first on the market which has both plug and socket completely insulated. SAFETY—high and low voltage plugs are not interchangeable, so that valves cannot be burnt out. CONVENIENCE—no tools required, unique loading device by which both tray and copper are gripped, plug and socket both engraved. FINISH—a feature of every BELLING-LEE product all over the world.

PRICE 9d.

Prov. Pct. (Panel portion 3d. each, Box portion 6d. each)

BELLING-LEE

Advertisement of Belling & Lee Ltd., Queensway Works, Ponders End, Middx.

BUY YOUR RADIO GOODS ON THE H. & B. GRADUAL PAYMENTS SYSTEM. IT COSTS YOU LITTLE MORE.

B.T.H. Electric Pick-up and Tone Arm, 6/- down and 7 monthly payments of 6/-. Blue Spot 66K and Chassis, 5/- down and 7 monthly payments of 5/-. Blue Spot Cabinet Speaker Model 49, 5/- down and 8 monthly payments of 5/-. Ever Ready H.T. Batteries, 120 Winner, 4/- down and 3 monthly payments of 4/-. Ever Ready 120 Popular Power, 8/- down and 3 monthly payments of 8/-. Amplion New Type Cone Speaker, 8/- down and 2 monthly payments of 7/6. Amplion A.R.9 Horn Speaker, 8/- down and 4 monthly payments of 7/6. Service C.A.V. Accumulators, 2-volt 60, 3/6 down and 3 monthly payments of 3/6—2-volt 100, 5/- down and 3 monthly payments of 5/-. Brown H.3 Speaker, were £3 5s., 8/- down and 5 monthly payments of 5/-. CARRIAGE PAID. Let us quote you Easy Terms for your radio requirements.

H. & B. RADIO CO. 34, 36, 38 BEAK ST., REGENT ST., LONDON, W.1. Gerrard 2834

THE 100% Broadcast Receiver

BUILD and OPERATE in ONE EVENING

FORMO Screened Grid



BRITISH Components Throughout SEND FOR CATALOGUE.

Famous FORMO COMPONENTS as used in this Set and in all Notable Published Circuits

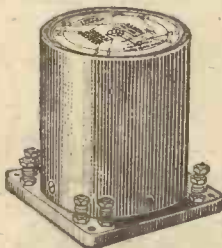

TRANSFORMER-OUTPUT FILTER CHOKE 25/-

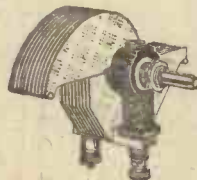

"1928" LOG CONDENSER 5/- '0005 '00035 '00025



COILS SG 1 & 2 10/6 each

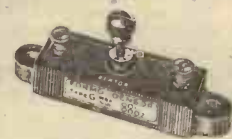

FORMO-DENSOR 2/- In four variable capacities

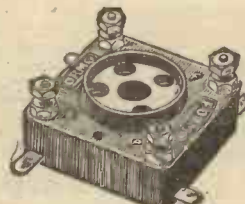

VALVE HOLDER 1/3

THE FORMO CO., CROWN WORKS, CRICKLEWOOD LANE, LONDON, N.W.2

The Sure Path to Perfect Reception

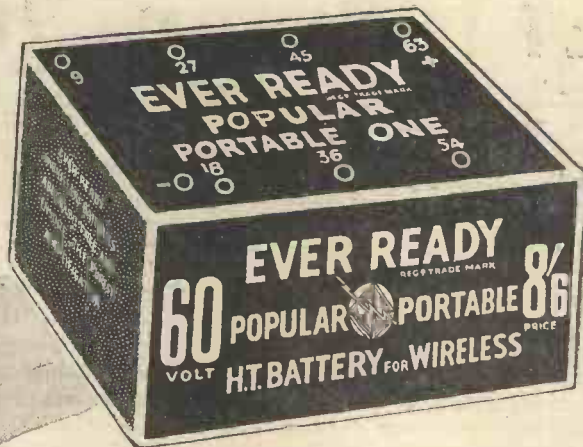

SPECIAL UNITS FOR PORTABLE SETS
 PORTABLE 1. 63 volts 8/6 Size 6" x 5" x 3"
 PORTABLE 2. 99 volts 13/6 Size 9" x 5" x 3"
 PORTABLE 3. 108 volts 15/- Size 10" x 5" x 3"

EVER READY

BRITAIN'S BEST BATTERIES



The Secret of successful reception

FROM 20-2,250 METRES

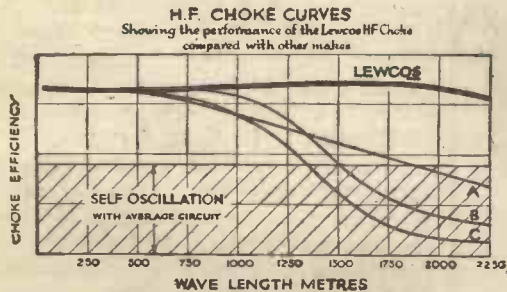

This diagram shows the percentage Choking effect of the LEWCOS H.F. Choke on all wave-lengths from 20 to 2,250 metres, as compared with three other popular makes.

The terminals are arranged one at the top and the other at the base of the coil to eliminate the risk of additional self-capacity in the wiring of the receiver. Equip your set with a LEWCOS H.F. Choke and get maximum efficiency on all wavebands from 20 to 2,250 metres.

LEWCOS RADIO PRODUCTS
 are available at 7 Playhouse Yard,
 Golden Lane, London, E.C.1.

**THE LONDON ELECTRIC WIRE COMPANY,
 AND SMITHS LIMITED.**

Church Road :: :: Leyton, London, E.10.

Trade Counter and Cable Sales : 7 Playhouse Yard, Golden Lane, E.C.1

You will Help Yourself and Help Us by Mentioning "A.W." to Advertisers.

LETTERS TO THE EDITOR



The Editor does not necessarily agree with the views expressed by correspondents

Correspondence should be brief and to the point and written on one side of the paper.

Those Empire Programmes!

SIR,—I have received a letter from a friend in Malaya, together with a cutting from a local newspaper regarding Empire broadcasting, and I am prompted by F. G. C.'s letter in your last week's issue to put yet further arguments in favour of 5SW. My friend tells me that the average receiver used in Malaya for picking up Chelmsford is a simple two-valver, with phones, of course. The price is fairly high, and reception is not easy, but "half a loaf . . ." There are quite a number of wireless enthusiasts who think nothing of sitting up at unearthly hours to hear the mother country. Indignation is felt at the fact that although only one-tenth of British subjects live in the British Isles, no world-wide radio service is provided for the remaining majority.

"People in England," writes my friend, "say that it is not fair that England should have to pay for Dominions broadcasting. Well, we agree. The Governments con-

cerned would surely be willing to contribute their share, in proportion to the area served. In any case, it would be cheaper than establishing relay-broadcasting stations in such places as Malaya, which would raise financial and administrative difficulties. The cost, to the amateur, of a receiver capable of picking up a central relay station in any part of the country would be about the same as that, at present, of a set to pick up 5SW; so the expense of a broadcast-relay station would not be justified."

I, personally, think that the B.B.C., now that it is a Government Department, should do more for the Dominions, through Chelmsford, than it does at the present time. What do other readers think?

PATRIOT (London, E.).

Birmingham Goes High-Brow!

SIR,—A paragraph I saw published recently in a daily paper, and which was quoted as the statement of a B.B.C.

official, said that the standard of musical taste among listeners is undergoing a change and is becoming high-brow. This fact, it is claimed, emerges from a long list of request hours given from 5GB. The Birmingham request list, now contains a preponderance of demands for so-called high-brow items, and the move in this direction is growing—or, at least, so the B.B.C. says. I don't think so, and I'm sure the majority of Birmingham listeners will agree with me. We have too much high-brow and unintelligible matter broadcast already, and for pity's sake save us from it in the request items! I think the real cause for its demand (if the report is true) is to be found in the old argument that the typical listeners do not write to the B.B.C. Only the cranks trouble to do so.

P. K. (Aston).

Short-wave Adaptor Results

SIR,—I had a short-wave adaptor unit made up strictly in accordance with details given in your journal of May 4. I joined it up to my set, with excellent results.

I got Schenectady W2XAD, 21.96 metres. The speech at a farmers' milk conference came through splendidly—every word could have been taken down, no atmospherics, no fading. A short concert followed. My set is a screen-grid four, Mullard valves, using the adaptor followed by resistance capacity and a Ferranti transformer in the last stages. High tension, about 120 volts on the three valves, viz., detector and two L.F.'s (inserted a potentiometer). Several similar adaptors, according to your May 4 design, have been made up here by a well-known electrical firm, and I hear they are all getting excellent results. I am able to get W2XAD every evening; Chelmsford comes through very well also. Very many thanks for your idea.

E. (Margate).

A Loud-speaker Appreciation

SIR,—As a five-years reader of your journal may I beg the favour of a small space for this letter? I lately bought a Blue Spot unit and a Blue Spot chassis. As these did not give me satisfactory results, I wrote to the firm, F. A. Hughes & Co., Ltd., who are the distributors, and they invited me to send the whole assembly back to them for inspection. I sent it by registered post, but during the journey it was badly damaged, and the firm kindly repaired and replaced damaged parts for what was practically cost of carriage. Now the whole assembly is working fine, and if any of your readers who think they have got a "best in the world" horn speaker, will only hear a Blue Spot assembly, they will soon alter their opinions.

H. L. (Stoke-on-Trent).

The "Ranger 4"

SIR,—A recent issue of AMATEUR WIRELESS was of unusual interest to me because it contained a letter from N.B. (Continued on page 110)



PHILIPS MODERN LOUD-SPEAKERS

ON MODERN TERMS

5/-

FIRST PAYMENT



Philips Type 2007. In 3 colour schemes. 10/- down and 11 payments of 9/6.

Build your own set the Easy Way NOW!

Our Catalogue contains all leading makes of Receivers, Accessories, Kits of Components for the Home Constructor

Mail Coupon in unsealed envelope under 1/2d. stamp now!

PETO SCOTT CO. LTD.

Please send me your big Illustrated Lists.

NAME

ADDRESS

.....A.W. 27/7

Free Demonstrations and Advice by Qualified Engineers at our Shops:—

77 City Road, London, E.C.1

62 HIGH HOLBORN, LONDON, W.C.1.

4 MANCHESTER STREET, LIVERPOOL.

33 WHITELOW ROAD, Chorlton-cum-Hardy, MANCHESTER.



The Easy Way TO PERFECT RADIO

Player's please



REGD No 1540LL

NCC 207

The Enchanter

An efficient and simple Five Valve Portable with only one tuning control.

Two high-frequency stages, leaky-grid detector, resistance-coupled amplifier and transformer-coupled amplifier.

Covers both wavelength ranges by the operation of a single switch.

Selectivity and range ensured by minimum of aerial damping.

Fully described in the August "Wireless Magazine"



OTHER CONTENTS INCLUDE:

MAKING YOUR SET MORE SELECTIVE. Eighteen simple methods explained by W. James—THE A.1 SIMPLE ONE-VALVER, with home-wound tuning coil—SHOULD RAILWAY WIRELESS BE COMPULSORY?—THE BINOWAVE SG3. A new dual range receiver by W. James—ARE PORTABLES SAFER THAN ORDINARY SETS?—THE ALL-WAVE LODESTONE FIVE. Building an A.C. power unit for the push-pull stage—SETTING UP YOUR GRAMOPHONE FOR ELECTRICAL REPRODUCTION, by W. James—WHAT THE DETECTOR REALLY DOES. Another Half-hour with the Professor—B.B.C. RESIGNATIONS AND DISMISSALS, etc., etc., etc.

WIRELESS MAGAZINE

for August, 1/-, is on sale everywhere TO-DAY.

Get yours NOW!

Brownie

3/6

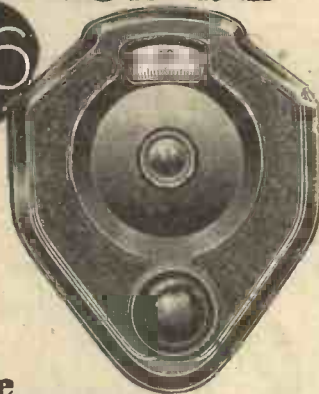

the 'DOMINION' Slow Motion Dial

A Vernier Dial at 3/6! Bring your set up-to-date by fitting this slow motion dial. The mechanism is of special non-back-lash construction which makes very fine tuning easy. Finished in smooth black or beautifully grained mahogany bakelite, this unique dial gives high-class finish to every set in which it is included.

Brownie

wireless

NELSON ST. WORKS, LONDON, N.W.1

TUNEWELL COILS

Special Notice

Our newly designed and provisionally patented DUAL RANGE COILS set a new standard of efficiency.

The leading Scandinavian Wireless Technical Journal "Hallo, Hallo" is full of praise. They have even gone so far as to print a special paragraph in English (issue No. 27, June 28th, 1929). Mr S. W Flood, their chief technical expert, writes as follows:

"They are without doubt and by far the best Dual Range Coils I have ever tested. They are altogether wonder coils and I have immediately specified them for my receivers to be published."

Praise from such a quarter is praise indeed. It is your guarantee of super efficiency. Coils for the following popular sets are in stock at most dealers:

Dominion 4, Cossor S.G.3, Mullard S.G.P.3, Clarion S.G.P.3, Broadcast Picture 4, Aerial or Anode Mullard Master 3, Bantam 3, Favourite 3, etc. Dual Coils:

Always fit our H.F. Choke on above circuits to ensure success. Price 5/9

2-pin coils, all types, from 1/6
6-pin coils, most types, from 3/11

Separate pins for converting Panel mounting coils to six-pin base type, 1/- per doz.

TURNER & CO.,
54 Station Rd., London, N.11
Stand 95 at forthcoming Olympia Exhibition

LETTERS TO THE EDITOR

(Continued from page 108)

(London) in which he gave a small account of the 'Ranger 4,' a set which I also made shortly after you published the description last October.

There must be hundreds of amateurs like N.B. and myself who are completely "at sea" with so many designs and layouts of three- and four-valve sets, some of which contain weird-looking coils and components, while other designs appeal to the ordinary lay amateur by their very simplicity of components.

Hence my "Ranger 4" and my delight in its possession, because wireless experts who have five-valve sets are surprised when they hear my "Ranger" first and insist on having the cabinet opened. I can get all the stations mentioned by N.B. on the loud-speaker, but use 130 volts instead of 60.

Re 5GB in Ireland. That is an almost impossible station with me, even on the "Ranger," and the same applies to a few of my friends who own five-valve sets; the difficulty is fading. D. (Dublin).

"HOW THE PRAGUE PLAN IS WORKING"

(Continued from page 96)

becoming very bad during the latter days of the Brussels Plan. The Prague Plan has effected an enormous improvement here. Good stations are Bratislava, Turin, Lille, Leipzig, Toulouse, PTT Breslau, Nuremberg, Cologne, and Cork.

Limitation of Power

So far, then, the Prague Plan is working well. Will it last? Such trouble, if any, as may arise is not likely to come from wavelength wandering or anything of that kind, for any such sins will be severely checked. The question, which only time can answer, is this: We are now hearing Continental stations at summer strength when their wipe-out effect is small, and therefore their heterodyning powers are reduced; when they return to winter strength shall we find heterodynes once more? It is, I think, quite possible that we shall, for a time at any rate. In certain cases it seems to me that wavelength neighbours are also rather too close together geographically. It may thus be found advisable later on to effect certain exchanges in wavelengths between stations. I shall not be surprised also to find efforts being made for a general agreement limiting the power of stations using the medium band. The greater the power of a station, the greater is its service area—and also its heterodyning area, to coin a phrase. The coming of many new giant stations may easily introduce an entirely new set of problems.

During the coming autumn and winter I expect, on the whole, much better reception and a much wider choice of stations than we have ever had before. Prospects

are distinctly rosy for sane long-distance listening—that is, not for logging Bombay on one valve, but for obtaining loud-speaker reproduction that is really worth while listening to of a big number of alternative programmes from European stations.

New Developments in Metal Rectifiers—Correction

In the article which appeared with this title on page 67 in last week's issue the diagram Figs. 1 and 4 were transposed, that is, the diagram shown as Fig. 4 should have been above the inscription Fig. 1, and the diagram shown as Fig. 1 should have been above the inscription Fig. 4.

"Amateur Wireless and Radiovision." Price Threepence. Published on Thursdays and bearing the date of Saturday immediately following. Post free to any part of the world: 3 months, 4s. 6d.; 6 months, 8s. 9d.; 12 months, 17s. 6d. Postal Orders, Post Office Orders, or Cheques should be made payable to "Bernard Jones Publications, Ltd."

General Correspondence is to be brief and written on one side of the paper only. All sketches and drawings to be on separate sheets. Contributions are always welcome, will be promptly considered, and if used will be paid for. Queries should be addressed to the Editor, and the conditions printed at the head of "Our Information Bureau" should be closely observed. Communications should be addressed, according to their nature, to The Editor, The Advertisement Manager, or The Publisher, "Amateur Wireless," 58-61 Fetter Lane, London, E.C.4.

SUPER-MICROPHONES

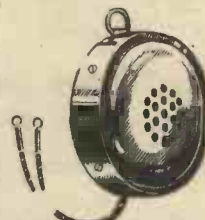

New, highly sensitive, made on latest principle, using secret process sensitized parts, will pick up faint sounds, whispered words, quiet conversation, etc., from a considerable distance; also strongly amplify and transmit Speech and Music through Loud-speaker or Headphones. Splendid instruments for making Detectaphone,

Deaf-aid, Loudspeaking Telephone, Announcements through Loudspeaker, Amplifier for Crystal or Valve Set, Electric Sound Detector. Experiments. No other Microphone of equal sensitiveness known. Entirely supersedes all others. Fitted with 8/6 3ft. silk flexible connecting cord

SPECIAL MICROPHONE TRANSFORMER, for obtaining best possible results from sensitive Microphones when connected to Radio phones, Loud-speaker, Valve Set, or Valve Amplifier 4/-

Full Directions for use of Super-Microphone and Diagrams of connections: free.

FREDK. ADOLPH, Actual Maker,
27, Fitzroy Street, London W.1.
Telephone: Museum 8329

INSURE

YOUR VALVES

USE only "Competa" Fuses. Each guaranteed fuse is branded on the cap and carton. Don't accept substitutes, or ordinary flash lamp bulbs and risk burning out your valves.

·06
·1
·15
·2
AMPS

TRADE MARK

COMPETA

THE WORLD'S SELECTED

Divl. of A. F. BULGIN & Co., 9/10/11 Curator Street, London, E.C.4

BROADCAST TELEPHONY

(Broadcasting stations classified by country and in order of wavelengths)

Metres	Kilo-cycles	Station and Call Sign	Power (Kw.)	Metres	Kilo-cycles	Station and Call Sign	Power (Kw.)	Metres	Kilo-cycles	Station and Call Sign	Power (Kw.)				
GREAT BRITAIN															
25.53	11,754	Chelmsford (6SW)	15.0	*329	914	Montpellier (PTT)	1.5	YUGOSLAVIA							
*200	1,500	Leeds (2LS)	0.13	396	892	Petit Parisien	0.5	*307	977	Zagreb (Agram)	1.25				
*242	1,238	Belfast (2BE)	1.0	*351	855.5	Algiers	2.0	*455	660	Belgrade	2.5				
*261	1,148	Newcastle (5NO)	1.0	413	788	Radio Toulouse	0.0	*506	530	Ljubljana	3.0				
288.5	1,040	Swansea (65X)	0.13			Radio Maroc (Rabat)	2.0	LATVIA							
288.5	1,040	Stoke-on-Trent (6ST)	0.13	436	687	Radio Flandre (Lille)	0.5	*525	572	Riga	2.0				
288.5	1,040	Sheffield (6LF)	0.13	*447	671	Paris (Ecole Sup. PTT)	0.7	LITHUANIA							
288.5	1,040	Plymouth (6PY)	0.13	*406	644	Lyons (PTT)	5.0	*1,935	155	Kovno	15.0				
288.5	1,040	Liverpool (6LV)	0.13	1,350	222	Tunis (testing)	2.0	NORWAY							
288.5	1,040	Hull (6KH)	0.2	*1,444	207.5	Eiffel Tower	8.0	*283	1,058	Notodden	0.7				
288.5	1,040	Edinburgh (2EH)	0.85	*1,725	174	Radio Paris	8.0	*304	824	Bergen	1.0				
288.5	1,040	Dundee (2DE)	0.13	GERMANY								*394	661	Frederikstad	1.0
288.5	1,040	Bournemouth (6BM)	1.0	*218	1,373	Flensburg	1.5	450	666.5	Rjukan	1.0				
288.5	1,040	Bradford (2LS)	0.13	*227	1,379	Cologne	4.0	453	662	Tromsø	1.0				
*301	995	Aberdeen (2BD)	1.0	*234	1,283	Muenster	4.0	463	662	Aalesund	1.0				
*310	968	Cardiff (5WA)	1.0	*239	1,256	Nurnberg	4.0	463	662	Porsgrund	1.0				
*356	842	London (2LO)	2.0	*246	1,220	Kiel	0.7	*493	608	Oslo	1.5				
*377	797	Manchester (2ZY)	1.0	*246	1,220	Cassel	0.7	POLAND							
*399	753	Glasgow (5SC)	1.0	*253	1,184	Breslau	4.0	*313	959	Cracow	1.5				
*479	626	Daventry (5GB)	17.0	*259	1,157	Leipzig	4.0	*335	806	Posen	1.5				
*1,554	193	Daventry (5XX)	25.0	*270	1,112	Kaiserslautern	1.5	385	779	Wilno	1.5				
AUSTRIA												*408	734	Kattowitz	10.0
*246	1,220	Linz	0.5	*276	1,083	Koenigsberg	4.0	*1,411	212.5	Warsaw	10.0				
*283	1,058	Innsbruck	0.5	*283	1,058	Magdeburg	0.7	ROUMANIA							
*352	851	Graz	5.0	*283	1,058	Berlin (E.)	0.7	*394	761	Bucharest	4.0				
*453	666	Klagenfurt	0.5	*283	1,058	Stettin	0.7	RUSSIA							
*517	581	Vienna	15.0	*319	941	Dresden	0.75	*351	855.5	Leningrad	20.0				
BELGIUM												*427	702.5	Kharkov (NKO)	5.0
230	1,300	Charleroy (LL)	0.25	*325	923	Gleitwitz	6.0	*483	621.5	Homel	2.5				
245	1,220	Schaerbeek-Brussels	0.5	*339	887	Bremen	0.75	*825	364	Moscow (PTT)	25.0				
250	1,200	Ghent	0.5	*360	833	Stuttgart	4.0	*1,304	202.5	Kharkov	15.0				
280	1,071	Liege	0.5	*372	806	Hamburg	4.0	*1,481	202.5	Moscow	30.0				
*509	590	Brussels	10.0	*390	770	Frankfurt	4.0	SPAIN							
CZECHO-SLOVAKIA												251	1,703	Almeria (EAJ18)	1.0
*263	1,139	Morava-Ostrava	10.0	*418	716	Berlin	4.0	*268	1,121	Barcelona (EAJ19)	10.0				
*279	1,076	Bratislava (Feriby)	12.5	*453	662	Danzig	0.75	314	956	Oviedo (EAJ10)	0.5				
*293	1,022	Kosice	2.0	*453	666	Aachen	0.75	*349	860	Barcelona (EAJ11)	8.0				
*342	878	Brunn (Brno)	2.4	*473	635	Langenberg	25.0	*368	875	Seville (EAJ5)	0.5				
*487	617	Prague	5.0	*533	563	Munich	4.0	403	743	San Sebastian (EAJ8)	0.5				
DENMARK												*424	707	Madrid (EAJ7)	3.0
*281	1,067	Copenhagen (Kjohbenhavn)	1.0	*560	536	Augsburg	0.5	453	662	Salamanca (EAJ22)	5.5				
1,153	260	Kalundborg	7.5	*560	536	Hanover	0.7	SWEDEN							
ESTHONIA												231	1,301	Malmö	0.5
*297	1,010	Reval (Tallinn)	1.3	*560.2	527	Freiburg	0.7	*257	1,160	Hoerby	10.0				
FINLAND												270	1,174	Trollhattan	0.4
*221	1,355	Helsingfors	0.8	*1,685	183.5	Zeesen	20.0	*322	932	Goeteborg	6.0				
*1,796	167	Lahä	20.0	2,100	142	Norddeich	10.0	322	932	Falun	0.5				
FRANCE												*436	689	Stockholm	1.5
170	1,750	St. Quentin	0.25	2,290	131	Norddeich	10.0	*542	554	Sundsvall	1.0				
*220	1,364	Béziers	0.1	GRAND DUCHY								*770	399	Ostersund	2.0
*237	1,265	Juan-les-Pins	0.4	1,233	234	Luxembourg	2	1,200	250	Boden	2.0				
238	1,260	Bordeaux (Radio Sud-Ouest)	2.0	HOLLAND				*1,348	222.5	Motala	30.0				
240	1,250	Radio Nimes	1.0	31.4	9,554	Eindhoven	25.0	SWITZERLAND							
*265	1,175	Toulouse (PTT)	1.0	HUNGARY				*403	743	Berne	1.0				
*265	1,130	Lille (PTT)	0.8	*550	545	Budapest	15.0	459	653	Zurich	0.6				
*272	1,103	Rennes (PTT)	1.0	ICELAND				680	444	Lausanne	0.6				
*286	1,049	Grenoble (PTT)	1.5	*1,200	250	Reykjavik	1.0	780	395	Geneva	0.5				
292	1,028	Radio Lyons	1.5	IRISH FREE STATE				1,010	297	Basle	0.25				
*293	1,022	Limoges (PTT)	0.5	*225	1,337	Cork (5CK)	1.5	TURKEY							
*304	986	Bordeaux-Lafayette (PTT)	0.5	*413	725	Dublin (2RN)	1.5	*1,200	250	Stamboul	5.0				
305	982	Agen	0.3	ITALY				All wavelengths marked with an asterisk have been allotted according to the Plan de Prague.							
*316	950	Marseilles (PTT)	0.5	*274	1,094	Turin (Torino)	7.0								
												*332	905	Naples (Napoli)	1.5
												*385	779	Genoa (IGE)	3.0
												*441	680	Rome (Roma)	3.0
												473	662	Bolzano	0.3
												*501	590	Milan (Milano)	7.0

CHIEF EVENTS OF THE WEEK

Date	Event
July 30	Vaudeville programme.
" 31	Werther (Massenet), libretto opera.
Aug. 1	Ingredient X, a thriller by L. du Garde Peach.
" 2	Speeches by Prince of Wales and Sir Robert Baden-Powell at Boy Scouts' World Jamboree, relayed from Arrowse Park, Birkenhead, S.B. from Liverpool.
" 3	The Tidworth Tattoo.
DAVENTRY EXPERIMENTAL (5GB)	
July 28	Popular Wagner concert.
" 31	Vaudeville programme.
Aug. 1	Constellations, an all-star revue, by Dorothy Evans, with meteorological music by various composers.
MANCHESTER	
July 28	Orchestral and vocal programme.
" 29	Request performance of <i>The Armada</i> , by William E. Rice.
" 31	Boy Scouts' Jamboree, relayed from Arrowse Park, Birkenhead.

NEWCASTLE

July 29 Band of Coldstream Guards, relayed from North-East Coast Exhibition.

The new Palace Hotel at Deauville, the famous French seaside resort adjoining Trouville, is to be equipped with wireless receiving apparatus with headphones in over two hundred and fifty rooms. The hotel is to be opened this month.

We are requested to state that the Electron Company, Limited, has now changed its name to Six-Sixty Radio Company, Limited. The address is 122 Charing Cross Road, W.C.2.

RAYMOND'S FOR WIRELESS

27 & 28a, LISLE ST., LONDON, W.C.2

Come to LEICESTER SQUARE TUBE. This address is at the back of Daly's Theatre. Phones: Gerrard 4637 and 2821

WE ARE OPEN
ALL DAY SATURDAY
ALL DAY THURSDAY
ALL DAY EVERY DAY
 Hours 9 a.m. to 8 p.m.
 Sat. 9 a.m. to 9 p.m.
 Sunday morning 11-1

CLARION S.G.3
 A.W. 9-3-20
KIT OF PARTS
 2 0005, No. 3 at 5/9. 0001 Reaction, 4/-, 2 Dual range C.T. Coils, with Reaction (Tunewell). Anode, 10/0; Aerial, 10/8. 3 Lotus or W.B.V.H. at 1/3. Formodener, "J," 2/-, Dubilier 1 mfd., 2/6. 01 Fixed, T.C.C. 1/8. 3-meg. Lissen or Edison Bell, 1/-, S.G. H.F. Choke, 5/6. H.F. Choke, Lissen, 5/8. L.P. Transformer, B.I. and Varley, 15/-. Ebonite Strips, 14x7 Ebonite Panel, Screen, 81x3. 8 Engraved Terminals, Push-pull Switch, Flex. Plugs, 16-g. Wire, 2 S.M. Diats.

The above for **70/-** Post Free U.K. .0002 Fixed and Series Clips 1/6 extra.

VALVES FOR S.G.3
 Screened Grid, Marconi, Mullard, Six-Sixty, 22/6 each, Detector, 10/6. Power, 12/6. S.G., 2-v., 12/6. C.T. 15 LF. or H.F., 4/- C.T. 15X. P. 6/-.

SENT FOR 16/8
FIRST PAYMENT 11 MONTHLY PAYMENTS OF 16/8

It is obviously impossible to advertise every Component or Set on the market. Will you therefore kindly make out a list of your requirements if

OVER 25/-
 and I will give you an inclusive Cash Price (without obligation to you). Further, any Portable Set, Loud-speaker, complete sets, etc., at makers' list prices supplied on deferred payments.

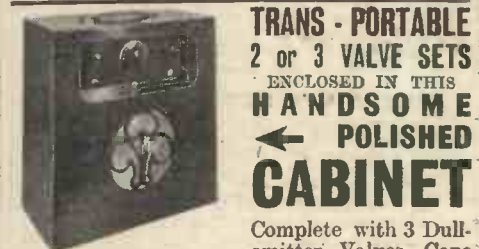

TRANS-PORTABLE 2 or 3 VALVE SETS ENCLOSED IN THIS HANDSOME POLISHED CABINET
 Complete with 3 Dull-emitter Valves, Cone Speaker, incorporated in set, 100 volt H.T., 2 volt L.T., Aerial Equipments (needs outdoor aerial). Ready to use. Tax paid. Opens at back.
 Or 2 valve in 12 equal monthly payments of **11/6**
 3 valve in 12 equal monthly payments of **13/6**

TUNEWELL CLARION COILS
AERIAL and 10/6 ea.
DUAL COIL for 7/9
 Britain's Fav. 2. Post extra.

BRITAIN'S FAV. 2 (UP-TO-DATE.) COMPONENTS
 Ormond, 0005, 6/-; 00025, 5/6; 7-ohm Ormond, 2/-; 2 W.B.V.H., 2/6; 6 pin Base, 2/-; 0003 and Series Clip, 1/6; 2-meg. leak, 1/-; H.F. Choke, 5/6; L.F. Transformer, 8/6; Push Pull, 1/3; Tunewell Dual Range Coil, 7/9.
PLEASE ADD POSTAGE

A.W., 25th May, 1929
IF YOUR ORDER FOR FAV. 2 PARTS EXCEEDS 32/- YOU CAN BUY for 1/- extra
 14x7 Ebonite Panel, Palt Panel - Brackets, Base-board, Battery Clips, 8 Engraved Terminals, Wire, Flex, Plugs.

BLUEPRINTS

Copies of the "Wireless Magazine" and of "Amateur Wireless" containing descriptions of all these sets can be obtained at 1s. 3d. and 4d. respectively, post free. Index letters "A.W." refer to "Amateur Wireless" sets and "W.M." to "Wireless Magazine" sets.
All Post Free

CRYSTAL SET (6d. each)
A Daventry-Local Crystal Set AW185

ONE-VALVE SETS (1s. each)
Beginner's One-valver AW140
Reinartz One WM127
The A.1 WM153

TWO-VALVE SETS (1s. each)
East to West Short-wave Two (D Trans) .. AW159
Beginner's Two (D, Trans) AW171
All-Mains Two (D, Trans) AW180
1929 Favourite Two (D, Trans) AW186
Loud-speaker America Two AW190
Key-to-the-Ether Two (D, Trans) WM107
Meteor Two (D, Trans) WM114
Clipper Two (D, Trans) WM135
Twinflex (Reflex) WM138
Continental Two (D, Trans) WM143

THREE-VALVE SETS (1s. each)
All purpose Short-wave Three (D, RC, Trans) AW147
Screen-grid Q Coil Three (HF, D, Trans) .. AW150
All-Britain Three (H.F., D, Trans) AW158
Bantam Three (D, RC, Trans) AW160
Listener's Three (HF, D, Trans), price 4d., free with copy of "AW" AW169
The Binowave Three (D, RC, Trans) AW172
Clarion Three (SG, D, Trans) AW175
1929 Favourite Three (D, RC, Trans) AW179
Local and Continental Three (HF, D, Trans or D, RC, Trans) AW189
Broadcast Three (SG, D, Trans) AW192
Everyday (D, 2 Trans) WM52
All-wave Screen-grid Three (HF, D, Trans) .. WM110
Standard Coil Three (HF, D, Trans) WM117
Wide-world Short-waver (SG, D, Trans) .. WM120
New Year Three (SG, D, Pentode) WM123
The Q3 (D, RC, Trans) WM124
Lodestone Three (HF, D, Trans) WM129
Simple Screen Three (HF, D, Trans) WM131
Dynamic Three (SG, D, Trans) WM136
At Home Three (D, 2RC) WM141
Short-Wave Link (D, RC, Trans) WM142
Binowave S.G. Three (SG, D, Trans) WM152

FOUR-VALVE SETS (1s. 6d. each)
Overseas Short-waver (HF, D, 2 Trans) .. AW133
Five-pounder Four (HF, D, RC, Trans) .. WM 01
Touchstone (HF, D, RC, Trans) WM109
Reynier's Furzehill Four (SG, D, 2 Trans) .. WM112
Economy Screen-grid Four (SG, D, RC, Trans) WM113
Binowave Four (SG, D, RC, Trans) WM119
Standard-coil Four (HF, D, 2RC) WM122
Dominions Four (2SG, D, Trans) WM134
The Drum Major (HF, D, RC, Trans) WM137
Music Player (HF, D, RC, Trans) WM144

FIVE-VALVE SETS (1s. 6d. each)
"Q" Gang-control Five (2HF, D, 2 Trans) .. AW161
Fidelity Five (HF, D, 2RC) WM130
All-wave Lodestone Five (HF, D, RC, Push-pull) WM146

SIX-VALVE SETS (1s. 6d. each)
Short-wave Super-6 (Super-het, Trans) .. AW67
Eagle Six (3 HF, D, RC, Trans) WM106

AMPLIFIERS (1s. each)
"A.W." Gramophone Amplifier (3RC) AW162
Searcher Unit (HF) AW176
Gramophone Amplifier (3 v.) AW187
Signal Booster (HF Unit) WM128
Audiotrol Amplifier WM132

PORTABLE SETS
House Portable (SG, D, RC, Trans) .. AW168 1/6
Arcadian Portable (SG, D, 2 Trans) with linen-diaphragm loud-speaker (half scale £5.5.0) Portable (D, Trans) AW177 1/6
Talisman Portable (SG, D, 2 Trans) AW184 1/6
Holiday Portable Three (D, 2 Trans) AW188 1/-
Chummy 4 (with modifications for LS and HT) WM80A 1/6
Wayfarer Portable (Super-het) WM139 1/6
1929 Chummy (SG, D, Trans, RC) WM145 1/6
Picnic Portable (D, RC, Trans) WM149 1/-
Enchanter Portable (2HF, D, RC, Trans) WM150 1/6

When ordering Blueprints please send Postal Order NOT STAMPS

AMATEUR WIRELESS 58-61 FETTER LANE LONDON, E.C.4

WIRELESS IN PARLIAMENT



(By our own correspondent)

MR. LONGDEN inquired if consideration would be given to the granting of an extension of free wireless licences to all incurably infirm persons.

Mr. S. P. Viant, the Assistant Postmaster-General, said that the Broadcasting Committee, 1925, considered the question of the grant of free wireless licences and recommended that this concession be made to blind persons only. Effect was given to the Committee's recommendation by the Wireless Telegraphy (Blind Persons Facilities) Act, 1926. He did not consider that he would be justified in asking Parliament to extend the concession to other classes of the community.

The Columbia broadcasting system, which now comprises a network of some fifty-one stations in the United States, is to be housed in a twenty-story skyscraper in the centre of New York. The five top floors of this building will contain fifteen studios, ranging from small "talk" rooms to a huge auditorium capable of accommodating two hundred and fifty musicians and artists. Several of the larger studios will have the upper part surrounded by a glass-enclosed gallery from which an audience may witness what is taking place; loud-speakers will bring the sound to them. It has been found that an audience in an open studio disturbs the singers and the applause may mar the transmission.

Dr. Albert Norman Shaw, of McGill University, Montreal, has challenged Frank T. Davies, a member of the Byrd Polar Expedition, which is now snowed under for the Antarctic winter, to a game of chess by wireless. The distance separating the players will be well over 7,000 miles.

SINQUERS

SAVE YOUR ACCUMULATORS SET A SINKER SENTRY! HE'LL NEVER LET YOU DOWN.



Double the life of your cells! Avoid being let down by a run-out accumulator. Sinquers tell you the exact state of your battery and warn you when it needs recharging. Just drop them in and leave them to it. 1/- per carton from most dealers or 1/3 post free from actual makers. FIDDIAN BAWTREE & CO., Oakhill Road, Sutton.

PREPAID ADVERTISEMENTS

Advertisements under this head are charged THREEPENCE PER WORD, minimum charge THREE SHILLINGS.

DEPOSIT SYSTEM

As the Publishers cannot accept responsibility for the bona fides of advertisers in this publication, they have introduced a system of deposit which it is recommended should be adopted by readers when dealing with persons with whom they are unacquainted. It is here explained.

Intending purchasers should forward to the Publishers the amount of the purchase money of the article advertised. This will be acknowledged to both the Depositor and the Vendor, whose names and addresses must necessarily be given. The deposit is retained until advice is received of the completion of the purchase, or of the article having been returned to and accepted by the Vendor. In addition to the amount of the Deposit, a Fee of 6d. for sums of £1 and under, and 1s. for amounts in excess of £1, to cover postage, etc., must be remitted at the same time. In cases of persons not resident within the United Kingdom, double fees are charged.

The amount of the Deposit and Fee must be remitted by Postal Order or Registered Letter (Cheques cannot be accepted), addressed to

"AMATEUR WIRELESS," ADVERTISEMENT DEPARTMENT, 58/61 FETTER LANE, LONDON, E.C.4.

GRAMOPHONE, Wireless, Electrical and Cycle business in busy West London district for sale owing to death of owner. Lease 11 years, ground rent £8 p.a. Price for quick sale, £1,200. Full details HEALEY & BAKER, 29 George St., Hanover Sq., W.1. Mayfair 2965.

THE new July edition of our famous Catalogue of Radio Bargains now contains 500 illustrations of electrical instruments, radio sets and COMPONENTS OF GREAT INTEREST. Many of these are unobtainable elsewhere and our prices are the very lowest.

The experimenter on Mains Sets, the expert transmitter, or the novice will find it advantageous to have a copy of

"THE CATALOGUE THAT SAVES YOU POUNDS"

Its scope ranges from a 3/- pair of British Headphones or a 12/6 Milliammeter to a 10,000-volt Generator and covers all requirements.

If you cannot call and inspect goods in our showrooms between 9 a.m. and 6 p.m., it will pay you to send 4d. for our Catalogue at once. Goods promptly dispatched all over the world.

ELECTRADIX RADIOS

218, Upper Thames Street, E.C.4 City 0191.

Build your own Dry Batteries

A New Wireless Hobby

We supply super capacity Dry Cells and all parts for building your own dry battery at home. This is the best and cheapest form of H.T. yet offered. Super Capacity Cells, each 1.5 volts, 22 milliamps, 3/6 per doz. Send 14d. stamp for Booklet: "How to Build a Dry Battery at Home" to-

THE LEYTON BATTERY CO. 305 Church Road : Leyton, E.10

For the Best in Radio



(THE BEST IN THE WEST) 10 LESLIE STREET, LEICESTER SQUARE, LONDON, W.C.2. OPEN TILL 7 P.M. WRITE FOR OUR CATALOGUE POSTAGE & FREE TO CALLERS



SUPPLY UNITS HIGH TENSION

For Multi-Valve Receivers Guaranteed silent: No valves: No expensive replacements:

Components from 47/6

THE TULSEMERE MANFG. CO., Dalton Street, West Norwood, S.E.27.



Guaranteed 7 DAYS' FREE TRIAL AGAINST CASH.

FOR A.C. MAINS LOW TENSION

Incorporating Westinghouse Metal Rectifier.

2, 4 or 6 volts at 1/2 an amp. No renewals: No attention:

Complete Units from 47/6

Phone: Streatham 6737.



HELLESEN DRY BATTERIES



SINCE 1887

In 1887 Helleesen invented his first dry cell.

For over 40 years Helleesens have concentrated exclusively on the manufacture of dry batteries, and to-day three large works and a small army of chemists are devoting their entire energies to maintaining the superiority of the Helleesen Battery.

There are more than 100,000 Helleesen dealers, and they are found carrying on the good work from London to Sydney and from Reykjavik to Valparaiso.

The Helleesen Battery is acknowledged as the standard against which other batteries are compared, and it is a proud position that has been won and maintained by one thing only—sheer merit.

- Standard Capacity.
- "Wiray" 9-volt Grid Bias Type 2/-
 - "Wirin" 60-volt H.T. Type ... 10/6
 - "Wirup" 99-volt H.T. Type ... 18/-
 - "Wisol" 108-volt H.T. Type ... 20/-
- Treble Capacity.
- "Kclin" 60-volt H.T. Type ... 19/-
 - "Kclup" 99-volt H.T. Type ... 32/6
- Your Dealer Sells Them.

HUNTS

HELLESEN DRY BATTERIES,
ELECTRICAL MEASURING INSTRUMENTS,
POLYMET MICA AND PAPER CONDENSERS,
HANDLAMPS, TORCHES, ETC.

P. & T.

A. H. HUNT, LTD., CROYDON, SURREY

WEARITE COMPONENTS TALISMAN PORTABLE

Mr. L. A. Chapman has designed this special coil on entirely new lines. Two windings are arranged in parallel for medium wavelength reception, but for long wavelength reception only one winding is used, the two halves of the medium wavelength winding being left "dead" at each end of the long wavelength winding. This introduces just enough damping to offset any tendency to oscillation, when working on the long wavelengths. The arrangement of the switching permits retention of the centre tapping whether switched for medium or long wavelengths, so that the coil can be used in either a tapped tuned-anode circuit or in a plain tuned-anode circuit.

The Chapman Dual-range Coil is specially designed for use with screen-grid valves

Price
7/6

Other WEARITE Components suitable for this Receiver are:

- Battery Switch (on and off) G22 ... 1/-
- Wave Change Switch (3 way) ... 1/6
- Screen, per pair ... 6/-

WRITE FOR NEW LIST

WRIGHT & WEARE LTD., 740 HIGH ROAD,
TOTTENHAM, N.17 Phone: Tottenham 3847 and 3848

WATCH FOR WEARITE A.C. VALVE HOLDER

DUBILIER FOR DURABILITY



PAPER CONDENSERS

- .01 to 1 ... each 2/-
 - .125 and .2 ... each 2/3
 - .25 and .3 ... each 2/5
 - .4 and .5 ... each 2/6
 - 1.0 each 2/6 2.0 each 3/6
- Prices of higher values on application.

MICA CONDENSER Type 620

- .00005 to .0009 ... 2/6
- .001 to .006 ... 3/-
- .007 to .009 ... 3/6

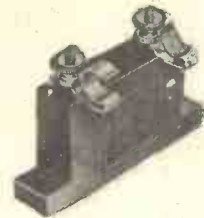

MICA CONDENSER Type 610

- .00005 to .0009 ... 2/6
- .001 to .006 ... 3/-
- .007 to .009 ... 3/6



MICA CONDENSER Type B775

- .01 - 4/- .1 - 8/6
 - .5 - 37/6
- Intermediate Capacities at proportionate prices.

"TOREADOR SCREEN-GRID FOUR." This set incorporates the latest developments in Receiver design—full constructional details free on request.

DUBILIER FIXED CONDENSERS

If unobtainable from your dealer, write direct to us giving his name and address.



Dubilier Condenser Co. (1925) Ltd., Ducon Works, Victoria Road, N. Acton, London W 7

©244/F

For Rectifiers

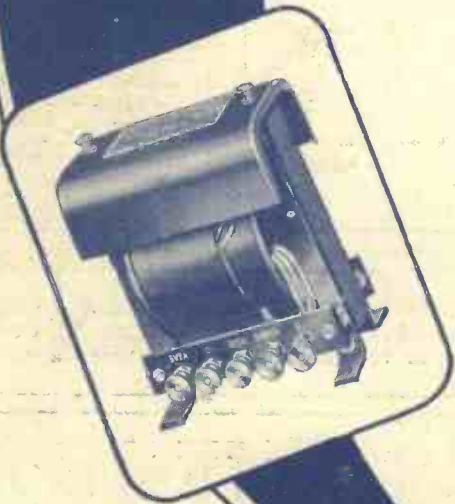
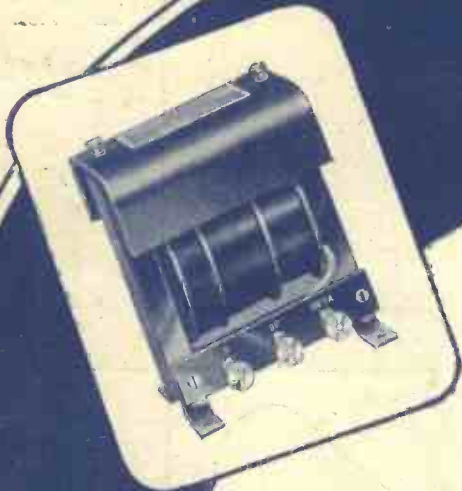

A full range of Power Transformers for Westinghouse Metal Rectifiers — Igranic-Elkon Metal Rectifiers, Valve Rectifiers, and for feeding ordinary and A.C. Valves.

These Transformers, which will shortly be placed on the market, are typical products of VARLEY research—(a research that has made the name VARLEY famous everywhere).



Advertisement of Oliver Pell Control Ltd.,
Kingsway House, 308 Kingsway, London, W.C.2.
Telephone: Holborn 5303.