

FREE Booklet and FREE Coloured Plate GIVEN AWAY

BRITAIN'S MOST POPULAR THREE-VALVER

Amateur Wireless

And Electrics

Vol. VIII. No. 195

SATURDAY, FEBRUARY 27, 1926

Price 3d

**With this Issue
We Present a**

FREE

**Booklet and
FREE**

**Large
Constructional
Guide in Colours**

showing how to build

**Britain's Most
Popular
Three-valver,**

as revealed by "A.W."s
recent Free Prize Ballot.

Registered at G.P.O. as a Newspaper.



This is a photograph of the set declared by readers in the "A.W." Free Prize Ballot to be "Britain's Most Popular Three-valver."

30 MILLION DUBILIER Condensers *Are now in use*

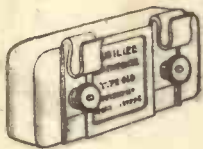

Type 610 Mica Condenser
for general use in receiver
and circuits. Capacities
0.0001-0.015 M.F.
Diam 3/8"



The Dubrescon
Permanent Valve
Protector - 6/-

These stupendous figures seem at first sight almost incredible. Yet they are correct, for Dubilier products are known and used all over the world.

The World's leading set manufacturers have standardised on Dubilier condenser equipment; the World's most important transmitting stations are equipped with banks of Dubilier Condensers, and every important Government department in the principal countries of the World makes use of Dubilier products for radio purposes.

The Dubilier Condenser Co. (1925) Ltd. manufacture Fixed Mica Condensers, Variable Air Condensers, Anode Resistances, Grid Leaks, the Dubrescon Valve Protector, the Duxon Aerial Adaptor, the Minicap Switch and the Mansbridge Variometer.

The Company are also sole concessionaires for the products of the Mansbridge Condenser Co. Ltd.

Specify Dubilier

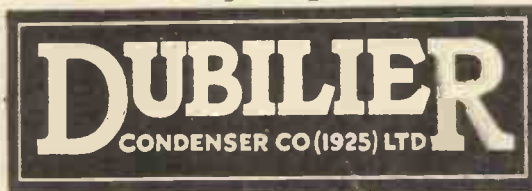

ADVERT. OF THE DUBILIER CONDENSER CO. (1925) LTD., DUXON WORKS, VICTORIA ROAD, NORTH MIDDLEBURY, N. J. TELEPHONE: CHISWICK 2741-2-3.
E.P.S. 172

Marconi VALVES for 2-volt accumulators



Type D.E.R.
 General purpose dull emitter valve which may be used with satisfaction in any position on a receiving set.
 14/-

Ensure the faithful rendering of broadcast music, song and speech by fitting the correct type of Marconi Valve in each holder of your set.

Marconi Valves are supreme by repute and actual test. For power and purity of reception, economy in current consumption and for long life they are invariably chosen by discriminating radio enthusiasts everywhere.



Type D.E.6
 Particularly suitable for use in the last stage of a L.F. amplifier using D.E.R. or D.E.2 in the initial stages.
 18/6

Table, showing recommended combinations for Marconi Valves for 2-volt Accumulators

	Type	Position	Grid Bias Volts	High Tension Volts
2-Valve Set One H.F. and Detector	DER	H.F.	0	40
	DER	DET	+2	40
	DE 2 H.F.	H.F.	0	60
	DE 2 H.F.	DET	+2	60
2-Valve Set Detector and one L.F.	DER	DET	+2	40
	DER	L.F.	-3	80
	DE 2 H.F.	DET	+2	60
	DE 2 L.F.	L.F.	-4.5	80
	DER	DET	+2	40
	DE 6	L.F.	-9	120
3-Valve Set H.F. Detector and L.F.	DER	H.F.	0	40
	DER	DET	+2	40
	DER	L.F.	-3	80
	DE 2 H.F.	H.F.	0	60
	DE 2 H.F.	DET	+2	60
	DE 6	L.F.	-9	120
3-valve Set Detector and 2 L.F.	DER	DET	+2	40
	DER	1 L.F.	-4.5	120
	DE 6	2 L.F.	-9	120
	DE 2 H.F.	DET	+2	60
	DE 2 L.F.	1 L.F.	-3	80
	DE 6	2 L.F.	-6	80
	DER	DET	+2	40
	DE 6	1 L.F.	-9	120
	DE 6	2 L.F.	-9	120
	DE 2 H.F.	DET	+2	60
DE 6	1 L.F.	-9	120	
DE 6	2 L.F.	-9	120	



Type D.E.2
 L.F. and H.F.
 The Marconi D.E.2 is an important advance in the design of valves for use with 2-volt accumulators, the filament consumption is very low without detriment to its other characteristics.
 15/6

For other recommended Marconi Valve Combinations, write for Publication RT 443

THE MARCONIPHONE COMPANY, LIMITED

Registered Office: Marconi House, Strand, London, W.C.2
 Head Office: 210-212 Tottenham Court Road, London, W.1

Branches: Aberdeen, Bristol, Birmingham, Belfast, Cardiff, Cheltenham, Dublin, Glasgow, Leeds, Liverpool, Manchester, Newcastle, Nottingham, Southampton, Swansea.



"It Certainly is—"

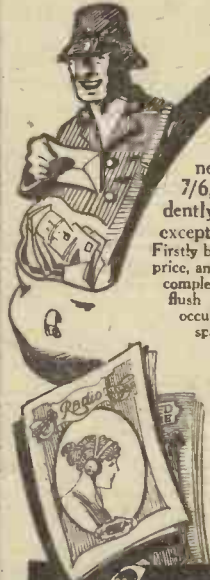

an achievement to produce reliable electrical meters whose size (1½" dial) is as remarkable as their smallness in price, viz., 7/6, and we confidently anticipate an exceptional demand. Firstly by reason of the low price, and secondly because a complete set can be mounted flush on a small cabinet occupying very little more space than an ordinary valve window.



Supplied as under:—
 Voltmeters 0-6 7/6
 Ammeters 0-3 & 0-6 7/6
 Milliammeters 0-20 10/6
 High and Low Reading Combined Voltmeters 0-12, 0-120, 11/6
 Order now to ensure early delivery.

Send name and address on P.C. for free copy of our 44-PAGE RADIO CATALOGUE

Economic Electric Ltd
 10 FITZROY SQUARE,
 LONDON. W.I.

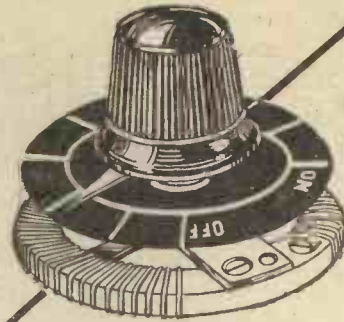

2/6

5, 15 or 30 ohms

Complete with KNOB & DIAL

**THE NEW MODEL
 ELLA-VARIC RHEOSTAT**

represents the last word in filament control, and no better rheostat can be obtained at any price.

It is British made, of British materials throughout, and will enhance the appearance of any panel.

From your dealer or direct from:—

LIONEL ROBINSON & CO.,
 3H, STAPLE INN, HOLBORN,
 LONDON, W.C.1.

Telephone: HOLBORN 6323.

Aldwych.

You want THE BEST!

When buying coil holders, Ask for "Lotus" and you will get the best.

LOTUS Coil Holders

are made from Bakelite mouldings with nickel-plated fittings, they are an ornament to any set and they give the best results. MOVING BLOCK CANNOT FALL.

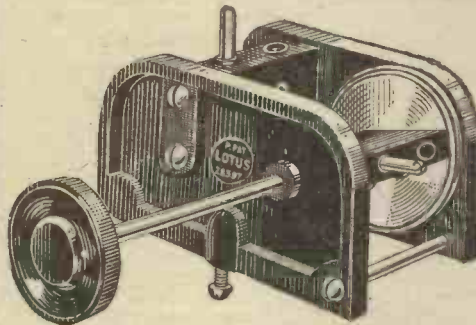

There are two types of "Lotus" Coil Holders.

For outside Panel Mounting, Two way 7/-. Three way 10/6.
 For Inside Baseboard Mounting, 6-inch handle. Two way 8/-. Three way 12/6.

The Vernier Movement is actuated by three sets of enclosed Precision Cut Gears, representing a reduction of 8 to 1.

TESTIMONIAL

"I should like to take this opportunity of saying how glad I am that I fitted your coil holder. I can now, without any other alteration to my set (Det. L.F.), receive 6 stations with comparative ease, where before, tuning in of 3 was an achievement."

GARNETT WHITELEY & CO., Ltd.
 Lotus Works, Broadgreen Road,
 LIVERPOOL

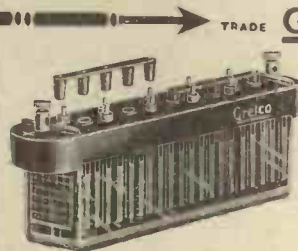

THE H.T. ACCUMULATOR

2 AMP. HOUR

Do you know that so many of the noises put down to atmospherics, etc., are entirely due to the inevitable polarisation of the Dry Battery?

Do you want absolute H.T. silence with far greater and purer volume? Do you want to be assured of a constant H.T. supply whose running costs are practically nil? The solution lies in the use of this exceptionally well made accumulator which can easily be recharged for a few pence in your own home after prolonged use whether you have D.C. or A.C.

- (1) Non-corrosive tapping points every 2 volts: each has its own grease cup.
- (2) Every cell readily inspected.
- (3) Thick clear Mono Block Moulding of annealed glass.
- (4) No separators, no frothing, no leaks.
- (5) Will last for years.

Price 12/- per 20 volt unit. In a dry charged state, only needs acid; also supplied fully charged with acid, 1/6 extra per 20 volt; 6 or more sent fully charged with acid or dry, carr. pd.

The RECTIFIER

Made especially for charging these accumulators from A.C. mains. Absolutely no trouble. State supply voltage, we will send correct lamp if ordered with accumulators.

Price 25/-, post 6d.
 Lamp extra 1/6.

HAVE YOU YOUR COPY OF OUR 132 PAGE ILLUSTRATED CATALOGUE POST FREE?

Telephone: MUSEUM 241

Works: BLOUGH

ELECTRIC GRAFTON COMPANY

54, GRAFTON STREET,

LONDON N.1

TOTTENHAM COURT ROAD,

Amateur Wireless

and Electrics

The Leading Radio Weekly for the Constructor, Listener
and Experimenter

Vol. VIII. No. 195

Edited by BERNARD E. JONES
Technical Adviser: SYDNEY BRYDON, D.Sc., M.I.E.E.

FEBRUARY 27, 1926

Chief Contents

	PAGE
Television — A Fascinating Problem - - - -	323
Tapping Low-loss Coils -	324
A "Kitten" One-valve Set	325
On 600 Metres - - -	326
Wiring a Super-Het - -	326
How Valves are Exhausted	327
On Your Wavelength -	333
More About the "Wet" H.T. Battery - - -	335
Getting the Distant Station	336
Practical Odds and Ends -	339
High-tension Supply From "A.C." Mains - - -	340
"A.W." Tests of Apparatus - - - -	343
Our Information Bureau -	344

"Amateur Wireless and Electrics," Price Threepence. Published on Thursdays and bearing the date of Saturday immediately following. Post free to any part of the world: 3 months, 4s. 6d.; 6 months, 8s. 9d.; 12 months, 17s. 6d. Postal Orders, Post Office Orders, or Cheques should be made payable to the Proprietors, Cassell and Co., Ltd.

General Correspondence is to be brief and written on one side of the paper only. All sketches and drawings to be on separate sheets.

Contributions are always welcome, will be promptly considered, and if used will be paid for.

Queries should be addressed to the Editor, and the conditions printed at the head of "Our Information Bureau" should be closely observed.

Communications should be addressed, according to their nature, to The Editor, The Advertisement Manager, or The Publisher, "Amateur Wireless," La Belle Sauvage, London, E.C.4.

TELEVISION—A FASCINATING PROBLEM

SEEING by wireless, perhaps the most fascinating of wireless problems, is coming to the fore, and from many quarters one hears prophecies and even promises of its accomplishment. Inventors are busy in England, in France, Germany and America, and sooner or later some really practical means is certain to be found which will enable us to see just as we now hear—by wireless transmission of energy.

The day may be long distant when we shall be able to see on a little screen fitted up alongside of the wireless receiver the actual happening of big events, the actual performance of the play to the music of which we are listening. But that day is nevertheless approaching, and before it arrives there will be many inventions of the nature of "stepping stones," some of which will provide interest and amusement and may appeal to every amateur with a wireless set.

Rich Rewards

There is more than one stimulus to the scientist and the inventor to get busy on a solution of television. Such new problems as the transmission of the view seen in the periscope of a submarine to its attendant battleship have been seriously considered; the enormous wealth of the cinematograph industry has assured a rich reward to the man who will discover a way to transmit motion pictures by wireless; and, what is equally important, one of the greatest difficulties in the way of television has been removed through the introduction of those wonderful photo-electric cells which will respond to the slightest change of light in the millionth part of a second.

We saw last year photographs sent by wireless across the Atlantic, and later the

transmission of photographs by simple apparatus which can be worked by anyone without special experience. The sending of a single picture in two or three minutes is only the precursor of the sending of a dozen pictures in a single second—and once this is done television will have arrived.

The news that application has been made to the Postmaster-General for permission to establish television broad-

casting stations is evidence that serious things are afoot, and though early results may be disappointing and crude, and the mechanism involved hopelessly complicated, this important and gigantic problem is one in which amateurs can help by their own interest and experiment.

Once again that versatile and energetic Frenchman, Edouard Belin, has promised us a speedy solution of the problem on which he has worked so long. It is eighteen years since we saw his first television apparatus in Paris, an apparatus which, like that of many other inventors, was destined never to see completion owing to the colossal expense that would have been involved in its construction.

At that time the light-sensitive units were made with selenium, an element we shall have a good deal to say about from time to time. Selenium, when suitably prepared, increases in electrical conductivity if light falls upon it, and a selenium cell thus acts as an "electric eye" which appraises the light intensity of what is before it and translates it into a current of corresponding strength, but its response is comparatively slow. Now something has come along as epoch-making in its way as the three-electrode valve—the photo-electric cell, which will be dealt with in an early issue.

T. THORNE BAKER.

ALTHOUGH it may be a considerable time before television is brought to such perfection that we shall be able to see broadcast events as well as we can now hear them, there is no doubt that some remarkable results are rearing the efforts of those engaged on the problem. With this in mind we have arranged with Mr. T. Thorne Baker, the foremost British authority on the subject, to contribute an exclusive weekly article on this, the newest of sciences. Here is his introductory article.

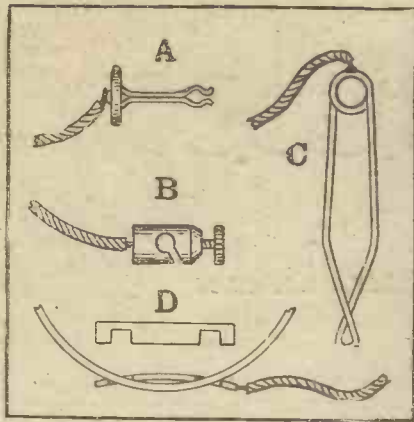

Fig. 1.—A Few Tapping Devices.

GENERALLY a single variable inductance tapping is preferable to a number of fixed tapplings with extended leads and selector switch, particularly where low-loss coils are concerned. The former method may not be quite so convenient in operation, but it presents fewer difficulties and complications on the constructional side, obviates the usual capacity effects between tapping leads and switch studs, and is decidedly more efficient. A low-loss coil wound with a fairly heavy gauge of bare wire over a skeleton cylindrical former lends itself admirably to the application of some simple and efficient form of variable tapping, yet so far no such device is available. To-day there is a demand, almost as colossal, for a "slide-tap," or otherwise a variable tapping device for low-loss coils, and any amateur might do well to pursue the subject with a view to producing the much-wanted gadget on a commercial basis.

Spring and Clip Devices

The following ideas and suggestions may be helpful. In Fig. 1 we have a small selection of the most common "make-shifts," A representing an ordinary paper fastener which is arranged as shown to be simply clipped on to any turn of the bare-coil winding. The chief drawback with this or other devices of a similar nature is that in order to open the clip and spring it over the wire it must be pushed against the wire with considerable force, and consequently the coil winding, being of soft copper, has a tendency to bend inwards. Then, again, when removing the clip the wire is subjected to an outward pull which is in no way agreeable. This, of course, is not so pronounced when the clip makes a very light contact, but if the coil is mounted vertically the contact must be fairly hard, otherwise the shank and head of the clip will fall and make contact with other turns on the coil. Now consider the weight of the flexible connecting lead and it will be seen that unless the coil is mounted horizontally, and the light and uncertain contact counted out, such a device is not likely to become a success.

By arranging a small terminal in the manner shown at B a much better contact

TAPPING LOW-LOSS COILS
Some useful tips for the experimenter

is obtained, and by tightening the milled nut sufficiently the terminal can be locked in any position and the weight of the connecting lead ignored. But in this case the spacing between turns would have to be somewhat greater than usual in order to pass the terminal body, and since it is not always convenient to place the hand inside

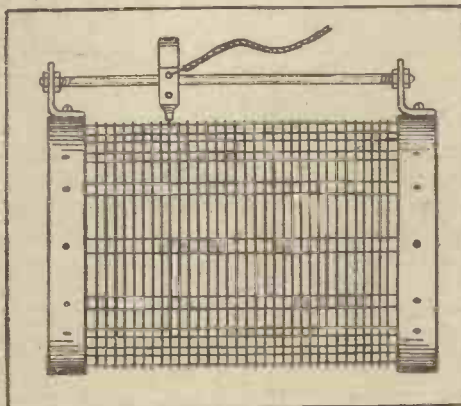

Fig. 3.—Side View of Slider Contact.

the coil to tighten the milled nut, such an arrangement leaves much to be desired.

The safety-pin arrangement shown at C might be placed in the same category as the paper-fastener, this being only suitable for use in conjunction with horizontal coils mounted high enough to permit easy manipulation from underneath, so as to avoid undesirable contact made by the body of the clip falling on to adjacent turns. The

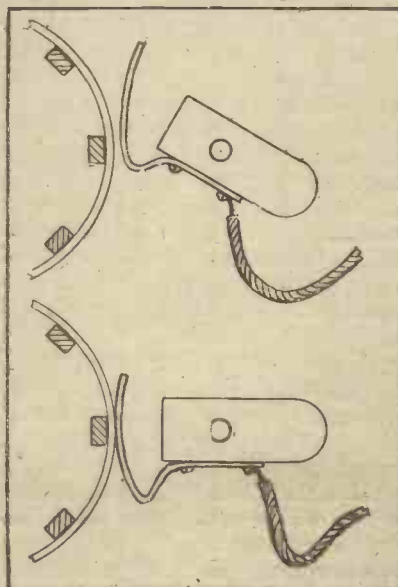

Fig. 2.—An Efficient Method of Tapping.

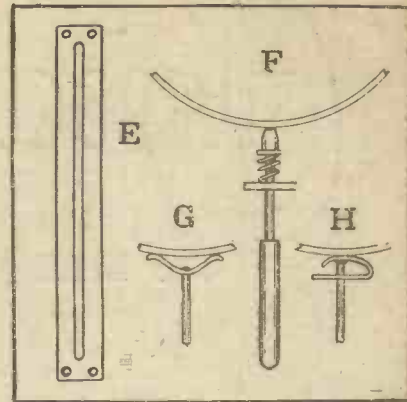

Fig. 4.—Other Contacting Devices.

simple spring brass clip at D will be found quite satisfactory providing the coil turns are well spaced. This makes efficient contact with the wire owing to its natural tendency to straighten out after being sprung on in the manner shown. A modification of this idea might be successful.

A Spring Slider

One of the most simple, convenient and efficient arrangements devised and adopted by the writer is shown in Fig. 2, where a narrow strip of thin springy brass (or springy copper-foil) is bent to the shape indicated in the upper sketch and attached to one edge of a small ebonite block, which is made to swivel and slide over a supporting metal rod. The rod is axial to the true diameter of the coil, and by swivelling the block to the position shown in the lower sketch the light spring cam engages any turn on the winding. (according to the position of the block on the rod), preferably at a point where the turns are supported on the inside by one of the ebonite spacers (shown in section). The guide rod is attached to the coil former by means of two small metal brackets in the manner shown in Fig. 3.

A few further suggestions are given in Fig. 4, where a strip of sheet brass is slotted as shown at E and fitted to the coil former in place of the guide rod in the previous example. A V-jawed brass plunger with spindle and ebonite handle is made to slide freely in the slot, a small compression spring keeping the plunger in good contact with the selected turn of the coil winding, as shown at F. To adjust the slider it is only necessary to withdraw the handle, slide the spindle to the desired position and release the handle.

The V plunger might be replaced by a simple flat spring as shown at G, or the plunger could be combined with the spring as at H, where a piece of spring brass is bent as shown, a hole being drilled through the flat portion to clear the spindle, which is soldered to the inner surface of the curved portion. The flat portion of the clip rests hard against the inside face of the slotted guide plate, a light pull on the spindle releasing the curved portion, or contact, when it is desired to make an adjustment. O. J. F.



Rear View showing Components.

A "KITTEN" ONE-VALVE SET



View with Back and Side Removed.

A COMMON fault of nearly all small one-valve sets is the fact that the valve is mounted outside, generally on the top of the cabinet. Moreover, the construction of most of these sets is far too difficult for the average amateur, and the wiring is crowded into such a small space that terminals, etc., are most inconvenient to get at.

The proposed design is carried out along new lines. The set shown in the photographs is a standard small cabinet set, with the valve mounted inside entirely out of harm's way. The only fitting mounted on the outside is the small Polar coil unit, which is detachable, and when this is removed a small box of 5 or 6 in. square at the most is left.

In this condition the set can be carried about quite easily, and as the valve is mounted on a cushioned Benjamin socket, it will not suffer unduly from the unavoidable shocks. This is just the kind of set to take round to a friend's house, to have with one on a car or when travelling generally.

The name given to this set may call for a word or two of explanation: The layout shown in the photographs was merely rigged up on a cardboard foundation to see how the parts fitted in. It appeared so small and compact that one was reminded of a curled-up kitten, for the latter makes a similar picture when nestling in its favourite cosy corner.

First a few words regarding the choice of components: The condenser is a Cosmos of .0005-microfarad capacity, its design fits in very well with the layout suggested if the condenser is mounted as shown, for the two top terminals lend themselves very easily to the connections to the Polar coil unit. In addition, the condenser is very compact.

Wiring, which is not shown in the photographs, can be done in comfort, and all parts are accessible. When completed, the set is slipped into the cabinet and the front panel secured to the front part of the cabinet by four small screws. To give access to the valve, the top portion of the cabinet, as well as the rear vertical board, could be hinged. Fig. 3 shows the circuit diagram.

With this design it would not be possible to place the filament rheostat in the position shown, and it is suggested that the smallest Lissenstat be mounted on the front panel in the right-hand bottom corner.

The front layout is clearly shown in one of the photographs; a small panel 5 or 6 in. square is used. Very little ebonite is necessary in the construction. Above the front panel and in front is a narrow strip of ebonite 2 in. wide, extending the whole width of the cabinet. This carries the Polar coil unit. Fig. 1, which is section through the cabinet, shows how this top panel is secured to the front panel and the base.

Two thin wooden strips are used; they are secured to a recess in the baseboard and also to the front panel by small screws. The edges of the top panel are also screwed to these wooden strips. Each of the strips lies against the outside of the wooden baseboard. The result is a very stiff structure, and the point gained is that the whole of the set can be pulled out when the base is removed.

The terminals are attached to the back of the baseboard, and the arrangement
(Continued in third col. of next page).



The Complete Receiver with Polar Coil Unit.

In the set photographed an attempt was made to house it in a small box, using a movable back section to allow access to the components; therefore the filament rheostat is shown mounted on the right-hand side of the container. A much better layout is, however, the one shown in the drawings Figs. 1 and 2. Here the entire set is mounted on a sliding baseboard, to which the front, back and top ebonite panels are attached.

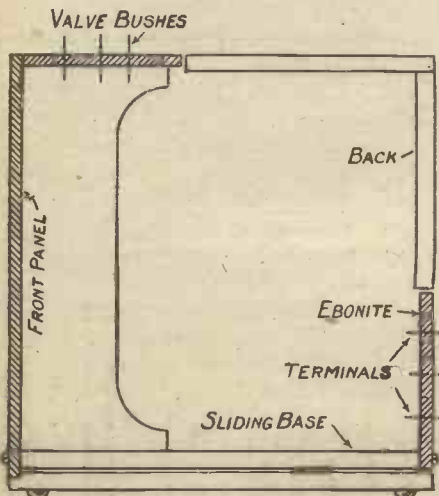

Fig. 1.—Section of Case.

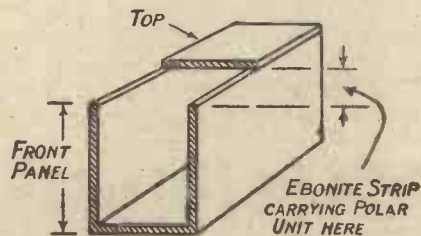

Fig. 2.—Diagram showing Position of Panels.

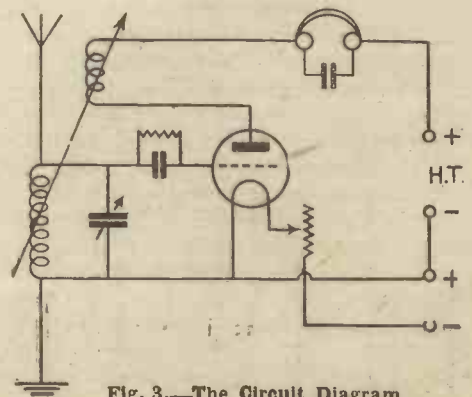

Fig. 3.—The Circuit Diagram.

ON 600 METRES

THE present strike of wireless operators affords an excellent opportunity of practice for those amateurs who wish to work up their morse code.

Many of the British ships putting to sea are carrying operators with restricted certificates, while some have no operator at all. Consequently the coast stations are compelled to transmit traffic at twelve words per minute or so, and at the same time interference is less all round.

In order to get full enjoyment from copying ship-to-shore working, it is necessary to know something about the procedure of traffic handling at sea.

First, a sound knowledge of the Q abbreviations is required. These have already been explained in "A.W.," but for the benefit of the absolute beginner the most common are detailed below in abbreviation.

QRB? How far are you from my station?
The distance is; or,
My position is

QRD? Where are you bound for?
I am bound for.....

QRF? Where are you coming from?
I am coming from.....

QRT? Shall I stop sending?
Stop sending.

QTC? Have you anything for me?
I have messages for you.

QRU
I have nothing for you.

It should be noted that when an abbreviation is followed by "?" (.) an interrogation is implied; when it is omitted an answer is implied. Thus:

QRB? Ans. QRB 50 miles S.W., or
QRB off Land's End.

When a ship comes within range of a coast station it is required to transmit certain information to that station. This information is prefixed "TR," and states:

- (1) The name of the ship.
- (2) Port of destination.
- (3) Last port of call.
- (4) Distance of ship from coast station, or its position with reference to some well-known landmark.

A typical "TR" is given below.

"Ere ss. *Nonsuch* bnd New York fm
Ldn QRB off Beachy Head."

The "bnd," "fm," and "Ldn" are, of course, abbreviations for bound, from and London respectively.

A radiogram proper may be divided into three parts—the preamble, the text and the signature. These parts are separated by the break sign (- . . . -). The preamble begins with the word Radio, followed by

the name of the ship in which the message originated. Then comes the number of the radiogram in the ship's lists, the number of words and the date and time of handing in, and finally the service instructions, if any. These particulars are always transmitted in the above order. The letters "nr" in a preamble mean "number of radiogram." A typical preamble might run:

"Radio ss. *Nonsuch* nr 2 wds. 12 date
14th. 0930 -"

Another interesting message which may be heard on 600 metres is the navigation warning or TTT signal. A station wishing to send a navigation warning transmits thirty groups of three T's. After a pause of half a minute the message follows.

Almost any type of receiver is suitable for the reception of shipping, but additional interest can be obtained if a frame aerial is used, since the approximate position of a station can be calculated.

Finally, a word of advice to would-be telegraphists. Don't shirk the fast stuff when it comes your way. Half a dozen letters written down correctly from a message sent at twenty-five words per minute will do you more good than pages of accurate copy taken at a speed below your average.

G. H. R.

WIRING A SUPER-HET

AT first the beginner is inclined to be nervous of the complicated wiring of a super-het. He may be tempted to think that the task is beyond his powers. This is a pity, because in reality the wiring is quite straightforward provided it is tackled systematically.

The receiver consists of seven valves, that is, oscillator, first detector, long-wave amplifier, second detector and note magnifier.

The best way of making the numerous connections is to finish the wiring by stages. First complete the battery leads, keeping the busbar close to the panel in order to leave room for the remaining wires.

The next step is to wire up the I.F. (intermediate-frequency) transformers. The connections are very similar to those of an ordinary low-frequency transformer; there is the primary winding which goes to the plate of the valve and H.T. + and the secondary winding which is connected to the grid of the next valve and to the potentiometer. The potentiometer controls the grid of the amplifying valves.

The wiring of the oscillator coupling should be carefully studied before the connections are made. The first pair of terminals represents the "pick-up" coil of the first rectifying valve; the second and third pair of terminals represent the plate and grid coils of the oscillator valve respectively. It should be noticed that the grid coil is tuned. The different terminals are always plainly marked by the maker of the kit.

It is a good plan to keep the different leads upon three levels. The battery wires should be laid flat upon the panel. The connections to the I.F. transformers, grid and plate leads, etc., should be kept 2 in. or so above the baseboard. The third level should be reserved for the busbar to the reservoir condensers. This system may seem at first to be scarcely worth the trouble, but in the long run it is far superior to the indiscriminate arrangement of the wiring on most home-built sets.

Avoid the use of systoflex on a super-het. Capacity effects are always undesirable, and there is really no danger of short-circuits so long as a fair space is left

between each wire and its neighbour. Keep the busbar rigid and make neat right-angle bends wherever necessary. Use the soldering-iron as carefully as possible and be sure to remove traces of surplus flux. Finally, test every connection before putting the receiver into operation. M.

"A 'KITTEEN' ONE-VALVE SET" (continued
from preceding page)

shown was found to be quite convenient. A slot is cut in the cabinet to allow them to project.

To test the efficiency of the set, the parts shown were mounted on a hook-up board and wired up as suggested by the Polar Co. Excellent phone reception from the nearest broadcasting station (Manchester, sixty-five miles away) was obtained, and many other stations were tuned in. Among them were Union Radio, Madrid, Munster, London, Dublin, Cardiff, Liverpool, etc. A great advantage of the Polar unit is that Daventry can be received as well, and the user is no longer confined to the lower wave band.

C. A. O.

HOW VALVES ARE EXHAUSTED

THE everyday user of receiving valves for broadcast purposes or small transmitting valves for experimental work is apt to compare the price of the valve with that of the ordinary electric lamp, and to ask the reason for the difference. Apart from the added cost of the additional electrode structure as compared with the simple filament of the ordinary electric lamp, the extra cost is largely made up by the intensive methods employed to obtain the extra degree of vacuum required compared with a lamp. The writer, who has had considerable experience in these methods, will endeavour to give a general insight into the methods employed in a modern factory.

Preliminary Gas-freeing

Taking the former class first, it is evident that some amount of the gas occluded in the anode and grid systems can be removed by preliminary treatment; that is to say, before these electrodes are mounted on to the pinch and sealed into

definite period. There are two classes of furnace (1) vacuum and (2) hydrogen. These are depicted in Fig. 1 and Fig. 2 respectively. In both cases the electrodes are contained in large tubes composed of fused silica or other suitable material. In the case of the vacuum furnace, one end of the tube is closed and the other end is connected to a vacuum system by means of a rubber bung and connecting tube. In the hydrogen furnace, the gas is passed in through one end and burnt off in a very small jet at the free end. After this treatment has been carried out for a definite period, the heat is cut off and the electrodes are allowed to cool down in the vacuum or in the hydrogen. When the electrodes are completely cooled down they are taken out of the tube, mounted on to the pinch; sealed into the bulb and the valve is now ready for pumping.

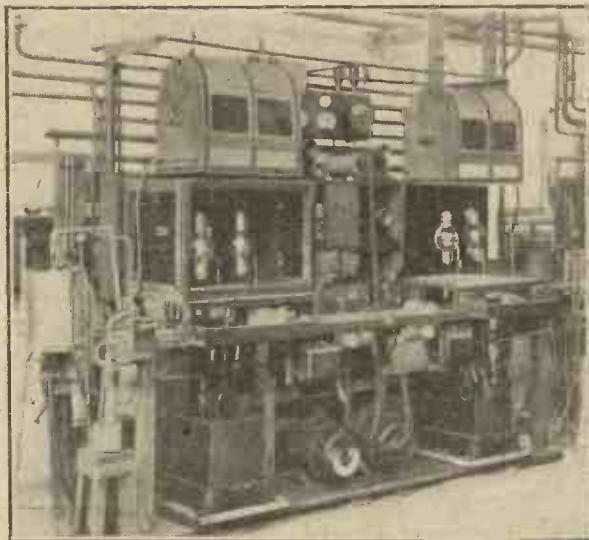

Photograph on the left:—Pumping Bench for the Exhaustion and "Gettering" of Transmitting Valves.

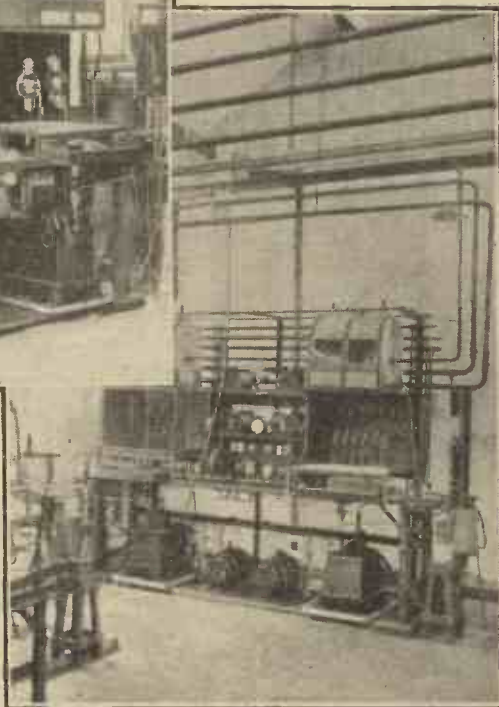

Photograph on right:—Pumping Bench for the Exhaustion and "Gettering" of Receiving Valves.

The Nature of the Gases

In general there are two classes of gas to be removed from the valve: the first of these is the gas occluded by the electrodes, that is to say, the anode, the grid and the filament. The nature of this is governed by the material used. The second class is the gas occluded by the glasswork; that is, the bulb, the pinch which carries the electrodes, and also to a lesser degree by the glasswork of the pumping apparatus itself. The chief gases in the glasswork are water vapour and carbon dioxide, and it will be understood that these must be entirely removed.

the bulb. This can be done by heating the electrodes in an electric- or gas-fired furnace at a given temperature for a

called a manifold, which is connected to the vacuum system. In the case of receiving valves, six or eight valves

The Pumping or Vacuum System

The valves are first sealed on to a glass fork connector, which is connected to the vacuum system. In the case of receiving valves, six or eight valves

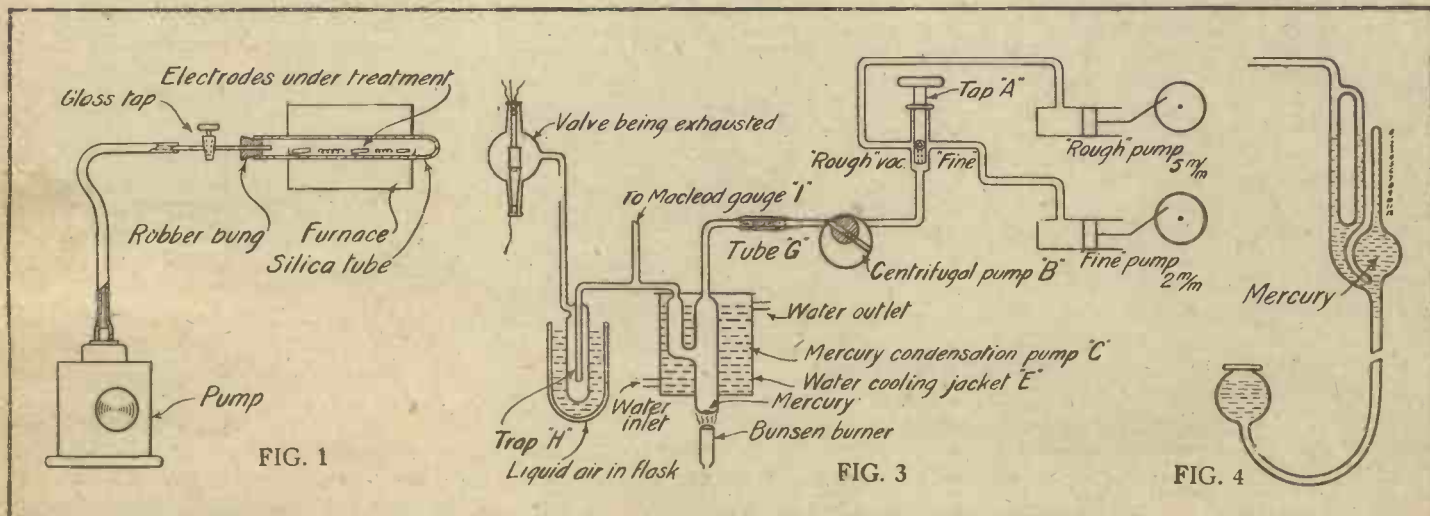

Fig. 1.—Vacuum Electrode-heating Furnace.

Fig. 3.—Diagram of Pumping System.

Fig. 4.—McLeod Vacuum Gauge.

are sealed on at once, but in the case of transmitter valves only one or two are put on at a time. Having sealed the valves on to the manifold, the operator turns the tap A in Fig. 3 to the left, thereby connecting the manifold to the "rough" factory exhaust. The rough vacuum is supplied by a large reciprocating pump, which gives about 5 mm. pressure to the whole factory. The function of this pump is merely to take the bulk of the air from the bulbs, and the

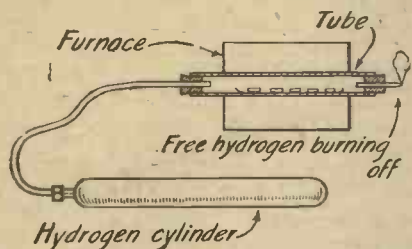

Fig. 2.—Hydrogen Electrode-heating Furnace.

system is only connected to this pump for a short period. The tap A is then turned to the right, thus connecting the system to the "fine" position; this consists of another large reciprocating pump of about 1 to 2 mm. pressure which backs up the small centrifugal pump marked B in the diagram.

The centrifugal box pump B backs up the mercury condensation pump C. The chamber of the box pump is divided into two halves by a pair of spring blades, which rotate eccentrically, pushing the gas before them, the rubbing surfaces being kept gas-tight by a liberal supply of oil.

The mercury condensation pump operates by a kind of ejector action. The larger inner chamber D (which is cooled by the circulating water jacket E) has a small

quantity of mercury at the bottom which is heated by the small bunsen burner. The mercury being heated gives off a dense blast of mercury vapour past the side aperture F, the velocity of this blast being so great as to prevent any gas molecules leaving the smaller side chamber, or ever returning.

The tube G contains some chemical drying agent such as phosphorus pentoxide to assist in absorbing water vapour. The tube H is in effect a trap and in operation is covered with liquid air. The function of this trap is to prevent any mercury vapour from getting into the valve (any mercury vapour coming this way will be condensed by the extreme cold and will fall to the bottom of the trap in the form of mercury). The instrument marked I is a Macleod gauge used for giving a rough indication of the pressure in the system (see also Fig. 4).

As soon as the vacuum (as indicated by the Macleod gauge) is good, a hood or oven is lowered over the valves and a temperature of 400-420° C. is kept constant for about half an hour. The pump is pulling during this treatment, and by this method the greater part of the gases occluded in the glass and also the water vapour clinging to the surface are cleared away. After this treatment the oven is raised and a high potential is applied to the anode and a suitable potential to the grid. In the case of receiving valves, the anode potential is usually in the nature of 1,500 volts and in the case of transmitting valves may be as high as 20,000 to 40,000 volts. By varying the filament temperature—that is, by controlling the filament current by means of a variable resistance—the electronic emission or flow of electrons from the filament to the anode is con-

trolled. This process is known as the bombardment of the valve, and during the early stages a considerable amount of gas has to be cleared by the pump as the electrodes slowly heat up. The ionisation of this gas gives the familiar blue glow discharge.

The valve is not sealed off until this ga

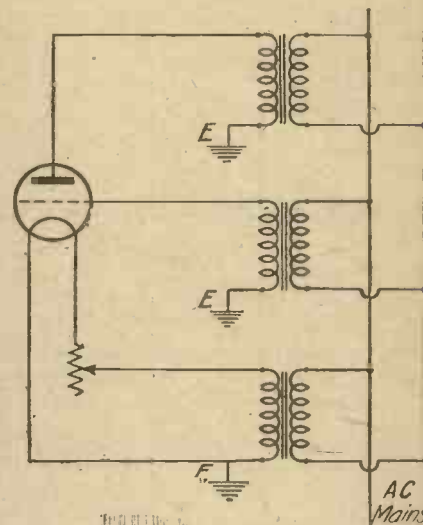

Fig. 5.—Electrical Circuit of Valve-pump Bench.

has been entirely expelled (in the case of the larger transmitting valves this takes a considerable time), the ultimate criterion of the degree of vacuum required being the ability of the valve being pumped to withstand a power dissipation test in the anode circuit for a definite length of time; the power usually being slightly in excess of the rated value of the valve. Fig. 5 shows the electrical circuit of a valve-pump bench.

The Use of "Getters"

It is a common thing for the bulb of a finished modern receiving valve to have either a dark yellow-brown colour running into a red or blue or else with a silvered mirror effect. This is an indication that chemical means have been employed to assist in the exhaustion of the valve. The yellow is an indication that phosphorus has been used and the silver that magnesium has been employed. Both these materials assist in materially reducing the time taken in pumping and consequently assist in reducing the cost of the finished valve. The lower photograph shows a small valve-pumping table in a modern factory, and the upper one a pump table set up for exhausting large transmitting valves.

A. H. H.



2 LO's NEW DANCE BAND

The B.B.C. has now formed its own dance band under the leadership of Mr. Sidney Firman.

An excellent feat in amateur transmission has just been performed by Mr. L. Bland Fagg (G 2 G O). He succeeded in getting into communication with Corporal Coates in India at 20.52 Indian standard time with a signal strength of R5. He was working with an input of 12 watts only, and attributes much of his success in long-range transmission to Osram valves.

OURSELVES—AND THE ELECTRICAL IMPULSE.



his secrets are ours

Think of it! Seventeen years' patient study of the vagaries of our jolly impulsive friend, the electrical impulse. And our laboratory experts have come through with intellects unscathed. Nay! Not only unscathed, but brightly furbished. They were able to establish friendly contact with the electrical impulse; he helped them with their plans for building radio sound reproducing instruments and encouraged their scientific research. Now, this electrical impulse uses his electrical energy to bring the radio as far as your receiver. To get him to talk easily and naturally is an operation we have perfected with his own help and advice. Seventeen years' study of the best way to capture and transform this spirit of radio sound has helped us to build the best radio speakers of the age; his secrets are ours. Get a Brandes and you will know that the properties of radio sound are harnessed as effectually as you can possibly desire.

Any good dealer stocks Brandes

THE TABLE-TALKER

The new goose-neck design is the result of research in radio acoustics, which definitely establishes its value in relation to the diaphragm fitted. Patent material used in the construction of the horn eliminates metallic harshness. Volume and sensitivity controlled with small lever located at the rear of the base. Elegantly shaped, tasteful neutral brown finish, felt-padded base. Height 18 ins., bell 10 ins.

30/-

MATCHED TONE HEADPHONES

The whole secret of Matched Tone is that one receiver refuses to have any quarrel with its twin. Aply schooled in these generous sentiments by our specially erected Matched Tone apparatus, their synchronised effort discovers greater sensitivity and volume and truer tone. There is no possibility of the sound from one earpiece being half a tone lower than its mate.

20/-

THE AUDIO TRANSFORMER

Ratio 1 to 5. The main objects in view are high amplification of applied voltage, together with a straight line amplification-frequency curve. That is to say, for a given input voltage, the amplification is constant over a wide band of frequencies, thus eliminating resonance. Mechanically protected and shielded so that the transformers may be placed close together without interaction.

17/6

THE BRANDOLA

Specially built to bring greater volume with minimum current input and exceptional clarity over the full frequency range. A large diaphragm gives new rounded fullness to the low registers and new clarified lightness to the high. Reproduction controlled by a thumb screw on the base. Polished walnut plinth with electro-plated fittings. Height 26 ins., bell 12 ins.

90/-

Brandes, Limited, 296 Regent St., London, W.1. Works—Slough, Bucks.

Brandes

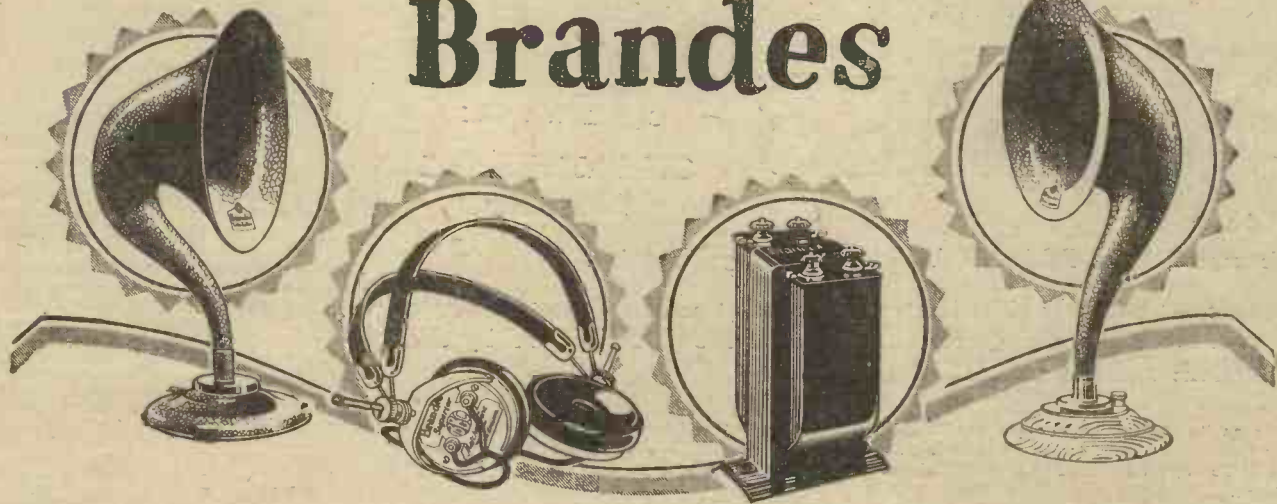

EXPERTS IN RADIO ACOUSTICS SINCE 1908

60/233

Service Advertisers

An evening with a Remarkable New Circuit

Although hundreds of wireless enthusiasts have responded to our advertisement which offered for sale the Ormsby Long Range Selective Circuit, there are undoubtedly many who are perhaps a little sceptical. To dispel all doubts concerning the extraordinary performance of this circuit, we give in illustrated form the results of an evening's actual test on 4 valves, under normal conditions, with a 75 feet aerial 25 feet high, 8 miles from London.

8-15
CUT OUT LONDON.

8-20
PRAGUE on speaker

9-5
PARIS speaker results

9-20
ROME speaker results

10-5
CARDIFF speaker results

11-0c
MADRID speaker results

This circuit is extremely selective without loss of volume, and for purity of tone it is irreproachable. **500 MILES ON LOUD SPEAKER.** This circuit will give loud speaker results 500 miles away and will **CUT OUT THE LOCAL STATION.** The Circuit Envelope contains two simple wiring charts, layout and template for baseboard and valves, and full instructions for building. Send Postal Order for 2/6.



Please state if for 3 or 4 valves, and write name and address clearly.

2/6

M. ORMSBY & CO.
28, PAGE ST., WESTMINSTER.
LONDON. Phone: Victoria 1987.

MAXIMUM

Efficiency

Strength



MINIMUM

Capacity

Damping Effects

Resistance

Ask your dealer for one of these coils for test, or write direct to us if he does not stock them and you will find them as good as, if not better than, the most expensive coils on the market.

NOTE.—Special Short Wave Coils at bottom of List.

Coil	Wave Length using '001 Variable Condenser in Parallel		PRICE.
	MAXIMUM	MINIMUM	
25	395	190	2/4
30	435	240	2/4
35	515	360	2/6
40	680	370	2/8
50	835	485	3/-
75	1250	600	3/4
100	1820	815	3/10
150	2300	960	4/8
200	3100	1870	5/4
250	3750	2200	5/8
300	4500	2300	6/-
400	4950	2500	6/6
3	154	75	2/6
10	195	105	
13	225	125	

Manufactured by
THE HAWK COIL Co., Ltd.
ST. MARY'S RD.
SURBITON
SURREY

Practical Help for the Home Lover

TOWN & COUNTRY HOMES

Edited by
Capt. G. C. CLARK

ONE SHILLING Monthly

It is essentially a PRACTICAL Home-Making Magazine.

Because—it not only gives illustrations of what can be done to create or improve the house and garden, but it shows **HOW TO DO IT** by clear illustrations and non-technical description.

It has on its staff those who are specialists in their particular line, so every article is a specialist's opinion based on practical experience.

It so arranges its schemes that they are applicable to the £300 or the £3,000-a-year reader. Every article is genuinely helpful matter and never camouflaged advertisement.

Its information bureau for giving sound advice **FREE TO READERS** is the most practical service of its kind in existence.

Its pages showing amateur mechanics how to make articles of various descriptions are of such a character as has never before been attempted.

SOME OF MARCH CONTENTS

SPECIAL ART SUPPLEMENT IN COLOURS

- A Small Home—Plans, perspective, elevation and particulars.
- A Country Cottage—Plans, perspective, elevation and particulars.
- On the Balcony—A delightful feature of the house.
- A Bungalow—Plans, perspective, elevation and particulars.
- Curtains and Draperies—Excellent ideas for window furnishing.
- The Ideal Bathroom.
- Notes on Antiques—An article of a helpful nature to lovers of antiques.
- Garden Lay-out—A special design prepared by our own Garden Architect.
- Garden Diary—A summary of garden work for the month.
- Greenhouse Notes—Work for the month.
- Poultry Notes—Practical Advice by an expert.
- Making a Lily Pond—Showing an amateur how simply such an attractive addition can be made.

ORDER YOUR COPY FROM YOUR NEWSAGENT TO-DAY

Cassell's
London, E.C.4.

CAXTON 4-VALVE CABINET

Made for Editor of Wireless Magazine for Set "As good as money can buy" described in issue February, 1925.

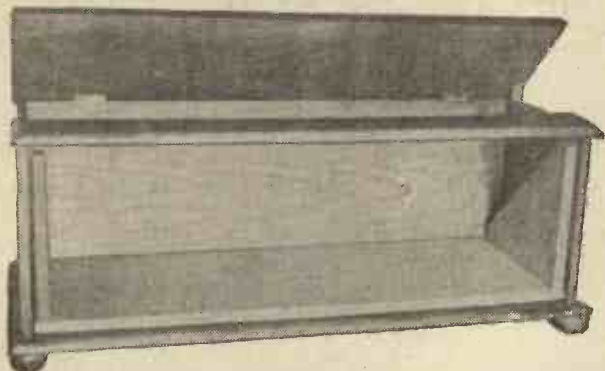

Cash with Order. Fumed Oak ... £1 5 0
or Real Mahogany polished ... £1 14 0

With detachable recess fitted Base Board to mount 21 in. by 7 in. panel to slide out of Cabinet front. Extra 10/- with two beaded front doors totally enclosing fitted panel. Cabinet overall length 22½ ins. Width 8½ ins. Height 9 ins. Polished with the new enamel that gives a glass hard surface that cannot be soiled or scratched. SENT FREE.—Catalogue of standard Wireless Cabinets in various sizes and woods. Special Cabinets made to customer's orders. PACKED AND DELIVERED FREE IN U.K.

CAXTON WOOD TURNERY CO., Market Harborough

All Post Free At Callers Prices

Orders 5/8, Value Carriage Paid. Under 5/6, 2d. per 1/- for Packing.

EBONITE PANELS. 8 1/16"

Matt	1"	3/10
9" x 6"	2/8	1/10
12" x 9"	4/6	3/9
12" x 12"	5/9	5/-
15" x 9"	5/6	4/9
15" x 12"	7/8	5/8
4" x 4"	6d.	6d.
7" x 5"	1/6	1/2
6" x 6" x 1/4"		10d.

Any Size Cut. Sq. in 1" id. 1" 1d. ADVANCE.

SQUARE LAW VAR. CONDENSER
With Knob and Dial
.001 panel type 6/6
.0005 5/-
.0003 4/6
Vernier Bladeex 1/4
"J.B." Ormond and "Utility"
Usual prices.
Vernier, no dial 2/6
"Polar" types 10/6
NO FOUNT

SEND FOR NEW FREE Comprehensive Price List. TRADE ENQUIRIES INVITED Generous Terms Prompt Service.

- TERMINALS**
MIII-Pol. Brass 2d.
4 B.A. Standard 1d.
Telephone type 11d.
Multiphone 4-w. 6d.
6-way 1/-
- AERIAL WIRE** 7/22 1/2
Enam. Bright 4 strd.
100' 3/8, 2/3 ... 1/1
do. Electron ... 1/8
Lead-in ... 4d. yd.
- INSULATORS**
Shell, 2 1/2" x 2 1/2" 3d.
Reel, 2" Id., Egg, 1d.
Cryolite cowl 1/-
Lead-in 4/-
4" & 6" do. 9d.
8" 1 1/2" - 12" & 15" 1/3
- VALVE HOLDERS**
Type A 7d., Polar 1/3
Screwed 8 nuts 6d.
Ebonite ... 10d.
Antiphonic ... 1/6
Security type ... 1/-
Baseboard type 6d.
- Sullivans 120-Ohm**
Phones. Ex-Govt. 4/6
COIL PLUGS Ebonite 10d.
Superior 1/-
Narrow 5d. Basket 11d.
Horned Coil Plugs 8d.
Coil Formers ... 21d.
Basket type ... 11d.
Coil Mounts ... 4d.
Athol "Ebonite" Coil Plug ... 1/3
Do. Porcelain ... 1/-
Basket Coil Sets ... 6, 1/9; 4, 1/-



VERNIER COIL HOLDER

Polished ebonite 2-coil type with plated fittings. Panel Mounting type with back connections. Extended handle with rubber contact roller gives exceptionally fine tuning, a splendid example of Reliability value

ONLY 3/6

- SWITCHES**, Ebonite
"Tumbler" 1/-
D.C.O. 1/8, S.C.P. 5d.
Dewar D.C.O. 2/6
D.P.S.T. 2/3
Utility 2-way ... 4/-
3w 5/-, 4w 6/-, 6w 8/-
Lever Type Stocked
Miniature Turn 6d.
Lissen 2-way ... 2/9
Series parallel 3/9
Double-arm do. 2/-
N.P. Panel type 9d.
- CONDENSERS**
Dubilier, McMichael's, Mullard (usual prices)
New Mansbridge, 2mfd. 3/6, 1mfd. 2/6

- NEW JAUSS** 4-contact, 1-hole fixing 1/9
Standard Plugs ... 1/3
Potentiometer 300 Ohms Ex-Govt. 5/-
Microphones ... 2/-
Ex-Govt. Dewar Switches, 12 contact ... 2/6
H'phone Cords 1/-
Alum. H'bands. 2/6
All "Igranite" "Eis-sen" "Burndept." "Edison-Bell" "Atlas" & "Sterling" Goods supplied.
- COIL HOLDERS**
Igranite 3 set. ... 8/6
Ebonite 3 coil ... 5/-
2 coil ... 2/6
Vernier, 2 coil ... 3/9
Anode Holder ... 9d.
- MIL. RESISTANCES**
Good quality ... 1/6
Igranite 3/6, Vern. 5/6
Ormond 2/-, Ajax 4/-
Vernier, No. 4 2/6
Burndept 5/-, 6/- & 7/6
Microstat ... 2/9
Spirals 4d. Former 7d.
Peerless Jr. ... 2/6

New 1 edition RE LIABILITY WIRELESS GUIDE, No. 2. Ready. Have you got one? IT'S FREE.

J.H. TAYLOR & Co
3 RADIO HOUSE, MACAULAY ST., HUDDERSFIELD
Tel 341 Grams "THOROUGH" HUDDERSFIELD

COSMOS PERMACONS

MICA DIELECTRIC

GUARANTEED ACCURATE CAPACITY

LOW LOSS

TESTED AT 500 VOLTS

FIXED CONDENSERS GIVING FIXED RESULTS

The "Cosmos" Permacon is an ideal fixed condenser being light in weight, of guaranteed accurate capacity, and having the lowest possible losses.

The dielectric is mica and each condenser is tested at 500 Volts during inspection. Nickel plated cases give them a particularly neat appearance.

'0001 mfd	1/6
'0002 "	1/6
'0005 "	1/6
'0003 " (with clip for grid leak)	1/8
'001 "	1/8
'002 "	1/10
'005 "	2/8
'01 "	3/9

"COSMOS" GRID LEAKS are uniform and permanent.
1, 1, 2 and 3 megohms, each 1/6
Ask for copy of the Cosmos Components Brochure.

METRO-VICK SUPPLIES LTD.
(Proprietors—Metropolitan-Vickers Elec. Co. Ltd.)
4, Central Buildings, Westminster, LONDON, S.W.1. R P29

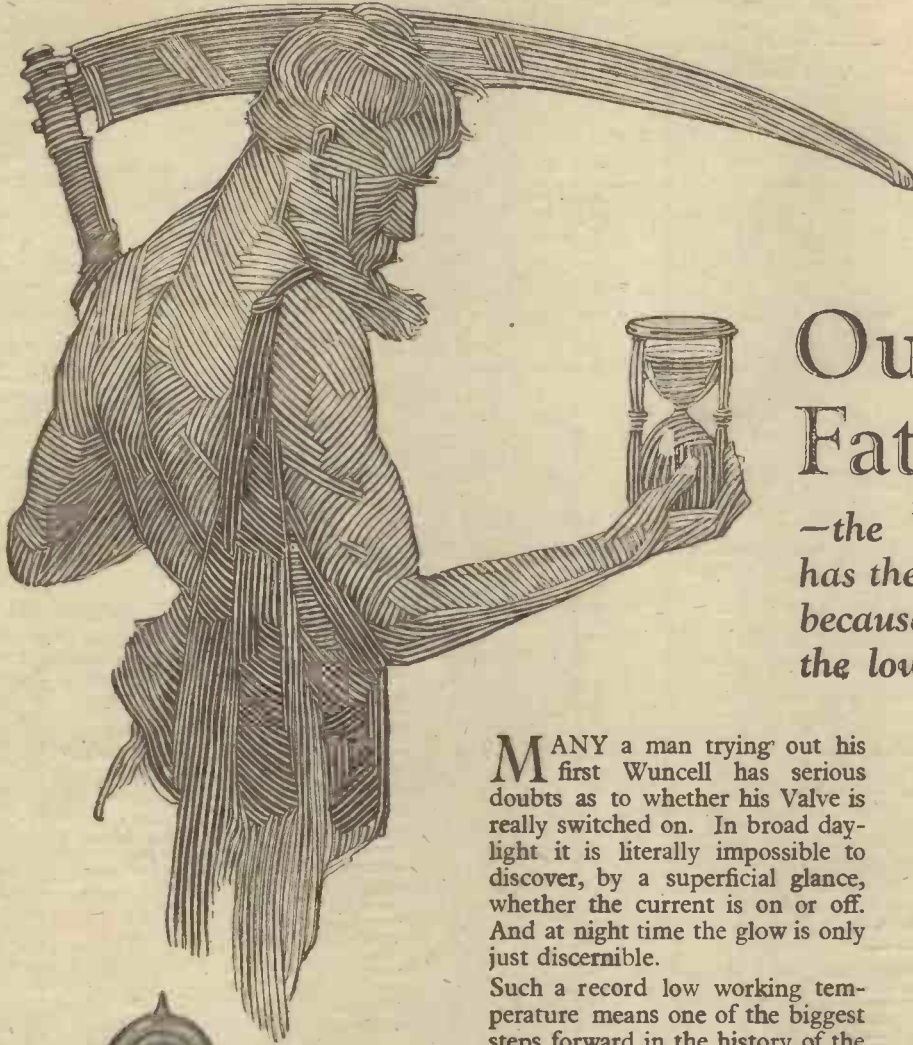

Outwitting Father Time

—the Wuncell Dull Emitter has the longest life of any valve because it operates at by far the lowest temperature.

MANY a man trying out his first Wuncell has serious doubts as to whether his Valve is really switched on. In broad daylight it is literally impossible to discover, by a superficial glance, whether the current is on or off. And at night time the glow is only just discernible.

Such a record low working temperature means one of the biggest steps forward in the history of the valve. A brilliant contribution to the fascinating quest for the "cold" valve.

The Wuncell functions at only 800°—yet some dull emitters operate at 2000°. And its filament—built up layer upon layer under the Cossor patent process—is practically as stout as that used in a bright emitter.

Allied to the Wuncell filament, of course, are the well proved Cossor principles of construction. A hood-shaped Anode which retains almost

the whole of the electron stream. An arched filament which is not subjected to the strains and stresses which every straight filament must undergo. And a hood-shaped Grid which—by a superb feat of engineering skill—is built up on a stout metal grid band with each turn of the wire secured in three distinct places. Every Wuncell Grid is secured in 35 distinct positions—such rigidity is not obtainable in any other valve. No wonder the Wuncell is acclaimed as the first non-microphonic Dull Emitter!

Remember, long life is only one of the Wuncell features—economy is another. Every Wuncell saves its cost in six months. An accumulator that lasted only one week on a charge with bright emitters would last nearly two months with Wuncell's. See your dealer about these super-economy valves at once and start saving money from to-day.



The Wuncell Dull Emitter
Voltage 1-8 volts. Consumption '3 amp.
*W1 for Detector and L.F. 14/-
*W2 for H.F. amplification 14/-

The Cossor Loud Speaker Valve W3
Voltage 1-8 volts. Consumption '5 amp.
Price 18/6

*Also in WR Series, with special switch and resistance in base to enable Valve being used with 2- 4- or 6-volt Accumulator:
WR1 for Detector and L.F. 16/-
WR2 for H.F. amplification 16/-

Cossor

On Your Wavelength!

Daventry's Quality

A GOOD many complaints have been received of late about the quality of the transmissions from 5XX. The engineering staff of the B.B.C. seem to be inclined to exonerate the transmitting station from blame and to put any roughness or harshness that may occur down to the excessive use of reaction in receiving sets. We are also told that a new and improved kind of microphone has been brought into operation which is capable of dealing much more faithfully with the lower frequencies than the type of instrument previously in use. As the bulk of the complaints received have come in since the installation of this microphone, the authorities are inclined to consider that if it does produce faulty reception this is due to the fact that transmitting sets have made a more rapid advance towards perfection than has been the case with receiving apparatus. If this were so it would mean that few, if any, of us were obtaining anything like the faithful reproduction that would be possible if only we knew how to deal properly with the transmissions that come our way. Personally I do not agree with this view.

After all, the surest way of testing the quality of a transmission is to hear it with the help of a good crystal set, for in these circumstances there is practically no distortion and you obtain the best possible results from the point of view of purity. With a view to comparing the London and Daventry transmissions, which at my place come in at almost equal strength, I rigged up recently a type of crystal set that is very useful for the purpose. It has two aerial tuning inductances and two aerial tuning condensers, a change-over switch enabling either circuit to be brought into action instantly. Choosing a night when Daventry is relaying 2LO, you tune in the latter station with one circuit, and then switch over and tune in 5XX with the other.

A Comparison

You now have a proper chance of comparing the two transmissions, since a touch of the switch is all that is needed to change from one station to the other. You can therefore make the change in a fraction of a second in the middle of a sentence of a talk or you can hear part of one musical passage from London and part from Daventry. If there is any difference in the quality of the two you will notice it at once. I used to find that Daventry varied a good deal, being sometimes pleasant and mellow and sometimes a little rough and with a tendency to tonelessness. At present it seems to me that

there is not so much variation, but that on the whole the transmissions are not so pleasant to listen to as those of 2LO.

It must be remembered that there are great difficulties in obtaining perfect modulation with an output as big as that of 5XX. Up to 5 or 6 kilowatts something approaching perfection in modulation is not difficult to obtain, but when you go beyond that figure the task becomes much more formidable. There is only one weak point in the crystal test that I have outlined. The crystal receiver is at its best when the modulation is very marked, though the valve rectifier does better when the modulation is not quite so complete. Daventry, however, is first and foremost a station for supplying users of crystal receivers with wireless entertainment, and the degree of modulation is probably adjusted primarily with a view to enabling them to obtain the best results. At the present time there is apparently something not quite right, for even the unaided crystal set at a range of forty-five miles shows up a good deal of roughness in the transmissions. Listeners may rest assured that the matter is receiving attention and that improvements are to be looked for in the very near future.

The Spring Atmosphere

Lengthening days and more frequent spells of sunshine have latterly made my thoughts wander forth to meet the spring. I was glancing through the winter wireless programmes thinking how their outlines could be made to lose their winter hardness and don the softer tones of the English springtime. The country listener can scarcely credit the yearning of the townsman for a glimpse of the opening Hawthorn. Here is the chance for our programme builders to brighten our hopes and flood our smoke-ridden windows with the breath of new-born hopes. Let us hear the songs and melodies of the birth of Nature with the lisp of the sea and the call of the wildfowl. Let them not trouble about stuffy pavilions and *effete* concert parties, but give us our best artistes, and a story, combining the whole with the sounds of Nature. There are writers and songs, artistes and orchestras, ideas to be had for the purchase; then rouse yourselves, you wireless listeners, and call for the strains of springtime.

I stared at my winter fire and the question repeated itself in my brain. How can my little set acquire this feeling? I shrank from the nigger minstrel, the underpaid pierrot and the cold riverside. What I craved was the hum of the insects in the dingle, and the song of the wind in the green winter oats as they lengthen their fingers to the softness of spring.

The artistes, the stories, the natural sounds—they are there. Can't we have these to help us along?

Pianoforte Interludes

A few months ago I remarked how infrequent were the transmissions of pianoforte pieces. One became quite thrilled with the gong-like notes of "the grand" coming through one's loud-speaker. It seemed as if the instrument floated up and down.

Now I have tired of my favourite instrument. I don't possess the scores of all these preludes, etc., and, what's more, I couldn't follow them if I had. Alas! they now have given me too much honey. The policy of forging through the works, confined to one instrument, of various composers, in my case, has over-drugged me. Cannot we keep before our eyes the golden principle of variety, or has wireless-programme building an unbalancing effect? There are many eyes at Savoy Hill, and I cannot think they have all lost sight of the violins, the 'celli, the quartettes and the saxophones and banjos. Shall we form a little party and help them to find these forgotten instruments—at least, forgotten between 7 and 8 o'clock?

I must be wrong, rather I choose to think that some genius with an axe to grind has led our dear friends up a cul-de-sac. This interlude in question comes at an important hour in our lives, so that what one would like is a varied programme, not too abrupt in its changes. I love the piano and its charming tones, but I am a promiscuous lover and would bask in the charms of the melodies of other instruments during this link between night and day.

The G.P.O.'s Share

The General Post Office have not done at all badly out of wireless licences, to judge from the figures published lately of the accounts for 1924-25. These show that of the total £685,593 paid for licences the B.B.C. received £472,003 (that odd £3 looks rather lonely all by itself!), whilst the Post Office pouched £213,590. After deducting from this all expenses in connection with the printing and issuing of licences, a net profit of £54,346 remains, which, when you come to think of it, is a very nice little sum. For the current year the Post Office share should be considerably bigger, for the number of licences issued is very much greater, and since the B.B.C. reached some time ago its limit of half a million pounds, the whole of each ten shillings received has been going into the G.P.O.'s coffers. Like a good many other people, I do not quite see why the Post Office should make a

:: :: **On Your Wavelength! (continued)** :: ::

profit out of broadcasting in which it takes no active part except to issue licences.

The Old Story

That hardy annual—*power transmission*—has again cropped up. A plumber or carpenter's mate in some out-of-the-way part of the British Isles has "discovered" that it is possible to light a number of lamps by wireless! It is strange that every time this claim is made, nobody seems to have the energy to unmask these would-be inventors. It is quite an easy thing to light a lamp or number of lamps by wireless. Anybody with a fair amount of power can light two or three flashlamp bulbs quite easily if they are inserted in a circuit having inductance and capacity and in tune with the transmitter. I have never tried it, but I should not be the least bit surprised if it were found possible to light a flashlamp bulb in this manner in Oxford Street when 2LO is working. In any event, I am quite certain that people living in the immediate vicinity of Daventry station could find sufficient energy to light such a lamp without any difficulty! If you try the trick in Oxford Street, please don't loiter, or possibly you may be in trouble for causing an obstruction.

American Slang

I suppose that most amateurs at some time or another chance across words which are apparently associated with radio but which convey only a vague meaning to them. For instance, passages as follow provide quite good food for reflection. "He sat down and donned the cans. On turning the tickler he could get f.b. sigs from hams in the earmuffs. The toobs were O.K. and he commenced brass pounding. Very soon sigs arrived good enough to rattle the cans—" I think that that is enough to show you what to expect when you meet a transmitting amateur who works with America!

Don't be Misled!

A number of amateurs recently gathered together were discussing the quality of broadcast programmes. Said one to another: "Did you notice how the strength faded last night when Violent Pushitout was singing," or words to that effect. The amateur addressed had to confess that he had not noticed the alleged fading, neither had any of the others. As a matter of fact, I have it on the authority of a responsible B.B.C. official that the strength of the transmission never varies apart from the rise and fall in strength of the music *according to plan*. Therefore it seems that our friend was being bothered by something other than a whim on the part of the broadcasting engineers to drop the strength a little. I think that you will often hear the suggestion that the transmitting station is playing "jig-

gery pokery" with the strength of transmission, and sometimes one hears an enthusiast complain that the programme for a whole evening was only half the usual strength. The cause of the trouble is not hard to seek. One of your neighbours possesses a receiver in which is embodied that excellent yet worrying component part, a reaction coil, and sometimes he boosts your signals to an alarming extent and at others he swamps them and throws them off your aerial. Therefore before you bother the B.B.C. with complaints of unequal transmission, make quite sure that it is not your neighbour up to his little games.

Wireless Humour

It seems that there is a funny side to wireless. A friend of mine, who is also an amateur transmitter, recently ordered

PLEASE watch this space for a special announcement next week

Our Free Prize Ballot revealed Britain's most popular *two-valver* also. Our Constructional Department has been devoting a lot of time to building and testing it. Next week we shall make an announcement concerning it—an announcement of a very special character, so

WATCH THIS SPACE, PLEASE

a large power transformer from a well-known manufacturer. The article eventually arrived, and as the carrier and his inevitable small boy lifted the thing from the van, the youngster was heard to say: "Bill, I've never seed such a little gas stove so heavy."

Another story relates to that very useful member of society, the policeman. Perhaps it is not generally known, but an amateur transmitter using a Hertz aerial on short waves inserts an electric-light bulb in the centre of the aerial wire to indicate when the aerial is radiating properly. Every time the key is depressed the lamp lights against the sky, giving a somewhat weird effect. My friend installed his Hertz aerial early this winter, and as the mast is a seventy-footer and, moreover, on the top of a hill, it is visible at some considerable distance. However, being satisfied that all was in order, he entered his dugout and at midnight commenced two-way communication with America. After all had been going merrily for half-an-hour or so, he was startled by a loud knocking at the door. On opening it he was still more startled by the outline of an out-size "limb of the law." Removing his helmet and mopping the perspiration from his brow, the descendent of Robert Peel demanded to know to whom my

friend was signalling with his "blinking light."

In the Theatre

The note-magnifying valve is always finding fresh fields of usefulness for its activities. In the House of Lords an installation of telephone receivers, coupled to an amplifying device, has made it easy to follow speeches in the Painted Chamber, formerly renowned for its bad acoustic qualities. The latest extension of this idea is to the theatres—or to one of them, anyhow. At the Court Theatre the experiment is at present being tried of providing in certain seats of the dress circle "lorgnette" telephones, intended for the use of those who are a little hard of hearing. In many of our theatres it is difficult to catch every point made from the stage, and those whose hearing is not of the best may often miss a witty aside either on account of an unexpected noise or because those near-by are chattering, as some people will always chatter in a theatre. The use of amplifiers in theatres seems to be an exceedingly good idea, and I am sure that it will be appreciated.

Some Fine Speeches

We had some exceedingly good speeches brought in by wireless in the last few days. The Prince of Wales is no novice at broadcasting, and it was good to hear him again when he spoke at the opening of the British Industries Fair. He speaks so clearly that every word of his comes through as distinctly as if he were within a few feet of the listener, instead, possibly, hundreds of miles away. A few nights previously we heard Prince Henry, who was, I believe, making his wireless debut. He, too, has just the voice and the clear diction that suit the microphone. At the same dinner at which Prince Henry spoke we heard Sir Austen Chamberlain, who made one of the wittiest speeches that I have heard for a long time. I have always felt that one of the most useful and entertaining sides of broadcasting was that it so frequently enables the owner of even the simplest receiving set actually to hear public men speaking. So long as your knowledge of any person is confined to seeing his photographs and reading his speeches in the papers, he must remain more or less in the abstract; but once you hear his voice you feel that you know a great deal more about him and he becomes somehow much more real.

"On With the Dance"

I am looking forward to Friday night when Mr. Bert Nielson is going to tell Birmingham what he thinks of modern dancing. He calls it "Candid Criticism." I should also like to give a "candid criticism," only, alas! too many of us nowadays do not ask for criticism, but approval, so why worry. THERMION.

MORE ABOUT THE "WET" H.T. BATTERY

THE original article dealing with the above subject in No. 159 of AMATEUR WIRELESS described a method of constructing a permanent H.T. battery from the dismantled parts of a shop-bought dry-cell unit after the latter has been worn out by long service.

Judging by the letters received from readers quite a large number of rejuvenated batteries have been built up in this way, and have given highly satisfactory results. In a few cases, however, some difficulty appears to have been met with in overcoming certain defects that are dealt with more fully below.

In the first place, for the benefit of those who may not have read the original article, it will be of interest to give a brief outline of the procedure to be adopted.

Preparing the New Units

The outer cardboard covering of the worn-out H.T. battery is first removed with a knife, and the exposed zinc cases are separated out from the black pitch surrounding the top, care being taken not to break off the small brass caps on each of the carbon rods.

Each individual cell is next stripped of its zinc casing. The inside bag, containing the carbon rod and a depolarising mixture of manganese dioxide and graphite, now forms the "positive" element of the new battery. A zinc strip is next cut out and soldered to the brass cap on the carbon rod to form the negative element, and the completed unit is then placed in a small glass beaker containing a solution of sal-ammoniac. Finally the beakers are housed in a wooden base-block and connected up in series.

Selection of Inner Cells

It will be found that different makes of H.T. batteries vary a good deal in their internal arrangement. For the particular purpose in view, the best results are obtained from cells which are still slightly moist and which contain no white plaster-of-paris packing.

This undesirable packing or plaster will be found between the inner "sack" and the outer zinc casing. When the battery is used up, the packing begins to set hard around the "sack" in the form of a solid white crust, which no amount of soaking will remove, and which, if forcibly detached, frequently brings away the walls of the "sack" and thus ruins the cell unit. If the battery has been lying exhausted for some considerable time the paste is usually absolutely stone-like in hardness, making the cell quite useless for our purpose.

Luckily there are many makes in which the plaster packing is replaced by a transparent jelly which can be easily washed off by the gentle application of warm water with an old tooth-brush. This type of cell is ready for action almost immediately it is placed in the sal-ammoniac solution after washing. Therefore, if possible, start operations with a high-tension battery which has only just been thrown out of use and before it has had time to get too dry and hard. Also preferably use cells with the jelly filling and free from plaster. Finally, reject ruthlessly any cells that have developed the above-mentioned stone-like coating, and also any that may get broken or damaged in the preliminary cleaning operation.

Breaking-up the Old Unit

The best way to break up the old battery in order to extract the inner cell is to cut off the cardboard casing with a sharp knife and then break up the pitch



The Elements of a Unit.

covering with a small hammer, being careful not to smash the tops of the carbon rods in the process. The individual cells can then be separated out one by one.

Take each cell separately and open the zinc at the top soldered joint with a knife, and then tear open along the joint with a small pair of pliers. The inner sack can then be lifted out quite easily and without being damaged. If they are available, open up two or three discarded units at the same time, so that a selection of the best thirty sacks can be made for a new 45-volt battery. Wash the selected sacks in warm water and soak them in sal-ammoniac solution prepared as follows.

Electrolyte

Water will dissolve about one-third of its weight of sal-ammoniac at normal temperatures. Make the soaking solution rather weaker than this, say 5 oz. to 1 pt. (20 oz.) of water. There will then be less likelihood of crystallising and "creeping" than if a fully concentrated solution is used. About two tablespoonfuls in a tumblerful of water is near enough for practical



Photograph of Single Cell.

purposes. Siebrosal is a special salt, made by Messrs. Siemens Bros., of Woolwich, which will be found to give good results and to be free from all creeping.

Internal Short-circuiting

If the sack has been damaged in the process of extraction so that the black powder escapes, it may form a conducting path at the bottom of the glass container between the zinc and the carbon. Should this happen the cell soon ceases to give its full voltage and will rapidly die out altogether, so that it is better to discard it from the first.

When cutting out the negative elements it is advisable to use zinc of as thick a gauge as can be comfortably cut and bent, as this makes for long life. Also it is best to bend the strip to a cylindrical shape, so as to embrace the sack—but not so closely as to cause a short circuit. Dry and varnish or coat the brass cap on the carbon thoroughly after soldering on the zinc connection.

Testing

In the case of units made from "sacks" which are still moist and free from hard coating, the full $1\frac{1}{2}$ volts per element will be given when tested with a voltmeter. Each unit will usually make an ordinary torch-lamp glow visibly, although this is not a test which the cell must necessarily pass, as the voltage may be all right, but, owing to internal resistance, the cell may not pass enough current (150 to 200 milliamperes) to light the lamp.

Provided it will pass one-tenth of this current, say 15 to 20 milliamps, at the registered voltage, the reconstructed unit will give perfectly satisfactory service on an ordinary three-valve set. In point of fact, an output of 10 milliamps will in general be found ample for the plate supply.

It may be added that three selected single units in parallel will supply the filament current for a dull-emitter valve of the .06 type (requiring 60 milliamps), and will be found to last for a surprising length of time on this work. M. A. L.

GETTING THE DISTANT STATION

Some Helpful Hints on DX Reception

NOW that it is becoming difficult to obtain DX records many amateurs are beginning seriously to think of improving their sets in order to obtain better reception over long ranges. It is now fairly well known that a large set does not necessarily possess a longer range than a small one, especially when it is well designed. The most famous feats of long-distance reception have been achieved not with large and complicated sets, but with simple and efficient two-valvers. In fact the detector-L.F. combination is quite a favourite one with leading experimenters.

If H.F. amplification is to be used the amateur should make sure that it is thoroughly efficient. Do not allow the H.F. valve to be a mere "passenger," as is so often the case in home-built sets. Wind good coils, and use a variable condenser of the low-loss type for tuning purposes. Serious losses often occur in condensers of poor design. Above all, keep the valve working under the right con-

ditions. There is always a danger of partial rectification on the part of the H.F. valves. This naturally leads to poor amplification, instability and distortion. It can always be prevented by following the directions of the manufacturers as regards filament and plate voltage, etc.

The Best Valve

The detector valve must be made as efficient as possible. Do not use the soft Dutch type on a large set, because it cannot handle heavy currents. Obtain a good English valve specially designed for rectification; there are several such valves now on the market. Buy a variable grid leak in order to get the most sensitive working conditions. Experiment with this on distant stations until the best results are obtained.

Always use low-loss tuning coils. There is no need to wind elaborate bare-wire coils on expensive ebonite formers; a good honeycomb coil with large air-spaced coils

and heavy wire will give excellent results if properly wound. Use No. 16 d.c.c. wire for the broadcasting wavelengths.

Many amateurs are apt to think that it is only the H.F. side of a set which counts in DX reception. This is far from the truth; a great deal depends upon the efficient and distortionless amplification of the note magnifier, which is invaluable for "boosting" faint signals.

Which Circuit?

The circuit is largely a matter of individual preference. The super-het is far away the best for DX reception "de luxe." No outside aerial is needed, and the operator has only to turn the tuning dials and point the small frame in the direction of the desired station. Atmospheric and jamming are entirely absent and the reception of the most distant transmission is delightfully simple. But not all wireless enthusiasts are able to afford this expensive set, and are content with small receivers which can be made perfectly satisfactory for distant reception. A detector with Reinartz tuning followed by an efficient stage of L.F. can scarcely be beaten for all-round usefulness and is a great favourite.

Above all, keep the aerial as high as possible and about 60 ft. in length. Make the earth lead short and thick and keep the lead-in free from dust. If these precautions are carefully followed the reader should have no difficulty in securing quite a good "bag" of call-signs. G. J. M.



LISTENING-IN TO ICELAND—AND SOME PROBABLE EFFECTS!

FIXING KNOBS FIRMLY

EVERYONE has had trouble at one time or another with the knobs of rheostats, variable condensers, variometers and the like which refuse to remain properly fixed in position. The commonly used method of fixing knobs by means of a lock-nut is not very satisfactory, since it is so difficult to get at the nut in order to tighten it hard down.

A much better plan is that described below. In the boss of each knob drill and tap a 6 B.A. hole, and insert a short round-headed screw of this size. File a small flat at the end of each spindle, screw the knob home and tighten down the binding screws. Knobs fixed in this way will never work loose. A fixing of this kind is essential for the knobs of wavemeter condensers, since if these turn at all upon their spindles the entire calibration of the instrument is upset. J. H. R.



Take the SHORTPATH to Better Reception

"Cosmos" S.P.18 Valves, by reason of the unique construction of their electrodes whereby the path—filament—grid—anode is reduced to an absolute minimum, provide a

SHORTPATH to **MORE POWER.
FAITHFUL REPRODUCTION.
GREATER ECONOMY.**

Obtainable from most Wireless Dealers.

METRO-VICK SUPPLIES LTD.
(Proprietors, Metropolitan-Vickers Elec. Co.)
4 Central Buildings, Westminster, London

S.P.18 Valves consume 0.3 Amp. at from 1.6 to 1.8 volts, and require only a single-cell 2-volt ACCUMULATOR.

Made in Two forms—

Green Spot } 12/6
Red Spot }

Get a copy of "A Talk to Valve Users."

Cosmos

RADIO VALVES

Gamage Service

Gamage Service offers you the choice of the most comprehensive Radio stocks in London—Sterling, Gecophone, Marconi, Burndept, Lissen, Bowyer-Lowe, McMichael, Igranic, to mention but a few and the complete Gamage Range. Send for full illustrated Lists of Wireless Goods for Cash or Easy Terms.

GAMAGES

GREAT ANNIVERSARY WIRELESS SALE

FEBRUARY 22nd — MARCH 20th

Deferred Terms

All makes of Wireless Sets and Components supplied on our Hire Purchase System—25 per cent. deposit secures delivery, balance payable in 6 months for orders of £5 and over, 12 months for orders of £10 or over. We instal Wireless Sets in all parts of the Country at a small extra charge.

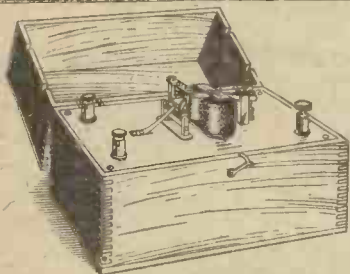

The Gamage Remote CONTROL SWITCH

for the control of Valve Sets from any room in which the loud speaker is used so that the instrument can be switched "on" or "off" without actually going to the receiver—thus saving considerably in H.T. and L.T. current. The Low tension current from the accumulators or dry batteries is not affected in any way by the introduction of this switch. Complete with special battery. Usual Price 27/6. Sale Price

21'

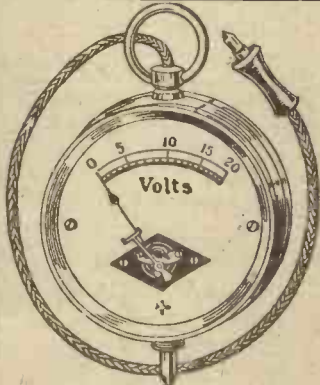

Special line of VOLTMETERS

Dead-beat type. A very reliable instrument at a low price. Readings 0-3 volts, 0-6 volts, 0-12 volts, 0-15 volts, 0-20 volts. Post 4d. Price, each

4'6



'IDEAL' CRYSTAL SET

Finest Value ever offered. The detector is the latest type and fitted with our famous "Permanite" Crystal. Complete with 1 pair phones, Lead-in tube, Lighting Switch, 100 feet Aerial Wire, two Aerial Insulators, 20 ft. Earth Wire. Usual Price £3 10s. Special Lending Call for 5XX 2/6 extra.

£2:15:6

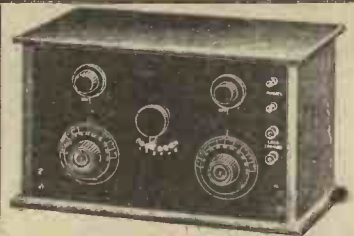

Special Offer of the Gamage SUPER II. RECEIVER

Specification—All the latest developments with the addition on one stage of well-designed Low Frequency Amplification for increasing the volume of sound. Provision is made so that one or two valves can be used. The Tuning Range of the set covers all B.B.C. Stations, including 5XX, the Daventry Station, without any extra coils. Best quality throughout. Complete with Valves, Accumulator, H.T. Battery, 1 pair Phones and Aerial Outfit. Loud-speaker Range 25 miles. Usual Price 13 gns. Sale Price

£10:13s.

A. W. GAMAGE, LTD., HOLBORN, LONDON, E.C.1
City Branch :—Benetfinks, Cheapside, E.C.2.

EDISWAN VALVES ARE ENTIRELY BRITISH MADE

THE PERFECT PAIR—

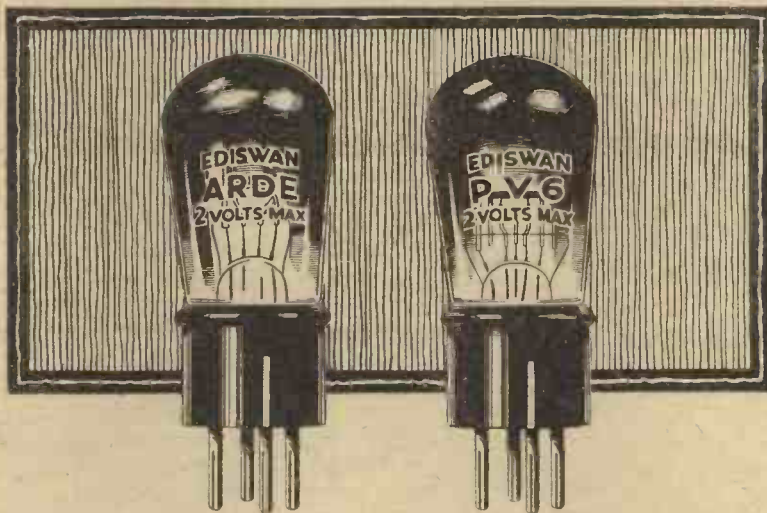

Use them together. It is the only way to get the real Edison quality of reproduction. Individually, Edison Valves are always better—very robust; very long in life; very reliable in service. But it is in co-operation that Edison Valves give the most remarkable results—you can test this on your own set.

Edison A.R.D.E. is made to function either as a H.F. amplifier or detector (red line) or as a L.F. amplifier (green line). Edison P.V.6. is specially designed for use when A.R.D.E. is used in the preliminary stages.

The following table indicates the combinations of Edison Valves that give the best results:—

Receiving	Accumulator or Battery Volts	Power
AR	6	PV5
ARDE	2	PV6
AR.06	3	PV8

With these groups and Edison H.T. and L.T. Accumulators the ideal is attained.

THE EDISON SWAN ELECTRIC CO., LTD.,
123-5, Queen Victoria Street, London, E.C.4

EDISWAN VALVES

The PIONEER VALVE

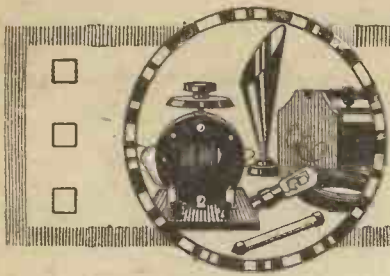

PRACTICAL ODDS AND ENDS

Coil-holder Tension

MANY coil holders do not incorporate a tension-adjusting device, and difficulty is therefore sometimes experienced in preventing large coils from falling back. The weight of the long-wave coils causes

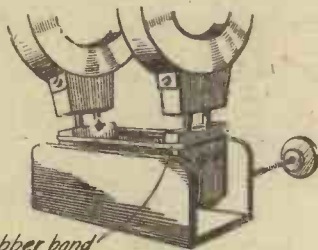

Rubber band
A Coil Holder Improvement

the movable sockets to drop over too freely, and it is not possible to obtain a stable coupling.

The difficulty may easily be removed by slipping an india-rubber band over the two sockets, thus increasing the effort needed to move the sockets. B.L.

Simple Reduction Gear

A CHEAP reduction gear used by the writer with a great measure of success is described below. The movement is quite as smooth as any bought dial, and

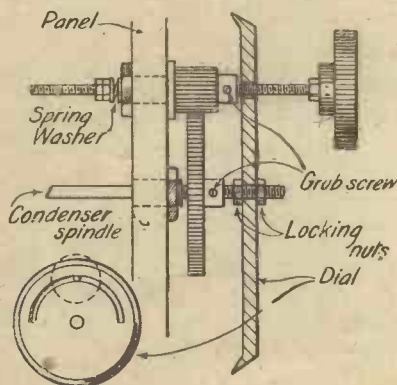

Side View of Reduction Gear.

it is practically impossible to "overshoot" a station. The materials are such as any amateur will have by him, with the exception of the gears. These are of Meccano make, a gear wheel and a small pinion wheel. Any Meccano dealer can supply them as they are both standard.

The sketch is practically self-explanatory. The gears must have their central holes enlarged to $\frac{3}{16}$ in. by running a drill of that size through. This presents

no difficulty as the brass is very soft, but care must be taken that the teeth are not injured in the vice whilst drilling. The large gear is securely fastened by its grub-screw to the condenser spindle.

Now with the $\frac{3}{16}$ -in. drill through the pinion, engage the teeth, and when a suitable position on the panel is found drill a slight hole. Enlarge this to take the condenser bush. This precaution is taken to ensure the gears locking properly in their final position. Tighten the bush up and mount the pinion on a piece of $\frac{1}{16}$ -in. brass rod. Two locking-nuts and a spring washer keep the pinion from rocking. The length of shaft must vary to suit individual requirements, and the knob is fastened in the usual way with a locking-nut. The dial presents no difficulty in mounting. H. B.

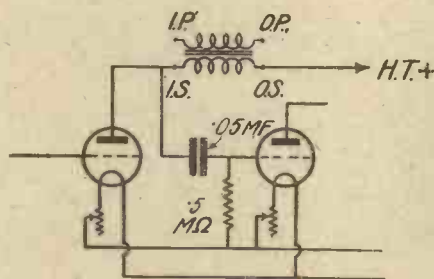

Circuit of Choke Amplifier.

A Cheap L.F. Amplifier

THOSE amateurs who wish to try the popular choke method of L.F. coupling need not go to the expense of buying a new choke. Most amateurs have discarded low-frequency transformers in their possession, and the secondary winding of these makes a very good choke. The diagram gives the necessary connections. The grid condenser and leak can be obtained from any wireless dealer, and an efficient stage of L.F. is obtained with very little trouble and expense. G. M.

Dial Indicators

NEAT dial indicators that give a more accurate indication of the dial position than do small scratches on the panel can be simply made in the following manner. A small screw is inserted in the panel (with or without its head being countersunk) near the point of maximum dial-reading, and its slot is filled in with coloured sealing-wax. The screw may be rotated slightly either way to secure the exact setting. K.

A Catwhisker Tip

THE catwhisker of a glass-enclosed crystal detector is often a very difficult object to see owing to the thinness of the wire and to reflection in the glass. A method of rendering the contact more visible is shown herewith; a tiny piece of white paper is attached to the catwhisker

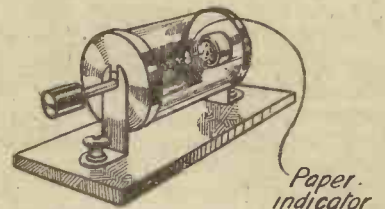

An Indicator for Enclosed Detectors.

a short distance from its point by means of shellac or Seccotine. This will clearly show, without straining the eyes, exactly where contact is being made. L.

Loud-speaker Adjustment

THE sectional sketch shown below illustrates an adjusting device for a pleated-paper-diaphragm loud-speaker. The essential feature of the device is the attachment of the phone to a hinged batten, the movement of which is regulated

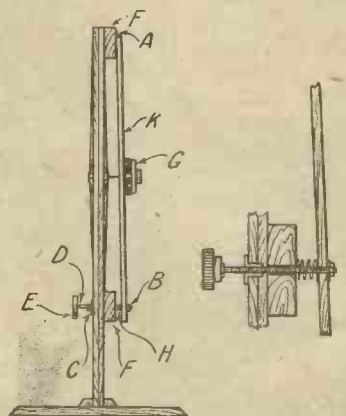

Details of Loud-speaker Adjustment.

by the adjusting screw. This does away with the rather unsatisfactory method of screwing the receiver into its ear-cap to obtain adjustment.

In the diagram the batten K supporting the ear-piece G is hinged at A. The adjusting knob E is connected with the batten by means of the screwed rod D and the nut B. An advantage of this arrangement is that adjustment can be made from the front of the instrument. A. W. E.

ONE of the many troubles associated with high-tension batteries composed of a number of dry cells is the noise which develops when the battery is slightly run down, and although these and certain other parasitic noises can be partly silenced, they cannot be entirely eliminated; they consequently cause disturbing sounds to distribute themselves through the loud-speaker or phone circuits, and are often mistaken for atmospheric interference.

When a receiving set is switched on, the dry battery is at a "peak" voltage, as after resting for a time it will recuperate somewhat, but steadily drop again, necessitating a readjustment of the reaction condenser or the reaction coil.

It may not be realised also that, when a large number of tapings are taken to the usual high-tension battery, coupling effects are caused, making reaction unstable and often resulting in low-frequency howling.

Advantages of A.C. Mains

When using the domestic alternating-current electric mains, as a constant voltage is available, the reaction and general control of any receiver are considerably improved, and the critical adjustments, when once set, remain so.

It has been said that the heart of a receiver is the valve; certainly it is so, but the heart cannot function healthily if the life-blood is weak and unreliable. High-tension accumulators obviously are

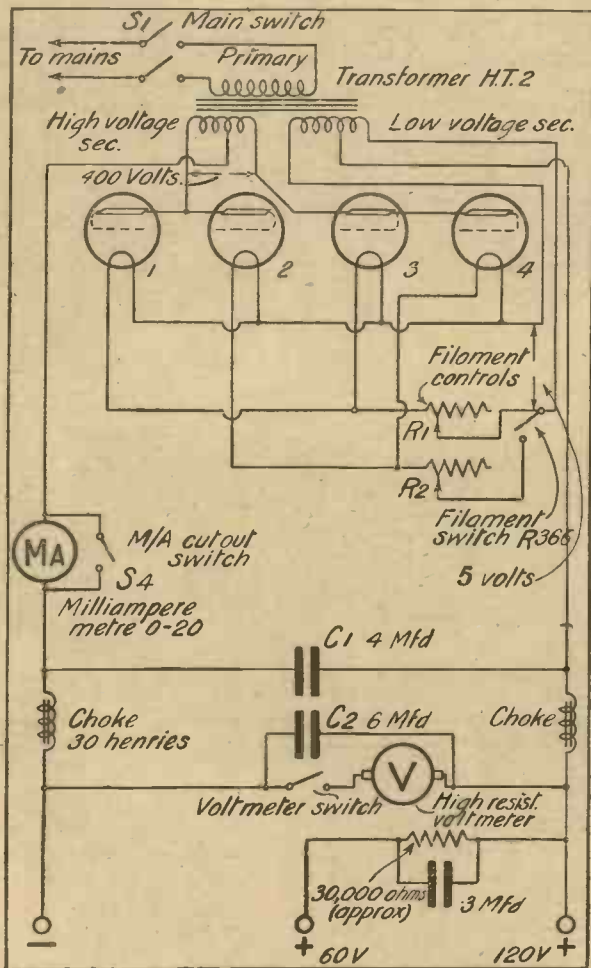
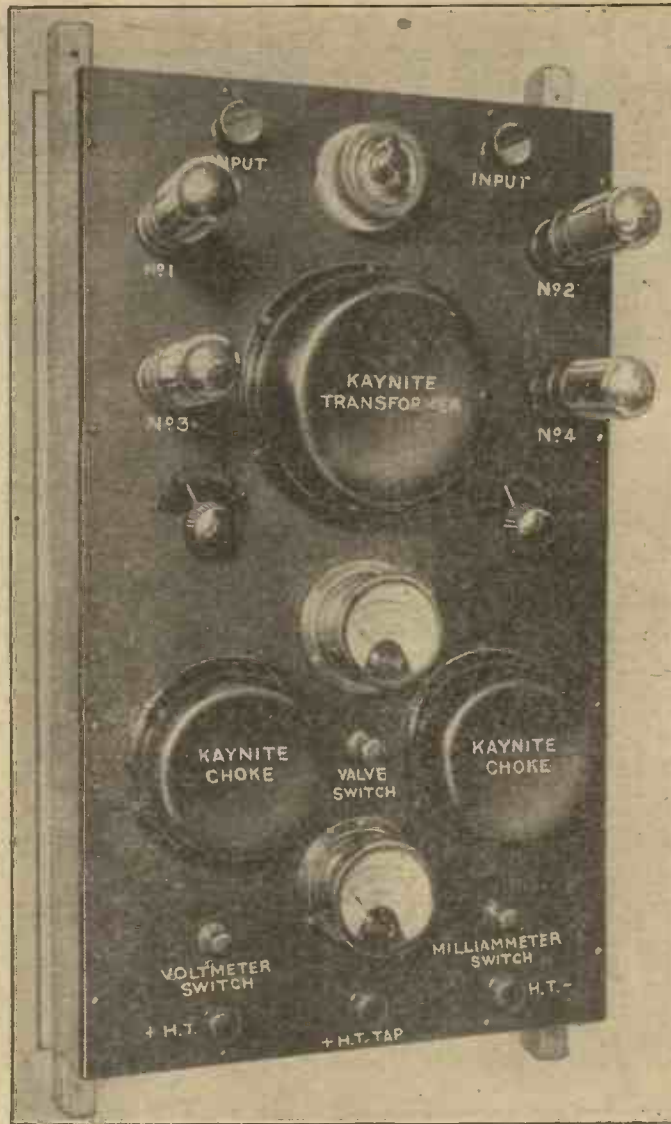

Fig. 3.—Circuit Diagram.



Front View of H.T. Battery Eliminator.

HIGH-TENSION SUPPLY FROM A.C. MAINS

By
A. W. KNIGHT

Many systems of obtaining high-tension current from the mains have been devised, but we claim that the one described in this article is at once decidedly the best and most reliable.

to be preferred to dry cells, and when direct current is available it is recommended that this be used to charge the accumulators, and not operate the receiving set direct from the D.C. supply.

The advantage of using rectified alternating current is that, provided a suitable transformer and smoothing system is installed, any high voltage can be obtained, whereas with direct current all the surplus voltage from the main supply must be dissipated by means of lamps or resistances (which incidentally consume current, which, of course, has to be paid for). Transformation losses are exceedingly low, and should the primary windings be accidentally left in circuit the recording meter will hardly indicate the consumption as it is so small.

Half- and Full-wave Rectification

A half-cycle rectifying transformer circuit (and its components) has been described in this journal, together with its application as the H.T. supply unit for reception purposes. The direct-current component from a half-wave rectifier is composed of a number of impulses, which are equivalent to the frequency of the alternations; that is to say, that if the frequency be 50 cycles, then 50 impulses of rectified A.C. are impressed on the first filter

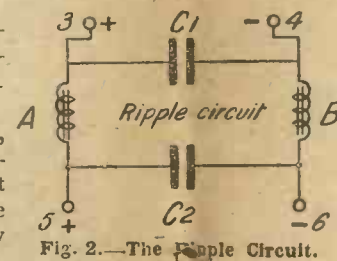

Fig. 2.—The Ripple Circuit.

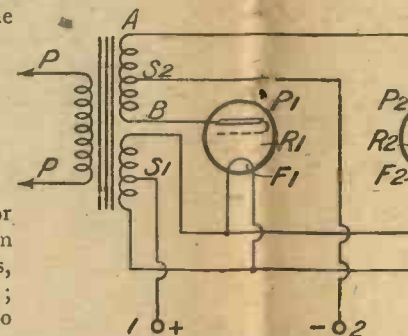
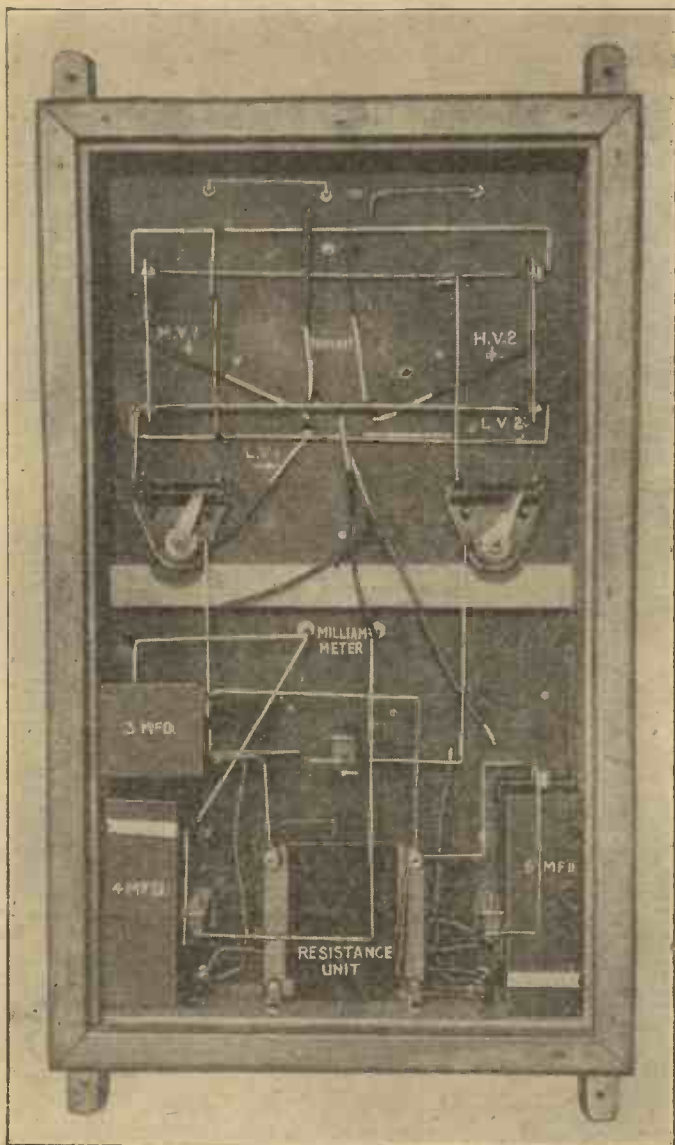

Fig. 1.—Transformer and Valve Connection.



Rear View showing Components and Wiring.

excessive load will cause their working temperature to rise and considerably shorten the life of all the components.

The usual high-voltage secondary winding for a half-wave rectifying transformer is wound to give about 180 volts, thus allowing for the voltage drop, which approximates 60 for the resistance of the valve and choke. In the full-wave or two-cycle type, as we have one or more valves on each outer limb of the high-voltage winding, this high-voltage winding must be duplicated, as our rectifying points are taken from a centre zero tap to each other.

With regard to little losses through the various components, it is better that the high-voltage secondary be wound to give 400 volts on the outers.

Current for Rectifying Valves

To supply the necessary current to the filaments of the rectifying valves, which may be two bright-emitters taking about .75 ampere each, or four valves of the small-power type each taking about .25 of an ampere, to be generous, the winding decided upon was for 5 volts at 2 amperes. Induction effects have also to be taken into consideration, because in many cases the switchboard may be quite close to the receiving instrument. This is limited by fitting the transformers in domed iron cases similar to the shielding method used in the case of low-frequency transformers. Circular ring stamping form the laminated iron cores of the transformers. To make the

condenser. When, however, a full-wave rectifier is used, the number of impulses is double the frequency, and consequently, as the greater the number of impulses per second the nearer we get to direct current, the full-wave system is to be preferred. Periodicities above 50 will obviously give superior results. The writer has not been able to test this circuit on a 25-cycle main, and it would be very interesting to hear the result of such a test. This frequency fortunately is rather rare and, as 50 cycles is gradually becoming standardised, will not exist for long.

The Transformers

Transformers for use for either half- or full-wave rectification to give the required output in watts must be designed to suit both the input frequency and voltage. Although the primary windings allow for a little latitude, it is important that the supply to which they are connected should not exceed a variation of 5 per cent. For example, a 220-volt primary, if connected to a 200-volt supply, will result in the output voltages being minus 10 per cent., and in all probability, according, of course, to the types of valve used for rectifying, the emission may result in a loss of 33 1/3 per cent. Likewise a 200-volt transformer connected to a 220-volt supply will result in a greater output from the secondaries, and consequently an

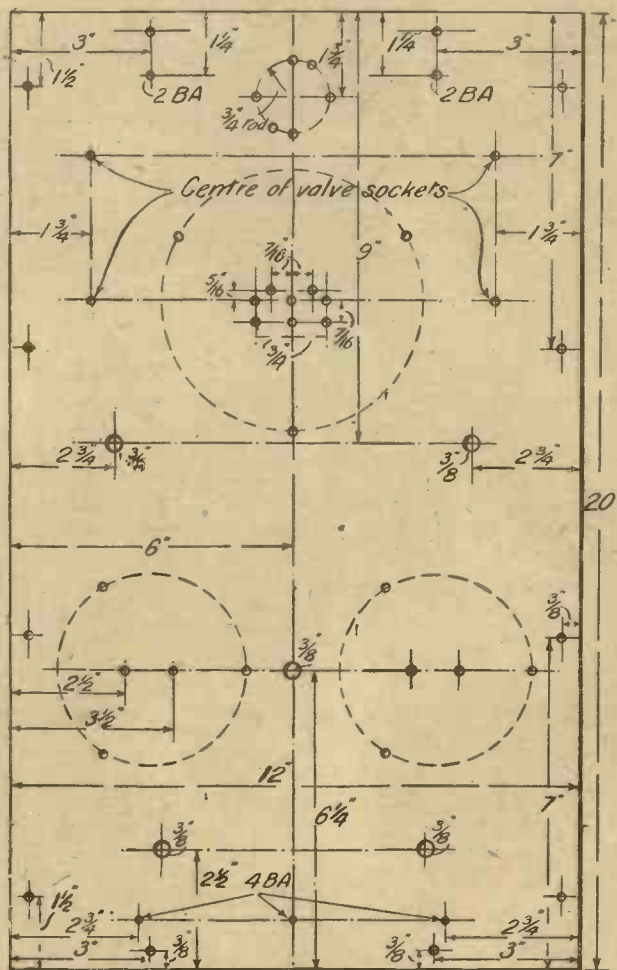

Fig. 4.—Layout of Panel

magnetic circuit as efficient as possible, and to obviate troublesome noises arising through loose laminations, the windings are wound around this ring, similar to the Gramme system of field winding.

Needless to mention, the insulation for this class of transformer has to be of a very high order, as the potential to earth is that of the highest voltage, namely, 400 volts.

The Circuit

The circuits mentioned are not by any means new; in fact, they are essentially those used by the writer and many other



Example of Ordinary Rectifier.

transmitting licence-holders for rectifying the alternating-current mains in order to obtain voltages from 1,000 to 3,000, and a photograph is reproduced which will illustrate the resemblance between a 50-watt rectifier switchboard for transmission and the instrument described.

The making of a receiving switchboard has hitherto been a costly item, but now that the necessary component parts can be obtained at a very reasonable figure, the position is, of course, somewhat different.

Fig. 1 illustrates the connections essentially from the transformer to the valves, and it will be seen that the two valves are arranged to work alternately, thus using the energy of both half cycles instead of wasting one of them as in the standard half-wave circuit. In our case the negative half cycle is reversed, and actually fills the gap between each positive half alternation. The circuit functions as follows:

Presuming that the primary winding is connected into circuit with the mains, and that a half cycle has been induced in the high-voltage secondary, so that the outer end A (see Fig. 1) is positive and the outer end B is negative, then the plate P2 of the valve R2 will be positive, and the plate P1 of valve R1 will be negative with respect to the filaments F1 and F2 respec-

tively. Consequently a flow of electrons will take place to the anode of valve R2, following the circuit via positive terminal 1, S1, F2, P2, A, S2 and the negative terminal 2. The next half cycle being in the reverse direction, the outer end of secondary B will become positive, and A will be negative, and the electron stream will now flow from F1 to P1 of valve R1 via positive terminal D1, F1, P1, B, S2 and the negative terminal. It will therefore be seen that for each complete cycle of alternating current in the primary winding P two impulses, both in the same direction, are produced at the output terminals 1 and 2, one half passing through R1 and the other half through valve R2.

The Ripple Circuit

The ripple filter circuit (Fig. 2) essentially consists of two large-capacity condensers (or a group of 2 microfarads in parallel) shunted across the positive and negative terminals of the transformer circuit, separated by two low-frequency iron-core chokes. Condenser C1 is 4 microfarads and C2 is 6 microfarads. A and B are the chokes. Presuming that a direct-current voltage of 120 volts is imposed across the condenser C1, having superimposed upon it an alternating-current ripple of 2 volts, the potential of the ripple will be applied to the condenser C2 through the chokes A and B; but as these chokes offer a very high impedance to the low-frequency impulses, and the condenser C2 is a very low one, the actual voltage change across condenser C2 will be extremely small, practically negligible.

The completed circuit for the switchboard is shown by Fig. 2 and the frame of the switchboard by Fig. 5. Needless to state, the voltmeter, voltmeter switch, milliammeter, milliammeter switch, two valve holders, two-way valve switch can be omitted in order to simplify construction and reduce the cost.

Valves

As there is not a special valve manufactured solely for use as a very small rectifier, it has been necessary to test out a number of standard receiving valves, both of the bright-emitter and dull-emitter class. Although some standard bright-emitters, such as the Mullard, Ccesor, Marconi and Osram are quite good, yet, owing to the filament consumption, they are not economical. Dutch valves, especially the cheaper brands, I should imagine—not having tested them, but judging purely by their mechanical construction—would give very poor results. I have, however, tried a number of French .06 type with success, amongst which the Microwelt can be recommended. Another French valve, the Microlux, with two filaments, was tried, and this was quite satisfactory also.

It is possible to use two valves only, the extra valves incorporated in our circuit being purely a refinement, and, on test, one Microlux valve on each outer limb, with the two filaments in each case in use, an

emission of 15 milliamperes was constant, and as the total consumption is only .24 of an ampere, these valves are extremely economical. It should be noted that almost any type of small power valve may be used.

The object of providing four valves on the switchboard is to permit of either two or four valves being used at will, according to the size of the receiver employed and the current consumption, as it may be found in practice that when the full load of 15-20 milliamperes is required, one valve on each half cycle will not supply

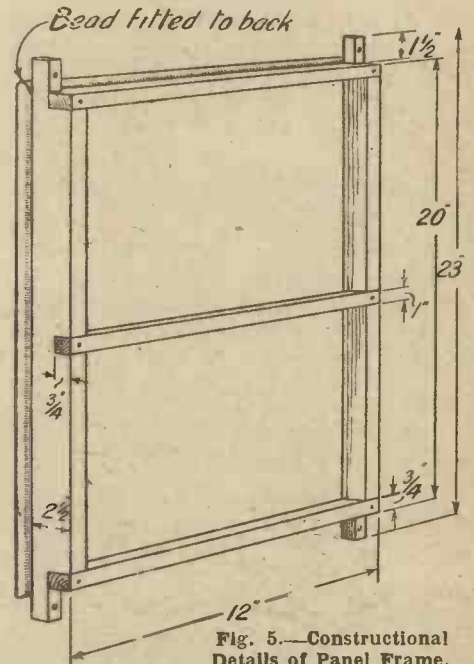

Fig. 5.—Constructional Details of Panel Frame.

sufficient anode current, particularly in cases where small power valves of British manufacture are not used. Four valves are not absolutely necessary, the additional two being merely provided for the latter contingency.

Framework

The framework is constructed entirely of wood, and the selection is left to the constructor. The wood required is as follows: One 4-ft. length of prepared 5-in. by 1-in. board and 6 ft. of 5/8-in. beading.

Carefully mark out the centre of the board and saw through, so that you now have two pieces of 2 1/2-in. by 1-in. each 4 ft. long. The sawn edges should be carefully planed and squared. From one of these two lengths cut two pieces each 23 in. long and from the other length three pieces each 12 in. long, and from one of the latter saw out a piece 1 in. wide to form the centre cross batten. Now carefully mark out the ends of the two 12-in. battens, as shown in Fig. 5, so that they will form a joint, easily nailed or screwed, to complete the assembly. After this portion has been completed, from the beading cut the four mitred pieces to form the framework, which is added to the width of the batten.

A. W. K.

(To be continued)

"A.W." TESTS OF APPARATUS

Conducted in the "Amateur Wireless" Research and Test Department

A New Coil Holder

IN the construction of a receiver employing plug-in coils it is certainly neater to place coil holder and coils behind the panel out of sight, altering the coupling between the coils by a control knob on the front part of the panel. For this purpose it is essential that the moving coil should move in a direction at right-angles to the plane of the panel and not parallel with the latter, otherwise a tremendous amount of waste panel space is required.

A well-designed two-way coil holder is produced by The London Electrical Stores, Ltd., of 13, Farringdon Avenue, London, E.C.4. This component is so designed that the axes of the two coils are parallel to the panel, and by rotation of the control knob in an anti-clockwise direction the right-hand socket moves away

whilst that of the bright-emitter winding was 4.7 ohms. The resistance of the dull-emitter winding is therefore 23.9 ohms. In action the rheostat is particularly smooth and is capable of carrying a fairly heavy current.

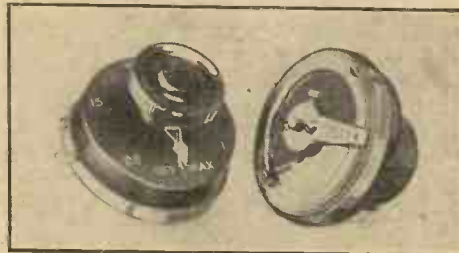

G.E.C. Universal Rheostat.

In order to test the straight-line-frequency effect a test was made, the results of which are given in the accompanying table. If a curve is drawn from this table it will be seen that the frequency of an oscillating circuit composed of a fixed coil and one of these variable condensers varies as the square of the angle of rotation. The phase angle, and consequently the power factor, is small.

A Novel Tuner

AN exceedingly novel and, incidentally, very efficient tuner has been sent to us for test by M. and A. Elliot, of Tunometer Works, Gosford Road, Beccles, Suffolk. These tuners are called Nick-o-time Tunometers, one of which we have tested with very good results. The coil itself is wound in the form of a flat spiral mounted

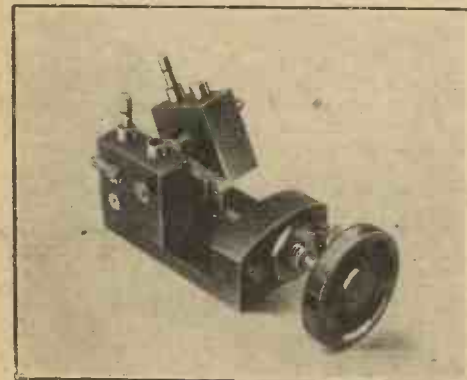

L.E.S. Coil Holder.

from the panel. One-hole fixing may be used, although two screws are provided for fixing purposes. By the ingenious use of a spring device backlash is entirely eliminated. The insulating properties of the ebonite are excellent, and altogether the component is well made and well finished.

G.E.C. Universal Rheostat

A VERY substantially-made filament rheostat suitable for bright- or dull-emitter valves is produced by The General Electric Co., Ltd., of Magnet House, Kingsway, London, W.C.2. The resistance wire is wound in two equal and distinct portions, one being suitable for use with high-consumption valves and the other with low-consumption valves. Between each half of the winding a small metal projection lifts the contact arm over from one winding to the other, at the same time serving to indicate when the change is being made. An engraved dial and pointer is supplied with each instrument.

On test the maximum resistance of both windings was found to be 28.6 ohms,

Raymond S.L.F. Condenser

WE have received for test purposes a variable condenser of the straight-line-frequency type from K. Raymond, of 27 and 28, Lisle Street, Leicester Square, W.C.2. The end plates (of triangular shape) are made of ebonite of a substantial thickness. The straight-line-frequency

Dial Reading in degrees	0	20	40	60	80	100	120	140	160	180
Frequency in Cycles, sec.	1,500,100	1,377,800	1,255,700	1,133,500	1,011,300	889,150	766,850	644,650	522,430	400,200

effect is obtained by the special shape of the fixed plates, out of each of which a peculiarly shaped portion is cut. The moving plates are semicircular, but have all superfluous metal removed. Both fixed and moving plates are of brass. This instrument possesses many good points, amongst which are to be found the flexible

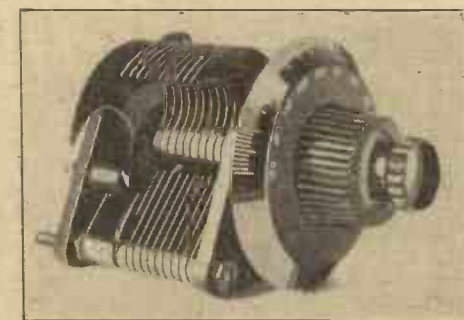

Raymond S.L.F. Condenser.

pigtail connection to the moving plates, ensuring silent working; the central position of the spindle, giving a minimum amount of panel space, and the special top brush giving a smooth movement. A very attractive knob and vernier dial is supplied.

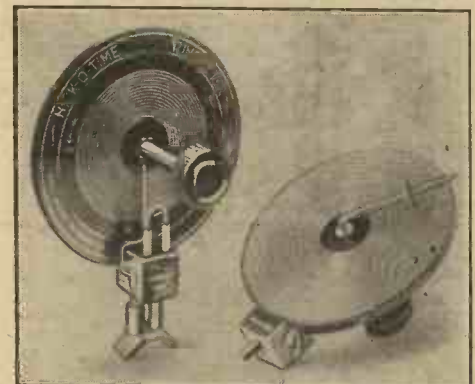

The Nick-o-time Tunometer.

on a circular disc of a polished insulating material. From the centre of the disc an axial arm, which may be rotated by an ebonite knob, makes contact with any part of the winding by means of a contact wheel which, when the axial arm is rotated, follows the spiral winding of the coil. For wavelengths from 350 metres (approximately) to 600 the insertion of a loading coil is necessary, a standard coil socket being provided for this purpose.

A short test proved that the efficiency of this coil is extremely high, the H.F. losses being low even in comparison with our standard. On our test aerial the maximum wavelength to which the coil would tune by itself was 368 metres. The insulating properties of the disc are good. The only disadvantage the coil possesses is its large bulk—a disadvantage which cannot, in the circumstances, be avoided.

The firm also produces fixed coils of the same type wound in a flat spiral on an insulating disc, fitted with the standard plug and socket. Each turn of the spiral rests on only two points of the insulation.

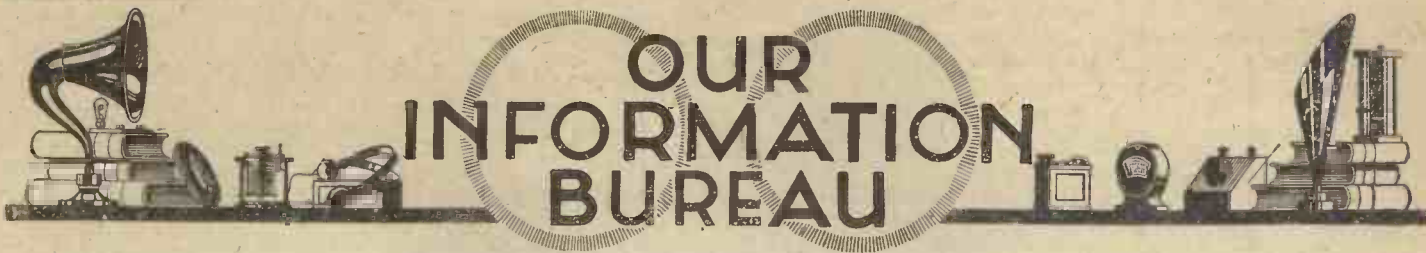

RULES.—Please write distinctly and keep to the point. We reply promptly by post. Please give all necessary details. Ask one question at a time to ensure a prompt reply, and please put sketches, layouts, diagrams, etc., on separate sheets containing your name and address. Always send stamped, addressed envelope and attach Coupon (p. 360).

Grid-bias

Q.—Are flashlamp batteries suitable for use as grid-bias batteries?—P. C. M. (Newcastle).

A.—They are suitable, but if used for this purpose some of the insulation should be removed so that they can be tapped at each individual cell. A close enough adjustment of grid-bias could not be obtained if it were only possible to regulate it in steps of $4\frac{1}{2}$ volts each.—B.

Loud-speaker Materials

Q.—I have experienced some difficulty in obtaining materials for the loud-speaker described in the issue for January 9. Could you let me have the address of the manufacturers of suitable paper for the diaphragm and also suppliers of three-ply mahogany?—F. C. (Rothwell).

A.—J. Holden and Co., Ltd., of 15, Broadway, Westminster, S.W.1, can supply suitable paper for the diaphragm of the pleated-paper loud-speaker. Three-ply mahogany can be obtained from E. A. Cross, of 93, London Road, Southwark, S.E.1.—M. J. C.

Neon Tubes for H.T.

Q.—The neon-tube H.T. unit described in Nos. 143 and 144 works quite satisfactorily, but as I require about 120 volts H.T., I have just inserted another tube in parallel. Only one tube will light up at a time, however, and the voltage is not increased. Either of the tubes will light but not both together, the current appearing to run through the tube first inserted.—L. S. (Manchester).

A.—It would seem that, for some reason or other, the tubes are presenting different resistances to the mains voltage. Is it quite clear that you are inserting both tubes in the circuit the same way round? If you insert them in one direction a larger amount of current will be passed than if they are put in the other way. Another point is that the resistance of the chokes may be somewhat high to allow the voltage to break down the gas as desired. Also it is quite clear that the tubes are of the same resistance? Although they may be rated the same there is often a large difference in the internal resistance of the tubes.—C.

Counterpoise Efficiency

Q.—I have read several times that a counterpoise is better than the usual earth connection. In what way exactly is it superior?—S. W. (Surrey).

A.—As the whole of the aerial circuit is metallic when a counterpoise is used, the resistance is very greatly reduced. This in itself is a very great advantage, meaning, as it does, stronger signals and increased selectivity. Again, the natural wavelength of the aerial system is reduced without lessening the collecting power of the aerial (as would be the case were the aerial made shorter to reduce the natural wavelength). This is a very great advantage if it is desired to tune to wavelengths below 200 metres. Also, as there is no actual connection to earth there is much less likelihood of experiencing interference from A.C. mains than when an earth connection is used. The reason for this is that most of such interference is picked up from earth currents by the earth connection.—J. F. J.

Non-inductive Resistance

Q.—How is a "non-inductive" resistance wound?—O. W. (Birmingham).

A.—The field of one-half the winding must be made to neutralise, as nearly as possible, that of the other half. This object can be attained by measuring off the wire required for the resistance on each of two spools and winding, so that the current flows through one-half of the turns in the reverse direction to the current in the other half of the coil. Join the two outside ends of the wires together and wind on the double wire as you would a single strand. When all the wire has been put on the two remaining ends can be connected up to the external circuit.—B.

Reaction Coil Tuning

Q.—Should the reaction coil be tuned by means of a variable condenser or not?—K. A. (Ilford).

A.—In theory it would be desirable to tune the plate circuit exactly to the wavelength of the station being received, but if this were done in practice the set would, in most cases, be almost uncontrollable. By de-tuning the plate circuit oscillation would cease, and a small condenser is sometimes useful for fine adjustment of reaction, but it is purely a refinement and is by no means essential, especially when a good coil holder with critical adjustment is used.—B.

H.F. Condenser

Q.—Is a .0005 variable condenser suitable for tuning the primary of an H.F. intervalve transformer?—D. N. (Buxton).

A.—Such a condenser might be used for the purpose with some success, but it is really too large, except when dealing with wavelengths of above 2,000 metres. The smallest condenser which will allow the desired waveband to be covered will prove best in practice. The largest condenser generally used for the purpose has a capacity of .0003 microfarad, though it is often of advantage to employ a smaller one having a capacity of about .00025 microfarad.—J. F. J.

Transformer Dimensions

Q.—Constructional details of a special super-heterodyne receiver were given in the October 17th issue. I see you omit to give dimensions of the $\frac{1}{2}$ -in. washers in the transformers, and I should be glad if you could give me the correct diameter. Also, in describing the fourth transformer, you do not give the number of turns for the secondary winding. Should I use iron or brass bolts?—S. B. (Belfast).

A.—The diameter of the washers for the transformers is $1\frac{1}{2}$ in. These are the washers for the centre windings to lay on. The fourth transformer secondary windings are the same as the others. Brass bolts should preferably be used in the construction of these transformers.—A. C.

Four-electrode Valves

Q.—What is a four-electrode valve, and for what is it used?—T. B. A. (Blackpool).

A.—Many different kinds of four-electrode valve have been made. Some have a filament and three plates, others have one filament, one grid and two anodes, but the most usual have a filament, two grids and one plate. A large number of elaborate circuits have been devised in which these valves are employed, but the most used circuits are those of the ordinary type in which the double-grid valve is employed. Everything is connected as usual with the exception that the inner grid is connected to a socket of the H.T. battery. This tends to neutralise the "space charge" within the valve and so a much lower H.T. voltage than usual may be employed. In some cases, indeed, no H.T. battery is required, the plate and the inner grid merely being connected to the positive terminal of the L.T. battery.—J. F. J.

OUR WEEKLY NOTE

CIRCUIT DIAGRAMS.

From the nature of many of the queries we receive it is obvious that a good many of our readers are afraid of circuit diagrams. They are prepared to trace out the intricacies of a complicated wiring diagram, but a theoretical circuit diagram they regard as something far too difficult for them to attempt to understand.

This idea, of course, is quite erroneous as a circuit diagram shows, much more clearly than any wiring plan could, the type of set with which they deal. It is really the same thing expressed with much fewer lines. One conversant with such diagrams could tell at a glance whether the circuit were a reflex or a "straight," just how many H.F. or L.F. stages were used, the nature of any switching arrangements, etc., while he would have to look much longer at a wiring plan in order to obtain as much information.

Every reader should make it his business to become familiar with circuit diagrams as soon as possible. Let him begin by finding a copy of A.W., in which a crystal set is described and both kinds of diagram are given. A brief comparison will enable him to understand the theoretical circuit. He can then proceed to a similar study of more elaborate circuits.

THE BUREAU.

Loose Coupling

Q.—Does the use of loose-coupled circuits result in stronger signals than when the set is connected directly to the aerial?—B. S. R. (E.5).

A.—The primary object of using loose coupling is to obtain greater selectivity than would otherwise be possible. It must not be expected that signals from the desired station will be stronger, but they will be stronger in proportion to those from interfering stations. That is to say, in most cases, there will be a slight reduction on the desired signals and a much greater reduction of those from unwanted stations. In some cases the desired signals may be slightly increased in strength owing to a reduction of damping.—B.

Neon Tubes for Wavemeters

Q.—I read with much interest the article on the neon tube in the issue of AMATEUR WIRELESS for January 23. I should be much obliged if you would send me details of the connections for the wavemeter mentioned, and also for supplying H.T. direct from the mains, which are 240 volts 50 cycles.—K. S. (Crowborough).

A.—The neon tube cannot be used for the supply of H.T. current direct from A.C. mains, and the paragraph referred to the use of D.C. mains only. As regards the wavemeter the tube is simply placed in series with an inductance of the required size according to the wavelength, and the whole is tuned with a variable condenser.—C.

Ask "A.W." for List of Technical Books

The Latest Development

THE 2-VOLT VALVE
with a Current Consumption of
·12 AMP.

Osram
D.E. 2
H.F. & L.F.

Osram Valves

for Broadcasting

2-Volt Valves with a
6-Volt Result

The G.E.C. - your guarantee



REPORTS received from listeners show that the arrangements for controlling the echo in the main studio of the Birmingham station's new headquarters have been very largely successful. The exceptionally large floor space has also enabled improvements to be made by the more effective disposition of the various parts of bands and orchestras in relation to the microphone. When heavy orchestral or military band music has been transmitted it has been found advantageous to place the drums as far away from the microphone as the studio permits.

The erection of the station at Prague, Czecho-Slovakia, which was opened formally a few weeks ago, was supervised for the Standard Telephone and Cables Co., Ltd., by Mr. A. E. Thompson, who was a member of the staff of the Birmingham station in its early days, and Mr. F. H. Amis, also formerly of 5 I.T.

For a long time would-be listeners in outlying parts of Scotland have been handicapped by the absence of adequate facilities for charging accumulators outside of the big towns. Much enterprise, however, is now being shown by country garages and wireless dealers in installing suitable charging plants.

Testing with a Glasgow listener, a Burntisland amateur (some forty miles distant) was heard without appreciable change of signal strength when using powers of 8 watts, 6.5 watts and 3.6 watts on a wavelength of about 170 metres. There was a change to R2 strength when the power was reduced to 2.4 and then 1.32 watts, while 1 watt was inaudible. At 1.3 watts, however, signals again came in at R2 in Glasgow.

An anonymous donor has installed a wireless set in Archdeacon Council School, Gloucester, and the School Old Boys' Asso-

ciation have followed, suit at Wellington Street Council School.

Mr. A. Corbett-Smith has severed his connection with the B.B.C. to take up work as artistic director of a new British film production scheme. He joined the B.B.C. in February, 1923, as director of the Cardiff station.

studio and relayed to the high-power station. In future Königswusterhausen will also relay the entire Berlin programmes from 5 or 6 p.m. onwards every evening.

The first broadcast of the opera *Kitesh*, by Rimsky-Korsakov, will take place towards the end of March. It is hoped to secure the services of several Russian artistes.

Mr. William Larkins, who has been a steeplejack for over forty years, will talk on his work at 2 LO in the near future.

Charlie Chaplin will broadcast from 2 LO in the early summer.

Receiving sets are installed in all the chief dressing-rooms at the Comedy Theatre, London, so that the artistes may listen-in during the intervals.

British residents abroad, particularly in France, have experienced great difficulty in procuring licences for their receiving sets. The Wireless League is at present trying to remedy the matter, and is making friendly representations to the French Government to bring about some modification of the regulations.

The broadcast of *The Blue Kitten*, which was held up at the last minute owing to the dispute with the musicians, will most probably be given towards the end of April.

On March 11 the Hallé Orchestra is to perform Sir Edward Elgar's "The Apostles." This will be relayed to all stations.

A system whereby broadcast talks by eminent people will be read by trained elocutionists is shortly to be given a trial by the B.B.C.

The total number of receiving licences in force on January 31 was approximately 1,841,000.

The educational work of the B.B.C. has grown to such an extent that at present there are more than 2,000 schools on its list and between 50 and 80 compositions are received each day.

The N.S.F. (Nederlandsche Seintoes-tellenfabriek), of Hilversum, has now almost completed the erection of the new 25-kilowatt transmitter, and it is hoped to effect tests on 1,050 metres within the next few days.

THIS WEEK'S FREE GIFTS

"Britain's Most Popular Three-valver"

EVERY purchaser of this issue of AMATEUR WIRELESS is presented with a booklet and coloured constructional guide. Readers will remember the Free Prize Ballot which we instituted in December. In this ballot, two sets came out very high, the first winning by a small proportion of votes over the second.

The winning set was a three-valver of the straight-circuit type and immediately we knew the result, our Construction Department set to work to design a set on the approved lines, to build it and to test it.

Our booklet and constructional guide given away this week show the result achieved. The set has been markedly successful, and we hope that its simplicity, the remarkable completeness of the detail of our description, and the lucidity of our diagrams and coloured constructional guide will encourage a large number of readers to build this set for themselves.

We are hoping that many thousands of new readers will read these editorial words. Our circulation, large as it is, is still on the up-grade, and gives us cause for great satisfaction, but we believe that there is yet a great number of wireless amateurs who would be all the better for becoming regular readers of AMATEUR WIRELESS, and we therefore invite every new reader to register his name with his bookstall or newsagent as a regular subscriber. It is only by having AMATEUR WIRELESS delivered to you definitely every week that you can always be sure of getting a copy. Here is an order form of which you may care to make good use. By the way, there is another big special issue coming, as to which see particularly an announcement we shall make next week.

**ORDER
FORM**

FILL IN THIS ORDER FORM NOW

To(Newsagent)
Please supply me every week until further notice, with
"AMATEUR WIRELESS," published by Cassell's.
(Signed)
(Address)

A scheme for the teaching of French, German, and Spanish through the medium of the Dublin broadcasting station is being arranged at the instance of the Free State Minister of Posts and Telegraphs.

A French air express flying on the London-Paris route has been fitted experimentally with a seven-valve receiving set, connected with which are 12 pairs of phones, one for each passenger in the saloon. The receiver is in the forepart of the plane and is manipulated by the engineer who accompanies the pilot.

The Königswusterhausen station has suspended its Sunday morning concerts, which will be given at the Berlin Vox Haus

Barcelona (Radio-Catalana, EAJ 13) transmits daily on a wavelength of 460 metres at a power of 4½ kilowatts.

Certain alterations are being made in the programmes of the Plymouth station. The gramophone recitals hitherto held on Wednesday and Saturday mornings from 11 to 12 noon will be substituted by an orchestral programme relayed from a local restaurant. In addition to the ordinary transmissions on Saturday afternoons, an extra programme will be broadcast from 3 to 4 p.m.

Phones are now installed in the Court Theatre, London, for the benefit of those who are slightly deaf. Microphones are placed near the footlights so that all stage noises can be picked up.

A new amateur record for long-distance communication has been made by an amateur at Vancouver (British Columbia), who recently communicated with a ship lying at Discovery, an islet of the Atlantic Ocean, a distance of approximately 10,000 miles.

On Sunday, February 28, a Gaelic service is to be relayed from the King's College Chapel, Aberdeen. This will be the first occasion on which a religious service in that language has been broadcast.

Sir Harry Lauder will give his second performance, simultaneously broadcast from all stations, on Saturday, March 6, at 9.15 p.m.

The Kiel station, which generally relays the Hamburg programmes, is now transmitting on a wavelength of 230 metres.

The new 500-watt transmitter at the Bergen (Norway) station is now in full operation on 358 metres.

Tests are now being made at the Thomson-Houston works in Paris on a wavelength of 430 metres.

A 1-kilowatt transmitter has been installed at KGW (Portland, Oregon) and is now in full operation.

A sketch *For the Love of the Flag* is to be broadcast on March 20. This is founded on Ouida's famous novel "Under Two Flags."

A submarine diver will, on March 8, give a short talk while at the bottom of the River Thames. The broadcast will last from 10.30 to 11 p.m.

The Geneva station (HB 1), which transmits with a power of 2 kilowatts, has altered its wavelength to 760 metres in order to reduce interference.

Birmingham's New Studio.—In the report of the opening of Birmingham's new studio, which appeared in our issue of January 30, Mr. P. J. Hannon is reported to have referred to .12 per cent. breakdowns, or twelve hours' loss of transmission in every thousand hours of broadcasting. This, of course, should have been twelve hours' loss in every ten thousand hours of broadcasting.

America's foremost Valve.

BRITISH MADE

CT.08

Filament Volts..... 3.0
 Anode Amps..... 0.08
 Voltage Amplification Factor..... 30-150
 Impedance..... 875
 Mutual Conductance..... 17,500
 Plate Current at 50 Volts over 6 milliamps.

MORE CLEARTRON CHARACTERISTICS

NOW we have the characteristics of the C.T.08, another excellent example among the seven different types of the CLEARTRON range. It is an every purpose Dull Emitter which will work equally well as a high or low frequency amplifier or as a detector. However used, it gives maximum volume without distortion. In your set it means greater distance, operatic purity, keener selectivity, lowest current consumption, and moderate initial cost. The "Ironclad" Guarantee goes with every valve. Your Dealer in giving you this knows that both you and he are fully protected by the efficient principles of the CLEARTRON organisation.

Send for Illustrated Price List—post free.

Type	Accumulator or Battery volts	Fil.volts.	Fil. amp.	Purpose	Price
C.T.08.	Dry cells	3	0.08	H.F., L.F. Detector	12/6
C.T.15.	2 volt Accumulator	1.8	0.15	H.F., L.F. Detector	12/6
C.T.25.	6 volt Accumulator	5	0.25	H.F., L.F. Detector	15/-
C.T.25.B.	6 volt Accumulator	5	0.25	General purpose resistance coupled amplification	15/-

CLEARTRON RADIO LIMITED

1 CHARING CROSS, LONDON : & BIRMINGHAM
 Telephone: Regent 2231/2. Grams: Cleartron, Westrand, London.

British Made

MUSICAL QUAVERS.

DURING the past weeks listeners may have noticed that the B.B.C. have been involved in a dispute with the Musicians' Union. The above statement hardly describes the case; rather one should borrow a simile and say that the "third party" has been made the butt of two interested bodies whose futures are not, to any large degree, affected by publicity.

An ultimatum was delivered to the B.B.C. demanding that extra payment should be made to members of the Musicians' Union when those individuals were taking part in an outside broadcast. Apparently this "shepherding" by the Musicians' Union was primarily extended to orchestral transmissions, such as are relayed by the B.B.C. from cinemas and restaurants; but it was naively added that if the demands of the union were not complied with the "down instruments" order would be extended to all classes of musicians.

This additional sabre rattling appears somewhat hollow, for one imagines that the affluent saxophone of an individual, invariably not a member of the Union in dispute, would continue its melodious task rather than lose £30 to £75 per week.

This is but a small and perplexing detail and must not allow the major issue to be lost to sight.

Musical Desires

It was pointed out by the Musicians' Union that though the employers got no direct gain in cash for their instrumental combinations being broadcast, yet there was a tangible advantage to the management on the score of publicity. This advantage, according to Marxian dicta, they argued, should accrue direct to the musicians who form the orchestras. But what of the management? They had contracted with these musical people to perform a certain labour, but, during the performance of this contract, they hit on the idea that if a window in their premises were opened, so that the public could hear what efforts were being made to create a cheerful atmosphere in their cinemas and restaurants, the credulous public might be tempted to come inside and sample the fare.

Now musicians have "temperament," and the sight of that "open window," though not adding to the labour expended on the task, produced a nervous strain

which had not in any way been covered by contract. What was to be done? Obviously the publicity value must strengthen those nerves, or temporarily—not permanently—that window must be closed.

Are These Transmissions Necessary?

The listener will at once ask himself the above question, and immediately the house whose foundations were set on the sands will at once come to mind. If music of this character, and at the times at which these orchestras play, is vital to the B.B.C., then surely the revenue is available for its production. The answer is a decided affirmative. The alternatives at the disposal of the B.B.C. are obviously many and simple and are such as would improve the standard of entertainment.

Alternative Production

It is interesting to examine one of the alternatives open to the B.B.C. There is the subsidy policy, by the employment of which the broadcasting authorities can

(Concluded on page 350)



250 to 2,000 metres

You can now receive the long wave stations as well as the ordinary broadcast band on the Super-Het. you make with Bowyer-Lowe Transformers.

The new Model III couplers for use with these Transformers are interchangeable on a fixed base and cover between them all wavelengths from 250 to 2,000 metres. Build your Super-Het. with Bowyer-Lowe parts and receive rich, pure signals on ALL wavelengths.

SPECIAL OFFER. If you already own a Bowyer-Lowe set with Model II coupler, this coupler will be exchanged for Model III, 250-550 metres, complete with base, at a nominal charge of 9/-. Send the old coupler direct to us enclosing P.O. and your name and address. Mark package "Exchange Dept."

Bowyer - Lowe Tested Super-Het. Transformers	
SET OF FOUR Transformers in box with instructions for building 7-valve Super-Het. ...	£4
Model III Coupler 250-550 M., in Ebonite case ...	£1
MODEL III Coupler 500-2,000 M., interchangeable on same base as before ...	£1
BASE to take either of above as required ...	4/-

BOWYER-LOWE CO. LTD., LETCHWORTH.

LOOK TO THE AERIAL CONNECTION



You may have a tip-top aerial and a fine set, yet, if the lead-in connection is faulty the results will be poor. The best way to attach the lead-in to the aerial is to twist the wires thoroughly together and solder with FLUXITE.

SOLDER WITH FLUXITE FOR THE MINIMUM EFFORT AND THE MAXIMUM EFFICIENCY.

Ask your Ironmonger or Hardware Dealer to show you the neat little

FLUXITE SOLDERING SET

it is perfectly simple to use, and will last for years in constant use. It contains a special "small-space" Soldering Iron with non-heating metal handle, a Pocket Blow-lamp, FLUXITE, Solder, etc., and full Instructions. Price 7/6. Write to us should you be unable to obtain it.

FLUXITE SIMPLIFIES SOLDERING

PRICE 7/6



All Hardware and Ironmongery Stores sell FLUXITE in tins, price 8d., 1/4, and 2/8.

Buy a Tin To-day
FLUXITE, LTD. (Dept. 326), West Lane Works, Rotherhithe, S.E.16.

ANOTHER USE FOR FLUXITE
 Hardening Tools and Case Hardening
 ASK for LEAFLET on improved methods.



ALL POSTAL Communications 7 GRAPE STREET Phone: Shaftesbury Avenue, W.C.2 GERRARD 2821 Back of New Princes Theatre



WONDERFUL LOW LOSS STRAIGHT LINE FREQUENCY CONDENSERS. THE CONDENSER OF THE FUTURE

LOW LOSS. UNSOLICITED TESTIMONIAL. 382, Cranbrook Road, Ilford, ESSEX. Messrs. Raymond. I am writing to let you know the wonderful change you have made in my one valve Straight set. On Sunday evening (with 2L0 working) I was successful in receiving Radio Berne, Dublin, Hamburg and Newcastle at excellent phone strength. All these stations had previously passed me by. I can only say that if there is a 100 per cent. condenser on the market, yours is IT. Harry R. Prockler.

Pigtail connection to rotor gives silent working. Special Spring top Bush gives a firm but easy movement. Including knob and dial as sketch. With vernier. *0003 ... 7/11 *0005 ... 8/6 Including knob and dial No vernier. *0003 ... 5/11 *0005 ... 6/6 POST 6d. PER SET.

Supreme SELECTIVITY. Each station has a CLEAR TUNING SPACE. CROWDING entirely ELIMINATED. SIMPLIFIED tuning. DISTINCT and DEFINITE Radio reception. PRECISION workmanship. HEAVY BRASS VANES. BRITISH MAKE. In 1924 the straight-line frequency condenser was never heard of. We were still using the straight-line wavelength condenser. Now look at the present-day sets and notice the silent revolution that has taken place. Now all of the new sets have straight-line frequency condensers and many are equipped with vernier dials. But there must be good and sufficient reasons for using straight-line frequency condensers, otherwise the manufacturers would not adopt them. This is why we are concentrating on this type in advance.

K. RAYMOND Phone: Gerrard 4637

Hours of Business 9 to 8 DAILY 9 to 9 SATURDAY 11 to 1 SUNDAY (LISLE STREET)

TWO SHOPS—so you will ALWAYS find ONE OPEN 27 & 28a LISLE STREET, LEICESTER SQUARE, W.C.2 Opposite DALY'S GALLERY DOOR (BACK OF DALY'S THEATRE) BE SURE IT'S RAYMOND'S

RECOGNISED WEST END DISTRIBUTOR of the manufacture of Edison Bell, Jackson's (J.B.) Polar, Igranite, Peerless, Eureka, Magnum, Burn-dept, Lotus, Dubilier, Marconi, Dorwood, Sterling, Success, B.T.H., McMichael, Lissen, Wood hall, Utility, R.L. Bowyer-Lowe, Amplion, Ferno, Brunet, Ormond, Newey, P. and M., and everything that is worth stocking. Every endeavour made to obtain goods not listed.

KAY-RAY VARIABLE CONDENSERS

DE LUXE LOW LOSS MODEL. SQUARE LAW With Vernier Without Vernier .001 7/11 .001 6/11 .005 7/8 .005 5/7 .009 6/11 .009 4/9 High-grade Ebonite ends one-hole fixing, knob and dial.



ONE VALVE AND CRYSTAL SET An Ideal Equipment

for your local station or Daventry, complete with Valve, Batteries, Headphones, and Aerial Gear. Can be erected and ready for listening in 20 minutes. This set incorporates a permanent Crystal Detector Set tuned by Variometer followed by one stage of low frequency amplification. Tested and guaranteed. Comprises Set, DE 06 valve, H.T. Battery 60 volts, 1 CHS L.T.3 Battery (Ewer-Beady), High-class 4,000 ohms Headphones. Lead-in, Insulator, Wander plug, Aerial Wire, ready to fix up. Inclusive price 45/11 POST 2/-

NEWBY BACK OF PANEL 2-WAY COIL STAND. No back lash .. 6/6

VOLTMETERS. Double Reading Low and High, Post Free, 7/11.

CRYSTAL SETS. Complete sets of parts ready to assemble. Good quality panel drilled box 7 x 5. All necessary components Post Free, 10/6.

1 VALVE AMPLIFIER. Complete sets of parts including Transformer, box panel drilled, all components. State if D.E. or Bright Rheostat. The lot ready to assemble, 14/11.

West End Depot for MAGNUM (Burne Jones)

Baseband Coil unit, 1/5. 2 coil type L or R, 9/6. 3-way, 12/8. Neurodyne Condenser, 4/6. Anti-cap V.H., 2/6. Vibro, 5/-. Brackets, 2/- pr., 2 1/2 x 1 1/2; 3/- 5 x 3. Tapped coil for Simplicity or T.A.T., 8/- each. Kendall Low Loss Cross former, 3/4, adaptor, 1/- extra. Wave Trap Form, ABC 5/6. H.F. Transformers Neurodyne, also 300/600, 500/1200, 1100/3000, 2500/7000 each 7/-. Also 500/2500 matched, 14/- pair.

Customers taking 25 worth of our own goods at full list prices can have a pair of BRUNET, DR. NESPER or ERICSSON RENTAL phones FREE.

Customers taking 30/- worth own goods full prices can buy a 12/6 pair of phones for 4/- EXTRA. (My selection)

Retail customers spending £10 own goods given a well-known Loud speaker retail value, 37/8, FREE.

MULLARD VALVES. P.M.4 .. 22/6 P.M.3 .. 16/6 Your old valve allowed for.

Sterling, Marconi, A.J.S. Parts stocked. Goswell Coils and all parts stocked.

U.S. SUPER L.F. TRANSFORMER. Highly recommended, 18/6.

PHILLIPS VALVES. 4 electrode for UNDYNE circuit. 4 pin .. 8/11 A.D.E. .. 7/11 Bright 4v. .. 4/11 Post Free.

BRANDES TABLE TALKERS. Very fine tone .. 30/- Ultra Loud Speaker 27/6

ERICSSON L.F. TRANSFORMER. Lettering in English. Post Free, 5/11. Beware of imitations.

ENERGO H.F. B.B.C. .. 3/11 5 X X .. 4/6

BROWNIE No. 2 Latest Model CRYSTAL SET 10/6

Complete with headphones, 4,000 ohm. Aerial equipment, Daventry coil, 18/11. Postage, 1/8.

CALLERS COLUMN

Post Orders Elsewhere. Nett Prices Callers: The next items are for you only ACCUMULATORS.—2 v. 40, 7/11; 2 v. 60, 9/6; 2 v. 80, 12/6; 2 v. 100, 14/6; 4 v. 40, 13/11; 4 v. 60, 17/11; 4 v. 80, 23/6; 6 v. 60, 26/11; 6 v. 80, 35/6. ALSO another good make 1/6 extra on each of above.

TERMINALS, SPECIAL PRICES.—Nickel W.O. or Phone, with nut and washer, good quality, 3 for 1d. Brass, 1d. each. No rubbish sold. AMERICAN Type boxes covered LEATHER. CLOTH with lid and signboard.—12X8X8, 7/11; 16X8X8, 10/11; 18X8X8, 11/9. Open boxes, 1/6 upwards. Polished from 2/4. H.T. Batteries ADI00, 60 v., 8/11; 100 v., 12/6. B.B.C. generous size, 60 v., 3/11; 36 v., 5/8. 1.5 B.B.C., 2/3. Grid Bias, 9 v. Tapped every 1 1/2 v., various makes, 1/6, 2/-, 2/3. EVEREADY 66 v., 12/6; 108 v., 22/-. L.T.3 for D.E. Valves, 7/6. SIEMENS H.T. 60 v., 12/6. Hellesen's 60 v., 14/6. Various 1.5 D.E. Batteries, 1/- to 2/6.

EBONITE.—"Grade A." cut white you wait, 3/6 at halfpenny per sq. inch. 1 in. at three farthings. Scrap ebonite on sale.

NEUTRON Flash Lamp Batteries.—4.5, 4jd. each; 2 for 6d. NEUTRON Crystal, 1.6. NEUTRON Valves stocked. Bulls eye bulbs, 3d.

DETECTOR VALVES from 2/6. Hard valves from 2/10. PHILLIPS genuine "R" type 4 v., 3/8. PHILLIPS 06 D.S., 7/11. Power Valve, 12/6. FAMA 06, 7/11. FAMA Power, 3/- D.E. Power, 7/11.

Switch Spade Terminals for H.T., L.T., etc., 1/8 pr. Spade tags, 6 a 1d. Spade screws, 2 for 11d. Red or Black, 3d. pr. Ins. staples, 5 a 1d. Ormond screws and nuts, 2 a 1d. Switch arms and studs, 1/-, Nickel, 1/4. Wander Plugs, 2d., 3d., 4d. pr. Plug and socket, red and black, 3d. to 1/2 pr. Twin Flex, red and black, 12 yds., 1/6. Miniature milk, 6 yds., 6d. Ins. hooks or cog insulators, 2 for 11d. Aerial wire, 7/22, 100 ft., 1/11. Extra heavy weight, 2/8. Stranded aerial, 100 feet (49 strands), 1/3. Also "Wonder" aerial multiple strands phosphor bronze, 110 feet, 2/11.

D.C.C. wire per lb., real 20 g., 9d.; 22 g., 10d.; 24 g., 11d.; 26 g., 1/4; 28 g., 1/1. Tinned copper, 1/16 sq. Bus Bar, 12 feet, 6d. Empire tape, 12 yds., 6d. Earth Tubes, Copper, good value, 2/6. Ohmcast 2/3, 5/-. Sets of 5 Coils (Dickenson Patent), air spaced, 25/300/75/100, 1/9 set. Mounted Coils, very efficient, all makes lowest prices.

COIL PLUGS, Ebonite shaped, brass sides, 6d. ea.; 6 for 2/9. Low Loss ditto, nickel, 9d. Plain coil plugs, 6d., with fibre, 7d. Lead-in Tubes, good quality, 6 in., 8d.; 9 in., 9d.; 12 in., 1/4; 18 in., 1/6. Ebonite 2-way coil stands, geared, 2/11 3/11. 3-way, 4/11, 5/11. Lotus, Polat, Newey Franco, all good makes stocked. Good line standard at 1/11 on base. 2-way with extension handles, 1/11 and 2/6.

VALVE HOLDERS.—Standard turned ebonite, 1/- Excelsior antipatterny, 1/-, Apex, 1/6. LOTUS BUOYANT, 2/3. H.T.C., 1/8 and 1/8. Various at 9d., 10d., 1/-. All makes stocked.

PANEL BRACKETS, 6 in., 10 par. Magnum, 2/- and 3/- pair. Panel 2-way coil holder, having reaction slide movement, wonderful little article, only knob and dial seen above panel, 2/6.

RADIO MICRO SPECIAL LOUSPEAKER VALVE, 2/6. .06 SPECIAL 8/6. HEADPHONES.—The latest model N. & K. absolutely genuine (not pattern or imitation), stamped in full on back of each case. As light as a feather. Beautifully finished, very comfortable to wear, 4,000 ohms at the simply absurd price of 11/6 pair. DR. NESPER ADJUSTABLE.—Genuine new lightweight model, 4,000 ohms, the perfect phone, per pair, 12/11. ERICSSON (REV) Continental, 4,000 ohms, exquisite tone, pair, 10/- N. & K. Standard pattern, comfortable leather head bands, 4,000 ohms, 8/11 pair.

VARIOMETERS.—Ebonite Ball Rotor Ebonite former wound D.S. full wavelength, 3/11. Model No. 2, excellent value, Ebonite wound D.S., 2/11. Duplex (Series Parallel) for 5 X X and B.B.C. No coils required, 6/11. Tapped Coupler, 200/800 metres, 7/11. B.B.C. also for B.B.C. and 5 X X, 10/11.

CRYSTAL DETECTORS (enclosed)—High class, 8d., 1/4, 1/2, 1.6, 1/9. McMichael, Nickel, 1/9. Permanent, 2/6. Mic Met, 4/6. All well-known makes stocked. CRISTAL. SHAW'S GENUINE BERYLITE in a sealed box with signboard, 8d.

Parts for one valve amplifier, box, panel, drilled Rheostat, L.F. Transformer, valve holder, Terminals wire, ready to assemble, 13/11. Parts for Crystal Set, Box, Drilled panel, Terminals Detector, Crystal, Wire, Variometer, Dial and Knob, 10/11.

SPECIAL PRICES given over the counter for sets of parts for various circuits, usable valves, bought or taken in exchange for new ones. Any parts you have no use for entertained in exchange or purchased. Goods may be bought without obligation either side. If you purchase new British valves I will buy a burnt out one for each valve you take. Right reserved to cancel this list without notice.

POLAR STOCKIST.—Complete Detector, 3/6; Junior Variable .0003, .0005, 5/6 each; Coil Unit, 7/6; R.C.C. Unit, 15/-; Neurodyne Condenser, 5/6; 2 way Cam Vernier, 6/-; 3-way, 9/6.

SUNDRIES.—Mansbridge TOC 2 mfd., 4/8; 1 mfd. 3/10; 25, 3/-; 5, 3/-; .01, 2/-; .02, 2/-; H.F. Transformers, McMichael, all wavelengths, 10/- each. A6, 10/-; A7, 12/6. Stradia 300/600, 1100/3,000, and Neurodyne, 6/6 each (made by Sirlings, Ltd.). Magnum, Burne-Jones, all 7/- each. Matched, same price, Bowyer-Lowe, 7/- ea. Crystal Detectors.—Enclosed Burndept, 4/-, Mic-Met, 4/6. Micrometer, 2/3. Open Polar, 3/6. Permanent RI, 6/-, 7/6. Liberty, 3/6. Kay Ray, 2/8. Chokes, RI, 10/-; Success, 10/-; Lissen H.F. or L.F., 10/- Geared Dial, Pelican Universer Latest type, 6/-; Combine, 5/6.

VARIABLE GRID LEAKS.—Lissen, Watmel, 2/6; Bretwood, 3/-; Lissen Aeron, 2/6; Watmel, 3/6; Bretwood, 3/- VERNIER OMBESSERS.—3-plate, 3/11; 5-plate, 4/6; Michron, 2/6; Colvern, 2/6; Ormond, 2/6; Gambrell, 5/8.

LISSEN PARTS.—Anode or Variable Grid Leak, 2/6 each; L.F. or H.F. Choke, 10/-; Switches, D.P.D.T., 5 point Reversing, 4/- each; 2-way series Par., 2/9 each; Minor, 3/6; Major, 7/8; Universal, 10/8. Potentiometer or Wire Rheostat, 4/- each. Neurodyne Condenser, 4/6.

RADION PANELS.—1d. square inch, postage 6d. piece.

EBONITE.—"Grade A." no fancy names for it, but really reliable quality. Cut to size while you wait, 14d. per sq., 3/16 inch 1d. sq. in. 1/4 thick. Postage extra. Panel drilled free if you buy 25/- worth of goods.

LISSEN LOUD SPEAKER UNIT, 14/6. 10/- cash prize given for the best article on this unit. Closing March, 15, 1926. Bill must accompany all efforts.

HEADPHONES.—Genuine Dr. Nesper adjustable, 12/11. Genuine Telefunken adjustable, 14/11 pr. Genuine N. & K. stamped on each, 12/-. Lightweight, 13/6. Genuine Ericsson (E.V.) (combinational), 10/6. Genuine Brunet, 11/9, 13/11. BRITISH Sterling, 22/6. B.T.H., 20/-, Ericsson, 22/8. Brandes Matched, 20/- Brown's A3, 30/-, Do. Featherweight, 20/-. All makes stocked.

V. and K.—The very latest lightweight model, Crystalline finish, exquisite tone, 4,000 ohms, Genuine N. & K., 11/6 pr.

LOUD SPEAKERS.—Brown's, 30/-, 60/-, 120/-, Amplion, 25/- to 27/7. C.A.V., 27/6. Sterling, Dinkie, 30/-. Baby, 50/-. Primax, 27/7.8. Amplion A.R.33, 38/-. A.J.S. wonderful model Brown finish, large size, 37/6. Sparta, 95/- N. & K. solid mahogany, dome centre, 28. Sterling Mellow vox, 48/-. Any model obtained immediately. Telefunken model, very fine speaker, 18/11. Nesper model, 14/11. Your old speaker accepted in part exchange or bought outright (always plenty of good second-hand ones on sale. No second-hand goods are sold by post.

VALVES.—Cosmos (Med. Vickers), D.E.11, 12/6. S.F.12; Red or Green, 12/6. A.45, 7/6. Neutron .06, H.F. or L.F., 12/6. Cleartron .08, 12/6. C.I.5, 12/6. All Mullard, Ediswan, Cosor, Marconi, Oram Valves, 8/-, 14/-, 16/6, 18/6, 22/8, 24/6, 30/-. (Bright, D.E., and Power stocked.) Your burnt-out valve taken in part exchange for each British valve purchased. Usable valves bought or exchanged.

VALVES.—The latest in .06 Neutron valves, 3-volt. Highly recommended, each 12/6. (Your old valve allowed for.)

L.F. TRANSFORMERS.—Ferranti A.F.3, 25/-; A.F.4, 17/6; Eureka Concert, 25/-; 2nd Stage, 21/-; Baby 1st or 2nd, 15/-; Reflex, 15/-; Ferno shrouded, 10/6. Success (Black), 21/-; Royal, 20/-; Ormond newest model, 15/6. Wates' Supra, 19/6. Croix (newest model), 7/6. Marconi "Ideal," all stages, 30/- each. C.A.V., 15/-; Pye, 22/6. Gambrell 2 stages, 25/6. Ideal Junior, 20/-; Lissen T3, 12/6. T2, 15/-; T1, 21/-.

EBONITE VARIOMETERS.—Ball Rotor, 4/6. Standard, 3/11. Duplex for 5 X X and B.B.C., 7/8. Tapped Variable Coupler, 200/800 metres, fine instrument, 8/11. Marconi series-parallel, 16/-; Edison Bell, 5/1, 10/6.

MOUNTED COILS: STAR.—25, 4/3; 35, 1/6; 50, 1/8; 75, 2/-; 100, 2/3; 150, 2/6; 175, 2/9; 250, 3/-; 300, 3/6. GRAM (Patent 206333), air-spaced, mounted, 25, 1/6; 35, 1/6; 50, 1/8; 75, 1/11; 100, 2/3; 150, 2/6; 200, 2/11; 250, 3/3; 300, 3/6; 400, 3/6.

IGRANT (Honeycomb)—25, 35, 4/3; 50, 6/6; 75, 4/40; 100, 6/3; 150, 7/7; 200, 8/-; 250, 8/6; 300, 9/-; 400, 10/-; 500, 10/3; 600, 11/-; 750, 12/6; 1,250, 15/6; 1,500, 17/6. LISSEN.—25, 35, 4/10; 50, 5/-; 60, 75, 5/4; 100, 6/9; 150, 7/-; 200, 8/6. LISSEN K., 50, 6/7; 60, 6/4; 75, 6/5; 250, 9/6. FINSTRON.—35, 1/6; 50, 1/8; 75, 2/-; 100, 2/6; 150, 2/9; 200, 3/6; 250, 3/9; 300, 4/-.

VALVE HOLDERS.—BENJAMIN, 2/8; Lotus, 2/3; Apex, 1/6; Excelsior, 1/8; Sterling Non Pong, 4/8; Burndept, 5/-; Magnum, 5/-; 2/6; Bowyer-Lowe, 3/-; Athol, 1/3; H.T.C., 1/6, 1/8; Aeronomic, 1/3; Bretwood, 1/4.

SETS OF PARTS.—ST.100, 84/- Twin-valve, Loud Speaker, 60/- P.P.V.2, 30/- One-Valve Reflex, 41/- Efficient valve set, 30/- All-Comet De Luxe, 118/- Simplicity 3, 62/- (FLEX Panel 130 x and valves)

FIXED CONDENSERS.—Dubilier .0001, 2, 3, 4, 5, each 2/6. Edison Bell, .001, .0001, 2, 3, 4, 5, 1/- .002, 3, 4, 5, 8, 1/6 .0005 and grid leak, 2/- (Post 2d.) Thiera, 1/6 and 2/- each. Dorwood .0005 with grid leak clip, 2/6. McMichael with clips, .0001, to .0005, 2/6 each; .001 to .006, 3/- each.

VARIABLE CONDENSERS.—Polar Standard, 10/6. Junker, 5/8 each. Bowyer-Lowe Popular, 10/8. Igranite, 24/6. 21/- Collinson's Low Loss, 21/-, Utility, 5/8, 10/8. Vernier, 2/6 extra. Utility Low Loss, stocked .0003 and .0005. J. B. (Jackson Bros.), Square Law, .001, 9/6; .0005, 8/-; .0008, 7/-; with vernier, 4/- each extra. Geared .0005, 15/-; .0006, 14/- Low Loss, 10/8, 9/- .0003, 13/6. Low Loss, grid drive, .0005, 15/- .0003, 13/6. Low Loss, .0005, 8/-; .0003, 7/6; with vernier 1/6 each extra. Ebonite ends same price. Newey 4 point, .360 in. geared control, square law, 15/-, 17/6.

FILAMENT RHEOSTATS.—Ormond 6 or 30 ohms, 2/6. Finston, 6 ohms, 2/8; 30 ohms, 2/6. Wates' Microstat, 2/3. Lissen Wire, 7 or 35 ohms, 4/- Do. Potentiometer, 4/8. Burndept, 4/6 to 2/8. McMichael, 4/6 to 2/8. Peerless 6 or 30 ohms, 2/6. Peerless Dual, 3/9.

COIL STANDS.—Lotus 2-way, 7/-; 3-way, 10/8 (extension handles extra). Polar 2-way, 6/-; 3-way, 9/6. Sterling Triple, 21/-. Kay Ray geared 2-way, 3/11. Back of panel, with knob and dial, 3/11. Panel 2-way, 2/- Goswell, 3/- Standard, 2/9. All makes stocked. Ebonite coil plugs, shaped brass sides, 6 for 3/6. Standard, 3 for 2/- New Low Loss type, 2 for 2/-.

ACCUMULATORS. Special quality, Post Free. 2 v. 40 .. 8/6 2 v. 60 .. 10/11 2 v. 80 .. 12/6 2 v. 100 .. 14/6 4 v. 40 .. 18/11 4 v. 60 .. 18/11 GAMBRELL.—Neurodyne .. 5/8 SEAMARK CONRODE .. 19/6 WOODHALL L.F. .. 28/6 WOODHALL VALVE HOLDER .. 2/6

"MUSICAL QUAVERS" (cont. from page 348) share the cost of certain orchestras and thus be in the position to call the tune of the piper. By this means, as the Musicians' Union insist on diverting a portion of musical capital from its present flow, the B.B.C. would be justified in this subsidy. The company, as part guarantor, would have the power to insist on the most suitable types of programme. At once the numbers of musicians to whom the benefits of wireless publicity would accrue become limited to the lucky contracting parties.

The listener can imagine the financial effect on the members of some unknown band playing possibly in the East End, when through the medium of wireless they are made tempting offers to migrate towards the West. One drawback to such an advantage is that the inflated salaries due to the individual's skill and talents causes forgetfulness when the payments to the Union become due. When Mr. Saxophone by careful practice and study has augmented his income to comfortable proportions, Mrs. Saxophone sees no reason why the total result of his efforts should not be reflected in all the little Saxophones.

A Musical Locarno

However, it appears that the listener will not lose his incidental music to lunch and tea, for the "Powerful Ones" have lost their zest and have retired to discuss

with the managements of the places concerned how far the advantages of this new medium can be made to flow their way. The B.B.C. refuse to be drawn into the conflict, as their only desire is the economical expenditure of listeners' money, and while publicity has its value, the company will contrive to obtain these transmissions for the listeners as cheaply as possible.

ROBERT GLENDINING.

THE B.B.C. SILENCE TESTS

THE full results of the tests conducted by the B.B.C. on Tuesday, February 9, are now known. The specially calibrated apparatus used enabled the wavelengths of interfering stations to be accurately ascertained. London was found to be transmitting on a wavelength of 361 metres, instead of the official 365, while Swansea was occasionally found to be about 10 metres out of its correct position.

Two stations causing interference with Bournemouth were located, one half a metre above and the other half a metre below it. A slight whistle in the transmission from Newcastle was caused by an interfering transmitter on a wavelength of 403 metres.

An area of great congestion between 350 and 450 metres was specially examined. Interference caused by oscillating receivers was very slight.

PARS AND PERSONALITIES

By THE LISTENER

ON Saturday reappear those clever duettists, Miss Grace Ivell and Miss Vivian Worth. It is interesting to note that they first made acquaintance during a cantata in St. Paul's Cathedral. Their syncopated music since that date presents considerable contrast.

It is a pity that the B.N.O.C. is only to give a seven weeks' season instead of its customary thirteen.

Gustave Holst was born at Cheltenham. His music is largely written round Eastern subjects, his best operas are *Savitri* and *Sia*, the latter on East Indian legends, while his symphonic suite "Beni Mora," "The Planets" and "Hymns of the Rig Veda" are prominent. His first appearance was made at the Old St. James's Hall in 1904, when he conducted his own Suite de Ballet. Later he was director of Morley's College.

Miss Helen Mar, who has associated herself so firmly with English concert halls, really hails from America, and as a raconteuse of stories, both of her own country and European, stands supreme. She did a great deal of war work, and has appeared before most of the Royal Family.

To-morrow (Friday) night an excerpt is promised us from Miss Sybil Thorndyke's

(Continued on page 352)

PHONES, 4,000 OHMS

Featherweight	4/9
N.K. Pattern	6/9
Foth adjustable diaphragms	7/9
Dr. Nesper adjustable	11/9
TELEFUNKEN Lightweight Genuine adjustable diaphragms	14/11
Brown's "F" type	20/-
Brown's "A" type	30/-
Brandes	20/-

LOUD-SPEAKERS

Nesper	16/9	Brown H4	30/-
C.A.V. Tom-tit	30/-	Brown Cabinet	6/6-7/9
Amplion Junior	27/6	Dulcivox	37/6
Brown H2	49/-	Gramophone	
Brown H3	3/-	attachment	2/2-
		Lissenola	13/6

Brown Loudspeakers on deferred payments

VALVES

Dutch Detector	2/6	Cossor W1, 14/-; W3, 18/6	
" Amplifier	2/7	Fama Detector	2/8
" Power	7/6	" Amplifier	2/10
Marconi	8/-	" Power D.E.	7/9
Cossor	8/-	Radio Micro	9/-
Phillips	5/6	Triotron 2, 4/6; 06, 6/-	
Telefunken	3/9	" Power 3	8/-

All Valves posted purchaser's risk.

BEST SHEET EBONITE

Accumulators. Best Quality. Ignition capacity				
2 volt 40	9/6	6 x 6	1/-	1/6
2 " 60	11/6	9 x 6	1/6	2/3
2 " 80	13/9	9 x 9	2/3	3/4
4 " 40	15/11	12 x 6	2/-	3/-
4 " 60	19/6	12 x 9	3/4	4/6
4 " 80	24/6	12 x 12	4/-	6/-
6 " 40	23/11	15 x 12	5/-	7/6
6 " 60	29/6	15 x 15	6/3	9/3
6 " 80	35/9	24 x 12	8/-	12/-
Davenport Coils (5 XX)				1/6
Sets of Basket Coils				1/9 1/11

Fixed Condensers: Edison Bell, .001 to .0006	1/-
" " " " .002 to .006	1/6
Edison Bell Coils, mounted, 25 35 50, 2/6 each; 75, 100, 150, 3/6 each; 200, 250, 4/6.	
Matchless Coils	2/3 2/9
Basket Coil Mounts	9d.
Variometers	2/-, 2/6, 2/11, 3/6, 6/6
Voltmeter	4/6 5/-
Combined Voltmeter and Ammeters	5/6
Voltmeters reading to 100	10/6
Benjamin Valve Holder	2/9

AERIAL WIRE

Ribbon Aerial, 100 ft. K. Brand	1/10
7/22 Hard Copper	2/3
5/26 "	1/11
Electron Wire	1/8
Hekoo Phosphor Bronze 25% better reception 100 ft. non-corrosive	3/3
Climax Earth	5/-
Special 49 Strand Copper Aerial	2/3
Tubular Earth	2/6

CRYSTALS

R.L. Detectors	6/-	Neutron	1/6
Tungstallite	1/6	Mighty Atom	6d.
Hertzite	1/-	Hertzite	3d.

Square Law Condenser, with dial, .001, 8/- .0005, 6/6; .0003, 5/6. Ebonite Ends, 6d. extra. With Vernier, 1/- extra.

H.T. Batteries, 30 Volt	3/9
" 60 Volt	6/9
Pocket Batteries, doz.	4/6
B.T.H. Dry Cell for Dull Emitter Valves, each	2/-
Bretwood Grid Leak 3/- Edison Bell Grid Leak 1/-	
Wamel	2/6
Microstat	2/9
Edison Bell Grid Leak	1/-
Grid Leaks, Variable	2/-
Lissen Grid Leak	2/6

TRANSFORMERS

R.L. 25/-; Croix, 7/6; Powquip, 10/6	
Ferranti AF4, 17/6; AF3, 25/-; Eureka, 15/-;	
Simplex, 7/6. Other makes in stock.	
H.F.—ALL B.B.C.	3/11. Other sizes stocked

Phone Cords	1/6
Coil Holder	2-way 2/9, 3-way 3/11
Flush Valve Sockets	4 for 6d.
Red and Black Spade Terminals	each 1d.
Phone Terminals, with Nuts	11d.
Terminals, with Nuts	1d.
Extra Large, with Nuts	11d.
Crystal Cups	2 for 11d.
Crystal Cups, Improved	11d.
Shellac Varnish	9d.
Valve Legs, with Nuts	1d.
Valve Sockets, with Nuts	1d.
Spade or Pin Terminals	1d. Switch Arms 7d.
Studs, with Nuts	doz. 6d.
Stops, 2 1d. Wander Plugs	pair 4d.
Twin Flex	yard 2d. Lead-in Wire yard 2d.
Earth Wire	yard 2d.
Adhesive Tape	roll 3d.
Insulated Hooks	each 1d.
Insulated Staples	doz. 3d.
Panel Transfers	sheet 4d.
Sleeving, yd., 3d.	Rheostat 1/-, 1/6, 1/10
Solder for Panels	stick 3d.
" Square Panel Wire	12 ft. 9d.
" Square Twisted Panel Wire	12 ft. 1/-
Special Lightning Switch	
Fluxite, 8d. Outfits	7/6
Panel Switch	1/-
Rawplug Outfits	3/6
Red and Black Twin Flex	yard 2d.
Copper Foil, 6 in. wide	foot 6d.
Earth Clips	2d.
Fibre Strip for coil mounting	yard 3d.
Special Soldering Irons	6d.
Maroon Twin Flex 12 yd.	1/7
Stalloy Phone Diaphragms	each 4d.
Valve Windows	4d.
Valve Mounts	9d.

CRYSTAL SETS

Brownie Crystal Set	7/6
" Model 2	10/6
I will include with the No. 2 model pair headphones, aerial and earth wire complete with insulator, etc. 21/-	

NOT OPEN SUNDAY. ASK FOR SPECIAL PRICE LIST. ORDERS OVER 2/6 CARRIAGE PAID. FOREIGN ORDERS EXTRA.

TELEPHONE: NORTH 2351

HENRY KENNETT
11, LIVERPOOL ROAD, ISLINGTON, N.

ESTABLISHED 1861 STILL HERE

Mellow as an old fiddle

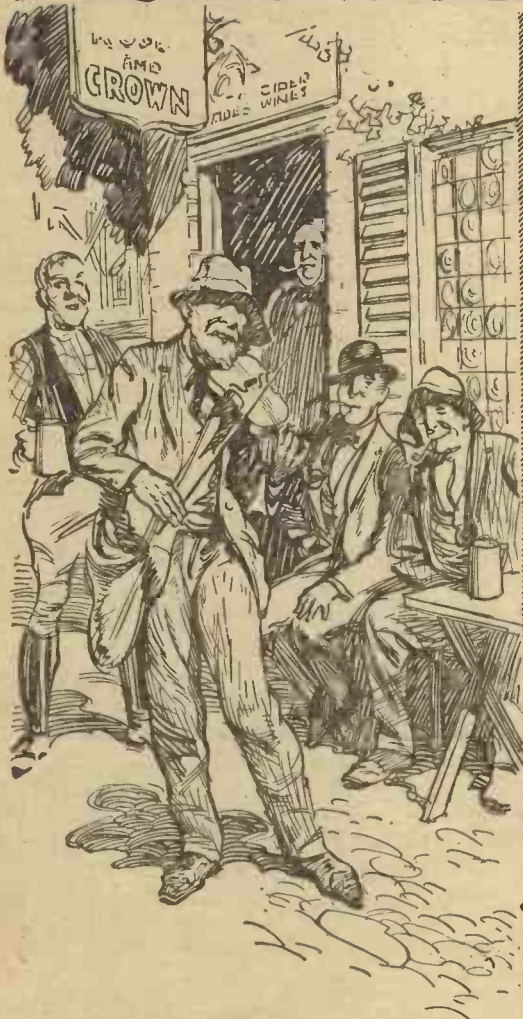

PLAYER'S wealth of experience in all that pertains to the maturing of tobacco enables them to place their cigarettes on the market as they reach prime condition, while the extraordinary demand forbids staleness. The maturing and blending is so skilfully done that the natural fragrance of the Tobacco remains unimpaired.



20 for 11½^{d.}
10 for 6d.



P.1213

It must be Players

"PARS AND PERSONALITIES"—(continued from page 350)

production of *Henry VIII* at the Empire Theatre, London. Included will be her husband, Mr. Lewis Casson, and Mr. E. Lyall Sweet, one of the best all-round actors on our stage. He will be remembered for his work in many Pinero plays and for the part of Lutz in the very first production over here of *Old Heidelberg*, as produced and played by Sir George Alexander. Its musical form is *The Student Prince*, now running at His Majesty's Theatre.

In that combination known as The Modern Trio, which plays on Sunday, the 28th, Mr. William Primrose has taken the place of Melzak, the former violinist leader. That ever-popular song cycle "In a Persian Garden," of Lisa Lehmann, will be played, with Miss Dorothy Bennett, Miss Mary Foster, Mr. Spencer Thomas and Joseph Farrington as the singers. In the evening will be heard Sandler and Edith Furmedge.

On March 2 will be heard another early broadcaster in Mr. Dan Jones. He possesses a tenor voice of particularly fine timbre and range, and we have missed him for some time.

Most of us have admired the work of "Poy," the well-known cartoonist. Mr. N. Pearson, to give him his real name, is the second artist to give a talk before the microphone.

CHIEF EVENTS OF THE WEEK

SUNDAY, FEBRUARY 28	
London	3.30 The Modern Trio.
Birmingham	9.20 Schubert Programme.
Cardiff	7.0 Evening Service from the Colston Hall, Bristol.
Manchester	3.30 Symphony Concert.
Newcastle	8.0 The Newcastle Cathedral Quartet.
MONDAY	
London	7.52 <i>Romeo and Juliet</i> (Act II).
Daventry	8.0-10.0 Welsh Programme from Cardiff.
Aberdeen	8.0 St. David's Day Programme.
Birmingham	8.0 Some Welsh Tunes.
Bournemouth	8.0 St. David's Day Programme.
Cardiff	8.0 A Song of the Welsh.
Glasgow	8.0 The Pianoforte Sonatas of Beethoven
Newcastle	8.0 The Novelty Trio.
TUESDAY	
London	8.5 The Wireless Military Band.
Bournemouth	8.0 Chamber Music.
Belfast	9.0 A Recital of Ancient Hebrew Melodies.
Glasgow	10.30 Dance Music by the Plaza Band.
Newcastle	8.0 Opera and Ballads.
WEDNESDAY	
London	8.0 <i>The Pied Piper</i> , a Musical Comedy by Reginald Benyon.
Birmingham	8.0 Popular Classics.
Cardiff	8.0 <i>Lady Windermere's Fan</i> , by Oscar Wilde.
Dundee	8.0 An Evening of Songs and Plays.
Edinburgh	8.0 Military Band Night.
THURSDAY	
London	7.30 The Halle Orchestra, conducted by Sir Hamilton Harty.
Birmingham	7.30 City of Birmingham Police Band.
Belfast	8.30 <i>The Death of Tintagles</i> and <i>An Unwilling Martyr</i>
Glasgow	8.40 Scottish Regiments, The Royal Scots.
FRIDAY	
Bournemouth	8.0 Some Old Masters.
Glasgow	8.0 Popular Programme.
Manchester	8.0 Lancashire Talent Series. A contribution by Nelson.
Newcastle	8.0 The Electric Sparks Concert Party

SATURDAY	
London	8.0 <i>Listening Time</i> , 9.0 Sir Harry Lauder, 10.30 Final episode of "Which?"
Aberdeen	8.0 <i>Orpheus and Eurydice</i> , by Gluck.
Birmingham	8.0 Popular Items.
Cardiff	7.40 A Merry Evening.
Glasgow	8.0 The Staff celebrating the third anniversary of the Station.

"A Kitchen Table Built in Sections" is well illustrated and described in the current issue of "The Amateur Mechanic and Work" (3d.). Other articles appearing in the same number are: "Covering Lamp-shade Frames," "Making Imitation Pearls," "Bookbinding for the Amateur," "Aligning Side-car with Motor-cycle," "Some Simple Vernier Devices," "Sealing-wax Decoration," "Hints on Bending Tubes," "Magnets: Natural, Temporary and Artificial," "Making a Backyard Garden," "Constructing Scales for Small Drawings," "Making a Wind-screen Wiper."

Mrs. Patrick Campbell will take part in a song cycle and reading at the 2 LO studio on Sunday afternoon, February 28.

Albert Sandler and his orchestra will be relayed from the Grand Hotel, Eastbourne, on the evening of February 28.

A new musical comedy *The Pied Piper*, based on Robert Browning's famous poem, with music by Reginald Benyon, will be broadcast from the 2 LO studio on Wednesday, March 3.

EDISON BELL

RADIO

IMPROVE YOUR RECEPTION BY USING EDISON BELL INDUCTANCE COILS

COIL NUMBERS : 15, 20, 25, 35, 40, 50, 75, 100, 120, 150, 200, 250, 300, 400

WRITE FOR CATALOGUES



WRITE FOR CATALOGUES

A ROW OF THE WORLD'S FINEST INDUCTANCE COILS

PRICES : Coils Numbered 15-50, 2/6 ; 75-150, 3/6 ; 200-400, 4/6

MANUFACTURED BY AN ALL-BRITISH FIRM, WITH OVER 30 YEARS' REPUTATION FOR QUALITY

J. E. HOUGH, LTD., Edison Bell Works, LONDON, S.E.15; and HUNTINGDON



"GOLTONE"
POCKET TYPE
RADIO METERS

British
Made

Reading
10 Volts and
100 Volts

Centre Zero Type
as illustrated. (Prov. Patent)
No. R22/144. Price 10/6

Side Reading Type, No. R22/142. Price 8/6
Strong Lined Cases, 1/6 each.

ARE
YOUR
BATTERIES
FULL VOLTAGE?

Do you experience insufficient volume, whistling, distortion, or unsatisfactory reception generally? Are you sure your batteries are not at fault?

The "Goltone" Double Reading Meters enable you to check the Voltages of both the High Tension and Low Tension Batteries.

See Catalogue No. R/113 for full details.

"GOLTONE"
PANEL MOUNTING
RADIO METERS

British
Made

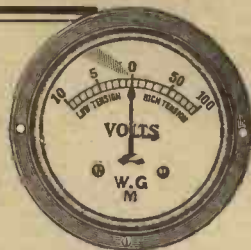

Centre Zero Flush Type
(Prov. Patent)

Reading 10 Volts and 100 Volts

Diameter of Dial, 1 1/2 ins.

No. R22/300. Price 12/9

Panel Mounting Push Buttons 1/6 pair:

Firmly refuse substitutes and insist on the trade mark.
"Goltone" Products are stocked by the Leading Radio Dealers.
Write direct if unobtainable.

Ward & Goldstone
PENDLETON. MANCHESTER LTD.



PANELS & CONDENSERS
ARE
GUARANTEED

Then WHY be CONTENT with?
INFERIOR SUBSTITUTES?

Ask your Dealer, or write to us direct,

PARAGON RUBBER MANUFACTURING CO. LTD.,
SCULCOATES, HULL.



YOURS for 20/-

The "Tonyphone" G II. is a two-valve receiver of remarkable selectivity, having a range of well over 1,000 miles. Receives all B.B.C. and most Continental Stations.



Will be sent on approval complete with all Accessories on receipt of 20/-. You pay a further £1 each month or 5/- each week afterwards until completed.

THE "TONYPHONE"
G II.

In handsome Mahogany Cabinet, complete with H.T. Battery Accumulator, Phones, Valves, Aerial and Insulators. Marconi Tax Paid.

Send to-day and enjoy broadcasting NOW.

Illustrated Price List free on application

BRITISH ENGINEERING PRODUCTS CO.
(Tonyphone Dept.), Abbey House, Victoria Street, London, S.W.1.

S.S.A.

ANOTHER LOTUS PRODUCT

The LOTUS Buoyancy
VALVE HOLDER

ANTI-MICROPHONIC

PATENTS PENDING

Price

2/3

With Terminals 2/6

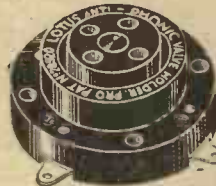

Price

2/3

With Terminals 2/6

The delicacy of your Valve filaments are subject to microphonic elements from numerous sources. The LOTUS Buoyancy Valve Holder has been specially designed and constructed to counteract and dissipate these disturbances, and will, by its original and unique spring construction, absorb any shock, protect your valves, and eliminate all microphonic noises.

The LOTUS VALVE HOLDER is scientifically designed and made by the manufacturers of the LOTUS VERNIER COIL HOLDER.

Obtainable from all reliable Radio Dealers.

Bakelite Mouldings.
Nickel Silver Springs and
Phosphor Bronze Valve
Sockets.
Nickel Plated.

Valve Sockets and Springs
are locked together by a
mechanical process, making
a definite and permanent
connection.

GARNETT, WHITELEY & CO., Ltd.,

LOTUS WORKS, Broadgreen Road, Liverpool.

There are many
good Coils-

But for
Complete Efficiency

Use
SLEKTUN

INDUCTANCE COILS

The following National Physical Laboratory Figures Constitute a Record:
COIL OF 200 INDUCTANCE: SELF-CAPACITY:
TURNS 1770 MICRO-HENRIES 3 MICRO-MICROFARADS

Send a p.c. for illustrated booklet—

SLEKTUN, WELLINGTON HOUSE, BUCKINGHAM GATE, S.W.1

The Service Battery

SPECIAL 2v. 66a for D.E. Valves fully charged 12/6 post free.

	AMPERES			
	44	66	88	110
2-volt	8/-	10/-	12/-	15/-
4-volt	16/-	20/-	24/-	30/-
6-volt	24/-	30/-	36/-	45/-

Dispatched 1st charged CARR. PAID within 24 hours to your door on money back terms.

Single Cells, 2 Non-Corrosive Terminals per Cell. Ebonite Separators, Non-Frothing and Practically Unspillable.

H.T. 60 volt. Every Cell separately sealed and removable. Tapped every 6 volts, with Wander Plugs, post free.

Adjustable carrier, takes all sizes, 2/6 each

SERVICE BATTERY CO., 8, Service House, 44, Upper Marylebone St., London, W.1.



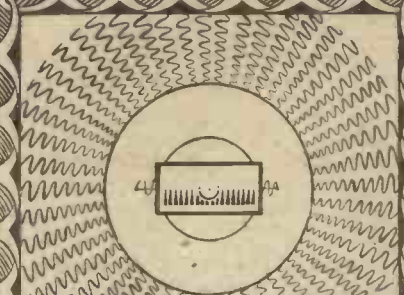

Stop that continued vibration of the filament!

USE the Clearer Tone Valve Holder and float your valves—secure from the ever-present, tone - destroying vibrations caused by street traffic, indoor footsteps and the hundred and one other microphonic disturbances. So thoroughly does this new holder cushion the valve that foreign noises are completely dissipated. The springs, though delicately adjusted, are immensely strong and the tightest valve can be inserted without fear of damaging them. Each spring has one turn only. Bakelite construction of the body of the holder ensures high insulation, low capacity and sturdiness.

each 2/9



There are terminal connections for the experimenter and soldering tags for the permanent set. The springs themselves form the valve pin sockets. No soldered joints—all one solid metal piece from tag to valve leg. No flexible wire connections. The spring supports are not affected by stiff bus-bar wiring. For good reception with Dull Emitter Valves, Benjamin Clearer Tone Anti-Microphonic Valve Holders are essential.

2/9 each.



Patents Pending.

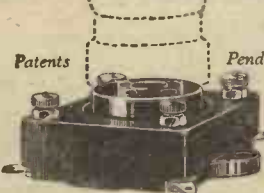

BRITISH BENJAMIN MADE CLEARER TONE VALVE HOLDER (ANTI-MICROPHONIC)

From your Dealer or Direct from THE BENJAMIN ELECTRIC Ltd., Brantwood Works, Tariff Road, Tottenham, N.17.

The Benjamin Battery Switch gives perfect current control, 2/- each.



Power and Range

SIR,—I see that THERMION expresses surprise at the failure of the new high-power broadcasting station in America to bridge the Atlantic as had been hoped. This result confirms my own observations, which have extended over a number of years. I find that power appears to have much less bearing upon the resultant range and signal strength of a station than is generally supposed. In most cases a power increase does effect an improvement in these factors, but so little in proportion that it is often scarcely worth while. Recent examples on the Continent are many. A short time ago Hamburg raised its rating from 1½ kilowatts to 10 kilowatts. The resulting signals are but 50 per cent. better than before the alteration. A similar result is observable in the new high-power station at Vienna. In this country it is generally known that in many cases the 200-watt relay stations may be heard as well, and sometimes better, than 1½-kilowatt stations situated at a similar distance. Again, a few months ago the B.B.C. were carrying out experiments with a 10-kilowatt transmitter at Chelmsford (5 GB). I found that it was in no way superior to the 1½-kilowatt sets used in their main stations, in spite of the fact that it was being heavily over-modulated. The failure of American stations to cross the Herring Pond on the 300-500-metre band this winter is probably ascribable to some freak of the atmosphere, but it should be remembered that when considerable power increases were made in some of their stations it was considered that this would ensure reliable Transatlantic communication.

In investigating these problems I have found that a good radiating system at the transmitting end usually accompanies a station which "carries" well, and I venture to say that this factor may eventually be found of greater moment than the power input. I have not, however, been able to obtain data on this point in a sufficiently large number of cases to emphasise it more strongly. I attribute what success Daventry may have had to its fine aerial.

I have mentioned that an increase in power is usually accompanied by some increase in signal strength, but I think it quite possible that an optimum power will be found, above which no consequent improvement in results will be obtained—a kind of "saturation point," as it were.

The observations of other readers on these matters would, I think, be of interest.—A. M. T. (Hale).

[Owing to the large demands upon our space we have been obliged to hold over a number of letters.—ED.]

"TESTRITE" BATTERY TESTER

THE IDEAL HYDROMETER FOR ALL WIRELESS ACCUMULATORS

3s.

The "Testrite" is the hydrometer you need if you want to keep your wireless accumulator in good condition. It tells at a glance if battery is fully charged, half-charged or discharged. Fitted with hexagon rubber nozzle to prevent rolling—rubber buffer to protect glass from damage, and hard rubber spout. GUARANTEED ACCURATE

LIBERAL TERMS TO THE TRADE

S. GUITERMAN & CO., LTD., 35 6, Aldermanbury, London, E.C.2.



CONE LOUDSPEAKER

(As described in "A.W." Jan. 30th, 1926). Our frames, etc., are ideal for this loudspeaker. It is easily made at home. Send stamp for particulars.

GOODMAN'S. (See advert. on p. 360)

Place a GRAMOPHONE ATTACHMENT on the D.1 Model of the

'ALLWOODORN'

And you have the best at the lowest price. 23" Oak horn-Aluminium casting-iron base 62/6. If with 2,000 ohms speaker 21/- extra; if with Amplion speaker 42/- extra. Other sizes in stock, send for list. YOU CAN'T BEAT WOOD FOR REPRODUCTION

Manufacturer: H. MADDISON

2a, Ronalds Road, Holloway Road, HIGHBURY, N.5 Colwyn Bay—get them at 2 Erw Wen Rd. Hours: 9 till 6.30. Sat. 2 o'clock.



The FAMOUS GENERAL RADIOPHONES

YOURS for

6^D

Latest Standard Model General Radiophones (made by the well-known General Radio Company, Ltd.), super-sensitive and highly efficient. Receivers matched in tone. Magnets of highly expensive Cobalt Steel. Diaphragms triple tested. Accurately designed sound chamber gives natural tone. Beautifully comfortable, highly finished. Weight: 7 ounces. Fully guaranteed. Sent on receipt of 6d. deposit. If satisfied, you send 2/6 more on receipt, balance 3/- monthly until only 21/- is paid. Price full cash with order or within 7 days, £1.

SIMPSON'S (Brighton, Ltd.) 1564, 14, Queen's Road, BRIGHTON.



The DRAGON AMPLION



The "New Junior"
Dragon Type
A.R.111
Price £2 : 10 : 0



The "Standard"
Dragon Type
A.R.19
Price £5 : 5 : 0

A still larger model—the
"Concert Dragon," Type A.R.23
is also available at £8 10 0.

Demonstrations gladly given during business
hours at the AMPLION Showrooms :

25-26, Savile Row, London, W.1.	10, Whitworth-Street West, Manchester.
79-82, High Street, Clapham, S.W.4.	101, St. Vincent Street, Glasgow.



"For Better Radio Reproduction"

OBTAINABLE from ALL AMPLION
STOCKISTS, Radio Dealers or Stores

Announcement of Alfred Graham & Co. (E. A. Graham), Crofton Park, London, S.E.4

Plug in a LEWCOS Coil — and listen!

Each LEWCOS Coil is
tested in our laboratory.
It is then boxed, sealed
up, and reaches you in
perfect condition. Be
sure the LEW seal is un-
broken.



THAT'S the test. It makes *all* the
difference when you tune in with a
LEWCOS Coil. Listeners everywhere
have been quick to realise the quality
and advantages of this guaranteed coil.
Ask your dealer for a demonstration.

LEWCOS Inductance Coil

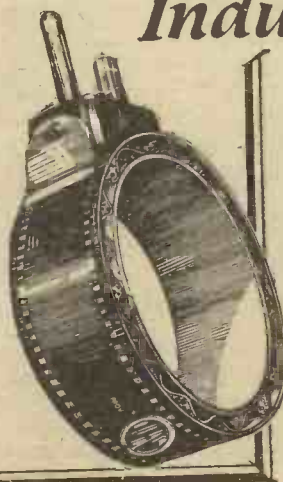

3 LEWCOS advantages

1. High electrical efficiency with great mechanical strength.
2. Great selectivity resulting in extremely fine tuning.
3. Exceptionally low high frequency resistance with increased signal strength.

The
LONDON ELECTRIC WIRE
CO., & SMITHS LTD.

Manufacturers of Glazite

Playhouse Yard, Golden Lane,
London, E.C.1.

JUDD



NOTE.—In the following list of transmissions these abbreviations are observed: con. for concert; lec. for lecture; orch. for orchestral concert; irr. for irregular; m. for metres; and sig. for signal.

GREAT BRITAIN

The times given are according to Greenwich Mean Time.

London (2LO), 364 m. 1-2 p.m., con. (Tues., Thurs, Fri.); 3.15-3.45, transmission to schools; 3.30-5.30, con. (Sun.); 4-5 p.m., con.; 5.15-5.55, children; 6 p.m., light music; 7-8 p.m., time sig., news, music, talk; 8.10-10 p.m., music; 9.0 news (Sun.); 10.0-10.30 p.m., time sig., news, talk; 9.30-10 p.m., special feature (Mon., Wed., Fri.). Tues. and Thurs. the Savoy Bands are relayed until 11.30 p.m., and on Sat. until midnight.

Aberdeen (2BD), 495 m. Belfast (2BE), 440 m. Birmingham (5IT), 479 m. Bournemouth (6BM), 386 m. Cardiff (5WA), 353 m. Glasgow (5SC), 422 m. Manchester (2ZY), 378 m. Newcastle (5NO), 404 m. Much the same as London times.

Bradford (2LS), 308 m. Dundee (2DE), 331 m. Edinburgh (2EH), 324.5 m. Hull (6KH), 335 m. Leeds (2LS), 321.5 m. Liverpool (6LV), 311 m. Nottingham (5NG), 323.5 m. Plymouth (5PY), 338 m. Sheffield (6FL), 301 m. Stoke-on-Trent (6ST), 304 m. Swansea (5SX), 482 m. Daventry (25 kw.), high-power station, 1,600 m. Special weather report 10.30 a.m. and 10.25 p.m. (weekdays), 9.10 p.m. (Sun.); 11.0 a.m. light music (exc. Sat. and Sun.); relays 2LO from 4 p.m. onwards, own con. on Mon. Dance

music daily (exc. Sun.) till midnight; on first Friday in each month until 2 a.m.

IRISH FREE STATE.

Dublin (2RN), 390 m.

CONTINENT

The Times are according to the Continental system; for example, 16.30 is 4.30 p.m., and 08.00 is 8 a.m. G.M.T.

AUSTRIA.

Vienna (Radio Wien), 590 m. (temp.) (10 kw.). 10.00, con. (almost daily); 14.30, con.; 18.25, news, weather, time sig., con., lec., news; 19.00, con.; 21.00, dance (Wed., Sat.).

Graz, 397 m. (1 kw.). Relay from Vienna. Also own con. (Tues., Wed., Fri.), 19.10.

BELGIUM.

Brussels, 262 m., (1½ kw.). 17.00, orch. (Tues., Thurs., Sat. only), news; 20.00, lec., con., news (opera, Mon. and Wed.).

Liège (Radio Wallonie), 285 m. (Con. irr.).

Liège (Radio Central), 205 m. 20.00, con. (Mon., Thurs., Sat.).

Seraing, 195 m. 20.00, con. (Thurs. only).

DENMARK.

Copenhagen (Radioraadet), 340 m. (2 kw.). Sundays: 14.30, lec.; 16.30, children; 19.00, play; 20.15, news, con.; 20.5, news, Esperanto (Mon.), silent night. Weekdays (Tues., Fri., Sat.): 19.00, lec., con., news, con.; 20.30, dance (Sat.).

Ryvang, 1,160 m. (1 kw.). Sundays: 08.00, sacred service; 16.30-20.30, same as Copenhagen; 19.00 (Wed., Thurs.), lec., con., news, orch.

Hjoerring, 1,250 m. (1.5 kw.)*

Odense, 950 m. (200 w.)*

Sorø, 2,400 m. (1½ kw.). Also occasionally relays 5XX from 22.00 G.M.T.

* Relay Copenhagen.

FRANCE.

Eiffel Tower, 2,650 m. (5 kw.). 06.40, weather (exc. Sun.); 11.00, markets (exc. Sun.

and Mon.); 11.20, time sig., weather; 15.00, 16.45, Stock Ex. (exc. Sun. and Mon.); 18.00, talk, con., news; 19.00 and 23.10, weather; 20.10, con. (2,740 m.) (daily).

Radio-Paris (CFR), 1,750 m. (about 3 kw.). Sundays: 12.45, con., news; 16.30, Stock Ex., con.; 20.15, news, Esperanto, con. or dance. Weekdays: 12.30, con., markets, weather, news; 16.30, markets, con. (irr.); 20.15, news, con. or dance. Le Matin gala con. every Sat., 20.30.

L'École Sup. des Postes et Télégraphes (PTT), Paris, 458 m. (800 w.). 14.00 or 15.00, studio con. or outside relay; 20.30, lec. (almost daily); 21.00, con. (daily).

"Le Petit Parisien," 358 m. (500 w.). 21.15, con. (Tues., Thurs., Sat., Sun.).

Radio-Toulouse, 413-418 m. (2 kw.). 12.30, con., time sig. (daily); 17.30, news (exc. Sun.); 20.45, con.; 21.25, dance (daily).

Radio-Lyon, 280 m. (2 kw.). 20.15, con. (daily).

Radio Agen, 318 m. (250 w.). 12.40, weather, Stock Ex.; 20.00, weather, Stock Ex.; 20.30, con. (Fri.).

*Lyon-la-Doua, 480 m. Own con., 20.00 (Mon., Wed., Sat.).

*Marseille, 351 m. (500 w.).

*Toulouse (PTT), 280 m. (500 w.).

*Bordeaux, 410 m.

*Relays of PTT Paris.

Montpellier, 186 m. (1 kw.). Relays Radio

Toulouse.

Angers (Radio Anjou), 248 m. (500 w.).

Daily: 20.30, news, lec., con.

GERMANY.

Berlin, on both 505 and 576 m. (4 kw.). 08.00, sacred con. (Sun.); 10.00, con. and tests; 11.55, time sig., news, weather; 14.00, educ. hour (Sun.), markets, time sig.; 16.00, orch.; 19.30, con., weather, news, time sig., dance music until 23.00 (nightly). *Relayed on 1,300 m. by Königswusterhausen and Stettin (241 m.).

(Concluded on page 358)

Abolish your H.T. Battery Worries

by making the "Amateur Wireless" Switchboard

from "KAYNITE" components

State Voltage and Frequency when ordering.



The New "Kaynite" H.T.2 Transformer

is the heart of the "Amateur Wireless" A.C. Switchboard, and substitutes should be declined. Each transformer is clearly labelled for connections.



"Kaynite" Chokes

are wound in pairs to correspond with the transformers.

COMPLETE LIST OF "A.W." COMPONENTS

No.	Price Each.	No.	Price Each.
1. Kaynite Transformer type H.T.2. Secondaries 400 volts and 5 volts, both centre tapped.	Price 27/6	10. Edison Bell Resistance Unit for H.T. Tap.	Price 6/6
2. Kaynite chokes for smoothing circuit.	Price 15/-	11. "Kaynite" Moving Coil High Resistance Voltmeter 0-120 volts.	Price 22/-
3. 20 x 12 x 5/16 in. Ebonite Panel.	Price 22/6	12. "Kaynite" Moving Coil High Grade Milliampere-meter 0-30 m/a.	Price 22/6
4. Drilling and engraving panels.	Price 7/6	13. T.C.C. 3 mfd. Fixed Condenser.	Price 3/-
5. Double Pole quick break Indicating Rotary Switches.	Price 2/6	14. T.C.C. 4 mfd. Condenser (C1).	Price 9/-
6. Edison Bell Filament Resistances.	Price 3/-	15. T.C.C. 6 mfd. Condenser (C2).	Price 13/-
7. Edison Bell R/334 Switches.	Price 2/6	16. Microwelt .06 Valves.	Price 9/-
8. Edison Bell R/336 Switches.	Price 3/3	17. Microlux Twin Filament Valves.	Price 12/6
9. Edison Bell Insulated Terminal Heads.	Price 2d.	18. Mullard P.M.3 Valves	Price 16/6

ALL COMPONENTS ARE CAREFULLY TESTED BEFORE DESPATCH AND THE VALVES ARE ACTUALLY TESTED FOR EMISSION ON A RECTIFIER.



"Kaynite" Instruments

for the Switchboard are fitted with back connections as illustrated. If you propose adding voltmeter and amp-meter to the filament circuits, we can supply them with moving iron movements at 9/6 each.

TRADE NOTICE.

Do not wait for the rush, but post your orders without delay. You know that our terms are good and our manufactures are always in demand.

Wireless Club Demonstrations.

Radio 2L.P. will gladly arrange to demonstrate the "Amateur Wireless" Switchboard to your members, and give an interesting talk upon the H.T. problem.

A. W. KNIGHT, LTD.

Kaynite Radio Works

180, Tower Bridge Road

S.E.1

IMPORTANT We have barely occupied our new factory, and personal callers, up till March 10th, should visit our old address at 167, Rye Lane, Peckham.

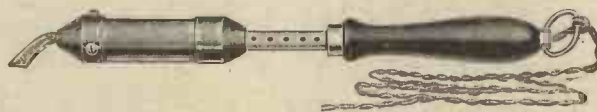

SOLDER ALL CONNECTIONS.

preferably with the new "Kaynite" quick-heating electric soldering iron. Stocked in various voltages. Suitable for A.C. or D.C. Price 17/6 each.

FELLOWS WIRELESS

BUY BY POST & SAVE MONEY

You can only purchase Fellows wireless apparatus direct from us by post or from one of our Depots. By so doing you save money "hand over fist." There is a 40-page illustrated catalogue free for you to select from, and it shows everything from an insulator to a 5-valve set.

The price of our goods is low. That is because we sell direct; the quality is of the same high standard for which we are famous.

You take no risk because all goods are fully guaranteed, and are sent on SEVEN DAYS' APPROVAL against cash, packing free, carriage forward (unless postage is stated). Complete sets can also be obtained on DEFERRED PAYMENT system. Here are some examples of our Components. Fill in your coupon to-day, and post to us.



AERIAL LEAD-IN INSULATOR Price 1/3 Postage 2d.

A simple, highly efficient insulator for carrying the aerial or any other exposed wire through a wall, partition or window frame. Adjustable within wide limits. Very strong and easily fixed.



FILAMENT RESISTANCES

With interchangeable 6-ohm or 30-ohm resistance spools (for D.E. Valves), exceptionally wide contact arm ensuring perfectly silent operation.

Price with 6-ohm spool 2/6
Price with 30-ohm spool 3/9
Postage 3d.

MICA CONDENSER AND GRID LEAK

As one of the first firms in the country to manufacture Mica Condensers, we are to-day in an unrivalled position to produce accurate and efficient fixed condensers at exceptionally low prices. Capacities guaranteed.

Mica Condensers 1/6 Grid Leaks 1/6
0.0001-0.001 mfd. Postage 2d. 5-5 megohms Postage 2d.



L.F. TRANSFORMER

You should have a FELLOWS Transformer in your set. Its price is only 11/6, but there isn't a better on the market even at double the price. The name Fellows has stood for pre-eminence in the making of transformers and magnetos for over 20 years. Every instrument accurate, distortionless, and made of the highest grade materials. Send for one on approval to-day. You will be amazed at the value offered.

Price 11/6 Postage 6d.

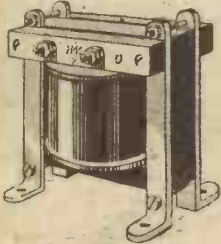

All Fellows apparatus can be inspected and purchased at London: 20, Store Street, Tottenham Court Road, W.C.1. (Telephone Museum 9200). Nottingham: 34, Bridlesmith Gate. Cardiff: Dominions House, Queen Street.

WRITE FOR SPECIAL ILLUSTRATED CATALOGUE FREE

To THE FELLOWS MAGNETO CO., LTD., Cumberland Av., Park Royal, London, N.W.10.

Name

Address

Herewith Remittance Value.....

Please forward me

on conditions as per your advertisement. A.W. 27/2/26.

Please write clearly in plain Block Letters, enclosing postage and register Cash or Treasury Notes.

Figures to Remember



PETER PAN

—to be remembered for the pleasure he gives, he has given, he will give. Besides, there is the charm of his Eternal youth. You want your valves to give you pleasure, to satisfy you: you would like them never to grow old. None will give you longer life or better service than 660 Valves. You have a wide range to choose from, and each valve is specially designed to carry out its particular job.

There's the S.S.2 (Red Disc)—a 2-volt Valve for H.F. Amplification, suitable as a detector when followed by resistance or choke. Or again, the S.S.2 (Green Disc)—for L.F. Amplification—just the valve you want for small and medium-sized loud-speakers.

Now let's consider the question of economy. These valves have a current consumption of only .3 amps, and further work at such a low temperature that the life of the filament is immeasurably increased—surely economy in the true sense.

And this is only the beginning of our interesting story. The S.S.3 Valves have a current consumption of only .06 amps, while with the S.S.7—a wonderful Dull Emitter Power Valve, current consumption .1 amps—no glow from the filament is visible when operating at the correct voltage.

For long life, good service, perfect tone, insist on Six-Sixty Valves.



S.S.2 L.F.

(Green Disc)

Voltage - 2'0 volts.

Consumption '3 amps.

PRICE 14/

Ask your Dealer for Leaflet S.S.1.7 for full particulars of complete range.

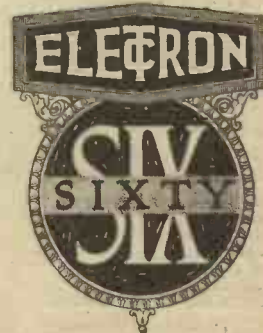

BETTER BY SIX TIMES SIXTY

The Electron Co., Ltd., Triumph House, 189, Regent St., London, W.1. 2

„BROADCAST TELEPHONY“ (cont. from page 356)

Königswusterhausen (LP), 1,300 m. (8 kw.). 10.30-11.50, relays Berlin (Sun.); 14.00, lec. (daily); 17.30, relay of Berlin (Vox Haus) con. (daily); 2,525 m. (5 kw.), Wolff's Buro Press Service: 05.45-19.10; 2,880 m.: Telegraphen Union: 07.30-18.45, news. 4,000 m. (10 kw.): 06.00-20.00, news.

Breslau, 416 m. (4 kw.). 11.00, con. (daily); Divine service (Sun.); 11.55, time sig. (Sun.), weather, Stock Ex., news; 15.00, children (Sun.); 16.00, con.; 18.00, lec.; 19.30, con., weather, time sig., news; 20.45, dance (Sun., Thurs.). Relay: Gleiwitz, 251 m.

Frankfort-on-Main, 470 m. (1½ kw.). 07.00, sacred con. (Sun.); 10.55, time sig., news; 11.55, Nauen time sig.; 15.00, con. (Sun.); 15.30, con.; 17.00, markets, lec.; 19.00, lec., con., weather, dance. Relay: Cassel, 273.5 m.

Hamburg, 392.5 m. (4 kw.). Relayed by Bremen (277 m.), Hanover (297 m.), Kiel 230 m.). Sundays: 06.25, time sig., weather, news, lec.; 08.15, sacred con.; 12.15, con.; 17.00, con.; 18.15, sports, weather, con. or opera, dance. Weekdays: 05.55, time sig., weather; 06.00 and 06.30, news, weather; 11.55, Nauen time sig., news; 13.00, weather, con.; 15.15 and 17.00, con.; 18.00, lec.; 18.55, weather, con.; 21.00, dance (daily, exc. Tues.).

Königsberg, 462 m. (1 kw.). 08.00, sacred con. (Sun.); 11.55, time sig., weather, news; 15.30, con.; 16.00, con. (Sun.); 18.30, lec.; 19.00, con. or opera, weather, news, dance (irr.).

Leipzig, 452 m. (700 w.). Relayed by Dresden (294 m.). 07.30, sacred con. (Sun.); 10.00, educ. hour (Sun.); 11.00, con. (daily); 11.55, Nauen time sig., news; 15.30, con., children (Wed.); 19.15, con. or opera, weather, news, cabaret or dance (not daily).

Munich, 485 m. (3 kw.). Relayed by Nuremberg (340 m.). 10.30, lec., con. (Sun.); 13.00, time sig., news, weather; 15.00, orch. (Sun.); 15.30, con. (weekdays); 17.30, con. (weekdays); 18.15, lec.; 18.30, con. (Sun.); 19.30, con.

Münster, 410 m. (2½ kw.). Relayed by Elberfeld (259 m.); Dortmund (283 m.): 10.45, Radio talk, Divine Serv.; 11.00, news (Sun.); 11.30, news (weekdays); 11.55, Nauen time sig.; 14.30, news, time sig.; 15.00, con.; 16.00, children (Sat.); 18.40, news, weather, time sig., lec., con.

Norddeich (KAV), 1,800 m. 23.00, weather and news.

Stuttgart, 446 m. (1½ kw.). 10.30, con. (Sun.); 15.30, con. (weekdays); 16.00, con. (Sun.); 17.30, time sig., news, lec., con. (daily); 20.15, time sig., late con. or cabaret.

HOLLAND.

Amsterdam (PCFF), 1,955 m. (1 kw.). Daily: 07.15-16.10 (exc. Mon. and Sat., when 1.10-11.10), news, Stock Ex.

Hilversum (HDO), 1,050 m. (2½ kw.). 09.40, sacred service (Sun.); 19.50, con.; 21.40, news, etc.

RUSSIA.

Moscow (RDW), 1,450 m. (12 kw.). Weekdays: 12.30 and 17.55, news and con.

(Popoff Station), 1,010 m. (2 kw.). 10.00, 11.00, lec.; 13.00, 19.00, con. (Tues., Thurs., Fri.).

Radio Peredacha, 375 m. (6 kw.). **Trades Union Council Station**, 450 m. (2 kw.). 18.00, con. (Mon., Wed.). 11.00 m.: 21.00, con.

Leningrad, 940 m. (2 kw.). Weekdays: 15.00.

Nijni Novgorod, 253 m. 20.30, con.

SPAIN.

Madrid (EAJ6), 392 m. (1½ kw.). Daily: con. (times vary daily).

Madrid (EAJ7), 373 m. (4½ kw.). Con.: 17.30-01.00 (almost daily).

Madrid (EAJ4), 340 m. (1 kw.). Relays EAJ7.

Barcelona (EAJ1), 324 m. (650 w.). News, lec., con., 17.00-21.00 (Sun.), 18.00-23.00 (Mon., Tues., Fri., Sat.), 18.00-24.00 (Wed., Thurs.).

Barcelona (Radio Catalana) (EAJ13), 460 m. (4½ kw.). 19.00-24.00, con., weather, news.

Bilbao (EAJ9), 315 m. (1 kw.). 19.00, news, weather, con. Close down 21.00 or 22.00.

Bilbao (Radio Vizcaya) (EAJ11), 415 m. (2 kw.). Daily: 22.00-24.00, con. (daily).

Cadiz (EAJ3), 360 m. (550 w.). 19.00-21.00, con., news. Tests daily (Mon., Tues., Wed., Sat.), 24.00.

Cartagena (EAJ15), 335 m. Daily: 19.00-22.00, con.

Seville (EAJ5), 357 m. (1½ w.). 21.00, con., news, weather. Close down 23.00.

Seville (EAJ17), 300 m. Daily: 19.00-22.00, con.

San Sebastian (EAJ8), 344 m. (500 w.). Daily: 18.00, con. Close down about 23.00.

Salamanca (EAJ22), 355 m. (500 w.). 21.00, con. daily.

SWEDEN.

Stockholm (SASA), 428 m. (1 kw.). 10.00, sacred service (Sun.); 11.30, weather; 13.00, con. (Sun.); 16.00, children (Sun.); 17.00, sacred service; 18.00, lec.; 20.15, news, con., weather. Dance (Wed., Sat.).

Relays.—**Boden (SASE)**, 1,200 m.; Eskilstuna, 250 m.; Falun (SMZK), 370 m.; Gothenburg (SASB), 288 m.; Gefle, 325 m.; Joenköeping (SMZD), 265 m.; Karlsborg, 1,250 m.; Karlstadt (SMXC), 221 m.; Linköeping, 467 m.; Malmo (SASC), 270 m.; Norrköeping (SMVV), 260 m.; Örebro, 218 m.; Sundsvall (SASD), 545 m.; Trollhättan (SMXQ), 322 m.; Varborg, 340 m.

SWITZERLAND.

Lausanne (HM2), 850 m. Testing on 348.5 m. (1½ kw.) (temp.). 19.00, lec., con. (daily).

Zurich (Högg), 515 m. (500 w.). 10.00, con. (Sun.); 11.00, weather; 11.55, Nauen time sig., weather, news, Stock Ex.; 12.30, piano soli; 16.00, con. (exc. Sun.); 17.15, children, women; 18.00, news, weather; 19.15, lec., con., dance (Fri.).

Geneva (HB1), 760 m. (2 kw.). 19.15, con. (daily).

Berne, 435 m. 09.30, organ music (except Sat.); 15.00, 19.30, con.

How is it done ?

Such a thought is the common experience of many a listener when he first uses the "Brownie Wireless." Never before has he heard such clear-toned voluminous reproduction from a crystal receiver. Results have conclusively proved that in spite of its moderate price the "Brownie Wireless" has no peer in efficiency. At a distance of 25-30 miles from the local station (15 miles relay stations) or 120 miles from 5 X X you can't hear "Brownie." The "Brownie Wireless" Model No. 2 embodies all the features of the Standard "Brownie" Receiver. It is capable of resisting extreme climatic conditions. The outer casing is hydraulically



moulded under a pressure of 60 tons, forming a pleasing and substantially designed piece of apparatus. The receiver has a natural wave-length up to 600 metres and a standard plug and socket coil attachment is provided, which, with the aid of a special coil (price 2/9 extra) makes the set adaptable to 5XX. Complete, including the famous D.L.5 Crystal and Palladium Catwhisker.

PRICE 10/6

"BROWNIE WIRELESS" MODEL No. 2

The Standard "Brownie." Just as good as ever, 7/6 but now complete with ebonite base ... 2/- 5 X X Loading Coil for the Standard ... 2/-

THE BROWNIE WIRELESS Co. (of Great Britain) Ltd.

(Incorporating the J. W. B. Wireless Co.);

310a-312a, Euston Road, London, N.W.1

Phone: Museum 3747

CONSTRUCT YOUR RECEIVING SET FROM THE BEST COMPONENTS!

WE HAVE THEM:—

The Marvellous Remler Condenser. A Revelation in Tuning, 3/9 each.

Our Guaranteed Ebonite cut to any size while you wait. Ordinary surface, 4/6 lb.; Matt, 5/- lb.

The New Lissenola Loud Speaker Base, 13/6 each.

Dayzite Regd. Crystal, 2/6 each.

McMichael Special H.F. Plug-in Units, also

Igranic Super Heterodyne Sets now in Stock.

The Bruno Short Wave Tuner, 25-100 metres.

Tuned with a .005 Var. Con. Special Low Loss. 36/- each.

Also a Good Selection of Low Loss Formers in Stock.

Send 6d. for the World's Finest Radio Catalogue (Callers Free), second edition ready shortly; or call and see our great Shop Window Display. (Mention this paper.)

WILL DAY, LTD.

19, LISLE ST., Leicester Sq., LONDON, W.C.2

Telephone: Regent 4577

Telegrams: "Titles, Westrand, London."

NOW ON SALE EVERYWHERE



THE
1926
RADIO
YEAR BOOK

(FOURTH YEAR)

Contains nearly 200 Pages of Entertainment, Information and Instruction, with 70 Photographs of Prominent Broadcast Artists—many actually as they appeared at the Microphone—and 38 Instruction Diagrams, etc.

Radio History in Pictures—Official Articles specially contributed by the B.B.C.—Authoritative Articles by Prominent Radio Engineers. Among others:—

- Amateur Aerials and Earths. By J. A. Fleming, M.A., D.Sc., F.R.S.
- Amateur Technical Progress. By Norman Edwards.
- Workshop Rust. By James Swinburne, F.R.S.
- How to Telegraph Pictures. By T. Thorne Baker, F.P.S.
- Seeing by Wireless. By T. Thorne Baker, F.P.S.
- Speaking Pictures. By C. F. Elwell.

"Full of good things."—*The Radio Times*.
"Full of valuable and authoritative information, both for the amateur and the expert . . . profusely illustrated."—*Daily Express*.
"Better than ever."—*Nottingham Evening News*.

PRICE 1/6 AT BOOKSTALLS. (Post Paid 1/9)

SIR ISAAC PITMAN & SONS, Ltd., PARKER ST., LONDON
KINGSWAY,

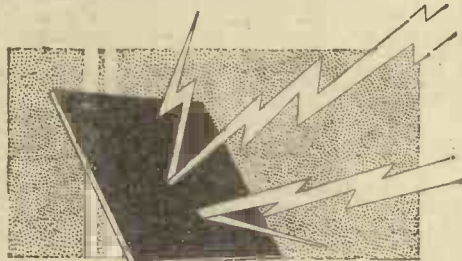

35,300 VOLTS!

How's that for a breakdown test? Every single sheet of Clayton Ebonite you buy is up to the standard indicated by Professor Low's test report, a short extract from which is here given:—

BREAKDOWN.

A portion of each sheet was turned down to about 1 mm. thick. Brass spheres of 3 cm. diameter were applied to each side of the thinned portion, and alternating pressure, frequency 50 cycles, was applied to the spheres and gradually increased until the material broke down under the stress. The results, in terms of breakdown volts per mm., are shown below:

Sample.	Volts per mm.
"A"	29,700
"A1"	35,300

(Signed) A. M. LOW (Professor).

Ask always for CLAYTON—the no-trouble.
POLISHED SHEET EBONITE.

CLAYTON RUBBER CO. Ltd.

DEPT. E7.
Progress Works, Croft Street, Clayton, MANCHESTER.



Pure and Clear as Mountain Air



THE distinctive features of the Ericsson Super Tone that strike the critical listener most are its clarity and its wonderful tone . . . the freedom from muffling and total absence of "tin" that jars.

Its full, rich, round tones are a tribute to the telephone experience of a generation (Ericsson's have been making telephones since they were invented).

18 in. high in gunmetal, gracefully shaped and mounted on a polished wood base. Price **63/-**

A worthy junior—the Junior Super Tone for small and medium-sized rooms. 15½ in. high, 9 in. flare. Complete with lead **32/6**
At all dealers.

Write to-day for Lists.

The BRITISH L.M. ERICSSON Mfg. Co., Ltd.,
67/73, Kingsway, W.C.2.

Ericsson
SUPER-TONE
LOUD-SPEAKERS

Constructors!

Send for our Illustrated Lists of Components, Sets, Super-sensitive Headphones, etc.

WIRELESS IN PARLIAMENT



From Our Own Correspondent.

LORD WOLMER, the Assistant Postmaster-General, informed Mr. Day that since the passage of the Wireless Telegraphy (Explanation) Act last session prosecutions for installing or working wireless receiving apparatus without a licence had been ordered in forty-nine cases. The number of these cases heard up to February 11 was forty-three, of which forty-two were successful and one was dismissed. The fines and costs imposed ranged from 4s. to £20 10s.

On February 16, in dealing with the Supplementary Estimate for £223,000 to be handed over to the B.B.C., Viscount Wolmer (Assistant Postmaster-General) explained that it was an amount accruing from the increased yield of wireless licences to which the B.B.C. were entitled under their agreement. It had been previously estimated that the number of wireless licences would entitle the B.B.C. to £350,000, but they had, in fact, been paid £573,000.

Mr. Ammon (Soc., Camberwell, N.) said that he thought that the House ought to have further information as to how the money paid to the B.B.C. was being spent. The company occupied a specially privileged position, and there was no check on its expenditure. A feeling was growing up in certain quarters that the business was being run extravagantly. Had the Post Office any means of auditing the accounts of the company?

Commander Kenworthy (Lib., Hull Central) asked how much profit the Post Office made out of the 2s. 6d. which it retained out of every 10s. spent on a wireless licence. He expressed the opinion that the retention of such a sum by the department was in his opinion ridiculous and preposterous. The whole of the money ought to go to the B.B.C.

Mr. Short (Soc., Wednesbury) asked what power the Post Office had over the B.B.C. programmes. He regarded these at present as "innocuous inanities fit only for invalids and imbeciles."

In reply, the Postmaster-General said that he did not desire to discuss the relations between the Post Office and the B.B.C. in view of the fact that the whole question of the future control of broadcasting was being examined by a strong committee, which had practically finished their

labours and were preparing their report, which would, he understood, be presented next month. It would then be considered by the Government, and legislation would probably follow.

TRADE NOTES AND CATALOGUES

B.S.A. RADIO, LTD., the subsidiary company formed by the Birmingham Small Arms Co., of Small Heath, Birmingham, have issued an attractive catalogue of wireless components.

A price list of Edison-Bell components has been issued by J. E. Hough, Ltd., of Edison-Bell Works, Glengall Road, S.E. 15.

GIFT NUMBER

Popular Gardening

With every copy of this week's "Popular Gardening"

A Free Packet of Shirley Poppy Seeds is presented.

The issue also contains particulars of other beautiful and easily managed flowers that amateurs should raise from seed for the embellishment of their gardens in summer.

Obtain your copy at once!
Usual Price—2d.

A number of useful wireless components are described in a catalogue published by the Hart and Hegeman Manufacturing Co., obtainable from Alan Wright, of Sentinel House, Southampton Row, London, W.C. 1.

An attractive showcard, illustrating wireless cabinets, has been sent us by the Compton Electric and Radio Trades Supplies, of 63, Old Compton Street, London, W. 1.

A WIRELESS "DOCTOR."

If your set is giving trouble or you want advice, an expert will call, anywhere in Greater London, and put you right. No result, no charge.

BLACK, 2a, Woodville Grove, N.16. Clissold 3687.

Amateurs! Let us make your Cabinets

In beautiful polished mahogany or oak, and sent on approval. De Luxe Models, Parlour Models from 25/- to £5. Crystal Cabinets from 1/6, any size made to order. Designs and Lists free. Estimates per return. Panels and accessories post free. Send to actual makers.

PICKETT BROS. (Members of B.B.C.)
A.M. Cabinet Works, Boxley Heath, S.E.

It will Repair!

ADVERTISEMENT INSTRUCTIONS for "Amateur Wireless" are accepted up to first post on Thursday morning for following week's issue, providing space is available.

PREPAID ADVERTISEMENTS.

Advertisements under this head are charged FOURPENCE PER WORD, minimum charge FOUR SHILLINGS.

IF YOUR SET is not working satisfactorily, let Phil Kay see to it. Personal visits London and Home Counties.—8, The Pavement, Worpole Road, Wimbledon, S.W.19. 3/3
2-VALVE ENCLOSED TYPE Powerful Set, with Loud-Speaker and all Batteries. Royalties paid. First-class make, £6.—8, Oakley Crescent, Chelsea. 1/6
BACK NUMBERS of all wireless publications.—Fangs Ltd., 11, Tavistock Square, W.C.1.

06 DE'S 10/6

Our Valves are admitted to be the best British made valves on the market. 3 Volt L.F. or H.F. only 10/6. 2 Volt 34 only 10/6. Power Valves from 12/6. Write at once for our FREE BOOK and get full particulars. If your dealer is "tied" we supply direct. **RADIONS LTD.** Radion Works, BOLLINGTON, Macclesfield, England.

RADION Reliable Valves

SANS PAREIL

ASHTON Perfect Aerial Spreaders Fit any Pole. Any length Aerial. PRICE 12/- PAIR. 8-10 Ball's Head Yard, MANCHESTER.

RECEPTION WONDERFULLY IMPROVED

You can get louder, purer and consistently better results on any set by increasing the efficiency of your aerial. Install an ABBEY now—it is as good as adding a valve.

Write for Lists and prices to—**ABBEY ENGINEERING WORKS, WATTON, NORFOLK.**

Complete with everything. **STEEL AERIAL MAST** Price from 26/-

EBONITE BUSHES

FOR MOUNTING ON WOOD. PERFECT INSULATION. Two required for each hole.

NUMBER	1	2	3	4	5
Size of hole	4BA.	2BA.	1/4"	5/16"	3/8"
Price each	1d.	1d.	1d.	2d.	2d.

DAREX RADIO CO.
Standard Works, Forest Hill, London, S.E.23

REPAIRS :: SETS :: PHONES :: T.FORMERS

Officially Approved By Radio Association

All Work Guaranteed. Lowest Rates. 24 Hr. Service

JOHN W. MILLER, 68, FARRINGTON STREET, E.C.A.
Phone: Central, 1950.

THE SKINDERVIKEN CRYSTAL LOUD SPEAKER SYSTEM

Complete Amplifier reduced to **£1 :: 18 :: 0**

Complete set in box with loud speaker, special reed phone etc., reduced to **£3 :: 18 :: 6**

Write to-day for price list and booklet—**"THE MARVELS OF THE MICROPHONE"** 4th Edition. Post free 61d. (P.O. Not Stamps).

MIKRO LTD., 32a Craven St., Charing Cross, W.C.2

Skinderviken Microphone Button ... price 5/-
Mikro "A" Special Radio Button ... " 7/6

Accumulators are Like Children

Improperly fed and looked after they quickly develop ills which may become chronic. Of vital importance to accumulators is the acid you give them.

OASIS Accumulator Acid

is selected as standard by leading Wireless Engineers, Power Stations and Battery Service Stations because of its consistent purity and dependability. Specific Gravity Chart No. 23 shows gravities for all types of accumulators. Has your charging station one of these charts? Oasis Acid is sent carr. paid in the U.K. The General Chemical & Pharmaceutical Co., Ltd., Willesden, London, N.W.10

"A.W." PAPER DIAPHRAGM LOUDSPEAKER

The **BROWN A** at 22/6, or **BROWN A2** at 15/- are far the best reed units for this purpose. 3-in. Length Rod to screw in Reed with nut to lock. 7d. Ditto 6-in. for cone-shaped loud speaker. 1/- Adjustable Centre Bushes and dome 2/3 (does away with the unsatisfactory cork and makes a neat and easy job). Paper, 3 1/2 by 6, 1.6. 3 1/2 by 7, 1/9. Also Gilded, (untarnishable), 2/3, 2/8, and 3/- res. actively. Not parchment substitute. 12-in. Frames, Gilded, Plated or Bronzed, give a very finished appearance. 5/6 per pair. Brass Back Stays to fit ear: tie to frame. These obviate drilling your case. 2/- per set of 3. Gilded, Plated or Bronzed, 2 9/16 per set. Highly polished Aluminium Caps, to fit Brown A or old A2 Earpieces, 2/6. The **LISSENOLA** at 13/6, Reed, 1/- can be used with our specialities. Stamp for particulars and diagram.

GOODMANS, 68, FARRINGTON ST., E.C.4, and at 42a, Myddleton St., E.C.4

Amateur Wireless

COUPON Available until Saturday, March 6th, 1926

PUT AN END TO BIG RE-CHARGING BILLS



The P.M.3 and P.M.4 only require the same H.T. current as for equivalent types.

USE the wonderful "N" filament valves and get SEVEN TIMES the life from your 4-volt accumulator charges.

Cut down the cost of upkeep and reduce recharging journeys to ONE-SEVENTH.

This unique "N" filament is so economical of heating power that NO SIGN OF GLOW can be discerned.

Ask for the P.M.3. . 16/6

A general purpose valve suitable for every circuit. Gives clear strong signals free from microphonic disturbances.

Ask for the P.M.4. . 22/6

A power valve for majestic loud speaker volume. The finest loud speaker valve ever produced.

These valves can also be run from 3 dry cells

BETTER RESULTS WITHOUT ACCUMULATOR EXTRAVAGANCE



Mullard

THE MASTER VALVE



Build your own Cone Loud Speaker

The LISSENOLA—the latest and most instantaneous success of all the famous Lissen parts—is the essential sound-reproducing base which you convert yourself into a loud speaker of whatever type you please. Used in accordance with the directions given with each instrument, the LISSENOLA yields results equal both in quality and in volume to loud speakers selling at several pounds. The secret of this remarkable efficiency lies in the effective manner in which the electro-magnetic sound reproducing system is concentrated.

Compare the price last. Make this test before buying: Go to your dealer—ask him to put on the best loud speaker he has in stock—then use the same horn on the LISSENOLA, and see if you can notice any difference.

A very successful type of speaker that can be made quite easily and cheaply from the directions given in almost any wireless journal is the Cone Diaphragm.



Make the Diaphragm yourself—then fit the Lissen Reed to the LISSENOLA and clamp it to the centre of the cone by means of the two nuts provided. The purity of tone and the volume—obtained will surprise and delight you. The illustration shows

one method of mounting a cone diaphragm speaker.

But for biggest volume of all, build a big horn from the directions and full-size exact patterns given with every LISSENOLA.

The illustration shows this effective horn, which can be covered with fancy paper and painted to resemble a factory article, and made by you for a few pence.

In addition, the LISSENOLA will fit the tone-arm of any gramophone, instantly converting it into a loud speaker.

Your dealer will gladly demonstrate and supply—or the LISSENOLA can be obtained post free by return from the makers—price 13/6, or with Lissen Reed 14/6.



THE LISSENOLA COSTS 13/6

—but compare the price last

Lissen Limited, 16-20, Friars Lane, Richmond, Surrey

'Phone: Richmond 2255 (4 lines).

'Grams: "Lissenium," Phone, London."

L.14

This Booklet Presented Free with "Amateur Wireless," No. 195, February 27, 1926

An additional gift is a Wiring Diagram (in colours) of the set described in this booklet

BRITAIN'S MOST POPULAR THREE-VALVE RECEIVER

Complete Constructional Details Fully Illustrated & Accompanied by a Folding Coloured Plate Providing a Clear Guide to the Building & Wiring of a Simple & Markedly Successful Three-valver. Built, Designed & Tested in the AMATEUR WIRELESS Constructional Department.



The Set
Placed
First in
the "Amateur
Wireless"
Free Prize
Ballot

WHY THIS IS BRITAIN'S MOST POPULAR RECEIVER

IN the "A.W." Free Prize Ballot Competition, which was first announced in the Christmas number of "Amateur Wireless," a list of ten circuits was given, out of which the competitors had to choose six and place them in what they considered to be the most popular order.

Judging from the thousands of entries received this must have been a most popular competition, and it has certainly proved that the straight-

forward type of circuit still holds its own in popularity against all the latest "supers." This is evidenced by the fact that the circuit placed first consists of a high-frequency valve amplifier followed by a detector and a stage of low-frequency amplification.

In this free booklet constructional details are given of a set built by the "Amateur Wireless" Technical Staff and embodying Britain's Most Popular Circuit.

**BRITAIN'S
MOST POPULAR
THREE-VALVE
RECEIVER**

ROTATION

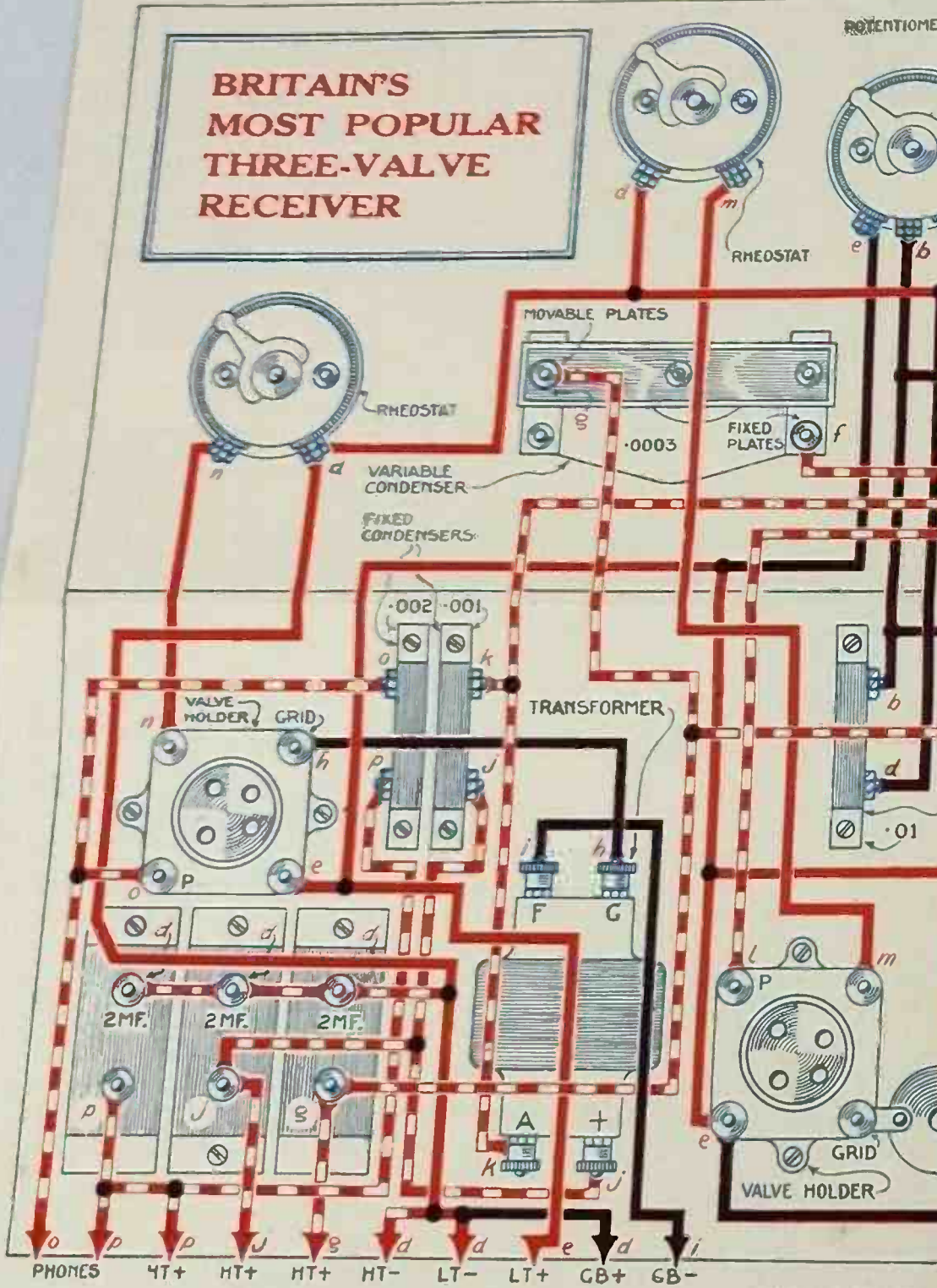

PHONES 4T+ HT+ HT+ HT- LT- LT+ GB+ GB-

Wiring Diagram and Easy Construction Guide

SCALE - EXACTLY TWO-THIRDS.

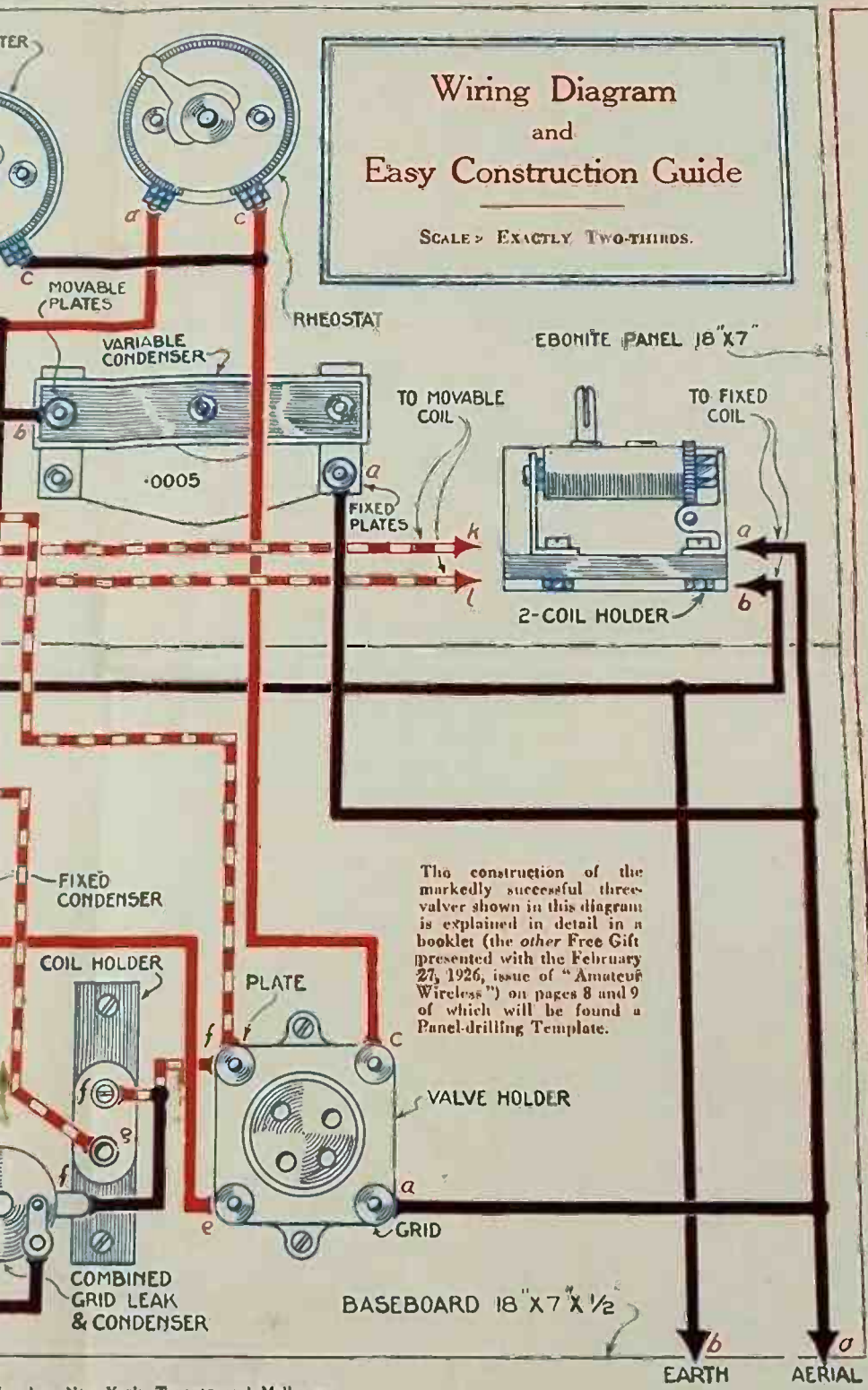

The construction of the markedly successful three-valve shown in this diagram is explained in detail in a booklet (the other Free Gift presented with the February 27, 1926, issue of "Amateur Wireless") on pages 8 and 9 of which will be found a Panel-drilling Template.

THE PROPER WAY TO USE THIS DIAGRAM

(b) You can ignore the lines of the wiring, if you like, and work entirely by means of the red letters shown at the various terminals. You just connect all like letters together with one wire or with as few wires as possible, thus all the a's together, all the b's together and so on, and you should do so in alphabetical order, the a's first. By this method you cannot go wrong if you are careful.
 (c) You will find, if you have gained a little experience, that the ideal method is to combine (a) and (b).

The constructor may choose the particular method of using this wiring diagram and constructional guide:—

(a) You may simply follow the wiring lines, red lines indicating the filament-lighting circuits; red-and-white lines the H.T. or plate circuits; and black lines the grid circuits. A black circle at the intersection of two wires indicates that the two are soldered together. At all other intersections there is no connection between the two wires.

BRITAIN'S MOST POPULAR THREE-VALVE RECEIVER

FULL CONSTRUCTIONAL DETAILS

IN spite of all that has been said concerning the economy of valves with regard to the reflex type of set, a valve cannot be expected to perform two duties simultaneously as efficiently as it can perform one. With quite a fair amount of "wangling" a valve can be made to amplify at high- and low-frequencies, but naturally the results are not so good as those obtained by employing a separate valve for each purpose.

It must not be considered for an instant, however, that we are condemning the reflex and other similar circuits. For some purposes there is no option but to use a circuit of this type, and they are capable of giving excellent results.

The Most Popular Circuit

As already indicated, the circuit chosen by the majority of competitors is a straight three-valver employing one stage of H.F. amplification on the "tuned-anode" principle, followed by a valve detector and one stage of L.F. amplification. The theoretical arrangement will be seen from the circuit diagram Fig. 1, on page 5. There are many reasons why such a circuit (which, if not identical to, must be typical of very many at present in use), is popular. Let us take the tuning system as an example. The requirements of a good tuner are selectivity

and simplicity in control. Both of these qualities are extremely important to the average man who finds that the three-coil tuning system, although giving great selectivity, is difficult to operate and cuts down signal strength by quite an appreciable amount. The two-coil system as used in this receiver is, by itself, not very selective, but when used in conjunction with an H.F. amplifying valve the selectivity is vastly improved, and (what is more important still) not at the expense of loss in signal strength.

H.F. Amplification

Coming to the H.F. amplifier, it will be seen that this takes the form of a valve, in the plate circuit of which is connected a coil "tuned" by a variable condenser. This form of H.F. amplifier, besides being the most popular, is, on broadcast wavelengths, the most efficient. Perhaps the most serious rival of this system is air-cored transformer coupling, the two windings of which are usually very tightly coupled together, giving an inter-valve coupling which is just as much electro-static as magnetic. This is due to the capacity between the two windings; and although this capacity may be reduced by loosening the coupling, signal strength is thereby bound to suffer. As with all methods of H.F. amplification, a tendency

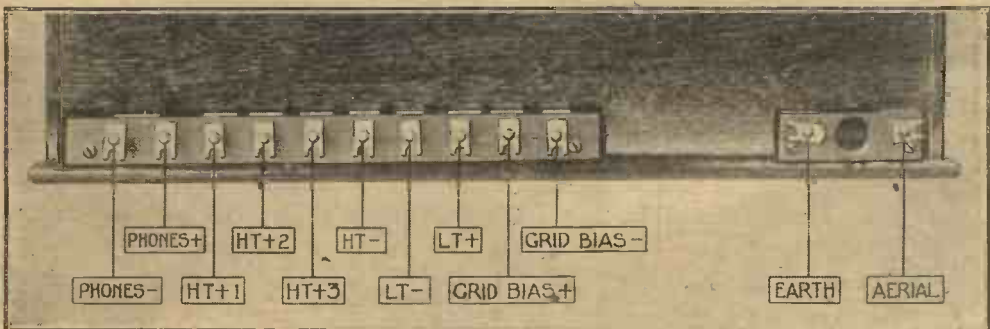

This photograph indicates very clearly the positions of the terminals at the back of the receiver.

on the part of the valve to oscillate will always make itself evident. Such oscillation constitutes a serious obstacle to distortionless reception, and in many cases renders the reception of any station practically impossible. Some means of checking self-oscillation must therefore be introduced, and this may take one of

the grid of the H.F. valve being connected through the aerial coil to a slider which makes contact with any desired part of the resistance. In this manner the potential on the grid may be made less negative with respect to the filament, thus introducing a damping effect to self-oscillation.



The neat appearance of the complete receiver is apparent by this photograph.

several forms, chief amongst which are the damping method by means of a potentiometer, the neutralising method in which the small stray coupling capacities are neutralised, or, lastly, by the super-sonic heterodyne method in which the original frequency of the incoming signal is changed to one of a lower value at which H.F. amplification is more stable and efficient.

The first method indicated is by far the simplest and the most universal. It consists, as will be seen, of a moderately high resistance connected across the terminals of the filament-lighting battery,

In all types of circuits the valve as a detector is almost universally used, and this circuit is no exception to the rule. Reaction is employed in the usual manner by coupling a coil connected in the plate circuit of the detector valve to the grid coil of the H.F. valve—that is, to the aerial coil.

Low-frequency Amplification

On the low-frequency side we have the usual transformer-coupled amplifying valve which, by applying a fairly high potential to the plate and negative grid bias to the grid, will give powerful ampli-

The Low-frequency Stage

fication with a minimum of distortion. In order that each valve may function at the best part of its characteristic curve, a separate plate potential is supplied to each valve by means of three separate + H.T. tapings, across each of which and - H.T. a 2-microfarad fixed condenser is connected.

With such a set wonderful results can be obtained. It possesses just enough

Components

We turn now to more practical details. In the first place a complete list of all the components required is given, together with the names of the manufacturers. Other components of high-class grade may be used, of course, and results will be satisfactory. It is essential, however, that whatever components are used, that they should be of the best quality.

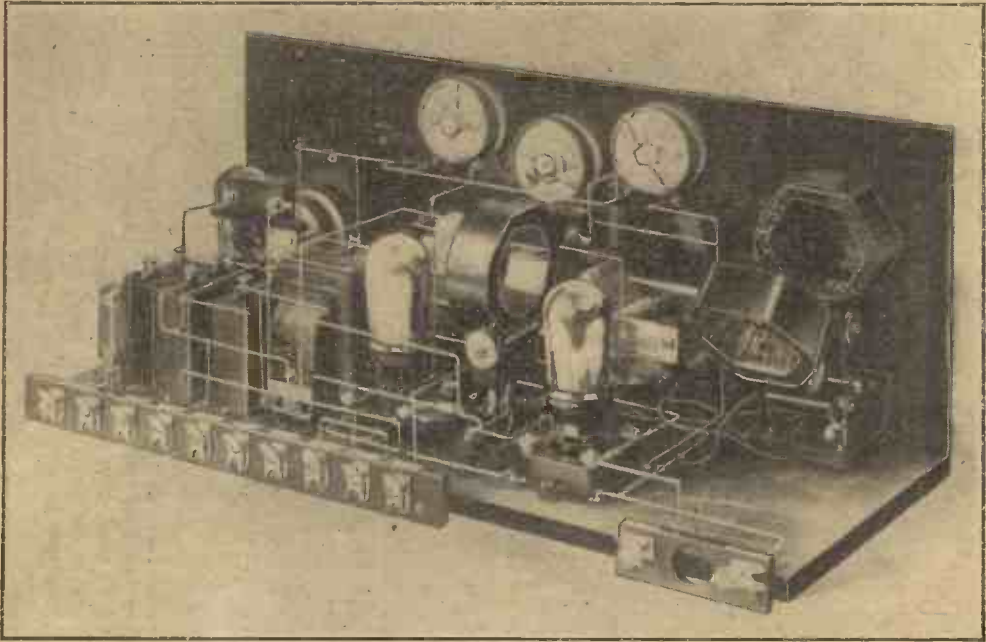

Compactness and accessibility are features of the design.

valves to give loud-speaker results, and too few to introduce serious distortion. Its receiving range, due to the H.F. valve, is unlimited, the reception of American stations being well within its limit. Indeed, the control and sensitivity compare favourably with most of the more complicated receivers. For the average man whose family only cares for the reception of the local station; on the loud-speaker, and who, when they (his family) have retired for the night, satisfies his cravings for long distance reception, such a receiver is ideal. It is indeed "Britain's Most Popular Three-valver."

Ebonite panel, 18 in. by 7 in. by $\frac{1}{16}$ or $\frac{1}{4}$ in. (American Hard Rubber Co.; or Paragon, Lowenadler, British Ebonite Co., Ltd.)

Ebonite terminal strip, 11 in. by 1 in.

Ebonite terminal strip, 3 in. by 1 in.

Baseboard, 18 in. by 7 in. by $\frac{3}{8}$ in. thick.

.0003-microfarad variable condenser (Bowyer-Lowe; or Radio Instruments, Sterling, Ormond, G.E.C., Raymond, A.J.S., Dubilier, Igranic, etc.).

.0005 microfarad variable condenser (see .0003-microfarad condenser).

Two Indigraph 4-in. dials (Igranic).

Three 30-ohm filament rheostats (Igranic-Pacent or Lissen).

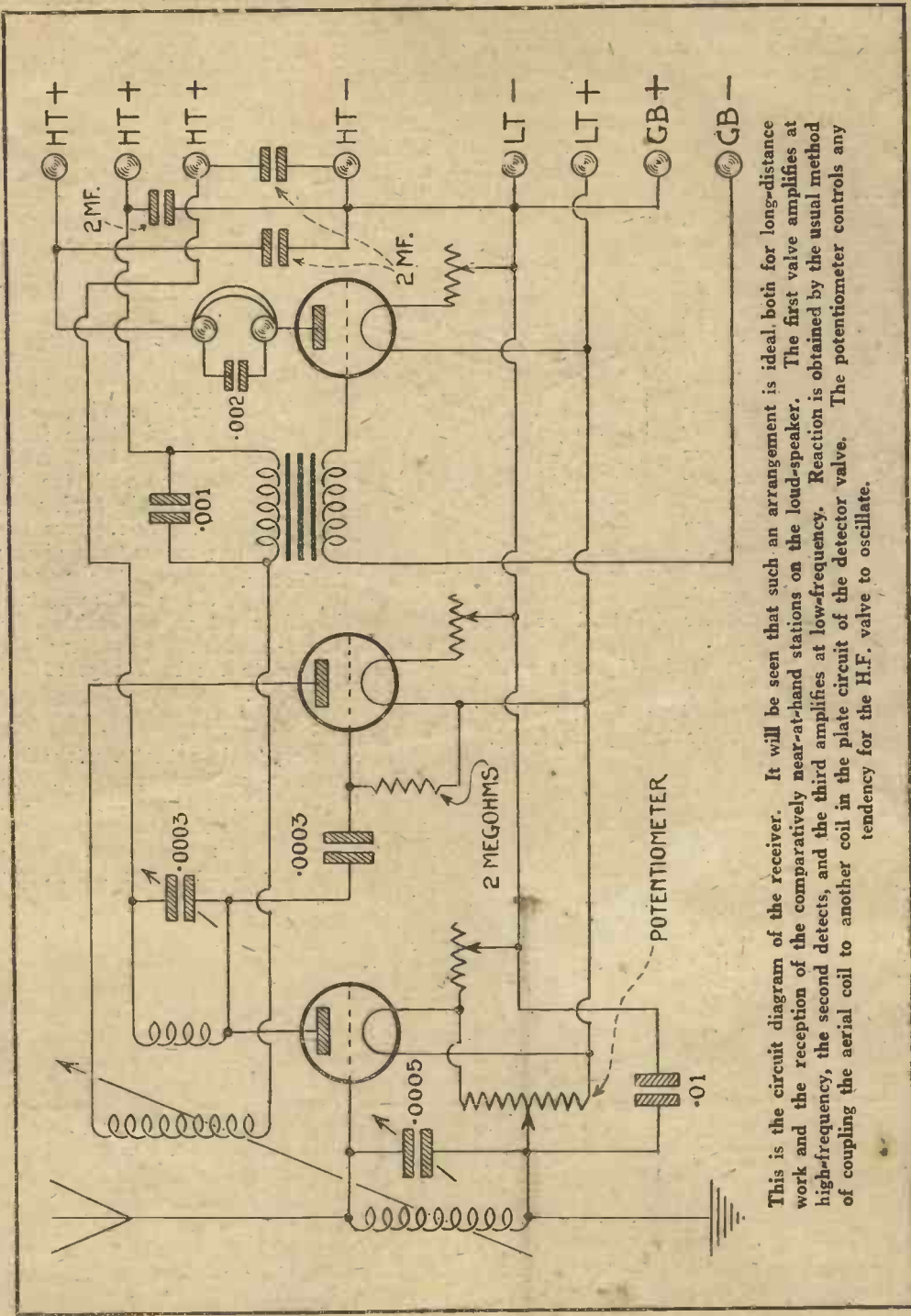

This is the circuit diagram of the receiver. It will be seen that such an arrangement is ideal, both for long-distance work and the reception of the comparatively near-at-hand stations on the loud-speaker. The first valve amplifies at high-frequency, the second detects, and the third amplifies at low-frequency. Reaction is obtained by the usual method of coupling the aerial coil to another coil in the plate circuit of the detector valve. The potentiometer controls any tendency for the H.F. valve to oscillate.

400-ohm potentiometer (Igranic-Pacent or Lissen).

Two-way coil-holder (G.E.C.).

Single coil-holder (Athol Engineering).

Three valve-holders for baseboard mounting (Benjamin or Lotus).

L.F. transformer (G.E.C.; or Radio Instruments, M-L, Igranic, Peto-Scott, Eureka, Lissen, Ferranti, Marconi Ideal, Energo).

Three 2-microfarad fixed condensers (T.C.C.).

.002 fixed condenser (Watmel or Dubilier).

.001 fixed condenser (Paragon or Dubilier).

.01 fixed condenser (Paragon or Dubilier).

Combined grid-leak and condenser (Watmel or Mulard).

One dozen terminals (Igranic spring clip or Belling Lee).

Cabinet of dimensions shown in sketch (Carrington Manufacturing Co., Ltd.).

The Cabinet

First of all we may start with the cabinet, a dimensioned sketch of which is given in Fig. 2. Those of our readers who are handy with carpenters' tools will possibly care to make up the cabinet for themselves, in which case a good job should be made of it, for nothing looks worse than a badly-made cabinet. The majority, however, will prefer to buy the cabinet ready made, identical to that shown in the photographs. One such as this may be obtained from the Carrington

Manufacturing Co., Ltd., of 18 to 20 Norman's Buildings, Mitchell Street, London, E.C. This cabinet may be obtained in mahogany or oak. The cabinet itself is built on the American fashion, having an upright panel opening and a lid hinged at the back, giving easy

access to the components arranged on the baseboard at the back of the panel.

Along the top of the cabinet, just above the panel, a thin strip of wood of the same thickness as the lid, and beaded at the front edge and sides, is attached, the lid fitting in flush with it. This serves the purpose of giving support to the panel along its top edge.

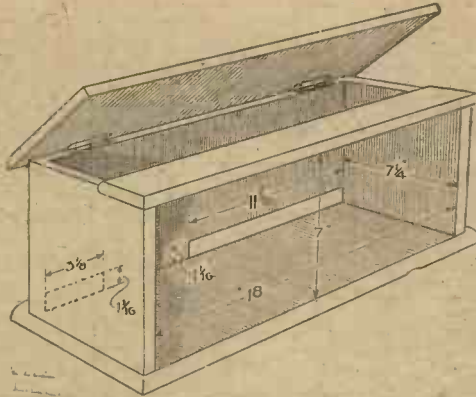

Fig. 2.—Constructional Details of the Cabinet.

Slots should be cut on the back of the cabinet, through which the two terminal strips attached to the back edge of the baseboard project.

The Panel

Next we come to the actual construction of the set, and our attention must first be turned to the panel. The use of high-class ebonite cannot be too strongly emphasised. Many of the faulty receivers which have come under our notice have had their fault traced to the use of poor ebonite introducing high-resistance leaks. To ensure good quality ebonite a branded variety should be purchased, and all unmarked samples regarded with suspicion. If the panel is obtained from the firm indicated first in the list of components, no cutting or trueing-up of the edges will be

The "Amateur Wireless" Free Prize Ballot revealed, also, which is Britain's Most Popular TWO-valver.

See NEXT Week's "Amateur Wireless" for a special announcement relating to it!

required, as the dimensions are a standard size. Assuming that an odd-sized panel is obtained, the superfluous area must be carefully cut off with a saw and the edges smoothed with emery cloth.

Having prepared the panel, drilling operations may be started, and for this purpose reference should be made to the

surface, with its outside face on top. Place the template exactly over the left-hand half of the panel so that the corners and edges coincide. With a sharp steel point mark through on to the panel the centres of all the holes shown in unbroken lines on the template. Having done this the template is removed, and holes of the

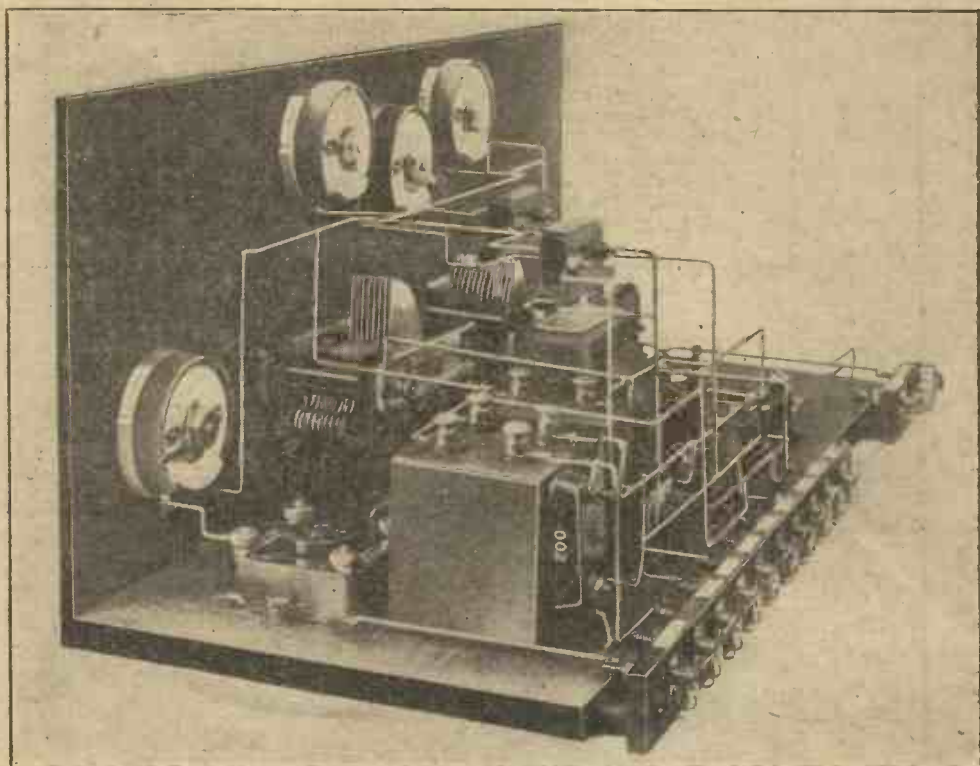

The components required for building the receiver are comparatively few.

centre pages of this booklet. On the two centre pages will be found a full-size drilling template of a little more than one half of the panel. As both halves of the panel are symmetrical, except for a rheostat on one side and the two-way coil-holder on the other, it has been considered sufficient to give a drilling diagram of only one half of the panel, showing in dotted lines the necessary alterations for the drilling of the other half. The method of using the template is as follows: Lay the panel on a flat

sizes indicated drilled through at these marks.

Now turn the template over and place it on the right half of the panel, marking through the holes as before, with the exception of those on the right-hand bottom corner, where the dotted holes should be marked instead of those drawn in full lines.

When drilling the panel care should be taken that the drill is at right-angles to the plane of the panel. For each of the two condenser dials two small holes must

PANEL 18" LONG

This is a full-size template of a little more than the left-hand half of the panel. The method of using this template is as follows: Place the panel flat on a table or bench and carefully apply the template to the left-hand half of the panel in such a manner that the outline of the template coincides with the edges of the panel. Then mark through the centre of all the holes shown in unbroken lines with a sharp steel point. Remove the template and, reversing it, place it on the right-hand half of the panel. The centres of all the holes should be marked through as before with the exception of those intended for the coil holder. In place of these the three holes shown in dotted lines should be marked.

7"

DRILL TO DOTTED CIRCLES FOR RHEOSTAT MOUNTING IN RIGHT-HAND HALF OF PANEL ONLY—FIRST REVERSING TEMPLATE AND MARKING THROUGH FROM BACK OF PAPER

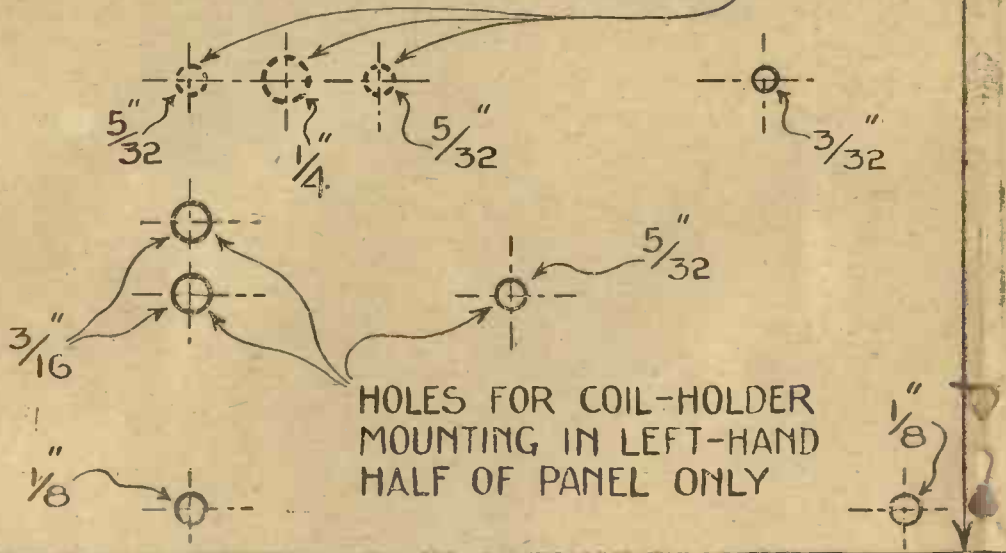

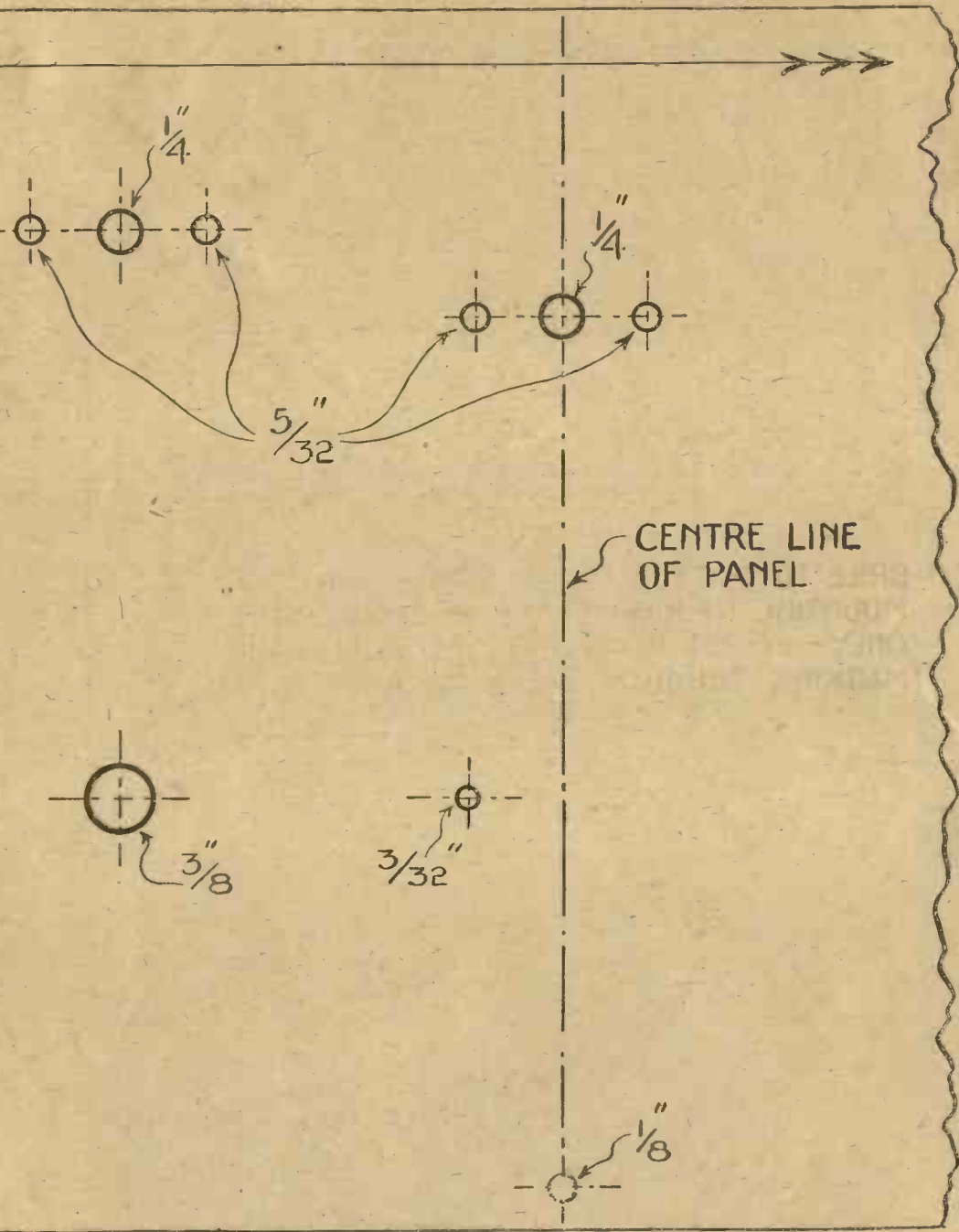

Marking Out the Panel

be drilled in the panel to prevent the dial casing from turning with the knob. Into these holes two small projections moulded on the dial are fitted.

In the left-hand bottom corner of the panel the two-way coil-holder is mounted in such a position that at the back the base of the coil-holder rests on the baseboard. In the centre of the panel, in the positions seen on the photographs and

to the baseboard. This consists of a piece of hard wood, such as teak, measuring 18 in. by 7 in. by $\frac{3}{8}$ in. thick. The surface may be stained with shellac varnish in order to improve the insulating and damp-resisting properties of the wood as well as adding to its appearance. To the back edges of the baseboard and at each end are fixed the two terminal strips, the larger strip carrying battery and 'phone

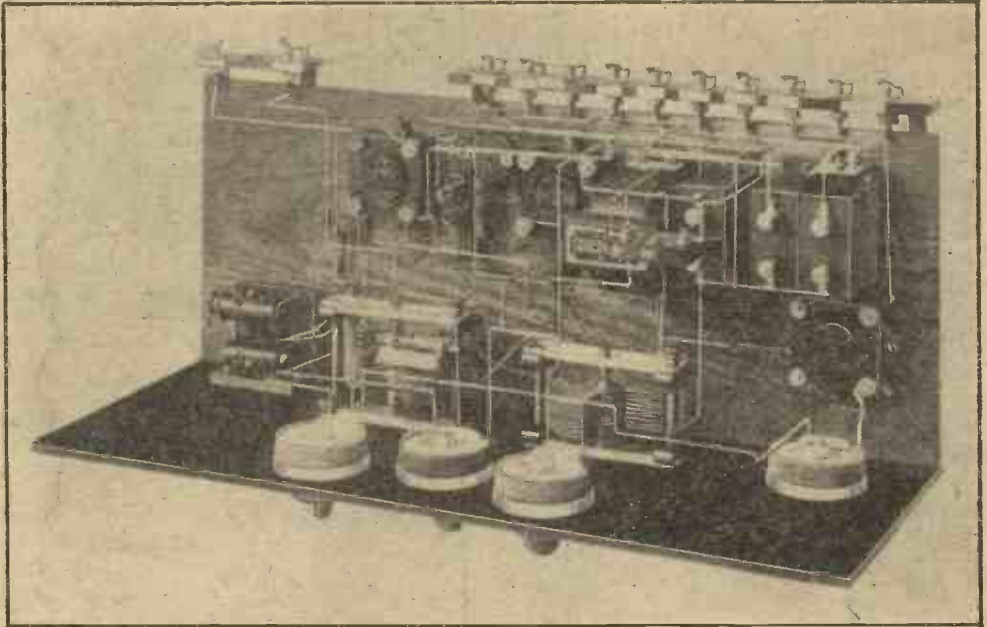

This photograph shows the arrangement of the components on the baseboard.

diagrams, the two variable condensers are mounted, whilst directly above them are seen two filaments, mounted symmetrically on each side of the potentiometer. The third filament rheostat is mounted in the bottom right-hand corner.

The Baseboard

In addition to the holes drilled for the fixing of the components to the panel, a further four holes are required, drilled along the bottom edge of the panel, for the attachment of the latter to the baseboard. As soon as those components specified have been mounted, the panel may be laid aside and attention turned

terminals, and the smaller strip aerial and earth terminals. (Figs. 3 and 4.) The smaller strip is fixed to the corner of the baseboard directly behind the two-way coil holder, whilst the larger strip is fixed to the other corner.

In order that the terminal strips may project through the slots cut in the back of the cabinet small pieces of ebonite tube are used as distance-pieces to separate the strip from the edge of the baseboard by approximately $\frac{1}{2}$ in. The brass wood-screws fixing the strip pass through the centre of the ebonite distance-pieces. On the baseboard itself the remainder of the components are mounted. An idea of

their disposition may be obtained from the photographs and the coloured wiring diagram.

It is essential that the moving coil of the two-way coil holder should be able to move unhampered by the wiring of the receiver. No instrument, therefore, is

condenser. It will be noticed that these connections are as short as possible.

Between the fixed coil holder and the L.F. transformer the detector valve holder is mounted, the transformer being screwed to the baseboard behind the smaller variable condenser. The small fixed con-

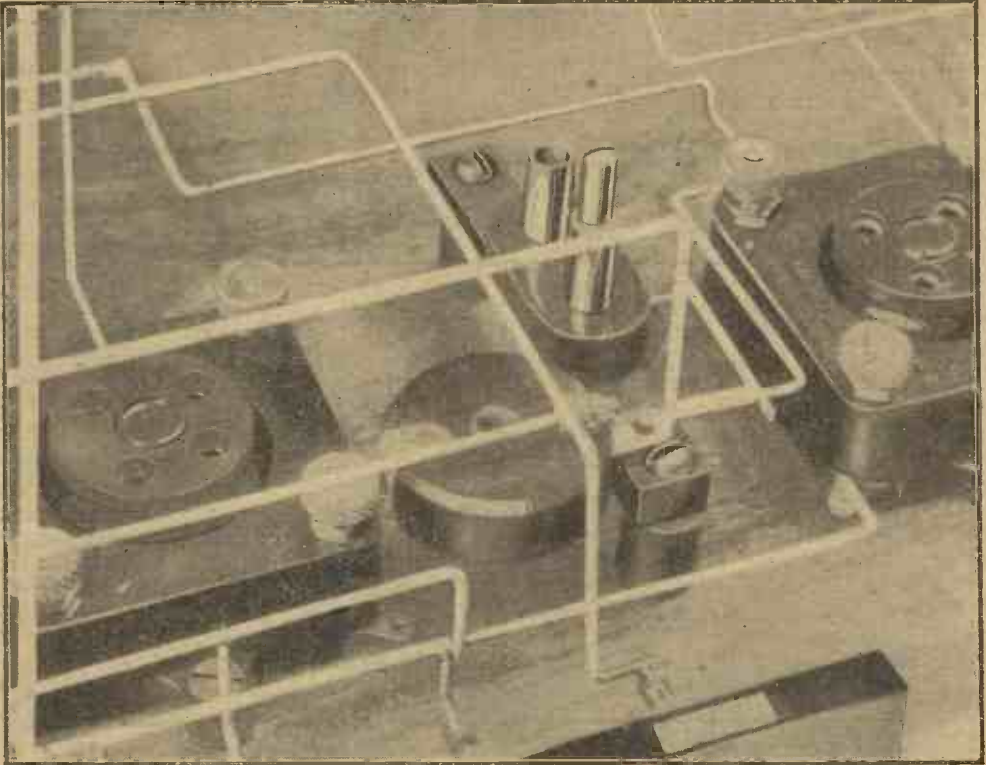

The method of wiring will be clear from this picture, which shows two of the valve holders and the fixed coil holder.

mounted directly behind the coil holder, as will be clearly seen from the photographs of the receiver. Directly behind the large variable condenser the high-frequency valve holder and the fixed coil holder are mounted. The latter is actually fixed to a thin ebonite strip (Fig. 5), screwed to the baseboard but separated from it by two ebonite distance-pieces. A close-up photograph of the coil holder is given, and this shows clearly the method of mounting the fixed coil holder and the Watmel combined grid leak and

denser connected across the primary terminals of the transformer need not necessarily be screwed or fixed in any way to the baseboard or panel, but may be held in position by the thick wire used for wiring the set. The three 2-microfarad fixed condensers and the low-frequency valve holder are mounted in the positions shown.

Wiring the Receiver

Having mounted the components, the panel may be attached to the baseboard

Assembling the Components

by four 1 in. brass wood-screws, after which wiring may be started with the help of the coloured wiring diagram which accompanies this booklet. In order to distinguish the grid, filament-lighting and plate circuits, these have been coloured in black, red, and red and white respectively. On close examination it will also be seen that all the terminals, including those on the actual components, are marked with a small letter of the alphabet. Some, for instance, are marked *a*, and all these should be joined together *first*, with one wire or as few wires as possible. Then all those marked *b* are connected together in a similar fashion; next all those marked *c*, and so on. In this manner the set may be wired up in the most convenient order.

If the coloured wiring diagram is frequently consulted during wiring operations there will be little likelihood of making mistakes. For those who prefer to wire up from a circuit diagram this will be found on page 5. The usual practice of keeping grid and plate wires

well separated should be remembered. Connections to the reaction coil should be made with two short pieces of flex, one being connected to the plate of the detector valve and to one side of the reaction coil, and the other connected to the primary terminal of the low-frequency transformer and to the other side of the reaction coil. It may be found when the set is given its preliminary test that these connections should be reversed. This, however, will be explained later.

Wherever possible connections should be soldered, a joint of this type being far more efficient and lasting than a clamped joint. In the photographs the wiring is shown with each wire either parallel or perpendicular to the others. This method looks very neat, but the constructor need not worry himself too much on this point.

This completes the actual construction of the receiver, which, before being placed in its cabinet, should be given a preliminary test for short circuits, etc. First of all place all the valves in their sockets, and turn the rheostats to the "full-on"

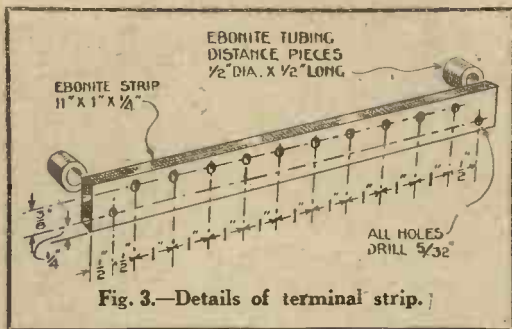

Fig. 3.—Details of terminal strip.

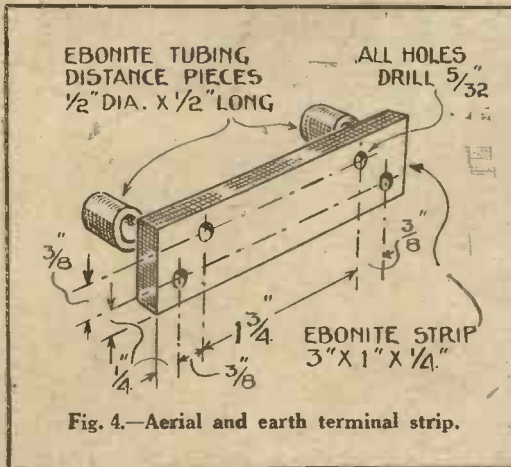

Fig. 4.—Aerial and earth terminal strip.

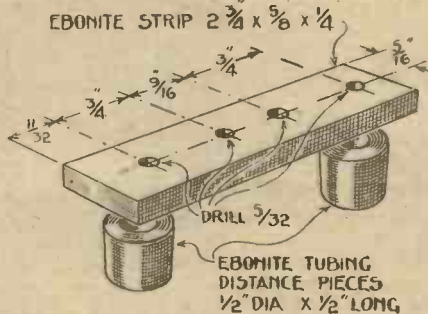

Fig. 5.—Anode coil support.

A New "Amateur Wireless" Handbook

Loud-Speaker Crystal Sets

HOW TO MAKE AND MANAGE THEM

Working instructions are given on the building of a number of highly efficient crystal sets with which particularly loud signals have been obtained. The special system of operating a loud-speaker from a crystal set—with results comparable to those obtained with one and possibly two valves—is fully described with diagrams and illustrations.

2/6 NET or post free 2/9 from the
Editor of "Amateur Wireless"
La Belle Sauvage, E.C.4.

Cassell's



CABINETS

A CAMCO CABINET
means a professional
finish to your set

THE CABINET ILLUSTRATED AND
DESCRIBED IN THIS BOOKLET IS A
CAMCO CABINET

This Cabinet may be obtained in mahogany
or oak.

PRICES: { OAK : 24/-
 { MAHOGANY : 27/-
 Including Baseboard.

Write at once for our Illustrated List of 100
Varieties of Cabinets for Radio Sets.

TRADE ENQUIRIES ESPECIALLY INVITED

CARRINGTON MFG. CO. LTD.,
18/20, NORMANS BUILDINGS,
MITCHELL STREET, CENTRAL STREET, E.C.1.
Phone: Clerkenwell 6903.

Amateur Wireless And Electrics

*Essentially a practical paper—exclusively
devoted to the interests of all listeners-in.*

Gives week by week expert replies to Readers' Questions and Practical Help in every kind of Difficulty. Straight-forward instructions for making every kind of Wireless Set. Wireless Club and Society Fixtures, and the latest news of Wireless Developments by skilled experts.

*Take "Amateur Wireless" each week
and get the best results from your set.*

3^d.

Every Thursday

CASSELLS
PUBLISHERS
LONDON

Britain's Most Popular TWO-valver

The Free Prize Ballot revealed it. We have built it, and are now testing it.

We shall make it the subject of a

SPECIAL "GIFT" NUMBER

and shall make a definite announcement with regard to it

NEXT WEEK.

Get "A.W" next week and read all about it.

position, next short-circuit the L.T. and grid-bias terminals with short pieces of wire. Also place all the coils in their sockets. Now connect the *accumulator* to the H.T. - terminal and to each of the H.T. + terminals in turn. If any short-circuit is present between plate and filament circuits the fact will be demonstrated by the lighting up of the valve filaments. Should this occur a search for the fault must be made and, when found, remedied.

With regard to the choice of suitable valves we can recommend any of the well-known makes, such as Cossor, Ediswan, B.T.H., Osram, Marconi, Mullard, etc. The best results are obtained not by the use of three general-purpose valves, but by employing a special valve for each stage. A good combination for 2-volt valves is as follows. As a high-frequency amplifier and detector use two Osram or Marconi D.E.2 H.F.s, and for the low-frequency amplifier a D.E.2 L.F.

Operation

The set may now be placed in its cabinet, and aerial, earth, batteries and 'phones connected to their appropriate terminals. For ordinary broadcast reception plug a No. 35 or 50 coil (depending

on the length of aerial) in the fixed holder of the two-way coil holder, and a No. 60 coil in the moving holder. In the fixed coil holder mounted on the ebonite strip place a No. 75 coil. Turn the rheostats until the filaments of the valves reach a suitable brilliancy, and, keeping the coupling between aerial and reaction coils fairly loose, search round for signals by slowly turning the two variable condenser dials in the same direction, starting from zero. If the set is inclined to oscillate with a very loose coupling between aerial and reaction coils, adjust the potentiometer until oscillation ceases. When signals are received they may be further strengthened by tightening the reaction coupling and by adjusting the potentiometer. Having obtained loud signals the H.T. and grid-bias voltages should be adjusted until the best quality of reproduction is obtained.

For longer wavelengths, such as that of Daventry, a separate series of coils will be required. The sizes for aerial, reaction and anode coils are Nos. 150, 100 and 200 respectively. In order to obtain good H.F. amplification the slider of the potentiometer should be kept over to the negative side as far as possible.

Q *The World's Greatest
Magazine of Wireless*

The
**Wireless
Magazine**

Edited by BERNARD E. JONES

Contains each month a wonderful collection of first-rate articles for Home Constructors; the fullest details being always given, together with helpful diagrams and photographs. Stories and articles of general interest to the Wireless enthusiast are contributed by first-class writers.

A special free question and answer service is provided. The production, contents and illustrations of the "Wireless Magazine" are unequalled among wireless publications.

Get a Copy NOW!

One Shilling Monthly

*From all Newsagents
Bookstalls & Booksellers*

CASSELL'S, Publishers, LONDON, E.C.4

Six of the best from the double IGRANIC range

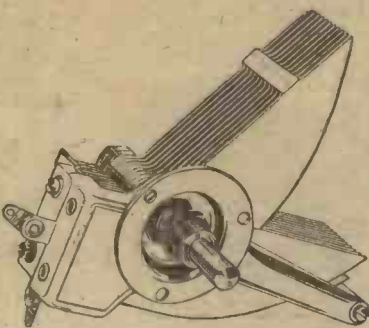

THE IGRANIC-PACENT TRUE STRAIGHT LINE FREQUENCY VARIABLE CONDENSER.

This Condenser distributes stations equally over the dial because they are spaced according to frequencies. Fixed and moving plates are of brass, riveted together and soldered. Only two small pieces of insulating material are used, so placed that the absorption losses are negligible. Substantial dustproof bearing gives a smooth movement which greatly facilitates tuning. Designed for single or three-hole mounting.

PRICES:—.00035 mfd 14/6
 .. .0005 mfd 18/6



THE IGRANIC-PACENT PORCELAIN RHEOSTATS AND POTENTIOMETERS.
 (Pat. No. 238462).

A porcelain base is used and they are fitted with moulded knob and gold or silver finished dial. Winding spaced to give maximum cooling effect. Elongated holes to accommodate varying spaced mounting holes on panel. Supplied in resistances of 6, 10, 20, 30 or 50 ohms with current carrying capacities of from .3 to 1.5 amps. at 2/6 each. Or as

POTENTIOMETERS

with resistance of 400 ohms, 2/6 each.

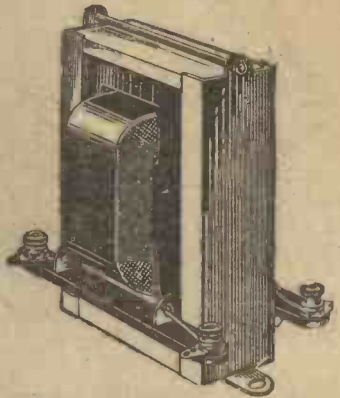

THE IGRANIC-PACENT SUPER "AUDIOFORMER" (Reg'd).

The special construction of the core and coils gives a uniform amplification of frequencies as low as 100 and as high as 8,000, resulting in perfect, distortionless amplification of speech and music. It is eminently suitable for use with general purpose valves and particularly for power amplification up to plate voltages of 500 volts. Price, 27/-.

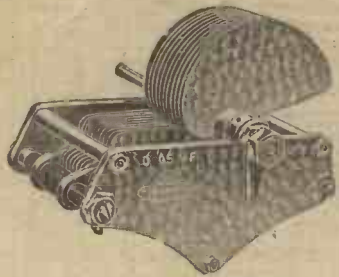

IGRANIC LOW LOSS SQUARE LAW VARIABLE CONDENSER.
 (Pat. No. 220312).

Sharp and selective tuning. Extremely low electrical losses. Smooth in operation and practically indestructible ball-bearings. Freedom from body capacity effects. Very low minimum capacity, and consequent wide tuning range with a given coil. Supplied complete with 4-in. Combined Knob and Dial.

Capacities	Price.	Capacities.	Price.
.0015 mfd. . .	19/6	.0005 mfd. . .	24/-
.0003 " . . .	21/-	.001 " . . .	27/6

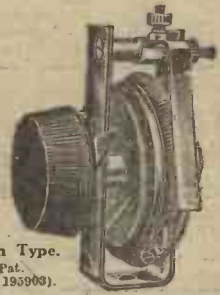

Plain Type.

(Pat. No. 193903).

IGRANIC FILAMENT RHEOSTAT.

Supplied with 4, 6, 8 or 10 ohms resistance. Specially suitable for highly efficient filament control. Prices: Plain type, 3/6. Vernier type, 5/6; and Dull Emitter type, 20 or 30 ohms, 5/6.



(Pat. No. 205013).
 (Reg'd. Nos. 697459 and 701369).

IGRANIC "E" TYPE AUDIO-FREQUENCY TRANSFORMERS.

Possess a high amplification factor which is constant over a very wide range of audible frequencies. They are absolutely free from distortion and from parasitic noises.
 Ratio 1 : 5 (1st Stage) 21/-
 Ratio 1 : 3 (2nd and subsequent stages) 19/6

Write for the IGRANIC Booklet Z984 which gives full details of them all.



Exclusive Manufacturing Licences of Pacent Radio Essentials.

149, Queen Victoria St., LONDON.

Works: Elstow Rd., BEDFORD.