

A SPECIAL CIRCUIT FOR FRAME AERIALS

Amateur Wireless And Electrics

Vol. II. No. 55.

SATURDAY, JUNE 23, 1923

Price 3d.

PRINCIPAL CONTENTS

POSITION AND DIREC-
TION FINDING

LOW POWER SPEECH
TRANSMITTER

INTERCHANGEABLE
FIXED CONDENSERS

CHARGING ACCUMULA-
TORS FROM THE CAR

RECEIVING CIRCUITS
IN DIAGRAM AND
PICTURE

FINDING THE BEST
TRANSFORMER

SIMPLIFIED CONNec-
TIONS

NOTES ON BATTERIES

SOME POSSIBLE DE-
VELOPMENTS

EXPERT REPLIES TO
READERS' QUESTIONS

WELL ILLUSTRATED

Registered at G.P.O. as a Newspaper

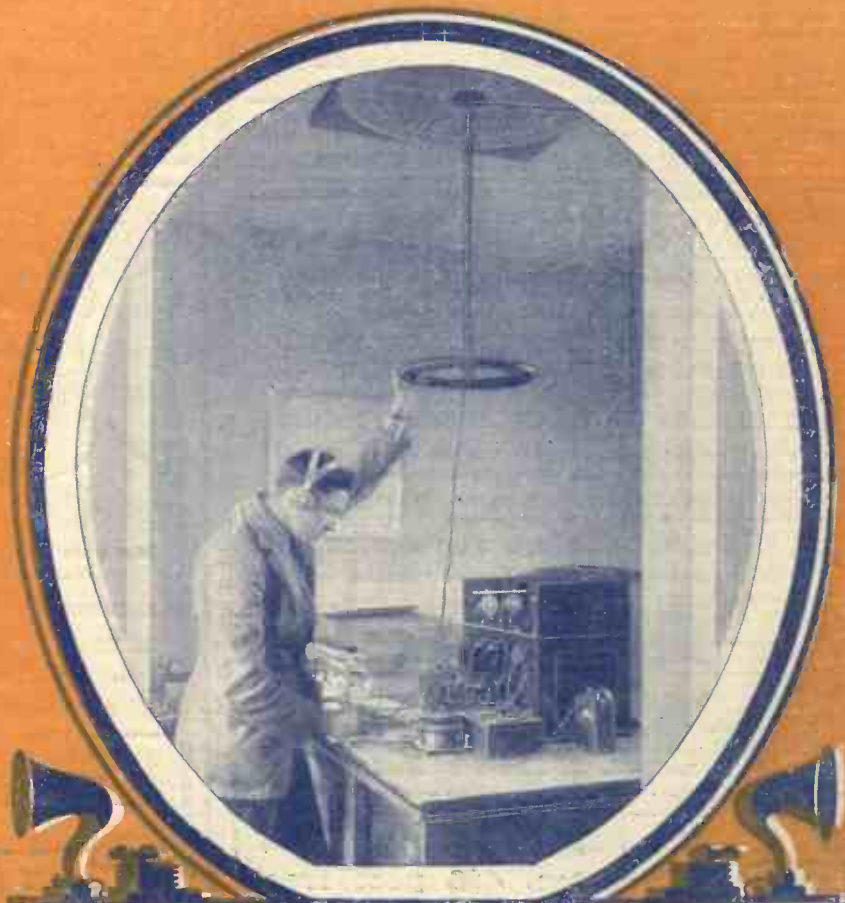

This photograph depicts an operator at Craydon Aerodrome determining the position of a cross-Channel aeroplane with which he is in communication.

ECONOMIC ELECTRIC LTD.

SENSATIONAL DATA re NEW "XTRAUDION" VALVE

The appended table is an extract from "THE RADIO EXPERIMENTERS HANDBOOK," Part II, by Philip R. Coursey, B.Sc. (Eng.), F.Inst.P., A.M.I.E.E., M.R.I. (Great Britain), F.P.S. (London), and needs no comment from us; suffice to say that the "XTRAUDION" takes only 4 amperes at four volts and requires an anode potential of 30-75 volts.

Name of Valve.	Internal Resistance in ohms.	Amplification Factor.
V24 (Ediswan), No. 3828	192,000	6.3
V24 (Ediswan), No. 3794	290,000	8.2
V24 (M.O.V. 1190)	70,300	5.0
Métal R.	73,200	11.5
A bad (cheap) French R	1,362,000	4.4
Ora 6122	376,000	8.2
Ora 6220	568,000	7.3
"Xtraudion"	90,700	12.0
M.O. valve, R4944	93,700	10.5
R4B (G.E.Co.), No. 248	84,200	13.8
B.T.H. "A" (28880)	130,000	6.9

WRITE NOW FOR OUR 40-PAGE RADIO CATALOGUE mailed post free for 4d.

Head Office: 10, FITZROY SQUARE, LONDON, W.1. Telephone: MUSEUM 1055 Showrooms: 303, EUSTON ROAD, N.W.1

AUCTION of Wireless Apparatus

An opportunity for Amateurs and Traders to secure small or large lots. Complete 2- and 3-Valve Receivers—B. Mark I 2-Valve Detectors and Amplifiers. B. Mark II 2-Valve Receiving Sets.

WESTERN ELECTRIC CRYSTAL SETS—VALVES—FRENCH HEADPHONES—LOUD SPEAKERS—BROWN'S HEADPHONES, Low & High Resistance—MARK III SHORT WAVE TUNERS (New & Perfect)

50 Watt Receiving and Transmitting Sets (new and unused). Large quantities of miscellaneous accessories. Condensers, Buzzers, Voltmeters, etc.

AUCTION DAY, MONDAY, JUNE 25th
Time, 3.30 p.m. Catalogues on application

On view 10 a.m.—6 p.m., Friday and Saturday previous.

POWELL & POWELL, 556, Oxford St., W.1

NO OTHER CRYSTAL WILL EQUAL OUR

"HERTZITE"

FOR BROADCAST RECEPTION

SIMPLE TO USE NO BATTERY REQUIRED

Price with Detector, 4/6 post free

Sample Specimens, 1/6

This Crystal is not a German Production. The Formula is our property and you are hereby warned against infringement.

TRY OUR "HERTZITE" RECEIVING SET, 67/-

RUSSELL & SHAW

38, Great James Street, Bedford Row, W.C.1.



4,000 OHMS PER PAIR

SPECIFICATION

Case.—Best hard Aluminium, solid drawn and accurately finished.

Magnets.—Latest type horseshoe pattern of finest Tungsten Steel, resulting in strong and permanent magnets.

Core Pieces.—Finest quality of special soft iron, with fibre insulating cheeks.

Wire.—Each earpiece is wound with best English high conductivity copper wire to 2,000 ohms by special machines.

Diaphragms.—Made from selected Ir.n. perfectly flat to ensure perfect tone.

Spacing Washers.—Special thin hard brass to obtain correct distance for perfect results.

Ear Caps.—Solid ebonite of ample size, best finish and correctly proportioned.

Insulation.—This is a particular feature and receives careful attention, finest materials only being used.

Head Bands.—Made from best quality Spring Steel, copper-plated, oxidized, and relieved, giving beautiful finish.

Testing.—Every earpiece is tested thoroughly during and after assembly.

Finish and Workmanship.—Of the best possible throughout.

Assembly.—By skilled labour under expert supervision.

BONTONE PHONES Britain's Best

Marvellous Efficiency—
: Marvellous Price :

16/6

per pair, plus 1/- extra for postage.

Manufactured entirely in our works, Goswell Road and City Road, under mass production, hence the quality and price.

Guarantee.—We agree to return cash in full if not satisfied, and returned to us undamaged within 7 days.

We specialize in the manufacture of Precision Tools, stamped and turned parts, in large quantities. Send us your enquiries.

We are experts in the production of Magnets of all shapes and from Tungsten or Chrome steels.

B. D. & Co.

(Edward A. Boynton)

ADMIRALTY AND WAR OFFICE CONTRACTORS.

Works: 167-173, Goswell Road, E.C.1.
1-9, Goswell Place, E.C.1.
361-363, City Road, E.C.1.

Offices: 173, Goswell Road, E.C.1.
Telephone: Clerkenwell 6238.

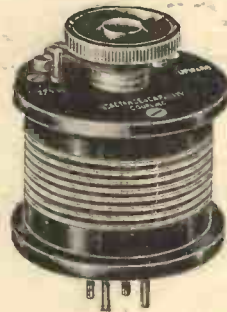

DISPENSE

with

PLUG-IN TYPE TRANSFORMERS,
and for
SELECTIVE TUNING USE

TRADE **Grelco** MARK
REACTANCE - CAPACITY COUPLING.

Made to fit into the ordinary "R" Type Valveholder, and needs only a slight alteration of the wiring.

HIGHEST GRADE WORKMANSHIP, BEST INSTRUMENT FINISH

RANGE "A" 180 to 500 metres (8 tappings) } 30/- Post 6d.
" B " 275 metres upwards (8 tappings)

THIS IS THE ORIGINAL AND STILL WITHOUT EQUAL.

SPECIAL: ANODE RESISTANCES, 100,000 ohms GUARANTEED.
Price 2/- each, post 2d.

OUR 100-PAGE CATALOGUE
CONTAINING OVER 12,000 ILLUSTRATIONS
Post 3d. Free. 6/-

GRAFTON ELECTRIC COMPANY,
54, GRAFTON STREET,
TOTTENHAM COURT ROAD,
LONDON

Telephone
MUSEUM 241

Works:
SLOUGH

MANUFACTURERS OF WIRELESS
GOODS FOR OVER 16 YEARS



Amateur Wireless

and Electrics

Vol. II, No. 55

June 23, 1923

Simplified Connections

The Use of Plugs, Connectors and Jacks

ONE of the outstanding features of the average amateur-made set is the entire lack of uniformity of the terminals and other connections. The appearance of the most elaborate valve panel is often ruined by an assortment of odd terminals, of varying shapes and sizes, in many instances taken off old electric bells and similar apparatus.

Another serious fault to be found with the average experimenter is his love of twisted wires, lightly wound around terminals, threatening to come adrift at any moment and cause a "short" somewhere. The continual undoing and doing up of the various connections tend to break the wires or to cause the insulation to fray and look untidy, and this trouble may be overcome by the use of metal lugs or cable ends sweated or soldered to the ends of the various connecting wires.

In the following article an attempt has been made to offer suggestions to the serious experimenter on the general improvement of the system of wiring, not only from the point of view of simplification but of effecting a real increase in efficiency and ease of manipulation. A number of small and useful fittings are described and illustrated, and all of them may be purchased—mostly quite cheaply—from retail dealers in electrical and wireless parts and apparatus.

Telephone Jacks

The commercial pattern telephone jack is at once the most useful and least known of accessories for the wireless experimenter. With the aid of a multiple contact jack several circuits can be opened or closed instantly and various combinations of switches operated by the movement of one plug. The general appearance and

arrangement of contacts of the standard telephone jack is shown in Fig. 1. An examination of the drawing will show that the jack consists of a pressed steel or brass frame F, with small lugs for mounting it on the panel. A short length of tube is soldered to one end of the frame, and

3 to 4. When the plunger is inserted 3 and 4 are disconnected first, and by pushing it right home 1 and 2 are also disconnected and a current may pass from 1 to 4 via the plunger.

The plunger consists of a central contact ending in a ball-shaped knob C, over which is placed an ebonite insulating tube enclosed in a second metal tube D, and terminating in an ebonite handle E. A length of twin flex is soldered to the metal contacts D and C, and on the plunger being inserted C makes contact with A and D with B. An excellent example of how useful this type of jack may be is in the case of the experimenter who wishes to use several sets of headphones.

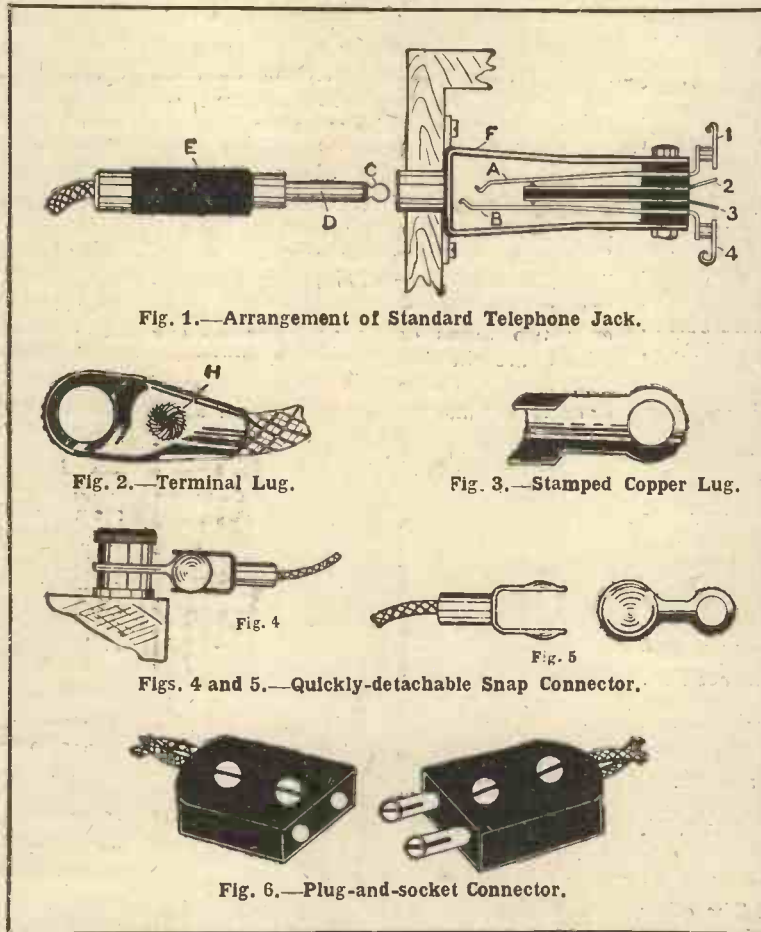

Fig. 1.—Arrangement of Standard Telephone Jack.

Fig. 2.—Terminal Lug.

Fig. 3.—Stamped Copper Lug.

Figs. 4 and 5.—Quickly-detachable Snap Connector.

Fig. 6.—Plug-and-socket Connector.

passing through the panel serves as a guide for the plunger portion of the jack. The opposite end of the frame F carries the various contact strips, together with small insulating strips of ebonite which separate and insulate the contacts from each other. Connections to the contact strips are by means of small lugs, numbered 1, 2, 3, 4, and in the normal position the contacts A and B are bent so that current may pass from 1 to 2 and from

while the act of withdrawing one of the plungers will disconnect that particular headphone; but at the same time the contacts 1 and 4 will spring together, making contact with 2 and 3, and the circuit remains complete but with one headphone less in circuit.

This is only one of many combinations that are made possible by the aid of the telephone jack; others will no doubt suggest themselves to readers and enable

them to solve switching problems of various kinds. Before leaving the subject of jacks the writer would strongly advise readers to solder carefully all connections; it is not sufficient to wrap the wires round the lugs, however carefully this may be done. Connections apparently dead tight have a habit of working loose in a most extraordinary way and are a common cause of bad signals and general inefficiency.

Terminal Lugs

The usual method of clamping connecting wires under a terminal and tightening up with the finger is more or less satisfactory when the connections are fairly permanent; in the case of experimenters constantly in the habit of trying out new circuits the connecting leads are apt to get brittle and break under the continual bending, while the insulation will tend to fray and look untidy after a short time. By far the most satisfactory way of overcoming the trouble is to solder to the ends of all connecting leads metal tags, or lugs as they are termed, of a type similar to the one shown in Fig. 2. This lug is made by cutting copper tube into lengths about $1\frac{1}{4}$ in. long, flattening one end and drilling a hole in the flattened portion, which enables it to be slipped over the terminals on the panel.

The insulation on the cable is removed carefully for about $\frac{1}{2}$ in. and the lug pushed over the end so that the bare wire projects through a small hole (shown by H in Fig. 2), and the strands of wire burred over and soldered firmly in position as indicated.

Terminal lugs of the pattern described above can be made very easily at home or may be purchased at a low price from any garage. They are generally known in the motor trade as "high-tension cable ends."

Other Types of Terminals

A cheap and simple lug is shown in Fig. 3, which consists of a stamped copper tag with two small projections which may be bent over to clamp the wire in position. It is, of course, much better to solder the wire to the tag in addition if a really permanent job is required, and the solder provides a better electrical connection.

A special type of quickly-detachable terminal is shown in Figs. 4 and 5. It consists of a small copper ball terminating in a lug for clamping under the terminal on the panel, as shown in Fig. 4. The other part of the terminal consists of a spring clamp which snaps over the ball and to which the end of the flexible cable is soldered in the usual way. To prevent the snap portion of the terminal being easily pulled off the ball portion, the sides of the snap are formed into slight cups, which help to grip the ball.

Terminals of this type are sold by motor dealers and are used for quickly detaching the high-tension wire.

A simple testing clip can be made at home by soldering a length of flex to an

ordinary tie-clip of the spring-to type. These are really useful for all-round testing purposes and have the advantage of being inexpensive.

For rapid connection of leads, such as those from the accumulator to the valve panel or from one portable unit to another, the plug-socket shown in Fig. 6 will be found exceedingly useful. It consists of two small slabs of ebonite, carefully finished and polished, one being fitted with

two valve-holder sockets sunk into the ebonite, the other being fitted with two legs from a burnt-out valve. The positions of both the sockets and plugs must be carefully aligned to ensure that they fit accurately one in the other. The ends of the flex are soldered to the opposite ends in the usual way.

The fittings described are only a few examples of the many available and only serve as suggestions. A. W. H.

Some Possible :: :: Developments

THE only definite opinion that anyone conversant with results now being obtained by wireless investigators would care to venture would be that many developments are probable and none can be safely dismissed as impossible. A successful experiment, the perfection of some appliance, some small improvement devised in a moment of inspiration, and the scientists dream becomes at once a practical working principle.

Everyone is familiar with "wireless" as applied to telegraphy and telephony. So much so that in our popular vocabulary the word is used to indicate these—and nothing more. Yet they represent only two forms of its activities. Many others are in being and in prospect. "Wireless" has become a valuable auxiliary to our mercantile marine. It saves

large sums of money by going to the aid of fog-bound ships and bringing them safely to harbour.

It is being applied to aviation in such a way that there seems every likelihood of the pilotless aeroplane becoming an accomplished fact. Of the experiments carried on to perfect such inventions as these the world at large hears little. They are always in progress, none the less, and astonishing successes have been achieved.

When considering possible developments one should keep in mind the marvels already accomplished. "Wireless" is only in its infancy, and nobody can set limits to what may be done by its agency. John Hays Hammond was laughed at when he first propounded the theory of "wireless control." Now ships are handled by that method almost every day.

The idea of running motor cars by wireless in place of petrol engines may seem a bit fantastic. Imagine how jolly it would be to just stick up your aerial and start off upon the road, taking power from the ether.

And "wireless" will one day be the best friend of the housewife, doing all sorts of work for her. The same agency that brings the voice of the great artiste who is singing hundreds of miles away will also light your lamps and cook your dinner. Practically speaking, we have merely discovered "wireless" and are slowly, though with greater success every day, learning how to use it.

When the enthusiastic amateur installs ever so modest a "set" for his own amusement he is doing far more than he wots of, for he is really helping to pioneer one of the greatest advances ever made in adapting a scientific discovery to the beneficent purpose of making life the better worth living. J. J. B.



A "Wireless" Fancy-dress Costume.
The designer is Mr. H. I. Whitely, of Stainland,
nr. Halifax.

"Wireless Telegraphy :: and Telephony" ::

The most Practical Handbook for the
Amateur. The price is 1/6 net.
Cassell & Co., Ltd., La Belle Sauvage, London, E.C.4

Charging Accumulators from the Car

THOSE readers who possess or have access to a car have at their disposal a very convenient source for charging small accumulators. Practically every modern car is equipped with a very efficient power station in miniature—the electric lighting and starting set—and with very little trouble and expense it can be made to perform another useful function. Quite satisfactory charging can be carried out without any bad effects on the battery of the car, which, it must be understood, is the most vulnerable point in a lighting set.

Preliminaries

Before attempting any charging it should first be ascertained if the lighting set is in good order (dynamo generating well and battery in good condition); if it is not so it

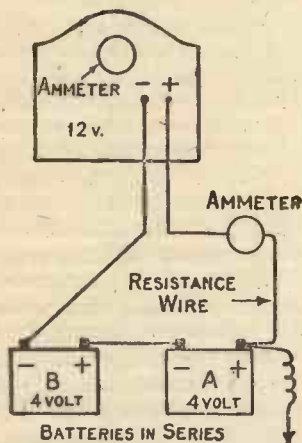

Fig. 1.—Plug-in Connection for Lucas System.

should be attended to before any attempt is made to charge your cells.

In the summer most car batteries are often overcharged. In the winter months conditions are generally reversed: shorter runs being made, a considerable amount of light used, and bad starting causing a heavy drain on the accumulator.

A twelve-volt set is most commonly used, and this will be found a convenient charging voltage, as a series group of cells up to ten volts can be put in circuit. Some cars are equipped with 6-volt sets, as, for example, the Ford, and these will charge four-volt batteries in parallel. If the cells be arranged so that those charging have an E.M.F. of about two volts above those being charged the most efficient result will be obtained and the minimum of resistance wire will need to be put in circuit.

Necessary Apparatus

Very little apparatus is required; a small ammeter of any type is essential, and a resistance (about 3 or 4 ft. of No. 22 gauge iron wire will be quite suitable). A voltmeter and hydrometer are, of course, valuable, but if a cell gasses freely when being

charged at about 30 per cent. of its normal charging rate, it can be considered to be well up. In the case of the Lucas system the charging connection is easily made by inserting a two-pin plug

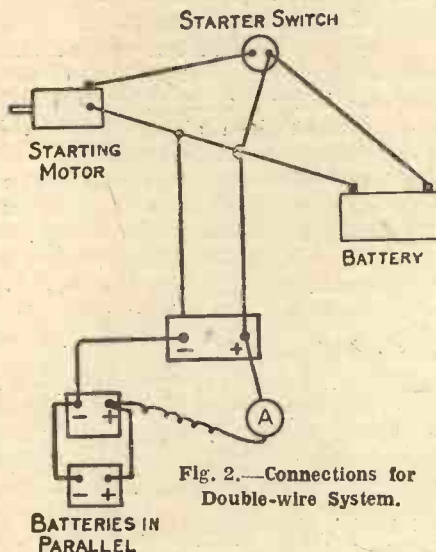

Fig. 2.—Connections for Double-wire System.

in the hole in the switch-box face, then with a few feet of wire connecting up to the battery to be charged, as in Fig. 1, in which it is assumed that two four-volt accumulators are being charged. Before connecting up the polarity of the wires should be ascertained by using pole-finding paper, or placing the two bared ends about 1/4 in. apart in a glass of vinegar and water. The negative wires will give off the bubbles. Mark it so that it is always inserted the same way.

Connections

Referring to Fig. 1, the right-hand pin is positive. Connect the ammeter to this

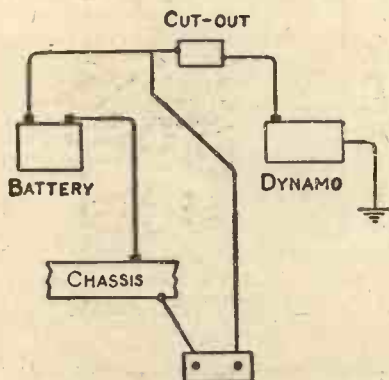

Fig. 4.—Alternative System Using Cut-out Connection.

pin and the resistance wire from the ammeter to battery A positive terminal, the negative of this battery to the positive of battery B, and the remaining negative terminal to the negative plug wire.

Note the ammeter reading; if it is too low, decrease the length of resistance wire, sliding it along the accumulator terminal until the correct charging rate is reached, then clamp up.

As the resistance wire may heat up to a certain extent take care that it does not make contact with any panel or paintwork. It is never advisable nor necessary to take more than 4 or 5 amperes through the switchboard or to attempt to utilise the usual ammeter or the dashboard. In no case should the existing wiring be tampered with. A connection can be made to tap the current by inserting an adapter plug in a sidelamp, but this necessitates the removal of the lamp front and the bulb, so is hardly worth while. Wires can be taken from any convenient point, either the main accumulator terminals, the charg-

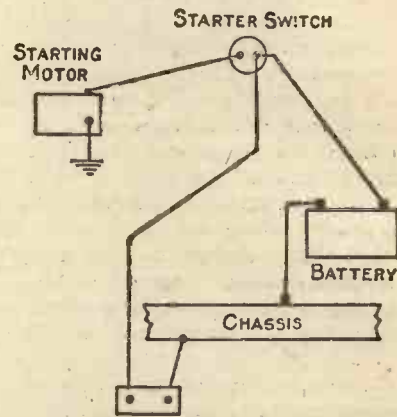

Fig. 3.—Connections for Ordinary Single-wire System.

ing wire from cut-out to battery, or a starter circuit, as shown in Figs. 2, 3 and 4, which illustrate the use of double- and single-wire circuits.

American Systems

It is impracticable to describe the connections for every make of car, but to a wireless enthusiast there should be no difficulty in the matter. A simple method that may be used on the Ford is to take a wire from the battery terminal of the cut-out (generally situated on the dynamo) and return the current to any part of the chassis, as it is a single-wire system (see Fig. 4). Being a six-volt system only a four-volt battery can be charged, or several, by connecting them in parallel, as shown in Fig. 2. The above remarks apply to the Overland also. On no account should the car battery be discharged below the point imposed by the makers, and when testing with the voltmeter a discharge of at least 4 amperes should be taking place or an inaccurate reading will result.

It will be observed probably that after (Concluded at bottom of third column on next page)

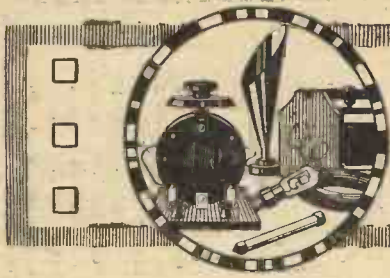

A PAGE OF ODDS—AND—ENDS

A Locking Device for Phone Nuts

THE very common trouble of earpiece terminal nuts working loose and causing mysterious scratching noises in the phones during reception, or even

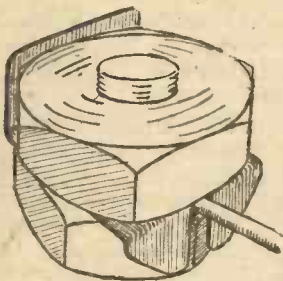

Locking Device for Nuts.

causing the disconnection of the leads and total loss of the locking nut, can be obviated by employing small locking plates on each terminal, as depicted in the adjoining illustration.

The plates are made from brass, copper or german-silver strip $\frac{1}{8}$ in. in thickness and about $\frac{1}{4}$ in. in width; a hole is drilled through the centre of each large enough to clear the terminal studs, and the overall length of the strips is about $\frac{1}{8}$ in. longer than the distance across the corners of the lock nuts.

A slot $\frac{3}{8}$ in. deep and a little wider than the diameter of the phone leads is cut in one end of each plate; this end should then be bent over at right-angles, so that when the plate is in position on the terminal stud the slot will straddle the phone lead.

All that now remains to be done is to screw on the lock nut until it grips the plate and lead wire and one of the flat sides of the nut is opposite the unbent end of the locking piece. To bring the locking device into operation this latter end is bent up sharp at right-angles, so that it lies close against the flat of the nut and thus prevents any further rotation.

A. P.

Enamelled Wire for Tuners

ONE of the greatest advantages of using enamelled wire for winding tuners is that it is non-hygroscopic, that is, it will not absorb moisture. It therefore does not need to be protected from the atmosphere as does silk- or cotton-covered wire. Moreover, enamelled wire is cheap, and this fact makes it ideal for experimental purposes. The enamel used is an exceedingly good insulator.

D.

Making Cheap Formers

MANY household preparations are now packed in cylindrical cartons which are fitted with tin tops and bottoms. As these are in most cases impregnated with wax to make them air-tight they make quite good formers for winding tuners. The tin top and bottom should be removed. A file can be placed under one edge and the tin forced off. Insulation is improved by dipping the cardboard in some molten paraffin-wax.

D. B.

Changing Crystals Quickly

WHEN using crystals which require to be soldered into cups, a good plan is to procure a large cup fitted with three clamping screws and some small cups which fit into the larger one. The crystal can then be soldered into the small cups which in turn can be inserted into the larger one and the clamping screws tightened. There will thus be practically no waiting while a new crystal is fitted.

A. R.

Insulating Double Aerials

WHEN using an aerial with two or more wires fixed to spreaders it is necessary, according to the practice of most amateurs, to use more insulators than when only a single wire is used. This is a mistake. By far the best method is to put all the insulators used in the lead

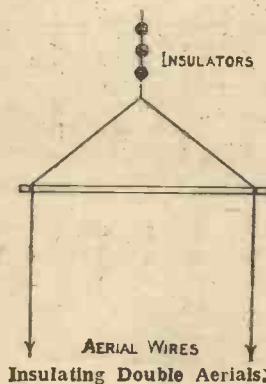

Insulating Double Aerials:

from the mast to the spreaders. The spreader itself acts as an insulator between the wires. It is not important that perfect insulation should be provided between each wire, but it is important that the whole aerial should be well insulated. This is best done in the way described. The arrangement is quite clear from the diagram.

D.

Earths in Sandy Ground

AMATEURS who live in places where the ground is very sandy may have some difficulty in fixing up an effective earth, owing to the speed with which the ground dries. This difficulty may be

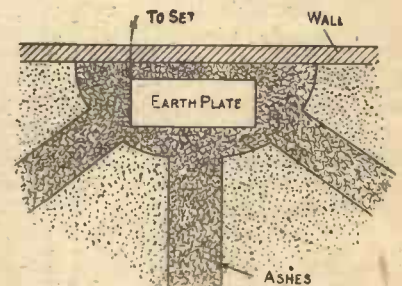

Arrangement of Earth Plate.

overcome to some extent in the following way. Dig a semicircular hole against the wall nearest the point where the earth lead is brought out of the house, about 5 ft. in diameter and as deep as possible. After this dig three trenches, as shown in the diagram. These should be about 2 ft. 6 in. deep and several feet long. Bury the earth plate, which should, of course, be as large as possible, and fill in the trenches with ashes. When the ground looks dry throw some buckets of water over it. The ashes will keep the earth plate more moist than the sand does.

E. A.

"CHARGING ACCUMULATORS FROM THE CAR"

(continued from preceding page)

charging some time the rate will decrease. This is merely due to an increase of the E.M.F. of the cells on charge and a falling off with the other, but this can be adjusted by the resistance. If permanent charging terminals are desired a small block should be fitted in some convenient place on the car and carefully wired up and marked.

Do not put the terminals where they can be "shorted" by tools coming into contact with them.

It is not necessary that the engine should be running during charging, but it will do no harm if it is required. Always remember to disconnect all wires before taking the car out and to remove apparatus from the running boards, or an unfortunate loss may result.

R. H. T.

Send a postcard to "A.W." asking for a list of Technical Books

150 Receiving Circuits

In Diagram and Picture

Fig. 9.—A circuit giving the choice of two crystals by means of a change-over switch. A carborundum crystal and potentiometer is shown on the right and a crystal which does not require an applied voltage is shown on the left. This is a useful arrangement where the crystal is apt to be put out of order by vibration or accidental movement of the crystal.

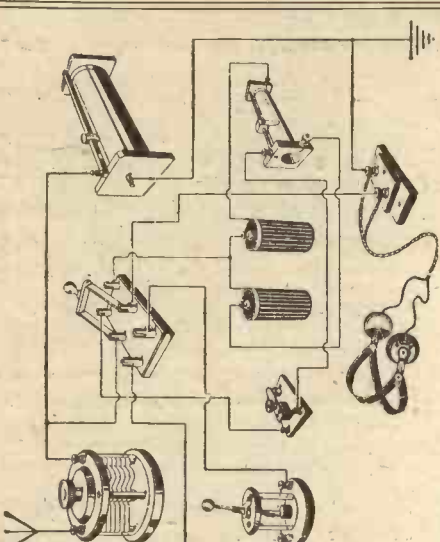
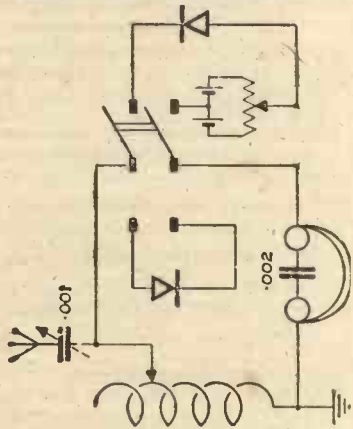

Fig. 10.—A circuit employing the loose-coupler type of tuning inductance. Both coils are made variable and L.2 is usually arranged to slide within L.1. A very useful circuit for cutting out interference from unwanted stations, and to a certain extent for the elimination of atmospheric. A small variable condenser of .0005 microfarad is placed in parallel with L.2.

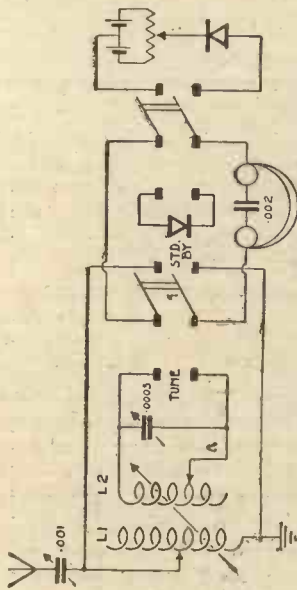
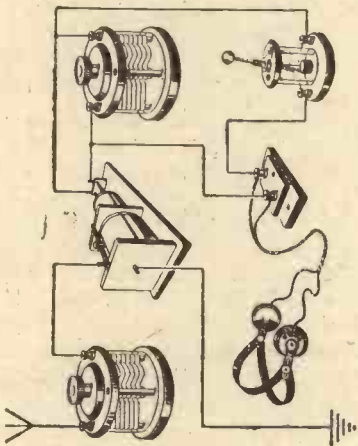
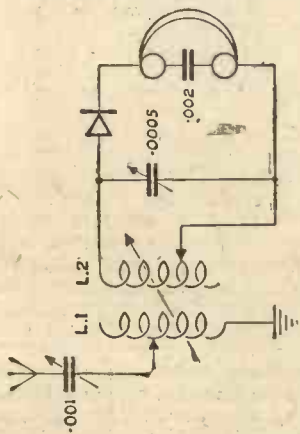

Fig. 12.—A combination of Figs. 9 and 11. A very useful circuit for experimental crystal work. It is based on the circuit of the well-known Mark III army tuner.

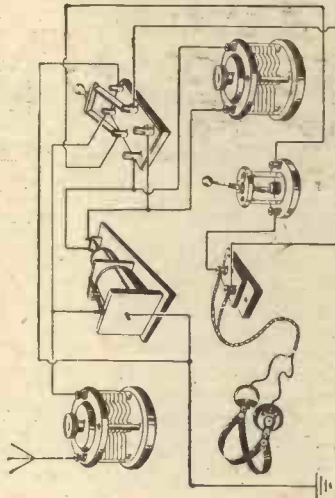
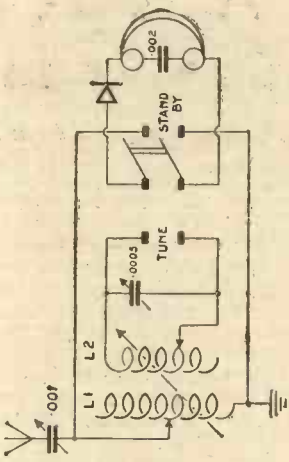
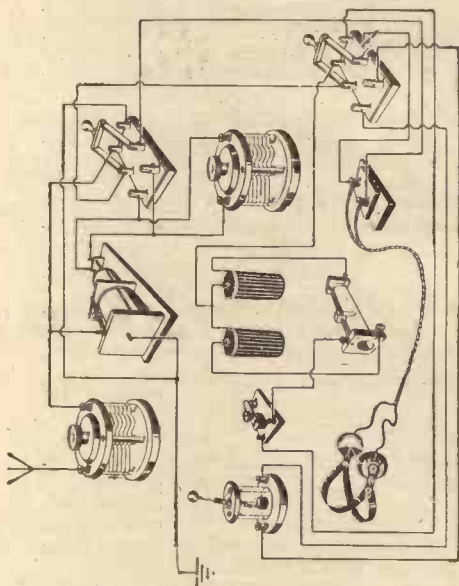
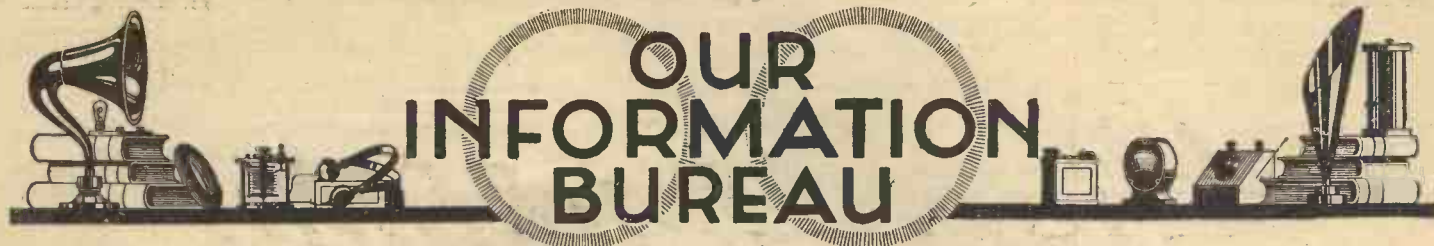

Fig. 11.—The telephones and crystal may be placed either across the aerial coil L.1, in which case L.2 is out of action, or across the secondary coil L.2. The switch is thrown over to the "stand-by" side, and signals are tuned in by means of adjustments on the coil L.1 and the aerial tuning condenser. The switch is now set to "tune," and the final tuning is done by the tappings of the coil L.2 and the variable condenser across it.





RULES.—Please write distinctly and keep to the point. We reply promptly by post. Please give all necessary details. Ask one question at a time to ensure a prompt reply. Always send stamped addressed envelope and Coupon (p. 875).

Use of Counterpoise

Q.—When is it best to use a counterpoise earth?—R. M. B. (South Kensington).

A.—A counterpoise earth should only be used when interference is experienced from high-power stations or when static is troublesome. This system is not to be recommended, as although it cuts down interference it also diminishes signal strength. It is only used in practice in conjunction with high-resistance aerial.—R.

Most Efficient Tuning Coils

Q.—Can you tell me what kind of tuning coil is the most efficient?—W. B. (Richmond).

A.—For all ordinary purposes single layer cylindrical coils are probably the most efficient. It is only when using multi-valve sets that any difference in signal strength is obtained by using special coils. Simple basket and honeycomb coils are very good, but not particularly easy for the average amateur to make satisfactorily.—R.

Storing Unused Accumulators

Q.—I wish to store my accumulators for about six months and should like to know how they are best prepared for standing unused for this period.—V. A. B. (Streatham).

A.—It is better to keep the accumulators in use if possible, and we advise you to lend them to a reliable experimenter who will keep them in use and regularly charged. Or you may empty the acid, fill up with distilled water, leave them for a few hours and then pour the water away. This should be repeated several times and finally the accumulators should be stood, bottom upwards, so that all moisture will drain off. They will be in much better condition when you require them again if you have them fully charged before emptying the acid.—B.

Spark Interference with Broadcast Reception

Q.—I am troubled with heavy spark jamming, which seriously interferes with my reception of the broadcast stations. Can I eliminate this in any way? I am using a valve detector and two note magnifiers.—SPARKS (Southend-on-Sea).

A.—You may fit your receiver with two-circuit tuning, that is, by employing a loose-coupler or arranging plug-in coils so that the aerial, earth and one coil form the separate aerial circuit, and the second coil, which is connected to the grid and low-tension negative of the first valve, as the closed circuit inductance. You will need a variable condenser of about .0005 mfd. across the secondary circuit coil. This should assist in the elimination of jamming, but you should also rearrange your circuit to use one stage of high-frequency amplification before the detector. The coupling between the high-frequency and detector valves may be transformer or tuned-anode. In either case the receiver will be very selective, which means that you stand more chance of tuning out unwanted stations.—B.

Making a Static Transformer

Q.—Please answer the enclosed queries relating to the charging of accumulators through an electrolytic rectifier, also give the design of a transformer to suit.—D. S. (Blackburn).

A.—The supply mains are at 230 volts 50 cycles alternating current, and querist wants a transformer to give him 15 to 20 volts on the secondary, to use in conjunction with a single-cell chemical rectifier and adjustable series resistance in the accumulator circuit. The size of the accumulator is 4 volts 40 ampere hours. The rectifier appears to consist of a single cell with one iron element 7 in. diameter by 8 in. high, and one aluminium element 5 in. diameter by 9 in. high; apparently these are

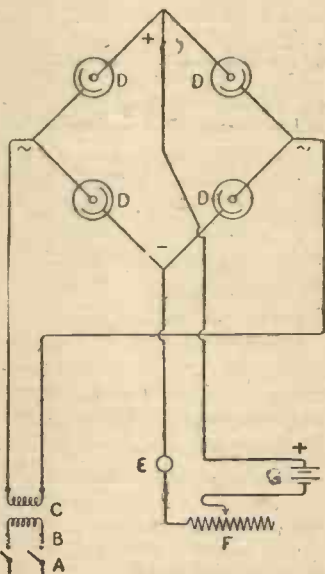

Circuit Diagram of Nodon-valve Rectifier.

in tubular form standing one within the other. It is required to be able to charge at $\frac{1}{2}$, 1, 2 $\frac{1}{2}$, and 3 amperes, and at anything between 15 and 20 volts. The arrangement as it stands is very unsatisfactory for the following reasons: a single-valve rectifier can only rectify one half of the alternating waves, consequently the other half is suppressed and no use made of it, which leads to a very low working efficiency. Four valves are needed, which will then make use of both waves, and a connection diagram of the complete circuit is given above. The second objection is the use of iron for one electrode. Owing to the difficulty in keeping the electrolyte free of acid which oxidises the iron and destroys the rectifying effect, iron is unsuitable, and lead sheet is preferable. The aluminium electrode is best made of $\frac{3}{8}$ -in. pure aluminium rod. A large surface means a very thin film of deposit which does not check the reverse wave so effectively as a thicker film on a smaller surface. The electrolyte is a solution of ammonium phosphate neutralised with ammonia. The battery resistance can be 10 ohms by 3 amps. carrying capacity. The reference letters in the diagram are:—A = alternating main switch, B fuses, C transformer, D rectifier jars, E ammeter, F resistance, and G battery. Details of a suitable transformer to use with this equipment will be found in reply on p. 835 in No. 54.—A.

Coil for Broadcast Wavelengths

Q.—Please give particulars of a tuning coil to cover the broadcast wavelengths.—T. V. M. (Salford).

A.—Wind a cylindrical former 5 in. long by 4 in. in diameter with No. 22 s.w.g. d.c.c. wire and take about ten tappings. You may use a condenser of approximately .0005 mfd. in series or parallel.

Honeycomb Coils as H.F. Transformer

Q.—Can honeycomb coils be used in place of the primary and secondary windings of a high-frequency transformer?—L. T. S. (Hereford).

A.—Provided the coils are of a suitable size to tune to the wavelength required, these coils may be used to form a high-frequency transformer, but you will probably have to connect a small variable condenser of about .0002 mfd. across each coil. The reason for this is that in the high-frequency transformer, where the primary and secondary windings are wound on together, or very close to one another, the closeness of the coupling makes the secondary winding practically aperiodic. But when two separate coils are used in the manner which you propose, they cannot be coupled sufficiently closely to get this aperiodic effect; hence the need for a variable condenser across both coils.—B.

Mark III Crystal Receiver

Q.—How can I connect a detector valve to a Mark III star crystal receiver?—GEORGE (Cardiff).

A.—On the panel of this receiver you will find two change-over switches. The right-hand switch has three positions marked "carbonyl," "perikon," and "valve." The switch should be set in the "valve" position. On the right-hand side of the panel are two terminals also marked valve; a connection is taken from one of them to the grid of a valve, with a grid leak and condenser inserted in the circuit, and the other terminal is connected to the negative lead of the filament battery. The telephones will be inserted in the plate circuit of the valve between the plate and the positive of the high-tension battery.—P.

Variometer Instead of Tuned-anode Coil

Q.—Can I use a variometer in the plate circuit of a high-frequency valve instead of the usual anode coil and variable condenser? Apparently it is only necessary for this circuit to be tuned to the wavelength of the incoming oscillations, and if this is correct, a variometer seems a more economical way of tuning the circuit.—ECONOMIST (Bath).

A.—A variometer may be used in place of the coil and variable condenser, and will give equally good results, but if you wish to couple the reaction coil to this circuit you will find it much easier if you use the ordinary tuned-anode coil. Of course a third coil (reaction) may be arranged to rotate within the variometer, but the construction would be rather difficult. For wavelengths over about 1,000 meters the variometer would become unwieldy on account of the large amount of wire required, and therefore honeycomb or slab coils, with a parallel condenser, are recommended.—B.

Yours faithfully

MARCONI VALVES

MADE AT THE OSRAM LAMP WORKS

In your choice of a Wireless Valve it is of paramount importance that you select one which will serve you faithfully

You cannot do better than place your faith in the valve that rendered indispensable service to our fighting forces during the war and is now rendering faithful service in the world's largest Wireless Transmitting Stations.

The same faithful valve is now available for you.

**MADE TO LAST
RENOWNED
FOR UNIFORMITY
OF QUALITY**

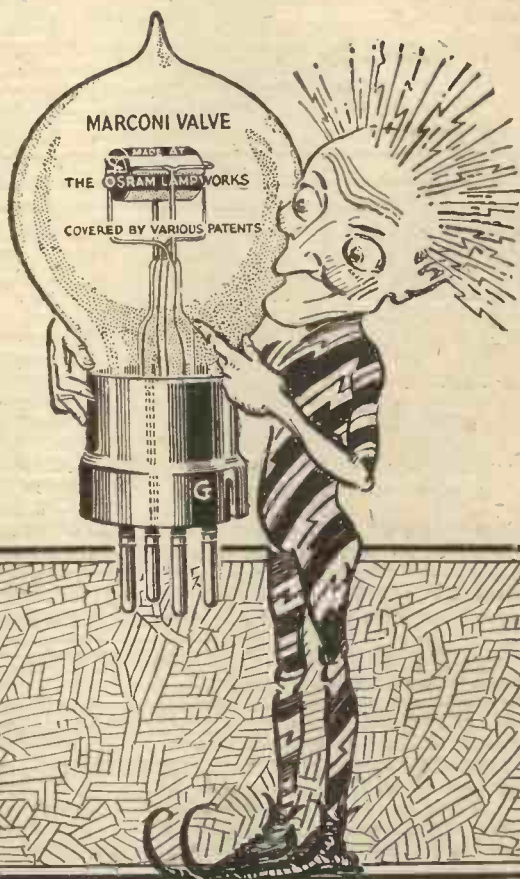
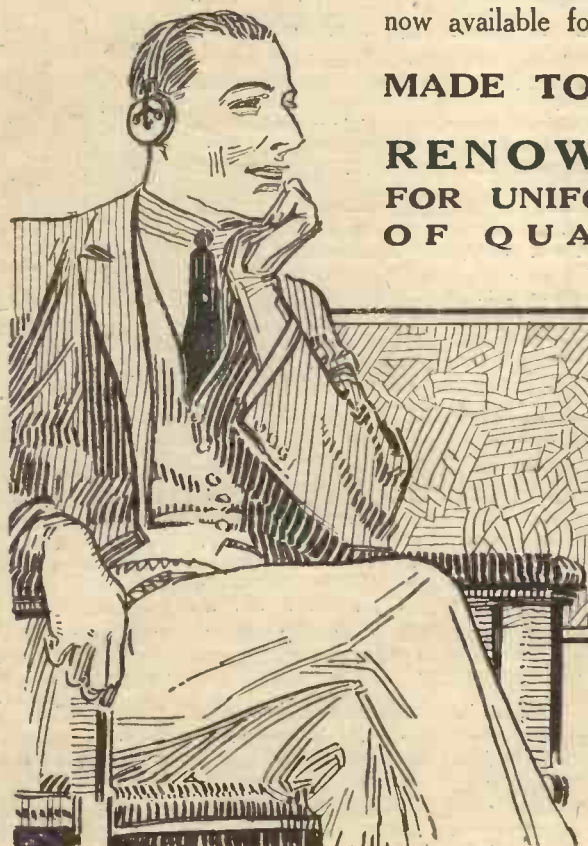

Sold by Electrical Contractors, Wireless Dealers, and Stores
(WHOLESALE ONLY)

The General Electric Co., Ltd.
MAGNET HOUSE, KINGSWAY, W.C.

(Branches throughout the United Kingdom
and in all the principal markets of the world)

EVERYTHING FOR WIRELESS
YOU WANT BEST VALUE FOR MONEY
WE GIVE BEST VALUE FOR LESS MONEY
 WE SELL SINGLE ARTICLES AT WHOLESALE PRICES TO THE PUBLIC.

ERICSSON HEADPHONES (Cont.)
 Our price, stamped B.B.C. ... **10/6**
SIDPE HEADPHONES, 4,000 ohms,
 our price **15/-**
THOMSON-HOUSTON HEADPHONES
 (French) 4,000 ohms, our price ... **16/9**
FAMOUS N. & K. HEADPHONES,
 our price **16/6**
BRUNET HEADPHONES, 4,000 ohms,
 our price **18/6**

This Week's "Snip"
BARBION HEADPHONES
 British make, Stamped B.B.C.
 4,000 ohms **14/6**
 Every pair Guaranteed

CRYSTAL DETECTORS, best quality, each 1/-
AERIAL WIRE, 7/22 bare copper, per
 100 ft. coil **1/11**

Special Offer

VARIOMETERS, for General Broadcasting. To obtain tuning perfection with Crystal & Valve Sets **4/6**



SWITCH ARMS, best quality ... each 10d.
GALVANISED PULLEYS, hook end, each 4d.
HERTZITE CRYSTAL ... 6d., 9d. & 1/-
TALITE CRYSTAL ... 6d., 9d. & 1/-
TERMINALS, complete with nuts and washers ... 1d. each, 11d; doz.
SOLID GOLD CAT'S WHISKERS, 2d. each 1/9 doz.
SOLID SILVER CAT'S WHISKERS, 1d. each, 9d. doz.

MAKE YOUR OWN WIRELESS SETS
 All parts complete with oak base-board and sides each **8/6**

All prices quoted net.
 Please send sufficient stamps to cover postage.

CITY: (our only entrance) JOHN BRAHAM WEST END:
200, Bishopsgate, E.C.2. 23, New Street,
 (Next Door to "Dirty Dick's.") **St. Martin's Lane, W.C.2.**
 Telephone: London Wall 4094. Telephone: Gerrard 6183.

NOTE: We have no connection with the Jewellers next door!

NEW "LISSEN" TUNER

—why it has been introduced

The old, plain wound, single layer inductance left much to be desired. It was not as efficient as it might be, and its bulkiness was proportionate to its range. The LISSEN TUNER (new) is not an ordinary plain wound, single layer inductance. It is wound so as to combine the greatest inductance per length of wire with the lowest H.F. resistance and least distributed capacity. NO DEAD-END LOSSES — extreme efficiency — used with the LISSEN REGENERATIVE-REACTANCE (the new H.F. amplifier, price £2 12s. 6d.) it will cut out 2 LO, and it also tunes in all Continental telephony.



It is complete with 11-point switch already mounted and connected — there are no taps to solder — no switch to connect — no complications — panel or table mounting without alteration — engraved dial — usual LISSEN ONE HOLE FIXING — simply

mount and connect in circuit—two minutes work. — Length only 4 inches, diameter 4 inches. Range 150 to 4,000 metres when used with a '0005 condenser. **Price 22/6**

LOSSES REDUCE CONDENSER EFFICIENCY Losses in condensers taking place through faulty materials or poor workmanship appreciably reduce signal strength. A condenser INCREASES IN EFFICIENCY AS THESE LOSSES ARE REDUCED.

LISSEN MICA VARIABLE CONDENSER is made so that these losses shall be the minimum possible. Low resistance—extreme efficiency—its high insulation is obtained by use of Ruby Mica of the best quality possible to procure. CONVENIENCE. — Panel or table mounting by trivial and ingenious alteration. Tuning over 360° of scale. Much smaller changes of capacity for a given movement of the scale on the lower readings than is the case with any other condenser. Economical of space—diameter 3 1/4", depth 1". LISSEN ONE HOLE FIXING, of course!

Those who have only used ordinary condensers will be surprised at the improvement in tuning possible with this LISSEN Condenser. Capacity: max. '0006, min. '00004. Complete with scale. **Price 17/6**
 Each piece of LISSEN Apparatus has some Special Feature.



GET THE MOST OUT OF THE ETHER

by using the following LISSEN equipment also: **TUNING IN ON LONG DISTANCE**—the LISSENSTAT is a new device for the perfect control of filament current which utilizes the tuning characteristics of the Detector Valve—it permits getting on the very spot necessary for perfect reception—each H.F. Valve and the Detector Valve should have LISSENSTAT control. (Ready in 7 days, order now). **Price 7/6**

ANY GOOD RADIO DEALER WILL SHOW YOU THESE—IF HE CANNOT, TAKE NO SUBSTITUTE, SEND DIRECT TO FACTORY, POST FREE.

DEALERS: Please order a few days ahead, through factor, or direct

LISSEN COMPANY
16-20, Woodger Road, Goldhawk Road, Shepherds Bush, LONDON, W.12. — Phone 1072 Hammersmith.
 N.B.—Close to Goldhawk Rd. Station (Met.), Shepherds Bush (Central London) or Hammersmith tube. Buses No. 11 and 32.

No. 5 of a Series
of talks on
Peto-Scott Units

No Batteries or Valves to buy

—start the famous
**Peto-Scott Unit
System with this
novel Crystal Unit**

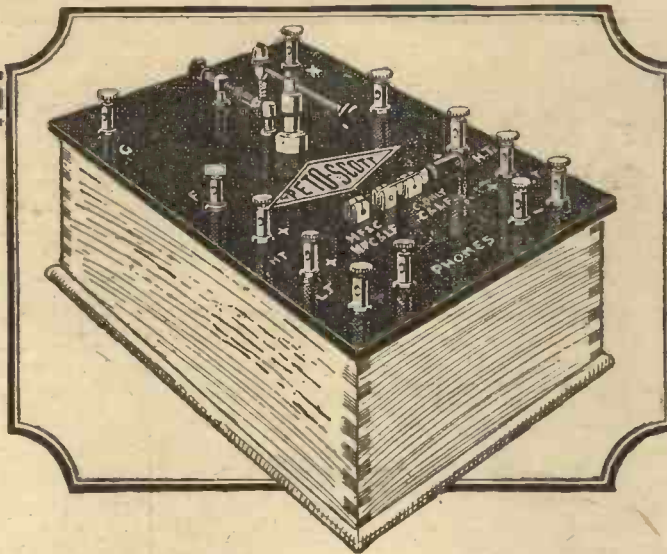

Pat. applied for

Once again the Peto-Scott slogan of "economical Wireless" has been demonstrated by the introduction of a new Crystal Unit (No. 6).

The Crystal as a *Detector* is considered by many to be vastly superior to the Valve and a large number of experimenters have reverted to its use. Besides consuming no current, it gives perfectly pure and undistorted speech. It can be preceded by an H.F. Amplifying Valve and followed by an L.F. one and the signal strength will be quite as great as if three Valves are used.

As will be seen from the illustration, this new Peto-Scott Unit is full of original features. The Crystal Detector permits instant change of crystal without altering a screw or a connection. It also allows cat-whisker adjustment over the whole of the surface of the Crystal.

The Unit has been fitted with a two-way switch which—when the Unit is working with the remainder of the series—gives *four different combinations of circuits.*

When connected after a No. 3 Unit (H.F. Amplifier) and before a No. 5 Unit (L.F. Amplifier), if the switch is *to the left*, it gives :

1. High-Frequency amplification followed by Crystal rectification.
2. H.F. Amplification, Crystal rectification and Low-Frequency Amplification.

When the switch is *to the right*, it gives :

3. Crystal rectification only with no H.F. Amplification.
4. Crystal rectification followed by Low-Frequency Amplification.

Many experimenters prefer to use a Crystal Detector always instead of a Valve. To these we say, the Peto-Scott Unit System covers every possible requirement, and is invariably in accordance with the latest practice.

It was the *original* Unit System and the only one to be licensed under Marconi Patents.

Read all about the ingenious Peto-Scott Unit System in a 24-page illustrated Booklet "Radio" (post free 6d.).

Price List of Units for home construction

- No. 1. Tuner Unit - - - 27/6
- No. 2. Condenser Unit - - 42/-
- No. 6. Crystal Detector Unit 15/6

The man starting Wireless cannot do better than commence with the above three Units (illustrated below). They form a wonderfully efficient Two-Circuit Receiver, very sensitive and particularly selective. At any time Valves for increasing its range or power can be added without making any alterations in the wiring or discarding a single piece of apparatus.

- No. 3. H.F. Amplifier Unit - 13/6
- No. 5. L.F. Amplifier Unit - 33/6
- No. 7. Reactode Unit - - - 28/6
- Cabinets for Nos. 1, 3, 5, 6 & 7 3/6
- No. 2 - - - - - 7/-

Postage 9d. per Unit extra, but paid over £2.

PETO-SCOTT Co., Ltd.,

Head Office :

64, High Holborn, W.C.1.

Demonstration Lounge :

99, High Holborn, W.C.1.

Branch :

3, Wellington Street, Strand, W.C.2.

Note the workmanlike appearance of this 3-Unit Crystal Receiver. A Set you will be proud to own and demonstrate.

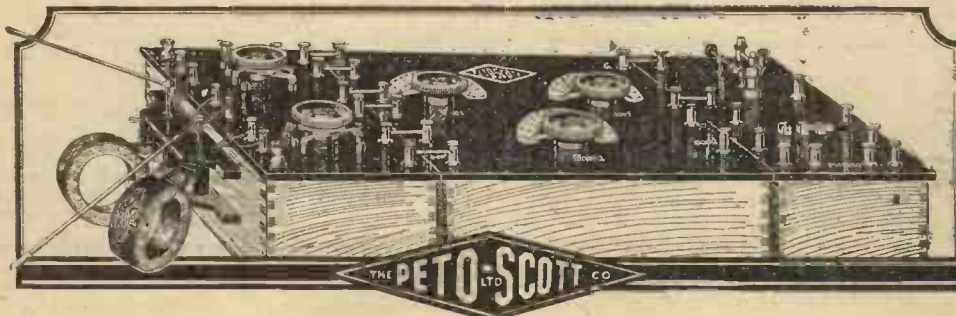

At any time and without discarding a single piece of apparatus you can add Valves (H.F. or L.F.) to this Set.

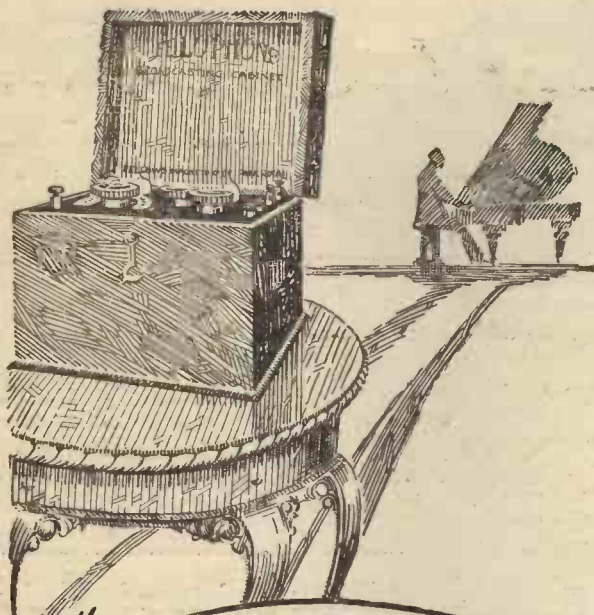

The FELLOPHONE

2-Valve Receiving Cabinet

A high-grade instrument at a very low price. This set has been especially designed for receiving broadcasting, and complies with all the Postmaster-General's regulations. It can be used either for listening-in with headphones or with a loud speaker.

Additional interest and use is secured because it will receive all amateur transmitting stations within a range of 20 miles. The "Fellophone" is mounted in a handsome oak cabinet, and is sent out complete with H.T. battery, 6 volt accumulator, 100 ft. aerial, 2 shell insulators, and one pair of Fellows 4,000 ohms double headphones, but without valves.

British Made Throughout.

Made under Marconi Licence and approved by the B.B.C. and Postmaster-General.

PRICE COMPLETE £12, inclusive of all taxes without valves. Carriage - 2/-

EXTRA FOR TWO VALVES - 30/-

EXTRA FOR ADDITIONAL FELLOWS DOUBLE HEADPHONES, 21/6 (Postage 1/-).

FELLOWS MAGNETO Co., Ltd.,
LONDON, N.W.10.

Telephone:
Willesden 1560-1

Telegrams:
"Quixmag," Phone, London.



*For they are
jolly good Fellows*

Something New!

THE MAGNORA LOUD SPEAKER

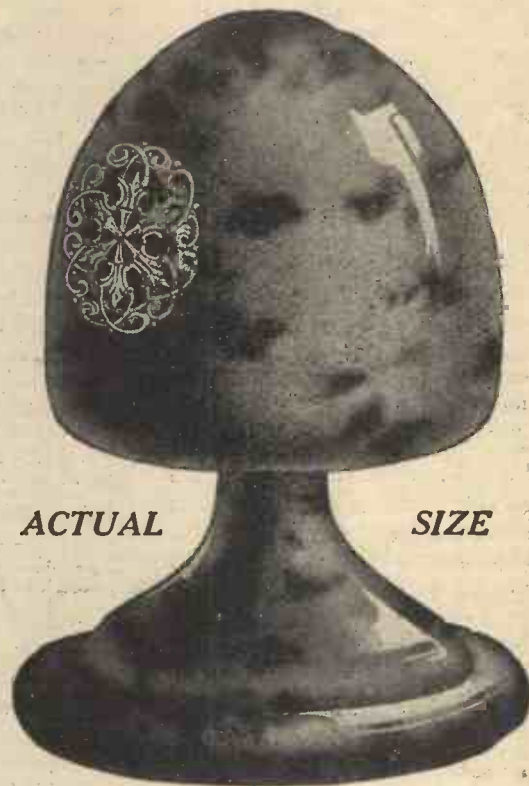

ACTUAL

SIZE

No larger than a wine glass but wonderful to hear

THIS wonderful little Loud Speaker surprises everyone. No grotesque trumpet. No cabinet required. In itself it is a thing of beauty, standing only four inches high, and looking like a small tortoiseshell vase.

It floods the room with beautiful melody. No distortion. No vibratory noises. The sound is dispersed in all directions. Spoken words can be heard with wonderful distinctness.

Can be fitted to any receiving set in a few seconds.

Simple and strongly made. Nothing to get out of order.

POST 35/- FREE

Complete with four feet of flex, and terminal leads.

Demonstrations during broadcasting from 5.30 p.m. until 10 p.m.

NOTE.—The Magnora is only for use with receiving sets which will operate an ordinary loud speaker. It cannot be used with Crystal Sets or Single Valve Sets. People who have heard it used with one detector and two amplifying valves have been amazed at the quality and volume of the tone.

C. HERING TELEPHONE ENGINEER
Washington House 41 Conduit Street Regent Street W

Oh Your Wavelength!

Reception Problems

THE note which I wrote a week or two back on the subject of being able to pick up any of the home broadcasting stations at will has brought in a very large number of letters from correspondents in all parts of the country. Broadly speaking, the writers may be divided into three groups. There are, firstly, those who live in or near a broadcasting town and can get nothing but the station on their doorstep, so to speak, even though they combine the cunning of the serpent with the patience of Job. Next come people, dwelling in the depths of the country, who report a variety of weird freak results, some only occasional, others fairly persistent. Glasgow, for instance, is received quite often on a crystal in the West Midlands.

The last group consists of those whose habitations lie neither in the broadcasting centres nor in very remote parts. Most of them tell me that they can on occasion go round all the stations, but that usually one or two of them are not to be brought in by any feats of tuning. Nearly all of this last group report that they are not able now to pick up so many stations as they could earlier in the year. Now this is just my own experience, and I confess that the phenomenon puzzled me not a little until a possible explanation dawned upon me recently.

* * * *

What the Pear Tree Did

I must explain that my aerial—a single wire 100 ft. in length, but owing to force of circumstances nowhere more than 28 ft. above the ground—points almost exactly due north and south. The southern end is attached to the house itself at a point several feet below the level of the top of the roof, the northern to a mast. The aerial runs diagonally across the top part of my garden. The mast stands close to a party wall, on the other side of which is a tall and very straggly pear tree, whose topmost branches are perhaps eight or ten feet higher than the truck, belonging to my neighbour. An apple tree in a garden was, if you remember, instrumental in bringing about the undoing of Adam. Though no Eve has had a hand in the matter, I trace my present woes to that pear tree. Six weeks ago I had no difficulty in picking up any of the northern broadcasting stations. Six weeks ago that pear tree was a scraggy-looking collection of bare branches and twigs. Now, covered with a dense mass of green foliage and generally soaked by the rain which has fallen so regularly of late, it stands literally playing the wet blanket between me and the north.

Trees as Wireless Sponges

Trees when covered with leaves have, especially in wet weather, considerable powers of absorbing wireless waves. A tree, in fact, may be used quite successfully as an aerial. And there it is. That wretched vegetable is revelling in my share of the transmission from Glasgow, Manchester and Newcastle, whilst the poor aerial stands starved and without the power of retaliation but a few feet away. What has happened to me has happened also, I believe, to almost everyone. They may not have such trees as this one of mine (or rather my neighbour's) growing hard by their aerials and mopping up like sponges the oscillations that reach the wires in less leafy seasons. But it must not be forgotten that the whole country is now a mass of green, every leaf and every blade of which is taking its toll of the waves as they pass. Hence it is not surprising that distant transmissions which have to pass overland come in now with less strength than they did a few short weeks ago.

* * * *

Oscillating Oswald Again

I believe, too, that the power radiated by the broadcasting stations must vary a good deal at times. One knows, of course, that climatic conditions make a vast difference to the strength of received signals, but my log seems to show that their variations are not always sufficient to account for the ups and downs that are experienced. Suppose, for example, that having found that Newcastle is coming in with about half his usual loudness you tune in Radiola or the Eiffel Tower and find them quite up to the mark, you are forced to the conclusion that 5NO is temporarily a little off colour. But it must not be forgotten that such a falling off may be due to some extent to the activities of one's wireless neighbours.

If a near-by set is being well handled it will usually make no difference to your own, though it may result in an increase in your power owing to a form of reaction between the two aerials. When, on the other hand, your fellow townsman is working his set after the most approved manner of Ham Handed Henry and Oscillating Oswald, matters assume an entirely different complexion. Even though the oscillations be insufficient to make your loudspeaker sing like a cageful of canaries, they will make their presence felt by causing a very marked damping. New aerials are springing up, mushroom-like, on every roof and in every garden (that, I fear, is a bad sentence, for mushrooms do not grow on roofs—still you see what I mean), and many of them are attached to sets

handled by the inexperienced. It is then quite within the bounds of possibility that they, or at any rate some of them, are responsible in part for the lost efficiency.

* * * *

H.F. Amplification

Personally I do not think that it is of very much use to attempt to bring in distant broadcast transmissions unless one has at least two or, better still, three stages of high-frequency amplification. If one relies largely upon the help of reaction and then calls upon note magnifiers to boost up the weak sounds that come in, there will undoubtedly be so much distortion that there is little pleasure in listening to speech or music so obtained. Properly controlled, high-frequency amplification does not distort at all. One can thus magnify signals to a reasonable strength before presenting them to the detector valve for rectification. Supposing that your set is not of this magnitude, you will, I think, obtain more pleasure from it if, when you are tired of home broadcasting stations that come in easily, you do not strain after others, but tune to longer wavelengths in search of, say, Radiola or the Eiffel Tower.

* * * *

The Enthusiastic Demonstrator

One correspondent brings out a point of some importance. He lives within a few miles of 2LO, but was assured by a demonstrator whose enthusiasm doubtless caused his love of accuracy to suffer a temporary eclipse, that a particular "broadcast" receiver would bring in any station even when London was working. I think that salesmen make a great mistake in saying such things. There is, I am told, a new set to be placed on the market shortly that will do it, but I do not believe that such a feat can be performed with any existing "hall-marked" apparatus. At close quarters 2LO's power is so great that he swamps everything else within fifty metres on either side of his own wavelength; you can, in fact, obtain him with no more complicated apparatus than a detector and a pair of telephones wired direct to aerial and earth.

A powerful transmission from a station near your aerial has upon it much the same effects as atmospheric; it sets the aerial vibrating by sheer shock, and nothing will tune it out. The only way to obtain other stations, if you live in the London district is to use a frame aerial and to add a stage or two of radio-frequency amplification to your set. The directional qualities of the frame make it the most selective tuning device known.

THERMION.



Fig. 1.—Lipowsky Transformer.

ONE of the best of the low-priced transformers that have come my way is that made by Messrs. Lipowsky and Co., which sells at something under a sovereign. In size it is very much the same as the Radio Instruments Co.'s transformer, its measurements being: Height (over terminals) 3½ in., length 2¾ in., width 2¼ in.

It is wound throughout with No. 44 wire, there being 18,000 turns in all, 3,000 in the primary and 15,000 in the secondary. The step-up is thus 1 to 5. The windings are guaranteed correct to a turn by the makers—though I cannot claim to have verified this by counting! Each layer is separately insulated from the next by greased paper.

The stampings of the laminated core are of the best iron specially chosen for its

Finding the Best Low-frequency Transformer

V.—The Lipowsky and Marconi Transformers

rapid magnetic response to current changes. Insulation between layers is all that could be wished for. The core has a good cross-section (¾ in. × ½ in.).

Test Results

I tried the transformer out in both positions, that is, immediately following the rectifying valve, and as the second of two note magnifiers. In the first, when two stages of high-frequency amplification were in use in front of the rectifier, a very slight degree of distortion was noticeable, but this was easily got rid of by means of the resistance-shunting method, described in an earlier article. With a single valve reception was quite pure, even though no shunt was used. Used as the second of two L.F. transformers the Lipowsky did excellently, giving a high degree of amplification and producing no distortion at all when its valve was properly balanced by means of extra negative potential applied to the grid.

I have not tried the Lipowsky, or, indeed, any of the transformers dealt with in these articles, on super-regenerative or dual-amplification circuits, but a friend who spends a large part of his spare time

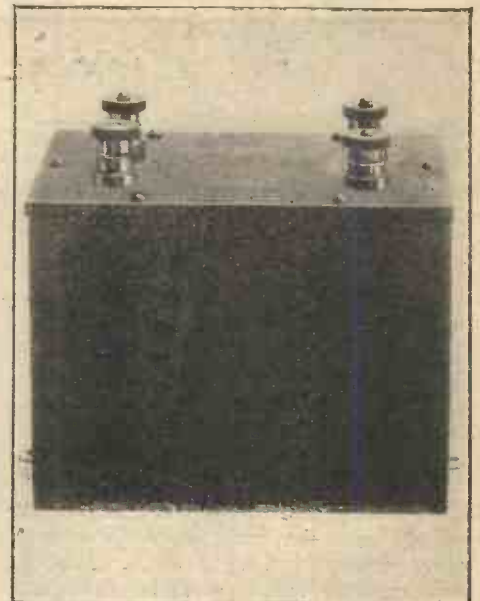

Fig. 2.—Marconi Box-type Transformer.

in wiring them up and testing them tells me that he has used one with first-rate results. This is a good testimonial to the quality of any transformer, for these circuits frequently lead to very high voltages, which are a severe practical test of the insulation and strength of the windings.

Criticism

The only criticism that I have to make of the design of the Lipowsky transformer is that the bolts used for clamping together the layers of the core actually pass through the stampings. As was previously pointed out, this does away to a small extent with the value of the paper insulation between layers. It is a small fault in this case, and one that could easily be obviated by a very slight modification of

(Continued in third column on next page)



An Amateur-made Three-valve Experimental Set

The photographs show an experimental three-valve set made by Mr. W. T. Cowling, of Stoke Newington, London, N. The tuner is an adaptation of the units described in the "Work" Handbook "Wireless Telegraphy and Telephony." Either valves or crystals may be used. A German valve will be seen in the top centre of the left-hand photograph.

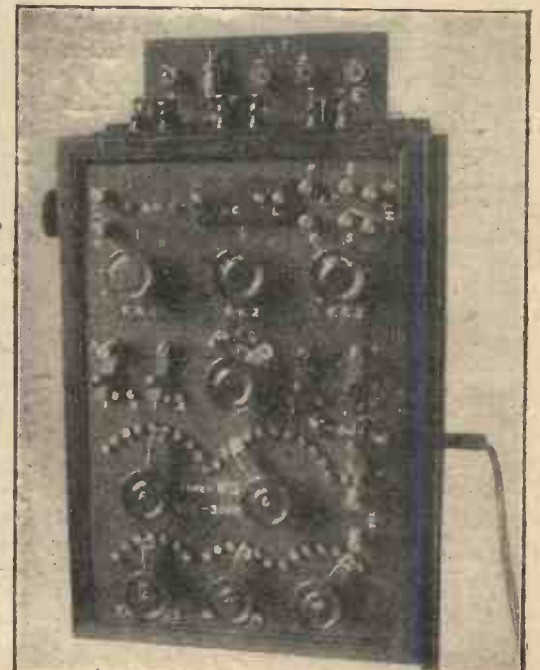

A Low-power C.W. and Speech Transmitter

THE writer has come to the conclusion, after listening-in on the amateur band of wavelengths, that if all transmitters were to use the minimum amount of power necessary to carry out their experiments the ether would be much quieter. One hears two amateurs who are scarcely two miles apart using about 8 watts each. Now 8 watts on 200 metres should carry speech considerably farther than two miles, and with these thoughts in mind the writer constructed a low-power C.W. set; and with the help of a friend and several amateurs in the London district, carried out interesting tests showing that low power *could* be used to advantage. When the broadcasting stations are transmitting there are no London amateurs working, and tests on these low-power sets can be carried out without interference or without interfering with broadcast listeners-in.

H.T. Supply

The H.T. supply consists of about 60 volts (dry cells of the usual H.T. supply for receiving). The circuit diagram is given on Fig. 1.

The coils are wound on 2½-in. cardboard tubes. The aerial coils are wound with No. 26 enamelled wire with twenty turns on the primary and thirty-six turns on the secondary. The plate coil is wound with about thirty or forty turns to suit the set. The aerial coil is wound

The modulating unit is worthy of some comment. It consists of an old motor ignition coil. The secondary is inserted in the negative high-tension lead with a by-pass condenser of about .002 mfd.

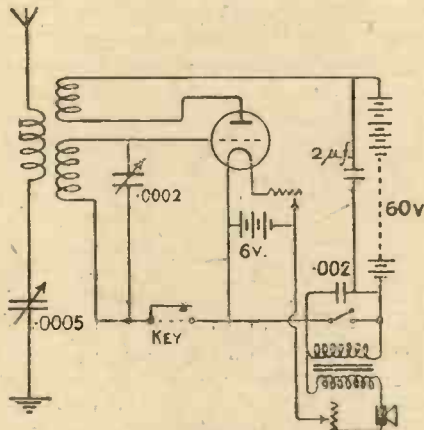

Fig. 1.—Circuit Diagram of Simple Transmitter.

across it. The primary is in series with the filament battery, microphone and resistances. This method gives very good results. A 2-mfd. condenser across the H.T. will be advantageous. The condenser across the grid coil is only about .0002 mfd. and is quite large enough for tuning this circuit.

If it is required to use tonic train the microphone is shorted and the contact breaker of the spark coil unscrewed. A key is then inserted in series with the primary and the spark coil has a boosting-up effect on the output.

In conclusion, this set has an effective range in quiet conditions of 10 miles C.W. and about 6 miles speech, using one rectifier and one note magnifier at the receiving end. At distances of less than two miles it is very loud. This shows clearly that low

power is quite good enough for short distances. The power of this set cannot be more than about .25 watts.

A suggested lay-out for the transmitting panel is given by Fig. 2. It is advisable to mount this panel in a vertical position supported by a light wooden frame, as this enables the operator to get at the wiring

at the back for making any desired alterations. A. G. W.

FINDING THE BEST LOW-FREQUENCY TRANSFORMER (continued from preceding page).

the design. The bolts might be taken, for instance, through waxed cardboard or paper tubes.

Marconi Box-type Transformer

Another excellent low-frequency transformer is the boxed-in type made by the Marconi Scientific Instruments Company. It is intended really rather for the experimenters' bench "hook-ups" than for mounting on or beneath the panels of a self-contained set. Mine was purchased some years ago, and I do not know whether this particular pattern is still made. In any case, it can often be picked up second-hand, and if you can buy one at a moderate price in this way you may congratulate yourself on having secured a bargain.

It works equally well immediately after the detector valve, or as the second of a pair of note magnifiers, giving good amplification with no distortion at all of either speech or music. Of its construction I cannot speak, since the entire box beneath the ebonite cover is filled with white wax—and I attach too great a value to the transformer to pursue my investigations into its anatomy beyond this point!

The primary impedance is high, and as the insulation has withstood the test of years of constant use with all kinds of circuits and voltages, it is presumably of a very high order indeed.

This and the preceding article have dealt exclusively with transformers of large and moderate size, except that the small Lissen was discussed, because it was one of a pair turned out by the same firm. The next article will describe tests made with smaller transformers, some of them retailing at very low prices.

The smaller types of transformers can do good work if they are scientifically designed, but if they are simply run together by those who know little of the theory and less of the practical considerations to be observed in their manufacture the results are anything but satisfactory. Next week we shall see what can be done with some of the best of these miniature types. R. W. HALLOWS.

(To be continued)

The first political speech to be broadcast will be one by the Premier, Mr. Baldwin, when he attends the Primrose League demonstration at the Crystal Palace on July 21

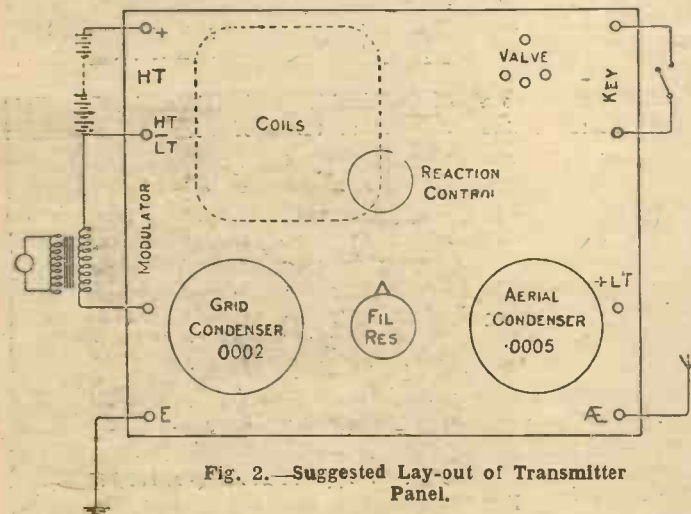

Fig. 2.—Suggested Lay-out of Transmitter Panel.

over the latter. The aerial series condenser is of .0005 mfd. capacity. This condenser was necessary in the above set as the aerial used was rather on the large size and as the wavelength employed was in the neighbourhood of 160 metres. The valve was an ordinary French "R" with about 4½ volts on the filament.

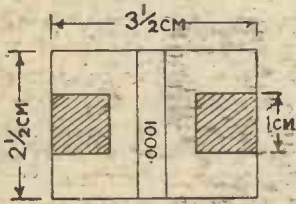

Fig. 2.—Finished Unit.

Interchangeable Fixed Condensers

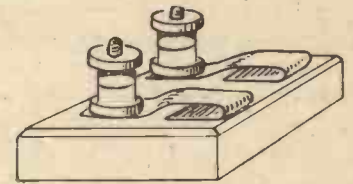

Fig. 3.—Base and Mounting.

INTERCHANGEABLE fixed condensers of various values form an ideal method of inserting capacity in a receiving circuit when the exact capacity required is not known. To mention two instances where interchangeable condensers are a distinct advantage, one place is in the grid circuit of the detecting valve, in most cases across the grid resistance, and another is across the two terminals of the aerial tuning condenser. As is often the case, the variable condenser may just fall short of tuning in the particular station you require, the wavelength being too high. The insertion of a small fixed condenser of suitable value will bring the wavelength up the desired amount, leaving the actual tuning to be done in the usual way with the variable condenser. This particularly applies when the variable condenser is in series, as is generally the case when receiving broadcasting.

It is a good plan to fix the fixed condenser-holder to the variable-condenser case, as it takes up but little room. The two terminals should be connected to the two terminals of the variable condenser. When not required, the fixed condensers are simply withdrawn from the spring clips.

The writer has found it convenient to have a set of five condensers, ranging from about .0001 microfarad to .0006 microfarad, although larger capacities may be used. These condensers are made up of .002 in. mica and good quality lead-foil. The mica should be cut into pieces 3 1/2 cm. long and 2 1/2 cm. wide, and the lead-foil into strips of 1 cm. wide.

The accompanying table gives a rough idea of the number of foils required and the approximate overlap.

Capacity Microfarads	No. of Foils	Cm. overlap
.0001	2	1
.0002	2	2
.0003	3	1 3/4
.0004	3	2
.0006	4	2

The actual construction of the condensers is extremely simple, as they merely consist of alternate layers of mica and lead-foil, with 1 cm. of lead-foil projecting at each end, a thin coat of shellac varnish being given between each piece of mica and lead-foil (see Fig. 1 A). The whole is then held firmly together and placed in a warm oven, preferably between two weights, until the shellac has set quite hard. It will then be found that the condenser is quite firm and rigid. All

that remains to be done is to clean the projecting ends of lead-foil at each end, bend them over, and stick them to the face of the condenser with a spot of shellac varnish, and allow to dry. In the case of there being two lead-foil projections

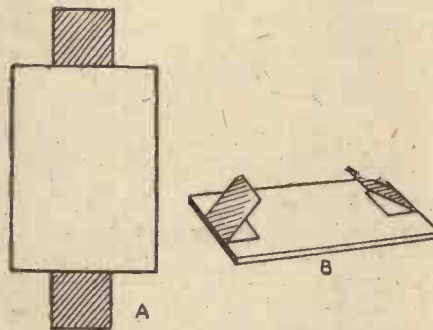

Fig. 1.—Constructional Details of Condenser.

one is cut slightly shorter than the other and stuck down first, the longer one then being pressed firmly over the shorter and stuck down at its farthest edge. The drawing B (Fig. 1) will make this clear. A thin strip of paper may be stuck round the centre of the condenser, and the capacity marked on it (see Fig. 2).

The holder for the condensers consists of a 3/8-in. ebonite base, upon which are mounted two spring clips held down by two terminals, as shown in Fig. 2. It is under these clips that the condensers are inserted, the contact being made from the lead-foil at the ends of the condensers to the spring clips.

The brass contact springs are made from the negative strip of an old pocket lamp battery and bent to shape. Two counter-sunk holes may be bored in the ebonite for mounting.

F. D. C.

Progress and Invention

The Dubilier Condenser

THE construction of the Dubilier condenser is described in Patent No. 197,566/23 (W. H. Goodman and the Dubilier Condenser Co. (1921), Ltd., both of London). Fig. 1 is a plan of the condenser and Fig 2 an end elevation. Suitable insulating material is moulded into a base and provided with a recess A, into

easily. A feature of the condenser is that three different kinds of connection may be used.

New Type of Slider

IT is pointed out in Patent No. 197,572/23 (E. Mallett, of Upminster, and R. Marx, of London) that the short-circuiting of a number of turns of wire by an ordinary

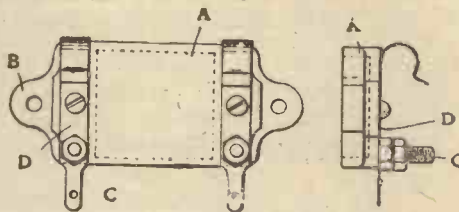

FIGS. 1 and 2.—Plan and Elevation of Dubilier Condenser (No. 197,566/23).

which a condenser may be placed. For convenience in fixing the condenser a pair of lugs B are provided. A pair of small terminals C are secured in the base and electrically connected to metal strips D, which terminate at one end in tongues, to which connections may be soldered. The other ends of the strips are bent into a clip, so that instruments similar to a grid-leak may be mounted across the condenser

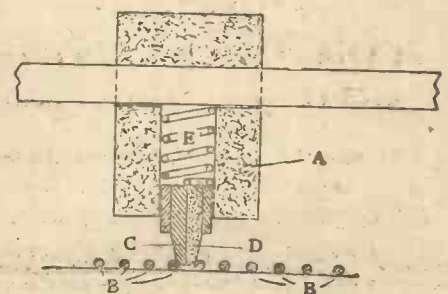

New Type of Slider (No. 197,572, 23).

slider produces an auto-transformer with a short-circuited secondary in which the bulk of the energy is dissipated. A slider is described which makes contact with only one turn at a time. In the figure A is the slider and B the wires on a cylindrical former. The contact piece consists of two parts, C of metal and D of insulating material. E is a spring to provide a firm

contact. It will thus be seen that contact is only made with one wire, and increased efficiency is thereby obtained.

Improved Plug-in Coil

PATENT No. 197,140/23 (A. Onwood) shows an improved type of plug-in coil wound on an insulating former. The arrangement consists essentially of two circular stampings, such as A, which may be of vulcanised fibre, connected by an insulated bobbin B. An extension C is pro-

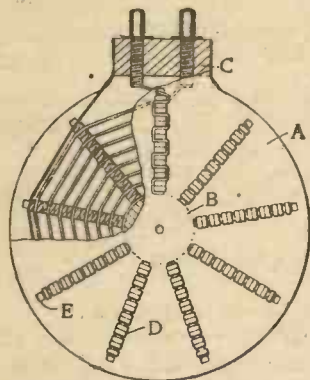

Onwood Plug-in Coil (No. 197,140/23).

vided so that split-pins may be fixed to the coil. Some turns are wound on the bobbin, and when this is full spacing strips D are placed in slots E, so that the next winding may be placed above the first one. Thus the turns are separated by a large space, which may be varied by altering the number of strips inserted. The object is to make coils of uniform size to cover a wide range of wavelengths. It will be seen that low-wave coils can be spaced more than high-wave coils, and this is particularly desirable, as it reduces the capacity for low wavelengths.

**Notes
on
Batteries**



Sixty-volt H.T. Accumulator (Wates Bros., London).

APART from the variation in construction and the chemical action taking place in a battery, the most important practical difference of various types is that of internal resistance. It is generally realised that any current-consuming device must have resistance, but often forgotten that the battery itself has a resistance, depending on its type and size. Now accumulators have such resistance, but for practical purposes it is so small that it can be ignored. With primary batteries there is a vast difference; they all have a certain internal resistance (r) which may reach such a value as to render them useless.

Current Output

The amount of current a battery can deliver depends on the resistance in circuit (except in special cases of batteries opposing). This comprises the external resistance (R) and the battery's internal resistance (r), which forms, of course, part of the circuit. Ohm's Law, which applies only to direct current, states that C (current in amperes) is equal to E (voltage) divided by R (resistance in ohms). Consequently if we could connect the terminals of a charged accumulator together with a wire of no resistance, C (current in amperes) would equal E divided by R, which is nil, and a current of infinite value should flow. What really

this current much too heavy to demand from it. It would not, however, be utterly ruined as is the case with an accumulator. Evidently, then, the internal resistance of a cell is a most important factor, and should it rise too high no current can be obtained from the cell. It must not be overlooked that the faulty cell may be part of a battery. The whole battery is, of course, affected, and this high-resistance cell must be located and cut out to remedy matters. Fortunately it is quite a simple matter to ascertain the internal resistance of a cell. The apparatus consists of a voltmeter reading to 2, 3 or even 5 volts and a piece of 2-ohm resistance wire.

Ascertaining Internal Resistance

If a filament resistance of known value is handy it is easy to count the turns and set the switch on a position equal to 2 ohms. The method is as follows: Connect up as shown in Fig. 1. Take a very careful reading of the voltage, to one decimal at least. Call this reading A. Connect up as in Fig. 2, joining up the battery last, and take the reading as quickly and accurately as possible. Call this B. Subtract B from A, multiply by 2, and then divide by B. This is the internal resistance of the cell under test $\frac{2(A - B)}{B}$.

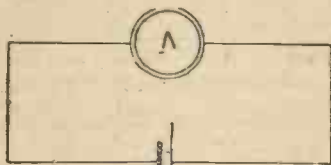

Fig. 1

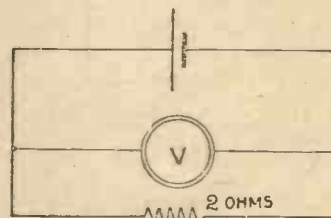

Fig. 2

Figs. 1 and 2.—Method of Determining Internal Resistances.

happens is this. The cell instantly discharges at an enormous amperage, the whole circuits heats up or melts, and the plates buckle up.

Now consider a dry cell of voltage (E) 1.5 and internal resistance (r) .5 ohms. If this cell is "short-circuited," C (current in amperes) = $\frac{E}{r} = \frac{1.5}{.5} = .3$ amp. A dry cell in good order having such a resistance would be a very small one, and

The ordinary test of applying a voltmeter to a dry cell is useless for the simple reason that the cell is doing no work at the time. Any number of cells can be tested in series, but the value 2 ohms per cell must be maintained. For example, if testing a 15-volt battery, a 30-ohm resistance would replace the 2-ohm resistance and the formula becomes $\frac{30(A - B)}{B}$.

H. E. H.

A New Wireless Handbook

**WIRELESS
COMPONENT PARTS
and How to Make Them**

A book that tells you how to make the components of Receiving Sets.

The Contents include detailed instructions for making Crystal Detectors, Coils, Condensers, Variometers, Vario-couplers, Resistances, Transformers, Buzzers, Tuning Stands, etc. etc.

ONE HUNDRED & TWENTY-EIGHT PAGES
OVER TWO HUNDRED ILLUSTRATIONS

Price **1/6** Net

CASSELL & CO., Ltd., La Belle Sauvage, LONDON, E.C.4

IN some previous articles the general methods by which it is possible to ascertain the direction and position of wireless transmitting stations were outlined. It was then explained that, owing to the directional effect obtained by frame aerials, it is possible to take "bearings" between a transmitting aerial and a receiving (frame) aerial. Also, by using two or more receiving aerials at some distance apart, a number of bearing lines could be obtained which would reveal the actual position of the transmitting station at their common point of intersection. In

Position and Direction

How a Subtle Problem of Modern Wireless

I.—HOW WIRELESS WAVES ARE

the following articles it is proposed to explain in simple terms the chief fundamental facts which make these phenomena possible.

Causes of Directional Effect

The causes of the directional effects manifested by frame aerials are to be found ultimately in the manner in which



A Complete Experimental Direction-finding Apparatus in use at Croydon Aerodrome.

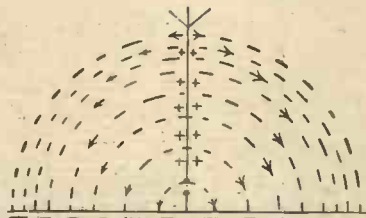

Fig. 1.—Diagram Explaining the Charging of the Aerial.

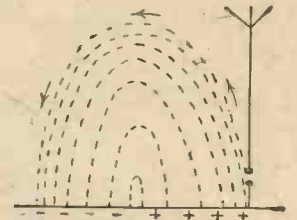

Fig. 2.—Formation of Strain Lines.

It must not be forgotten that the whole subject of directional wireless is one which requires a good deal of foundational technical knowledge for its full comprehension. It is intimately connected with some of the deepest and most subtle problems of modern experimental wireless, and it continues to occupy the attention of some of our greatest experts.

Theory and Practice

This does not mean that directional wireless is still more a matter of theory than of practice; no other branch of the science has achieved better results in practice. But it does mean that the theories underlying these practical results are of a very fundamental nature and need a detailed study of numerous facts before their full significance can be grasped. In what follows, therefore, the reader will be presented with a simple explanation of those primary phenomena which must be understood before he can attempt any more comprehensive survey of the subject.

wireless waves are radiated from a transmitting aerial. It is common knowledge that wireless waves are "radiated simultaneously in all directions," and we shall have to consider closely what this simple statement really implies. Fig. 1 shows a single-wire vertical aerial which is connected to earth through a small spark-gap; this represents our transmitting aerial. When the transmitter key is pressed, the aerial becomes gradually charged up in a certain direction—say positively, as shown in the illustration.

As the aerial acquires this positive charge, electrostatic strain lines stretch down from it on all sides to the earth. The earth thus becomes negative with respect to the aerial. (Fig. 1, of course, represents a section of these electrostatic lines.) Presently the accumulating charge on the aerial becomes so great that the resistance of the gap is no longer able to withstand it, and the current bursts across the gap.

A conducting path to earth is now pro-

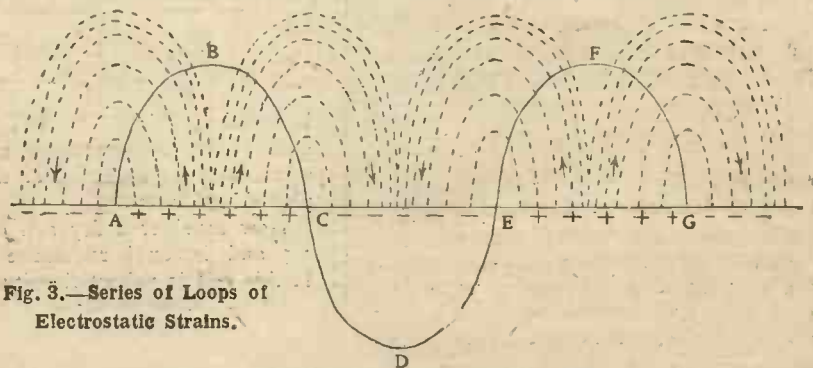

Fig. 3.—Series of Loops of Electrostatic Strains.

Direction Finding

Experimental Wireless is Being Solved

WAVES ARE PROPAGATED



vided for the charges that have been accumulating on the aerial (if we regard the whole charge as comprising a vast number of little charges for the sake of simplicity). These little charges, therefore, rush down to earth along the aerial wire, and at the same time the little negative charges rush in to the foot of the aerial to meet them. As the resistance of the aerial is less than that of the earth, the positive charges may be regarded as having an easier path to travel than the negative ones. This would mean that the positive charges would reach the earth shortly before the negative charges reached the foot of the aerial. The effect of this discrepancy is that a loop of strain lines is formed on the earth at some little distance from the aerial, as shown in Fig. 2.

Aerial Charges

The movement of the charges down the aerial and along the earth in the first instance is due to the natural tendency of all conductors to exist in a state of electrical equilibrium. Previous to the spark taking place the aerial and earth did not comprise a conducting circuit. When the spark took place, rendering the air gap a conducting path, the whole system (aerial and earth) began to function as a single conductor, with aerial at one end and earth at the other. The moment this condition came about the positive and negative charges rushed to meet one another in order to bring the whole system into a state of electrical equilibrium.

So anxious are they to accomplish this that they overshoot the mark, as it were, and tend to go to the other extreme. That is, in their rush to restore equilibrium they not only do so, but actually bring about a state of instability in the opposite direction! In other words, the earth now becomes positive and the aerial negative. Once more an attempt is made to establish equilibrium, and once more the mark is overshot in the effort, although this time to a lesser extent than previously.

Wave Propagation

In this way the electrical energy surges up and down the aerial-earth system, getting weaker and weaker at each "swing," until equilibrium is once more established. A similar set of events is now started by the next spark discharge, in this instance the aerial being charged

negatively and the earth positively at the outset. At each surge of current between aerial and earth a loop of electrostatic strain lines is "thrown off" from the

between two points on the earth. Once more, the earth, being a conductor, tends to rectify this state of affairs by producing electrical equilibrium; the positive and negative charges flow together (along the earth), and the loop of strain lines collapses.

In so collapsing an electro-magnetic field is built up around the diminishing strain lines. As this in turn dies down it gives rise to another set of electro-static strain lines at some distance from the first. This second set of electrostatic strain lines again produces an electro-

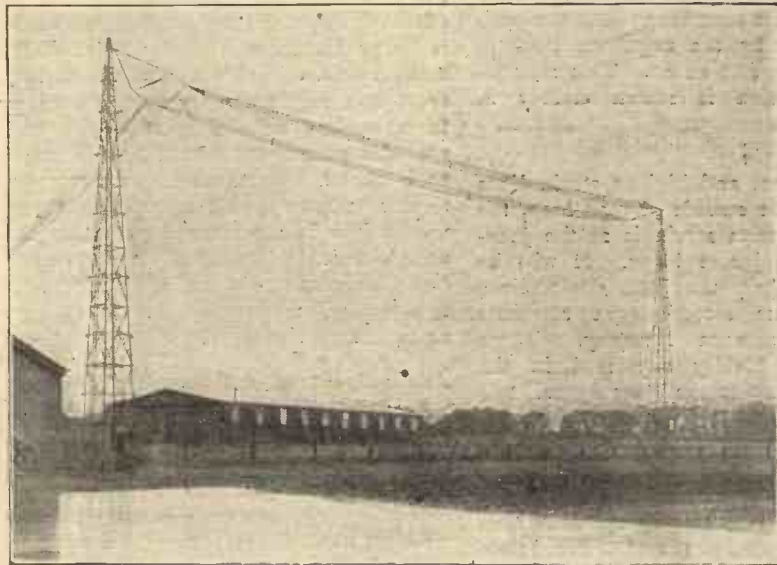

The Main Transmitting Aerial at Croydon, used for Directing Aircraft.

aerial, the feet of one set of legs being positive and those of the other negative. This means that whilst a loop of strain lines exists, there is a potential difference

magnetic field, which, in its turn, gives rise to yet another set of electro-static strain lines farther on. In this manner the initial loop of strain lines formed be-

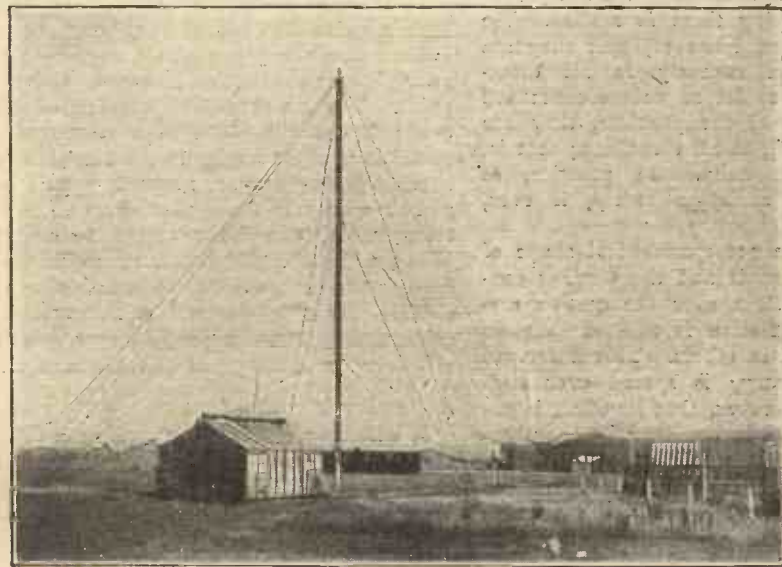

Directional Receiving Aerial at Croydon. On this Aerial are Received the Reports from Aircraft.

side the aerial is propagated outwards through the ether. As each loop moves away from the aerial its place is taken by the succeeding loop formed by the next surge of current up (or down) the aerial.

A series of these loops in section is shown in Fig. 3. The loops must be regarded as dying down into, and rising up from, the earth in very rapid succession. The relative direction along which the strain acts in alternate loops is denoted by arrow-heads. It will be seen that the neighbouring feet of two adjacent loops act in the same direction. Thus, if we imagine ourselves walking away from the transmitting station, we would pass through, say, the positive, then the negative, lines of the first loop; then the negative, followed by the positive, lines of the next loop; then the positive, followed by the negative, lines of the third loop, and so on. This alternation of direction is shown clearly in Fig. 3.

Maximum Strain

As the biggest and highest strain lines are those on the outside of each loop, the point of maximum strain is at the juncture of two adjacent loops. It will be observed, further, that the strain lines act in opposite directions at alternate points of maximum intensity. These facts are graphically expressed in the curve ABCDEFG in the same figure. B is one point of juncture between two successive loops acting in an upward direction. D is the next point of maximum intensity, but it acts in a downward direction. F is the next, again acting in an upward direction. Similarly A, C, E and G are points of minimum (zero) intensity. In this way the motion of a wireless wave through the ether may be represented by such a curve—as, indeed, it frequently is represented in text-books.

Universal Radiation

Until now we have only attempted to understand how wireless waves are propagated by studying them *in section*. We must not forget, however, that they are "radiated simultaneously in all directions." Also, so far as we are concerned in this survey of the problem, they are radiated *equally* in all directions; that is, with equal intensity. In practice, of course, equal radiation rarely, if ever, takes place.

Owing to the non-symmetrical shape of transmitting aeriels and the varying conditions that obtain over the earth's surface, better radiation is effected in some directions than in others. This difference in radiated energy is spread over such large areas, however, that its effect is entirely negligible in the small space occupied by a single receiving aerial. The transmitting station with which we are concerned, therefore, is one which radiates equal energy simultaneously in all directions.

To grasp the significance of this we must try to imagine a vast number of waves (like ABCDEFG) radiating in all

directions from a transmitting station (ABCDEFGF represents a wave and a half, of course). The best way to do this, perhaps, would be to imagine oneself looking down on the transmitted waves from a central point above the aerial. From this position they might be conceived as manifesting themselves in the form of concentric circles of energy in much the same way as visible concentric circles of energy spread out from the source of disturbance when a stone is dropped into a pond.

These circles would be alternately bunched closely and loosely together to represent points of maximum and minimum intensity respectively. The most important thing to note about them, however, is that each circle represents a certain intensity of radiated energy. In other words, the same amount of energy is being manifested at any point on the same circle. If, therefore, we were to erect two single-wire aeriels at two different points on the same circle, equal amounts of current would be induced in each aerial. Furthermore, at any particular moment, these equal currents would flow in the same direction in each aerial, that is, upwards or downwards. Consider now the effect of joining these two vertical wires at top and bottom so as to form a rectangle.

Aerial Currents in Opposition

In the first place, when a complete circuit is thus formed the two currents will oppose one another in it. Secondly, since they are of equal intensity, they will mutually negative each other. In other words, although there may be a comparatively large current induced in each vertical wire forming a side of the rectangle, the resultant current flowing in the circuit will be zero. Therefore, when a rectangular aerial is so placed that two opposite vertical sides are equidistant from a transmitting station, no signals will be picked up by that aerial. But if the vertical sides of a rectangle are equidistant from a point (the transmitting station), it follows that the plane of the rectangle is at right-angles to the direction of that point. We can thus alter our formula to read: When the plane of a rectangular aerial is at right angles to the direction of a transmitting source, no energy will be picked up by it from that source. And this, again, can be reversed to read: When a rectangular receiving aerial has been put in position to receive zero signals from a particular transmitting station, that station will be along a line at right-angles to the plane of the rectangle.

A Fundamental Fact

It will be worth while spending a little time over this single fact. Once it is clearly grasped, there will be no difficulty in understanding what follows. If the formula that we have just derived is not immediately obvious, a little reflection on the facts discussed will soon make it so. Try to think of a rectangular aerial as two single-wire vertical aeriels joined

horizontally at top and bottom. Look out through the window of your room and fix a point in the centre of the floor as the transmitting station. The sides of the window represent the single-wire vertical aeriels joined by the horizontal ledges above and below.

Now, since the sides of the window are equidistant from the transmitting source (the point on the floor), currents of equal strength will be induced in them simultaneously. Moreover, these currents will flow in the same direction—either upwards or downwards—in both wires at any particular moment. Suppose they are flowing upwards, then the two currents will collide, as it were, at the centre point of the top ledge, and, being of equal strength, they will totally nullify each other. In other words, as already stated, no resultant current will flow in the rectangular loop. The next point to be considered is how the bearing of a transmitting station is to be obtained when there is a resultant current flowing in the loop.

AERIAL NAVIGATOR.

(To be continued)



Retaining Slider Adjustment

A USEFUL refinement in slider construction is shown in the accompanying diagram. The ordinary type of slider has an adjusting screw fitted in the top, by means of which one is able to keep its position quite rigid when once the best

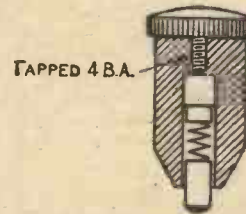

Section of Slider showing Retaining Device.

tapping has been found. This is of particular convenience when using a coil with two or more sliders, as each may be fixed in position whilst the others are being adjusted. There is thus less likelihood of moving one of them accidentally with one's arm.

E. A.

THE "WORK" HANDBOOK WIRELESS TELEGRAPHY AND TELEPHONY

TELLS YOU HOW "wireless" works, and how to make a complete range of crystal and valve receiving apparatus.

IT IS ONLY EIGHTEENPENCE

But it is the Best Yet!

CASELL & COMPANY, LIMITED, LA BELLE SAUVAGE
LONDON, E.C.4.

Our Information Bureau—(Continued)

Buzzer for Testing Crystal

Q.—Where in my receiver circuit should I connect a buzzer for testing the crystal detector?—F. W. (Northwood).

A.—The buzzer should not be connected to the receiver in any way, but should be set buzzing somewhere near the receiver. A buzzer acts as a small untuned transmitter, and the waves sent out are received by the crystal set. When the buzzer is heard loudest, the best point on the crystal has been found.—W.

High-frequency Coupling

Q.—What is the best type of high-frequency coupling for all wavelengths from 300 to 30,000 metres?—AMBRIOUS (Grimsby).

A.—You will have to employ two separate methods of coupling the high-frequency valves: tuned-anode or high-frequency transformer coupling for wavelengths below 1,000 metres, and resistance-capacity coupling for 1,000 metres and upwards. If you use tuned-anode coupling by means of plug-in coils, it is a simple matter to remove the coil and plug in a high resistance of about 70,000 ohms when you wish to change from short- to long-wave reception.—P.

Telephone Transformer

Q.—Please give me the windings for a telephone transformer.—H. L. (Swansea).

A.—The core should be made up of iron wires and should be 3 in. long by ½ in. in diameter. The primary winding will consist of 3 oz. of No. 44 s.w.g. s.s.c. copper wire, and the secondary 4 oz. of No. 36 s.w.g. s.s.c. copper.—B.

Different Values of H.T. Voltage for Different Valves

Q.—How can I put different values of high-tension voltage on the plates of my three valves (one high-frequency, one detector and one low-frequency)?—AMPLIO (Thornton Heath).

A.—The leads from the plates of the valves, after passing through the high-frequency transformer primary, low-frequency transformer primary and telephones respectively, should be of flexible wire fitted with plugs. These three plugs may thus be connected to any point of the high-tension battery, and the negative of this battery will be connected to positive or negative of the low-tension battery as usual. You will find that this arrangement works best when the last plug (from the telephones) is connected to full value of the high-tension voltage, that is, the socket which is marked positive on the high-tension battery.—B.

U.S.A. Broadcast Stations

Q.—Please give a list of the important American broadcasting stations, preferably those using a large transmitting power.—H. G. A. (Northants).

A.—The list given below represents the high-power American broadcasting stations:

Stations	Call	Wave-length
Atlanta	WSB	400
Arlington	NAA	710
Boston	WNAC	360
Buffalo	WGR	360
Chicago	KYW	400
Chicago	WDAP	360
Chicago	WMAQ	360
Cincinnati	WLV	360
Dallas, Tex. ..	WFAA	400
Davenport, Iowa ..	WOC	400
Dearborn, Mich. ..	WVI	366
Fort Worth, Texas	WBAP	400
Havana, Cuba ..	PWX	400
Indianapolis	WLK	360
Lockport, N.Y. ..	WMAK	360
Louisville, Ky. ..	WHAS	360
Medford Hillside ..	WGI	360
Minneapolis	WLAG	400
Newark	WJZ	360
New York City ..	WEAF	400
Philadelphia	WFI	400
Philadelphia	WOO	400
Pittsburg	KDKA	360
Schenectady	WGY	370
Springfield, Mass. ..	WBZ	422
St. Louis	KSD	400
Toronto, Canada ..	CFCA	400
Troy, N.Y.	WHAZ	400

They have an approximate transmitting range varying between 1,500 miles and 2,500 miles. These stations transmit intermittently throughout the day between 11.45 a.m. and 9 p.m. Eastern standard time. Greenwich mean time is five hours in advance of Eastern standard time.—C.

Tuning the Secondary Winding of H.F. Transformer

Q.—Why is the secondary winding of a high-frequency transformer left untuned, and would there be any gain in efficiency by connecting a small variable condenser across this winding?—L. W. A. (Reading).

A.—The secondary winding of a high-frequency transformer is always closely

coupled to the primary and consequently any change in wavelength of the primary, caused by adjustment of its variable condenser, will be communicated to the secondary. The secondary may have a condenser across it if you wish, but you will find that this will introduce strong reaction between the circuits which will spoil your reception.—B.

2-valve Set Oscillating

Q.—I cannot prevent oscillation in my two-valve receiver, of which the first is a high-frequency valve. Consequently I cannot receive the broadcasting clearly, and I am afraid that I am interfering with reception of others in the neighbourhood.—A. C. V. (Rams-gate).

A.—In all probability the connections in your receiver are not properly spaced, and the grid and plate connections of each of the valves may be running very close together. As this is usually sufficient to cause reaction between the circuits, you should arrange the connections as far apart as possible. Where it is necessary to run one wire across another, it should be at right-angles. You may also try fitting a potentiometer to the grid of the first valve, in which case the connections are made as follows: The lead from the earth end of the aerial tuning inductance should be disconnected from low-tension negative or positive, as the case may be, and taken to the slider of a potentiometer of about 400 ohms. The windings of this potentiometer are connected across positive and negative low tension.—P.

Spacing Turns on Coil

Q.—I understand that if I wind a piece of string between successive turns of an inductance coil, thus spacing the windings, I shall get better results. Is this correct?—TUNER (Ayr).

A.—This method of winding certainly reduces the self-capacity of the coil, but it is doubtful if any advantage is gained in increased signal strength or easier tuning. This method of winding will, of course, reduce the wavelength to which a given amount of wire will tune.—B.

"B" Valves

Q.—What are "B" valves, and can they be used as detectors?—E. G. (Bath).

A. The valves you mention are probably the small transmitting valves as used in army transmitters, and put on the market by the Disposals Board. They are probably much too hard for rectification purposes, but should make good low-frequency amplifiers with about 100 to 150 volts on the plate.—B.

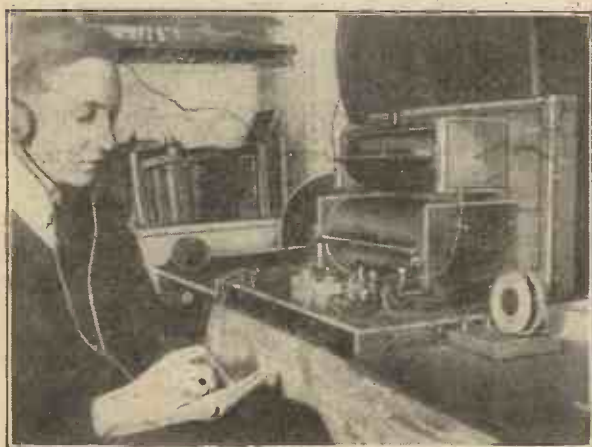

Left:
Mr. E. C. H. Smith
(Ilford) and his Home-
made Long-wave
Crystal Receiving Set.

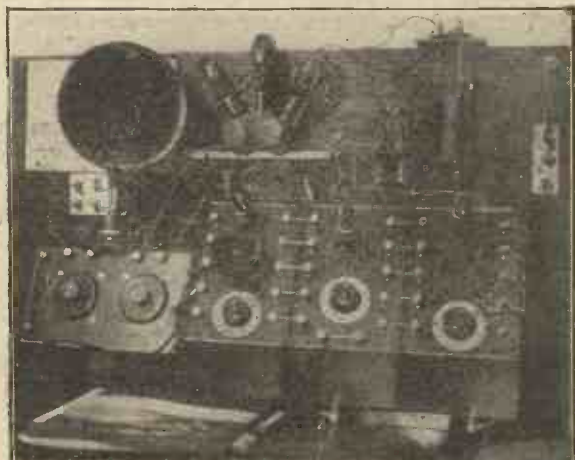

Right:
The "A.W." Ideal
Unit Set built by
Mr. R. S. McLellan
(Glasgow).

Three-valve Circuit for Use with Frame Aerial

NO doubt many amateurs who have used the frame aerial in place of an outside aerial have been disappointed with the results obtained, as the signal strength

circuit shown by the diagram, which introduces double reaction, was found by the writer to be the best three-valve circuit for use with a frame aerial.

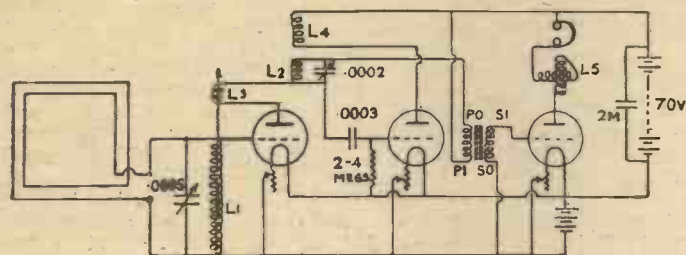

Three-valve Circuit for Frame Aerial.

seldom exceeds twenty-five per cent. of the strength obtained by an outside aerial when connected to similar receiving apparatus. After much experiment the

d.c.c. wire, L₂ with fifty turns of No. 32 d.c.c. wire, and L₄ with seventy turns of No. 32 d.c.c. wire. The variometer, L₅, in the plate circuit of the last valve consists of a

The aerial consists of seven turns of No. 24 d.c.c. wire wound on a frame 3 ft. square. The inductances, L₁, L₂, L₃, L₄, are all of the honey-comb type, wound on a 2-in. former. L₁ is wound with sixty turns of No. 24 d.c.c. wire, L₂ with one hundred turns of No. 32

cardboard former 3 in. in diameter wound with forty turns of No. 32 d.c.c. wire and an inner former 2 in. in diameter wound with forty turns of No. 32 d.c.c. wire, and mounted so as to revolve inside the larger tube.

The circuit is well worth trying out by the experimenter who wishes to get the last ounce out of his set, for it has some special attributes. For instance, signal strength generally exceeds seventy-five per cent. of that obtained on an outside aerial connected to the usual three-valve set. Jamming is almost entirely eliminated, and tuning is extremely selective. Experimenters living within two miles of a broadcasting station will find difficulty, as far as my own experience goes, in tuning out the local station when searching for the most distant broadcasting stations.

W. E. N. W.

Around the Showrooms

Cheap Coil-holder

MANY experimenters have wanted from time to time a holder for plug-in-coils which will permit of less restricted movement than is obtainable with the usual stand-mounted type. Such a coil-holder



Simple Coil-holder Allowing of Unrestricted Movement.

can be made in a few minutes with two or three components like that shown in the figure. Besides being very cheap, these holders have the advantage that they can be moved about at all angles, and are thus of great convenience to experimenters. Moreover, should the wrong connections

have been made to the reaction coil when one is used, it is only necessary to reverse the holder without changing the connections. These holders can be obtained from Spencer's Stores, Mason's Avenue, Basinghall Street, E.C.2.

Amateur Transmitting Valves

In connection with the patent mentioned under the heading "Repairing Transmitting Valves" ("Progress and Invention," AMATEUR WIRELESS, No. 53, p. 803), we hear that the Mullard Radio Valve Company, of 45, Nightingale Lane, Balham, S.W.12, is putting these valves on the market. They are low-power valves for the use of amateurs, and the filaments can be replaced almost any number of times at a cost equal to about fifty or sixty per cent. of the original price. As even small transmitting valves cost several pounds each, it will be seen that the experimenter will be able to save a considerable amount by using these new valves.

Laminated Phone Magnets

An ordinary telephone which gives such clear and loud signals as that in conjunction with a horn it can be successfully used as a loud-speaker is illustrated in the photograph. This phone is a larger pattern of the Sidpe phones mentioned under above heading in No. 52, and is known as the type B "Superphone." Special points

to notice are the laminated magnets and their position. Being so close to the centre of the diaphragm they exert a much stronger pull on it than usual, with the result that better signals can be obtained. As shown in the photo, the phone is mounted for use as a loud-speaker, the



Base of "Sidpe" Loud-speaker with Laminated Magnets.

horn being prevented from rattling by the springs on to which it is screwed down. The genuine "Sidpe" phones can only be obtained by the trade from the Premier Telephone Company, of 62, Oxford Street. They are marked SIDPE and PTC on the back.



THE scheme for the Sheffield relay station has so far advanced that experimental operations were begun early this week. It is probable that listeners-in will themselves be able to put to the test transmissions made from the Sheffield end, and they are advised to listen-in for these. Special arrangements have been made for testing reception in various parts of the city and district.

The new cable which is to be laid between London and New York next year will have an estimated speed capacity of 600 letters per minute both ways simultaneously. A rival to wireless?

Major W. B. Zappert, of the Alexandra Fire Brigade, intends fitting his fire-engines with wireless apparatus to enable the firemen to summon help if needed at a serious outbreak.

The first message to be sent across the English Channel by wireless was addressed to Professor Branly, inventor of the coherer, and ran as follows: "Signor Marconi sends his respectful compliments by wireless telegraph across the Channel, this admirable result being in part due to the remarkable work of M. Branly." This was on March 20, 1899, nearly a quarter of a century ago.

American phones are now being made with four magnets in each earpiece instead of the two usually fitted. By means of a switch the resistance can be altered from 4,000 to 1,000 ohms, and the phones are thus of use with either crystals or valves.

A wireless set built in the base of a table lamp has been put on the market by a dealer in the United States. The lamp also contains a gramophone.

Brighton and Hove people are now asking for a broadcasting station, pointing out that the population of Brighton is just twice that of Bournemouth. We hope they get it!

Barnet Council have decided that tenants of their new housing estate, now in course of construction at West Barnet, must not erect wireless aerials in their gardens until

they have obtained the sanction of the Council. The object of this decision is "to preserve the amenities of the estate."

The League of Nations Union have arranged with the B.B.C. to broadcast talks on international affairs to children.

A new record in aircraft wireless telephony has been set up by Capt. W. R. Hinchcliffe on the London to Berlin airway, who spoke to Croydon while circling over Bremen, 400 miles distant.

WOW (Omaha) has arranged with the police to be available at all times for the broadcasting of police news in emergency, such as descriptions of escaped convicts, etc.

We cull the following from the "Indigest" column of *Radio Digest*, Chicago: "A listener-in had a sleepy-looking parrot which he kept as a pet in the same room with his set. One day while the receiver was tuned in on a station he was called out of the room to answer the telephone. A few seconds after he had left the loud-speaker broke forth in a clear tone, 'Hello!' This was repeated several times,

IN corresponding with
Advertisers it pleases
them and us—and it is
also to your advantage
—that

you mention

**“Amateur
Wireless”**

the parrot paying not the slightest attention. At the final 'Hello!' the bird opened one eye, gazed at the set, and snapped out, 'H—l, man, the line's busy.'

Senatore Marconi has returned from a cruise in his yacht *Elettra* in the Atlantic, and states that experiments relating to directional wireless have been completely successful. He contemplates another cruise, this time in the Mediterranean, in order to effect further improvements in his directional apparatus.

Until the Government Committee have announced their report on the broadcasting situation, negotiations between the B.B.C. and Secretary of Commerce for Northern Ireland regarding a broadcasting station for Belfast, have been discontinued.

The B.B.C. are trying to decide what to do regarding the proposed sub-stations, as it is thought that any more stations, besides the eight already working, even if low-powered, on the same band of wavelength (350-425 metres) will lead to confusion.

On Thursday, June 14, the "Meister-singers" was broadcast from 2LO and also relayed and broadcast from 5SC (Glasgow).

Senatore Marconi, while at Casablanca, was able to hear a concert broadcast from 2LO.

The Handel Choir was relayed to 2LO and then broadcast on Monday, June 11

There is a movement afoot among the theatrical managers to limit the amount of entertainment broadcast.

Captain A. G. D. West, B.A., B.Sc., has been appointed assistant chief engineer of the B.B.C. During the last year he has been engaged in research in the Cavendish Laboratory under Sir Ernest Rutherford on the propagation of electric waves. Captain West is to be in charge of the experiments in connection with the Sheffield sub-station.

It is intended by the B.B.C. to broadcast a quarter of an hour's criticism, beginning at 7.15 p.m., on various things during the week. Monday will be for literary criticism, Wednesday the cinema, Thursday musical, and Friday dramatic.

A paper on "Atmospherics" will be read before the Radio Society on June 27.



Accumulator Capacities

SIR,—I note that in your issue dated June 16 a correspondent gives the formula $C = N \times L \times W \times K$ to find the capacity of an accumulator. This formula only applies to a third of a 6-volt battery.

The best way to prove that in practice this formula is incorrect is by actual example. An accumulator I handle every day has two positives measuring 4×4 . Its actual capacity shown by tests at the N.P.L., Teddington, varies between 26 and 30 ampere-hours at the 10-hour rate. According to the above formula its capacity would work out to 19.84 ampere hours. The mistake is due to the fact that no mention is made of the actual thickness of the plate, whether it be $\frac{3}{8}$ in. as is usual or $\frac{1}{4}$ in. as is more satisfactory.—G. H. D. (London, S.E.).

Wireless Patents

SIR,—We beg to point out what appears to be an important omission in your article in issue dated June 9 on "Taking Out a Wireless Patent," wherein you state, in the case of a wireless circuit, "the bare use of a patented circuit, etc., lays the user open to an action for an injunction and damages for infringement." This is not the case where the aim of the user is to experiment and improve upon the patent in question.

We draw your attention to this point as its value to the wireless experimenter is obvious, for without this provision it is difficult to see how progress could ever be made in inventions generally. Of course, if a patented device is made for personal and advantageous use infringement will occur, as your contributor rightly points out.—RAYNER AND CO., Patent Agents (London, W.C.).

"Improving the Tuned-anode"

SIR,—With reference to the article in AMATEUR WIRELESS, No. 53, with the above title, I have already tried this with a cylindrical coil and slider. A band of thin sheet brass was made to go round the coil at the end where the wire was in use and broad enough to come within $\frac{1}{2}$ in. of the slider when on the wavelength of 2 L O, this being the lowest. The band was hinged and fastened with a catch so that it could easily be taken off. A wrapping of rubber insulating tape was put on the coil in order to prevent the band from shortening turns. It does all the article says, but in my experience, contrary to the author's, the strength is reduced a little.—H. D. C. (Sandbach).

Long-distance Crystal Reception

SIR,—In your issue No. 53 A. A. M. T. (6 J Z, Innellan) states he has received broadcasting from all stations except Cardiff on a crystal set, using only a variometer and a hertzite detector. I shall be glad of further particulars, as I have been told repeatedly that I cannot receive broadcasting on a crystal set in this district although we are situated on a hill 700 ft. above sea-level.—C. B. (Stokenchurch).

Range of Apparatus

SIR,—As a regular reader of AMATEUR WIRELESS and a keen wireless enthusiast, I feel I cannot let the letter of J. H. J. (Liverpool), under the above heading on page 736 of AMATEUR WIRELESS, pass unchallenged. It may interest J. H. J. and your readers to know that I received very clear speech and music from 5 SC on a home-made crystal set in Birmingham, which is considerably over 300 miles from Glasgow. The first time I heard 5 SC loud enough to be able to enter in my log was on April 3, 1923, when I was able to enjoy for about twenty minutes the British National Opera Company then playing at the Coliseum Theatre, Glasgow.

Perhaps a few details of my set will be of interest: Aerial, 100 ft. single-stranded wire, 24 ft. high, screened by trees at one end (north); set, tapped inductance, 3-in. former, 110 turns, hertzite detector (the only ebonite used is in the two switch knobs and the phone condenser; no other condenser is used); phones, 4,000 ohms; earth, iron crowbar driven into the ground.—E. W. R. (Wythall).

H. J. B. (East Sheen) informs us that telephony from 2 L O was received successfully in Victoria Street, London, S.W., using a small piece of crystal, some wire, a radiator and a pair of phones.

Proposed Schools' Radio Society

A SUGGESTION to form a "Schools' Radio Society of Great Britain" was recently placed before the Radio Society of Great Britain with the proposal that the Schools' Society should be affiliated to, and under the guidance and control of, the Radio Society of Great Britain. The matter was carefully considered by the com-

mittee, and it was decided to give support to such a scheme. Dr. Eccles, F.R.S., has undertaken to act as president of the schools section, whilst it is suggested that two vice-presidents might be selected from prominent educationists.

The organising secretary is Mr. R. J. Hibberd, Grayswood School, Haslemere, Surrey.



Some of these transmissions are commercial or official. Wavelengths and times are liable to alteration without notice. The times given are British Summer Time.

London B.B.C. Station (2 L O), 369 metres. Weekdays, 11.30 a.m. to 12.30 p.m., concert; 5.30 p.m. to 6 p.m., women's half-hour; 6 p.m. to 7.30 p.m., children's stories and concert; 8 p.m. to 11 p.m., concert and news. Sundays, 8.30 p.m. to 10.30 p.m., concert and news.

Manchester B.B.C. Station (2 Z Y), 385 metres. Weekdays, 11.30 a.m. to 12.30 p.m., concert; 5.30 p.m. to 6 p.m., women's half-hour; 6 p.m. to 7.45 p.m., children's stories and concert; 8.15 p.m. to 11 p.m., concert and news. Sundays, 8.30 p.m. to 10.30 p.m., concert and news.

Birmingham B.B.C. Station (5 I T), 420 metres. Weekdays, 3.30 p.m. to 4.30 p.m., concert; 5.30 p.m. to 6 p.m., women's half-hour; 6 p.m. to 6.45 p.m., children's stories; 6.45 p.m. to 8.15 p.m., concert and news; 8.45 p.m. to 11 p.m., concert and news. Sundays, 8.30 p.m. to 10.30 p.m., concert and news.

Newcastle B.B.C. Station (5 N O), 400 metres. Weekdays, 11.30 a.m. to 12.30 p.m., concert; 5.30 p.m. to 6 p.m., women's half-hour; 6 p.m. to 8 p.m., children's stories and concert; 8.30 p.m. to 11 p.m., concert and news. Sundays, 8.30 p.m. to 10.30 p.m., concert and news.

Cardiff B.B.C. Station (5 W A), 353 metres. Weekdays, 11.30 a.m. to 12.30 p.m., concert; 5.30 p.m. to 6 p.m., women's half-hour; 6 p.m. to 8 p.m., children's stories and concert; 8.30 p.m. to 11 p.m., concert and news. Sundays, 8.30 p.m. to 10.30 p.m., concert and news.

Glasgow B.B.C. Station (5 S C), 415 metres. Weekdays, 5.30 p.m. to 6 p.m., women's half-hour; 6 p.m. to 7.45 p.m., children's stories and concert; 8.15 p.m. to 11 p.m., concert and news. Sundays, 8.30 p.m. to 10.30 p.m.

Croydon (G E D), 900 metres. Daily. **Eiffel Tower (F L), 2,600 metres.** Daily. 6.40 a.m. and 11.15 a.m., weather forecast; 6.20 p.m. to 7 p.m., concert, and 10.10 p.m., weather forecast.

The Hague (P C G G), 1,050 metres. Sundays, 4 p.m. to 6.40 p.m., concert. Mondays, 9.40 p.m. to 10.40 p.m., concert. Thursdays, 9.40 p.m. to 10.40 p.m., concert.

Paris Concerts Radiola (S F R), 1,580 metres. Daily, 5.5 p.m. to 6.15 p.m., concert; 8.45 p.m. to 10.30 p.m., concert; also concert from 2 p.m. to 3 p.m. on Sundays.

Rome (I C D), 3,200 metres. Daily, 11 a.m. **Königswusterhausen (L P), 2,800 metres.** Daily, 5 p.m. to 6.30 p.m.

Amsterdam (P C A), 1,800 metres. Daily, 2.20 p.m.

Haren (O P V H), 900 metres. Daily weather report on 1,100 metres at 1 p.m. and 5.50 p.m.

Ecole Supérieure des Postes et Télégraphes, 450 metres. Tuesdays and Thursdays, 7.45 p.m. to 10 p.m., concert. Saturdays, 2.30 p.m. to 7.30 p.m., educational lectures and concert. Daily, at 11 a.m., 5.5 p.m., and 9.10 p.m., news and concert.

Dependable Radio Service

AERIAL WIRE, 7/22 bare copper, stranded, 100 ft.	2	6
INSULATORS, Reel 1 1/2 d., Egg 3 d., Shell ...	6	
VARIOMETERS, silk wound, fitted with ebonite dial knob...	4	6
CRYSTAL RECEIVING SET, variometer tuning	10	0
" " " " (unassembled)	7	0
CRYSTAL DETECTORS, on ebonite base, 3/- and	2	0
" " (glass covered)	3	6
COJAH BASKET COILS, set of 7 (150-4,000 metres)	5	0
" SLAB " " " 8 (150-26,000 ")	7	6
BASKET COILS, our Special Line, set of 6 (170-3,500 metres)	2	6
COIL HOLDERS, 3-Way } Extraordinary Value ... } 8 6		
" " 2 " } ... } 6 6		
INTERVALVE TRANSFORMERS, not rubbish, 12/2-, 12/6, 16 6		
VALVES, Soft, Dutch, ideal for detecting ...	10	6
" Hard " " " amplification ...	11	6
AMPLION LOUD SPEAKERS ... upwards from	2	12 6
VARIABLE CONDENSERS. For Panel Mounting. In Celluloid Case.		
.001 ... 12/6	15/-	
.0005 ... 10/6	13/-	
.0003 ... 9/6	11/-	
HEADPHONES.		
"SIDPE" 4,000 ohms, £1 0 0	8,000 ohms, £1 2 6	
"BRITISH" 4,000 ohms, £1 0 0	8,000 ohms, £1 2 6	
"BRUNET" 4,000 ohms, £1 2 6	PIVAL ... £1 2 6	

The WATERLOO ELECTRIC Co. 129, WATERLOO Rd., LONDON, S.E.1.
(Hor. 5649.)
Closed on Thursdays, 1 p.m. Sat. 9 p.m. Other nights 8 p.m.
CATALOGUES FREE.

VARIOMETERS.

UNDoubtedly the most efficient method of economically tuning aerial. Ebonite Ball Rotor of most approved design, positive connection to ebonite stator. Wavelength range on 100 ft. "P.O." aerial, 800-700 metres. Gives a very tight coupling, equal in finish to instruments at £1 or more. Secured to panel by simply drilling 3/4-in. clearance hole. Price 8s. 11d. each. Postage 1s. extra.

VARO-COUPPLERS. As above, but wound for use as tuned anode coil and reactance, A.T.I. and reactance, etc. Price 8s. 11d. each. Postage 1s. extra.

L.F. TRANSFORMERS. FINEST value yet offered. Unusually free from distortion and parasitic noise. Laminated Stalloy Cores. Wound on ebonite bobbins with silk-covered wire. Fitted with terminal mounts. Ratio 4 to 1.

This instrument is not to be classed with similar-priced competition lines. Results and finish are remarkable. Extraordinary amplification. Insulation tested at 1,600 volts. Correct impedance for average "hard" valve. Will safely stand 25 m.a. current without unduly heating. Price 14s. each. Postage 1s. extra.

All Goods 7 Days, Free Approval against Cash and Dispatched within 24 Hours

ECONOMIC ASSEMBLIES, 18A, UPPER TALBOT ST. BLACKPOOL
Send P.C. for Comprehensive List. TRADE SUPPLIED

Buy from the Actual Manufacturers

DETECTORS
Fitted with the famous Galvarite Crystal, the most sensitive on the market. Ordinary ... each 3/-
High-grade dust-proof, enclosed (as shown) ... 5/-
Galvarite Crystal only ... 1/6

HONEYCOMB BASKET Inductance COILS
Rigid as honeycomb coil; more compact than basket type; minimum self-capacity, maximum efficiency.
50-2,000 metres ... set 5/- | Broadcasting Coil, 50-1,000 metres ... 2/9 | 1/3 each

CONDENSERS Complete Set of Parts Assembled
.001 ... 8/6 ... 9/6
.0075 ... 5/6 ... 6 6
.0005 ... 5/- ... 6-
.00025 ... 4/- ... 5-

CASH WITH ORDER
Remit ample Postage. Liberal Trade Discount

RADIO COMPONENTS CO.
115A, North View Road, Hornsey, N.8

BEHOLD!!!

V BEST COMPONENTS

V BEST PRICES

HAVING ALREADY SECURED the Manchester Business for Components at the right price we have decided to give Amateurs in all parts of the world an opportunity to get them at "V BEST" prices. We have organised a Mail Department, and can offer all the following goods ex stock.

AERIAL WIRE, 7/22's Hard drawn bare copper	per 100 ft.	2/6
AERIAL WIRE, 7/22's Hard drawn enamelled	per 100 ft.	3/6
AERIAL INSULATORS, REEL, each 2d., 2 for 3d.	STRAINER	each -/3
AERIAL INSULATORS, EGG, each 2d., 2 for 3d.	SHELL	each -/6
AERIAL PULLEYS, 2 1/2" Galvanised		each -/6
BATTERIES, FLASH LAMP, 4-volt (Make your own H.T.), each 5d.		per doz. -/6
CONDENSER WAVES. Fixed or moving		per doz. -/4
CONDENSER SPACERS. Accurate small, per doz. 3d., large, per doz.		each -/5
CONDENSER SCALES, IVORINE. Engraved, not printed		each -/4
CONDENSER DIALS, EBONITE. Engraved, beautiful finish		each 1/3
CONDENSER SPINDLES, SQUARE Section, screwed, 2 BA, Vernier to .0005, each 4d.; .00075 and .001		each -/5
CONDENSER ADJUSTABLE PIVOTS		each -/3
CONDENSER TOP BUSH with flange		each -/11
CONDENSER TOPS AND BOTTOMS. Drilled for standard fittings		each -/10
CONDENSER. Fluted Knob and Dial combined. Beautiful finish		each 2/-
CRYSTAL CUPS. 3 Fixing screws		each -/2
CRYSTAL DETECTORS. Mounted on Ebonite. Adjustable in every way		each 2/-
CONTACT STUDS. 1/2" x 1/4" with nut and washer		per doz. -/6
CONTACT STOPS. 1/2" x 1/4" with nut and washer		per doz. -/3
CORE WIRE. Soft Iron		per lb. -/6
COIL MOUNTING PLUGS. Universal fitting		each 1/3
DUCONS. While they last		each 7/6
EBONITE. Don't buy loaded ebonite. Get maximum area for minimum weight (cut to size)		per lb. 3/6
EBONITE. Manufacturer's scrap pieces in 1 lb. parcels		per lb. 2/6
EARTH CLIPS. Fix on water pipe. Adjustable to any size		each -/4
FOIL COPPER. per sheet 4d. FOIL TIN		per sheet -/3
FILAMENT RESISTANCES. A real piece of apparatus		each 2/6
FILAMENT RESISTANCE. EBONITE DIALS, engraved		each -/10
FILAMENT RESISTANCE. SCALE, engraved ivory line		each -/9
FORMERS, PIRTOLD, for Honeycomb coils		each -/3
INDUCTANCE TUBES. Specially impregnated, 12" long 3/4" diam.		each -/4
INDUCTANCE TUBES. Specially impregnated 12" long 1/2"		each -/5
INDUCTANCE TUBES. Specially impregnated 12" long 5/8"		each -/7
INDUCTANCE SLIDERS with spring and plunger		each -/4 1/2
INDUCTANCE SLIDER ROD. 13" drilled		each -/4
INSULATORS LEAD-IN. Sturdy Ebonite. Terminals each end 6"		each -/10
INSULATORS LEAD-IN. Sturdy Ebonite. Terminals each end 12"		each 1/1
IVORINE TABLETS, Black on White or White on Black. Engraved. A nice job. AERIAL, EARTH, PHONES, ETC.		each -/2
INSULATING SLEEVING		per yd. -/3
INSTRUMENT WIRES. A huge stock of specially purchased wire in all coverings. Perfect. At bargain prices. Send 1/4d. stamp for price list.		per sq. ft. 1/-
INSULATING SILK SHEET		each -/4
KNOBS, EBONITE. Blind bushed 2 BA. One quality only—The BEST		each -/1
MICA. Pure Ruby. Pieces 2 1/2" x 2 1/2"		each -/21
NUTS, Brass, Hexagon, 2, 3 and 4 BA, per doz. 3d., 5 and 6 BA, per doz.		per yd. -/1
RESISTANCE WIRE for Filament resistances		each -/2
ROUND LOCKING NUTS 2 BA brass		each -/3
SCREWED BRASS ROD. 12" lengths 2 BA, each 3/4d. 4 BA		per pkt. -/6
SHELLAC. Flake		each 1/6
SWITCH ARMS, 4 LEAF, Splendid Knob, Hefty bush, beautifully polished, with nuts and spring washer		per doz. 1/6, 2/-, 2/6
TERMINALS, not Nutsacks. Standard pattern according to size		per doz. 2/6
TERMINALS. Telephone		per doz. 2/6
TERMINALS. Telephone, wood screw		per doz. 1/6
WASHERS, BRASS. 2 to 6 BA		each 1d., per doz. -/8
WASHERS, COPPER SPRING		each -/1
VALVE SOCKETS with nut and washer		each -/1
VALVE PINS with nut and washer		each -/7
VALVE HOLDERS with 8 nuts and 4 washers		each -/10

ON THE STRENGTH of the above prices you have doubtless already decided to send us your order. But perhaps you want some scientific components also. Then take our advice—Buy the Best, don't be "PENNY WISE, POUND FOOLISH." We Supply—

SCIENTIFIC COMPONENTS

CRYSTALS (J. L. Cartwright and Co.'s), Carborundum, Copper, Pyrites, Galena, Bornite, Iron Pyrites, Silicon, Manganese	per box	-/3
CRYSTALS, Best Hericite or Zincite	per box	1/-
CRYSTALS, WOOD'S METAL	per box	-/6
FIXED CONDENSERS (J. L. Cartwright and Co.'s)	each	2/-
GRID LEAKS (J. L. Cartwright and Co.'s) 1, 2, 3, 4, or 5 meg.	per set	32/-
HEADPHONES, Western Electric. 4,000 ohms	per set	32/-
HEADPHONES, Western Electric while they last, 8,000 ohms	per set	15/-
HEADPHONES, Special French, very sensitive	each	50/-
LOUD SPEAKERS, Western Electric, 4,000 ohms		
TRANSFORMERS, High Frequency Plug in Type (J. L. Cartwright and Co.'s) double groove, No. 1, 350M 6/6, No. 2, 550M 7/-, No. 3, 830M 7/6; No. 4, 1400M 8/-; No. 5, 2000, 8/6; No. 6, 3500M 9/-; No. 7, 10,000M, 10/6.	each	21/-
TRANSFORMERS. Low Frequency (J. L. Cartwright and Co.'s)		
TRANSFORMERS. Telephone (J. L. Cartwright and Co.'s), while they last		
VALVES. Ediswan A. R. Type	each	12/-
VALVES. Marconi Osram. R. type	each	15/-
VALVES, DUTCH	each	17/6

HUGE CASH WITH ORDER. Money back if not entirely satisfied. Please remit ample stocks postage, any balance returned. ADVISE FREE

VICTOR BEST CO.
THE COMPONENT KING
Dept. A
24, London Road
MANCHESTER

Tel. No. City 9242 (Opposite London Road Station)

WIRELESS IN PARLIAMENT



(From Our Own Correspondent)

THE question of wireless communication within the Empire is to be considered at the forthcoming Imperial Economic Conference, and any question of principle, requiring the attention of the Conference itself, will be referred to the Conference, stated Mr. Ormsby-Gore, the Under-Secretary for the Colonies, in the House of Commons last week.

Sir L. Worthington-Evans, the Postmaster-General, replying to Sir H. Brittain, said it was not the fact that the Post Office wireless stations at Leafield and Northolt were being worked at a heavy loss. On the contrary, these services were practically paying their way. The size of the new Government wireless station, and the services which would be conducted from it, had not yet been definitely settled.

"Box Ottomans in Cretonne and Tapestry" is the subject dealt with in the series of Practical Upholstery articles appearing in the current issue of "Work" (3d.). Other articles in this number deal with: "Silverwork: Useful and Beautiful, with Notes on Niello Decoration"; "Making an Up-to-date Cinematograph";

"Laying Garden Footpaths"; "Enamels and Enamelling"; "Home-made Inter-communication Telephone Sets"; "Easily-made Bedside Table"; "Notes on the Fly-wheel"; "Contact Board for Door Mat."

Reception in a Mine

IT was mentioned in last week's AMATEUR WIRELESS, p. 844, that the Glasgow broadcasting had been heard in a mine 330 ft. below the surface. The experiment was carried out with one of the Burndept Ethophone broadcast sets with four valves at a mine in Larkhall, near Glasgow. The set was fixed on a truck in the cage at the top of a shaft and an earth connection made to the wire netting at the side of the cage.

About a pound of No. 22 d.c.c. wire was used as an aerial, but reception was poor owing to the large amount of iron. As the cage was lowered gently signals gradually became louder, until the best results were obtained at a distance of about 165 ft. below the surface. On lowering the cage still farther signals became weaker. At the bottom of the shaft the truck was run into the workings of the pit, with the set still on it. Down in this position there was interference due to electrical disturbances and mineral substances. The depth was 330 ft., and the carrier wave of the Glasgow station could be heard

plainly. As it was found almost impossible to stop the set from oscillating, signals were distorted although quite loud. The aerial was about 35-40 ft. long. At first an earth connection was made to the truck rails, but better results were obtained by making contact to a water-pipe which passed along the roof. The music could be heard plainly and the announcer's words were quite understandable. It is hoped to carry out further experiments at a later date with an ordinary set, as it is thought that better results will be obtained with this than with the usual broadcast receiver.

On June 29, from 2 L O, Mr. T. E. N. Phillips, under the auspices of the Royal Astronomical Society, will broadcast a lecture on "Jupiter."

ANNOUNCEMENTS

"Amateur Wireless and Electric." Edited by Bernard E. Jones. Price Threepence. Published on Thursdays and bearing the date of Saturday immediately following. It will be sent post free to any part of the world—3 months, 4s. 6d.; 6 months, 8s. 9d.; 12 months, 17s. 6d. Postal Orders, Post Office Orders, or Cheques should be made payable to the Proprietors, Cassell & Co. Ltd.

General Correspondence is to be brief and written on one side of the paper only. All sketches and drawings to be on separate sheets.

Contributions are always welcome, will be promptly considered, and if used will be paid for.

Communications should be addressed, according to their nature, to The Editor, The Advertisement Manager, or The Publisher, "Amateur Wireless," La Belle Sauvage, London, E.C.4.

BEGINNER'S GUIDE TO WIRELESS

Explains in plain, everyday language, everything you wish to know about Wireless Telegraphy.

HOW TO ERECT, CONNECT, AND MAKE

the apparatus required, and full instructions for making coils, tuners, and complete valve and crystal sets. Instructions and diagrams for a two-valve receiver are alone worth four times cost of the book. 112 pages, price 1/- post free.

SAXON RADIO CO. (Dept. 12) South Shore, BLACKPOOL



AMATEUR CONSTRUCTORS!

We supply everything

This tuner has been tested and found very efficient as A.T.1 or Anode Tuner for the new S.T.100 Circuit.



Tapped inductances are far in advance of any other tuning, providing the tappings are correctly arranged. Our tuning inductances are wound on specially impregnated 4" tubes with 26 s.w.g. double cotton-covered copper wire in the following ratio: 10 sections of 10 turns each, and 10 sections of 1 turn each. This winding will tune from 200 to 1,000 metres. Price 3/6.

Ebonite panels for the tapped inductances 7" x 5" x 3/16", drilled for 2 sets of 11 each contact studs and terminals, complete with 22 studs, 3 switch arms, complete, 2 phone, earth and aerial terminals and blue print of connections. Price 7/-. Polished Mahogany sloping front Cabinet for above panel. Price 6/-. The Coil and Panel make a most efficient tuner for Crystal or Valve.

H.F. Resistance Coupling, 50,000 to 100,000 ohms, cartridge type, with brass clips . . . 1/6

L.F. Transformer. Resistance Ratio, 4:1. Turns Ratio, 4:1. Tested at 1,000 volts. Primary to secondary and Winding to Iron. Best Swedish Iron used in the Core and impregnated between laminations by a special process to ensure freedom from distortion. Price 12/6 each.

Ebonite cut to any size, 3/6, 1d.; 1/4d.; 1/2d. per sq. inch. Turned Ebonite dials, engraved 0-180 as illustrated . . . 1/6 Without Knob . . . 1/3



P. H. BOYS & Co.

Electrical & Wireless Engineers,

187, Goswell Rd., London, E.C.1.

Phone: Clerkenwell 4454.

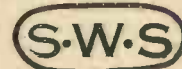

STRAND WIRELESS SUPPLIES

408, STRAND, LONDON, W.C.2

(Telephone: GERRARD 1668)

RIGHT THROUGH THE HAT SHOP

SPECIAL OFFER FOR ONE MONTH ONLY

THE BEST SETS ON THE MARKET

including

- | | |
|--------------------|------------|
| MARCONIPHONE V.2/A | REVOPHONE |
| GECOPHONE | RADIOPHONE |
| COSMO—2-VALVE SETS | SUPERCRYST |
| FELLOPHONE | FELLOCRYST |
| EVER-READY—1 VALVE | RE-ECHO |

with or without Amplifiers and Amplifiers.

BY

EASY PAYMENTS

ARRANGED TO SUIT YOUR CONVENIENCE

Call and choose your Set and then arrange terms TO SUIT YOURSELF

CALL AT ONCE, THE TIME IS LIMITED THIS OFFER WILL NOT BE REPEATED

RIGHT THROUGH THE HAT SHOP

HULLO EVERYBODY

VARIABLE CONDENSERS

ASSEMBLED AS ILLUSTRATED.

Drilled Ebonite Ends to fix yourself, 1/- per pair extra.

Approx. Capacity in Mfd.	No. of Plates.	PRICE
·001	57	6/6
·0005	29	4/6
·0003	19	3/3
·0002	13	2/6
·0001	7	2/3
Vernier	3	1/9

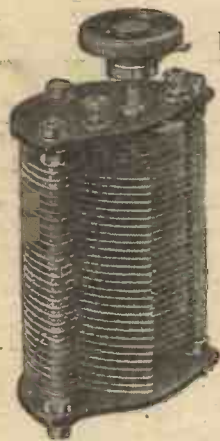
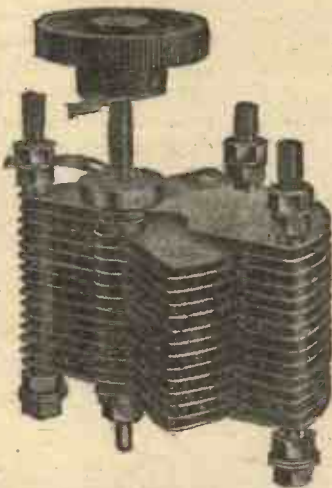

NOT Thrown Together

COMPLETELY ASSEMBLED AS SHOWN



·001	8/-
·0005	5/11
·0003	4/11
·0002	3/11
·0001	3/6
Vernier	3/3

ALL ORDERS BY POST MUST BE ACCOMPANIED by 1/3 per set EXTRA. — OTHERWISE NOT EXECUTED —

ALL GOODS ORDERED BY POST must be accompanied by the *Correct Post Prices* marked on each article. The quality and value given do not permit of them being sent otherwise. No rubbishy catch lines here. All real value for money. PLEASE NOTE.

- Rubber Lead-in Wire (good), 12 yd. 1/9. By post, 2/6.
- Bell Wire, 12 yds. 8d. By post, 1/- doz.
- Twin Flex, 12 yds 1/9. By post, 2/- doz.
- Switch Arms, 10d., 1/-, 1/3, 1/6. Post, 6d. each extra.
- Rotax Accumulators, 4 v. 40 amp., 17/-. Carriage, 2/- each.
- Fixed Condensers. Good value. 11d., 1/3. Post, 6d. each extra.
- H.T. Batteries, 60 volt, 9/-. Carriage, 2/- each.
- H.T. Batteries, 15 volt, 2/6. Carriage, 1/- each.
- Ebonite Valve Holders, 10d., 1/-, 1/3. Post, 6d. each extra.
- Basket Coils, "Oojah," set of 7, 5/-. By post, 6/- set.
- Basket Coils, 2/8 and 3/6 set. Post, 6d. extra.
- Insulated Sleeving, 5d. and 6d. length.
- Crystals (Mounted), Hertzite, 1/-. By post, 1/6.
- Crystal Detectors, on ebonite, 1/6. By post, 2/-.
- Perikon Detectors, enclosed with 2 crystals, 2/4. By post, 3/3.
- Perikon Detectors, suit expensive set, 3/9. By post, 4/6.
- Enclosed Detectors, 1/8, 2/9, 3/6, 3/9. Post, 1/- each extra.
- Valve Pine, slotted, 1d. doz. By post, 1/-.
- Aluminium Vanes, 22 gauge, 5d. doz. By post, 9d. doz.
- Tapped Coils on Ebonite, 10 tappings, broadcasting size, price 2/6. Post, 1/- each extra.
- S.P.D.T. Switches on Ebonite, 1/9, 2/6 each. Post, 9d. each extra.
- D.P.D.T. Switches on Ebonite, 2/6, 3/6 each. Post, 9d. each extra.
- Accumulators, 6 v. 60 a., absolutely the best, 35/- Carriage, 2/- extra.
- Slider Knob and Plunger, 3d. each. By post, 7d. each.
- Terminals, W.O., Telephone, P.O. and all patterns, including nuts and washers, not junk, 2 for 3d. 1/6 doz. By post, 1/- doz. extra.
- Aerial Wire, 100 ft., 7/22, 2/1d. By post, 3/3 a hank.
- Intervalve Transformers, very best, 25/- Also 12/6 each, 16/-, 20/- each. Post, 1/- each extra.
- Knobs, bushed 2 B.A. (best), 3d. each. By post, 7d.
- 3 Way Coil Holders, Ebonite and brass fittings, 7/6. Post, 1/- each extra.
- Dubiller Condensers, at usual prices.
- Telephone Transformers (R.I.), 20/-. Post, 1/6.
- H.T. Batteries, 30 volt, 4/6; 36 volt, 5/-. Post, 1/- each extra.
- Telephone Leads, long, 1/- Post, 6d. extra.
- Filament Resistances, 1/6, 1/8, 2/-, 2/6, 3/- Post, 9d. each extra.
- Transformers, L.F. (Radio Instruments, Ltd.), 25/- Post, 1/- extra.

D.C.C. Wire Stocked—22, 24, 26, 28 Gauge.

"BRUNET" FRENCH PHONES

4,000 ohms (different headbands) (post 1/6 pr.) ... 22/6 and 25/-
 B.B.C. Phones, best quality (post 1/6 pr.) ... 17/- and 19/6
 T.M.C., 4,000 ohms, stamped B.B.C. (post 1/6 pr.) 24/6 pair.

(Phones supplied by T.M.C. themselves, taken from expensive sets to clear.)

ERICSSON E.V. (not the imitation phones with wooden ear-pieces) Double Headphones. Stamped B.B.C. 17/9
 Post 1/6 pair extra. per pair

ON FRIDAY, SATURDAY AND SUNDAY
 SPECIAL CHEAP PRICES TO CALLERS

TO CALLERS!

I sell everything you want for your home-made Sets. No junk. No cheap job lines. All low in price, but first-class quality.

TRADE SUPPLIED

RIGHT OPPOSITE
 DALY'S
 GALLERY DOOR

M. RAYMOND

27, LISLE STREET, W.C.2

PHONE: GERRARD 4637
 OPEN 9 to 8
 Saturdays 9 to 6 p.m.
 Sundays 11 to 2

RECOGNITION



**THE FAMOUS
R.I. Intervalve Audio-Frequency
TRANSFORMER**

Price **£1 5 0**

Further recognition for the famous R.I. Transformer

THE R.I. Transformer is universally acknowledged the most perfect intervalve transformer ever produced, and is known and used throughout the universe.

It has been adopted in all the famous circuits at present in use and is invariably recommended by the radio expert.

John Scott-Taggart, P. Inst. P., Member of I.R.E., describing the famous S.T. 100 Circuit:—

"The two transformers used in this set were actually those manufactured by Radio Instruments, Ltd."

Three or even more of these transformers can be used in one instrument without distortion.

It is ideal for Power Amplification.

Many new transformers now appearing are close imitations in external appearance of the R.I., but are unable to give the results only obtained with the actual transformer.

Look for R.I. on every instrument.

RADIO INSTRUMENTS, Ltd.

Managing Director J. JOSEPH, M.I.E.E.
Chief Designer W. A. APPLETON, M.B.E., M.I.R.E.,
late Admiralty Technical Research Officer.

ONLY ADDRESS—Works, Offices and Showrooms:

12, HYDE STREET

NEW OXFORD STREET, LONDON, W.C.1

Phone: Regent 6214-5-6.

Telegrams: "Instradio, London."
(E.P.S. 59)

The "BROWN" LOUD SPEAKERS

with new improved
Curved Horns

THE requisites of a Loud Speaker are pure tone, clear articulation, and good volume of sound. The BROWN Loud Speaker possesses all these qualities in a marked degree. Type H. 2 has been designed to meet home requirements, both as to volume of sound and price.

PRICES

H. 2 (Small), Low Resistance.
120 ohms, height 12 in. **£3 0 0**

H. 1 (Large), Low Resistance.
120 ohms, height 21 in. **£6 5 0**
(High Resistances for either size, 2/6 to 5/- extra.)

THE BROWN MICROPHONE AMPLIFIER.

This amplifier gives a magnification much greater than that obtained from a two-valve amplifier.

Prices

Low Resistance (120 ohms input), **£8 0 0**
High Resistance (2,000 ohms input), **£8 2 5**

Our apparatus can be obtained from all wireless dealers.



H. 2
(small
size).

Height
12 in.

Illustrated Catalogue of Head-phones, Loud Speakers and Amplifiers, post free.

Sole Manufacturers:

S. G. BROWN, LTD.

London Showrooms:

19, MORTIMER STREET, LONDON, W.1

Head Office and Works: Victoria Road, North Acton, W.3

EDISWAN VALVES

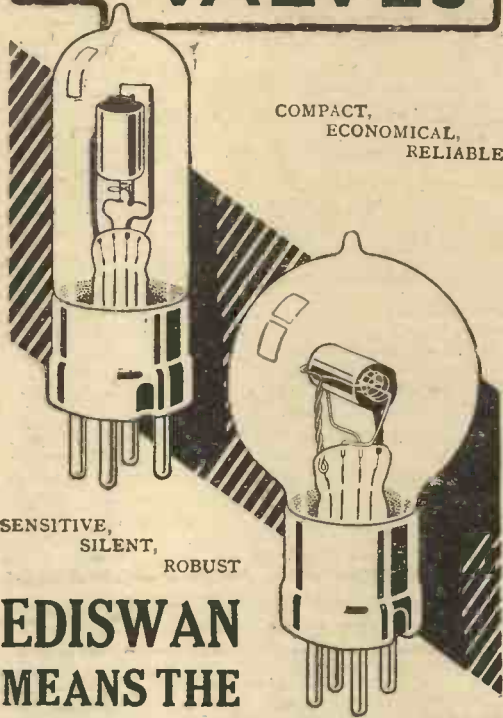

COMPACT,
ECONOMICAL,
RELIABLE

SENSITIVE,
SILENT,
ROBUST

EDISWAN MEANS THE BEST VALVE

Actual performance has proved beyond all question the superiority of the Edison Valve for wireless work. Every day adds to its reputation.

TYPE A.R. **15/-** TYPE R. **17/6**

We have had unique experience in the development and manufacture of the Thermionic Valve. The first experiments in connection with the investigation of the "Edison Effect" on which the working of a valve depends were carried out at our Ponders End Works by Prof. J. A. Fleming, who was the Company's Scientific adviser.

WHAT USERS SAY

A typical example of the splendid results constantly being brought to our notice:—

Dear Sirs,
Dudley, 16/10/23.
Last December I purchased one of your A.R. type receiving Valves, and I could not wish for a better Valve. My set is a home-made, single-valve, variometer tuned. My aerial is 18 ft. high and 110 ft. long; with this I can receive Glasgow, 250 miles distance, Newcastle, Manchester, London, Cardiff, Birmingham, 12 miles away.

Also Manufacturers of complete Receiving Sets, Accessories and H.T. and L.F. Batteries. Dealers should write at once for particulars and terms. Descriptive Leaflets free on request.

THE EDISON SWAN ELECTRIC CO., LTD.

Contractors to H.M. Admiralty, War Office, Royal Air Force.
123/5 QUEEN VICTORIA ST., E.C.4
and 71 VICTORIA STREET, S.W.1.

Works: Ponders End, Middlesex.
Branches in all Principal Towns.



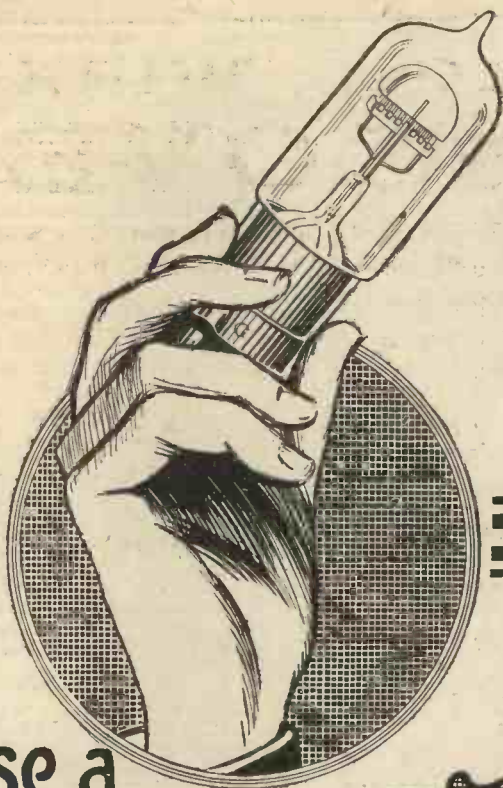

Use a
Cossor
—for better results

THE marked superiority of the **Cossor** as either a Detector or Amplifier is due to its unusual design. Any Valve depends for its efficiency upon the correct use of the electron stream given off by the glowing filament. In the **Cossor** practically the whole of the electrons impinge on either the hood-shaped Grid and Anode and none can get as far as the glass.

The two outstanding **Cossor** features are:—

- (i) Clear undistorted speech with a total absence of microphonic noises.
- (ii) *Unvarying* service throughout its long life, owing to its curved filament and hood-shaped Grid—the wires of which are interlaced and anchored in three positions, not merely in one.

Sold by all Dealers in
Wireless Components
and manufactured by

Cossor Valve Co., Ltd.,
Highbury Grove, N.5.

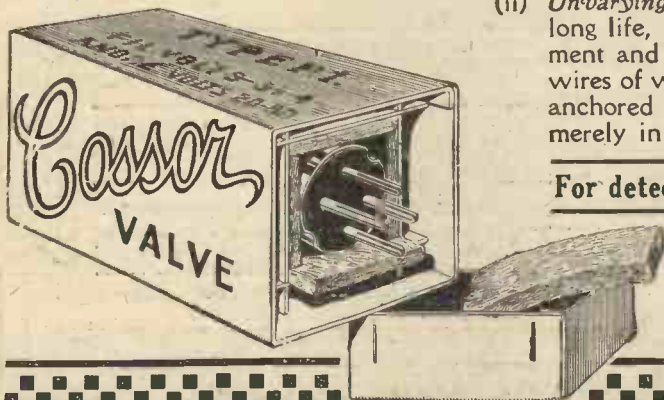

For detecting or amplifying

15/-

CLUB DOINGS (continued from page 878)

On June 8 Mr. G. A. Y. Sowter gave the first of his lectures on "Amplification." In this lecture he confined himself to high-frequency amplification, and dealt with the theory of H.F. circuits in a very lucid and exhaustive manner. Some interesting figures were given showing the great importance of avoiding stray capacity in radio-frequency circuits, and the theory of the rejector circuit for intervalve coupling was clearly expounded.

West London Wireless and Experimental Association.
Hon. Sec.—H. W. COTTON, 19, Bushey Road, Hayes. The secretary will be pleased to answer all inquiries respecting objects of the association and membership qualifications.

Radio Association. Eastern Branch.
Hon. Sec.—W. E. V. BULLIMORE, 2, Haig Road, Plaistow. At a meeting held on May 31 Prof. P. M. Baker gave an instructive lecture which was greatly appreciated by the large number of members present.

Stratford-on-Avon and District Radio Society.
Hon. Sec.—E. W. KNIGHT, 17, Park Road, Stratford-on-Avon. An exhibition of apparatus is to be held in the near future by this society, and the secretary will be pleased to forward particulars to prospective members concerning the society, terms of subscription, etc.

Oldham Amateur Radio Society.
Hon. Sec.—W. SCHOFIELD, 92, Sharples Hall Street, Oldham. On June 1, this being "Gadgets Night," two members brought forward, and illustrated, a convenient little panel for switching telephones in series with a receiving set, and an economical and novel design for a variable condenser.

The material and design for the club's portable three-valve receiving set were discussed, and an interesting debate was evolved concerning "double reaction," on which experiments were conducted by a number of members during the following week.

Newport and District Radio Association.
Hon. Sec.—H. W. WINSLOW, 3, Dock Street, Newport. At a general meeting of the association held on June 7 Mr. G. Betts lectured on "A Simple Crystal Circuit."

Variometers and Parts

IN connection with the paragraph under the above heading which we published on p. 803 of AMATEUR WIRELESS, No. 53, it will be as well to point out that the variometer referred to as being built of well-finished ebonite was the better-class one. Messrs. John Braham, of 200, Bishopsgate, are also selling a cheaper model, but this is wound on strong cardboard formers which are impregnated with a kind of insulating enamel.

Catalogue

BOOKLET B.C.2984, which we have just received from the General Electric Co., Ltd., gives particulars of a full range of wireless accessories and components. Most of the apparatus listed is the same as that used in the construction of "Gecophone" sets. Their leather-covered phones are particularly comfortable. A copy of this catalogue, which is of interest to all who are thinking of making their own sets, can be obtained by writing to Magnet House, Kingsway, W.C.2, mentioning AMATEUR WIRELESS.



Reactance on the Anode will bring in the distant stations and double your amplification. Our principle is approved P.M.G. and doesn't radiate. **RADIAX** Regd. Variable Reactance Coil for all wavelengths, 10/- Toned Anode Coil for same to plug into any H.F. Transformer Sockets, 350-300 metres, 5/6

If you haven't H.F. add our unit.
H.F. Unit in Oak Case, 2/6
Variable Condenser .0003 for same in case, 1/6

RADIAX LTD., 20, Radio House, Percy St., Tottenham Ct. Rd., London, W.1
Museum 490



RADIAX
WE SATISFY YOU

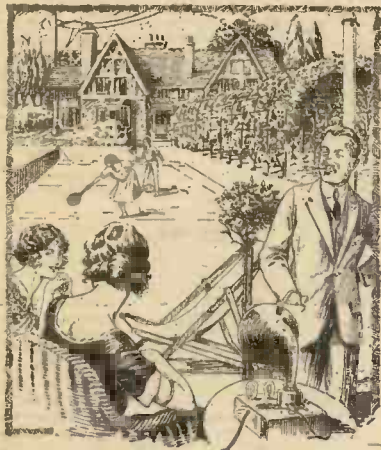

Take Your Wireless into the Garden

It is a simple matter to make a portable aerial from this Wire or to run a lead-in from the house to the Garden, whether it is a few yards or half a mile.

Ideal for all Training Purposes, Telephone Work, etc. etc., all over the World.

Supplied in three thicknesses all suitable for Wireless.

	300 ft.	500 ft.	1,000 ft.
CLASS 0 (thin) for light work	3/9	5/9	9/9
CLASS 1 (medium) for most jobs	4/3	6/3	10/3
CLASS 2 (thickest) for heavier work	5/3	7/6	11/6

Carriage Free.

On Original Drums, ABSOLUTELY NEW, as received from the manufacturer, carriage forward.
 On 1/2-mile drums ... per drum 15/-
 On 1 mile drums ... per drum 35/-
 On 2 mile drums ... per drum 70/-

Orders for 3 miles and upwards sent CARRIAGE PAID



Showing drums of Nos. 1 & 2 securely packed

NEW LONDON ELECTRON WORKS, LTD.,
 89, REGENT'S DOCK, LIMEHOUSE, E.14.

Special Terms to Shippers

Telephone: East 1821.

Telegrams: Stannum Step London.

Here's what you Want at the Right Price

- Brunet Type Headphones 4,000 ohms, 18/6. Postage 6d.
 - Scientific Basket Coils, set of six with calibration & circuit leaflet, 2/6. Postage 3d.
 - Oajah Baskets, set of seven, 3/6. Postage 3d.
 - D.P. 3-way Switch on Ebonite for Series-Parallel and Multi-Valve Circuits, 2/9 each. Postage 3d.
 - 4-inch Tens and Units Tapped Coils. Ideal for all Broadcast Concerts, 20 Tappings in all, 2/6 each. Postage 3d.
 - New Continental L.F. Transformers, 1-112/6, 2-113/6, 4-115/6, 5-116/6
 - Basket Coil Holders, to fit Standard Tuning Stands, enables you to use Basket or Slab Coils instead of Duolateral, 1/6 each. Postage 3d.
 - 2 Meg Grid Leaks, each 9d. Postage 2d.
- EX-GOVERNMENT BARGAINS**
- High Tone Reed Type Buzzer, 2/9 Postage 6d.
 - Morse Tapping Key with Silver Contacts, 1/3 Postage 3d.
 - 800 ohm, Silk Covered Eureka Resistance Bobbin, approx. 66 feet, 1/- Postage 2d.
 - Transformer, Ratio 150 to 1 ohms, 1/- Postage 4d.

SCIENTIFIC SUPPLY STORES

Phone: HOP 4177.—126, NEWINGTON CAUSEWAY, LONDON, S.E.1

ELECTRONITE

THE FAMOUS CRYSTAL which, when used in conjunction with our TORDINODIUM WIRE, gives WONDERFUL RESULTS

VERSE No. 6

We cupped it 'neath the quivering wire,
 Made good the contact light;
 Then listened to the Abbey Choir,
 Enhanced by our "Electronite."

ESTABLISHED — 1920



In box with Contact Wire

1/6 Postage 2d.

Trade Supplied.

234, HIGH HOLBORN, LONDON, W.C.1.

The Ideal **INSULATING VARNISH HARDICOL SHELLAC INSULATING VARNISH CEMENT**

Guaranteed made from pure shellac. A saturated solution in the cold. Perfect for all insulation work :: ::

Inquiries invited from the Trade.

6d. and 1/- Bottles. Also in bulk. HARDICOL IS OBTAINABLE FROM THE USUAL DEALERS AND THE MAKERS: A. F. Harding & Co. Ltd., Exmouth St., Stepney, E.

If you have NOT a VALVE SET adopt the next best and use



SCIENTIA CRYSTALS

1/6 each or 3 for 4/- post free.

SCIENTIFIC METALS CO. LTD (Estd. 1912)

Rare Metals Specialists

IMPERIAL HOUSE, KINGSWAY, W.C.2. Telephone: REGENT 3420.

OUR IMPROVED

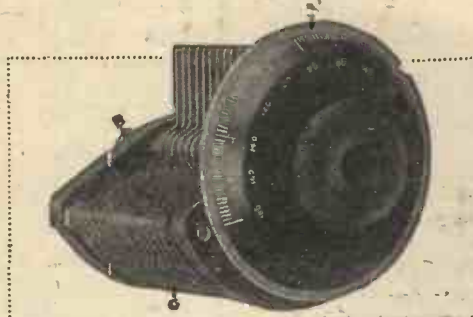

Complete in every respect, and exactly as illustrated, to the following specification:—

Rotary, Air Dielectric, 22 Gauge Aluminium Vanes, Metal to Metal Adjustable Bearings, Spacing between plates sufficient for pressure up to 1,000 volts. Engraved Ebonite Dial. Is suitable for mounting on any panel up to 3/8" thick by drilling 3 holes. Supplied with screws for fixing.

PLATES	PRICES:
57 ...	'001 10/-
29 ...	'0005 8/6
19 ...	'0003 6/9
13 ...	'0002 5/6

Postage and Packing:
1. 1/-; 2. 1/3; 3. 1/6.

If more than 3, kindly include ample for packing and carriage.

Don't allow our low prices to prejudice you. They are no criterion whatever of the value we offer. Our motto is **QUALITY FIRST**, and every Condenser carries our money-back guarantee.

type AII. CONDENSER

← —for Panel Mounting—

—is unsurpassed for workmanship, quality of materials employed, efficiency and **PRICE**, which, by the way, has **NOT** been INCREASED.

TESTIMONIAL—ONE OF HUNDREDS:—

Gentlemen,
23a, Old Bond Street, W.1.
With reference to the Condenser '001 which you supplied to our order yesterday. This was fitted to an H.P.R. Tuner and amplifier last night with the most satisfactory results. The tuning of the Paris concerts has been made infinitely easier. We consider your instrument the most wonderful value and a model of what workmanship should be. You can make any use of this letter you like.
All originals can be inspected.
Yours truly, A. O. FRENCH BREWSTER.

WARNING!

Don't buy shoddy sets of Condenser parts which are well nigh impossible of assembly, or half assembled Condensers, which are merely thrown together. **BUY OURS.** We specialise in Condensers. Complete in every respect and exactly as illustrated.

FALLONS

In response to numerous enquiries we beg to state we manufacture Variable Condensers only.

THE CONDENSER PEOPLE,

Prompt Delivery.

Cash with Order.

230a, HERMITAGE ROAD, LONDON, N.4.
Finsbury Park, near the Manor House.

FALLON CONDENSER MFG. CO., LTD., Makers of Half the World's Variable Condensers.

EBONITE SHEETING

Good Quality, all Substances in Stock
IMMEDIATE DELIVERY

PER **3/-** LB.

Good Trade Discounts. Write for Catalogue

Wireless Installations Ltd.

81, TURNMILL STREET
FARRINGDON ROAD, E.C.1

'Phone - - CLERKENWELL 5434

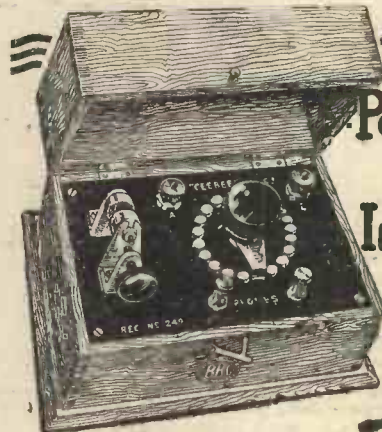

Perfect results
with
Indoor Aerial
for

£1.12.6

The Ceebee No. 3

THIS highly efficient instrument is given a most thorough test before dispatch, and is guaranteed to give perfect reception over a broadcasting range of 25 miles. Wonderful results can be heard at our Showrooms on this identical set attached to an Indoor Aerial.

Price £1 : 12 : 6 including Royalties

TRADE
SUPPLIED

FOWLER & BRIGDEN

130, Euston Road, King's Cross, London, N.W.1

'Phone: MUSEUM 4827.

THE WADE LATHE

(PATENT APPLIED FOR)

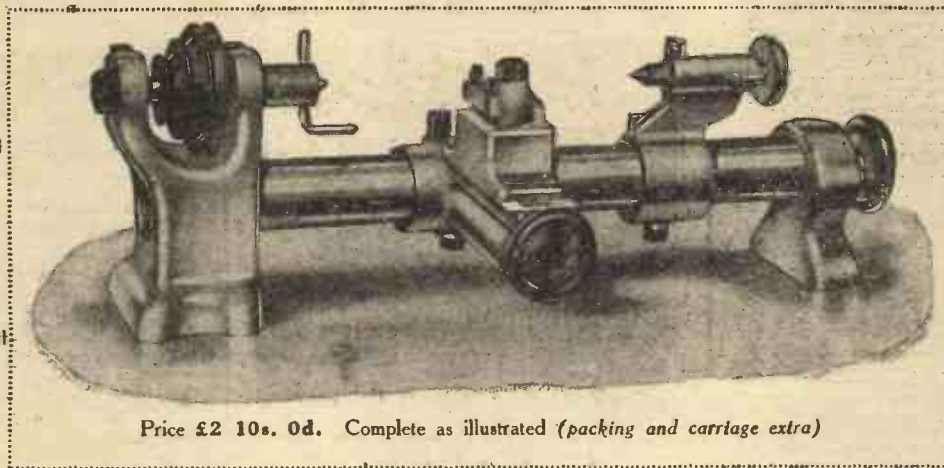

Price £2 10s. 0d. Complete as illustrated (packing and carriage extra)

Particulars and Prices of Accessories on Application to :

C.A.V. SMALL TOOLS, LTD., 181, QUEEN VICTORIA ST., LONDON, E.C.4.

Works: HOVE, SUSSEX.

TO THE TRADE

Send Your Inquiries to
LONDON METAL WAREHOUSES, LTD.,

- FOR
BRASS RODS, TUBES, SHEETS, ANGLES, etc.
COPPER SHEETS, FOIL, WIRE, etc.
ENAMELLED COPPER WIRE; RESISTANCE WIRE.
BRASS SCREWS, NUTS, AND WASHERS.
ALUMINIUM, BRONZE, etc.
CASTINGS IN ALL NON-FERROUS METALS.
ALUMINIUM AND GUNMETAL PULLEYS.

Foundry and Warehouse :

Hill St., Pockock St., Blackfriars Rd., S.E.2.

Telephones:
HOP 1913 & 6196

Telegrams:
"STEBWARE. SEDIST. LONDON."

SOLDER OR SORROW—

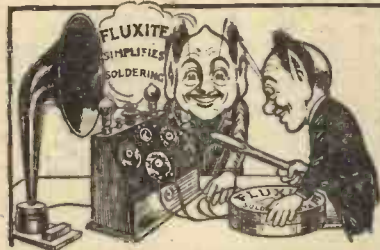

WHICH IS IT TO BE?
The Wireless aspirant who is satisfied in leaving the connections of his aerials and set terminals to look after themselves by just twisting them together is asking for trouble. Apart from the untidy appearance, careless connections are going to lower the efficiency of the finest receiving set in the world. SOLDERING will make doubly sure of them, and, incidentally, FLUXITE will make sure of the soldering. Soldering is child's play when you've a tin of FLUXITE at hand to help you, or, better still, a complete Soldering Set that we have had specially prepared for the convenience of customers. Ask your Ironmonger or Hardware Dealer to show you the neat little

FLUXITE SOLDERING SET.

It is perfectly simple to use, and will last for years in constant use. It contains a special "small-space" Soldering Iron with non-heating metal handle, a Pocket Blow-lamp, FLUXITE, Solder, etc., and full instructions. Price 7/6 Sample Set, Post Paid United Kingdom.



FLUXITE SIMPLIFIES SOLDERING

All Hardware and Ironmongery Stores sell FLUXITE in tins, price 8d., 1/4, and 2/8.

Buy a Tin To-day.

FLUXITE LTD., 326, Bevington Street, Bermondsey, England

For the tool-kit of your car or motor-cycle or any soldering jobs-about the home.

SPECIFICATION:
Set comprises sold best ebonite drilled detector panel, wound induction coil, tuning slider, screw, clamp crystal cup, best quality crystal, universally jointed detector, giving accurate and easy adjustment, terminals, screws, and all parts for assembling by our patent method

The "BROWNIE WIRELESS"

CRYSTAL RECEIVER.
7/6 COMPLETE. BY POST 8/6.

Contains every part necessary for simple erection. A scientific achievement. Guaranteed equal to sets costing many times the price. Full and complete instructions enclosed with each outfit. London make. Money returned if not as advertised.

Read what "Amateur Wireless" says: "It was tested by a member of our staff in the north of London, and with four pairs of headphones attached in parallel gave clear and sufficiently loud speech. . . . We can answer for the excellent results to be obtained."

Send postcard for folder "The Brownie Wireless and all about it."
The J. W. B. WIRELESS COMPANY,
19, GARRICK STREET, LONDON, W.C.2.
(First Floor). Near Leicester Square Tube Station.



HALL'S WIRELESS ACCESSORIES

The "HALL MARK" of QUALITY

- Crystal Detectors, adjustable in every way ... 1/11
- ditto, ditto, enclosed in glass case ... 3/6
- Engraved Ivorine Scales, 0-100 ... 2/4d.
- Filament Resistances, extraordinary value, velvet action ... 2/1
- Switch Arms, complete with knob, collar, washers, bush nuts, etc. 1st quality, 1/-; 2nd quality ... 10d.
- Valve Holders, turned ebonite, complete with nuts, 1/-; 2nd quality ... 10d.
- Crystal Cups, plain, 1d.; one, two, or three screw ... 2d.
- Terminals, with nut and washer, 1d., 2d., and 3d. ... 3d.
- Basket Coils, set of 7 ... 3/6
- Contact Studs, 1/2 in. by 1/4 in., 3/4d. per doz.; complete with nut and washer ... 5d.
- Insulators, white egg, 2d.; green egg, 2/4d.; green shell ... each 3d.
- Stop Pins ... 7d. doz., each 1d.
- Valve Pins, with nut and washer, each ... 1d.
- Brass Nuts, 2, 3, 4 B.A., doz. 3d.; 5 and 6 B.A. ... doz. 2/4d.
- Ebonite Sheet, 1/2, 1/4, 3/8 (cut to any size) ... lb. 3/6
- Fixed Condensers, any capacity ... each 11d.
- Grid Leak and Condensers Combined ... each 2/6
- Slider Plunger, complete ... each 4d.
- Slider Rods, 12-in. or 13-in. 3/4-in. square brass, 4d.
- Hertzite, 1/-; Boronite, Carborundum, Galena ... 4d.
- Screwed Brass Lengths, 12-in. 2 or 4 B.A. each ... 2d.
- Inductances, wound 22/24 enamelled wire each ... 2/6
- Leading-in Tubes (Ebonite), 6-in. 9d.; 9-in. 10d.; 12-in. ... each 11d.

Orders under £3 kindly remit ample postage. Balance refunded if excess sent.

MAKE UP YOUR OWN SET. ALL PARTS IN STOCK.

Send for Free List

TRADE HALL'S SUPPLIED

Phone: Regent 1282

71, Beak St., Regent St., London, W.1
Our only Address. We have no Branches
Hours: 8.30 a.m.—8 p.m.; 1 p.m.—Saturdays.

BARGAINS IN WIRELESS

H.T., 25 volts, 5/-; 60 volts, 9/-; Valve Holders, 8d.; Pulleys, 8d.; Valve Legs, 8d.; doz. Terminals, W.O. 1/3 doz.; Phone, 1/6 doz.; Scales, 3/4d.; H.F. Transformers, 300/600, 2/6; Condenser Parts '00r, 5/8; Contact Studs, 5d. doz.; Fixed Condensers, 9d.; Ebonite Knobs, 8 for 7d.; Engraved Dials, 11d.; Switch Arms, 10d.; Slider and Plunger, 3d.; Slider Rod, 2 1/2 in. 4d.; Condenser and Leak, 2/9; Filament Resistance, 2/6.

POSTAGE EXTRA. No Waiting. Send for Lists.

W. J. BANES, POTTON RD., BIGGLESWADE.

NOTICE

to all Engaged in

ENGINEERING

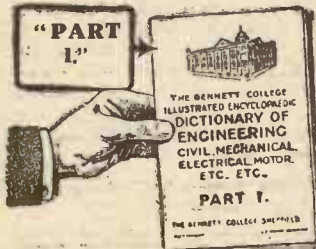

DICTIONARY FREE

3d. Postage only to pay

To extend the name of the Bennett College to every one engaged in the different branches of Engineering, we are publishing an ILLUSTRATED DICTIONARY OF ENGINEERING in about 24 monthly parts. You can have each monthly part as it comes out.

The Dictionary is free to those engaged in any of the following trades:—Engineering, Civil, Mechanical, Electrical, Structural, Motor, Sanitary, Boiler, Internal Combustion, Draughtsmanship, Marine, Shipbuilding, Naval Architecture, Building, Architecture, Quantity Surveying, Aviation, Chemistry, Foundry Work, Metallurgy, Matriculation, Mining, Surveying and Levelling, Telegraphy, Telephony, Wireless, and the conditions are that you send your name and address, your age and occupation, with three penny stamps (to cover postage), writing your name and address very clearly. We shall then place your name on our Free List, and send you Part I at once. The others will be forwarded as issued.

Do not fail to give the particulars required and use this full address.

Department D 54,

The Bennett College, SHEFFIELD.

Use

Ashley Radio Products

Ashley Wireless Telephone Co Ltd.
69 Renshaw St. Liverpool
Sole Agents

Modern Wireless

The National Wireless Monthly with over 100,000 regular readers

Price—ONE SHILLING

ELECTRADIX RADIOS

IMMEDIATE DELIVERY FROM OUR HUGE STOCKS

Everything from a Wavemeter to an Earth Clip. The best equipped City depot.

WAVEMETERS, all types, 100 to 10,000 metres Govt. calibrated. Limited number, special prices

COME AND SEE US
9, COLONIAL AVENUE is first opening on left in the Minories, near Aldgate Station, Metropolitan Railway.

LESLIE DIXON & CO. Tel: 4900
9, COLONIAL AVENUE, MINORIES, E.1

YOU WANT THIS!

Ebonite Holder.

Solid Brass Fittings.

Save money and increase the efficiency of your Set by using Coil Holders which you can place in any position.

PRICE 1/9 each. Post 5/- Set of 3. Free.

Ask your Dealer for them or from the Makers:

LEIGH BROS., Tel: Mus. 4547.
37, Sidmouth St. & 1a, Prospect Terrace, LONDON, W.C.1.

ADVERTISEMENT INSTRUCTIONS for "Amateur Wireless" are accepted up to first post on Friday morning for following week's issue, providing space is available.

PREPAID ADVERTISEMENTS.

Wireless.—The Newtonia Wireless Factory (S. Newton & Co.), established 25 years, supply dealers with raw material and partly manufactured parts at the right prices. Write for our list, 13/15, Whitcomb Street, Pall Mall, London, near Trafalgar Square.

Telephone Receivers Rewound up to 1,000 ohms, 5s.; 2,000 ohms, 7s. 6d.; cash with order.—M. E. Hampshire, 139, Sydenham Road, S.E.26. [7r]

Pickett's Cabinets. They're good value, 1s. 6d. each; highly polished. Write for lists, Manufacturers, Albion Road, Bexleyheath, S.E. [6r]

Improve Your Set.—Perfect Reception of speech and music with a variable grid leak; guaranteed; no pencil line; 4s. 6d. post free.—Steele Brothers, 7, Fraser Road, Aberdeen. [13s]

To Clear.—Aircraft spark transmitters with ammeter, 58s.; ex-G.P.O. and complete, Simplex telegraph set, 52s. 6d.; 200-ohm relays, 29s. 6d.; double current tapping keys, 10s.; sounders, 10s.; galvanometers, 11s. 2d.; various Dewar switches, from 3s.; twin twisted 20 tinned I.R.D.C.C. bell wire for indoor aerials, etc., 110 yd., 10s. 6d.; 55 yd., 6s.; Keenite, the super-sensitive crystal, from 1s.; our make perfect filament rheostats, 3s. 6d., 3 and 5 ohms; 28 M/F blocking condensers, 6d.; T.E.C. water-tight transmitting microphones, 15s. 6d.; postages extra. Everything for wireless.—Keen Wireless Co., 1, Dane Road, Ealing, W.13. [14s]

Wanted to Purchase stocks of wireless accessories, spot cash.—Apply Box No. "B.J.," "Amateur Wireless." [12s]

2,000 Ohms French Earphones. New, with leads, 6s. 6d. each, or 12s. pair; postage 1s.—Apply, J. J. Dooley, 398, Wandsworth Road, S.W.8. [11s]

Wireless Valves Repaired, 7s. 6d. and postage. Satisfaction guaranteed.—Milnes, 22, Wayland Road, Sheffield. [18r]

WIRELESS COMPONENTS FROM THE MANUFACTURERS

A few of our standard high grade, low priced lines

Three coil tuning stands, 12/-; H.F. "plug in" transformer formers, 1/6; Filament Resistances (former wound), 3/6; Slides complete with rod and terminal, 1/2; Switch arms (4 laminations), bush and knob, 2/-; Crystal-Detector (without Crystal), 3/4.

All Brass and other parts. Trade supplied.

D.S.S. ENG. CO., ALMA ROAD, WINDSOR

HAVE YOU THE

ONE IS WAITING FOR YOU.

It is just what you want. Covers Units and Sets in parts for home assembly. How to extend the range of your Set. Reactance apparatus at small cost. And the whole range of components and sundries.

RADIAX LTD., 20, Radio House, Percy St., Tottenham Ct. Rd., London, W.1. (Museum 490)

TELEPHONES

—Note My Prices

ERICSSON (Continental) E.V. (B.B.C.) 19/6

C.E.S. Silk wound to 4,000 ohms guaranteed. Perfect reception, superior finish 21/-

FRENCH 4,000 15/6

Delivery at once. No waiting. Cash with order.

Postage

1 pair 9d. 2 pairs 1s. 4 pairs 1/3

ROBT. DEANE,
137, Englefield Rd., London, N.1

THE MOST STARTLING WIRELESS OFFER EVER MADE

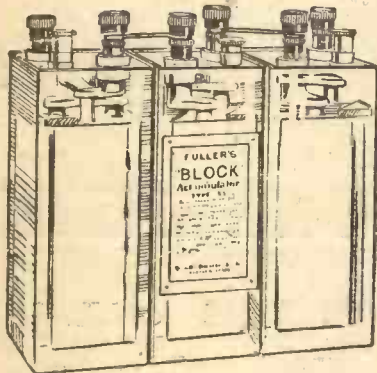

Test the Wonderful
FULLER
"BLOCK" TYPE
ACCUMULATOR
at our Expense!!

WE are giving away, **ABSOLUTELY FREE OF CHARGE,**
2,500 6-volt 40-amp.
"BLOCK" ACCUMULATORS

each listed at £2 8s. 9d.—a total of over £7,000—to our next 2,500 customers who place an order for certain of our goods to the value of £5 or over. In doing so, we are confident that it will be money well spent, as the many thousands of testimonials we have received from all parts of the world positively ensures that the "BLOCK" Accumulator, when once used, will prove to the user all that is claimed for it.

In framing an offer of this magnitude it is of course necessary to make a few stipulations. Briefly these are as follows:—

- (i) Only one free Accumulator will be allowed to any one customer.
- (ii) The offer will open with all orders received by first-post on Saturday morning (May 12th, 1923), and no claims for the free Accumulator in respect of orders received prior to that date will be entertained. One week's notice will be given of the withdrawal of the offer in the Wireless Press, and after the date then specified no claims for the free Accumulator will be entertained.
- (iii) In order that the Trade may extend the same offer to individual customers, we invite bona-fide retailers to write to us for particulars.
- (iv) Orders, to be eligible for this free gift, must be made up of any of the following items from our Catalogue:—Accumulators, High-tension Batteries, Variometers, Coil Holders, Sets of Parts for Home-made Sets, Loud Speakers, Variable Condensers, Rheostats, Transformers, Valve Holders, Aerial Wire, Lead-in Tubes, Terminals.

Polished Teak Cases to hold this size Accumulator, with leather strap, outside terminals, etc., can be supplied, if desired, at 10s. 6d. each.

WE are the Sole distributing Agents for

The McCLELLAND VARIOMETER

This instrument was the **FIRST INTERNALLY WOUND HIGH RADIO (9-1) Variometer** placed on the British Market. Mechanically and electrically it is efficient, and it is as strong and durable as **BRITISH** craftsmanship can make it.

Information will be gladly given to all interested in Variometer Tuning.

Fully mounted with connections made and carried to terminals

Price - 27/6

Packing and Carriage, registered, extra 1/6

TRADE TERMS ON APPLICATION

Send for our Booklet, "Variometers and Variometer Practice in Modern Wireless," 6d. post free.

French Thomson - Houston Headphones.

WE can confidently offer these Headphones as the most sensitive on the market. The clarity of the reproduction of music and speech is absolutely wonderful. Within a few days of our first offering these phones to the public, the repeat orders entirely disposed of our first contract of 10,000 pairs. We have now obtained an unlimited supply and owing to our having taken advantage of the recent depreciation of the franc, we are passing this advantage on to our clients by offering these phones at a price very much below that asked elsewhere, in some cases as much as 32/6 per pair is being obtained.

4,000 ohms, £1 0 0
per pair

[Postage (registered) which must be prepaid, 1/- extra.]

THE CITY ACCUMULATOR CO.

79, MARK LANE, LONDON, E.C.3.
10, RUPERT STREET, COVENTRY ST., W.1.

Agents (where the free Accumulators may also be obtained):

- LANCASHIRE & CHESHIRE:**
Henry Hollingdrake & Son, Ltd., Princes Street, Stockport.
- S. WALES:** South Wales Wireless Installation Co., Ltd., 18, West Butte Street, Cardiff, and at Cambrian Road, Newport.
- YORKSHIRE (West Riding):** Messrs. H. Wadsworth Sellers & Co., Standard Bldgs., Leeds.

Phone: AVENUE 1316

- GLOUCESTERSHIRE, SOMERSET & WILTS:**
Bristol Wireless Co., 52, Cotham Hill, Bristol.
- LEICESTERSHIRE:**
Walter Kowe, Ltd., Eldon House, 97, London Road, Leicester.
- FRANCE:** 33, Rue d'Hautville, Paris.
- AUSTRALIA:** 4, Teakle Street, Summer Hill, Sydney.

Our WEST-END SHOWROOMS are now open and inspection of our stocks is cordially invited. The showrooms are situated within a hundred yards of the new Lyons' Corner House.

WE, THE DUBILIER CONDENSER CO., Ltd., OFFER AN APOLOGY

to all those customers who have been kept waiting for delivery of our

“VANICON” VARIABLE CONDENSERS

For the first time in the history of this Company we have failed to give prompt delivery. This position has arisen entirely through our insistence on obtaining the best raw materials, without which we will not manufacture an article, as we know that by this policy we can guarantee you complete satisfaction.

Having now overcome all difficulties regarding supplies of materials, which measure up to our standard, we are in a position to give prompt delivery of

Vanicon

in the following standard capacities :

			£	s	d.
·0003 mfd.	-	-	0	17	6
·0005 ”	-	-	1	0	0
·0007 ”	-	-	1	2	6
·001 ”	-	-	1	5	0

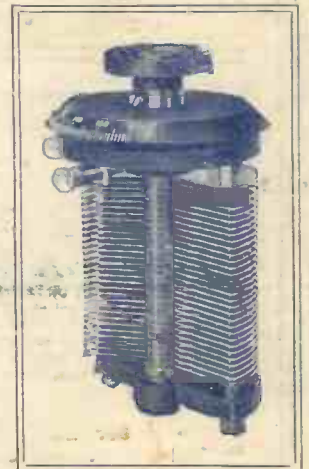
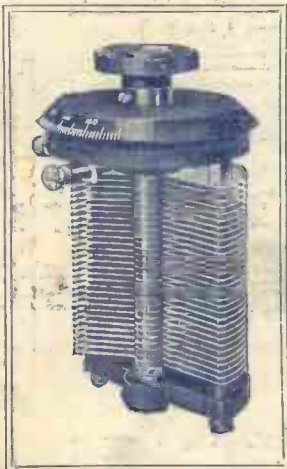

**IF YOU WANT THE BEST RESULTS FROM
YOUR SET INSIST ON DUBILIER CONDENSERS**

The Dubilier Condenser Co. (1921), Ltd.
Dept. A, Ducon Works, Goldhawk Road, Shepherd's Bush, W.12

Telephone : Hammersmith 1084.

Telegrams : Hivoltcon, 'Phone, London.