

Amateur RADIO

For all two-way radio enthusiasts

Build a Linear Amplifier

Construct an Easy
Two-Element Quad



On test: the Butternut
HF6V Vertical HF Antenna

EME 1296/2 INTERDIGITAL
FILTER REVIEW



RAYCOM give you MORE PURCHASING POWER!

FOR FAST SERVICE PHONE IN YOUR ORDER WITH ANY MAJOR CREDIT CARD OR IN MOST CASES WE CAN OFFER YOU INSTANT CREDIT OF UP TO £1 000.00 (SUBJECT TO STATUS RAYCOM ARE LICENSED CREDIT BROKERS APR 29 8% SUBJECT TO VARIATION FREE CREDIT ON CERTAIN PRODUCTS AT LIST PRICES. 50% DEPOSIT AND SIX MONTHLY PAYMENTS PLEASE TELEPHONE FOR MORE DETAILS AND APPLICATION FORMS

NEW HELPLINE 0836 28228 (until 9pm Daily)



ORDERING INFORMATION

ALL PRODUCTS WE ADVERTISE ARE NORMAL STOCK ITEMS OUR NEW MAIL ORDER DEPARTMENT CAN NOW DESPATCH MANY LINES SAME DAY BUT PLEASE ALLOW UP TO 14 DAYS DELIVERY TIME IS SUBJECT TO CARRIAGE METHOD IF ORDERING BY MAIL PLEASE INCLUDE CARRIAGE AND STATE YOUR DAYTIME TELEPHONE NUMBER ALL PRODUCTS OVER £750.00 CARRIAGE FREE PLEASE ALLOW TIME FOR PERSONAL CHEQUES TO CLEAR PLEASE CALL BEFORE ORDERING AND FOR MORE DETAILS

PLEASE TEL: 021 544 6767

THROUGH YOUR CONTINUOUS AND VALUED CUSTOM, RAY WITHERS COMMUNICATIONS LTD. HAS MOVED AND EXPANDED TO ENABLE US TO OFFER YOU EVEN BETTER SERVICE AND PRICES - STILL WITH THE RAYCOM GUARANTEE, BEST EQUIPMENT, BEST SERVICE, BEST PRICES, BEST BACK-UP, AND PLENTY OF PARKING FACILITIES AND EASIER TO GET TO! WE NOW BOAST THE BEST CENTRAL FACILITIES IN THE COUNTRY, WHY NOT POP ALONG AND SEE THE LATEST TRANSCIEVERS, SHORTWAVE SCANNING RECEIVERS AND ACCESSORIES? MOST OTHER PRODUCTS ADVERTISED IN THIS MAGAZINE ARE AVAILABLE AT RAYCOM, AND DON'T FORGET OUR EXCLUSIVE PRODUCTS AND MODS!

NEW PRODUCTS

NEW IC781
ICOM



Come and see the NEW ICOM IC781 HF Professional transceiver with built in Band Scope, Auto ATU and PSU, the new KENWOOD RZ1 Mobile Scanner, the new YAESU VHF Base Station and Mobile, and the new FOX mobile Scanner... because of our purchasing power and overseas contacts we get the new models first! And offer the best introductory prices!

SPECIAL OFFERS

WHILE STOCKS LAST!	NORMAL	SPECIAL
YAESU FT726 BASE STATION C W 2MTRS	£999 00	£695 00
YAESU YD844A BASE STATION MIC 800 50K	£39 95	£19 95
YAESU FT77 5W-120W 1.6 30MHz PA UNIT	£149 00	£75 00
YAESU HORN RELAY ALARM UNIT WITH 555	£12 50	£4 50
ICOM ICA20 AIR BAND CAA APPROVED H H	£429 00	£379 00
ICOM ICA2 AIR BAND CAA APPROVED H H	£399 00	£279 00
KENPRO KT400EE 2W UHF H H C W CHARGER	£279 00	£199 00
COLOUR ROTA 40KG ROTATOR 3 CORE CABLE	£48 00	£37 50

Please ask for our SPECIAL OFFERS LIST USED LIST SCANNERS LIST and LATEST PRODUCT NEWS Please send a large S A E

BASE STATIONS

YAESU FT767GX RWC MK2 ALL MODE BAND BASE STATION	£1499 00
YAESU FT767GX RWC MK2 AS ABOVE C W 2 OR 6 METRES	£1590 00
YAESU FT757GX MK2 MODEL WITH IMPROVED FEATURES	£895 00
YAESU FT726R MULTI BAND MULTIMODE SPECIAL OFFER	£695 00
YAESU FT747GX NEW MULTIMODE 100W HF TRANSCIEVER	POA
NEW YAESU FT736R MULTIMODE BASE STATION C W 2 METRES	POA
ICOM IC735 HF HIGH PERFORMANCE MINI HF TRANSCIEVER	£892 50
ICOM IC275 25W 2 METRE MULTI FEATURE SUPERB BASE STATION	£949 00
ICOM IC575 10W 10 & 6 METRE ALL MODE SUPER BASE STATION	£949 00

CALL FOR BEST PRICES ON OTHER ICOM AND YAESU BASE STATIONS

YAESU

FT767
GX RWC
MK2



Raycom offer our own improved version of this fabulous HF-UHF transceiver, we fit a small SMD chip component mod board in the VCO to improve the RX dynamic range by up to 20dB, FOC when purchased new from us. If you are lucky enough to own the FT767 already, send your unit + £59 50 and we will fit it for you! (inc return carriage) Also available at some Yaesu dealers. YAESU HAVE ADOPTED OUR UP-GRADE IN CURRENT PRODUCTION MODELS.

ANTENNAS & ACCESSORIES

NOW AVAILABLE AT RAYCOM CUSCRAFT, BUTTERNUT, HY-GAIN ANTENNAS, JAYULAM, TONNA, MET, HAM-M ROTATORS, Call for full details, prices, availability and delivery costs

ICOM AH7000 SUPER 2501300MHz DISCONE	£79 50
G5RV HALF SIZE HF ANTENNA ready to use	£16 50
G5RV FULL SIZE HF ANTENNA ready to use	£18 50
G8KW-TYPE 7 1MHz TRAP DIPOLE KIT SO239	£24 50
G8KW-TYPE as above for use with 300 OHM	£23 50
G8KW-TYPE 2X 7 1 TRAPS ONLY LESS CABLE	£9 95
RAYCOM AIRBAND-VHF SIX ELEMENT DISCONE	£12 50
RAYCOM DISCONE VHF 60-600MHz BE 80239	£29 50
SUN K209 SE2 5' 8 MOBILE TILT-OVER 259	£14 50
RAYCOM CAST GUTTERMOUNT C W SO239 COAX	£8 50
GAMMA TWIN 2 METRE SLIM JIM KIT inc instr	£14 50
RAYCOM/RWC HB9CV 2 METRE 2E MINI BEAM	£12 50
RAYCOM/RWC HB9CV 70CM 2E MINI BEAM	£8 95

The above popular products POST FREE

SCANNERS

YAESU FRG9600 from the company who specialises in fitting extra options as supplied to Government departments and professional bodies. We also upgrade existing models, please call for more details prices, delivery and information

Yaesu FRG9600 Basic Model Improved S Meter + Sens	£465 00
Yaesu FRG9600 RWC Mk2 60-950MHz N Connector Fitted	£495 00
Yaesu FRG9600 RWC Mk3 HF 100KHz 950MHz plus Mk2 Spec	£595 00
Yaesu FRG9600 RWC Mk5 HF 50KHz 950MHz Active Mixer	£625 00
Icom ICR7000 25M-2GHz superb quality professional Rx	£859 00
Icom ICR7000/AH7000 Receiver plus Matching Discone	£937 50
Kenwood RZ1 New 25 905MHz Mobile Wide and Narrow AM FM POA	£139 00
Fox VHF-UHF Multi Function Mobile Scanner FM only	£99 50
Unden-Bearcat UBC 50XL VHF UHF 10ch H held Scanner	£199 00
Unden-Bearcat UBC 70XL VHF UHF 20ch Miniature H held	£189 00
Unden-Bearcat UBC 100XL VHF UHF Airband H held Scanner	£175 00
Unden-Bearcat UBC 175XL VHF UHF Airband Desk Top	£220 00
AOR 2002 25-550 800 1300MHz Desk-Top Mobile AM FM	£245 00
Sony Air 7 Top Quality VHF Airband Handheld Scanner	£245 00

Package deal on above Mk3 5 FRG9600 c w AH7000 discone G5RV PA4 AC PSU complete receiving station HF UHF including delivery UK mainland Add £100 00 to above price
PACKAGE DEAL AVAILABLE ON ALL MAKES
SHORT WAVE RECEIVERS

Yaesu FRG8800 Short Wave 100KHz 30MHz all Mode Mem	£589 00
Yaesu FRG8800 FRV8800 as above with VHF Conv fitted	£679 00
Icom ICR 1 HF Top Grade Communications Receiver	£799 00
Sony PRO80 HF VHF Handheld Scanner c w accessories	£345 00
Sony 200TD Short Wave Airband DEI IIXF RX with ANI kit	£395 00

Many more makes and models in stock PLEASE CALL FOR PRICES DELIVERY COSTS and any advise or information or send large SAE (Insured post and packing £10 00 Carrier £12 50)

HANDHELDS

* Extended Receiver coverage available call for details	
YAESU FT727R FNB4A 2 5W (5W) DUAL BANDER C W CHRGR	£395 00
*YAESU FT23R FNB1D 2 5W (5W) 2MTRS C W CHARGER	£249 00
*YAESU FT73R FNB1D 2 5W (5W) 70CM C W CHARGER	£259 00
*ICOM MICRO 2E 2 5W 2MTR HANDHELD WITH CHARGER	£209 00
CTE1600 (SAME AS ICOM IC2E) C W NICAD CHARGER	£179 00

Many other types of handheld stocked please enquire

PORTABLES

FT290RMK2 2 5W MULTIMODE STANDARD ACCESSORIES	£399 00
FT290RMK2 2 5 WATT M M AS ABOVE C W NICADS CHRGR	£425 00
FT290RMK2 FL2025 (STD) WITH 25W LINEAR AMPLIFIER	£395 00
FT690RMK2 6MTR 2 5W MULTIMODE STANDARD ACCES	£429 00
FT690RMK2 6MTR 2 5W M M AS ABOVE C W NICADS CH	£425 00
FT790RMK2 NEW 70CM 2 5W MULTIMODE DUE OUT SOON	£499 00

MOBILES

YAESU FT211E 45W 2MTR MOBILE WITH FREE 1 4 WAVE ANT	£299 00
YAESU FT212R NEW 45W 2MTR MOBILE DVS FEATURE OPT	£349 00
*ICOM IC28E 2MTR 25W MOBILE WITH FREE 5 8 ANTENNA	£359 00

Many other types and makes stocked please enquire

Opening hours 9am-5 30pm 6 days, late nights Thursday & Friday till 7pm

SCANNERS

Bearcat
by unden



UBC 175XL



UBC 100XL

RAYCOM ARE TRADE AND RETAIL DISTRIBUTORS FOR THIS SUPERB RANGE OF QUALITY SCANNERS THE POPULAR UBC 100XL HAND HELD HAS SOLD IN THOUSANDS, BUT IS NOW COMPLEMENTED BY THE UBC 70XCL POCKET SIZED HANDHELD ALSO THE NEW COST EFFECTIVE UBC 50XL HANDHELD SEE THE NEW MODELS IN OUR SHOWROOMS OR SEND A S A E FOR DETAILS

FROM £99 50

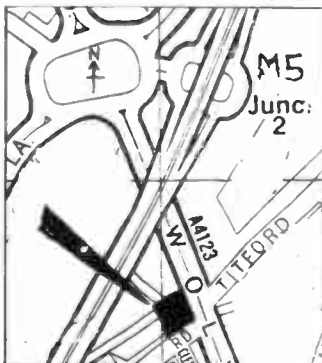

SONY RAYCOM now appointed official Sony dealers, full range of both professional and domestic models available to order.



RAYCOM COMMUNICATIONS SYSTEMS LTD.
INTERNATIONAL HOUSE, 963 WOLVERHAMPTON ROAD
OLDBURY WEST MIDLANDS B69 4RJ
Telephone 021 544 6767. Fax 544 7124. Telex 336483 Identi-G

Amateur RADIO



Editor:

Jane Berry

Assistant Editor:

Lisbeth Stedman

Editorial Assistants:

Nicola Woodford
Bob Farmer

Advertisement

Manager:

Marian Vidler

Subscriptions:

01-760 0409

Accounts:

Clare Brinkman

Publisher:

Peter Williams

On sale: Last

Thursday of the
month preceding
cover date

Next issue: Cover date

May 1988, on sale
28 April 1988

Published by:

Amateur Radio
Magazines,
Sovereign House,
Brentwood, Essex
CM14 4SE, England
(0277) 219876

Printed: In England

ISSN: 0264-2557

News Trade Sales by:

S M Distribution,
6 Leigham Court,
Streatham,
London. SW16 2PG
Tel: 01-677 8111

The Sony SW1S
world-band receiver.

Photo by Dave Morgan

Whilst every care is taken when accepting advertisements we cannot accept responsibility for unsatisfactory transactions. We will, however, thoroughly investigate any complaints. The views expressed by contributors are not necessarily those of the publishers. Every care is also taken to ensure that the contents of *Amateur Radio* are accurate; we assume no responsibility for any effect from errors or omissions.

© Copyright 1988
Amateur Radio Magazines

6 Straight and Level

All the latest news, comments and developments on the amateur radio scene

12 DX Diary

Don Field G3XTT with this month's DX news

14 Noise – the Final Frontier

These are the voyages of Ian Poole G3YWX on his mission to seek out new sources of interference, to boldly look at the bane of the amateur's existence. Read on!

17 Angus McKenzie Tests

The Butternut HF6V vertical multiband antenna, the EME Model 2 1296MHz interdigital filter and RN Electronics' RF sensed RF attenuator are all examined this month

25 Linear Amplifier Part 2

This month Brian Kendal gives construction details for an inexpensive linear amp that won't get the bailiffs knocking at your shack

32 QSLing – The Inside Story

How to get them, where to send them – tips and hints from Phil Whitchurch G3SWH

36 A Two-Element, Full-Size Quad

DV Pritchard G4GVO describes an easy-to-make quad to get you onto twenty painlessly

40 Short Wave Listener

Trevor Morgan on communications receivers – what to look for when buying second-hand

42 The Sony ICF-SW1S

We look at the very new and very small ICF-SW1S, Sony's latest world-band radio

44 Bits to Build

Save your rig from reversed power supplies with George Dobbs' polarity protection device

45 Coming Next Month

What's in store for you

46 50MHz

Ken Ellis with a host of six metre beacon lists and sound and video data, not to mention news from Japan

48 On the Beam

Glen Ross with more ghost stories and tales of new and horrible noises

50 Secondhand

Hugh Allison tells you how to blow up Microwave Modules transverters and avoid the police

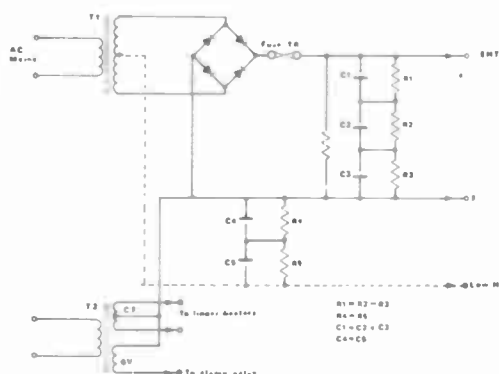

52 Project Book

Martyn Williams continues his series on component codes

53 Free Classified Ads

The market for buying and selling

SERVICES

16 Subscription Order Form

41 Back Issues Order Form

55 Free Classified Ad Form

58 Newsagents Order Form

58 Advertisers Index

58 Advertising Rates and Information

Price change

We regret to inform readers that, due to constantly rising production costs and to enable us to maintain the high standard of content in *Amateur Radio*, the price of the magazine will be £1.50 from this issue



P.M. COMPONENTS LTD

PHONE 0474 6052 1

STOCK OF BRANDED OUR

SPRINGHEAD ENTERPRISE PARK, SPRINGHEAD ROAD

GRAVESEND, KENT DA1 1 8HD

TELEX 966371 TOS PM

A SELECTION FROM OUR STOCK OF BRANDED VALVES (Cont'd)

Table listing various valve types (e.g., DL35, DL63, DL73) with columns for model, price, and other specifications.

Table listing various valve types (e.g., 30P13, 31USC, 33A158M) with columns for model, price, and other specifications.

OVER 1 MILLION VALVES IN STOCK. Specialist experience and matched valve available on request.

CALLERS WELCOME. OPEN MON-THUR 9AM-5:30PM. FRI 9AM-5:00PM. 24-HOUR ANSWERPHONE SERVICE.

ACCESS & BARCLAYCARD PHONE ORDERS WELCOME. UK ORDERS P&P BY PLEASE ADD 15% VAT. EXPORT ORDERS WELCOME. CARRIAGE AT COST. PLEASE SEND YOUR ENQUIRIES FOR SPECIAL QUOTATIONS FOR LARGE REQUIREMENTS.

STRAIGHT &

LEVEL

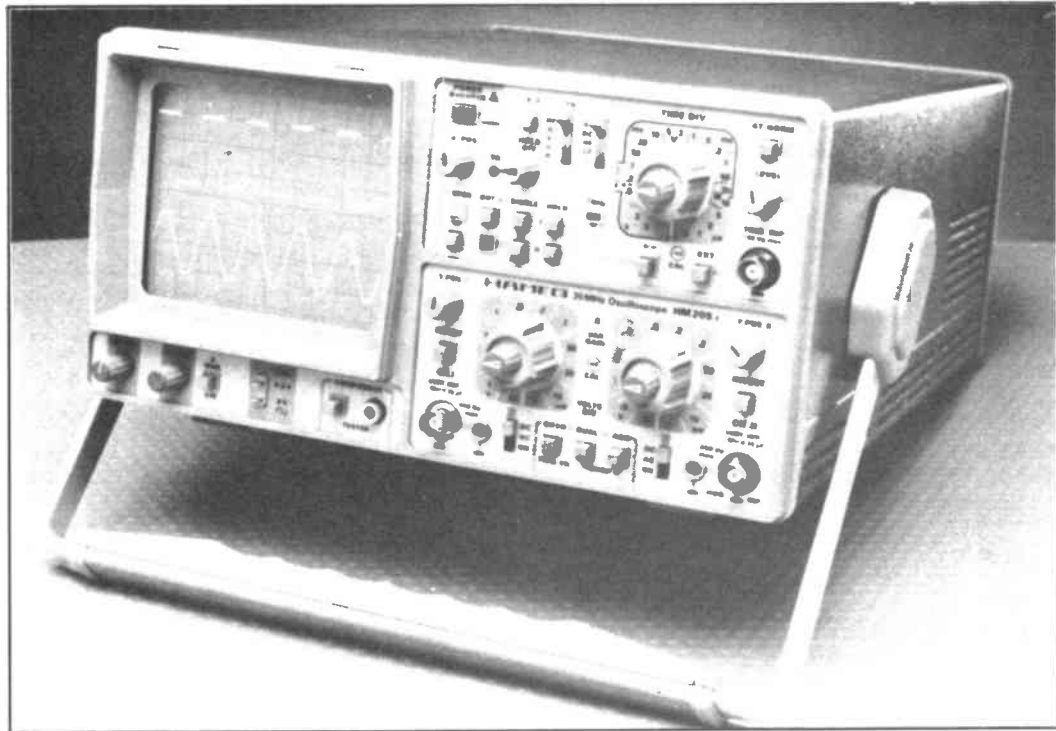

DIGITAL OSCILLOSCOPE

New from Electronic Brokers is the Hameg HM205-2 – a versatile 20MHz oscilloscope that offers digital storage capability at an extremely economical price for a scope of this kind.

In addition to the numerous features on this economically engineered 20MHz instrument, the new HM205-2 proffers $2 \times 1K$ of digital storage and a sample rate which can be varied from 100kHz to 5MHz; particularly useful for

analysis of slow events. Analogue features include a component tester, active video trigger and integral calibration.

The HM205-2 gives full 2-channel dc – 20MHz capabilities, with a (maximum) 2mV/cm deflection, 0.2s – 20ns/cm timebase and triggering from dc – 40MHz. Noisy and distorted TV signals may still be triggered stably with the instrument's active video trigger, and

there is a variable hold-off for other complex inputs.

Where operated as both an analogue and digital 'scope, the HM205-2 is impressive with its functional versatility, aimed at providing increased user productivity. It is available from Electronic Brokers at a cost of £527.

For further information, contact: *Electronic Brokers Limited, 140-146 Camden Street, London NW1 9PB. Tel: 01-267 7070.*

CLEANING UP

Geefor Enterprises have introduced a new service for the busy amateur whose XYL is also tied to the airwaves.

The company is offering a 10% discount on carpet and upholstery cleaning to anyone who buys a rig from them. Also included is free delivery within 25 miles of the company address.

Another free service for amateurs relates to the company's news sheet, *Barter News*. If equipment is stolen, details can be sent to Geefor who will publish them as soon

as possible. Anyone who is interested in either of these services should send an SAE for details to Martyn Bolt.

For further information please contact: *Geefor Enterprises, 112 Leeds Road, Mirfield, W Yorkshire WF14 0JE. Tel: (0924) 495916.*

POWER DIVIDER

Available from Anglia Microwaves Ltd, the broadband AMC PD-1000-2 two-way power divider has a frequency range from 10MHz to 1GHz. The divider gives

a low insertion loss of less than 0.6dB (maximum) and features a return loss of 20dB from 20MHz to 1GHz.

There is a choice of BNC, TNC, SMA and N connectors for the three ports. The divider circuitry gives a symmetrical output, with amplitude balance of within 0.2dB and phase balance to within 2° .

For further information please contact: *Anglia Microwaves Limited, Radford Business Centre, Radford Way, Billericay, Essex CM12 0BZ. Tel: (0277) 630000.*

All the latest news, views, comment and developments on the amateur radio scene

FREQUENCY SOURCE

Crystal-controlled long term stability and reproducibility are two of the benefits offered by the Philips PM 5191 programmable synthesizer/function generator, which is now available from Electronic Brokers.

All parameters (frequency, amplitude and dc offset) can be easily and quickly entered using the front-panel keyboard. The current setting is stored in non-volatile memory, and can be used again after switching on the instrument. Alternatively, full IEEE/IEC bus compatibility allows all functions to be remotely selectable. Settings and status data can be transmitted to a remote controller and recalled whenever required.

The PM 5191's accuracy (negligible setting error is at $<1 \times 10^{-6}$; there is a low aging figure of <1 ppm/year) makes it a true reference standard in R & D, production line testing quality control and service applications. Frequencies are provided at very high accuracy – the distortion

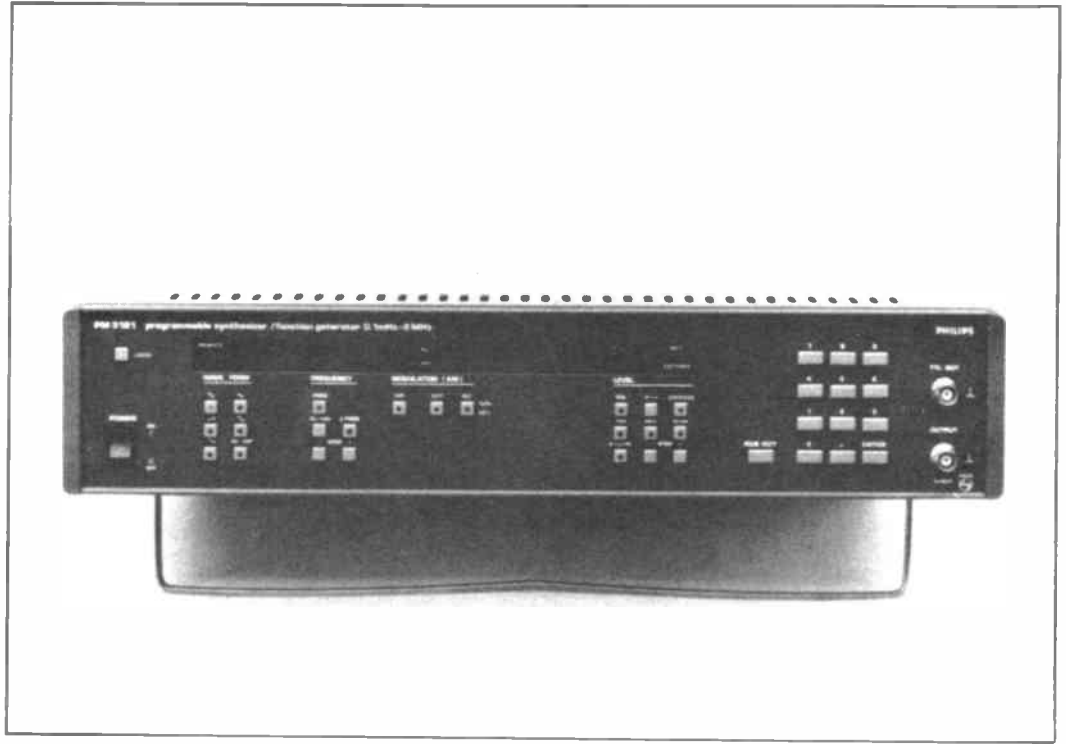

is typically only 0.35% between 1Hz and 200kHz.

The PM 5191's capabilities and precision are combined with a very economic cost of

£2667. This new instrument from Electronic Brokers is an attractive, general-purpose tool for a wide range of different applications.

For further information, contact: *Electronic Brokers Limited, 140-146 Camden Street, London NW1 9PB. Tel: 01-267 7070.*

ATTENUATOR/MODULATOR

The AMC AGH Series current-controlled attenuator/modulators cover a very wide frequency range, from 1 to 18GHz. There are seven models in the range, each covering a bandwidth of greater than an octave (3:1).

Introduced by Anglia Microwaves Ltd, the AGH Series of attenuators is non-reflective at all signal levels and features a maximum attenuation of 60dB.

The RF circuit consists of two microstrip arrays of pin diodes that are hybrid coupled at the input and output with large couplers. This results in a highly repeatable low-loss performance.

Reliability is ensured by a totally solid-state construction.

The attenuators are small, just $2.6 \times 2.0 \times 0.33$ inches for the largest, which is the AGH-1020. They can be fitted with male or male and female

SMA RF connectors.

For further information please contact: *Anglia Microwaves Limited, Radford Business Centre, Radford Way, Billericay, Essex CM12 0BZ. Tel: (0277) 630000.*

TANTALUM CAPACITORS

The Kemet T110 Series solid tantalum capacitors are designed for miniaturised circuitry and are especially suitable for coupling, bypass, filtering and R-C timing circuits. Introduced by STC Electronic Services, they are available to IECQ 300020/US0001 and are provisionally approved to BT D2281C, these compact devices are ruggedly constructed.

They also feature excellent stability, extremely low dc leakage current and dissipation factor as well as having impedance over a wide temperature and frequency range.

Hermetically-sealed, the series is offered in four standard sizes with operational voltages between 6.3V and 50V, a $\pm 10\%$ tolerance and a capacitance range from $0.1\mu\text{F}$ to $330\mu\text{F}$.

For further details, contact: *The Capacitor Group, STC Electronic Services, Edinburgh Way, Harlow, Essex CM20 2DF. Tel: (0279) 626777.*

ANALOGUE/DIGITAL MULTIMETERS

The world's first range of high resolution dynamic pointer analogue/digital multimeters – the AVO M2000 Series – is available from STC.

Until now instruments featuring both digital and analogue readings have offered only a limited analogue capability which has normally been in bar form.

This series of analogue/digital multimeters offers a dynamic response

analogue display with high resolution, which provides an accurate measurement of a particular value plus a clear indication of its variations.

Comprising five hand-held instruments (M2004 – M2008), the series features auto-range, range hold, data hold and peak hold facilities. In addition, they feature analogue LCD scales with seventy divisions; integral probe holders; good frequency response; and true root mean square measurement (M2008).

Encased in a highly rugged rubber buffer, these instruments offer accuracy extending from $\pm 0.7\%$ for the M2004 to $\pm 0.1\%$ for the M2007 and M2008 with an operational voltage range from 300mV to 1000V.

For further details, contact: *STC Instrument Services, Dewar House, Central Road, Harlow, Essex CM20 2TA. Tel: (0279) 641641.*

STRAIGHT & LEVEL

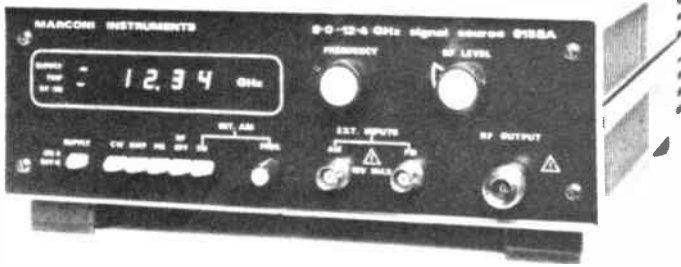

AM-FM SIGNAL SOURCES

The Marconi 6150A Series – 6158A and 6156A – Microwave AM-FM signal sources from STC Instrument Services are tunable solid state oscil-

lators which use a GaAsFET as the active element with a YIG resonator.

Offering full IEEE-488 or IEC control, with the optional

6140 GPIB adaptor, the user is able to interface commands from the bus to an instrument.

A wide range of modulation facilities are offered via several panel-selectable modes. CW is a single low-residual FM mode, whilst SWP enables swept frequency when a 0 to +10V drive is applied to the rear panel auxiliary or BNC sockets. A combination of CW and SWP offers slow sweeps (<1Hz), or steps between frequencies with low residual FM using rear panel sockets and external drive. FM provides fast frequency modulation up to ± 20 MHz deviation for a ± 10 V input to the front

panel BNC socket, at up to 100kHz for –3dB response.

Other modes are RF OFF, INT AM ON and AM. All AM functions are performed using a PIN modulator. AM and FM functions are independent, which allows complete control of the signal source. The rear panel auxiliary socket enables remote control of centre frequency, output power, 1kHz internal modulation, RF on/off and display banking.

For further details, contact: *STC Instrument Services, Dewar House, Central Road, Harlow, Essex CM20 2TA. Tel: (0279) 641641.*

BOOKS · CATALOGUES · BOOKS · CATALOGUES

GREENWELD SUPPLEMENT

Greenweld have just released their 1988 spring supplement – a 24-page catalogue detailing many new lines introduced since publication of the main 88-page catalogue last October.

Included within its pages are a CCTV system for less than £200, 2 pages of in-car audio products, sophisticated mixing consoles, tools, video equipment and books. Plus the bargain pages – 10 pages of surplus lines.

For more details, contact: *Greenweld, 443 Millbrook Road, Southampton SO1 0HX. Tel: (0703) 772501.*

SAFETY FIRST

The general safety requirement of the new Consumer Protection Act came into force on October 1st 1987, making it a criminal offence to supply goods that are not reasonably safe. This legal requirement is now backed up by a set of safety standards which will provide the benchmarks needed by courts, business and consumers.

The publication of the first 30 safety standards to be approved under the Consumer Protection Act 1987 covering a wide range of goods, from children's carry cots and protective hats for horse and pony riders to pressure cookers and central heating boilers was announced on February 3rd by John Butcher, Minister for Industry and Consumer Affairs.

In his maiden speech as



Consumer Affairs Minister at the BSI Annual Consumer Reception, Mr Butcher stressed the strong links forged between consumer safety and sound safety standards.

Mr Butcher announced his intention to publish lists of approved standards every six months and he also made public the 47 standards which are currently being considered for approval. These cover the areas of children's equipment, personal protective equipment, vehicle accessories, household equipment, fire resistance, DIY equipment, gas equip-

ment and standards for fire-works.

Details of these standards are available from BSI, who can also test equipment to the approved standards.

Their address is: *BSI Testing, Maylands Avenue, Hemel Hempstead, Herts HP2 4SQ. Tel: (0442) 230442.*

CROTECH CATALOGUE

Crotech's latest Test and Measuring Instruments catalogue contains a wide selection of cost-effective oscilloscopes, audio test equipment and accessories. The oscillo-

scopes featured include Crotech's new model 3133, a dual-trace 25MHz instrument. This has such features as variable hold-off, built-in component comparator and a triple output dc source.

For testing and developing AF systems, Crotech offers the type 2017 auto-tune distortion analyser/level meter. This is described along with a precision low-distortion signal generator and output power meter. These three items integrate to form a complete AF test system.

More information is available from: *Crotech Instruments Ltd, 2 Stephenson Road, St Ives, Huntingdon, Cambs PE17 4WJ. Tel: (0480) 301818.*

THE ELECTRONICS BOOK

STC Electronic Services has been appointed by Erwin Sick – a leading manufacturer of advanced photoelectric control devices – to stock a comprehensive range of sensing products which will form the basis of an entirely new section in the distributor's 1100-page catalogue *The Electronics Book*.

Amongst the reflex and diffuse proximity photoelectric sensors available are the VT and VL series pf control devices; the low cost FR2 range; the WL and WT27, designed for universal applications; and the WL36 long-range types.

For details, contact: *STC Electronic Services, Edinburgh Way, Harlow, Essex CM20 2DF. Tel: (0279) 626777.*

CLUB NEWS

Nom de plume

Spring is in the air, and the rally is beginning to raise its head again. We have news of a great open day (which sounds like a rally to us!) in Motherwell, hosted by the Mid Lanark Amateur Radio Society.

Taking place on June 12th, this event may seem to be a long way off, but it presents a great opportunity to persuade the XYL to take a holiday in Scotland...

There will be traders, a bring and buy stall, demonstrations of packet radio, RTTY, lectures and the annual awarding of the club's EHI Trophy—and lots, lots more. A rally by any other name is still as much fun to attend!

The new, improved venue for the open day is the community centre at Newarthill, near Motherwell. To find out more, contact David Williams GM1SSA on (0698) 732403.

Countdown

The amateur space community is passing through the '3 months and counting' milestone for the mid-April launch of Phase 3C, the most complex and capable OSCAR ever built. As the countdown proceeds, AMSAT planners are organising a major launch support project, to bring the excitement of the live launch countdown to AMSAT members and members-to-be across the globe.

The V22 launch will take place on or about April 15th at about 12.30 UTC. The AMSAT launch information network service, ALINS, will provide extensive pre-launch, launch countdown and post-launch coverage on a world-wide radio and telephone hookup. Operations Vice President Ralph Wallio, W0RPK, says a team of stations will combine to cover the HF bands. The morning (Kourou time) launch of V22 should provide good ALINS coverage on several HF bands. ARRL Headquarters station W1AW will join the team of ALINS stations covering the launch

of Phase 3, according to ARRL membership communications manager John Lindholm, W1XX.

The launch of the first Ariane 4 rocket from the ELA-2 pad is designated V22. The 'V' in V22 stands for the French word 'vol' or 'flight'. There will be three satellites aboard V22. In addition to AMSAT's Phase 3C, there will be the METEOSAT and PANAMSAT spacecraft. These two spacecraft and the two to be launched next on V21, SPACENET IIR/GEO-STAR R01 and TELECOM 1C, are already in Kourou. The two satellites to be launched on V21 have recently completed their preparations in the S1 preparations building at Kourou, and will be launched from the ELA 1 pad on an Ariane 3 vehicle on the evening of March 4th.

The Phase 3C satellite has completed its programme of testing in Marburg, West Germany and, after some last minute fine tuning, will be prepared for shipment soon to Paris and then on to the airport at Cayenne, French Guiana. From there it will be trucked by special vehicle to the ESA launch site at Kourou.

All Wight

We get club news from the top to the toes of Britain for your entertainment, and to prove it, here is some news from the Isle of Wight!

The Binstead 10W Radio Society meets every Monday at 7.30pm in 'Brickfields', Newnham Road, Binstead, IOW. The first Monday of the month is 'auction night' and the last, 'lecture night'. The lecture for March is on astronomy, and will be given by Ken G1RHU. This should have universal appeal!

If any other clubs feel that they qualify for one of the *Amateur Radio* 'book of records' titles, by being unique in some way, please write and tell us—largest, smallest, geographically unusual or just the best there is, we'd like to hear!

To find out more about this club, please contact R Griffiths, 29 Dubbers Godshill, IOW.

Low-down

It's going to be very quiet in Yeovil, Somerset on Sunday, May 8th. This is because the fourth Yeovil QRP Conven-

tion is going to be held in the Preston Centre, Monks Dale, Yeovil.

Lots of wonderful low-powered things will be happening—lectures by G3MYM and G4FAI, for a start. Many of you will recognise the latter callsign as belonging to the illustrious Tony Smith, editor of *Morsum Magnificat* and our very own *Morse Report*. He will be talking about the history of Morse and G3MYM will be talking about 80m propagation.

A special event station, with the very appropriate callsign GB2LOW, will be on the air using 1930s and modern QRP rigs. There will be components stands, and a display of homebrew equipment, as well as refreshments and a natter area.

There will be talk-in on S22 from 9.30am, so keep your ears open for the QRPerfect sending of Yeovil ARC. To find out more about the convention, contact G1MNM on (0935) 79804.

Where are you?

If you have been wondering just where the RAF Amateur Radio Society's overseas stations actually are, your curiosity may now be satisfied. Squadron Leader Mike Farmer G3VAO of the RAF wrote to *Amateur Radio* to tell us that he has been compiling a list of calls held by RAFARS members.

The list contains details of more than 190 calls in 59 different countries, and the RAFARS committee has agreed that details can be made available to other radio amateurs, some of whom might be waiting to exchange QSLs. So, if you are interested in receiving details of contacts with RAFARS, send an SAE to Squadron Leader M Farmer, 15A Butlers Drive, Carterton, Oxon OX8 3QX.

Verulam Interesting

An active evening is promised on Tuesday, 12th April by the Verulam ARC, who meet at the RAF Association Headquarters, New Kent Road (off Marlborough Road), St Albans. On Tuesday, 26th April, David Evans will be giving a talk on the subject of 'RSGB into the 21st century', starting at 7.30pm.

Publicity officer, Walter Craine, says that visitors are welcome to attend any of the

club's meetings, which take place on the second and fourth Tuesdays of every month. If you would like to know more about the club's events, you can contact Walter at 5 The Crescent, Abbots Langley, Watford WD5 0DR or on Kings Langley 62180.

White Rose Rally

Yorkshire's favourite, the White Rose Rally, will be taking place on Sunday, March 27th—the 22nd such annual rally.

Bigger than ever, the rally will house seventy trade stands, the usual bring and buy, a bar, food and a raffle.

Entry is 60p and includes a programme. OAPs will be admitted free of charge.

The venue is the refectory at the University of Leeds. This is well signposted, but in case of problems there is talk-in on S22 and UHF. Parking is plentiful.

For further information, contact Mike G0EGM or Mike G1SBN, QTHR.

Password?

After a year of secrecy, mystery and rolling up one trouser leg (?), the closed doors of the Paddington College Amateur Radio Society are being opened to all and sundry. Formerly only people who had studied for the RAE at the college were eligible to join, but now all radio amateurs and short wave listeners are welcome to go along.

The society meets at 7pm on the first Wednesday of every month at Paddington College, Paddington Green, London W2. The college is near Edgware Road underground station and plenty of buses run past: the 6, 8, 15, 16, 16a, 18, 27, 36 and 36a.

If you would like to know more, contact Don Pye on 01-723 3847 after 7pm. Or you could write to him at 98 Hall Place, Edgware Road, London W2 1NG.

A new space

And now some news from MARS... no, not the planet but the Midland Amateur Radio Society, although if they continue to have problems with their clubhouse (as reported in this column over the past few months) it might be less bother to move the society to another planet altogether.

As the society is still under

STRAIGHT & LEVEL

'Notice to Quit', it would be advisable to make sure of the venue if you're interested in attending John Harris' chassis bashing session on Tuesday 18th April.

It is expected that the club will have moved to Unit 16, 60 Regent Place, Birmingham by that time. MARS' publicity officer, G8GAZ, suggests that you approach from Caroline Street (between St Pauls Square and Warstone Lane) to comply with the complicated one-way system in the area. For more details, phone (021) 357 1924.

Any old iron?

Another Mike, Mike Antony G4THN, has been elected to a position of power at the Reading and District Amateur Radio Club AGM - well actually, he's been voted in as club secretary. The club meets at the White Horse pub, Emmer Green, Reading on alternate Tuesdays.

A junk sale will take place at their next meeting on 29th March, and on Tuesday, 12th April there will be a talk on contest operating by Ian Shepherd G4LJF. On Tuesday, 26th April there is a double feature: a talk concerning the HF NFD arrangements followed by some RSGB videos.

If you would like more information or directions, phone Mike on Reading (0734) 774042.

Torbay AGM

Torbay Amateur Radio Society's AGM is on Saturday, 23rd April at the English China Clay Social Club, Highweek, nr Newton Abbot. If you'd like more information, phone Bob McCreddie on Haytor (03646) 233.

Square eyes

There will be square-eyed people wandering around Barry College of Further Education this month, and

most of them will be members of the college amateur radio society. On 14th April a video film presentation will take place at the college on the subject of 'Amateur Television as used in our hobby', then two weeks later, on 28th April, there will be another one entitled 'DXpedition to St Pierre et Miquelon Island'.

If you'd like to join in, write to Dr Kevin Johnston GW4BCB, Barry College of Further Education, Colcot Road, Barry, South Glamorgan CF6 8YJ. Don't forget the popcorn.

Over to you

Is London the best place to hold the RSGB AGM? Martyn Bolt has other ideas and would like to know how many of you would prefer the meeting to be held elsewhere. He suggested Cleckheaton.

Cleckheaton is within one mile of junction 26 on the M62, which makes it reasonably central to the whole of the UK. The main area at Cleckheaton Town Hall has the capacity to hold 377 people and only costs £70 to hire, including use of a coffee lounge and bar area.

If you are a member of the RSGB and agree that this would be a better venue for the AGM, send a QSL card or a postcard to Martyn Bolt at 112 Leeds Road, Mirfield, West Yorks WF14 6JE.

Measure for measure

A demonstration of measurements will take place on 13th April at the Fareham and District Amateur Radio Club.

The club meets every Wednesday at 7.30pm (with a Morse class from 6.30pm). Meetings are held at the Portchester Community Centre, Westlands Grove, Portchester, Hants. For more information, contact Alan Chester G3CCB on Fareham 288139.

Publicise your club - send us details of your meetings. Tell us the time, date, place, event and club contact and we'll tell the world. Our address is on page 3.

NEVADA

HIGH QUALITY BRITISH MADE PRODUCTS

TM1000 1KW All Band ATU



Our unique wide band roller coaster enables effortless matching of G5RV, LW, Vertical and Coax fed antennas with this unit.

Standard model £139
For balanced feed £165
Fitted with 2 Kw Balun
TM1000 Kit complete £115
(Add £5 carriage for all versions)

BUILD YOUR OWN HIGH POWER ATU WITH OUR RANGE OF ATU COMPONENTS

Roller Coaster 1KW 30uH	£24.00 +£1 p+p
250 pF Var. Capacitor 1KW (4mm air gap)	£19.95 +£1 p+p
250 + 250 pF Ganged Variable 1KW (4mm air gap)	£28.00 +£2 p+p
TC48 Turns counter for RC26	£12.95 +£1 p+p
Case (Pre-drilled for above)	£26.00 +£3 p+p



U.H.F. REMOTE ANTENNA SWITCH

(For masthead mounting)

Freq: DC - 1.2 Ghz

Power: 300W P.E.P.

Insertion Loss: 0.19 dB at 900 Mhz
Connectors: Green Par 'N' Type

£49.95

ALLOWS SELECTION OF 2 ANTENNAS FROM 1 COAX FEEDER

H.F. REMOTE ANTENNA SWITCH

(For masthead mounting)

Now you can switch between two HF Antennas on one coax feeder.

Freq: DC - 185 Mhz

RF Power: 1KW P.E.P.

Insertion Loss: 0.15 dB at 144 Mhz

Connectors: SO239

£39.95

50 Mhz LINEAR AMPLIFIER

WITH HARMONIC FILTER

SPECIFICATIONS

Supply: 13 V DC

Input Power: 2.5 Watts

Output Power: 15 Watts

Freq: 50-52 Mhz

Power Gain: Approx 8dB

£29.95

+ £1 p+p

29Mhz FM R.F. POWER AMPLIFIER

WITH HARMONIC FILTER

SPECIFICATIONS

Supply: 13 V DC

Input Power: 1-4 Watts

Output Power: 25-30 Watts

ONE YEAR GUARANTEE

£24.95

+ £1 p+p

USE YOUR CREDIT CARD FOR IMMEDIATE DESPATCH

HOTLINE (0705) 662145

NEVADA COMMUNICATIONS
189 London Road, North End,
Portsmouth PO2 9AE. Telex: 869107

DISKS

3.5" DS, bulk packed, with labels etc, 10 off.....**£8.50**
 5.25" DS, 48 tpi, bulk packed, with labels etc, 10 off.....**£3.10**
 Disk notcher.....**£2.95**

RIBBONS

Apple Imagewriter II... £2.95	Cannon PW1080A..... £2.69
Citizen 120D..... £3.50	Citizen MSP 10..... £2.75
Epson MX/RX/FX80..... £2.75	Epson LX 80/86..... £2.40
Epson MC/RX/FX100... £3.10	Kaga Taxan..... £2.69
Man Tally MT80..... £2.90	Seikosha GP 100..... £2.10

Finance at 17% (incl. service charge)

T-systems Ltd

The Signal Cabin, 61 High Street, Orpington, Kent BR6 0JF
 ACCESS Card accepted. Tel: 0689 22196

R. N. Electronics

Professionally designed equipment for Amateurs 6 METRE Linear TRANSVERTER

Reviewed in
 this issue

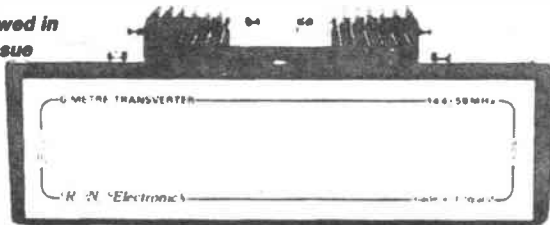

Allows any popular 2 Metre Transceiver (up to 3W)
 to be used on 6 Metres any mode (ssb, FM, CW, Packet etc.)

Low harmonic output *DC or RF switching*
 Low noise BF981 front end

Boxed versions supplied with either PL259 or BNC plug to
 2 metre transceiver

- 25W pep o/p complete boxed transverter **£172** +4.00 p&p
- 2W pep o/p complete boxed transverter **£135** +4.00 p&p
- 2W pep o/p assembled and tested P.C.B. **£105** +2.00 p&p
- 25W pep o/p add on P.C.B. **£47** +2.00 p&p
- 25W PA for use with FT690 etc. with 2-3W drive including
 switching and low pass filter **£75** +4.00 p&p
- 7dB Switched 10W Attenuator **£22** +2.00p&p
- ★ 4 meter transverter (145MHz I.F.) **£243** +£4 p&p

ALL PRICES INCLUDE VAT

**37 Long Ridings Ave Hutton Brentwood
 Essex CM13 1EE. Tel: 0277 214406**



VICTOR COMMUNICATIONS

SALE AND MAINTENANCE

AMATEUR RADIO MARINE PMR
 WE ARE ALSO MANUFACTURERS OF
 COMMUNICATION EQUIPMENT KITS AND
 CUSTOM BUILT ANTENNAS
 MATCHING NETWORK
 PLUS R F COMPONENTS NOW AVAILABLE
 BY MAIL ORDER

**9 STALISFIELD PLACE, MILL LANE,
 DOWNE, KENT BR6 7HN
 TEL: 0689 58825**

NEVADA

THE UK'S SCANNER SPECIALISTS



BLACK JAGUAR MkII POCKET SCANNER

Switchable AM/FM
 Covers CB plus the following
 frequencies 26-30MHz, 60-88MHz,
 115-178MHz, 210-260MHz,
 410-520MHz

£225

Bearcat 100 XL HAND HELD

Scanner with 16 channels
 memory scan covering
 66-88 Mhz, 118-174 Mhz,
 405-512 Mhz
 Super sensitive receiver

£199⁹⁹

Bearcat 70 XLT

New pocket size scanner
 with 10 memories. Covers
 66-88 Mhz, 118-174 Mhz,
 405-512 Mhz

£229

Bearcat BC 50 XL

Handheld
 scanning receiver
 with 10 memories
 Covers: 66-88MHz,
 136-174MHz, 406-512MHz

£99⁹⁹

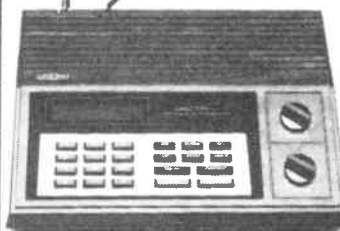

Bearcat 175 XL BASE

Scanning receiver with 16 channel
 memory scan covering 66-88MHz,
 118-174 Mhz, 405-512 MHz

NEW LOW PRICE

£189⁹⁹

SCANNING ANTENNAS CTE DISCONE WIDEBAND ANTENNA

Receive: 70-700 Mhz
 Transmit 70-500 Mhz
 Power: 500W
 8 Element High Quality

£26

SSE DISCONE RX ANTENNA

70 - 500 Mhz
 With 3 Elements

£24⁹⁵

**SEND FOR OUR BUMPER CATALOGUES
 OF AMATEUR, CB, SCANNING EQPT.
 ONLY £2 (Includes a £2 voucher)**

**USE YOUR CREDIT CARD FOR IMMEDIATE DESPATCH
 HOTLINE (0705) 662145**

**NEVADA COMMUNICATIONS
 189 London Road, North End,
 Portsmouth PO2 9AE. Telex: 869107**



DX DIARY

News for HF operators compiled by Don Field G3XTT

There was a time not so very long ago, after the British sovereign bases were added to the DXCC list, when I would have said that this was our lot for quite some years to come. Since then we have had a brand new 'country' added to the list by way of Peter 1st Island. In addition, Aruba has also been added since its independence from the Netherlands Antilles. Now, contrary to expectations, comes news that Western Sahara will become country 319 on the current list.

It is not yet clear whether it will be a new country or a re-activation of the deleted Rio de Oro (Spanish Sahara), so don't send your S0RASD cards off to the ARRL for credit until further details have been announced. As you may recall, some equipment was left in Western Sahara after last October's DXpedition and the two local operators, Naama and Mulay, have been very active indeed on all bands. In the 24 hours before I wrote this piece, I worked them on 20 metres and heard them on 15. They were also due up on 40, although I didn't get a chance to listen out for them.

All this talk of countries is important because, of course, DXCC is the premier award for HF DX chasers. Over the last couple of years the ARRL has invited comments on the future of the DXCC awards programme, which led to over 1500 responses in all. In a press release dated February 1st, the initial results of this rethink became apparent.

New single-band DXCC awards (which can be incremented for every additional ten countries confirmed) will come into effect for 10, 40 and 80 metres; the 5-band award will become endorsable for other bands (160m and VHF) and various other minor changes will come into effect. These include a new-style application form. The changes will be phased in

during the next twelve months or so to reduce the impact on the processing of other applications. Full details are due to be published in the April issue of QST.

As these changes are of major interest to all HF DXers, I will aim to get photocopies of the full details and will be happy to provide them to any *DX Diary* readers in return for an SAE.

A good month

If you are a country chaser, for DXCC awards or simply for pleasure, then February should have been a good month for you. Several DXpeditions were active, in particular ZL9 (Auckland Island), KP1 (Navassa Island), Abu Ail and PY0F (Fernando de Noronha). The Abu Ail operation was totally unexpected, although it was announced about two days in advance on the *DX News Sheet* Hambank (Tel: 01-725 7373). DJ6SI and other Germans were active for 5 days, principally as A15AA on CW, UK stations working them on 15, 20 and 40m.

ZL9 signals were remarkably strong on 40 metres morning after morning and they too were worked on 20 and 15m. I don't know of any 80 metre QSOs with the UK, although this should have been possible because there was good down propagation to New Zealand on both 80 and 160m during most of February.

Light may possibly be shed on this non-appearance by Ron ZL9AMO's reply to a European DXer, who asked him when he would work Europe on 80m. Ron's response, apparently, was 'Why should I?'

Add to the above the first stirrings from DL1VU in the Pacific (from KH2 and C21); an operation from Lord Howe Island by DJ5CQ and DL8NBJ; the Colvins turning up as W6KG/4S7 from Sri

Lanka; Grenada (J3) as promised by K4LTA and friends, plus several other interesting operations, and February proved to be a fascinating month on all fronts.

I was pleased to work VX6OCO, operating from Calgary during the Winter Olympics, though this is not rare DX in the traditional sense. A nice one, that, for the prefix chasers too. Mention of the J3 operation reminds me that they made an effort to be active on the WARC bands. I worked J34WG on 18MHz, for example. If you think there isn't much DX to be found on these new bands, then think again. Tom GW3AHN has now worked over 100 countries on each of the three WARC bands, a real tour de force.

Of course, this has taken a lot of doing, but I am often surprised at what a casual tune around those bands will produce. Naturally, the incentive will increase as more countries get access to the three bands (a process which is happening all the time) and also once the power and mode restrictions on 18 and 24MHz are lifted by the DTI. When all this has happened and the sunspots really start to come back, I predict a heavy increase in interest in those bands. Why not plan at least to give them a whirl this year?

Bouvet or not Bouvet?

As I write this, there are rumours of a very brief early-March operation from Bouvet Island. I doubt that it will come off, which is probably just as well. An operation lasting just a few hours would leave many more frustrated DXers than satisfied ones. What we could really do with is the kind of operation from Bouvet Island that we got from Peter 1st Island last year.

Fortunately, I can give you advance notice of some other interesting operations. F6EXV, one of the operators of the forthcoming KH5

expedition (see last month's column), will stop off on Christmas Island (T32) on the way home. Look for him as T32BH from May 11th to 18th. The callsigns for the KH5 operations will be K9AJ on CW and W0RLX on SSB, appending /KH5 and /KH5K as appropriate. The frequencies will be 5kHz from the band edges on CW and 3805, 7095, 14155, 21205 and 28505kHz on SSB. Only split operation will be used, listening down. Do make sure you don't transmit on top of this rare DXpedition.

ZS3/DL8ZBL is reported in *DX News Sheet* to be active from Namibia and will be there until about July. J52US is very active as promised, both on SSB and CW. Y24LN should now be signing Y88POL for a year from Antarctica. DK9FE will sign DK9FE/OY from May 8th to 27th, operating on CW between 10 and 15kHz above the band edges. W2PN was due to be active from the Seychelles until April 5th, paying particular attention to Top Band. Harry G3MCN should be in the Cook Islands (ZK1) when you read this. His visit lasts until April 20th and he plans to activate various islands in the group.

For island chasers, J16KVR promises to be active from Amakusa Island (AS12 for Islands on the Air) on April 23rd/24th, and from the Tokara Archipelago (AS49) on May 21st/22nd. In each case, check 21250kHz. Further into the future, look out for the special callsign TV6WAT from L'Isle Houat (EU48) from July 1st to 15th. In addition, 5H1HK has been extremely active from Zanzibar. Prior to 1974, this would have counted as a separate country in its own right. Now of course, in DXCC terms, Zanzibar counts only as Tanzania. Incidentally, despite a short-lived QSY to 15 metres, the Islands on the Air net continues to take place on Saturdays from 1300GMT on 14260kHz.

Prefixes

There are lots of interesting prefixes to look out for this year. For instance, FV8NDX will be active from France in all major contests, as well as being used from some offshore islands. 3A8E and 3A8F will be active from Monaco during contests, and stations in the North West Territories of Canada have permission to use the C18 prefix until June 15th. There will be a special award issued by VE3XN for contacting three stations in the NWT plus three in the Asiatic USSR, one contact with a Ski Trek base camp station in either Canada or the USSR and one contact each with stations in Moscow and Ottawa. All this must occur during the period February 15th to June 15th.

This award, of course, is inspired by the joint Canadian-Russian trans-polar Ski Trek which has attracted world-wide publicity and which has relied totally on amateur radio for its communications. Even navigational data has been fed to them via Oscar 11.

RTTY and packet

There have been several operations recently paying special attention to the data modes, RTTY, Amtor and packet. The Abu Ail expedition signed A15AC on RTTY; there was a special 'digital mode' expedition to the Galapagos Islands; the Andaman Islands operation (see below) made a special effort on RTTY, and so on.

In addition, there are many rare countries regularly active on RTTY, Amtor and HF packet radio, including stations like SU1ER and 5H3ZO (who also operates a 'mail-box' service). ARRL bulletins are put out each week on 14090kHz on RTTY, and the BARTG (British Amateur Radio Teleprinter Group) also put out regular news bulletins on RTTY on 80 and 20 metres, as well as sponsoring an annual RTTY contest and several RTTY awards.

If all this is of interest, look out for my forthcoming series of articles on amateur data communications. If you are already active on RTTY, it is worth looking for DXpedition operations on this mode. You could well be in for some pleasant surprises.

Andaman Islands

DX News Sheet recently carried an interesting breakdown of the contacts made by

the VU4GDG operation from the Andaman Islands last October. This superb expedition netted a staggering 31,007 contacts, including 153 on Top Band and 506 on RTTY. Arrangements had been made to mail the QSL cards from within Europe, the USA and so on, to avoid problems which have occurred in the past with bulk postings from India.

An apology must be made at this point. The KH1 operation which I mentioned last month was to be from the Baker and Howland Island Group, not from Canton Island. This makes no difference for DXCC purposes, but will count differently for the Islands on the Air awards.

Contests

The 1988 Helvetia Contest will take place on April 23rd/24th for 24 hours, starting at 1300GMT on the Saturday. This is a mixed-mode multi-band contest with single-op, multi-op and SWL categories. Three points are gained for each contact with a Swiss station, and the multiplier is the sum of Swiss cantons (26 in all) worked on each band. The contest exchange is RS(T) and serial number, and Swiss stations also give a two letter abbreviation for their canton. Logs go to HB9AGA, with a deadline of May 31st. There will be an award for the highest scoring entry from each country.

The Israel Amateur Radio Club is sponsoring a contest to celebrate the 40th anniversary of Israel's independence. This will take place on April 9th, for the full 24 hours, all bands and mixed-mode. Exchange RS(T) and serial number; 4X stations should also send a three letter code indicating their zone (there are 18 in all).

Each 4X station may be worked twice on each band, once on SSB and once on CW. 5 points are scored for each contact and every zone worked (regardless of band) and every 4X and 4Z prefix (4X1, 4Z9, etc) per band, totalled together, counts as a multiplier. 4Z9, incidentally, is the Israeli novice prefix and can be found only on CW and in the band segments 7000-7050 and 21100-21150kHz.

There will be certificates for the highest three scorers in each continent, the leading scorer in every country and for everyone who scores at least 3,000 points. This is all

quite complicated, as are the rules for submitting entries. I can supply a photocopy of the complete rules on request.

The Polish SP-DX Contest is a phone event this year, on April 2nd/3rd (from 1500 Saturday to 2400 Sunday). Looking into May, there is the Russian 'CQ M' Contest on May 14th/15th. This is a mixed-mode all-band event, from 2100 to 2100 and is always a good opportunity to work those rare oblasts. It often brings a clutch of Mongolian amateurs on to the bands as well.

US states

I don't know if, like me, you get confused by the two letter abbreviations for US states. Most of them are obvious, but I have found myself getting confused by some of them in the recent ARRL contests. Just to set the record straight I have compiled a full list for your future reference (see *Table 1*).

Mentioning, as I have in this column, DXCC, IOTA, oblasts,

prefixes, states, cantons and so on makes me think that amateur radio has much in common with hobbies such as stamp collecting. There are hundreds of thousands of amateurs to be worked on the HF bands and most of us try to narrow down our activities to sizeable proportions. This is thematic collecting, to use the philatelic analogy. Country chasing is by far the most popular theme for HF enthusiasts, although there are many others. I remember one amateur who specialised in working maritime mobile stations (there are still plenty of these to be found on the bands) and there are many such specialisations.

Drop me a line

If you follow a particular theme that, in your opinion, I don't cover as much as I should, then drop me a line and I will try to put matters right. Remember, though, that the quality of my output depends on the quality of the input I receive!

US STATES

W1

Connecticut..... CT
Maine..... ME
Massachusetts..... MA
New Hampshire..... NH
Rhode Island..... RI
Vermont..... VT

W2

New Jersey..... NJ
New York..... NY

W3

Delaware..... DE
Pennsylvania..... PA
Maryland..... MD
District of Columbia..... DC

W4

Alabama..... AL
Florida..... FL
Georgia..... GA
Kentucky..... KY
North Carolina..... NC
South Carolina..... SC
Tennessee..... TN
Virginia..... VA

W5

Arkansas..... AR
Louisiana..... LA
Mississippi..... MS
New Mexico..... NM
Oklahoma..... OK
Texas..... TX

W6

California..... CA

W7

Arizona..... AZ
Idaho..... ID
Montana..... MT
Nevada..... NV
Oregon..... OR
Utah..... UT
Washington..... WA
Wyoming..... WY

W8

Michigan..... MI
Ohio..... OH
West Virginia..... WV

W9

Illinois..... IL
Indiana..... IN
Wisconsin..... WI

W0

Colorado..... CO
Iowa..... IA
Kansas..... KS
Minnesota..... MN
Missouri..... MO
Nebraska..... NE
North Dakota..... ND
South Dakota..... SD

KL7

Alaska..... AK

KH6

Hawaii..... HI

NOISE

THE FINAL FRONTIER

By Ian Poole G3YWX

Noise is the limiting factor in most communication systems. It is an unfortunate fact of life that noise is always present in one form or another, causing interference and making it difficult to copy weak signals. Although noise can never be totally eliminated, it is possible to improve matters in some circumstances. In order to do this it is necessary to know where the noise is coming from and how it is being generated.

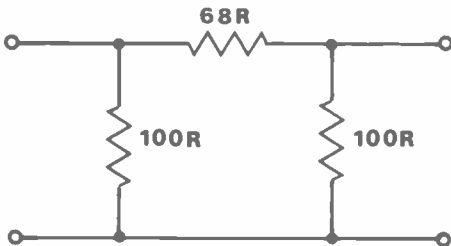

Fig 1 A 10dB, 50 ohm attenuator

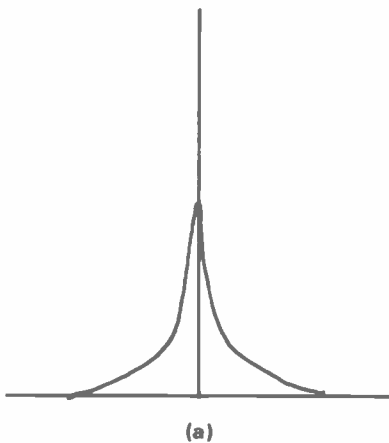

Fig 2a Phase noise of a good VFO

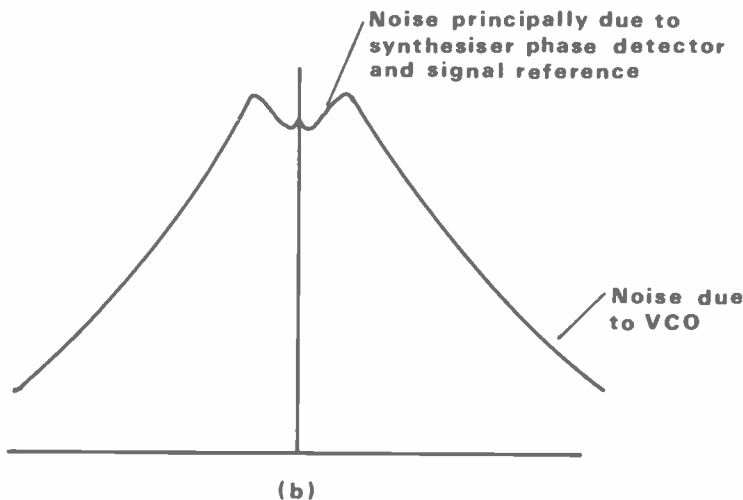

Fig 2b Phase noise of a typical synthesized oscillator

Noise can be generated in a variety of ways. It can also come from a large number of sources. Sometimes the noise will be generated within the receiver itself. Alternatively, it may be picked up by the aerial. So, by careful design and siting of the aerial, together with a wise choice of receiver, it is possible to keep the effects of noise to a minimum and make the station more effective.

The receiver

The performance of the receiver is obviously very important because it will affect the performance of the whole station. Factors like phase noise and reciprocal mixing will be very important on any receiver, as will its dynamic range. Then, of course, there is its overall noise figure and in particular its front end. This parameter will be of great interest to VHF and UHF operators where the noise figure is all important.

The noise figure

This parameter is of much greater interest to VHF and UHF operators than to those who spend their time on the HF bands. This is because the levels of noise which are picked up by the antenna are much higher. This noise comes from several sources. Much of it is atmospheric noise, but there is also a lot which is man made; this means that there

is little point in improving the front end noise specification of an HF receiver beyond a certain point. In fact, most HF receivers have noise figures which would make most VHF operators hold up their hands in horror. Yet what is the point in striving for better performance if it yields no results?

On the higher frequencies at VHF and above the picture is different. The atmospheric and man-made noise picked up by an aerial is much less, and the noise generated in the receiver itself becomes the dominant factor. This makes it worthwhile spending some time, effort and a little extra money ensuring that the front end of the receiver has a good noise figure.

This will obviously mean different things to different people. To the DX enthusiast it will involve the use of an extremely high performance, low noise mast-head preamplifier. Others will be satisfied with a less elaborate amplifier in the shack.

Whatever the choice of pre-amp, there are a few points to note. The first is that the noise figure of the pre-amp will generally determine the performance of the whole receiver, so it is worth looking around and not just buying the cheapest.

The second point is that the extra gain can sometimes cause overloading in the receiver if there are strong signals on the band. Because of this it is wise to have some means of manually switching the pre-amp out. On top of this there is certainly no point in having more than one pre-amp. Modern receivers are generally very sensitive and unless there is something very wrong with it, there should not be any need for too much extra gain. The main reason for adding a pre-amp is to improve the noise figure of the receiver so that weak stations in the noise can be copied. Obviously, the extra gain will make the strong signals sound stronger, but this is not the reason for using the pre-amp. If there is too much extra gain in the front end it will overload the input of the receiver and actually make the weaker signals more difficult to copy.

Strong signals

It does not always take an excess of pre-amps to overload a receiver. Many

HF receivers, for example, come to grief on 40 metres when they are trying to pick out weak amateur signals between the exceedingly strong broadcast stations. Often, these broadcast stations can overload the receiver front end and to overcome this an attenuator can be put into the aerial feeder. This serves to reduce the level of the broadcast stations to a point where they do not overload the input. Hopefully, the amount of attenuation required does not reduce the weak signals to below the noise level.

It is quite easy to construct a simple attenuator. A design for a single 10dB pad is shown in *Figure 1*. If necessary two or more stages could be used or, alternatively, it could be made switchable.

When building attenuators, the resistors to be used should be non-inductive. Wire-wound resistors are obviously non-starters; however, most of the small one quarter or one third watt CR25 types will be suitable for low power HF applications.

Care should also be taken in determining the layout, particularly if the attenuator is to be switched. If not, the signal will tend to radiate across the attenuator and the signal levels will not be as expected. In spite of this, it should be possible to obtain quite satisfactory results in most cases.

Phase noise

There is a lot of talk these days about phase noise. It is often mentioned in connection with synthesizers, where it is one of the major drawbacks. As a result, many people do not use equipment with synthesizers and prefer to use older rigs with the more conventional VFOs.

In spite of the importance of phase noise, it is very seldom, if ever, mentioned in the glossy advertising literature. Even if it were, it may appear at first sight to be unimportant. This may be so on a band where there are few strong signals. However, when weak signals are being sought in the vicinity of several strong ones it is of vital importance.

What is phase noise?

It is found that any oscillator will have a slight amount of frequency or phase modulation on the carrier. This is caused by noise within the oscillator circuit itself. Obviously, this modulation has sidebands which stretch out either side of the carrier.

With low frequency VFOs having very high Q tuned circuits, such as those used in many early rigs, the phase noise performance is extremely good. Unfortunately, with the VCOs (voltage controlled oscillators) which often operate at much higher frequencies and have lower Qs, the phase noise becomes

much worse and it is a distinct problem.

This phase noise causes problems by a process which is known as reciprocal mixing. Looking at *Figure 2*, it can be seen that in a normal superhet the local oscillator would mix with an incoming signal to give a signal in the IF bandwidth. However, it is possible for an off-channel signal to mix with the phase noise to give an in-band signal. This may not cause a problem if the receiver is on a band where there are few strong signals. Unfortunately, it does cause a problem if a weak signal is being sought in a band filled with strong ones. For example, on a band like 7MHz reciprocal mixing will often mask out the weaker stations. There are also problems on bands like 2 metres where strong local stations can cause havoc up and down the band. In some cases it may be the transmitted signal itself at fault, but in other cases it might be the receiver.

There are several hundred electrical storms occurring at any time, causing a lot of atmospheric noise

Noise from the ether

If on the bands above 30MHz the main source of noise is within the receiver itself, this is certainly not so on the HF bands, and especially bands such as 160 and 80 metres. Here, noise picked up by the antenna from a whole host of sources easily dominates any receiver noise. Unfortunately, it is not always easy to improve matters. Even so, it is sometimes possible to take some steps to make a few reductions or at least discover what the cause is.

Naturally generated noise

There are two main types of naturally occurring noise. The first is atmospheric noise. This is caused mainly by electrical storms occurring all over the world. As there are several hundred storms in progress at any time and each discharge radiates a very large amount of energy, the resultant noise can be very high, particularly on the lower frequencies.

The other main source of naturally generated noise is called cosmic or galactic noise. This comes from a multitude of sources outside the atmosphere. The sun and stars all produce large amounts of RF energy which is radiated across space, and some of it reaches the earth. On the lower frequencies much of it is absorbed by the ionosphere, but as the frequencies rise it manages to penetrate it. It is found that at frequencies of about 10MHz or so it is

the dominant type of naturally occurring noise.

Man-made interference

Apart from noise which is generated naturally, there is a lot of man-made noise as well. It comes from the whole spectrum of electrical and electronic apparatus. There are the obvious examples like electrical motors. It can be very annoying when the next door neighbour starts up with his electric drill and completely wipes out the entire HF spectrum. It is also quite common to pick up passing cars, but fortunately this interference does not last too long unless someone is just revving their car up for fun!

Another electrical item which can cause interference is, surprisingly, the fluorescent light. Owing to the way in which it operates, RF energy is generated and it can be detected right up into the microwave bands.

It is not only electrical apparatus which can cause problems. Many pieces of electronic equipment can create interference as well. Take, for example, a standard television set. This is a notorious generator of interference on the HF bands, and in particular Top Band and eighty metres.

When a nearby television set is on, nasty rasping noises fill the band and make it difficult to copy anything through it. The problem arises in the scanning circuitry, which has to scan the 625 lines 25 times a second. From simple mathematics this gives a fundamental frequency of 15.6kHz.

The waveform which is produced is a nice sharp sawtooth rich in harmonics. To make matters worse, a considerable amount of power is required in this area, and it is also not particularly well screened.

All of this means that significant levels of harmonics are radiated, even at the higher harmonics. In fact, they can be very strong on Top Band and eighty, and audible on fifteen metres and possibly higher.

Another source of interference can be generated by home computers. Not only do they have a clock oscillator running all the time they are on, but every time a logic gate switches it produces a pulse of energy. As the edge on the waveform is very sharp, it will also be full of harmonics. Unfortunately, most home computers are not very well screened, and this means that significant levels of energy can be radiated. This will often appear as a noisy hash which can be quite audible on a nearby receiver. In fact, the same problem occurs on a smaller scale with many pocket calculators. It is often quite easy to hear a calculator on a transistor portable if it is close by.

NOISE

Reducing Interference

Although it is not really possible to reduce the amount of naturally occurring noise, except by erecting a directional aerial, there are some steps which can be taken to reduce the amount of man-made noise which is picked up. One possible solution is to move out into the country away from all the sources of noise. Although the noise levels will be significantly less, it is not a viable proposition for most of us and improvements have to be made on a more modest scale.

As neighbours do not usually take kindly to requests for them to stop using their electric drill or to turn off their televisions, steps have to be taken not to reduce the interference at source, but to minimise the effects. The first step is obviously to place the aerial as far away from any interference source as possible. This usually means that it is best to put it at the bottom of the garden or at least a distance away from the house. By doing this the aerial should pick up less of the interference.

It is also not advisable to use aerials like long-wires or windoms. This is because they will start to pick up signals

as soon as the wire leaves the tuning unit. This will normally be in the shack and, as this is likely to be in the house or

As neighbours do not usually take kindly to requests for them to turn off the TV, steps will have to be taken to minimise the effects of interference

at least near a source of mains, it is more likely to pick up interference than an aerial like a dipole.

Baluns can also be very useful. Usually, they are thought of as being an addition to an aerial which gives little or no improvement. This is not so. It is found that if a balun is not used the signals can be picked up on the outer shield of the co-ax and transmitted down to the receiver. This means that the screening effect of the co-ax will be greatly reduced and the station will be much more susceptible to unwanted noise or

interference as it enters the shack or house.

It is also interesting to note that all of these ideas may help in reducing TVI if it is a problem. This is because it is often possible to cure it simply by removing the point of radiation away from the television which is suffering.

Some of the other forms of interference can be reduced by making sure that noise generators are not used in the shack. For example, if a fluorescent light is found to cause problems it could be replaced by an ordinary light bulb or filament strip lamp. It might also be wise to turn off the home computer if it is not being used. In fact, if anything is found to cause problems it should be turned off when not in use.

Conclusion

Noise is a great barrier, and there are limits to the amount by which it can be reduced. In spite of this, there are usually many improvements which can be made in the average station. This is obviously very worthwhile, as it makes copy much easier on weak signals, and it will often open up a completely new field of DX which was not audible before.

THE PERFECT COMPLEMENT TO AMATEUR RADIO

Packed with construction projects and the latest technology plus pages of readers' classified ads



Take out a POST-FREE (UK) sub while offer lasts

- Delivery to your door by publication date each month
- Inflation proof – price guaranteed for 12 months

On sale NOW at your newsagent and at equipment dealers

RADIO & ELECTRONICS WORLD SUBSCRIPTION ORDER FORM

To: Subscription Department • Radio & Electronics World • 1 Clarendon Road • Croydon • Surrey • CR0 3SJ. Tel: 01-760 0409

PLEASE SUPPLY: (tick box) for 12 issues, all rates include P & P

Inland World-Surface Europe-Air World-Air
 £17.40..... £19.30..... £23.05..... £30.00.....

NAME

ADDRESS

Postcode.....

PAYMENT ENCLOSED: £ — Cheques should be made payable to Radio & Electronics World. Overseas payment by International Money Order, or credit card.

CREDIT CARD PAYMENT EXPIRY DATE

..... /

Signature

ANGUS McKENZIE

TESTS

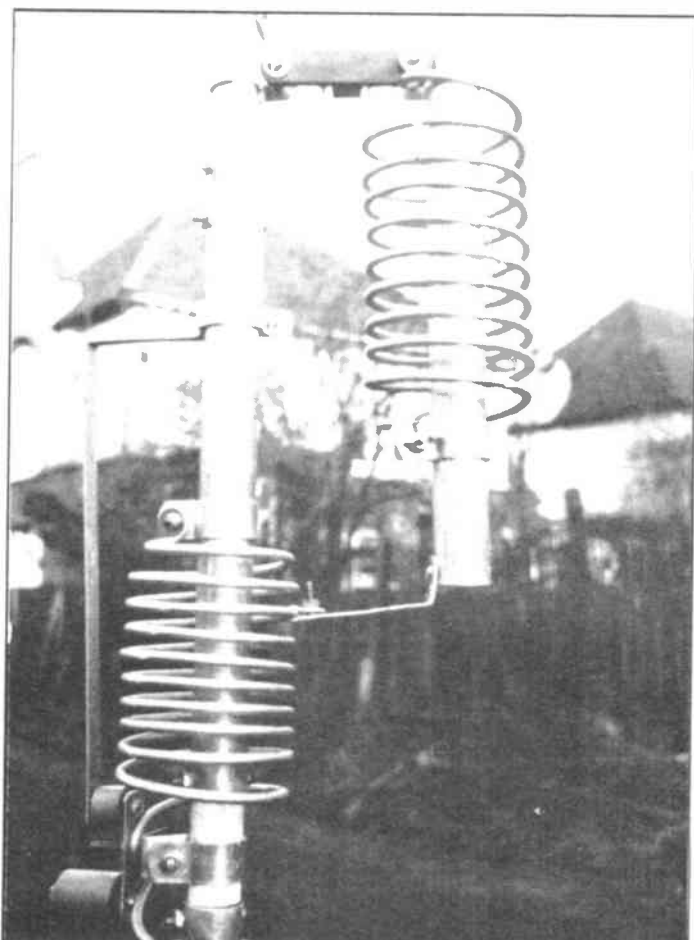
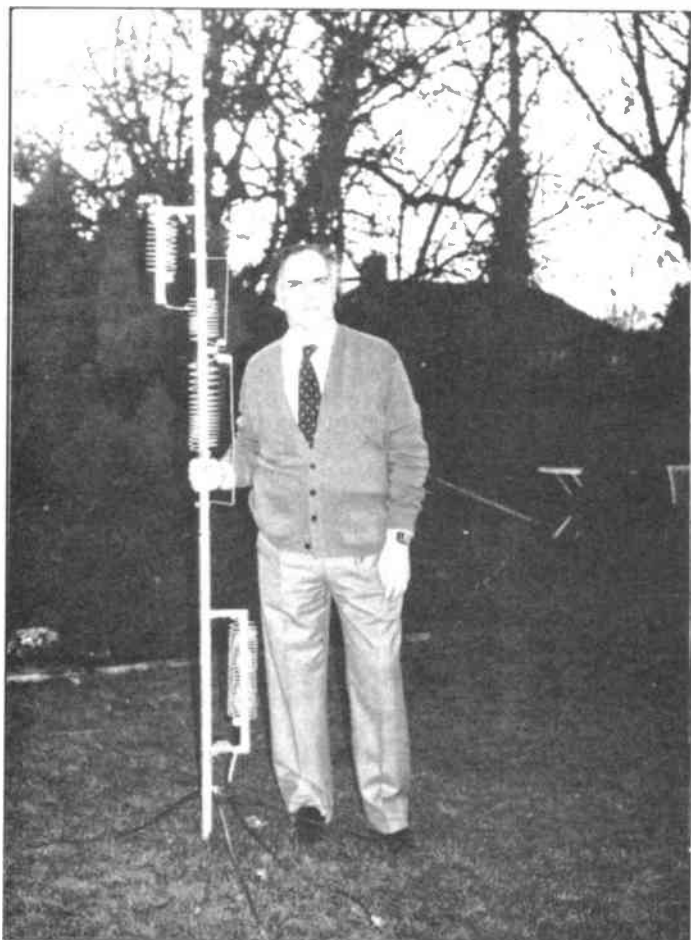

BUTTERNUT HF6V

Vertical multiband antenna

Judging by the amount of discussion about Butternut antennas on various HF bands, the HF6V might be thought of as a 'new discovery', although this antenna has actually been around throughout this decade.

For some reason, it did not catch on in Europe until very recently and just a few enthusiasts who had heard about the antenna had them sent over from the US. A small quantity had also been imported by a dealer, but they were not marketed properly. This was possibly because the basic US price was quite low and the retail price in the UK had to be so much higher because of importation costs and profit margins.

Let's have a look at what the antenna does and the qualities that have helped it to become one of the most extraordinary HF antennas available.

The review sample included the HF6V with the TBR-160SHF2/6V 160m band extension and STR11 radial kit. The basic antenna covers 10, 15, 20, 30, 40 and 80m. It

is just under 9 metres tall if you also include the additional 160m coil and capacitor kit, which give it seven band coverage.

If adjusted carefully, the SWR should be better than 2:1 at resonance on each of the bands mentioned. An additional kit is available, type A18-24, which covers the new 18 and 24MHz bands, but this is not legal in the UK as horizontal polarisation is stipulated here.

One of the most important points about this extraordinary antenna is that it is intended to be driven from a 50 ohm unbalanced coaxial feed line. In most circumstances, it can be driven directly from a rig without the addition of an ATU. It can be re-packed in its small cardboard transport container and the antenna can be dismantled sufficiently to be eligible for posting virtually anywhere in the world.

This, in fact, means that you can either purchase it from a dealer in the UK strictly speaking or you can get someone

to buy one for you in the US and send it over by ordinary parcel post, thus keeping down the costs of importation. The US uses air freight in the same way that we tend to use ordinary post. I should, however, warn you that importing items via air freight into the UK is a very expensive business because of the costs of customs clearance, handling and other importation charges, including delivery to your door.

You will find that if you do import air freight, you run the risk of paying more for the equipment than you would if you bought it in the UK. The retail cost in the States for the HF6V has been noted to be as low as \$120. The same item in the UK costs £159, including VAT. It would make sense for some enterprising manufacturer in the UK to do a royalty deal with Butternut and actually produce them over here to cut costs.

A normal trapped vertical only radiates from the bottom up to the trap relevant to the band in use; only the lowest intended

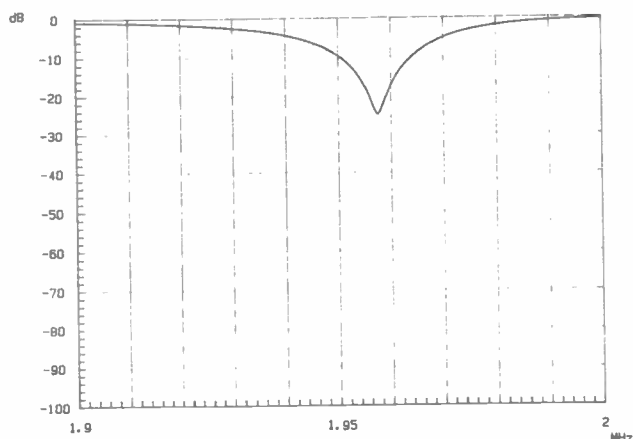

Plot 1 HF-6V with 160m ground mounted single 80m radial and complete kit. Resolution bandwidth; 1kHz, 10kHz per division

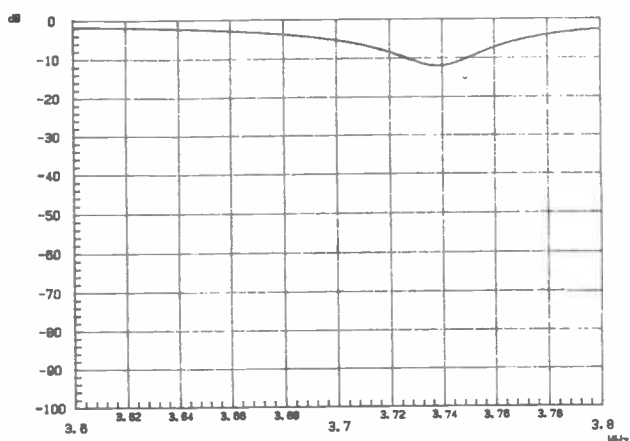

Plot 2 As above, but 20kHz per division

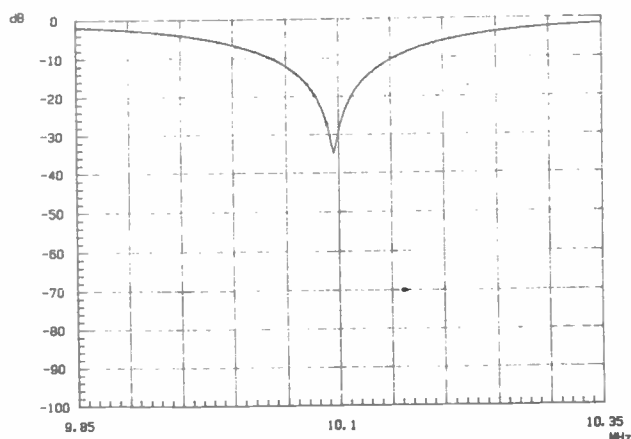

Plot 3 As above, but 50kHz per division

band radiates from the entire antenna. If you have a trapped vertical antenna mounted on the ground, such as the Hokushin reviewed last month, then on 10m you may well find that it is very poor for working mobiles on ground wave, because houses and trees get in the way. With the Butternut HF6V, virtually the entire antenna is used on all bands (except for 15m) by using a clever arrangement of coils, bypass capacitors and resonant stubs.

The antenna is supplied with an electrical quarter wave length of 75 ohm feeder in order to improve the SWR on the 14MHz band. This transforms an impedance of 100 ohms at 14MHz at the base of the mast to 50 ohms at the other end of the 75 ohm co-ax, where it should be connected to normal 50 ohm co-ax. On

other bands, this length of co-ax, which is part of the feed circuit, has much less effect.

If you have the 80 to 10m version, excluding the 160m extension, the co-ax line feed goes straight on to the bottom of the 80m coil assembly. The screen is connected to the radial system and earth post, if fitted.

A special choke should be put in between the coaxial inner feed and the braid to give a dc path from the base of the antenna down to the radial system, etc. The actual value of this choke plays a minor part in the matching at low frequencies. If you add the 160m extension, which is placed below the 80m section, then the feed is connected to the bottom of the 160m coil assembly and the earthing choke is omitted.

Strictly speaking, the entire antenna radiates on all bands, although this is not quite true for 15m, and is thus much more efficient than any other commercial multiband vertical I know of. The only exception is the Hy-gain tower system, which used to be available many years ago at a very high price. The Butternut is easily portable and does not take too long to assemble once you are well acquainted with all its bits and pieces.

Specification notes

The shipping weight of the HF6V is just 12lbs (5.4kg), which is astonishingly light. Excluding the 160m extension, the height is 7.8m and the SWR at resonance is actually claimed to be 1.5:1 or better, although I did not achieve this. The power rating is 2kW PEP or 1kW CW on 80, 40, 20, 15 and 10m, with a reduced rating on 30m of 500W PEP and 300W CW. The antenna is rated at 1kW PEP and 500W CW on 160m, which should certainly be more than enough in the UK!

The wind loading is specified to be 1.5 sq ft (0.15 sq m). The antenna is designed to withstand winds of up to 80mph (125kph) without guying.

Description of the antenna

Photographs of this antenna show it to be quite complicated, and its actual design is very clever indeed. Starting from its base, and with the 160m extension fitted, you will see the long vertical coil. This can be adjusted to tune for resonance anywhere between 1.8 and 2MHz by simply pulling the coil in and out, compressing and expanding it, and then screwing it into position.

If you pull out an inductance, retaining, of course, the same number of turns, you decrease the total value of inductance; if you push it in so that the turns are closer to one another, you increase the L value. The greater the L value in series with the remainder of the antenna above it, the lower the resonant frequency will be on the band being adjusted.

Just considering 160m, there is much more to it than you might think, for the 80 and 40m coils are also adding inductance vertically; thus the total antenna, although only just less than 9m high, acts like a quarter wave vertical on 160m.

Effectively in parallel with the 160m coil are two high voltage ceramic capacitors feeding a bypass bar to the top of the 160m coil. This actually makes a parallel tuned circuit, although at first I wondered what on earth this was doing, since we certainly do not want a parallel tuned circuit in series with the RF at one of the antenna's resonant frequencies! The two capacitors are described in the instruction book as being bypass capacitors, which allow RF at higher frequencies than 160m to jump across the 160m coil.

The situation with the 80m coil is identical, other than the fact that the actual construction and positioning are different. The 80m coil passes both 80 and 160m, forming part of the antenna's inductive loading, but once again, the

parallel bypass capacitors are there to pass the higher frequency bands.

The 40m coil also has a bypass capacitor, and the 30m band is catered for in the same coil section. By adjusting each of the very thick coils in and out in a trombone fashion, the resonant point for minimum SWR on each band can be set up very accurately. In many cases, it will be necessary to readjust coils after the first attempt; a remarkably small adjustment of a few millimetres can give quite a frequency shift on 80 and 160m. Great care must be taken and a lot of patience shown in order to detect the resonance point, which can otherwise be missed.

On 30m, the antenna is too long for a normal $\frac{1}{4}$ wave, but this is corrected by the effect of capacitors in the circuit. Thus the antenna gives a good match at 10.1MHz. On 20m, the antenna becomes $\frac{3}{8}$ wave, which is why it needs the transmission line transformer in the form of the 75 ohm co-ax previously explained. On 15m, the antenna has to be effectively shortened and, rather than using any form of resonant parallel tuned trap, Butternut have done something much more clever: they have built in a $\frac{1}{4}$ wave resonant trap, by simply having a parallel length of wire open-ended at the bottom and shorted at its top to the main vertical rod. The effect of this is to isolate the entire top of the antenna from the bottom vertical section just on 15m, leaving a fairly normal $\frac{1}{4}$ wave for the band below it.

On 10m, the antenna is $\frac{3}{4}$ wave and the point of minimum SWR is adjusted by telescoping the top section in and out of the one below it. The 15m stub is tuned by simply altering the length of the vertical wire held off from the vertical pole by stand-off insulators. The position of connections to the 30/40m coil assembly also adjusts the resonant point on 20m. The SWR curve on all the HF bands becomes surprisingly wide, because of the very unusual combination of design features.

Radials and earthing

The HF6V is designed to be used on the ground, just above the ground or at roof (or top of mast) height. When the antenna is ground mounted, the quality of the soil can be quite important (the soggy the better!). All the experts say that a really enormous earth mat extending for at least $\frac{1}{4}$ wave in all directions below the antenna is required when the antenna is to be used on an LF band.

In practice, this requirement is only for gilding the lily when the lowest possible angle of radiation is required, combined with maximum rejection of higher angle radiation.

This is for DX operating, of course, but a very high percentage – certainly the majority – of LF band enthusiasts use the bands for fairly local nattering, in general around the UK and Europe.

A good earth ground planing effect near the antenna is important for improving the radiation efficiency, however, and so it should pay dividends

Plot 4 Resolution bandwidth: 3kHz. 500kHz per division

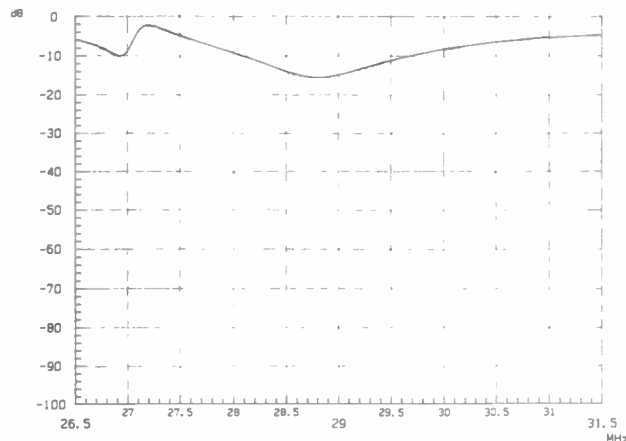

Plot 5 Resolution bandwidth: 3kHz. 100kHz per division

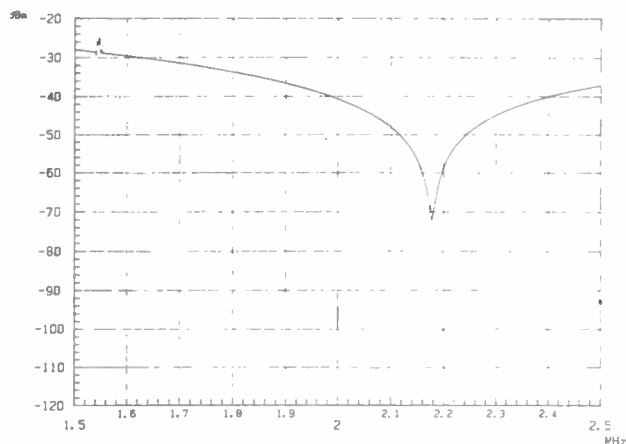

to put in as many radials as possible just underneath the soil for a few metres, preferably in all directions.

A good way round the problem is to put chicken wire under the turf for two or three metres in all directions, being careful to bond the different sections of wire together electrically, and of course also to the earthed braid at the bottom of the aerial. An earthing post going down 2m or so into the ground underneath the antenna will serve as a dc earthing connection, but is not really effective at all as an RF earth, despite many claims to the contrary by manufacturers of 'magic' earth rods!

Even if the conductivity of the soil is poor, the actual area of chicken wire earth plane gives a considerable capacity to the real ground, and thus gives a very respectable RF earth, which can actually be better than just a few $\frac{1}{4}$ wave radials of thin wire. If you are lucky enough to have a stream going through your garden, or you live near the sea and have a water table only a few feet below your soil, then you will be well away with the vertical. Particularly so if you have an earth mat, as you will be able to work much DX on the LF bands with the Butternut, to the envy of many listeners! It is also true to say, in the old BBC gardener's language, 'The answer is in the soil!'

If you mount the antenna some distance above the earth, you will need to use resonant radials, and you will find the Butternut resonant radial kit very useful here. It includes four 300 ohm

ribbon radials, in which both sides of the ribbon are fed at the antenna end but each length of ribbon has cuts in one side only to allow it to be $\frac{1}{4}$ wave, or a multiple of this, on several bands.

The radial kit also contains around 205ft of 18 gauge copper-clad steel wire for preparing four 30m radials and one 80m radial, with some wire to spare. Five insulators are supplied in the kit for 30 and 80m radials, in addition to the ribbon radials which work on 10, 15, 20 and 40m. These radials are intended to be spread out reasonably evenly, either horizontally or sloping down when the antenna is used above ground, and the ends of the radials should not be earthed to the ground – hence the insulators.

No guys needed

Unless we are going to get regular winds like those experienced in the South East in October 1987, and in Northern Ireland and the North in February 1988, you will not need any guys for this antenna. Butternut do not recommend them, and only advocate them if you wish to transmit in a hurricane zone in which winds peak more than 80mph. Under no circumstances should guys be fixed higher than about 4m up from the base, and any guys should be decoupled several times along their length if metal, so it would be better to keep to nylon or plastic if you absolutely must have them.

The antenna is remarkably strong, and yet quite whippy, particularly near the top. The massive coils, combined with

the very high quality capacitors, allow component losses to be at a minimum, and it is in this area that the antenna also scores over trapped verticals.

Subjective trials

Many fun hours were spent putting the antenna together and tuning it, and I would like to express my thanks to Phil G3BSN, Terry G0GTO and Robert G4XDD, all of whom helped with the project. The antenna was tuned to resonate at 1.96, 3.74, 7.05 and 10.1MHz, with the higher bands set for optimum near the centre of each band.

It took a degree of patience to get everything right, and all the tests were done with the antenna mounted on a metallic copper-coated steel ground post, which was sunk about 2 metres into the ground. The Butternut radial kit was used, with the 300 ohm feeders laid out over the grass, and with the 10MHz radials and a single 3.7MHz radial laid out across the lawn. I used the installation throughout November and December 1987, and was able to make comparisons with my normal large LF trapped dipole, 30m dipole and TH6 HF beam.

On 160m, optimum SWR was completely acceptable, but the bandwidth of the antenna was extremely narrow. However, the antenna was usable down to 1.9MHz, if an aerial tuning unit was put into the system. In the late evenings I was amazed to find that I could cover the UK on SSB and, whilst my signals were fairly weak, they were usually readable even in GM with stations up to 500 miles away. The signals were judged to be around 15dB down on those from the trapped half-wave dipole, the latter being a particularly good antenna for inter-G working.

The performance surpassed what I would have expected from a vertical of its height, especially bearing in mind that there were no 160m radials. It would most certainly allow many amateurs to try 1.9MHz who had previously considered the band impossible because of restricted space for horizontal long wires.

On 80m, I was primarily interested in the antenna's use for inter-G working on various morning and afternoon nets, and in working into Europe in the evenings. Time after time I switched the Butternut over to the dipole and back, switching in the IC2KL linear with the Butternut whilst running the dipole barefoot, with an Icom 751 as the main rig.

The general reaction was that the two installations were similar, so the difference was around 7.5dB; the Icom's maximum PEP has been set well below 100W so that it is cleaner. 7.5dB lower gain on the Butternut is very much an average, differences in the range of 0 to 10dB being noted at various times. Even with 100W barefoot into the HF6V, my signals were easily adequate for me to hold my own on various morning nets on 80m, but it was in the evenings that I needed more power.

Try as I might, I did not notice very

much improvement in the reception of real DX on the Butternut as compared with my dipole, and I offer two explanations for this. My soil is diabolical (impervious clay down to at least 12ft), and I did not use an earth mat, so the antenna was not favouring low angle radiation. I have had many reports from stations using the Butternut with infinitely better earths and radial systems than I have, and they have all claimed significant improvements in DX reception and transmission when compared with a simple dipole at the same location.

What was very noticeable, however, was the very narrow frequency range that the antenna gives on 80m with an acceptable SWR, 30kHz being typical with the 160m extension kit installed. The instructions claim that the available bandwidth is quite a lot greater if the 160m extension kit is omitted.

Returning to the subjective tests, dozens of amateurs on 80m reported that my signals were much stronger than they would have expected from an average vertical. I suspect that in my case I might well have been enhancing the high angle of radiation, as well as limiting the low angle, by not installing an earth mat; if you only want to use 80m for inter-G working, you may well save a lot of time and bother by making yourself a simple short-tuned radial specially for 80m, using a home-made inductance in series with a shortened radial. You would be better to do this than not have one at all, because you might have a matching problem in the absence of any radial for 80m.

I was fascinated to find that on 40m the antenna more or less equalled the half-wave dipole, and comparative reports could be an S point up or down. I thought that I did detect a slight improvement on DX reception on the vertical. On 30m, it was very definitely superior for working across the pond and, incidentally, the match was absolutely superb. On 20, 15 and 10m, the antenna was decidedly better than I would have expected, and far outshone the performance that I had been used to many years ago from a Hy-Gain 18AVT trapped vertical.

I can well remember the Butternut coping with my sked with W0QM in Boulder, Colorado, even better than did the Hokushin, even though the conditions at the time the Butternut was used were slightly inferior. What I did find fascinating was that the vertical brought in far more stations at any one time than did my TH6 beam, and so it is clearly an advantage to have a good vertical antenna around, which you can switch to when you are checking a band for DX activity.

I had a lot of fun working on HF, running just 100W PEP, and in particular I was very impressed with the performance on 21MHz when the band was open. During the testing period, 28MHz was never properly open, but I did have some excellent contacts on ground wave with mobiles, most of these QSOs being on FM. Although the antenna was at ground

level, results were only slightly down on what I used to achieve with a 5/8 at 30ft above ground before the October disaster.

Comparison with TH6 beam

Over a period of an hour or two, we carried out many checks on nearby and DX stations on 14 and 21MHz. Whereas the Butternut was at ground level, the TH6 was at approximately 40ft above ground and has three elements active on 14 and 21MHz, whereas four of the elements are functional on 28MHz. The beam is completely in the clear in all directions, although there are a few trees in the vicinity. The Butternut averaged 12dB down on 14MHz and 10dB down on 21MHz as compared with the TH6, but quite frequently there were interesting deviations from this.

The Butternut was never better than the TH6, but occasionally there was only an S point or so in it. If you bear in mind that I did not have a proper earth mat, this comparison is saying quite a lot for the remarkable efficiency of the Butternut, and comparisons with a beam at last year's HF convention at Oxford proved fascinating, for the Butternut actually equalled the beam on occasions.

I did notice that after very wet weather, when our garden is a sea of mud, the Butternut's performance improves significantly. However, I am not advocating that you should have available a bevy of watering cans!

A crazy idea!

When my TH6 beam was unusable for many weeks after the storm, I had an odd idea, and I would be fascinated to know if anyone else has actually attempted what I would like to do myself. It would be enormous fun to put tow Butternuts back to back horizontally, balun fed in such a way that each HF6V would see the other as a counterpoise. It would be the equivalent of having an amazing multi-band dipole. If one could get the monster at, say, 20m above ground level, just how good would it actually be on the LF bands, and would its properties be worthwhile?

Anyone who installed such an odd creation would of course have the kudos of being able to say on 160m 'QRX, I'm just turning the beam!' This whole idea could be promoted by Butternut and their agents as an excellent means of selling more Butternuts.

Bandwidth/SWR plots

After the aerial had been adjusted, Phil, Terry, Fiona and I managed to obtain some very interesting plots of the return loss curves of the HF6V on various bands. Plots 1, 2, 3 and 4 show the return loss curves taken for the 1.8, 3.5, 10.1 and 28MHz bands. The minimum point on each plot corresponds with the resonant point, and this was checked with my Kenwood TS940S with Bird thurline wattmeter and a field strength meter used fairly close to the Butternut to avoid interactions with irrelevant objects.

The depth of the null corresponds to the return loss – the deeper the null the better, and a null of 20dB, for example, would correspond to $\frac{1}{100}$ of the power being returned – roughly 1.2:1 VSWR. 2:1 SWR corresponds to a return loss of just over 9dB.

Note that, on 160m, the null which is just below 1.960MHz is exceptionally steep. You can see that you only have to QSY ± 7 kHz or so to be at 2:1. The situation on 80m is that, while the bandwidth is better, the SWR is not so good. On 40m (not shown) the SWR was very satisfactory and the whole band was within 2:1. Note the phenomenal null at 10.1MHz. The performance on 14MHz was very satisfactory, but on 21MHz we were unable to do better than around 1.6:1, although the bandwidth was wide. The 28MHz performance can also be seen to be very acceptable.

At various times I checked the SWR on the LF bands, especially when the garden was rather soggy, as it was all too frequently this winter. The SWR did improve when the ground was wettest and I got down to around 1.3:1 on one occasion on 80m, although I had to persuade my three dogs to leave the radials alone long enough for me to take a measurement!

High impedance

The fifth plot is quite an interesting one, for it shows an extremely high impedance across the 160m coil assembly at its parallel resonant frequency of about 2.17MHz. An approximate estimate of the impedance at this point would be around 20,000 ohms, showing that the entire antenna would be nearly open circuit here. Plots taken across the 80 and 40/30m coils showed similar dips, previously referred to.

The plots were taken by feeding an accurate 50 ohm source to one end of the relevant coil, whilst the other end of the coil was loaded into an accurate 50 ohms, the source/load being interconnected with the Marconi spectrum analyser. The entire exercise was necessary because my aged grid dip oscillator was completely and utterly on the blink, so for the time being I am without one.

The results enabled me to understand what was actually going on in the antenna for, as good as the instructions are, they do not go into sufficient technical detail. I well remember that on first looking at the antenna after assembly, I was puzzled by three parallel tuned circuits apparently in series with one another!

The way in which Butternut use the inductive reactance of a tuned circuit to lower the resonant frequency of the antenna, whilst using the capacitance to bypass frequencies around the inductance when the frequency is well above resonance, is of particular interest, for we normally use a circuit at or near resonance rather than well away from it.

On this band the antenna only radiates up to the base of the trap, which consists of a top-fed wire stub coming down in

parallel with the main antenna; the stub being open ended at the bottom. You can adjust the length of the stub and its top feed point, and we experimented with varying both of these. We could most definitely alter the frequency of the point of minimum SWR, but we were unable to improve this below 1.6:1, although other HF6V owners have achieved far better results. For the time being this has to remain a mystery, but it is probably due to my poor soil.

Incidentally, the assembly and tuning instructions are extremely good, and blind members of the Radio Amateur Invalid and Blind Club will be interested to know that the entire instructions are available read onto cassette for any member.

Conclusions

If you have been put off verticals in the past, either because of a bad personal experience or as a result of someone else's experiences – or even perhaps, prejudice – then think again, for the Butternut HF6V has most certainly proved to me to be an extremely worthwhile antenna.

I have been surprised at the prejudice against trapped antennas for LF bands, but I have always found them to behave as one would predict, just 2dB or so down on a pure dipole in exactly the same location, provided the traps are very good ones. It is just the same with the Butternut, for you are actually getting nearly a 9 metre vertical antenna, which is designed to be resonant and 50 ohm matched on seven bands (if you include 160m).

Differences between efficient verticals and horizontal dipoles could form an excellent long article in its own right, but since I am not an expert in this field, I would not wish to write it.

The reason for my enthusiasm about the Butternut was that many of my friends in the RAIBC were desperate for a good vertical antenna which would not take up too much space, yet would give better results than a heap of wire in their attic.

Not only have I been surprised by the HF6V's performance, but I have also realised how much I have missed on HF in the past by not having a good omnidirectional 'search antenna'. If it is to be your only antenna, and you are going to take plenty of time installing it together with an earth mat, I am sure you will not be disappointed. You will have to have a lot of patience when you set it up, and Butternuts should do quite well for the sales of chicken wire!

If you are prepared to accept the fact that you will have to use an ATU on 160 and 80m if you want to transmit outside the area of resonance, you should find the results acceptable over a much wider bandwidth.

I am afraid, though, that you will not be able to use it satisfactorily at both around 3.75MHz for resonance and down at the bottom of the CW section with really good results. This would only be possible

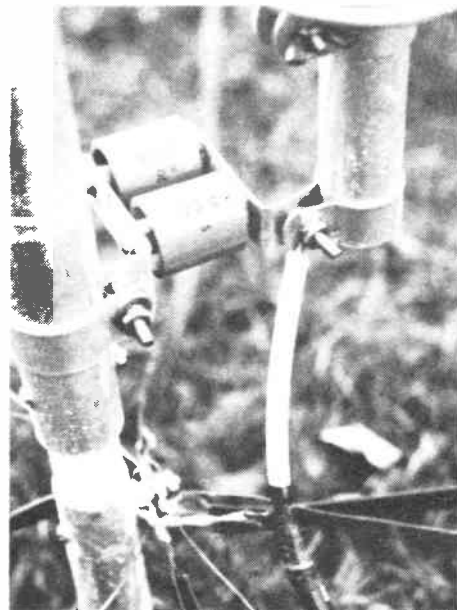

if you are prepared to readjust the 80m coil in and out.

Some amateurs have installed two or even three Butternuts in the form of an equilateral triangle, using various matching and phasing networks, thus obtaining directional arrays at LF. These are quite successful if great care is taken in the matching, and I understand that the facility of notching out an unwanted signal or direction is just as important as obtaining additional gain in the wanted direction. You will need a very large garden for such an array, though.

The very fact that the Butternut is so easy to send through the post, etc, is a great advantage, too, and you will find it a useful antenna for portable use. Many DXpeditions have used it, including the well known Peter 1st Island one, with excellent results. It is an ideal antenna for a disabled person, for it can be used successfully without an antenna tuning unit if correctly installed in the first place. With more time available than we had, it should be possible to obtain the very best SWRs.

This antenna is most definitely a good answer to the amateur who is always grumbling that he cannot get on to HF because he is not allowed a beam for one reason or another, and does not have a long enough garden for even a trapped dipole. However, the Hokushin antenna reviewed last month is more adaptable for the most difficult locations, if you have no garden at all and very severe planning problems.

The cost of the basic antenna is typically around £160 including VAT, the 160m add-on kit is around £54, the radial kit averages £33 and a roof mounting adaptor around £15 – prices varying from one source to another.

I would like to thank the importers, HRS Electronics Ltd, very much for providing the review sample and many amateurs for providing me with a great deal of technical information. This is a really fascinating HF antenna which seems to have taken the UK by storm.

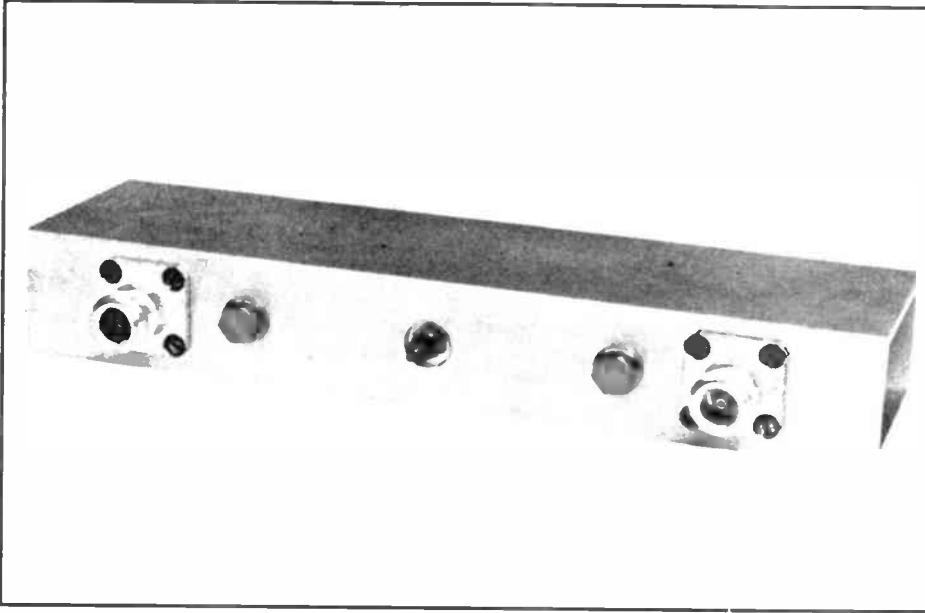

EME MODEL 2

1296MHz interdigital filter

Almost all enthusiastic users of 1296MHz employ a masthead pre-amp in order to offset the considerable losses of average co-ax down leads. It is not unusual for the effective system noise figure to be as poor as 8dB or so without the masthead pre-amp, but as good as 1dB with it. Unfortunately, most pre-amps have a very wide bandwidth, 100MHz or so at 1296MHz, and much noise can be added from the pre-amp at 1240MHz, a frequency which becomes the image if you use a 28MHz IF in a 1296MHz transverter.

More convenient

For many operators, a 28MHz IF is far more convenient than 144MHz. It allows the average system RF input intercept point to be very much better and dependent only in effect on the performance of the transverter itself.

However, a broadband pre-amp can make just as much noise at 1240MHz as it adds at 1296MHz, and transverters such

as the SSB Products LT23 have an image response near 0dB in the 28MHz IF version. This not only adds 3dB noise to all received signals, but any radar or amateur TV around the image frequency breaks through just as badly when you are tuned to 1296MHz/28MHz as it would if the interference was on the wanted channel.

It is vital to add enough selectivity to the front end to reject the image area, and EME offer three different models of interdigital filters which can solve the problem completely. I chose to purchase the intermediate model which seemed to offer the best specification in terms of bandwidth versus through loss and overall cost. As originally supplied, the bandwidth was rather wider than specification and the loss quite a lot greater at 2.5dB, the passband being centred at around 1290MHz with the tuning rather asymmetrical.

Three tuning screws are provided for precise alignment purposes. It is wise to

do the adjustment with a tracking spectrum analyser, although you should be able to set it up moderately well by adjusting for maximum gain. Careful adjustment using a Marconi 2383 4.2GHz analyser resulted in the frequency response shown in the accompanying plot.

The through loss was reduced to just over 1dB at 1296MHz and the bandwidth was even narrower than specified. Note the very rapid attenuation outside the band, which completely removes any image problems.

The filter is supplied with N type sockets, and costs £56. The type 1 filter costs about the same, has a much wider bandwidth of 28MHz and a claimed insertion loss of 0.5dB. The Mk II has a specified bandwidth of 15MHz for 3dB down with an insertion loss of 1dB.

An even tighter filter, type 3, is available having five poles and costing £66 with 9.5MHz bandwidth. However, it has an insertion loss of 2.2dB, which may not be acceptable.

EME also do two models of 2320MHz tunable filters. Both EME and SSB Products are available from Piper Communications, 4 Severn Road, Chilton, Didcot, Oxon OX11 0PW. There, Dave Aram G8DVK will be found to be most helpful.

Some of the advertising literature for these German products has not been translated into English. Fortunately, however, Piper's main catalogue gives most helpful details in English, but I did not have it to hand at the time. Have you ever tried looking up incredibly long German words in a small dictionary!

Fiona had problems with strange translations of 'insertion' seeming to be 'throughway steam pressure'. She also muddled up 'ripple' with 'budgerigars'. The time has really come for us to get a better dictionary.

Finally, whilst recommending the EME filters very highly, I would also like to make the point most strongly that 28MHz IF versions of the LT23 are a far better bet. The importers have said that they don't stock them, but get them to order. As there is relatively little demand, several friends have told me that they have had to accept the 144MHz version because of the long delivery of the 28MHz IF. I strongly advise you to persist in ordering the 28MHz version, so that you can use the transverter directly with a good HF rig to benefit from all its obvious advantages.

Dave Aram has promised to stock the 28MHz IF LT23, and I trust that it will become at least as popular as the 144MHz version. The LT23 far outclasses any other 23cm transverter that I have checked and is easily the best way to get going on the band.

For enthusiasts of SSB Products' equipment, news has just come to hand that a 25W complete transverter, the LT70, will be released shortly; I hope to be reviewing this soon. This will fulfil an urgent need that exists for a first class 70cm transverter.

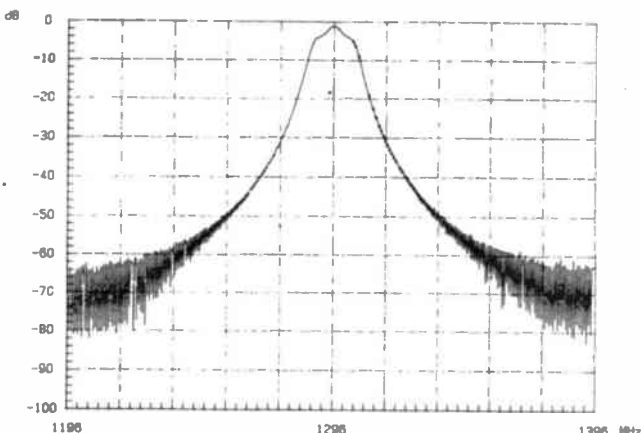

EME 2 1296MHz
interdigital response plot.
Insertion loss 1.2dB
Resolution bandwidth:
30kHz, 20MHz per division

Whilst many VHF rigs give an output in the range 1W to 15W, quite a number of transverters require a maximum of 0.5W on the input to give full output. Excessive input power at the IF input on Tx can cause damage to a load resistor and other parts of the circuitry, and many a Microwave Modules' transverter has been blown up by overloading the IF input.

Roger Ray of RN Electronics is marketing a useful little box which includes some circuitry which is unique, as far as I know, and which will solve many problems that can result if you are trying to drive a rig which is too powerful for a particular linear or transverter. It is, of course, easy enough to put in an attenuator, and one can make up quite a reasonable one with fixed high wattage carbon resistors, but the problem is to overcome the loss of the network on receive.

Microwave Modules got over the problem by providing an excess Rx gain in both their 1296 and 144/432MHz transverters, but the input intercept point suffered as a result. More than one SSB Products' LT23 1296MHz transverter has been damaged by users accidentally transmitting more than 1W into the 144MHz IF Tx input.

The RN Electronics solution

Roger Ray's solution is to build into a die cast box not only a 7 or 11dB power attenuator, but also an RF sensed relay. This bypasses the complete attenuator when less than 100mW is present in the circuit for longer than approximately 0.6 seconds. The box is normally fitted with BNC input and output sockets, and a pin is provided for connection to dc between 10.8 and 15.6V.

If the power attenuator is not energised with dc, the attenuator is permanently in. When dc is switched on, the attenuator switches out and only switches in again when the sensing circuit detects at least 100mW. The relay then drops out, and the attenuator comes in. The hang time is just under 1 second, and there is around 3dB of hysteresis

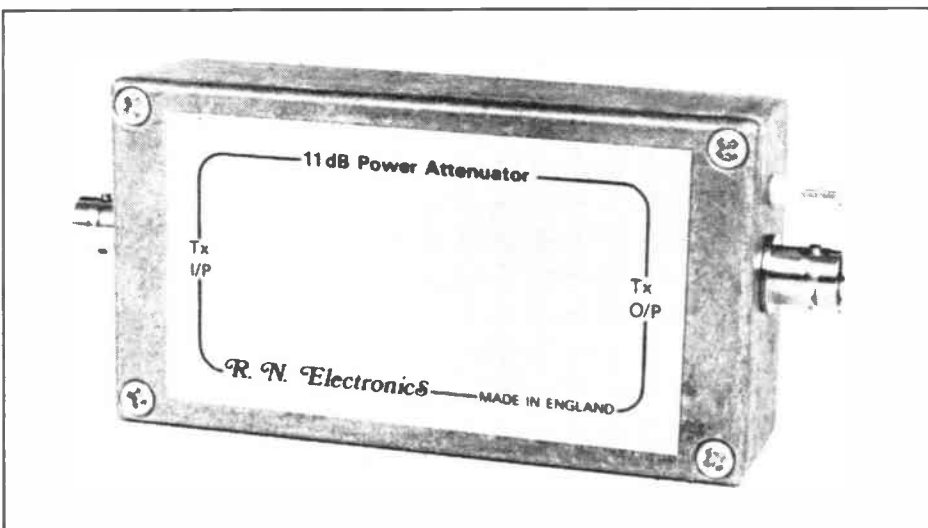

RN ELECTRONICS

RF sensed RF attenuator

between the power required to switch the attenuation on and that necessary for it to hunt or switch off.

With the review sample, approximately 1W was required with 11dB attenuation, but the manufacturers, on my recommendation, have agreed to increase sensitivity to avoid continual hunting.

My one criticism is of the labelling, for when I originally switched it on, Fiona and I had connected up the unit the wrong way round. I connected the transmitter output to the socket marked Tx o/p and Tx i/p was connected to the test load, as I took this to be the antenna input. Maybe I wasn't thinking hard enough, but I feel that the labelling was misleading. Incidentally, we first realised something was wrong when smoke started to come out.

Although many VHF rigs have a power output control, the use of this unit may be much more satisfactory than winding power back, since the protection is safer.

It is not only very easy to forget to wind the power down when you are driving your transverter or sensitive linear, but many VHF transceivers do put out little kicks of very high power before the ALC cuts it back. Constant very short transients, which cause severe over-drive, can create nasty spreading problems especially in a contest.

The SWR with the attenuator in action measured 1.15:1 on 145MHz, and the attenuation was very accurate from HF up to 146MHz. With dc connected, the unit took 40mA on Rx, and just 6mA on Tx. There was no significant Rx power loss.

I particularly recommend both of RN Electronics' active attenuators, which are priced at £22 each. They now have their 4m transverter available as well as the 6m one (reviewed recently), and should be producing 28MHz IF versions of both by the summer. Thanks to RN Electronics, 37 Long Ridings Avenue, Hutton, Brentwood, Essex CM13 1EE.

G4ZPY PADDLE KEYS

Gordon proudly presents his Keys as illustrated in the November Issue

PUMP (Straight) KEY	Brass £25.00	Nickel £30.00
SINGLE PADDLE KEY	Brass Std £42.00	Deluxe £44.50
	Nickel on Brass Std £47.00	Deluxe £49.50
TWIN PADDLE KEY	Brass Std £47.00	Deluxe £49.50
	Nickel on Brass Std £52.00	Deluxe £54.40

IAMBIC ELECTRONIC KEYS (with Auto Inter-Character Spacing) £40.00
 1K PEP BALUNS 3.5-30 Megs £15.00
 10-70 Megs £16.50, P&P UK: - KEYS £3.00
 IAMBICS AND BALUNS £2.00

SAE for further details to
41 Mill Dam Lane, Burscough, Ormskirk, Lancs L40 7TG
 or Phone: 0704 894299

RADIO AMATEUR LICENCE

Start training now - No previous knowledge required.
 Study for 3-6 months. Post Coupon now for free brochure - without obligation:

Radio & Telecommunications Correspondence School, 12 Moor View Drive, Teignmouth, Devon.
Tel: 06267 - 79398.



(AR.4)

NAME

ADDRESS

..... POST CODE

TX - 3 RTTY/CW/ASCII TRANSCEIVE

The high performance, low cost system

Slit-screen, type-ahead operation, receive screen unwrap, 24 large memories, clock, review store, callsign capture, RTTY auto CR/LF, CW software filtering and much more. Uses interface or TU. **BBC-B/Master** and **CBM654** tape £20, disc £22. **SPECTRUM** tape £35 inc adapter board. For **VIC20** we have our RTTY/CW transceiver program. Tape £20

RX - 4 RTTY/CW/SSTW/AMTOR RECEIVE

This is still a best-selling program and it's easy to see why. Superb performance on 4 modes, switch modes at a keypress to catch all the action. Text and picture store with dump to screen, printer or tape/disc. An essential piece of software for trawling the bands. Uses interface. **BBC-B/Master**, **CBM64** tape £25, disc £27. **VIC20** tape £25. **SPECTRUM** tape £40 inc adapter board. The **SPECTRUM** software-only version (input to EAR socket) is still available £25. **TIFI INTERFACE** Perfect for TX3 and RX4, it has 2-stage RTTY and CW filters and computer noise reduction for excellent reception. Transmit outputs for MIC, PTT and KEY. Kit £15 (assembled PCB + cables, connectors) or ready-made £25, boxed with all connections. Extra MIC leads for extra rigs £3 each. State rig(s). **WORLD AND UK/EUROPE MAP LOCATOR** Maps, great circles, distances, bearings, contest scores. Lat/long, locators, NGR, hundreds of placenames. **BBC-B/Master**, **ELECTRON** ONLY. Tape £10. **MORSE TUTOR** £6, **LOGBOOK** £8, **RAE MATHS** £9 for BBC, **SPECTRUM**, **ELECTRON**, **CBM64**, **VIC20**. All **BBC** and **CBM64** programs are available on **DISC** at £2 extra. Prices include VAT and p&p, 1st Class inland, airmail overseas, normally by return. Eire, CI, BFPO deduct 13%.

technical software (AR)

Fron, Upper Llandwrog, Caernarfon
LL54 7RF. Tel: 0286 881886



RADIO AMATEURS EXAMINATION TO ALL RAE STUDENTS

- 1) Are you finding home study difficult?
- 2) Would you like some C&G style practice questions?
- 3) Do you need some extra questions to supplement your college or correspondence course?
- 4) Would you like a Q&A manual designed to progress with an RAE course?
- 5) Are you having difficulty recognising circuits?
- 6) Could you do with some worked through examples on the scientific calculator?

IF THE ANSWERS TO ANY ONE OF THE ABOVE QUESTIONS IS YES, THEN YOU MUST OBTAIN THE THIRD EDITION RADIO AMATEURS' QUESTION & ANSWER REFERENCE MANUAL THIRD EDITION BY REG PETRI, T ENG MI.ELEC I.E. G8CCJ

WITH ADDITIONAL SECTIONS ON CIRCUIT RECOGNITION AND USING THE SCIENTIFIC CALCULATOR CONTAINING OVER 340 PAGES, 23 SECTIONS, 20 OF WHICH CONTAIN APPROXIMATELY 1100 PROGRESSIVE MULTIPLE CHOICE QUESTIONS AND ANSWERS. THE OTHER SECTIONS INCLUDE COMPUTER PROGRAMS FOR RAE FORMULA, CIRCUIT RECOGNITION, WORKED THROUGH, EXAMPLE, ON THE SCIENTIFIC CALCULATOR AND THE C&G SYLLABUS. ISBN 0 9509335 2 x size A5 (210 x 148mm)

Available By Return Post From:

WP PUBLICATIONS
11 WAYVILLE ROAD
DARTFORD, KENT DA1 1RL
price £6.95 & £1 p&p UK

ALSO AVAILABLE a suite of computer programmes for the Commodore 64/128 only. Contains formula for the RAE and morse tutor.
Tape £5.95 inc p&p Disc £6.95 inc p&p

Penetrate the four corners of the earth with the IN USE FROM VK7 to VE7!

HERE'S THE SPECIFICATION ...

- * 3 elements on each band
- * Broadband operation
- * heavy duty 2Kw rated
- * Stainless steel hardware
- * Gain up to 8dB
- * SWR less than 1.3:1

HERE'S WHAT THE CUSTOMERS SAY!

1. G0CCX. 'I have owned one of your DX-32 antennas for a couple of years now and have been very pleased with its performance. I am now even more pleased with it, for despite the horrendous weather that lashed the south coast last week, the antenna is still in one piece and working perfectly. Exposed as my location is, and with Hy-gain TH3's and cushcraft beams coming down in locations just a few hundred yards away, it speaks wonders for the strength of the antenna, even if it did give a passable imitation of Magnus Pike at the time!'
2. VK7NOW 'I have recently installed a DX-33 beam and would like to advise you that I am extremely satisfied with it. It certainly outperforms the TH3JNR which I previously used and also the VSWR is lower.'
3. G3AAE 'This letter is to tell you how pleased I am with the DX-33 antenna. On unpacking the DX-33 I was immediately impressed with the quality of the hardware and in operation it is just as impressive. I have used it on all three bands and have been obtaining excellent reports from DX stations all over the world. I have conducted tests with other stations and these show that the electrical figures included in the DX-33 specification are fully met in practice. Congratulations on a very fine product!'

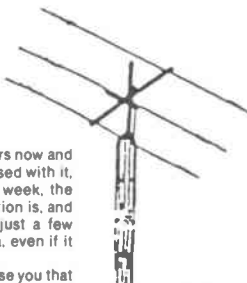

DX 33
3 Element
3 Bands

MADE IN ENGLAND! NO SPARES PROBLEMS AS WITH IMPORTED BRANDS!

THE ULTIMATE in DESIGN ... the ULTI-MAST

Our structural engineering department came up with the maximum of strength for the minimum of cost.

It's impossible to get MORE strength for LESS cost

... so beware of cheap copies

... they may not have the correct materials!

OURS IS THE ORIGINAL MAST ... there are copies!

Slim, unobtrusive
For VHF and HF antennas
Simple ground fixing

One-winch operation
Telescopic and Tilt-over
Self-supporting

We do towers over 300' so rest assured that your 30' is safe!

Mail order only to: (Send 3x18p stamps for details of any item.)

PRICES (inc carr & Vat)

Ultimast UM-1	£328.90
Reducer head. UHD-1	£11.50
Rotor head. UHD-2	£37.95
D8-1 Detachable base	£28.75

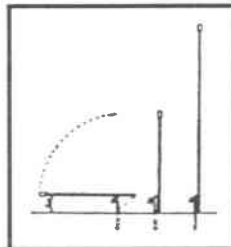

**THIS IS THE ONLY STOCK IN THE UK!
BUY NOW AT LOW PRICES**

KENWOOD BARGAINS

R-1000 £480. R-2000 £555
TRANSCEIVER, Tm-411E £299
SSB POWERMETER - THE PM-2000A GIVES A
STEADY READING OF PEP O/P on SSB 200/
1000/2000W. SCALES AND SWR. **£86.82**

Western Electronic (UK) Ltd

A.R. FAIRFIELD ESTATE, LOUTH, Lincs LN11 0JH

LINEAR AMPLIFIER

Build one and stay friends with your bank manager. By Brian Kendal G3GDU

PART 2 – CONSTRUCTION

In last month's article we discussed the design and the parts necessary to construct an inexpensive linear amplifier. The most important message is that if you attempt to duplicate a piece of equipment described by someone else, you will either spend a great deal of money purchasing new components or a great deal of time at rallies, junk sales and emporiums looking for the specified components second-hand.

If, however, you purchase the right type of components, such as those described last month, you will very soon acquire sufficient to construct an amplifier to one of the standard designs which will fully satisfy your needs.

First steps

Assuming that you have already sought out a selection of transformers, variable and electrolytic capacitors etc, it is then time to consider the case in which the amplifier is to be constructed.

With the size of transformers necessary to provide the power, the unit will certainly be quite heavy. Flimsy chassis construction is not acceptable. If home constructed, the chassis should be of

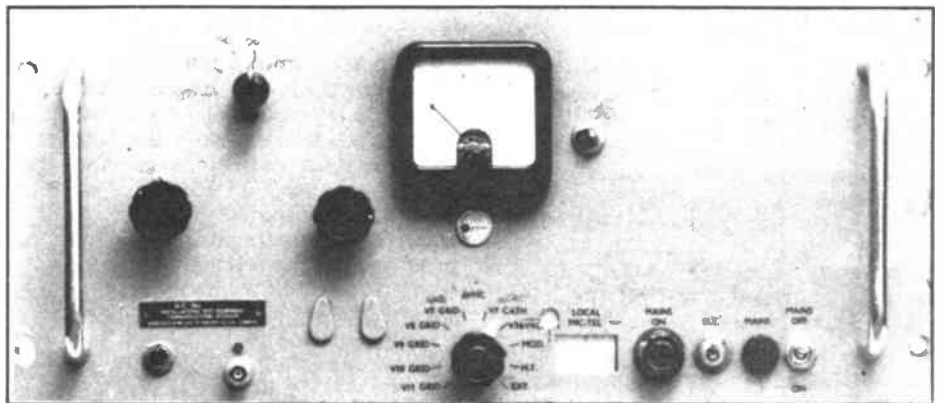

Photograph 1: Front view of author's amplifier. With the exception of the meter function switch, the original panel legends are valid. Only the aperture for the local mic/tel socket had to be blanked off.

heavy gauge aluminium or steel.

For those of us whose mechanical construction skills are not what they might be, probably no better start can be made than using the case from some commercial piece of equipment. If the existing holes in the chassis cannot be utilised in the construction, a simple remedy is to cut away the top of the existing chassis, leaving a half inch lip all

around; then bolt on a heavy (16 gauge) aluminium plate.

There is little to be gained by attempting to construct in as compact a form as commercially manufactured equipment. The best advice is to start with a standard rack-size chassis (17 inches wide, 14 inches deep and 3 inches high). This will give adequate room for the power pack and all components whilst allowing sufficient natural air circulation to obviate the need for forced air cooling. With the power unit located on the amplifier chassis, there will also be no problems arising from feeding high voltage cables around the shack.

The layout

With the chassis selected, the layout of the components can be decided. Simply by placing the major components on the uncut chassis and trying them in different positions the most convenient layout can be determined. The power transformers are most conveniently placed along one side with the rectifiers and smoothing capacitors close by. This will leave the majority of the space available for the amplifier itself.

Although we have all been brought up to believe that short wiring is essential, this is not nearly so critical as on VHF. In general, even in the grid circuit, an inch or so of wire is unlikely to cause serious trouble, whilst the anode leads may be several inches long without detriment.

Obviously the spindles of the tuning capacitors and the wavechange switch must pass through the front panel, so it is convenient to mount these components

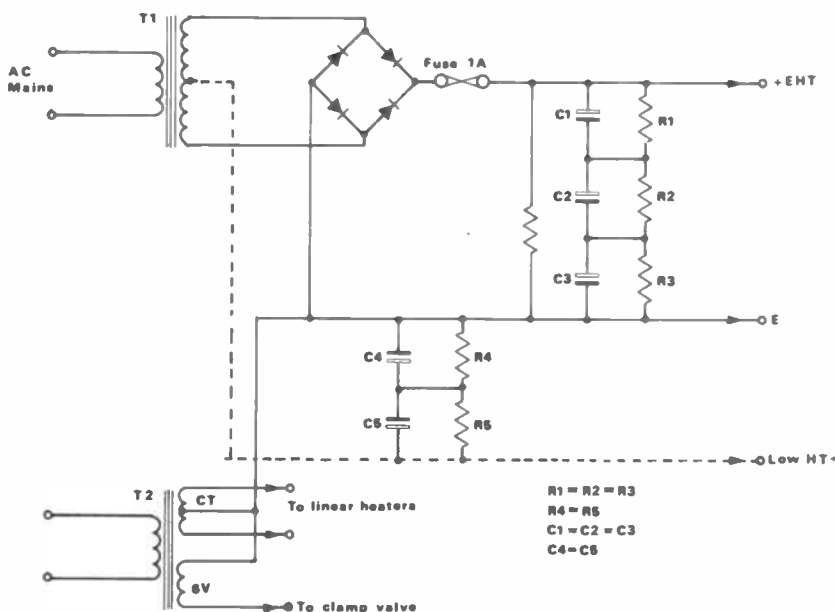

Fig 1: Typical linear amplifier power supply circuit. T1 should be 400-0-400 or higher voltage and the rectifiers and capacitors' working voltage rating chosen to suit the voltage given by the transformers. The dotted lines indicate how a second, lower HT voltage may be gained from the same transformer to feed screen grids or other stages

LINEAR AMPLIFIER

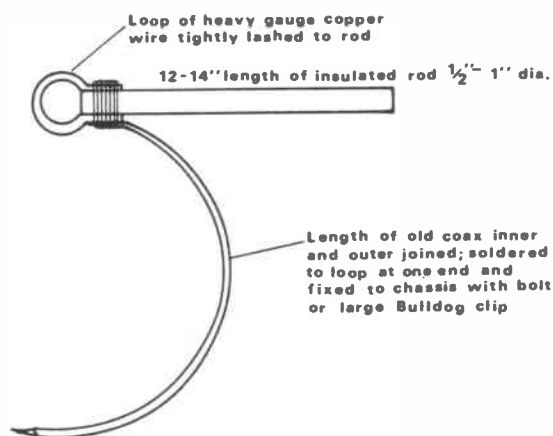

Fig 2 Construction of earthing wand

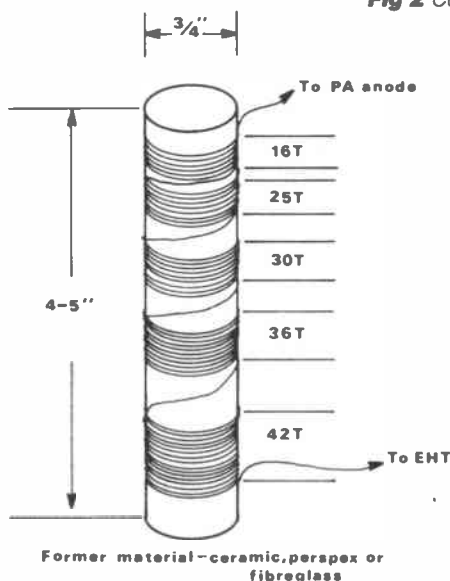

Fig 3 Construction of anode circuit RF choke. The choke is wound with 24swg enamelled copper wire. The purpose of winding in sections is to reduce self capacity

at the front of the chassis. Obviously, full advantage should be taken of any holes in the existing front panel.

The position of the tank coil depends largely on its diameter and the space available. If there is sufficient room, it could be mounted above the associated variable capacitors. If adequate clearance is not available, it could be positioned behind these capacitors.

The output valve(s) can probably be most conveniently positioned towards the centre of the chassis. If they are too tall for the case when mounted at chassis level, the holder(s) can be mounted on a panel an inch or two below chassis level to provide the necessary clearance.

The layout can be varied infinitely, but provided that it is not crowded ample room should remain for all the other necessary components.

With the layout having been decided, it is a convenient time to cut the major holes before mounting any components.

The power unit

When using either the ZL/G2MA tetrode or zero bias triode circuits, only three power outputs are necessary – EHT, heaters and relay supplies. EHT and

heaters should be provided from separate transformers whose primaries should be wired so that it is impossible to switch on the EHT before the heaters.

Twelve volts for the relay supplies may be available from an additional winding on the heater transformer, but, if not, a small separate transformer should be provided with its primary in parallel with that of the heater transformer, as should a transformer provided to supply bias. A transformer supplying screen grid voltage should be wired in parallel with that for EHT. This, however, is rarely necessary, for half of the EHT voltage can be obtained from the centre tap of the EHT winding.

The rectifiers, bleeder chain, smoothing capacitors and their associated balancing resistors should be mounted on sub panels insulated from earth.

Normal hook-up wire has insufficient insulation for EHT lines; however, an acceptable alternative is to use the inner core of quarter inch coaxial cable.

Having completed the wiring of the power unit, check that the heater voltage is present and the EHT voltage is close to its theoretical peak value. Very great care should be taken during the latter test, as a shock from this unit could prove fatal. Use only a well insulated prod in good condition, and make sure that no part of your body can possibly make contact with the chassis while the test is in progress.

After completing the test, switch off, wait a few seconds and then discharge the smoothing capacitors to earth with a well insulated screwdriver or preferably an earthing wand.

The RF section

The wiring of the RF section is relatively straightforward, provided that it is remembered that the heater circuits will take quite a heavy current and that a very high voltage will be present on the anode.

The heater circuits

If a grounded grid amplifier has been selected, it will be necessary to construct a bifilar heater choke. This requires a six inch length of half inch ferrite rod and two lengths of heavy (at least 16swg) enamelled copper wire. The

two lengths of wire are attached to one end of the rod with a tie wrap and are then wound, side by side, along the whole length of the rod and secured by a further tie wrap at the other end. If long ends are left, these may be further insulated by sleeving and used to complete the heater wiring.

As a pair of 811s take eight amps, and an 813 takes five, even the very low resistance of the heater choke and/or wiring may cause a substantial voltage drop. Transmitting valves are quite critical in their heater requirements, so when the heater circuit has been wired, it is a wise precaution to check the voltage at the valve holder. Should it be found that the voltage is low, this may be corrected by changing the mains tap on the heater transformer.

The grid circuit

The design of the grid circuit depends to a considerable degree on the power available from the transceiver. In almost every case, several watts of drive will be necessary, but if the driving transmitter can supply several tens of watts, considerable latitude in the design is possible. A further problem is that most modern transceivers have to look into a 50 ohm impedance.

In the case of tetrode linear amplifiers, most textbooks show the drive link coupled to a tuned circuit feeding the grid. Although this is a perfectly practical circuit, in the author's experience this usually leads to instability, as there is invariably a lot of RF floating around a high power amplifier and feedback is almost inevitable. Others must have had the same experience as a neutralising circuit is almost invariably shown.

If sufficient drive power is available, the author much prefers the passive grid configuration. In this, a low (50 ohms or less) resistor is placed between grid and earth and the RF drive is fed directly to the grid. This also ensures that the transceiver is 'looking into' 50 ohms.

Adequate RF power must be supplied from the transceiver to generate the required grid voltage swing. The low impedance between grid and earth, however, tends to keep the amplifier extremely stable. This circuit was tried during the design of the present linear and it was found that on the lower HF bands it even kept the 811A triodes stable.

The resistor must be capable of handling the RF output from the transceiver, and it was found that a small commercial 50 ohm RF dummy load was very convenient for this purpose.

If, however, the output of the transceiver cannot be reduced sufficiently to drive the linear at the correct level, this can be further reduced by introducing a matching resistive attenuator circuit in combination with lowering the value of the passive grid resistor, which will further enhance the stability of the amplifier.

If power triodes have been selected for the amplifier, unless the constructor

LINEAR AMPLIFIER

wishes to use neutralising the only practical configuration is the grounded grid circuit. In this, the grid is connected directly to earth and the drive fed to the heater, which is isolated (to RF) from the heater transformer by bifilar RF chokes.

Impedance matching

The input impedance of a grounded grid amplifier is two or three hundred ohms and to improve the matching between the transceiver and amplifier input, the author inserted a small bifilar transformer, wound on a ferrite ring. Initially both windings were ten turns, but in final testing, the number on the primary winding was gradually reduced until the best VSWR (better than 1.5:1) was obtained on the input line.

In last month's article it was mentioned that 811As require four to five volts negative bias in grounded grid service. Some readers may wonder how this can be achieved; however, the term 'grounded grid' refers to RF potential and such grounding can be achieved conveniently by bypassing each grid to earth with a high value capacitor. The bias voltage can then be fed through a small RF choke.

The screen grid circuit

In the G2MA and ZL linear circuits, the screen grid and the anode of the clamp valve are fed through a high wattage resistor chain from the EHT supply.

A moment's consideration will reveal that at some times during the modulation cycle and also during no-drive conditions, the junction of the screen grid and the clamp valve anode will reduce to very close to earth potential.

The power rating of the screen resistor must therefore be sufficient to accept the full EHT. In general, with the 50k Ω resistor recommended for this position, a total dissipation of at least 50 watts is necessary. This may take the form of a large single resistor or a series chain of resistors of lower value.

The selection of the clamp valve is fairly critical, for its characteristics must be such that the unclamping action must commence immediately the bias is applied. Many valves have this property, the 12A6, 6L6, 6F6 or 5881 being recommended for the ZL linear circuit and the 6Y6 for the G2MA version.

The anode circuit

The anode circuit may take one of three forms: a series or parallel feed single tuned circuit or a PI output network.

Which of these to use is a matter of personal choice as each has its advantages and disadvantages.

The series single tuned circuit has the advantage that no RF choke or high voltage blocking capacitor is required, but the disadvantages are that the spindle of the tuning capacitor is at EHT potential and that any band switching has to handle full EHT and RF voltages.

The parallel fed single tuned circuit also has the disadvantage of requiring

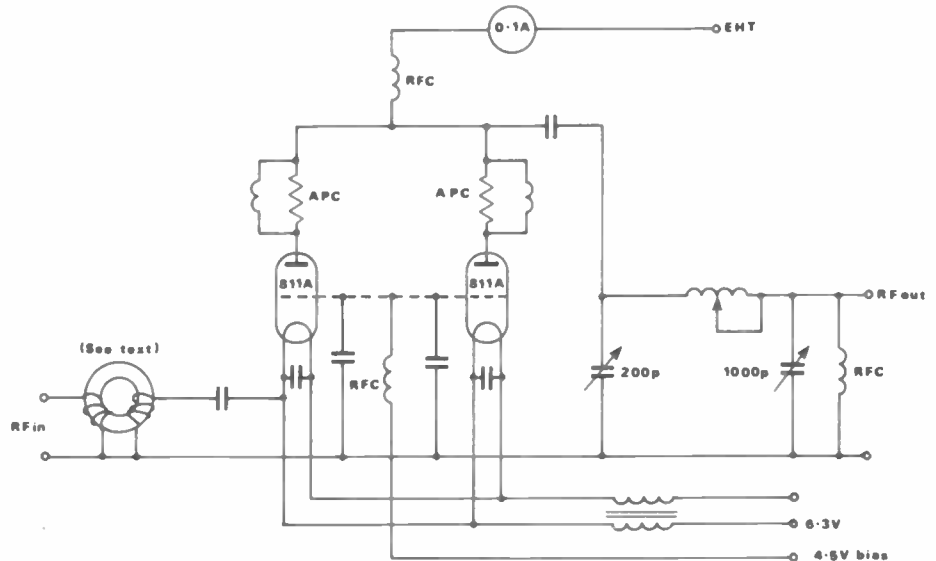

Fig 4: The RF section of the author's 811A linear amplifier. Unmarked capacitors are all 1nF at appropriate voltage ratings. The anti-parasitic chokes comprise 3 to 5 turns of wire around a 100 Ω composition resistor.

high RF voltage switching and, in addition, it requires an RF choke in the anode circuit and a high voltage blocking capacitor. If plug-in coils are contemplated, however, this circuit has the advantage that the coils are at earth potential to dc.

Both of these circuits give a single output impedance, so an aerial matching unit will usually be required.

The PI output circuit has the disadvantage of requiring an RF choke in series with the valve anode plus a high voltage blocking capacitor. It has, however, the great advantages that all coil switching may be achieved at the 'cold' end of the coil and that the output can match a wide range of impedance, frequently obviat-

ing the need for an aerial matching unit. The fitting of the RF choke across the output of the PI circuit is a wise safety precaution for without it, should the blocking capacitor become short circuited, the full EHT potential will appear on the aerial. With the RF choke in circuit, the EHT will be short circuited to earth and the fuse will blow, rendering the aerial safe.

One of the great problems in constructing linear amplifiers is to find a suitable RF choke for the anode circuit. So far, the author has been lucky in finding commercial chokes for the purpose, but if none are available, one can be home wound.

Alternatively, the author has

Photograph 2: Top view of author's linear amp showing the open layout. Also evident is the use of the original chassis for the power section, but a new plate for the amplifier section.

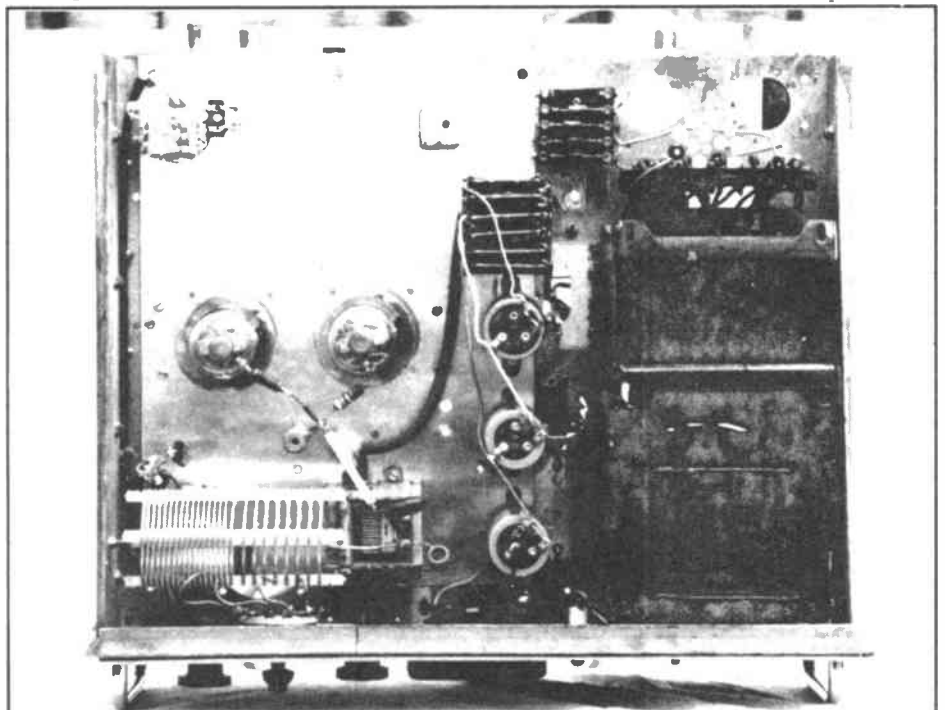

LINEAR AMPLIFIER

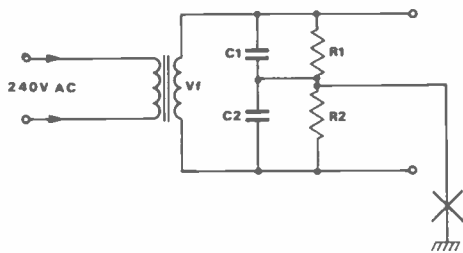

Fig 5 A means of providing a filament voltage balanced about earth for supplying directly heated valves when the transformer is not centre tapped. $C1 = C2 = 1nF$. $R1 = R2 = 22$ ohms. A meter at point X will indicate combined grid, anode and screen grid current

heard of many amateurs using a 100 ohm wirewound resistor of sufficient rating to take the half amp or so peak current present in the anode circuit.

Where PI tank circuit switching is incorporated, care should be taken that the contacts are capable of handling a high current, as several amps of RF will be circulating on some wavebands.

The output impedance of high power linear amplifiers is much lower than may be expected. Due to this, in order to achieve good output matching, the output tuned circuits have to be of much lower L-C ratio than for traditional class C amplifiers. The output impedance for valves in linear service can be obtained from manufacturers' literature, and the

necessary circuit constants from standard tables.

The difficulty of using tables is that they quote both capacitance and inductance and few amateurs have the means to measure the latter. The method used by the author is to first set up the necessary capacitance, either by 'guesstimating' the enmeshment of a variable capacitor or by the use of fixed capacitors in series and/or parallel. These are then attached across the inductance and the frequency of the combination determined using a grid dip oscillator.

The inductance is then adjusted until resonance occurs on the correct frequency and is then removed and fitted into the amplifier.

The switching circuits

The switching circuits may conveniently be considered in two sections, mains and RF.

The main consideration in the former is that it must not be possible to switch on the EHT circuit before the heater/relay transformer(s). Application of EHT to the output valves before the heaters have reached operating temperature can strip their cathodes, with consequent reduction of life.

The simplest way of avoiding this problem is to wire the mains input to the heater/relay transformer in the con-

ventional way and then take the feed to the EHT transformer from there, via the EHT 'ON' switch.

An improved method would be to switch the EHT transformer via a relay, which in turn is controlled by a transistor circuit powered from the relay supply, to give a delay of a minute or so. If this refinement is not included, it is up to the operator to refrain from switching the EHT until the necessary time has passed.

After switch-on it is normal practice to leave the EHT supply on throughout the operating period.

A further problem might be that the power surge, which occurs during the switching of the EHT transformer and the charging of the electrolytic smoothing capacitors, may even be sufficient to blow the mains fuse and/or the rectifier bridge.

In such circumstances some means must be found to reduce this surge. This is most conveniently achieved by inserting a resistor in series with the primary of the EHT transformer. Across this resistor should be a pair of relay contacts arranged to close some 20-30 seconds after EHT switch-on. Obviously the value of the resistor would have to be selected to suit the particular transformers in use, but 50 ohms might prove a convenient starting point. As the current surge will probably be in the region of several amps, both the resistor and the relay contacts should be adequately rated.

The RF switching is, by comparison, far less complex, for it comprises only changeover relays on the input and output of the amplifier. Contrary to general belief, there is no need to use coaxial relays for this. On HF any mismatch caused by the relays will be negligible and, provided that they will take the RF power, almost anything will prove satisfactory.

For the input circuit it has been found that RF relays removed from Pye business radio equipment are satisfactory, whilst for the output, provided that the contacts will take three or four amps, most reasonable quality relays should suffice. The voltage rating is not that important, as even 400 watts across 50 ohms only generates about 150 volts.

The primary circuits for both changeover relays should be wired in parallel and fed from the relay supply. By hard wiring the switching back to the transceiver, a more satisfactory operation will be achieved than with any RF operated circuit.

Conclusion

Throughout these articles, I have steered away from giving precise constructional details for the very reasons which I gave in the first few paragraphs of last month's article.

In order to homebrew almost any project economically and reasonably quickly, it is necessary to design around components to hand or which may be easily obtained. It would certainly be almost as expensive to build with new

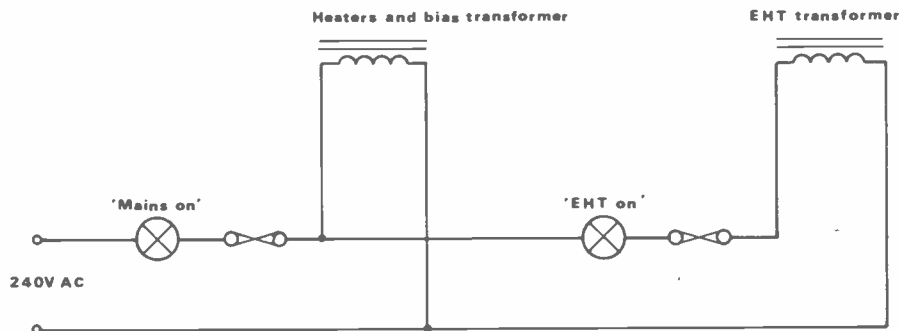

Fig 6 Simple manual method of ensuring that the heaters and bias are on before the EHT

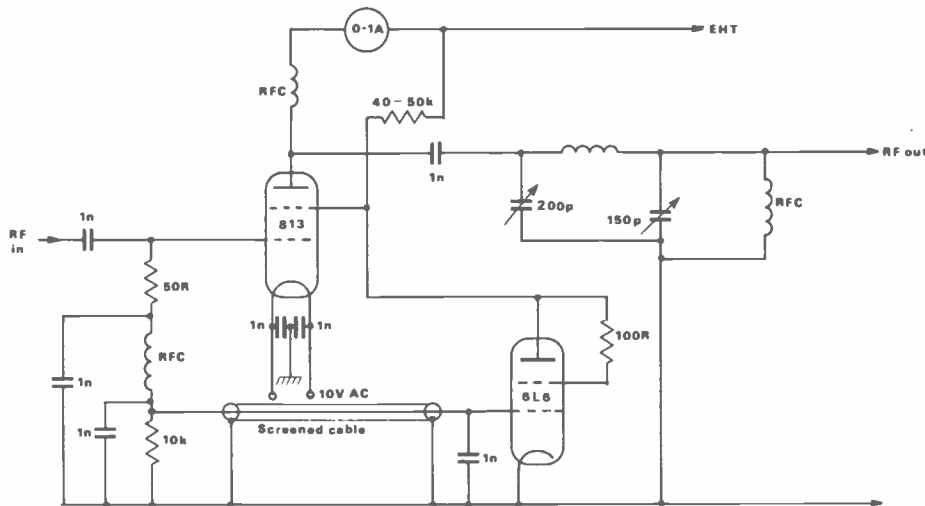

Fig 7 Suggested ZL linear circuit for a low cost amplifier. The input uses passive grid for improved stability

LINEAR AMPLIFIER

components as to purchase new commercially-produced equipment.

If you feel nervous about designing and constructing a high power linear, why not have a 'dummy run' by building a small one, just for experience, before attempting 'the big one'? An 807 in the ZL linear circuit would make a very good, inexpensive introduction to the subject.

Provided that care is taken and the basic principles followed, there is no reason why any amateur should not successfully construct a linear amplifier capable of running the full legal power.

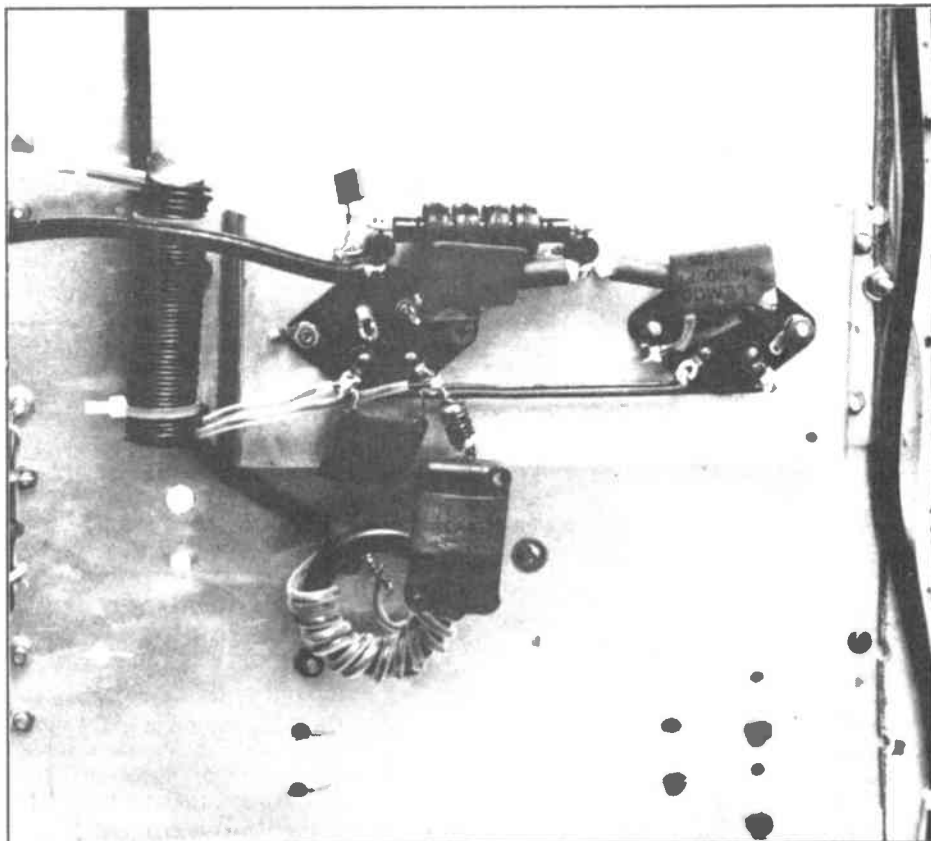

Photograph 3 Close-up of the 811A valve bases, showing the heater choke on the left and the bifilar input transformer

BAND	L (μ H)	C (pF)
80	7	300
40	3.75	145
20	2.35	75
15	1.35	50
10	.95	35

Table 1: This gives a set of values for output tuned circuits for 400W linear amplifiers employing EHT voltages in the region of 1500-2500. It should be noted that if a PI tank circuit is used, C corresponds to the value of the tuning and loading capacitors in series

Part 1 of this article was in the March issue

TRAINEE RADIO OFFICERS

Are you looking for a secure shore-based job which offers a rewarding career in the forefront of modern Telecommunications technology... then consider joining GCHQ as a Trainee Radio Officer. Training involves a 32 week residential course, (plus 6 weeks extra if you cannot touch type) after which you will be appointed RADIO OFFICER and undertake a variety of specialist duties covering the whole of the spectrum from DC to light.

We offer you: Job Security · Good Career prospects · Opportunities for Overseas Service · Attractive Salaries · and much more.

To be eligible you must hold or hope to obtain an MRGC or HNC in a Telecommunications subject with an ability to read Morse at 20 wpm (City and Guilds 7777 at advanced level incorporating morse transcription would be advantageous). Anyone with a PMG, MPT or 2 years relevant radio operating experience is also eligible.

The Civil Service is an equal opportunity employer.

Salaries: Starting pay for trainees is age pointed to 21 years. For those aged 21 or over entry will be at £7,162. After Training an RO will start at £10,684 rising by 5 annual increments to £15,753 inclusive of shift and weekend working allowance.

Write or telephone for an application form to -

GCHQ THE RECRUITMENT OFFICE, GCHQ, ROOM A/1108
PRIORS ROAD, CHELTENHAM, GLOS GL52 5AJ
OR TELEPHONE (0242) 232912/3

STATE OF THE ART SPECTRUM SOFTWARE

G1FTU SSTV TX/RX

8, 16, 24, 32, 48 and 96 second SSTV. Colour text and graphics transmit. Brightness and contrast controls. Frame stores for saving and printing. 9 text memories. Good RX performance on HF and VHF. £12 on cassette, £14 on microdrive or Opus disc.

G1FTU RTTY TX/RX

The classic RTTY program, still going strong. Split screen, type ahead operation 45-110 baud amateur and commercial reception. Reverse tones, unshift-on-space, tuning indicator, etc, etc... £10 on cassette, £12 on microdrive or Opus disc.

G1FTU CW TX/RX

The ultimate morse transceiver program. Split screen, type ahead, software filters, QSO review, print, re-send. Variable speed and tone. INCLUDES A BUILT-IN LAMBIC KEYS. This program has it all. £10 on cassette, £12 on microdrive or Opus disc.

Write or phone for full details. Return of post despatch on all orders. (Please include your callsign with the order).

PEARSONS COMPUTING

42 Chesterfield Road, Barlborough
Chesterfield, Derbyshire S43 4TT
Tel: 0246 810652

ICOM

IC-4GE 70cm FM Handportable

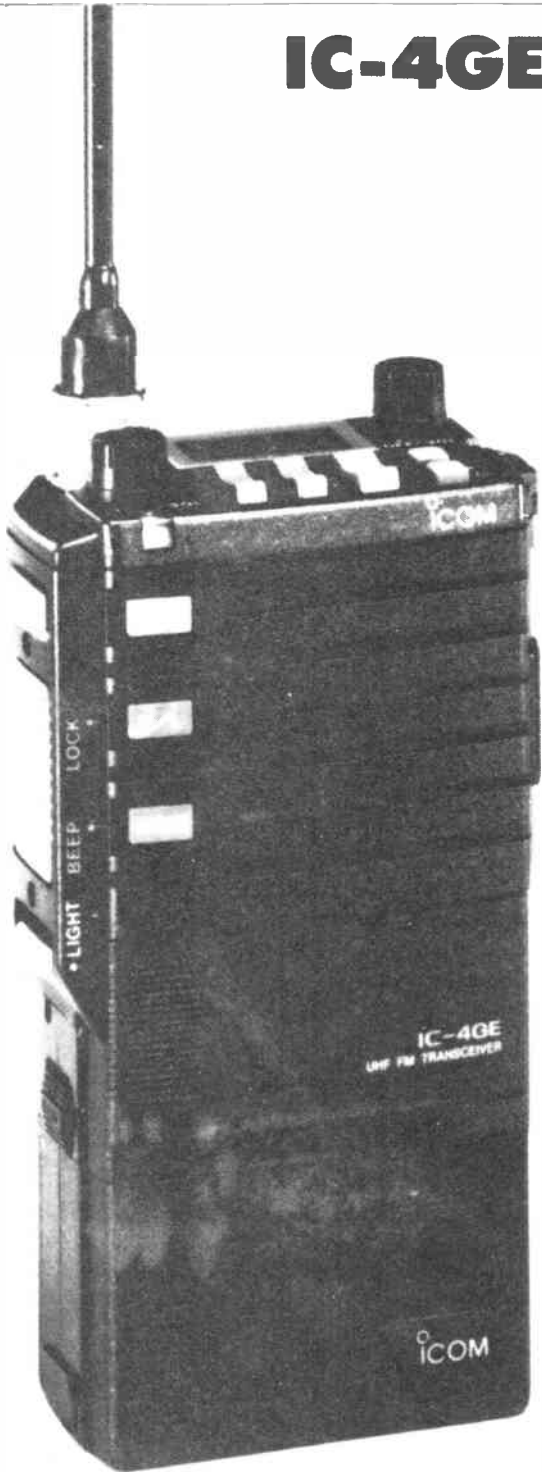

The IC-4GE is the first in a line of new handportables to be announced from ICOM. The small compact style provides easy operating and rugged durability. Other models for 2mtrs and 23cm will be released later this year.

A full 6 watts of RF power is available when using the IC-4GE with the option IC-BP7 nicad pack. The IC-4GE is equipped with a total of 20 memory channels. Each memory can independently memorise frequency, offset direction and frequency.

All circuits are designed using low power dissipation techniques to create a special power save circuit in the transceiver. The power saver circuit functions if no signal is received or no switch operation is performed for more than 30 seconds. In addition, the power saver circuit can be turned off for packet communications.

Two different scans, programmed scan and memory scan are provided and in addition memory skip channels can be programmed to skip selected memory channels during memory scanning operating. The squelch monitor function allows you to monitor weak signals without having to adjust the squelch control. The high impact case is splash resistant by the inclusion of rubber gaskets. The IC-4GE is supplied with a IC-BP3 nicad battery pack, flexible antenna, AC wall charger, belt clip and wrist strap. It is compatible with many of the existing accessories for ICOM's IC-2/4 and IC-02/04 series of handportables.

Also available for the IC-4GE is a large range of optional accessories including a variety of rechargeable nicad power packs, dry cell battery pack, desk charger, headset and boom mics and new slimline speaker mics. For more information on the IC-4GE or any other ICOM handportable contact your local ICOM dealer or ICOM (UK) LTD.

◀ Actual Size ▶

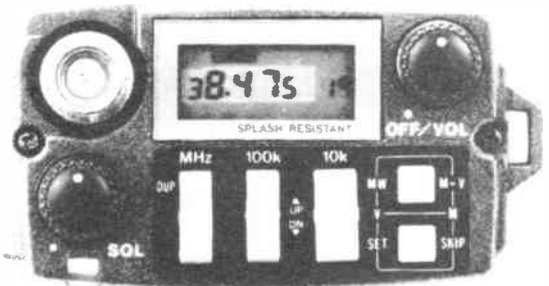

Icom (UK) Ltd.

Dept AR , Sea Street, Herne Bay, Kent CT6 8LD. Tel: 0227 363859. 24 Hour.

Count on us!



IC-575, 28/50MHz Dual band multimode.

The ICOM IC-575 base station has been developed to meet the demand for advanced communications for the recently acquired 6m band. Similar in appearance to the IC-275/475 2m and 70cm base stations, the beauty of this new transceiver from ICOM is that it gives you the best of both worlds, 6 & 10m in one compact unit. The IC-575 covers 28-30MHz and 50-54MHz.

Operating modes are SSB, CW, AM & FM. Power output is 10 watts (AM 4 watts) with a front panel control to reduce output for QRP operations. A pass band tuning circuit narrows the I.F. passband width, eliminating signal in the passband. A built-in notch filter eliminates beat signals with sharp attenuation characteristics.

Some PLL systems have difficulty meeting the lockup time demands placed on them by new data communications. This is why ICOM developed the DDS (Direct Digital Synthesizer) method. With a lockup time of just 5msec the DDS method allows the IC-575 to handle data communications such as packet or AMTOR. 99 programmable memories can store frequency, mode, offset frequency and direction. A total of four scanning functions for easy access to a wide range of frequencies, memory scan, programmed scan, selected mode memory scan and lock out scan. The IC-575 has an internal A.C. power supply, but can also be used on 13.8v DC for mobile or portable operation.

Optional accessories available are the UT36 voice synthesizer, the IC-FL83 CW narrow filter, SM7 external loudspeaker, HP2 communication headphones and SM8/SM10 desk microphones. Other transceivers available in this range are: IC-275E 2m multimode 25w, IC-275H 2m multimode 100w, IC-475E 70cm multimode 25w, IC-475H 70cm multimode 75w.

IC-505, 50MHz Transceiver

The IC-505 is a 6mtr BAND SSB, CW, FM (Optional) transceiver. It can be used as a portable or like other transceivers of this type as a base station unit. When used with an external 13.8v power supply the 505 gives 10 watts RF output, 3 watts or 0.5 watts on low power is available when using internal batteries. Other features include 5 memories with memory scan, program band scan, dual VFO's with split operation.

The easy-to-read LCD readout includes frequency, memory scan and call modes. Full metering of battery condition signal strength and power output is provided. When fitted with the optional EX248 FM unit the IC-505 offers 50MHz operation at an affordable price.



Helpline: Telephone us free-of-charge on 0800 521 145, Mon-Fri 09.00-13.00 and 14.00-17.30. This service is strictly for obtaining information about or ordering Icom equipment. We regret this cannot be used by dealers or for repair enquiries and parts orders, thank you.

Datapost: Despatch on same day whenever possible.

Access & Barclaycard: Telephone orders taken by our mail order dept, instant credit & interest-free H.P.



73 de
G3KPO
(GB 3WA - FORMN)

Douglas Byrne Op.
52 West Hill Road
St. John's Park
Ryde, Isle of Wight. PO33 1LN
Lat. 50° 43' 30" N
Long. 01° 09' 05" W
QSL LOC — ZK25H.
QSL — ARS

GUGLIELMO MARCONI conducted his early experiments from Alum Bay near the Needles Rocks on the Isle of Wight, England

G1EFU

73's from Alan Nixon

Hotel ●●●●
Interpalace

Puerto de la Cruz

Tenerife

Another friendly **iberotal**

CANARY ISLANDS (Zone 33)
EA8

Confirming QSO with

Day/Mo	Yr	U T C	MHz	2x	R S T

Pse QSL direct to

73

It has been said that the final courtesy of a QSO is a QSL. Some amateurs even go so far as to have this motto printed on their QSL cards, but whether this pricks the conscience of the amateur receiving such cards is open to some conjecture. In short, as in all other aspects of amateur radio, and indeed life generally, there are those who take part in the game by the rules and those who don't. It is normally referred to as human nature, and can be very frustrating at times. Thus, as far as QSLing is concerned, the purpose of this article is to perhaps transform a few of the 'don'ts' into 'dos', and to offer a little practical assistance to, and improve the lot of, those who already do, but are perhaps discouraged by poor returns.

In the world of professional/commercial radio communication, the meaning assigned under the International 'Q' Code to the expression 'QSL (. . .)' is literally 'I acknowledge receipt (of. . .)'. In the parlance of amateur radio, this meaning still holds good and the expression is in regular use in its literal form, especially in contests. However, its meaning has also been adapted by the amateur radio fraternity so that the expression 'QSL card' has become a written confirmation that a particular contact between two stations actually took place.

Historically speaking, when amateur radio was in its relative infancy, written confirmation was a valuable and essential part of the experimentation and self-training aspect of our hobby, and to a degree this is still relevant in the LF and UHF/SHF parts of the spectrum. On HF, however, in these days of black boxes, linear amplifiers, six-element beams and 25 metre towers, confirmation for the sake of confirmation has little or no value, except to the individual operator(s) concerned.

Why, then, do we expend a large amount of time, effort and not a little money to collect small pieces of pasteboard which, once obtained, sit forever more in a filing cabinet drawer?

I must be one of the worst offenders in this respect, as I have still got my QSL card collection from the days when I was a short wave listener – and I've held my licence since 1964. I rarely look at my collection, but will definitely not throw it away, much to the chagrin of the XYL. In my opinion there are several main answers, which I will set out, in no particular order of preference.

First and, as far as most serious QSL

card collectors are concerned, foremost, the DXCC Award programme, which is run by the ARRL, insists that QSL cards are submitted for checking prior to the issue of the award. Now, sending a parcel of 100 or more QSL cards, together with the cost of the award and the return postage on the QSL cards to the United States is not a cheap exercise, although it has been reported recently that the ARRL will now accept payment by Barclaycard (Visa), which greatly simplifies matters.

It is therefore a measure of the prestige in which the DXCC programme is held by the rest of the world that it cheerfully submits to these rules imposed by the ARRL.

Secondly, certain other prestigious awards, such as the RSGB's 'Worked British Commonwealth' and the 'Commonwealth DX Certificate', require applicants in the UK to submit QSL cards, but will accept applications from amateurs from outside the UK who provide a 'certified list' of contacts. However, the very popular 'Islands on the Air' award, which is now run by the RSGB, requires all applicants worldwide to submit cards for checking, in the same way as the DXCC programme.

Many other amateur radio administrations who issue awards will accept 'certified lists', the format of which varies from award to award, but most require evidence in the form of QSL cards to be provided to the person responsible for the certification. Further details are contained in the RSGB's publication *Amateur Radio Awards*, a new edition of which is expected to be published shortly.

Thirdly, cards from rare and exotic places can be used to decorate the 'shack', and to impress one's friends, amateur and non-amateur alike; although, if you have ever tried to explain the DXCC programme to a non-amateur, you will have seen the look of total incomprehension spread across his face, usually at the stage of explaining DXpeditions.

Many cards are extremely attractive, particularly those from Japan, but it does not mean that you have to spend a small fortune on artwork and printing in order

to get replies to your cards. Colourful, original cards do promote interest, especially amongst the non-amateur fraternity, and my family are always very interested to see the latest batch of cards. However, simple black on white cards seem to attract as many replies as the more spectacular designs.

To send and receive QSL cards, the first thought is of the world-wide QSL bureau network. The major bureau in the UK is that run under the auspices of the RSGB by Ted Allen G3DRN and his numerous sub-managers. The bureau service is available for RSGB members to send QSL cards and for both members and non-members alike to receive QSL cards free of charge, notwithstanding the costs of postage to and from the bureau. *The RSGB QSL Bureau – A Service to Members* is published by the RSGB and can be obtained free of charge.

However excellent a facility the bureau system may be, it is a tool to be used, and like any tool it must be used properly to get the best results. Most of the world-wide QSL bureaux are operated by the appropriate national amateur radio society, but are not necessarily free of charge. Consequently, some countries have a better reputation for returning cards than others, ie, amateurs in countries such as Spain, France and Canada are less likely to reply to your card via the bureau than amateurs in Brasil, Japan, and Yugoslavia.

Additionally, and with the best will in the world, cards do go astray with so many links in the chain and the manual sorting operations involved. They are either lost in the postal system or mis-sorted in the bureau system. On several occasions, I have received cards following direct requests to DX stations which have been endorsed 'second card – first card sent via the bureau', and I am still waiting for the first cards several years later. Another important factor is that not all active amateurs are interested in collecting QSL cards and do not therefore maintain a stock of stamped, addressed envelopes at the QSL bureau.

No figures are published, but it would

QSLing – The



Inside Story

appear that a high percentage of people holding amateur licences fall into this category. In almost all instances, cards arriving at the bureaux addressed to such stations are destroyed after a short interval, although I have recently received some of my own cards returned from the W3 Bureau endorsed 'Unclaimed'. At least then you know, although I would not like to argue the relative merits of this practice on a large scale, and the additional load on an already heavily loaded bureau network.

In 1968/69 I was licensed as G3SWH/MM on board a large oil tanker, SS 'Ottawa', on a deep sea voyage around the Atlantic and Indian Oceans, at a time when British maritime mobile stations were something of a rarity. I therefore decided to QSL 100% to each new station contacted on each band. In five months of operating, I made about 500 world-wide contacts on both CW and SSB, and each one I religiously confirmed via the bureau.

The rate of return was, to say the least, abysmal - only 80 cards were ever received, representing a magnificent 16%. To add insult to injury, a number of stations in the Canadian city of Ottawa were contacted; all made enthusiastic promises of QSLs, but not one was ever received.

My experiences related above are, in all fairness, a particularly bad example. I think that 30 to 40% is a more usual figure, but it is still very low. My comments are certainly not intended as any form of criticism of the way in which the RSGB QSL Bureau is operated. On the contrary, Ted Allen and his sub-managers handle some 2,500,000 QSL cards each year and they certainly do their best to diligently sort and distribute the cards which they actually receive.

Obviously, there are mis-sorts which are attributable to many factors, including the terribly careless handwriting of some amateurs when addressing cards. Fortunately, the numbers of mis-sorts represent only a very small percentage of the cards handled, and tend to be those printed on very thin card or even on paper. If ever I should receive a mis-sorted card from the bureau, my procedure is to return it

with my next batch of outgoing cards and it (hopefully) ends up with the correct addressee in the fullness of time.

The bureau system does not claim to be the fastest way of exchanging cards, as intervals of 12 months between contact and receipt of card are usual, and delays of several years are not uncommon. My bureau sub-manager (G4CMM) told me in 1984 that she had recently sorted some cards dated 1956, and that 1971 is not unusual.

If used properly, the bureau system will produce QSL cards with relative ease from the more populous countries of the world, especially from the USA, USSR and Western Europe. Even on a 10% return basis it is not difficult to contact perhaps 10 French or Canadian stations to have a fair chance of receiving a QSL card from at least one of them.

Consider, then, the situation of the amateur in one of the less populous countries of the world. He probably only has to send his callsign twice to generate a huge pile-up, and handling one of those is not everybody's idea of fun. The consequent demands for QSL cards must be very time-consuming, and many rare DX stations will tell you during the contact that they do not reply to requests for QSL cards (Henry KP2J in the US Virgin Islands is a good example of an 'honest' amateur).

Others will say nothing, and just not reply (Herik FR0FLO - now FR5DX on Reunion Island is a notorious example of this sort). Fortunately, most resident amateurs take a pragmatic approach and either handle the cards themselves, or appoint a 'QSL Manager', whose task it is to handle the clerical side of the business. More about these later.

It is an unfortunate fact of life that the more exotic the callsign, the less the likelihood is that there will be a QSL bureau operated by an IARU member society in that country. The *DX News Sheet*, a weekly publication by the RSGB, recently circulated a list of 59 DXCC countries having no QSL bureau facilities, including such relatively common places as Tanzania and Saudi Arabia.

It is therefore most important to obtain the appropriate QSL routing information

from the DX station at the time of the contact. If a QSL manager's callsign is quoted, the option exists to send the card to the manager via the bureau, making sure that the manager's callsign is very clearly stated on the card (I always write 'QSL via...' in large red letters on the back of the card). Otherwise you can send the card directly to the QSL manager's postal address, but please note that some QSL managers state that they will not reply to cards received via the bureau. If the DX station quotes a post office box number, or similar, then there is no option but to send the card directly to that address.

DXpeditions form a major part of both the DXCC and the IOTA programmes, and are very heavily relied upon for their QSL cards. The major expeditions, such as those arranged by the YASME Foundation or the NCDXF are excellent. The minor expeditions are less reliable, and some individual operators are notoriously bad at forwarding their logs to their QSL managers. This, of course, leads to long delays in the time it takes managers to despatch the cards, and also to unjustified criticism of the particular QSL manager involved.

When sending QSL cards direct, there are a few simple 'rules' which, when followed, will greatly improve your chances of getting the much wanted card in return.

Firstly, it is a good idea to send a self-addressed envelope, with an 'Air Mail' sticker attached if appropriate. Please be sure to check with your local Post Office whether an air mail service exists to the desired destination. The use of air mail stickers on European mail can actually delay its delivery, so you should bear in mind that the amateur radio definition of Europe is not the same as that used by the Post Office, eg, Turkey, Greenland and the whole of the USSR count as Europe for postal purposes.

Surface mail is obviously cheaper than air mail, but takes very much longer and tends to trigger a reaction at the other end along the lines of 'if he only sent it by surface mail, he can't be in much of a hurry, so I'll deal with it on the next rainy day'.

Secondly, send the right number of International Reply Coupons (IRCs) with the card and envelope. The number required tends to vary with the destination and routing, eg, 1 IRC for Europe, 2 IRCS for USA, Canada, Australia etc, and 3 IRCS for most of the Pacific Islands. If you are sending more

QSLing

than two cards to a station, then an additional IRC should be included.

Incidentally, some QSL managers, eg YASME, ask for one reply paid envelope per contact per station in order to streamline their operations.

Thirdly, only use definitive stamps on your outgoing envelopes, as British commemorative stamps are very collectable items and the use of them may lead to the envelope being stolen en route.

Fourthly, include a short note, particularly to stations who handle their own cards, expressing your thanks for the contact etc, possibly with a local view postcard or the like.

And finally, keep a register of those stations to whom you have sent QSL cards direct, as in *Table 1*. This will more readily collate the information at a glance, and saves you having to pore over pages and pages of your logbook. It will also give you some idea of the average length of time it takes to get a reply by the direct method. A 90% return rate within six months is quite normal, but I recently received some QSL cards from the manager of 9Y4VT, more than 18 months after I posted mine.

Since 1st January 1986, the cost of one International Reply Coupon has been 55p and IRCs are available from the larger Post Offices in Great Britain and Northern Ireland. By international agreement, IRCs are exchangeable in virtually all countries of the world for stamps representing the minimum international postage payable on a letter sent abroad. This usually means a 20 gram overseas surface letter and in current UK terms is equivalent to 18p to EEC countries, and 22p to all other places.

It is thus immediately clear that IRCs are not terribly good value for money and many Post Offices, particularly in the USA, refuse to exchange them in the quantities which an active DX station or his QSL manager must quickly amass. Imagine the number of IRCs which 'professional' QSL managers like W3HMK, who handles cards for over 200 stations world-wide, must receive. I understand that he also finds time to get on the air!

A comparatively economical and practical alternative to the use of IRCs is

to pre-stamp the self-addressed envelope with the correct value of unused stamps from the recipient's country. Stamps from most places can usually be obtained from your local stamp dealer, and he may even be prepared to buy back the used stamps from the more exotic places when you get your QSL card back. Steve Jones GW4BKG has compiled a list of return postal rates from a number of countries, and an SAE to him will produce full details. His address is: S Emlyn Jones GW4BKG, Lan Farm, Blackmill, Bridgend, Mid Glam CF35 6EP.

Quantities of 'second-hand' IRCs do come onto the amateur market, and are advertised in the *DX News Sheet* from time to time at 60-70% of face value. It is sometimes claimed that IRCs have a six month validity period, but this is not the case as the international agreement for their redemption is irrespective of either the country or date of issue. For more details about IRCs, see the *Post Office Guide*.

Second-hand IRCs are thus quite a good deal, but please make sure that the ones you send are of a reasonable age, that they have been properly validated by the issuing officer in the left-hand box, and that there are no marks in the right-hand box.

A second alternative is to enclose hard currency notes with your QSL card. These are sometimes referred to by the euphemism of 'green stamps', and in the days of the UK's £1 note were a reasonably economical alternative to IRCs, as well as being more acceptable at the far end! This practice is of course more susceptible to theft than just sending IRCs. These days, it is not quite so easy unless you have ready access to either US or any other 'hard' currency in small denomination notes.

I have already mentioned the RSGB's *DX News Sheet*, which is a very useful source of up to the minute information for the HF bands DX enthusiast, including extremely valuable information on addresses and routings for QSL cards, as well as data on QSLs received. This latter information quickly identifies the 'bad boys'. In addition, there are several other sources of QSL routing information:

a) The W6GO/K6HHD QSL Manager List

is available in Europe from Brian Russell BRS33915, 163 Halton Road, Runcorn, Cheshire WA7 5RJ for £1 or 8 IRCs. It is a computer-prepared listing of over 5,000 DX operators and their managers, and is published monthly.

b) The DXer's QSL Manager Directory is available from Fred Smith WB4KCL, 2265 Sweetbriar Drive, Alexandria, VA 22307, USA. It costs \$12.95 without supplements or \$19.95 with supplements. It is a computer-prepared listing of over 10,000 QSL managers, including foreign and US, covering the period from 1979 to the present.

c) The HF section of the News and Views feature of the *Radio Communication* journal, published by the RSGB.

For actual postal addresses of DX stations or their QSL managers, by far the best (but not the only) source is the *Radio Amateur Callbook*, published by the ARRL in two parts - *North American Listings* and *Foreign Listings*. It is available in the UK from RSGB Publications (Sales), and the prices are mentioned in *Radio Communication*.

One interesting feature of the June 1986 supplement to the Callbook is that it carries full QTH information on many USSR stations and it must now, in theory at least, be possible to correspond directly with the operators concerned, rather than be restricted to the official route for QSLs via the famous Box 88, Moscow.

I have been in correspondence for some time with a group who operate a UK4 'club' station, without any apparent problems. It must be stressed that it is prohibited for citizens of the USSR and many of her satellites to receive 'currency' through the post from abroad (this apparently also refers to used postage stamps). Incidentally, it is claimed that Russian stations are required to QSL under the terms of their operating authority.

However, I don't think that my poor experiences with returns from Russia can be in any way unique, and it appears that one of the more common problems is obtaining QSL cards for contacts with some of the more unusual Russian Republics. Franz Josef Land and Tadzhikistan seem particularly troublesome.

My friends in UK4 have informed me that if any amateur has problems in obtaining cards from Russian stations, he should write to the CRC Executive Committee, PO Box 88, Moscow, detailing his complaint, providing duplicate QSL cards and stating how long he has waited for a reply through normal channels. The Executive Committee is reputed to have the authority to punish those operators who do not reply to QSL requests.

I am reliably informed by some of the UK's top DXers that, given a little more time, a reminder sent to the CRC does produce results. When I wrote my reminder earlier this year, I received after a few weeks, a beautifully

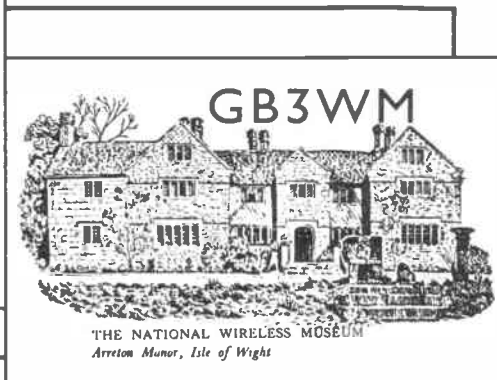
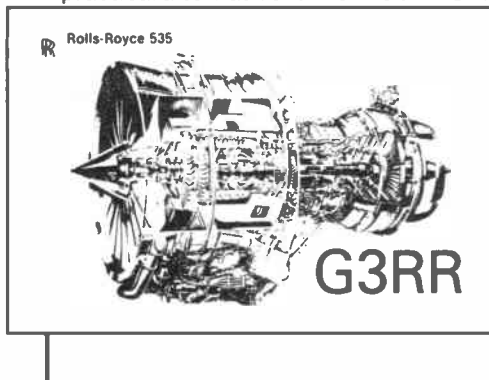

typewritten reply – in Russian!

This totally confounded me, until I sent it, with a short note of explanation, to the Russian Embassy in London. After a few days, a typewritten English translation was received, informing me that 'special reminders' had been sent to the stations involved 'pointing out the necessity of sending QSL cards confirming radio communication in due course'. At the time of writing this article, I am still waiting but have not given up hope.

I don't myself operate on any of the VHF/UHF bands, so cannot comment first hand on QSLing practices on these bands. However, from the content of the numerous letters to the editors of the various amateur radio magazines, it would appear to be fraught with the same sort of problems and frustrations as the HF bands. Consequently, the same sort of approach to the problem should work just as well, although the bureau system probably works better and faster for inter-UK contacts, as the number of links in the chain are greatly reduced.

QSL cards from SWLs are an ever-present dilemma, as they so rarely seem to give any useful information, especially when received via the bureau upwards of a year after the contact upon which the report is based. Much has been written elsewhere about how to compile a useful SWL report and it is an area which is

outside the scope of this article. As a self-confessed CW 'nut', who now operates 100% on this mode, I always reply to SWL reports provided they are reasonably well presented, on the basis that SWLs who take the trouble to learn Morse are to be encouraged. It may not be significant, but I have never received an SWL report from a British SWL!

Similarly, I always reply to cards sent to me in the first instance, even though the number of cards for contacts with Yugoslavia, Brasil and East Germany

accumulate in large numbers. We all had to start our collections somewhere; cards are not usually sent out without a reason for wanting one in return. However, it does make it easier to comprehend the request for a card if a reason is stated, such as 'Please QSL for...Award'.

I hope that the various comments and other information in this article are of some help in increasing the reader's percentage of QSL returns.

PA Whitchurch G3SWH

QSO DATE	STATION	ROUTE VIA	QSL SENT	QSL RECVD
25 1 86	T77C	CBA		
31 1 86	VE3CPU/VP2M	VE3CPU	1 2 86	17 2 86
15 2 86	3V8PS	I1FOU	1 2 86	28 3 86
18 2 86	W6QL/Z2	YASME	22 2 86	9 4 86
4 3 86	VQ9QM	W4QM	22 2 86	20 3 86
23 3 86	DL0MAR/9G	DJ6SI	22 3 86	9 6 86
30 3 86	7X2AX	DIRECT	5 4 86	
8 4 86	ZF1MM/9	VE5RA	5 4 86	8 5 86
3 4 86	5H3ZO	K0LST	26 4 86	
10 5 86	TA2D	DIRECT	5 4 86	1 5 86
17 5 86	DK6AS/SV5	DK6AS	7 6 86	9 7 86
28 6 86	3C0A	TR0A	7 6 86	8 8 86
8 7 86	OH0MA/OJ0	OH2BH	12 7 86	
			19 7 86	

WIRRAL BASED COMMUNICATIONS

YAESU

CIRKIT

AERIALS

CMHOWES

ALINCO

ICOM

WOOD & DOUGLAS

MICROWAVE
MODULES

MGR SERVICES

BUSINESS
RADIO

NEW &
SECONDHAND

MARINE
RADIO

SPECTRUM COMMS

HEATHERLITE

CELLPHONES

MET ANTENNAS

PART EXCHANGE

BEST
PRICES



48 SHREWSBURY ROAD, BIRKENHEAD, WIRRAL, MERSEYSIDE
TEL: 051-653 3437



— Callers by appointment only —

2-Element Full-Size Quad

An easy construction project for 20m

Although there is still some controversy about the relative merits of the quad and the yagi antennas, in my opinion the 2-element quad possesses many features that will attract the DX enthusiast. Not only is it renowned for its quietness of reception and for being less affected by rain static (a nuisance to which the yagi is peculiarly prone), but its commendable 7dB forward gain, with reference to the dipole, is matched only by a carefully constructed 3-element yagi with wide spacing. This is a further consideration which often places the quad high in the estimation of many operators.

On the debit side, however, conventional construction of a full-size 2-element quad for 20 metres calls for 14ft spreaders mounted on centre-plates at the end of a boom; a method which, while often resulting in a very robust structure, is nevertheless unwieldy and often requires at least two people to assist in its assembly and erection. This article describes a method of construction which not only reduces the spreader lengths to 9ft 6in, but enables the whole operation to be easily undertaken by one person.

Design considerations

The following information will be needed by those who may be unfamiliar with quad design.

A full-size quad loop has four quarter-wavelength sides with a total wire length corresponding to the formula:

$$\text{length (feet)} = \frac{1005}{f(\text{MHz})}$$

which, divided by four, may conveniently be expressed:

$$\text{length (feet)} = \frac{251}{f(\text{MHz})}$$

A quad loop having a frequency of 14.175MHz will therefore contain 70.89 feet of wire, a figure which corresponds to four equal sides of 17ft 8in. Such a loop, suitably erected at a half-wavelength above ground, has an impedance of about 125 ohms and a gain of approximately 1.4, with reference to a dipole.

The addition of a parasitic reflector increases the power gain because of the

by D V Pritchard
G4GVO

triple functions of Q, tuning and spacing; its general efficiency being proportional to the coefficient of its coupling to the driven element.

For these reasons a high-Q loop of thin wire placed at $\frac{1}{4}$ wavelength from the radiator gives optimum gain at an impedance of approximately 75 ohms, thus allowing the use of twin feeder – which is a recommended practice.

However, as most modern transmitters are designed for a 50-ohm load and many operators have to use co-ax for various reasons, a 50-ohm impedance is obtained with no loss of efficiency by making the spacing approximately 0.08 of a wavelength.

The horizontal angle of a 2-element quad is approximately 60° at its half-power positions, which corresponds roughly to the pattern of a 3-element yagi. This angle, however, can be sharpened considerably in quad design by ensuring better current distribution in the reflector element.

This is achieved, not by using the traditional tuning stub, but by increasing the total wire length uniformly around the loop perimeter. In my view, this method has much to commend it since the efficiency of the antenna is considerably raised; improvements include better gain, front-to-back ratio and greater operating bandwidth.

The total wire length for this recommended reflector is found by the formula:

$$\text{length (feet)} = \frac{1030}{f(\text{MHz})}$$

which, for quarter-wavelength sides, corresponds to:

$$\text{length (feet)} = \frac{258}{f(\text{MHz})}$$

or 18ft 2in.

For spacing at approximately 0.08

wavelength, the formula:

$$\text{length (feet)} = \frac{97.3}{f(\text{MHz})}$$

shows that a frequency of 14.175MHz calls for 6.86 feet, or 6ft 10in.

These figures show that a full size 20-metre quad will occupy a space approximately 18ft by 7ft and, as mentioned earlier, this will make conventional construction and erection difficult for one person. These considerations led me to search for alternative methods of construction and, after a great deal of experimenting, the design described here was discovered to combine both strength and simplicity.

The twin support system

As will be seen from the diagrams, two sets of supports are employed, the upper being joined to the lower by an 18ft, 2in x 1in stretcher. This arrangement allows the elements to be attached to the upper support at a comfortable working height, the hinged stretcher being laid away at an angle while this is carried out.

When the tops of both the driven element and the reflector have been made off, the upper support is raised by the halyard until the lower support is at a convenient level. Then the stretcher is bolted in position, the elements are fixed and the feedpoint is completed. A length of plastic clothesline, attached to one of the lower spreaders before hoisting into position, allows the array to be rotated and anchored as required. A pair of ropes fastened to the lower end of the stretcher may act as guys if needed.

Although the construction may appear complicated, in reality it is quite simple. The overall weight is quite light and windage is at a minimum. The 18ft stretcher, while supporting the lower assembly, also acts as a strengthening brace to prevent distortion of the elements in windy weather.

Construction

Figure 1 shows the layout of the two assemblies required for the upper and lower supports, and Figure 2 demonstrates their appearance on erection. Two centre-plates of $\frac{5}{8}$ in waterproof plywood measuring 2ft by 1ft are required, together with two lengths of 2in x 1in prepared timber. Eight

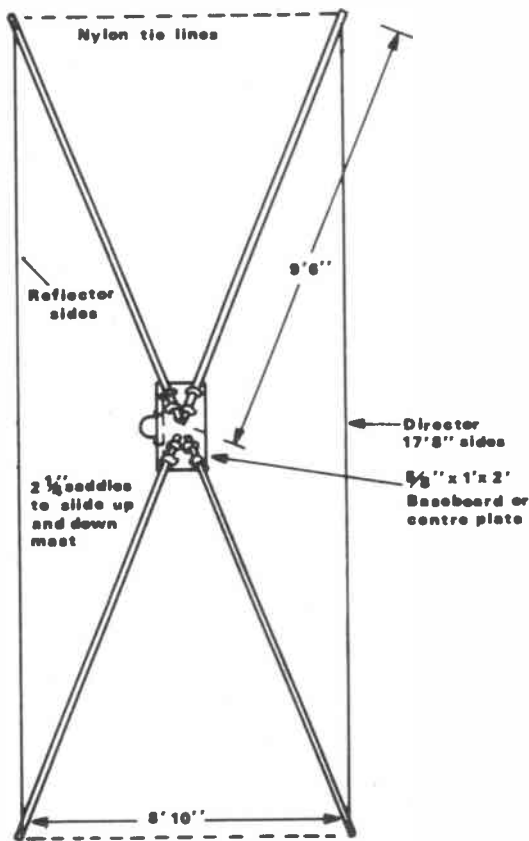

Fig 1 Layout of the two assemblies

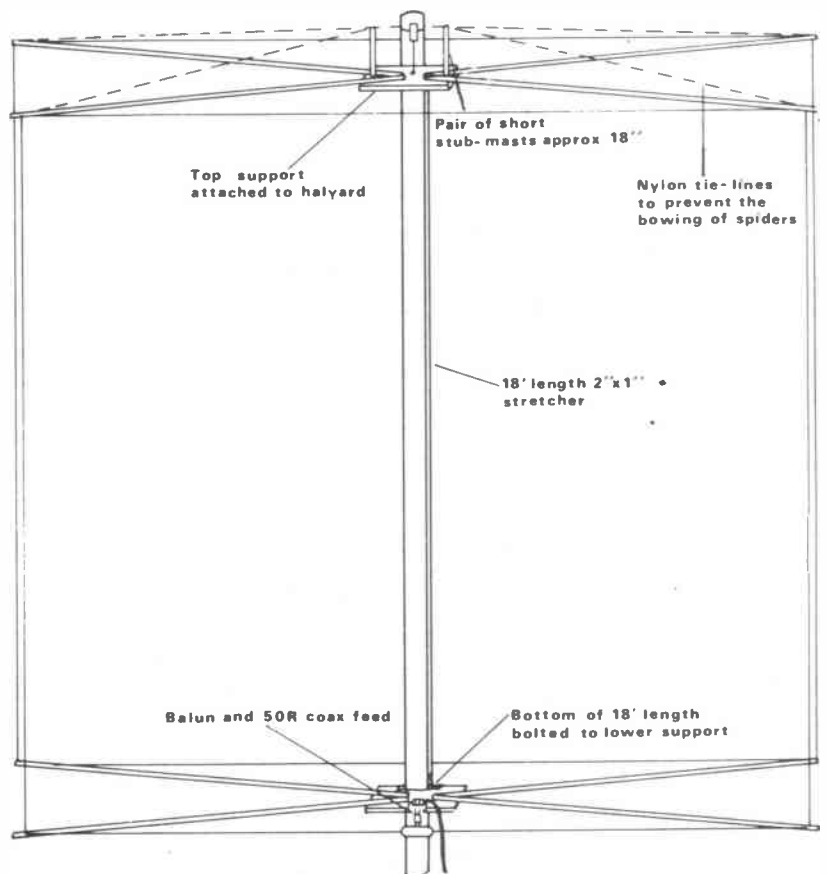

Fig 2 The assemblies when erected

lengths of 9ft 6in bamboo are also needed, though this size may be difficult to obtain, in which case 8ft lengths overlapped by 3ft pieces and securely bound by tape at the appropriate points will serve just as well.

It is suggested that the spreaders are laid out as shown in Figure 1 and

carefully measured; the holes for the saddles or clamps being marked at the same time. It is a good idea to arrange the ends of the spreaders at a spacing of just over 7ft initially, thus allowing the nylon tie-lines to supply the tension to maintain the required spacing of 6ft 10in on completion.

Before assembling the spreaders, the 2ft lengths of 2in x 1in are offered up and holes marked for drilling. Figures 3 and 4 show how these, together with the stub masts, the T-hinge for the stretcher and the bottom brackets are mounted. The metal saddle mast guides shown may be formed from galvanised pipe clamps if desired, although U-bolts could conveniently be used in their places. The

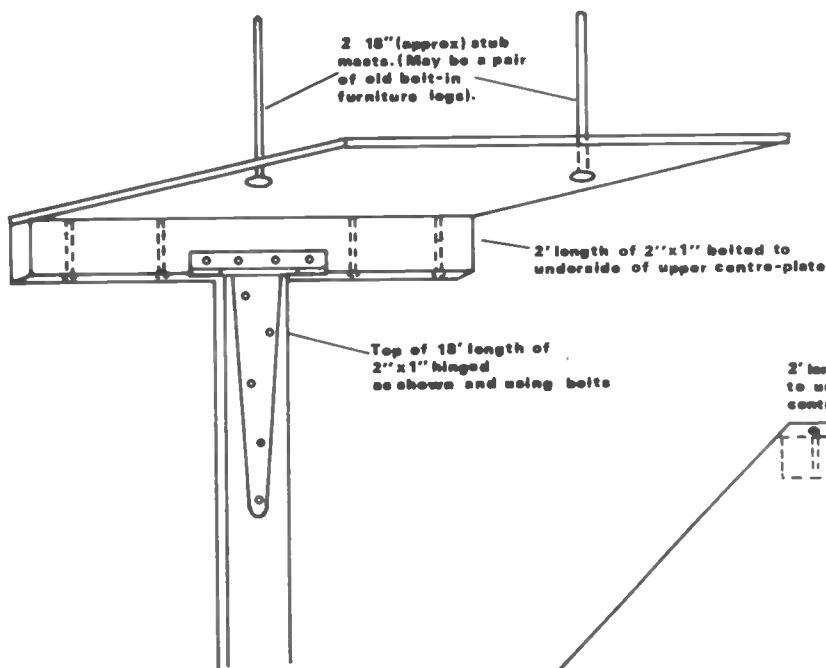

Fig 3 The upper support

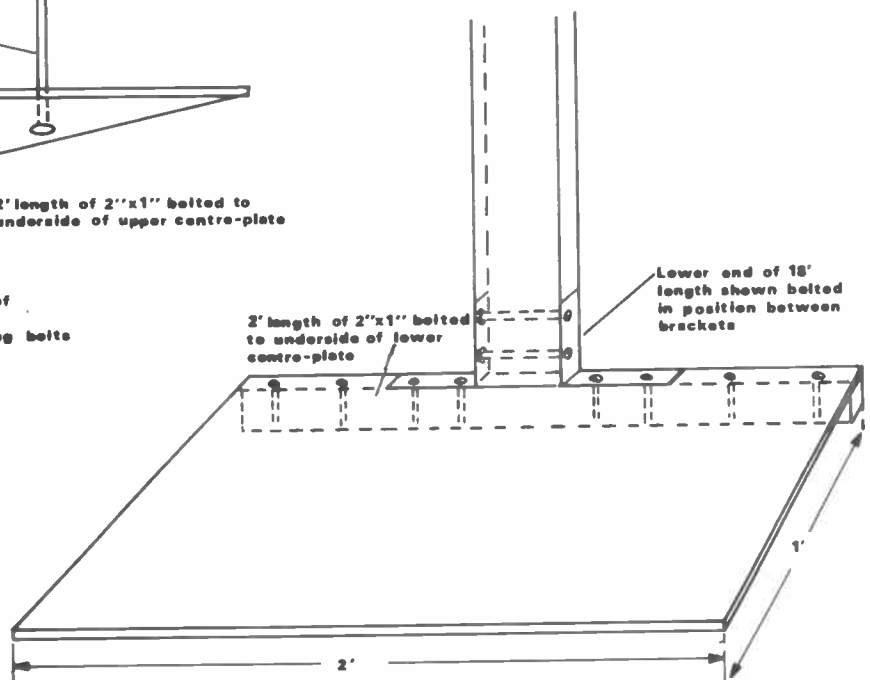

Fig 4 The lower centre plate

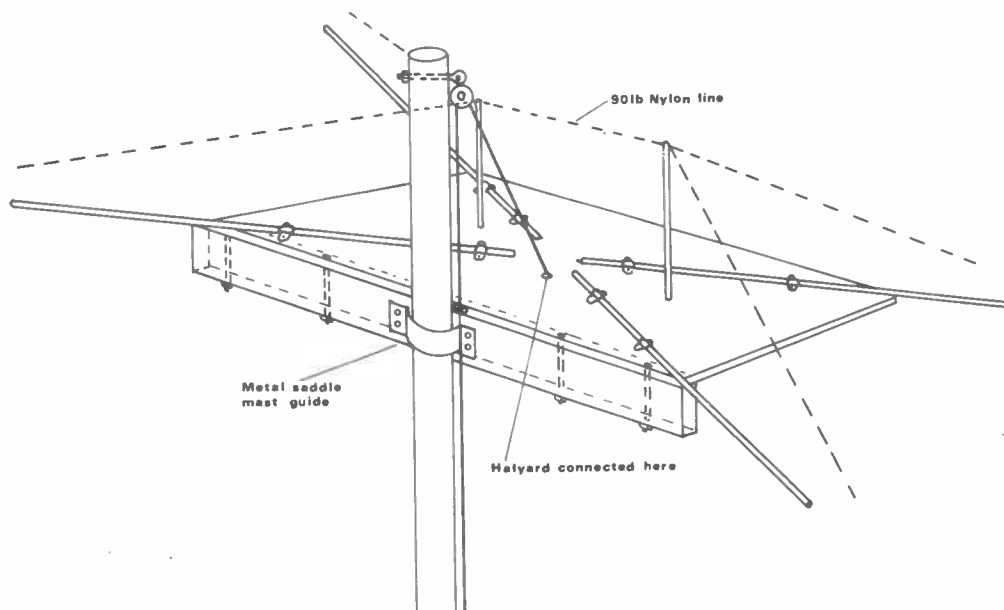

Fig 5 Detail of halyard support tie-lines and mast guide

stub masts on the upper support may be a pair of old bolt-in furniture legs, often found in second-hand markets. If it is difficult to obtain a complete 18ft length of 2in x 1in prepared timber, two shorter lengths butted together and joined by a 2ft strip bolted in place will serve.

Before any assembly takes place it is strongly suggested that all woodwork is given a coat of primer and, if possible, an undercoat. Woodwork will last for a surprising length of time if these precautions are taken first. Another point that must be emphasised is that wood screws should not be used, tempting as they may be. All parts should be bolted together firmly, after all woodwork has been primed. In my view many amateur erections come to grief because these simple points are overlooked.

Figure 3 shows the upper support details. The 2ft length of 2in x 1in, with the mast guide attached, is bolted to the centre-plate, and the 18ft stretcher and T-hinge is aligned and similarly fixed. While the centre-plate is at a right angle, the stub masts are bolted in place. The centre-plate may now be raised on to a suitable support, allowing the stretcher to lie at an angle while the spreaders are fastened. On completion, the assembly is moved out of the way so that work on the lower support may proceed.

Figure 4 gives the layout of the lower centre-plate and shows how the bottom of the 18ft stretcher is bolted in position during erection. The brackets shown should be heavy duty ones, preferably galvanised and, as can be seen, these are bolted right through the centre-plate and the 2ft strut to make an extremely rugged assembly. The brackets and the end of the stretcher must be centralised carefully, and the bolt holes in the stretcher must be drilled squarely.

When the brackets and the bottom strut have been assembled, the

spreaders are fixed and the nylon tie-lines attached as for the upper support. Provision is also made at this stage for a convenient anchoring point for the 50-ohm co-ax and balun. Although no details have been shown for this as it is a relatively simple matter, it is suggested that a short length of wood or plastic should be extended from the lower centre-plate to the feedpoint, to prevent the weight from distorting the lower part of the driven element.

Before the assembly is mounted on the mast, nylon tie-lines are attached to the ends of the spreaders of the upper

support and fastened to the stub masts, as shown in Figures 5 and 6. It is useful to strap a length of line between these to provide extra strength, and 90lb nylon fishing line is ideal for this purpose and is also very suitable for attaching the element wires to the spreaders.

At this point I would like to give a tip about the use of bamboo. These canes will last a long time (hurricanes excluded) if they are well protected from ordinary weather. Ideally, wrapping them with fibreglass cloth and coating them with the appropriate resin makes an extremely robust array, but this method

Upper gantry hoisted to comfortable working height. Saddle mast-guide bolted in position and element wires attached.

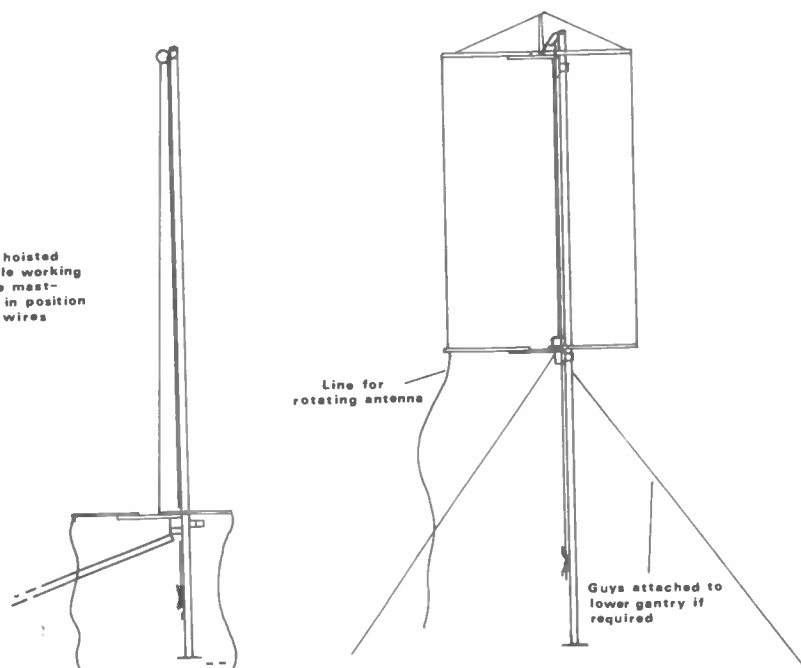

Fig 6 Antenna in position

is expensive, so instead a firmly applied layer of tape with a coat or two of paint can be used, and will do quite well. It is nevertheless worth remembering that bamboo is a poor insulator when wet, and for this reason the driven element should not be fixed directly to the ends of the spreaders but attached to them with nylon line, space having been included in the design for this to be done.

Mounting the elements

Lightweight stranded plastic wire is used for the elements, and a quick way of mounting them is to prepare the loops first. 72ft 9in of wire is cut for the reflector, half an inch of insulation being removed from each end and the wires twisted together and soldered to make a loop of 72ft 8in, ie, four sides of 18ft 2in. The driven element is prepared in similar fashion.

The upper support is mounted at the base of the mast and the halyard made off to the position shown in *Figure 5*. The angle thus provided means that an equal strain is taken, and while this is being done the 18ft stretcher is allowed to lie at an angle. The support is then hoisted a few feet, and the top section of each loop is carefully measured and attached to the spreaders.

The remaining sides are now measured and marked, and the assembly is hoisted until the bottom end of the stretcher is at a convenient height for it to be bolted in position and the mast guide attached. The bottoms of the loops are now tied off at the marks, and the balun and co-ax connected to a feedpoint at the exact centre of the bottom of the driven element, the co-ax being dressed away down the mast, allowing sufficient slack for rotation. On completion, the assembly is hoisted to its optimum height ready for use.

Conclusion

As with most antennas, the quad gives best results when erected as high as possible. The lowest angle of radiation, about 16°, occurs at $\frac{7}{8}$ wavelength above ground. However, even when erected on a 30-foot mast with the bottom elements barely 12 feet from the ground, this antenna can give a good account of itself. Raising it to a $\frac{1}{4}$ -wavelength gives an angle of radiation of 40° – which compares very well to that of a dipole's 90°. Again, much depends on the ground itself.

It might be argued that a beam antenna for only one band is a waste of time and energy, an opinion which I do not entirely

share. Nevertheless, there is no reason why the principle of construction described here should not be adapted for a 2-element triband array by using the formula given earlier. Impedance matching for such an assembly might well employ a series of gamma matches, for example, although the use of a reactance capacitor at the common feedpoint would probably be necessary. In any event, the assembly lends itself very well to many adaptations and I hope that the ideas given here will prove useful to the experimenter and communicator alike.

**Don't miss the
May edition of
Amateur Radio
– on sale
28th April**

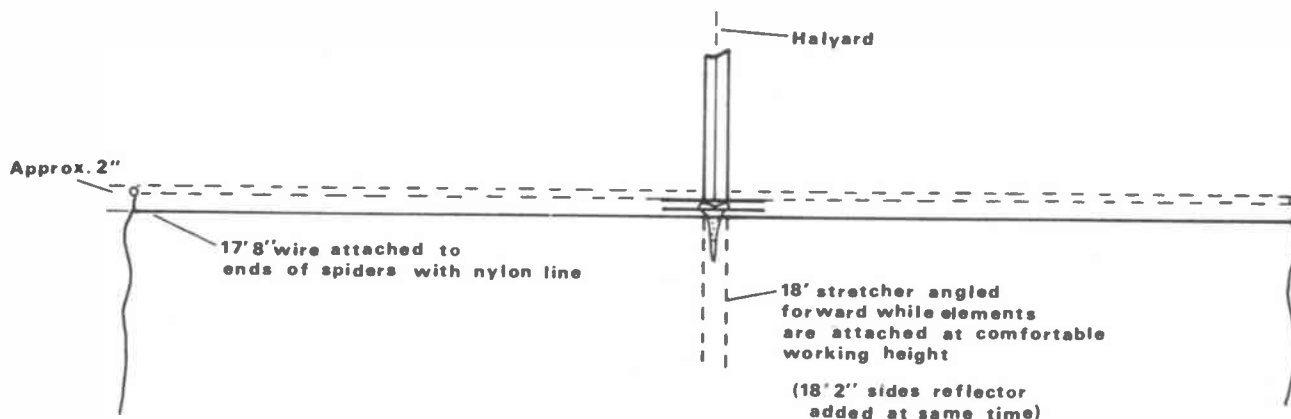

Fig 7 How the element is attached to the upper support

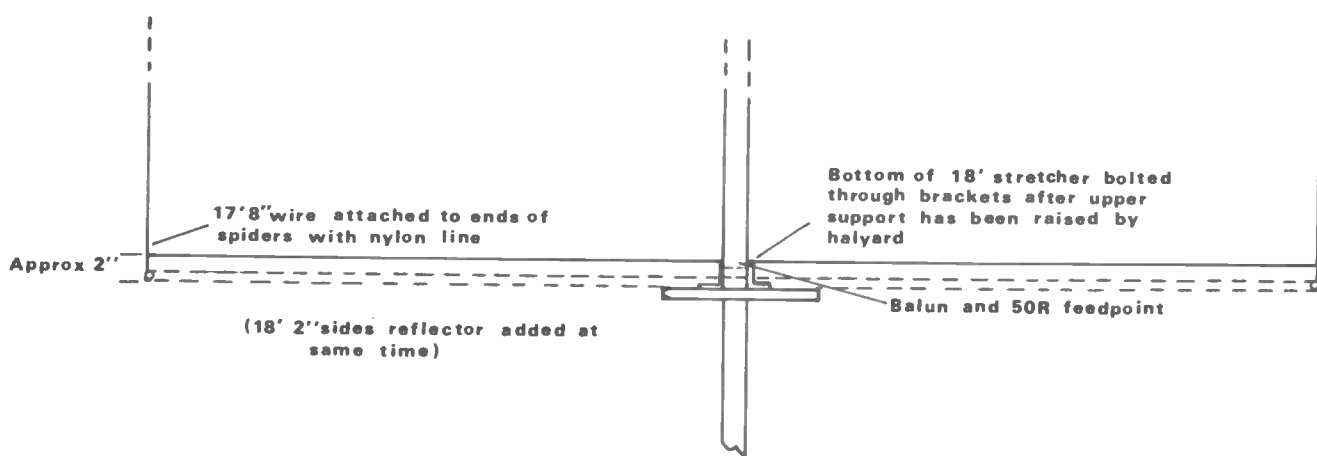

Fig 8 How the driven element is attached to the lower support

SHORT WAVE LISTENER

TREVOR MORGAN GW40XB

In past columns, I have covered the use of cheaper receivers to get into the hobby and, in particular, listening to the broadcast stations. Many listeners do, in fact, base their whole hobby on these stations and have little, if any, interest in any other part of the radio scene. However, it is interesting to look at the requirements of the listener who wants to step into the world of amateur radio.

The communications receiver is built to receive all forms of radio signals, and this includes single sideband. But what is single sideband? Let's look at the standard AM (Amplitude Modulated) signal that you are used to on your broadcast receiver. When a 1kHz audio tone is transmitted, it consists of a carrier wave and two other signals, one at 1kHz above and the other at 1kHz below the carrier. A 2kHz tone would produce signals 2kHz either side. The spacing of these signals is always equal to the modulating frequency. In practice, transmitted speech produces many frequencies in each sideband but these would still be symmetrical to the carrier.

At the receiver, the two sidebands react with the carrier to produce the original audio frequencies. This poses a problem, in that if two transmitters are operating in close proximity (frequency wise) they can react with each other with the result that neither station will be heard to full effect.

OK, what do the amateurs do that's different? Clever lads that they are, they found that all the necessary information was, in fact, present on one of the sidebands so, by suppressing the carrier and the other sideband, the signal could still be transmitted using less bandwidth. The problem was how to get the original signal back at the receiver end.

Well, they could forget about the other sideband as this contained the same

information, so there was just the carrier to worry about and this could be re-inserted by using an oscillator at the receiver.

Thus, amateur SSB signals can be resolved using a suitable receiver – but a good receiver does more than this and is a very technical and efficient piece of equipment.

A good receiver will faithfully select one minute signal from the thousands present at the aerial, is stable enough to hold that selected frequency for hours if necessary, and delivers good audio signals without introducing any other noise or wasting signal power. Modern receivers have added filter systems to help cut close proximity heterodynes or whistles, narrow the acceptance range of the receiver and cut background noise. Some have memory banks for preset frequencies and means of scanning these memorised frequencies until a signal is present or you hear something interesting.

However, as I've always maintained, the 'bells and whistles' are not essential to good reception. They are there if you want them, and can be very useful if you are doing a lot of listening on regular frequencies which can be programmed into the receiver for instant access, or want to quickly scan a range of preset frequencies.

To buy a reasonable quality receiver, I would suggest budgeting for around the £150 mark. This may seem a lot of money, but with new receivers costing well over £1,000 nowadays cheaper second-hand receivers do not stay on the market long and, with that sort of money, you stand a chance of picking up something worthwhile that will give you good service and hold a fair price if you want to upgrade later to a better receiver or transceiver.

Recent adverts in the pages of *AMRAD* have offered the Yaesu FRG7 at £125 including ATU, Racal RA17L at £150, Lowe SRX30 for £75, Sony

ICF6700W at £100, or you could buy a nice new Matsui 4099 portable for £130. A couple of quid for aerial wire and insulators, a few bits to knock up an antenna tuner and you are in business.

One point I would make is to take someone who knows about receivers with you when you buy a second-hand receiver. Preferably, buy from a dealer... you've got someone to kick a fuss up with if the thing doesn't work. If you buy from a rally 'bring and buy', make sure you see the thing working and get your experienced pal to give it the once-over... he'll know what to look for (hopefully!).

A couple of quick tips on receivers. Check the voltage input on the back (it could be a foreigner designed for 110V, or have a variable voltage, with the setting on the wrong place). Switch on and listen with the gain turned down and you should hear nothing (a noisy transformer can spell future trouble). Turn up the AF gain, tune to a Morse signal and give the receiver a couple of light taps. The signal should remain constant (failure means a dodgy oscillator board).

Tune to an SSB signal and note the frequency. If the signal remains steady and the digits on the meter stay on the same frequency, that's fine (if not, you either have drift or a dodgy readout). Turn the AF control up and down and listen for rough bits. Worn out tracks on the controls can be expensive. Check that the tuning control is smooth. If it's an analogue dial, make sure it stops at the end of the run after a couple of turns. Finally, get a receipt with the seller's name and address on it. At local rallies, many sellers are known by the organisers who will vouch for the chap, but be wary if the price seems low or you get 'that feeling'. Many a purchaser has lost his equipment and his cash to a wily bird.

Radio reception on the amateur bands is a little different to what you may

have been used to on the broadcast bands. If you thought the broadcast bands were crowded, you only have to listen to eighty metres on a Sunday morning, or twenty metres later in the day to realise that things can get very hectic here too.

What you have learned on the broadcast bands about certain areas only coming on during the morning or evening, applies here as well. You will find it of little use listening for American stations at 0800 or the Pacific area at 1800. For one thing, at those times, those areas are in darkness and most people are in bed!

One of the most useful things to have handy is either a world map showing the relative time zones or a clock that shows the times in other areas relative to GMT. This way you will know that, at least, most people are awake in the area you are listening for.

The amateur band coverage is laid down by international agreement (but not all countries have the same band coverage). However, the segments of bands that are used for different modes are only recommendations, but nevertheless are agreed upon by the recognised radio 'bodies'. Strictly speaking, you can use Morse on the phone end of the band or transmit slow scan TV anywhere you like. However, an operator would not remain very popular or make many contacts if he did so (and I wish those who called CQ on 14.230 would think twice!).

Some countries only allow their licensees on certain frequencies until they are experienced, an idea that should be international, judging by the performance of some licensees!

The band plans give the operators a chance to make contact without being interfered with by users of another mode, but this does not prevent others using the same mode intruding on the same frequency – *it is only*

good operating that avoids that!

So, if you have the band plan, you know where to look for the mode and frequency that you want to monitor. All you need now is a pair of decent headphones and you are ready. Good headphones are a must when monitoring the bands, though you don't want the super hi-fi type as these emphasise audio frequencies which you are not interested in. Get a pair of lightweight phones that are comfortable to wear for a long period (I use the Saisho HF40s). These will enable you to concentrate on weak signals when necessary and you won't annoy anyone else either.

Now you are all set up and ready to go, and next month we'll have a look at the bands and see what's about. Meanwhile, have a slow scan through the bands and see what you can find. Now to the mailbag and our ever increasing band of award hunters.

This month starts with Herbert Yeldham ILA274, of Burnham on Crouch, who submitted a claim for the Continental Award for North America. He had some nice ones among them, like W200AQL, VX3JGC, J37AH, HI8RFA, HP5OLZ and TI2JJP. Herbert uses the Yaesu FRG8800 with two 80m end-feds to pull in the signals...and to good effect too!

Next on the list is Stan Porter ILA062, of Malawi, who has just moved QTH but managed to claim the Continental Awards for Europe and the USSR. Stan has the FRG7 and a couple of Sonys in the shack, while the 14AVQ vertical and inverted V pull in the signals.

Joan Slater ILA185, of Matlock, gets into the lists again this month with a claim for the Continental Award for North America, showing that her HF125 is still working well into the end-fed.

Dave Howes ILA041, of Rochester, also claimed the same award. After a bit of a break from listening to pursue his love of photography, he came back to the fold and still has his ears well tuned. Philip Davies ILA023, of Market Drayton, also got in on the act and, in addition, logged the American Bicentennials and the Canadian Winter Olympics stations. Philip latched on to the 73 Magazine contest which enabled him to log the required 100 stations in less than a month. Not idle

otherwise, he also caught OHOMB/OJO on Market Reef, UA6ECU in oblast 109, Cherkessk, and AX5PGT in Adelaide on 15m.

Hedley Falkinder ILA150, of Malton, also claimed the same award and particularly mentioned W2GD/P/OH0, W200ACW and the Olympic stations. A card for the winter Olympics event requires two different special call signs on two bands or modes plus a VE6. Claims to VE6.

VX3XN stated that they were going to do a new award called the Polar Bridge award, requiring 3VEs, 3UA9s or UA0s, 1 Moscow, 1 Ottawa and 1 base camp contact. The base camp was, apparently, NP28T on Resolute Island and the call CY8C was being applied for. More news when it arrives...thanks, Hedley.

Ken Burnell ILA097, of Milton Keynes, put in his third claim for the Continentals, and is trying hard to make a sweep of the board. Ken also received a nice one in VK0AT/MM on a trip to Antarctica. He'd heard about him on the VK net and hunted around but reception was bad in the UK as the /MM was calling 'G' stations without reply on 14113.

Stan Taylor ILA070, of Hartlepool, sends us the news that the 'G4V' Group are issuing an award for licensees and SWLs for logging 30 stations in the 4V, 2 and 3 letter call signs within the G4V, GD4V, G14V, GJ4V, GM4V, GU4V and GW4V series. Only half of the loggings can be made from the G4V nets. The cost of the award is £1.00 and claims should be in log style and sent to Ann G4VXS, QTHR. The G4V net can be found on 3.715 at 14.30 each Sunday during winter months, or 20.00 during the summer (provided that we have one!).

Geoff Hughes ILA302 wrote in from Dover about his Tatung TMR7602 receiver which he uses with a random wire about 22ft long or a 'Royal Blue' folded dipole. With no ATU, he gets good reception on 20 and 80, fair on 15 but little on 10. I have suggested an aerial tuning unit between the aerial and receiver but this may not improve 15 and 10 as these bands are not at their best at the moment.

Congratulations to Janet Richards of Reading, who now has the call sign G7AIV. Jan asked about the AMRAC which used to be broadcast on Ceefax but, apparently,

the BBC have stopped listing addresses. Does anyone know what's happened? Finally, Jon Baker G1PGH, is studying hard at the moment for a degree and has had to curtail his listening for the most part, but is still logging the broadcast bands between studios. He is using a Russian 'Astrad' which cost him the princely sum of 75p at an auction! It has a slight fault in a couple of loose transistors but he's now using it to good effect with R Australia, R Japan (via Gabon), and many of the regulars. He's asking for an award for 'thousand miles per pound cost'...cheeky, but it proves a point!

Regular readers will have noticed the 'ILA' numbers alongside many reporters' names and the report on GB2ILA last month. Perhaps an explanation is due.

Way back in 1985 one of our readers, Geoff Curtis, suggested that other readers might like to swap information directly and suggested that a little group could be formed. I agreed to act as an intermediary and published the idea in this column. The

idea became very popular. So popular, in fact, that the 'International Listeners' Association' was formed and now has well over 300 members.

Amateur Radio magazine has wholeheartedly supported the group from the outset and has allowed me to use this column to announce any activities, such as GB2ILA, but I don't take liberties and 'plug it to death'. However, anyone interested in the group can contact me directly.

Membership of the ILA is £1.00 a year and for this you get a quarterly 'Newsletter' with all sorts of hints, tips and news. There is an extensive awards scheme, including the *Amateur Radio* 'Prefix Awards'. Drop me a line at 1 Jersey Street, Hafod, Swansea SA1 2HF.

Well, that's it for this month. With a bit of luck, we will see some more activity on fifteen and ten over the next few months, so if you hear anything interesting please drop me a line. The address is: Jersey Street, Hafod, Swansea SA2 2HF. Meanwhile, 73 and good listening!

AMATEUR RADIO

BACK ISSUES SERVICE

TO: Back Issues Department • Amateur Radio
• Sovereign House • Brentwood • Essex •
CM14 4SE

NAME

ADDRESS

POSTCODE

PLEASE SUPPLY: (state month and year of issue/s required) **NOTE:**
Only issues from August 1986 are available

..... at £1.45 each

PAYMENT ENCLOSED: £ -

Cheques should be made payable to **Amateur Radio** Overseas payment by International Money Order or credit card

CREDIT CARD PAYMENT: EXPIRY DATE

..... /

SIGNATURE

.....
C P I I I I I I

USER ○ ○ REVIEW



The new Sony ICF-SW1S, pictured on the front cover, is the latest – and smallest – offering from Sony. *Amateur Radio* was lucky enough to receive an SW1S for review the day after it was introduced to this country.

Nicknamed 'Victoria' by Sony staff because of the latter half of its serial number, this newcomer is tiny indeed – only 118.2 × 71.4 × 23.7mm (w/h/d). In fact, Sony say that the SW1S is the smallest world-band receiver in the world, having a coverage similar to its big brother, the ICF 2001D, but excluding the air band. This means that 150-29995kHz is covered on AM, plus 76-108MHz FM. FM is a superheterodyne, AM is a dual conversion superhet.

The SW1S comes in an attaché-style grey case which snaps open to reveal a complete, and very miniature, system – inimitably styled in a distinctively Sony fashion. Everything is low profile, with rounded edges and rounded keys, tiny sliders and a concealed telescopic antenna. In addition to the radio, the case contains an active antenna, a set of headphones, an ac power adaptor, antenna controller, carrying case and carry strap. Awesome . . .

The SW1S isn't battery hungry, taking

two AA size batteries, though the active antenna needs four more. The manual indicates that for this, on a power output of 250mW, you can expect twelve hours of listening, based on an average four hours a day at a 'normal' volume.

Now to examine the numerous facilities. The front panel houses the speaker, which is on the extreme left. Next to this is the square power on/off button and rectangular sleep/timer button. This turns the radio off automatically after 65 minutes and will be useful for the late night listeners trying to catch rare stations after others have signed off.

Below these is the key protect button, a tiny low-profile round thing – as are most of the front panel buttons. Perhaps the radio of the future is destined to be less angular? The key protect facility disables the front panel buttons in case of accidental contact – not a bad idea on something scarcely larger than a bar of soap.

Below this lies the band/alarm set, a dual function button which is used in conjunction with the manual tune key. With the radio on, these are used to produce the lowest frequencies of each band in turn. With the radio off, the same

buttons are pressed to set the alarm, which turns the radio on automatically.

The lowest key in this set is another dual function control, the enter/time set key. Again, this is used simultaneously with the manual tune key, the function depending on whether or not the radio is on. With the radio off, it allows the user to set the current time, which will be displayed in the LCD when the radio is not being used. With the radio on, it is used to preset a station in conjunction with one of the numeric buttons, thus entering the displayed frequency and allocating it to that particular number.

Moving swiftly along, we find the LCD and numeric keys, manual tune + or – and AM/FM execute buttons, plus a tiny red LED – the tuning indicator.

The AM/FM execute keys are used before and after entering a frequency; the first time in their function of mode selector, the second time as an 'execute' command. Many of the keys have dual functions, doubtless necessary because of the tiny area available for controls.

On top of the radio is the main power switch and a rectangular light switch. The power slider is minute and the light switch scarcely bigger, so they need little effort to use. The light is, happily, quite adequate, although it deactivates when the button is released. The radio's size makes holding this easy; it can be held down with one finger while the radio nestles snugly in the palm of the hand.

On the right, there is a slender volume control thumbwheel, below which is the tone switch. This can be set for best results between 'music' and 'news' settings. Then comes the minijack for the supplied headphones, the external power input jack and the handstrap.

On the left side, at the top, is the telescopic antenna. This is concealed within the body of the radio, unfolding to a surprising and robust 20in in length, with a ball joint at the bottom for directional adjustment. Below this is a slider marked 'sens', labelled 'DX' and 'local'. Normally, 'DX' provides better reception, unless the signal is so loud that it becomes distorted.

At the bottom of the left side is a recording output minijack, for connection to a tape recorder. Not a bad list of features for such a small radio but, as the man says, there's more . . .

FREQUENCY	STATION	POWER (kW)	LOCATION	SIGNAL
162kHz	R France Inter	2000	Allouis	Good
218kHz	R Monte Carlo	1400	Monaco	Good
272kHz	Hvezda Prog	1500	Topolna	Fair
738kHz	RNE1	250	Barcelona	Poor
747kHz	Hilversum 2	400	Flevoland	Good
792kHz	Chiltern R	0.3	Bedford	Excellent
873kHz	American Forces Network	150	Frankfurt	Poor
927kHz	BRT1	300	Wolvertem	Fair
963kHz	RRE	600	Turku	Fair
1008kHz	Hilversum 5	400	Flevoland	Good
1026kHz	R Cambridgeshire	0.5	Cambridge	Good
1044kHz	DDR1	250	Burg etc	Fair
1062kHz	Danish Prog 3	250	Kalundborg	Fair
1071kHz	R France Inter	40	Lille	Fair
1125kHz	RTBF2	20	La Louvière	Poor.
1143kHz	R Moscow	150	Kaliningrad	Fair
1179kHz	R Sweden	600	Sölvesborg	Good
1197kHz	Voice of America	300	Munich	Poor
1206kHz	Polish Prog 2	200	Wroclaw	Fair
1224kHz	Sofia 1	500	Vidin	Fair
1233kHz	Hvezda Pr	400	Prague	Good
1269kHz	DLF	600	Neuminster	Fair
1305kHz	Polish Prog 2	100	Rzeszow	Poor
1314kHz	Norway Prog 1	1200	Kvitsoy	Good
1377kHz	R France Lille	50	Ukraine etc	Fair
1440kHz	RT Luxembourg	1200	Marnach	Excellent
1539kHz	DLF	700	Mainflingen	Fair
1593kHz	Westdeutscher RF	400/800	Langenberg	Good

There's more in the case than the radio, as indicated. This is intended to be a complete kit, with everything necessary for catching DX included. For extra listening power, two additional attachments are included. A miniature extra console, the external antenna controller, plugs into the tape out socket. This has three sliders: power off/on; an attenuator with two settings, 0dB and -20dB; a band select switch for SW or LW/MW. The attenuator is normally set on 0dB, but when strong interference or intermodulation is present the setting can be changed to -20dB.

The other side of this console has two sockets—a tape output and a 'from module' socket, the active antenna being attached to the latter. This has a state-of-the-art reel of cable ending in a minijack. I like the fat winder, which occupies most of one side of the antenna module and has a recessed finger hole for quick re-winding of the cable. Everything tucks away neatly, the jack fitting into a recess. This radio will definitely appeal to anyone who likes things to look good . . .

The active antenna unfolds to a tad under 46in long, guaranteed to impress the guy next to you on the beach. It terminates thoughtfully in a deep yellow knob, which could save the odd eye. The headphones are also designed to cause jealousy, being tiny things in an elegant case which has the same fat finger-winder and recessed jack housing as the active antenna. Each earpiece is on its own length of cable.

The connoisseur will appreciate those earphones. The only relationship they bear to the standard tranny earpiece is that they fit in the ear . . .

The last extra in the case is the adaptor plus, of course, the manual and a copy of the *Sony Wave Handbook*, which gives details of times, frequencies, station identifiers, etc for countries all over the world.

In use, this radio-ette is remarkable. We were fortunate to be able to compare it to the ICF-2001D, which Sony also kindly lent us, and which Angus McKenzie reviewed shortly after its release. There are differences, of course—the ICF-2001D has more memories (36 against 10 for the SW1S), synchronous detection, four different sleep timer settings and the ability to choose between wide and narrow filters for AM, CW and SSB reception. There are other obvious differences, including the size—the 2001D is much bigger, looking more like the conventional tranny. Its dimensions are 288 x 159 x 52mm (w/h/d)—quite a difference. As a consequence, the SW1S's speaker is considerably smaller, 66 x 88mm against a 4in diameter speaker in the 2001D.

Having said this, in use it would be expected that the sound reproduction of the SW1S would be worse—in fact, we were amazed at how good it was. Though such comparisons are purely subjective, everyone who heard the SW1S remarked on the quality of sound 'from such a small radio!'

The SW1S proved simple to use, with an extremely good manual which detailed the use of the facilities in a clear, precise and uncomplicated way. From this point of view the manual is excellent—if you want the technical info or circuit diagrams, then it isn't. Again, it's a personal choice, and I feel that Sony probably expect that buyers of this radio won't be too disappointed by the omission.

Stations heard on the SW1S using the active antenna are listed in the table. The reception of some of the further stations was remarkable, although the ones that are labelled as 'poor' were mainly suffering from co-channel interference which was relieved by using the attenuator. Anything labelled as excellent sounded like the transmitter was down the road, not several hundred miles away. Not having a signal strength meter like the 2001D, the measurements had to be fairly imprecise. That's one thing I wish they could have squeezed in.

In conclusion, the SW1S is certainly an unusual radio and well worth a listen, although at £250 it's not for the Scrooges among us. The 2001D is a hundred pounds more—a hard choice to make; ultimately, one that can only be made by careful consideration of the features which you really want in a radio. The SW1S is very beautiful, very portable, with an excellent range and coverage, not to mention high quality reception. A personal favourite, I'd have to rob a bank to afford it. Anyone got a mask?

WORLD RADIO TMR 7602

OUR PREVIOUS PRICE WAS RIDICULOUS!

NOW WE ARE FORCED TO
REDUCE YET AGAIN

£99.99

WHILE STOCKS LAST
+ £8 CARRIAGE & PACKING

**FULL AFTER SALES SERVICE
CALL IN FOR DEMONSTRATION!
YES! WE DO KNOW HOW IT WORKS!**

**THIS IS A CRAZY PRICE, SO RUSH
US YOUR ORDER TO AVOID
DISAPPOINTMENT**

DIGITAL FREQUENCY DISPLAY

P.S.U. 400 MW OPTIONAL EXTRA £10

FREE RECENT WRTH HANDBOOK WITH ANY RADIO PURCHASED. YOU JUST PAY £2 HANDLING AND POST.

SPECIFICATIONS & FEATURES TATUNG (AMBASSADOR 2020)
(Realistic DX440)

- * Full AM/FM frequency range 150-29999kHz plus FM 87.5-108MHz, mono/stereo.
- * Five Tuning Functions
 - Direct press button frequency input
 - Auto scanning, manual scanning
 - Memory recall and manual tuning knob
- * Built-in clock and alarm. Radio turns on automatically at preset time & frequency.
- * Fourteen memories
 - Nine memory channels for your favourite station frequencies.
 - Last setting of mode & waveband stored in 5 memories.
- * Direct press-button access to all 12 shortwave broadcast bands.
- * Two power sources—battery or AC mains adaptor.
- * General coverage of all AM bands in LW/MW/SW (dedicated broadcast band coverage on all versions). Plus of course the FM band for quality Sound broadcasts in headphone stereo.
- * SLEEP Function turns the radio On or Off after an adjustable time of 10-90 minutes.
- * Separate BASS & TREBLE controls for maximum listening pleasure.
- * External antenna jack for better reception.
- * Adjustable RF GAIN control to prevent overloading when listening close to other strong stations or if there is interference.
- * BFO control (beat frequency oscillator) enables reception of SSB/USB/LSB (single side band) and CW (Morse Code) transmissions.
- * Illuminated display to facilitate night-time use.
- * Designed for both portable and desk top use.
- * Five dot LED signal strength indicator.
- * Dimensions: 29.2cm x 16.0cm (11.5in x 6.3in x 2.36in)
- * Output — 1200mW (10% THD)
- * Weight — 1.7kg (3.75lbs) without batteries.
- * Wide/narrow filter switch.

OFFICIAL
SONY
DEALER

AN-1 active antenna with FET RF amplifier made for any **SONY** radio ever made plus any other make of receiver. Works on batteries or mains. It simply is the best! £40 + £2.50 p&p. It's the cheapest way round the world.

New **ICF-7600A** and improved **ICF7600DS** in stock. **ICF2001D**, **PROBO**, **AIR7**. Plus we stock **Sony** accessories and their hi-fi range.

DIPLOMAT 80789L 10 waveband pocket miracle, 13, 16, 19, 25, 31, 41, 49 shortwave bandspread + VHF/FM, long and medium wave and stereo VHF into headphones. £39.95 + £2 p&p for radio, headphones, carry case, 100 page waveguide.

8 band **VEGA 215 Mk II SELENA**—mains and battery, true Russian technology and ruggedly made. Complete with long range aerial and earpiece, £29.95 + £3 p&p or add £2 extra for security delivery. **VEGA 208** 8 band 24.95.

FULLY ILLUSTRATED CATALOGUE

£1.00

S.A.E. WITH ALL CORRESPONDENCE

PANASONIC MULTI-BAND
PORTABLES

B600 - RFB20L - RFB60L

HIGH TECH AND QUALITY WORLD RADIOS

GRUNDIG

650 & 400
SATELLIT RADIOS

**WE STOCK A RANGE OF AIRBAND RADIOS &
SCANNERS. TELL US WHAT YOU WANT.**



JOHNSONS SHORTWAVE RADIO

43 FRIAR ST, WORCESTER WR1 2NA

0905-25740

OUR SETS ARE SO SENSITIVE THEY CRY WHEN THEY HEAR "THE SOUND OF MUSIC"



BITS TO BUILD

POLARITY PROTECTION – This Article Could Save Your Rig!

If the transistor is the 'three legged fuse', then the integrated circuit is certainly the device for which reversing the terminals is terminal. They don't like it...but most of us have done it. Accidentally reversing the polarity of the supply to a piece of equipment is easy, and then we have to count the cost.

So much amateur radio equipment these days is designed to run on a nominal 12 volt (frequently 13.8) supply and comes without a built-in power supply. This is when Sodd's Law comes into play. Sodd's Law for supplying power to equipment has three theses:

- 1) Where a power supply can be reversed, it will be.
- 2) Where there is a non-reversible plug and socket on a power supply lead, the wires will be soldered on the wrong way round.
- 3) Where a piece of equipment has reverse polarity protection, the supply polarity will never be reversed.

Adding polarity protection is very simple and costs next to nothing, so hunt around the shack for non-protected equipment and try out one of the circuits described below.

The simple (and cheap) method

Figure 1 shows the simplest way of protecting a piece of equipment from reversed polarity. It is simply a diode wired in series with the positive lead. The diode, as we all know, only allows current to flow in one direction. If the diode is connected in the way shown, it will pass current and the supply then reaches the equipment.

The diode should be capable of passing the current required by the equipment. Silicon rectifier diodes are ideal. Little general purpose diodes

pulled out of the junk box will probably 'pop' in many protection applications. The commonest types, like the 1N914 and 1N4148 are only designed to pass 75mA. Suitable types might be:
 1N4001: 1 amp (100 volts)
 1N5400: 3 amp (50 volts)
 MR751: 6 amp (100 volts).

Equipment which draws a current greater than these will require a more sturdy diode, probably one with a good heatsink. This suggests the first problem of this simple method: it is only really viable with low current equipment. For as the current rating of the equipment rises, so does the physical size of the diode and associated heatsink.

Another disadvantage is the voltage drop across the diode. A forward biased diode will not conduct until approximately 0.75 volts dc is applied, so there will certainly be a voltage drop across the diode. In many applications this may not be a problem, but some equipment uses relays which may not change over properly with a reduced voltage. Such problems will be more noticeable with battery operated equipment because the battery voltage will not be able to fall quite as far before malfunctions occur.

The any-way-round circuit

The circuit shown in Figure 2 is the familiar bridge rectifier circuit commonly used to convert the ac voltage from a transformer into the required dc voltage in a power supply. This circuit can also be used at dc for polarity protection.

If you follow the possible current paths through the four diodes, there are two alternatives. If a positive voltage is applied to the top of the left-hand side of the circuit, D2 will allow the positive voltage to appear at the top (+) of the right-hand side of the circuit. Also if a positive voltage is applied to the bottom of the left-hand circuit, current can pass through D3 to give a positive voltage at the same (+) point. The same applies to the negative voltage.

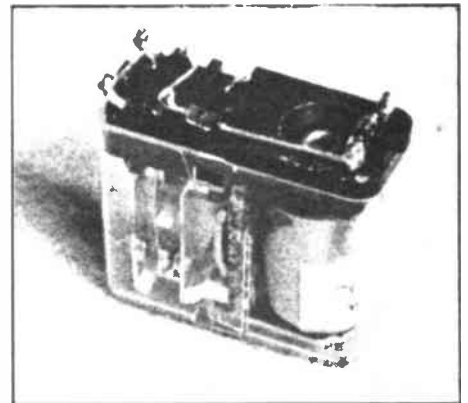

What a good circuit! Because whatever polarity is applied to the left-hand side of the circuit, positive voltage will always appear at (+) and negative voltage will also appear at (-) on the right-hand side of the circuit. Whichever way round the supply is connected, the equipment will receive the correct polarity. A circuit to beat the idiot!

But there are problems, and they are exactly the same problems associated with the simple circuit above...only twice as bad. There will be double the voltage drop in this circuit because the supply has to pass through two diodes, and the diode bridge must be rated to suit the current requirements of the equipment.

The polarity fuse

The circuit shown in Figure 3 uses a fuse to protect the equipment from reversed polarity. If the circuit is connected as shown, the supply reaches the equipment directly. Should the polarity of the supply be reversed, the diode (D1) will conduct and a short circuit will result. The fuse (F) will blow and the equipment will not receive the reversed supply.

A nice, simple circuit, but it can have drawbacks. The fuse has to be capable of passing the current required by the equipment and the diode has to be capable of passing a high current for long enough to blow the fuse. Otherwise the diode will blow before the fuse, and

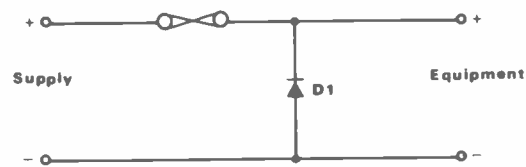
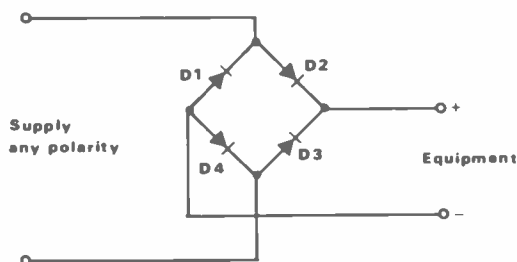
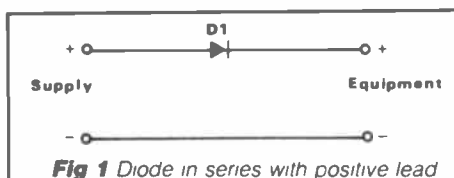

the very purpose of the circuit is negated. So this is a good, simple circuit, but capable of going wrong if the diode fails to fulfil its purpose!

The polarity protection relay

The best method of polarity protection for home constructors to build is shown in Figure 4. This circuit uses a relay and two diodes. The circuit may seem more complex than the other methods but is, in fact, very simple. Only the positive line is shown; the negative line runs directly from supply to equipment.

The relay (RL1) is a 12 volt relay with one or more changeover contacts. The example shown has two sets of changeover contacts. These are marked as normally open (NO) and normally closed (NC). The two sets of contacts are wired in parallel.

The positive line of the supply is connected to the centre of the changeover contacts and since the normally open contacts go to the equipment, no current can pass until the relay has changed over. The positive line also passes via a diode (D1) to the coil of the relay.

A second diode is wired across the coil in the reversed bias position to keep down voltage surges from the magnetic field of the coil.

If the circuit is connected the right way round, the positive voltage can reach the top of RL1. Closing the switch (SW1) allows the coil to receive 12 volts, and the relay is energised. The relay contacts

change over, switching the supply to the equipment. If the voltage applied is of the wrong polarity, the relay will not receive the supply line power because of D1, and the equipment will not be switched on.

There are several advantages to this circuit. The equipment cannot 'see' the supply voltage at all unless the polarity is correct. D1 need only be capable of passing enough current to energise RL1 and thus can be a small diode (1N914 etc). The switch is in the ground return line of the equipment and, if used as the main switch for the equipment, it only requires one wire: the ground point can usually be picked up near the switch. The power handling capability of the circuit is only limited by what the relay contacts can handle. If these contacts are in parallel, as in this example, twice the current can be switched.

The circuit does require a relay in addition to the diodes, but a cheap relay with sturdy contacts can be used. Kanga Products will supply a suitable relay already wired, with the two diodes, for £1.45 complete (see footnote). For a modest outlay, a piece of equipment can be well protected.

So protect your expensive commercial, or precious home-built, equipment by adding polarity protection.

Footnote

Sources:

Reverse polarity protection relay – a relay, with contacts capable of handling

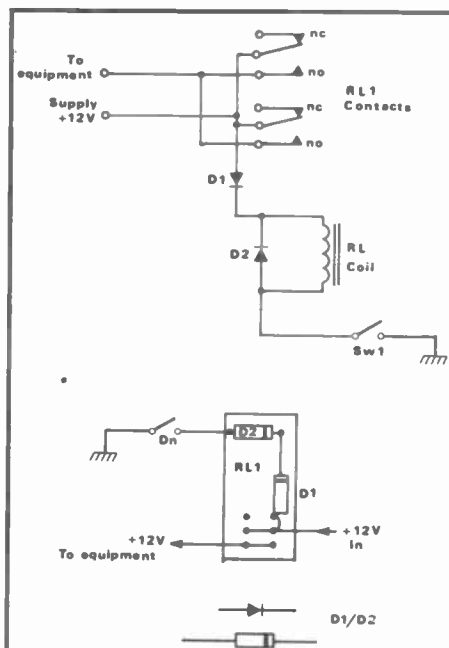

Fig 4 Table of values:
D1/D2 1N914 or similar silicon diode
RL1 12 volt relay with changeover contacts
SW1 Single pole on/off switch (if required)

16 amps, complete with diodes already wired in place (as in Figure 4), £1.45 including postage, from Kanga Products, 3 Limes Road, Folkestone, Kent CT19 4AU.

**NEXT
MONTH**

Amateur RADIO

all the regulars. . .

DX Diary
On the Beam
Secondhand
SWL
Straight and Level
Your letters and
features covering
the whole of
Amateur Radio

■ ANGUS MCKENZIE TESTS

G3OSS takes a look at the Yaesu FT736 and the Hokushin HFWX1 2m/70cm dual-band base station collinear antenna, plus the HF727 VME 2m/70cm mobile collinear antenna – two new high gain dual-banders from Lowe Electronics

■ OUT OF AFRICA

David Saul tells the exciting story of A22KZ

■ POWER SUPPLIES FOR BEGINNERS

J and S Goodier introduce beginners to the common regulators

DON'T MISS THE MAY ISSUE
On sale 28 APRIL

50MHz

by Ken Ellis G59KW

Due to space limitations caused by the beacon and TV information kindly sent by KA3B, G3COJ and others, I have reluctantly had to hold over contributions to the mailbag section of this column. Please continue to send in your reports, though, and I will publish as many as possible next month.

In the March issue, I referred to negotiations between Eric F9LT and the REF (French authorities) for relaxation of 50MHz restrictions, to allow limited access to the band on a regional basis. As explained last month, there are two areas where Band 1 transmitters are operating, and the authorities say that no operation will be allowed on 50MHz within 150km of these stations. Eric is still trying to get this distance decreased, however, so watch this space for further developments. I have received a map from Eric illustrating the proposed areas, but it is only provisional at present and not for publication. I will publish it as soon as I can.

Eric has received over 150 applications from French hams for six metre permits. He confirms that modes will be the same as ours (CW, SSB and RTTY, although he did not specify FM!).

February activity

On February 21st there was a major solar disturbance. The following day the solar figures were 105 with the A index at 70; the highest for a long time. During the afternoon there was extensive aurora, stretching to my QTH in Folkestone and also to the Channel Isles. My best QSOs were with EI9Q and GJ4ICD. I did not hear any Scottish or LA stations, but many were worked by other stations.

My thirteen A QSOs took place between 1510 and 1730Z, but contacts via auroral activity took place between 1300 and 1600 for G6XM in the West Country

and between 1331 and 1850 for G4UPS. In the north, G3MY had contacts between 1400 and 1850 and G3CCH between 1400 and 1900. There was no repeat of these conditions during the evening.

The following day, 23rd February, the solar figures were the same, 105, and the A index was again at 70, but for some unexplained reason, despite continuous monitoring all over the country, no aurora was reported. There was extensive tropo, however, with GM4RMK being a consistent signal.

Outstanding performance

Geoff GJ4ICD had seventy-three QSOs during the auroral opening on the 22nd; quite an outstanding performance for a station so far south! From the north, visible patches of aurora were reported, but there were no tangible results.

Last month, due to a typing error, I incorrectly reported the number of countries QSOd by Ted Collins whilst operating as ZD8TC from Ascension Island. It should have read 71 countries worked and confirmed. Ted still ranks 11th on the ARRL six metre list, published in QST.

Australian Beacons

52.200MHz	VK8VF	Darwin
52.320MHz	VK6RTT	Wickham
52.325MHz	VK2RHV	Newcastle
52.345MHz	VK4ABP	Longreach
52.350MHz	VK6RTU	Kalgoorlie
52.370MHz	VK7RST	Hobart
52.418MHz	VK0MA	Mawson
52.420MHz	VK2RSY	Sydney
52.525MHz	VK2RGB	Gunnedah
52.435MHz	VK3RMV	Hamilton
52.440MHz	VK4RTL	Townsville
52.450MHz	VK5VF	Mount Lofty
52.460MHz	VK6RPH	Perth
52.465MHz	VK6RTW	Albany
52.470MHz	VK7RTN	Launceston

Beacon problems

In my article 50MHz - What to Expect, published in *Amateur Radio* in March 1987, I referred to the practice of checking the rising MUF levels during the run-up to solar peaks by monitoring beacons, radio stations and TV sound and video stations. This month I am able to reproduce, thanks to Harry Schools KA3B, Brian Bower G3WOJ and others, six metre international beacon lists and sound and video data around 50MHz.

I have attempted, through a series of letters and telephone calls to beacon custodians, to provide the most accurate and up to date listing of the US six metre beacons that are currently operational. This was no easy task, as beacons come and go with great frequency, confusing even the most active operators on the band. Also, the operating parameters of beacons change quite often.

Because of these factors, inaccurate information has a tendency to get into print in the various magazines and newsletters covering the subject. There are many beacon lists that are grossly out of date.

Western United States Beacons

50.064MHz	N7DB	CN 85	(OR)	(C)
50.065MHz	W0IJR	DM 79	(CO)	(C)
50.065MHz	KA0CDN	DM 79	(CO)	(C)
50.067MHz	W0BJ	DN 91	(NE)	(C)
50.070MHz	WB0CGH	EM 13	(TX)	(C)
50.070MHz	WA7ECY	CN 85	(OR)	(C)
50.077MHz	N0LL	EM 09	(KS)	(C)
50.095MHz	K7IHZ	DM 43	(AZ)	(C)

(C) Continuous operation

Eastern United States Beacons

50.060MHz	WA80NQ	EM 79	(OH)	(C)
50.060MHz	K4TOR	EM 63	(AL)	(C)
50.061MHz	K1NFE	FN 31	(CT)	(C)
50.062MHz	W3VD	FM 19	(MD)	(C)
50.063MHz	N4PZ	EL 87	(FL)	(C)
50.064MHz	W5VAS	EL 59	(LA)	(C)
50.067MHz	W4RFR	EM 66	(TN)	(C)
50.067MHz	WB8IGY	EM 79	(OH)	(C)
50.069MHz	W4HHK	EM 55	(TN)	(C)
50.070MHz	WB4GJG	FM 06	(VA)	(I)
50.070MHz	K0HTF	EN 31	(IA)	(C)
50.070MHz	KA4VEY	EM 64	(AL)	(C)
50.070MHz	KB4UPI	EM 63	(AL)	(C)
50.070MHz	W2CAP	FN 41	(MA)	(C)
50.070MHz	N4LTA	EM 94	(SC)	(C)
50.072MHz	WA2YTM	FN 12	(NY)	(C)
50.077MHz	N5JM	EL 49	(LA)	(I)
50.080MHz	WB4OOJ	EL 87	(FL)	(C)
50.080MHz	W1AW	FN 31	(CT)	(I)
50.092MHz	W5GTP	EM 40	(LA)	(I)

NB: The US square numbers shown will be a useful indication of the location of stations QSOd on 6m

(I) Intermittent operation
(C) Continuous operation

TV Stations in Europe, 45-54MHz: Sound

Freq (kHz)	Station	Country	Loc/Grid
49224.0 (Vision 55724.0kHz)	Arbresle	France	JN25
53729.2	Goettelborner Hoehe	FR Germany	JN39
53739.6	Oerebro	Sweden	JO79
53742.2	Muro	Portugal	IN51
53744.8	Biedenkopf	FR Germany	JO40
53746.1	Gulen	Norway	JP21
53749.7	Varanger	Norway	KP59
53750.0	Bantiger	Switzerland	JN36
	Navacerrada	Spain	IN80
	Santiago	Spain	IN52
	Sankt Poelten	Austria	JN78
	Vaennes	Sweden	JP93
53752.6	Greipstad	Norway	JO38
53756.1	Melhus	Norway	JP53
53760.4	Gruenten	FR Germany	JN57
	Steiqen	Norway	JP77

One of my main goals is to publish accurate beacon information. The only way to do this is to obtain first-hand information direct from the beacon operator or custodian. A major problem with preparing beacon lists is that there is too much misinformation floating around and that this type of information is constantly changing.

Special QSLs

Beacons provide valuable information for calculating long-term propagation trends and spotting band openings. Many custodians have been confirming reception reports of their beacons with specialised QSL cards or letters. Stations doing this include N4LTA in South Carolina, W0IJR/KA0CDN in Colorado and K1NFE in Connecticut.

It's big in Japan!

As most of the commercial equipment used by six metre operators in the UK and many other countries is made in Japan, it is only natural for there to be a lot of activity in that country.

I recently received news of an annual VHF SSB/CW operators' meeting in Kobe, JA3. The last such gathering was

held on 5th and 6th September 1987, and 160 ladies and gentlemen attended this meeting from all areas.

DX in JA

The following is an excerpt from a letter received by Harry A Schools KA3B from Hatsu Yoshida JA1VOK:

'As far as Japan is concerned, I cannot guess the number of six metre stations. Probably there are 3,000 or more active on six metres. Active DXers number less than 200. Among the 10 call areas in Japan, the JA1 call area (Tokyo) has about 50 per cent of the ham population. Therefore, the pile-ups for DX stations are terrible in all JA1 call areas.

'In Japan, 50.050 to 50.090 is used for CW, 50.100-50.130 is used for international DX and 50.110 is the international DX calling frequency.

Legal beacon

There is only one authorised six metre beacon in Japan, on 50.010MHz, which is controlled by the Japan Amateur Radio League (JARL). Its location is Mie (near Nagoya, grid PM84), and it has 10 watts

output and a ground plane antenna. Our legal power is 50 watts for higher class and 10 watts for novice class.'

JA1VOK is a member of the RSGB 50MHz Reporting Club.

New awards

According to Ray Cracknell, co-ordinator of the RSGB 50MHz Reporting Club, the RSGB VHF Committee has been very busy preparing rules for the new 50MHz awards. A squares certificate, a countries worked certificate and a DX award are planned. The last of these will include crossband working. Details of a planned construction contest will be announced soon.

Sign-off

That is all for this month. Many thanks to all those who have contributed to this month's column, especially KA3B, G3COJ and JA1VOK. Apologies to those whose letters have been held over until next month.

73 de Ken Ellis G5KW, 18 Joyes Road, Folkestone, Kent CT186NX.

Eastern Canadian Beacons					
50.086MHz	VE2STL	FN 46	(QUE)	(I)	
50.088MHz	VE1SIX	FN 65	(NB)	(C)	
(I) Intermittent operation (C) Continuous operation					

South African Beacons					
50.010MHz	ZS1STB	Stilbaai	40 watts 4 el hygan		
			beamed north		
50.0225MHz	ZS6LW	Roslyn	50 watts 6 el at 35 feet		
50.025MHz	ZS6LN	Pietersburg	150 watts 5 el at 66 feet		
			(beacon runs only 10		
			watts between 1800-		
			0600Z)		
50.050MHz	ZS6DN	Irene	Unknown power and		
			operating parameters		

European Beacons					
50.015MHz	SZ2DH	Athens, Greece	10 watts 5 el at 25		
			metres (I)		
50.020MHz	GB3SIX	Anglesey	25 watts 3 el		
			pointed NW (C)		
50.029MHz	CT0WW	NE Portugal	40 watts dipole		
			with NE/SW		
			pattern (I)		
50.035MHz	ZB2VHF	Gibraltar	Temporarily QRT		
			due to damage		
			by rats		
50.050MHz	GB3NHQ	Potters Bar	25 watts crossed		
			dipoles at 40ft.		
			RSGB HQ station		
			(C)		
50.060MHz	GB3RMK	Inverness	40 watts folded		
			dipole with N/S		
			pattern (C)		
(I) Intermittent operation (C) Continuous operation					

TV Stations in Europe, 45-54MHz: Vision				
Freq (kHz)	Station	Country	Loc/Grid	ERP (kW)
48239.6	Goettelborner Hoehe	FR Germany	JN39	100
	Oerebro	Sweden	JO79	60
48246.1	Gulen	Norway	JP21	30
48247.4	Bredenkopf	FR Germany	JO40	100
48242.2	Muro	Portugal	IN51	40
48249.7	Varanger	Norway	KP59	30
48250.0	Bantiger	Switzerland	JN36	50
	Navacerrada	Spain	IN80	250
	Santriago	Spain	IN52	40
	Sankt Poelten	Austria	JN78	60
	Vaennes	Sweden	JP93	60
48252.6	Grepstad	Norway	JO38	60
48256.1	Melhus	Norway	JP53	100
48260.4	Gruenten	FR Germany	JN57	100
	Steigen	Norway	JP77	60
49739.6	Budapest	Hungary	JN97	150
	Lvov	USSR	KN29	150
	Prague	Czechoslovakia	JN79	150
	Simferopol	USSR	KN74	50
	Tcherepovets	USSR	KO89	35
	Voronezh	USSR	KO62	35
49740.9	Lovozero	USSR	KP78	10
49744.8	Nagykanizsa	Hungary	JN86	50
49747.6	Moscow	USSR	KO85	240
49750.0	Krasnodar	USSR	KN95	50
	Krivoi Rog	USSR	KN67	35
	Kuzema	USSR	KP75	10
	Leningrad	USSR	KO59	240
	Minsk	USSR	KO33	150
	Sochi	USSR	KN93	35
49751.3	Bydgoszcz	Poland	JO93	100
49757.8	Novosokolniki	USSR	KO56	90
	Sukhozero	USSR	KP63	10
49760.4	Kuldiga	USSR	KO06	50
	Ovutich	USSR	KO41	50
	Rostov on Don	USSR	KN79	35
	Unetcha	USSR	KO91	35
53739.6	Monte Nerone	Italy	JN63	34
53740.9	Glanmire	Ireland	IO51	0.05
53760.4	Monte Cammarata	Italy	JM67	35
	Monte Caccia	Italy	JN81	34
	Trieste Muggia	Italy	JN65	1.6

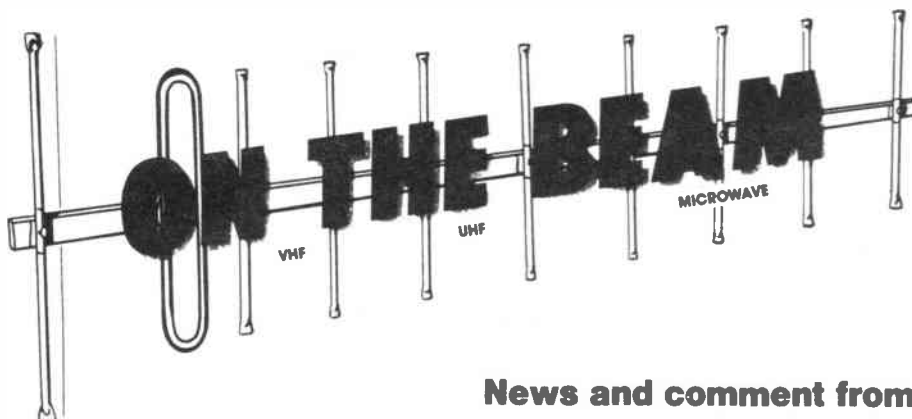

News and comment from Glen Ross G8MWR

The ghostly voices were back with a vengeance on Monday 22nd February when, from around 1300 to 1800GMT, all bands from 28 to 144MHz were going crazy. This has to be one of the best aurora openings of the last few years and at times 50MHz was so full of QRM it sounded more like a contest on twenty metres.

It is known that about eighteen different countries were worked on two metres from EI in the west to Russia in the east and unconfirmed reports of contacts into Italy have been circulating.

Noisy sun

Sunspot activity is increasing, with the current spot count being around sixty, and there are possibilities of further magnetic storms occurring and so giving rise to auroral activity. These events often occur at twenty-eight day periods (the sun's rotation brings the active area into view again), so it is well worth keeping an auroral calendar to remind you when following events become possible.

For newcomers to the mode, the ghostly voices are due to reflection from the aurora and, because this is not a solid sheet and the effective reflection point is constantly moving, there is a lot of doppler shift on the signal. This makes tuning very difficult.

Steady on

Due to all this shifting it is not easy to make out what the voices are saying until your ears get accustomed to the sound. Also, remember that when you go back to a station you should speak much more slowly than usual.

You should repeat the information several times to give the other station a reasonable chance of getting you the first time, otherwise you are in for an awful lot of repeats.

Interference

New and horrible noises are starting to creep into the bottom end of the two metre band. These take the form of a very

warbly data type transmission, which puts out a stream at regular intervals. Most of this crud seems to be centred around 144.03MHz and has been reported from several parts of the country.

Here in the Midlands the noise appears to come from a site to the west of Birmingham and seems to tie up with what are believed to be Mercury transmissions which are originating at about 138MHz. If you are getting similar problems let the RSGB know, so that things can be stopped before they get out of hand. If it is a Mercury based problem then we can expect it to slowly cover the country as the network is expanded.

Talkback

Some discussion is going on in the microwave world as to the best frequencies to use for talkback on the bands above 10GHz. At present, most people use frequencies close to 144.175MHz, but these can suffer from interference, especially when there is a two metre contest in full swing. The idea is that perhaps we ought to move onto the 70cm band and so get away from this problem. This is great in theory, but the main idea of 10GHz and above operating is that it is cheap.

It knocks the whole thing on the head if, having built the gear for about £40, you then have to spend around £400 to equip yourself for talkback. Most people already have an FT290 or something similar for two metres and, in spite of the occasional problem, this does seem the best band to stay on, at least for the time being.

Incidentally, if you are coming on microwave and are looking for some cheap talkback, keep an eye open at the rallies for the little Mizuho SSB portable. It is often available for around £50 and does a great job. The only problem you sometimes get with them is a noisy tuning control, but this is a standard transistor broadcast receiver component and dead easy to replace.

Contests

While on the subject of microwaves, you might like to make a note of the dates for this year's 10 and 24GHz cumulative contests. They are 17th April, 15th May, 19th June, 7th August and 11th September.

The usual scoring of one point per kilometre worked applies and you are allowed to change site once per contest provided you stay within 5km of your original starting point. You may just get this in time to remind you of the 70MHz cumulative contest on 27th March. This is followed by the 50MHz fixed contest on 2nd April and the 70MHz fixed (the contest, not the result) on 3rd April.

Moving on a little, we have the 144MHz do on 2nd and 3rd April, which also includes a special short wave listener section.

You might like to get yourself in trim for the mammoth multiband 432 to 24000MHz inclusive affair on the weekend of 7th and 8th May.

G0HXO

Some news on the awards front, and a plea to G0HXO to get in touch with me. I have the awards waiting for you but you did not include your QTH and I can't find you in the callbook, please come out of the woodwork! Several operators have asked if Alderney and Sark can be counted as countries for the award in the same way as Orkney and Shetland are.

The thinking is that in terms of distance from the centre of the country they are all equally difficult to work. The fact that there are only about four operators on Alderney and two on Sark will probably make them even more difficult to get.

Fair's fair

However, we go along with popular demand and, so as to make it fair for everyone, these islands can be counted back to the start of the award scheme.

On the same basis you may also count the Scilly Isles, but that's your lot; no claims will be entertained for the Isle of Wight, etc. I am still getting enquiries about 50MHz awards but little input as to what you think acceptable levels are for each grade. One of the big problems is that any country score which would be fair under current conditions would be far too easy when the band really opens up in a year or two. The fact that more countries are getting access to the band is also not making life any easier. How about sending a line with your ideas for the award?

The VHF net

A passing mention of this a few months ago has brought several enquiries from people who want to know the days and times on which it operates. Actually, it does not work like that.

In effect the net, around 14.34MHz on twenty metres, runs more like a calling frequency, in that people simply drop in and out whenever they are available. If you are a Class B person, it means simply monitoring the frequency and waiting for activity. You do not usually have to wait long. If Class A, then put out a call and see who is on frequency.

ON THE BEAM

User groups

Two of our higher bands that have been rather neglected in the past are now starting to receive the attention they deserve. These are the bands at 3.4 and 5.6GHz. A newsletter has been started by G0CZD and G3KFD, QTHR, to co-ordinate the activity and keep up a supply of technical articles. If you are interested, please send the usual SAE for information.

The only problem is that this new venture may clash with the excellent microwave newsletter which is supplied by the RSGB. Perhaps the solution would be to co-opt the organisers of the new venture to be responsible for these special interest areas in the microwave newsletter. Or is that just too much like common sense to succeed?

Early birds

News of the satellites now. The launch for the new Phase 3 unit still seems set for around mid-May when the next Ariane rocket shoots skywards. The special rate launch costs for this satellite are around \$10,000, so if you intend to use it a good idea would be to send Amsat-UK a donation. You can contact them via Ron Broadbent G3AAJ, of AmSat, who is QTHR.

There is also news of a new series of experiments called HART-1. This will involve a team of British amateurs who

will fly balloon-based transponders to try out some new ideas.

Technical

The basic specification for these devices will be input on 435.045MHz with the output on 145.845MHz. The passband will be around 10kHz wide so there will only be room for three or four transmissions to get through at any one time. Power output is expected to be about two watts.

There is no gain control system included, in a bid to beat the 'Alligators' (all mouth and no ears) and make sure that weak signals get through. This means that stations running high power will not be welcome.

It is estimated that stations running 10 watts to a small beam should be able to access the transponder at a range of 250 miles when the balloon is at an altitude of 30,000 feet.

Amsat are still waiting for a licence for the experiment so for the latest news, watch this space.

Odds and ends

Those of you looking for more indications of good conditions on two might like to keep an ear open for the repeater FZ5THF. This is located in AC08e which is in the Pyrenees, not far from Andorra. It has unusual frequencies of 144.825 on the input and S17 for output. Located

around 2,300 feet asl, it puts out a good signal.

Be ready for a surprise if you work it. As well as its other tricks it will greet you with 'Bonjour' and speed you on your way with 'Au revoir'. Nice touch that.

Someone else to look out for is HG1YM, who is now active with 100 watts and good aerials on both two metres and 70cm. He put a good signal into Britain during last year's sporadic E season and is a good catch if you can find him.

Tail spin

Down to the end of the column again, but still not out of news.

The French are now on 50MHz, more information next month.

Please send your news and comments to me at 81 Ringwood Highway, Coventry, or via Prestel on 203616941. Good hunting till next time.

Make sure that you are 'On the Beam' - ask your newsagent to reserve your copy of **Amateur Radio**

C. M. HOWES COMMUNICATIONS

Eydon, Daventry,
Northants NN11 6PT
(mail order only)
Phone: 0327 60178

NEW! 2M and 6M CONVERTER KITS

If you have a receiver that covers the 20M amateur band, you can use it to monitor the 2 and 6 Meter bands by adding the new **HOWES CV220** and **CV620** frequency converter kits to your station. Suitable for use with our popular **DcRx20** receiver kit, these new converters can also be used with any general coverage communications receiver (no modifications to the receiver are involved, they simply connect externally to the antenna socket).

An excellent constructional project could combine these two new kits, together with one of our **DcRx20** SSB/CW receiver kits. This will give a great little monitor receiver covering three of the DX chasers most favoured bands. A really cost effective way of enjoying the 'weak signal mode' DX on 2 and 6 meters, together with the most popular HF DX band.

CV220 or CV620 kit: £17.50 Assembled PCB module: £23.90

HOWES FINISHED EQUIPMENT RANGE

HC266 to 6M transverter. 10W RF output with ALC, VSWR protection and very low harmonics. Case specially manufactured to high standards by computer controlled machine tools. 1 to 5W drive level standard, 5 to 10W drive available as a no cost option. Operators handbook includes block and schematic diagrams. **HC246** 4M output version may be available by the time you read this. Price including post and VAT: **£179.90**, normally available off the shelf from us, and from selected retailers.

HOWES KIT RANGE includes:

		Assembled KIT	PCB
DcRx20,	DcRx40, DcRx80, DcRx160 SSB/CW Receivers	£15.30	£20.90
CTX40,	CTX80 QRP CW Transmitters for 40 and 80CM	£13.40	£19.40
MTX 20	10W CW TX for 20M	£21.90	£27.70
CVF20	CVF40, CVF80 VFOs for above transmitters	£9.90	£15.90
HC220,	HC280 2M to HF transverters, 10W output	£52.50	£83.50
CSL4	Dual bandwidth SSB/CW filter for DcRx	£9.90	£15.90
ASL5	Dual bandwidth filter for 'black boxes'	£14.90	£22.50
TRF3	Shortwave Broadcast receiver	£14.50	£19.90
CTU30	HF bands ATU for receiving or 30W TX	£24.90	£29.90
SWB30	SWR/Relative power indicator, 160 to 2M	£11.90	£16.50
CM2	Quality microphone with VOGAD	£11.20	£15.20
AP3	Automatic Speech Processor	£15.90	£22.80
ST2	Sine-wave side-tone/practice oscillator	£8.60	£12.90
XM1	Crystal Calibrator with 8 marker intervals	£16.80	£21.90

All HOWES KITS include a high quality glass-fibre PCB with screen printed parts locations, full instructions and all board mounted components. Tuning capacitors to suit our receivers and VFOs (except 160M) are available at £1.50 extra (DcRx needs two, TRF3 and CVF need one).

A copy of our free catalogue and information sheets on any products you are interested in available for an SAE.

Please add 90p P&P for kit orders.

UK delivery is normally within 7 days.

73 from Dave G4KQH,
Technical Manager.



HELPING TO BUILD YOUR STATION

SECONDHAND EQUIPMENT GUIDE

by Hugh Allison G3XSE

I've said it before and I'll say it again. Microwave Modules stuff doesn't normally go wrong, people *make* it go wrong. For one reason or another, I recently spent a whole day repairing stacks of ten-metres-transceiver-in, two-metres-out Microwave Modules transverters. The sheer variety of approaches used to coddle them up was awe-inspiring. Do amateurs actually go out of their way to think up new methods of making them stop going? Maybe it's the reliability of the gear that makes it such a challenge...

By far the best way to kill a transverter is to wop the full poke of the driving HF rig up it, rather than just the low level drive. No prizes for originality here, but it's interesting to think about the damage you can do.

The massive incoming RF will trip over the RF sensing switch, which is what it is there for after all. A fair proportion of the 150 watts will then be shoved up the pair of 40673 MOSFETs in the transmit mixer. These have a maximum rating of about 400 milliwatts each, so handfuls of watts grieve them greatly and they pop.

Unfortunately, the damage is not yet over. The diodes in the RF sensing switch give up and go funny – more of this anon – and the switch drops out. You are now transmitting up the back end of the receive converter mixer, again a 40673 MOSFET. This, too, isn't happy about being overdriven and gives up. It's fortunate that 40673s only cost 50p or so!

'twixt diodes and relay, normally survive.

Component wise, a been-transmitted-up example isn't too expensive to repair. We are talking about only a couple of quid for the bits. I normally give it a quick check over to see if the mixer oscillator chain is going, check that the RF sensing *isn't* going but the 'earth-to-transmit' line gives a relay click (often the relay welds itself up), then I haul the board out, replace all the 40673s in sight and change the sensing diodes. The 40673s should be soldered hard down against the board and earthed down either directly or RF wise via a capacitor in the way it came in.

Techniques here have varied over the years. Solder the board back in, bolt it down (this is important otherwise it will hoot on Tx) and try it out. Most will work if you carry out the above instructions, and I think the few bob wasted on changing maybe one surviving 40673 is money well spent to save the twenty minutes wasted by hauling the board out twice.

Most hapless owners who have managed to blow up the above rig have done it either by mistake – connecting it up the wrong rat hole in the rig – or as a temporary 'I'll just see if the band is worth going on' quick lash up. The main rig is, of course, on vox. The 'phone rings, the vox trips and the transverter's a gonner. Don't do it!

OK, now into the prize giving ceremony. In true Miss World style, in reverse order we have third prize for the most amazing display of ineptitude, which

inattention to re-biasing the new devices, so he re-fitted the originals. Pause. 180° round the wrong way. Pause. All of them.

In second position we have the man who, for no apparent reason, opened his transverter up and, to use his own words, 'had a poke around'. Afterwards, it didn't work. It didn't on my workbench either – well not in the diecast box. As a nude board, powered up after being hauled out of the box, it worked a treat. Back in the box, nuffink. You know the two little capacitors on the power in/PTT line socket? He'd shorted the PTT one out by bending the capacitor wires together.

For sheer pointlessness, first prize must go to a young amateur who shall remain nameless. Someone had given him a boxful of high quality close tolerance resistors. He had decided to change the resistors in his transverter, admittedly in perfect working order, for these 'better' ones. His reasoning was that the closer tolerance would equate to better performance. You would think that Microwave Modules know about production tolerances, component variations and parameter spreads already, yet a still wet-behind-the-ears amateur knows better, huh? Well, after his operation, it was definitely different. It hooted, not only on transmit but also on receive; believe me, you've really got to try to get them to do that. Microwave Modules use lots of low value resistors, often 10 ohms, to decouple the rails between stages. 10 ohms is brown, black, black. His 'high quality close tolerance' 10 ohms were brown, black, gold. OK, gold means a close tolerance, *sometimes*. It can also be a range multiplier, like $\times .1$ – he had fitted one ohm resistors throughout. Arrgh!

Dealing with a pest

Relating the above story over lunch, a colleague told me of a bloke who was always on the cadge for components. It so happened that he was building a stereo audio mixer and needed six one megohm resistors. My colleague had some 15 ohms, brown, green, black, with the values printed onto the brown body of the resistor. Thus, one way up it looked like one meg, because one brown ring 'disappeared' into the brown body and a brown ring magically appeared in the appropriate place, again due to the body colour. It took the 'pest' three weeks to sort that one out!

It's smarter to barter

I wish I'd thought of that slogan. Unfortunately it belongs to Geefor



The Microwave Modules transverter: If it works, leave well alone!

About half of the diodes in the RF sensing which look OK on an AVO are conducting like good 'uns one way and not the other, but absolutely refusing to produce dc out for any amount of RF in. Surprisingly, the dc amplifier transistors,

goes to the man who decided to fit 'better' MOSFETs. Although these cost more, and worked well at a couple of GHz, they were no better at 145MHz than 40673s. He fitted them and found the performance worse, probably due to his

Enterprises, who are at 112 Leeds Road, Mirfield, West Yorkshire WF14 0JE. This outfit market two products that may be of interest to devotees of this column. One is Barter News which is an up-to-date A4-size listing of equipment for sale, either Geefor owned, held on commission or available as a sale from the owner. It is sent *free* to anyone interested, if you send an A4-size envelope. 'For sale' adverts to be included cost 10p a word.

The second product is a Secondhand

Price Guide. To quote from the advertising blurb I received: 'By adding the prices of equipment seen advertised in the amateur press each month, it provides both the buyer and seller of amateur equipment with a useful reference work.' To translate that, what you get for your two quid is a computer printout of equipment and their advertised prices. Bear in mind, though, that the equipment you are interested in might not even feature if none have

recently been advertised for sale and that the price at which something is offered for sale may not be the price at which it sells. For example, the FT200/FP200 is often seen advertised at £200, but they usually sell for about £175.

Panic

'Tis the week after Christmas. A 'mate' is banging at the door, he is skint. He has an arrears of maintenance order or something and the bailiffs are coming. Will I buy his FRG7700? No, go away. The price comes down £50. No, go away. The price comes down another £50 and an ATU is chucked in. I'm getting interested, but I tell him to go away. The price comes down another £50 if I'll throw in a litre bottle of Scotch. I am now very interested and money changes hands, plus a bottle!

A quick play with it (birdies everywhere but otherwise OK) and it's off to the 'phone to see who will offer what for it. Very surprisingly, a local emporium offers me much much more than I thought it was worth, and also much more than other dealers were offering, so I drive it down to them pronto before they realise their mistake.

After a preliminary look over it the salesman still seems interested and asks if he can take it out to the workshop to check it over. He disappears with it and I spend an agreeable five minutes alone in the shop reading their selection of radio books, then I hear police sirens in the distance. They get closer. A screech of tyres and the police car stops outside, lights flashing. The car doors fly open and four burly policemen come running in.

Paralysed with fear, I am unable to move. The bastard has nicked it! Am I going to sing? Like a canary. Grass? Like a mower. By the time they get across the shop and close to me by the counter I've even managed to remember the bloke's telephone number, and also decided that there is no point in doing a runner.

'Shop!' screams one of the policemen. 'It's OK officer', I start to stammer, as the salesman reappears.

'Four pence batteries, and move it!' says the lead policeman. They are charged 80p. The policeman throws down a pound coin and they sprint out without waiting for their change.

The salesman pays me for my set. I reckon I aged twenty years that day.

Thanks

A few months ago I published a reader's sketch of a mystery object with the letters KH on it. Many thanks to the readers who kindly wrote in with suggestions as to what it might be. There were a few votes for it being a Loran type receiver (ie, a navigation aid), but the overwhelming majority of letters suggested that it was a flaw detector. These were used extensively in the mid '50s to mid '60s to detect otherwise invisible failings in castings. London Transport apparently had large numbers of these for checking railway wheels. Not mega-useful to your average radio amateur - that's probably why they sell for a couple of quid at rallies!

'Modern' PMR gear

Taxi firms are run to, hopefully, make a profit. No one would argue with that. A radio down means money lost. Taxi owners are not renowned for their patience while waiting for crystals to arrive for their new rig. Believe me, they are just not interested in the niceties of the fact that their old rig had a receive crystal of (F required -10.7)/12 and the new one is (F required +22)/3. They just want the damn thing in the cab and channelled up. In answer to this, many PMR rigs (Private Mobile Radio is the sort used by taxis, construction firms, etc) are now synthesized. To get onto frequency, you either add diodes as required into a matrix (Icom) or snip out the ones you don't need (Tait). There is normally a matrix for Tx and another for Rx, thus allowing for simplex or duplex working.

At first sight, a synthesized rig would seem ideal for two metre conversion, but beware. For starters, it's often difficult to add more channels than the selector switch allows for, and this is sometimes only two. Remember, the cab owner who wants an emergency crystal service will be paying £25 to get each rock within three working days, and that kind of dough will nowadays pay for a two channel synthesizer in production quantities.

An example of a two channel synthesizer PMR is the wonderful, excellent, superb Tait 500. Most of these are high band FM, so we are talking 165MHz and up. The synthesizer is an oscillator, prescaler and MC145151 Motorola chip, so a bit of re-programming and two metres is all yours; well two channels of it are. I've seen the odd one or two at rallies around the £40 to £60 mark, but you've got to be quick because a street-wise taxi driver, who would willingly pay double that, will hurt you to get at it first.

Incidentally, we are talking about well under half a microvolt for 20dB quietening, plus 15 watts on Tx. Tasty, if you can live with just a repeater and a chat channel.

Icom market a range of hand-helds for PMR that is also quite exciting. The hassle is cracking the synthesized code. The matrix board is quite clearly labelled out, although the channel line wiggles about a bit.

The best trick is to dial up an unused channel (or snip the diodes out on one run) and find where it parks itself. By then adding up the channel count on a worker, you can confirm everything is as you thought and start converting. Not a job for a severe hangover though.

Icom PMR handportables are often seen second-hand at the rallies for £60 to £80. Battery packs aren't expensive, they are frightening, so make sure you get a good one thrown in. I've picked up non-workers for £20 a throw. Some variants are six, others twelve channels a go.

In all cases with high band PMR, you are taking a bit of a chance on getting it onto two. Obviously, the synthesizer has to come down; not a job for the kitchen table.

A decent counter is a must, and that's only for starters. The 'direct' synthesizer is going to cost brainpower to re-program. Remember that you may have to change a hard wired address to go down 20MHz or so. The mixing sort is going to cost you that, plus, probably, a mix crystal. The problems still aren't over because the RF stages, Tx and Rx, may not be super-keen to whizz 25MHz or so slower. For example, the Tait seems a couple of dB of quietening worse on 145 than 170. For example, you go from excellent down to good. Mind you, I'm a lazy so-and-so and just re-tweak. If you are up to LC ratios etc, you could probably improve things.

Beat the taxi drivers and you could have a PMR to convert



PROJECT BOOK

by Martyn Williams

Feedback from our reader (*sic*) has shown that the information on colour coding seems to have answered a need, so I have decided to press on with some more codes. We have looked at the colour coding system for capacitors and resistors and it will come as no surprise to find that the same idea is used to code inductors. As inductors and resistors look the same, the only way to be sure which you have picked up is to work out what the colour code stands for and then check the unit with a meter.

If the meter reads what the colour code says, then you have a resistor; if the meter reads a lot less then you have an inductor. This is because the resistance of a coil of wire is always less than its inductance. The codes used are the same as for resistance, except that a decimal point is shown using gold and

the bands are placed in a different order (that should come as no surprise by now). *Figure 1* should clarify things for you.

Well, at least this system of marking components uses letters, not blobs of paint; whether that makes it more understandable or not is a moot point. The new thing to learn is the tolerance coding and this is shown in *Table 1*.

The three basic capacitor types are shown in *Figure 2* and would be decoded as follows: the disc ceramic gives 10000pF, 10nF or .01 microfarad, depending on which you prefer to think in. The mylar type comes out at 22000pF, 22nF or .22mF and the tubular ceramic decodes as 1000pF, 1nF or .001mF.

On this one we have two extra bands, and these show the tolerance rating as 5%, the last band indicating 5 volts rating.

More resistance

Resistors are now often coded in plain language, using a combination of letters and figures to indicate the various parts of the specification.

The first letter in the code is a multiplier and uses R to indicate a decimal point, K as a $\times 1000$ multiplier and M to show a 1 million multiplier. Reference to *Table 2* should make everything clear.

Table 1 Tolerance codings

F	=	1%
G	=	2%
J	=	5%
K	=	10%
M	=	20%

Table 2 Resistance codings

R27M	=	0.27 ohm at 20%
6R8J	=	4.7 ohm at 5%
470RK	=	470 ohms at 10%
2K7F	=	2.7 kilohms at 1%
47Km	=	47 kilohms at 20%
2M2J	=	2.2 megohms at 5%

The E series

Resistors are built in a series of values depending on the tolerance required, so as to use the minimum number of types. The most common is the E12 series which produces values of 10, 12, 15, 18, 22, 33, 47, 56, 68 and 82 ohms. This series, together with the multipliers, allows any value with 20% tolerance to be produced. For 1% resistors the E96 series is used, but that would be too long to reproduce in full.

Coming soon

Next month we will round off this series on coding by looking at the codes used to identify valves and transistors – believe it or not, it is possible to make some sense out of those apparently meaningless jumbles of letters and figures!

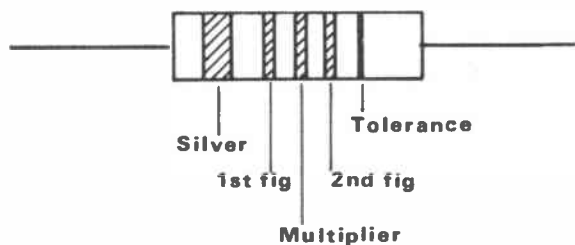

Example:
Coding silver, red, brown, red, gold
decodes at 220 microhenry at 5%

Fig 1 Resistor colour codings

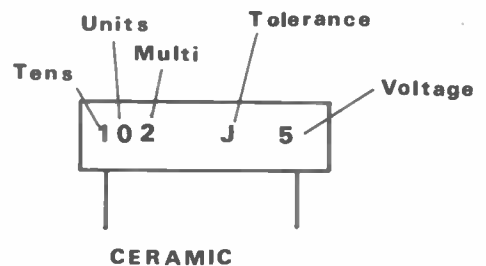
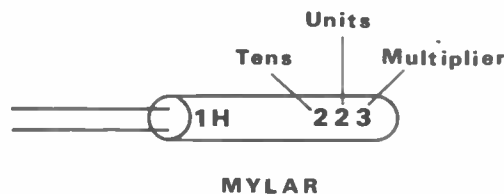
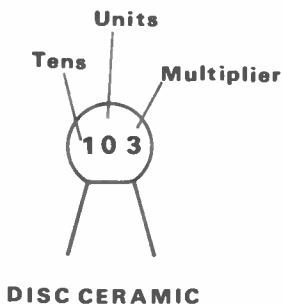

Fig 2 Three basic capacitor types

FREE CLASSIFIED ADS

FREE CLASSIFIED ADS CAN WORK FOR YOU

We are pleased to be able to offer you the opportunity to sell your unwanted equipment or advertise your 'wants'.

Simply complete the order form at the end of these ads. Feel free to use an extra sheet of paper if there is not enough space. We will accept ads not on our order form.

Send to: **Amateur Radio Classified Ads**, Sovereign House, Brentwood, Essex CM14 4SE.

DEADLINE AND CONDITIONS

Advertisements will be published in the first available issue on a first come first served basis. We reserve the right to edit or exclude any ad. Trade advertisements are not accepted.

FOR SALE

■ Pye Cambridge, one complete and working, £15. Three in various states of repair, £7 each or all three for £16. Stereo receiver by Realistic, model STA77L, £40. PSU by Farnell with +12V, -12V output and +5V, -5V heavy duty output, £25. Iambic keyer with built in side tone - variable speed, £15. Ex-arcade game circuit boards packed with TTL chips and other components. 3 boards for £5. EPROMs 2708, 2716, 2732, 3 for £2.50 inc post and packing. Contact Gino. Tel: Melton Mowbray (0664) 500228

■ Army landrover receiver type R210, covers 2MHz-16MHz. WWII NAAFI receiver - medium wave - new, boxed. Leads/connectors for WS19 - including control boxes. US radio altimeter RT7-APN1 - very good condition. Want headphones and operators manual for R209 mk11 - have much to swap - or will buy. Contact Tony Howard. Tel: Milton Keynes (0908) 73114

■ Grundig Satellit 1400 professional, pristine condition, sell for £75 or swap for 2m h/held IC2E, ICO2E, FT23R with cash adjustment, must be in vgc. M Colley G1JGE, 118 Devon Crescent, Birtley, Tyne and Wear DH3 1HP. Tel: (091) 4100305

■ Sony ICF2001D, 150kHz to 30MHz, FM and air band, 32 memories, USB, LSB, sync, ex cond. The ideal portable comms Rx, £210 or swap for Bearcat DX1000 with cash adjustment. Tel: (0535) 600667 after 7pm

■ Yaesu FT708R 70cm hand-held with speaker/mic, perfect condition, £130. CWR610E CW/RTTY decoder with high resolution monitor (green screen) and Nite 2 Scarab filter, £130. Datong automatic notch filter, £30. Microwave Modules 20W 70cm linear (2W drive), £30.00. Tel: G6HSM (0227) 750471 after 5pm/weekends

■ Icom GT1 personal transceiver, still in box, never used, offers? Will swap for any transceiver any cond, cash either way, all letters answered. Frank McInally, 3E Langlands Court, Glasgow G51 4XJ. Tel: (047) 445 2155

■ Icom R71E receiver 8 months old, immaculate condition with box and excellent instruction manual, c/w a Dressler ARA30 active antenna, only ever used indoors, £700 ovno, could deliver within 100 miles of Leicester. Tel: (0509) 506552 after 5pm

■ FRG7700M plus manual, no mods, seldom used, good condition, £220. Carriage paid to nearest rail station. Seon Smyth, 'De Porres', 67 East Princes St, Helensburgh G84 7DG

■ Racal 17L Rx. Also RA98 sideband adaptor, MA197B selection and protection unit, with manuals, £250. Buyer collects. Also Yaesu Musem FT7 Tx/Rx with instruction book, vgc, £200. Wegg, 23 Kardane, Dane Park Rd, OPE Hull HU6 9EB. Tel: 855052

■ 934 collinear, £40. 934 linear amp 40W, £150. 934 SWR mtr, £25. All in excellent condition, separately as priced, altogether, £190. N Kaberry, 45 Regents Drive, Tynemouth, Tyne and Wear NE30 2NR. Tel: (091) 2576030

■ 1957 Philips B3G75U ac/dc BC Rx, LW-MW-FM, 8 valves, works with crackles and bangs, grubby. Ideal restoration project for enthusiast, with service data, £18. Also for sale, two EL34 valves with output transformer, £12. Also Howe new factory made ST2 CW side tone oscillator, never used, £4. Write: Marris, 35 Kingswood House, Farnham Road, Slough, Berks SL2 1DA

■ Realistic DX302 receiver, covers 10kHz to 30MHz, CW, SSB, AM, mains/battery. Absolutely mint condition, digital readout, complete with original box and manual etc, £140 ono. David Linnell. Tel: Northampton (0604) 711647

■ General coverage communication receivers, good condition, for sale: Sony 7600D with power supply, £80. Eddystone 730/4, £75. JR310 ham band only, £60. Zenith royal transoceanic model 3000, with leather case and circuit diagram, £90. Ron

Simpson, 20 Blythwood Road, Tyseley, Birmingham B11 2BY. Tel: (021) 708 1473 anytime

■ Eddystone 940 gen cov, overhauled, excellent receiver, £135. KW2000B transceiver, overhauled by KW, excellent, £195. Trio R600 near mint, £235. T Wood, St Anthony Cottage, 143 Station Road, Burgess Hill, Sussex RH15 9ED. Tel: (04446) 41567

■ Eddystone 1830/1 professional HF Rx. British MPT spec for marine reserve receiver and civil aviation, ref no IOD/CA10696. Coverage 120kHz-31MHz, 9 bands, with incremental facility and crystal control on bands 1.5MHz-31MHz. A1,A2,A2H telegraphy. A3,A3A,A3H telephony. Selectable on USB and LSB in SSB mode. Little used, impeccable condition, c/w manual, accessories, omnimatch, joymatch, *Library of Radio and Electronics* tech book in mint condition. Best offer over £350. Buyer collects. Pat, 'Shorland', Lowham, Langport TA10 9DT. Tel: (0458) 250235 evenings.

■ Exchange Hamgear preselector plus ATU, mains powered, cost £78, for Mizuho KX2/3 or Global AT1000, mint cond, (reason for exchange, won't work with Lowe's HF125). 1 Kent Gardens, Hetton-le-Hole, Tyne and Wear DH5 9LA. Tel: (091) 5267902

■ Kenwood TS530S transceiver (WARC bands), mostly used Rx, in immaculate condition with boxes, manuals, performance analysis, £525. AT230 matching tuner, £145. Yaesu FT690R Mk1, NiCads charger purchased last year, not used, £289. Yaesu FT23R, case, dc/dc, two batt packs (FNB10s) as new, £199. Bob G8ZGI. Tel: (0277) 354378 any time

■ 934MHz Commel, mobile Les Wallen collinear, £275 no offers. Delivery could be arranged within 50 mile radius of Cheltenham. Tel: (0242) 579103

■ Sony ICF2001D plus AN1 active antenna, plus many extras. Also DR100 airband radio and Regency R537 airband radio. All in excellent condition. Sony ICF2001D plus AN1, £350. Airband radios, both for £60. David Rowan. Tel: Newport (0633) 853583

■ FT726R, fitted 2m, 70cm, 6m and satellite unit, £675. Racal RA17 and preselector unit, £200. Tibbert, 32 Prescott Close, Mickleover, Derby DE3 5TB. Tel: 515212

■ Trio JR599 special HF bands with 2 mtr module receiver, plus manual, good condition, £110, also space in radio for 6 mtr module. Moonraker 4 four ele crossed yagi with quad reflector, suitable 10 mtr, £80. Frank G1HPF, Canvey Island. Tel: (0268) 680596

■ APR4Y receiver, £45. Tuning units available 36MHz-12GHz. Freq meters: TS323/UR 20MHz-480MHz. Narda 804, 805, 200MHz-500MHz, 500MHz-1500MHz. TS117/GP 2.4GHz-3.4GHz. Signal generators: TS382 10Hz-200kHz 0-10V output. URM-25D, 26B, 27B 10kHz-410MHz. TS497/URR 2MHz-400MHz. TS510 10MHz-420MHz. TS419/U 900MHz-2100MHz. TS403/U 2GHz-4GHz. URM-20 power measuring unit, 20MHz-4GHz. 4A micromatch unit, variable electronic filter 302, Eddystone S-meter unit. Will sell or exchange for receiver or panoramic adaptor, any freq. Bob Wright, 247 Sandy Lane, Hindley, Wigan, Lancs WN2 4ER. Tel: (0942) 55948

■ Yaesu FT709 70cm hand-held, almost unused, good condition, complete with spkr-mic, NiCads charger, rubber helical, boxed and complete, £175. Brian Barwick G0HRF, 100 Westwood, Golcar, Huddersfield HD7 4JY. Tel: (0484) 846253

■ Yaesu FT101ZD Mk3, FM, fan, CW filter fitted, new tubes, plus FC902 ATU, FC901 ext speaker, all boxed in vgc. Consider exchange for FT757GX plus FC707 ATU, or FT707 plus FC707 ATU and FP707 PSU and FV707 DM VFO. Tel: Ian, Stalham (0692) 82075

■ Icom 751A Tx/Rx, fitted CR64 and RC10 controller, Icom AT500 ATU, used receive only, 8 months old, mint, cost £2,080, o/a £1,500. Trio 440S, built-in ATU fitted 1.8kHz narrow SSB filter, used

receive only, under guarantee, cost £1,350, o/a £1,000. Tono 5000E RTTY terminal, built-in monitor, separate keyboard used receive only 2 hours, mint, £750 ono. Trio 9130 multimode 2 metre complete, boxed, vgc, £350. FRG9600 Withers Mk3 scanner 100kHz to 950MHz, mint, £400 ono. Dressler ARA500 active antenna, 14dB gain, cost £139, unused, £90. BNOS amplifier, 144-10-180, unused, £275. Datong ANF, mint, £50, Hamgear PMX preselector, mains/battery, unused, £60. YM48 microphone with keypad, £15. Minolta 7000AF camera, f1:7 lens, with 2800AF flash. Cost £440, sell £300. Robert McAllister, 218 Eckington Road, Coal Aston, Nr Sheffield S18 6AZ. Tel: Dronfield (0246) 413413

■ Nine GEC Osram-type KT66 valves, comprising four new boxed, one pair matched, five new or used. Also one new boxed, type KT88. All ten offered at £30, carriage paid. John G3JHL QTHR. Tel: (0794) 512283

■ Marconi CR150 receiver, 2MHz to 60MHz, £50. R206 Mk II receiver 500kHz to 30MHz, £50. Lafayette HE40 receiver 500kHz to 30MHz, £15. AVO all wave oscillator, 90kHz to 40MHz, £10. Valve voltmeters: Marconi CT208/TF958, £20; Hewlett Packard 400H, £15; Advance WM79 transistorised, £15. All above working. Technical manuals, copies: R210, CR100, CR150, AR88, £4 each. Others, list available. Bentley, 27 De Vere Gardens, Ilford, Essex IG1 3EB. Tel: 01-554 6631

■ Nato 2000, quite a lot of extras, suitable for conversion, in lovely condition, offers over £140. Hand-held Alba CB radio, £33. SX200N JIL scanner, £165. Tel: (0283) 221870

■ Ham Concorde 3, offers or p/x for Ham Jumbo 3. Tel: (0298) 78268

■ Realistic PR32A hand-held scanning receiver, 200 memories plus NiCads, £150. Also Dressler ARA500 active antenna, £75. Tel: Greenford, Middlesex. 01-902 4914

■ Cossor solid state oscilloscope CDU150, dual channel 35MHz bandwidth sensitivity 5mV/cm to 50V/cm, can cascade internally for 1mV/cm, invert facility, built-in calibrator, dual timebase with variable calibrated delay, timebase modes 'A', 'A' brightens 'B', 'A' delayed by 'B', 'A' delayed by 'B' gated, trigger source internal/external line, auto trigger or single shot sweep-out and Z modulation facility, including servicing handbook, £150. Tel: (0234) 61234 after 6pm

■ This receiver tunes television sound, plus the following: (PSB) weather, CB, FM/radio medium wave; the television channels are marked 2-6 and 7-13, so possible DX/TV monitor; was made in Hong Kong, runs off 4 'D' cells or 240V ac, £20 ovno or would swap for Triax 4000/1LN WB band one pre-amp, or Triax 40055 WB HF pre-amp; whatever, the pre-amps wanted anyway. Please write for more details to Mike Evans, The Housekeeper, 185 Fleet Street, London EC4

■ Icom IC751 HF Tx/Rx, 250Hz CW filters, £995 ono. Kenwood TL922 2kW HF linear amplifier, including spare pair 3-500Z valves, £875 ono. Tau SPC-3000 3kW roller coaster ATU, £175 ono. Philips CD304 CD player, £149 ono. Olympus OM-2N 50mm/f1.8, £130 ono. Vivitar (OM) 75-205mm zoom, £45 ono. Bruce G4WVX QTHR. Tel: (06286) 64415

■ Datong MK Morse keyboard, vgc, £60, or will p/ex for 2m FM trans. Tel: (0305) 813202

■ Trio R1000 general coverage receiver, 0.1-30MHz, good cond, £200. Wanted: FRG7 Yaesu receiver. A Rowbottom, 19 Carisbrooke Road, Bushbury, Wolverhampton. Tel: 781726

■ VCR rabbit, £60, sends video audio signals from your VCR to any TV set in your home. Also TR8400 70cm FM transceiver with Kenwood PSU, built-in speaker and back-up, £150. David G0HSH, QTHR, Croydon. Tel: (0689) 42157

■ Trio 751E 2 metre multimode, absolutely as brand new, complete with box and all items, £485. SSB Electronics (German) LSM 24 23/24CMS local

FREE CLASSIFIED ADS

oscillator mixer unit, 2 metre TF, £135. ICS/AEA CPI computer patch RTTY terminal unit with BBC driver (G3WHO) EPROM £85. Met 17XY 70cm cross-yagi, new, unused, £20. Paul GX4HF. Tel: (0293) 515201, evenings preferred

■ Complete RTTY system for sale: comprising micro-patch 64 modem (Morse/Baudot/ASCII), Commodore 64 computer, 1541 disc drive, MPS801 printer, £350 or will split. Also Icom FM hand-helds, IC2E (2m) £125, IC4E (70cm), £150, or £260 the pair. Vgc with soft cases, chargers, spare NiCad pack and dc pack. Contact G4HNNH. Tel: (021) 472 3845

■ Sommerkamp TS802 80 channel 2m FM hand-held, 2 watts low/high power, scan, squelch, repeater, switches. Also soft case, NiCads, charger, extra PTT mic/spk with curly lead. Vgc, with handbook, any test, £100. GM3TBV. Tel: (0250) 26220

■ Eddystone 770R Rx, 19/165MHz intermittent working, needs attention, £50. With manual – heavy item. AVO valve tester, good condition, £15 c/w testing manual, 80 serv assorted valves, 40p each. 25 serv unknown assorted valves, 20p each, or £100 the lot, buyer collects. C P Mason, Fidges Lane, Eastcombe, Stroud, Glos GL6 7DW

■ Yaesu FRG8800 communications receiver, 150kHz to 30MHz, AM, LSB, USB, CW, NBFM, direct frequency entry from keypad and two speed tuning. There are twelve memories with three types of scanning, dual clocks, timer etc, £400, cash only please. Sorry no packing, so buyer must air test and collect. Philip. Tel: Huddersfield (0484) 843388

■ Microwave Modules transverter 144MHz in, 70MHz out, 10 watts on 4 metres, £70. G8SIG. Tel: (0606) 554178

■ Sommerkamp SRG8600 DX scanner (same as FRG9600), c/w UHF antenna. Good condition, still boxed with PA-4C PSU, £350. Yaesu FT227R FM Tx/Rx, £110. Stewart Davies. Tel: (0229) 875139 daytime, (0229) 33272 evenings

■ AVO test meter, model 8 Mk3, approx 1970, vgc for age, very clean, complete with instruction book. Offers around £50. May be able to deliver at cost. Have also bought mobile shack (caravan), so many camping items for sale, cheap, including three tents, cooker, gaz cylinders, etc. Chris G8LRY, QTHR. Tel: Wantage (023) 572205

■ Trio TS830S, with CW filter, two years old, £750 or exchange for FT757 GX11 with power supply. AR2002 25-550MHz, 800-1300MHz, £350. Tel: Northwich (0606) 44670

■ IC2 micro 2m hand-held charger, new, £180. SEM transmatch ATU, Ezitune dummy load, £90. Microwave Modules 144/100 2m linear amp, £100. R G Holland, 37 Danvers Way, Westbury, Wilts BA13 3UF. Tel: (0373) 826939

■ HF transceiver, model Swan 500C, 400 watts with power supply and mic, vgc. Yaesu ATU, model FC902. Reason for sale, OAP with problems selling up. Yaesu receiver FRG7, vgc, would exchange FRG7 plus ATU for good all mode, 2 metre Tx. Tel: Boston 870152

■ AR2002 communications receiver 25-550, 800-1300MHz in mint condition and original box, buyer to inspect and collect or pay carriage price, £345. Tel: (0282) 34688 any time

■ Three Swift DL14 electric door latches, £8 each. Two Swift DPS600 multiple entry door-phone panels, £12 each; DPSM wooden surface surround for DPS600, £4. Unisef personal stereo, £4. Pair of Eurosonic walkie-talkies, £8, all items plus carriage. Icom GT1 personal Tx-Rx, new in box, never used, offers. Toshiba XR9J CD player, like new, £85. Icom IC-PS740 PSU, offers. Two station phone type intercom, no wires needed, just plug in, new in box, £40. Pioneer KEH 9030 car radio cassette, Dolby 25+25W, £125. NEC T330E stereo tuner, £20. Swift DP249 door phone intercom, two systems, £35 each. Frank McNally, 3E Langlands Court, Glasgow G51 4XJ. Tel: (041) 445 2155

■ Sommerkamp FT250, no gadgets, mint, reliable HF transceiver, plus FP250 100W PEP matching power supply with speaker + Shure 450 mic, with manual. Direct exchange either for Icom R70/71E or Panasonic RF-9000 Rx – or sell for sensible cash offer. Tel: (061) 7431570 any time

■ *Amateur Radio* mags and *Practical Wireless* mags. *Amateur Radio* mags from October 1986 to February 1988. *Practical Wireless* mags from November 1986, January 1987 to February 1988

open to offers. Will swap for a good ATU valve £15 – to £20 – Sorry! Will not sell one monthly issue at a time. Andrew Nevill, 1 Humber St, Old Goole, North Humbs DN14 5UJ. Tel: Goole 2235

■ Free to whoever collects: aeriads, DX Band II FM, Bands I/III, Bands IV/V UHF, Continental manufacture, except I/III Antiference. All new, unused, plus used working rotator. Tel: Bristol (0272) 685767 evenings

■ Trio R2000 boxed, mint cond, complete with phones, £375. Rascal RA17L, £90. Datron D17 oscilloscope, 17MHz dual trace, £150. Sinclair DM450 digital multimeter plus case and adaptor, £25. Thandar PFM200 frequency meter, £15. Atari 800 computer with data recorder, £30. Tel: (08894) 79830

■ MET 8 element 2 metre beam with N type plug, £20 ono. Buyer collects. Tel: (021) 445 1586

■ Yaesu FT757GX, FC757AT auto ATU, FP757HD heavy duty power supply, all boxed as new, £925. Datong FL3, £75. Tel: 01-514 5998

■ FT780R 70cms multimode mobile, 10 watts, in excellent condition, has not been used mobile, only as a base station, £350 onvo. NATO 2000, working on 10 metres AM, FM, CW, SSB, 12 watts, 28MHz to 29.7MHz, 1W, 10kHz steps with 5kHz RIT on Tx/Rx, £150 onvo. Tel: Mike (0895) 443524

■ T1154 R1155 PSUs, 24V input rotaries, complete cased units. Pye SSB130 HF SSB/CW mobile Tx/Rx, as new, unused unit, £85. 240/24V PSU to suit, £15. HRO MX, £40. BU221, £35. TCS12 Tx, £20. Rare FAA WWII Rx, 6m type, £40. Storno Viscounts, £5. Pye Bantam, £25. Bendix TA12 Tx, £25. Wanted: good GC Rx, Collins 390 or similar. Command Tx, PSU/mod, any model. Cain G3DVF QTHR. Tel: (0665) 602487

■ Icom 271E 25W/op 32 memories, 2 VFOs, immaculate, £600. Microwave Modules 50W linear, £50; Welz SP420 SWR/pwr meter, £30. AKD VHF/UHF wavemeter, £10. Oskerbloc SWR/WV3 plus 2m coupler, 20W max m/w min meter, £40. 9 ele tonna. N type Conex, £15. Sony ICF 6800W Rx/HF, needs attention, hence, £25, or all above for £750. Buyer must inspect and collect. Howard G1OYH. Tel: (0235) 813160, Oxford area

■ National HRO receivers in mint to grotty condition. Tel: St Albans 39333

■ Sell or exchange for decent HF, VHF receiver, 1976 3-door Chevetté, MOT failure. Four new tyres, new exhaust, recent rad, recent head overhaul, new valves, springs, timing chain etc. Good condition engine, gears diff, body moth-eaten, asking £150. Car suitable for spares or major rebuild, can be driven. Would consider 2mtrs or 70cms multimode or good 934MHz CB. Bray, 28 Henshall Ave, Latchford, Warrington, Cheshire WA4 1PY. Tel: (0925) 415554 after 7pm weekdays

■ Kenwood TS5670 all mode quad bander 40-15-10-6 metres gc Rx, £625. Era microreader, RTTY/CW decoder with built-in display, just checked/updated by Era, £80. Kenwood YK88C 500Hz CW crystal filter, £30. Tel: (0926) 498388

■ MBA reader, complete multicode decoder and display unit, to copy Morse and RTTY signals direct from a comms receiver. Contains built-in 32 character vacuum fluorescent display. Requires a 12V dc source, good condition, £100. R Williams, Stroud, Glos. Tel: (04536) 6171

■ Ten Tec Century 22 transceiver, also SEM transmatch. Jeff. Tel: (0484) 645923

■ Yaesu FT775 HF 100W o/p Tx/Rx, solid state transceiver c/w Addnis desk mic, £400, plus FTV700 transverter inc 50MHz module, 10W out, £150, accept £525 for both items. Buyer inspects and collects. Howard G1OYH. Tel: (0235) 813160

■ BBC Master 128K computer, plus two VX540 modems, £300 the lot, may split or swap for gen coverage Rx, ie, FRG9600 (or sim) or 2m transceiver, ie, FT290R Mk2 or WHY? Paul G7ALW. Tel: 01-572 7217 after 6pm, any time weekends

■ Creed 444, ST5 mcd, built-in matching dialling unit, paper winder 45.45 cog paper tape, plus spare 444 and ST5 all working, £70, will deliver if not too far. Icom 720A, £475, mint. FT1012D, fan, FM mint, extra xtals + workshop manual, Mk3 version, £500. FT726R 2m 70cms sat unit, new condition, £1000 ono, selling up. ATU FC902 new cond, £90. Tel: Bambury 50169 daytime, weekends

■ FRG7 receiver, hardly used, with manual, £100. Tel: Northwood 25466

■ Lowe HF125 receiver, 30kHz-30MHz con-

tinuous, CW/SSB/AM, provision for FM/AM and 30 memories, 4 independently selectable IF filters. LCD readout, built-in speaker, tone control. Compact, simple to operate, good performer. Unmarked, with original packing and user manual. Bought Sept '87, will sell for £295, no offers. Mr S Wilkinson. Tel: (0482) 898322 6pm/8pm

■ Air Ministry type Rx 1392D VHF (95-155MHz), VHF Rx, type R220 (70MHz), complete with PSU and LS (14 valves), £10. Solartron scope, type CT315, works but needs attention, £8. HF Rx type R210 – covers 2MHz-16MHz – 24V supply, £45. Naggard Double Pulse generator (valved), type 5002C. Box *Practical Electronics* mags (total 88) 1965-1983, £6. Domestic Rx – Ekco type U339 – made around 1957/58, offers, has Bakelite cabinet. WWII Rx – covers medium wave, runs on 6V in wooden cabinet, new and boxed, £30. Old HMV TV – model 1805, pre-1953, b/w, offers. Many hundreds of new-style electrolytics, 1µF at 50V, 4µF at 35V, 22µF at 25V, 10µF at 100V, 100µF at 10V, 470µF at 35V, 1000µF at 25V. No fair offer refused. Also see wanted section, everything negotiable. Contact Tony Howard. Tel: (0908) 73114

■ FT277ZD with FM board fitted plus AM board, dc/dc converter, CW filter, fan, perfect working order, used only for short wave listening. FC902 ATU, as new, offers. PO Box 3, Wishaw, Scotland. Tel: (0698) 357869

■ Icom 751A tcvr, gen cov Rx, AM narrow filter; PS35, hvy duty switched PSU. RC10 freq controller, AT100 auto ATU. Service manual, original packing, as new, reluctant disposal due to possible QTH change, £1500. Tel: (0727) 51518

■ Spectrum +3 computer, disk drive, unopened birthday gift, would like to exchange, so WHY? Interested in 2m, 4m, 6m, 70cms, HF, can you tempt me? Tel: (0266) 45527

■ Trio TS530SP, used only 2 hours Tx, mint condition, boxed, with manual and Lowe passport, £600, no offers. Tel: (0282) 64236

■ AOR2002 scanning receiver, 25MHz-550MHz, 800MHz-1300MHz, boxed, £310. Comax telereader CD670, LCD display, brand new, boxed, virtually unused, cost £327, sell for £275. Tel: Folkestone 58685

WANTED

■ R4187 receiver, A1134 amplifier, R1355 receiver, type F Morse key. I have, for sale or exchange, an army portable station type 128, gwo, with manual, also a telegraph unit type TS413 (part of the R230 Rx), with manual. Vernon Kelk, 7 Rowan Place, Garforth, Leeds LS25 2JR. Tel: (0532) 866435

■ Trio, Icom or Yaesu Rx, around £100. Tel: (041) 445 2155

■ Exchange FT1012D Mk3 with FM board for R2000 ICF2001D, FRG8800, HF125 or equiv receiver with memories, having to swap as unable to take RAE due to circumstances. Duncan. Tel: (0623) 823001 any time

■ National company Malden USA receivers, speakers, manuals, equipment, also National 'dancing men', toys activated by microphone or magnetic gramophone discs or reeds. WWII and pre or post war military receivers and equipment, 'biscuit tin' and 'suitcase' spy set, plus other clandestine sets. Wooden and Bakelite broadcast radios. Interested in all valued junk. Tel: St Albans 39333

■ 16mm films – any subject; instruction/service data for GB Bell & Howell projectors type 631/633. Buy military radio, such as R107, R109, R208; R209 Mk1, R216, R308, R1155, T1154 (and all related items), BC341, BC342, BC348 etc. WHY? Manual/information for 6V radio, type BV316 (medium wave) and AR88LF. Contact Tony Howard. Tel: (0908) 73114

■ Rascal RA121 sideband adaptor, also Rascal ATU protection unit, must be in mint condition, reasonable price paid, I pay carriage. T P McClelland, 25 Emmett Road, Inchicore, Dublin, Ireland

■ Short wave HF receiver, with SSB mode and BFO switching, covering the 1 to 30MHz band. Prepared to pay up to £80. Contacts from Durham or Tyne and Wear areas. Ring after 4pm. Andrew Appleby. Tel: Durham (091) 3733783

■ Collector requires pre 1940 QSL cards and postcards relating to wireleses, amateur radio etc. Please send details and prices to: Tom

Amateur RADIO SMALL ADS

MRZ COMMUNICATIONS LTD
STOKE-ON-TRENT, NEWCASTLE UNDER LYME
DESK DC SUPPLY AND BASE FOR ICOM PORTABLES
ICOM-AMATEUR/PMR/MARINE/AIR
YAESU - AMATEUR UK AND EXPORT



TEL: (0782) 619658
7 DAY SERVICE



IAN FISHER COMMUNICATIONS OF STANHOPE
CB Works, The Market Shop, Market Place, Stanhope (0388) 528464

Main Distributors of 27MHz CB radios and the NEW CEPT models including ATRON and DNT.

Large stocks of coaxial cable, plugs, sockets and adaptors. All available via mail order. Retail/Wholesale

OPEN: MON-SAT 10.30am-6.00pm
 SUN 2.30 - 4.30
 RING FOR DETAILS (0388) 528464

NEIGHBOURHOOD WATCH BURGLAR ALARM D.I.Y KIT
 will offer a professional system at a DIY price

Ham mini beam 10,15,20 meters. Parts integrated circuits, transistors, diodes, valves, resistors, etc.

Service Manual and parts for spectrum and Amstrad

Send a 8" x 5" SAE for list

M.J. SEAWARD (Mail Order)
 St. Olafs Road, Stratton, Nr. Bude, Cornwall
 Telephone: 0288 4892

JAYCEE ELECTRONICS LTD
 JOHN GM30PW
 20 Woodside Way, Glenrothes, Fife KY7 5DP
 Tel: 0592 756962
 Open: Tues-Fri 9-5, Sat 9-4

Quality secondhand equipment in stock. Full range of TRIO goodies. Jaybeam - Microwave Modules - LAR.





AGRIMOTORS
MERTON CB AND RADIO CENTRE
MERTON GARAGE AND POST OFFICE, MERTON, Nr OAKHAMPTON, DEVON EX20 3DZ

OPEN 6 DAYS 9-6 LUNCH 1-2pm THURSDAY 9-1 (SUNDAYS BY APPOINTMENT)
 SPECIALIST IN 934 MHz
 SUPPLIERS OF ALL 27MHz AND 934 MHz EQUIPMENT
 AMATEUR EQUIPMENT CATERED FOR
 08053 200

JAPANESE Ic's (PART OF OUR RANGE)

AN7178 £2.95, BA5406 £2.20, HA1377 £2.20, HA1392 £2.50, HA1394 £2.95, HA1397 £2.75, HA1398 £2.75, HA13001 £2.95, LA4460 £1.80, LA4461 £1.80, LA4507 £4.25, LC7137 £4.50, M51517 £2.80, MB3705 £1.80, MB3712 £1.50, MB3722 £3.50, MB3730 £2.50, MB3731 £3.50, STK461 £7.50, STK463 £8.40, TA7205AP £1.00, TA7222AP £1.30, TA7240 £2.95, TA7241 £2.95, TA7270 £2.75, TA7271 £2.75, TA7274 £2.95, TA7280 £3.50, TA7281 £2.95, TA7282 £2.95, TA7283 £2.95, TA7286 £2.95, TA7611 £3.20, UPC6575 £1.00, UPC1156 £2.95, UPC1181 £1.10, UPC1182 £1.10, UPC1185 £2.50, UPC1188 £2.75, UPC1230 £2.50, UPC1263 £2.50, UP1277 £2.75, UPC1278 £2.75, UPC1365 £3.80, UPC1394 £1.95.

ADD 60p POST AND PACKING AND THEN ADD 15% VAT TO TOTAL
T POWELL, 16 PADDINGTON GREEN LONDON W2 1LG
 OPEN MON-FRI 10AM-5PM, SAT 9AM-12 NOON.
 TELEPHONE: 01 723 9246
 ACCESS/VISA. TELEPHONE ORDERS ACCEPTED OVER £5.00

SMC/TMP ELECTRONICS
 Unit 27 Pinfold Workshops
 Pinfold Lane, Buckley, Chryd 
 Tel: 0244 849863

For all your amateur equipment and accessories. Open Tues, Wed, Fri 10am-5pm. Saturday 10am-4pm. Other days by appointment

★ **PSSS....** ★

ALL THE SUPER BARGAINS ARE ON THE INSIDE-FRONT COVER OF THIS MAGAZINE!!



★ ★

Amateur RADIO SMALL ADS

This method of advertising is available in multiples of a single column centimetres — (minimum 2cms). Copy can be changed every month.

RATES
 per single column centimetre:
 1 insertion £7.00, 3 — £6.60, 6 — £6.30, 12 — £5.60.

AMATEUR RADIO SMALL AD ORDER FORM

TO: **Amateur Radio - Sovereign House**
Brentwood - Essex CM14 4SE - England - (0277) 219876

PLEASE RESERVE.....centimetres by.....columns

FOR A PERIOD OF 1 issue..... 3 issues..... 6 issues..... 12 issues.....

COPY enclosed..... to follow.....

PAYMENT ENCLOSED: (Add 15%VAT).... £ — Cheques should be made payable to Amateur Radio. Overseas payments by International Money Order and Credit Card

CHARGE TO MY ACCOUNT..... CREDIT CARD EXPIRY DATE /

COMPANY

ADDRESS

SIGNATURE TELEPHONE.....

C P I

VALUABLE SPACE FOR SALE!

Telephone the advertising department on: 0277 219876 for details

RF DEVICES AT ROCK BOTTOM PRICES!

Nobody beats us!

Over 30,000 RF devices at low prices

REPLACEMENT RF TRANSISTORS

MRF454 HF/SSB 80W	£20.00
MFR450 HF/SSB 50W	£11.60
MRF238 VHF/FM 25W	£12.80
MRF475 HF/SSB 20W	£2.99
2SC1969 HF/SSB 18W	£2.50
2SC2043/1307 HF 16W	£2.00
2SC1947 VHF 3.5W	£7.60
2SC1946A VHF 32W	£14.30
BLW 60R HF/VHF 50W (Special)	£7.50

REPLACEMENT RF POWER MODULES

M57704/SAU3 UHF 15W	£36.00
M57712/37 SAV7 VHF/FM 25W	£39.00
M57713/SAV8 VHF/SSB 15W	£39.00
M57718/SAU4 UHF/SSB 15W	£49.00
M57719 VHF/PMR 15W	£29.00
M57727 VHF/SSB 38W	£45.00
M57749/SAU11 934/FM 7W	£29.00

Send £1.00 p&p or SAE for full list
All prices inc. VAT
Many Ic's and other types in stock

RAYCOM LTD
DEPT AR INTERNATIONAL HOUSE, 963,
WOLVERHAMPTON ROAD, OLDBURY,
WARLEY, W. MIDLANDS. B69 4RL
021 544 6767
 (24hr answer phone)

24v ni-cad battery contains twenty XD type cells, used condition, some cells may be faulty **£12.00**
Spring tension gauges, set of 3. 0-4 ounce, 0-16 ounce, 0-6lb..... **£8.00**
Ex Vulcan bomber hitch and roll assembly, contains gears, shafts, bearings etc **£15.00**
Range and bearing marker unit, contains bevel gears, servos, shafts etc..... **£15.00**
Radar drive unit, contains 2 ex 24v motors, gears, components etc **£15.00**
Eddystone type 770R VHF receiver, 19-155 MHz **£120.00**
Type R210 receiver 2-15 MHz, complete with plug and headphones..... **£55.00**
ITT UHF TX-RX base station **£40.00**
ITT 149 MHz VHF transmitter..... **£40.00**
Collins R390A receiver, poor condition **£150.00** Ring for details
Readyphone 100 watt, LIN, amplifier, complete with ATU..... **£75.00**

Prices include postage and packing

A C ELECTRONIC SERVICE
17 APPLETON GROVE, LEEDS LS9 9EN
TELEPHONE: 0532 496048

Selectronic

The UK's leading suppliers of 934MHz personal radio equipment

**203 High Street
Canvey Island, Essex,
Tel: 0268 691481
(Open Mon-Sat 9-5.30)**

Amateur radio equipment also in stock

BEAM VIDEO
Throughout the house on Channel 36.
Price £10.50 + P&P £1.00. Phone for leaflet:

Electronic Mailorder A
62 Bridge Street, Ramsbottom
Lancs BLO 9AG
Tel: 070682-3036 (24hrs)

QUARTZ CRYSTALS and FILTERS

Large numbers of standard frequencies in stock for amateur, CB, professional and industrial applications. Stock crystals **£5.00** each (inc VAT and UK post). Any frequency or type made to order from **£6.50**. Phone or SAE for lists.

GOLLEDGE ELECTRONICS
Merriott, Somerset TA16 5NS.
Tel: (0460) 73718.

2 METRE COLLINEAR UVRAL X2⁵/₈ over 5⁵/₈

An omni directional antenna giving low angle radiation. The ideal base station vertical. Ruggedly constructed for long life

Technical Specification

Gain	-: 6 dB
Impedance	-: 50 Ohms
Max Power	-: 100 Watts
Length	-: 3.14 metres
SWR 144 to 146Mhz	-: Less than 1.5
Wind Loading	-: 4.6 Kgf at 100mph
Weight	-: 1.2 Kgs
Mounting Diameter	-: 25mm
Termination	-: Free 'N' Socket

N Plug extra, costs **£3.99**

Send cheque or postal order for **£29.95** plus **£2.00** postage to:

BUCKLEYS (UVRAL) LTD
Beta Works, Range Road
Hythe, Kent CT21 6HG
Tel: (0303) 60127/60122
Various Frequencies Available

ETESON ELECTRONICS

**15B Lower Green,
Poulton-le-Fylde, Blackpool
Tel: (0253) 885107**

Open: 9.30am - 12.30, 1.30 - 5.30. Closed Wed & Sun.
Electronic Component Specialists.

A wide range of electronic components, IC's, capacitors, transistors, resistors, plugs and sockets etc.

ELECTRO COMM NEW CB SHOP

**2A Tennyson Road, Luton
Tel: 0582 458310**

CB RADIOS ALL ACCESSORIES.
RELIABLE SPEEDY REPAIR SERVICE.
USED CB's BOUGHT AND SOLD
(Open 9-6 Tues-Sat) 1/2 mile town centre

PROFESSIONAL GRADE VHF-FM BROADCAST EQUIPMENT

The Galaxy range offers superb specifications at an economic price. We offer a special range of high quality transmitters, power amplifiers, stereo encoders, UHF repeater links, compressors, antennas. Powers 10w to 1kw. Built to high specifications at an economic price. Meets IBA & Full Broadcast specifications.

Phone now for prices and delivery:
Cyberscan International
3 Eastcote View, Pinner,
Middx HA5 1AT. Tel: 01-866 3300

ALAN HOOKER ELECTRONICS

**42 Nethernall Road
Doncaster**
Tel: 0302 25690

Large stocks of electronic components

NEXT ISSUE OF

Amateur
RADIO

**On Sale Thursday
28th April**

**Please mention
Amateur Radio
when replying
to any
advertisements**

DISPLAY AD RATES		series rates for consecutive insertions			
depth mm x width mm	ad space	1 issue	3 issues	6 issues	12 issues
61 x 90	1/8 page	£86.00	£62.00	£59.00	£33.00
126 x 90 or 61 x 186	1/4 page	£115.00	£110.00	£105.00	£92.00
126 x 186 or 263 x 90	1/2 page	£225.00	£210.00	£200.00	£180.00
263 x 186	1 page	£430.00	£405.00	£385.00	£345.00
263 x 394	double page	£830.00	£780.00	£740.00	£660.00

COLOUR AD RATES		colour rates exclude cost of separations	series rates for consecutive insertions			
depth mm x width mm	ad space	1 issue	3 issues	6 issues	12 issues	
126 x 186 or 263 x 90	1/2 page	£305.00	£290.00	£275.00	£245.00	
263 x 186	1 page	£590.00	£550.00	£530.00	£470.00	
263 x 394	double page	£1,130.00	£1,070.00	£1,010.00	£900.00	

SPECIAL POSITIONS	Covers	Outside back cover 20% extra, inside covers 10% extra
	Bleed:	10% extra (Bleed area = 307 x 220)
	Facing Matter:	15% extra

DEADLINES		*Dates affected by public holidays			
Issue	colour & mono proof ad	mono no proof & small ad	mono artwork	on sale thurs	
May 88	31 Mar 88	6 Apr 88	8 Apr 88	28 Apr 88	
Jun 88	28 Apr 88	4 May 88	6 May 88	26 May 88	
July 88	2 Jun 88	6 Jun 88	10 Jun 88	30 Jun 88	
Aug 88	30 Jun 88	6 Jul 88	6 Jul 88	28 Jul 88	

CONDITIONS & INFORMATION	
<p>SERIES RATES Series rates also apply when larger or additional space to that initially booked is taken. An ad of at least the minimum space must appear in consecutive issues to qualify for series rates. Previous copy will automatically be repeated if no further copy is received. A 'hold ad' is acceptable for maintaining your series rate contract. This will automatically be inserted if no further copy is received. Display Ad and Small Ad series rate contracts are not interchangeable.</p>	<p>If series rate contract is cancelled, the advertiser will be liable to pay the unearned series discount already taken.</p> <p>COPY Except for County Guides copy may be changed monthly. No additional charges for typesetting or illustrations (except for colour separations). For illustrations just send photograph or artwork. Colour Ad rates do not include the cost of separations. Printed - web offset.</p>
<p>PAYMENT Above rates exclude VAT. All single insertion ads are accepted on a pre-payment basis only, unless an account is held. Accounts will be opened for series rate advertisers subject to satisfactory credit references. Accounts are strictly net and must be settled by the publication date. Overseas payments by International Money Order or credit card.</p> <p>FOR FURTHER INFORMATION CONTACT Amateur Radio, Sovereign House, Brentwood, Essex CM14 4SE (0277) 219876</p>	<p>Commission to approved advertising agencies is 10%.</p> <p>CONDITIONS 10% discount if advertising in both Amateur Radio and Radio & Electronics World. A voucher copy will be sent to Display and Colour advertisers only. Ads accepted subject to our standard conditions, available on request.</p>

Amateur Radio
– the monthly magazine for all two-way radio enthusiasts

Don't take a chance on being able to get your copy

AVOID DISAPPOINTMENT
Place a regular order with your newsagent

Should you have any difficulties obtaining a copy, phone (0277) 219876 or write to Circulation Department, *Amateur Radio*, Sovereign House, Brentwood, Essex, CM14 4SE.

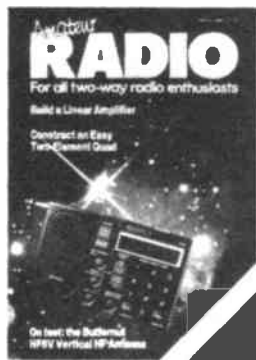

NEWSAGENT ORDER FORM

To (name of newsagent)

Please order a copy of *Amateur Radio* for me every month

NAME

ADDRESS

.....

..... POSTCODE

Newstrade distributors: SM Distribution, 16-18 Trinity Gardens, London SW9 8DX. (Tel: 01-274 8611)

ADVERTISERS INDEX

J Bull	59
P M Components	3/4
R N Electronics	11
GCHQ	29
C M Howes	49
ICOM	30/31
Johnsons Shortwave	43
G4ZPY Paddle Keys	23
Pearsons Computing	29
W P Publications	24
Radio & Tele Corres Sch	23
MGR Services	35
T Systems	11
Technical Software	24
Telecomm	10/11
Victor Communications	11
Waters & Stanton	60
Weston Electronics	24
R Withers	2



£1 BAKERS DOZEN PACKS

Price per pack is £1.00. Order 12 you may choose another free. Items marked (sh) are not new but guaranteed OK

- 1 - 513 amp ring main junction boxes
- 2 - 513 amp ring main spur boxes
- 5 - 3 flush electrical switches
- 7 - 4m flex line switches with neons
- 8 - 2 80 watt brass cased elements
- 9 - 2 mains transformers with 6V 1A secondaries
- 10 - 2 mains transformers with 12V 1/2A secondaries
- 11 - 1 extension speaker cabinet for 6 1/2" speaker
- 12 - 5 octal bases for relays or valves
- 13 - 12 glass reed switches
- 14 - 4 OCP 70 photo transistors
- 16 - 4 tape heads, 2 record, 2 erase
- 17 - 1 ultrasonic transmitter and 1 ditto receiver
- 18 - 2 15000 mfd computer grade electrolytics
- 19 - 2 light dependent resistors
- 20 - 5 different micro switches
- 21 - 2 mains interference suppressors
- 22 - 2 25 watt crossover units 2 way
- 23 - 1 40 watt 3 way crossover unit
- 28 - 1 6 digit counter mains voltage
- 30 - 2 Nicad battery chargers
- 31 - 1 key switch with key
- 32 - 2 humidity switches
- 34 - 36 x 1 metre lengths colour-coded connecting wires
- 36 - 2 air spaced 2 gang tuning condensers
- 37 - 2 solid dielectric 2 gang tuning condensers
- 38 - 10 compression trimmers
- 41 - 6 Rocker Switches 10 amp mains SPST
- 43 - 5 Rocker Switches 10 amp SPDT Centre Off
- 44 - 4 Rocker Switches 10 amp DPST
- 45 - 1 24 hour time switch mains operated (sh)
- 46 - 1 6 hour clock timeswitch
- 48 - 2 6V operated reed switch relays
- 49 - 10 neon valves - make good night lights
- 50 - 2 x 12V 2C 24V 4C relays
- 51 - 1 12V 2C 0 very sensitive relay
- 52 - 1 12V 4C relay
- 55 - 1 locking mechanism with 2 days
- 56 - Miniature Uniselector with circuit for electric jigsaw
- 57 - 5 Dolls Houses switches
- 60 - 5 ferrite rods 4 x 5/16 diameter aerials
- 61 - 4 ferrite slab aerials with L & M wave coils
- 62 - 4 200 ohm earpieces
- 63 - 1 Mullard thyristor trigger module
- 64 - 10 assorted knobs 1/4 spindles
- 65 - 5 different thermostats, mainly by metal
- 66 - Magnetic brake - stops rotation instantly
- 67 - Low pressure 3 level switch
- 69 - 2 25 watt pots 8 ohm
- 70 - 2 25 watt pots 1000 ohm
- 71 - 4 wire wound pots - 18, 33, 50 and 100 ohm
- 73 - 4 3 watt wire wound pots 50 ohm
- 77 - 1 time reminder adjustable 1-60 mins
- 78 - 5 5 amp stud rectifiers 400V
- 85 - 1 mains shaded pole motor 3/4 shaft - 1/4 shaft
- 86 - 2 1/2 ali fan blades 1/4 shaft
- 87 - 3 plastic fan blades 1/4 shaft
- 88 - Mains motor suitable for above blades
- 89 - 1 mains motor with gearbox 1 rev per 24 hours
- 91 - 2 mains motors with gearbox 16 rpm
- 93 - 4 11 pin moulded bases for relays
- 94 - 5 B7G valve bases
- 95 - 4 skirted B9A valve bases
- 96 - 1 thermostat for fridge
- 98 - 1 motorised stud switch (sh)
- 101 - 1 2 1/2 relay switch
- 103 - 1 6v mains power supply unit
- 104 - 1 4 1/2 V mains power supply unit
- 105 - 1 5 pin flex plug and panel socket
- 107 - 1 5 speaker size radio cabinet with handle
- 109 - 10 1/4 spindle type volume controls
- 110 - 10 slider type volume controls
- 112 - 1 heating pad 2000 watts mains
- 114 - 1 1W amplifier Mullard 1172
- 115 - 1 Wall mounting thermostat 24V
- 118 - 1 Teak effect extension 5 speaker cabinet
- 120 - 2 pcb with 7 amp full wave and 17 other recs
- 122 - 10 mtrs twin screened flex white pvc outer
- 132 - 2 plastic boxes with windows ideal for interrupted beam switch etc
- 155 - 3 varicap push button tuners with knobs
- 188 - 1 plastic box sloping metal front 16x95mm average depth 45mm
- 243 - 2 speakers 6 x 4 15 ohms 5 watt made for Radiomobile
- 266 - 2 mains transformers 9V 1/2A secondary split primary so OK also for 115V
- 330 - 2 6V 0.6V mains transformer 3a pcb mounting
- 350 - 40 double pole f.e.c. switches
- 365 - 1 7ul 660V 50Hz metal cased condenser
- 453 - 453 - 2 2 1/4 in 60 ohm loudspeakers
- 454 - 2 2 1/4 in 8 ohm loudspeakers
- 453 - 1 mains operated relay with 2 sets c/o contacts
- 464 - 2 packets resin tiller sealer with cures
- 465 - 3 5A round 3 pin plugs will fit item 193
- 466 - 4 7 segment led displays
- 470 - 4 pc boards for stripping lots of valuable parts
- 498 - 4 1000uf 25V axial electrolytic capacitors
- 504 - 1 Audax PM 8 speaker 15 ohms 5 watt rating
- 515 - 100 4BA 1 1/2" cheesehead plated screws and 100 4BA nuts
- 541 - 1 pair stereo tape head as in cassette recorder players
- 546 - 1 bridge rectifier 600V international rectifier ref JSB100
- 548 - 2 battery operated relays (3-6v) each with 5A c/o contacts 2 pairs
- 553 - 2 lithium 3V batteries (everlasting shelf life)

5A BATTERY CHARGER KIT all parts including case only £5 add £1 postage

OVER 400 GIFTS YOU CAN CHOOSE FROM

There is a total of over 400 packs in our Baker's dozen range and you can become entitled to a free gift with each dozen packs.

A classified list of these packs and our latest News Letter will be enclosed with your goods and you will automatically receive our next news letter.



THIS MONTHS SNIP

3 1/2" Floppy Disk Drive made by the Chinon Company of Japan. Beautifully made and probably the most compact device of its kind as it weighs only 600g and measures only 104mm wide 162mm deep and has a height of only 32mm other features are high precision head positioning - a single push loading and eject - direct drive brushless motor - 500K per disc - Shugart compatible interface - standard connections - interchangeable with most other 3 1/2 and 5 1/4 drives. Brand new with copy of makers manual. Offered this month at **£28.50** post and VAT included.

CASE - adaptable for 3 or 3 1/2" FDD has room for power supply components price only **£4** includes circuit of PSU Our Ref 4P8

POWER SUPPLY FOR FDD - 5V and 12V voltage regulated outputs. complete kit of parts will fit into case 4P8 price **£8** or with case **£11**

MULLARD UNILEX AMPLIFIERS

We are probably the only firm in the country with these now in stock. Although only four watts per channel these give superb reproduction. We now offer the 4 Mullard modules - ie Mains power unit (EP9002), Pre amp module (EP9001) and two amplifier modules (EP9000) all for **£8.00** plus £2 postage. For prices of modules bought separately see TWO POUNDERS

CAR STARTER/CHARGER KIT

Flat Battery? Don't worry you will start your car in a few minutes this unit - 250 watt transformer 20 amp rectifiers case and all parts with data case **£17.50** post £2

MINO MONO AMP

On pcb size 4 x 2 (app) Fitted volume control and a hole for a tone control should you require it. The amplifier has three transistors and we estimate the output to be 3W rms. More technical data will be included with the amp. Brand new perfect condition offered at the very low price of **£1.15** each, or **£13** for **£12.00**.

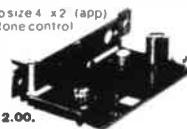

LIGHT BOX

This when completed measures approximately 15 x 14. The light source is the Philips fluorescent W tube. Above the light a sheet of fibreglass and through this should be sufficient light to enable you to follow the circuit on fibreglass PCBs. Price for the complete kit that is the box, choke, starter, tube and switch and fibreglass is **£5** plus £2 post, order ref 5P89

TANGENTIAL HEATERS

We again have very good stocks of these quiet running instant heat units. They require only a simple case or could easily be fitted into the bottom of a kitchen unit or book case etc. At present we have stocks of 12kw 2kw, 2.5kw and 3kw. Prices are **£5** each for the first 3 and **£6.95** for the 3k. Add post £1.50 per heater if not collecting.

CONTROL SWITCH enabling full heat half heat or cold blow with connection diagram 50p for 2kw 50p for 3kw

FANS & BLOWERS

- 5 **£5** £1.25 post 6 **£6** £1.50 post
 - 4 x 4 Muffin equipment cooling fan 115V **£2.00**
 - 4 x 4 Muffin equipment cooling fan 230 240V **£5.00**
 - 9 Extractor or Blower 115V supplied with 230 to 115V adaptor **£9.50** £2 post
- All above are ex computers but guaranteed 12 months to + 3 Tangential Blower New Very quiet - supplied with 230 to 115V adaptor on use two in series to give -ing blow **£2.00** - £1.50 post or **£4.00** - £2.00 post for two

9" MONITOR

Ideal to work with computer or video camera uses Philips black and white tube ref. M24 306W. Which tube is implosion and X-Ray radiation protected VDU is brand new and has a time base and EHT circuitry. Requires only a 16V dc supply to set it going. It is made up in a lacquered metal framework but has open sides so should be cased. The VDU comes complete with circuit diagram and has been line tested and has our six months guarantee. Offered at a lot less than some firms are asking for the tube alone only **£16** plus £5 post.

LOW COST OSCILLOSCOPE

Kit to convert our 9" monitor into an oscilloscope with switched time bases to allow very high and very low frequency waveforms to be observed and measured. Signal amplitudes from as low as 10mV and as high as 1kV can easily be observed and measured. Ideal for servicing also for investigating TV radio and audio circuits.

Kit containing all the parts for the conversion and the power supply to operate from mains **£25** our ref 25P3

TELEPHONE LEAD

3mtrs long terminating one end with new BT flat plug and the other end with 4 correctly coloured coded wires to fit to phone or appliance. Replaces the lead on old phone making it suitable for new BT socket. Price **£1** ref BD552 or **£3** ref 2P161

COMPACT FLOPPY DISC DRIVE EME-101

The EME-101 drives a 3.5" disc of the new standard which despite its small size provides a capacity of 500k per disc which is equivalent to the 3 1/2" and 5 1/4" discs. We supply Operator's Manual and other information showing how to use this with popular computers - BBC Spectrum Amstrad etc. All at a special snip price of **£27.50** including post and VAT. Data available separately **£2** refundable if you purchase the drive.

POWERFUL IONISER

Generates approx 10 times more IONS than the E1 and similar circuits. Will refresh your home office shop/workroom etc. Makes you feel better and work harder - a complete mains operated kit case included **£11.90** £3 P&P

J & N BULL ELECTRICAL

Dept AR, 250 PORTLAND ROAD, HOVE BRIGHTON, SUSSEX BN3 5QT
MAIL ORDER TERMS: Cash PO or cheque with order. Orders under £20 add £1 service charge. Monthly account orders accepted from schools and public companies. Access & B card orders accepted Brighton (0273) 203500

NEW ITEMS

Some of the many described in our current list which you will receive with your parcel

POWERFUL 13v MOTOR - was intended for the Sinclair electric car. Rated approx 13hp £15 Ref 15P8

BURGULAR ALARM BELL - 6 gong - OK to fit outside in the rain and shelter - mains operation £8 Ref 8P2

AGAIN AVAILABLE - 12 mini fluorescent tubes - Price £1 each Ref BD314

POWER PACK OF AMPLIFIER CASE - Size approx 10 x 8 1/4 x 4 3/4 plated steel - with ample perforations for cooling. Front panel has on/off switch and EEC mains inlet plug with built-in RF filter - undoubtedly a very fine case which would cost at least £50 from regular sources. Our price is £5 each and £3 post Ref 5P111

MINIATURE BCD THUMP WHEEL SWITCH - Matt black edge switch engraved white on black - gold plated make before break contacts - size approx 25mm high 8mm wide 20mm deep - made by the famous Cherry Company and designed for easy stacking - Price £1 each Ref BD601

EDGE METER - miniature whole size approx 37mm x 13mm 100 uA f.s.d. - centre zero scaled 0 to 10 and 10 to -10 Price £1 each Ref BD602

24hr TIME SWITCH - 16A c/o contacts - up to 6on/off per day - cased intended for wall mounting Price £8 Ref 8P6

CAPACITOR BARGAIN - axial ended - 4700uf - 25v Jap made Normally 50p each but you will get 4 for £1 Ref 613

CLEANING FLUID - Extra good quality - intended for video and tape heads - regular Price £1.50 per spray can - our Price - 2 cans for £1 Ref BD604

DON'T FREEZE UP! - We have had the strongest winds for over 200 years and who knows we may be in for the coldest winter so if you have not already protected your water pipes you should do so now - our heating wire would round the pipes will do this and will only about 50p per week for 10 - 15 metres (minimum length to connect to 230/240v mains) Price £5 Our Ref 5P 1059

PIEZO ELECTRIC FAN - an unusual fan more like the one used by Madame Butterfly than the conventional type. It does not rotate. The air movement is caused by the two vibrating arms. It is American made, mains operated, very economical and causes no interference. So it is ideal for computer and instrument cooling. Price is only £1 each Ref BD605

SPRING LOADED TEST PRODS - heavy duty made by the famous Bulgin company. Very good quality. Price four for £1 Ref BD599

CURLY LEAD four core standard replacement for telephone handset, extends to nearly two metres. Price £1 each Ref BD599

TELEPHONE BELLS - these will work off our standard mains through a transformer, but to sound exactly like a telephone they then must be fed with 25Hz 50v. So with these bells we give a circuit for a suitable power supply. Price 2 bells for £1 Ref BD600

ULTRA SENSITIVE POCKET MULTIMETER - 4k ohms per volt - 11 ranges - carry one of these and so be always ready to test ac/dc volts to 1000, DC milliams and have an ohms range for circuit testing - will earn its cost in no time. Price only £7 Ref 7P2

BLOW YOUR ROOF OFF! 140 watt speaker systems - new type you must not hide! They have golden cones and golden surrounds and look really Bootiful! 12 Woofer Midrange and Tweeter and comes with a crossover at a special introductory price of £49 carriage paid. Two sets for £96 carriage paid! 140w Woofer only £35 carriage paid

SWITCH MODE PSU Mains input 2 output plus 5v at 3.5 amps 12v at 1.5 amps. Very compact (5 1/2" x 4" x 2") ideal for driving 1 or more floppy discs. Regular price around £30. Our price only £10 brand new Ref 10P34

APPLIANCE THERMOSTATS - spindle adjust type suitable for convector heaters or similar price 2 for £1 Ref BD582

COMPUTERS

Big consignment of computers expected in mid Jan, various makes and numbers, write or phone for details

NOVEL NIGHT LIGHT - plugs into a 13A socket. Gives out a surprising amount of light, certainly enough to navigate along passages at night or to keep a nervous child happy. Very low consumption, probably not enough to move the meter. Price £1 Ref BD563

CASE WITH 13A PRONGS - to go into 13A socket nice size and suitable for plenty of projects such as car battery trickle charger, speed controller, time switch, night light, noise suppressor, dimmers etc. Price £2 Ref £1 Ref BD565

SPEAKER EXTENSION CABLE - twin 0.7mm conductors so you can have long runs with minimum sound loss and for telephone extensions or burglar alarms, bell intercoms etc. 250m coil only £3 plus £1 post Ref 3P28

ALPHA-NUMERIC KEYBOARD - this keyboard has 73 keys with contact capacitive switches giving long trouble free life and no contact bounce. The keys are arranged in two groups, the main area field is QWERTY array and on the right is a 15 key number pad. Board size is approx 13 x 4 - brand new but offered at only a fraction of its cost namely £3 plus £1 post Ref 3P27

TELEPHONE EXTENSIONS - it is not legal for you to undertake the wiring of telephone extensions. For this we can supply 4 core telephone cable 100m coil £8.50. Extension BT sockets £2.95. Packet of 500 plastic headed staples £2. Dual adaptor for taking two appliances from one socket £3.95. Leads with BT plug for changing old phones 3 for £2

MODULAR SWITCH - Panel mounting highest quality and ideal where extra special front panel appearance is required. Can be illuminated if required. Price £2 and £1 Ref BD607

WIRE BARGAIN - 500 metres 0.7mm solid copper tinned and pvc covered. Only £3 - £1 post Ref 3P31 - that's well under 1p per metre and this wire is ideal for push on connections.

INTERRUPTED BEAM KIT - this kit enables you to make a switch that will trigger when a steady beam of infra-red or ordinary light is broken. Main components - relay photo transistor, resistors and caps etc. Circuit diagram but no case. Price £2 Ref 2P15

3-30V VARIABLE VOLTAGE POWER SUPPLY UNIT - with 1 amp DC output. Intended for use on the bench for experiments, students, inventors, service engineers etc. This is probably the most important piece of equipment you can own. After a multi-range test meter. It gives a variable output from 3-30 volts and has an automatic short circuit and overload protection which operates at 1.1 amp approx. Other features are very low ripple output a typical ripple is 3mV pk pk 1mV rms. Mounted in a metal fronted plastic case. This has a voltmeter on the front panel in addition to the output control knob and the output terminals. Price for complete kit with full instructions is £15 Ref 15P7

TRANSMITTER SURVEILLANCE (BUQ) tiny easily hidden but which will enable conversation to be picked up with FM radio. Can be housed in a matchbox, all electronic parts and circuit. Price £2 Ref 2P52



ALINCO DUAL BANDER

- ★ 2m/70cm
- ★ 25 Watts output
- ★ Full duplex operation
- ★ 21 Memories
- ★ 2 Call channels
- ★ Priority channel
- ★ Dual VFO's
- ★ 12.5 & 25kHz steps
- ★ Memory Scan
- ★ Programme Scan
- ★ Memory Skip

£449 inc vat

ALD-24E



This transceiver could transform your operating habits! It contains completely separate 2m and 70cms transceivers, permitting full duplex operation. To the un-initiated, this means you can transmit on 2m whilst receiving on 70cms, or vice versa. The built-in duplexer means a single antenna socket with a full 25 watts output on both bands. Measuring only 5.5"x2"x6.5" it is the ideal mobile rig. Its comprehensive memory and scanning facilities provide rapid access to both

simplex and repeater channels on 2m & 70cms. Using the dual VFO's you can instantly switch between 2m & 70cm and the single knob tuning provides simple and quick frequency selection. The large LCD readout incorporates an S-meter and is back lighted. If you are looking for a completely self contained 2m & 70cm station, then look no further. At this price it has to be a bargain. For further details of this amazing transceiver, send today for the full colour brochure.

OUR FAMOUS FREQUENCY MANUALS!

UK LISTENERS CONFIDENTIAL FREQUENCY LIST LATEST EDITION

This publication has now sold well over 3500 copies since it was advertised only a few months ago. Now the recent updated version is selling even better. No self respecting listener should be without a copy. If you enjoy exploring the short wave bands then this publication will add to your enjoyment. It covers the hf spectrum from 2 to 30 mHz and gives details of transmissions outside the amateur bands. Specially designed for the UK and European listener it sets out in a very easy way a comprehensive list of hundreds of interesting transmissions that will keep you occupied for days on end! Only a fraction of the cost of other similar publications it contains details of Marine, Air, Military, Embassy, Press and News agencies. Many listings have time schedules included together with comprehensive RTTY details. It tells you the frequencies used by civil and military aircraft whilst flying the Atlantic, when and where to pick up the press bulletins, long distance marine traffic etc and much more. Send today for your copy of this worthwhile publication.

NEW 1988 EDITION £6.95 p&p 90p

4th EDITION VHF-UHF AIRBAND FREQUENCY LIST

This frequency manual is without doubt the most comprehensive list of VHF/UHF aircraft listings available in the UK. Of vital importance to the airband enthusiast or indeed any keen VHF/UHF listener it sets out in a very easy to follow manner full details of a whole host of stations. Every known UK airfield frequencies, etc. Included are Civil, RAF, USAF, MOD, Naval fields on both VHF and UHF bands. There are also air to air frequencies, the Red Arrows frequency, and much more. Send today for your copy and find out just how much you have been missing!

£5.95 p&p 90p

THE COMPLETE UHF-VHF FREQUENCY GUIDE 26-2000 mHz

New 1988 Edition. Many listeners have asked for a guide to the wide VHF/UHF spectrum and to meet this request we have recently published this frequency manual. It covers the range 26 to 2000 mHz and has been specially prepared for the UK listener. Anybody who has used a scanning receiver will know that the wide frequency range involved means that it is difficult to know exactly where to listen. This guide takes all the guessing out of monitoring. It lists all the services throughout the spectrum together with both simplex and duplex frequency splits. If you've spent your hard earned money on a scanning receiver or are considering buying one you'll find that this publication contains a wealth of information that has previously remained un-published!

£5.95 p&p 75p

HF OCEANIC AIRBAND COMMUNICATIONS 1988 EDITION.

Prepared in response to many requests for more information about the air traffic on the hf bands this little guide sets out to explain to the beginner how the hf band works in relation to air traffic. It contains full details of the world aircraft frequency bands in the range 2 to 23 mHz together with control frequencies and those commonly used for Oceanic control. Also included are many VOLMET frequencies, the Search and Rescue frequencies used by RAF helicopters and Nimrods, the Hf RT network, London Company frequencies, European control centres etc. An ideal companion for the hf airband listener. Send today for your copy.

£3.50 p&p 70p

**WATERS
& STANTON
ELECTRONICS**

18-20 MAIN ROAD, HOCKLEY, ESSEX - 12 NORTH STREET, HORNCHURCH, ESSEX.
MAIL ORDER TO: 18-20 MAIN ROAD, HOCKLEY, ESSEX TEL: (0702) 206835

