

*Amateur*

# RADIO

**For all two-way radio enthusiasts**

**Using a transverter  
with the TS440S**

**Countermeasures**

**The project book**

**50MHz –  
what to expect**

**Bits to build**

**On test: Lowe HF125  
general coverage receiver**

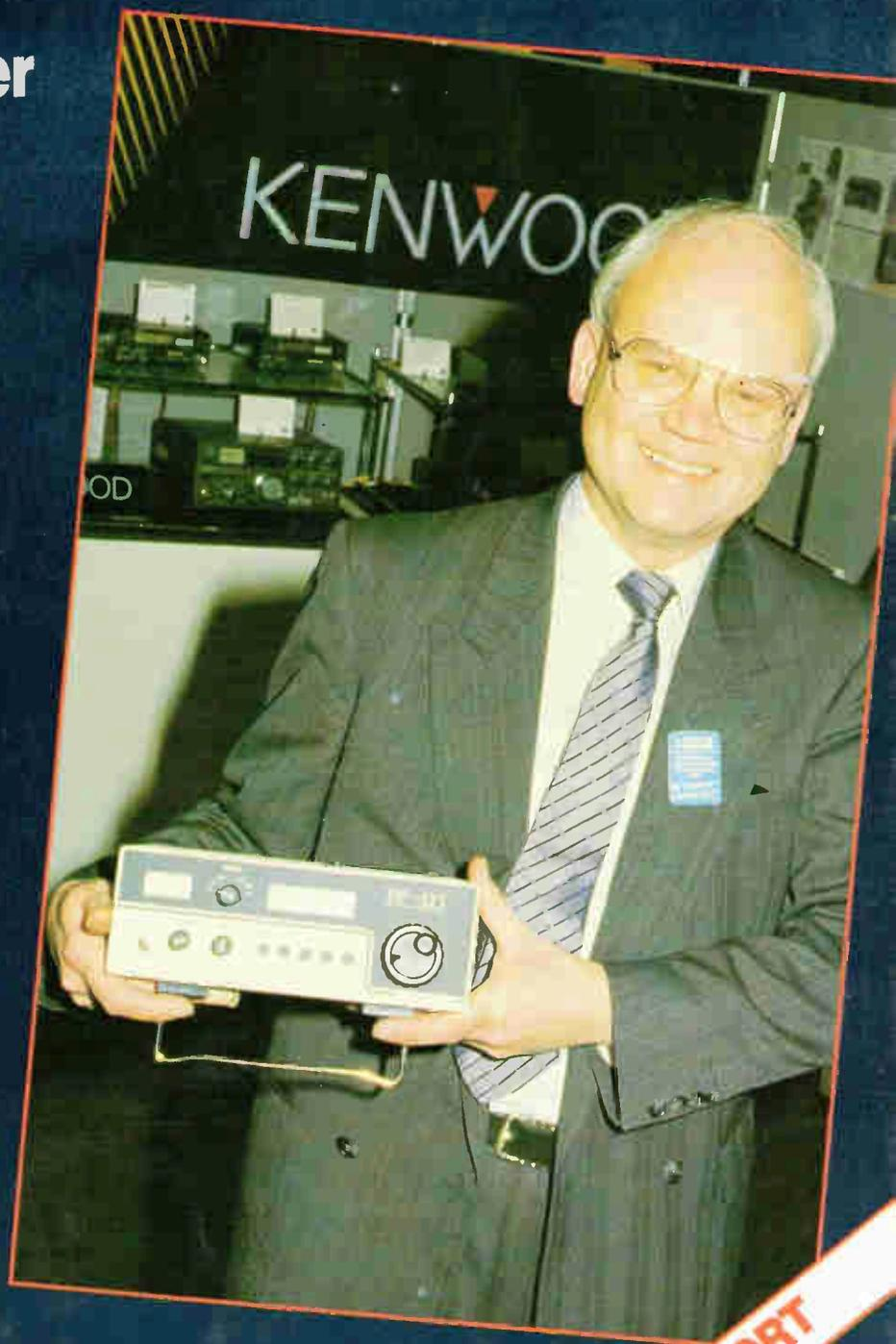

**MORSE REPORT**

# R. WITHERS COMMUNICATIONS LTD

Manufacturers, importers and suppliers of world famous communications products  
 584 HAGLEY ROAD WEST OLDBURY, WARLEY, BIRMINGHAM B68 0BS  
 021-421 8201/2/3. CELLNET 0860 323056. PRESTEL MBX 214218216 FAX 0215614074  
 Amateur Radio. Business Radio. Radio Telephones. Sales. Service Accessories and antenna systems.



**YAESU**



**THE TECHNICALLY ORIENTATED  
 RADIO COMMUNICATIONS  
 SPECIALISTS.**

## A WORLD FIRST FROM RWC LTD

### YAESU FRG9600/RWC MK3 HF-UHF SERIES

After many months of research and development RWC LTD are pleased to announce their latest HF modification for the Yaesu FRG9600 which now includes LF/HF/VHF/UHF coverage from 100kHz to 950MHz and improved 'S' Meter and a typical receiver \*sensitivity now  $>2\mu\text{V}$  pD HF,  $>1.5\mu\text{V}$  60-950MHz all @ 12dB SINAD. (Please contact us for detailed specifications).

We have fitted a High performance HF Front-End made for us by AKD. The new HF section **is fitted internally** with switching circuits and a small toggle Switch on the rear apron to enable band change whereby the display changes to read actual frequency (100kHz-60MHz). The standard SO239 antenna connector has now been changed for an 'N' connector for coverage from 60-950MHz and an SO239 connector fitted for HF coverage 100kHz-60MHz. (UHF extended coverage is now standard as per our original MK2 modification up to 950MHz).

As an 'N' connector is now fitted to all RWC FRG9600s for VHF-UHF coverage it is possible to use a wide-band disccone antenna such as the ICOM AH7000 which is supplied with low-loss coaxial cable and 'N' connectors. A dipole or long-wire antenna can be used for HF coverage with very good results. **This facilitates use of two antennas for all bands.**

All modifications are Fully Guaranteed for twelve months from date of purchase/modification providing our modifications seals are unbroken.

© RWC LTD 1987

\* We reserve the right to change specifications due to continuous development and modification of this product.



### YAESU FRG9600/RWC MK3 AM-FM (WIDE & NARROW) LSB, USB. 100kHz-950MHz Broadcast Monitor and Scanning Receiver



Generous part exchange on Shortwave Receivers, EG FRG7 up to £125, FRG7700 up to £225. WHY NOT UPGRADE NOW!?

**FRG9600 MK2 Model 60-950MHz** 'N' connector @ £519.00 + £5.00 carriage. (Modified unit only).

**FRG9600 MK3 Model 100kHz-950MHz** 'N' connector and SO239 for HF @ £625.00 + £5.00 carriage. (Modified unit only).

**RWC Exclusive Base Station Complete HF-UHF Package** FRG9600 MK3 Model, Icom AH7000 ant, G5RV HF multiband, PA4C ac-13V dc adaptor, inclusive carriage UK £725.00.

EXPORT & TRADE ENQUIRIES INVITED.

PLEASE ASK FOR COLOUR BROCHURE & SPECIFICATIONS.

**Tel: 021 421 8201** (24hr answerphone)  
**Telex: 334303 G TXAGWM**



### ICOM AH-7000 SUPER WIDEBAND OMNIDIRECTIONAL ANTENNA

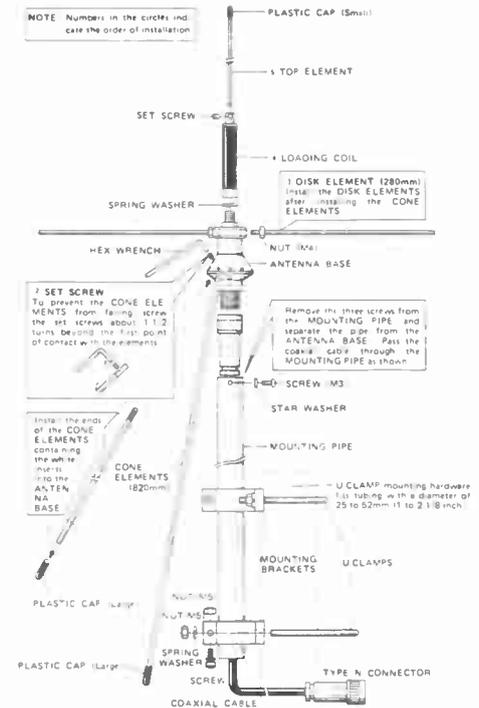

# Amateur RADIO



## Editor:

Anita Ley

## Assistant Editor:

Jane Berry

## Advertisement Manager:

Marian Vidler

## Advertisement Executive:

Karen Turner

## Subscriptions:

01-760 0409

## Accounts:

Clare Brinkman

## Publisher:

Peter Williams

## On sale: Last

Thursday of the month preceding cover date

## Next issue: Cover

date June 1987 on

sale 28 May 1987

## Published by:

Amateur Radio Magazines,

Sovereign House, Brentwood, Essex CM14 4SE, England (0277) 219876

Printed: In England

ISSN: 0264-2557

## News Trade Sales by:

Argus Press Sales & Distribution Ltd, 12-18 Paul Street, London EC2A 4JS. 01-247 8233

Front cover: Nice rig, shame about the face p. 21. Photo by Jay Moss-Powell G6XIB

Whilst every care is taken when accepting advertisements we cannot accept responsibility for unsatisfactory transactions. We will, however, thoroughly investigate any complaints. The views expressed by contributors are not necessarily those of the publishers.

Every care is also taken to ensure that the contents of *Amateur Radio* are accurate, we assume no responsibility for any effect from errors or omissions.

© Copyright 1987  
Amateur Radio Magazines

## 6 Straight and Level

All the latest news, comment and developments on the amateur radio scene

## 12 Letters

Your opinions on topics of interest

## 13 Vanuatu Disaster

Another example of a situation where third party message agreements proved invaluable

## 15 RSGB National Convention 1987

It was all there. Were you?

## 16 DX Diary

Don Field G3XTT with this month's DX news

## 18 Using a transverter with the TS440S

Get around the impossibility of using this rig without a transverter

## 21 Angus McKenzie Tests

This month G3OSS reviews the new Lowe HF125 HF receiver, two multimeters from Thanet Electronics and some new Japanese co-ax from Telecomms

## 28 50MHz – what to expect

G5KW with tips on what to look out for on 50MHz

## 32 SWL

Trevor Morgan GW4OXB highlights the way we take radios for granted without actually thinking about what they're capable of

## 35 Countermeasures

The concluding chapter of Brian Kendal's story

## 38 Raynet – the operation

Ken Michaelson looks behind the scenes of the Raynet operation

## 41 Bits to Build

Rev George Dobbs with the first in a series of occasional articles

## 43 2YH – an early amateur

It wasn't all bells and whistles in those days!

## 45 A two metre transmatch

A useful device to correct mismatch in the antenna

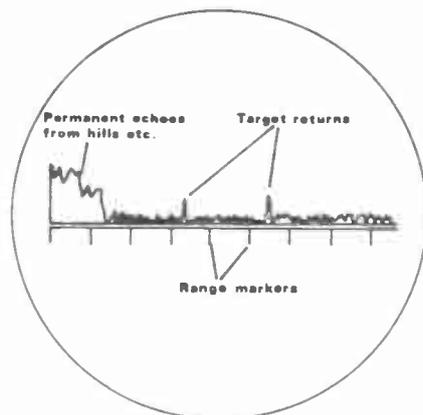

## 46 Morse Report

G4FAI with his bimonthly look at the world of 'dits' and 'dahs'

## 47 Project Book

How much should you rely on the readings of your SWR meter?

## 48 On the Beam

Glen Ross G8MWR with all the latest news from VHF, UHF and microwaves

## 49 Coming next month

What's in store for you?

## 50 Secondhand

Bodges for memory chips and remedies for slipping drive belts you just wouldn't believe!

## 52 Free Classified Ads

The market for buying and selling

## SERVICES

- 14 Radio and Electronics World subscription order form
- 17 Newsagents order form
- 51 Subscription order form
- 54 Free Classified Ad form
- 58 Advertisers Index
- 58 Advertising rates and information



PHONE  
0474 60521  
3 LINES

**P.M. COMPONENTS LTD**  
**SELECTRON HOUSE**  
**SPRINGHEAD ENTERPRISE PARK, SPRINGHEAD ROAD**  
**GRAVESEND, KENT DA11 8HD**



TELEX  
966371  
TOS PM

**A SELECTION FROM OUR STOCK OF BRANDED VALVES**

A1714 24.80	EBC41 1.95	EL155 1.75	M8163 5.50	QV03-20A 28.00	U191 0.70	2AS15A 11.50	6AJ7 2.00	6GK6 1.95	12BA6 1.50	4311U 4.50
A1998 11.80	EBC81 1.50	EL153 12.15	M8190 4.50	QV03-20B 32.00	U192 1.00	2B22 69.80	6AK6 1.95	6G57 2.15	12BH7A 2.25	572B 5.50
A2087 11.80	EBC90 0.80	EL183E 3.50	M8195 6.50	QV06-40A 27.50	U261 1.00	2C39A 32.80	6AK6 2.80	6G67 2.50	12B7A 2.50	5636 1.50
A2134 14.95	EBC91 0.80	EL183P 3.50	M8196 5.50	QV07-50 55.00	U801 0.75	2C39BA 39.50	6AL5 0.80	6G78 2.50	12B7A 2.50	6146A 7.50
A2283 14.50	EBC92 0.80	EL183P 3.50	M8196 5.50	QV07-50 55.00	U801 0.75	2C40 37.00	6AM4 3.25	6G88 2.50	12B7A 2.50	6158 3.20
A2426 35.00	EBC93 0.80	EL183P 3.50	M8196 5.50	QV07-50 55.00	U801 0.75	2C42 29.80	6AM5 6.00	6G98 2.50	12B7A 2.50	6386 14.50
A2599 37.80	EBC94 0.80	EL183P 3.50	M8196 5.50	QV07-50 55.00	U801 0.75	2C51 0.75	6AM6 1.95	6H6 1.95	12C45 1.95	6883B 9.00
A2792 27.50	EBC95 0.80	EL183P 3.50	M8196 5.50	QV07-50 55.00	U801 0.75	2C52 1.50	6AM7 4.50	6H6GT 1.95	12C46 1.20	6973 5.95
A2900 11.80	EBC96 0.80	EL183P 3.50	M8196 5.50	QV07-50 55.00	U801 0.75	2C53 0.75	6AM8 3.50	6H6GT 1.95	12D06B 3.50	705A 8.00
A3042 24.00	EBC97 0.80	EL183P 3.50	M8196 5.50	QV07-50 55.00	U801 0.75	2C54 0.75	6AM9 2.50	6H6GT 1.95	12D06B 3.50	725A 275.00
A3283 24.00	EBC98 0.80	EL183P 3.50	M8196 5.50	QV07-50 55.00	U801 0.75	2C55 0.75	6A08 0.85	6H6GT 1.95	12D06B 3.50	7527 89.50
AC/THI 4.00	EBC99 0.80	EL183P 3.50	M8196 5.50	QV07-50 55.00	U801 0.75	2C56 0.75	6A09 5.95	6H6GT 1.95	12E1 17.95	7703 395.00
ACT22 59.75	EBC100 0.80	EL183P 3.50	M8196 5.50	QV07-50 55.00	U801 0.75	2C57 0.75	6A10 2.00	6H6GT 1.95	12E14 3.80	8003 14.95
AC/S2PEN 8.50	EBC101 0.80	EL183P 3.50	M8196 5.50	QV07-50 55.00	U801 0.75	2C58 0.75	6A11 2.00	6H6GT 1.95	12G17 4.50	805 39.00
AH221 1.25	EBC102 0.80	EL183P 3.50	M8196 5.50	QV07-50 55.00	U801 0.75	2C59 0.75	6A12 1.75	6H6GT 1.95	12H7A 4.50	807 25.00
AH238 35.00	EBC103 0.80	EL183P 3.50	M8196 5.50	QV07-50 55.00	U801 0.75	2C60 0.75	6A13 1.75	6H6GT 1.95	12K5 1.95	811A 15.00
AL60 6.00	EBC104 0.80	EL183P 3.50	M8196 5.50	QV07-50 55.00	U801 0.75	2C61 0.75	6A14 2.00	6H6GT 1.95	12K7GT 1.50	813 27.50
AN1 14.00	EBC105 0.80	EL183P 3.50	M8196 5.50	QV07-50 55.00	U801 0.75	2C62 0.75	6A15 0.95	6H6GT 1.95	12K8 1.95	813 Philips 15.00
ARP12 0.70	EBC106 0.80	EL183P 3.50	M8196 5.50	QV07-50 55.00	U801 0.75	2C63 0.75	6A16 2.00	6H6GT 1.95	12S47GT 1.95	829B 14.50
ARP34 1.25	EBC107 0.80	EL183P 3.50	M8196 5.50	QV07-50 55.00	U801 0.75	2C64 0.75	6A17 2.00	6H6GT 1.95	12S47GT 1.95	832A 15.00
ARP35 2.00	EBC108 0.80	EL183P 3.50	M8196 5.50	QV07-50 55.00	U801 0.75	2C65 0.75	6A18 1.75	6H6GT 1.95	12S47GT 1.95	833A 95.00
AZ11 4.50	EBC109 0.80	EL183P 3.50	M8196 5.50	QV07-50 55.00	U801 0.75	2C66 0.75	6A19 2.00	6H6GT 1.95	12S47GT 1.95	866A 5.50
BL63 2.00	EBC110 0.80	EL183P 3.50	M8196 5.50	QV07-50 55.00	U801 0.75	2C67 0.75	6A20 2.00	6H6GT 1.95	12S47GT 1.95	872A 20.00
BS450 57.00	EBC111 0.80	EL183P 3.50	M8196 5.50	QV07-50 55.00	U801 0.75	2C68 0.75	6A21 2.00	6H6GT 1.95	12S47GT 1.95	884 5.50
BS810 55.00	EBC112 0.80	EL183P 3.50	M8196 5.50	QV07-50 55.00	U801 0.75	2C69 0.75	6A22 2.00	6H6GT 1.95	12S47GT 1.95	884 5.50
BS814 55.00	EBC113 0.80	EL183P 3.50	M8196 5.50	QV07-50 55.00	U801 0.75	2C70 0.75	6A23 2.00	6H6GT 1.95	12S47GT 1.95	901A 19.50
CK 21.75	EBC114 0.80	EL183P 3.50	M8196 5.50	QV07-50 55.00	U801 0.75	2C71 0.75	6A24 2.00	6H6GT 1.95	12S47GT 1.95	954 1.00
C3JA 20.00	EBC115 0.80	EL183P 3.50	M8196 5.50	QV07-50 55.00	U801 0.75	2C72 0.75	6A25 2.00	6H6GT 1.95	12S47GT 1.95	958A 1.00
C6A 20.00	EBC116 0.80	EL183P 3.50	M8196 5.50	QV07-50 55.00	U801 0.75	2C73 0.75	6A26 2.00	6H6GT 1.95	12S47GT 1.95	1299A 1.00
C1112G 70.00	EBC117 0.80	EL183P 3.50	M8196 5.50	QV07-50 55.00	U801 0.75	2C74 0.75	6A27 2.00	6H6GT 1.95	12S47GT 1.95	1619 2.50
C1108 60.00	EBC118 0.80	EL183P 3.50	M8196 5.50	QV07-50 55.00	U801 0.75	2C75 0.75	6A28 2.00	6H6GT 1.95	12S47GT 1.95	1625 3.00
C1134 32.00	EBC119 0.80	EL183P 3.50	M8196 5.50	QV07-50 55.00	U801 0.75	2C76 0.75	6A29 2.00	6H6GT 1.95	12S47GT 1.95	1626 3.00
C1148A 115.00	EBC120 0.80	EL183P 3.50	M8196 5.50	QV07-50 55.00	U801 0.75	2C77 0.75	6A30 2.00	6H6GT 1.95	12S47GT 1.95	1626 3.00
C11501 135.00	EBC121 0.80	EL183P 3.50	M8196 5.50	QV07-50 55.00	U801 0.75	2C78 0.75	6A31 2.00	6H6GT 1.95	12S47GT 1.95	1626 3.00
CCA 2.00	EBC122 0.80	EL183P 3.50	M8196 5.50	QV07-50 55.00	U801 0.75	2C79 0.75	6A32 2.00	6H6GT 1.95	12S47GT 1.95	1626 3.00
CCAL 0.80	EBC123 0.80	EL183P 3.50	M8196 5.50	QV07-50 55.00	U801 0.75	2C80 0.75	6A33 2.00	6H6GT 1.95	12S47GT 1.95	1626 3.00
CL33 2.00	EBC124 0.80	EL183P 3.50	M8196 5.50	QV07-50 55.00	U801 0.75	2C81 0.75	6A34 2.00	6H6GT 1.95	12S47GT 1.95	1626 3.00
CV Nos Prices on request	EBC125 0.80	EL183P 3.50	M8196 5.50	QV07-50 55.00	U801 0.75	2C82 0.75	6A35 2.00	6H6GT 1.95	12S47GT 1.95	1626 3.00
D3a 29.50	EBC126 0.80	EL183P 3.50	M8196 5.50	QV07-50 55.00	U801 0.75	2C83 0.75	6A36 2.00	6H6GT 1.95	12S47GT 1.95	1626 3.00
D93 1.20	EBC127 0.80	EL183P 3.50	M8196 5.50	QV07-50 55.00	U801 0.75	2C84 0.75	6A37 2.00	6H6GT 1.95	12S47GT 1.95	1626 3.00
DA4 22.50	EBC128 0.80	EL183P 3.50	M8196 5.50	QV07-50 55.00	U801 0.75	2C85 0.75	6A38 2.00	6H6GT 1.95	12S47GT 1.95	1626 3.00
DA42 17.50	EBC129 0.80	EL183P 3.50	M8196 5.50	QV07-50 55.00	U801 0.75	2C86 0.75	6A39 2.00	6H6GT 1.95	12S47GT 1.95	1626 3.00
DA90 4.50	EBC130 0.80	EL183P 3.50	M8196 5.50	QV07-50 55.00	U801 0.75	2C87 0.75	6A40 2.00	6H6GT 1.95	12S47GT 1.95	1626 3.00
DA100 128.00	EBC131 0.80	EL183P 3.50	M8196 5.50	QV07-50 55.00	U801 0.75	2C88 0.75	6A41 2.00	6H6GT 1.95	12S47GT 1.95	1626 3.00
DAF91 0.45	EBC132 0.80	EL183P 3.50	M8196 5.50	QV07-50 55.00	U801 0.75	2C89 0.75	6A42 2.00	6H6GT 1.95	12S47GT 1.95	1626 3.00
DAF91 0.70	EBC133 0.80	EL183P 3.50	M8196 5.50	QV07-50 55.00	U801 0.75	2C90 0.75	6A43 2.00	6H6GT 1.95	12S47GT 1.95	1626 3.00
DAF96 1.00	EBC134 0.80	EL183P 3.50	M8196 5.50	QV07-50 55.00	U801 0.75	2C91 0.75	6A44 2.00	6H6GT 1.95	12S47GT 1.95	1626 3.00
DC70 21.75	EBC135 0.80	EL183P 3.50	M8196 5.50	QV07-50 55.00	U801 0.75	2C92 0.75	6A45 2.00	6H6GT 1.95	12S47GT 1.95	1626 3.00
DC90 1.20	EBC136 0.80	EL183P 3.50	M8196 5.50	QV07-50 55.00	U801 0.75	2C93 0.75	6A46 2.00	6H6GT 1.95	12S47GT 1.95	1626 3.00
DCX4-1000 12.00	EBC137 0.80	EL183P 3.50	M8196 5.50	QV07-50 55.00	U801 0.75	2C94 0.75	6A47 2.00	6H6GT 1.95	12S47GT 1.95	1626 3.00
DCX4-5000 25.00	EBC138 0.80	EL183P 3.50	M8196 5.50	QV07-50 55.00	U801 0.75	2C95 0.75	6A48 2.00	6H6GT 1.95	12S47GT 1.95	1626 3.00
DET16 28.50	EBC139 0.80	EL183P 3.50	M8196 5.50	QV07-50 55.00	U801 0.75	2C96 0.75	6A49 2.00	6H6GT 1.95	12S47GT 1.95	1626 3.00
DET18 28.50	EBC140 0.80	EL183P 3.50	M8196 5.50	QV07-50 55.00	U801 0.75	2C97 0.75	6A50 2.00	6H6GT 1.95	12S47GT 1.95	1626 3.00
DET23 35.00	EBC141 0.80	EL183P 3.50	M8196 5.50	QV07-50 55.00	U801 0.75	2C98 0.75	6A51 2.00	6H6GT 1.95	12S47GT 1.95	1626 3.00
DET24 39.00	EBC142 0.80	EL183P 3.50	M8196 5.50	QV07-50 55.00	U801 0.75	2C99 0.75	6A52 2.00	6H6GT 1.95	12S47GT 1.95	1626 3.00
DET25 22.00	EBC143 0.80	EL183P 3.50	M8196 5.50	QV07-50 55.00	U801 0.75	2C100 0.75	6A53 2.00	6H6GT 1.95	12S47GT 1.95	1626 3.00
DF91 1.50	EBC144 0.80	EL183P 3.50	M8196 5.50	QV07-50 55.00	U801 0.75	2C101 0.75	6A54 2.00	6H6GT 1.95	12S47GT 1.95	1626 3.00
DF92 0.50	EBC145 0.80	EL183P 3.50	M8196 5.50	QV07-50 55.00	U801 0.75	2C102 0.75	6A55 2.00	6H6GT 1.95	12S47GT 1.95	1626 3.00
DF96 1.25	EBC146 0.80	EL183P 3.50	M8196 5.50	QV07-50 55.00	U801 0.75	2C103 0.75	6A56 2.00	6H6GT 1.95	12S47GT 1.95	1626 3.00
DF97 1.28	EBC147 0.80	EL183P 3.50	M8196 5.50	QV07-50 55.00	U801 0.75	2C104 0.75	6A57 2.00	6H6GT 1.95	12S47GT 1.95	1626 3.00
DF97 1.28	EBC148 0.80	EL183P 3.50	M8196 5.50	QV07-50 55.00	U801 0.75	2C105 0.75	6A58 2.00	6H6GT 1.95	12S47GT 1.95	1626 3.00
DM73 1.20	EBC149 0.80	EL183P 3.50	M8196 5.50	QV07-50 55.00	U801 0.75	2C106 0.75	6A59 2.00	6H6GT 1.95	12S47GT 1.95	1626 3.00
DM77 0.90	EBC150 0.80	EL183P 3.50	M8196 5.50	QV07-50 55.00	U801 0.75	2C107 0.75	6A60 2.00	6H6GT 1.95	12S47GT 1.95	1626 3.00
DM79 0.90	EBC151 0.80	EL183P 3.50	M8196 5.50	QV07-50 55.00	U801 0.75	2C108 0.75	6A61 2.00	6H6GT 1.95	12S47GT 1.95	1626 3.00
DM79 1.20	EBC152 0.80	EL183P 3.50	M8196 5.50	QV07-50 55.00	U801 0.75	2C109 0.75	6A62 2.00	6H6GT 1.95	12S47GT 1.95	1626 3.00
DM79 1.20	EBC153 0.80	EL183P 3.50	M8196 5.50	QV07-50 55.00	U801 0.75	2C110 0.75	6A63 2.00	6H6GT 1.95	12S47GT 1.95	1626 3.00
DM79 1.20	EBC154 0.80	EL183P 3.50	M8196 5.50	QV07-50 55.00	U801 0.75	2C111 0.75	6A64 2.00	6H6GT 1.95	12S47GT 1.95	1626 3.00
DM79 1.20	EBC155 0.80	EL183P 3.50	M8196 5.50	QV						

# STRAIGHT &

# LEVEL



## ICOM IC761

Thanet Electronics Ltd have now announced the arrival of the new Icom IC761 HF transceiver in the UK.

This all mode transceiver features an ac power supply and an aerial tuning unit which boasts a 3 second band selection and tune up with a VSR matching of less than 1.3:1.

For the serious operator the 100kHz-30MHz general coverage receiver and 105dB dynamic range make it ideal for DX chasing. Frequency selection is by the main VFO or via the front panel direct access keypad, and for when reception is difficult, passband tuning, IF shift, notch filter, noise blanker, pre-amp and attenuator should enable you to copy even those weak DX stations, whether amateur or broadcast.

The CW operator will appreciate the electronic keyer, 500Hz filter and full break-in (40wpm), other filter options being available. The IC-CR64 high stability crystal is standard, as is the CI-V communications interface for computer control. With twin VFO's and split mode for crossband contacts, the IC761 features program scanning memory scan and mode select scan and the 32 memories can store frequency and mode.

The transceivers operating system is held permanently in ROM and is not dependant

upon the lithium battery; this being used for memory back up only. A new style meter gives PO, ALC, IC, VC, COMP and SWR readings.

This new equipment is fully compatible with existing Icom accessories, such as the IC-2KL 500 watt linear amplifier.

For more information please contact: *Thanet Electronics Ltd, Sea Street, Herne Bay, Kent CT6 8LD. Tel: (0227) 363859.*

## MORSE TUTOR

Technical Software have recently released an improved version of their Morse Tutor program. The program introduces the alphabet in easy stages and has comprehensive facilities for the student to learn the characters by ear. The pitch of the tone used for sending can be varied from the keyboard and, with most computers, the volume also.

Random characters are used for initial learning, and new groups of letters are introduced quickly to allow the student to become fluent in the whole alphabet as soon as possible, which is recognised as the best technique. The program can send any amount the student wishes, at any speed from 1 to 40wpm. The student, therefore, remains in complete control of his or her learning.

It is quite common for

students to have problems with certain individual characters, and to help with this, difficult characters can be typed in and the program will send them more frequently. After each sending run, the copy can be checked so that any problems can be quickly identified and corrected.

As speed increases, the characters are broken up into random length words, to train the student to recognise the inter-word gaps. In order to preserve the rhythm of the Morse, when sending at slow speeds the program sends the character at 12wpm and follows it with a pause of the correct length to achieve the desired overall speed.

When the alphabet has been learnt, the figures are introduced and, if required, common punctuation marks. Again, these are learnt by ear and practised using random characters, though for these the 'word' length is fixed at five characters.

When the student has reached test speed on random characters, he or she can prepare for the plain language test by having the program send the 40 pre-recorded texts supplied with it. It is also possible to have someone type in a text for sending.

The program deliberately omits any facility for the student to send. Computer programs do not teach this

# All the latest news, views, comment and developments on the amateur radio scene

well and unchecked keying is likely to produce bad sending habits which could be difficult to correct later. Using a friend to check sending is preferable.

The program is available for the BBC-B, Electron, Spectrum, CBM64 and VIC20 (+ at least 8K), at £6 on tape and £8 on BBC or CBM64 disc. Owners of the previous program can get a 50% discount by sending their old program in part exchange. The original ZX81-16K program is still available, for a limited period, at £6 on tape.

For further information contact: *Technical Software, Fron, Upper Llandwrog, Caernarfon, Gwynedd LL54 7RF. Tel: (0286) 881886.*

## ASTRID MOVE

Eighteen months ago a revolutionary satellite earth station, ASTRID (Automatic Satellite Telemetry Receiver and Information Decoder) was launched, at an all in price of £149.

The system enabled BBC-B and Spectrum 48K computer owners to automatically access the educational scientific satellites, UoSAT 1 and UoSAT 2, and display the masses of scientific news and data.

ASTRID now works with all the Spectrum computers (48K upwards), all the BBC range (model B upwards), and is still only £149. It even works with the Amstrad range of computers (when the correct Amstrad serial port and a little extra software is used).

With the extra software available for the BBC and Spectrum computers, graphs can be produced from the whole orbit data and the telemetry can be fully decoded without using look-up tables, satellite orbits can be predicted and displayed over maps, and on Spectrums even the UoSAT 1 pictures can be displayed.

During 1986 ASTRID sold by word of mouth only, no money being available from the marketing company for advertising.

However, as ASTRID is sold

via mail order, this lack of advertising was not good for its future. Consequently sales are now handled by the inventors, Sue and Steve Webb of SRW Communications Ltd, from whom full information is available.

Write to: *ASTRID House, The Green, Swinton, Malton, N Yorks YO17 0SN.*

Or alternatively telephone your address to the ASTRID design lab on *Malton (0653) 697513*, for immediate despatch of data sheets.

## DESOLDER BRAID

Cobonic Limited (a Spirig company) are pleased to announce that, after many years of being asked by their customers to produce the world's most often patented desolder braid in longer lengths, 3S-Wick is now available in 15 meter and 25 meter lengths.

The cost per length on this new package has been reduced in comparison to the standard 1 and 5 meter dispenser reels, which are still available.

3S-Wick is characterised by its high heat conductive weaving pattern of the pure copper fibres and its patented coating.

The extraordinary heat-conductivity of the weaving is necessary to quickly draw-off any excess heat from solder-



ing tips, to limit rate of temperature increase and peak temperature level.

For further information contact: *Cobonic Ltd, 32 Ludlow Rd, Guildford, Surrey GU2 5NW. Tel: (0483) 505260.*

## SCANNERS

Link Electronics of Peterborough recently sent in their Tandy catalogue, highlighting the range of programmable and portable scanners.

Manufactured under the Realistic trade name, the range includes: the PRO2004 solid-state scanner; the

PRO2021, which features direct keyboard entry, search and scan in two speeds and covers VHF lo 68-88MHz, VHF Air 108-136MHz, VHF hi 138-174MHz, UHF lo 380-370MHz and UHF hi 470-512MHz; the PRO32 200 channel portable programmable scanner, which covers the same frequencies as the PRO2021; and the PRO31 10 channel programmable scanner.

Further information on price and facilities can be obtained from: *Link Electronics, 228 Lincoln Road, Peterborough PE1 2NE. Tel: (0733) 45731.*



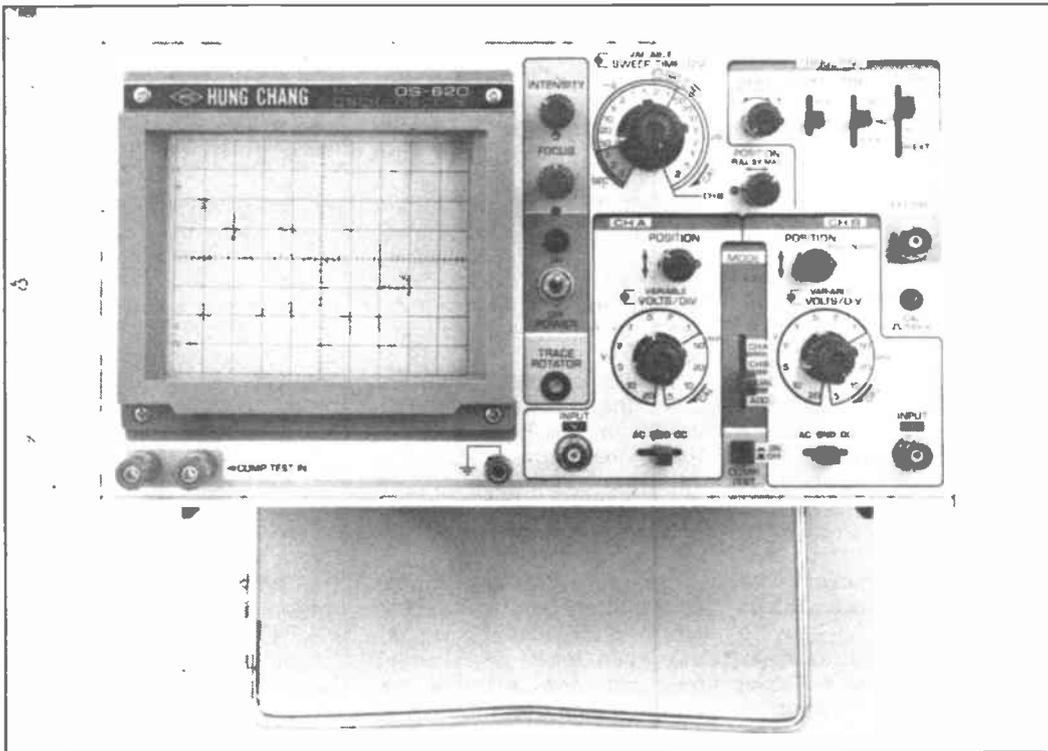

## NEW 20MHz OSCILLOSCOPE

The Hung Chang range of oscilloscopes are now available in the UK.

The first model in the range is the 20MHz OS-620 which includes a component tester. Vertical -3dB bandwidth is dc-20MHz, with vertical amplifier sensitivity of 5mV/div to 20V/div, on each of two channels. Add and Invert functions are also provided.

The Horizontal system provides a timebase of 0.2 $\mu$ S to 0.5S/div in 20 ranges, with fine control and a switched  $\times 5$  magnifier on all ranges. In X-Y mode, the OS-620 uses vertical amplifier B to control X deflection, at full specification. Triggering sources may be internal (channel A or B), external, TV frame, TV line, ac or dc coupled, with manual or automatic level control.

A particularly useful feature of the OS-620 is its component tester, which displays the ac current/voltage characteristic of a component under test, either in or out of circuit. For service departments and field engineers, suspected faults or out-of-range values are quickly revealed without needing removal of the component from the board.

Other features of the OS-620 include a high brightness, flat-face square tube with a graticule of 8 $\times$ 10cm. Z-axis intensity modulation, front panel trace rotate control,

and a calibration signal are also provided. Weight is light at about 7kg, and the unit consumes just 19W from 240V ac supply. The price is £295.00 including probes.

Further information is available from: *Black Star Ltd, 4 Stephenson Road, St Ives, Huntingdon, Cambs PE17 4WJ. Tel: St Ives (0480) 62440.*

## LOW COST TEST GEAR

Scopes, function generators, multimeters and power supplies are among a new range of test and measurement equipment available from Flight Electronics. The units are around 20 per cent cheaper than the same 'branded' units available from traditional sources.

A sole distribution deal with Taiwanese manufacturer GW Instrumentation now allows Flight to directly market these instruments in the UK and Eire. Other equipment includes intelligent frequency counters, audio/RF generators, a distortion meter, ac millivoltmeter, curve tracer, auto IC-tester, and a wide range of accessories, test leads and probes.

The range will be of interest to anyone who has the need for reliable test instrumentation in electronics and electrical production, QA, prototyping, service and education. A range of 26 bench power supplies covers

most user applications, ranging from 18 to 200W, with either single, dual or quadropole outlets. Seven oscilloscope types offer capabilities up to 40MHz dual-beam delayed sweep. Seven function generators are stocked, from basic types to a double-function model with a 0.1Hz to 14MHz range.

For further information contact: *Flight Electronics, Ascupart Street, Southampton SO1 1LU. Tel: (0703) 227721.*

## AUDIOKITS

Audiokits have introduced two new audio amplifier kits to their range.

The PE 30+30 is a slimline

integrated amplifier which incorporates tone controls, two tapes with dubbing both ways and a switched mike socket. The kit costs £140.

The Everyday Electronics Apex preamp and power project is expected to be available shortly.

Audiokits have also introduced a range of bulk foil resistors which are manufactured to high standards of accuracy with low internal capacitance and inductance and a very low temperature coefficient.

Further information is available from: *Audiokits, 6 Mill Close, Borrowash, Derby DE7 3GU. Tel: (0332) 674929.*

## ELECTROSTATIC PROBLEMS

Conductive wriststraps are used to drain off electrostatic charges from operators handling static sensitive electronic components. This prevents damage of very expensive parts in almost all cases.

Wriststraps can be, depending on their design, quite an annoyance to their users and can lead to them disregarding the antistatic precautions in force, but the Wristex by Cobonic features a flexible and skin-friendly wristband. The snap fastening can be rotated 180 degrees and incorporates in the mould a 1 megohm protection resistor.

The highly flexible, coiled cord extends easily from 60cm unstretched length to a full 180cm length, without significant force. The Wristex costs £8.50.

For further information contact: *Cobonic Ltd, 32 Ludlow Rd, Guildford, Surrey GU2 5NW. Tel: (0483) 505260.*

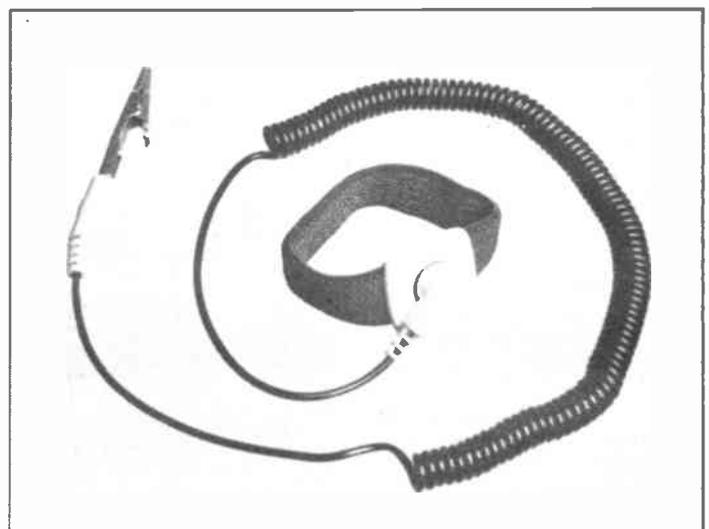

## CLUB NEWS

### Big Brother's watching

In 1986 the Department of Trade and Industry's Radio Investigation Service (RIS) contacted some 60,000 radio users about the licensing requirements of their radio transmitters and problems concerning reception and interference.

Much of the RIS's time is taken up inspecting stations and advising users on their operation. In 1986 over 10,000 new and established private mobile radio transmitter base stations were checked.

Many installations were found to deviate in some respect from the licence conditions imposed to prevent users causing each other interference. Most of these problems were solved by the licensees responding to RIS advice and without disrupting services.

Under the Wireless Telegraphy Act 1949, unlicensed radio users can face fines of up to £2,000 and/or three months' imprisonment.

The courts can also order forfeiture of the equipment used in the offence. During the year the RIS issued 2,800 formal warnings about unlicensed radio use, mainly to users of Citizens' Band radio, illegal cordless telephones, private mobile radio and marine radio. Continued unlicensed use resulted in 727 convictions, of which 601 were for CB misuse, 18 for the illegal use of mobile radio and 16 for the use of unapproved cordless telephones.

The RIS carried out 209 raids on 70 unlicensed 'pirate' broadcast stations and during the year 74 people were convicted for illegal broadcasting.

In addition to ongoing work, the RIS carried out two nationwide campaigns to counter licence evasion and abuse of marine radio and Citizens' Band, during which a total of 19,200 users were contacted.

Almost 5,000 reports from householders concerning

television and radio interference and reception problems were dealt with during the year—a £21 charge is made to diagnose individual reception problems.

Some 2,600 reports of interference and reception problems from business radio users were also handled by the RIS, the latter on a consultancy basis.

### Transistor testing

The Kanga Gang are a group of amateurs in the Dover area who love construction, and wish to share their love of this part of the hobby with our readers.

Everyone involved in the amateur world has a 'junk-box', and what you find in it usually reflects the mind of the collector. Some keep bits in the hope that they 'may be useful' or 'too good to throw away'; others keep a list of parts for a project in mind.

Almost all avid collectors have a few transistors scuffling about that they don't have a clue about.

The purpose of this short piece is to enable the home constructor to not only tell if the rogue transistor is PNP or NPN, but to see if it works.

The circuit (see Figure 1) is

no stranger to those in the know, and it is not considered original. The suspect transistor is plugged into the tester and by pressing the test button it can be seen if it works. If nothing is seen throw switch S1 from PNP to NPN, if it then shows a gain then you know what type of transistor it is. If still nothing happens, try the 500/100 switch. If the meter still remains dead file the transistor in the bin.

Should the meter go hard over, then switch to 500 to decrease the base current. Remember, juggle with all the switches until you get a reading. Some very high gain units may require the  $\times 10$  button to be pushed.

I am sure that most home constructors have most of the bits available in the 'junkbox', but even when purchasing new components the whole unit in a nice box should still cost under £5.00.

The meter is anything available that covers approximately  $200 \mu\text{A}$  (often you can use an old CB SWR meter). The components required are: a  $\frac{1}{4}$  watt resistor; S1, double pole, double throw; S2, single pole, double throw; S3/S4, single pole, push to

make; and SK1, a transistor socket.

Construction is very easy and the unit can be made on a 1in square piece of Veroboard. The battery is 9 volt.

For those who do not wish to go to the trouble and expense of the transistor tester, you can also check them with a multimeter.

If the type of semiconductor is known, make reference to a book to find which is the base, collector etc. Then with the AVO etc, set to the ohms range (ie applied voltage of 1.5 volts). Voltages in excess of 5 volts may cause failure of the base emitter junction, so take care.

Assuming that you have located which leg is the base (remember that with an AVO-meter used for continuity checking, the red lead is negative), connect the red lead to the base and the black to one of the other two. If the meter shows a high resistance then the transistor is most likely to be an NPN. If the resistance is low, the transistor is most likely to be PNP.

The checking diagram (see Figure 2) gives a much more detailed explanation. Best of luck, and happy testing.

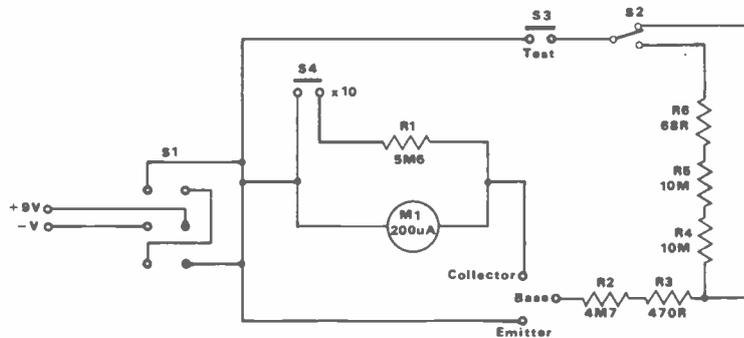

Fig 1 Transistor tester circuit diagram

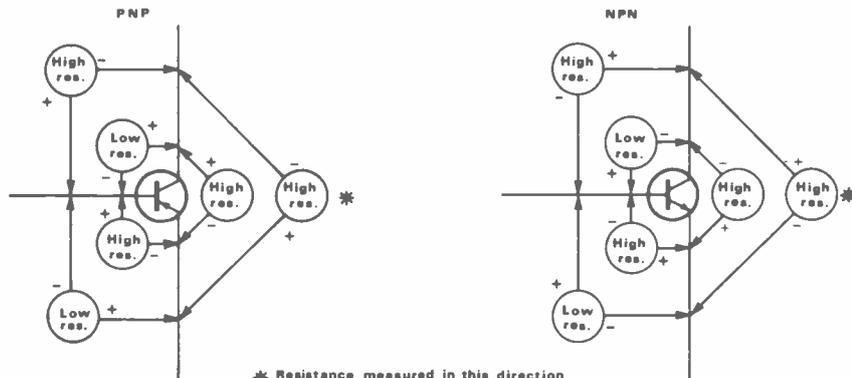

Fig 2 Checking procedure diagram

## Swansea Rally

The Swansea Amateur Radio Society Rally is being held on Sunday, 3rd May in the Patti Pavilion, adjacent to the County Cricket Ground, on the Swansea to Mumbles coastal road (A4067).

The rally will include the usual trade stands, bring and buy, Morse test facilities (pre-book with the RSGB), and refreshments. There will also be a free 'lucky programme' draw. Doors open from 10.30am-5.00pm, and further details are available from the rally secretary, Roger Williams GW4HSH, on (0792) 404422.

## Mid-Ulster Rally

The Mid-Ulster Amateur Radio Club (G13VFW) meet on the second Sunday of each month (except July and August) for 3.00pm at the Guide Hall, Castle Hill, Gilford, Co Down. There is usually a talk of interest to radio amateurs and everyone is welcome.

The annual club rally is on Sunday, 17th May at the usual venue; Parkanaur House, near Dungannon on the Ballygawley Road. There will be the usual trade stands, bring and buy stall, RSGB bookstall and QSL bureau stand and talk-in on S22 145.550MHz FM.

Doors open at 12.00 noon and the entrance fee is £1. The entire proceeds of the rally go to the Stanley Eakins Memorial Fund, so they are hoping for a good turn out to support this worthy charity.

Further details can be obtained from Sam White G11BIW, tel: (07622) 22855.

## Denby Dale Rally

The annual rally organised by the Denby Dale and District Amateur Radio Society will be held on Sunday 21st June at the Shelley High School, five miles south east of Huddersfield on the B6116.

The usual trade and club stands will be in attendance, in addition to a bring and buy, a lucky draw, children's entertainments and good food.

Doors will open at 11.00am (10.30am for the disabled), and talk-in will be available on S22, SU22 and 10FM. Further details are available from G3SDY on (0484) 602905.

The club meets every Wednesday evening in the Pie Hall, Denby Dale, Huddersfield, and events lined up

include noggins and natter nights, surplus sales and quiz nights. Further details on membership and club activities can be obtained from G1MOZ on (0484) 686573.

## RNARS Rally

The Royal Navy Amateur Radio Society hold an annual rally, which this year will be held on Sunday 14th June at HMS Mercury, East Meon, Petersfield, Hampshire.

In addition to presenting a wide variety of attractions and trade stands for radio amateurs, many other kinds of goods, including toys, costume jewellery and novelties, will be there to attract the whole of the family. Rides and amusements for children, exhibitions and demonstrations of crafts, archery, vintage steam machines and fire engines, radio controlled model power boats, trains and racing cars should provide something of interest for everyone.

Refreshments will be on sale throughout the day and talk-in will be available on both 2m and 70cms.

Further details are available from Cliff Harper G4UJR, 34 Neva Road, Bitterne Park, Southampton, Hants SO2 4FJ. Tel: (0703) 557469.

## West Kent Rally

The West Kent Amateur Radio Society are holding a rally on Sunday, 6th September at the Angel Centre, Tonbridge, Kent.

In addition to the many trade stands, various club stands, a bring and buy and a stamp fair will be in attendance. Doors will open at 10.30am and free parking and talk-in on S22 and SU8 29500MHz will be available.

Further details can be obtained from G4KIU QTHR, tel: (0892) 515678.

## Booking for the future

The Bridgend and District Amateur Radio Club Rally will be held at the Bridgend Recreation Centre, Angel Street, Bridgend, Mid-Glamorgan on Sunday, November 15th. Doors will open at 11.00am, but disabled visitors will be able to gain access to the rally at 10.30am.

Free car parking will be available, in addition to the usual bring and buy stands and Morse testing facilities. However, those wishing to use the Morse test facilities

should book through the RSGB in the usual fashion. Talk-in will be on S22.

Further details are available from GW1OUP QTHR, tel: (0656) 723508.

## Welsh Islands expedition

The Newport Amateur Radio Society (GW4EZW/GW1NRS) are at it again. After the successful trip to Lundy in September 1985 (will they allow them back?) a group of 15 members will attempt to activate, for the first time, three islands off the Dyfed coast on 160-10m and 144.432MHz, during the first week in August.

The three islands are: GB4WIE Skokholm (WAB SM70); GB2WIE Skomer (WAB SM70/71); and GB0WIE Grassholm (WAB SM50/60). The Maidenhead locator is IO71 (Old XL).

The main operation will take place on Skokholm, which will be the base for one week. On Monday 3rd some of the group will be taking the boat to Grassholm for a maximum of 1½ hours operation, and will concentrate on the HF and VHF nets of WAB. GB4WIE will act as the Net Controller to speed up the contacts via a list. Please let the group work the list first before opening to all others. For WAB members, signal reports only please.

Later in the week another trip is planned to Skomer, where the operation will be for approximately 8 hours (batteries allowing). Again GB4WIE will act as Net Controllers.

As with their previous expeditions, you will be given a signal report and a serial number, which is the number of the contact on that band, and this time QSL cards will be written as they go along. Please mark your card to them with the contact number to make checking easier.

An award will be available on their return for either working them on all three islands, or for working 3 different operators irrespective of call sign. Just send details of the call signs and serial numbers. The cost of the award will be £1.00 or 4IRCs to help us towards the costs of approximately £2,000 for the whole party, and to help towards the next expedition.

Skeds can be arranged via GW6ZUO QTHR, or via NARS,

PO Box 33, Newport, Gwent, which is also the address for the award or QSLs direct.

The group should be able to hear you and are looking forward to working as many readers as possible, but please be patient through the expected pile-ups.

## GB4SVC

The Spenn Valley Amateur Radio Society will be using the call sign GB4SVC from the summit of Pen-y-Ghent in North Yorkshire on Saturday, 16th May. Pen-y-Ghent is 680m asl and in IO84 with WAB SD87NY.

Operation will be on 2 metres and 70cm multimode and 10 metres FM. They will also be active on the evenings of Friday 15th and Saturday 16th, when HF will also be used from the base camp at Little Stainforth. Talk-in for possible visitors will be on S23, the club's net frequency.

Further information and sked details are available from G3SVC, c/o the Old Bank Working Mens Club, Old Bank Road, Mirfield, West Yorkshire.

## GB6BH

The special event station GB6BH will be operating from the Barlborough Hall, near Chesterfield for a 24 hour period, from 13.00hrs GMT on the 4th July. The station is being sponsored for each contact made during this period, and all funds will be awarded to the Barlborough Hall Appeal.

Each contact will be QSL'd and simultaneous operation will take place on 80m, 20m, 2m (FM), 2m (SSB) and 70cm (SSB, FM and RTTY). Equipment is being loaned by SMC (Jack Tweed) Ltd, and the station will be on the air from the 9th June for 'general nattering'.

Further details are available from Rev P McArdle G0DAG QTHR.

## SKE 87

The Edgware and District Radio Society are holding their Sixth Straight Key Evening on Friday, 29th May from 1900BST on 80m CW around 3.550MHz.

The evening is intended to provide an enjoyable evening on the key for all CW operators, and to encourage new A licensees to put their Morse on the air. Whether your CW is on the nursery slopes or

glides easily through the tightest gates, SKE is for you (Yuk! - Ed).

The Edgware Club will again be running GB2SKE and look forward to working old friends and making new ones.

Your views and comments will be most welcome by John Bluff G3SVE, 52 Winchester Road, Kenton, Harrow, Middx HA3 9PE, from whom further details are available.

## Morsum Magnificat

Since the first issue of *Morsum Magnificat* last October, a very good response has been received from Morse enthusiasts around the World, who have welcomed the opportunity to have a quarterly journal devoted exclusively to their favourite mode.

Most of the articles published are of English language origin (UK, USA, Canada and Australia etc), but there are also articles translated from the Dutch edition of *Morsum Magnificat* originating from a number of European countries.

This truly international background demonstrates how much in common Morse operators around the World have with each other. The difference between *Morsum Magnificat* and other Morse publications, however, is that it is available to all Morse enthusiasts, beginner or veteran, no matter what their operating ability.

It is not necessary to belong to any organisation whatsoever. The only qualification for a reader of *Morsum Magnificat* is that he, or she, must like Morse operating!

For further information on how to get your copy, send an SAE to Tony Smith G4FAI, 1 Tash Place, London N11 1PA.

## QTI-TNA new equipment

QTI-TNA, the talking newspaper for blind radio amateurs world-wide, took delivery of a Telex 1-3 mono high speed copier at the end of February. This machine, which copies both sides of a C90 tape in just over 2 mins in batches of 3, cost £1700 and is the second new copier that the association has bought.

The funds were raised over the past four years at rallies and through the Worked All Britain Group, RNARS, RAFAS and many other clubs and individuals.

The copier will be known as the Rod Young copier, in memory of the first treasurer of QTI who died unexpectedly on February 27th this year.

QTI-TNA is a registered charity providing a fortnightly magazine to visually handicapped amateurs and SWLs in IARU region 1, and a monthly technical magazine world-wide. Donations and new members are always welcome.

The magazine is now searching for a volunteer, skilled in physics and maths, to read those articles involving complex formulas and Greek letters!

QTI-TNA can be contacted at: 2 Cartmel Walk, North Anston, Sheffield S31 7TU. Tel: (0909) 566301.

## AMRAC

AMRAC, the national Amateur Radio and Computer Club, has revised its member-

ship subscriptions. With effect from 1st May the subscriptions will be: UK - £8; Europe - £10; and the rest of the world £12.

AMRAC produce a bi-monthly 40 page newsletter, *AMRAC User*, which covers all the latest news, ideas and technical items on Packet Radio, as well as coverage of AMTOR and RTTY. In addition to the newsletter the club also produce a 'Hot-news sheet' in the alternate months, to ensure members are kept right up to date.

AMRAC is keen to encourage the formation of local AMRAC groups, which hold regular meetings and promote digital communications at a 'grassroots' level. Such groups have already been formed in Hampshire, the Thames Valley, and Essex, and it is hoped that many more will be formed around the country.

Further details on the club may be obtained by sending an SAE to the secretary: Phil Bridges G6DLJ, AMRAC, PO Box 39, Hythe, Hants SO4 6WY.



## AX.25 PACKET RADIO

Your gateway to the network



**New MFJ-1274 lets you work VHF and HF packet with built-in tuning indicator for £189 ...**

... you get MFJ's latest clone of TAPR's TNC-2, TAPR's VHF/HF modem and built-in tuning indicator that features 20 LEDs for easy precise tuning

**Pac-Comm TNC-220 £149 KIT £169 ASSEMBLED**

The TNC-220 is a newly designed successor to the TNC-200 and other TNC-2 "clones", giving more features at lower cost. It uses a single-chip modem that is software switchable between two radio ports, conveniently supporting both VHF and HF packet

operation. Each of the TNC-220 radio ports may be configured with jumpers for 300 or 1200 bauds. Switching between ports is entirely done in software and no cable changing, no switch setting and no retuning is required! Both ports have provision for

an active bandpass filter to optimize HF operation, one filter is standard. An optional tuning indicator will mount inside the cabinet. A standard modem disconnect header is provided to allow the use of accessory high-speed or satellite modems.

**HAVING PROBLEMS TUNING HF PACKET? NEW MFJ 1273 Tuning indicator £49.00 Built Fits all TNC 2 clones**

## G WHIPS HF + VHF Aerials

AMDAT now stocks the full range of G Whip aerials which includes NEW Compact 8 band HF Base Station antenna £97.50 + PP  
NEW Lightweight 2 metre Base Station antenna £44.75 + PP

Come and see us at Drayton Manor Rally and Plymouth

# AMDAT

Crofters, Harry Stoke Road  
Stoke Gifford, Bristol BS12 6HQ  
(0272) 699352/559398



## TX-3 RTTY/CW/ASCII TRANSCIVE

All the features you've ever wanted in this really top class program. Some of the facilities are:

Split-screen, type-ahead, receive screen unwrap, 24 large memories, clock, review store, call sign capture, RTTY auto CR/LF, CW software filtering and much more. Uses interface or TU. For **BBC-B** and **CBM64**. Tape £20, disc £22. For **VIC20** we have our RTTY/CW transceive program. Tape £20.

## RX-4 RTTY/CW/SSTV/AMTOR RECEIVE

This is still a best-selling program and it's easy to see why. Superb performance on 4 modes, switch modes at a keypress to catch all the action. Text and picture store with dump to screen, printer or tape/disc. An essential piece of software for trawling the bands. **SPECTRUM** needs no hardware, **BBC-B**, **CBM64** and **VIC20** need interface. Tape £25, BBC or CBM64 disc £27.

**TIF1 interface** has 2-stage RTTY and CW filters for improved reception and transmit outputs for MIC, PTT and KEY. Kit £15 (assembled PCB + cables and connectors), or ready-made £25 in a box with all connections. Extra MIC leads for extra rigs £3 each.

**BBC World map and locator** shows daylight and darkness zones and realtime clock updated as program runs. Accepts input of lat/long, QTH or Maidenhead locator, NGR or one of 245 placenames. Prints distance, bearing, VHF contest score and long path details. Plots distant station and great circle path on map. Runs on **ELECTRON** also. Tape £7, disc £9.

For **CBM64**, **VIC20**, **SPECTRUM** we have our original locator program (no map, NGR or placenames) tape £7.

**Morse tutor** is now fully revised with every feature to learn morse the quick and easy way. Graded learning for beginners and 40 plain language texts for test preparation. Tape £6 for **BBC-B**, **ELECTRON**, **CBM64**, **VIC20**, **SPECTRUM**. The original **ZX81-16k** program is still available at £6.

**Logbook** date, band, mode, call and remarks for all your contacts. Easy to use, printout to screen or printer, callsearch. For all the above computers, tape £8.

**RAE Maths** All the practice and testing you need for the exam. For all the above computers inc **ZX81-16k**, tape £9.

All BBC and CBM64 programs are available on **disc** at £2 extra. All VIC20 programs (except locator) need expansion.

Prices include VAT and p&p, 1st class inland, airmail overseas, normally by return. Eire, CI, BFPO deduct 13%.



## technical Software (AR)



Fron, Upper Llandwrog, Caernarfon LL54 7RF. Tel: 0286 881886

# L·E·T·T·E·R·S

## FACT OR FICTION

It has been apparent for some time that the policy of the RSGB Council has been one of revealing as little as possible to the members. Not only are the reports of Council Meetings censored to conceal what is really happening, but the accounts are also being kept deliberately vague. As far as the Council proceedings are concerned, it is evident that commercially sensitive matters should be omitted. I challenge the 1987 President to allow the 1985 and 1986 minutes to be compared with the Council proceedings, as published in *Radio Communication*, by an independent person, such as the Editor. Of course I do not expect the challenge to be taken up because it would be too embarrassing.

I would emphasise that I am not suggesting anything improper with regard to the accounts, but that members are not being given as full a picture as they are entitled to. At the 1985 RSGB AGM a breakdown of the committee expenses was requested and it was stated that these would be forthcoming. Some nine months later a note appeared in *Radcom* from the Finance & Staff committee stating that it 'was not the committee policy to publish these figures'. At the 1986 AGM the question was again raised and a similar assurance was given that the figures would be made available. On the day following the AGM I wrote to the Honorary Treasurer requesting the figures. As might be expected I have not even received an acknowledgement, much less a reply. At the meeting the Honorary Treasurer was asked whether the 1986/87 budget showed a surplus or deficit. The reply was a classic - 'I have two budgets; one shows a surplus and the other shows a deficit'. The policy of being 'economical with the truth' is obviously not confined to Whitehall.

**PL Crosland G6JNS,  
Worcester**

*A copy of Mr Crosland's letter was forwarded to the RSGB. Mr Angus McKenzie kindly supplied the following reply.*

*I am most concerned to see Mr Crosland writing a critical letter yet again, and felt it appropriate to reply, especially as I have already discussed many of his views with him personally at my home during 1986. Other members of Council have also given up a considerable amount of time to Mr Crosland, but there comes a point where one wonders if it is fair to 37,000 other members that so much time should be spent in answering the questions of one member, rather than carrying out additional work more promptly for so many others.*

*I cannot speak for Council in 1985, since I was not elected until December of that year, but I do remember commenting some years ago at an AGM that Council should be trusted more, especially by the vocal minority who seem to criticise so frequently. This was before I ever anticipated standing for Council, and now that I have been on it for over a year, I consider it a pretty good bunch of members, containing a very considerable amount of expertise of all kinds.*

*I am myself quite stunned that Mr Crosland seems to imagine that Council is trying to hide all manner of subjects from members. This is most certainly not true, but perhaps he does not appreciate that much of Council's business is frankly quite boring, though important, and I am sure that members are not interested in who said what, and the lengthy details of how the solution was arrived at. It is the solution that is important, and any implications resulting, which all have to be considered. Some Council meetings are eight hours long, and few are less than six hours (excluding the lunch break).*

*In looking over Council proceedings published in *Radcom*, and comparing these with the minutes, and my own memory, I just cannot see any trace of concealment, nor of Mr Crosland's outrageous suggestion that the RSGB is 'economical with the truth'. What I do see is a worthwhile summary of what*

*could become extremely boring if published with minute details of who said what in arriving at a democratic solution. A transcript of a typical Council meeting would occupy some 18 pages of small print in *Radcom*, and would mean that regular articles etc would have to be severely curtailed or omitted.*

*The situation about the accounts published in *Radio Communication* is exactly the same, and the Council feels, as does the Finance and Staff Committee, that more than enough detail is already published. One could of course fill an entire issue with extremely detailed accounts for the year. Mr Crosland seems to require not only the individual expenses of each committee (which he has already been sent by David Evans, the Chief Executive), but of each member of each committee. Each chairman is responsible for individual member's expenses, and the Finance and Staff Committee is responsible to Council for ensuring that committee expenses are kept within pre-determined budgets.*

*There are many members of committees and of Council who hardly ever claim expenses, whilst there are others who have to travel a very long way to attend meetings, and would be seriously out of pocket unless they could claim reasonable expenses. Not only would even closer reporting of committee expenses be far more costly to enact, but I know for a fact that there are Council and Committee members who do not normally claim any expenses and who would refuse point blank for this fact to be made known to members, as it might embarrass others. One such member has stated at Council that he would immediately charge all expenses in future if there was an insistence on the publication of individual expenses.*

*There are obviously just a few members who feel in sympathy with Mr Crosland, and about 4% of the RSGB membership indeed voted for him in last year's Council ballot. However, 96% either voted for someone else, or*

*did not feel strongly enough to vote at all. I am thoroughly satisfied that Council is acting democratically, and please don't forget that for someone to sit on Council, and accept the enormous amount of work that has to be done, means that he or she is not only dedicated to amateur radio, but to the RSGB and its members.*

## UNFAIR TRADING

I am writing to inform you of a fraudulent advertisement which appeared in your Free Classified Ads section of the magazine. However, I fully realise that you cannot take any responsibility for this, as you accept all adverts 'in good faith'.

The advert in question was for a Yaesu FR7700, which appeared in the February issue. The advert stated that the rig had a 'fitted memory' and was priced at £300.

I have today received the radio in question, only to find that there is no memory unit fitted. I have contacted the advertiser who claims he has used the memory, even though it isn't fitted.

I have contacted the Fair Trading Office and they have advised me to write to the advertiser, by recorded delivery, asking for a repayment of the original price. If this is unsuccessful they have suggested that I take the matter to the small claims court, which I shall do if necessary.

The recognised price for the 7700 without the memory unit is £250, so I feel the £50 difference is worth taking the trouble for.

**Mr D J Howes, Rochester**

*Unfortunately we do not have any means of checking on readers using the Free Classified Ad service, and occasionally something of this nature occurs.*

*It's always a good idea to view the goods advertised before parting with your hard earned money, and checking that the equipment is being sold 'as advertised'. However, this is not always possible, and if any readers have similar problems we would be pleased to hear about them.*

# ... STOP PRESS ... AMATEURS HELP IN VANUATU DISASTER ...

On Sunday 8th February, news reached Australia that a cyclone had hit Port-Vila, capital of Vanuatu, formerly the New Hebrides. The extent of the disaster was then unknown, although later reports estimated damage totalling some \$200 million, with further unknown damage in the Southern Vanuata Islands.

Hearing this news, Sam Voron VK2BVS, co-ordinator of the Australian Traffic Network, monitored 14MHz for amateur transmissions from Vanuatu. Within thirty minutes he was in contact with Gaetan YJ8LT, whose native language was French. An English speaking non-amateur was put on the microphone who reported that a major disaster had occurred, with '200km winds last night and everything wiped out.'

VK2BVS immediately offered the help of Australian amateurs, 1) by monitoring the frequency 14.307MHz, and taking emergency traffic, and 2) by activating nationwide third party traffic handling resources as soon as a temporary third party amateur radio agreement could be concluded between the two countries. This would allow members of the public in Australia and Vanuatu to exchange health and welfare messages via amateur radio. As it was Sunday, however, no appropriate government department in Australia could be contacted, and for the time being life and death emergency messages could only be legally accepted from the stricken island.

On Monday 9th February, Australian amateurs, through VK2BBT, sought approval from the Department of Communications for a temporary third party agreement with Vanuatu without success. In Vanuatu amateurs could find no official with whom they could place a similar request. The following day the Department of Foreign Affairs suggested to the DOC that the situation was so serious that an immediate temporary agreement was advisable.

Many Australian amateurs were now on the traffic net, taking time off from work to be available to respond whenever they were required. Links were maintained across Australia and with New Zealand, Hawaii, USA, Canada and Israel.

VK2BVS initially telephoned amateurs in Israel, Canada and USA to let them know about the disaster. As a result of information from KB7FE, the American media learned of the gravity of the situation and reported how amateurs were helping. In London G4FAI informed the RSGB of the involvement of amateurs in the disaster in the hope that this could be properly publicised, but this does not seem to have been followed up.

By linking up with countries with which they already had third party agreements,

Australian amateurs were in a position to relay messages through those countries to others which had third party agreements with the relaying country. The USA, for instance, has agreements with over 40 countries.

And so, for ten days, a vast emergency network was set up to pass health and welfare enquiries and information about friends and relatives to and from Vanuatu. Radio stations in the US broadcast the telephone numbers of amateurs who could take messages from Vanuatu. 4Z40X provided a link for the Israeli Department of Foreign Affairs, passing traffic on the Australian/Israeli network which was routed through the trans-Australia net and onto the Australia/Vanuatu net.

The Australian media also publicised amateurs' telephone numbers, as did the Red Cross and the DOC. The Australian Associated Press and the broadcasting authorities fed information to all radio, TV, and print media, resulting in widespread publicity about the international work of amateur radio in a crisis situation.

Radio Vanuatu, which had initially been put off the air by the cyclone, put out regular bulletins telling listeners how they could get messages to Australia and elsewhere via amateur radio. As the public telephone system was out of action, they were advised to go to a general store in the centre of Port-Vila. Here, radio amateurs posted up messages received and the store's owner, Robert Laelie YJ8VRL, helped the public compose their amateur radiogram messages for transmission to other countries.

To begin with, only two operators were able to keep in touch with the outside world. Most YJ8 amateurs are associated in some way with electronics professionally, and their immediate task was to help get the city back into operation. YJ8JG, for instance, is a computer expert, and he was trying to get the country's banking system working again. YJ8JH, President of Vanuatu ARS, was deeply involved in air traffic control. All available members of the Society helped in many stricken areas, however, and as the days passed more were able to assist in the welfare communications work. In Australia, VK4BWR offered to go to Vanuatu, taking equipment loaned by amateur retailers, but as more operators became available in Port-Vila the need for outside help lessened.

The Australian geoscience research vessel, *United Venturer*, in Fiji, carried a helicopter and was ideally fitted for survey and relief work. Using its satellite communications, its offer to assist Vanuatu was received, but no-one was available to reply. VJ80K personally took

the offer to the President whose reply came back on 14MHz, 'Please come urgently and immediately'. Eight days after the cyclone, the *United Venturer* was the first foreign vessel to arrive in Port-Vila. As they neared the coast, VK2BPW/MM, the amateur station on board the ship, described the scene of utter devastation which greeted them.

On Wednesday evening H44AF, in Honiara, offered communications facilities to the Solomon Islands Red Cross. Once again there was no third party agreement with Australia. Next day a Solomon Islands official telephoned the DOC in Canberra and gave verbal authority for a temporary agreement. At times neither Australia or the Solomons could not hear Vanuatu, but as a result of the new agreement each was able to relay traffic on behalf of the other into Vanuatu.

Once again amateurs have demonstrated that they can provide assistance for emergencies occurring thousands of miles away. People in one part of the world often have links with other parts and sometimes there is a particularly strong bond between whole communities on one side of the globe and the other.

Amateur radio has a world-wide facility which is not fully exploited in this connection, and agreements are needed in advance to avoid bureaucratic delay when an emergency occurs. Australian amateurs have demonstrated to us the value of third party communications, plus the bureaucratic pitfalls. They had actually obtained agreement in principal with Vanuatu for a third party agreement last year, but the paper-work had not been exchanged.

Following the emergency it is expected that the temporary agreements with Vanuatu and the Solomon Islands will become permanent. In the meantime, Australia will continue seeking agreements with other countries so that eventually there can be a world-wide amateur emergency network providing health and welfare traffic for the general public whenever needed.

Where the UK will stand in this is another matter. We don't have third party privileges to begin with, and the RSGB seems unwilling to air the matter, having recently refused to allow a discussion paper on the subject to be published in *Radio Communication*. Meanwhile, we can only admire our VK friends, the amateurs in Vanuatu, and those in all the other countries who joined in, and congratulate them on another fine effort on at least a semi-global basis! *This report was prepared by Tony Smith G4FAI, based on information provided by Sam Voron VK2BVS, a co-ordinator with the Australian Traffic Network.*



# CAP CO ELECTRONICS LTD

63 Hallcroft, Birch Green  
 Skelmersdale, Lancs  
 WN8 6QB  
 Tel: 0695 27948

**Stay Tuned Forever with a Cap.Co ATU —  
 Once Bought — Never Replaced**

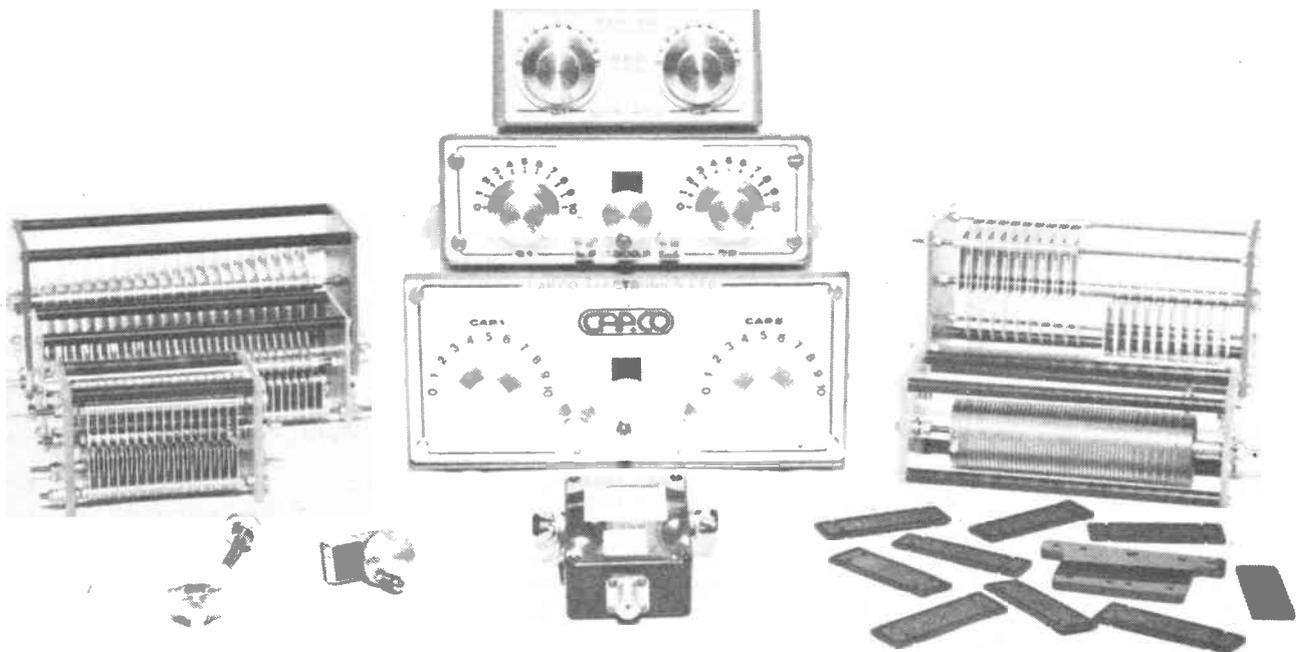

### Special Features of CAP CO HF ATU's

- ★ Renowned SPC transmatch circuit
- ★ CAP CO innovative modular design eliminates stray inductance
- ★ Unique built-in lightning protection
- ★ Roller Coaster Inductor – infinitely variable
- ★ Balun built in 1Kw 4 to 1
- ★ Transmitter switch, THRO ATU or DIRECT to antenna

- ★ Unsurpassable transmission strength and clarity
- ★ Solid, traditional precision radio engineering – Lifetime Investment
- ★ Superb ultra compact cabinet design
- ★ Superlative finish and looks compatible with most rigs
- ★ Will tune any Transmitter/Aerial combination to optimum

### Special Features of CAP CO VHF ATU's

- ★ Will tune Co Linear aeriels and VHF beam aeriels
- ★ Tunes existing HF & Dipole arrays for use on 144-145Mhz

- ★ Solid Die Cast cabinets
- ★ ATU used very low loss ceramic silver-plated capacitors

### Special Features of CAP CO Capacitors

- ★ Endplates made of epoxy random weave glass
- ★ Capacitor plates stamped from NS4 alloy sheet

- ★ All other metal work machine quality brass
- ★ Totally insulated – a must when carrying very high voltages

All our range of equipment including Baluns, G40GP Aerial Kits, Roller Coasters, etc, is British workmanship of Superb Quality.

Antenna Tuning Units, Capacitors, Roller Coasters and Baluns can be made to your own specification – Commercial or Military use.

### PRICES – CAPACITORS

<b>+2.00 8kv 2.5mm plate spacing</b>	
CAP-25S S.GANG 250 pfd .....	£15.50
CAP-25T T.GANG 250 pfd .....	£18.95
CAP-10S S.GANG 500 pfd .....	£21.95
CAP-25D DIFF 500 pfd .....	£18.95
<b>+2.50 12Kv4.5mm plate spacing</b>	
CAP-31S S.GANG 250 pfd .....	£17.95
CAP-31T T.GANG 250 pfd .....	£22.95
CAP-12S S.GANG 1200 pfd .....	£25.95
ROLLER COASTER +2.00 .....	£22.95
<b>28 micro henries</b>	
BALUNS 4:1, 1:1 +2.00 .....	£15.50
<b>Fully encapsulated</b>	
AERIAL KIT +1.00 .....	£5.30
<b>Clip-on Spreaders</b>	
TURNS COUNTER +1.00 .....	£22.50
<b>Digitals</b>	

SPC-300D 1Kw p.e.p.....	£225.00
SPC-300D3Kw p.e.p.....	£325.00
<b>NEW PRODUCT – VHF A.T.U.</b>	
SPC-100 1Kw p.e.p.....	£59.95
<b>LOOP ANTENNA TRI BANDER 160 to 40mts KIT FORM, READY TO ASSEMBLE .....</b>	<b>P.O.A.</b>

**ALL OUR PRODUCTS ARE MANUFACTURED BY US AND ARE THE RESULT OF LENGTHY PERIODS OF R & D AND TESTING. PLEASE DO NOT PURCHASE INFERIOR COPIES HOPING THAT THEY WILL PERFORM TO OUR HIGH STANDARDS. USE CAPACITORS AND ROLLERS COASTERS PROVEN TO WORK, BUY THE BEST – BUY CAP.CO.**

**WE ALSO STOCK INLINE METAL COUPLERS 0.75, FLEXIBLE COUPLERS £2.50 and REDUCTION DRIVES £2.16. PLEASE PHONE ABOVE NUMBER FOR YOUR LOCAL STOCKIST.**

# RSGB

# NATIONAL CONVENTION 1987

When the weather deteriorated to galeforce winds and driving rain, we knew it must be time to go somewhere. Sure enough, it was that time of the year when all parties interested in amateur radio migrate to the centre of the country – the NEC in Birmingham to be precise – for the Radio Society of Great Britain's National Amateur Radio Convention.

The effort, of course, was well worth it. Hall 3A was packed with items of interest and many dreams grew in the minds of enthusiasts about the sophisticated rigs they could use to bring in that elusive DX. Of course, you didn't have to be armed with the plastic to enjoy the exhibition, numerous stands selling intriguing bits and pieces were there to fill everybody's junk boxes. There were also all the specialist clubs and societies in attendance, including the RAIBC (Radio Amateur Invalid and Blind Club), the G-QRP Club, Raynet and AMSAT UK, to cater for those with a particular interest in one aspect of this diverse hobby.

The exhibition was opened by Mr John Butcher, Industry Under Secretary, who gave an encouraging speech for progress in the hobby. He chose the occasion to announce a prize to be awarded by the Department of Trade and Industry, to recognise the achievements of young people in the field.

In recent years there has been a decline in the number of admissions to university electronic engineering

courses, and it is hoped that this award will encourage more youngsters into the hobby, and ultimately further their interest in communications technology. As Mr Butcher said, "today's enthusiasts are tomorrow's technologists".

In the last year several advances have been granted by the DTI to radio amateurs. Class B amateurs can now use Morse code, old call signs can be reclaimed by their original owners, a pass in the Morse test lasts for life and, of course, the use of the 50MHz band was released to Class A amateurs.

Into the bargain, radio amateurs now pay half of what they used to to sit the Morse test and, since the RSGB became responsible for the administration of the test, have far more choice of centres at which to take it.

To keep the momentum of this progress going, Mr Butcher announced that the DTI is looking favourably on Class B access to 50MHz, and that they hope to link 50MHz to access at 70MHz for all amateurs. An extension of the band at 70MHz for both classes is also in the pipeline. Discussions are currently taking place between the DTI and the RSGB, and it is hoped that an announcement will be made in the near future (*watch this space – Ed*).

During the coming year the DTI and the RSGB will also be looking at the current licence. A review is long overdue and it is expected that aspects like log-keeping, the maritime amateur requirements, the place of new technology (such as



Mr David Evans, Mrs Joan Heathershaw and Mr John Butcher

Packet radio) in the licence and the incorporation of the common CEPT licence will be under discussion.

Following Mr Butcher's speech, the Convention got properly underway. The comprehensive lecture programme included talks by some very familiar names to this magazine. Angus McKenzie G3OSS gave useful advice on 'Getting the Best out of VHF', highlighting the importance of good co-ax and connectors, and the difference an extra 15ft on the height of your aerial can make. Don Field G3XTT lectured on 'HF Antennas for the Small Garden', and George Dobbs G3RJV spoke on 'QRP in the Workshop'.

The subject matter of the lecture programme ranged from 'HF linears' to 'Operation Raleigh' and 'Preparing for the Morse Test'. All in all there was something of interest to everyone, whatever their capability.

The traders were very busy, especially on the Saturday when the attendance improved on Friday's figure. Lowe Electronics were proudly exhibiting their new HF125 receiver (reviewed on page 21) and Icom UK were displaying their new range of multimeters (reviewed on page 25). CapCo UK did brisk business with their ATUs, but mixed views were expressed by everybody about the change of days for the Convention.

Until this year the Convention has been held on

the Saturday and Sunday, but due to demands (we are not sure from whom), the days were changed. However, the reduced attendance figures for the first day could have been due to the adverse weather conditions, as much as the fact that it was a weekday. The RSGB did a very good job of organising the Convention, and everybody seemed to approve of the new layout, the wider aisles providing lots of space for those clammering for the best bargains.

Judging by the numbers of amateurs leaving the NEC laden with armfuls of goodies at the end of each day, the RSGB National Amateur Radio Convention was a success in everybody's books.

Here's to the next one.

Things are looking up at Jaybeam



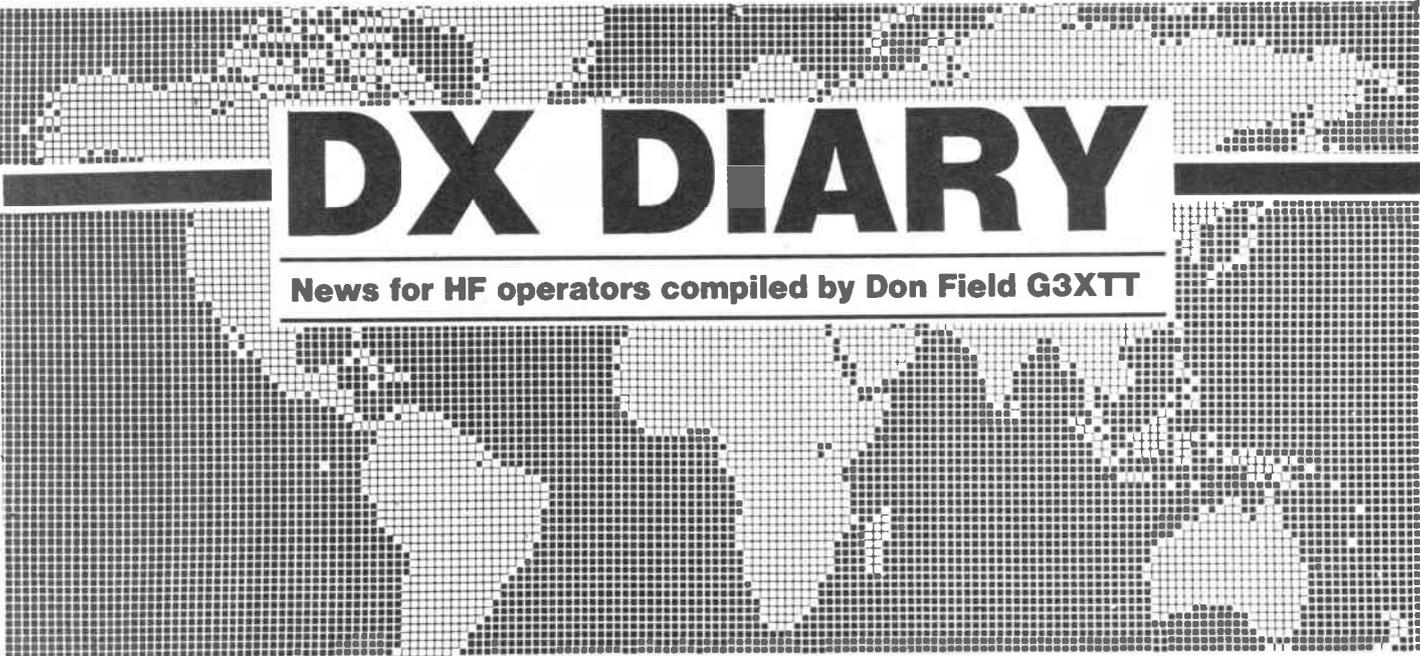

# DX DIARY

News for HF operators compiled by Don Field G3XTT

DXing has always been the elite activity of amateur radio. The earliest amateurs sought to work over greater and greater distances and, in doing so, developed improved equipment and discovered much about antennas and propagation. Over the years the term DX has become embedded into the amateur vocabulary. Rigs and antennas are advertised on the basis of their DX capability; indeed some have the letters DX in their very names. The rig reviews which appear in this and other magazines dwell at great length on intercept points and intermodulation distortion, which would hardly matter for short-distance high signal strength contacts. And yet, in the midst of all this, many UK amateurs on both HF and VHF dismiss DX and DXers as an irrelevance or, worse, polluters of the bands as they chase 'those rare ones'.

## Resentful

I have a sneaking suspicion that those who dismiss DXing and DXers often do so because they are failed DXers themselves. For whatever reason they have failed to make the grade and are now trying to pretend that they were not really worried in the first place. However, I have been struck by the enthusiasm which has attended my talks on 'HF Antennas for Small Gardens', given at various clubs and, most recently, at the RSGB's NEC Convention. I know that many of those who heard me speak are also readers of this col-

umn and I wish all of you well in your endeavours to get the best out of a confined space.

## Frustration

With limited means it can be very frustrating to try and chase some of the difficult DX. The recent VU4APR operation from the Andaman Islands was an example of an operation mounted with the best of intentions, but little know-how, and ended up leaving many frustrated DXers in its wake. In contrast, the 4M0ARV operation from Aves Island in late March was conducted in an extremely efficient manner. There seemed to be no time during the day or night when they were not audible on at least one band, usually with extremely strong signals. As a result, even those with the most modest of stations must have been able to achieve a contact.

Of course, one of the joys of DXing is that time does not stand still. There is always another expedition in the offing, and the country which is elusive today will be the subject of a major operation in the future. This, at least, is the hope which drives the true DX enthusiast and prevents him from taking up golf or some other such more predictable but less exciting pastime (my apologies to any golfers out there!).

During March, in fact, the bands were fairly buzzing with DX, and much of it on the lower bands. One of the great benefits of LF DX is that it makes DXers more equal. Very few European amateurs boast beams on the LF bands,

so those of you with limited space and means can often compete effectively with the best. My 40 metre log for March, for example, includes CW contacts with KC6CS and KC6MX on the Western Caroline Islands, 8Q7QL and 5Z4KG (Lloyd and Iris Colvin on the last two of their stops before returning to the USA), and various interesting Commonwealth call signs in the RSGB's 50th Anniversary Commonwealth Contest. All these were worked on a sloping dipole attached to my tower.

## The wives came too!

There were plenty of others to be worked as well. K1MM, K1MEM, K1ST and their respective wives turned up as TU4A and, later, K1ST/6W1, paying particular attention to the LF bands and putting out some excellent signals, even on Top Band. DK7PE was particularly active from the Gambia as C56/DK7PE, again paying special attention to CW on the LF bands. When I worked him on 80 CW, his signal was fairly weak but easy to copy and he was extremely easy to work, most 80 metre DX enthusiasts seeming to prefer the cacophony at the SSB end of the band.

What the above perhaps emphasises as much as anything, is the value of the CW mode when trying to work difficult DX. The pile-ups are usually smaller than on phone, operator behaviour better than on phone, and the DX easier to copy, especially if you are using a good CW filter in your receiver.

While on the subject of CW versus SSB DXing and the problems which beset the latter, the VU4APR expedition and others have again brought into question just what constitutes a contact. Given that the DXCC awards programme has a vast following of DXers aiming to have two-way contacts with 100 countries or more, it seems surprising that the ARRL fails to define what a two-way contact should actually consist of. When the VU4 was on 80 metre SSB, signals were usually so weak that call signs had to be passed via a master of ceremonies at some intermediate point along the path.

As a result the only true exchange of information was the signal report, counted out slowly at each end to make it as easy as possible to copy. Even so, it was clear that there was a lot of guessing going on, made easier because the VU4 operator seemed to be handing out the same report to almost everybody. I suspect that, as a result, many European amateurs will end up with a QSL card for a two-way contact with a station that they couldn't even hear. If that's what makes them happy, then so be it I suppose. It does make me wonder, though, whether some new approach is required.

Several variations on the theme of signal reports have been proposed at IARU Conferences over the years. All are based on the idea that what we want to pass is information about the strength and readability of the signal. For most DX con-

tacts this is clearly not the case at all. Take a not untypical QSO heard on 80 metres and reported in *DX News Sheet*. A G station is called by ZL and replies, 'Thanks for the call Old Man. You're only 5x3, but not very good copy at all...'

In other words, the report was being given as a formality, and bore no relation to how the ZL's signal was actually being received. In contests this situation is even more common.

It leads me to wonder whether we need a completely fresh approach. We could, for example, have exchanges which consisted of a random two-digit number between 11 and 99. A QSO would be deemed to have taken place when such numbers had been copied and correctly confirmed on each side.

The possibility of guessing would be reduced to negligible proportions, and the ease with which the number was copied would immediately give an indication of how well the two stations really were hearing each other. Of course, because of the way in which it would prevent random guessing I suppose it would never catch on!

If readers have any suggestions of their own as to what should constitute a QSO, I would be interested to hear. Though perhaps in these days of Packet radio, with mailboxes and international repeaters, the whole question will very soon become academic?

### DX news

K6EDV, who was in Manila earlier this year, reports that the unstable political situa-

tion in the Philippines contributed to the cancellation of the proposed DXpedition to Spratly Island. However, he is reported to have permission from the Philippine authorities for an operation in January 1988.

7Q7LW continues to be very active from Malawi, obviously trying to give as many people as possible a contact before he leaves. Unfortunately, a lightning strike blew up the power transformer in his linear amplifier, which has caused him problems in making himself heard, particularly on the LF bands.

KH6GDR/T32 is currently active from Christmas Island and will remain there for the foreseeable future. UA1ODX is now active from Franz Josef Land. I'm beginning to think that the population of this place must consist of nothing but polar bears and radio amateurs! 5A0A continues to be very active on all bands, and has now been sent an FT901 by the European DX Foundation. He will apparently remain in Libya until the middle of the year.

For those needing a contact with Honduras, *DX News Sheet* reports that WB8VMN/HR1 is especially active on Sundays around 14160kHz from 2100GMT, except during contests. 9G2MR is reported to be active almost daily from 1900GMT around 14197kHz, with promise of 15 and 40 metre activity in the near future.

TK5BL hopes to return to French St Martin in June to operate as FG5EQ/FS. In fact, however, the prefix for St Martin has recently changed to FJ, so the callsign for this operation may well turn out to be something different.

### Palmyra Island

The Fullard-Leo family, owners of remote Palmyra Island for the last sixty years, have recently put this exclusive piece of real estate on the market. Palmyra, six hundred acres of coconut grove, lagoon and jungle, located nearly a thousand miles south of Hawaii is currently uninhabited, following an abortive attempt by the owning family some years ago to establish a copra plantation.

The island was used as a military hospital and supply base in WWII, but the airstrip and buildings have fallen into decay, to the extent that a group of DXpeditioners suffered a plane crash when trying to land there some years ago. Quite recently there was a short operation by KB1HM/KH5, which has now been accepted for DXCC credit, but I know of no European stations who contacted this one. Whether Palmyra becomes more or less rare in future will obviously depend on who can find the asking price, believed to be several million dollars. Any takers?

### Contests

The Russian CQ-M Contest takes place on 9/10th May, from 2100GMT on the Saturday for 24 hours. The other major event is the CQ WPX CW on the last full weekend of May, the 30th/31st. However, there are several other events to note, including the Utah QSO Party on May 2nd, the USA County Hunters SSB Contests on 2/3rd May, the Nevada QSO Party on 9th May, and the Ibero-American SSB Contest on 30th/31st. In addition, the IARU Telecomms Day Contest (CW and

SSB) takes place on 16/17th May, and usually brings some interesting callsigns on to the bands.

### World QRP Day

On a related topic, June 17th has been designated by the IARU as World QRP Day. Why not use it as an excuse to have a go at QRP if you haven't already tried this particular challenge? If not, then do try both then and at other times to avoid the traditional QRP calling frequencies in order to give the low power enthusiasts a chance.

### Prefix list

Geoff Watts, founder of *DX News Sheet*, has written to remind me that his Prefix-Country-Zone List is still available for just £1. The list contains full information on the location of Antarctic stations, on USSR club stations, on obsolete prefixes used during the past 10 years, and much else. I always keep a copy of Geoff's list close to hand in my own shack, and can heartily recommend it. Geoff's address is 62 Belmore Road, Norwich NR7 0PU.

### Wrapping up

And that about wraps it up for another month. With summer approaching it is time to get outdoors and repair the ravages of winter. The winds over the weekend of the RSGB's NEC event certainly took their toll. At least one G4 was called away from the Convention when his quad came to grief, and I know that others had similar problems. Still, we all know that if your antenna *didn't* fall down over the winter period, it clearly wasn't big enough! 73 de Don.

## SATELLITE TV RECEIVING EQUIPMENT

Dish spinnings, from 60cm-2.7m LNB's, and Feed Horns available - for further details contact:

**HARRISON ELECTRONICS**  
Century Way, March, Cambs PE15 8QW  
Tel: (0354) 51289

## NEWSAGENT ORDER FORM

*Amateur*  
**RADIO**

To (name of newsagent)

.....  
Please order a copy of *Amateur Radio* for me every month

NAME.....

ADDRESS.....

.....

.....

Newtrade distributors: Argus Press Sales & Distribution Ltd, 12-18 Paul Street, London EC2A 4JS. (Tel: 01-247-8233)

# USING A TRANSVERTER WITH THE TS440S

by John and Steven Goodier G4KUC/G4KUB

One of the major omissions from the Trio TS440S is the lack of a transverter socket, and it's hard to understand why the Japanese designers forgot to add such a vital socket to this fine piece of equipment. Perhaps it was lack of room inside the case, or lack of room on the back panel; either way, as far as most amateurs are concerned, it's impossible to run this rig with a transverter.

This however is not true, as I have been using my TS440 with a Yaesu FTV707 2m transverter for the last four months. I must admit that I have to be a little careful of the position of the 'car' control on the 440, as too much drive will damage the transverter, but careful operation will help to prevent this. This article describes my own experiences of using a 2 metre transverter with the 440, a simple modification that can be carried out to the rig, and some ideas about transverter changeover and safe operation on

transmit. There are also some tips about using the very excellent memory facilities on this rig.

## Receive

My TS440S was modified by Lowe Electronics so that the spare phono socket (ACC-3) was wired to the Rx side of the changeover relay inside the rig (see Figure 1). This enabled me to take the 28MHz output from the transverter to the 440 without having to have an extra changeover relay. It also kept the receive side of the transverter well away from the RF drive source. It is advised that the modification is carried out by an authorised dealer, but if you would like to have a go yourself, the following may be of some help. Please note that if the auto ATU is fitted, then this modification will be very difficult to perform due to the lack of space inside the rig. The ATU could always be removed first however.

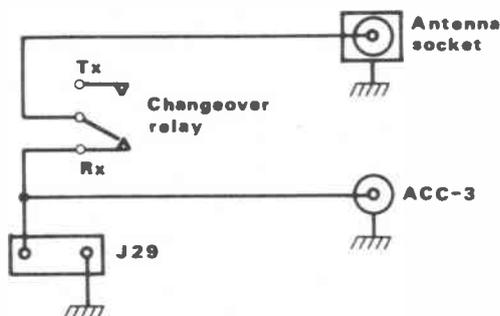

**Fig 1** Showing the connection of ACC-3 to the Rx side of the changeover relay. See diagram 8-8 in the handbook for detailed wiring of the main switch unit

**Fig 2** Showing the layout of my TS440S, ATU and transverter. The 2m Rx line is taken into ACC-3 on the back of the rig. The RF drive is taken via position 3 on the ATU antenna selector. Changeover is via the remote socket

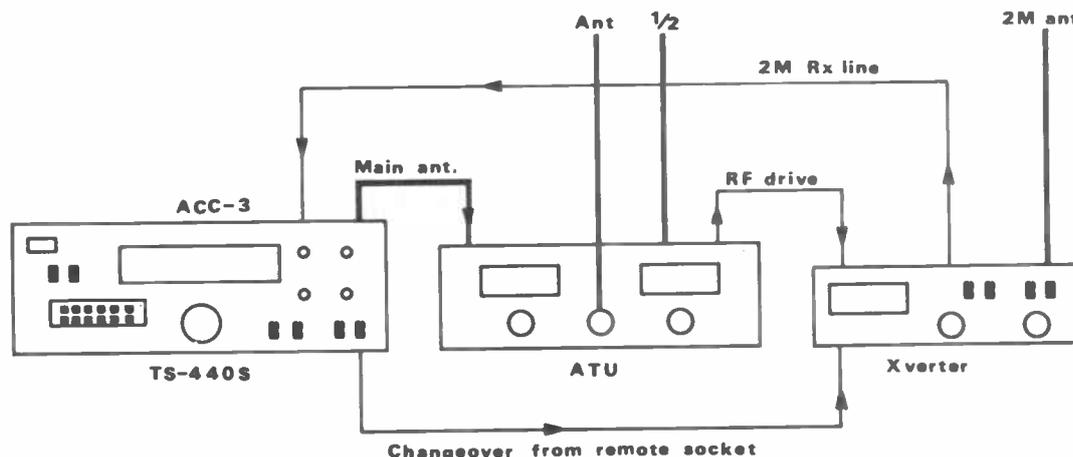

First remove the bottom panels of the TS440. ACC-3 is located on a small PCB along with the phonos for AFSK out and AFSK in. This board is held in with two screws located on the back panel, and once these have been removed the board will pull out easily. It is then a simple matter to solder a piece of screened lead to the spare holes already on the board. Make sure the screen of this lead is connected to earth and there are no shorts. Refit the PCB. The other end of the lead is taken to the main changeover board, which is easy to see as it has the antenna socket connected to it.

The screen lead from ACC-3 can be connected to this board in two ways. The most efficient way is to solder the cable to the underside of the board, but to do this the board has to be removed from the back panel, which is a little tricky. The cable has to be connected to the normally closed side of the changeover relay, which is best located at J29 which takes the received signal directly to the RF unit. Initially remove the two screws holding this board in place and, if you have the correct tool, remove the nut holding the SO239 socket to the back panel.

If you are unable to loosen this nut, then the board can be removed by placing a soldering iron tip onto the SO239 connector and pulling the board back as the solder melts; this should free the board from the socket. Once free it should then be possible to gain access to the PCB track, solder the screen lead to where J29 connects to the PCB, check there are no shorts and that there is a good connection between ACC-3 and the main antenna socket. Refit the changeover board and re-check the connections.

The other method is to connect the lead from ACC-3 directly to J29 on the top side of the changeover board. This method does not require the board to be removed but is less efficient than soldering. First cut a piece of tinned copper wire (20/22swg) and solder it to the inner of the screened cable from ACC-3. Locate the live side of J29 and push the copper wire into the socket, ensuring it is a tight fit and will not fall out

when the rig is turned over. Next solder the braid to any convenient earth point. Check for a good connection between ACC-3 and the antenna socket. When satisfied, replace the bottom panels. This modification can be checked by connecting an antenna, or the output of a converter or transverter to the ACC-3 socket and checking that signals are received.

### Transmit

The only way of putting RF into the transverter is via the main antenna socket on the TS440. It is obvious that if the 'car' control is set too high, it is possible to put as much as 100 watts straight into your transverter. Due to careless operation this happened to me, and the result was a few burnt out resistors and a blown ALCFET; not too much damage when you consider what I had just done. My system is set up as shown in *Figure 2*. When position 3 is selected on the antenna switch on the ATU, RF is taken from the TS440 into the RF input on the transverter, but what you must remember to do is turn the 'car' control to minimum before transmitting.

When the 'car' control is turned to minimum on FM, AM and CW, there is very little power output, in fact just enough to drive a transverter. Most transverters are fitted with a variable attenuator, and this can be set to give full power output or a low power setting. The 'car' control can then be used as a variable power output control. It is important to monitor the output of the transverter to check that you are not over driving. If this is not possible then it is best to set the attenuator for about half power output, because you will find that the output power will vary as the TS440's PA gets warm. Again, too much drive into the transverter will result in damage to the input stage. I have wired in a resistor and a couple of back-to-back diodes into my transverter to give a certain amount of protection if I forget to turn the 'car' control to minimum. *Figure 3a* shows the type of circuit used, and *Figure 3b* shows a variable attenuator of the type used in the FTV707.

There is no low power setting on the TS440 for SSB operation, but I have found it is possible to run SSB whilst transverting. This is best done by turning the mic gain down to zero, talking into the microphone and then increasing the mic gain slowly to give the required output on a power meter. Be very careful; again too much RF drive will damage the transverter.

### Changeover

Most transverters can be put 'on air' by shorting a pin to earth (0V), which can be achieved by using the 'remote' socket on the TS440. Page 11 of the handbook shows this socket in detail. *Figure 4* shows the wiring needed for most transverter types. My Yaesu FTV707 is a little different as I have modified it to run with rigs other than the FT707.

### Memory facilities

A useful feature of the TS440S is its ability to store 100 memory channels.

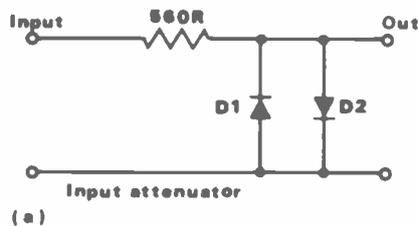

**Fig 3a** Showing a one resistor attenuator. The value of the resistor may be varied to suit. The two back-to-back diodes give protection

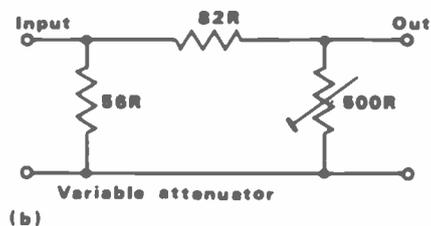
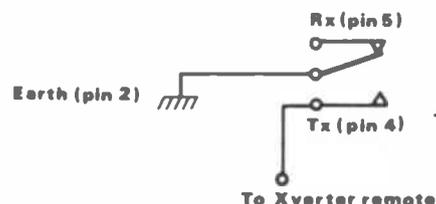

**Fig 3b** Showing a variable attenuator as used on the FTV707 transceiver. The diodes may be added after the variable resistor if wished

Under normal HF operation it has been suggested that this is of very little use, and is only good if the user wishes to store DX nets and many broadcast stations. However, the 100 memories are very useful when the rig is used in conjunction with a transverter or converter.

I used my transverter with an FT102, which worked very well but was slow to move about the band. If I was on S20 and wanted to check S22, S23 or the repeater channels, I had to press the 500kHz up button, and then wind the VFO down to the wanted frequency. Not really too much trouble, but it can be a little slow for a fast QSY. What I have done with the 440 is program the memories with the whole of the 2 metre band. If you start at memory 20 and program in 29.500 (145.500 S20), then move up and down programming in 25kHz steps, you will eventually program in all of the 2 metre band in what appears to be 25kHz steps. You can program in as much or as little of the band as you want, but the amazing thing is that when the rig is in memory mode, and is used with a transverter, it operates as a dedicated 2 metre rig tuning in 25kHz steps. If programmed correctly, the simplex channel should correspond with the memory channel, ie memory 16 = S16 or 29.400 (145.400). QSYing is now very quick indeed, either by the main VFO, pressing the up/down buttons or by entering the memory channel directly from the 440's keypad.

It is also possible to program the repeaters into memories 90-99, and the useful feature about these memories is that you are able to work split frequency with them, because it remembers the



**Fig 4** Showing the relay wiring to the remote socket on the TS440S. Page 11 of the handbook shows this in greater detail

frequency of both the 440's VFOs. All you have to do is set one VFO on the repeater input and the other VFO to its output, then store them in memories 90-99. When these memories are recalled, the 440 enters split frequency operation and will give you automatic repeater shift. It is also possible to listen to the input of the repeater by pressing the T-F set button.

### Conclusion

I have been running my transverter and 440 combination for over 4 months, and apart from one accident (which was entirely my fault) the system has been faultless. The only thing to remember is to turn the 'car' control down before transmitting, and this has now become a habit each time I select antenna 3 on the ATU. I have the greatest respect for solid-state PAs anyway, and the 'car' control is always turned to minimum when not transmitting. The memory facilities are excellent and once programmed QSYing and general listening is quick and easy. Reports on transmit are very good, on both FM and SSB, receive sensitivity is excellent, and I find the whole set-up ideal.

The Trio TS440S as reviewed in the June issue of *Amateur Radio*



# AVAILABLE APRIL

4th EDITION OF

## U.K. LISTENERS CONFIDENTIAL FREQUENCY LIST

**LARGER, SMARTLY BOUND  
with semi-stiff cover.**

**Completely revised:- Now includes even more  
information on MILITARY, CIVIL, AIR,  
MARITIME, PRESS BULLETINS, RTTY etc.**

**£5.95 + p.p 75p**

**4 PUBLICATIONS  
YOU SHOULDN'T BE WITHOUT!**

### UK LISTENERS CONFIDENTIAL FREQUENCY LIST LATEST EDITION

This publication has now sold well over 2500 copies since it was advertised only a few months ago. Now the recent updated version is selling even better. No self respecting listener should be without a copy. If you enjoy exploring the short wave bands then this publication will add to your enjoyment. It covers the hf spectrum from 2 to 30 MHz and gives details of transmissions outside the amateur bands. Specially designed for the UK and European listener it sets out in a very easy way a comprehensive list of hundreds of interesting transmissions that will keep you occupied for days on end! Only a fraction of the cost of other similar publications it contains details of Marine, Air, Military, Embassy, Press and News agencies. Many listings have time schedules included together with comprehensive RTTY details. It tells you the frequencies used by civil and military aircraft whilst flying the Atlantic, when and where to pick up the press bulletins, long distance marine traffic etc and much more. Send today for your copy of this worthwhile publication.

**£5.95 p&p 75p**

### NEW 4th EDITION VHF-UHF AIRBAND FREQUENCY LIST

This frequency manual is without doubt the most comprehensive list of VHF/UHF aircraft listings available in the UK. Of vital importance to the airband enthusiast or indeed any keen VHF/UHF listener it sets out in a very easy to follow manner full details of a whole host of stations. Every known UK airfield frequencies, etc. Included are Civil, RAF, USAF, MOD, Naval fields on both VHF and UHF bands. There are also air to air frequencies, the Red Arrows frequency, and much more. Send today for your copy and find out just how much you have been missing!

**£5.95 p&p 50p**

### THE COMPLETE UHF-VHF FREQUENCY GUIDE 26-2000 MHz

Many listeners have asked for a guide to the wide VHF/UHF spectrum and to meet this request we have recently published this frequency manual. It covers the range 26 to 2000 MHz and has been specially prepared for the UK listener. Anybody who has used a scanning receiver will know that the wide frequency range involved means that it is difficult to know exactly where to listen. This guide takes all the guessing out of monitoring. It lists all the services throughout the spectrum together with both simplex and duplex frequency splits. If you've spent your hard earned money on a scanning receiver or are considering buying one you'll find that this publication contains a wealth of information that has previously remained un-published!

**£4.95 p&p 40p**

### HF OCEANIC AIRBAND RADIO SUPPLEMENT NEW SECOND ADD.

Prepared in response to many requests for more information about the air traffic on the hf bands this little guide sets out to explain to the beginner how the hf band works in relation to air traffic. It contains full details of the world aircraft frequency bands in the range 2 to 23 MHz together with control frequencies and those commonly used for Oceanic control. Also included are many VOLMET frequencies, the Search and Rescue frequencies used by RAF helicopters and Nimrods, the Hf RT network, London Company frequencies, European control centres etc. An ideal companion for the hf airband listener. Send today for your copy.

**£2.95 p&p 35p**

**WATERS  
& STANTON  
ELECTRONICS**

**18-20 MAIN ROAD, HOCKLEY, ESSEX - 12 NORTH STREET, HORNCHURCH, ESSEX.  
MAIL ORDER TO: 18-20 MAIN ROAD, HOCKLEY, ESSEX TEL: (0702) 206835**



# ANGUS MCKENZIE

---

# TESTS

---

The Lowe HF125 is a receiver which is clearly intended to fill the price gap between the top end short wave capable Japanese transients and the lower end of the communication receiver market. There has been a lot of criticism in the past that the Japanese put in far too many bells and whistles, and that they pay so much attention to presentation and appearance that they sometimes forget that what users actually need is a receiver that works extremely well as a first priority, with appearance as a secondary consideration.

When John Thorpe first joined Lowe Electronics, some years ago, he had his heart set on designing a really superb HF transceiver. After carrying out much research he was able to put his experiences into practice by designing this particular receiver, which is not the super model that he has always longed to design, but one that makes use of a lot of his ideas, and is designed specifically to a low cost.

## Facilities

In marketing this new model, Lowe Electronics decided to put in many interesting features which are considered important priorities, whilst foregoing many less important facilities which are not really necessary for most users. The receiver tunes from 30kHz up to 30MHz in approximately 15Hz steps. A front panel rotary switch selects CW, LSB, USB, AM, AM synchronous detection and NBFM; the last two modes being an optional extra, type D125, and costing £59.50 additional to the receiver's basic price of £375 including VAT.

The on/off switch is built into the audio gain control on the front panel, which is complemented by a rotary tone control having treble or bass cut with a flat centre. A row of buttons selects many microprocessor controlled functions. These include selectable 20dB RF input attenuator, audio peaking circuit on/off for CW, and choice of four filters for SSB and AM (2.5, 4, 7 and 10kHz). Two buttons provide 1MHz up and down steps, holding either of these down changing MHz quite rapidly. One button is provided for memory access, and allows cycling through either of two banks of 15 memories, the second functions of two other buttons selecting the required bank. Writing to or reading from memory is extremely simple, and you can immediately VFO from the selected memory.

One very important optional extra is the K125 matrix keypad, which allows direct entry of frequency to 1kHz resolution. The keypad costs an additional £59.50 including VAT, and works very well. When normally supplied, an external 13V mains adaptor is provided, but of course you can run it off an external

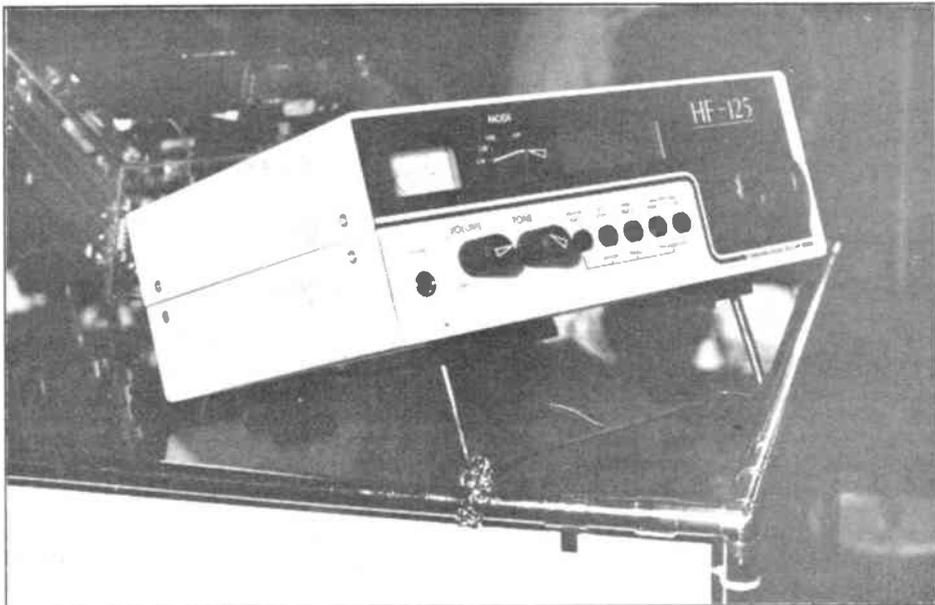

## LOWE HF125

---

## HF receiver

---

supply of up to 15V. An optional portable pack, P125, provides internal NiCad rechargeable batteries complete with charger circuit, and an active antenna input circuit designed to have a very high input impedance so as to get the best out of the accessory telescopic whip. The active antenna circuit has considerable gain, and is switchable in and out when fitted. This option costs £69.50.

On the front panel is a large digital frequency readout with just 1kHz resolution, but some status functions are also included when various functions are selected. There is a separate S meter, which is clear and easy to read. The very free running VFO knob does have an easy to use finger hole, and when this is rotated rapidly the tuning rate is increased very considerably, allowing you to QSY very rapidly.

There is a quarter inch stereo headphone jack on the front panel which parallels up the left and right headphone connections to the receiver's output. There is a large pull-forward bail stand under the front panel giving quite a steep up-tilt, which many users will prefer as it enables you to see the front panel more easily.

On the back panel there are 3.5mm jack sockets for feeding an external speaker and a tape recorder or RTTY terminal (fixed output level). In addition to an SO239 socket for use with a coaxial antenna input, or with the optional telescopic whip, there are two spring loaded clamp sockets for connecting a

long wire antenna and an earth, these being labelled 600 ohms. A special jack socket is fitted for interfacing the optional keypad. A small pre-set can be adjusted through a hole on the back panel to vary the FM squelch threshold when the FM option is fitted.

The internal loudspeaker is mounted under the top panel, and the receiver's aluminium casework is finished in cream and black. The styling is what one would describe as extremely basic, and much simpler than one expects from a more expensive product, with none of the chrome knobs and buttons and flashing coloured lights which make so many modern rigs look like microprocessor controlled pin tables!

## Brief circuit description

The antenna input feeds through switchable bandpass filters directly to the first mixer, which is an active Plessey IC. The first IF is 45MHz, and incorporates a 15kHz bandwidth roofing filter. A second active mixer drives into the 455kHz second IF, in which there are various filters for SSB and AM modes. These are arranged in sequence so that the narrower bandwidth selectivities use more than one filter to improve the skirt steepness. After the AM or SSB detectors, the signals are amplified and switched through to the output audio amplifier via the volume and tone controls. The optional synchronous AM/FM board provides switched audio lines through to the audio amplifier.



The local oscillator for the first mixer tunes in 1kHz steps, and the second local oscillator is provided with 64 steps to cover the 1kHz difference between the first mixer steps. Whereas the first oscillator is a microprocessor controlled synthesizer, the second one is actually a varicap diode tuned circuit, in which the dc levels are provided by a D to A converter, with the digits provided by the microprocessor. This allows the 15Hz steps to be quite stable.

### Subjective tests

Initially I tried out an early prototype of the receiver last year, but I did not feel it appropriate to jump the gun and write a review based on a prototype. By the time the review sample arrived in February, John Thorpe had already made some circuit changes which have improved performance. My first impression of the receiver was that it gave a remarkably good subjective quality on all modes, with the exception of FM, for the selectivity was not narrow enough for 27

or 29MHz FM.

AM quality was particularly good, and after I had become used to the synchronous AM detection, I found this very useful indeed for coping with short wave signals which were subject to continual selective fading. With good synchronous AM detection, the sudden bursts of distortion caused when the propagation of one of the AM sidebands is greatly enhanced above that of the carrier almost completely disappear. A reinserted carrier developed in the synchronous detector circuitry allows more linear demodulation, and the carrier is kept phase locked to the original carrier frequency. The IF bandwidth switching for AM was ideal, and most of the time I found myself using the 4 or 7kHz filter positions. The actual AM quality was excellent without synchronous detection, but seemed to be just slightly more noisy when the synchronous detection was switched on. Synchronous locking was very effective and was easy to achieve.



The quality of SSB signal was also much liked, apart from one slight problem which worried me a little. The synthesizer seemed to have a continual very short term wobble, causing a slight gargle to be audible on speech and carriers. This was noticeable on high frequencies, but much less so on the LF bands. The effect was also noticeable on CW unfortunately, but it is only fair for me to add that I am particularly sensitive to this problem, although one or two friends calling at the house did notice it.

CW reception was quite good, and although the 2.5kHz SSB filter is used for it, an audio peaking filter centred at 800Hz does give additional rejection of unwanted signals.

I was quite surprised to find that not only did the front end intercept point seem to be very good, but the close-in blocking performance was also superior to that of many other sets costing a lot more money. Even the performance on medium wave was above average, and the dynamic range was excellent, particularly for such a modestly priced receiver.

I tried feeding the tape recorder output through to my main hi-fi system, and was agreeably surprised by the very flat audio response down to very low frequencies from the better medium and short wave stations. The signal to noise ratio on stronger stations was good, but not quite as good as I have heard from some more expensive models, and I noticed some hiss on the output, which leads me to suggest that there is perhaps not quite enough level getting through the filters.

### Stability

The receiver seemed very stable over long periods, and I only noticed a drift of 15Hz or so over periods of half an hour when taking various selectivity plots. Although there is an RF attenuator provided which can put in 20dB attenuation, you will probably only rarely need to use it, as the front end is so good. The optional active antenna was a lot more sensitive than that in the Sony 2001D, and again the intermodulation performance was excellent. I was surprised to find that I could pick up many amateur signals during the day on the LF and HF bands with only the telescopic whip, and the reception quality was definitely superior to that of the Sony; another important point being the excellent selectivity, a lot better than that of the Sony on SSB and CW.

I quite liked the tuning ergonomics, but there was one annoying factor, a 1kHz audio breakthrough as you turned the tuning knob fairly fast. This is caused by breakthrough from the synthesizer's 1kHz steps onto the AM carriers as you tune them through. You will soon get used to this, but it certainly does sound odd, and there is no trace of breakthrough once the tuning is at rest.

The receiver tuned in the 60kHz Rugby signal very well indeed, and I only felt a lack of sensitivity at HF. I did note that a

# G3OSS TESTS

normal external antenna used with the active antenna switch on did produce a much higher sensitivity, and this helped 28MHz. However, I do not really recommend this as you may find the input intercept point degradation quite marked, which will cause problems at LF.

One rather odd problem showed up when I used the receiver either on top of my spectrum analyser, or anywhere near equipment including a mains transformer. Mains field seems to get into the internal circuitry and create ripple modulation when SSB or CW modes are in use. It seems that some component is inadequately screened, which is rather unfortunate.

## Laboratory tests

The front end sensitivity on SSB varied from fairly poor on 28MHz to fair on the LF bands. However, one must put this into perspective, for whilst you will find in practice that on a good outside aerial the receiver noise should be substantially below band noise up to around 15MHz, signals on the 21 and 28MHz bands will be poorer by a few dBs, as compared with the apparent sensitivity of a receiver costing over twice as much. The HF125 is similar to the Drake TR7 at HF, but the very best receivers have a sensitivity around 10dB better. You will not lose out as much as you might think, for when the HF bands are properly open, band noise comes up a lot and will overtake receiver noise, even on 28MHz.

If you switch on the active antenna circuitry, which is primarily intended for use with short whips, such as the one that is supplied, the sensitivity is improved considerably to be only marginally inferior to that of a very good receiver. This made quite a difference when I was receiving GB3RAL on 28.215MHz, the signal to noise ratio from the beacon improving quiet dramatically. However, the input intercept is degraded quite noticeably when you switch on the pre-amp if you are using a large external aerial, but what a difference it makes to the telescopic whip! The whole set comes alive right up to HF.

The set's sensitivity was constant on the LF bands, right down to the middle of medium wave, but on long wave it degraded by around 13dB, although in practice I found that I could receive long wave signals very well. The RF input intercept point measured very well, and the measurement was maintained to quite close-in spacings, although the presence of reciprocal mixing noise precluded very close in measurements being taken. The excellent blocking performance is clearly due to John Thorpe's very careful design, and the use of narrower first IF filters than usual.

We checked the intercept point on many bands, and whilst it was very good at LF, it was particularly good on the 14 and 21MHz bands, but rather poorer on 28MHz. The performance in this area far outclasses many earlier receivers, some of which are up to 30dB worse than the HF125!

*HF125 RF/AF selectivity plot for CW filter. Nb 800Hz hold tone. Resolution bandwidth 10Hz*

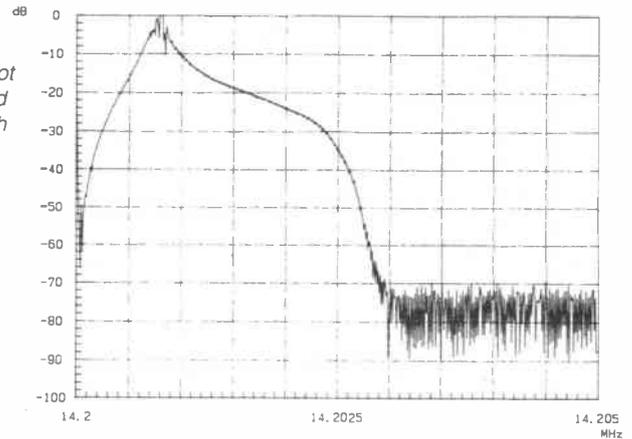

*HF125 RF/AF selectivity plot for 2.5kHz filter. Nb 1kHz hold tone. Resolution bandwidth 30Hz*

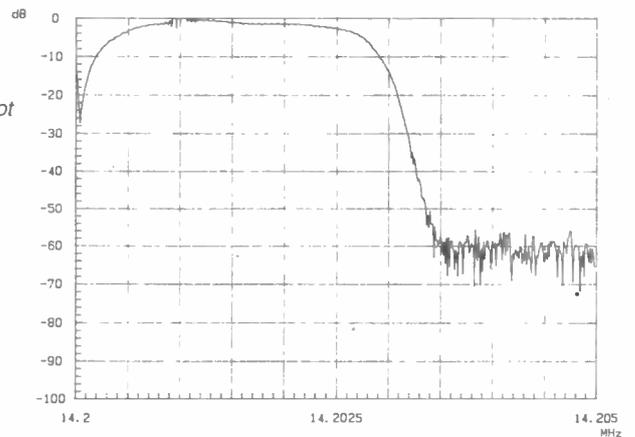

*HF125 AM response with 7kHz filter. 14.2MHz overall audio response/selectivity. Resolution bandwidth 30Hz*

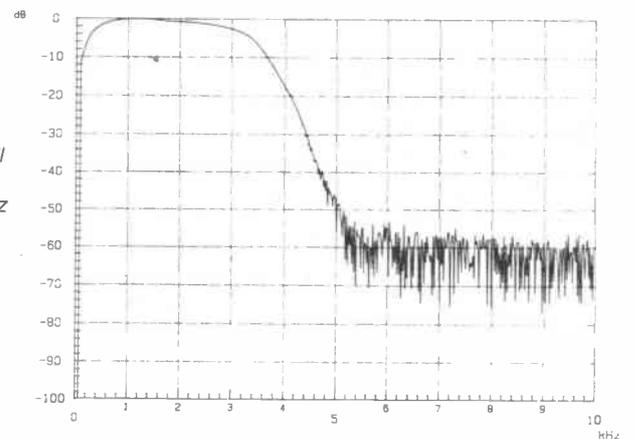

*HF125 AM response with 4kHz filter. 14.2MHz overall audio response/selectivity. Resolution bandwidth 30Hz*

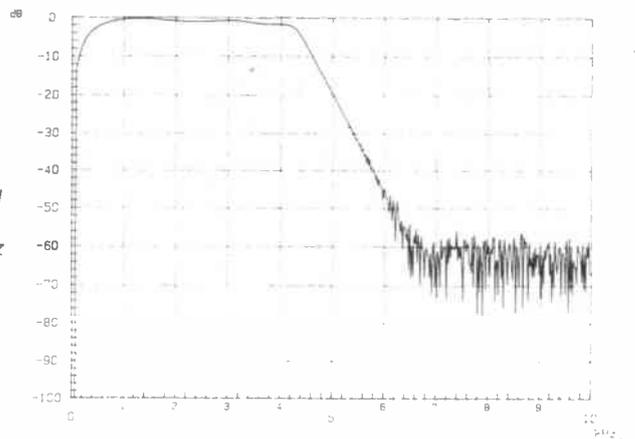

# G3OSS TESTS

The reciprocal mixing performance was a little inferior to that of the TS440S and the R5000, but is a little better than that of most Yaesu modern rigs. It did not improve quite as much as I might have expected further out from the carrier, but this is not a problem.

The 2.5kHz SSB filter had a bandwidth which was a little wider than usual for SSB, but the new plotting technique shows that the skirt is very steep indeed. The selectivity is a good compromise between maintaining the good quality of SSB signals for short wave listening,

whilst giving excellent rejection of adjacent channels. For CW, the audio peaking filter response is also shown in a separate plot. I was much impressed with the 4 and 7kHz AM filters, the plots again showing quite steep skirts. The 10kHz bandwidth filter response on AM can be seen to give a very flat audio passband up to 5kHz, with the response falling rapidly above 6kHz. Note that on AM a flat audio bandwidth of 5kHz is given by a filter having a 10kHz overall bandwidth, as the filter has to pass both sidebands. The provision of so many AM bandwidths is a

very strong point in favour of this receiver, and the fact that the audio response is so flat makes all the difference in the world to the clarity of audio reproduction.

The FM selectivity was fairly wide, and the shape was not symmetrical, but rejection of 25kHz offset stations was good. FM distortion did not measure particularly well, but was adequate. AM distortion generally measured well at high modulation levels, and was very clean at lower levels. To put this into perspective, the distortion was better than that of many Japanese rigs, but not as low as one or two very recent ones, including the R5000. What was particularly interesting was that distortion remained low up to extremely high levels, and was below 5% at -10dBm, but climbed rapidly for even higher levels. This all shows extremely careful attention by the designer to gain optimisation and AGC performance. As expected, distortion was degraded by turning the tone control clockwise, increasing from 1.6% to around 2.5%, for example, on one particular level setting.

## Low HF125 Laboratory Test Results

### RF sensitivity (12dB sinad) SSB 2.5k filter

28.5MHz	-114dBm
21.2MHz	-115dBm
14.2MHz	-115dBm
7.05MHz	-116dBm
3.7MHz	-117dBm
1.9MHz	-117dBm
28.5MHz (active antenna input)	-123dBm

### RF sensitivity 12dB sinad FM

29.6MHz	+111
---------	------

### RF input intercept point 100/200kHz spacing

28.55MHz	+10.5dBm
21.2MHz	+17dBm
14.2MHz	+17dBm
7.05MHz	+11.5dBm
3.65MHz	+12dBm
1.85MHz	+15dBm

### Reciprocal mixing performance ratio of disturbing carrier/noise floor. 2.5k filter at 28.55MHz

5kHz	70dB
10kHz	77dB
20kHz	83dB
50kHz	93dB
100kHz	100dB
200kHz	106dB

### S meter SSB/FM 28.55MHz

S1	-109dBm
S3	-101dBm
S5	-94dBm
S7	-82dBm
S9	-71dBm
S9 + 10	-59dBm
S9 + 30	-39dBm
S9 + 50	-17dBm

### Selectivities

See plots

### Audio distortion and power output

FM 1kHz mod 2.5kHz	dev.2%
AM 1kHz mod 80%	1.6% typical
SSB/CW product detector distortion	typically 1.5% with 1k beat note

### Power output at 1kHz for 10% THD

8 ohms	1.1W
4 ohms	1.6W
Typical output of tape recorder socket	100mV max

### Frequency error at 28.5MHz

60Hz after 15 minutes, reducing to around 20Hz after one hour, then more stable

### Dimensions (WxHxD)

255 x 100 x 200
-----------------

### Weight, basic without options

1.8kg

## S meter accuracy

The S meter has an excellent law between S1 and S9, and the difference of 38dB between these points is as wide as I have measured for a long time. The law above S9 was also excellent, so this S meter really does mean something! The readings on FM were extremely close to the SSB ones. S9 was set at around 60µV on 28MHz, and around 50µV for lower frequencies, which is just about right.

AGC speeds seemed well chosen, SSB having a sharp attack time and a fairly slow recovery. Despite quite a high degree of IF gain, I did not notice any pumping effect, nor did I hear any transient distortion, unless I was overdriving the loudspeaker.

On SSB the product detector distortion averaged around 1.5% on a 1kHz beat note, and this is reasonably good. I did notice a slight gurgly sound on the carrier, which must have been due to the slight synthesizer wobble when this was checked at 28MHz, but the wobble was not so noticeable when the beat was obtained from a lower frequency carrier.

The maximum power output into an external 8 ohm speaker was rather limited at only 1.1W, and this increased to just 1.6W into a 4 ohm speaker. The internal speaker is a small one, but I suspect that it could take more power at middle and high frequencies. Since there is much to be gained by using an external speaker for short wave listening, I feel it unfortunate that a higher power audio output IC was not used. It should have been possible to have had an output of at least 2.5W into 8 ohms, and, say, 4W into 4 ohms.

The tape recorder output is at a constant maximum level, as it is fed from a point before the receiver gain control. The maximum level that you are likely to get from this socket from an AM broadcast is 100mV, and this is not

sufficient for most external amplifiers on the market if their controls are to be used in reasonable positions. I would have preferred a nominal maximum level of around 500mW, which would be convenient for feeding phono line input sockets on cassette decks and hi-fi amplifier systems.

The frequency response of the recording output is very flat indeed right down to 50Hz (-2.3dB), and listening to some higher quality short wave and medium wave broadcasts on my own hi-fi system with very high quality components, gave AM reproduction quality of a very high standard. The loudspeaker output was reasonably flat at LF into open circuit, but the output electrolytic capacitor did give some bass cut into an external 8 ohm load; an attenuation of 7.7dB being noted at 50Hz, and 2.6dB at 100Hz, which I feel is a little too much attenuation.

### Drift checks

Long term drift checks revealed maximum drifts of a few tens of Hz over an hour or two, rather than hundreds, and this is very good indeed for an inexpensive receiver. On switch on, the received error was only 60Hz in 28.5MHz, and this error actually decreased with time.

I decided to have a closer look at the local oscillator short term wobble by

beating the receiver with an input carrier to produce a 3.15kHz beat, using the 4kHz filter on SSB. This audio output was taken to a conventional wow and flutter meter which gave readings averaging around 0.1%, but peaking 0.3% somewhat jerkily every now and again. The meter was switched to peak weighted DIN, as if to measure a cassette deck, and the weighting roughly corresponds to the annoyance value of any pitch variations. Since the pitch variation would be the same number of Hz for any audio frequency, rather than a logarithmic pitch variation from a cassette deck, the variations become far more noticeable on lower pitches than 3kHz, and thus corresponds to short term frequency wobbles in excess of  $\pm 10$ Hz. This is audible, and though most users would not be worried, it does mean that you will have to try the receiver for a while to see if you are worried by it, especially at the HF end.

### Conclusions

I have no doubt that the Lowe HF125 represents extremely good value for money, and the performance far exceeds so much of its competition, including some receivers costing rather more. It is clearly an excellent choice for a keen short wave listener, and it is most

surprising how compact Lowe Electronics have made it. What is particularly important is the fact that so much attention has been paid to RF and IF performance, areas so lacking in very many Japanese sets. SWLs will be particularly pleased about the many choices of selectivity on AM, and the inclusion of synchronous detection for AM, which was so helpful in improving received quality.

Many radio amateurs will want to consider this receiver for many purposes, but they will probably find the Kenwood R5000 that I reviewed last month more appropriate for amateur radio use. The HF125 was not quite so good as the R5000 on 28MHz as an IF for VHF/UHF converters, but you should remember that the HF125, even with all options, is under half of the cost of the R5000 with options.

Lowe Electronics deserve to do very well with this receiver, and I would like to thank them very much for loaning an early prototype to me first, followed by the latest production sample. They have clearly proved that British design can be first class in a less expensive piece of equipment, from which Japanese engineers could take a few broad hints! I would also like to thank Fiona for helping with all the measurements.

It has perhaps been surprising in the past that very few amateur radio equipment manufacturers have marketed test equipment for use by the amateur, other than power and SWR meters. Consequently, I particularly welcome an interesting new range of small multimeters marketed by Icom, distributed by Thanet Electronics and manufactured by Soar Instruments of Japan.

### Icom DM20

Probably the most interesting one is actually the cheapest, the model DM20 costing £25 including VAT. Rather resembling a thick credit card, the meter is a 3.5 digit type and has auto ranging on dc and ac volts, and also on its ohms ranges.

There are just three switches on the front panel, one selecting off/volts/ohms, whilst a second press button selects either dc or ac volts, or ohms indication/continuity buzz. A third miniature button is used for selecting manual range control. If this button is held down for more than a second or so, it will transfer back from manual range selection to auto ranging.

Cycling through the manual ranges is very simple, requiring consecutive short button pushes. dc volts ranges are from 2V to 200V FSD, with an additional 450V FSD range coming in. Negative polarity can also be indicated, which is very useful. ac ranges are also from 2V to 450V FSD. Ohms ranges are from 200 ohms to 2Mohms.

Two captive probe leads are provided, each 460mm long, which are terminated in fairly long test prods. The entire meter,



## NEW ICOM MULTIMETERS

with leads and wallet case, weighs only 100g! Dimensions are 51 (W) x 106(H) x 10(D)mm, and the instrument is fairly well protected. Changing the batteries is just slightly awkward as you have to lever the back off with a coin, and you will need to take care doing this as I feel that the battery spring clips could wear just a little after some time.

This really is a super little meter, the sort of instrument that is useful to carry in your breast pocket to check the odd

PA valve that is going rather cheap at a rally. You will be able to watch the red faces as you can test that the heaters are open circuit! The display is quite large and clear and is black on grey, without illumination. It is easy enough to take out of its wallet, but you will have to push and manipulate a bit to get it back in again for storage.

On dc volts I checked the instrument against my laboratory standard dc calibrator, which gives a source with 0.01%

accuracy. The meter never misread by more than two digits, and this is way within its published specification, the average being only one digit. On ac volts the response was virtually flat from well below 50Hz to around 1kHz, but fell off so that it was 10% down by 4.6kHz. By 17.3kHz the reading was one half of what it should have been. The average error near FSD was around six digits low, and this is again well within specification as a total error on ac. With only 10mV input the meter read 8mV, ie two digits low, which is not bad, the test frequency for this being 100Hz.

I tested the ohms range using a resistance box of 0.1% accuracy, and continuously checked this against a very accurate HP 5.5 digit multimeter. I was astonished to find that all the low resistance values were generally within one digit, even down to a 10.3 ohm resistor, which read absolutely correctly. A 10kohm resistor, however, did read 1% low, although 100kohms was correct. At one Mohm, whilst the average reading was about 0.2% low, we did notice some dither noise of  $\pm$  two digits, thus giving a minimum reading which was -0.4% in passing.

The instrument draws about 5mW from its batteries, which should therefore last quite a long time. You should not attempt to measure more than 450V, so do not try to check your HT power supply voltage, nor the anodes of a PA valve that could be up at 2kV, as you will almost certainly vapourise the input circuits. You should also be careful not to allow RF to get into the instrument. Incidentally, you will see a special 'battery low' symbol coming on when the battery is nearly exhausted. This always seems to happen to me on various instruments just when I want to take a reading in an emergency!

## Icom DM10

The model DM10 is in the form of an oblong shaped pen with a probe sticking out of the left end, and a receptacle for a banana plug at the right hand end. Both long and short probes are supplied, but there is no provision for using anything other than these on the business end. If you are left handed, this is not the model for you (unless you are incredibly adept at reading numbers upside down!) as its design is strictly for right hand users. The display is 3.5 digits, with a minus indication where appropriate. A slide switch to the left of the display selects volts or ohms, but along the top of the instrument there are three buttons: on/off; ac/dc or ohms/bleep continuity; and a large button for holding the reading when depressed.

The meter is attractively styled and supplied with a negative lead (one metre long) terminated in a well insulated test probe. An insulated adaptor is provided with a built-in insulated croc clip to tap it onto a chassis, for example, but one has to prod around by hand on the equipment being tested with the business end to take readings. You may well need a steady hand for this. This instrument

weighs 63g and measures 150(L) $\times$ 30(H) $\times$ 1.5(D)mm, and the probe lengths are 12mm and 50mm.

In comparison to the DM20, the DM10 includes an additional range of 200mV on dc only, and the maximum voltage that can safely be used is 500V dc/ac. On the ohms range there is also an additional range of 20Mohms. Otherwise, the DM10 has the same facilities.

Batteries are easier to change, but in other respects the performance is very similar. On the dc voltage ranges the instrument was always correct within  $\pm$  one final digit, and discrimination on the 200mV dc range is thus 100 $\mu$ V. On ac volts readings were within  $\pm$  three digits, thus allowing very accurate readings of higher level sinusoidal ac within the frequency range of the instrument, again nominally 40Hz to 500Hz. The response was around 2% down at 1kHz, 10% down at 2.5kHz and 50% down at 9.1kHz, thus proving slightly inferior to the DM20. On the ohms ranges, the readings were generally within  $\pm$ 2 digits, although low resistances were up to four digits in error. The Mohm ranges worked very well, and no dither was noted.

The instrument is supplied in a wallet, which should last a few months, or much longer with care! I quite liked this model, but I do feel that some users will find that it is irritating that the manufacturers have not supplied a mini banana socket adaptor to plug into the probe socket, which could allow one to clip on a lead to a measurement point. A very simple accessory that Icom didn't think of! This model will retail at £45 including VAT.

## Icom DM500

By far the largest model is the DM500, which includes current ranges. This model is a lot more versatile than the others, as dc volts range automatically from FSDs of 200mV up to 1000V, ac ranges being from 2V up to 750V. As on the DM10, the instrument is 3.5 digit, and the ohms ranges extend from 200 ohms to 20Mohms. The dc current ranges extend from 200 $\mu$ A to 200mA, with an additional 10A range included, the same ranges being available for ac.

There are three banana type sockets for common, volts, ohms and mA, and a third one for the 10A range which is not fuse protected. An additional selectable function is diode test, which gives a useful indication of diode and transistor junction performance in the usual way. This larger instrument weighs 180g including batteries, and measures 70(W) $\times$ 141(H) $\times$ 34(D)mm. Two probe leads (one metre long) are supplied with long insulated probes on the end. No adaptors are supplied, but multimeter lead kits are available on the market which would be completely compatible, as the input sockets are banana types.

There is no 2mA FSD current range, so currents between 200 $\mu$ A and 2mA have reduced resolution on the display. There is of course a similar situation between 200mA and 10A, as there is no 2A range. Four buttons below the display select:

on/off; hold reading; manual/auto ranging; and ac/dc or ohms/continuity buzz. These buttons operate in the same way as those on the DM10.

When checking the dc volt ranges I was agreeably surprised to find that 10V read just 10mV low, whilst 1V, 50mV and 5mV all read correctly to the maximum resolution of the meter. On ac the frequency response was flat from LF up to 500Hz, and 1kHz was just 1.6% low. By 2.8kHz the response was 10% down, and 50% down by 10kHz. ac accuracy on a 100Hz very low distortion sine wave was amazingly good, 1V being read just 0.2% low! A 10mV input signal slipped one final digit, so that it read 9mV.

I then checked the ohm ranges and found that the 100kohm range, whilst reading correctly on average, dithered by  $\pm$  the two final digits. On the 1Mohm range, whilst the average reading was just one digit low, noise caused  $\pm$  four dither digits, the 20Mohm range also dithering  $\pm$  four final digits. The average seemed to be about two digits low. Very slight errors of up to four final digits, usually positive, were indicated on the lower ranges, although curiously 10 ohms actually read one digit low. The performance was well within the published specifications, and compared quite favourably with 3.5 digit instruments costing quite a lot more.

The DM500 costs around £70 including VAT, and comes complete with probe leads.

## Conclusion

The instruction books are quite helpful, and the specifications are well laid out so that you should know where you are with them. You should bear in mind, that whilst there is quite a high degree of input circuit protection, you must not attempt to measure voltages in excess of the maximum listed in the manuals. All the meters are well presented, and I feel that they are all good value for money. Furthermore, you would be buying them from a very reputable importer that will want to preserve their excellent name by giving good after sales service. The meters are guaranteed for at least three months, but you cannot expect the importers to foot the bill if you have misused a meter.

They are beautifully made and my only regret is rather a personal one, for as an audio man I do feel that it is a pity that the rectification diode of input circuitry could not have been made flat to at least 10kHz. The best buy is undoubtedly the DM20 but it is worth looking at all the models, for the DM500 will be very useful in the shack and a lot quicker to use than an analogue meter. The one thing that a digital meter will not show you, however, is minor changes and twitches in levels, and an analogue meter can give one a much better feel for some types of fault condition.

Thanks to Fiona for all the help in measuring, and to Thanet Electronics for providing some of the first samples to come into Europe.

There is rather a large gap between the standard of coaxial cables, such as UR67, and much more expensive types, such as Andrews heliax. From time to time there is news of a new product that looks promising, but a number of these seem to hit the dust a year or so after they become available, as their cost goes sky-high due to international currency fluctuations. One very popular cable, which is both relatively cheap and a good performer, is Pope H100. This has established itself very well indeed in the last few years, and is readily available. However, it is much stiffer than UR67 and is also extremely difficult to terminate with many types of coaxial plug.

In my book, *The buyers' Guide to Amateur Radio*, published by the RSGB, I asked readers to let me know if they hear of a really low loss co-ax, suitable for use at UHF and microwave frequencies, which is also reasonably pliable. I explained in the coaxial cable chapter that many microwave enthusiasts are desperately looking for a co-ax to use for turning loops above a guying point, pliable enough to turn easily and not be damaged in a major wind, and with a low enough loss to avoid performance degradation on bands such as 1296 and 2320MHz.

### Telecomms tip

One reader kindly tipped me off about the Telecomms cables, and at last two of them have arrived, although the cheapest one seems to have got forgotten somewhere. The cables are made in Japan and seem to be just what we are looking for, as they are more pliable, spec for spec, than H100.

There are three types, 5D-FB, 8D-FB and 10D-FB. The 8D has very similar loss characteristics to H100, but definitely seems a lot more pliable, and will probably be a lot easier to use. 10D is quite a lot thicker than H100, and yet it does not seem to be any less pliable. Its loss performance is similar to that of Andrews FSJ4/50, and approximately half way between that of Pope H100 and Andrews LDF4/50. It is thus a very good cable indeed, and one would be able to produce a large turning loop with it, although I would prefer to use the 8D for this.

The three cables are of similar construction, and as an example I will describe the 8D. The centre core is solid bare annealed copper wire of 2.9mm diameter. Around this is a 2.55mm thickness of foamed polyethylene dielectric. There are two outer metallic sheaths, the innermost layer being longitudinal aluminium/polyester/aluminium laminate. Outside this is a tinned annealed copper high quality braiding. The outside protection is a 1.05mm thick layer of white PVC, thus making a total thickness of 11.1mm.

We checked 25m lengths of 8D and 10D, and plotted the loss characteristics between 0 and 400MHz, having normalised the gain. The plots represent the loss of the cable fitted with N connectors

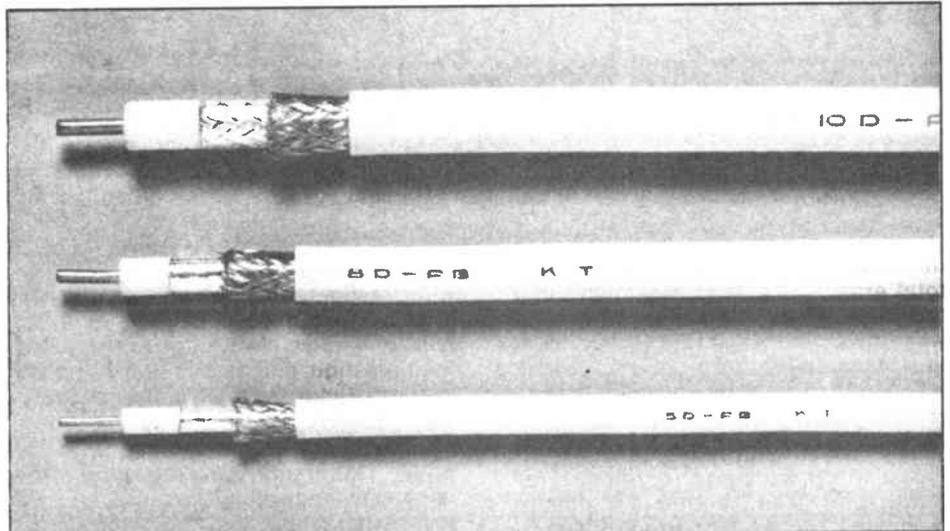

## NEW CO-AX from Telecomms

and one N back-to-back adaptor. The loss measurements coincide very closely to calculated losses based upon manufacturer's specifications, as shown in the table.

I felt it important to check the velocity ratio, as many users might want to make up special types of phasing harness with it. My measurements indicate a ratio of 0.8 for both 8D and 10D.

The current prices for the cables are 76p/m for 5D-FB, £1.79p/m for 8D-FB and £2.52/m for 10B-FB, including VAT, but excluding delivery. All enquiries should be made to Telecomms, 189 London Road, North End, Portsmouth. Tel: (0706) 660036. The N type plugs cost between £3.50 and £3.70 each, depending on type. A long length of 10B-FB for microwave, which will give you only slightly more loss than Andrews LDF4-50, will be so much cheaper, including much cheaper connectors, so a lot of money can be saved.

Chris G8CHW in Bushey, Herts, has already installed a length of the 10D co-ax to feed his 2.3GHz quad loop yagi. He found the cable very easy to cope with, and easy to solder on to, rather better than H100. Tests using the co-ax confirmed that the cable was somewhat better than H100. At the last minute I

carried out some loss tests on the two 25m lengths at 2320MHz, and much to my surprise the 8D lost only around 6.5dB, and the 10D around 5.5dB, these figures being approximate. The measurements included the additional loss of the N plugs.

Bearing in mind that Andrews LDF5/50 would lose 2dB at least, including plugs, for a similar length, but would cost around £300, and even Andrews LDF4/50 would lose perhaps 3.5dB or so at a cost of £180 or so, a 25m length of 10D costing around £70 makes a pretty incredible saving, and will prove viable for this high frequency. On 1296MHz, the performance of both 8D and 10D is just as competitive, and these are obviously going to be most recommendable cables for this band too, provided no long term snags crop up.

I warmly recommend this interesting new co-ax, which comes from Japan, but it is apparently only available in white, which is attractive, but perhaps rather obvious to neighbours. You may very well find it worthwhile trying some, the most recommendable and useful type being the 8D-FB. I am in the course of installing a length, and will comment further in the magazine after the cable has been in use for a while.

### COAXIAL CABLE LABORATORY TESTS

Parameter		5 D-FB	8 D-FB	10 D-FB
Attenuation	10m/100MHz	0.55dB	0.39dB	0.31dB
	400MHz	1.2dB	0.85dB	0.68dB
	900MHz	1.9dB	1.3dB	1.05dB
	1000MHz	Not known	1.35dB	1.1dB
	2320MHz	Not known	(approx) 2.6dB	(approx) 2.2dB
Outside diameter		8.1mm	11.1mm	13.1mm
Minimum bending radius		48mm	72mm	86mm
dc resistance/km		6.14Ω	2.76Ω	1.74Ω
Inner conductor diameter		1.9mm	2.9mm	3.6mm
Velocity ratio		0.8	0.8	0.8
Capacitance/m		86pF	86pF	86pF

# 50MHz *What to*

## A 50MHz WAC?

The possibility of working all continents on any band is an intriguing challenge. On the DX bands it is now fairly commonplace, but on six metres from the British Isles it is something we have dreamt about for many years. In QST for January 1948, the late Dennis Heightman G6DH, one of the most knowledgeable and successful six metre propagation experts of that time, wrote: 'It is interesting to speculate on the possibility of working all continents on 50MHz'. So far as European stations are concerned the writer considers that, with the exception of the Australasian contact, this would already have been possible with the conditions present on a few days during the period October-December 1947, and should again be possible during the period January-March 1948. Australia to Europe would present the biggest problem, and a suitable path will probably only occur from *Western Australia*, since this path passes nearer the high MUF equatorial zones than that from VK2, etc. This path should be most favourable during February-March and October-November periods.

By the middle of November 1980, the flat peak of cycle maximum was providing some real DX conditions on six metres and we were wondering if the 1947/48 prediction of G6DH would be realised? We were not allowed to operate direct on six metres at that time, but worked crossband; ie listen on six and reply on other frequencies, mainly 28.885. At about 0955 GMT on 26th November, Gordon Pheasant G4BPY alerted the six metre gang that he was receiving the Australian Beacon VK6RTT. It was heard by several of us for a few minutes, finally fading out at my QTH (Isles of Scilly) at 1010 GMT.

## The big day arrives?

After the VK6RTT beacon faded out we had an excellent day with world-wide DX on six. During the evening double-hop contacts across North America, with crossband QSOs to W6ABN (California) and other west coast stations were made, and simultaneously east coast stations were S9+. The band was open until a late hour. The following day just before 10.00am it happened! Gordon G4BPY had a crossband QSO with VK6OX in Carnarvan, West Australia, to make the first historic six metre crossband WAC. As Gordon signed, Brian Bower took over to make the second QSO, whilst I was waiting my turn in desperation as VK6OX started to fade out. It took from 0950 to 0955 for me to complete my QSO, as Andy was having difficulty reading his report. We were the only three to make it, and as far as I know no other QSOs have taken place since.

## From the mailbag

G4BPY of Walsall writes: 'My first reception was VK6RTU in Perth on 27/10/79 from 0858 to 0909 UTC, peaking 549. In 1980 I received very weak signals from VS6BE at 1050, RST229, on 20/11/80. I heard VK6RTT in Carnarvan on 27/11/80 from 0959-1010 UTC, peaking 589 (and couldn't raise a soul on 28.885!). The following day I initially logged VK6RTT at 0924, RST559, and finally at 1001, RST429.

'In the last couple of years my main interest has been keeping a careful check on 28MHz. Openings to VK seem to occur even in the minimum, as we are at present, but the peak time seems to be from about 25th October, tailing off gradually through November and December. Last year I logged VK6RTW in Albany, VK2RSY near Sydney and VK5WI in Adelaide, as well as V6TEN. However, it is probably not a good thing to try to compare 28MHz under low sunspots with 50MHz under high ones.

'One of the parts of the world I expected to come through well on 50MHz, before Cycle 21 actually, commenced, was South America. This was based on my experiences on 28MHz during the last sunspot minimum. In the event you may recall how hard Fred PY2XB tried to work us crossband without success, and I have never heard an LU, CX, or CP on 50MHz to this day! Going on my experience of ten metres in the last minimum, I remember how sceptical I was that propagation to the USA was possible – it's a real treat to get an opening to the States during a sunspot minimum. That's what makes it interesting, you never know what you might hear next time you switch on the rig!

P Radcliffe writes: 'I read with interest your comments on six metres in the March issue of *Amateur Radio*. Prior to returning to Yorkshire about six months ago, my QTH was the North-West Territories of Canada. For the past 28 years I was the only VE8 operating on 50MHz in the NWT (call VE8BY). During this time I worked thousands of stations on six, all being over a thousand miles away, with some as far as three thousand miles away (Hawaii, Bermuda etc). Each year I was able to work regular DX stations in the States via aurora or Es, so I must agree with the comments of K1JRW. On one occasion I was able to 'break-in' on two New York stations who were having a rag-chew across town on what they thought was a dead band. Due to time zones it was late at night for them, but early morning for me. The band was wide open, but nobody was listening.

'I now have a G0FNP call, and as soon as I can get some gear together I hope to be back on the band – if only in a listening capacity.'

John Baker GW3MHW of Powys, N

Wales, writes: 'GB3RMK was reinstated last Sunday (1st March) and was heard as considerable bursts took place. Some bursts were long enough for complete callsigns to be copied. The key speed is rather slow for MS but excellent for aurora. At 1635 GMT on the 5th March, the signal went aurora for about 15 minutes, when I received the message: 'GB3RMK IO77UO'. This message takes approximately half a minute to transmit, and as far as I could make out with my element beam, there was no deviation from the north with this aurora.

'Some operators are staying on the calling channel after contact has been established, however four metres has been excellent from the point of operators moving away once contact has been established, and generally so has six. Perhaps a word in print drawing attention to recognised procedure would reduce this.

'In my period of operating from 1st February 1986-31st January 1987 I made 927 two-way contacts involving 239 different stations. The countries worked included G, GD, GI, GJ, GM, GU, CT, CU, D, EI, LA, WI, ZB2, and EI.

Brian Bower G3COJ, Chairman of the Six Metre Group, writes: 'The usual frequency on 80 metres for crossband to six metres is 3718kHz. Much of the time this is fine, but there are times when (a) there is a commercial on the frequency or (b) six metre operators are nattering on 3718 when urgent traffic is waiting. More liaison frequencies are undoubtedly needed! One possibility is 3614kHz, which has been used and is usually quiet. However, it has never been very popular, possibly because of the difficulty of covering both 3718 and 3614 – easy if you have a broadband receiver with two VFOs, but not if you have to wind the VFO several turns and peak the drive, which all takes time.

## DXpeditions

Ted Collins G4UPS, ex ZD8TC, plans to make another expedition to Andorra (C31) this summer, with the callsign C30DAW (note C31 is the prefix for residents, C30 for visitors). He is planning to cross from Weymouth to Cherbourg on the 15th May, and be in the south of France by 20th May. Last year he found the road too steep to pull the caravan, but this year the new Ford Sierra should help, and he hopes to spend a longer time there. Unfortunately, most of the caravan sites in Europe have just three amps of electric power, just enough for the fridge, lights and a small battery charger. The authorities in Andorra are very good as long as you don't cause any problems. They don't bother much about frequency usage, so if the six metre band is open he hopes to operate on that band. He

# Expect.....

by Ken Ellis G5KW

intends returning via LX, hoping to operate crossband.

A very successful DXpedition was organised in July 1983 by the Harlow group. I had a QSO with C31XV/P on 23rd July 83 at 0430-0500 on 50.433 by MS, with Robin G8APZ on the key.

Last month I referred to the RSGB GB2RS Bulletins each Sunday which give useful information about radio propagation conditions. With the permission of Ray Flavell G3LTB, Chairman of the RSGB Propagation Studies Committee, I am able to publish his Carrington Rotation Number Solar Rotation Base Map for 1987, and extracts from the *Explanation of Solar and Propagation information* prepared by Charlie Newton G2FKZ for the GB2RS Bulletins.

The full text and full size Rotation base map can be obtained from the membership services officer of the RSGB on receipt of an SAE.

## Explanation of Solar and Propagation Information

Every week the GB2RS Bulletin includes information about solar and geophysical events, which either have affected or may affect radio propagation, together with forecasts of likely conditions. Since the presentation of the bulletins is rather compressed, this brief guide has been prepared to help listeners to use this information to best advantage.

Bulletins include both factual data and propagation forecasts. The factual data usually relates to the week up to the Tuesday preceding the transmission. This is as up to date as can be arranged, because factual data is obtained from many sources, but inevitably, as this has to be collated and despatched by various data centres, there are delays. Use is also made of the Mendon (France) ursigram radio transmissions of solar data to get as up to date as is possible.

## Solar activity

Solar information may refer to rotation numbers (see Figure 1). Each 27 day rotation has its Carrington Rotation Number. Interesting activity centres (such as major sunspot groups, flares, coronal holes etc) can be referred to in Latitude north or south and Heliographic longitude, which gives both position on the disc and the date of central meridian passage (frequently the radio effects of solar events are experienced around the time of central meridian passage, but this is not always the case. Large flares can have almost instant effect on the ionosphere regardless of their position on the solar disc, whereas auroral effects usually occur 30 to 50 hours after the event, and usually, but not always, after the central meridian passage of the

event).

Large sunspots of an area in excess of 500 millionths of the visual disc are sometimes brought to the attention of the RSGB. They are given as 'date first seen' (dependant on the weather at Hurstmonceux). The date on the disc gives the total passage time from appearing over the east limb to its disappearance over the west limb. The date of disappearance over the central meridian passage is given as a day and a fraction of a day, eg 7.3.

The general background flares and sunspots, mostly small in size and short in lifetime, are what is referred to as solar activity. This varies depending on the number of active regions and the type of flare emissions that occur, both in the optical X-Ray, and radio spectrum in general. The effects are classified as: Solar Quiet - no active regions erupting; Solar Moderate - active regions erupting, but with low intensity; Solar Active - one or more active regions erupting, but with high intensity bursts, or new regions forming, or both.

## Solar flares

These are divided into three types: C, M and X. C type flares are very common

and are of low intensity, about 80 to 100 per week are normal at the present time. In effect they give the general background to the solar flux.

M type are of increased intensity over C and can cause events such as magnetic storms (usually minor) and short wave fade-outs (SWF) of varying amounts. These are sub-classified in M1 to, say M4. The resulting magstorms of M3-M4 type flares usually give Scottish type weak auroral events.

X type are violent, big and accompanied by X-Ray type emissions. They usually cause widespread blackouts of the HF spectrum. There does not appear to be any definite association between auroral events and X type flares. X8 and below flares are detected by satellites, in excess of this it is necessary to deduce (such as the event of 11 July 1978 which reached X15, the largest known, though it produced no aurora).

## Next month

Next month I shall include a report on Transequatorial Propagation (TEP), which due to the large and interesting mailbag has been held-over from this issue.

Fig 1 1987 Solar rotation base map (map dates refer to 1200 GMT) (reproduced courtesy of R G Flavell G3LTP and the RSGB)

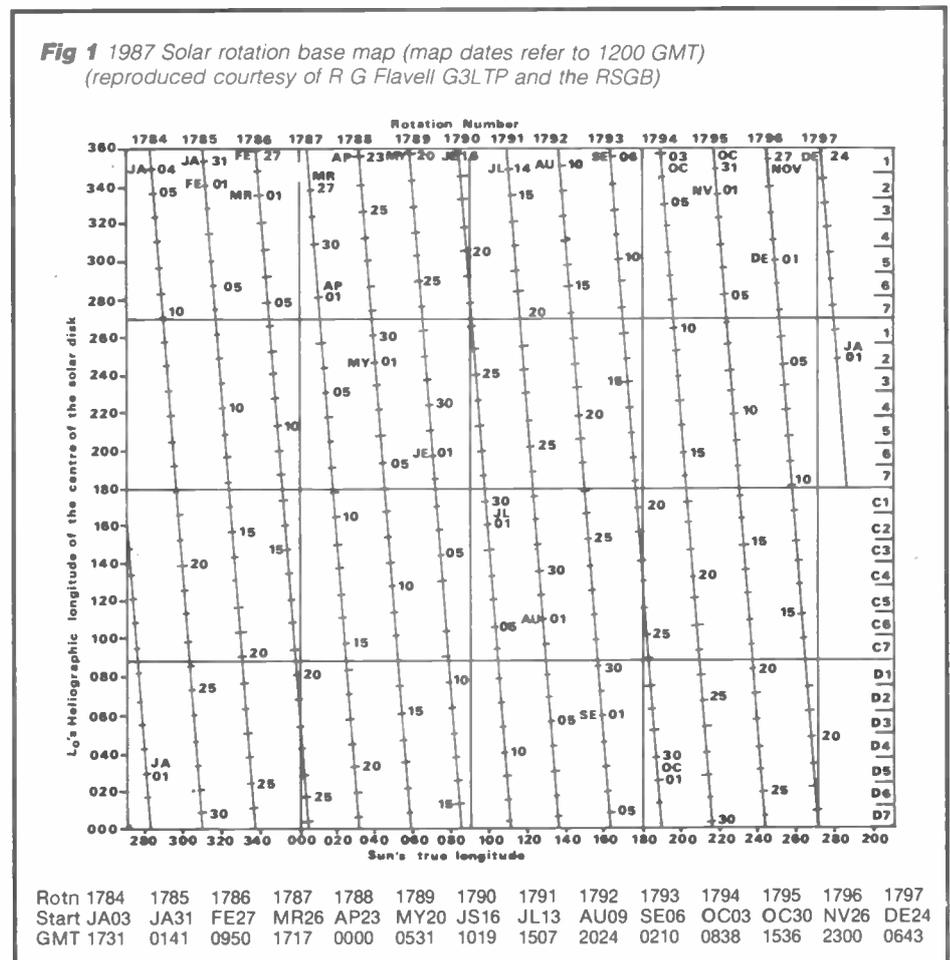

# The Amateurs' Pro

**1. IC-2E. 2 metre FM Handportable.**

1.5 watts with standard nicad pack. Thumbwheel frequency entry.

**2. IC-MICRO 2E. 2 metre FM Handportable.**

1.5 watts with standard pack. 2.5 watts possible. Toggle switch frequency entry, LCD display, 10 memories.

**3. IC-02E. 2 metre FM Handportable.**

2.5 watts with standard nicad pack, 5 watts from 13.8 volts DC. LCD display, keypad frequency entry, 10 memories, scanning.

**4. IC-28E. 2 metre FM Mobile**

25 watts, 21 memories, scanning.

**5. IC-27E. 2 metre FM Mobile.**

25 watts, 9 memories, scanning

**6. IC-290D. 2 metre Multimode mobile.**

25 watts, 5 memories, scanning.

**7. IC-275E. 2 metre Base station.**

Multimode operation, 25 watts power output. New DDS system, 99 memories, high sensitivity and dynamic range. Ideal for PACKET and AMTOR.

**8. IC-271E. 2 metre Base station.**

Multimode, 10 or 25 watt models. IC-271H 100 watt model also available, 32 memories scanning

**9. IC-3200E. Dual-band FM Mobile.**

2 metre and 70 cm operation 25 watt on both bands, 10 memories scanning.

**10. IC-SP3.**

External base-station loud-speaker 8 ohms

**11. IC-1271E. 23 cm Base station.**

10 watt power output. 1240MHz-1300MHz. Multimode operation. 30 memories scanning

**12. IC-PS55. External power supply.**

Styled to match IC-735 120 amp rating

**13. IC-735. HF Transceiver.**

Amateur Bands 160-10 metres general coverage receiver from 100 kHz to 30 MHz. CW SSB AM FM modes. 100 watt power output. 12 memories

**14. IC-AT150. Automatic antenna tuner.**

Styled to match IC-735 100 watt power rating

**15. IC-GC5. Station world clock.**



The World

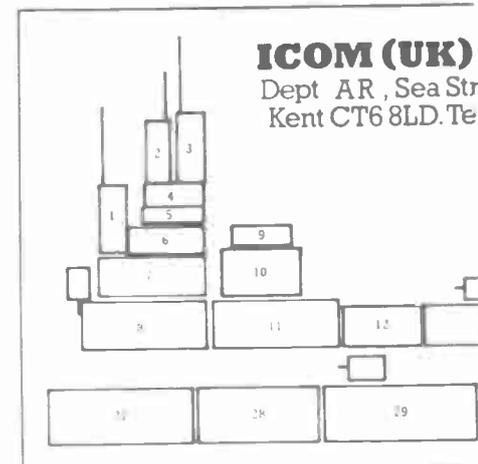

**ICOM (UK)**  
Dept AR, Sea Str  
Kent CT6 8LD. Te

**16. IC-AH2a. HF Mobile antenna tuner.**

IC-AH2a mobile whip and mount also available. Fully automatic when used with IC-735 HF transceiver

**17. IC-505. 6 metre Portable or Base station.**

50-54 MHz CW SSB FM (optional) 10 watt power output from 13.8 volts

**18. IC-551. 6 metre Base Station.**

50-54 MHz CW SSB FM (optional) 10 watt power output A C mains PSU standard. IC-551D 80 watt model also available

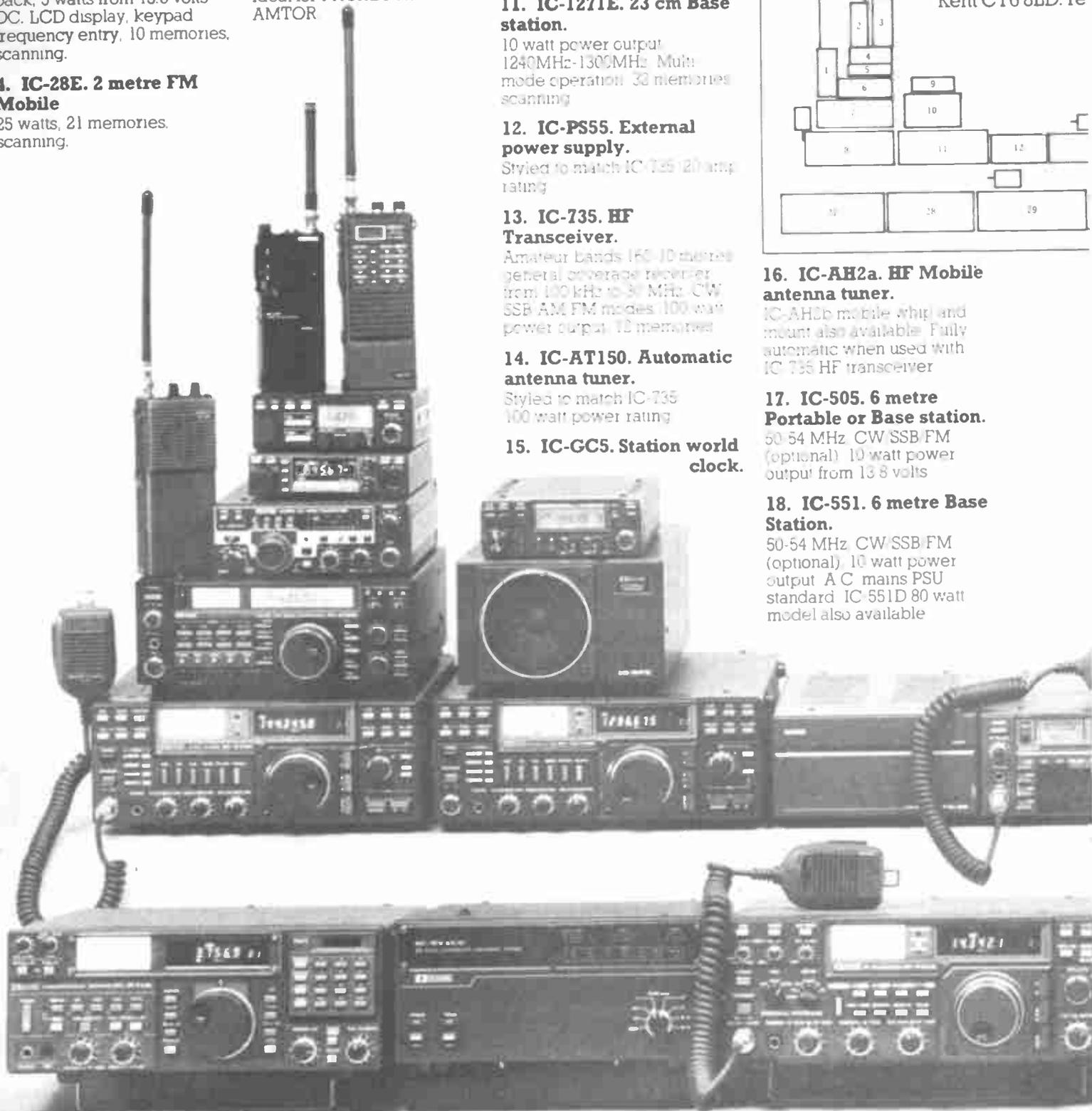

# Professional Friend.

## COM System

LIMITED  
Street, Herne Bay,  
(0227) 363859.

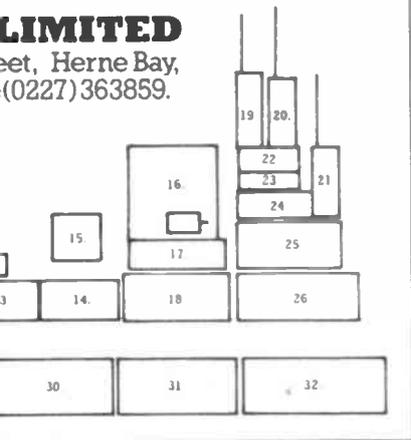

**19. IC-12E. 23 cm. FM Handportable.**  
1260-1300 MHz. 1 watt with standard nicad pack. Keypad frequency entry, LCD display 10 memories, scanning

**20. IC-04E. 70 cm. FM Handportable.**  
2.5 watts with standard nicad pack, 5 watts possible. Keypad frequency entry, LCD display, 10 memories, scanning.

**21. IC-4E. 70 cm. FM Handportable.**  
2.5 watts with standard nicad pack. Thumbwheel frequency entry.

**22. IC-48E. 70 cm. FM Mobile.**  
25 watt, 21 memories, scanning.

**23. IC-47E. 70 cm. FM Mobile.**  
25 watt, 9 memories, scanning.

**24. IC-490E. 70 cm. Multi-mode Mobile.**  
10 watt power output. 5 memories scanning

**25. IC-PS30. System power supply.**  
25 amp rating fully protected. Up to 4 ICOM units may be connected

**26. IC-471E. 70 cm. Base station.**  
Multimode 25 watts power output. IC-471H 75 watt model also available. 32 memories scanning

**27. IC-R71E. HF Base Receiver.**  
100 kHz-30 MHz CW/SSB/AM/

RTTY/FM (optional). Direct frequency entry. 32 memories, scanning. Remote control option. 12 volt DC. option.

**28. IC-AT100. Automatic antenna tuner.**  
100 watt power rating. Also available is IC-AT500 with 500 watt rating. Autoband switching with ICOM HF transceivers.

**29. IC-751A. HF Transceiver.**  
Amateur bands 160-10 metres. General coverage receiver

from 100 kHz to 30 MHz. CW/SSB/AM/RTTY/FM modes. 100 watt power output, 32 memories.

**30. IC-2KL. HF 500 watt Linear amplifier.**  
Automatic band switching with ICOM HF transceivers. 2KLPS power supply is required. Solid state broadband tuning.

**31. IC-2KLPS. AC. Power supply.**  
For use with IC-2KL. Regulated voltage of 40 volts DC. and metered current of 25 amps.

**32. IC-R7000. VHF/UHF Continuous coverage receiver.**  
25 MHz-2000 MHz FM/AM/SSB modes. Direct frequency entry 99 memories, scanning, remote control option

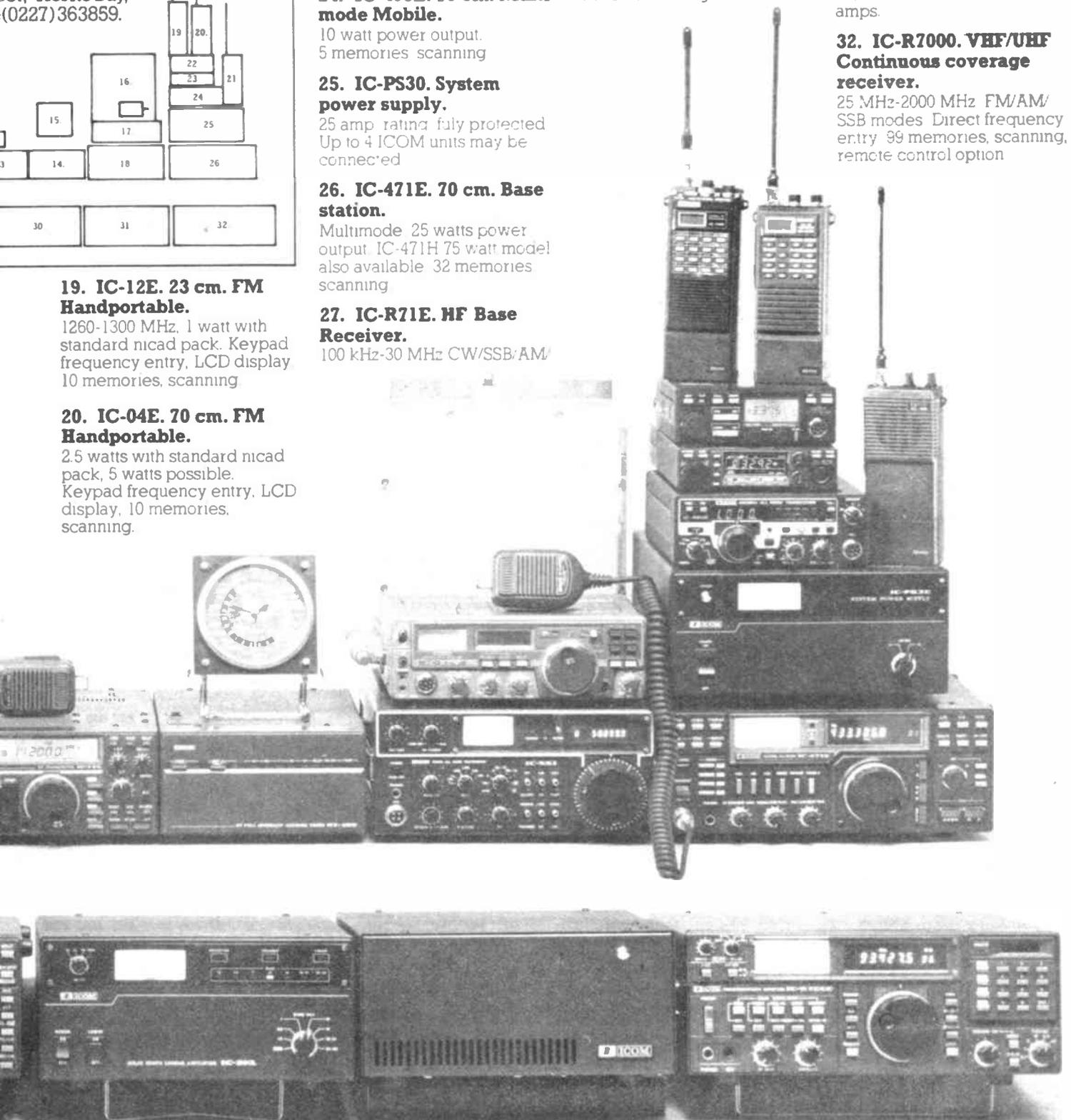

# SHORT WAVE LISTENER

TREVOR MORGAN GW40XB

Maybe it's a sign of the times, or perhaps some people just don't like to spend too much of their hard earned cash on their hobbies, especially if it's a new venture for them. Either way, I get quite a few letters asking what sort of receiver can be bought for around £25.

## The vogue

It's only just over a decade since the 9R59DS was the vogue, the DX160 was a new receiver and the FRG7 was yet to 'break new ground' in a market that, until then, had been the preserve of few dedicated industries and mostly served by the buyers of ex-government stocks. Yes, we were served well in those days by the little back street shops, crammed full of AR88s, B18s, Eddystones and Camouflage green boxes that contained all sorts of goodies... all marked with that 'WD' sign. But in those days the radio amateur was little heard of. Those that ventured into this mysterious world were, for the most part, ex-servicemen who knew about such things and who, to the uninitiated youngster, were reclusive old men.

Today the youngster is brought up in a world of electronics and there are few who do not own some sort of radio, even if it is only used to receive the 'pop charts'. But how many of them listen to the radio with the same enquiring mind of the youngster from the pre-transistor era?

## We don't listen

So, what has this got to do with cheap receivers? It's simply that we are so used to the sound of the radio, that many of us just don't listen to it any more! I had a quick look around my own house the other day and was surprised to find that there were no less than *eleven* radios of one sort or another, ranging from a single band novelty 'cuddly toy' on the XYLs dressing table, cassette/radios belonging to my sons, the radio

alarms in the bedrooms and the 'all singing and dancing' hi-fi system in the front room! I dread to think what I would find in various cupboards and boxes if I was to really look!

To be honest, very few of us buy radios for domestic use with 'DXing in mind and, not surprisingly, rarely give much thought to the radio facilities of our hi-fi systems or cassette players. While writing this piece, I have the hi-fi system on 1140kHz receiving 'Voice of America', while the wife's cuddly toy is tuned to 'Radio World', a programme from the Flemish Broadcasting service in Belgium, which includes some very interesting DX news in the programme on 1512kHz (1800, Sunday).

## Nothing special

You don't have to have a special receiver to get these programmes, or a digital readout to get the frequencies. Any receiver with a reasonably accurate tuning dial will suffice, as most station announcements include schedules of their programmes, giving frequencies and times of their transmissions. Some give full frequency details, while others just give the metre band. However, this is quite sufficient to give you an idea of where to look for the station again.

## Stereo systems

Often the average portable radio or stereo system only has the medium, long and VHF bands, but these can be very fruitful for someone prepared to listen carefully. There are literally hundreds of stations to be heard on the medium wave band alone and medium wave DXing has become a hobby in itself, with many enthusiasts concentrating their efforts in logging as many of these stations as they can. Receiving techniques and equipment are the same, in basis, as for the wider used short wave bands.

Regardless of what receiver you have, it's the aerials

that has the job of gathering the signals, and the medium wave listener is as keen as his short wave counterpart to get the best from his set-up. Probably the most commonly used DXing aerial is the medium wave loop, which has been featured in this magazine many times. This aerial is designed to be directional, enabling the listener to 'null out' unwanted signals.

## DXing

If you want to receive stations from further afield than North Africa, then you should invest in a receiver with the short wave bands. This need not be expensive and many listeners have logged hundreds of stations using the simplest receivers and a random length of wire for an aerial. Probably the cheapest receiver on the market today is the Russian Vega 242. It is very bulky by modern standards but is capable of excellent results despite its rather dated design.

Besides the medium and long wave bands, the Vega has seven short wave bands covering the 13 16, 19, 31, 41 and 60 metre broadcast bands. Besides the built-in ferrite and telescopic aerials, it also has sockets for an external aerial and earth, which are essential for reception of distant signals. However, reception using the built-in aerials is quite good, so it would probably be adequate for portable use or where any sort of external aerial would be out of the question (Bear in mind that even a few metres of very thin wire concealed on top of a picture rail or around a window frame can make a lot of difference!).

## A cheap route

Although, of course, these receivers are not suitable for amateur band reception (as amateurs use single sideband which cannot be resolved by them as they stand), they are certainly a means of getting into the hobby of listening for

a small outlay.

Using a simple receiver such as the Vega can be as interesting and useful as you want it to be, and you can learn quite a lot about radio wave propagation. Ask yourself why Radio Moscow only broadcasts on certain frequencies (quite a lot, in fact) at certain times? Or why some frequencies appear empty at certain times of the day or night while others are busy?

There are many books published to help the beginner, and I would recommend *The International Radio Stations Guide* and *An Introduction to Radio DXing*. Both are published by the Babani Press and are available from The Grampians, Shepherds Bush Rd, London W6 7NF.

## Award front

The band of award hunters has been busy again this month, and first honours go to Charles Morgan G0EIW of Addiscombe, who finally made the Gold Prefix Award for 1000 prefixes heard. Not satisfied with that, Charlie also put in his claim for the Bronze award for 250 prefixes worked. He also mentioned some interesting QSL information: 8P9DX - QSL via home call VE3ICR; 4U1ITU via his home call AA4V; OY6FRA via the bureau or direct to PO Box 343; LJ2Q via LA7DFA; Y11BGD via PO Box 24093 Baghdad; NP4BW to PO Box 8656 Ponce, Puerto Rico 00732; and C53BU to PO Box 720 Banjul, The Gambia. Thanks for the info Charlie.

## Not enough time

Angela Sitton G1XEO has found that her new licence has meant more time working the key on 2m than listening, and at present she's really getting keyed-up (?) for the test. However, her ventures back to the HF bands have put a few more prefixes into the log, despite getting a severe case of GBH of the ear when in the sidebands. Funny how regular listening seems to tune the ears against the QRM!

An interesting letter from Goff Curtis RS20104, of South Harrow, mentions that there is a DX 'Phone in' being operated in his area by the *DX News Sheet* team. There are separate phone numbers for news input and playback and some well known DXers are taking part. A line to the usual Geoff Watts address should get you the details.

### New hunter

New on our award hunters list is Evan Newlon of New Mexico. Evan is a very keen broadcast band listener and has just claimed the Broadcast Listeners Award for logging 100 stations. Some interesting calls appear in his list, including Botswana, Burkina Fasso, Gabon, Paraguay, Solomon Is, and Togo.

Mick Hudson RS87259 of Canterbury sent in claims for Bronze for 40m SSB and Silver for 80m SSB. Mike is still using the old 9R59DS to good effect and lists 3A2, 4N7, 5N8, 6W1, 6Y5, 8Q7, 9K2, A90, AZ1, HC5, J87, KH9, SJ9, and S90 amongst the 80m catches. 40m brought AA4, CQ0, HC5, KL7, T77, XE1 and YB5.

Jane Mullany G4GIG of Birmingham submitted her claim for the Gold award. She seemed to enjoy the challenge and says 'It has proved most beneficial to listen on a regular basis as it gives you a much greater understanding of the effects of propagation'. All her listening was done on the Philips D2935 with a large proportion of this using the whip aerial. Her other aerial is a multiband trap dipole at 15ft. Jane's lists included 1A0, 5H3, 5T5, 8J9, 8R1, A71, AP2, BY4, CQ9, HV3, J3, J49, OE5/YK, P40, PS8, YC2 and ZP5.

### Broadcast award

Another listener on the broadcast award hunt is Thomas McElvey of Norfolk, who sent in his claim for the 100, and included the Central African Rep, Dodecanese Is, Mariana Is, and Papua New Guinea amongst his lists. There's a lot of interest in this award and enquiries have been made regarding a similar award for medium wave DXing. Details of this are being worked out and I will probably be announcing them next month.

David Glow KDX1A of Townsend, followed last month's Broadcast Award claim with

claims for Bronze, Silver and Gold, for prefixes logged on 23 computer sheets containing some really choice stuff. 1B9 (Blenheim Reef), 1G5 (Minerva Reef), 3B6 (Agalega Is), 3C0 (Annobon Is), 3W8 (Sth Vietnam), 4M0 (Monks Is), 5H1 (Zanzibar), 5R8 (Malagasy), 6V1 (Goree Is), plus a mass of prefixes that are a refresher course in geography: 9L2, 9N1, A35, AC3, AH7, AM9, CR9, FB8, HD8, HK0, NP2, TI9, and masses more. My eyes are still watering from reading his lists.

John Upsher RS52008 of Wolverhampton was the next in line with his claim for the Gold award, with an impressive collection including VK7, ZY5, VS5, VP9, A71, HI3 and ZD7.

### ILA plug

Sneaking in a plug for the International Listeners' Association, I will be at the Swansea Rally on 3rd May, and will be pleased to meet any of our readers who are there. The rally is held in the Patti Pavilion, which is alongside the St Helens rugby/cricket ground. The rally is organised by the Swansea ARS, who will have talk-in by GB2SWR. Morse tests will be conducted and refreshments will be available. All the usual trade and bring and buy stands will be there, and doors open at 10.30. See you there.

Hamgear Electronics of Norwich have redesigned their original preselector quite considerably. The new model offers an HF band preamplifier and PI tank

antenna coupler covering 1.7 to 34MHz. The antenna coupler section is designed to tune almost any length of wire to any frequency, in the range which makes it ideal for the experimenter. The pre-amp section offers an average gain of +20dBs or an attenuation of 15dBs below the signal, as seen by the receiver alone. The unit can also be bypassed.

Although there is full coverage in the range specified, the range switch is very conveniently marked with the amateur bands.

This seems an ideal addition to the listener's shack, especially where simple receivers that may be prone to image rejection or mixing problems are in use. The price of £78 for the mains powered model does not seem excessive considering what it offers, and more details are available from 125 Wroxham Road, Sprowston, Norwich NR7 8AD.

### Band reports

A number of requests have been received for band reports in the column, so, without further ado, here are the reports received from our readers this month.

Angie Sitton reports EA2ASI on 10m SSB on 8th February, PT7BZ, JY5DK, CU3GD, JE3QLX, RB5LL and LU3EN on 15m during February, and IR8CS, 7X2LS and DU7FGJ on 20m. S2PM was also heard on 80m on 8th February, but she queries whether he was legal.

Mick Hudson reports eighty metres being very much alive

with 6Y5IC, VP2VA, AH2F, YC6XE, 6W1CK, S79KG, 5B4SA, 6W2EX (via F6EYS), FM5AB and TZ6MG coming in during January. Twenty also started to come alive with 3D6BW, 9K2YS/IC5, FK8FS, 9Y4CR, HK6MCX, J87CD, VP2MO, A92EM, DX9HT, 5N2KRC, J40DX, S92LB, TU4CG, ZB2J, 7P8DP, FY5YE, TZ6LPY and V44KAR among the catches.

### Reception conditions

Reception conditions seemed to be pretty evenly spread during late January and early February, with the usual ZL/JA crop in the early morning, HK/VP around mid day and the South Africans coming up in the afternoons. After dark it was the Americas as usual, however the occasional VK was found in the afternoon (late evening down there) to make things interesting.

There were also a few strays on eighty, where JAs were heard at 2200 (early birds, obviously). Mike uses the Trio 9R59DS with an end fed wire aerial.

Forecasts of an early rise in the sunspot level seem to be coming true, and many listeners have reported regular DX being heard on fifteen and ten, showing early signs of life. If you've heard any good DX or anything unusual on the bands (amateur or broadcast), please send your reports to me at 1 Jersey Street, Hafod, Swansea SA1 2HF.

Well, that's it for this month. Have a good month's listening. Best 73.

The Hamgear PMX preselector - ideal for the experimenter

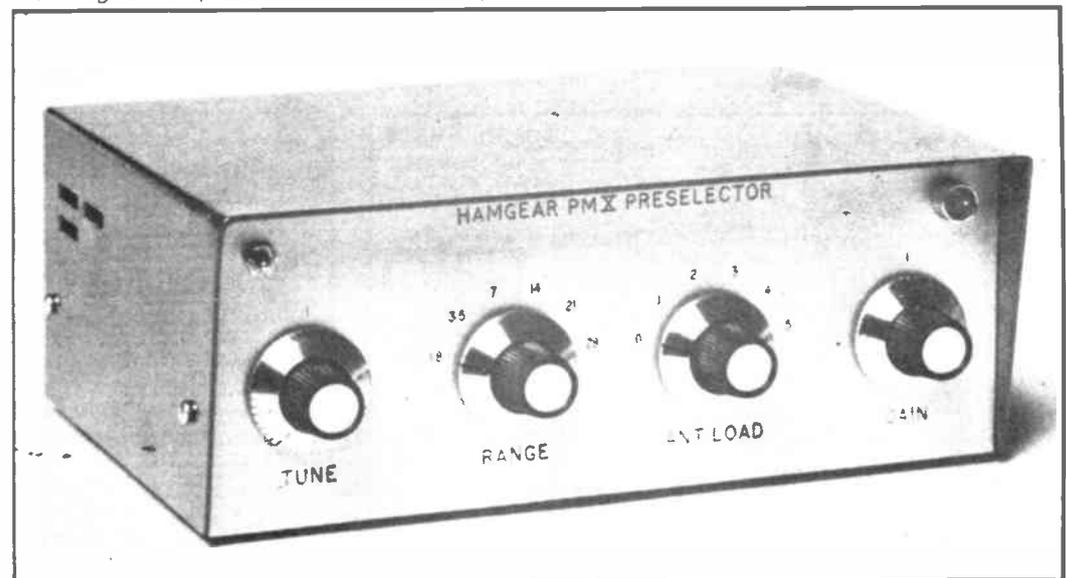

# BI-PAK BARGAINS

Pack No	Qty	Description	Price	Pack No	Qty	Description	Price	Pack No	Qty	Description	Price
<b>RESISTORS</b>											
VP1	300	Assorted Resistors mixed values & Types	£1.00	VP74164	4	74164 9-Bit Parallel Output Serial Shift Registers	£1.00	VP226	20	DIN Chassis Skts. metal 2-8 pin 180°/240°/360° mixed	£2.50
VP2	300	Carbon Resistors 1/4-1/2 watt pre-formed, mixed	£1.00	VP74187	4	74187 Synchronous Decade Rate Multipliers	£1.00	VP227	18	DIN in-line Skts. plastic 2-8 pin 180°/240°/360° mixed	£2.50
VP3	200	1/2 watt Min Carbon Resistors mixed values	£1.00	VP74174	4	74174 Max D-Type Flip-Flops	£1.00	VP228	10	C15 Computer Cassette Tape leadless	£3.00
VP4	200	1/2-1 watt Resistors mixed values & types	£1.00	VP74181	4	74181 Arithmetic Logic Units/Function Generators	£1.00	VP229	10	C60 Cassette Tape 2x30 min. low noise	£5.00
VP16	50	Wirewound Resistors mixed watt values	£1.00	VP74193	4	74193 Sync Up/Down Dual Clock Counters Binary clear	£1.00	VP230	10	C90 Cassette Tape, 2x45 min. low noise	£5.00
VP112	1	Sub Resistance Box 36 values 5 ohms-1K ohms	£4.75	VP74279	4	74279 Quad S-R Latches	£1.00	VP231	1	Cassette Head Cleaner/Tape, non abrasive, in case	£1.00
VP140	50	Precision Resistors 1% Tol	£1.00	BPX6	1	TTL Data Book 74 Series, including "LS" Complete with Pin out Diagrams, 7400-74670 TTL Interchangeability Guide Function Selection Guide and Explanation of Function Tables "NO VAT"	£1.00	VP232	1	Cassette Head Cleaner/Demagnetizer, in case	£1.00
VP181	100	1 and 2 watt Resistors, assorted values	£1.00	<b>TOOLS</b>							
<b>CAPACITORS</b>											
VP5	200	Assorted Capacitors all types	£1.00	VP246	1	25 watt High Quality Low Cost Soldering Iron 240v AC Long Life Element, 1.7m lead	£3.50	VP238	4	AA Ni-Cad Batteries 1.25v 500mAh C/R mA	£4.00
VP6	200	Ceramic Capacitors Min mixed values	£1.00	VP247	1	15 watt "Lightweight" High Quality Low Cost Soldering Iron 240V AC 1.7m lead	£3.50	VP239	2	C-HP11 Ni-Cad Batteries Rechargeable	£3.50
VP8	100	Mixed Ceramic Disc 68pF-015pF	£1.00	VP248	1	High Suction Desoldering Pump, Teflon nozzle Auto Eject Heavy duty return spring	£4.00	VP240	2	D-HP2 Ni-Cad Batteries Rechargeable	£4.00
VP9	100	Assorted Polyester/Polystyrene Capacitors	£1.00	VP249	1	High Quality Soldering Iron Stand Cast iron base Tip cleaning sponge	£4.00	VP241	2	ORP12 Light Dependent Resistor	£1.50
VP10	50	C280 Capacitors Metal foil, mixed values	£1.00	VP250	1	Long Finger Grip, soldering aid Heavy metal base Serrated jaws with rev. tweezer action. Ideal for holding small components Fully adjustable	£3.00	VP242	2	Tri-colour LED's 5mm Dia 5mA 2v R G Y	£1.00
VP11	50	Electrolytics all sorts	£1.00	VP251	1	Multi-tester Pocket size 18 ranges 10000 ohms/VDC - 4000 ohms/VAC, Fuse and diode protection Mirrored scale Leads with 2mm plugs. Batt & instructions inc	£8.50	VP243	3	Tri-colour LED's Rectangular 5mm R G Y	£1.00
VP12	40	Electrolytics 47mf-150mf, mixed volts	£1.00	VP252	1	Multi-tester & Transistor Tester 20000 ohms/V 19 ranges Audio output Test term Fuse & Diode protection Test leads & Transistor tests leads Batt & instructions Mirrored scale Size 147x97x45mm	£18.50	VP244	1	High Power Piezo Electric Siren Emits Earpiercing warbling sound. Ideal alarms. White plastic body with at 1m typ Freq 2.5KHz Size 57x42x37mm	£6.00
VP13	30	Electrolytics 150mf-1000mf, mixed volts	£1.00	VP253	1	Digital Multi-tester 3 1/2 digit. Side switches for single-hand operation. High quality construction tough ABS body Fully guaranteed. Overload protection input imped 10Mohms 19 ranges incl 10ADC plus diode & transistor test. Accuracy 0.8% Complete with leads Batt. and manual. Size 145x70x31mm	£35.00	VP245	1	Automatic Lighting Switch Photo electric, weatherproof Switches lights or equipment "ON" at dusk "OFF" at dawn. Leads up to 3m at 240V AC. Size 50x45mm	£3.00
VP15	25	01/250V Min Layer Metal Caps	£1.00	<b>74 SERIES SALE "ROCK BOTTOM" PRICES</b>							
VP146	25	Solid Tantalum Caps, mixed values	£1.00	VP223	50	Asst 74 TTL IC's "ALL GATES" new & coded our mix 7400-7453	£8.00	VP224	100	Asst 74 TTL IC's "ALL GATES" new & coded our mix 7400-7453	£10.00
VP180	25	Tantalum Bead Caps, assorted values	£1.00	VP7413	4	7413 Dual Nand Schmitt Trigger, 4-Input	£1.00	VP7440	4	7440 Dual 4-Input Positive-Hand Buffer	£1.00
VP182	4	1000µF 50V Electrolytics	£1.00	VP7440	4	7440 Dual 4-Input Positive-Hand Buffer	£1.00	VP7470	4	7470 And-gated Positive-edge-triggered Flip-Flop with preset	£1.00
VP192	30	Min Electrolytics mixed values 47mf-1000mf 6-16V	£1.00	VP7480	4	7480 Gated full Adder	£1.00	VP7481	4	7481 16-Bit Random Access memories	£1.00
VP193	6	Sub Min Electrolytics 2 x 1000/2200/3300mF 10-16V	£1.00	VP7490	4	7490 Decade Counter	£1.00	VP7491	4	7491 8-Bit Shift Register	£1.00
<b>74 SERIES SALE "ROCK BOTTOM" PRICES</b>											
VP223	50	Asst 74 TTL IC's "ALL GATES" new & coded our mix 7400-7453	£8.00	VP7492	4	7492 Divider by 12 Counter	£1.00	VP7493	4	7493 4-Bit Binary Counter	£1.00
VP224	100	Asst 74 TTL IC's "ALL GATES" new & coded our mix 7400-7453	£10.00	VP7494	4	7494 4-Bit Shift Register	£1.00	VP7495	4	7495 4-Bit Shift Register	£1.00
VP7413	4	7413 Dual Nand Schmitt Trigger, 4-Input	£1.00	VP7496	4	7496 4-Bit Shift Register	£1.00	VP74111	4	74111 Dual J-K Master Slave Flip-Flop	£1.00
VP7440	4	7440 Dual 4-Input Positive-Hand Buffer	£1.00	VP74141	4	74141 BCD Decimal Decoder/Driver	£1.00	VP74151	4	74151 1 of 8 Data Selectors/Multipliers	£1.00
VP7470	4	7470 And-gated Positive-edge-triggered Flip-Flop with preset	£1.00	VP74153	4	74153 Dual 4 line to 1 line Data Selectors/Multipliers	£1.00				
VP7480	4	7480 Gated full Adder	£1.00	<b>MISC</b>							
VP7481	4	7481 16-Bit Random Access memories	£1.00	VP223A	6	Tag Boards 36way Paxaline	£1.00				
VP7490	4	7490 Decade Counter	£1.00	VP225	20	DIN Plugs plastic 2-8 pin 180°/240°/360° mixed	£2.50				
VP7491	4	7491 8-Bit Shift Register	£1.00								
VP7492	4	7492 Divider by 12 Counter	£1.00								
VP7493	4	7493 4-Bit Binary Counter	£1.00								
VP7494	4	7494 4-Bit Shift Register	£1.00								
VP7495	4	7495 4-Bit Shift Register	£1.00								
VP74111	4	74111 Dual J-K Master Slave Flip-Flop	£1.00								
VP74141	4	74141 BCD Decimal Decoder/Driver	£1.00								
VP74151	4	74151 1 of 8 Data Selectors/Multipliers	£1.00								
VP74153	4	74153 Dual 4 line to 1 line Data Selectors/Multipliers	£1.00								

# BI-PAK

Send your orders to Dept RE, BI-PAK, PO BOX 6, WARE, HERTS

TERMS CASH WITH ORDER. SAME DAY DESPATCH. ACCESS. BARCLAYCARD ALSO ACCEPTED. TEL 0763-448851. GIRO 388 7006 ADD 15% VAT AND £1.50 PER ORDER POSTAGE AND PACKING



Use your credit card. Ring us on 0763-448851 NOW and get your order even faster. Goods normally sent 2nd Class Mail. Remember you must add VAT at 15% to your order. Total Postage add £1.50 per Total Order

## CAVITY WAVEMETERS & CAVITY FILTERS

If you operate on 144 MHz or above then the Cavity Wavemeter is for you. It covers 144 MHz to over 2500 MHz. A short version covering 430 MHz to over 2500 MHz is also available for the UHF operator.

Other types of Cavities are available i.e. BAND PASS & NOTCH FILTERS as used in most Repeater Stations.

10 GHz Wavemeter Kits also produced.

SAE brings you more information. Write to:  
PAUL SERGENT

G4ONF,

6 GURNEY CLOSE, COSTESSEY NORWICH  
TELE. (0603) 747782

# L F HANNEY

77 Lower Bristol Road, Bath, Avon

TEL: 0225 24811

Your electronic component specialist for Avon, Wilts & Somerset  
Closed Thursdays

REG WARD & CO LTD  
1 Western Parade  
Axminster Devon EX13 5NY

South Wests  
Largest Amateur  
Radio Dealer

Official Agents Yaesu, Trio, Icom, FDK  
:Complete range stocked:  
:Full demonstration facilities:  
:Mail/Phone orders on all items:  
:Barclaycard, Access, Instant Credit:

APPROVED  
**TRIO**  
DEALER

Ancillary equipment: Adonis, AKD, AOR, Benchor, BNOS, CAP, CO, Datong, Diawa, Drae, Hansen, Hinound, JIL, Kemprow, Microwave Modules, Mutek, SEM, Snare, TAU Tolcvo Hypower, Tono, Toyo, Welz, Wood & Douglas

Aerials by: G Whip, Hygain, Jaybean, Mini Products, Rexco, TET, Tonna

New complete range Wood & Douglas Kits  
TAU Tuner SPC 3000



Cables, plugs, sockets, insulators, etc.

Opening hours: Tues-Sat 9.-5.30 (lunch 1-2) Closed Mondays

Tel: Axminster (0297) 34918

## GROSVENOR SOFTWARE

G4BMK

AX25 Packet Radio  
DRAGON 32/64 and TANDY Color

A breakthrough in Packet Radio-AX25 stand-alone software in ROM cartridge, plus a built VHF/HF modem for just £99! New DRAGON 32 Computers available at £54.00. Full AX 25 implementation with up to 6 simultaneous connections, optional beacon, and digipeater operation. Modem Kits & PCB's available. Send SAE for full details of this & RTTY, CW, SSTV & AMTOR.

2 Beacon Close, Seaford, East Sussex BN25 2JZ

Tel: (0323) 893378

# COUNTERMEASURES

PART TWO

BRIAN KENDAL

Last month I described how the German navigational beams over England were detected and jammed. However, as time passed the military strength of the Allies increased and the emphasis changed from defence to attack.

Countermeasures take many forms, from defence (as described last month) to jamming the enemy detection equipment or, alternatively, arranging that the enemy equipment receives totally misleading information. At this time, however, there was a strong body of opinion against initiating a jamming war because of the vulnerability of our own radar equipment. The issue was settled, however, in January 1942, when the battleships Scharnhorst and Gneisau made a dash from Brest, where they had been for a considerable period, through the Channel to north German ports. Their passage was covered by systematic jamming of all the south coast radar stations. The jamming war had begun.

## The German radar equipment

At the outbreak of war in 1939, the radar equipment available to the German armed services were far in advance of any possessed by the Allies. The UK relied on the Chain Home 30MHz system backed by some metric equipment which was just being introduced. The Royal Navy was also experimenting with metric shipborne radars, but by 1939 very few were operational.

In contrast, Germany had had radar available since 1934 and for defence purposes had standardised on two basic types: the Freya, which was metric (125MHz) long range search equipment, and the Wurzburg, operating on about 500MHz, which acted as the precision element of the system. The advantages gained by the Allies lay not in the superiority of the equipment, so much as the type of display used and its method of use.

From the inception of CH it was realised that the system, although blessed with an extremely long range, was not particularly accurate in determining bearings. As each radar was part of a chain, it was therefore possible for the same targets to be tracked by one or more stations, each indicating a slightly different position. To overcome this, a filter system was derived in which plots from each station were relayed back to a central control room where experienced officers deduced which plots were valid.

This system proved invaluable throughout the Battle of Britain. However, the reaction time was too slow

for active control during interceptions, so when the metric radar equipment became available, a new type of display was introduced. Known as the PPI (Plan Position Indicator), the radar head was maintained in continuous rotation while the timebase of the display originated at the centre of the tube and rotated in sympathy with the aerial. Targets caused a bright-up of the trace, and thus the overall picture presented a map of the airspace surrounding the radar station. A further advantage of this type of display was that many targets could be displayed and tracked simultaneously by one radar head.

In contrast, both types of German radar

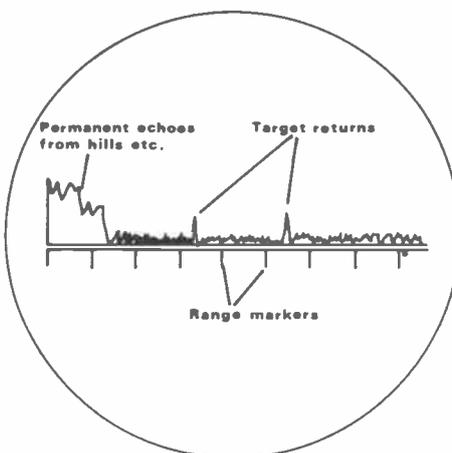

The 'A' scope range display as used on CH and other early British radars. The range markers are produced electronically

used only range displays in which the trace formed a circle on the tube face and the target caused the trace to move outwards. The range was therefore indicated by position of the deflection. This display system limited each radar to tracking only one target at a time, which was the weakness in an otherwise excellent radar.

The backbone of the German radar defence was a series of Freya equipment which detected the Allied aircraft at ranges up to 100 miles. As the range shortened, each plot was notified to one of two or three associated Wurzburg radars, each of which in turn controlled one or more fighter aircraft.

Comparing the British and German systems, it will be seen that the former used an area system, whereby every threat could be evaluated and suitable reaction arranged, whilst the latter was localised and could be overwhelmed by a concerted attack.

By the time that the RAF was in a

position to start large scale raids, the basic techniques for nightfighters had been developed, and both Allied and German aircraft were equipped with short range Airborne Interception radar (AI) equipment. The main task of the defender was, therefore, to detect the intruders using the ground radar and to vector the defending aircraft into a position whereby their AI could locate the enemy bombers.

To minimise the threat from nightfighters, therefore, the attacking force could either:

- Overwhelm the ground radar with multiple plots.
- Jam the ground radar.
- Create a diversion to ensure the fighters were elsewhere when the main force arrived.
- Jam the RT channels controlling the fighters.

All these methods were used by the RAF, one of the earliest being Moonshine.

## Moonshine

Moonshine was an airborne device which enabled a single aircraft to appear on the enemy radar as a large formation, and was developed in 1942 by the Telecommunications Research Establishment at Swanage. The equipment comprised a receiver tuned to the Freya radar frequency (125MHz) and a two stage transmitter on the same frequency. The output of the receiver was fed to a multivibrator, and thence to three 300kHz oscillators which were each slowly frequency modulated. The output of these was combined and used to drive the modulator.

The overall result from this rather complex circuit was that the transmitter returned a much stronger echo than the aircraft alone. Furthermore, the output level varied irregularly in the same way as the return from a large formation of aircraft.

A special unit (515 Squadron) was formed using Boulton Paul Defiant aircraft, an obsolete but still relatively high performance fighter. On 6 August 1942, eight aircraft orbited Portland and 'Moonshined' the German radar screen. Immediately the entire fighter defences in the Cherbourg area took off to meet the threat!

Eleven days later, while a large force of American Flying Fortresses (B17s) attacked Rouen, 515 Squadron operated over the mouth of the Thames. 144 enemy fighters assembled to meet the attack from the Thames, whilst less than half that number intercepted the actual raid.

The difficulty with Moonshine was that separate equipment had to be used to

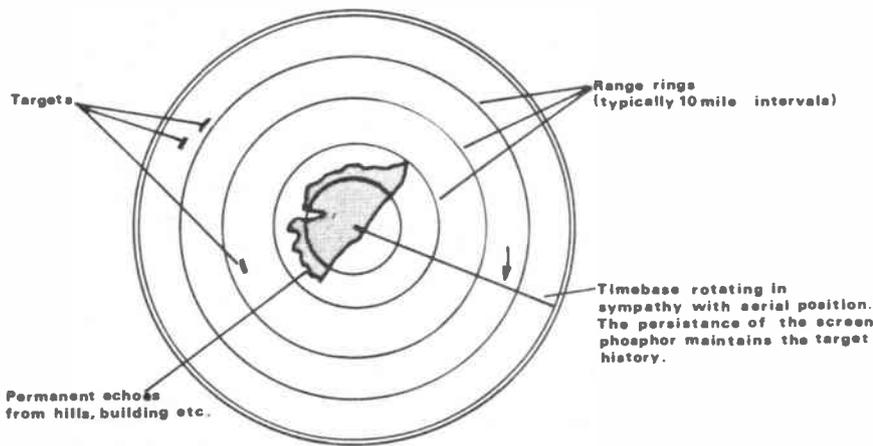

The PPI radar display – still the most common display in use. The introduction of this type of display made active control of fighter aircraft possible

counteract each Freya radar, and also that the 'spoofing' aircraft had to remain out of sight of the enemy ground defences.

Faced with these difficulties, and a rapidly expanding Freya radar system, the last Moonshine sortie was flown in the late autumn of 1942. This was not the end of the Moonshine story, however, for the idea was further developed by Sven Doddington of ITT in the United States, who expanded the system into a multi-band device with automatic frequency tracking of the received signals. This development was not completed by the end of hostilities, but remained in the military inventory until the late 1950s.

### Bagful

Before attempting to jam an enemy radar system, it is necessary to analyse the frequencies and positions of the opposing radar stations. This was achieved by the Bagful receiver.

This was a continuously tuning receiver whose output was recorded on a roll of paper by a pen moving across the paper in synchronism with the mechanical tuning of the local receiver oscillator. A received signal would therefore show as a line on the paper with its lateral position indicating its frequency.

The approximate position of the radar could be derived by a correlation of the position of the trace on

The circular range of displays as used on the Freya and Wurzburg radar equipment

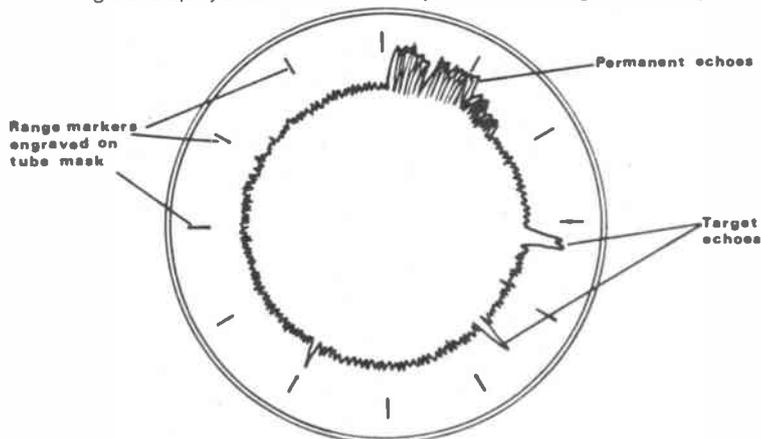

the roll of paper and an examination of the aircraft log.

### Mandrel (T1408 and variants)

These were devices intended to jam the German metric radars, such as Freya. They provided a 10MHz wide band of noise, but as a continuous transmission would provide an excellent target for enemy night fighters to home on, the transmission was only maintained for 60 seconds, followed by a 120 second silent period before a further 60 seconds of noise. As no specialist aircrew were required to operate the device, they were fitted in a number of aircraft to maintain continuous jamming. A later version, Mandrel 111, was tunable in order to jam individual radars.

### Carpet 11 (TR1621)

This was another airborne equipment, this time against the 300-500MHz Wurzburg and gun laying radars. In this the receiver swept a 40MHz bandwidth within the specified range each 1.5 seconds. On receiving a signal, the automatic sweep was stopped and noise modulated jamming was transmitted for a maximum of eight minutes. At the end of the transmission, the automatic sweep was restarted.

### Window

Without doubt, the most effective anti-radar device is Window (now called

Chaff), yet it comprises only short strips of tin foil ejected from an aircraft in flight.

The suggestion for jamming radar by dropping clouds of metal foil strips had been made as early as 1937, but it was not until early 1942 that TRE determined just how effective it could be. As a result, vast quantities of tinfoil strips were ordered from manufacturers in preparation for operational use.

On hearing of this, however, the Chief of Air Staff, Sir Charles Portal, placed a ban on its use. This may seem surprising, but the fact remains that, at this stage of the war, the Luftwaffe still had a bomber force numerically superior to the RAF, and to reveal such a simple device as Window may well have opened the floodgates for similar jamming of our own defences and a resumption of bombing of our own cities.

Strange as it may seem, at almost exactly the same time German scientists had also developed a version of Window, called 'Duppel', but a report to Reichsmarshal Goering, the head of the Luftwaffe, had stressed the danger to the German radar system should it be employed by the Royal Air Force.

Goering was horrified with the thought and decreed that all evidence of the development should be destroyed.

This, however, was to no avail, for an Intelligence report from Germany, hinted of the Duppel experiments. The RAF therefore decided that it would be used as soon as they had an air interception radar which could operate through the Window interference. This arrived later in the year in the form of the American SCR720 equipment, which was given the British designation AI Mk X.

Window received its baptism of fire during the night of the 24th July 1943 in a major raid on the German port of Hamburg. 746 heavy bombers took off from airfields in eastern England carrying, in addition to their normal bomb load, 92 million strips of Window. The effect of this blocked the German radar defences, and when the attacking force returned, the losses were only twelve aircraft compared with fifty which would have been statistically expected.

### Jamming the RT

So far, I have only described the jamming of the German ground radar systems. However, it is rare that any single countermeasure can be 100% effective. The radar jamming was, therefore, supplemented by an equally ferocious attack on the communications between the enemy fighters and their associated control stations.

At the present time most military communications are in the UHF waveband, but in the wartime period, MF, HF and VHF (38-42MHz) were used at various times for various purposes.

One of the earliest means of jamming the nightfighters RT was for a second, German speaking operator to continually tune across the HF waveband using his R1155 receiver, and when an enemy fighter control frequency was identified, switch on his T1154 transmitter modulated from a

microphone fitted in the engine bay of the aircraft. This basic form of noise jamming was codenamed 'Tinsel'.

This was highly effective and continued until the end of the war, but the effect caused the enemy to fit new RT equipment, this time operating in the 38-42MHz band.

To counter this, the RAF introduced 'Airborne Cigar' (ARI5558) equipment which incorporated a panoramic receiver (believed to have been developed by Martin Ryle, later knighted and made Astronomer Royal) and three 50 watt transmitters. The special operator observed the display and on receiving a signal, flicked a switch to aurally verify that it was of enemy origin. If so, one of the transmitters was tuned to the signal and then the operator continued the search until all three transmitters were operating.

Of very similar codename was 'Ground Cigar'. This used fifteen very high power transmitters in the UK (including the Alexandra Palace BBC TV transmitter) to put a barrage across the whole 38 to 42MHz wave band.

The German fighters also used frequencies in the region of 300kHz. This again was countered by transmitters in the UK. The transmissions were monitored at West Kingsdown and the transmitters used were at Crowborough, Moorside Edge and Droitwich. The overall operation was coded 'Dartboard', whilst the transmitters were known under the collective name of 'Aspidistra'.

The Crowborough transmitter, at that time the most powerful equipment in the world, was known as Aspidistra 1, or more affectionately 'Aspie 1'. After the war it radiated the BBC Overseas Service until it was dismantled nearly forty years on.

Possibly the most powerful airborne jammer was 'Jostle'. This provided a high power (2.5kW), frequency modulated, continuous wave jamming of enemy RT

in the 3-6, 6-12, 1-18, 26-35, 35-45 and 45-54MHz bands. Spot jamming could be undertaken in all six bands and barrage jamming in the two highest.

The equipment was of enormous size and weighed over half a ton. Due to its size, it could only be carried in the B17 Flying Fortress or B24 Liberator aircraft.

In addition to these, various other methods were used. One of these (Corona) used high power transmitters on the German HF nightfighter frequencies. These were operated by German speaking operators who gave confusing instructions to the pilots. The British and German operators could often hear each other and this led to heated arguments as to who was genuine! Sometimes music was radiated, whilst at other times recordings of Hitler's speeches were found to be most effective!

The combined effect of these jammers was such that it was frequently almost impossible for the German nightfighters to receive any instructions. Under such circumstances the nightfighter crews tuned to the Anne-Marie broadcast station. This radiated a programme of continuous music, but the type of music (waltzes, marches, etc) indicated the area in which the RAF was operating.

#### Operation Overlord

No story of WW2 countermeasures could be complete without some mention of contribution of countermeasures to the invasion of Europe. Although the main invasion fleet moved forward under a heavy barrage of every type of jamming available, it was considered desirable for the enemy to believe that the main invasion force was, in fact, only a feint attack. The job of 'spoofing' the German defences was given to two RAF Squadrons (218 and 617), four RAF launches and fourteen small naval craft.

Their task was to produce images on the enemy radar screens which would indicate that two large convoys were preparing for landings well to the north of the selected invasion beaches.

As the final preparations for invasion were made, the naval and RAF launches left Newhaven, each trailing a naval balloon in which was fitted a 9ft radar reflector giving the same radar return as a 10,000 ton ship. The RAF launches were also equipped with modified Moonshine transmitters.

Once clear of Newhaven, the small armada split, one part heading for Boulogne (Operation Glimmer) and the other for Cap d'Antifer (Operation Taxable).

The Stirling bombers of 218 Squadron flew above the Glimmer boats dropping carefully calculated bundles of Window in a highly accurate racetrack pattern, gradually moving forward at six knots and creating the radar image of a large slow moving convoy of ships.

Farther west, the same process was taking place with the Taxable boats and the Lancaster bombers of 617 (Dambusters) Squadron.

How far the enemy were misled by the two spoof invasion fleets is open to conjecture, but the fact remains that the German Commanders refused to permit any reinforcement of the troops opposing the invasion forces for fear of another assault further north. It is probable that this was more than partially due to the radar reports of operations Glimmer and Taxable.

Information about the countermeasures used in WW2 is often very hard to obtain, partially due to the gap of forty years and partially because at the time they were *Top Secret*. These articles have only barely skimmed the surface of the subject, but anyone wishing to research further is sure of a fascinating task.

An Auro 'Lancaster' bomber, similar to those used by 617 Squadron on operation Taxable (photo courtesy of Cossor)

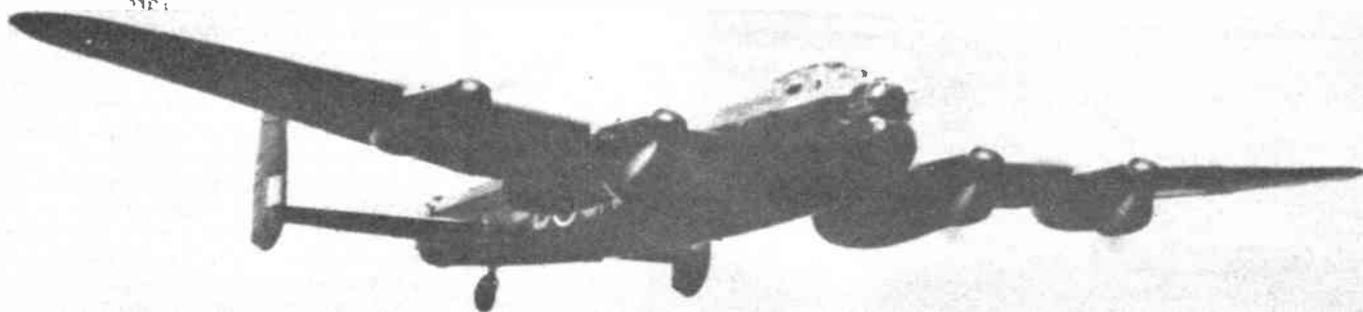

# RAYNET

## the operation

There is a Walter Mitty in all of us. We see ourselves like knights of old, rushing to the rescue of a fair princess. No wonder Raynet has so many enthusiastic members who are ready and available to participate in emergency and 'User Service' events. But seriously, the more I look into the construction, organisation and operation of Raynet, the more impressed I am.

Raynet is sponsored by the Radio Society of Great Britain, and is a voluntary organisation consisting of radio amateurs and other interested people who are ready and willing to give their time, expertise and, in the case of radio amateurs, the use of their own radio equipment to the User Services. The User Services are the Police, the (County) Emergency Planning Officer (CEPO), the St John's/St Andrew's Ambulance Brigades and the British Red Cross Society. In the beginning, Raynet which, by the way, stands for 'Radio Amateur Emergency Network', was formed on suggestions made by the Radio Society of Great Britain. This occurred in 1954, following the help given to the local authorities and coastal shipping by radio amateurs in the vicinity during the disastrous east coast floods of 1953. At the time, the government, or rather the Ministers concerned, did not believe that we could offer anything to the authorities in an emergency of this kind. However, the operation of amateurs during the flood conditions strongly made the point that they could, and subsequently the Home Office, as it was then, amended our licence so that we can now handle disaster and emergency traffic for third parties.

Raynet is organised in the normal pyramid fashion. That is to say the RSGB Council is at the top and the Raynet members at the bottom. In between, from the top down, are the Raynet Committee, the Zonal representatives, County/Regional controllers and the Group Controllers/Organisers. The operation is highly decentralised, being

actually run on a county or district level. Nationally Raynet is controlled by a committee of the Radio Society of Great Britain. This committee has responsibility for liaising with the Home Office, the User Services and, via the RSGB, the Department of Trade and Industry. The DTI lays down the licensing conditions under which Raynet operates, but the committee vets all Controller appointments and is responsible for the provision of Raynet supplies, the Raynet Manual and a technical information service. The latest news relevant to Raynet is reported in a column published in the RSGB's monthly magazine, *Radio Communication*. A new facility is that the latest Raynet news is now available on the RSGB pages in Micronet 810, commencing at page 810733, as well as on the RSGB Data Base, which is Prestel compatible and available on (0707) 52242, 24 hours a day.

There are twelve zones in England, Wales, Scotland and Northern Ireland, which are subdivided into about 200 groups, each with an average of 20/30 Raynet members. These members are controlled by an elected 'Group Controller', or where there is more than one group in the county or in the case of the Scottish region, a 'County/Regional Controller', who normally has the responsibility for co-ordination with the User Services. Today Raynet has about 5000 members, spread over almost every part of the United Kingdom, the great majority of them being licensed amateurs who are prepared to use their own equipment voluntarily for the public service. In some areas the local authorities arrange to have permanent stations available for Raynet use, many of which are equipped with teleprinters as well as transceivers using radio telephony. In certain instances the authorities have erected antennas on their district offices so that Raynet members can bring their own equipment and set it up to operate with minimum

delay in an emergency.

There have been many instances of Raynet playing a key role in rescue operations, and although in theory all licensed radio amateurs are on hand to deal with these emergencies, Raynet is an organisation which has been structured to meet all contingencies. Luckily in England there are fewer cases of natural disasters than occur in other countries, notably the United States of America, but when an emergency does arise it is Raynet that voluntary organisations turn to for help. There was the case of a bitter January night when blizzard conditions hit South Glamorgan, blocking a number of roads and bringing down telephone lines. In conditions which were deteriorating steadily, the County Emergency Planning Officer (CEPO) decided that additional means of communications were required to cope with the situation, and called in Raynet. The call was not without warning, as the local members had been on standby for the previous three days. It was to be a further ten days, however, before the emergency was overcome, and Raynet members were operating full time with the regular services during this period. Initially, they were used to find out the state of the food and fuel supplies in the area, but as transportation became easier they provided radio links for 23 emergency centres established by the county emergency planning group.

Another example was the case of three eleven year old boys who had been missing overnight on the moors. They were wearing light clothing and their lives were in danger from exposure. The Police called on Raynet at 0545 and 14 operators assisted the police until the boys were found. In yet another case a super tanker collided with a terminal jetty spilling some 9000 tonnes of crude oil in an estuary. Raynet was called out, this time by the CEPO, at 0015 and assisted the local authorities with a pollution survey, reporting over a 30 mile radius until the emergency was under control at 2045 the following day.

However, it is not only in emergencies that Raynet gets called out. It can, and does, provide communication links for User Services over a wide range of social and sporting events. The yellow Raynet tabards have become a well-known sight at over 500 events a year. These events are the larger type of gathering where the St John's Ambulance and Red Cross are widely dispersed around the course or site. Radio communication is required both to maintain communication with the field stations and to provide immediate service or ambulance assistance should it be needed. As the events concerned can be varied (marathons, car rallies, carnivals, air shows etc), the Raynet operators have to be very capable. To this end, and with the idea of keeping up

### RAYNET OPERATING FREQUENCIES

80 metres	3.663MHz	Emergency listening frequency (Also used on first Sunday in the month at 0830 hours local time for national Controllers net)
		RTTY listening frequency
40 metres	3.615MHz	
4 metres	7.090MHz	Emergency sub-band (all modes)
2 metres	70.350-70.400MHz	SSB calling frequency
	144.260MHz	Group operating channels
	144.775MHz	
	144.825MHz	
	145.200MHz	Inter county and group channel
	145.225MHz	Group operating channel
	145.800MHz	This channel is on the edge of the Space allocation and members would be asked not to use it except in an emergency and then with a power limit of 10 watts vertical polarisation
70cms	433.700MHz	Group operating frequencies
	433.725MHz	
	433.750MHz	
	433.775MHz	

operational efficiency, many Raynet groups hold their own practice exercises, or even joint exercises with the User Services. These can cover the full range of incidents from internally organised exercises testing map reading and communications skills, to full scale disaster simulations involving all the services. Most groups also hold regular meetings, either on the air in the form of a net, or by arrangement personally at a mutually convenient venue.

Previously I mentioned responsibility for the provision of the Raynet Manual. This is available from the RSGB and provides a detailed account of the Raynet organisation and a guide to procedures, although some groups publish their own procedure manuals. A variety of accessories are also available to members, ie car stickers, ties and lapel badges, all showing the organisation's logo in black and yellow (the Raynet colours), or plain Raynet stickers to facilitate identification by the User Services.

Raynet is open to anyone who is interested and is willing to commit him/herself to be readily available, within reason of course, to participate in both User Service and emergency events, and to spend some time in training. Obviously, an emergency cannot be planned in advance, but participation in an exercise of the type mentioned above would be known well in advance. The first thing to do is to contact your local Group Controllers, whose name can be found by contacting either your local Raynet Zonal representative or the Membership Services Department at RSGB HQ (tel: (0707) 59015).

Although Raynet is sponsored by the Radio Society of Great Britain, one does not have to be a member of the RSGB in order to belong to Raynet. Naturally, it is better if you have a current amateur transmitting licence, but there is always a place for short wave listeners, wives and friends in important tasks such as log keeping or message taking. One has to be aged 14 or over, and if under 18 years it is necessary to obtain the consent of a parent or guardian, and also your Group Controller, before joining. Your

Controller will also want to discuss the local activities and your own personal involvement before the completion of the registration form. There is no national charge for joining Raynet, but most local groups do make a small charge to cover their running costs. One point which is often overlooked in this context is postage. At 13p a time this can soon run up to a tidy sum. If you are accepted, membership lasts for either one or two years, according to the practice of the group, and is then renewable by completing a new form before the expiry of the old one. Raynet operates with the full authority of the Department of Trade and Industry, and because of this the County Controller can write an official letter to the employer of a member asking for leave of absence for the member during the time of an emergency, should it occur during working hours. In practice genuine emergencies, fortunately, are rare and a call out seldom lasts more than 24 hours.

It would help if you, as a licensed amateur, had some 2 metre equipment, as this is the main band for Raynet activity, although many groups make limited use of other bands, particularly 70cms. Also of great assistance is your

own transport and that you are available by telephone, as most call outs are initiated in this way. If you are an amateur, you have to be responsible for the serviceability of your own equipment.

The frequencies listed in the table are recommended by Raynet if you want to listen in out of interest.

Finally, it is not a stipulation that only people with amateur licenses or private transport need apply. It is a help, but don't let that deter you. There is another point too. Under policies held and paid for by the RSGB, members are covered in respect of personal accidents while on Raynet business. Policies also cover third party liability and motor contingency claims against Raynet. Cover is free to all members commencing from the time you receive your validated membership card. However, members' equipment is *not* covered by these policies. This is essentially a personal responsibility, although I understand that some groups have taken out their own policies to cover loss or damage to their own members' radios and accessories.

Acknowledgement is made to Raynet for the reproduction of diagrams.

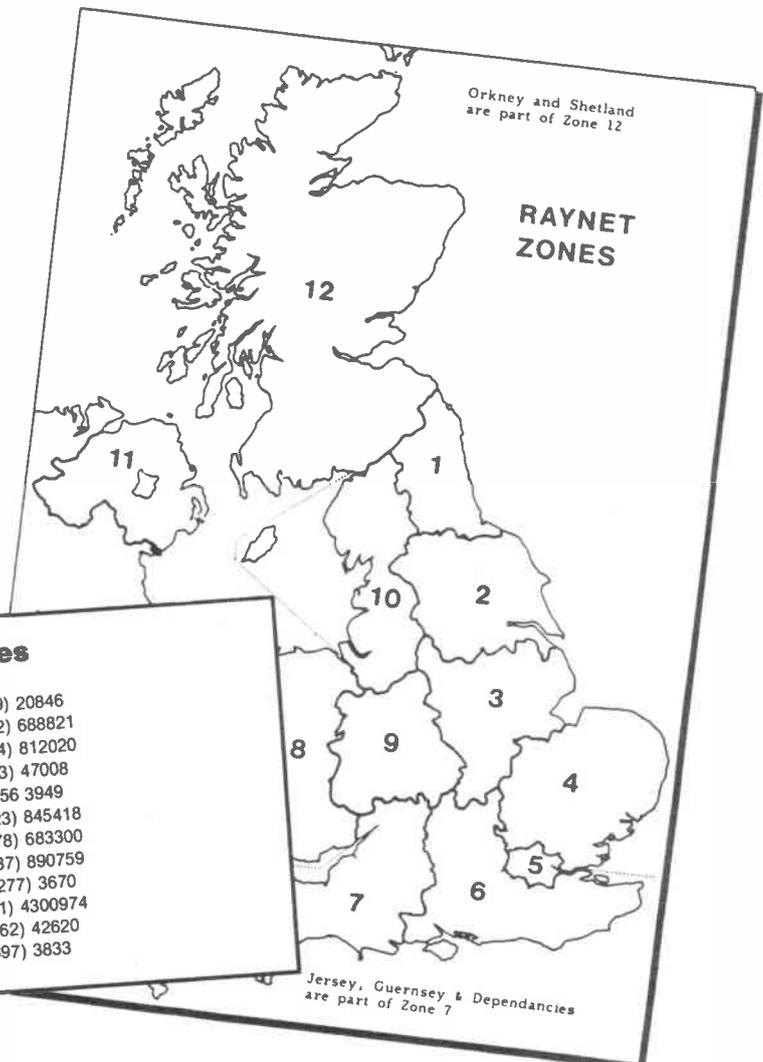

### Raynet Zonal Representatives

1	Les Graves G4BCP	(0669) 20846
2	Ivor Shaw G3KWT	(0532) 688821
3	Geoff Griffiths G3STG	(0664) 812020
4	Bill Holmes G4TWT	(0603) 47008
5	Graham Cluer G4AVV	01-656 3949
6	Dick Jeffries G4KAR	(0323) 845418
7	Brian Smith G4ETN	(0278) 683300
8	John Jones GW3IGG	(0437) 890759
9	John Arrowsmith G4IWA	(08277) 3670
10	Paul Gaskell G4MWO	(051) 4300974
11	Danny Campbell G14NKD	(0762) 42620
12	Eric Garrington GM3RFA	(0397) 3833

**SONY**

# SHORT WAVE

■ ■ ■ ■ **RADIOS** ■ ■ ■ ■ **ACCESSORIES** ■ ■ ■ ■**DIPLOMAT 4950 by GOODMANS  
HERE IS THE RECEIVER EVERYONE NEEDS!  
Introductory Price £39.95 (£1.50 p&p)**

The perfect radio for the person on the go – The Student or a second shortwave for office or home. Slightly larger than the Sony ICF 49000, otherwise The Diplomat is identical and covers more!

Medium wave AM550-1670kHz. ● LED tuning and stereo indicators. FM 88 to 108 with stereo head set out. ● Battery portable (3 AA not included)

Shortwave 2.3 to 5 MHz continuous 120, 90, 75 and 60 meter bands (not covered by Sony ICF 4900 and 49, 41, 31, 25, 19, 16 and 13 meter band each expanded for easy tuning.

AC adapter optional ● Low battery drain for extended listening. Amazing sound for a small package.

**WE ARE OFFICIAL SONY DEALERS & GIVE YOU THE FULL BACKING OF SONY (UK) LTD.**

We introduce the **AIR 7** to this magazine and it is truly a great radio/scanner. (Beware 'grey imports'.) Ours is the genuine article. Air AM Band 108-136MHz, VHF/FM 76-108MHz, VHF/NFM 144-174MHz covering radio hams, **MARINE** VHF, Public service bands, plus long and medium waves 150-2194kHz. Works off 4 AA batteries, rechargeable battery pack **£15.95**. Mains PSU/charger **£13**. Waterproof casing **£15**, AN-3 antenna **£45**, radio **£249**, carriage **£2.50**. Visa and Access by telephone.

SONY ICF2001D + Airband complete with PSU..... **£349**

SONY ICF7600D Complete with PSU, earpiece, etc..... **£179**

SONY AN 1 Active antenna, suitable for any Sony multiband radio ever made. Suitable other makes as well..... **£49**

**£49**

(p&amp;p £2.50)

**AN 1**

The AN 1 external antenna with built-in FET RF amplifier is a recommended option for the ICF 2001D and ICF 7600D and any other Sony world radio. This high performance antenna pulls in distant, weak stations with ease. An attenuator control is provided so that the AN1 can be used for both distant and local reception. Controller: 80 x 31 x 140mm  
Antenna: 1.5m.  
Coaxial cable: 12m.  
Weight: 340g (approx).

**VEGA SELENA  
DE LUXE MK II  
TUNED AND TESTED  
PRIOR TO DESPATCH  
MULTIBAND RADIO****£42.95**

(£3.00 p&amp;p)

**MAINS & BATTERY  
8 WAVEBANDS**

## PHILIPS · GRUNDIG

**D2999-D2935 + SATELLIT 650  
MULTIBAND WORLD RADIO RECEIVERS IN STOCK****AIRBAND RADIOS****£10****£19.50****£69****£399****£487****PANASONIC B6000 & DR3100 – SHORT WAVE RADIOS  
VERY HIGH QUALITY RECEIVERS AND REASONABLY PRICED**

We are Agents for UNIDEN BEARCAT &amp; REGENCY/AOR.

Comprehensive catalogue – £1 (refundable against purchase).

S.A.E. for all correspondence please!

We are a very old established family business with personal service.

**STOP PRESS.....10 CHANNEL MARINE SCANNER BACK IN STOCK.....£85****CONTRACTORS TO THE M-O-D**

# JOHNSON'S SHORTWAVE RADIO

**43 Friar Street, Worcester Telephone: 0905 25740****GT. BRITAIN'S FIRST APPOINTED SONY DEALER**

# BITS TO BUILD

A series of occasional articles by Rev George Dobbs G3RJV

The quest for an antenna that will fit into the average back garden and yet work on all the HF bands is as old as amateur radio itself. Over the years many designs have been offered, some good, some bad, some new, but mostly variations on old ideas. An old design that has found new popularity in recent years is the W3EDP antenna. I have mentioned the W3EDP in several magazine articles and lectures and, perhaps in some small way, have helped to revive its popularity.

I came across the antenna in that excellent little book, *Digest of Horizontal Wire Aerials* by Dennis Hoult G4OO. I saw its potential as a convenient antenna for portable HF operation and have often used it strung up to trees as a temporary antenna. On two occasions when I have moved house, I have strung up a quick W3EDP in lieu of installing a better system. It proved subversive on both occasions: it worked so well that I became idle in providing a better system.

My information on the W3EDP was scant. I had read a couple of items from the 1940s and seen brief mentions in more recent times. I was therefore pleased to receive a copy of the original article from G2DYP, which described the W3EDP antenna; and what a surprise the article proved to be!

The article was not written by W3EDP but by his friend, Yardley Beers W3AWH. In the *QST* for March 1936, in a regular monthly feature called *For The Experimenter*, W3AWH describes the antenna experiments of his friend W3EDP. For some reason I had always assumed that the W3EDP was based upon some theoretical or mathematical calculations, but I had forgotten the good old radio amateur 'cut and try' methods. Perhaps we who are weaned on commercial equipment and antennas, and the magazine writings of semi-professional 'amateurs', overlook the amount of sheer experimentation that our hobby forfathers undertook.

## A cut and try antenna

W3EDP was licensed as a radio amateur in 1934 and spent two years, consuming over a thousand feet of wire, experimenting with simple antennas. His goal was a simple antenna which could be operated efficiently on all bands. Looking at the best compromise between radiating angle and theoretical efficiency, he decided that the former depended upon the height above ground, orientation with respect to the horizontal and the length. The simplest to alter was the length.

So, he began his experiments with a 100 foot wire inductively coupled to his final power amplifier by a parallel tuned circuit; a common practice in those days. Beginning with the 100 foot wire, he tried the antenna for several weeks, carefully

tabulating his results. The wire was then reduced by 4 feet at a time, with new tabulations of the results. Almost every reasonable length of wire was tried and the whole process repeated several times. When the experiments were complete, an antenna 84 feet long seemed to stand out as the best of all combinations.

The system so far required a good earth connection to work as an end fed single wire antenna. W3EDP recognised, as many of us have, the problems in obtaining a good electrical earth system (on the higher frequency bands even the length of the earth wire can have a significant effect on the system), so he set about finding the best length of counterpoise wire for his 84 foot radiator by his cut and try methods. The pruning process showed that a length of 17 feet gave the most successful counterpoise in combination with the antenna. This worked well on 160, 80 and 40 metres, but on 20 metres a length of 6½ feet seemed to outshine all others. Further experiments on 15 and 10 metres showed that results were as good with no counterpoise wire at all. In the original experiments the antenna was only some 20 feet above the ground and the counterpoise wires were strung around the room.

## A good backyard antenna

Figure 1 shows the final arrangement of the W3EDP antenna. An 84 foot radiating wire feeds into a tuner and is loaded against a counterpoise wire whose length depends upon the band in use. The chart in Figure 1 shows the counterpoise wires for each band. The system represents a very simple 'backyard' antenna capable of being installed in an average sized garden.

But...you might say, my garden is not 84 feet long! Well – the W3EDP does not appear to mind being bent around to fit the available space. Also the 84 feet includes the entire length from the far end to the point where the wire enters the tuner, so quite a lot of the length is used in taking the wire up to its maximum height. The counterpoises present little problem and in many cases can be placed around the floor of the shack. I have thrown mine from upper floor windows, run them under carpets and generally 'lost' them in any convenient space. They do seem to work indoors or out, but sharp bends and kinks ought to be avoided as these may inductively load the length of wire. The single radiator can be made of quite thin wire so it is possible to install the antenna in 'no-go areas' for outdoor aerials. Put up the wire when nobody is around (early Sunday morning is a good time) and these days there are so many overhead wires that people do not notice a thin extra wire.

## The antenna tuner

The original W3EDP experiments were done in the days when radio amateurs built their own equipment and used valves. It was common practice to tune the anode of the final power amplifier stage with a single parallel tuned circuit and to inductively couple this tuned circuit to match the antenna. These days the tail has wagged the dog, and the common use of 50 ohm coaxial cable has ensured that, whatever the design difficulties, transmitters and transceivers have a nominal 50 ohm output impedance. Therefore we have to match this 50 ohms to whatever antenna is being used. Simplification to cause complication – could this be the story of modern technology?

Fig 1 W3EDP Antenna

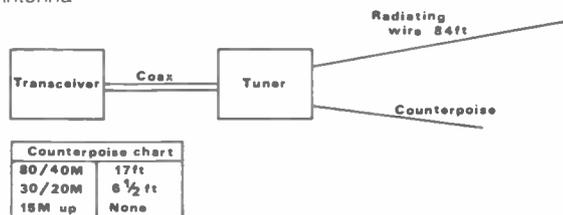
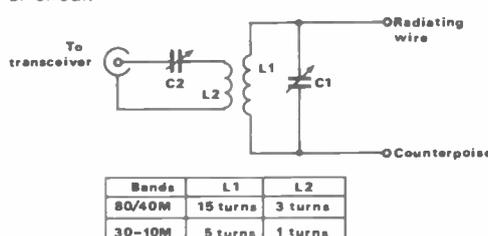
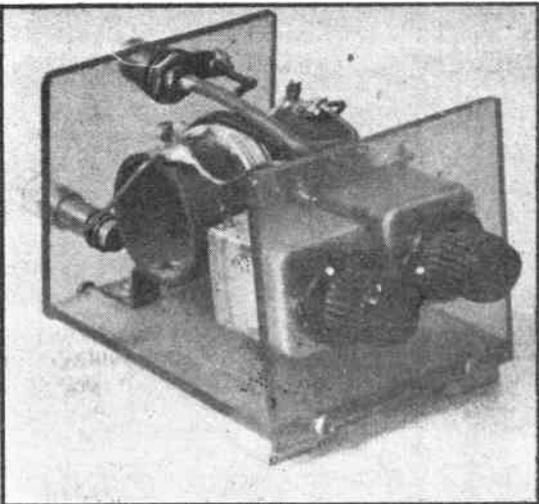

Fig 2 Antenna tuner circuit





Mini-tuner for W3EDP

Thankfully the solution is simple in the case of the W3EDP antenna. A simple tuned impedance matching antenna tuner may be used to link the W3EDP to 50 ohms. The circuit of such a tuner is shown in Figure 2. The antenna is at high impedance and is fed to a single parallel tuned circuit, L1 and C1. This is link coupled via L2 to the transmitter or transceiver output. To this winding I have added a large series variable capacitor to bring down the SWR to please the operator or his modern solid-state power amplifier. This capacitor, C2, could be left out but it does help to produce a pleasing standing wave ratio on the SWR meter, so often a part of modern equipment.

The values given in the chart for L1 and L2 enable all the HF bands to be tuned using two coils. This is something of a compromise, as in the original article on the W3EDP, W3AWH mentions the importance of low capacitance in the antenna circuit. I have seen figures of around 2pF per metre of wavelength quoted. The values I suggest here give rather more than that on some bands, but I found they worked in practice. But do not be fooled: a good SWR indication does not always mean that the RF power is being radiated. The only real test is the performance of the system on the bands.

Should the reader be doubtful about the performance of the tuner in practice,

simple experiments with home wound coils and low value capacitors are worth trying. It is surprising how effective even the most unlikely antenna tuner can prove to be. I have a very small version of this tuner which uses the small polycon variable capacitors used in cheap Far Eastern transistor AM radios. I have used it on 40 and 20 metres with QRP transceivers, which run only about a couple of watts of RF output, and have had many worthy QSOs.

### Building the tuner

This antenna tuner has the advantage of not only being simple, but also only requiring a few inexpensive parts. The coils for L1 and L2 are home-wound on a one inch outer diameter former. I used a piece of scrap plastic tubing and wound the coils with cheap PVC covered 'hook-up' wire. The windings are laid side by side: close wound, with L2 placed in the centre of L1. Make the windings tight and secure each end with a piece of sticky tape, then coat the windings with polystyrene cement to hold them in place.

In my prototype tuner two coils were required. Switching coils in antenna tuners is bad practice, so I decided to use plug-in coils. The arrangement I used is very simple, if not crude. I mounted the coils on two sections of a component group board. The board was cut to have six tags and the outer four were used as connections for the wires from L1 and L2. 2mm plugs were soldered under the boards which mate into four 2mm sockets. With a little care to get the pins of the plugs parallel, this makes a simple but effective plug-in arrangement.

The capacitors, C1 and C2, were not new components but culled from old radio sets. The larger capacitor requires 1000pF, which can be achieved by wiring two sections of a two gang 500pF tuning capacitor wired in parallel. Attempt to find capacitors with wide spacing if possible. The capacitor for C1 was another junk box item with two gangs, which in parallel give 500pF. A more common way to find a suitable capacitor for C1 would be to use one gang of the same type of capacitor used for C2. A vital point to note is that both sides of the capacitors C1 and C2 must be insulated from ground or earth, which means that they have to be mounted on insulating material and *not* on a metal front panel. I happen to have a lot of offcuts of perspex and so fabricated a base plate from these to hold both capacitors and the coil sockets.

My tuner never got itself into a box, but this is no real hardship as the input and output terminals are also placed on the same perspex panel. However, the more fastidious constructor may like to house his tuner. Take care if a metal case is used, and make sure that neither side of C1 and C2 touch the metal. It is always good practice not to have any of the circuitry too close to the metal sides or base of the case when housing ATUs.

The W3EDP is tuned up in the conventional manner using an SWR meter. The tuning of C1 will be quite sharp and C2 will probably spend most of its time at around full mesh of the plates.

I am fond of tuning up transmitters by checking the RF output; what the old timers call 'maximum smoke'. To this end, I often use a 'maximum smoke meter', which is simply an RF sniffer placed at the output of the tuner.

A simple circuit for a maximum smoke meter is shown in Figure 3. It is the simplest of devices. A winding on a scrap ferrite toroid former picks up a 'sniff' of RF power from the radiating wire. A diode rectifies the RF to give an indication on a meter. The meter can be any meter with a full scale deflection of less than about 1mA. I usually use those cheap ex-tape recorder meters which almost always seem to have a full scale deflection of around 200µA. A variable resistance, R1, allows a range of RF powers to be monitored by the same meter. With this basic device the object is simply to try to knock the needle off the end of the scale with RF power. Even if you do not try the W3EDP antenna, then build one these – they are handy things to have around.

What power will the tuner handle? Well, I have nothing in my shack that can produce more than about 5 watts of RF output, so life is easy for me! I would imagine that my tuner would handle around 100 watts before it ran into problems. Any problems would be from voltage flash-over on the plates of the capacitors, so the answer for higher powers would be to look out for widespaced variable capacitors of the sort used in old valve radios.

Which brings us back to the 1930s and Mr Siegel. He seemed well pleased with his cut and try antenna, as did Yardley Beers. The article ends with some results:

'W3EDP has consistently received R7-8 reports on 7 and 14MHz from five continents using a pair of 46s to the final PA. In addition the writer has used this antenna in a badly screened location, between two houses and under several trees, yet without altering the dimensions from those given by W3EDP he has obtained excellent results on 3.5MHz, having worked Europe several times with a pair of 10s'.

Ah...the days of *real* amateur radio! Why not have a go at it yourself with Mr Siegel's antenna?

### Antenna Tuner Circuit

#### Components

C1	500pF variable
C2	1000pF variable (500 + 500)
L1 & L2	wound on 1in diameter former using 22swg PVC covered wire

### Output Meter

#### Components

C1	0.1µF
R1	50k Linear
D1	Germanium diode
L1	a few turns (10 in my case) on a ferrite toroid core
Meter	1mA or less

Fig 3 Output meter

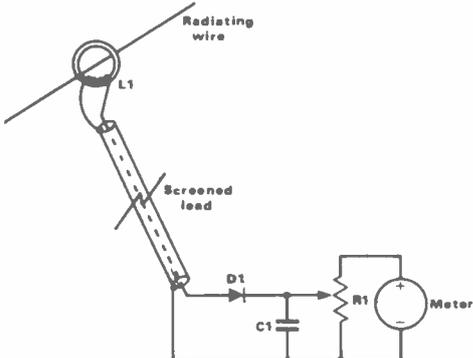

# 2YH An Early Amateur

by Old Ham

Towering above London, on the roof of the Mansions at the corner of Park Lane and Marble Arch, one could once see a most impressive aerial standing proud against the London skyline. Back in those early days, many a 'Radiophan', as they were proud to be called, stopped briefly to look up and take a mental note of the wire formation, in the hope of erecting something similar. Even then, when the majority knew little of the new science which was sweeping the country, such a vision must surely have made a lasting impression on those possessing a mild interest in amateur radio, starting them on the path towards a most fascinating hobby.

From this antenna, the signal '2YH' was regularly propagated, and received with absolute clarity all over London and the home counties. Licensed in November 1922 by Mr G E Duveen, the station was used to transmit and receive telephony and music.

In comparison to many early amateur stations, one could hardly refer to it as being a 'workman-like' station. But for its radiated power, it was most efficient and, unlike many others, compact being housed in a roll-top desk; something of an accomplishment during those days of mammoth components and bench layouts.

## The equipment

On opening the desk, one found both the transmitting and receiving equipment, but the generator was stored at some distance from the main equipment. Three black ebonite panels gave an imposing appearance, the wiring being carefully concealed behind them. The right-hand panel contained the now legendary Burndept AM transmitter. This was a ten watt set employing the latest grid control facility. The grid and anode tuning capacitors could be clearly seen, between which an R valve was mounted flanked by two meters, 'anode current' and 'aerial current', the latter being a hot-wire ammeter.

The R valve was exceedingly versatile, being able to function in the transmit or receive mode on anode voltages of 1000 down to some 30V. Indeed, the RAF used them extensively in the T21 transmitter on very high voltages. Microphones were few and far between, being mainly of the carbon granule type. There were many hand-held versions that were Government surplus, some from WW1, but the one illustrated is either a type 21 or 22 of the GPO design.

To the right of the microphone the gramophone was partly visible. It was the double-motor cabinet wind-up type, the

sound-box arm being fitted with a magnetic reproducer, sometimes colloquially known as a 'tone-arm'. It was a simple matter to withdraw the microphone plug, replacing it with the gram-plug in order to play the old 78s (a most appropriate one being 'What are the wild waves saying?'). Mr Duveen was something of an organist, as well as an organiser, and his nightly broadcasts entertained many of the local listeners.

In order to switch from transmit to receive, a switch at the bottom of the panel was used to bring in the motor-generator, which had a high starting torque so as to facilitate a quick and regulated power supply. It supplied 1000 to 1200 volts, which was smoothed and dropped in order to keep within the specified 10 watts for the transmitter.

## Receiver

The left-hand and centre panels comprised the receiver. This was the Burndept Ultra Five in standard form (one could request modifications when buying apparatus back in 1922). The receiver had one stage of HF amplification and one detector, followed by three stages of note magnification; that is three AF stages. They were all triodes, taking the form of bright emitters which could be used to read a book as well as to listen in. Each valve had a means of separate filament control, ie the current was controlled by a variable filament resistance, often referred to as a rheostat, the purpose of which was to conserve current from the LT batteries, save wear and tear on the valves, and limit emission, thereby controlling the set's volume.

Many of the valves were terribly sensitive during this operation, picking up local vibrations or sometimes voices. The stages also had interstage switching, so that when receiving louder signals a stage could be taken out of circuit. Wave change was achieved by using a Burndept plug-in coil which had a leg and a socket to match the holder. These interchangeable inductors took little longer than operating a switch, reducing HF losses and end-effect as on the earlier slider inductances. These coil formations may be seen on the centre panel, below which is a piece of card inscribed with the station wavelengths, the word frequency being little used at the time. The switch underneath the left-hand valve is the variable 'reactance' switch, its function being to alter the HF performance. The earphones appear to be the old Sullivan type. Two pairs can be seen, one probably being high resistance, the other low.

## Range

Geoffrey Duveen regularly carried out tests with other stations about 100 miles from London. These stations reported good signals from 2YH. Mrs Duveen, who had a house in Limpsfield, Surrey, operated a receiver with four valves. This wireless set was installed in her bedroom, as she listened far into the night for her husband's signals. Mrs Duveen was a keen enthusiast who reported the reception of several American and European transmitters. Geoffrey Duveen often communicated with his more local fellow amateurs exchanging information, and their calls may well be remembered by some of the older readers - 2FQ, 2QQ, 2TJ, 5AJ, 2MO, 2VK and others. The swan-necked loudspeaker was of the Amplion manufacture.

## On reflection

On reflection, it's a pity that permission to transmit music was taken away from radio amateurs, for apart from being entertaining, high quality AM might still have remained the rule rather than the exception.

*Not all early amateur stations were of 'breadboard' construction. 2YH's shack in London was both neat and efficient and housed in a roll-top desk.*



# Western your "SINGLE SOURCE" for KENWOOD & YAESU

**RECEIVERS: FACTORY FRESH STOCK JUST IN!**

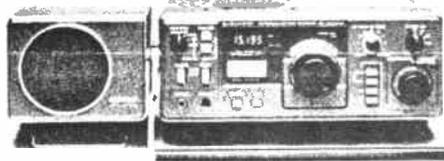

R-1000

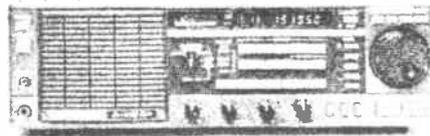

R-2000

**R-1000**

The R-1000 is a high class general coverage receiver covering 30 bands from 200 kHz-30MHz with a PLL synthesizer that incorporates a variety of KENWOOD's sophisticated electronic technology acquired over many years. Both a digital display readout (1kHz step) and analog dial are provided for more convenient operation. The R-1000 also boasts a quartz digital clock with timer, three IF filters, RF ATT and TONE control, etc, to enhance receiving conditions for each mode. Due consideration has been given to innovative design and compactness, making the R-1000 indispensable for Amateur radio operators, professionals, BCL's and SWL's etc.

**R-2000**

The R-2000 provides outstanding performance through use of microprocessor controlled operating functions, allowing maximum flexibility and ease of operation throughout its operating range. An all mode receiver, it covers 150kHz-30MHz in 30 bands, on SSB, CW, AM and FM. Key features include digital VFO's, ten memories that store frequency, band, and mode information, memory scan, programmable band scan, digital display with 24 hour dual clock, plus timer, and a host of other features to enhance the excitement of listening stations around the world.

**PRICES: R-1000 £470; R-2000 £555**

ACCESS - VISA CARDS ACCEPTED - HP ARRANGED  
(WRITTEN QUOTATIONS ON REQUEST)  
ALL LISTED PRICES INCLUDE VAT AT 15% AND CARRIAGE

**FAIRFIELD ESTATE, LOUTH, LINCS LN11 0JH**

**Tel: Louth (0507) 604955; Telex: 56121 WEST G**

**Western Electronics (UK) Ltd**

OPEN HOURS: 09.00-12.00, 13.00-17.00 Mon-Fri; SATURDAYS: BY APPOINTMENT

**WE MAKE TOWERS OVER 102m HIGH!  
DESIGNED FOR 100mph WINDS AND EARTHQUAKE!  
BUY FROM STRUCTURAL EXPERTS WHERE EXPERIENCE COUNTS  
The ULTIMATE in DESIGN  
... the ULTI-MAST**

Slim, unobtrusive, for VHF and HF antennas, simple ground fixing.

One-winch operation, telescopic and tilt-over, self-supporting.

Our structural engineering department came up with the maximum of strength for the minimum of cost. It's impossible to get **MORE** strength for **LESS** cost.

... so beware of cheap copies  
... they may not have the correct materials

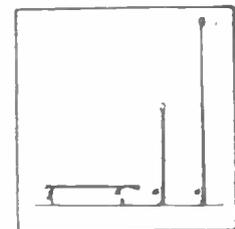

PRICES (inc carr & VAT)

Ultimast UM-1	<b>£299</b>
Reducer head UHB	<b>£10.36</b>
Rotorhead UHD-2	<b>£34.50</b>
Detachable base DB-1	<b>£26.45</b>

# AKD

TEL. 0438 351710

Unit 5  
Parsons Green Estate  
Boulton Road  
Stevenage  
Herts SG1 4QG

MAIL ORDER DEPT.  
Stock Items Normally  
Despatched within 48 hours,  
21 days latest.

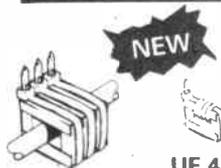

**NEW**

**Unifilter 'CLAMP-ON' RADIO-FREQUENCY CHOKE**

PHONE OR SAE FOR PRODUCT SPECIFICATION & APPLICATION NOTES

Allows leads to be toroidially protected without the need to cut or remove plugs or connectors. Ideally suited for moulded plugs, leads, ribbon, and large diameter cables. Can easily be fitted and stacked in multiples to increase rejection. 'UNIFILTER' works by suppressing the interference currents that flow along the outside of cables without affecting the signals or power flowing inside. This means that you don't need to worry about upsetting normal operation or invalidating guarantees. Suitable for both reducing the emission of, or rejecting the effect of, 'common mode' interference as experienced on computer, hi-fi & speaker leads, as well as the normal mains & aerial cables.

UF 4 KIT (SUITABLE FOR SMALLER INSTALLATIONS) **£9.89**

UF 8 KIT (FOR MULTI INSTALLATIONS) **£19.55**



**WA1**

**WAVEMETER**

**£24.95**

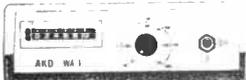

Our Waveabsorption meter for 2 Mtre transmitters meets licensing requirements range 120MHz to 450MHz, very sensitive, can also be used as field strength meter within its range. Requires PP3 type battery (not supplied).

**HFC1**

**CONVERTER**

**£49.00**



For the FRG 9600/965 our new HF Converter, connects to the aerial socket, and powered direct from the 8 Volt a/p of the FRG 9600. Tune from 100, 1MHz to 160MHz, gives tuning range of 100kHz to 60MHz, uses double balanced mixer, with low pass filter on input.  
\* Can be supplied with BNC termination for other scanners \*

**GPA1**

**PRE-AMP**

**£24.95**



2 Mtre RF Pre-amp using BF961 dual gate FET 18 db gain: Low noise, 2Mhz Bandwidth SO 239 termination 25 watts through power. Failsafe switching, can be left in line when not required, auto RF sensing even at 1/2 watt, can be factory tuned between 28-170MHz.  
\* Can also be tuned for 6-4 mtrs \*

**A SELECTION OF OUR MOST POPULAR FILTERS (PHONE OR SEND SAE FOR FULL RANGE DATA SHEET)**

**RB1**

A range of UHF notch filters (for inner only) stocked at the following frequencies: 435MHz (70cms channel 36 (for radar blips), 846MHz (RAF Boulmer interference) can be factory tuned from 420MHz to 890MHz. **£6.75 each**  
To order quote RB1/ followed by type.

**HPF1**

Low insertion loss high pass filter with capacitive braid breaker for use with UHF TV, VIDEO & PRE-AMPS. **£6.75 each**

**HPFS**

High pass filter with transformer braid breaker, better performance than HPF1 but the insertion loss is a little higher. 1-2db best for severe problems for UHF only. **£7.00 each**

**TNF2**

A range of notch filters specifically tuned for the frequency of interference on inner and outer bandwidth >1Mhz (2Mhz above 100MHz). VERY LOW INSERTION LOSS TYPICALLY <0.5db. Stocked for the following frequencies. 14MHz, 21Mhz, 27.5MHz (CB), 29MHz, 50Mhz, 71Mhz, 145Mhz. Also spot tuned at any frequency to 300Mhz. **£6.75 each**  
To order quote TNF2/ and the frequency.

**BB1**

Transformer braid breaker >25db at 30Mhz, often used with other filters in our range for very severe interference. Ideal at the input of VCR and PRE-AMPS **£6.75 each**

**IDEAL FOR CLUBS OR EMC GROUPS FOR EVALUATION OF INDIVIDUAL SITUATIONS DK1 FILTER KIT**

Kit of all filters in our range (11 in all) except for RB1/846MHz. **£41.70**

WE ALSO STOCK TORROID RINGS @ **£2.50 PER PAIR.**

\* **EMC PROBLEMS** \*

PHONE OUR TECHNICAL HELPLINE ON THE ABOVE PHONE NO. BETWEEN 10am & 12 NOON ANY WEEKDAY.

ALL PRODUCTS ARE AVAILABLE FROM US DIRECT MAIL ORDER OR C.O.D. ALSO AVAILABLE FROM LEADING AMATEUR RADIO DEALERS

ALL OUR PRODUCTS CARRY THE USUAL AKD 2 YEAR GUARANTEE. PRICES QUOTED ARE CORRECT AT TIME OF GOING TO PRESS AND INCLUDE VAT, POSTAGE & PACKING.

RSGB NOW STOCK OUR FILTERS AND MEMBERS CAN OBTAIN THEM AT A DISCOUNT FROM RSGB HQ.

**Props: RT & VEL Wagstaffe. Technical Adviser: John Armstrong**

# A Two Metre Transmatch

by H Goble

This is a very useful little device and is used to correct a mismatch in the antenna, which can easily occur in bad weather or other adverse conditions. My own antenna is an old Ringo-Ranger and is mounted in a very exposed position on an end gable wall, where the rain and icy conditions cause the SWR to rise on occasion. However, there would appear to be no significant losses with it in circuit, and the rig always sees 50 ohms.

The original circuit for this transmatch came from the 1976 *ARRL Handbook* and the construction details are taken from my own unit, which was built by a local amateur (now a silent key). He was very skilled in amateur construction, and most of the equipment he used himself was home brewed.

## Construction

The unit is housed in a die cast box measuring approximately  $4\frac{3}{4} \times 3\frac{3}{4} \times 2$  inches. The layout diagram shows the positions of the components and should be adhered to as far as possible. The stand-off at the junction of the link winding (L1) and the coaxial cable should be ceramic. The coils are of a fairly heavy gauge, and are supported by the components on which they are soldered.

A high wattage iron should be used in the construction, as the copper coils do tend to conduct a lot of heat away whilst the joints are made. An old fashioned soldering iron heated on the gas or by blow lamp is even better. The link coil can either be inserted between the turns of L2 and pushed to the bottom, or can be mounted on the outside of the former.

The link from L2 and the antenna socket need only be a piece of single wire, thick enough to be self supporting and rigid. For matching co-ax fed antennas, omit the earthed tap on L2.

The dimensions for drilling the box are shown in *Figures 3 & 4*. These holes are for the two SO239 sockets and the capacitors on the front. If the ex-Pye Cambridge type butterfly capacitor is used, you will find that it has a short shaft with a slot for a screw driver for adjustment, and two small countersunk bolts to fix it in place. Holes are shown for these bolts in *Figure 3*, but these can be omitted if a normal type of capacitor is used with a  $\frac{1}{2}$  inch shaft.

The Pye one used in my unit has five fixed, and six moving plates. Some of these have been removed to leave it at the correct capacity, and this can easily be done if you should find difficulty in obtaining the 10pF per section one specified.

## Setting up

The unit should be connected in circuit between the antenna and the SWR bridge. With RF going through it, adjust C1 and C2 for minimum SWR on the

bridge. If this is not reading almost zero, adjust the position of L1 relative to L2 to give minimum SWR. Re-check C1 and C2 and the unit is ready for use. After this initial setting up, only the capacitors need be used for adjustment in the future.

## Components

L1 - Two turns of close wound 14 gauge copper wire,  $1\frac{1}{2}$  inches in diameter, sleeved with plastic sleeving.

L2 - 5 turns of 10 gauge copper wire, 1

inch in diameter, spaced by one wire thickness. Lead outs should be  $\frac{1}{2}$  inch long as illustrated in *Figure 2*.

C1 - 35pF variable (moving plates earthed)

C2 - 10pF per section butterfly (see text). Moving plates earthed.

One ceramic or other low loss stand-off.

Two SO239 sockets.

One die cast box or other well screened box, ( $4\frac{3}{4} \times 3\frac{3}{4} \times 2$  inches) approx

Two control knobs.

One short length 50 ohm co-ax.

Fig 1 Circuit diagram of the transmatch

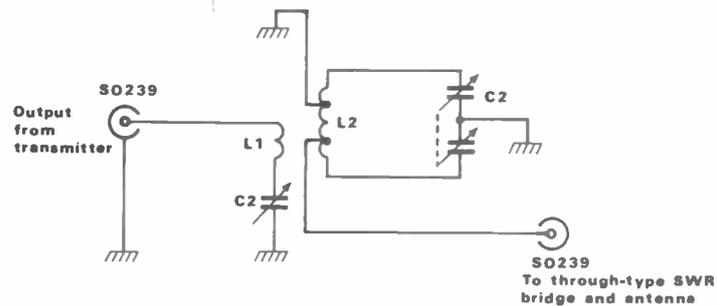

Fig 2 Layout diagram

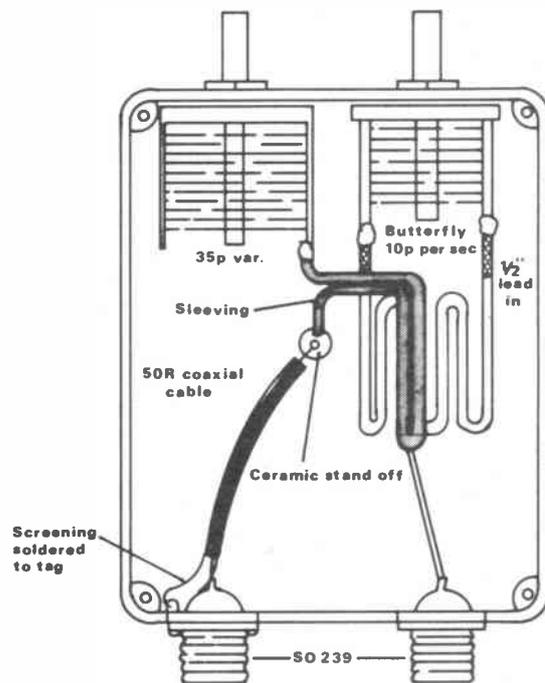
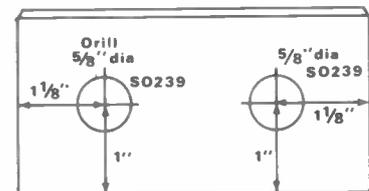
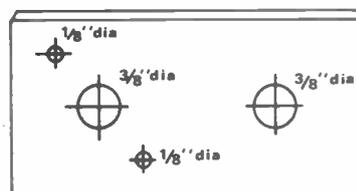

Fig 3 Front panel dimensions

Fig 4 Rear panel dimensions



On 24th May 1844 Samuel FB Morse sent the famous message, 'What hath God wrought!', from Washington to Baltimore, where Alfred Vail immediately repeated the message back over the line as confirmation of its reception. This first public demonstration of the new Morse telegraph was the beginning of the communications revolution which changed the world in Victorian times.

Last May 24th, members of the Morse Telegraph Club re-enacted this historical event over long-distance telephone lines between railroad museums in North Freedom, Wisconsin, and Strasburg, Pennsylvania, using a 'Dial-up Horse terminal'; a telephone interface enabling old-time telegraph keys and sounders to be used on the lines.

Over the weekend 23-24th May 1987 the event is to be repeated and expanded. Other railroad museums across the USA, willing to have MTC members demonstrate Morse telegraphy, will be invited to establish contact with the Mid-Continent Railway Museum at North Freedom by wire, and an amateur radio station, AD9E, will also be operational at the museum. Look out for this CW only station, 44kHz up from the bottom of each band, from 80 to 10 metres.

The 'wire' stations will, of course, be using American Morse, but the radio station will be using the international code, enabling amateur stations to share in this commemoration of the work of the 'Father of the Telegraph'. If you get an opportunity to call AD9E, tell them you read all about the event from a report by MTC member G4FAI in *Amateur Radio*!

#### QRP Convention

For me, one of the highspots of the year is the Yeovil QRP Convention. It is the one event open to all, where almost everyone attending is a CW enthusiast. The emphasis is, naturally, on low-power operating, with lectures, equipment displays, and demonstration stations intended to interest existing QRPers or to persuade the non-converted that QRP is worth trying.

The majority of QRPers undoubtedly use the key. Most circuits in the QRP Club's journal *Sprat* are CW orientated, and the club itself is a founder member of the European CW Association. So, if you want to talk QRP and Morse and put a face to some of the fists you have worked, go to Yeovil on Sunday, May 10th.

The convention, which is organised by the Yeovil Amateur Radio Club, deserves to be better known. It is much more personal and friendly than the 'giant' events, the catering is excellent and its a fine day out in the best amateur tradition. Send an SAE to Eric Godfrey G3GC, Dorset Reach, 60 Chilton Grove, Yeovil BA21 4AW, for full details. Maybe I'll see you there?

#### Kent keys

Several correspondents have commented favourably on the solid brass key kit from RA Kent (Engineers), which was developed by G4POY, himself a keen Morse enthusiast. The company is now



## Tony Smith G4FAI takes his bimonthly look at the world of dots and dashes

manufacturing a new paddle key, available in kit form 'in the near future', along with a kit of parts to build an electronic keyer designed and developed at Lancaster University on their behalf.

Any British manufacturer serving the amateur Morse market deserves encouragement and support, especially if their products are of high quality. When I contacted them in February, they were preparing to exhibit at the Dayton Hamvention (USA) on 24-26th April. All power to their keying arms! Details of their Morse equipment is available from 243 Carr Lane, Tarleton, Preston PR4 6YB.

#### End of maritime Morse?

Jonathan Hanson GW0FJT has drawn my attention to an article in *Lloyd's List*, the international daily shipping newspaper, of January 8th. This describes in some detail the requirements of the Future Global Maritime Distress and Safety System, due to be introduced on 1st August 1991, with full implementation by February 1st 1997.

These requirements are expected to be finalised by the International Maritime Organisation next year, and, according to the article, they herald the end of the radio officer as the ship's communicator, and the disappearance of Morse from the maritime airwaves. All communications will be conducted from the bridge by the watchkeeping deck officer using equipment ranging from VHF to satcoms, depending on which type of waters the ship is sailing in.

Radio Officers may be retained as on-board electronics maintenance engineers, or ships may simply duplicate or triplicate their electronics installations against the possibility of breakdown and arrange for servicing when in port. GW0FJT comments, 'With the increasing use of satellites and VHF/UHF frequencies, there may be space vacated on the HF bands. If it becomes available for amateur use, let us see that the amateur CW operator gets his fair share!'. The full article from *Lloyd's List* will be reproduced in *Morsum Magnificat* later this year.

#### Signal reporting

Jess Luxton G4GOF has told me about the signal reporting system he uses, which is a combination of RST and the SINPO code used for reports on broadcasting stations. He calls it RSTINF. RST is used normally to indicate readability, signal strength and tone. INF gives further information regarding Interference, Noise and Fading, on a scale of 1 to 5, as sometimes used with the Q code; ie 1 - very slight, 2 - slight, 3 - moderate, 4 - severe; 5 - extreme.

A report of 389532 therefore would explain why a reported strong signal was only readable with considerable difficulty. This seems a very commendable idea, reporting comprehensively on QRM, QRN, and QSB at the same time as RST, with a very economical use of signals. Jess says that it has been submitted to the HF Committee of the RSGB with the suggestion that it might be adopted by the IARU, and has 'been favourably commented on'.

It would be interesting to know if other readers have ideas about improving procedures on the air. According to the *RSGB Operating Manual*, the RST code was due originally to W2BSR, so it would appear there is scope for individuals to influence amateur practice. If anyone has information on how RST came to be adopted, I would be glad to hear from them too.

#### Not forgotten!

I have outstanding letters from readers on a number of subjects, and in some cases they have been so for several months. However, they have not been overlooked, I just don't have the space to get everything in straight away and in some cases I am holding correspondence to link with others on a particular subject I want to deal with later. All letters will be referred to in due course, so don't hesitate to write to me if something in the column interests you, and you can add to what has already been said, or if you can suggest further ways of exploring the world of Morse. Please address all correspondence to 1 Tash Place, New Southgate, London N11 1PA.

# PROJECT

# BOOK

## How much should you rely on the readings of your SWR meter? Martyn Williams answers. . .

### Postscript

This magazine has always prided itself on coming up with the latest ideas, and so this month we are going to start this article with the end of another one. In last month's article on the combined power supply and NiCad charger, it was not made clear that the charger will handle anything from a single cell up to a battery of cells, with a maximum of about 16 volts. Over the whole of this range the unit will automatically keep the correct charge rate for the cells employed.

### Be careful

It cannot be too strongly emphasised that you should *never, under any circumstances*, connect NiCads in parallel. If you do this it is possible for a current of several hundred amps to be dumped into the lowest voltage cell, with great risk of fire or explosion. If you look up the manufacturer's data you will find that C cells, as used in the FT290 etc, can provide a maximum current of over 800 amps for a short period. That is about six times the capacity of an average car battery . . . you have been warned!

### The SWR meter

This handy little device is used in most shacks. It is usually purchased, but can be built very simply and at little cost; in fact it is an ideal project for the newcomer. The SWR meter is also

probably the least understood piece of gear the average amateur owns. Its readings are accepted as true without question, and the idea that an SWR of 1:1 is essential for good performance is a matter of faith.

### The technical bit

An SWR of, say, 3:1, simply means that the load, in most cases the aerial, deviates from the expected 50 ohms by a factor of three. This means that the true impedance is either 150 ohms or 16.6 ohms, we do not know which because the meter has no way of telling us. This mismatch means that all the power sent up the feeder will not be accepted by the aerial and some of it will be reflected. Contrary to popular opinion, this power is not lost and neither does it heat up your rig, but that is too deep a subject to go into now.

### Up top

The SWR meter finds out what the mismatch is by measuring the power that you are sending to the aerial and, at the same time, the power which is reflected. It then 'does the sums' and indicates what it thinks to be the SWR on the meter. I say 'what it thinks', because the SWR meter design is based on the assumption that the aerial and feeder system is perfect, and that there are no feeder losses. In actual fact, this is never the

case and so, unless you are prepared to do some maths, the only place to put the SWR meter is actually where the feeder joins the aerial. A new generation of commercial meters enables you to do this by putting the sensor at the aerial and the meter in the shack. The meter to be described next month will allow you to do this, or to use it in the conventional in house way.

### The belief

Let's substantiate what has just been said. Without going into all the details, you must accept the fact that if you have an SWR of 3:1, then 25% of the available power will be reflected. If we disconnect the aerial and connect a 150 ohm resistor in its place, we will know that, whatever the SWR meter may tell us, we have a known 3:1 SWR. So, assuming a system with no losses, we measure 100 watts going up to the aerial, we know the SWR is 3:1 and, sure enough, the SWR meter reads 25 watts of reflected power. It tells us that the SWR is 3:1 and everything looks the way we expected it to do (see Figure 1a).

### The truth

In the real world we are going to have some losses, so let us look at our figures again. We will assume a frequency of 145MHz (although the effect is actually independent of frequency), 100 watts of RF power and cable losses of 3dB. Our SWR meter correctly reads 100 watts on the upward journey but, because of the 3dB loss, only 50 watts actually arrives at the aerial. We know that our 150 ohm resistor means 25% reflected power, so 12 watts comes back down but, because of the 3dB loss, only 6 watts gets back to the SWR bridge. The meter does its work and tells us that the SWR is a fairly healthy 1.6:1 or so (see Figure 1b). The problem is we *know* that the SWR is 3:1, because we arranged it that way at the start of the test. Do you still think you can believe your SWR meter?

### Throw it away?

Not really. It is like most other things, an excellent tool to use if you understand its limitations. If you leave it in line you will know what your normal readings are for forward and reverse power, and also the normally indicated SWR on the line. These figures are probably not accurate, any more than the petrol gauge in your car is, but they are the normal ones for your station and any deviation from them should immediately alert you to the fact that you have a problem.

### Coming soon

Next month I will describe an SWR meter that can be used in a variety of ways and that is easy for the newcomer to build and calibrate. I would very much like to hear from you as to what you would like to see described or explained in this series. However, do not ask for complete transmitter or receiver circuit as they are outside the scope and space available to this series. Please send all your ideas via our illustrious editor (*preferably written on the back of ten pound notes . . . Ed*), at the usual editorial address.

Fig 1a Shows readings under no loss conditions

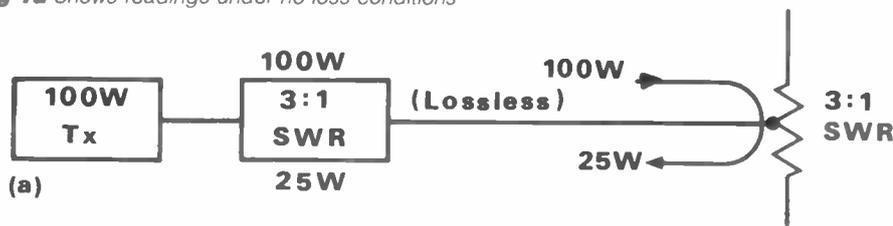
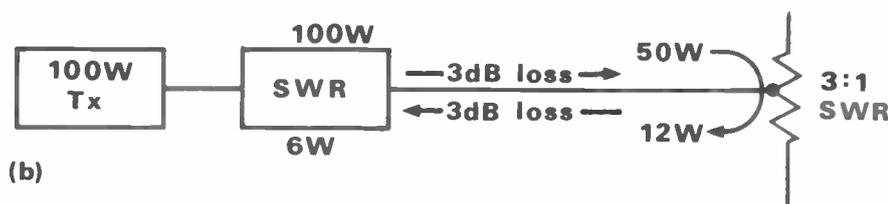

Fig 1b Shows readings with 3dB loss on cable





## News and comment from Glen Ross G8MWR

### The Sting

We all expected that an announcement would be made at the NEC show to the effect that 50MHz would be released to class B operators. All we actually got was a statement that the time was right for a review of the band and a hint to the effect that they were looking at the idea of more general access to the 70MHz band. So the disappointment of not getting 50MHz straight away is made more bearable by the thought that we might eventually get more than we bargained for; no time scale was mentioned.

Another interesting point was that the DTI thought that more encouragement should be given to young operators. To help in this they will be presenting a prize which will be given next year to mark the 75th anniversary of the RSGB. All very nice, but when are we going to get the band?

### Crystal gazing

I am going to stick my neck out again, with predictions that are based on the black arts and informed discussion with 'usually reliable sources'. It seems likely that the present power limit will be raised by 2 or perhaps 3dB, and it is just possible that vertical polarisation will be allowed. The restrictions on portable and mobile use could well go, but it seems unlikely that the band will be extended to 52MHz. If this is true it would rule out FM operating and there would not be sufficient space to put in a repeater network. Another hint to class B people; you might start thinking about aerial systems for 70MHz.

### Activity update

More good news for the DX fraternity as news arrives that, as from 16th March, our Australian friends will be permitted to monitor the band from 50 to 54MHz. This will not allow anything other than crossband contacts at the moment, but it is at least another foot in through the 50MHz door.

In terms of UK activity, the band is about as dead as the Dodo bird. During one four hour monitoring period on a Sunday morning, only two stations were

heard at my Coventry QTH. The aerial is a dipole at 30 feet above ground and the Potters Bar beacon was running at S7 during this period, so no equipment problems.

### Novice licence

This correspondence is now closed! The response to my request for your ideas on novice licencing has been overwhelming to say the least. The response was also predictable in that what most people wanted was not really a novice licence, but simply a way on to the amateur HF bands.

There were some good ideas, and I will bring these to your attention, but the averaged out line of attack seems to be for 50 watts of SSB to dipole aerials on 80, 20 and 15 metres, and the licence being available without any sort of test. The idea that it should be a slow speed CW only licence did not even get to the starting post, and neither did a VHF only novice licence, although many people thought that VHF should be included because it 'would be nice to keep in touch with the locals'.

The reason to back up the need for a novice licence was predominantly 'because I want one' and the RAE was looked upon as an imposition that actually required some work (a four letter word if ever there was one), and something that should not be required in these days of all singing, all dancing rigs. As is so frequently the case these days, the whole thing can be summed up as 'we want the rewards but not the work'.

### Readers comments

G1XED says, 'Low power and few bands; the novice licence must never be an easy way out of taking the RAE. The exam should be based on interference, operating procedures and electrical safety only'. G1EMD of Market Drayton says 'FM only around 29MHz with 25 watts. The RAE to be taken within two years and if less than 25% marks achieved the novice licence to be withdrawn for a year. You have to pass a Morse test to get on the HF bands and yet you can work moonbounce and other

specialised modes without having to demonstrate that you know what you are doing ... odd, isn't it'.

J Parnell, from the Isle of Man says, 'A novice band could be made by increasing the CB band from 27 to 28MHz with all modes available, and writing this new area into all existing amateur licences. The novice users could be charged a higher fee than an amateur licence so as to encourage taking the RAE, so getting more facilities for less money!'

Ian Duffin of Stalham suggests '15 watts of SSB on two metres ... It works well in Belgium as the first step of a three tier licence'. Gordon Morris from Wrexham has an idea that could work - '10 watts of CW and SSB on HF issued for one year, a simple exam before continuing for the second year and proof of use before a full licence issued in the third year'. He also says that the current CB band is in effect a novice band, and that many people have already graduated from there into amateur radio.

A Bury St Edmunds family who hold four call signs between them say they managed well without a novice band, all it took was 'CB for a year and then interest and some work'.

G0CKQ from Bristol says, 'I obtained my A licence in one year. It took some work but it was interesting and not that hard, despite the fact that I have no electronics background (I am 68 years old)'. He also mentions that the novice licence was being pressed for in *Practical Wireless* letter columns in 1971. I have copies of that magazine with similar requests in 1953; there is nothing new is there? G4XJK of Kettering, obviously a CW enthusiast says, 'All class B operators should have to take a CW test after two years, if this is failed, a test every year. There should also be a retest for lapsed class A operators'.

### Question time

Why is it that so many people think of amateur radio as meaning HF operating? They always think of a class B licence as a stepping stone to HF and look down on those who do not want to take that path. Many of us are interested in technical pursuits that do not require use of the HF bands, anyone tried moonbounce on twenty metres I wonder? It is not that we will not take Morse, it is simply that, for our interests, we do not need it. What is so special about operating on the HF bands? It has all been done before, usually 60 years ago. I sometimes listen to the racket on 80 metres, great for those who like it, but it quickly sends me back to the problems of getting a bit more power out on 24GHz SSB. Why not live and let live?

### More ideas

G1ULV hails from Camborne and says, '934MHz would make a good novice band, the idea of 25 watts on HF is just not on. If you want to learn about amateur radio buy a short wave receiver and listen. I found the RAE hard work but I passed at the age of 15 years; above all I did not look for the easy option. Tell them that if they want amateur radio then work for it ... we did'.

## ON THE BEAM

GJ2FMV takes me to task for saying that in a Morse test an understanding of what is being sent, rather than 100% copy, is what is really required. He goes on to say that accuracy is the essence of Morse operating. I could not agree more, if you are a Morse enthusiast. To most people the ability to recognise a CW request from, say, a coast station to QSY and then to act upon it is more important than the accurate reading of the message. It is also the purpose of the Morse requirement as part of the test. Regarding the novice licence he says, and I tend to agree with him, 'Do we really have to ape the USA and have five year olds playing the fool on the air?'

GW0FYO says, 'Let's face it, CB is in effect a novice band needing no licence, and just listen to it. The RAE and the Morse test are necessary to filter out the less dedicated rather than prove real knowledge of the subject'.

G1NNM from Cobham thanks all the slow Morse senders for their help, but says that, 'I learnt more about the hobby in one hour of doing than in months of short wave listening. I think an upgrade for the B licence using 5wpm Morse and an allocation on 28MHz makes sense'.

### Still more

From Christchurch comes some comments from G8KMV. 'Proposals to put novices on 70 or 23cms and in designated

areas is a recipe for disaster; they would only have other novices to talk to. Two metres with a three year limit on the licence seems reasonable. It would crowd the band but make people move to more effective narrow band modes and directional aerials etc. Do not link a novice licence to a Morse requirement'.

Mr L Colyton-Smith from Norwich feels that a novice involved in undesirable conduct would amass points against a future RAE pass. The only problem is one of who is going to do all the monitoring and keep the score?

One of the best thought out ideas comes from G0GSZ of Norwich, who says 'Before getting a novice licence you should be required to get a Certificate of Competence from your local radio club to ensure a knowledge of operating procedures and the licencing requirements. This would then give you all modes on limited bands, perhaps four metres would be ideal, and a power restriction of ten watts. It should be issued for one year only with no renewals. This would give at least two chances of taking the RAE'.

G Rider of Rugby says, 'A novice licence is required, not so as to increase the number of people in the hobby, but organised in such a way as to improve the quality of operators. A slow speed CW test coupled with some questions on interference, operating techniques and

the regulations, with limited use of SSB on ten metres and perhaps 70cms, and CW only on a restricted area on 20 metres'.

Bob Slater of Cheltenham says 'No way! If you really want something you will work for it. If they are not prepared to put in some effort, do we really want them?'

J Rogers of Nuneaton is very much a man of few words. 'Novice . . . No way'.

### The last rites

G0ANX from West Hanney says 'If an aspiring licence holder is not prepared to put in a certain amount of effort, I think we are entitled to wonder whether we really want them as part of our hobby'.

Doug Hill of Kettering says, 'It could give a new lease of life to the hobby. With safeguards it could work . . . it might even give old timers a new interest in training the newcomers. The points far outweigh the points against'.

The penultimate word goes to G1VNJ who says, 'Either you have an interest in amateur radio or you have not'. The final word comes from me (after all it is my column); if you are really interested in an activity surely you are prepared to undergo the initiation ceremony?

### Close down

Keep those letters coming to me at 81 Ringwood Highway, Coventry CV2 2GT or on Prestel 203616941. Good hunting.

**NEXT  
MONTH**

*Amateur*  
**RADIO**

### all the regulars. . .

DX Diary  
On the Beam  
Secondhand  
SWL  
Straight and Level  
Your letters and  
features covering  
the whole of  
Amateur Radio

### ■ ANGUS McKENZIE TESTS

G3OSS reviews the new CapCo SPC100 VHF ATU for 2m and the Kenwood TH205E and TH215E hand-helds

### ■ R1475 RECEIVER

If an extremely low budget determines which receiver you can use, the R1475 reviewed by Brian Kendal will be of interest to you

### ■ WHICH AERIAL?

The choice of the vital element by Ian Poole G3YWX

**DON'T MISS THE JUNE ISSUE**  
**On sale 28 MAY**

# SECONDHAND EQUIPMENT GUIDE

by Hugh Allison G3XSE

It's amazing how repairing rigs can be like waiting for a bus. You don't see an example of a particular model for ages, then suddenly you get four in all at once. Mind you, if you happen to need another example of a rig to use for a cross check, a well known law will swing into action and you'll not get another in for ages.

## On the workbench

Take the Multi FDK700E, a two meter FM 20W+ synthesized rig. Suddenly there were four awaiting attention, yet I'd not seen one for months. Of these, three had loose screws rolling about inside. I've not noticed a tendency in these rigs to shed screws before, but I pass on the information just in case your example is about to blow itself up. All the rigs that had shed screws had dropped them from the PA pre-drive board – that's the one on the underside with the TO5 transistor with the heatsink on it. I'd suggest a walk round the boards with a cross head screwdriver to check the board mounting screws for tightness next time you are inside. No tightening up of ferrite cores in the coils though!

The Multi FDK700E seems to have earned itself a bit of a reputation as a PA module eater, and genuine new replacement modules are not cheap either. I would very definitely recommend using the rig at the lowest power level you can, consistent with making the contact. For those not familiar with the rig there is a fully variable power control knob on the front panel, so the reduction of power is not difficult to achieve. This is good operating practice anyway.

When faced with a no power output example of the rig, try and ignore the sharp stabbing pain in your wallet and, if you feel it is within your capability, open up the rig. With it upside down, and with the front panel facing you, the PA module is the black 'slab' at the back mounted on the heatsink. Look very carefully at the lead-out wires and see if any have fused. I made a prize donkey of myself once by breaking the hapless owner's heart with a diagnosis of a duff module when the problem was one of the wire lead-outs had fused. In my defence I would like to point out that it had blown inside the ferrite bead on the power-in lead, but even so it was an embarrassing incident.

If all the lead-outs look OK then have a look down the lead-outs with an AVO and check that the pins that should have volts on (driver etc) do have volts, and that earth pins don't. I'd suggest you do this check right where the wires go into the module. I'm assuming obviously, that you have drive going in. If it's still bad news,

all is not necessarily lost. Provided you are prepared to waste some time taking out the PA module (it's got to come out anyway to fit the new one), then try carefully cutting round the black plastic top of the module and lifting it off.

About 30% of the ones I've come across have been repairable – wires coming unsoldered is a favourite, closely followed by metal swarf inside (or ragged edges) shorting out all the action. At this stage I would give up and spend a week's pocket-money on a new module, though some of my acquaintances have carried on by replacing transistors etc. This isn't too easy due to having to mount the replacement onto the module backplane, then getting the whole mess to line up with holes you've got to cut in the rear panel heatsink, but it can be done.

I don't want to give the impression that a secondhand Multi FDK700E is to be avoided at all costs. Provided you don't over-volts them (ie no more than an absolute maximum of 13.8V) and have a reasonable airflow over the heatsink, then you are in with a chance of a long trouble-free life. Most people who have got them swear by them, but one unfortunate owner, now on his third PA, swears at his!

Price-wise, a good 'un shouldn't really be more than, say, £165. Several non-workers (you are gambling big money here if the PA is totally duff) have been picked up by yours truly for £30, plus or minus a fiver. As a parting thought, why do the aforementioned loose screws head by supernatural forces to the aerial plug and lodge themselves there to totally short it out to earth, thus damaging the PA?

## 3 pin mike sockets

For the purpose of the following story, the thing at the other end of the mike lead to the mike itself is the plug, and the thing on the rig that you plug the plug into is the socket. In came an IC255 box with the complaint 'no deviation'. A quick dose of RF out of the rig and into a deviation meter nearly agreed with this, for whilst nothing happened when you bellowed into the mike, on repeater the rig was giving a tone. 'The mike' you would cry, and open it up and go in with a scope. No. 'The lead' next, and using a scope at the plug end, again no result. Audio present? Into the rig again, but no audio, not nohow, nowhere. As a last resort, check the mike socket – one pin, the mike one (as distinct from earth or Tx/Rx switch) was totally open circuit front to back. It's amazing how much stuff you've got to strip off to change it.

## Memory chips

Quite a lot of well known names in the home and business computing field, including the supplier that revolutionised the world with personal electric tricycle transport, use 'duff' memory chips. Before I get dragged off to court on a charge of slander, I had better explain. Suppose you were in the memory manufacturing market. It would make sense to make, say, a 16K memory device as 2 x 8K on one die. The reason is that if half failed, you could still sell it off as an 8K chip, thus increasing your yield of saleable devices. To distinguish between the 'good' and the 'bad' it would seem a reasonable idea to give the two devices differing part numbers.

The trouble comes many years later. In the computing and integrated circuit world many years later means two. Whereas say, two years ago a 64K device may have been state-of-the-art and mega expensive, today you can pick them up for under a quid. It thus follows that, whilst two years ago there may have been a ready market for half working 64K devices, ie 32K, today there isn't. Carrying the above argument just a little further (bear with me, I'm there) the old half working part number just disappears.

It thus came about that an engineer was trying to repair an old memory expansion board for an in-its-day industry standard computer. He had gone through dozens of handbooks looking for information on a 4114 memory chip.

What he didn't realise was that it was a half working 4116, which is, of course, still freely available. As ever, the story is complicated, this time by the fact that there does exist a 4114/2 which is an analogue chip of some sort, upon which our hero spent much time and effort before realising he was on a loser. Your scribe fitted a 4116 and all was well. Barely a week later another engineer was swearing and cursing over his inability to locate a 3732L for a Spectrum. Your scribe prescribed a 4864 and all was well.

The trick is to have a guess at what the dead device might be half of, dig out the spec sheet of that, then wander along the IC pins on the duff chip in your computer or what have you, see what you have volts and pulse-wise then work out if you are right or not. Very occasionally there is a short cut. Unsolder the duff 'half chip' and look underneath. Although the number on the top may be unknown, there may be a number underneath that refers to the 'proper' part.

## Working on PCBs

I was covering my ears, as with my sheltered upbringing I had never heard such bad language. In the end I could take it no longer and strolled over to see what the matter was. A colleague had found the fault on a rig (a short circuit electrolytic, an axial type, ie one wire out of each end) but couldn't unsolder it from the board since he had no layout diagrams to show him which pads underneath the board held in the duff capacitor. He had solder-sucked a dozen joints and still hadn't managed to find even one relevant pad. When I suggested that he held it up to a light he looked at me blankly.

The technique involves the fact that most modern fibreglass based boards are slightly opaque. Thus if you hold the board up to a strongish light, say a 60 watt bench lamp, you can see the track through from the component side. If you now move a finger about on the track side (whilst viewing from the component side) you can move it about until its shadow is in the position of the track or pad that you are trying to locate. It's then simply a matter of turning the board over whilst keeping your finger on the appropriate spot, and you have found the pad you wanted.

The following should definitely be filed in the 'get-you-home-only' department,

and concerns slipping drive belts.

When confronted with a knob that turns but a shaft that doesn't, drive being via a belt (as on some 'tune' controls) or motors that are not driving their appropriate gubbings due to a slipping belt, the first move should be a general clean-up of the area (pulleys and belts) with an industrial solvent, such as IPA. If this doesn't work you should try replacing the belt. The problem is that often the belts are not to hand and may take a while to come from the supplier. To get you through the wait try, with due regard to your own safety, holding the offending band in boiling water for five seconds. Amazingly it works, but not for long!

# LOOK WHAT YOU GET EVERY MONTH IN

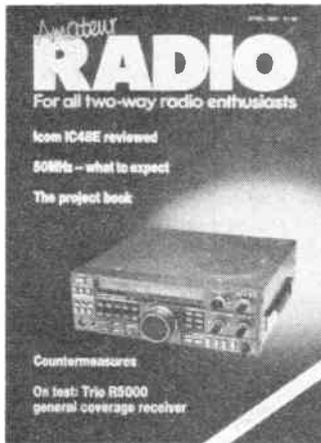

# Amateur RADIO

- ★ **DX DIARY** Don Field G3XTT with all the news of rare DX, contests and DXpeditions
- ★ **ON THE BEAM** Glen Ross G8MWR with all the news and comment from bands above 50MHz
- ★ **G3OSS TESTS** Angus McKenzie – the fairest, most comprehensive reviews available anywhere

## MORE NEWS, MORE FEATURES, MORE FUN, MORE STYLE THAN ANY MAGAZINE AVAILABLE ON THE MARKET TODAY

Make sure of your copy by placing a regular order at your newsagents or by taking out a post free, inflation proof subscription, with early delivery to your door each month

### AMATEUR RADIO SUBSCRIPTION ORDER FORM

To: Subscription Department • Amateur Radio •  
1 Clarendon Road • Croydon •  
Surrey • CR0 3ST Tel: 01-760 0409

PLEASE SUPPLY: (Tick box) for 12 issues, all rates include P & P

Inland World-Surface Europe-Air World-Air  
 £16.00  £18.70  £22.45  £27.50

NAME .....

PAYMENT ENCLOSED: £ -

Cheques should be made payable to Amateur Radio. Overseas payment by International Money Order, or credit card

ADDRESS .....

CREDIT CARD PAYMENT  VISA   EXPIRY DATE

.....

..... / .....

..... Postcode .....

Signature .....

# FREE CLASSIFIED ADS

## FREE CLASSIFIED ADS CAN WORK FOR YOU

We are pleased to be able to offer you the opportunity to sell your unwanted equipment or advertise your 'wants'.

Simply complete the order form at the end of these ads. Feel free to use an extra sheet of paper if there is not enough space. We will accept ads not on our order form.

Send to: **Amateur Radio Classified Ads**, Sovereign House, Brentwood, Essex CM14 4SE.

## DEADLINE AND CONDITIONS

Advertisements will be published in the first available issue on a first come first served basis. We reserve the right to edit or exclude any ad. Trade advertisements are not accepted.

## FOR SALE

■ Icom IC745 general coverage transceiver, FM board, SM6 mike, £660. Mini quad 10, 15, 20, metre aerial, £90. All mint. Tel: Wormley 3017 or Godalming 22421

■ Yaesu FT200 tcvr, 80-10m, plus FP200 PSU, £195. Shure 401A mic, £10. Pair boxed 6JS6C PA valves (unused), £25. FV200 remote VFO, £55. DC200 matching dc/PSU (unused), £55. *Admiralty Handbook* 1938, parts I and II, £15. Wanted: Trio VFO 230/240, speaker SP230, 16mm silent projector. T Knight G2FUU QTHR. Tel: Nazeing 2274 (Essex)

■ Tokyo hypower 2 metre linear, pre-amp metered model HL82U, (current) up to 10W in, 85W out, mint, £75 ono. Welz diamond GH22 2 metre collinear antenna, 6.5dB gain (new), £33 ono. EME (German) 13cms inter digital 3 pole filter, £33. Wanted: Trio TW4000A 2m/70cms FM dual bander, complete, must be mint. Paul G4XHF. Tel: (0293) 515201

■ 934 Cybernet Delta 1, Telecomms masthead pre-amp, mobile pre-amp base collinear, mobile collinear, 2 x 23 element beams, tonna, splitter box, base microphone, all excellent condition, boxed, £600 complete. Tel: (091) 2688466

■ TR9130 2 metre multimode transceiver. Complete with mobile bracket and mike, boxed, £350. Seven element crossed yagi, gamma matched, boxed, £15. PSU 10 amp, £50. Eddystone 840C HF receiver, mint condition, £85. Mr C Richardson. Tel: (0723) 863035 after 6pm

■ Yaesu FT101ZD, mint condition, 11m, 45m fitted professionally, £375. Mick Davies. Tel: 01-586 9851 daytime, 01-904 7420 evenings

■ Model 888 Eddystone radio, 6 bands, 10 valves, £45. A Slark. Tel: (0204) 26684

■ Boxed pair of QVO8-100 valves with bases, what offers? Redifon R408 solid-state marine Rx, covering 13kHz to 28kHz cont, large beast, can deliver within 40 miles. Tel: (0443) 683912

■ Yaesu FT480R multimode, scan mic, mobile mount, handbook, plus workshop manual, only £275. Tel: (0753) 28304 after 8pm only

■ Kenpro KR500 elevation rotator and control unit, as new, £99. Datong SRB2 'Wood Pecker' blander unit, £61. Mains toroidal (new) for 1.5kV EHT supply, £33. Jaybeam D15/1296 23cms antenna new, £35. Tokyo hypower 2m linear (model HL82V) up to 10W in, 80W out, metered with pre-amp (switchable), £75. 2 metre antenna polarisation switch unit, £35. Tel: Paul (0293) 515201

■ Marconi CR300 general coverage receiver, 15kHz-25MHz, 8 valves, complete with original handbook and power supply unit type 889. Another CR300 receiver for use as spares, £50 the lot. Tel: Medway (0634) 54652

■ Selling Sony Air-7 receiver, purchased from Sony, £170. Also Tono 550 RTTY, CW, terminal, £180. Tel: (0772) 704009 evenings

■ VHF valve receiver, type R220 (mains, fixed freq receiver 70.2MHz) Civil Defence Rx. 14 B7G valves + B7G xtal, 10.890MHz. Naffi Rx, 6V input (could easily be mod for mains use), circa 1946, 6K8/6K7/6Q7/6V6, conventional domestic radio chassis, brand new and unused. 1942 Fullerphone MKII, can supply CV valves lists, photocopies of AR88, R210 (user guide), A13 (user guide) and a number of others, including R209, WS62 etc. VHF receiver circa 1944? May be R1392D. Large qty electrolytics and 2000 ICs, too many to bother to count - must have the space! Swapping/buying military radio gear, from WW2 to about 1960. Tony Howard, Milton Keynes. Tel: (0908) 73114

■ Grundig Satellit International 650 Rx, new, five months old, 7 month guarantee left, in vgc, best from Grundig, £270 plus p&p. Tel: North Shields 2585289, 6-7pm

■ Trio TR7930 2m FM mobile, 5/25W output, 21 multi function memories, c/w mobile bracket and mike, £150. Also Hygain V8795, AM, FM, SSB, CW.

Suitable for 10m conversion, £100. Tel: (05753) 231 (Tayside)

■ Yaseu FT208R hand-held, will p/ex for a Belcom LS202E. Plans or circuit diagrams wanted for 2m and 70cms valve linear. Tel: Co Durham 701429

■ 23cms PA, by Parabolic, complete with PSU and 7289 valve, but unboxed, £95 ono. Peter Crosland Tel: (0905) 620041 anytime

■ Yaesu FL2100Z linear with two new spare valves. Buyer to collect, realistic offers please as sale prompted by impending OAP status. Allen G3DRN QTHR. Tel: 01-947 3914

■ Hammarlund SP600/IO Rx, good, £120. Colins TCS12 Tx/Rx/PSU, all working, good cond, £100. Colins TCS12, working, fair cond, £65. Heath DX40U Tx, plus Heath VFO, £45. TRI935B VHF Tx/Rx, good cond, plus a/c band xtls, £35. AVO 'All wave oscillator', good cond, collectors piece. Marconi Atalanta Rx, £65. R1132, mods, £5. WS19, mods but working well, £10. BCC9 - 300MHz, S/Gen, £20. Scope CT316, £10. Pye Vanguard Hi-Band, unused, £10. Fullerfone, new cond, £8. WS19 c/boxes, new £5 each. BC221, new cond, PSU, £35. R2A-ARR3 Rx, £25. BC348, mods, good, £60. T1154M, £60. Type 210 test set, as new, £15. Marine HF SSB Tx/Rx, 1.5 to 4.5MHz, unused but small items missing, £35. 1950s Rover car radio, complete, working, £15. Unused VHF Marine R/T, 55 channels £200. Several 100 valves, CRTs, SAE for list. Tel: (0665) 602487, evenings. A H Cain, 18 Oaky Balks, Alnwick, Northumberland NE66 2QE

■ Trio 700G 2m multi-mode, vgc and performer, £275. Consider ten metre multi in part exchange, ie Cobra or Super Star etc. Tel: Storrington (09066) 2435 evenings

■ DX400 Rx, portable and mains, 150kHz-30MHz, £100. R532 air band Rx scanner, NiCad batt-pack, mains charger, 110MHz-139.975MHz, £100. Will consider deals for h/held 2m Tx/Rx or 70cm against above. John G1HPG. Tel: (0226) 713854

■ Trio R600 receiver, little used, with Global 1000 ATU, £160, no offers please. Datong Morse Tutor, also little used, £30. Tel: (061) 480 6950

■ FT902DM 9 band all mode, fan, dc power cord, £500 ono. FC902 ATU, £90. Super Star 360, converted 10m, freq readout, £100 ono. Jaybeam TB3, £199. X-CB, ½ wave OK 10m, £10. TR2200 FM, S20-19-17-16-14-WL, no more tatty offers. Datong ANF, £50. Adois compressor microphone, model AM802, £30. Spectrum preamplifier, RP105, £15. Power amplifier KLB110DX, tuned for 10m, £50 ono. Jim G0BGY QTHR. Tel: 01-942 7094

■ Honeywell 132 column, 150 cps, RS232 dot matrix printer, £125. ICL termi printer, 118 column, RS232, includes key board, £65. Scotch DC300A cartridges, £15. AMD9511 arithmetic processors, £95. Wanted: counter plug-in adaptor HP10536A, converters HP5254B and HP5255B. Tel: (07842) 51409 after 7pm

■ Atlas enthusiasts, genuine Atlas mobile mount to accept 210 and 211 models, also Atlas broadband transformer, model MT1 for use with mobile whip, £10. Carriage paid. G2HJV QTHR. Tel: Leamington Spa 25395

■ Yaesu 726R with 2 metres, 70cms, isotellite board, open to offers over £850. Boxed etc. 88 ele multibeam, £25. HF5 vertical, £25. MD1 desk mike, £35. Tel: Paul 01-549 9390

■ Amstrad CPC464 colour computer, with monitor, plus screen designer program and some games. Excellent condition, £160 or near offer. Michael Grace, 117 Coronation Avenue, Keynsham, Avon BS18 2QD. Tel: Keynsham (02756) 3195

■ Sony ICF2001, £75. Two Spectrum plus computers with datacoders, £65 each. Yaesu FT2F two metre xtalled tanscvr, £50. CB SWR meter and magmounted whip antenna, £10 pair. Technical software logbook for Spectrum, £5. Hallicrafters Sky Challenger 1938, working, £100. Realistic DX302, £175. Standard C58 multimode with NiCads,

soft case, speaker mike, mobile, mount, linear, 25 watts, rubber duck, £335. D-Scope metal detector TR, £15. Mike G1XGM, 10 Doverfield Road, Brixton, London SW2 5NB. Tel: 01-671 3545 anytime

■ Amstrad 464CPC with colour monitor and Plus Boss joystick, around £300 pounds worth of games. All together £600s worth. Sell for £399 ono. Mr Brygdes, 12 Pleasance Rd, Putney, London SW13 5HP. Tel: 01-876 9971

■ Trio R2000, mint cond, little used, owner just licensed, £385. FT107 wanted. Nick. Tel: (0326) 241044

■ FT102 in vgc, filter, FM and mic, £550. Peter G3JXR. Tel: (0908) 642398

■ FT250 HF tcvr, plus matching PSU/spkr mic and handbook, vgc, £230 ono. Pye Cambridge, hi-band AM, with controller, mic, circuit info, gc, £30 ono. Tektronix 541A 'scope with dual trace and fast rise plug-ins, probes, manuals, gc, £50 ono. Wayne Kerr sig/gen, type CT53, 8-300MHz AM, gc, £50 ono. Garrey GM4XDA, Bishopton (Renfrew). Tel: 862875

■ Trio 430S 6kHz AM, 1.8 SSB, filters fitted, also FM module, MC60A desk mike, good, as new, original boxes, mainly used SWL, cost new £1140, asking £750 inc MC42S mike and /M p/lead, ex Lowe's. I want TS820 Rx, also Pocom 2010 RTTY decoder, Rascal 197 protector unit, BRT400. Above must be in good condx. Tel: Milton Keynes 313507

■ 934 handset, NP900 plus personal radio charger for in car. Yaesu MH12 speaker mike plus other extras, £450. Quad FM3 stereo tuner, Quad 33 control unit, and Quad 303 stereo power amplifier, £170. Tel: Basildon 555836

■ Trio 830S, as new condition, used mostly on receive, genuine reason for sale by licensed amateur, £725. Tel: (061) 6537525

■ Trio TS700 2m multimode transceiver, matching mic, all xtls fitted, SWR meter, speaker, manual, mint condition, £250. Aerials can be supplied. G4LW L Huntley, 118 Bradford Road, Trowbridge, Wilts BA14 9AR. Tel: Trowbridge 3166

■ Sony CRF320 deluxe 32 band receiver, mint, manual, plus service circuit trouble finder, buyer collects, £270. E K Weale, 1 Candy Croft, Gt Bookham, Surrey. Tel: Bookham (Surrey) 56741

■ Tono 550 communications terminal (RTTY, CW) for TV output, £130. Tel: (0273) 673556, Brighton after 2pm

■ Kenwood B2000 receiver, VHF fitted, £400 ovno. Tel: Medway (0634) 41191

■ FT101ZD, 4 band, fan, mic, manual, vgc, unmarked, orig pkg, £425 incl carriage. Dave GOAWZ. Tel: York (0904) 424817

■ Yaesu FT102, fitted AM/FM board, with FV102DM VFO unit and SP102 speaker, mint and little used, £725. Prefer buyer to collect. Hanson power meter, FSS0HP 20/2kW, £55. 2m transverter MMT144/28, 3 months old, ok above Tx, £75. Swedish 2m 3 el beam, £20. A F Sephton, 16 Bloemfontein Ave, Shepherds Bush, London W12 7BL. Tel: 01-749 1454

■ IC2E NiCad charger, sp/mic, ½ mobile ant, vgc, £140 ono. Marconi TF144G sig gen, £25. Tel: after 6pm (0582) 872407 Whipsnade, Beds

■ Kenpro KR400 rotator, brand new, never used, also G4MH mini beam, new and unused, best offer secures. Would consider part exchange or swap for good two metre SSB tcvr. Tel: evngs 01-423 6119, John Harris G3XIN

■ Panasonic RF3100L general coverage Rx with LW, MW, FM, as new, boxed. Also BSA Airsporter S, top of the range air rifle, c/w telescopic sights and sling, as new, boxed. Swap either or both for GFBA144E masthead pre-amp, heavy duty rotator, HF linear (QRO) or WHY? Cash adjustment either way, anything considered. Calum GM0EWX QTHR. Tel: (047) 032256 after six

■ Icom R71E receiver, absolutely mint, no more than approx 20 hours use, £650, no offers. Yaesu FRT7700 ATU, £30. Tel: 01-281 2493 anytime

# FREE CLASSIFIED ADS

■ Datong multimode filter, model FL2, as new, with instruction booklet, £60 ono. Peter Rosamond G4LHI, 13 Newnham Close, Hartford, Huntingdon, Cambs PE18 7RP. Tel: (0480) 52304

■ Sony FRG7600D, little used, mint condition, with PSU and manual, original packing, £100. Tel: (021) 430 6047

■ Trio 2m TM201A slim mobile, £180. Tel: Luton 505112 (Beds)P

■ Yaesu FT726R, fitted 144, 50MHz, also CW filter and MD1 base mic, ex cond, £775. 60ft tower, base mounted, £200. 2m xtal scanner, £50. 10m rig, £15. Buyer collects or pays carriage. Tel: Lee G4RKV (0227) 360841

■ ZX81 Scarab RTTY cassette with interface, ZX81 16K built as integral unit with Maplin keyboard. Lot cost £96, sell for £45. G1FTU RTTY cassette for 48K Spectrum, just plug Tx/Rx into ear/mic sockets. Cost £10, sell for £5. G3EGC. Tel: Bolton 51502

■ Yaesu FT101E, G3LLL FM fitted (worth £70), new valves, mint cond, fan, mic, speech proc, bargain, £325 ovno. Tel: G1ULV (0209) 714342 after 6pm

■ Access Prestel, Micronet and the RSGB data base. Have Prism modem 2000, suits BBC, Apple, Amstrad and Amiga. This is brand new, unwanted gift, would cost £50 new, selling mine for £25. Also have for Commodore 64/128 miracle technology multi modem, just plug in back of computer, switch on and off you go. Cost £116 new, selling mine for £79 ono. Tel: 01-845 4008

■ Get onto RTTY cheaply. GPO type 7 teleprinter, with cover and base, £19. Buyer collects. Nick. Tel: Thanet (0843) 32505

■ TH21E hand-held, spare NiCad, car adaptor, £170. TW400A dual band 2/70 rig, £400. FT707 HF rig with KW ATU, £400. Revco 2000E scanner with Revco discone, £250. Thandar hand-held frequency meter, £75. Breml 10m 200W PEP FM/SSB linear, £75. TW100A SWR meter 2/70, £25. HK707 Morse key, £12. Datong Morse Tutor, £40. Altai GDO, £25. Superstar 2000 10m, £150. Tel: Cardiff (0222) 797852

■ Trio TS830S with YK88C filter, AT230 ATU, SP230 speaker, low pass filter, MC50 desk mic, T200 dummy load, manuals, mint cond, £795 ono. G4ZCI QTHR. Tel: (0536) 513897

■ Yaesu FT290, extd coverage, 144-148MHz, c/w NiCads, chqr, case, new rig forces reluctant sale of

Balun 1 to 1, not used, £4. Dave Howes, 149 Warren Wood Rd, Rochester, Kent. Tel: (0634) 404096

■ Yaesu FT790R 70cm multimode with NiCads, charger, etc, £260 ono. Six metre 50MHz 5 ele tonna, boxed, £30. *Practical Wireless* meon six metre transverter, 28MHz IF, 500mW on 50MHz, boxed with room for Spectrum PA, £35. G3ILO, Nailsworth, Glos. Tel: (0453) 833411

■ AOR2001 scanner, as new, boxed, £200. Revcone antenna, £10. Heath HD121P desk mike, £20. Aluminium parabolic dishes: 24in (Grampian), 18in (PW), new, £10 each. Cirkut HF linear amp, kit, unopened, 1W in gives 15W out, £15. Fine HB RF speech processor (PW March '86), needs aligning, £10. New Woden UMO/DT1 potted modulation txfmrs, £2.50 each, inc spec sheets. NB all items buyer pays carriage. Steve GM4GTU QTHR. Tel: (0224) 743039 or (0903) 776570

■ Scanner SX200 26-514MHz, 1 year old, £170. Revcone wideband discone aerial to match, £20. Microwave Modules, 28MHz to 144 transverter, £60. Will consider p/x of any of the above for any of the following: 2m SSB transceiver, 144 to 28 transverter, 2m valve amp. Could deliver reasonable distance. G1XCO QTHR, Lincoln. Tel: (0522) 750057

■ SX200N scanning Rx, UHF, VHF 26-514MHz, £165.00. Sony ICF5900W, AM, FM, SW BFO, boxed, £49.00. Tel: 01-657 0430

■ Pocom AFR2010 all mode RTTY decoder, with software modules, 1, 2 & 3 installed, fully automatic decoding of Baudot, ASCII, CW, ARQ/FEC (Sitor A+B) and special codes: ARQ's E, M28, PLEX, INV, 56, S, FEC A & S plus other codes, £900. Technical software RX4 multimode receive program with interface for Commodore 64, £18. Eskab phase locked AM synchronous tuning/detection unit for Icom R71, as seen in DSWCI, £50. Icom FL44A 2.4kHz crystal SSB/AM filter for Icom R71 receiver, £60. Icom SP3 external speaker, £40. Psion Organiser II, model XP, 16K RAM, 32K RAM datapak, mains unit, £110. All items boxed. As new, with manuals. Tel: 01-570 5603

■ Trio R1000 HF comms receiver, full AM, SSB, CW reception from 200kHz to 30MHz. Perfect working order, £200 ono. Mr Robertson, Ipswich. Tel: (0473) 717573

■ Yaesu 203R with speaker mike, charger and soft case, mint condition and nearly new. £200. G1 TC

either way. Tel: 01-991 2013

■ Drake ATU MN75 matching network. Ask for Rodney. Tel: (0689) 58825

■ Eddystone EA12 amateur bands only receiver. Good condition, £130. Tel: Staines (0784) 50947

■ Kenwood TR9130 2 metre multimode, £365. Breml 10 amp power supply, £60. Eddystone 840C HF receiver, mint, £135. Seven element X-Yagi, £18. Buyer collects or carriage extra. Mr C Richardson, 47 Leighton Close, Cross-Gates, Scarborough YO12 4LA. Tel: (0723) 863035 after 6pm

■ Cossor 4in CRT, pair Leak 2030 speakers, offers. Cooper, 52 Eastheath Avenue, Wokingham, Berks RG11 2PJ. Tel: (0734) 791488

■ B28 Admiralty (collectors' item) radio, six wave bands from 60kHz to 30MHz, complete with AP63993 transmitter, 8-10 watts, crystal controlled, frequency coverage ranges from 2-12MHz CW, complete with original handbooks, good working order. If it's transmitted this set will tune it in. First sensible £45. Also Woods SSB 3 wave ship's radio, perfect, £35. Reg Wright. Tel: Wearside (091) 586 4858

■ FDK725X multi 2 metre FM 144-148MHz, Heath-erlite mobile safety mike, 5/8+3/8 mobile whips, Drae VHF wavemeter, Titan 5/7 amp PSU with Baildon over-voltage protector unit. Slim Jim for the house, all vgc, sell £260 ono, or exchange for FT707 +FM (reason for sale). Wanted: G-whip mobile. Tel: 01-247 6097 daytime only

■ Trio TS711E, with DCS system. Too many extras to list. 12 months old, mint condition, still boxed, redundancy forces sale of this flag ship 2 mtr transceiver, £650. Any trial at QTH. Buyer must collect. Tel: Dronfield (0246) 410409, 9am-4.30pm

■ Sony CRF320 FM/MW/LW/SW, 32 band digital receiver, excellent condition, £250 post paid, or swap above for National Panasonic RF8000 onward model receiver. Also have Sinclair ZX81 16 key, plus PSU. Would exchange for marine band Rx. Tel: (061) 743 1570 anytime

■ Racal RA17L cased and with manual, professionally serviced and aligned, vgc, £187. KW E-Zee match, £45. G8ZWW. Tel: (0322) 63968

■ TS780 dual band multimode, 10W, 2m/70cm, boxed, vgc, £600 ono. TW4000A dual band FM, 25W, boxed, vgc, £350 ono. FRG7700 ATU and Daiwa AF606K filter. £350 ono. FT690R, 6m multimode...

Advert Form Removed

## FREE CLASSIFIED ADS

### WANTED

■ Belcom LS102 tcvr, must be in very good condition, no mods. Tel: Belfast 795783

■ Marine MF/HF transceiver (mobile), for example Icom ICM700, along with marine automatic antenna tuning unit, Icom AT120 and HF AATU, Icom AH2. Mr D V Smith, 7 Clos Gors Fawr, Grovesend, Nr Gorseinon, Swansea SA4 2GZ

■ Urgently wanted: mobile HF transceiver, all bands, ATU, mobile HF whips. Tel: (0753) 28304 after 8pm only

■ Philips Laser Vision video discs. Need these titles: 'American Werewolf in London', 'Blues Brothers', 'The Howling', 'Saturday Night Fever', '2001 Space Odyssey', 'Escape From New York', 'Apocalypse Now', 'Jaws', 'Capricorn One', 'Cat people'. Also SEM transmatch or cheap ATU, Yaesu FL50B Tx, and Hubbs for AV140 beam. Good price paid for discs etc. No phone. All letters answered. Tom Lee, 15 Talkin Drive, Middleton, Lancs M24 3LS

■ Service manuals and sheets for all amateur radio sets. Trio 2000 service manual, Trio 430S manual, Trio 530 manual. Also AR2002, FT290, SX400, SX200N, MX800, Heathkit HW101, FT707, RW200B, FT7700 manuals. Please phone after 5pm. Tel: (0288) 4892

■ Amstrad 6010 multiband radio or similar. Tel: (0608) 2373

■ Any information on SCR718, especially indicator 1-152AM and a working or non working indicator No 62, or 97. Also surplus radio conversion manual No 1 (USA). J A Brown, 57 Mountbatten Road, Braintree, Essex. Tel: (0376) 45023

■ T1154/R1155, or accessories, eg loop aerials, J switches (for aerial switching), aerial winches etc. Any leads or plugs, especially Jones plugs (4,6, & 8 flat pins). Manual (AP1186), left/right visual indicator meters, etc. In fact anything for this set-up is of interst. For R210/C11 set-up I require ATU and ac power supply, connector boxes, headgear etc, and workshop manual. Also whip aerials for WS19 and WS31. Tony Howard, Milton Keynes. Tel:

(0908) 73114

■ 48K Spectrum with micro drive and interface I, plus all leads, books, and two games cassettes, in original boxes. Swap for any of the following items: FP707, FV707DM, FC707, FRB707 or an FTV707 with both modules. I pay cost of post from me to you via Securicor. Mr J D Bolton, G4XPP, 10 Bowness Road, Coniston Park Estate, Timperley, Cheshire WA15 7YA

■ Belcom LS202 hand-held, will p/ex Yaesu FT208R VHF/UHF valve linear, plans circuit diagrams wanted. Tel: Durham 701429

■ Receive oscillator multiplier module for hi-band Olympic FM. Also Pye A200 amplifier. Tel: (0733) 78685

■ I'm looking for an oldish HF transmitter or transceiver in good working condition, with CW and perhaps AM or SSB. Tel: (0425) 54371

■ Yaesu FT290R with NiCads, unmodified. Exchange for my Yaesu FT208R inc speaker, microphone, spare NiCad pack, base charger/PSU and quart wave telescopic whip. Jon Carp GM8XFT QTHR. Tel: (095) 781 555 ext 212 during office hours

■ Datong D70 Morse Tutor. A good old fashioned Morse key in good working order. Tel: (0206) 394338 Essex

■ Yaesu CPU2500R FM 2m trans. Trio Kenwood VFO 120, also VIC20 computer, for my own collection, Dinky or Corgi spot-on, boxed, unboxed toys. Tel: Weymouth (0305) 813202

■ Manuals for Samwell Hutton type 78 wobulator, also Bradley electronic testmeter, CT471 Airmec sig gen, type 365. J M Allsop G1FEX, 15 Woodland Grove, Mansfield Woodhouse, Notts NG19 8AZ. Tel: (0623) 641709

■ Reftec 934, preferably Mk II, working and unmolested please. Tel: (061 427) 4317

■ Service manual or circuit for Arvin communications receiver, type CV-920BURR, and IF unit, type AM2477BURR. Will buy or pay photocopy costs. P J Lawrence, 39 central Avenue, Maylands, West Australia 6051

■ WW2 German radio, radar gear, parts, spares,

literature. Also Resistance radio set, Electra receiver, R208 rcvr, remote controls: C-D-F-H WS65/66, AD67, S2ERT, R637. Will collect. Available: WS19, 22, 38, 58. Collins radio S/JY W/3 mech filters, Siemens Funk 745 all-wave rcvr. OZ8RC Rag Otterstad. Vejdammen 5, DK-2840 Holte, Denmark. Tel: (010 452) 80 1875

■ Nato 2000 and Stalker ST9FDX and Cobra 2000, good price paid. Tel: Belfast 249453

■ Yaesu FT707 10/100W model in any condition, but must be reasonably priced. For sale AM/SSB CB mobile, c/w Digiscan, giving 26-28MHz in 5kHz digital read-out steps, £95. 350W AM out, 500W PEP SSB mobile amp, the very best, £150. Also wanted: Hi-gain 105BA 10m beam. Phil G4ZOW. Tel: (0442) 86931 Herts

■ Nato 2000 wanted, will pay up to £100. Must not have been tampered with inside, urgent: any equipment for band 1 & 2 continental television. Tel: (0283) 221870

■ Have been saving the pennies and would like an Icom IC735 rig, ICP555 PSU and CapCo SPC300C ATU. Items must be clean, in full working order and reasonably priced please. Tel: Dunstable (0582) 600033

■ 2m FM Tx or Rx, and cheap Spectrum 48K computer. Tel: (0631) 65104

■ Carrying handle for Barlow-Wadley receiver, XCR30 MK2. I have broken mine. Alan Edwards, 32 Heldhaw Road, Bury St Edmunds, Suffolk IP32 7ES. Tel: (0284) 60984

■ Exchange SEM 100W linear/pre-amp, and micro processor computer 64K, compatible Apple II programs, with PSU and manuals, for Icom 402 70cms SSB rig or similar, or linear only 70cms to 2 meter transverter. Alan, 1 Manor Terrace, Terrington St. Clement, Norfolk PE34 4NF. Tel: Kings Lynn 829075

■ BBC-B owner wants to contact other users for information on computer programs to be used for Morse, teletype, news bulletin etc decoding. Any other relevant information, such as books, circuits, programs most welcome. Will pay towards expenses or for any reasonable requests. Please

## FREE CLASSIFIED AD FORM

Form Removed

# FREE CLASSIFIED ADS

write to: A Toutountain, 19 South Luton Place, Adamsdown, Cardiff CF2 1EX

- Exchange Yaesu CPU 2500R 2m FM trans, must be in vgc, for my own collection Dinky, Corgi, 'spot-on' toys, boxed, unboxed. Tel: Weymouth (0305) 813202
- Yaesu FRG7 or similar, also Cobra 148GTL, standard. Prefer if both are in vgc. Can view and collect in Norfolk area. Please send details to Patrick, Meadow View, Pound Green, Shipdham, Norfolk IP25 1LJ
- Service manual for Eddystone 888, or photocopies of manual. Tel: Bob G1FAH (0707) 335627
- FT107 with PSU, mint condition or similar transceiver. Nick. Tel: (0326) 241044
- Have pair Burndept 357 h/holds, crystallised, together with batteries, charger, manual. Pye Starphone with battery, Pye P1 x'mitter, c/w battery. Also Philips complete dictating outfit LFH0085 desk console, mains operated, with foot control, head set, two pocket memos and cassettes. Swap the lot for h/held scanner with cash adjust. Eyles, 41 Bredon Grove, Poolbrook, Malvern, Worcs WR14 3JS. Tel: Mal 62385
- Grundig Satellit 1400 professional communication Rx, similar Rx considered, but in any case must be in good condition. Trade will probably have to be done by post, as I live in the back of beyond! If you can help please write to: Victor McKaig, 15 Islandranny Road, Bushmills, Co Antrim, N Ireland BT57 8YE
- Manual for Heathkit digital multimeter, model IM1202. Also manual for Heathkit capacitor checker, model IT-28. Colin Smallwood, 35 Dakin Avenue, Fairfield, Buxton, Derbyshire SK17 7EE. Tel: (0298) 77007
- Yaesu FT101, Yaesu FT101E, any Trio Tx/Rx, any 3 band 3 el beam, T160L, 572B, EZ35 valves. Tel: (0787) 280259
- Newly licensed ham requires some cheap ex PMR gear. Pye, FM Westminster, Storno, etc, for use on 70cm and 2m. Must be in good working order but condition of case etc unimportant. Also

- CW filters for Trio TS830 and TS830 ext speaker. G1XCO QTHR. Tel: Lincoln (0522) 750057
- Monitor scope urgently required. Any make considered, eg YO901, SB610, SB614, KW108 etc, WHY? Alternatively, do you have a scrap Heath SB610 scope? I need txfmr, will pay good price, any help much appreciated. 73. Steve GM4GTU QTHR. Tel: (0224) 743039 or (0903) 776570
- Circuit diagram for general coverage receiver, Lafayette HA600. Any help would be gratefully received. Mr J Barton, 9 Fordworth Cottages, Hallsands, Kingsbridge, S Devon. Tel: Chivelstone 447, evenings
- AOR2002 scanner wanted, I can only exchange any of the list below. Tandy PC6 pocket 8K computer, Trio TH21E h/port with Vox h/set, DC21 adaptor, s/manual, Thandar TC200, TP600 600MHz f/counter, TRS80 model 100 32K lap computer, with 100K 3.5in disc drive and all manuals, working very well plus few discs, one on Packet radio. Ring anytime for swap agreement. Tel: (04738) 5526, 9am to 10pm
- CW filter and three point SSB filter for Collins 75S-3 receiver. Collins 32V series transmitter. T&R Bulletins, 1930 and older. *Bulletin* March, 1957. SWM March, 1946, July '46, Jan '48, July & Aug '59, and Jan through Aug '79, Dec '82, most of '83, '85, and Jan, Feb, May '86. Circuit of Citizen Band 'Globe phone' transceiver model no GS480DX and any mods for 10 metre operation. Cabinet for BC221. Sell/swap many WW, CQ, QST, SWM, *Bulletins* '40s onwards available, but please SAE enquiries to: The Advertiser, Ty-Top, Castle Caerinion, Welshpool, Mont Powys. Tel: (0285) 83625, Gloucestershire
- T1154/R1155 equipment of all types, including aerials and related gear. Also, information on following: ATU No8 (2A46835) RAF switch unit type, 78A (10FB366), and condition tester WSB70 (2D02573). (I have these items but need info on use). Help would be appreciated. Tony Howard. Tel: (0908) 73114
- FT101 or similar, must be in good working order.

John GOGUL. Tel: (0203) 450476

- Technical books: *History of Marconi Company*, MIT radiation series, *Threshold Signals*, *Crystal Rectifiers*, *Principles of Microwave Circuits*, *Components Handbook*. Medium duty rotator, KR400 etc. Manual for an APR4Y CV253. Cooper, 52 Easthate Avenue, Wokingham, Berks RG11 2PJ. Tel: (0734) 791488
- Sony ICF2001D, must be in good condition and with original packing and accessories. Tel: (0905) 620041 or write G6JNS, Red Lion Cottage, Holt Heath, Worcester WR6 6LZ
- Epson FX80 printer, fully working, will collect north-west, secondhand or new. Good price paid for mint cond. Kevan G1UGG QTHR. Tel: Blackpool (0253) 49493 evenings after 7.30pm
- 70cm FM mobile or dual bander, must be in good condition. Chas. Tel: 01-764 6767
- Collector requires WW2 radio, radar and test gear in vgc, plus original manuals, spares etc. Also want ATU for C12, coils for National 1-10, Canadian 19 set, rough examples of R1116, B13, B21A, B50, SSB unit for B40, original S-meters for AR88 and S-P27, full service data for Eddystone S880. A R Burks, Bridge Farm House, Tumby Woodside, Boston, Lincs. Tel: (0526) 42173
- Maximal MK4000 scanner, 70-90MHz, plus 140-176MHz. Fairmate scanner with above frequency coverage. Realistic (Tandy) DX302 HF/Rx, or any other Tandy with digital read-out. Also DX200 or DX100L. Letters only please. J Bidgood, 27 Ashdown Close, Chandlersford, Eastleigh, Hants SO5 1QF
- Ex WD service manuals, air publications, to purchase or swap. Cheap communications receiver for young SWL, anything considered, even incomplete. ATU No 8 for B47. Accessories for WS C12. AVO valve characteristic meter MK4 instruction book, photocopy OK. Accessories for WS C11, R210, baseboard etc. Telefunken ECH11 and EZ11 valves. Jim G4XWD. Tel: Kidderminster (0562) 3674 evenings

# SURPLUS COMPUTER HARDWARE

## ITT SCRIBE IN WORD PROCESSING SYSTEM.

Professional system originally selling at around £8000 without printer. Now offered with software included & a variety of different options available. This system is available from us ALL BRAND NEW at the cost of current budget systems, but with office-quality performance & features.

### SOFTWARE INCLUDED:

- \*DATABASE — allows information storage & retrieval by user-selectable criteria.
- \*EDITING — including easy reformatting, global search & replace, save & move, cursor control etc.
- \*AUTOMATIC LETTERWRITING — with merge, glossary file for much used phrases etc.
- \*MATHS FUNCTIONS — screen maths allows addition of rows, columns & complete tables.
- \*PROGRAMMABLE COMMANDS — allows format changes, accessing record block files, prompts etc.
- \*HELP FILES — quicker to use than the comprehensive manual supplied.
- \*BASIC COMPILER.

### HARDWARE INCLUDED:

- \*SCREEN/WORKSTATION — dual processor (16 bit T1 9995 & Z80H) with 128K memory, 12" green screen 25 x 80 character display with slow scrolling, QUME printer interface.
- \*KEYBOARD — low-profile keyboard additionally has 43 clearly marked dedicated function keys.
- \*DISC DRIVES — dual SHUGART 5 1/4" DSDD drives each 430K capacity formatted. **£295.00**

### OPTIONS:

- \*10mbyte MiniScribe WINCHESTER disc drive (£195).
- \*NEC Model 3500 35cps daisy wheel printer (£295).
- \*NEC Model 7700 55cps daisy wheel printer (£395).
- \*128K additional memory with spelling check software (£40).

- \*Communications hardware & software (£95).
- \*\*COLOUR LEAFLET AVAILABLE\*\*

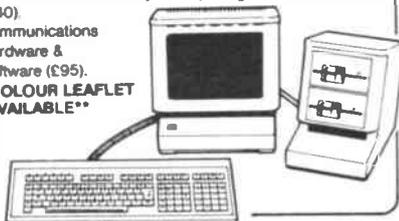

## HITACHI Model 3055/SX 3" disc drives.

With SHUGART compatible interface (34 way edge connector) and suitable for BBC with DFS.

AMSTRAD 684/6128, TATUNG EINSTEIN & many others. Will usually replace 5 1/4" drives directly. 250K (double density unformatted) per side reversible; 40 track; standard power connector for 12V & 5V; overall power consumption typically 3.7W. Supplied BRAND NEW with connector pin-out details etc. but uncased without PSU. Data cables are available for AMSTRAD & BBC (£7.50) and an installation pack including data & power cables with instructions is available for the TATUNG EINSTEIN (£12.00) **£29.95**



MATMOS PC. Available without disc drives only. 64KB Z80A based keyboard sized machine with RGB, composite video outputs & UHF modulator. Serial, parallel, cassette & peripheral bus interfaces are provided, together with a ROM port. MICROSOFT BASIC is in ROM. Office quality machine originally sold at £350 by its big-name manufacturer. **BRAND NEW**

\*Over 1500 already sold by us **£49.00**

MATMOS TERMINAL (Ver.2). MATMOS PC as above but with additional plug-in terminal emulation ROM. Features include "SET UP MENU" "RS232 with handshake" all BAUD RATES to 9600" access to MICROSOFT BASIC which is still available to the user. Cursor addressing and character attributes are VT-52 compatible. (ROM is available separately at £20.) **£99.00**

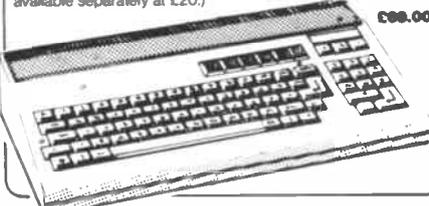

TOSHIBA Model T300 system (semi-compatible with IBM PC). With 6MHz 8088 processor, 256KB RAM, single half-height 5 1/4" floppy disc drive (640KB), high resolution green display, serial & parallel interfaces. Included are MS-DOS Ver 2, MICROSOFT T-BASIC, good manuals & comprehensive diagnostic disc. Available options include a colour monitor and memory extension. BRAND NEW **£295.00**

AS ABOVE but with dual floppy disc drives. **£350.00**

TOSHIBA Model T100 CP/M system. With 64KB RAM, dual 500K 5 1/4" floppy disc drives, serial & parallel interfaces & MICROSOFT BASIC in ROM. BRAND NEW **£199.00**

DEC PDP 11/73 system. With 500KB RAM, twin AMPEX 20MB WINCHESTER disc drives, single TANDON 8" floppy disc drive (DIALOG controllers), DLV-11 serial interface & DZV-11 4 line async. multiplexor. All DEC system, except for disc drives/controllers, in DEC cabinet. **£4900.00**

DEC PDP 11/23 system. With 256KB RAM, single FUJITSU 20MB WINCHESTER disc drive, single TANDON 8" floppy disc drive, DLV-11J, & XENIX operating system with all original manuals. **£1900.00**

CANON Model A-1300 twin 5 1/4" disc drives. Cased BRAND NEW half height drives, DSDD, 80 track, 640 KB per drive, SHUGART compatible interface. Without PSU, per pair **£99.50**

FUJITSU 5 1/4" WINCHESTER disc drives. 5MB capacity with ST506 interface. BRAND NEW **£75.00**

### Please note:

\*VAT & CARRIAGE must be added to all items. Carriage is £3.00 + VAT for 3" disc drives, and £10.00 + VAT for most other items.

\*SAE please, for further details of any item and complete stock list with details of many other items including test equipment, terminals, plotters etc. etc.

MATMOS Ltd., 1 Church Street, Cuckfield, W. Sussex RH17 5JZ. (0444) 414484/454377  
COMPUTER APPRECIATION, 111 Northgate, Canterbury, Kent CT1 1BH. (0227) 470512. TELEX 966134 COMPAP

matmos & COMPUTER APPRECIATION

# Amateur RADIO SMALL ADS

## IAN FISHER COMMUNICATIONS OF STANHOPE

CB Works, Bondisle Way, Stanhope,  
Bishop Auckland Co Durham DL13 QTY  
(0388) 528464

Main Distributors of 27MHz CB radios and the  
NEW DELTA 1 series 2 model transceiver with  
the latest cybernet board. Also the NEW  
Nevada range of 934MHz aerials to suit, also  
934MHz pre-amplifiers and VSWR meters and  
GREENPAR BNC and 'N' type plugs.

Large stocks of coaxial cable, plugs, sockets  
and adaptors.  
All available via mail order.

OPEN: MON-SAT 10.30am-6.00pm  
RING FOR DETAILS  
(0388) 528464



## USED AMATEUR EQUIPMENT? I Buy, Sell & Exchange!

SELLING? I pay the BEST POSSIBLE PRICES  
for your Clean Used Equipment!

BUYING? I have the BEST SELECTION of top  
Quality Used Equipment Available!

For the Deal You've been Looking for, Phone Dave, G4TNY  
ANYTIME ON HORNCHURCH (04024) 57722 (0836) 201530 9am -  
7pm Mon - Sat or Send SAE

**G4TNY AMATEUR RADIO**  
132 Albany Road, Hornchurch, Essex RM12 4AQ

**D.P. HOBBS (Norwich) Ltd**  
13 St Benedicts Street, Norwich Tel: 615786  
Open Mon-Sat 9-5.30  
Closed Thurs 1.00pm  
Stockists of: ICOM  
YAESU, FDK, ICOM, JAYBEAM  
& Electronic Component Specialists

## NORTH WALES AMATEUR RADIO MART

AMATEUR RADIO - CB RADIO - MARINE  
RADIO - PMR

25 ABBEY STREET  
RHYL

Open Monday-Saturday: 11am-5.30pm  
All repairs and accessories available ex  
stock Mail order welcome  
Tel: 0745-51579

## MRZ COMMUNICATIONS LTD STOKE-ON-TRENT

DESK DC SUPPLY AND BASE  
FOR ICOM PORTABLES

ICOM-AMATEUR/PMR/MARINE/AIR

YAESU - AMATEUR  
UK AND EXPORT



TEL: (0782) 619658  
7 DAY SERVICE



## JAYCEE ELECTRONICS LTD

JOHN GM30PW

20 Woodside Way, Glenrothes,  
Fife KY7 5DP

Tel: 0592 756962

Open: Tues-Sat 9-5

Quality secondhand equipment in stock. Full  
range of TRIO goodies. Jaybeam - Microwave  
Modules - LAR.

## JAPANESE Ic's (PART OF OUR RANGE)

AN301 £3.50, AN7140 £2.20, AN7145 £1.95, AN7146 £2.20, BA532 £1.60,  
BA536 £2.40, HA1377 £2.20, HA1398 £2.75, HA13001 £2.95, LA4460 £1.80,  
LA4461 £1.80, LA4507 £4.25, LC7137 £2.75, M51515 £2.50, M51517 £2.80,  
MB3705 £1.80, MB3712 £1.50, MB3722 £3.50, MB3730 £2.50, MB3731 £3.50,  
MB3756 £2.60, MB8719 £3.85, STK461 £7.50, STK463 £8.40, TA7205AP  
£1.00, TA7222AP £1.30, TA7229 £3.25, TA7240 £2.95, TA7607 £2.95, TA7614  
£2.75, TA7628 £2.95, TA7640 £1.75, UPC575 £1.00, UPC1001 £2.20,  
UPC1031 £1.95, UPC1158 95p, UPC1181 £1.10, UPC1182 £1.10, UPC1185  
£2.50, UPC1188 £2.75, UPC1230 £2.50, UPC1277 £2.75, UPC1365 £3.60,  
ADD 60p POST AND PACKING AND THEN ADD 15% VAT TO TOTAL

T POWELL 16 PADDINGTON GREEN LONDON W2 1LG  
OPEN MON-FRI 10AM-5PM, SAT 9AM-12 NOON.  
TELEPHONE: 01 723 9246  
ACCESS/VISA. TELEPHONE ORDERS ACCEPTED OVER £5.00

# Amateur RADIO

This method of advertising is available in  
multiples of a single column centimetres -  
(minimum 2cms). Copy can be changed  
every month.

### RATES

per single column centimetre:  
1 insertion £7.00, 3 - £6.60, 6 - £6.30, 12 - £5.60.

# SMALL ADS

## AMATEUR RADIO SMALL AD ORDER FORM

TO: Amateur Radio · Sovereign House  
Brentwood · Essex CM14 4SE · England · (0277) 219876

PLEASE RESERVE.....centimetres by.....columns

FOR A PERIOD OF 1 issue..... 3 issues..... 6 issues..... 12 issues.....

COPY enclosed..... to follow.....

PAYMENT ENCLOSED: (Add 15%VAT).... £ -

Cheques should be made payable to  
Amateur Radio. Overseas payments  
by International Money Order and  
Credit Card

CHARGE TO MY ACCOUNT..... CREDIT CARD EXPIRY DATE [ ] / [ ]

COMPANY .....

ADDRESS .....

SIGNATURE ..... TELEPHONE.....

C P I

# NEXT ISSUE OF *Amateur* **RADIO** ON SALE Thursday 28th May

## HEATHERLITE PRODUCTS

### MOBILE MICROPHONES

Complete with control box, mic gain control, PTT, LED on Tx.

TYPE A suits the majority of rigs with plug, with scan buttons ..... **£25.00**  
with plug, without scan buttons ..... **£23.00**  
TYPE B with second stage amp (for some Icom rigs) ..... **£23.00**  
FOR SINGLE EARPHONE ON ANY OF ABOVE..... add **£2.00**  
TYPE SW for hand portables using jack plug connections, mic with switching box, earphone, jack plugs..... **£14.50**  
MIC and COAX only - mic, coax, circuit **£7.00**  
mic, coax, circuit, earphone ..... **£9.50**  
POST AND PACKING on above ..... **£1.50**

### AMPLIFIERS

HF Explorer amplifier - pair of 3-500Z valves ..... **£950.00**  
2m Explorer amplifier - 144MHz - single 4CX250B ..... **£485.00**  
2m Explorer amplifier - 144MHz - single 4CX350A ..... **£525.00**

Carriage extra at cost

**No.1 Beverley Business Centre,  
1 St. Nicholas Road,  
Beverley, North Humberside**

TEL: 0482 871762 ACCESS/VISA cards accepted

## AGRIMOTORS

**MERTON CB AND RADIO CENTRE  
MERTON GARAGE AND POST OFFICE, MERTON.  
Nr OAKHAMPTON, DEVON EX20 3DZ**

OPEN 6 DAYS 9-6 LUNCH 1-2pm THURSDAY 9-1  
(SUNDAYS BY APPOINTMENT)

SPECIALIST IN 934 MHz

SUPPLIERS OF ALL 27MHz AND 934 MHz EQUIPMENT  
AMATEUR EQUIPMENT CATERED FOR  
08053 200

## PNP Communications Communications Interface for RTTY - Morse - AMTOR

Our popular range of communication modules is now available, fully boxed and tested under the model number.

### CTU 20

The CTU20R is RTTY only & costs **£62.50** whilst the CTU20RM is for morse as well and costs **£75.25**  
For shortwave listeners the MF2-DX gives the option of 170Hz, 425Hz or 850Hz shift reception and costs **£56.95**

Send a large (A4) SAE for full Cat  
Please add VAT at the current rate.  
Access & Barclaycard (VISA) welcome.

**62 Lawes Avenue, Newhaven  
East Sussex BN9 9SB  
Tel: (0273) 514465**

## DW ELECTRONICS G3 XCF

Amateur Radio Supplies  
**71 Victoria Rd, Widnes** ICOM  
Tel: 051-420 2559  
Open Mon-Sat 9.30-5.30 (closed all day Thurs)  
We supply YAESU, ICOM, Tonna, Jaybeam,  
Microwave Modules, Datongs etc

## ETESON ELECTRONICS

**E.E.** 15B Lower Green,  
Poulton-le-Fylde, Blackpool  
Tel: (0253) 885107  
Open 9.30am - 12.30, 1.30 - 5.30 Closed Wed & Sun  
Electronic Component Specialists  
A wide range of electronic components. IC's, capacitors,  
transistors, resistors, plugs and sockets etc

### TV AERIAL BOOSTERS

UHF AMPLIFIER, 20 DBS GAIN, NEXT TO THE SET  
FITTINGS PRICE £7.70 + P&P £1.00  
PHONE FOR LEAFLET

### ELECTRONIC MAILORDER A

62 BRIDGE STREET, RAMSBOTTOM, LANCS BL0 9AQ  
Tel: 070682 - 3036 (24hrs)

## Selectronic

The UK's leading suppliers of  
934MHz personal radio equipment

**203 High Street  
Canvey Island, Essex,  
Tel: 0268 691481  
(Open Mon-Sat 9-5.30)**

Amateur radio equipment also in stock

### HEATHKIT U.K.

Spares and service centre.  
Cedar Electronics, Unit 12, Station  
Drive, Bredon, Tewkesbury,  
Glos. Tel. 0684 73127

## RADIO ENGINEER WANTED

Due to an ever increasing range of ICOM products, we are now looking to expand our service department. Prospective candidates should have a sound background in radio and computer servicing techniques. They will be involved in all aspects of servicing using modern test equipment in extensive workshops at our main office.

If you are interested in joining our expanding company please contact us at the address below.

### ICOM (UK) LIMITED

**Unit 9 Sea Street  
Herne Bay, Kent CT6 8LD**

TEL: (0227) 363859 ICOM

## Booth Holdings Bath

**GOLF CLUBLANE  
SALTFORD  
BRISTOL  
Tel: 02217 2402**

Open Tues-Dat 9am-9pm  
Closed Monday

See you at Longleat Sunday 28th June

## RF DEVICES AT ROCK BOTTOM PRICES!

**Nobody beats us!**

Over 30,000 RF devices at low prices

REPLACEMENT RF TRANSISTORS	
MRF454 HF/SSB 80W	£18.20
MFR450 HF/SSB 50W	£11.60
MRF238 VHF/FM 25W	£12.80
MRF475 HF/SSB 20W	£2.99
2SC1969 HF/SSB 18W	£2.50
2SC2043/1307 HF 16W	£2.00
2SC1947 VHF 3.5W	£7.60
2SC1946A VHF 32W	£14.30

### REPLACEMENT RF POWER MODULES

M57704/SAU3 UHF 15W	£36.00
M57712/SAV7 VHF/FM 25W	£39.00
M57713/SAV8 VHF/SSB 15W	£39.00
M57716/SAU4 UHF/SSB 15W	£49.00
M57719 VHF/PMR 15W	£29.00
M57727 VHF/SSB 38W	£45.00
M57749/SAU11 934/FM 7W	£29.00

Send **£1.00 p&p** and SAE for full list  
All prices inc. VAT  
Many Ic's and other types in stock

**RAYCOM LTD  
DEPT AR 584 HAGLEY RD WEST  
QUINTON BIRMINGHAM**

**B68 OBS**

**021 421 8201-3**

(24hr answer phone)

### WORKSHOP SERVICE MANUALS

Thousands stocked. Most makes. Models, Types, Audio, TV, Video, Test, Amateur etc. SAE Enquiries/Quotation. Bumper Catalogue £3.00 including free phonograph speed disc, details unique, Repair and Data Guides

### MAURITRON (AR)

6 Cherry Tree Rd, Chinnor, Oxon OX9 4QY

### MORSE CODE PREPARATION

Cassette A 1-12 wpm for amateur  
Cassette B 12-25 wpm for professional examination preparation  
Each cassette is type C90  
Price of each cassette (including booklets) **£3.95**.  
Morse key with separate battery (PP3) - driven solid-state oscillator and sound transducer produces clear tone for sending practice. Price of key with electronic unit **£8.95**.  
Price includes postage etc. Europe only  
MH ELECTRONICS (Dept AR)  
12 Longshore Way, Milton, Portsmouth PO4 8LS

**VALUABLE  
SPACE FOR  
SALE!**

**Telephone  
the advertising  
department on:  
0277 219876  
for details**

# ADVERTISERS INDEX

AKD .....	44	Icom .....	4, 5
Amdat .....	11		
Bi-Pak .....	34	Johnsons Shortwave .....	40
J Bull .....	59	Paul Sergent .....	34
Capco .....	14	Technical Software .....	11
P M Components.....	30, 31	Telecomms .....	60
Computer App/Matmos ...	55		
Grosvenor Square .....	34	Reg Ward .....	34
L F Hanney .....	34	Waters & Stanton .....	20
Harrison Elec .....	17	Western Elec .....	44
		R Withers .....	2

## Amateur RADIO

## ADVERTISING RATES & INFORMATION

DISPLAY AD RATES		series rates for consecutive insertions			
depth mm x width mm	ad space	1 issue	3 issues	6 issues	12 issues
61 x 90	1/8 page	£66.00	£62.00	£59.00	£53.00
128 x 90 or 61 x 186	1/4 page	£115.00	£110.00	£105.00	£92.00
128 x 186 or 263 x 90	1/2 page	£225.00	£210.00	£200.00	£180.00
263 x 186	1 page	£430.00	£405.00	£385.00	£345.10
263 x 394	double page	£830.00	£780.00	£740.00	£660.00

COLOUR AD RATES		colour rates exclude cost of separations	series rates for consecutive insertions		
depth mm x width mm	ad space	1 issue	3 issues	6 issues	12 issues
128 x 186 or 263 x 90	1/2 page	£305.00	£290.00	£275.00	£245.00
263 x 186	1 page	£590.00	£550.00	£530.00	£470.00
263 x 394	double page	£1,130.00	£1,070.00	£1,010.00	£900.00

SPECIAL POSITIONS	Covers Bleed Facing Matter:	Outside back cover 20% extra, inside covers 10% extra 10% extra [Bleed area = 307 x 220] 15% extra
-------------------	-----------------------------	--

DEADLINES					*Dates affected by public holidays
issue	colour & mono proof ad	mono no proof & small ad	mono artwork	on sale thurs	
May 87	2 Apr 87	8 Apr 87	10 Apr 87	30 Apr 87	
Jun 87	30 Apr 87	6 May 87	8 May 87	28 May 87	
Jul 87	28 May 87	3 Jun 87	5 Jun 87	25 Jun 87	
Aug 87	2 Jul 87	8 Jul 87	10 Jul 87	30 Jul 87	

CONDITIONS & INFORMATION			
<p><b>SERIES RATES</b> Series rates also apply when larger or additional space to that initially booked is taken. An ad of at least the minimum space must appear in consecutive issues to qualify for series rates. Previous copy will automatically be repeated if no further copy is received. A 'hold ad' is acceptable for maintaining your series rate contract. This will automatically be inserted if no further copy is received. Display Ad and Small Ad series rate contracts are not interchangeable.</p>	<p>If series rate contract is cancelled, the advertiser will be liable to pay the unearned series discount already taken. <b>COPY</b> Except for County Guides copy may be changed monthly. No additional charges for typesetting or illustrations (except for colour separations). For illustrations just send photograph or artwork. Colour Ad rates do not include the cost of separations. Printed - webb-offset.</p>	<p><b>PAYMENT</b> Above rates exclude VAT All single insertion ads are accepted on a pre-payment basis only, unless an account is held. Accounts will be opened for series rate advertisers subject to satisfactory credit references. Accounts are strictly net and must be settled by the publication date. Overseas payments by International Money Order or credit card. <b>FOR FURTHER INFORMATION CONTACT</b> Amateur Radio, Sovereign House, Brentwood, Essex CM14 4SE. (0277) 219876</p>	<p>Commission to approved advertising agencies is 10%. <b>CONDITIONS</b> 10% discount if advertising in both Amateur Radio and Radio &amp; Electronics World. A voucher copy will be sent to Display and Colour advertisers only. Ads accepted subject to our standard conditions, available on request.</p>



## £1 BAKERS DOZEN PACKS

Price per pack is £1.00. \*Order 12 you may choose another free. Items marked (sh) are not new but guaranteed ok.

1. 5 - 13 amp ring main junction boxes
2. 5 - 13 amp ring main spur boxes
4. 5 - surface mounting
5. 3 - electrical switches, white flush mounting
7. 4 - in flex line switches with neons
9. 2 - mains transformers with 6V 1A secondaries
10. 2 - mains transformers with 12V 1A secondaries
11. 1 - extension speaker cabinet for 6 1/2" speaker
12. 1 - glass reed switches
17. 2 - ultrasonic transmitters and 2 receivers with circuit
19. 2 - light dependent resistors
25. 4 - wafer switches - 6p 2 way, 4p 3 way, 2p 6 way, 2p 5 way, 1p 12 way small one hold fitting and good length 1/2 spindle your choice
28. 1 - 6 digit counter mains voltage
30. 2 - Nicad battery chargers
31. 1 - key switch with key
33. 2 - aerosol cans of 101 Dry Lubricant
34. 96 - 1 metre lengths colour-coded connecting wire
39. 1 - long and medium wave tuner kit
41. 8 - rocker switch 10 amp mains SPST
45. 1 - 24 hour time switch mains operated (s.h.)
49. 10 - neon valves - make good night lights
50. 2 - 12V DC or 24V AC, 3 CO relays
51. 1 - 12V 2 CO miniature relay very sensitive
52. 1 - 12V 4 CO miniature relay
54. 10 - rows of 32 gold plated IC sockets (total 320 sockets)
55. 1 - locking mechanism with 2 keys
56. 1 - miniature unselector with circuit for electric jigsaw puzzle
60. 5 - ferrite rods 4" x 5/16" diameter aereals
61. 4 - ferrite slab aereals with L & M wave coils
63. 1 - Mullard thyristor trigger module
66. 1 - magnetic brake - stops rotation instantly
67. 1 - low pressure 3 level switch can be mouth operated
69. 2 - 25 watt pots 8 ohm
70. 2 - 25 watt pots 1000 ohm
71. 4 - wire wound pots - 18, 33, 50 and 100 ohm your choice
77. 1 - time reminder adjustable 1-60 mins clockwork
85. 1 - mains shaded pole motor 1/2" stack - 1/2 shaft
89. 1 - mains motor with gear box 1 rev per 24 hours
91. 2 - mains motors with gear box 16 rpm
96. 1 - thermostat for fridge
98. 1 - motorised stud switch (s.h.)
101. 1 - 2 1/2 hours delay switch
103. 1 - mains power supply unit - 6V DC
104. 1 - mains power supply unit - 4.5V DC
107. 1 - 5" speaker size radio cabinet with handle
112. 1 - heating pad 200 watts mains
114. 1 - 1W amplifier Mullard 1172
115. 1 - wall mounting thermostat 24V
118. 1 - teak effect extension 5" speaker cabinet
120. 2 - p.c. boards with 2 amp full wave and 17 other reacs
121. 4 - push push switches for table lamps etc.
122. 10 - mtrs twin screened flex white p.v.c. outer
124. 25 - clear plastic lenses 1 1/2" diameter
127. 4 - pilot bulb lamp metal clip on type
128. 10 - very fine drills for pcbs etc.
129. 4 - extra thin screw drivers for instruments
132. 2 - plastic boxes with windows, ideal for interrupted beam switch
134. 10 - model aircraft motor - require no on/off switch, just spin to start
137. 1 - 6 1/2" x 4 ohm 10 watt speaker
142. 10 - 4 BA spanners 1 end open, other end closed
145. 2 - 4 reed relay kits 3V coil normally open or c/o if magnets added
146. 20 - pilot bulbs 6.5V 3A Philips
154. 1 - 12V drip proof relay - ideal for car jobs
155. 3 - vaicap push button tuners with knobs
169. 4 - short wave air spaced trimmers 2.30f
172. 10 - 12V 6W bulbs Philips m.s.s.
178. 3 - oblong amber indicators with hiliplugs 12V
180. 6 - round amber indicators with neons 240V
181. 100 - p.v.c. grommets 1/2" hole size
182. 1 - short wave tuning condenser 50 pf with 1/2" spindle
184. 1 - three gang tuning condenser each section 500 pf with trimmers and good length 1/2" spindle
188. 1 - plastic box sloping metal front, 16 x 95mm average depth 45mm
193. 6 - 5 amp 3 pin flush sockets brown
195. 5 - B.C. lampholders brown bakelite threaded entry
196. 1 - in flex simmerstat for electric blanket soldering iron etc.
197. 2 - thermostats, spindle setting - adjustable range for ovens etc.
199. 1 - mains operated solenoid with plunger 1" travel
200. 1 - 10 digit switch pad for telephones etc.
201. 8 - computer keyboard switches with knobs, pcb or vero mounting
206. 20 - mtrs 80 ohm, standard type co-ax off white
211. 1 - electric clock mains driven, always right time - not cased
216. 1 - stereo pre-amp Mullard EP9001
232. 2 - 12V solenoids, small with plunger
236. 1 - mains transformer 9V 1 amp secondary C core construction
241. 1 - car door speaker (very flat) 6 1/2" 15 ohm made for Radiomobile
241. 2 - speakers 6" x 4" 4 ohm 5 watt made for Radiomobile
243. 2 - speakers 6" x 4" 16 ohm 5 watt made for Radiomobile
244. 1 - mains motor with gear-box very small, toothed output 1 rpm
245. 4 - standard size pots, 1/2 meg with dp switch
249. 1 - 13A switched socket on double plate with fused spur
266. 2 - mains transformers 9V 1A secondary
267. 1 - mains transformers 15V 1A secondary p.c.b. mounting
291. 1 - ten turns 3 watt pot 1/2 spindle 100 ohm
296. 3 - car cigar lighter socket plugs
298. 2 - 15 amp round pin plugs brown bakelite
300. 1 - mains solenoid with plunger compact type ceramic magnets Mullard 1" x 3/8 x 5/16
301. 10 - ceramic magnets Mullard 1" x 3/8 x 5/16
303. 1 - 12 pole 3 way ceramic wave charge switch
305. 1 - tubular dynamic microphone with desk rest
308. 1 - T.V. turret tuner (black & white T.V.)
310. 2 - oven thermostats
313. 5 - sub miniature micro switches
314. 1 - 12" 8 watt min fluorescent tube white
315. 1 - 6" 4 watt min fluorescent tube white
316. 1 - round pin kettle plug with moulded on lead
453. 2 - 2 1/2 in. 80ohm loudspeakers
454. 2 - 2 1/2 in. 80hm loudspeakers

**FROZEN PIPES** Can be avoided by winding our heating cable around them, 15 mtrs connected to mains cost only about 10p per week to run. Hundreds of other uses as it is waterproof and very flexible. Resistance 60ohms/metre. Price 28p/metre or 15m for £3.95.

## CAR STARTER/CHARGER KIT

Flat Battery! Don't worry you will start your car in a few minutes with this unit - 250 watt transformer 20 amp rectifiers, fuse and all parts with data £17.50 post £2.



Ex-Electricity Board Guaranteed 12 months.

## VENNER TIME SWITCH

Mains operated with 20 amp switch, one on and one off per 24 hrs. repeats daily automatically correcting for the lengthening or shortening day. An expensive time switch but you can have it for only £2.95 without case, metal case - £2.95, adaptor kit to convert this into a normal 24hr. time switch but with the added advantage of up to 12 on/off per 24hrs. This makes an ideal controller for the immersion heater. Price of adaptor kit is £2.30.

## SOUND TO LIGHT UNIT

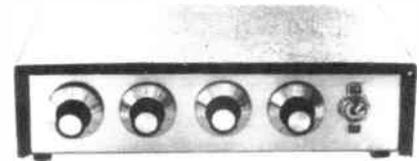

Complete kit of parts of a three channel sound to light unit controlling over 2000 watts of lighting. Use this at home if you wish but it is plenty rugged enough for disco work. The unit is housed in an attractive two tone metal case and has controls for each channel, and a master on/off. The audio input and output are by 1/2" sockets and three panel mounting fuse holders provide thyristor protection. A four pin plug and socket facilitate ease of connecting lamps. Special price is £14.95 in kit form.

## 12 volt MOTOR BY SMITHS

Made for use in cars, etc. these are very powerful and easily reversible. Size 3 1/2" long by 3" dia. They have a good length of 1/2" spindle - 1/10 hp £5.75, 1/6 hp £7.50.

## 25A ELECTRICAL PROGRAMMER

Learn in your sleep. Have radio playing and kettle boiling as you wake - switch on lights to ward off intruders - have a warm house to come home to. You can do all these and more. By a famous maker with 25 amp on/off switch. A beautiful unit at £2.50.

## THIS MONTH'S SNIP

**BENCH ISOLATION TRANSFORMER. Toroidal wound 400 watt but very compact. Has a separate 10V winding which can be added or subtracted to give fine voltage control. Normally £40, our price £10 plus £2 post, ref 10P9.**

## TANGENTIAL BLOWER HEATERS

We can supply 1-2KW - quite definitely the smallest tangential blow heater we have ever had, measuring approx. 6 x 6 x 4. This could be just the thing for a small bedroom or to fit under desk or table if you suffer from cold legs. In addition to normal heating functions it can be used as a simple enclosure for a pop up heater (much safer than a blow lamp) possibly even a paint stripper, hair dryer or hand dryer. Price is £5, plus £1 post, ref 5P23.

2-5KW - width approx. 8" (plus motor), elements made up of two 1-2kw sections, so with switch supplied you can have 2kw, 1kw or cold blow. Over heat cut-out eliminates fire risk. Should fan stop or air flow be impeded. Fan blades are metal. Price £5 plus £1.50 post, ref 5P22.

3KW - width approx. 13" plus motor, element made up of 1kw and 2kw section, supplied with 4 section rocker switch, allowing 3kw, 2kw, 1kw and cold blow. Price £8.95 plus £2.00 post.

2KW D.I.Y. SPECIAL - if you want a really cheap tangential heater, this is your opportunity, made for 115v mains, to use it on 230v. Simply join elements in series, needs only simple on/off switch, as you will only have one heat level 2kw and no cold blow. Price £2 plus £1 post, ref 2P68.

VERY LOW RUNNING COST - only a 300w element. So would cost only approx. 1p per hour to run. Should be enough for an airing cupboard or a hot box for seed germination. Might even be enough to keep a damp corner dry. Normal construction approx. 4 1/2" plus motor wide. Price £5 plus £1 post, ref 5P78.

500W-115V TRANSFORMER to isolate you or yours from mains to earth shock dangers. We are able to offer these transformers at less than the price of an auto transformer. Our price for the 500w mains to 115v isolation transformer is £10 plus £5 post, ref 10P6.

**RESIN CURED FILLER/BUILDER/STICKER** made by the famous Hoffs company, suitable for repairs, not only to car bodies but also to sinks and wash basins, water tanks, drain pipes and gutters, tiles, roofs, filling holes in walls and concrete, repairing cracks in gates, window frames, etc. etc. It is weather resistant and adheres well to metals, wood, concrete and some plastics. Special bargain price 2 large tubes for £1, ref 8D464.

**STEPPER MOTOR** By American Philips corporation. Step angle 7.5° Coil resistance 27 ohms. Operating volts 10-14. Size approx. 2 1/2" dia by 1 1/2" deep on a square mounting plate. This is in fact two bi-directional motors with P.M. rotors. Applying correct pulse causes a 7.5° step angle of spindle. Number of steps through which it rotates and the speed at which it rotates is determined by the applied impulses. Properly used this provides an ideal method of speed and position control. Brand new and unused price £5, ref 5P81.

**BIG GLASS FIBRE SHEETS**. Virtually unbreakable, size 4' x 3' approx. Flat, approx. 1/16" thick. Intended for job's but ideal for roof repairs, car ports, greenhouses etc. £2 each, Minimum quantity we can despatch is 10. Carriage cost £6.50 per 10. £8.50 for 15.

**IONISER KIT**  
Refresh your home, office, shop, work room, etc. with a negative ION generator. Makes you feel better and work harder - a complete mains operated kit, case included £11.95 plus £2.00 post.

**TELEPHONE BITS**  
Master socket (has surge arrester - ringing condenser etc) and takes B.T. plug £3.95  
Extension socket £2.95  
Dual adaptors (2 from one socket) £3.95  
Cord terminating with B.T. plug 3 metres £2.95  
Kit for converting old entry terminal box to new B.T. master socket, complete with 4 core cable, cable clips and 2 BT extension sockets £11.50  
100 mtrs 4 core telephone cable £8.50

**MINI MONO AMP** on p.c.b. size 4" x 2" (app.)  
Fitted volume control and a hole for a tone control should you require it. The amplifier has three transistors and we estimate the output to be 3W rms. More technical data will be included with the amp. Brand new, perfect condition, offered at the very low price of £1.15 each, or 13 for £12.00.

## £2 POUNDERS\*

- 2P2 - Wall mounting thermostat, high precision with mercury switch and thermometer
- 2P3 - Variable and reversible 8-12v psu for model control
- 2P4 - 24 volt psu with separate channels for stereo made for Mullard UNILEX
- 2P6 - 100W mains to 115V auto-transformer with voltage tappings
- 2P8 - Mains motor with gear box and variable speed selector. Series wound so suitable for further speed control
- 2P9 - Time and set switch. Boxed, glass fronted and with knobs. Controls up to 15 amps. Ideal to program electric heaters
- 2P10 - 12 volt 5 amp mains transformer
- 2P12 - Disk or Tape precision motor - has balanced rotor and is reversible 230V mains operated 1500 rpm
- 2P14 - Mug Stop kit - when thrown emits piercing squawk
- 2P15 - Interrupted Beam kit for burglar alarms, counters, etc
- 2P17 - 2 rev pr minute mains driven motor, ideal to operate mirror ball
- 2P18 - Liquid/gas shut off valve mains solenoid operated
- 2P19 - Disco switch-motor drives 6 or more 10 amp change over micro switches supplied ready for mains operation
- 2P20 - 20 metres extension lead, 2 core - ideal most Black and Decker garden tools etc.
- 2P21 - 10 watt amplifier, Mullard model reference 1173
- 2P22 - Motor driven switch 20 secs on or off after push
- 2P26 - Counter resettable mains operated 3 digit
- 2P27 - Goodmans Speaker 6 inch round Bohm 12 watt
- 2P28 - Drill Pump - always useful couples to any make portable drill
- 2P31 - 4 metres 98 way interconnecting wire easy to strip
- 2P32 - Hot Wire amp meter - 4 1/2 round surface mounting 0-10A - old but working and definitely a bit of history
- 2P34 - Solenoid Air Valve mains operated
- 2P38 - 200 R.P.M. Gearing Mains Motor 1" stack quite powerful, definitely large enough to drive a rotating aerial or a tumbler for polishing stones, etc.
- 2P43 - Small type blower or extractor fan, motor inset so very compact, 230V
- 2P46 - Our famous drill control kit complete and with prepared case.
- 2P49 - Fire Alarm break glass switch in heavy cast case
- 2P51 - Stereo amplifier, 3w per channel
- 2P55 - Mains motor, extra powerful has 1 1/2" stack and good length of spindle
- 2P62 - 1 par Goodmans 15 ohm speakers for Uniflex
- 2P66 - 1 five bladed fan 6 1/2" with mains motor
- 2P69 - 1 2kw tangential heater 115v easily convertible for 230V
- 2P81 - 1 12v-0-12v 2 amp mains transformer
- 2P88 - 1 15v-0-15v 2 amp mains transformer
- 2P89 - 1 250v-0-250v 60 mA & 86.3v 5A mains transformer + 50p post
- 2P70 - 1 E.M.I. tape motor two speed and reversible
- 2P72 - 1 115v Muffin fan 4" x 4" approx. (s.h.)
- 2P75 - 1 2 hour timer, plugs into 13A socket
- 2P82 - 9v-0-9v 2 amp mains transformer
- 2P84 - Modern board with press keys for telephone redialler
- 2P85 - 20P=0-20V 1/2 A Mains transformer
- 2P88 - Sangano 24 hr time switch 20 amp (s.h.)
- 2P89 - 120 min. time switch with knob
- 2P90 - 90 min. time switch with edgecase engraved controller
- 2P94 - Telephone handset for EE home telephone circuit
- 2P95 - 13A socket on satin chrome plate
- 2P97 - mains transformer 24V 2A upright mounting
- 2P98 - 20m 4 core telephone cable, white outer
- 2P99 - 500 hardened pin type staples for telephone cable
- 2P101 - 15V mains transformer 4A upright mounting
- 2P105 - capillary type thermostat for air temperature with c/o switch
- 2P108 - mains motor with gear box giving 110rpm
- 2P109 - 5" wide black adhesive pvc tape 33m, add £1 post if not collecting

## OVER 400 GIFTS YOU CAN CHOOSE FROM

There is a total of over 400 packs in our Baker's dozen range and you become entitled to a free gift with each dozen pounds you spend on these packs.

A classified list of these packs and our latest "News Letter" will be enclosed with your goods, and you will automatically receive our next news letters.



## £5 POUNDERS\*

- 5P1 12 volt submersible pump complete with a tap and switch, an ideal caravan unit.
- 5P2 Sound to light kit complete in case suitable for up to 750 watts.
- 5P3 Silent sentinel ultra sonic transmitter and receive kit, complete.
- 5P6 12V alarm bell with heavy 6" gong, suitable for outside if protected from direct rainfall. Ex.GPO but in perfect order.
- 5P12 Equipment cooling fan - mini spiral type mains operated.
- 5P13 Ping pong ball blower - or for any job that requires a powerful stream of air - ex computer. Collect or order £2.
- 5P15 - Unselector 4 pole, 25 way 50 volt coil
- 5P18 - motor driven water pump as fitted to many washing machines
- 5P20 - 2 kits, matchbox size, surveillance transmitter and FM receiver
- 5P23 - miniature (appr. 2 1/2" wide) tangential blow heater, 1-2kw
- 5P24 - 1/2 hp motor, ex computer, 230V, mains operation 1450rpm. If not collect add £3 post
- 5P25 - special effects lighting switch. Up to 6 channels of lamps can be on or off for varying time periods
- 5P27 - cartridge player 12V, has high quality stereo amplifier
- 5P28 - gear pump, mains motor driven with inlet and outlet pipe connectors
- 5P32 - large mains operated push or pull solenoid. Heavy so add £1.50 post
- 5P34 - 24V 5A toroidal mains transformer
- 5P35 - modern board from telephone auto dialler, complete with keypad and all fcs
- 5P37 - 24 hour time switch, 2 on/off's and clockwork reserve, ex Elec. Board loading up to 50A. Add £1 post
- 5P41 - 5" extractor fan, very quiet runner (s.h.), grid 12 mths.
- 5P48 - telephone extension bell in black case, ex-GPO
- 5P51 - 200W auto transformer 230V to 115V toroidal
- 5P52 - mains transformer 26V 10A upright mounting, add £2 post
- 5P54 - mains motor with gear box, final speed 5rpm
- 5P58 - Amstrad stereo tuner FM and LM and S. AM
- 5P80 - OC Muffin type fan 18 to 27V, only 3W
- 5P61 - drill pump mounted on frame, coupled to mains motor
- 5P62 - 2 1/2 kw tangential blow heater, add £1.50 post if not collecting
- 5P73C high pressure mains operated gas or water valve with tube connection suitable soldering
- 5P74 6rpm 60W mains motor and gearbox with instant stop
- 5P79 30rpm 80 watt mains driven motor with gearbox
- 5P82 1 25rpm mains 60w motor with gearbox
- 5P84 1 delay time switch, adjust 0-20 seconds
- 7P1 1 instant heat solder gun - mains with renewable tip and job light
- 10P10 1 9" extractor fan 115V so supplied with adaptor

**LIGHT CHASER KIT** motor driven switch bank with connection diagram, used in connection with 4 sets of xmas lights makes a very eye catching display for home, shop or disco, only £5 ref 5P56.

## J & N BULL ELECTRICAL

Dept A.R., 250 PORTLAND ROAD, HOVE BRIGHTON, SUSSEX BN3 5QL

MAIL ORDER TERMS: Cash, P.O. or cheque with order. Orders under £20 add £1 service charge. Monthly account orders accepted from schools and public companies. Access & B/card orders accepted. Brighton 0273 734648. Bulk orders: write for quote

# NEVADA 934 MHz EQUIPMENT

Have you tried this exciting new band yet? Available for private or business use, by simply purchasing a £10 licence from any post office. Range is from 10 - 250 miles according to your location and WX conditions

## DELTA 1 934 Mhz TRANSCIVER



£365

THE DELTA 1 IS A STATE OF THE ART TRANSCIVER AND NOW IN USE BY OVER 70% OF 934 MHz ENTHUSIASTS!

- FEATURES:
- Scan facility
  - 16 channel memory scan.
  - Sensitive RX

### ACCESSORIES

P7M-E Mag. Mount 7dB Antenna	£49.72
P714R-E GTR Mount 7dB Antenna	£49.72
PA7-E Base Colinear 7dB Antenna	£67.75
PA15 Base Colinear 11dB Antenna	£79
TC12L 12 Element Beam 18dB Antenna	£39
HRA 934L in line Pre-amp	£139.95
HRA 900 Masthead Pre-amp	£139.95

PLUS MANY MORE ITEMS  
Send £1 for our full 934 Mhz catalogue.

Packed full of CB, 934MHz & Amateur Equipment—plus useful info. **Only £2.00**  
Includes a £2 voucher

# NEVADA AMATEUR PRODUCTS

## HIGH POWER VARIABLE CAPACITORS



IDEAL FOR ATU'S OR AMPLIFIERS UP TO 3KW  
TC 500 26-500 pF £28 (£2 p.p.)  
TC 250 13-250 pF £19.95 (£1 p.p.)

## HIGH POWER "ROLLER COASTER" VARIABLE INDUCTOR

NEW

£24 (£1 p.p.)

Suitable for 1 kW ATU  
Frequency 1.8 - 30MHz  
IND 26.5 uH  
SIZE 5 1/2 x 10 1/2 x 14 1/2 cm

### SPECIAL OFFER

TC250 TC500, & ROLLER COASTER, COMPLETE FOR

£59 (£2 p.p.)

## NEW LOW PRICE

### 2 MTR HAND HELD CT1600

Through bulk buying we can now offer this superbly sensitive handheld at an all time low price. Unit covers 2 Mtr Ham Band Plus 142-149 Mhz (For Export)

- Repeater Shift
- Hi-Low power 1/2 - 1 1/2 Watts
- Thumbwheel Freq. Selector

Each set supplied C/W re-chargable battery pack and free mains charger unit

£169

### VHF MOBILE AMPLIFIERS

MOD. B110 144 MHz 110 Watt FM Plus Low Noise Pre-amplifier Switchable	£169
MOD. B42 144 MHz 40 Watt FM Mobile AMP	£64.66

SEE OUR HAM CATALOGUE FOR FULL RANGE

# R/F AMPLIFIERS

All amplifiers except broadband (2-30 MHz) models are tuned for 29.6 MHz centre freq. Should you require a lower freq. ie. 28.5 MHz please state when ordering. Export models available for 26-30 MHz.

### C.T.E. MOD 767

76 Watts FM (150W P.E.P.)  
INPUT: 05-10 Watts  
SWITCHABLE: Class AB Class C  
SUPPLY: 13.8 Volt  
REMOTE CONTROL FACILITY

£49.90

### MOBILE AMPLIFIERS

CTE MOD 737 50W FM (80W P.E.P.)	£44.76
CTE MOD 767 80W FM (100W P.E.P.)	£49.90
CTE MOD 757 150W FM (300W P.E.P.) (3-30MHz)	£116.87
ABOVE MODELS HAVE REMOTE CONTROL FACILITY PLUS CLASS AB & CLASS C SWITCHING (NOT MOD 737)	
ZETAGI B35 25W FM (26-30MHz)	£23.72
ZETAGI B150 70W FM (150W P.E.P.)	£49.96
ZETAGI B300 200W FM (400W P.E.P.) 2-30 Mhz	£136
NEVADA TC35 DX 25W FM (W/LOW PASS FILTER)	£23.99

### MAINS AMPLIFIER

ZETAGI B132 SOLID STATE (240W P.E.P.) 2-30 Mhz £119

# SCANNING RECEIVERS

## C.T.E. DISCONE WIDEBAND ANTENNA

RECEIVE 70-700 MHz  
TRANSMIT 70-500MHz  
MAX POWER 500W  
GAIN 35dB

WIDEBAND DISCONE RECEIVING ANTENNA (3 Element) 70-500MHz

£24.95

## HANDHELD SCANNING RX BEARCAT 100XL

A super sensitive low cost handheld which covers:  
66-88MHz, 118-174MHz, 405-512MHz  
Includes Public Service, Aircraft, Marine, etc.

- ★ 16 Channels memory scan
- ★ Priority keyboard lock
- ★ Lighted display

£229

## BASE SCANNING RX BEARCAT 175XL

For the enthusiast a sensitive base receiver which covers:  
66-88MHz, 118-174MHz, 405-512MHz

Same specifications as the popular 100XL handheld model

£209

# TEST EQUIPMENT

## ZETAGI DL150 RF DUMMY LOAD AND POWER METER

A very accurate unit for the service dept. or discerning enthusiast  
FREQ.: 0.5MHz-500MHz  
POWER: 150 Watt Max in 3 ranges 0-3, 0-15, 0-150W

£85.19

## ZETAGI 500 SWR AND POWER METER

For the enthusiast who wants the very best! A twin meter unit with push button control for either 75 OHM or 50 OHM cable  
FREQ.: 3-200MHz  
POWER: Up to 2kW

£41.40

## FD 1350 130MHz FREQUENCY COUNTER

FREQ.: 10Hz-135GHz  
SENSITIVITY: 43mV at 1GHz  
DISPLAY: 8 Digit  
SUPPLY: 9-12 Volt DC

£139.53

# NEVADA

## HIGH QUALITY BRITISH MADE 29MHz FM PRODUCTS

### NEVADA TC35 DX

R.F. POWER AMP. WITH HARMONIC FILTER

INPUT: 1-4 Watts  
OUTPUT: 25-30 Watts  
SUPPLY: 13.8V DC  
FREQ.: 26-30 Mhz

Can be centred on 29.6 MHz or 28.5 MHz (state which) A new top quality amp, which now features harmonic filter to reduce harmonic O/P

### NEVADA TC27 RX RECEIVER PREAMP FOR 26-30MHz

A superior low noise pre-amplifier for 29MHz FM operation  
Variable gain -6dB's to +18dB's suitable for use with transceivers up to 25 Watts output

£23.99

# TELECOMMS

HOTLINE (24 HOURS)  
**0705 662145**

189 LONDON ROAD, PORTSMOUTH, HANTS, PO2 9AE, TELEX 869107 TELCOM G

USE YOUR CREDIT CARD (AMERICAN EXPRESS, ACCESS OR VISA) FOR IMMEDIATE DESPATCH.

TRADE ENQUIRIES WELCOME.