

Montreal Section IRE
Communications Symposium
Program of Technical Papers
Page 43



See cover story on page 5.

electronics and communications



an age publication
OCTOBER 1960

- The design of broad band radio relay equipment for use in a long haul military system page 57

MR F W PREZIOSI
8 EASTGATE CRES
SCARBOROUGH ONT

1092 SENSITROL[®]

the versatile relay

LOOK AT THIS RANGE OF APPLICATIONS FOR WESTON'S FULLY-ADJUSTABLE, ULTRA-SENSITIVE RELAY. SENSITROL CAN SIMPLIFY YOUR ALARM OR CONTROL PROBLEM!

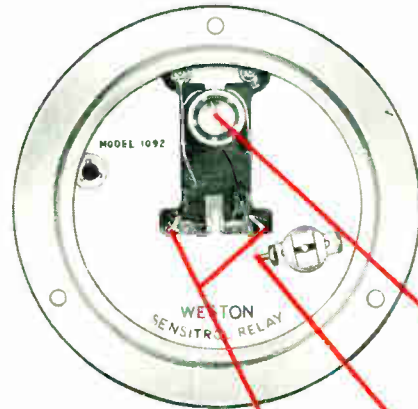

In breadboard circuits, the 1092 makes it unnecessary to pinpoint electrical operating values through elaborate calculations or measurements. A single, moveable contact adjuster **1** provides variable and accurately repeatable settings. In production equipment, the 1092 eliminates the need for stocking a variety of relays.

Model 1092's contain built-in reset mechanisms **2** and chatter proof locking magnetic contacts **3**. They can be set to close at any value of D-C from 5 to 50 microamps, or a comparable millivolt span of 10 to 100 . . . and will handle 100 milliamps at 120 volts A-C or D-C.

For full information, write to Daystrom Limited, 1480 Dundas Highway E., Cooksville, Ont., or 5430 Ferrier St., Montreal, Que., a subsidiary of Daystrom Incorporated, or any office of Northern Electric Co. Ltd.

5929

WESTON

Relays

WORLD LEADER IN MEASUREMENT AND CONTROL

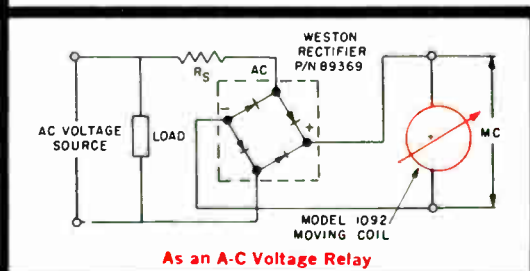
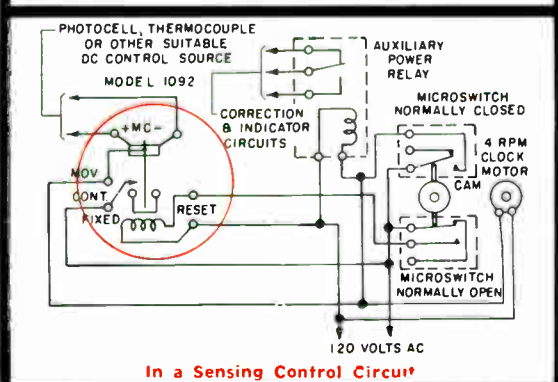
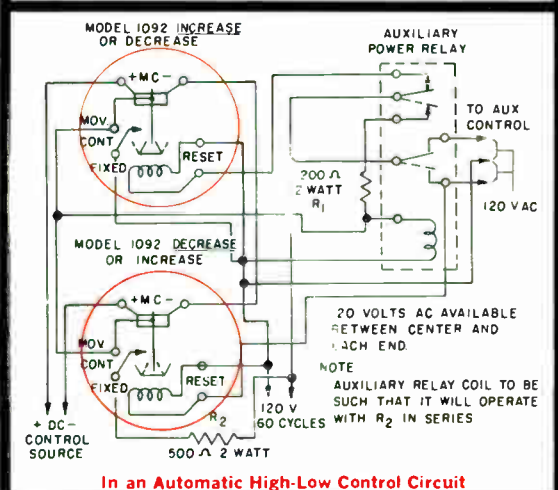
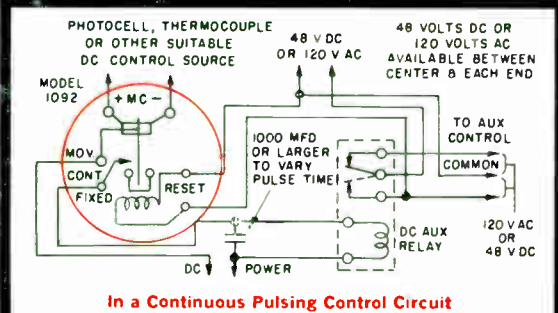
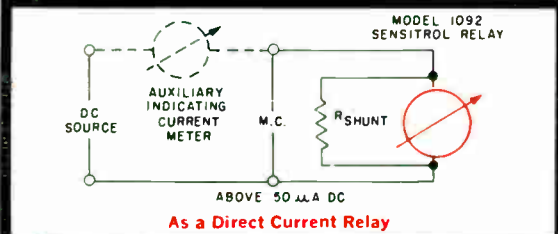
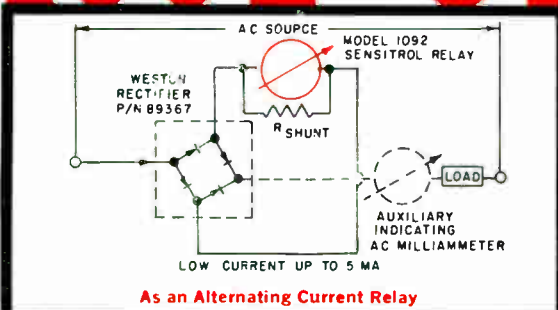

For complete details check No. 16 on handy card, page 67

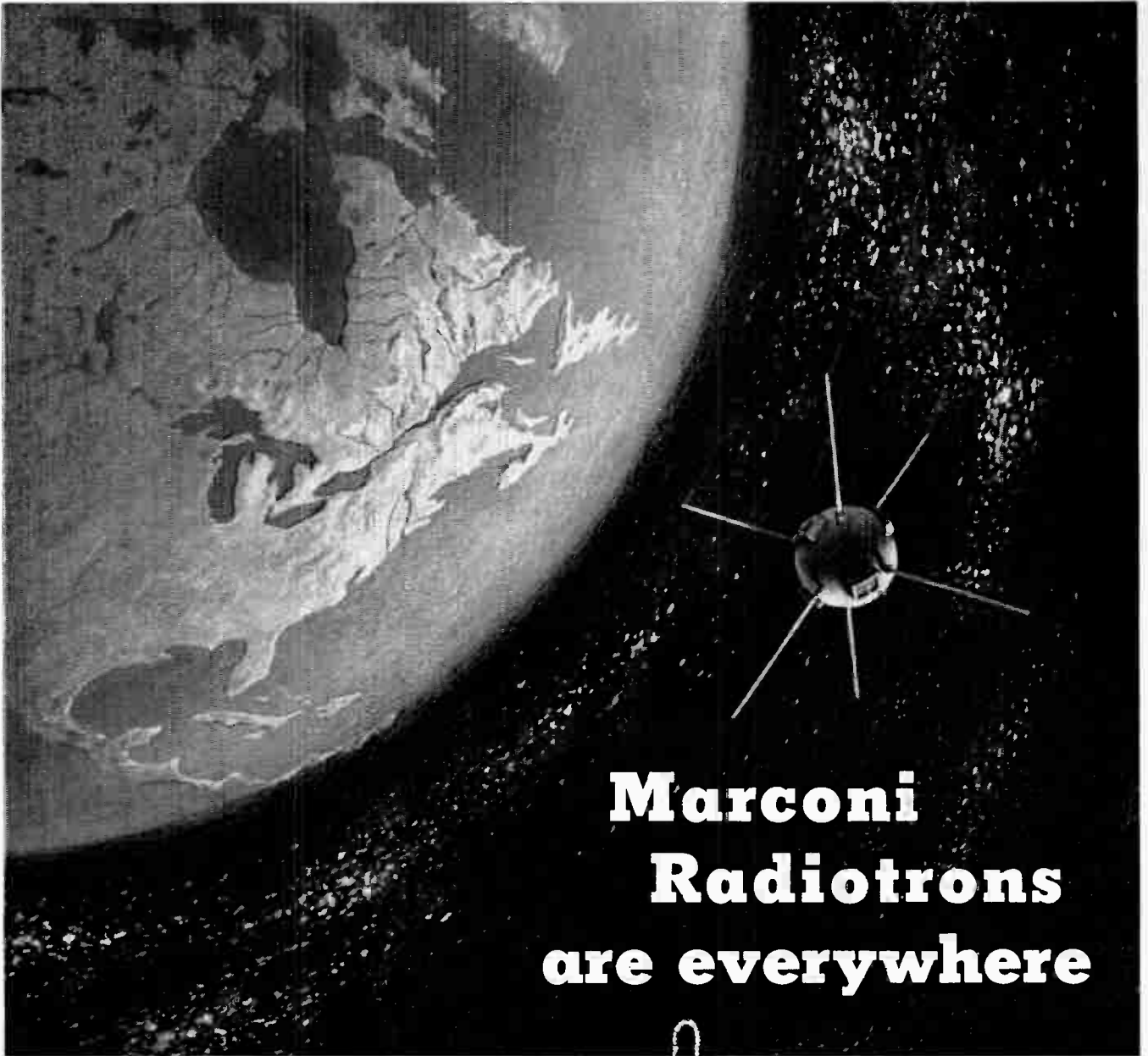

Marconi Radiotrons are everywhere

The complicated electronic equipment used in today's far reaching scientific experiments requires dependable, precision-made components which must function under the most critical of operating conditions. Marconi radiotrons are used in many of these applications because they meet—and surpass—these quality requirements. And this same quality is built into *all* Marconi tubes for *all* types of installations . . . for radio and television stations . . . for home receivers. Marconi tubes assure superior performance—greater power—longer life. Be sure to recommend Marconi—greatest name in radio and television.



ELECTRONIC TUBE AND COMPONENTS DIVISION

CANADIAN **Marconi** COMPANY

830 BAYVIEW AVENUE, TORONTO, ONTARIO

Branches: Vancouver • Winnipeg • Montreal • Halifax

For complete details check No. 11 on handy card, page 67

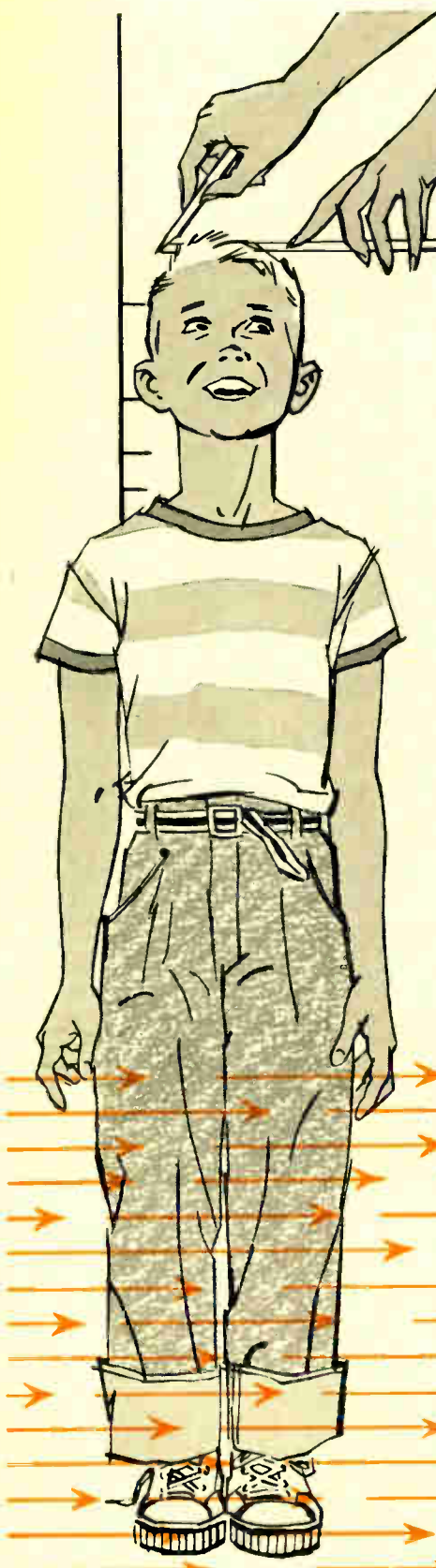

look ahead

Consider "Growth Potential"

Only Standard Electronics TV transmitting equipment can grow from 500 to over 50,000 watts.

As your market grows, so can your station. "Growth Potential" lets you boost power economically by adding Standard Electronics amplifiers to your present equipment, regardless of make. Amplifiers of 10 - 25 and 50 KW output may be used with any basic 500 watt driver.

These amplifiers are self-contained units; easily adaptable to any station layout.

In emergencies, the built-in Patchover protection keeps you on the air. Impedance matched units permit connecting the driver to the antenna in seconds, in the event of amplifier trouble. A spare driver can provide full power in reserve, eliminating the need for an entire transmitter line-up for standby.

Operations and maintenance are planned-for. Large-faced meters, controls mounted in front, full length glass doors, and Interlock and overload systems make daily work easier.

Engineered auxiliary equipment includes: antenna diplexer, harmonic filter, linearity correction amplifier, RF dummy load wattmeter, vestigial side-band filter, visual demodulator, wave-form and picture monitoring console.

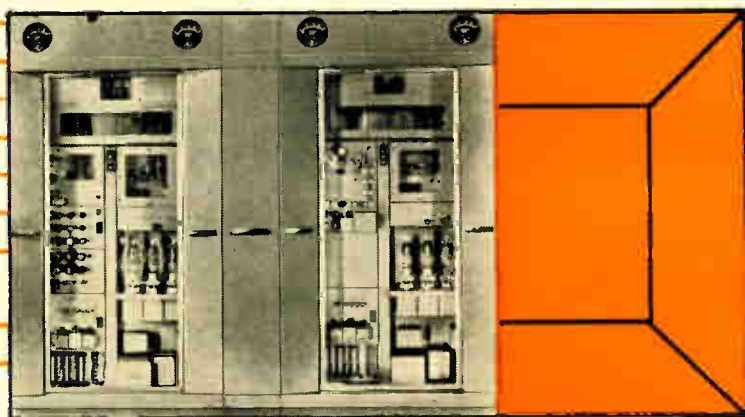

Standard Electronics TV transmitting equipment is distributed in
Canada by

Northern Electric
COMPANY LIMITED

SERVES YOU BEST



an age publication

Thomas W. Lazenby, editor
R. C. Poulter, P.Eng., associate editor
D. K. Trowell, editorial assistant
William Bowers, art editor
Jerry Davey, photo editor

H. E. Dallyn, sales manager
Derek Reynolds, advertising manager
Nevill A. Campling, production manager
Brian Mottershead, circulation department

L. R. Kingsland, president
K. E. Gould, executive vice-president
Paul A. Irwin, secretary-treasurer

Published by
AGE PUBLICATIONS LIMITED
450 Alliance Avenue, Toronto 9, Ontario
Telephone RO. 2-7225

publishers of
Wine/Beer/Spirits
Restaurants and Institutions
Automatic Heating/Plumbing/Air Conditioning
Food Service Equipment Supplier

MONTREAL
J. R. "Tom" Graham
308 Merton Avenue,
St. Lambert, Que.
Telephone: OR. 1-1532

WEST COAST
Dillenbeck-Galavan, Inc.
226 S. Alexandria Avenue,
Los Angeles 4, California

U.K. and EUROPEAN REPRESENTATIVE
Norman F. Keenan
Regency House,
1 Warwick Street,
London, W.1, England

Indexed in the Canadian Business and
Technical Index of the Toronto Public Library.

Subscription Rates: Canada, British Possessions
and United States: 1 year — \$5.00; 2 years — \$9.00;
3 years — \$12.00. Foreign 1 year — \$10.00.

Member Canadian Circulations Audit Board

Authorized as second class mail
by Post Office Dept., Ottawa



PRINTED IN CANADA
60

electronics and communications

Canada's pioneer journal in the field of
electronics and communications engineering

contents

OCTOBER, 1960 Vol. 8, No. 10

- 44 Technical Program — Montreal Section IRE Communications Symposium
- 49 Time table for technical papers
- 51 Exhibitors — personnel — products . . . at the IRE Communications Symposium
- 53 The use of transistors for power conversion
Part I Basic circuits and laminations
by John E. Pinnell, B.Sc. (Hon.) Sen. M.I.R.E.
- 57 The design of broad band radio relay equipment for use in a long haul military system
by H. A. Hamilton, Ph.D.

departments

- 14 Industry Personnel
- 23 EIA Report
- 24 The Industry's Business
- 26 CRTPB Newsletter
- 64 Product Panorama
- 70 Close-Up
- 72 Scatter Matter
- 77 Briefing the Industry
- 84 Editorial

COVER STORY

How much radiation man will meet in space will be measured by new cigar-size detectors developed by Hughes Aircraft Company nuclear physicists for the U.S. Air Force. In experiments by the USAF school of aviation medicine, the detectors will be carried in high-altitude balloons and Atlas missile space flights. Our cover illustration shows a company scientist examining the detector's thin silicon tip which will "count" radiation penetrating simulated space-crew cabins.

Introducing—

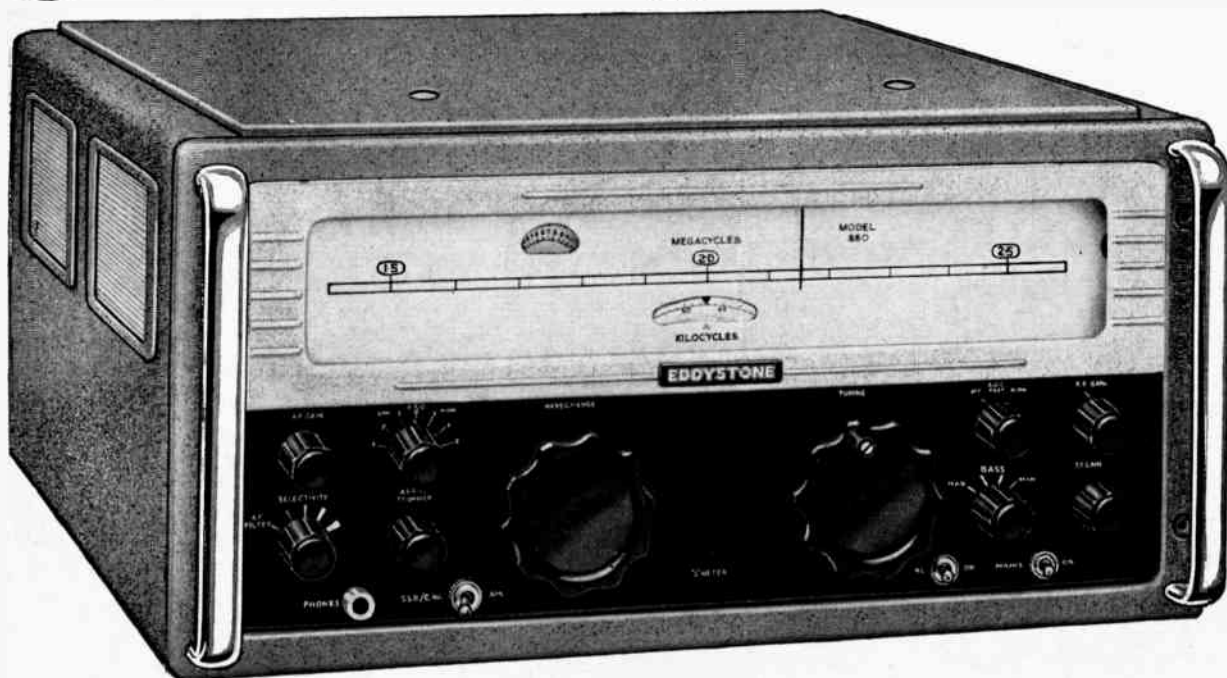

— the **EDDYSTONE "880"** High Stability Communications Receiver



The Eddystone 880 Very High Stability Communication Receiver, now in full production, attains the highest professional standards. It has been designed expressly for use in professional communication systems and, with the many refinements provided, is widely versatile in its applications.

An ultra-stable double conversion super-heterodyne technique is employed for A.M., C.W. and S.S.B. reception. Long term drift is less than 50 CPS; re-setting accuracy within 1 KC; noise factor 5dB; image rejection greater than 70 dB. This is a brand-new receiver which combines the performance of crystal control with the convenience of continuous tuning.

Particular care has been taken to reduce spurious responses to an absolute minimum and the figures for such characteristics as cross-modulation, blocking, inter-modulation and image ratio are extremely good. The electrical performance is well maintained in every way and conforms to accepted professional standards.

Ideal for military, aviation and for critical operational service conditions.

CONWAY ELECTRONIC ENTERPRISES

REGISTERED

1514 EGLINTON AVE. W., TORONTO 10, ONT.

RU. 3-6576 — RU. 3-6676





For complete details check No. 14 on handy card, page 67

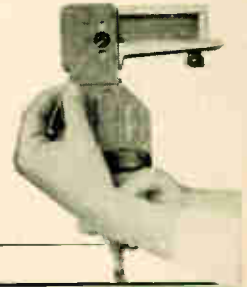

BURNDY READY REFERENCE CONNECTION SELECTOR CHART

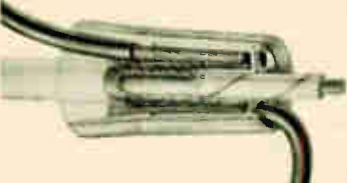
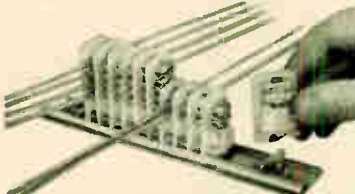

Photographs of products are not to scale.

	DEFINITIONS	TYPES	FEATURES
<p>HYFEN[®]</p> 	<p>Plug and receptacle connectors with crimp-type, snap-locked contacts.</p>	<p>Miniature rectangular, rack and panel, general purpose, modular, plug-in relay base, printed circuit—pin and edge type, coaxial—miniature and standard, BANTAM, round.</p>	<p>Tool-installed crimped contacts are individually or gang connected and disconnected. Extremely versatile and reliable. Quality materials used for inserts and contacts which are normally gold plated. Modular concepts.</p>
<p>STAPIN[®]</p> 	<p>Solid shank, solid barrel taper pins for wire terminations in variety of receptacles.</p>	<p>Sealed, terminal blocks, modular frames and inserts, coaxial, console mount, bussed, stacking strips.</p>	<p>Rugged solid construction provides protection against repeated and rough handling. Tool-installed STAPIN quality-controlled by tooling.</p>
<p>UNIRING[®] • HYRING[®]</p> 	<p>Compression sheath connector for terminating and grounding shielded or coaxial cable.</p>	<p>one-piece UNIRING, two-piece HYRING, both in complete size ranges.</p>	<p>Tool-installed, eliminates possible heat damage to conductors, dielectric, and insulation. Both available preinsulated or uninsulated. Conforms to MS25311 and MS25312 (AER).</p>
<p>MODULOK[®] • CRABLOK[®]</p> 	<p>Quick-disconnect or permanently-connected terminal blocks.</p>	<p>2- or 4-tier MODULOK. 5- or 15-bay CRABLOK.</p>	<p>Extremely versatile modular design. Reliable electrical contact in both quick-disconnect or permanent connection position. Tool-installed crimp-type contact tips.</p>
<p>INSULUG[®] • HYLUG[®]</p> 	<p>Compression terminals, splices.</p>	<p>Round, fork, right angle, flag, high temperature insulated and uninsulated.</p>	<p>Hand, semi-automatic, and fully automatic tooling—with removable dies—provide up to 1000 quality-controlled connections per hour.</p>
<p>WIRING SPECIALTIES</p> 	<p>Cable hangers, pig-tail splices, strip terminals.</p>	<p>NYLOCLIP[®] BURCAP[®] FINGRIP[®]</p>	<p>Compression connections, tool controlled. NYLOCLIP strong, light, environmentally resistant.</p>

Catalogs available covering these and other product lines . . .

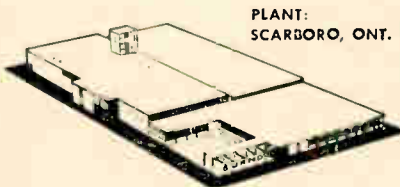

PLANT:
SCARBORO, ONT.

BURNDY

CANADA LTD. TORONTO, ONT.

HALIFAX • MONTREAL • TORONTO • WINNIPEG • REGINA • CALGARY • VANCOUVER
6016

For complete details check No. 9 on handy card, page 67



Northern's City

POPULATION 15,000



Great things happen where Northern Electric employees live. Great, because they're good citizens . . . they're socially minded . . . and they represent a tremendous purchasing power in their respective communities — a necessary ingredient in our modern economy.

The residents of the Northern Electric community design, manufacture, and install a large



proportion of Canada's telephone communication systems and equipment.

They also produce all types of electrical wires and cables for communication and power transmission, and distribute a complete line of electrical apparatus and supplies.

At Northern Electric, product research and development never stops and advances are continually being made.

Northern Electric

COMPANY LIMITED

SERVES YOU BEST

For complete details check No. 36 on handy card, page 67

6660-4R

A PARTIAL LISTING OF INDUSTRY'S

WIDEST LINE!

VOLTAGE REGULATOR SILICON DIODES

HERMETICALLY SEALED

1584 TYPES AVAILABLE

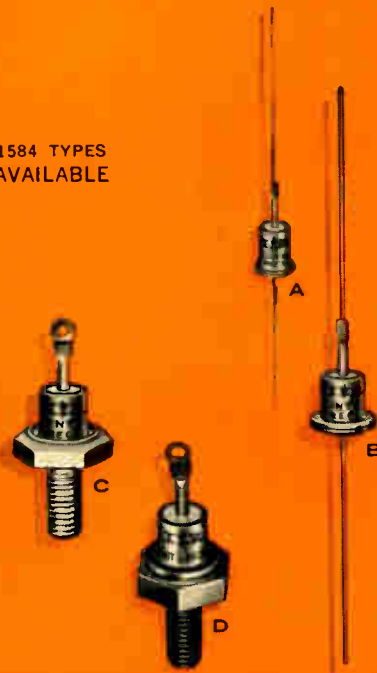

Write for this 6-page folder containing selection data on over 1584 Standard and Special Voltage Tolerance Zener Type. Request SR-260.

Ratings and Characteristics at 25°C

Nominal Zener Voltage and Typical Dynamic Impedance				Nominal Zener Voltage and Typical Dynamic Impedance			
Type Number	E_z (Volts)	@ I_z (MA)	Z_z (Ohms) @ I_z	Type Number	E_z (Volts)	@ I_z (MA)	Z_z (Ohms) @ I_z
A - 750 Mw Rated Basic Series (88 Closer Tolerance Types Also Available)				C - 3.5 Watt Rated Basic Series (88 Closer Tolerance Types Also Available)			
1N1507	3.9	35	14	1N1588	3.9	150	2.6
1N1508	4.7	30	12	1N1589	4.7	125	2.3
1N1509	5.6	26	5.2	1N1590	5.6	110	1.4
1N1510	6.8	22	1.5	1N1591	6.8	100	.58
1N1511	8.2	18	1.5	1N1592	8.2	80	.5
1N1512	10	15	1.8	1N1593	10	70	.7
1N1513	12	12	2.8	1N1594	12	50	1.4
1N1514	15	10	5	1N1595	15	40	3.4
1N1515	18	8	9	1N1596	18	35	6
1N1516	22	6	19	1N1597	22	30	9
1N1517	27	5	50	1N1598	27	25	13
B - 1 Watt Rated Basic Series (88 Closer Tolerance Types Also Available)				D - 10 Watt Rated Basic Series (88 Closer Tolerance Types Also Available)			
1N1518	3.9	50	9	1N1599	3.9	500	.84
1N1519	4.7	40	8.5	1N1600	4.7	400	.68
1N1520	5.6	35	5.5	1N1601	5.6	350	.3
1N1521	6.8	30	1.6	1N1602	6.8	300	.2
1N1522	8.2	25	1.1	1N1603	8.2	250	.25
1N1523	10	20	1.5	1N1604	10	200	.55
1N1524	12	15	2.4	1N1605	12	170	.95
1N1525	15	13	5.4	1N1606	15	140	1.5
1N1526	18	10	11	1N1607	18	110	2
1N1527	22	9	18	1N1608	22	90	3
1N1528	27	7	28	1N1609	27	70	4.5

SPECIFY THE LEADING LINE...

Choose from the most complete zener diode line in the industry, right "off-the-shelf" from our exclusive Canadian Representative, Douglas Randall, Canada, Ltd. Providing our Canadian friends and customers with a complete coast-to-coast service, Randall Limited sales engineers offer immediate personalized attention and prompt delivery of the International Rectifier Line.

INTERNATIONAL RECTIFIER



SYMBOL OF QUALITY IN SEMICONDUCTORS

INTERNATIONAL RECTIFIER CORPORATION: EL SEGUNDO, CALIFORNIA • PHONE OREGON 8-6281 • CABLE RECTUSA

REPRESENTED IN CANADA BY: DOUGLAS RANDALL, CANADA, LTD.
126 MANVILLE ROAD, SCARBOROUGH, (TORONTO), ONTARIO • TELEPHONE: OXFORD 8-3081

For complete details check No. 31 on handy card, page 67

ELECTRONICS AND COMMUNICATIONS, October, 1960

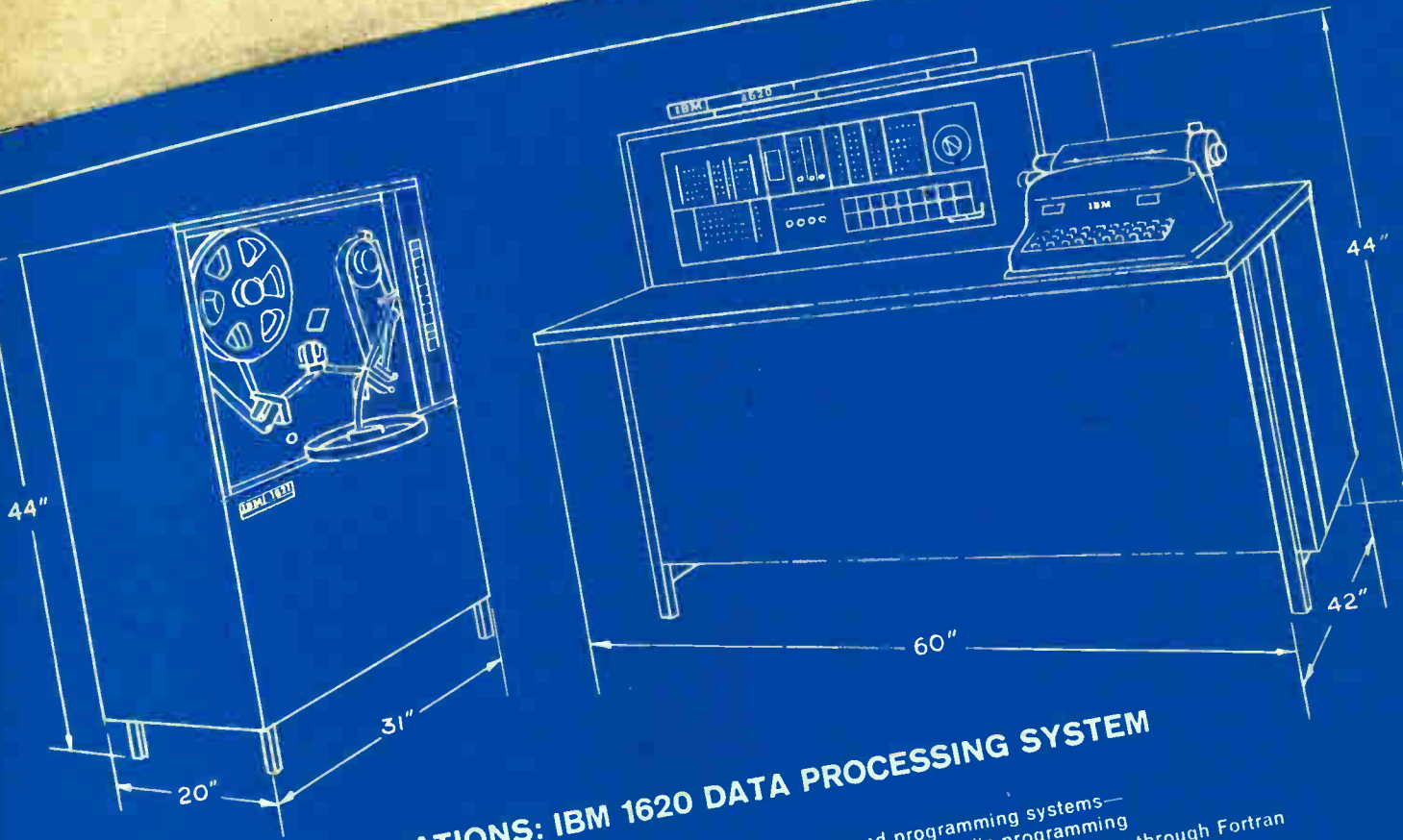

SPECIFICATIONS: IBM 1620 DATA PROCESSING SYSTEM

- Core storage—20,000 digits
- Automatic operation—stored programming
- High computing speed—20 microsecond machine cycle
- Powerful instructions with two data addresses
- Decimal and alphabetic
- Variable field and record length—any size numbers

- Advanced programming systems—Fortran and symbolic programming
- Compatibility with other computers through Fortran
- Simple console with logging features
- Self checking throughout
- Transistorized circuitry—compact, economical, reliable
- Paper tape input and output

The 1620 will meet technical computing requirements too complex for the conventional desk-type calculator. It provides many advantages of larger systems at a much lower cost. In addition, it can be used to support other data processing systems such as the IBM 650, 704, 705, 709, 7070 and 7090. Information enters the system from the typewriter of the 1620 Central Processing Unit, or from the 1621 Paper Tape Reader. Output is to the typewriter or 961 Tape Punch.

Machine	Weight in lbs	Current Requirements	Power cord	Interconnecting cable	Heat Load Specification BTU/Hr
1620	1,000	20 Amps., 115 Volts, single phase 10 Amps., 230 Volts, single phase 6.5 Amps., 208 Volts, three phase	10' 3-Wire for 115 and 230 Volts 10' 4-Wire for 208 Volts	10' signal 10' power	5,000 2,000

1621 280



FREE YOUR ENGINEERING STAFF FOR MORE CREATIVE WORK . . .

IBM 1620

LOW-COST, DESK-SIZE COMPUTER

RELIEVES YOUR STAFF OF TIME CONSUMING WORK

. . . SOLVES WIDE RANGE OF SPECIALIZED PROBLEMS

Problems that used to tie up your engineering staff for days can now be solved . . . with electronic accuracy . . . in minutes! The IBM 1620 is a low-cost, desk-size engineering computer that solves a tremendous range of routine and specialized engineering problems quickly and easily. The 1620 offers you an economical way to increase staff productivity, helps pave the way for profitable growth.

The 1620 is easy to learn, easy to operate, easy to communicate with. It adapts readily to specialized and general problems such as design development, blending problems involving matrix arithmetic, research calculations with differential equations. It facilitates the development of mathematical models for plant and shop operation, and evaluation studies employing statistical techniques such as regression analysis.

IBM also makes available a comprehensive library of mathematical routines and programs as well as reliable customer engineering. These services supporting the 1620 are an important part of IBM Balanced Data Processing. They make it easy for you to make full use of the 1620 in your operations without delay. Like all IBM data processing equipment, the 1620 may be purchased or leased.

BALANCED DATA PROCESSING



IBM

International Business Machines Company Limited
Don Mills (Toronto), Ontario

Please send me further information and complete specifications for
the IBM 1620 Engineering Computer. I am particularly interested in:

_____ (engineering application)

NAME _____

POSITION _____

COMPANY _____

ADDRESS _____

CITY _____

PROV. _____

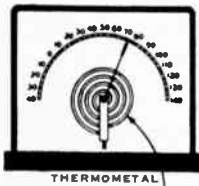

THERMOMETAL® for dependable control applications.

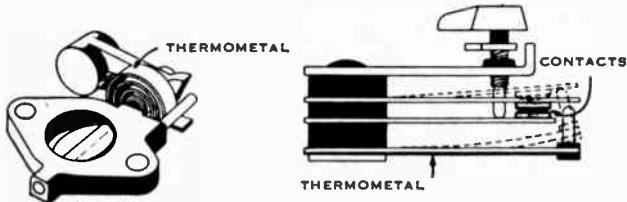

Leading manufacturers depend upon the outstanding performance of Thermometal in electrical appliances, thermal cutouts, heating controls and many other applications involving the indication and accurate control of temperatures, electrical currents, voltages, etc. Thermometal is supplied in strip form, rolled and slit to close tolerances and tempered to specification. Thermometal elements and sub-assemblies are also supplied to specifications, with or without contacts attached. Send for literature.

precious metal contacts for high-reliability



For high-reliability and long operating life, precious metal contacts in pure or alloyed forms of silver, platinum, palladium and gold are very definitely indicated. These contacts provide unmatched high resistance to atmospheric corrosion, deformation, arc erosion, binding and metal transfer. Baker precious metal contacts are supplied as wire, rod, sheet and in a complete line of fabricated forms. Facilities are also available for manufacture to your specifications.



WRITE FOR
CATALOG MATERIAL
AND DETAILS

ENGELHARD INDUSTRIES
OF CANADA, LTD.

512 KING STREET, EAST • TORONTO, ONTARIO, CANADA

✱
Sales Office: Engelhard Industries of Canada Ltd.
1255 University Street • Montreal 2, Quebec

LEADING IN
PRECIOUS METAL
RESEARCH

fine wire for every application



Here, you will find a thoroughly dependable source for fine wire of ductile and non-ductile materials for every application. Special processes have been developed for bare drawing wire as fine as .0004". Where smaller fine wire is required, the Wollaston Process for ductile metals and the Taylor and Extrusion methods for non-ductile materials are employed. All standard wire requirements are stocked for prompt delivery.

gold and rhodium plating for corrosion-resistant surfaces

ATOMEX® is a 24k gold immersion solution that permits the deposition of a thin, dense, uniform layer of 24k gold on printed circuits and metallized plastics by means of a simple bath. The Atomex procedure is more permanent and less expensive than electroplating of comparable thickness. Costly analytical control is unnecessary. **RHODIUM**—a complete line of Rhodium plating solutions are also available. Rhodium plating is indicated when a low-resistance, long-wearing, oxide-free contact is required.



DOMESTIC DIVISIONS: AMERICAN PLATINUM & SILVER DIVISION • AMERSIL QUARTZ DIVISION • BAKER CONTACT DIVISION • BAKER DENTAL DIVISION • BAKER PLATINUM DIVISION • BAKER SETTING DIVISION • CHEMICAL DIVISION • HANOVIA LIQUID GOLD DIVISION • INSTRUMENTS & SYSTEMS DIVISION • IRVINGTON-BAKER REFINING DIVISION • O. E. MAKEPEACE DIVISION • RESEARCH & DEVELOPMENT DIVISION • H. A. WILSON DIVISION. COMPANIES ABROAD: ENGELHARD INDUSTRIES OF CANADA LTD., TORONTO • ENGELHARD INDUSTRIES LTD., BAKER PLATINUM DIVISION, HANOVIA PRODUCTS DIVISION, LONDON • SOCIEDAD SURAMERICANA DE METALES PRECIOSOS S. A., BOGOTA • ENGELHARD INDUSTRIES S.A.R.L., PARIS • GLOVER & GOODE PTY., LTD., MELBOURNE • ENGELHARD INDUSTRIES, K. K., TOKYO • ENGELHARD INDUSTRIES, PTY., LTD., MELBOURNE • ENGELHARD INDUSTRIEN A. D., ZURICH • INDUSTRIE ENGELHARD S. P. A., ROME • GIULIANO STACCIOLI—METALLI PREZIOSI S. P. A., ROME • INVERSIONES EN INDUSTRIAS NACIONALES, S. A., BOGOTA. ASSOCIATED COMPANIES: KALIE-CHEMIE-ENGELHARD KATALYSATOREN G. M. B. H., MANDVER

For complete details check No. 19 on handy card, page 67



Our staff is always happy to see you and discuss your instrumentation problems.



Watch for the Atlas Travelab visit to your area. This mobile demonstration laboratory features the latest in electronic instrumentation in operating display.

Extensive Stock for
Immediate Delivery — Factory
Warranty Service

at the . . .

COMMUNICATIONS SYMPOSIUM

Visit us at . . .

BOOTHS 11 and 12

See demonstrations of new electronic equipment . . .

- **HEWLETT-PACKARD COMPANY—**
Comprehensive line of electronic test equipment
DC through microwave.
- **DYMEC, INC.—**
All types of electronic instrumentation systems.
- **GERTSCH PRODUCTS, INC.—**
Frequency measuring equipment and ratio transformers.
- **KINTEL, DIVISION OF COHU ELECTRONICS, INC.—**
Wide range of DC instrumentation and
closed circuit television.
- **MASSA, DIVISION OF COHU ELECTRONICS, INC.—**
High speed recording systems.
- **TEL-INSTRUMENT ELECTRONICS CORP.—**
Voltage regulators and vibration calibrators.
TV test equipment.
- **SIERRA ELECTRONIC CORPORATION—**
Transmission line test equipment.
- **ELECTRO PRODUCTS LABORATORIES, INC.—**
Magnetic pickups and proximity controls.
- **ERIK A. LINDGREN & ASSOCIATES—**
R. F. screen rooms.
- **SKYDYNE, INC.—**
Test equipment transit cases and mobiles.

and

The newest addition to our list of Distinguished Principals:—

- **GREIBACH INSTRUMENTS CORPORATION,**
315 North Ave., New Rochelle, N.Y., U.S.A.
Manufacturers of Precision Instruments
for Extreme Accuracy.



ATLAS INSTRUMENT CORPORATION LTD.

50 Wingold Avenue, Toronto 19, Canada

BRANCHES IN: MONTREAL • OTTAWA • VANCOUVER

For complete details check No. 4 on handy card, page 67

industry personnel



R. E. Magnus

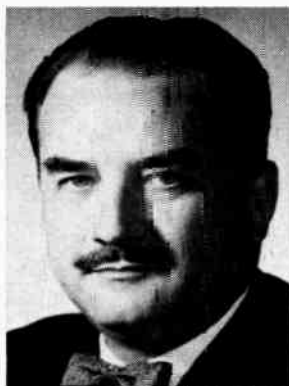

C. F. Whittaker



H. Shannon

Appointments follow SPC re-organization changes

The Communications Department, formerly under the Electrical Engineering Division of the Saskatchewan Power Corporation, now reports directly to **W. B. Clipsham**, assistant general manager in charge of engineering. The change was made recently when the Electrical Engineering Division was sub-divided into a Construction Division and an Electrical Design Division.

Head of the Communications Department is **Harold Kaldor**, communications engineer since 1956.

Beckman sales engineer serves western Canada

Appointment of **Donald G. Drew** as process sales engineer in the north-west section of the United States and western Canada has been announced by the Scientific and Process Instruments Division of Beckman Instruments, Inc. The announcement was made by **Paul E. Paules**, western regional manager for the division.

Mr. Drew's territory will include the provinces of British Columbia, Alberta and Saskatchewan.

Muirhead Instruments' appointments

Staff appointments were recently announced by **A. J. Muirhead**, executive vice-president of Muirhead Instruments Limited, Stratford, Ont.

R. W. Watler, P.Eng., has been named general manager of the company. **R. G. Roth, B.A., C.A.**, has been appointed accountant.

Muirhead Instruments Limited are makers of precision electrical instruments.

CGE names manager of sales for tube section

Ross E. Magnus has been appointed manager of sales to equipment manufacturers for Canadian General Electric's Electronic Tube Section. In his new position, Mr. Magnus directs and is responsible for the national sales of General Electric tubes, capacitors and devices to original equipment manufacturers in the entertainment, industrial and defense markets, according to **V. B. Dowdell**, manager of marketing, who made the announcement.

Mr. Magnus joined the Canadian General Electric Company in 1953. After completing various company training programs, he was appointed as a sales representative to call on equipment manufacturers, in which capacity he has served for the past three years.

Arborite Company appointments

The Arborite Company Limited announces the appointment of **Allen G. Ballard** as manager of the new Continental-Diamond Fibre Division in Toronto, exclusive fabricators and distributors of industrial laminates. Mr. Ballard has been associated with Continental-Diamond since it was founded in 1919. A former subsidiary of the Continental-Diamond Corporation of Newark, Delaware, its assets were recently purchased by The Arborite Company Limited.

Edward L. Crossman has been named assistant manager of the new division, which operates a plant in Toronto and sales offices in Montreal and Vancouver. Mr. Crossman joined Continental-Diamond in 1929, and is well-known throughout the industry.

Divisional appointments by RCA Victor

G. L. Mansour, vice-president, Consumer Products, RCA Victor Company, Ltd., has announced two senior company appointments.

C. F. Whittaker, formerly manager of Product Development, Home Instrument Marketing, is appointed to the new position of general manager, Home Instrument Merchandising Division.

H. B. Shannon becomes manager, Brand Line Sales, Home Instrument Merchandising.

Jacques Wolff, formerly general manager, Home Instrument Marketing Division, has been transferred to RCA International. He will take up his new position in Geneva, Switzerland.

Mr. Whittaker joined RCA Victor as a field engineer in 1946. He served as western sales manager and branch manager before being appointed manager of Product Development for Home Instruments in 1959. In his new position he will report to the vice-president, Consumer Products.

Mr. Shannon first joined RCA Victor as an equipment salesman in 1953. In 1956 he was promoted to manager, Industrial Sales and the following year was transferred to the RCA Victor Semiconductor and Materials Division in Somerville, N.J.

Staff changes at Instronics

John E. Knowles, president of Instronics Limited, Stittsville, Ontario, has recently announced several staff changes in the company.

John Westlake, formerly ITTESCO depot manager in Montreal, has been employed by Instronics Limited as Western Canada sales manager, located at 4912-26th Avenue S.W., Calgary, Alberta.

Douglas Leach, formerly Ottawa sale representative, is located at 113 Winthrop Avenue, Pointe Claire, P.Q., and will act as sales manager for the area of Quebec and the Maritimes.

L. G. Cote, formerly Capt. Cote of the Directorate of Signals, Ottawa, join Instronics Limited, October 1, as general sales manager.

For the present Mr. Leach will retain the duties of advertising manager. A sales engineer to replace Mr. Leach in the Ottawa area has not yet been located.

Edward Rockerfeller joins Instronics, October 1, as service manager.

G. C. Gibson joins Elcom Marketing Ltd.

E. E. (Ted) Thompson, president of Elcom Marketing Limited, announces the appointment of **George C. Gibson** to the firm's staff as of September 12 to be responsible for component sales to industrial electronic, electrical apparatus and appliance manufacturers.

Mr. Gibson has been with Philco Corporation of Canada Limited for the past five years with responsibility for sales, firstly in Northern Ontario and latterly in Toronto West. Prior to this, he was service manager for Hallicrafters Canada Limited for three years. During the last war he was loaned by the RAF to assist in the training of wireless operators at No. 1 Wireless School in Montreal.

Northern Electric appoints six vice-presidents

Six Northern Electric officials have been promoted to the rank of vice-president, R. D. Harkness, president of the company, announced recently.

A. B. Hunt, general manager, research and development, becomes vice-president, research and development; **C. A. Peachey**, general manager, communications equipment division, becomes vice-president and general manager, communications equipment division; **J. G. Little**, general manager, wire and cable division, becomes vice-president and general manager, wire and cable division; **F. F. Fulton**, general manager, telephone contract division, becomes vice-president and general manager, telephone contract division; **V. O. Marquez**, general manager, sales division, becomes vice-president and general manager, sales division; **S. B. Wickes**, comptroller, becomes vice-president and comptroller.

These appointments reflect the growth of the company and the many new developments which have occurred during recent years in all spheres of the company's activities.

Canadian equipment sells in the United States

U.S. Radium Corporation has announced plans to sell in the United States a line of Geiger tubes produced by Electronic Associates Limited of Canada.

Electronic Associates developed its first Geiger tube in 1946. Since that time EA tubes have been used in a variety of industrial and research applications.

United States Radium Corporation is a leading supplier of radiation sources and related nuclear products.

Wholesale Radio appointment

George R. Gardiner, chairman of the board of directors, recently announced the appointment of **W. F. Saynor** as general manager of Wholesale Radio & Electronics Limited, a subsidiary of Zenith Electric Supply Limited.

Paisley Products appointed Canadian distributor

Announcement has recently been made of the appointment of Paisley Products of Canada, Ltd. as sole distributor for London Chemical Company of Chicago. The latter company manufactures a line of chemical products widely used in the electrical and electronic industries.

First commercial station north of Arctic Circle

Canadian General Electric Co. Limited has shipped complete station equipment for the first commercial-type radio broadcasting station north of the Arctic Circle.

The complete 1 KW station, consisting of transmitter, studio equipment, control console, and other associated facilities, will be located at Inuvik, in the Northwest Territories, a new town site of the former Aklavik.

Being installed by the Canadian Broadcasting Corporation, the new station will be the Corporation's newest and largest in the Canadian north. It will carry the call letters CHAK.

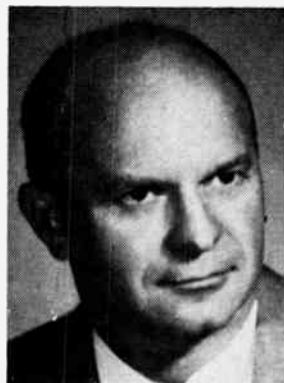

G. C. Gibson

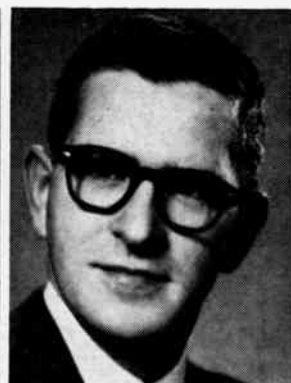

W. F. Saynor



S. B. Wickes



V. O. Marquez



A. B. Hunt

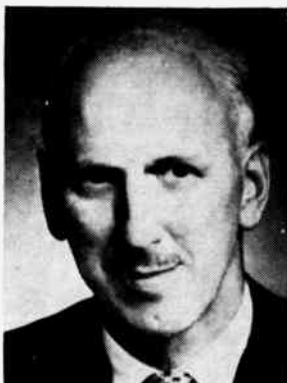

C. A. Peachey



F. F. Fulton



J. G. Little

Call your  rep today for a demonstration of one of these

3

POPULAR





OSCILLOSCOPES





Production or lab instruments—Simple to use, even for non-technical personnel—Moderately priced—Full 10 cm x 10 cm display—Automatic calibration waveforms—Low phase shift—Automatic triggering for optimum presentation—"Times-5" sweep expander magnifies trace, improves resolution.



DC to 200 KC

Models 120A/AR combine minimum controls with  automatic triggering for utmost speed, convenience. Horizontal amplifier dc to 200 KC; phase shift only $\pm 2^\circ$ to 100 KC. More X-axis information due to horizontal amplifier sensitivity control, with vernier, 5% accuracy. Balanced input on most sensitive ranges for low level work. Times-5 sweep expander, all ranges. 15 calibrated sweep speeds, 5 $\mu\text{sec}/\text{cm}$ to 0.2 sec/cm. Vernier, expander extend speed range 1 $\mu\text{sec}/\text{cm}$ to 0.5 sec/cm. 10 mv/cm sensitivity calibrated vertical amplifier, drift-free trace.  120A (cabinet) or  120AR (rack), \$435.

DC to 200 KC - DUAL TRACE

Models 122A/AR provide simultaneous two-phenomena presentation, are ideal for direct comparison of filter, amplifier output/input phenomena; vibration testing. Unique  front-panel automatic calibrator waveform switch. Twin vertical amplifiers operate independently, simultaneously, differentially. Automatic triggering, automatic synchronization, single trace operation when desired. Sensitivity 10 mv/cm to 100 v/cm, 15 calibrated sweeps, vernier extension. Horizontal amplifier dc to 200 KC.  122A (cabinet) or  122AR (rack), \$625.

DC to 300 KC - "BIG SCOPE" PERFORMANCE

Models 130B/BR provide wide usefulness, simple operation and rugged dependability. 21 calibrated sweep times, 1 $\mu\text{sec}/\text{cm}$ to 5 sec/cm. Vernier, expander extend range 0.2 $\mu\text{sec}/\text{cm}$ to 12.5 sec/cm. Twin horizontal and vertical amplifiers, phase shift $\pm 1^\circ$ to 50 KC; sensitivity 1 mv/cm to 125 v/cm. Balanced input on 6 most sensitive ranges. Common mode rejection 40 db. Stability 1 mv/hour after warmup. Triggering automatic, internally, line power, externally, 0.5 v or greater.  130B (cabinet) or  130BR (rack), \$650.

Data subject to change without notice. Prices f.o.b. factory.

Thirteen precision
 oscilloscopes,
dc to 1,000 MC



HEWLETT-PACKARD COMPANY

CANADA

Montreal, Quebec
Atlas Instrument Corporation, Ltd.
3333 Cavendish Blvd.
HUnter 9-8495 and 8496

Ottawa, Ontario
Atlas Instrument Corporation, Ltd.
77 Danforth Street
PArkway 2-7668

Toronto 10, Ontario
Atlas Instrument Corporation, Ltd.
50 Wingold Avenue
RUssell 1-6174

Vancouver 2, British Columbia
Atlas Instrument Corporation, Ltd.
106-525 Seymour Street
MUtual 3-5848

For complete details check No. 25 on handy card, page 67

AN IMPORTANT ANNOUNCEMENT to Training Executives and Chief Engineers



RADIO COLLEGE OF CANADA PRESENTS TWO NEW TRAINING SERVICES

1. GROUP TRAINING PROGRAMS

Now you may take advantage of electronics training courses tailored specifically to the requirements of your technical personnel. A qualified Radio College of Canada training consultant will work with you or your staff to determine training requirements.

Based on joint findings, training programs will be developed to create new technicians or to up-grade your present employees. These courses may include instruction in new equip-

ment, methods and applications specific to your field of operations.

Three Ways are available for this RCC training:

- In-plant training by qualified RCC instructors
- Well planned courses at modern RCC schools
- Easy-to-follow Home Study courses

2. MANUALS AND LESSON TEXTS designed for your personnel

Radio College of Canada will produce training and equipment manuals, lesson texts and brochures specifically designed for your internal training program.

Lesson materials are designed as you want them . . . for on-the-job or self-help instruction.

**WRITE
TODAY**

NOW! A Brand New
and Up-to-date Course
**INDUSTRIAL and AUTOMATION
ELECTRONICS**

An expertly conceived course to meet today's increasing demands for up-to-the-minute instructions on instrumentation controls, and other industrial applications of electronics.

To: RADIO COLLEGE of CANADA,
Dept. EC, 461 King St. W., Toronto, Ontario.

Please send me additional information, at no obligation, on the items checked below.

- | | |
|--|--|
| 1. GROUP TRAINING PROGRAM | } In our Plant.....
At RCC School |
| 2. MANUALS and LESSON MATERIAL for our own use..... | |
| 3. NEW INDUSTRIAL and AUTOMATION ELECTRONICS Course | |

NAME.....
POSITION.....
COMPANY.....
ADDRESS.....

SPECIFY STROMBERG-CARLSON "511" MULTIPLEX

FOR YOUR MICROWAVE SYSTEM

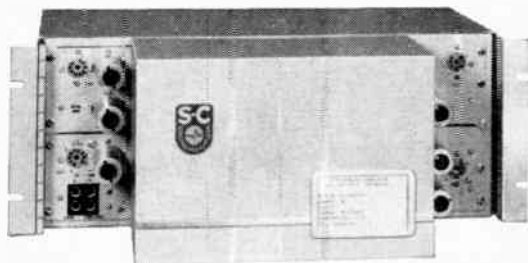

Stromberg-Carlson "511" Multiplex, compatible with all major RF systems, is engineered for low-cost application to a wide variety of system arrangements.

You may use these units singly; or, with translators, combine them into groups to build up high-density systems. To your communications, "511" Multiplex brings an unsurpassed combination of:

Flexibility: applications include point-to-point radio, telephone, teletype, telemetering, facsimile and control systems.

Economy: the units employ frequency division, single side-band, suppressed carrier techniques for more economical use of available frequencies.

Reliability: quality components, with safety ratings well above accepted norms, assure long life while reducing maintenance and replacement costs to a bare minimum.

Appliques: also available are various types of adaptors for: Dial Station, Dial Trunk, Teletype or V.H.F. Transmitters; Selective Ringing Units; Line and Station Adaptors; and 4-wire Switching Equipment.

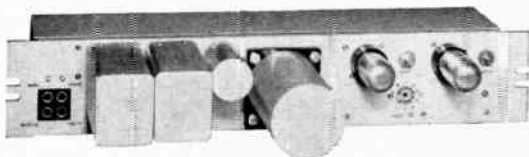

STROMBERG-CARLSON TONE UNITS

... fill your growing need for amplitude-modulated tone transmitting and receiving equipment in telegraphy, telemetering and control on wire line, carrier and radio circuits.

Delivery on multiplex and tone signaling equipment is prompt; service is available from our field engineering staff. Write for descriptive literature.



Exclusive Canadian representatives

HACKBUSCH ELECTRONICS LIMITED

23 Primrose Ave., Toronto 4, Ont.

STROMBERG-CARLSON

A DIVISION OF GENERAL DYNAMICS

For complete details check No. 23 on handy card, page 67



FROM INDUSTRY'S BROADEST
LINE OF SEMICONDUCTORS

Transitron

CONTROLLED RECTIFIERS & SWITCHES

SILICON CONTROLLED RECTIFIERS

For Complete Information,
write for Bulletin TE-1356

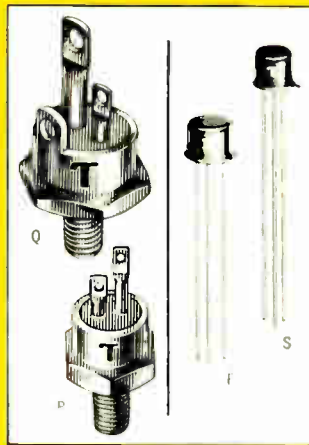

Type	Minimum Peak Reverse Voltage and Minimum Forward Breakover Voltage (Volts)	Maximum Average Forward Current (amps)		Hex Size of Package	Package
		at 25°C case	at 100°C case		
TCR 520	50	20	10		
TCR 2020	200	20	10		
TCR 4020	400	20	10	1 1/16	Q
TCR 510	50	10	5		
TCR 2010	200	10	5		
TCR 4010	400	10	5		
Type	Minimum Peak Reverse Voltage and Minimum Forward Breakover Voltage (Volts)	Maximum Average Forward Current (amps) at 80°C case	Maximum Gate Current to Fire (ma)	Maximum Holding Current (ma)	Package
2N1595	50	1	10	25	
2N1599	400	1	10	25	F
TCR 4001	400	1	0.2	5	
2N1600	50	3	10	25	
2N1604	400	3	10	25	P
TCR 4005	400	5	20	25	

TRANSWITCHES

For Complete Information, write for Bulletin TE-1357

Type	Service	Minimum Breakover Voltage V_{BO} (Volts)	Maximum Forward Current I_F (ma)	Maximum Gate Current to Turn-On $I_{GT, ON}$ (ma)	Maximum Gate Current to Turn-Off $I_{GT, OFF}$ (ma)	Package
TSW-31	Military	30	50	1.0	10	
TSW-101A	Military	100	100	1.0	15	S
SW-30	Commercial	30	30	1.5	10	

CONTROLLED SWITCHES

For Complete Information, write for Bulletin TE-1356

Type	Minimum Breakover Voltage V_{BO} (Volts)	Maximum Current Range (ma)	Maximum Gate Current to Turn-On (ma)	Typical Output Capacitance (μ uf)	Package
TSW-31S	30	1 to 200	.02	5	S
TSW-101S	100	1 to 200	.02	5	S

BINISTORS

For Complete Information,
write for Bulletin TE-1360



Type	Service	Maximum Collector Voltage (V_{CE})	Maximum Critical Injector Current (ma)	Maximum Collector Cutoff Current (μ A)		Maximum Temperature Range (°C)
				25°C	150°C	
3N56	Military	15	0.5	0.2	10	-65 to +150
3N57	Commercial	15	0.5	0.2	-	-55 to +100

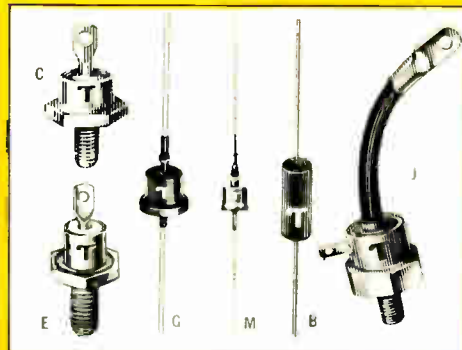

SILICON RECTIFIERS

For Complete Information,
write for Bulletins TE-1351 and TE-1336

Ratings at 150°C

Type	Maximum Average Forward Current (Amps)	Peak Recurrent Inverse Voltage (Volts)	Maximum Inverse Current (ma)	Package
TK21	.5	200	.2	M
TK41	.5	400	.2	M
TK61	.5	600	.2	M
1N2506 (SL710)	.1	1000	.2	G
1N2507 (SL712)	.1	1200	.2	G
1N2508 (SL715)	.1	1500	.2	G
1N538 (JAN)	.25	200	.35	G
1N540 (JAN)	.25	400	.35	G
1N547 (JAN)	.25	600	.35	G
2W91	.05	900	.2	B
2W151	.05	1500	.2	B
2W20A1	.075	2000	.2	B
1N253 (JAN)	1.0	95	.1	E
1N254 (JAN)	0.4	190	.1	E
1N255 (JAN)	0.4	380	.15	E
1N256 (JAN)	0.2	570	.25	E
TM67	3	600	.5	E
TM47	3	400	.5	E
TM124	1	1200	.5	E
TM104	1	1000	.5	E
TM155	0.4	1500	.5	E
1N249A	20	100	5	C
1N250A	20	200	5	C
1R402	20	400	5	C
1N411B	50	50	15	J
1N412B	50	100	15	J
1N413B	50	200	15	J
1H402B	50	400	15	J

*JAN TYPES Rated at 135°C Case Temperature

†Rating at 125°C

SILICON DIODES

FAST SWITCHING

For Complete Information, write for Bulletin TE-1350

DIFFUSED					
Type	Maximum Inverse Operating Voltage (Volts)	Maximum Average Forward Current @ 25°C (ma)	Maximum Recovery Time (μsec)	Military Types	Package
1N643	180	40	0.3	USA	A-1
1N658	100	200	0.3	USA	A-1
1N659	50	100	0.3		A
1N660	100	100	0.3		A
1N661	200	100	0.3		A
1N662	90	40	0.5	USA	A-1
1N662A	90	200	0.5		A
1N663	90	60	0.5	USA	A-1
1N691	70	200	0.8*		A
1N693	180	200	0.8*		A
1N808	100	100	0.3		A
1N809	200	100	0.3		A
1N840	40	300	0.3		A
1N906	20	50	0.004‡		A
1N914	75	10	0.004‡		A
1N922	100	500	0.03		A
1N928	100	20	0.15		A
*Switching from 500ma to 40 volts 110ma to 6 volts					
BONDED					
1N251	30	30	0.15	JAN	A-1
1N252	20	40	0.15		A
1N993	8	20	0.004		A

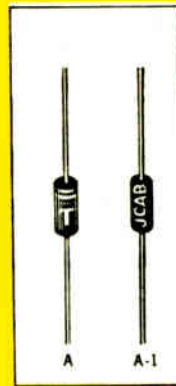

FEATURES

- Operation to 200°C
- High forward conductance
- High voltage ratings
- Fast switching time
- Low shunt capacitance.
- Subminiature size

HIGH CONDUCTANCE SILICON DIODES and SUBMINIATURE RECTIFIERS

For Complete Information, write for Bulletin TE-1350

HIGH CONDUCTANCE					
Type	Maximum Inverse Operating Voltage (Volts)	Maximum Average Forward Current at 150°C (ma)	Maximum Inverse Current at 150°C (μa @ V)	Military Types	Package
1N457	60	25	5 @ 60	JAN	A-1
1N458	125	25	5 @ 125	JAN	A-1
1N459	175	25	5 @ 175	JAN	A-1
SUBMINIATURE RECTIFIERS					
Type	Maximum Inverse Operating Voltage (Volts)	Maximum Average Forward Current at 150°C (ma)	Maximum Average Inverse Current at Rated Voltage (μa)	Military Types	Package
1N645	225	150	15 @ 100°C	USAF	A-1
1N646	300	150	15 @ 100°C	USAF	A-1
1N647	400	150	20 @ 100°C	USAF	A-1
1N648	500	150	20 @ 100°C	USAF	A-1
1N649	600	150	25 @ 100°C	USAF	A-1

GERMANIUM DIODES

FEATURES

- High forward conductance
- Fast switching time
- Low inverse currents
- Excellent stability
- Small size

Very fast switching types

	1N994	1N995	
Recovery time (10ma Ifwd. 6V Inverse to 3ma Inverse with 120 ohms resistive load)	.002	.006	μsec max.
Forward Voltage drop @ 10ma	1.0	.5	volts max.
Inverse current @ -6 volts	30.0	10.0	μa max.
Maximum inverse voltage rating	8.0	15.0	volts
Maximum temperature	75.0	75.0	°C
Components S570G and S555G refer to package A			

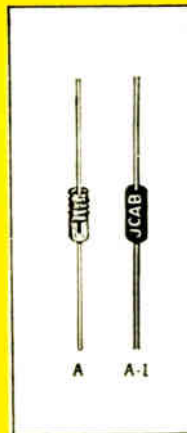

For Complete Information, write for Bulletin TE-1319.

Specifications and ratings at 25°C

Type	Minimum Forward Current at +1V (ma)	Maximum Inverse Current at Specified Voltage (μa @ V)	Maximum Operating Voltage (volts)	Description
1N270	200	100 @ -50	80	JAN TYPES (Package A-1)
1N277	100	250 @ -50 @ 75°C 75 @ -10 @ 75°C	100	
1N276	40	100 @ -50	50	
1N281	100	500 @ -50 30 @ -10	60	
1N283	200	20 @ -10	20	COMPUTER TYPES (Package A)
1N695	100	2 @ -10 20 @ -10 @ 70°C	20	
1N695A	40	10 @ -20	60	
T16G	40	100 @ -50 20 @ -10	60	HIGH TEMPERATURE TYPES (Package A)
1N278	20	125 @ -50 @ 75°C	50	
T20G	20	500 @ -50 @ 75°C 30 @ -10 @ 75°C	50	
T22G	40	20 @ -10 @ 75°C	15	
T9G	100	20 @ -50 2 @ -10	60	HIGH RESISTANCE TYPES (Package A)
T13G	40	2 @ -10	70	



"Leadership in semiconductors"

SPECIAL PRODUCTS

In addition to the wide range of components, Transitron offers Special Products and Devices to meet your requirements. We welcome inquiries and offer engineering advice on your particular needs.

SILICON REGULATORS AND REFERENCES

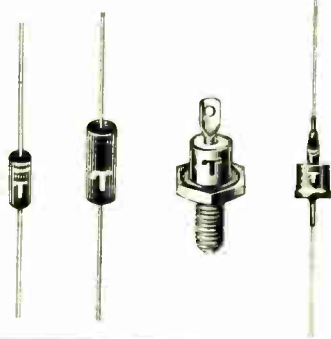

Transitron's advanced line of silicon regulators and references features the industry's most stable series of precision voltage reference units. Product line spans range from 100 MW microregulators to 50 watt power types. For complete information, write for Bulletin TE-1352.

DIFFUSED SILICON MICRODIODES



The industry's widest line of reliable silicon microdiodes offers high conductance types, fast and very fast switching microdiodes, microregulators and a microstabistor. For complete information, write for Bulletin TE-1358.

SEMICONDUCTOR ASSEMBLIES

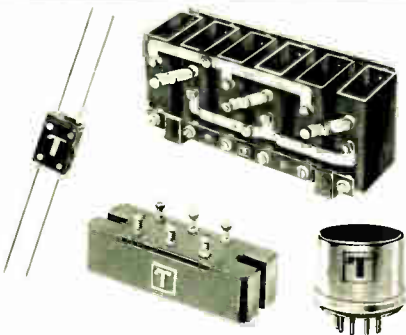

Transitron operates a large modern facility devoted to the manufacture of rectifier stacks, diode quads, high voltage assemblies, and other special semiconductor assemblies. Send your detailed requirements to the Special Products department for prompt evaluation and quotation.

**ALSO... call on
Transitron for:**

- MICROCIRCUITS
- SILICON VARIABLE CAPACITORS
- THERMOELECTRIC MATERIALS & DEVICES

Transitron



electronic corporation

CLifford 9-5461

1229 the queensway toronto

SALES OFFICES IN PRINCIPAL CITIES THROUGHOUT THE USA AND EUROPE

World Radio History

EIA report

by R. T. O'Brien

D. A. Golden Speaks on Defense Sharing

Addressing electronics manufacturers attending the C.N.E. Directors' Luncheon on Radio and TV Day, David A. Golden outlined the main aspects of the work of his department in the development and production sharing program. Mr. Golden is Deputy Minister, Department of Defense Production in the Federal Government.

"It would be impossible," Mr. Golden said, "for modern transportation, modern communications, modern business and education to assume their present forms without electronics. What is not so obvious, however, is the role played by electronics in defense and the role which defense plays in introducing new concepts, techniques, and skills into the electronics industry".

Mr. Golden said that the primary purpose of the production sharing program is to provide greater opportunities for Canadian industry to compete for defense business in the United States. The key words here are "opportunity" and "competition". All that officials can do is to ensure that the opportunities are afforded to industry; the competing for these opportunities can only be done by industry itself.

"Many Canadian companies have been successful", Mr. Golden said, "in participating in United States contracts". He cited a number of examples to show that contracts have been won for memory drums and tape readers, klystrons, short range battlefield radar, tropospheric scatter communications systems, rigid radomes, and navigation computers. He went on to say that a concentrated effort is required, and should be confined to those areas where a company knows it has genuine competence and is likely to be competitive as far as price and delivery are concerned."

Outlining his department's view on development sharing Mr. Golden said that, "over the longer term, there will be three main aspects of the development sharing program:

- (1) A formal U.S. military requirement, its development funded by the U.S. Government, for which Canadian industry competes with U.S. industry. There is evidence that contracts of a study or research nature may be obtained by a relatively modest effort on the part of the contractor. Over a period of years, work in the research area could lead to unique development capabilities in Canada and should greatly improve our competitive position for future development bids.
- (2) An original Canadian concept, financed by Canada, but whose successful development would be of confirmed interest to U.S. military. Support is being given to a number of Canadian companies, some of them in the electronics industry, and we are hopeful that production orders will result in at least some instances.
- (3) A formal U.S. military requirement, the development of which, by mutual agreement, is financed by Canada using Canadian facilities and capabilities. Much time has been spent on preliminary problems such as ownership and use of proprietary rights, responsibility for project monitorship, availability of specifications and classified documents, security clearances, and the like. An agreement has been signed between Canada and the U.S. army as a result of which we hope to be able to negotiate about a half dozen significant Canadian development projects before the end of this fiscal year."

Mr. Golden concluded his address by saying that the Government can encourage; they can provide goals and opportunities; and, within limits, can give financial support. But only industry can provide the drive by its ingenuity, energy, and willingness to take risks. Mr. Golden said that he believes in Canadian industry, its management, its technicians, its workers, and its dynamism.

CANNON

makes

PLUGS

for every purpose!

the

CANNON "CRIMPEE"

solderless U.H.F. coaxial plug



This inexpensive plug may be used in mobile communications equipment, ham radio sets, television master antenna sets, and other equipment. It can be assembled in minutes, without soldering, with the aid of a specially designed crimping tool. It is readily interchangeable with Military PL-259 plugs, mates with the SO-239 receptacle and is available for five cable sizes: RG-8/U, 9/U, 11/U, 58/U, and 59/U. Write today for bulletin T-180A.

In Canada and throughout the free world, Cannon Plugs are answering the specialized problems of industry and defence.

CANNON PLUGS



CANNON ELECTRIC CANADA
Limited

160 Bartley Drive, Toronto 16, Ont.

MONTREAL, Montreal Airport,
Dorval, P.Q.

OTTAWA, 1168 Edgeland Place

For complete details check No. 12

the industry's business

Waterloo firm to make semiconductors

How to meet the inroads of foreign competition in the Canadian electronics market? "Diversify," says J. McK. McLean, Vice-President and General Manager of General Instrument-F. W. Sickles of Canada Ltd., one of the country's largest producers of electronic equipment and components.

Stressing the company's long range confidence in the Canadian electronics industry, Mr. McLean announced a new line of semiconductors will soon go into production at the firm's 50,000 sq. ft. plant in Waterloo, Ont. New facilities are now being installed and additional staff will be employed so that manufacture of the new silicon and germanium devices can begin in early autumn.

The new line will be patterned after similar devices manufactured by the parent company, General Instrument Corporation, Newark, N.J., one of the leading producers of semiconductors in the U.S.

Railway and Power appointed Canadian representative

Railway & Power Engineering Corporation, Limited announce their appointment as Canadian distributor of Wood Electric Co., Inc., Lynn, Mass., who are manufacturers of Circuit Breakers and RF Coaxial Connectors.

Railway & Power has sales offices and warehouses from coast to coast in Canada. Literature is available from any of these points, or from the Advertising Department, 3745 St. James Street West, Montreal 30, Que.

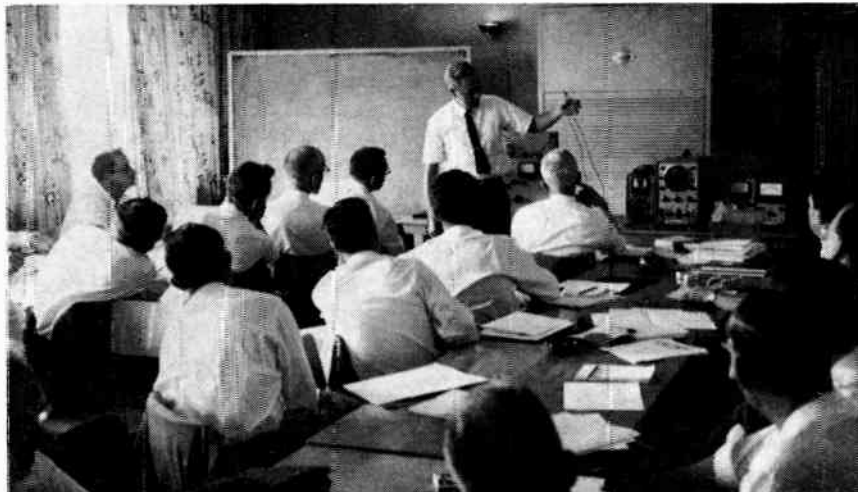

S. Ramey of the Hewlett-Packard Company is shown above conducting a seminar on the use of Hewlett-Packard instruments. A series of seminars, held in Montreal, Valcartier, Ottawa and Toronto, were sponsored by Atlas Instrument Corporation, Toronto, Canadian representatives for the Hewlett-Packard Co.

Atlas Instrument Corp. hold service seminars

The Hewlett-Packard Company of Palo Alto, California and their Canadian representative, Atlas Instrument Corporation recently concluded a series of service seminars on the use of a wide range of instruments manufactured by Hewlett-Packard. The seminars were held in Montreal, Valcartier, Ottawa and Toronto and covered service and calibration techniques applicable to Hewlett-Packard instruments.

The sessions consisted of lectures and practical demonstrations augmented by slides and technical notes.

The lectures and demonstrations were conducted by S. Ramey of the Hewlett-Packard Company.

Transistorized two-way radio for Sask. utility

The Saskatchewan Power Corporation is currently investigating the practicability of low-band transistorized mobile two-way radio sets for its communication system. Canadian General Electric Co. Ltd. has announced receipt of an order for ten 30 watt transmitter-receiver sets which the Corporation will compare under Saskatchewan conditions with conventional equipment now in use.

The Corporation maintains an extensive VHF radio network for the operation of its electrical and natural gas systems. Some 650 mobile units in vehicles and 43 fixed base stations provide a province-wide system of rapid communication for the transmission of instructions, or the reporting of operating conditions.

Coast to coast tour for IBM showcase

With a successful eastern tour under its belt, a travelling show of IBM machines is rolling west from Toronto.

Known as the IBM Series 50 Showcase, it gives businessmen and the general public a chance to see a machine system capable of IBM's punched card methods at a price within the reach of small companies.

Opening in Hamilton on September 6, it will then travel to London and Windsor. In October, it will tour the Prairie cities of Winnipeg, Regina, Calgary and Edmonton and will wind up with a Vancouver appearance in November.

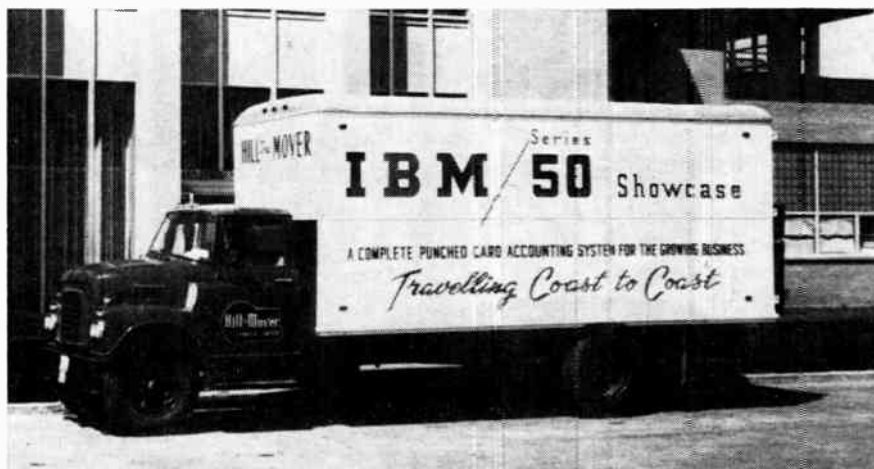

Shown above is IBM's travelling showcase containing \$60,000 worth of modern business equipment. The van has completed an eastern Canadian tour and in October will tour the Prairie Provinces, ending up in Vancouver in November.

Lorain announces Canadian distributor

C. P. Stocker, president of Lorain Products (Canada) Limited, has announced the appointment of Automatic Electric Sales (Canada) Limited as exclusive Canadian distributors for all products except those required by the Bell Telephone Company of Canada, which will be sold through Northern Electric Company Limited.

Lorain Products (Canada) Limited manufacture a complete range of Sub-Cycle Ringing Machines, Power Supply Units and Flotrol Battery Chargers, developed and produced by their parent organization at Lorain, Ohio, U.S.A. These products have been widely used and accepted by communications companies in Canada for many years.

The Canadian company, located in St. Thomas, Ontario, now provides modern manufacturing facilities in Canada.

Automatic Electric Sales (Canada) Limited, a major supplier of communications equipment, offers national sales distribution from its sales offices and warehouses across Canada.

Toronto section IRE hears Col. Rorholt

On Thursday, September 22, 1960 the Toronto Section of the Institute of Radio Engineers and the American Institute of Electrical Engineers held a joint meeting at which Colonel Rorholt, head of Norwegian Joint Signals Administration, spoke on "Manning and Operation of Microwave Systems in Arctic and Sub-Arctic Areas".

Colonel Bjorn Arnold Rorholt is head of the Norwegian Joint Signals Administration and chairman of the Norwegian Joint Signals Board. His organization is charged with the planning, building and operation of microwave relay systems and other electronic installations in Norway.

View of Raytheon Canada Limited's new headquarters-plant in Waterloo, Ontario, officially opened (Tuesday, September 27) by the Honorable Raymond O'Hurley, Minister of Defense Production.

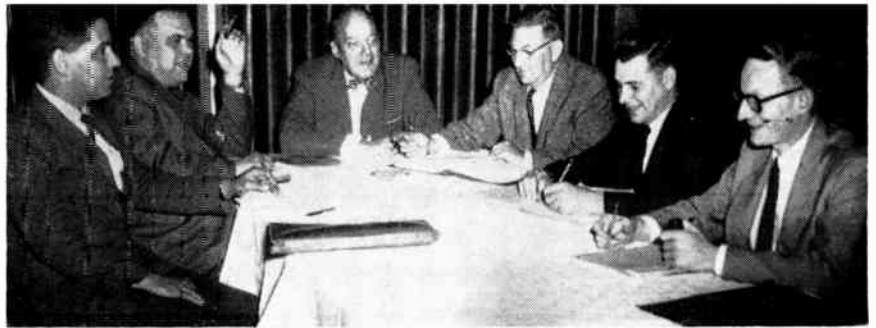

Seated above, left to right, are members of the Montreal Section IRE Communications Symposium Committee. They are: D. J. Watson, chairman, finance committee; J. J. Schwartz, assistant general symposium chairman; E. P. Turton, general symposium chairman; R. J. Wallace, president, Montreal Section and chairman of the steering committee; David L. Thibodeau, chairman of publicity and public relations; A. F. Wells, chairman local arrangements committee.

Geloso forms Canadian Electronics, Ltd.

Mr. Samuel J. Spector, President of American Geloso Electronics, Inc., 215 Park Avenue South, New York 10, N.Y., has announced the formation of Canadian Geloso Electronics, Ltd., with headquarters at 700 Weston Road, Toronto 9, Ontario, Canada, as an affiliate corporation to sell and promote the sale of Geloso's complete line of products exclusively to the growing Canadian market.

Canadian Geloso Electronics, Ltd., is under the leadership of Mr. A. T. R. Armstrong, a long established leader in the Canadian electronics industry. Geloso quality products are made by SPA Geloso of Milan, Italy.

Among the first Geloso products to be introduced in the Canadian market, are the Geloso StenOtape Dictating Machines, Tape Recorders, Amateur Transmitters, Amateur Receivers, Microphones, AM/FM Radios, FM Tuners, and some electronic components.

Raytheon factory officially opened

A new electronics plant was dedicated at Waterloo, Ontario, recently by the Honorable Raymond O'Hurley, Minister of Defense Production, with the official opening of Raytheon Canada Limited's new headquarters.

Built to house the expanding activities of the firm, the new 34,000-square-foot, single-storied brick headquarters combines under a single roof the marketing, engineering, production, sales and management functions formerly located in three separate sites in the Waterloo-Kitchener area.

Located on a 25-acre tract, the new \$400,000 building investment is the latest milestone in Raytheon Canada's

Blonder-Tongue acquires Benco Television

Blonder-Tongue Laboratories, Inc. have acquired controlling interest in Benco Television Associates, Ltd. of Toronto.

The Benco is Canada's oldest and largest firm in the community and master antenna field, and markets a wide variety of other industrial electronic products.

Blonder-Tongue is a leading U.S. producer of equipment for community and master antenna installations, as well as antenna boosters, UHF converters and AM/FM radios.

The two firms have major distribution in both countries.

In a joint statement just released Blonder-Tongue Board Chairman Isaac S. Blonder and Philip Freen, president of Benco, said that the new affiliation is significant in pointing up Canada's increasing importance in manufacturing and marketing, particularly in the electronics field.

rapid progress, John R. Cann, executive vice-president and general manager, pointed out.

Formed in 1956 with only three employees, the firm now has 190 employees with a \$650,000 payroll and multi-million dollar sales.

In the past year alone, Mr. Cann stated, both payroll and number of employees have increased about 30%.

If proposed plans are achieved, Mr. Cann continued, Raytheon Canada in 1963 will have an annual payroll of more than \$1 million. Employee count will rise to about 270, and sales volume will more than double today's figures.





Completely
CANADIAN MADE

 **PANEL
MEASURING
INSTRUMENTS**

 **PORTABLE
AND LABORATORY
INSTRUMENTS**

 **ELECTRONIC
INSTRUMENTATION**

Only a complete Canadian instrumentation facility can offer the kind of service Canadians need. Bach-Simpson Ltd. is complete — in research, design, tooling and manufacture.

If our standard line of instruments, complete as it is, won't meet your requirements, ask us to demonstrate the unique combination of skills we can offer in the design of specialized instrumentation to meet your specific problem.

Others have, and have been completely satisfied!

Bach-Simpson
LIMITED

JA 5187

C RTPB newsletter

Prepared by Canadian Radio Technical Planning Board

Precision Approach Radar For Malton

Transport Minister George Hees has announced that a precision approach radar (PAR) will be installed at Toronto's Malton Airport this fall, and is being proposed for several other major Canadian airports in the next four years.

The equipment at Toronto will complement the Transport Department's existing surveillance radar which enables air traffic controllers to guide aircraft to a point from which pilots may complete their landing by reference to their instruments.

The new equipment will provide the air traffic controllers with highly accurate and detailed information on the position of an aircraft on its final approach to the runway. With this information the controller directs the pilot by radio, enabling him to stay both on course and on the glide slope to the touchdown point. This method is particularly valuable when visibility is reduced by precipitation or fog.

Activity On Split Channelling

All Sponsors and Committees have been notified of a letter received from the Director, Telecommunications and Electronics Branch, Department of Transport, F. G. Nixon, which explains that the Department is extending the frequency range of Radio Standards Specifications 126 and 127 to cover the full band 150.8 to 174 Mc/s to apply to certain areas along the Canada-United States border. The effective date was September 1st, 1960.

The Department has now combined and re-issued these specifications as Radio Standards Specification 126, Issue 2, **Provisional**. There is no change in the technical requirements of the replaced specifications except that the frequency range has been extended. The introduction of this new issue will not affect in any way type-approvals previously granted under the replaced specifications. The Land Fixed and Mobile Committee is meeting on September 28th at the Board of Trade Building, Toronto, and the main item on the agenda will be the discussion of the Recommendations on the Department of Transport Radio Standards Specifications mentioned above.

Will Beam Signal To North Pole

The first CBC radio station north of the Arctic Circle will go on the air by November of this year. The new station, CHAK, will have a power of 1,000 watts and will be located at Inuvick in the Northwest Territories, 1,200 air miles north of Edmonton.

The station equipment travelled 3,500 miles by truck, train, and barge from the manufacturer's plant in Toronto. The studio will be located in the center of the townsite and the transmitter and 190 foot mast a mile and a half away on the road to the airport.

This is the first time that a Canadian radio station will be broadcasting regularly in the Eskimo language.

Dot Index Of Land Mobile Assigned Frequencies

The CRTPB Vice-President, C. J. Bridgland, has announced the receipt from the Department of Transport of a data processed list of Radio Frequency Assignments for Fixed and Mobile Radio Stations, dated July 19, 1960. The list was presented to the Canadian Radio Technical Planning Board by the Department for reference at the headquarters, 200 St. Clair Avenue West, Toronto, Ontario.

The General section of the list covers all Fixed Stations, including "Point-to-Point", and Mobile Base Station functions are included in three volumes: (A) 30-50 Mc/s, (B) 150.8-174 Mc/s, and (C) 450-470 Mc/s. Broadcast Stations, Microwave Relay, and other fixed stations are also included in this grouping and could be requested under the appropriate frequency band if sufficient need arises. Detailed Information for Fixed and Base Stations includes the assigned frequency, the date in service, the call sign, and the name of the station.

SORTING...

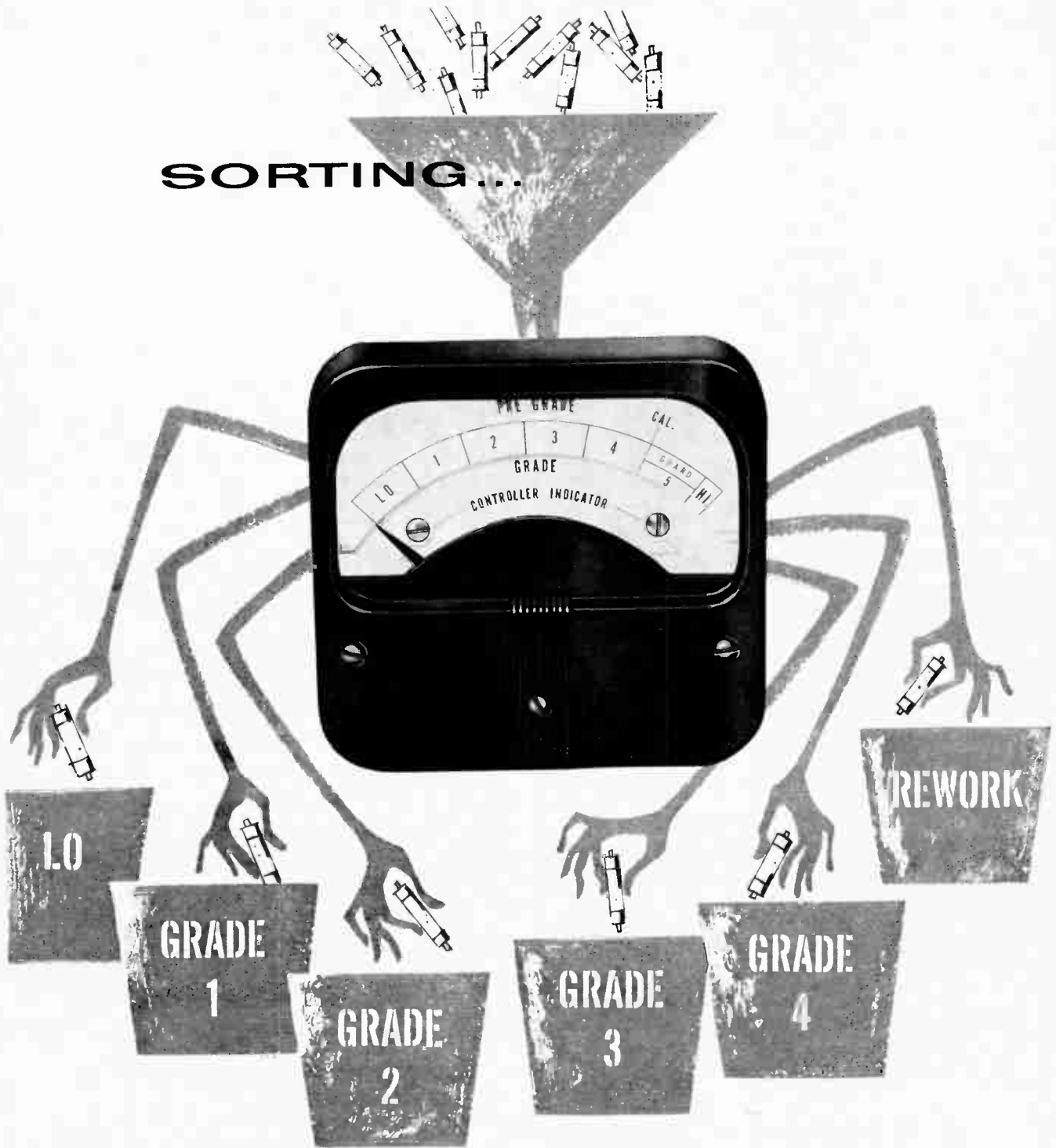

with speed, reliability, accuracy using Bach - Simpson Controller Indicators

No, it isn't quite as simple as this! But how many times have you come up with a terrific idea, only to find that the key element, the device that translates *information into action*, just doesn't exist in the form you require?

The versatility of the Controller Indicator allows its adaptation to a great variety of applications, encompassing limit control of voltage, frequency

or temperature, selection and grading (through a unique memory facility) and timed process control.

Bach-Simpson Limited will welcome the opportunity to assist you in the design of a system to solve *your* problem.



1255 BRYDGES STREET, LONDON, ONTARIO

For complete details check No. 8 on handy card, page 67

BEST TEST SET YET!

For fast, foolproof measurement of GAIN, LOSS, VSWR, Q, X_L , X_C , Z

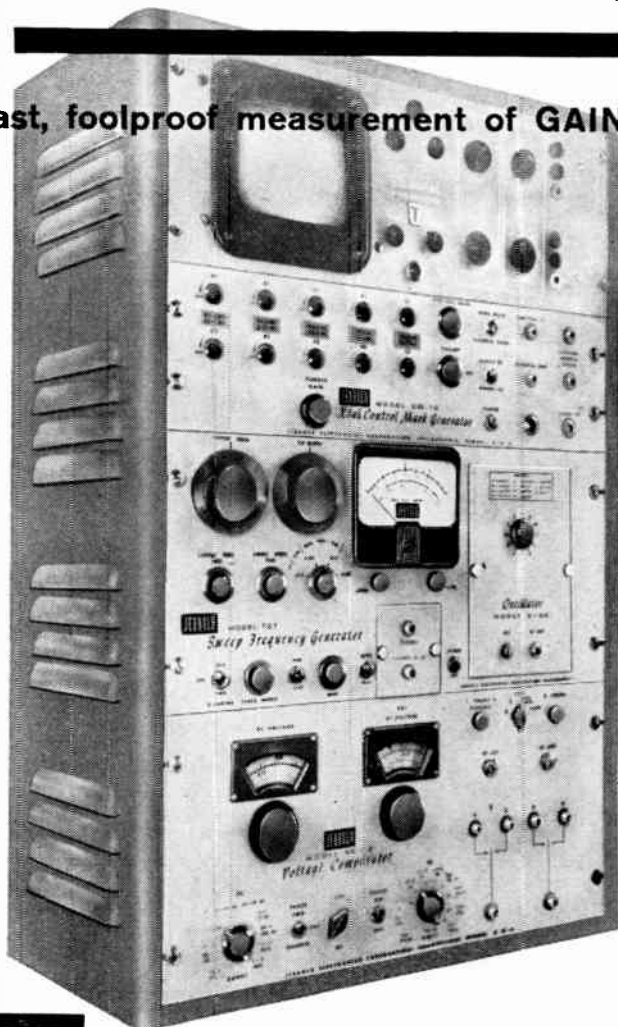

Crystal Controlled Marker Generator

Model CM-10—A 10-crystal unit producing any selected fundamental and/or harmonic frequencies. Each oscillator has its own independent amplitude control. Features built-in scope pre-amplifier and VSWR filter.

Precision Sweep Generator

Model 707—The heart of the test set. Features an extremely flat RF output ($\pm 5/100$ db) and variable rate, all electronic sweep with plug-in oscillators available covering 2 to 265 mcs. Provisioned for use with an X-Y plotter.

Accurate Voltage Comparator

Model VC-12 — The unit that makes Measurement By Comparison possible. A 3-section instrument that contains regulated DC and RF voltage supplies and a wide band coaxial comparator for the simultaneous visual presentation of reference standards against which the test information is compared.

Model 1707 Price **\$1,570.00**
(Oscilloscope, rack, or recorder not included)

JERROLD

MODEL 1707

Complete RF TEST SET employs the **Measurement By Comparison** technique

Interested in more than one frequency . . . an entire band, octave, or spectrum? Now it's no longer necessary to employ the slow, tedious, point-by-point method of measurement when working with a spectrum of frequencies. Jerrold's new 1707* test set will do the same measurement job *Faster*, more accurately, and with fool-proof results. Featuring the **Measurement By Comparison** technique, the model 1707 provides a continuous visual presentation and self calibration against precision standard attenuators (and/or accurate DC and RF voltage sources referenced against a standard cell). So, whatever your laboratory, production, or field needs—Jerrold's sweep frequency **MBC** method will serve them better.

Write today for complete catalog and technical newsletter series on *MBC* procedures.

JERROLD

ELECTRONICS (CANADA) LTD.

50 WINGOLD AVENUE, TORONTO 19

Jerrold Electronics Corporation, Industrial Products Division, Dept. ITE-77, The Jerrold Bldg., Phila. 32, Pa.

PRICES F.O.B. PHILADELPHIA — F.O.B. TORONTO PRICES ON REQUEST

* Similar test sets available for other ranges

For complete details check No. 32 on handy card, page 67

a *Genie at your command—*

the **CALL** director



The 30-button CALL director helps secretaries handle more calls, streamlines office operation.

From Northern Electric comes a new-style genie . . . the CALL director telephone. It's the versatile virtuoso of modern business communications. To reach many inter-office extensions—just press a button. To hold a telephone conference—just press a button. To connect outside calls to others—just press a button. The CALL director is available with 12, 18 or 30 buttons and many features to save precious business time.

The CALL director telephone is another step forward in the science of business communications by Northern Electric, who design and manufacture most of Canada's telephones and related equipment.



Northern's extensive experience in this field, along with their creative engineering and design personnel and modern manufacturing facilities are at your command. Branches are strategically located across Canada to serve you.

Northern Electric

COMPANY LIMITED

SERVES YOU BEST

2060-5

For complete details check No. 37 on handy card, page 67

ELECTRONICS AND COMMUNICATIONS, October, 1960

29

New Tab-Indicator Toggle Switch

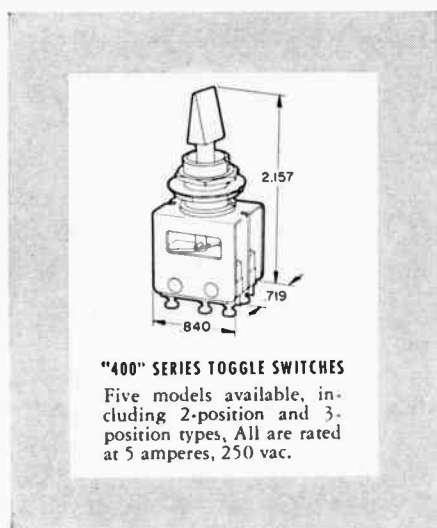
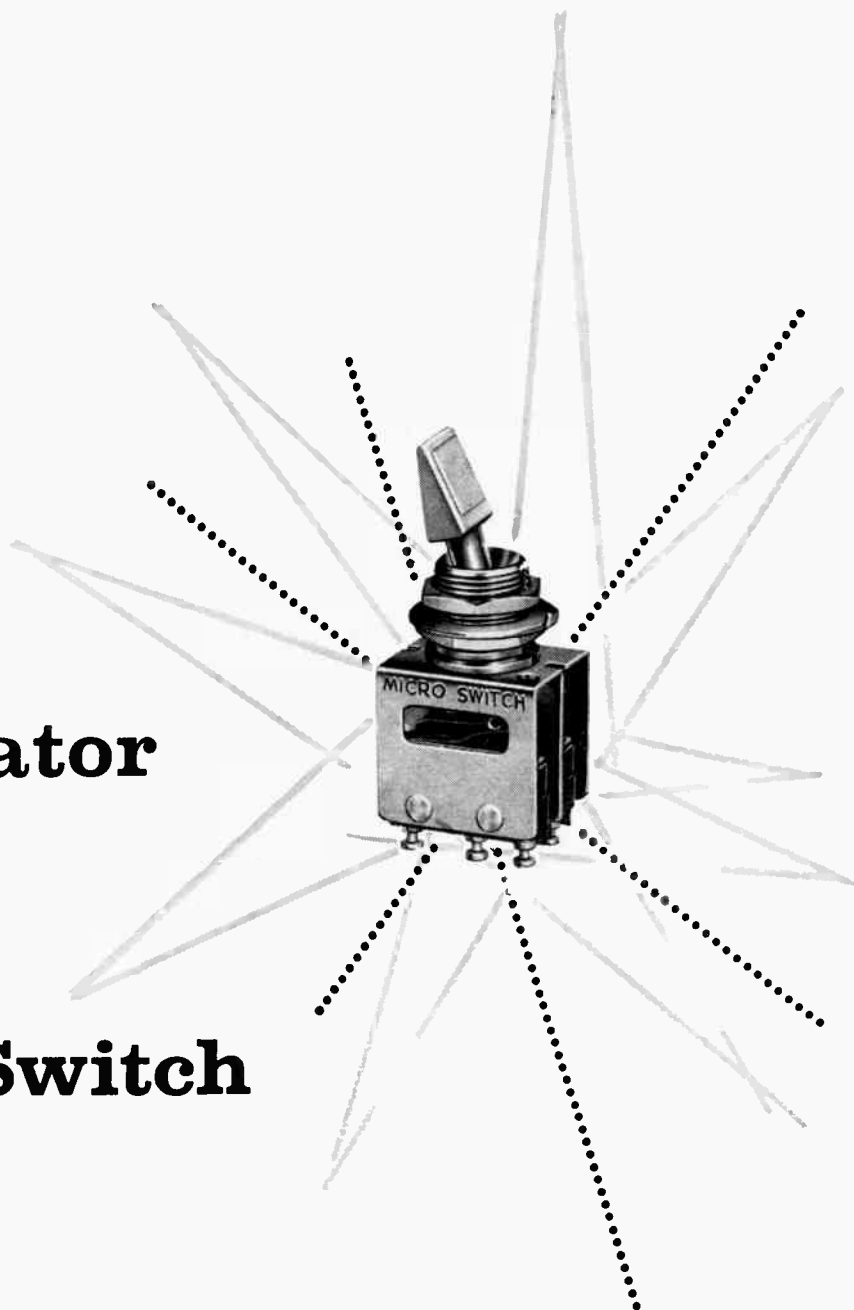

The new "400" Series Toggle Switch from MICRO SWITCH has a paddle-shaped tab which can be numbered or color-coded as an indicator. The standard model has a natural metallic finish which will maintain a fresh appearance through long and constant use. The anodized aluminum tab is also available in black or in colors.

The basic switches used are precision snap-action, long-life units, requiring a minimum of space. They conform to specifications for MIL-S-6743, with two isolated single-pole double-throw circuits. Turret terminals make wiring easy, and contact enclosures are dust-tight.

Five models are presently available in the "400" Series, including both momentary and maintained contact types. Write for Data Sheet No. 174 describing these new tab-indicator toggle switches.

For complete details check No. 26 on handy card, page 67



MICRO SWITCH Precision Switches



"ITL" Series



"4TL" Series



"ITL" Pull-to-Unlock



1-Pole "TS"



2-Pole Scaled "TS"



Hermetically Sealed Assembly



4-Switch Assembly

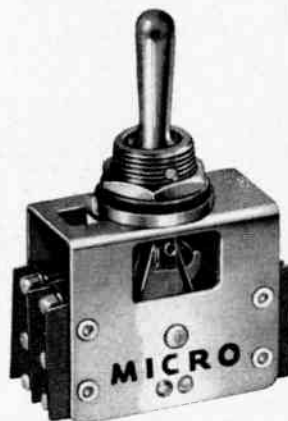

"Electrical Memory" Assembly

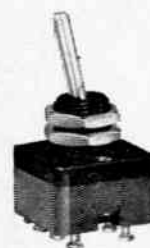

Subminiature "TM"

Precision Toggle Control Can Be Customized

MICRO SWITCH manufactures hundreds of different toggle switches and toggle switch assemblies. In this complete line you can find the exact characteristics and contact arrangements you need.

"TL" Series Silicone sealer between cover and case seals against dust or moisture. These switches are approved under MIL-S-3950A, operate in a temperature range of -85°F to $+250^{\circ}\text{F}$. Available in 1, 2 and 4-pole models with integral terminals.

"TS" Series The toggle lever is sealed against dust and moisture. "TS" toggles meet specifications for MIL-S-3950A. Special plastic barrier plus extra distance between terminals.

A keyed bushing prevents rotation. Wide choice of contact arrangements includes 1, 2, 3 and 4-pole types.

Subminiature "TM" Weighs only $4\frac{1}{2}$ grams, measures only $\frac{1}{2}'' \times \frac{1}{2}''$ at the base. Double-pole double-throw with wide temperature range and low circuit resistance.

"AT" Series Toggle Assemblies MICRO SWITCH offers toggle switch assemblies of up to 16 basic switches. Hermetically sealed types are also available.

For prompt engineering help on the selection of toggle switches, call the nearest Honeywell office or write Honeywell Controls Limited, *Precision Components Division*, Toronto 17, Ontario. Ask for Catalogue 73.



Honeywell

MICRO SWITCH Precision Switches

**The
one
who
can
"kill"
you
!**



Surveys show that an average of three to six men have a voice in recommending, specifying or approving an industrial purchase.

Any one of them may be able to swing the decision your way . . . or "kill" your chances completely.

Your salesmen simply cannot reach all the buying influences with a sales-clinching story. Good business paper advertising can do it for them for very few cents a contact.

One or more of the over 140 B.N.A. publications spe-

cializes in the particular market you want to reach . . . gets your message straight to the men who specify and buy.

Today, over 5,000 companies place their confidence and their advertising in business publications to the tune of \$30,000,000 per year. For most companies, business publication advertising is the most economical and most effective medium for influencing customers and prospects. Business Newspapers Association of Canada, 100 University Ave., Toronto 1.

6-5

THE BEST CANADIAN BUSINESS
PUBLICATIONS BEAR THIS EMBLEM



BUSINESS **N**EWSPAPERS

GET YOUR MESSAGE THROUGH CLOSED DOORS TO PEOPLE WHO SPECIFY AND BUY

TOP PERFORMANCE AT "BUILD-IT-YOURSELF"

Savings...

TEST INSTRUMENTS from **HEATHKIT**!



MODEL V-7A **\$36.95**
MODEL W-V-7A (wired) \$56.95

depended upon for maximum accuracy and stability. Battery and test leads included. Shpg. Wt. 7 lbs.

TUBE CHECKER KIT



HEATHKIT MODEL TC-3
\$55.95

This modern tube tester will check all tubes encountered in everyday radio and TV service work. Tube condition is indicated on an easy-to-read 3 1/2" meter. A neon bulb indicator shows filament circuit continuity and leakage or shorts between elements. Ten 3-position lever switches are provided to select individual tube elements for testing. Neat professional wiring and simplified construction is assured through a color-coded cable harness and easy-to-follow instructions. All parts supplied are of high quality for years of dependable service. Shpg. Wt. 12 lbs.

For a free catalogue listing more than 150 easy-to-build HEATHKITS, write —

DAYSTROM LIMITED

1480 DUNDAS HIGHWAY E., COOKSVILLE, ONT.

6048

For complete details check No. 15 on handy card, page 67
ELECTRONICS AND COMMUNICATIONS, October, 1960



get the shortest
etching time with

HUNT ETCHANTS



Wherever Hunt Etchants are used production rates jump. **HUNT R. C. E.** (Rapid Circuit Etch) is a fast acting, specially balanced etchant for printed circuit board production.

HUNT S. C. E. (Solder Circuit Etch) is the only prepared product formulated to etch solder-plated boards at room temperature without attacking the solder.

Send for: **R. C. E. TECHNICAL BULLETIN 1 & 1A**
S. C. E. TECHNICAL BULLETIN 3

FOR SUPERIOR RESULTS AROUND THE CLOCK USE HUNT GRAPHIC ARTS CHEMICALS

PHILIP A. HUNT COMPANY (CANADA) LTD.

207 QUEEN'S QUAY WEST
TORONTO 1, ONTARIO
TELEPHONE EMPIRE 3-5456
MONTREAL SALES OFFICE
TELEPHONE WE 2-3607



For complete details check No. 28 on handy card, page 67



(CANADA) Ltd.

*takes pride in announcing receipt of
an exclusive manufacturing franchise granted by*

Burnell & Co., Inc.

*leading U.S. manufacturer of electronic filter networks and delay lines. This
franchise covers Canada, Great Britain and other Commonwealth areas.*

Edo (CANADA) Ltd.

Cornwall, Ontario

For complete details check No. 17 on handy card, page 67



foremost in design and performance

RADIO COMMUNICATIONS

**HF, VHF AND UHF EQUIPMENT FOR FIXED
AND POINT TO POINT SYSTEMS
AM AND FM VHF MOBILE SYSTEMS
PORTABLE LOUDSPEAKING EQUIPMENT**

*See us at Booth 40,
I.R.E. Communications Symposium.*

PYE CANADA LIMITED

Head Office: 84 Northline Rd., Toronto 16

For complete details check No. 41 on handy card, page 67



EXTRA QUALITY AT NO EXTRA COST WITH BENDIX TRANSISTORS

Bendix Bulletin



Up-to-the-minute news about transistors

NEW DRIVER TRANSISTORS SWEEPING THE FIELD

Extra-versatile Bendix units beat high costs, design limitations over wide front

Called the "workhorse of the transistor industry," the new Bendix* Driver Transistor series is winning the nod from more and more engineers daily. These men find it the answer to audio frequency and switching applications requiring extra performance without extra cost.

Here is a special device for use where reliability, versatility, and low cost are primary requirements. The Bendix units combine higher voltage rating and high current gain with more linear current gain characteristics for low distortion and more efficient switching.

They're now in high production for rapid delivery in JEDEC TO-9 packages.

NEW BENDIX SEMICONDUCTOR CATALOG on our complete line of power transistors, power rectifiers, and driver transistors available on request. Write SEMICONDUCTOR PRODUCTS, BENDIX AVIATION CORPORATION, LONG BRANCH, N. J. For information about employment opportunities write personnel manager.

*TRADEMARK

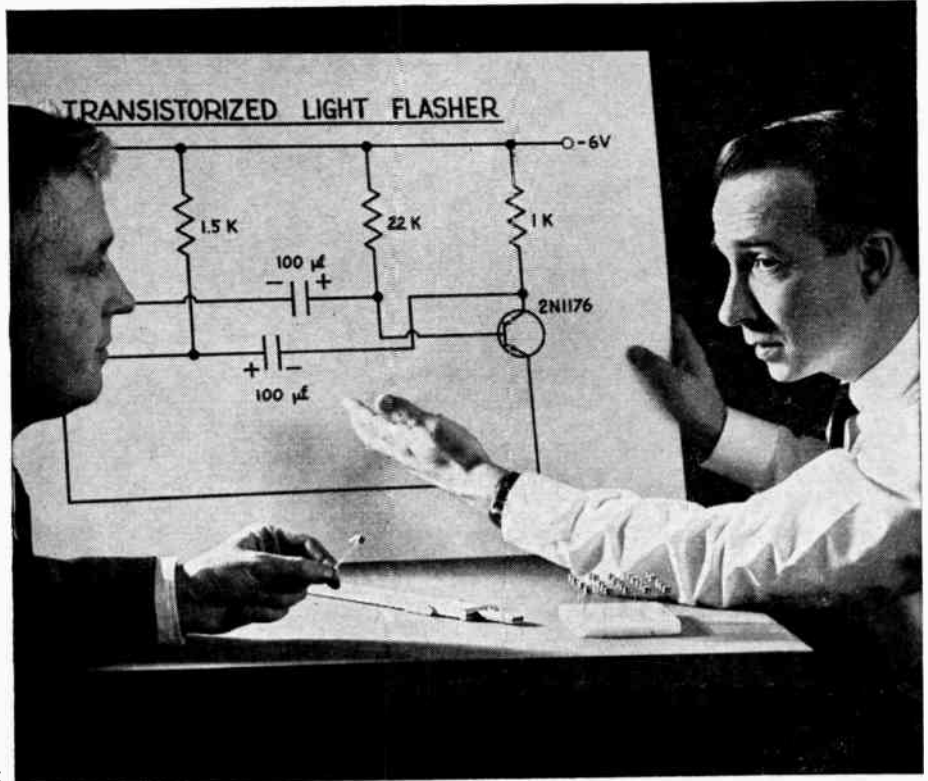

ENGINEERS KNOW the new Bendix Driver Transistor line-up meets an unusually wide range of circuitry applications. Bendix Applications Engineering Department suggestions on circuitry problems are helpful, too.

APPLICATION, PERFORMANCE DATA INDICATE BROAD USAGE

TYPE NUMBERS	MAXIMUM RATINGS					TYPICAL OPERATION		
	V _{ce}	I _c	P _c	T _j	T storage	h _{fe}	f _{αB}	V _{ce} (Sat)
	Vdc	mAdc	mW	°C	°C	I _c = 10 mAdc	I _c = 100 mAdc I _b = 10 mAdc	
2N1008	-20	300	400	85	-65 to +85	90	1.2 mc	0.15 Vdc
2N1008A	-40	300	400	85	-65 to +85	90	1.2 mc	0.15 Vdc
2N1008B	-60	300	400	85	-65 to +85	90	1.2 mc	0.15 Vdc
2N1176	-15	300	300	85	-65 to +85	65	1.2 mc	0.15 Vdc
2N1176A	-40	300	300	85	-65 to +85	65	1.2 mc	0.15 Vdc
2N1176B	-60	300	300	85	-65 to +85	65	1.2 mc	0.15 Vdc

Ideal for such applications as:

TRANSISTOR DRIVER • AUDIO AMPLIFIER (CLASS A OR B)
POWER SUPPLY • SERVO CONTROL • AUDIO OSCILLATOR
MOTOR CONTROL • RELAY DRIVER • POWER SWITCH



COMPUTING DEVICES
OF CANADA LIMITED
P. O. BOX 508 • OTTAWA • CANADA

For complete details check No. 13 on handy card, page 67

NEW VENTURES BEGIN HERE



In the modern laboratories of Northern Electric, new concepts in communications are constantly taking shape. Each project is approached with vigour, as a new and challenging venture, by a skilled research and development team — a group of men who keep their minds poised and eager to pioneer new techniques and improve established products — transistors, electronics, microwaves, carriers, video and audio.

At Northern Electric, research and development are setting the pace in the science of communications.

Research and Development Laboratories

Northern Electric

COMPANY LIMITED

SERVES YOU BEST

AAAS-13

For complete details check No. 38 on handy card, page 67

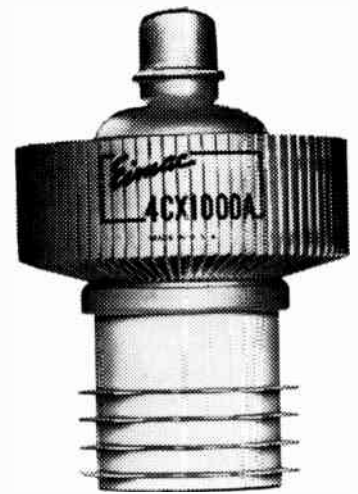

Now... Eimac tubes off the shelf to you



Eimac's distributor policy offers you the fastest possible service on advanced Eimac electron tubes. Because every authorized dealer now keeps a full stock of tubes on hand, quick local delivery is assured. Your order is filled as quickly as a tube can be taken off the shelf!

Canadian Electronics Limited
109 Street at 107 Avenue
Edmonton, Alberta
Telephone: GA. 4-6451.

Payette Radio Limited
730 St. James Street West
Montreal, P.Q.
Telephone: UN. 6-6681.

Electro Sonic Supply Company
Ltd.
543 Yonge Street
Toronto 5, Ontario
Telephone: WA. 4-9301.

L. A. Varah Limited
1451 Hornby Street
Vancouver 1, B.C.
Telephone: MU. 1-0104.

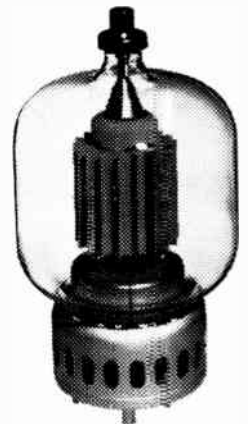
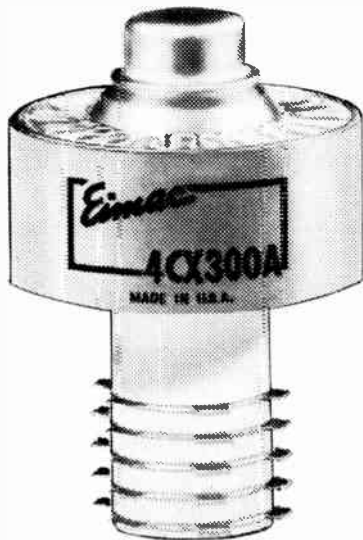

Visit the Eimac booth at the Montreal Symposium

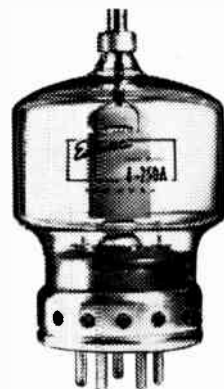

EITEL-McCULLOUGH, INC.
San Carlos California
The World's Largest Manufacturer of
Transmitting Tubes

Canadian Representative: **R. D. B. SHEPPARD** 2036 Prince Charles Rd., Ottawa 3, Canada

For complete details check No. 18 on handy card, page 67

ELECTRONICS AND COMMUNICATIONS, October, 1960

6008

37

The widest choice of "Off the Shelf" BARRIER TERMINAL STRIPS available in Canada!

300 SERIES

TAKES UP TO 6 CONNECTIONS
PER TERMINAL IN ANY DESIRED
ARRANGEMENT

- Accepts all standard types of solderless connectors
- Lends itself to automatic and semi-automatic assembly
- Base supplied in a variety of materials
- Commercial ratings up to 30 amps.—2500 volts

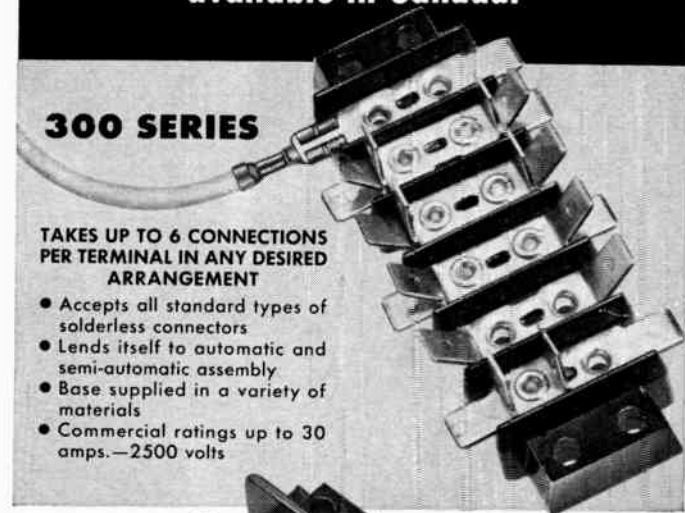

500 SERIES C.S.A. APPROVED

- Supplied with up to 31 terminals
- Accommodates a variety of connectors
- Terminals produced to customer specification
- Wide range of mountings
- Commercial ratings up to 30 amps.—4000 volts

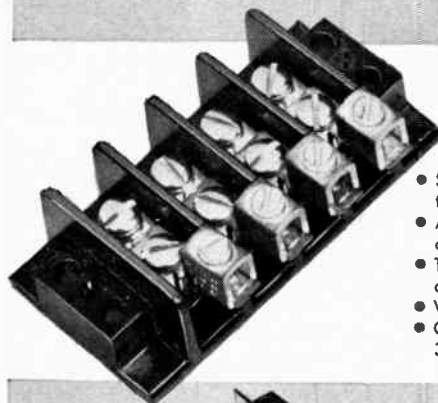

100 SERIES A WIDE RANGE TO CUSTOMER SPECIFICATIONS

- Models with 3 standard types of soldered terminals
- Available as special configurations supplied for customer's own application
- Commercial ratings up to 30 amps.—2500 volts

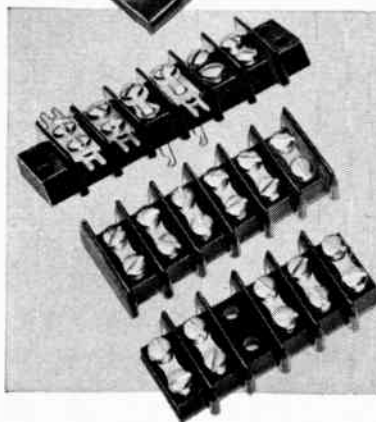

Write for H. B. Jones Division
Catalogue for detailed information
on Barrier Strips, Fanning
Strips, Plugs and Sockets, and
Terminal Panels.



UNITED-CARR

MAKER OF **DOT** FASTENERS

H. B. JONES DIVISION
UNITED-CARR FASTENER COMPANY OF CANADA LIMITED

231 Gage Avenue North, Hamilton, Ontario
Sole Offices: Hamilton, Toronto, Montreal

For complete details check No. 55 on handy card, page 67



DYNAMIC MUTUAL CONDUCTANCE



TUBE TESTER

(VALVE CHARACTERISTIC METER)

Completely analyzes practically all receiving tubes and many small transmitting types.

Will provide you with: complete tube characteristic measurements... plate, screen and grid currents... amplification factor, plate resistance... mutual conductance... interelectrode insulation measurement in megohms... breakdown of cathode or heater to other electrodes in megohms... cathode-heater insulation in megohms... heater continuity... quick "Good/Bad" reading... overload cut-out.

Designed to meet progressive trends in tube development.

R.H. **Nichols** LIMITED 584

4544 DUFFERIN STREET, TORONTO

TORONTO MAIL:
P.O. Box 500
DOWNSVIEW, Ontario

VANCOUVER
624 Vancouver Block
736 Granville Street

For complete details check No. 34 on handy card, page 67



compact, portable
easy to operate

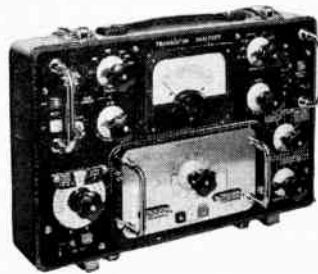

TRANSISTOR ANALYZER

A battery-operated instrument for checking small signal and medium power transistors under normal operating conditions. Provides for use of external supplies. Both internal and external supplies can be monitored on the internal meter.

COLLECTOR VOLTAGE: 1.5, 3, 4.5, 6, 10.5 volts or external.

BASE CURRENT: 0-40 ma. in two ranges using internal supply.

COLLECTOR CURRENT: Can be measured to 1 amp in five ranges.

BETA: (h_{fe}) Measured at 1000 c/s in two ranges 0-25 and 20-250.

NOISE: Noise equivalent of transistor under test is directly indicated on the attenuator scale. Ranges are calibrated 1-20 and 20-40 db.

The internal meter ranges, amplifier, and oscillator are available for voltage and current measurement, signal tracing, etc.

R.H. **Nichols** LIMITED 601

4544 DUFFERIN STREET, TORONTO

TORONTO MAIL:
P.O. Box 500
DOWNSVIEW, Ontario

VANCOUVER:
624 Vancouver Block
736 Granville Street

For complete details check No. 58 on handy card, page 67

71A . . . a new family of light-route radio systems

by *Lenkurt*

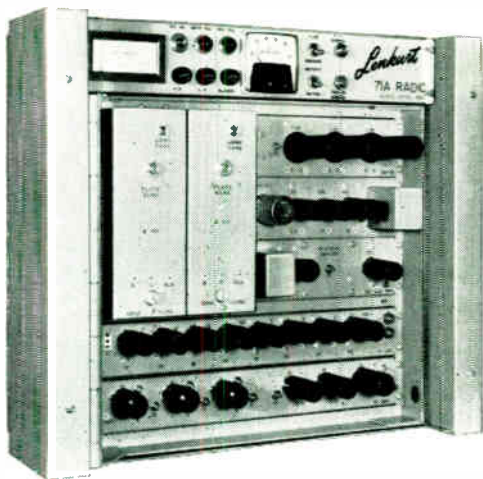

The new Lenkurt 71A light-route radio equipment is available for operation in the 150 mc, 450 mc and 900 mc bands. It provides toll-quality transmission of up to thirty multiplexed voice channels over distances of up to 500 miles or ten tandem repeater sections. Greater channel capacity can be obtained over shorter distances.

Designed for high-reliability service, the 71A utilizes proven circuit techniques, and rugged long-life tube types. The transmitter, receiver and power supply are in one compact unit requiring only 17½ inches of rack space. The front panel of the terminal hinges out to provide front access to all components.

Built-in metering facilities permit complete in-service performance testing and maintenance checks.

Transmitter power output and receiver noise alarms are provided including both local indication and facilities for connection to remote equipment.

Automatic transfer panels and combiners are available for applications requiring diversity operating standby, or hot standby systems. Service channel equipment including order-wire and supervisory units, is also available.

The Lenkurt 71A light-route radio equipment was designed and manufactured in Canada.

For complete information on this new light-route radio by Lenkurt, call or write any Automatic Electric office today.

6063

See Us at the Montreal I.R.E. Communications Symposium

AUTOMATIC ELECTRIC

Subsidiary of

GENERAL TELEPHONE & ELECTRONICS



REDUCE YOUR COSTS...

INTERCEPT PROFITLESS CALLS AUTOMATICALLY

With the new recorder-announcers by Automatic Electric, you can provide faster, more efficient service for your subscribers, and substantially reduce your operating costs as well.

The Type SCC for instance will serve up to 70 callers at a time. You simply record the required announcement by speaking into a standard telephone handset, and set the announcer for automatic operation. The unit consumes very little power even when transmitting to all 70 callers, and it is designed for extreme dependability with negligible maintenance.

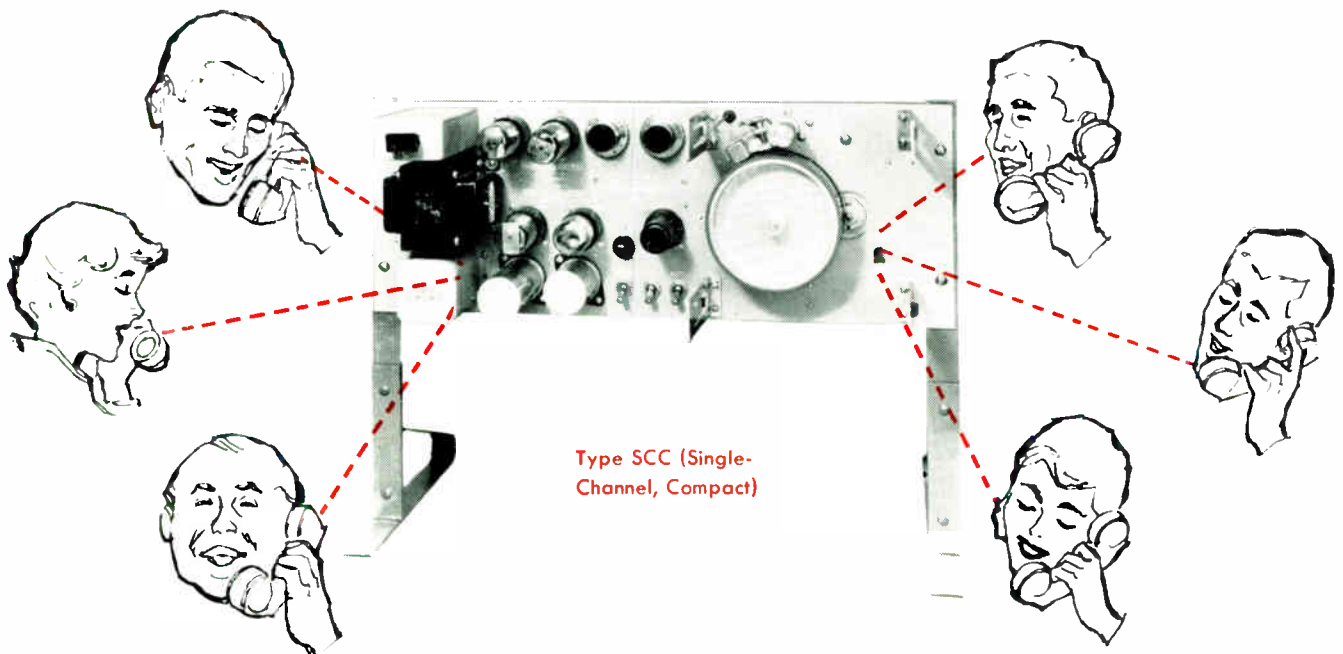

Type SCC (Single-Channel, Compact)

The Type MCF provides repetitive services such as interception of calls to disconnected lines, dead levels, etc. It will repeat up to five messages to a maximum of 70 callers, simultaneously.

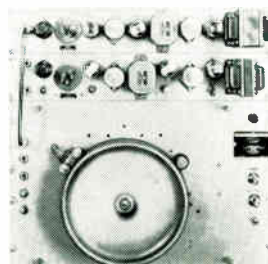

Type MCF (Multi-Channel, Fixed Message Length)

Keep your operators free to handle revenue-producing calls. Ask for complete details on recorder-announcers by Automatic Electric today.

INCREASE YOUR REVENUES...

SELL YOUR SUBSCRIBERS AUTOMATIC DIALING

The Kilburg Dialaphone is a popular and valuable time saver for hard-pressed business executives—and a useful source of extra revenues for telephone companies as well.

It provides a handy, built-in directory of up to 850 most-used and most-important telephone numbers, chosen by the subscriber—and any number can be selected in a second and dialed automatically. To put through a call, the subscriber simply turns a crank till the required name appears in the view-frame, listens for the dialing tone, and presses a button.

The Dialaphone can save hours of time and irritation. Offer this welcome, modern telephone convenience to your subscribers. Call or write any Automatic Electric office for details.

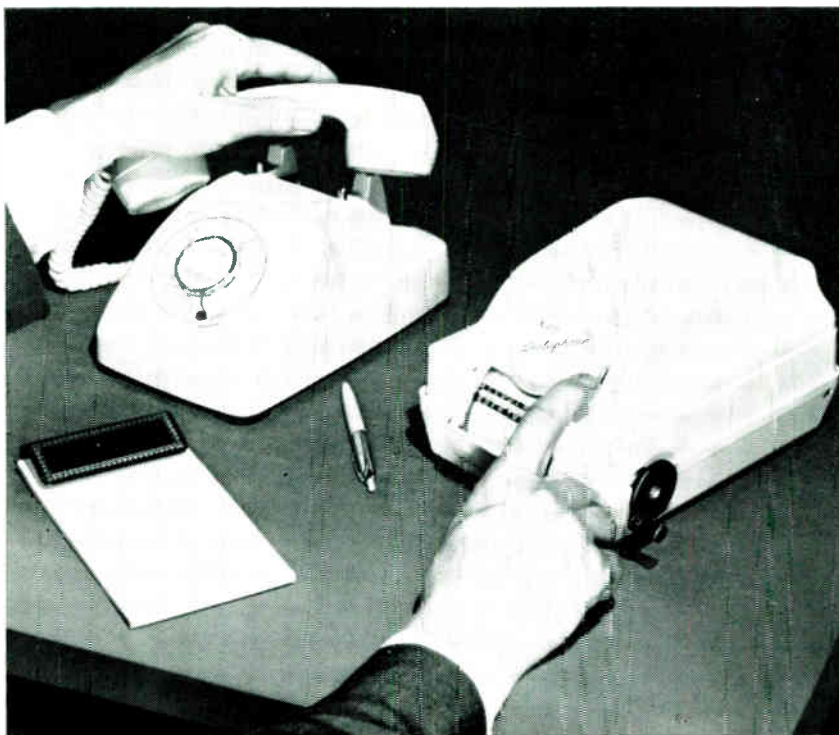

The Dialaphone—no bigger than a telephone, neat, trim and compact. It is available in 10 pleasing colours to meet every requirement.

AUTOMATIC ELECTRIC



Subsidiary of

GENERAL TELEPHONE & ELECTRONICS

6059

**CHARACTERISTICS THAT DETERMINE
RELAY SELECTION.....NO. 5**

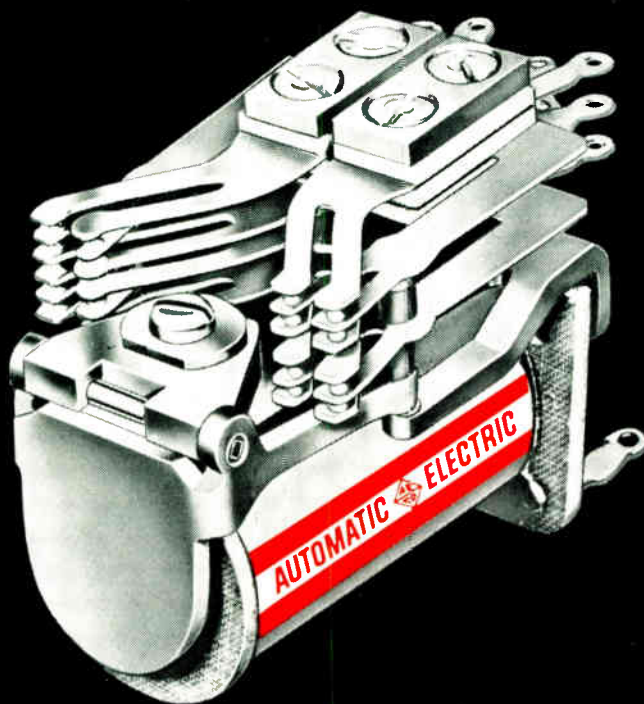

Class E—light, compact, rugged and completely reliable.

**where telephone type features are required,
with minimum size and weight**

**Helpful selection data
Class E Series**

OPERATING VOLTAGE

Up to 220 volts d.c. or a.c.

CONTACTS

Twin, Code 0-18 ga. make or break 135 watts. Large, single contacts are available for heavy duty.

CONTACT CAPACITY

Maximum of 13 springs per pile-up.

COILS

Single wound up to 20,000 ohms.
Multi-wound with up to three windings.

OPERATING TIME

Range, 0.002 to 0.050 sec.

RELEASE TIME

Range, 0.005 to 0.125 sec.

The Class E relay by Automatic Electric, is a miniaturized relay that provides the best of the telephone type relay features, with the least possible weight and space requirements. Its life is anything from 100 to 200 million operations, or more, and it has many features that are available for the first time anywhere in a relay of this size and shape.

Terminal spacing has been given particular attention for ease and speed of wiring, especially on the inside rows of terminals. The armature bearing and backstop design assure

maximum dependability, and "sag-off" is prevented by the rugged construction of the armature arm, so that the original contact adjustment and reliability are maintained permanently.

The Class E is ideal for many small size computer applications, and can be used for a variety of purposes where light weight is particularly important. If you would like further information, call or write Automatic Electric Sales (Canada) Limited, 185 Bartley Drive, Toronto, Ontario. Branches across Canada.

AUTOMATIC ELECTRIC



Subsidiary of

GENERAL TELEPHONE & ELECTRONICS

AN ORGANIZATION SERVING CANADIAN INDUSTRIES WITH COMMUNICATION AND CONTROL SYSTEMS

6046

For complete details check No. 7 on handy card, page 67



This is your copy of the

OFFICIAL PROGRAM

of the Montreal Section
Institute of Radio Engineers
Communications Symposium

*presented with the compliments
of Electronics and Communications*

Montreal Section IRE

Communications Symposium
Queen Elizabeth Hotel, Montreal,
November 4th and 5th, 1960

- Technical papers 44
- Time table for papers 49
- Exhibitors — personnel —
products 51

**electronics • and
communications**



an age publication

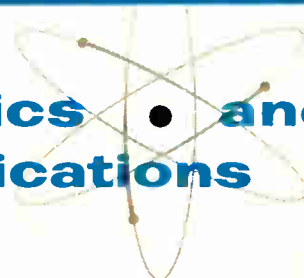

Technical Program

Montreal Section I. R. E. Communications Symposium

Queen Elizabeth Hotel — November 4-5, 1960

Paper (1)

CONTROL OF INTERFERENCE BETWEEN SURFACE MICROWAVE AND SATELLITE COMMUNICATION SYSTEMS

by

W. L. Firestone¹, S. G. Lutz²,
and Jack Smith³

Satellite technology is capable of expanding global communication capability by orders of magnitude, but only by sharing frequencies with earth-surface services which now occupy the spectrum. Co-existence principles⁴ are here applied to microwave links, as being illustrative of services employing horizontal high-gain antennas in frequency bands of interest. 600-channel active satellites in both stationary and 3000 mile circular orbits are considered, as well as a 60-channel passive (ECHO-type) system. The assumed minimum elevation for earth-terminal antennas is ten degrees. Actual antenna patterns are approximated by simpler 3-dimensional "keyholes".

Possible sources of interference are either "surface" (earth terminal to or from microwave) or "orbital" (to, from or via the satellite). All are examined for all three satellite systems and at 2.0 and 6.5 Mmc microwave frequencies. Methods of calculating interference levels are illustrated.



S. G. Lutz



Dr. W. L. Firestone

The surface problem, of siting high-power low-noise passive-satellite terminals and co-ordinating the adjacent microwave systems, may be worst but the vertical angle of terminal antennas prevents main-beam and reduces tropo-scatter interference. For a 16 Kw terminal transmission at 2Kmc to be 20 db below microwave receiver noise might require smooth-earth separation of 90 miles if the terminal is in the microwave main beam. This is reduced to 35 miles if microwave routes are dog-legged to not beam at the terminal. Protected terminal sites and local frequency co-ordination permit reduced separation.

Microwave main-beam interference with satellites can come only from a narrow ring at the satellite's horizon and from only the fraction of stations within this ring having their beams toward the satellite. Such interference would remain below receiver noise even with a 10:1 microwave growth. Integrated sidelobe interference from all stations in sight of the satellite is even less.

This beam-interference ring for a stationary satellite is fixed; an important advantage toward interference control. In fact, from any point on earth there are at most two horizontal directions intersecting the stationary orbit. Even with this orbit eventually filled with satellites, horizontal beam interference can be controlled by protecting these two directions.

1. Motorola, 2. Hughes Aircraft, 3. General Electric, 4. "On the Co-existence of Celestial and Terrestrial Communication" by S.

G. Lutz and F. A. Losee, Fourth National Aero-Com Symposium, Utica, New York, October 1958. Hughes Report No. OP-13, October 1958.

Paper (2)

THE MM-600 MICROWAVE SYSTEM

between

RIMOUSKI AND MT. CARLETON

N. M. Lopianowski, J. E. H. Elvidge, L. A. Martin
RCA Victor Company Limited

This paper describes the Rimouski-Mt. Carleton Microwave Television Relay System supplied to the Canadian National and Canadian Pacific Railway Companies by RCA Victor Company, Ltd., Montreal, Quebec.



N. M. Lopianowski

This system is the first one installed using the recently developed type MM-600 equipment operating in the 2 Kmc/s band. The paper begins with a general description of the system. The geographical layout, path profiles, and tower heights are dealt with briefly. The frequency plan of 9 rf channels, of which 5 belong to a parallel system owned by New Brunswick Telephones, is described illustrating the difficulties involved in arriving at the plan and the method of reversing one of the rf channels carrying television. The specially designed MM-600 antenna and the waveguide runs are discussed and photographs included of typical sites. Expansion capabilities and special switching arrangements for the future are mentioned. Block layouts of the system are shown.

A detailed description of the type MM-600 equipment follows with emphasis on the more interesting and unusual aspects such as the travelling wave tube transmitters and their ventilating system, the quadruplexers, and the transistorized service channel equipment. Some of the more important system and unit levels and gains are given. Photographs of various details of the equipment are included. The operation of the service channel equipment is explained with the aid of block diagram.



J. E. H. Elvidge



L. A. Martin

Because of the high quality of the MM-600 equipment special test equipment has been developed for maintenance purposes. Some of these special units and the testing procedures used are described.

The remainder of the paper presents the results of tests performed on the system. These tests include both video and message performance. Photographs of oscilloscope traces actually obtained on the system serve to illustrate the results of these tests.

Paper (3)

NEW CONCEPTS IN MOBILE RADIO DESIGN

Maurice A. Robbins
Canadian Marconi Company

Canada's population distribution and our national consciousness have combined to produce a set of communications requirements which are increasingly different from those of the United States.



M. A. Robbins

In recent years, radio licensing and frequency allocation procedures here have become divergent from U.S. practice, yet remain consistent with good international co-operation.

These factors are producing effects in many ways. Confining ourselves to the VHF Mobile Radio field, however, some of the more significant effects are as follows:—

a) Narrow band point-to-point service is common in the UHF region here, largely confined to the UHF region in the U.S.

b) Complimentary frequency allocations are made along the U.S. border while "individual merit" allocations are made in the interior.

c) The use of multi-frequency systems is common here and rare in the U.S.

d) The emphasis on fringe area performance here, particularly in the prairie mobile radio telephone service.

e) A thrifty interest in low maintenance costs and an increasing market for higher quality communications equipment.

f) A growing need for a compact mobile unit that can be easily adapted to multi-channel systems, used with selective calling and various group calling systems.

An intensive study has been made of service records of a mobile radio system, employing 800 mobile units. This information has led to a systematic evaluation of recurrent faults, and in many cases, sizeable reductions in their rate of occurrence.

The above information has been used to assist in the design of a new mobile unit, which should show a considerable improvement in reliability, over previous units.

Recent trends in automotive styling have led to a versatile packaging arrangement. The new unit can be mounted in one, two, or three sections, the later two arrangements requiring interconnecting cables. This system permits greater adaptability to the various types of vehicles.

A brief description will be given of the outstanding circuit features of both transmitter and receiver. These include extensive use of transistors, high receiver sensitivity while maintaining 100 db spurious response attenuation and a transmitter whose P.A. plate circuit efficiency has been increased to 80% (at 160 No).

Multi-channel circuits will be shown, with automatic channel reversion and other system features.

OPENING LUNCHEON

Duluth Room

Friday, November 4

12.30 p.m. to 2.30 p.m.

**A TRANSISTORIZED
FREQUENCY SYNTHESIZER**

G. Husson and B. N. Sherman
Canadian Marconi Company
Montreal, Canada

A description is presented of an instrument providing 30,000 discrete frequencies between 2-32 Mc/s in steps of 1 Kc/s with the stability of the driving frequency standard. It will be shown how any number from 2,000 to 32,000 can be produced from the arithmetic processes of addition, subtraction, multiplication and division, with the most economical use of a set of readily available basic numbers. Practical electronic processes perform these operations.



B. N. Sherman

G. Husson

In particular, use is made of the phase locked loop principle. A variable frequency oscillator (VFO) covers the 2-32 Mc/s range and, for each desired frequency, a suitable arrangement of frequency conversion and filtering allows this VFO to lock on a fixed frequency directly derived from the standard. Thus no frequency error exists between the wanted frequency and the standard, since the comparison is made with a phase discriminator. Also, spurious signals and noise generated respectively by mixers and harmonic generators, are greatly attenuated, since the phase locked loop acts as an "active filter". In particular the "catching range" of an automatic phase control (APC) loop is examined and a method is shown whereby this catching range can be greatly increased by very simple and economical means.

Paper (15)

DATA SYSTEMS

P. Pascali
Northern Electric Company Limited

Digital data is normally transmitted over long distances by modifying the characteristics of a sine wave by modulation techniques. To date, four modulation systems have been proposed.

1. Frequency Modulation
2. Phase Modulation
3. A.M. Double Sideband
4. A.M. Vestigial Sideband



P. Pascali

A common feature to all systems is that the transmitting and receiving terminals must be operated in synchronism. To achieve this, different synchronizing signals are employed in each modulation system. The performance of these systems is measured by the rate of transmission and rate of error.

The signal in any system may be broken into three components:—

1. "Synchronization" — to indicate word or message separation.
2. "Data" — or the actual message format.
3. "Timing" — to mark out successive bit intervals in the signal.

The Vestigial Sideband method was adopted in the SAGE System mainly due to the high transmission rate attainable. In this system the signal is sent over the lines at different levels and as such is immune to impulse noise and ampli-

the Vestigial
the use

rate in this system is in the range of 600 bits/sec.

The most reliable system is frequency shift. It has an advantage over A.M. methods as a result of its immunity to impulse noise and level variations. This modulation method was adopted for B MEWS, an all transistorized and highly reliable system. F.M. systems have a disadvantage in that the maximum transmission rate attainable is about 1000 bits per sec. The carrier frequency lies in the range of 1500-1800 cycles and the frequency difference between mark and space must be equal to the bit rate in order to avoid inter symbol interference.

In B MEWS three oscillators are used to derive the three frequencies i.e. carrier, mark, and space.

Development is presently underway on phase modulation systems for high speed reliable data transmission. This is achieved mainly due to a more effective utilization of the voice frequency bandwidth. In such systems, however, synchronization between transmitter and receiver is absolutely essential.

The system briefly described herein, and commercial applications of these principles are the basis for the talk on "Data Systems".

Paper (16)

**A NEW ELECTRONIC TUBE,
THE LECTRON**

Jean-Charles Bernier
Ecole Polytechnique, Montreal

The LECTRON, as its name suggests, is an electronic tube intended for "reading" magnetic tape.



J. C. Bernier

In one method of video recording on magnetic tape, the signals are written and read by cross-wise scanning of the tape with multiple high speed rotating heads.

For many reasons (tape wear, synchronizing difficulties, cost of equipment), it would be advantageous to read the tape by purely electronic means, without the use of high speed mechanisms. Such a process would also greatly facilitate monitoring and editing of recorded video programs.

For the above motives, a new electronic tube the LECTRON has been developed in the "Laboratoire d'Electronique Appliquée", Ecole Polytechnique, Montreal.

Other methods have been previously described for reading recorded tape by electronic means, but their use is limited to lengthwise recorded tape.

Our LECTRON involves the action of the recorded dipole fields on a beam of photo-electrons by means of an appropriate electrode arrangement.

A number of prototype LECTRONS have been developed and have shown promising results; our tubes and associate equipment are relatively simple.

We have considered the application of the LECTRON mainly to video recording but it seems possible that it may also be useful in other fields such as computing and control devices.

The lecture will be given by Mr. J. C. Bernier and Messrs. P. J. Piché and R. P. Langlois will take part in the discussion.

Paper (17)

**THE TRANSISTORIZED
THYRATRON RING COUNTER**

Joseph A. Pecar
University of Detroit, Detroit, Michigan

In spite of the fact that many different types of ring counters are presently available, none of these seem to possess all of the features which would make them truly flexible.



J. A. Pecar

The characteristics normally sought in a ring counter include: high frequency response, good driving capabilities, and a considerable latitude with respect to the number of possible stages. Add to this, the further requirements of low voltages for

transistor circuit applications, and virtually all of the currently available types are eliminated.

This paper describes a recently developed ring counter which satisfies the above requirements and others as well.

The bi-stable element of the "Transistorized Thyatron Ring Counter" are PNP (or NPN) configurations, made up from two separate transistors. Individual transistors were used in three elements so that each stage could be temperature stabilized and so that anti-saturation circuit techniques could be employed. As a result the operation is practically independent of ambient temperature conditions and operating frequencies as high as one megacycle can be attained with general purpose, germanium, switching transistors.

The interstage capacitive storage components found in ordinary ring counters have been replaced by "interstage transistors". This arrangement eliminates the necessity of any capacitors in the circuit whatsoever and allows the upper frequency response of the ring counter to approach the intrinsic capabilities of the particular transistors utilized.

All of the bi-stable elements are connected to a common anode resistor which is selected so that it will pass enough current to sustain conduction in only one stage. Hence, one stage alone can be conducting at a given time and no bias current is demanded from that stage to keep the remaining bi-stable elements nonconducting. Theoretically, then, the number of stages which can be assembled in a single ring is unlimited. (I_{cc} considerations do impose a practical limit.)

Since the PNP configuration yields a "thyatron type" operation, each stage is capable of driving a considerable load. (Approximately 10MA/stage for the ring counter illustrated.)

An additional feature can be realized when two interstage transistors are employed per stage. If one of these transistors is connected to a preceding stage, and the other to a proceeding stage, the conducting stage can be made to proceed in either direction. This "backward-forward" operation provides an added facility for obtaining the difference in numbers of pulses from two sources.

The ring counter described is an all semiconductor device and as such, will operate on nominal transistor supply voltages. The many operational features, the reproducibility and the already wide acceptance of the "Transistorized Thyatron Ring Counter" indicate a bright future for this unique device.

A patent is being sought.

Paper (18)

**A SOLID STATE SELECTOR
FOR TELEPRINTER CIRCUITS**

T. C. Rankin
Canadian Aviation Electronics Limited,
Montreal

The solid state selector was developed to modernize existing teleprinter plant and to permit the use of low cost printers in circuits where selection is required. However, its applications can be extended to include message routing signal regeneration and others. The circuitry involved has been designed so that the major component of the selector can be used for such applications as error detection where small amounts of computation are involved.

Two basic transistor circuits are used in the selector, the resistance coupled NOR circuit and flip-flop. These are arranged in groups on printed circuit boards and wired as required for the particular application at the printed circuit connector.

A separate printed circuit board contains the miscellaneous circuits such as the trigger for coupling the line to the selector, the pulse generator for timing amplifiers for driving selector magnets and relays, and a flip flop and gates for control.

Emitter follower circuits are provided where a large number of NOR circuits are to be driven from one flip flop and for additional relay drivers.

All circuits were designed using "Worst Case" methods. That is all circuits must operate satisfactorily under the worst extremes of all components and voltage at the worst extremes of temperature.

A selector can be divided into three main parts: The control and timing circuits, a six bit shift register to convert the serial signal to parallel for use by the selection gates, and finally, the selection circuits. The input and output circuits are included with the control. These are considered in detail including circuit and physical design.

Technical Program

Further uses of the basic equipment are also considered. In particular, the details of an error detection system are discussed.

In the design of this type of equipment reliability and error free operation is paramount. This has been achieved by use of reliable components, and using the minimum number of components. The result is a calculated mean time to failure of over two and one half years.

Paper (19)

MINIATURIZED SOLID STATE DEVICES FOR COMMUNICATIONS SYSTEMS

John Clark

Sperry Microwave Electronics Company, Clearwater, Florida

There have been many recent advances in the development of miniaturized ferrite coaxial isolators and coaxial Y-junction circulators. These advances have resulted in new devices with exceptional features that are now becoming available for the use of the systems engineer. Other devices that offer promise for the near future are miniaturized UHF strip transmission line isolators, solid state limiters, parametric amplifiers, and solid state switches. In this paper primary emphasis will be placed on the recent advances in the development of miniaturized isolators and Y-junction circulators.



J. Clark

From the standpoint of miniaturization of coaxial isolators, the most significant recent advance is an isolator design that eliminates the necessity for a bulky external magnet and, incidentally, solves the problem of magnet shielding. This "internal magnet" design will be described and the theory of its operation briefly discussed. Complete characteristics including size and weight will be presented in frequency bands of interest for communications purposes. Additional information will be presented on the temperature performance of these devices, including information on differential reflection coefficient under conditions of temperature change. Typical uses of these devices will be presented, along with some discussion of the system problems they solve.

Miniaturized coaxial Y-junction circulators are a more recent development than the "internal magnet" isolators. Sufficient time will be devoted to explaining the nature of their operation to give some insight into their limitations and possible applications. These circulators, in general, can be made with biasing fields that are either above or below ferrimagnetic resonance. The nature of each of these types of operation will be explained, and their implications for communications applications explored. The characteristics of operative devices in several bands will be presented. In addition to small size and exceptional ruggedness, these devices will be seen to demonstrate superior high power capacity and temperature stability. One circulator, for example, designed for operation in the 5.4 kmc to 5.9 kmc range, has been observed to maintain excellent electrical characteristics up to power levels of 25 kw peak power and 25 watts average power, and over the entire temperature range from -55°C to 125°C. Exclusive of connectors, but including permanent magnets, the device measures only 1.5 inches in diameter and 0.75 inches in height.

Paper (20)

THRESHOLD EXTENSION FOR A QUADRUPLE DIVERSITY TROPOSPHERIC SCATTER SYSTEM

P. S. Christensen

Northern Electric Laboratories

J. P. Wilde

Bell Telephone Co. of Canada

The IF bandwidth of an FM receiver is normally chosen to give equal intermodulation and thermal noise under average propagation conditions. In a tropospheric scatter system, the received signal level

fluctuates violently about the average so that any fixed IF bandwidth will only be the optimum choice for a small proportion of the time. Careful design of circuitry can insure that the intermodulation noise which is controlling during periods of high received signal level is kept within system requirements. In periods of poor propagation the thermal noise will raise sharply and may reach 30 db above intermodulation noise. Better overall performance will result if the receiver bandpass can be narrowed as the signal fades to reduce the controlling thermal noise.

While the above argument indicates that a continuously variable IF bandwidth is desirable the main advantage can be secured by automatically switching to a narrow IF bandwidth when the thermal noise becomes excessive. The reason for this will be explained. The paper discusses the choice of IF bandwidth for a system carrying 48 multiplex channels on a quadruple diversity scatter link, and describes the receiver block schematic for bandwidth switching on an already existing system.

The choice of the switching point is discussed with graphs illustrating the factors involved in assuring a smooth transition in the voice channel signal to noise curve during switching from broad to narrow band.



J. P. Wilde



P. S. Christensen

The paper concludes with experience obtained during the first installation on the Emeril/Knob Lake path of the Bell Telephone Co. Quebec-Labrador Scatter System. A tape recording to demonstrate the effect of threshold extension is available.

Paper (21)

AN AUTOMATIC COMPUTER-TO-COMPUTER COMMUNICATION SYSTEM FOR VOICE-BAND APPLICATION

David N. Lytle, Beckman Instruments Inc., Anaheim, Calif.

R. L. Ellsworth, Lockheed Aircraft Corp., Sunnyvale, Calif.

Digital communication over long distances using voice frequency facilities imposes severe accuracy, efficiency and cost requirements on these facilities.

An application exists where data must be collected, reduced and transmitted over long distances with an extremely high order of accuracy, speed and reliability. Data from many sources and of varied types is assimilated in several large random-access core storage units located throughout the world. Key data must be transferred between these locations with the probability of error introduced by the transmission system reduced to a minimum. In addition, routine alphanumeric traffic is handled between transmission of key data with less stringent error detecting requirements.

Any system used for this application must reduce the probability of undetected errors entering the system during transmission to a value less than that normally obtained in closed computer systems. The system must also possess a high transmission line utilization efficiency, and be capable of on-line computer-controlled operation. Feedback verification control is incorporated for automatic message handling and the control of repeating message blocks in error.

The system developed for this application transmits digital data over existing voice-band circuits. Because of the stringent technical requirements, the system incorporates a number of unique features designed to minimize the probability of undetected errors occurring in burst noise environments.

Paper (22)

SIMULTANEOUS TRANSMISSION AND RECEPTION WITH A COMMON ANTENNA.

W. V. Tilston,

Sinclair Radio Laboratories Limited, Downsview, Ontario

When two or more transmitters or receivers are connected to a common antenna it is necessary to provide a certain amount of isolation between them.



W. V. Tilston

The first problem is to establish the amount of isolation needed over the band of frequencies to be used. This may be done by examining the properties of the transmitters and receivers. Once the isolation-frequency relationship has been determined, the next problem is to be faced in the manner in which the isolating equipment is to be constructed. Here, several possibilities exist, and of these, only those containing solely passive linear networks are treated. Networks including bandpass, band-stop, low-pass and high-pass filters are described and are the particular advantages and disadvantages of each type.

It is shown that the particular filter type to be used depends, among other things, on the number of transmitters and receivers to be coupled, on the frequency separation between them, and whether the frequencies are to be fixed or variable.

Examples are given of two channel and eighteen channel set-ups, which illustrates the different approaches that can be made to the problems.

In addition, practical information is given on how the various types of filters may be constructed and used in the various frequency bands from 2 Mc. to 10,000 Mc.

An account is given of the difficulties encountered when the frequency separations become very narrow, and of what steps have been taken to overcome them to date. One of the difficulties discussed is that of combining the desirable off-resonant properties of band-pass filter duplexers, with the low insertion-loss properties of the band-reject types. This has been overcome by the use of a hybrid-ring duplexer which allows a transmitter and a receiver to be operated on one antenna with a frequency spacing of 500 Kc/s in the 150 Mc. band.

Paper (23)

CBC TELEVISION NETWORK PROGRAM DELAY CENTER

G. E. Waters

Canadian Broadcasting Corporation

This paper discusses the geographical problems which prompted the Canadian Broadcasting Corporation early in 1956 to undertake the project of providing an establishment along the coast to coast microwave network at which television programs originating in Eastern Canada could be recorded and later played to sections of the TV network in other time zones.

The selection of the city and the building locations with problems of attendant services are investigated and available facilities are described.



G. E. Waters

BUFFET DINNER

St. Laurent and
Gatineau Rooms

Saturday, November 5

7

Decisions which had to be taken regarding the methods to be employed, the quantity and layout of equipment for the proposed center are discussed.

The system design in its simplest form as mentioned shows how a minimum number of electronic units can be utilized and yet a maximum of operational convenience can be attained. Auxillary and test equipment which have been installed are mentioned and the uses to which this equipment has been put are described.

The systems performance is given and the results obtained are outlined. Briefly the Video System of the station including the recording process is within ± 3 db up to 2.5 megacycles and is within 10 db at 4 megacycles. However this response seems to be relatively less important than the

more faithful grey scale reproduction for which the video tape recorders are noted.

The observance of good engineering practices has assisted in the performance of the system being more than adequate to pass the network signal to the recorder, and to pass the replayed signal back to the microwave network without any significant deterioration.

An alternative method of delaying TV programs is indicated and comments on its comparative complexity are mentioned.

The operational problems associated with the recording and double replay of TV programs are outlined and the staff requirements for the entire operation are given. An emergency operational procedure is described for incoming network failure.

Paper (24)

A VARIABLE REACTANCE AMPLIFIER FOR A UHF TROPOSPHERIC SCATTER RECEIVER

Stanley S. Kostashuk

Northern Electric Company Ltd.,
Belleville, Ont.

A description is given of a variable reactance amplifier which has been developed for use as the front end of a tropospheric scatter receiver operating at approximately 900 Mc/s. An overall receiver noise figure of 2 db with an amplifier RF Bandwidth of 10 Mc/s to the 1 db points is achieved. A review is given of some of the problems encountered in adapting a reactance amplifier into an operating system.

Time table for Technical Papers

Montreal Section IRE Communications Symposium

Friday, November 4, 1960

- 9:00 a.m. to 5:30 p.m. Registration
9:00 a.m. to 10:00 p.m. Exhibits
12:30 p.m. to 2:30 p.m. Opening Luncheon —
Duluth Room
2:30 p.m. to 5:00 p.m. Technical Sessions in
The Gatineau and
St. Maurice Rooms

Gatineau Room
2:30 p.m. to 5:00 p.m.

- Paper (2) 2:30 p.m.
"The MM600 Microwave System Rimouski to
Mt. Carleton"
Authors: L. A. Martin, J. E. H. Elvidge,
N. M. Lopianowski,
RCA Victor Co. Ltd.

- Paper (4) 3:10 p.m.
"A New 450 Mc Radio Relay System"
Author: G. H. Colberg,
Northern Electric Co. Ltd.

- Paper (5) 3:50 p.m.
"A Two Hop 450 Mc/s Diffraction Plus Scatter
System For Telephone Service"
Author: J. C. Gillespie,
Manitoba Telephone Systems

- Paper (7) 4:30 p.m.
"An Improved Design of Radio Relay
Equipment in the 132 to 174 Mc/s Range"
Author: A. A. Seljack,
Philips Electronics Industries Ltd.

St. Maurice Room
2:30 p.m. to 5:00 p.m.

- Paper (19) 2:30 p.m.
"Miniaturized Solid State Devices for
Communications Systems"
Author: John Clark,
Sperry Microwave Electronics Co.

- Paper (14) 3:10 p.m.
"A Transistorized Frequency Synthesizer"
Authors: G. Husson,
B. N. Sherman,
Canadian Marconi Company

Paper (16) 3:50 p.m.

A New Electronic Tube "The Lectron"
Author: J. C. Bernier,
Ecole Polytechnique.

Paper (17) 4:30 p.m.

"A Transistorized Thyatron Ring Counter"
Author: J. A. Pecar,
University of Detroit.

7:00 p.m. to 9:00 p.m. Panel Discussion —
St. Laurent Room

9:00 p.m. to 10:30 p.m. Cocktails — St. Laurent and
Gatineau Rooms

Saturday, November 5, 1960

- 9:00 a.m. to 5:30 p.m. Registration
9:00 a.m. to 6:00 p.m. Exhibits
9:30 a.m. to 12:00 noon Technical Sessions in
The St. Laurent and
St. Maurice Rooms

St. Laurent Room
9:30 a.m. to 12:00 noon

- Paper (1) 9:30 a.m.
"Control of Interference Between Microwave
Links and Communication Satellite Systems"
Authors: W. L. Firestone,
S. G. Lutz,
J. Smith,
Motorola Inc., Hughes Aircraft Co.,
General Electric Co.

- Paper (10) 10:10 a.m.
"Siting of Microwave Systems in a Radar
Environment"
Authors: A. J. Kingan,
L. W. Dennison,
Bell Telephone Co. of Canada

- Paper (11) 10:50 a.m.
"Electromagnetic Wave Propagation Over
Natural Obstacles"
Author: M. P. Bachynski,
RCA Victor Co. Ltd.

- Paper (9) 11:30 a.m.
"High Frequency Oblique Sounding"
Author: W. L. Hatton,
D.R.T.E. Communications Laboratory
Continued on page 50

Time table for Technical Papers

St. Maurice Room

9:30 a.m. to 12:00 noon

- Paper (3) 9:30 a.m.
"New Concepts in Mobile Radio Design"
Author: M. A. Robbins,
Canadian Marconi Company
- Paper (18) 10:10 a.m.
"Electronic Telegraph Selector" and "Solid State Control in Telegraph Systems"
Author: T. G. Rankin,
Canadian Aviation Electronics Ltd.
- Paper (20) 10:50 a.m.
"Threshold Extension for a Quadruple Diversity Tropospheric Scatter System"
Authors: P. S. Christensen,
Northern Electric Co. Ltd.,
J. P. Wilde,
Bell Telephone Co. of Canada
- Paper (24) 11:30 a.m.
"A Variable Reactance Amplifier for a UHF Tropospheric Scatter Receiver"
Author: Stanley S. Kostashuk,
Northern Electric Co. Ltd.

2:30 p.m. to 5:00 p.m. **Technical Sessions in
The St. Laurent and
St. Maurice Rooms**

**St. Laurent Room
2:30 p.m. to 5:00 p.m.**

- Paper (12) 2:30 p.m.
"Lunar and Space Communications"
Authors: B. C. Blevis, J. W. S. Day,
D.R.T.E.

Paper (13) 3:10 p.m.

"Evaluation of The Communication Systems on The CL-28 Argus Aircraft"
Author: S. J. Kubina, Canadair Limited.

Paper (15) 3:50 p.m.

"Data Systems"
Author: P. Pascali,
Northern Electric Co. Ltd.

Paper (21) 4:10 p.m.

"An Automatic Computer-to-Computer Communications System for Voice Band Application"
Authors: David N. Lytle, Beckman Instruments
R. L. Ellsworth, Lockheed Aircraft.

**St. Maurice Room
2:30 p.m. to 5:00 p.m.**

Paper (23) 2:30 p.m.

"C.B.C. Television Network Program Delay Centre"
Author: G. E. Waters,
Canadian Broadcasting Corporation.

Paper (8) 3:10 p.m.

"Application for Transmission Media"
Author: Joseph H. Vogelmann,
Capehart Corporation.

Paper (22) 3:50 p.m.

"Simultaneous Transmission and Reception with a Common Antenna"
Author: W. V. Tilston,
Sinclair Radio Laboratories Ltd.

Paper (6) 4:10 p.m.

"Phased Array Communications"
Author: V. E. Trinter,
Bendix Corporation.

An Invitation

The staff of Electronics and Communications will be on hand to greet you at Booth No. 41 at the Montreal IRE Communications Symposium in the Queen Elizabeth Hotel, Montreal on November 4th and 5th and are particularly proud to be able to provide you with details of many of the most advanced new products produced by the Canadian electronics industry in the past year. If you are seeking up-to-the-minute information on the latest communications equipment and components visit our booth and look over the wide range of new product photographs and specifications.

ELECTRONICS AND COMMUNICATIONS

An AGE Publication

450 Alliance Ave., Toronto 9, Ont.

● Exhibitors

● Personnel

● Products

Aeromotive Engineering Products Ltd., 147 Hymus Blvd., Pointe Claire, Que. Booth 15.

Attending Personnel: N. Silberberg, sales manager; S. Galloway, sales engineer; K. Tucker, sales engineer; P. Wheatley.

Exhibits: Electric components, electronic components and instruments, servo components.

Alfax Paper & Engineering Co., Washington Street, Westboro, Mass. Booths 38-39.

Attending Personnel: M. Alden, president; E. D. Cross, chief engineer; S. C. Sviokla, plant manager.

Exhibits: Electrosensitive recording paper, new simple recording techniques of "Flying Spot" recorders by ALDEN.

Ampex of Canada Ltd., Room 607A Commonwealth Bldg., 77 Metcalfe St., Ottawa, Ont. Booths 1-2.

Attending Personnel: Charles Wirth, Data Products marketing manager; Edward Koller, Data Products sales manager; James Detlor, manager, Ampex of Canada Ltd.; Maurice Grefard, Data Products service engineer.

Exhibits: CP-100, portable laboratory magnetic tape recorder/reproducer; FR-100B general purpose scientific magnetic tape recorder/reproducer; PR-10 professional audio monophonic/stereophonic tape recorder.

Andrew Antenna Corporation Ltd., 606 Beech St., Whitby, Ont. Booth 3.

Attending Personnel: R. P. (Dick) Matthews, manager; John C. Annett, sales engineer.

Exhibits: HELIAX, new fiberglass high gain antenna, microwave antennas, HUBLOC construction technique.

Atlas Instrument Corporation Ltd., 50 Wingold Ave., Toronto 19, Ont. Booths 11-12.

Attending Personnel: F. W. Sargeant, field sales engineer; L. C. Bradford, field sales engineer; M. Kusmierak,

field service engineer; A. L. Rosenthal, P.Eng., manager.

Exhibits: Precision electronic measuring instruments for communications application.

Automatic Electric Sales (Canada) Ltd., 185 Bartley Drive, Toronto 16, Ont. Booths 4-5.

Attending Personnel: C. L. Littler, manager, Telephone Equipment Division; R. C. Fawcett, manager, Carrier & Radio Division; E. E. Hucal, manager, Supplies Division; A. C. Stewart, manager, Industrial Products Division; R. McCracken, district manager; J. R. Simpson, radio systems specialist.

Exhibits: Lenkurt Type 71A Light Route Radio System; Lenkurt Type 81A Exchange Trunk Carrier; Lenkurt Type 54A Urgent Alarm & Supervisory System; Automatic Electric AT-2 and AT-3 Repeaters; Automatic Electric Telephone Type Relays; Lorain Power Supply Units; Electronic Secretary Telephone Answering Units (Models DCR, BPR, MR, Tt and Tele-trainer); Telautovision Industrial Closed Circuit Television.

Bach-Simpson Ltd., 1255 Brydges St., P.O. Box 484, London, Ont. Booth 29.

Attending Personnel: G. F. Bates, H. Leah.

Exhibits: Panel Meters and accessories — featuring New Controller Indicator Systems.

Barnard Stamp & Stencil Ltd., 8 George St., P.O. Box 295, Hamilton, Ont. Booth 32.

Attending Personnel: R. F. O'Connor.

Exhibits: Rejafix marking and printing equipment.

Beatty Bros. Ltd., Fergus, Ontario. Booth 23.

Attending Personnel: A. A. Royle, supervisor of engineering sales; H. Van Denham.

Exhibits: Beatty Masts.

Belden Mfg. Co., 415 S. Kilpatrick Ave., Chicago 44, Ill. Booth 24.

Attending Personnel: James F. Olson, manager, Export; Mr. Timmons, electronic engineer.

Exhibits: Electronic wire and cable.

Boston Insulated Wire & Cable Co., Ltd., Hamilton, Ont. Booth 16.

Camloc Fastener Corporation, 22 Spring Valley Rd., Paramus, N.J. Booth 42.

Attending Personnel: Bennet F. Becker, eastern sales manager; Herbert F. Peppel, sales representative.

Exhibits: Quarter-turn fasteners, electronic chassis latches, container latches.

Canadian Electronics Engineering, Maclean-Hunter Publishing Company Ltd., 481 University Ave., Toronto 2, Ont. Booth 35.

Attending Personnel: Harold Price, editor; Ian Dutton, associate editor; K. E. Winchcombe, Montreal editor; C. A. King, advertising manager.

Exhibits: The technical publication serving Canada's electronic industry in research, management, design and application.

Canadian Westinghouse Co. Ltd., Electronics Division, P.O. Box 510, Hamilton, Ont. Booths 9-10.

Attending Personnel: K. B. Jenner, E. M. Hepburn, G. Pope, A. J. Lipinski, W. W. Fines.

Exhibits: "Microscatter".

Allan Crawford Associates Ltd., 5590 Yonge St., Willowdale, Ont. Booths 33-34.

Attending Personnel: James H. Smiley, William G. Jordon, George H. Singer, John Zevenbergen, Al Crawford, Gordon Micklewright, Olivia Padgett.

Exhibits: Phase measuring instruments and phase shifters, data reduction equipment, Electronic Associates' totally transistorized analog computer, complete line of John Fluke power supplies, precision voltmeters, calibration equipment and bridges, precision pulse generators, Ferrite Isolators, devices and specialized antenna systems, Weinschel precision attenuators, and attenuator calibration equipment.

Eitel McCullough, Inc., 301 Industrial Way, San Carlos, Calif. Booth 8.

Attending Personnel: R. D. B. Shepard, Canadian representative; G. Badger, sales manager, klystrons; F. A. Speaks, assistant director of marketing; C. Warner, sales engineer; P. T. Kirwan, export manager.

Exhibits: Power transmitting tubes, power klystrons, reflex klystrons, TWT's, negative grid tubes.

Electrodesign, 9124 St. Lawrence Blvd., Montreal, Que. Booths 27-28.

Continued on page 52

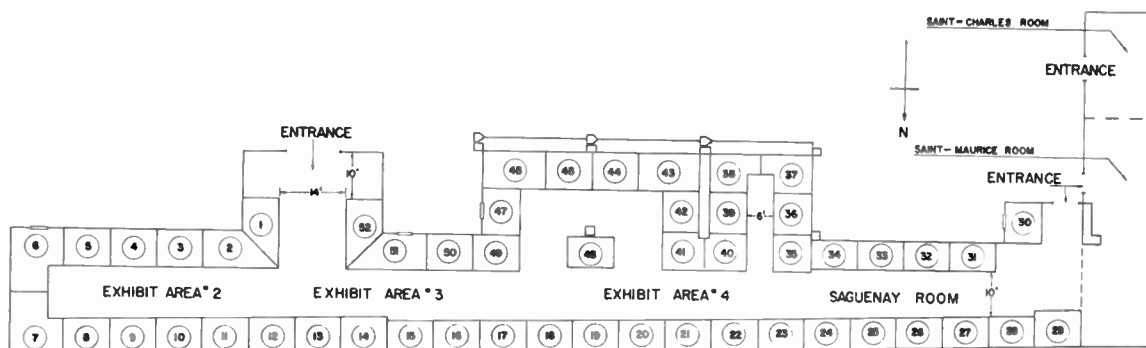

Floor plan of exhibitors' booths — Montreal IRE Communications Symposium, Queen Elizabeth Hotel — November 4 and 5. Booth numbers of firms exhibiting are shown in accompanying listings.

Exhibitors - personnel - products

Electronics and Communications, Age Publications Limited, 450 Alliance Ave., Toronto 9, Ont. Booth 41.

Attending Personnel: T. W. Lazenby, editor; H. E. (Bud) Dallyn, sales manager; Derek Reynolds, advertising manager; J. R. (Tom) Graham, Montreal Representative.

Exhibits: Photographic display of new products of the Canadian electronics industry and *Electronics and Communications* magazine, Canada's pioneer journal serving the electronics industry in engineering and management.

The Institute of Radio Engineers, 72 West 45th St., New York 36, N.Y. Booth 30.

Attending Personnel: William C. Copp, exhibits manager; Herbert A. White, sales representative.

Exhibits: IRE pins, membership forms, directory, Proceedings of the IRE, IRE Transactions, and all matters pertaining to IRE.

Instronics Limited, P.O. Box 100, Stittsville, Ont. Representatives in Toronto, Montreal and Calgary, Alta. Booth 52.

Attending Personnel: John E. Knowles, president; Larry G. Cote, sales manager; Ronald W. Price, Ontario sales manager; Douglas E. Leach, Eastern sales manager; Edward F. Rockafellow, service manager.

Exhibits: RACAL communications equipment, Kahn Labs' communications equipment, Potter high speed printers, Lavoie Labs' communications test equipment, Empire Devices' noise and field intensity meter, miscellaneous smaller equipments of particular interest to the communications industry.

International Systcoms Ltd., 8235 Mountain Sights Ave., Montreal 29, Que. Booth 26.

Kay Electric Co., Maple Ave., Pine Brook, Morris Co., N.J. Booth 25.

Attending Personnel: Thomas Dougherty, sales engineer.

Exhibits: Sona-Sweep Model M, Therma-Node, Auto-Node, Transmission Measuring Set, Ligna-Sweep SKV, 20-0 or 30-0 Attenuator, Marka-Sweep Model Video 50.

E. G. Lomas, 227 Laurier W., Ottawa, Ont. Booth 45.

Attending Personnel: E. G. Lomas, J. Jolly, K. Lomas, Erik Stromsted.

Exhibits: Mixer and variable capacitance diodes for communications circuitry — Integrated mixer preamp assemblies — Solid State sine wave inverters and harmonic generators — Flexible waveguide.

McCurdy Radio Industries Ltd., 22 Front St. W., Toronto, Ont. Booth 6.

Attending Personnel: G. E. McCurdy, Ken MacKenzie, Norman Farr, John Simpson.

Exhibits: Audio Consoles.

Microwave Systems, 46 Crockford Blvd., Scarborough, Ont. Booth 43.

Attending Personnel: G. Grant Cooper, manager, Microwave Systems; H. H. Emker, vice-president, Radio Frequency Laboratories, Inc., Boonton, N.J.; T. P. Matthews, sales manager, Technicraft Division, Thomaston, Conn.

Exhibits: R. F. L. Terminals for telegraph, control, telemetering; Technicraft waveguide products.

Northern Electric Co. Ltd., 1600 Dorchester St. W., Montreal, Quebec. Booths 49-50-51.

Attending Personnel: Engineering personnel from research and development laboratories and Belleville electronics manufacturing plant.

Exhibits: Parametric amplifier, 450 M/c radio equipment, "OJ" carrier, video monitors, semiconductors.

Payette Radio Ltd., 730 St. James St. W., Montreal 3, Quebec. Booth 7.

Attending Personnel: W. G. Garnham. **Exhibits:** Contact Cleaner, Components, Precision Potentiometers, Breadboard, Embossing Machine, Conduit, Insulating Tape, Relays, Resistors.

Potter & Brumfield Canada Ltd., Oxford St., Guelph, Ont. Booth 31.

Attending Personnel: Alan Laws, manager; Norman Silberberg, representative; Ken Tucker, representative.

Exhibits: Electro-magnetic relays.

Prentice-Hall, Inc., Englewood Cliffs, N.J. Booth 37.

Attending Personnel: Wally Matheson, Gerald Halpin, John H. Davis.

Exhibits: Appropriate text and reference publications for electronic and communication specialists.

Pye Canada Ltd., 84 Northline Rd., Toronto, Ont., 1167 St. James St. W., Montreal, Que. Booth 47.

Attending Personnel: F. F. Richaur, chief engineer; M. F. Golding, Quebec service manager; David L. Thibodeau, Quebec sales manager.

Exhibits: Two-Way Radio and associated items, Portable Loud Speaking Equipment.

RCA Victor Company Ltd., 1001 Lenoir St., Montreal 30, Que. Booths 13-14.

Attending Personnel: Ken Logan, George House, Bill Roloff — Communication System Sales Department; Gina Leahy, manager, Communication Projects.

Exhibits: Microwave products, data processing products, SSB equipment.

Radionics Ltd., 8230 Mayrand St., Montreal 9, Que. Booths 17-18.

Attending Personnel: S. H. Ungar, president; G. G. Beyroudy, sales engineer; H. Watson, sales engineer; J. Lastra, sales engineer; R. Delcamp, sales engineer.

Exhibits: Precision microwave components and equipment, Antenna and Receiver test equipment, Travelling

Wave Tubes and Backward Wave Amplifiers, Oscilloscopes and general purpose test equipment.

R-O-R Associates Ltd., 1470 Don Mills Rd., Don Mills, Ont. Booths 21-22.

Attending Personnel: J. S. Root, manager; E. J. Wootten, systems engineer; W. W. Hastings, field engineer; W. N. Mainguy, field engineer; R. Wood, field engineer.

Exhibits: Microwave tubes for communications, carrier telephony test sets, audio frequency analyzers, carrier signal generators, logarithmic amplifiers.

Sigma Instruments Inc., 170 Pearl St., South Braintree, Mass. Booth 47.

Attending Personnel: Frank C. Burridge, district sales manager; Donald H. Stewart, district sales supervisor; Douglas T. Shaw, Canadian representative.

Exhibits: High speed polar relays for relaying pulses, magnetic amplifier relays, 60 and 400 cycles, stepping motors and stepping switches incorporating flush printed circuits.

A. C. Simmonds & Sons Ltd., 100 Merton St., Toronto 7, Ont. Booth 36.

Attending Personnel: David S. Simmonds, G. Douglas Pettifer.

Exhibits: Guardian relays, solenoids, stepping switches, etc.; Johnson variable capacitors, sockets, inductors, connectors, etc.; Mallory tantalum capacitors, premium-grade and computer-grade electrolytic capacitors, silicon rectifiers, vibrators, etc.; Ohmite resistor and rheostat products; Shure mobile communication microphones.

Sinclair Radio Laboratories Ltd., P.O. Box 179, Downsview, Ontario. Booth 44.

Attending Personnel: Peter Yachimec, general manager; Dr. W. V. Tilston, director of research.

Exhibits: Antennas and duplexers.

Spaulding Fibre of Canada Ltd., 70 Coronet Rd., Toronto 18, Ontario. Booth 48.

Attending Personnel: V. Christensen, sales manager; M. P. Komar, sales engineer; D. I. Kearney, sales engineer; J. N. Kelly, sales engineer; M. E. Davis, liaison engineer.

Exhibits: Fabricated industrial plastics, fiberboards, vulcanized fiber.

Texas Instruments Incorporated, P.O. Box 312, Dallas, Texas. Booths 19-20.

Attending Personnel: Paul Zuk, John Sawatsky, Brock Hayes, Tom Connors. **Exhibits:** Semiconductors and components.

Whittaker Electronics Ltd., 1171 Whitmore Ave., Ottawa 3, Ontario. Booth 46.

Attending Personnel: Ernest E. Whittaker, president; Allan Smith; Lorna Pelton, secretary.

Exhibits: Electronic and electro-mechanical components, test equipment.

The use of transistors for power conversion

Part 1 - Basic circuits and laminations

Much of the pioneering work on the commercial use of static power conversion equipment has been done in Canada and the problems of design and development of equipment to meet Canadian requirements are discussed in the following article.

by John E. Pinnell, B.Sc. (Hon.) Sen. Member I.R.E.

The basic circuit of most static converters is that of the saturable core transistor switch or multivibrator. (Ref. Figure 1) The principles of operation or design of this oscillator have been well covered elsewhere (1, 2, 3, 4 and 5) and will not be treated in detail. Examination of the capabilities of this circuit indicate that there are several serious disadvantages which limit its use commercially.

The maximum voltage that can be applied to the input terminals of the basic oscillator of Figure 1 is determined by the voltage breakdown of the transistors between collector and emitter. During part of the switching cycle, the voltage between collector and emitter will be twice that of the input, not including spikes or transients that may be present. Hence the practical limit for input voltage is usually little more than 30V DC.

A considerable amount of "hash" is transmitted to the primary power supply due to the input current waveform where the input supply is a common source of power for mandatory. As the capacity of the oscillator is increased, the isolation becomes increasingly difficult to maintain. Transformers that operate in the saturated condition with large input currents tend to be physically noisy due to a magnetostriction effect. This noise is proportional to transformer power output and frequency.

There are practical limits beyond which the power handling capabilities of the oscillator transformer cannot be increased. This transformer operates with a saturated core and is responsible for about two thirds of the lost power in the circuit of Figure 1. Even under more or less ideal conditions, the overall efficiency will not likely exceed 85 per cent. Consequently, the problem of removing heat from the control core and windings becomes increasingly difficult and costly as the size of the transformer increases. Application of this circuit is thus limited to roughly 150 watts continuous output with a maximum efficiency of about 85 per cent.

The use of semiconductors in power equipment is a relatively new branch of electronics. Proof of performance of germanium and silicon rectifying elements stimulated attempts to make application of the transistor to this field. The development of the square wave transistor power oscillator¹ made the principle of static conversion from DC to AC and subsequently, DC to DC practical. With this tool, the military design engineer was able to achieve efficient and light weight conversion.

Commercial use of the transistor for power conversion did not become widespread until fairly recently. The two main reasons for this lag were firstly, a lack of circuit development to cover the larger input voltage and power requirements, and secondly, a hesitancy to develop new equipment for an untried market. Although it is not generally appreciated, the pioneering of much of the commercial use of static power conversion equipment has been done in Canada. Problems of design and development of equipment to meet Canadian requirements will be discussed in two parts. The first will deal with the basic problems and limitations of early equipment and, the second with the description of equipment with capabilities of input voltages in excess of 130V DC and power outputs of a kilowatt and upwards.

The output waveform of the oscillator is square with voltage spikes which must be removed if reasonable transistor life is to be expected. The amplitude of these spikes can be calculated from the equation $e = L \frac{di}{dt}$ where L is the leakage inductance of the transformer primary.

*Chief Engineer, Pylon Electronic Development Co. Ltd., Montreal, Que.

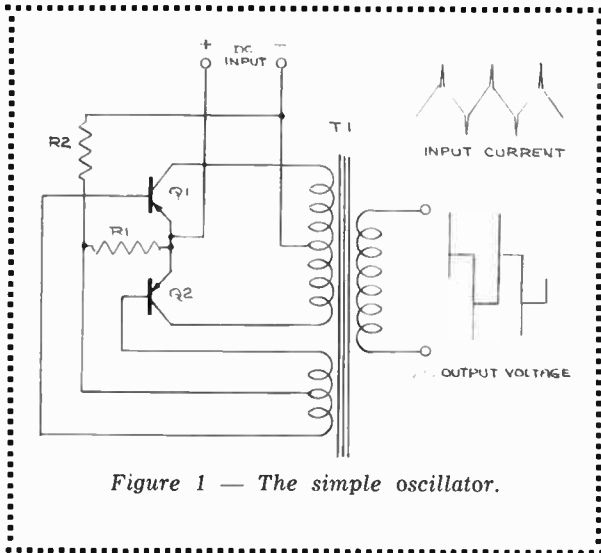

Figure 1 — The simple oscillator.

The AC output from the basic oscillator is not in itself of much practical use. The output is very rich in harmonics and suffers from an inherent frequency instability not apparent in the formula

$$f = \frac{E_{dc}}{4NBsA} \quad \begin{array}{l} N = \text{prim. turns} \\ A = \text{core area} \\ Bs = \text{sat. flux density.} \end{array}$$

This instability is caused by change in the saturation flux density with load. The result is that the frequency tends to increase with increasing load even though the input voltage remains constant. In order to make an effective substitute for 60 cycle mains power, considerable circuitry is required to remove harmonics and stabilize the frequency. These are special problems that necessitate a more detailed discussion than is possible in this article.

It is necessary at this point to define an inverter as any DC powered equipment which produces an AC output. Similarly, a converter is defined as any DC powered equipment which produces a DC output. One use of the basic oscillator (or inverter) for which the disadvantages do not apply is illustrated by the equipment of Figure 2.

A simple inverter

The Transistor Switchboard Supply as shown, makes use of the basic circuit of Figure 1 to generate a 20 cycle output for bell ringing purposes. The frequency stability, power output and waveform requirements are

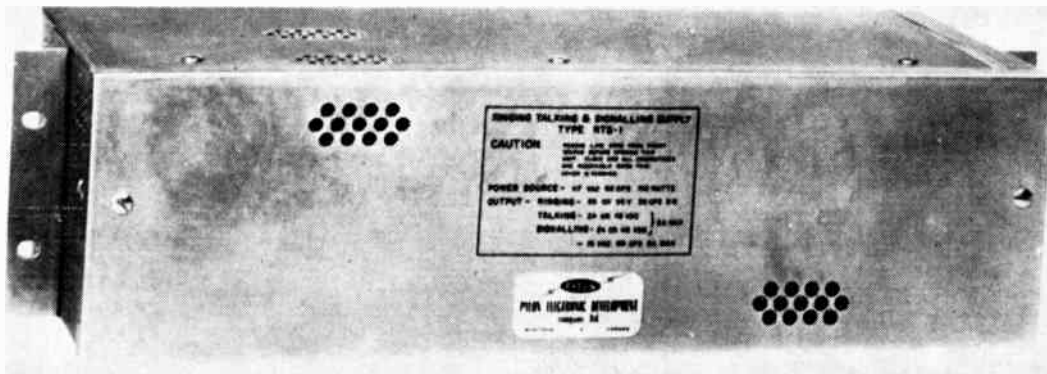

Figure 2 — Transistor switchboard supply

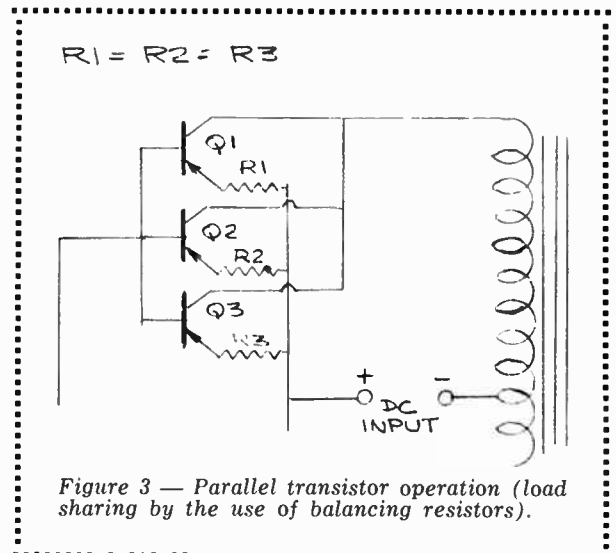

Figure 3 — Parallel transistor operation (load sharing by the use of balancing resistors).

ideally met with the circuit of Figure 3. A pure sine wave output is not required hence waveshaping by means of capacitor C3 is adequate. A controlled 120 cycle signal for a telephone reversion tone is obtained by designing the filter R1 and C1 such that the rectified input signal has a sufficiently large ripple for modulation of the 20 cycle output.

Voltage spikes at the collectors of transistors Q1 and Q2 are eliminated by a simple RC filter across the transformer primary. Since the inverter has its own power supply, the need for filtering and isolation from the primary supply is met. In general, where there is a choice of input supply or voltage, the basic circuit fulfills the simple needs of the equipment described. A more common requirement is operation from a 48 or 130V DC battery.

Increased input voltage

The inverter of Figure 1 is of little use where inputs of 48V or larger are demanded. It is true that the problem might be solved at 48V by use of hand selected transistors but this is a rather poor design technique.

The development of the simplified series circuit of Figure 4 was found to be a satisfactory method of sharing the input voltage across the transistors. A unit which has given field service proof of these principles is shown in Figure 5.

Operation of the series circuit of Figure 4 depends on the correct phasing of the feedback to the base of

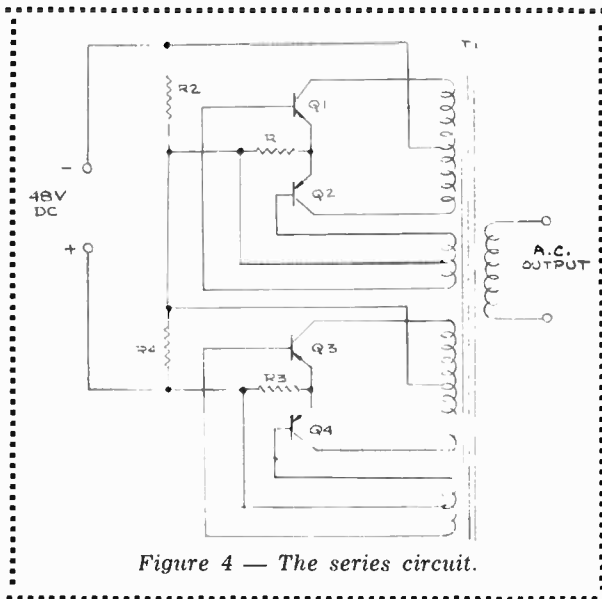

Figure 4 — The series circuit.

the transistors. Assume say Q1 and Q3 are driven to conduction while the feedback to Q2 and Q4 is such as to prevent conduction. The transformer core is driven to saturation by a current through two transistors in series. At saturation, a reversal of the base feedback will occur and oscillations will be sustained as in the case of the simple inverter⁵.

Several interesting points can be stated about the series circuit which may not be apparent at first glance.

- (a) Precise Voltage Division.
- (b) Equal Current Sharing.
- (c) Unmatched Transistors.

Suppose transistors Q1 and Q2 are of the same type and manufacture and that the large signal gain of these units is less than Q3 and Q4 (any type). If then Q1 and Q3 are conducting, then the same collector current flows through both units. The maximum current is thus limited by the transistor with the least gain. The applied voltage will be divided equally between Q1 and Q3 (or Q2 and Q4).

The validity of this statement can be demonstrated by consideration of the factors which might cause an unequal division. It can be seen that transformer unbalance and variations in the "bottoming" of the transistors are the only two factors involved. In practice, transformer unbalance is less than 1 per cent and can be disregarded. For small transistors, the "bottoming" may vary greatly between units, even of the same type. However, for the larger power transistors, the "bottoming" voltage is very small and at worst would not result in an unbalance greater than that due to the transformer. Providing the peak voltage and current capacity of the transistors is not exceeded, the circuit will function quite well with four transistors of considerable difference in type and capacity.

The case of unequal current gain of transistors Q1 and Q2 is usually insignificant due to a tendency to overdrive at the base. If however a very great difference in gain exists, the circuit may oscillate asymmetrically due to saturation of the transistor with the least gain. If on the other hand, both transistors have comparable gains, but lack drive, the waveform will be symmetrical. The frequency would remain virtually unchanged, but the time of conduction of each transistor would be reduced. This is equivalent to the case of an overloaded unit where the protective "bias" reduces the drive.

As an example of the stability of the circuit and

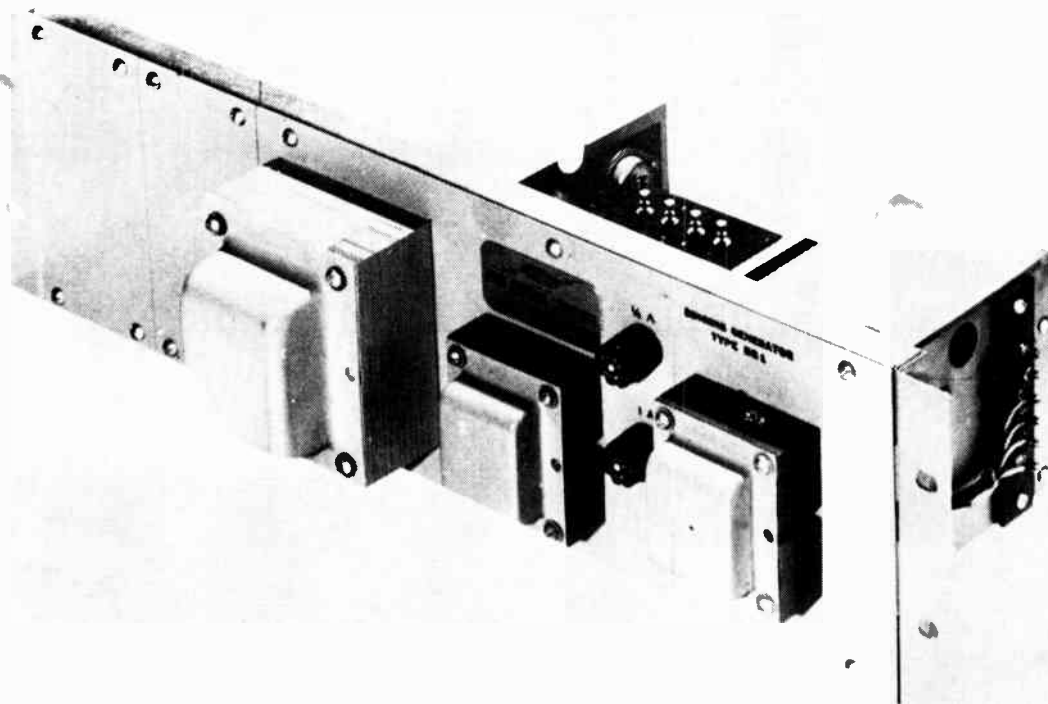
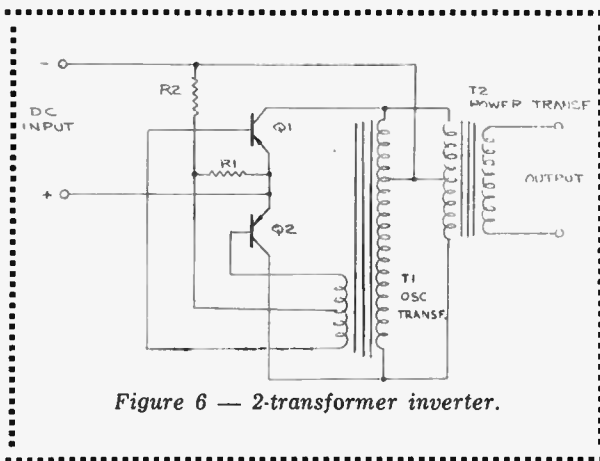

Figure 5 — 20 cycle ringing tone generator. This unit operates from 24 or 48V DC to provide 20 cycle output for bell ringing.



independence on transistor characteristics, four transistors of different types and capacities can be utilized. The circuit will function quite well providing the peak voltage and current of the smallest unit is not exceeded.

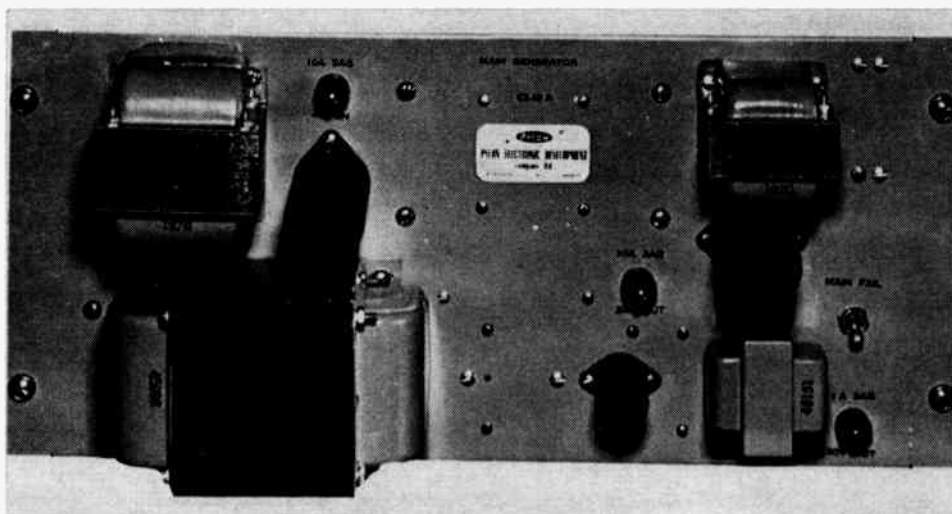

Figure 7 — Static power converter type CX48. Operates from 24 or 48V DC output and gives 130V DC output at 2.5A or 24V output at 10A.

Extension of power capabilities

As previously stated, the power handling capabilities of the circuit of Figure 1 are limited. The use of the series circuit of Figure 4 does allow an improvement, but not sufficient as the power transfer is dependent on a transformer which is operated in the saturated condition. The "two-transformer" unit of Figure 6 illustrates a means of obtaining efficient transformer action and minimum oscillator transformer loss. The DC-DC converter of Figure 7 utilizes a two transformer technique.

Basically, the two-transformer circuit is that of a

small oscillator transformer operating in a similar manner to the basic oscillator of Figure 1, with the addition of a non-saturating power transformer which carries the current to the transistor collectors. The power output from the oscillator transformer is generally from 2 to 4 per cent of the larger transformer. Since there is no difficulty in obtaining 95 per cent efficiency in the latter, a highly efficient inversion can be obtained by use of relatively inexpensive transformers. Figure 6 illustrates one form of the two-transformer circuit which gives a considerable extension of power over that obtainable from the basic circuit.

Theoretically, it might be supposed that there is no limit to the power that can be obtained from the two-transformer series circuit where parallel operation of transistors is allowed. In practice, circuit complexity under favorable conditions determines a practical limit to output. Recent improvements in the current handling capacity of transistors has placed the practical limits of conversion in excess of 5KW. In the second part of this article, a discussion of high power equipment will be given.

¹A New Self Excited Square Wave Transistor Power Oscillator

George C. Uchirin and Wilfred O. Taylor
Proc. Ire. Vol. 43 pp. 49. Jan/55.

²Transistors Take Over

J. W. Bates and J. Sanjana
Electronics Engineering June/57.

³Magnetic Inverter Uses Tubes or Transistors
C. H. R. Campling, *Electronics*, March 14/58.

⁴Design of Transistor Power Converters
T. R. Pye, *Electronics* Sept. 4/59.

⁵Equations for Designing Transistor Power Supplies
Theodore Hamm, *Electronics* Oct. 23/59.

Part II of Mr. Pinnell's article on "The Use of Transistors for Power Conversion" will appear in the November issue of *Electronics and Communications* and will deal with high power equipment.

The design of broad band radio relay equipment for use in a long haul military system

The employment of new circuit techniques and new and better components means that future equipments will not only have better performance but will be much more compact and will consume less space and power.

by H. A. Hamilton, Ph.D.*

The Canadian Marconi Company has supplied to the Canadian government two of the largest microwave systems in the world today — the communications system on the Mid-Canada Radar Line, and the Adcom II Communications System. Without counting the other microwave radio relay systems supplied by this company, these two systems alone account for more telephone channel miles than the aggregate of all systems installed by any other single supplier of microwave equipment in the world, excepting only those systems installed by the American Telephone & Telegraph Company and its associated companies.

The successful construction, installation and operation of these systems has provided a wealth of knowledge and experience to the Canadian Marconi Company. This article is intended to give a brief résumé of the factors affecting the design of high quality radio relay equipment, and of the design philosophy and the principles of design which have been followed by the Marconi laboratories in the development of equipment suitable for use in both commercial and military systems.

In particular, this article will describe a commercial equipment operating in the 2000 Mc/s frequency range, capable of carrying up to 600 telephone channels of toll line quality. This equipment, the Canadian Marconi Company DQ 58B radio relay equipment, is in service in the Adcom II communications system, where it forms a part of the Defense Communications System of North America, carrying vital SAGE data signals.

In most areas of design and performance, radio relay equipments used for commercial and military systems are quite similar. In two areas, however, the requirements differ in some degree.

The standards of performance required of modern long haul radio relay equipments in use in commercial systems, are extremely high; nevertheless, the standards required of equipments operating in military data-handling circuits are often even more stringent. Commercial circuits are usually required to carry only voice signals, which tend to load individual circuits for only a fraction of the total time; while a data channel usually carries a high level signal all the time. There-

fore, the overall loading caused by a number of voice channels is usually much less than that caused by a number of data channels. For this reason, standards of performance on military data-carrying channels are usually extremely stringent.

In the operation of commercial circuits, the operating authority ordinarily adopts all means possible within the operating budget of his system to provide reliable, interruption free service. In a military system, whether carrying voice communications or data signals, the urgency of the signals is such, that no interruption of signals can be tolerated. The highest possible reliability must therefore be achieved in both equipment and system design. These matters will be treated in detail later in this article.

In selecting an equipment for use in a large military defense circuit in Canada, it was found that commercial design practice in radio relay equipment has reached a sufficient standard, that the Canadian Marconi Company DQ 58B, a standard commercial equipment, was suitable for use in vital defense systems.

Design standards

The standards which designers of radio relay equipment usually attempt to meet are those recommended by the CCIR (Comite Consultatif Internationale de Radio). While this article does not propose to examine these standards minutely, it may be useful to outline these requirements briefly, and to consider how they are used in the design of radio relay equipment.

In brief, the CCIR standards are not those of a radio system at all; they refer, rather, to the noise in a single telephone channel in a telephone system, without reference to whether that channel be carried on a radio system, a cable or a wire line. The specifications state that the noise in a telephone channel, not including noise contributed by multiplex or exchange equipment, but only that contributed by the system itself, at a point of zero reference level, over a circuit 2500 km (or 1500 miles) in length, shall not exceed

*Chief Engineer, Development Group,
Telecommunications Dept., Canadian Marconi Co. Ltd.

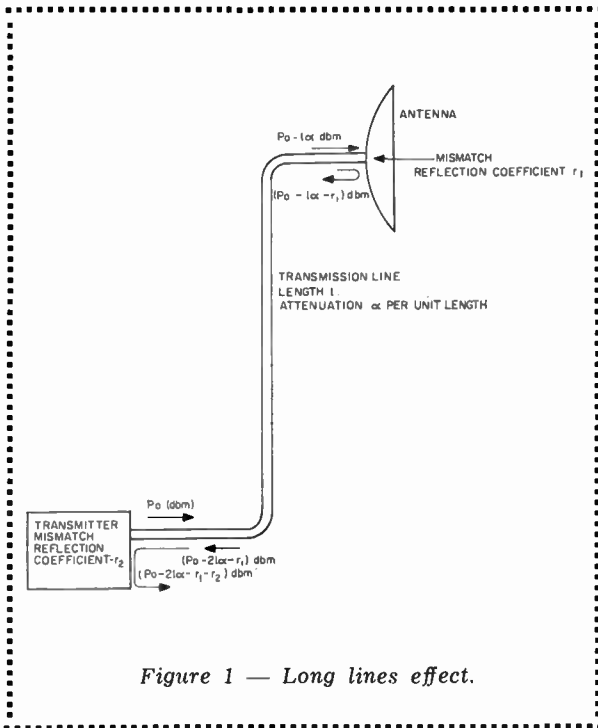

Figure 1 — Long lines effect.

of these specifications, it is useful to realize that 7500 pw of noise in a telephone channel at a point of zero reference, represents a weighted signal to noise ratio of 49 db. The average telephone handset alone contributes a signal to noise ratio of 35 to 40 db. The noise in a telephone circuit, with a signal to noise ratio of 40 db verges on the inaudible. This means that if a radio system 3000 miles in length were built to meet CCIR standards, pro rata, the noise contributed by the entire radio system would be less than that contributed by the exchange or handset at its terminal.

The difficulties encountered by a design engineer attempting to meet these standards may readily be imagined. The circuits used and performance obtained in modern radio relay equipment, represent the limit of the art of design. The problem of measuring the performance of a single station, much less that of a single unit or even worse of a single stage, may be understood by considering that the distortion allowance for a station is less than 1/100 that for a single AM broadcast transmitter. If for example one were to undertake to measure the distortion caused by a modulator, one would normally modulate a signal, using the instrument, demodulate it again, using a high quality demodulator, and measure the distortion of the signal. In the case of a high quality, broad band modulator, as used in radio relay systems, the performance of the modulator unit has been advanced to the limit of the art. The performance of the best available demodulator—which is usually that also used in the same radio relay equipment—is of the same order as that of the demodulator. It is therefore impossible to differentiate between distortion contributed by the modulator and that contributed by the demodulator. It is obvious that this situation

a mean of 7500 pw in any hour. Further recommendations allow the reference system to have five sections, such that at the four intermediate terminals (usually assumed to be spaced at 300 mile intervals) the traffic is fully demodulated and available for distribution.

In order to obtain some conception of the stringency

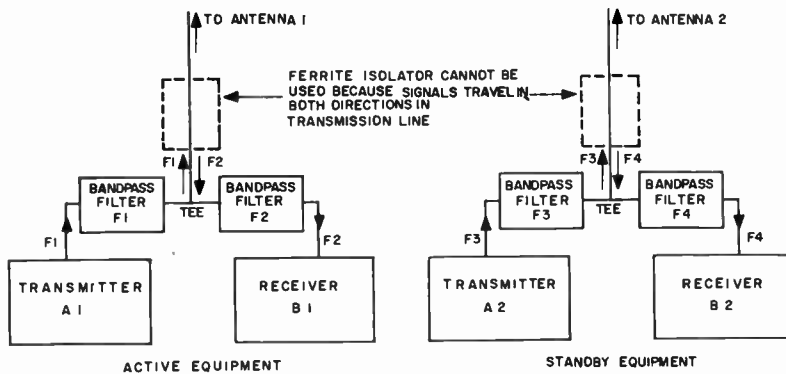

FIG. 2(a)

Figure 2 (b) — This configuration is undesirable, since both active and standby equipments make use of the same antenna systems.

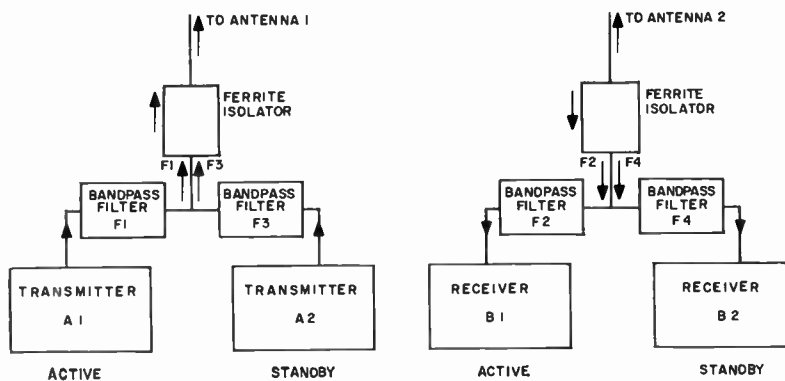



Figure 3 — Canadian Marconi Company Travelling Wave Tube — type N1001/B201. This tube delivers in excess of 100 watts in the 2000 Mc/s frequency range, and offer extreme reliability.

creates great difficulties in a design laboratory — difficulties which are only overcome by the application of great care in design, a great deal of ingenuity, and of wisdom born of extensive experience.

There are, of course, good reasons for requiring such an extremely high standard of performance on long haul heavy route systems. In fact, the standards are chosen to permit the provision of a telephone channel of adequate quality on circuits completely circling the world. In more practical terms in radio systems consisting of a large number of stations in tandem, sufficient margins of performance must be built into the equipment that the severe degradation of a single hop or even several links such as may occur in severe fading conditions, will not degrade the system as a whole to a point where it is no longer of service. Further, the margins of performance should permit expansion of the system at a later date, either by

lengthening the system, or by the addition of spur links (of possible lower quality). In addition, it must be recognized that the performance of any electronic equipment will gradually suffer some degradation over years of service. Since it is rarely permissible to interrupt the service to allow for realignment of equipment in order to regain the original performance of the system, it is necessary to allow a sufficient margin of performance in the original design to permit some degradation in service.

It is noteworthy that modern design techniques have greatly alleviated most of the difficulties noted above. It is now possible to design equipment with extremely stable performance, by using circuits which are relatively insensitive to aging effects, temperature, and even to tube degradation from aging. Modern switching and combining techniques, together with better systems designing have greatly reduced the effects of severe fading or difficulties in individual links.

In designing radio relay equipment to meet the standards recommended by CCIR, it is necessary to

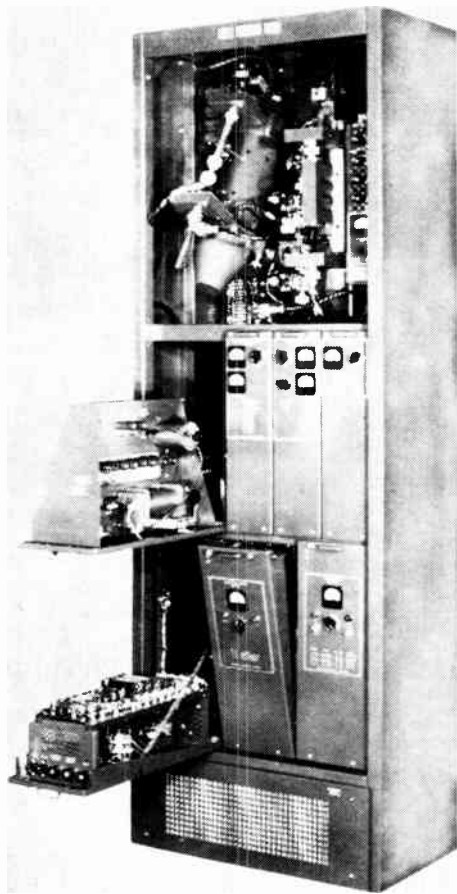

Figure 4 — Canadian Marconi Company DQ-58B repeater cabinet. This equipment is a broad band equipment operating in the frequency range 1700-2300 Mc/s.

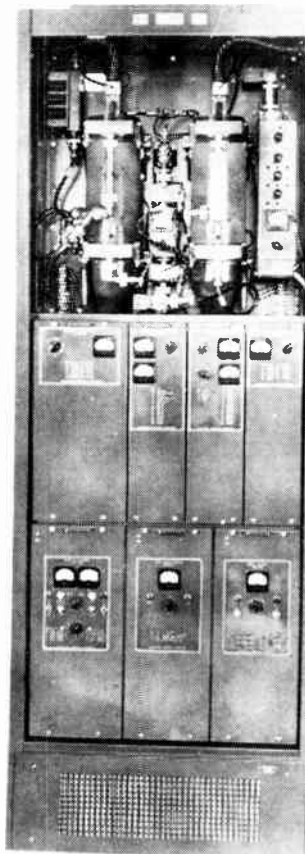

Figure 5 — Canadian Marconi Company DQ-58B repeater cabinet, showing facilities for front access to all chassis and components.

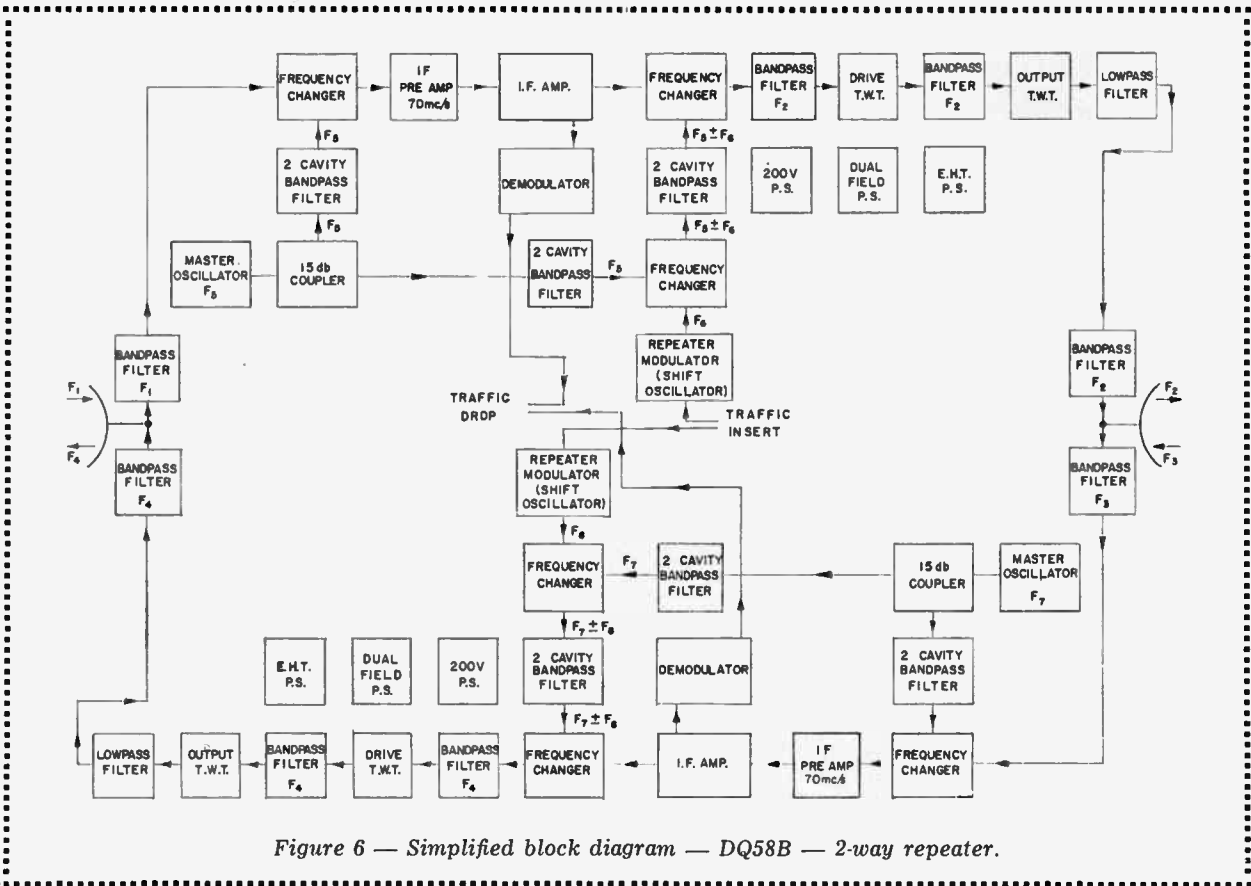

Figure 6 — Simplified block diagram — DQ58B — 2-way repeater.

apportion the noise allowance for the whole system to the various sources of noise and distortion in the equipment. This division is done on the basis of the knowledge and experience of the designer; the performance of individual units is therefore specified by the designer, not by the international authority. From the previous discussion, it will be seen that the designer is forced to place performance specifications on each unit which represent the limit of the art. Baseband amplifiers, if amplifiers and rf amplifiers, filters, mixers, limiters, modulators and demodulators, interconnecting cables, rf cables and antennas, all represent sources of distortion. To each of these units, a noise allowance is made; the total noise allowances of all units in the system must add up to less than the total system allowance made by CCIR. The causes of distortion for each individual unit are then analyzed in terms of the noise allowance for that unit, leading to the specification of performance parameters for that unit.

For example, in an fm system, distortion in if amplifiers, rf amplifiers, in mixers and in filters, arises from variations in the phase response of the circuit with the signal frequency. This phase response is in turn related to the amplitude response of the circuit. From the noise allowance made for the unit, it is therefore possible to specify the necessary phase and amplitude response of the circuit. For a 600 channel system, the rf — if bandwidth requirements for each unit ordinarily works out to a bandwidth of about 20 mc/s, whose response is flat to within 0.1 db. In practical terms, this means that an if amplifier or an rf filter must have a 20 mc/s bandwidth flat to 0.1 db. Not only does this design represent the limit of the art of design, but the measurements of this performance also represent the use of instruments and techniques which are on the limits of modern practice.

It is of interest to consider the case of the input and output matching of the equipment, the matching of the rf feeders and the matching of the antennas. It is obvious that severe mismatches in any of these cases, where the mismatches are frequency dependent, will cause troublesome variations in amplitude and phase response. However, another effect is also present, even in the case of slight mismatches (Figure 1). A signal leaving the transmitter, and reaching the antenna, encounters a slight mismatch. Some small fraction of the energy is reflected back down the line to the transmitter where it encounters another mismatch. Again, a small fraction of the reflected energy is reflected. This energy is out of phase with the signal being transmitted at that instant and therefore represents a source of distortion. It will be seen that the amount of this distortion is proportional to the reflection co-efficients of the mismatches at each end of the transmission line, and to the length of the line. For this reason, this effect is usually known as the long lines effect. The noise allowance usually made for this source of distortion in a 600 channel system, yields a specification for the effective VSWR at the antenna and the transmitter, for a 100 foot transmission line of about 1.06 over the significant operating rf bandwidth. These considerations explain in some degree the apparent preoccupation of microwave engineers engaged in radio relay work, with the attainment of outstanding matching performance in all components. An enormous amount of work has been given to the design of antennas and transmission lines or waveguide runs, capable of meeting this extremely stringent requirement. In recent years, the increasing availability of microwave ferrite isolators has somewhat alleviated this problem in some cases, since these components pass energy in only one direction, and have

the effect of absorbing reflected energy. Nevertheless, such components represent only a partial solution, since it is not possible to use a ferrite isolator effectively in many of the more economical configurations of microwave components used in radio relay systems (Figure 2). Further, a ferrite isolator, of itself, may present a severe mismatch to the transmission line. It is necessary that the VSWR of the ferrite isolator meet the requirements calculated for the long lines effect. This in itself, often represents a formidable problem.

Radio relay systems usually use frequency modulation in order to take advantage of the noise improvement achieved with this system, and the possibility of eliminating external atmospheric noise and AM interference. It is interesting to note that the case of the long lines effect, and the necessity for obtaining superlative matches in rf components, is one case where the choice of an fm system materially increases the difficulties of a designer. Whereas, VSWR's of components required in fm systems lie in the region of 1.05, comparable VSWR's in AM systems lie in the region of 1.5, since distortion arising from this individual source in AM systems is very much less than that in fm systems. The equipment designer may be excused for wishing he could, in some manner, obtain the advantages of both systems, without any of the attendant difficulties.

One of the major sources of distortion in any radio relay system is in the traffic modulators and demodulators. Because of the difficulties in designing such units, the noise allowance ordinarily made for a modulator-demodulator pair is relatively high; it is in the order of 200 pw. This is a major fraction of the allowance of 1500 pw for a CCIR section of 300 miles. If each of the 11 stations in the standard section contained a modulator-demodulator pair, the noise for the section contributed by this cause alone, would cause the CCIR noise allowance to be exceeded by 30 per cent. In order

to achieve CCIR performance, therefore, it is necessary to design through or non-demodulating repeaters, for use at intermediate stations, in order to avoid the unnecessary repetition of this source of noise. It will also be seen that on systems shorter in length than the CCIR standard section, the noise and distortion contribution of the modulator-demodulator becomes proportionately larger, and when combined with the noise contribution of the other components, makes it an extremely difficult task to attain pseudo CCIR performance on shorter systems on the basis of a pro rata 3 pw per km of system. Indeed, equipments which obtain this performance must, of necessity, have some margin of performance over CCIR standards over a standard section. It is for this reason that CCIR specifications are not given for systems other than the standard system of 1500 miles.

Reliability

One of the primary considerations in the operation of any communications system, is its reliability. Every operating authority aims to have useable circuits available for as nearly 100 per cent of the time as possible. In the case of commercial circuits, outage times represent loss of revenue, and, in some cases, further losses because of penalties exacted by customers for lack of service. The possible amounts of these losses must be balanced against the additional cost of equipment required to reduce outage time, and to increase reliability. In the case of military systems, the vital nature of the information being passed over the system is often such that virtually no outage time can be tolerated, and that ultimate reliability must be achieved.

The experience and knowledge obtained by companies and designers in supplying military systems, now makes it possible to provide commercial radio relay systems of extremely high reliability, at a cost which is economically possible. For a system of 10 hops provided with duplicated radio equipment, is is now feasible to quote reliability in the order of 99.98 per cent

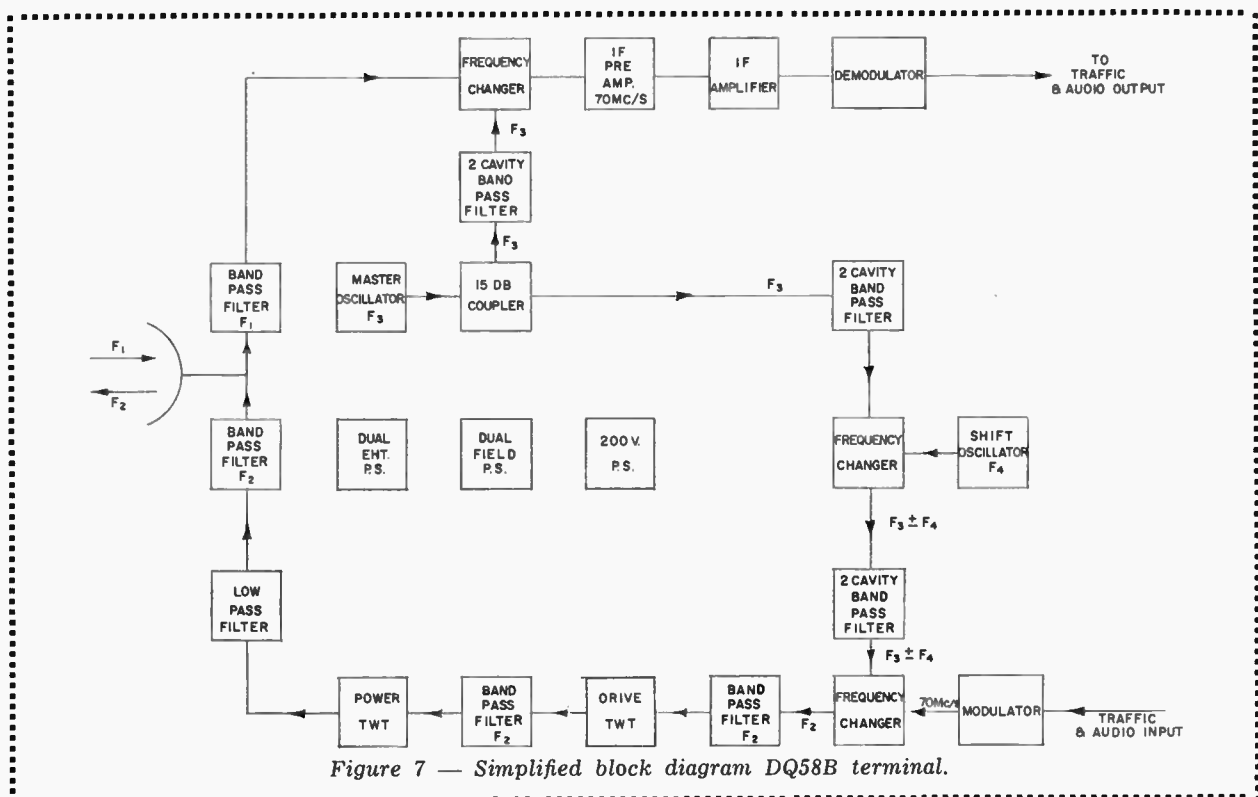

Figure 7 — Simplified block diagram DQ58B terminal.

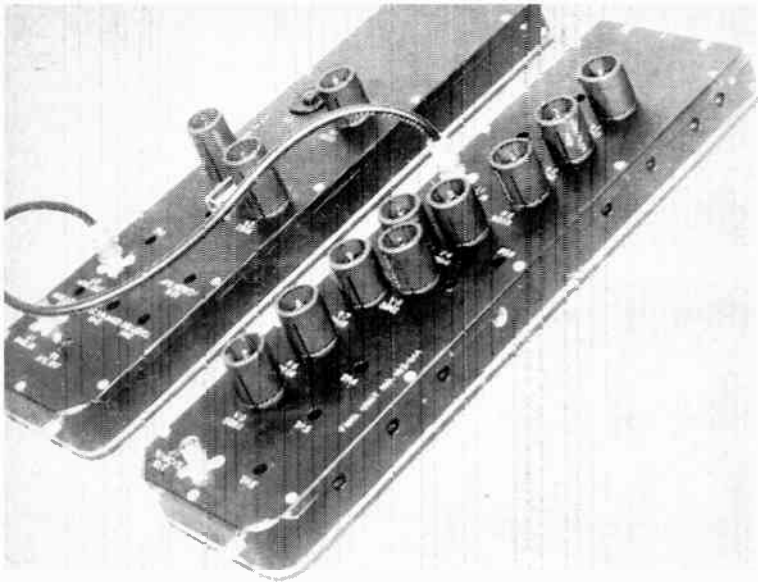

Figure 8 — A printed circuit broadband modulator unit, together with its associated AFC unit. These chassis can carry 600 telephone channels or one TV channel to standards in excess of those required for CCIR performance.

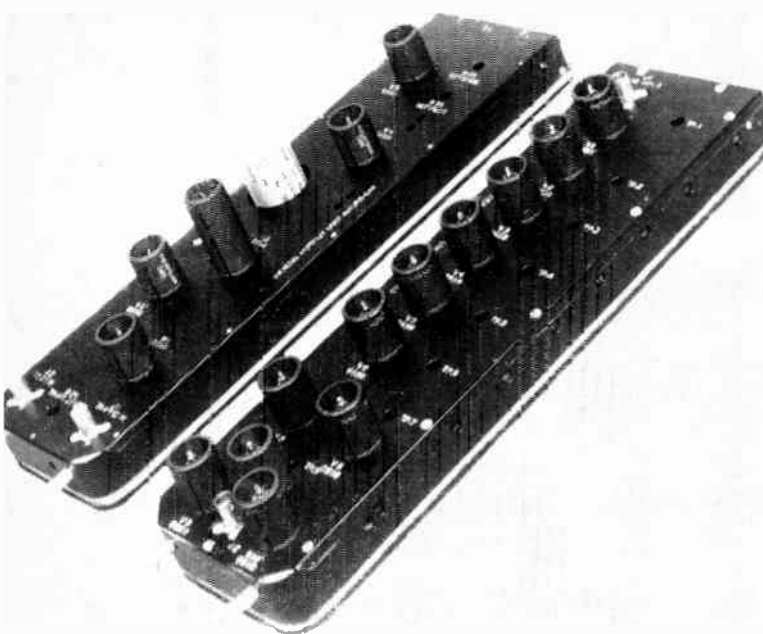

Figure 9 — A printed circuit demodulator unit, together with its output unit. These units provide CCIR performance for 600 telephone channels or one TV channel.

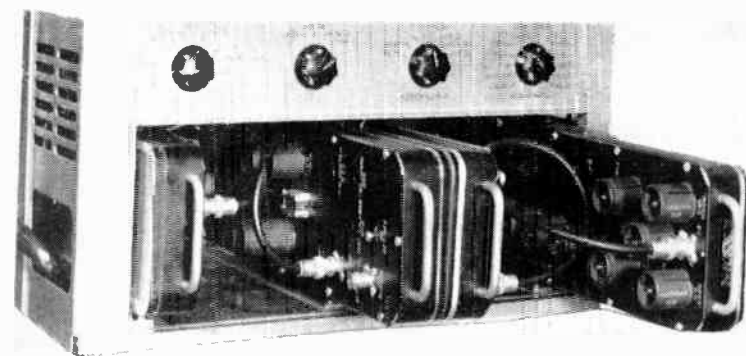

Figure 10 — Canadian Marconi Company DQ-58C modern unit, showing means of mounting and ease of replaceability of plug-in printed circuit modulator and demodulator units.

on a long term basis. This represents a total system outage time averaging only one hour and 44 minutes per year. This high reliability is obtained by reducing the number of faults per equipment to 6 per year, together with the provision of an equipment design and a servicing facility which permit the average time consumed in repair of any fault to be reduced below 2 hours. This must include time elapsed before a service technician arrives at the site. This calculation assumes, of course, that modern techniques are employed for the duplication of equipment and for automatic switching or selection of operative equipment when a fault occurs.

Techniques involved in the design of modern radio relay equipment, the use of modern components of higher performance and reliability, together with the knowledge obtained from long years of experience, enable the modern designer to develop circuits and equipments of inherently higher stability and reliability. Whereas it was formerly necessary to operate components and circuits at or near the limits of their capabilities, it is now possible to operate virtually all components at conservative ratings. This results in units which not only have many fewer faults, but which are much easier to adjust and whose adjustment is non-critical. This in turn, means that higher performance can be attained over very extended periods of time without the periodic readjustment which was formerly necessary.

Improvements of this nature have occurred throughout the designs of radio relay equipment; in modulators, demodulators and if circuits higher performance can now be achieved with a much greater degree of stability. Indeed, in the proper design of radio relay circuitry, the designer should choose the form of circuit which offers higher stability and greater freedom from critical adjustment over that offering still higher performance.

An excellent example of the improvements obtained in the use of modern components, is the trend to the use of travelling wave tubes in wide band equipment. The tubes formerly available for the generation or amplification of microwave power, such as microwave triodes or klystrons, suffer from a number of limitations. Because they operate in cavities, they tend to have limited bandwidths of operation. Adequate bandwidths for wide band systems can only be obtained by very careful adjustment of the associated cavities, a factor which inevitably leads to the need for relatively frequent readjustment in service to maintain optimum performance. Further, the small physical size of these tubes limits the power which can be drawn from them, and further, means that they are inherently fragile with relatively short lives. The travelling wave tube on the other hand, is a physically large, robust tube, with relatively large power output, and, an added advantage, a much higher gain than its competitors. The N1001 travelling wave tube, shown in Figure 3, operating at 2000 Mc/s, gives a power gain in excess of 40 db, compared with a gain of about 10 db from a microwave triode. Further, the travelling wave tube is inherently a broad band device, since neither it nor its mount contains any frequency limiting devices. This means that the travelling wave tube can be operated with no critical adjustment. A travelling wave tube in the Canadian Marconi DQ 58B equipment can be replaced, and the system returned to full operation in under 120 seconds, nearly all of which is taken up in filament warm-up time. And lastly, and most important of all, the travelling wave tube, if properly designed,

can give very extended lives because of its relatively large size. The N1001 tube in Figure 3, is guaranteed in the DQ 58B equipment, to give a life in excess of 8000 hours; it is confidently expected that such tubes will give an average life in excess of 15000 hours. In a test system which has been in operation for 18 months or 13000 hours containing 24 travelling wave tubes, not a single tube of the N1001 type has required replacement. One tube of this type was operated for a period of over 5 years (34000 hours) and when eventually removed from service for purposes of exhibition, showed no appreciable degradation in its performance. It can readily be appreciated that the availability and use of components and techniques such as these, contributes greatly to the improvement of equipment reliability.

Of course, it is insufficient to merely design better and more stable circuits using longer life components, since even the best circuit will inevitably develop faults. It is further necessary to design equipment in such a manner that faults can be anticipated and avoided by preventive maintenance and can be easily identified and located if and when they occur. These aims can be accomplished only if an equipment contains a carefully designed monitoring and metering system. For example, the Canadian Marconi Company DQ 58B equipment (Figure 4) incorporates a system of front panel meters which measures the currents of all tubes, and the levels of signals at significant points throughout the equipment. This means that a maintenance technician, noting all meter readings on bi-weekly or monthly visits to a station, can detect any gradual degradation in circuits, and replace failing components or tubes. Thus all but catastrophic failures should be avoided. Of course, the same metering and monitoring facilities permit the rapid location of a fault. The metering facilities shown on the DQ 58B equipment are only one form of the very necessary comprehensive monitoring system which is essential in any radio relay equipment which is required to give reliable service.

In order to achieve the maximum reliability, it is essential that the service technician be able to service the equipment quickly and efficiently. This can only be achieved if all portions of the equipment are readily accessible for servicing. Figure 5 shows one method of obtaining the necessary accessibility. Further, it is essential that individual units be readily replaceable, since it may be necessary to replace units in the field and return the faulty unit to base for repairs. Provisions of this nature must be made in order to achieve the ultimate in reliability.

The competent and conscientious design engineer is not satisfied merely to design a circuit which should be more reliable and less critical to adjustment. He can only be certain he has achieved his purpose by actually operating his equipment under field conditions in an extended life test. For this reason, radio relay laboratories often contain racks of units, operating on life test; many laboratories operate extensive test systems, which serve two important purposes. They not only permit the performance of the equipment to be determined when operated in a system, but they provide

Figure 11 (left) — Canadian Marconi Company DQ-58C terminal rack. This equipment, operating in the frequency band 1700-2300 Mc/s, is capable of carrying 600 telephone channels or one TV channel to CCIR standards.

Figure 12 (right) — Canadian Marconi Company DQ-58C terminal rack, with panels open, showing ready access to all circuits.

priceless data on the life and reliability of the equipment. For example, the four station test system of DQ 58B equipment operated by the Canadian Marconi Company, has operated for a period of over 18 months, with a fault record much less than the 6 per year per equipment allowed in the reliability calculations. Life test data from this link and from even more extended tests on individual units would indicate that the excellent reliability figures discussed earlier, can be achieved and surpassed with ease.

The Canadian Marconi Company DQ 58B

The DQ 58B equipment, chosen for use in military defense circuits, represents the results of design considerations such as those discussed in this article. This equipment is one of a family of DQ 58 equipments, all operating in the 2000 Mc/s frequency band, and intended to carry 600 telephone channels of toll line

Continued on page 75

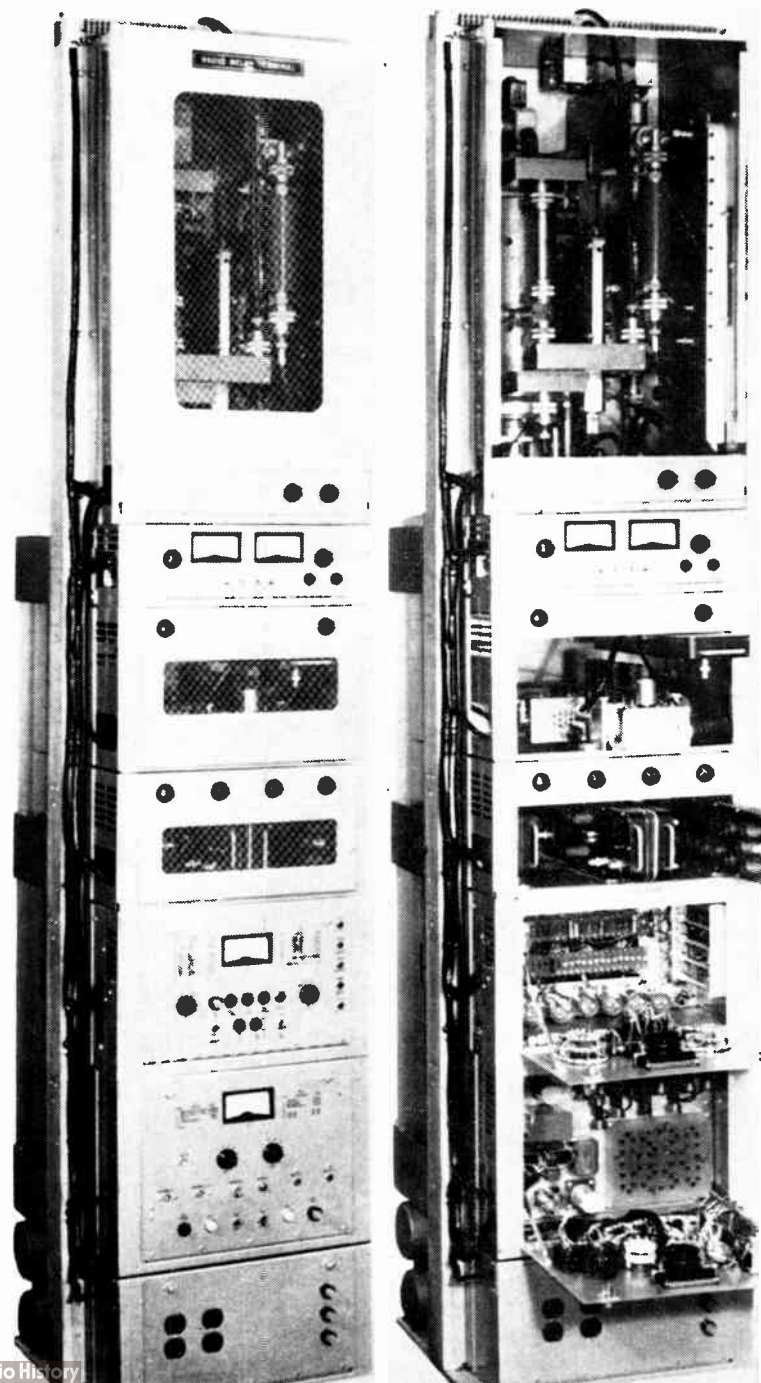

product panorama

For further information on New Products use Readers' Service Cards on pages 67 and 68.

Oscillographic recorder

Item 609

A new two-channel oscillographic recorder with heated stylus direct writing is housed completely in a portable case less than one cubic foot in size. Its compactness and broad recording capabilities make it extremely useful in the plant, laboratory or on field assignments. The new Sanborn Model 320 system has two current-feedback amplifiers—each with floating and guarded inputs, and a rugged, two-channel recorder assembly with low impedance, enclosed galvanometers.



The dependability and small size of the instrument are achieved through the use of completely transistorized circuitry with most of the components for each channel mounted on one easily serviced card; the remaining ones are easily accessible.

The Model 320 also has provision for connecting an external monitoring 'scope to either channel; pushbutton chart speeds of 1, 5, 20 and 100 mm/sec, and a marker-timer stylus with internal 1 second timer. Overall dimensions are 12 3/4" sq. x 8 3/4" high and the system weighs approx. 55 lbs. Complete specifications are available on request from Sanborn Company, Industrial Division, 175 Wyman Street, Waltham 54, Mass., U.S.A.

Sigma series 33 relay

Item 610

For applications where relay compactness and dependable operation under extremes of vibration and temperature are required, Sigma Instruments, Inc. now has available a new 100-milliwatt adjustment of their subminiature Series 33 relay. Major characteristics of this relay are DPDT contacts rated for 2 amp. resistive loads; polarized, magnetically biased operation—armature normally occupies one closed position when the relay is unenergized.

The new adjustment of the Series 33 relay is designated "VG" and has the following standard specifications: 30 g to 5000 cps vibration, 70 g shock and constant acceleration will not cause contacts to open, with relay energized or de-energized; -65°C to +125°C operating temperature range; silver contacts rated at 2 amperes (28 VDC/120 VAC, resistive load) for a minimum of 100,000 operations at +125°C; single coil; 0.80" x 0.40" x 0.90" high; weight—18 grams; hermetically sealed enclosure; plug-in, solder terminal or 3" wire connections in 0.100" grid; and stud or flange mounting. On special order, the 33 VG is available with dual coils, and gold alloy contacts rated at 0.5 amp. for dry circuit applications.

Further information from Sigma Instruments, Inc., 192 Pearl St., So. Braintree 85, Mass.

Terminals

Item 611

Where a single- or multi-channel duplex radio system is used in place of lines over difficult terrain or to off-shore islands, it is now possible to provide subscriber part-line service.

Developed by the Secode Corporation, a system consists of one C.O. terminal and one subscriber-end terminal. All the necessary facilities for signalling and talking, in both directions, are provided; included are subscriber talking battery, coded ringing to and from the central office—divided code ringing, as well. The actual 20-cycle ringing current at the subscriber end is supplied by a local ringing generator switched by relay equipment in the subscriber-end terminal.

Completely self-contained, each terminal is powered by 117-volt 60-cycle supply; mounts in a standard 19-inch rack and has all terminals ready for connection to the radio equipment and telephone lines.

Further information available from Tele-Radio Systems Ltd., 3633 Dundas St. West, Toronto 9, Ont.

Temperature indicator

Item 612

Fliden Electronics Ltd., announces a precision self-balancing electronic temperature indicator designed to operate with resistance bulbs but the use of transistors, and modern production methods, enable the instrument to be offered at a price comparable with filled systems or galvanometer equipment.

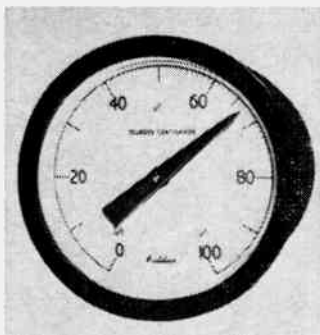

The indicator is presented in a sealed case similar in size and appearance to a mercury-in-steel indicator or to a circular scale electrical meter and, in fact, the extensive tests carried out on the equipment have convinced the manufacturers that it is no more likely to require attention than a normal electrical indicating meter.

Resistance bulbs are used as the temperature sensitive elements and with the inexpensive cable specified, these can be any distance from zero to 300 ft. away from the instrument without affecting the calibration or accuracy.

The instrument has a calibration accuracy of 0.5% of range and reproducibility is better than 0.25%. It is, therefore, particularly suitable for those industries where high accuracy, long term stability and trouble free service are prime requirements but, in view of the low cost and simple installation, it offers a modern replacement for filled systems and galvanometer type indicators.

For further details, contact Measurement Engineering Ltd., Arnprior, Ont.

Ground outlets-plugs

Item 613

Amphenol Canada Limited announces the availability of a new 160 series of heavy duty U ground outlet type plugs and receptacles. Available in five styles, they are ideal for use in home appliances and tools, industrial equipment and replacement parts.

Features include . . . rugged construction . . . molded in grounding pin . . . mounting plate and motor housing shell make ground when installed in equipment.

Electrical rating 125 volts at 15 amps. They are CSA approved. For further information, write to Amphenol Canada Limited, 349 Carlisle Avenue, Toronto 8, Ont.

Insertion loss scanner

Item 614

The Pye Insertion Loss Scanner, Model PTC 1206, has been designed to measure characteristics of co-axial cable systems and submarine cables, and for testing frequency translating equipment (single group and supergroup) and similar applications. The overall scanning bandwidth provided is 50 Kc/s-8 Mc/s with facilities for narrower band operation of 0.2 Mc/s or 0.4-5 Mc/s. The equipment consists of four chassis, a send unit, a receive unit (which incorporates a CRT) and two power supply units. Each unit is designed for rack mounting, or is available in individual cabinets. The equipment can be used for uni-directional or loop tests and in addition to measuring system losses, bandwidth characteristics, etc. it can be used as a return loss bridge. Two sweep rates are provided, 25 sweeps per sec. for the CRT, and a forward rate of approximately one sweep per min. for recording. Neither rate is synchronous with the mains frequency. The trace displayed or recorded can be marked at 60 Kc/s, and at frequency intervals of 250 Kc/s, 500 Kc/s or 1 Mc/s.

Pye Canada Limited, 84 Northline Road, Toronto 16, Ontario.

Klystron tube mounts

Item 615

Klystron Tube Mounts, which will eliminate the problems of setting up a complex apparatus for testing and operating Klystron tubes, have been introduced by Narda Microwave Corporation, Mineola, L.I., N.Y.

Designed for ultimate convenience and safety, these mounts incorporate adequate forced cooling (with the enclosed fan directing the air away from the operator), and positive electrical connections by means of "AN" type connectors. A mating cable connector is supplied with each mount.



Klystron tubes are positioned in the mount so as to provide free and easy access to the Klystron tuning adjustments. In the case of Model 991 (for Sperry Klystrons), an output SKL Type N adapter is provided.

Constructed of rugged cast aluminum, Narda Tube Mounts are available for use with Varian, Sperry, Raytheon and EMI Klystrons.

Complete specifications are available from The Narda Microwave Corporation, 118-160 Hericks Rd., Mineola, L.I., N.Y.

DC digital voltmeter

Item 616

A new low cost DC Digital Voltmeter for general laboratory and industrial applications has been introduced by Electro-Logic Corporation. This unit, known as the Model V-1 converts an unknown voltage into decimal numbers with an accuracy of 0.5% of full scale. The V-1 has high speed response, 1/24th of a second for full scale. Quick response saves operator's time and eliminates annoying delays normally occurring with even expensive digital voltmeters.

Small in size, extremely rugged and dependable, the Model V-1 has the acknowledged advantages of reliable digital presentation. Both digital and quasi-digital readout can be obtained with this unit. The digital presentation is a bright number on a dark field



in a viewing window. In the quasi-digital mode the numbers do not "frame" as in the digital mode but slide smoothly by the window; particularly useful for observation of trends or interpolation between numbers.

The V-1 is available in three ranges 0-2.5V, 0-250V (ranges of 0-0.25 and 2500 volts can be supplied).

For further information contact Computing Devices of Canada Ltd., P.O. Box 508, Ottawa, Ontario.

Level trigger

Item 617

Cambridge Thermionic Corporation has added a new high speed 10 MC Level Trigger to its expanding line of CAMBION(R) computer components.

CAMBION's level trigger is a circuit possessing an output which rapidly assumes the one level when input voltage is raised above critical triggering level and quickly changes to zero level when input voltage falls below turnoff level.

The design of the model #LT-1 Level Trigger provides a unique storage feature . . . If the input is open circuited at any time, the output remains at the value corresponding to the last input voltage applies. The level trigger is only 0.35 cubic inches in size and has a superior frequency response from DC to 10 MC. It weighs only 9 grams and operates over a wide temperature range, -55°C to +55°C. The standard 7-pin base design permits easy insertion into sockets for development work, dip-soldering in printed circuit boards an rapid incorporation into finished computers.

For further information, write Cambridge Thermionic of Canada Limited, 2425 Grand Boulevard, Montreal 28, P.Q.

Coaxial isolators

Item 618

Special Microwave Device Operations of Raytheon Company has added two broadband coaxial isolators to its product line. The new units, designated ICLM2 and ICSM2, open new design possibilities in "L" and "S" band equipment.

The Model ICLM3 operates in the "L" band region from 1250 to 1600 megacycles. Designed to handle peak power of 5 KW and average of 25 watts, it has minimum isolation of 20 db, a VSWR of 1.25, and insertion loss of 1.0 db maximum. Overall length of the 3.8 lb. unit is 12 inches.



The Model ICSM2 covers 2000 to 4000 megacycles in "S" band and handles peak power of 5 KW with an average power capability of 5 watts. Maximum isolation is 30 db with a minimum of 20 db. Maximum VSWR is 1.25. Maximum insertion loss is 2.0 db with 1.0 db possible over a narrow band. Overall length of the new isolator is 9.8 inches. Weight is 2.3 lbs.

Both new isolators have Type N female connectors.

Special Microwave Device Operations, Raytheon Company, 130 Second Avenue, Waltham 54, Massachusetts.

Instructional servo systems

Item 619

A Servo System intended for demonstration purposes and student use is available through The Glendon Instrument Company Ltd. It will illustrate the principles of closed-loop position control. Many important aspects of basis theory such as the effect of gain on alignment accuracy and the combined effect of gain and damping on transient response may be demonstrated directly on the equipment by visual observation.

The equipment consists of a Servo Control Unit and a Servo Assembly. The system operates on DC signal throughout and can be switched to operate as a velocity-lag system characterized by a single fixed time constant of 0.16 second in the forward path, or to a condition in which a suitable time constant can be determined by the users' own mechanical loading on an extension of the motor shaft.

Two ranges of forward gain are available, a low gain which gives a wide range of linear operation, and a high gain to enable the improved performance with compensating networks to be realized.

The Glendon Instrument Company Ltd., 46 Crockford Blvd., Scarborough, Ontario.

Micro-circuitry

Item 620

A new technique in Micro-circuitry has been developed by IRC. Called the MU circuit, it is particularly adaptable for adder, pre amplifier, binary counter and logic circuits. MU circuits offer increased space efficiency and afford the designer the opportunity to use existing tried and proven circuitry ideas merely by translating them into MU circuitry.

For further information on IRC's New Micro-circuitry, write for a copy of Advanced Engineering Bulletin AE-12 to IRC Resistors, Division of Renfrew Electric Co. Limited, 349 Carlaw Ave., Toronto 8, Ontario.

Analog tachometer

Item 621

The Analog Tachometer Type SA .507 is a fully transistorized analog frequency meter utilizing the characteristics of a saturated core to provide constant voltage-time integral pulses. This output pulse train is used to operate a $3\frac{1}{2}$ " scale meter calibrated 0-3,000, 0-10,000 and 0-30,000 r.p.m.

The instrument operates from a photo-transistor transducer type SA .508 which enables shaft speed measurements to be made without physical connection to the shaft under test. For other applications the co-axial magnetic transducer type MA .95B is available, operating direct from a rotating toothed wheel.

The SA .507 is housed in a strong, industrial type wooden case which provides sufficient space to house the batteries and photo-transistor transducer.

Racal Instruments Limited, Western Road, Bracknell, Berkshire, England.

Recorder/reproducer

Item 622

The first magnetic tape system that does the work of two by storing both analog and pulse data with equal facility has been announced by the Electrical Products Division of Minnesota Mining and Manufacturing of Canada Limited.

Known as the model CM-100, this wide band recorder/reproducer is a product of the Mincom Division of Minnesota Mining and Manufacturing Company in the United States.

A unique characteristic of the CM-100 is its bandwidth of 400 cycles to 1.0 megacycle. Another feature is that there are seven wide-band tracks to a single $\frac{1}{2}$ " wide magnetic tape. Six speeds from $7\frac{1}{2}$ ips to 120 ips provide greater bandwidths at each speed than has heretofore been available. For example, at 15 ips the CM-100 records frequencies up to 125 kc, at 60 ips it records frequencies up to 500 kc.

More information regarding the CM-100 may be obtained by writing to the Electrical Products Division of Minnesota Mining and Manufacturing of Canada Limited, P.O. Box 757, London, Ontario.

Microwave components

Item 623

Long known as a major manufacturer of microwave tubes, Bomac Laboratories, Inc. is now placing added emphasis on pre-packaged, pre-tested microwave assemblies, complete with components and associated hardware, ready for installation in the customer's radar unit.

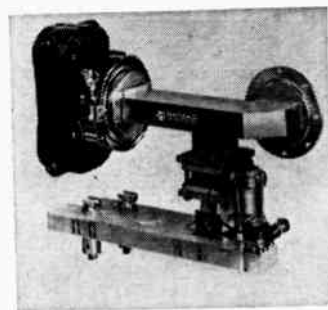

Typical is the assembly shown here—a "package" consisting of a branch guide duplexer and a balanced mixer, with magnetron, tunable TR tube, klystron and crystals.

Bomac engineers will design on order the modulator for this typical unit or other R.F. package to supply negative pulses for the magnetron, either as part of the same package or separately.

Bomac Laboratories, Inc., Salem Road, Beverly, Mass., U.S.A.

Sub-miniature switch

Item 624

A new completely sealed sub-miniature precision snap-action switch has been introduced by Micro Switch, Toronto, Ontario, a division of Honeywell Controls Limited.

This switch, Catalog Listing 1XE1, is the smallest and lightest environment-free switch available to meet the pressing demand for miniaturization combined with reliability in mobile, marine, aircraft and railway applications. The 1XE1, .616" wide x .600" high x .316" thick, and weighing only .20 oz., opens a new world of possibilities for the designer of compact devices where space and weight savings are important.

The switching unit and the extending leadwires are embedded in epoxy resin within the treated, corrosion-resistant aluminum housing; an elastomer seal around the actuating plunger completes the sealed construction to prevent entry of dust, dirt, and moisture. The 1XE1 provides dependable operation in a temperature range from -65° to 230°F, and presents a single-pole double-throw contact arrangement. Electrical rating includes 4 amps, inductive, 28 vdc; 5 amps, 115/230, 60 cycles.

Ask for Data Sheet 169 from B. Colwell, Merchandising Dept., Honeywell Controls Limited, Vanderhoof Avenue, Toronto 17, Ontario.

MIL rheostats and resistors

Item 625

Ohmite Manufacturing Company has now expanded what is claimed to be the world's largest stock of ready-to-ship power resistors and rheostats to include MIL rheostats and resistors.

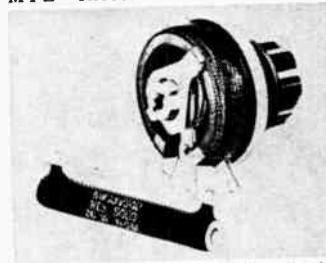

These components will be stocked in all popular values and tolerances listed by MIL-R-26C and MIL-R-22A, respectively. At present, Ohmite is also stocking tantalum capacitors to meet MIL-C-3965B: Styles CL24, CL25, CL34, CL35, case sizes C1, C2, C3; and Styles CL44, CL45, case size T1.

Distributors of Ohmite components throughout the country will also stock many of these MIL items enhancing even further Ohmite's renowned service to industry through distributors. Components produced by Ohmite for military use include the products described above as well as adjustable power resistors, precision resistors and relays. All these components are described in "Catalog 50", available upon request from Ohmite Manufacturing Company, 3680 Howard Street, Skokie, Illinois, U.S.A.

Dynamic tube tester

Item 626

To meet the progressive trend in tube design, the new Avo Valve Characteristic Meter Mark IV has been introduced. It is designed to test almost any receiving tube (American or European) and many small transmitting types.

AC voltages are used throughout the instrument, which eliminates the regulation problems and inaccuracies usually associated with DC circuitry. A new system of mutual conductance measurement permits readings up to 60 ma/V, and provides

extreme accuracy when measuring high-slope tubes. Facilities for monitoring filament current are included. Internal circuitry incorporates semiconductors, so that no warm-up period is required.

Rectifier tubes are checked at each plate separately at the full rated load and with an 8 mfd. condenser in circuit.

This tester will provide all characteristics of a tube, whether checking or in development or experimental work. Additionally, a quick "GOOD/BAD" check can be made. An overload relay is incorporated.

R. H. Nichols Limited, Box 500, Downsview, Ontario.

Soldering iron holder

Item 627

To provide safer, more efficient production soldering, engineers at Ungar Electric have created a unique soldering iron holder, with safety guard design. One significant feature is the exclusive safety guard design which fully protects the soldering operator against painful "hot tip" burns. With the Ungar Soldering Iron Holder, the operator no longer need worry about accidentally brushing against exposed hot irons.

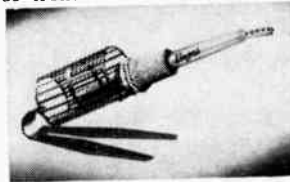

This new Ungar Soldering Iron Holder keeps the soldering iron cradled safely and securely in one convenient place, increasing soldering efficiency and providing greater protection against iron breakage.

Designed for versatility, the new holder incorporates many features to add to the operator's convenience. The operator may attach the holder to (1) the top of the bench, (2) to a wall or side of the bench, or (3) to the underside of the bench. In addition, the operator can adjust the angle of the holder, so that the soldering iron is positioned for easy, instant use.

For further information, write Ungar Electric Tool Co. of Canada, 44 Danforth Road, Scarborough, Ontario.

R.F. converter-amplifier

Item 628

The Daven Company, Livingston, New Jersey, announces the development of a new R.F. Converter-Amplifier for use in closed circuit tests of missile telemetering and data transmission systems.

The unit consists of an R.F. amplifier and converter section, a crystal-controlled oscillator and multiplier section, and a high gain, high output I.F. amplifier. Using a ceramic triode in a grounded grid circuit, the R.F. amplifier accepts any one of four pre-set frequencies in the 200 megacycles and is amplified to the final output level of 5 volts at an impedance of 200 ohms.

The maximum overall voltage gain is 500,000 from the 50 ohm input to the 200 ohm output, and the bandwidth is 200 kc at the -1 db points. A manual gain control provides for gain adjustment over a 40 db range. The output versus input characteristic is linear for output levels as great as 5 volts and for all input levels up to 100 microvolts. Overall gain stability is better than ± 1 db over a 10 hour operating period, achieved by conservative design and the use of negative feedback stabilized I.F. amplifiers.

For further information, write to The Daven Company, Livingston, New Jersey, U.S.A.

Continued on page 76



Announces expanded manufacturing and service facilities in new Canadian electronics plant

Raytheon has long been regarded as the symbol of excellence to Canadian users of electronic equipment and supplies... and their number is constantly growing.













New Canadian headquarters have been established in a modern 34,000 sq. ft. plant at Waterloo to produce and bring you Raytheon products quickly and efficiently, and to provide information and service on the application of these products.

Every facet of the engineering knowledge and exacting quality control in manufacture that have brought recognition to the name Raytheon, is reflected in our new plant facilities and personnel.

Examples of Raytheon electronic equipment are shown here. Address your enquiries to Commercial Sales Division, Raytheon Canada Limited, Waterloo, Ontario.



Some of the products we supply:

 *Semi-conductors—Transistors, Diodes and Rectifiers*
 *Industrial and special purpose tubes in a wide range*
 *Microwave and Power Tubes*
 *Machlett Power Tubes*
 *Microwave Communication Systems*
 *Welding Equipment*
 *Ultrasonic Machine Tools*
 *Knobs and Captive Hardware*
 *Transformers, Rectifiers and special telephone switchboard battery chargers*
 *Radarrange Electronic Ovens*
 *Marine Radar*
 *Fathometer Depth Sounders*



excellence in electronics

RAYTHEON CANADA LIMITED
WATERLOO ONTARIO

For complete details check No. 45 on handy card, page 67

APPLICATION FOR FREE SUBSCRIPTION

**Use this
convenient
card to
facilitate
receiving
E & C**

**For more
information
or literature
about
any
product
described or
advertised
in this issue -
use these
post paid
"more
information"
cards
for quick
results**

Please **ADD** my name to receive **ELECTRONICS & COMMUNICATIONS**
Please **CHANGE** my address for mailings.
Note — Card must be completed in full to be valid.

My Name _____ (Please Print)
Mail copies to my **home, or** **business address as noted below.**

Street _____
City _____ **Zone** _____ **Prov.** _____
If you have recently **CHANGED** your address please note former address here:

Company _____ **Nature of Business** _____
(State, when applicable, whether electronic equipment or components are manufactured, sold, or used in manufacturing, etc.)

ARE YOU AN ENGINEER? Yes No

Signature _____ **Position** _____
10-60

BUSINESS REPLY CARD
No Postage Stamp Necessary if Mailed in Canada

5c POSTAGE WILL BE PAID BY

ELECTRONICS AND COMMUNICATIONS

450 Alliance Avenue

Toronto 9, Ontario



PLEASE SEND FURTHER INFORMATION ON FOLLOWING PRODUCT ITEMS AS NUMBERED BELOW. (All Literature & Product Items Numbered)

- | | | | | | | | | | | | |
|------------------------------|------------------------------|------------------------------|------------------------------|------------------------------|------------------------------|------------------------------|------------------------------|------------------------------|------------------------------|------------------------------|------------------------------|
| <input type="checkbox"/> 609 | <input type="checkbox"/> 610 | <input type="checkbox"/> 611 | <input type="checkbox"/> 612 | <input type="checkbox"/> 613 | <input type="checkbox"/> 614 | <input type="checkbox"/> 615 | <input type="checkbox"/> 616 | <input type="checkbox"/> 617 | <input type="checkbox"/> 618 | <input type="checkbox"/> 619 | <input type="checkbox"/> 620 |
| <input type="checkbox"/> 621 | <input type="checkbox"/> 622 | <input type="checkbox"/> 623 | <input type="checkbox"/> 624 | <input type="checkbox"/> 625 | <input type="checkbox"/> 626 | <input type="checkbox"/> 627 | <input type="checkbox"/> 628 | <input type="checkbox"/> 629 | <input type="checkbox"/> 630 | <input type="checkbox"/> 631 | <input type="checkbox"/> 632 |
| <input type="checkbox"/> 633 | <input type="checkbox"/> 634 | <input type="checkbox"/> 635 | <input type="checkbox"/> 636 | <input type="checkbox"/> 637 | <input type="checkbox"/> 638 | <input type="checkbox"/> 639 | <input type="checkbox"/> 640 | | | | |

PLEASE SEND FURTHER INFORMATION ON THE FOLLOWING ADVERTISEMENTS AS NUMBERED BELOW. (Key numbers in column overleaf)

- | | | | | | | | | | | | |
|-----------------------------|-----------------------------|-----------------------------|-----------------------------|-----------------------------|-----------------------------|-----------------------------|-----------------------------|-----------------------------|-----------------------------|-----------------------------|-----------------------------|
| <input type="checkbox"/> 1 | <input type="checkbox"/> 2 | <input type="checkbox"/> 3 | <input type="checkbox"/> 4 | <input type="checkbox"/> 5 | <input type="checkbox"/> 6 | <input type="checkbox"/> 7 | <input type="checkbox"/> 8 | <input type="checkbox"/> 9 | <input type="checkbox"/> 10 | <input type="checkbox"/> 11 | <input type="checkbox"/> 12 |
| <input type="checkbox"/> 13 | <input type="checkbox"/> 14 | <input type="checkbox"/> 15 | <input type="checkbox"/> 16 | <input type="checkbox"/> 17 | <input type="checkbox"/> 18 | <input type="checkbox"/> 19 | <input type="checkbox"/> 20 | <input type="checkbox"/> 21 | <input type="checkbox"/> 22 | <input type="checkbox"/> 23 | <input type="checkbox"/> 24 |
| <input type="checkbox"/> 25 | <input type="checkbox"/> 26 | <input type="checkbox"/> 27 | <input type="checkbox"/> 28 | <input type="checkbox"/> 29 | <input type="checkbox"/> 30 | <input type="checkbox"/> 31 | <input type="checkbox"/> 32 | <input type="checkbox"/> 33 | <input type="checkbox"/> 34 | <input type="checkbox"/> 35 | <input type="checkbox"/> 36 |
| <input type="checkbox"/> 37 | <input type="checkbox"/> 38 | <input type="checkbox"/> 39 | <input type="checkbox"/> 40 | <input type="checkbox"/> 41 | <input type="checkbox"/> 42 | <input type="checkbox"/> 43 | <input type="checkbox"/> 44 | <input type="checkbox"/> 45 | <input type="checkbox"/> 46 | <input type="checkbox"/> 47 | <input type="checkbox"/> 48 |
| <input type="checkbox"/> 49 | <input type="checkbox"/> 50 | <input type="checkbox"/> 51 | <input type="checkbox"/> 52 | <input type="checkbox"/> 53 | <input type="checkbox"/> 54 | <input type="checkbox"/> 55 | <input type="checkbox"/> 56 | <input type="checkbox"/> 57 | | | |

Name _____ **Position** _____

Company _____

Street _____ **City** _____ **Prov.** _____
10-60

BUSINESS REPLY CARD
No Postage Stamp Necessary if Mailed in Canada

5c POSTAGE WILL BE PAID BY



ELECTRONICS AND COMMUNICATIONS

450 Alliance Avenue

Toronto 9, Ontario

PLEASE SEND FURTHER INFORMATION ON FOLLOWING PRODUCT ITEMS AS NUMBERED BELOW. (All Literature & Product Items Numbered)

- 609 610 611 612 613 614 615 616 617 618 619 620
- 621 622 623 624 625 626 627 628 629 630 631 632
- 633 634 635 636 637 638 639 640

PLEASE SEND FURTHER INFORMATION ON THE FOLLOWING ADVERTISEMENTS AS NUMBERED BELOW.

- 1 2 3 4 5 6 7 8 9 10 11 12
- 13 14 15 16 17 18 19 20 21 22 23 24
- 25 26 27 28 29 30 31 32 33 34 35 36
- 37 38 39 40 41 42 43 44 45 46 47 48
- 49 50 51 52 53 54 55 56 57

Name _____ Position _____

Company _____

Street _____ City _____ Prov. _____

10-60

BUSINESS REPLY CARD
No Postage Stamp Necessary if Mailed in Canada

5c POSTAGE WILL BE PAID BY



ELECTRONICS AND COMMUNICATIONS

450 Alliance Avenue

Toronto 9, Ontario

INDEX TO ADVERTISERS

Page number is on the right. Key number for use with READER SERVICE CARD is on the left.

Key No.	Page No.
1. Adcola Products Ltd.	76
2. Amphenol Canada Ltd.	74
3. Arrow-Hart & Hegeman (Canada) Ltd.	78
4. Atlas Instrument Corp. Ltd.	13
5. Automatic Electric Sales (Canada) Ltd.	39
6. Automatic Electric Sales (Canada) Ltd.	40-41
7. Automatic Electric Sales (Canada) Ltd.	42
8. Bach-Simpson Limited	26-27
9. Burndy Canada Ltd.	7
10. Cambridge Thermionic Corp.	76
11. Canadian Marconi Co.	3
12. Cannon Electric Canada Ltd.	23
13. Computing Devices of Canada Ltd.	35
14. Conway Electronic Enterprises Reg'd.	6
15. Daystrom Ltd. (Heath Div.)	33
16. Daystrom Ltd. (Weston Div.)	2
17. Edo (Canada) Ltd.	34
18. Eltel-McCullough, Inc.	37
19. Engelhard Industries of Canada Ltd.	12
20. Ericsson Telephone Sales of Canada Ltd.	81
21. Freed Transformer Co., Inc.	75
22. General Radio Co.	86
23. Hackbusch Electronics Ltd.	18
24. Hellerman Canada Ltd.	75
25. Hewlett-Packard Co.	16
26. Honeywell Controls Ltd.	30-31
27. Honeywell Controls Ltd.	73
28. Hunt Co. (Canada) Ltd., Philip A.	33
29. I.R.C. Resistors, Division of Renfrew Electric Co. Ltd.	74
30. International Business Machines Co. Ltd.	10-11
31. International Rectifier Corp.	9
32. Jerrold Electronics (Canada) Ltd.	28
33. Kester Solder Co. of Canada Ltd.	82
34. Nichols Ltd., R. H.	38
35. Northern Electric Co. Ltd.	4
36. Northern Electric Co. Ltd.	8
37. Northern Electric Co. Ltd.	29
39. Payette Radio Ltd.	73
40. Philco Corp. of Canada Ltd.	83
41. Pye Canada Ltd.	34
42. Pylon Electronic Development Co. Ltd.	73
43. R.C.A. Victor Co. Ltd.	69
44. Radio College of Canada	17
45. Raytheon Canada Ltd.	66
48. Sarkes Tarzian, Inc.	79
47. Sinclair Radio Laboratories Ltd.	73
48. Stark Electronic Industries, Inc.	77
49. Stark Electronic Industries, Inc.	82
50. Stark Electronic Industries, Inc.	83
51. Stark Electronic Industries, Inc.	72
52. Syntron (Canada) Ltd.	80
53. Transatron Electronic Corp.	19-22
54. Tung-Sol Electric Inc.	85
55. United-Carr Fastener Co. of Canada Ltd.	38
56. Welwyn Canada Ltd.	82
57. Wind Turbine of Canada Ltd.	78

At the I.R.E.,

RCA VICTOR will present a comprehensive communications package, including:

- BROADBAND MICROWAVE SYSTEMS
- SINGLE SIDEBAND RADIO-TELEPHONE EQUIPMENT
- TELEPHONE SWITCHING APPARATUS

RCA VICTOR engineers will be on hand to discuss technical aspects of these units as well as applications of multiplex equipment and data communications.

See the RCA VICTOR exhibit, No. 13-14

TECHNICAL PRODUCTS DIVISION,



RCA VICTOR COMPANY, LTD.

The Most Trusted Name in Electronics



Scientist tests SNAP 10 nuclear core for use in a compact reactor which will generate electricity for space vehicles directly without moving parts.



Parametric mode transistor operating at ultra-high and microwave frequency ranges has been developed by Hughes Aircraft Company for operation in circuits invented by Lenkart Electric Co., Inc. Pointer indicates transistor mounted in circuit. Inventors believe both will lead to circuit simplification in communications equipment and possibly in electronic computers.

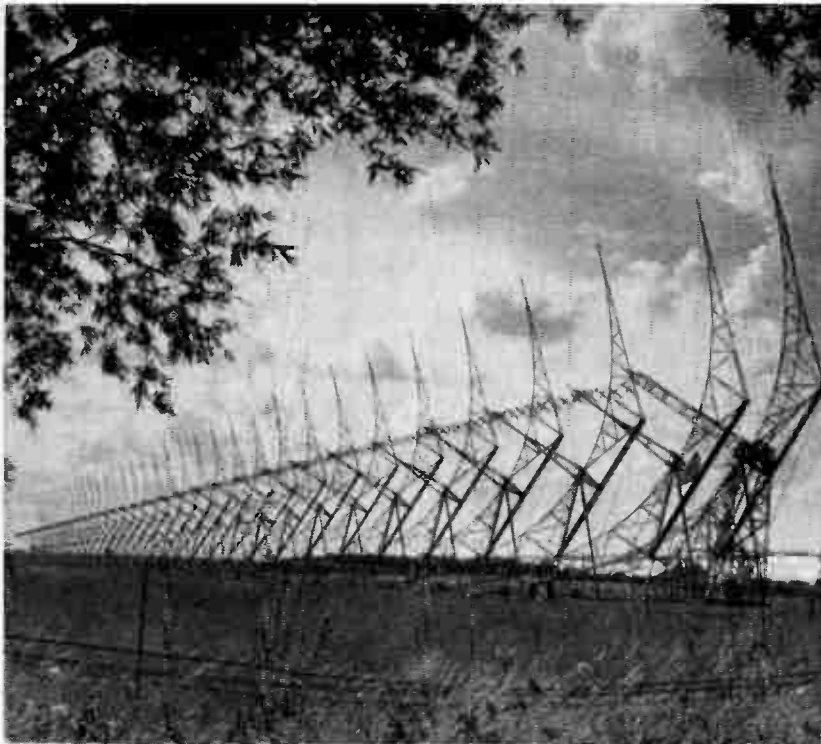

The radio telescope of the Mullard Radio-Astronomy Observatory at the Cavendish Laboratory, Cambridge, England — part of which is seen here — recently was instrumental in discovering a nebula 5,000 million light years away from the earth. The nebula, designated 3C295, was located by radio observations from Cambridge which enabled American astronomers at Mount Palomar to photograph the star galaxy, the most distant object ever seen in the whole universe.

close-up

looking lenswise at your industry in action

In the photograph below a technician of C. R. Snelgrove Company Ltd., Don Mills, Ontario, is shown aligning crystal filters which are fast becoming a vital component in better spectrum utilization.

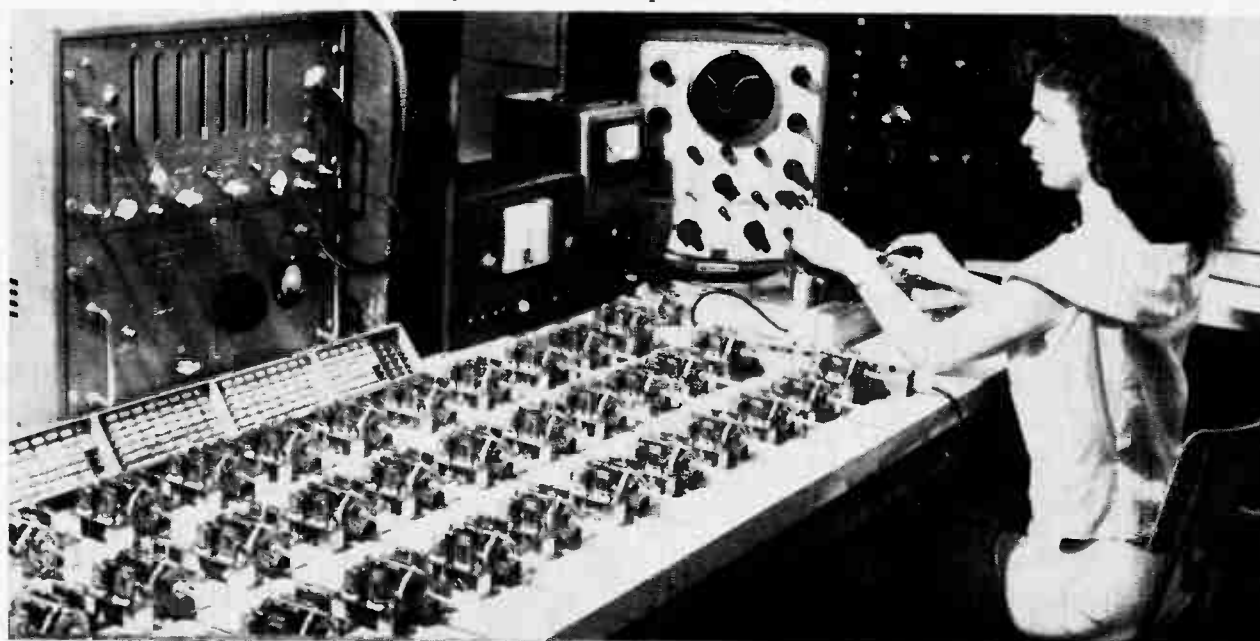

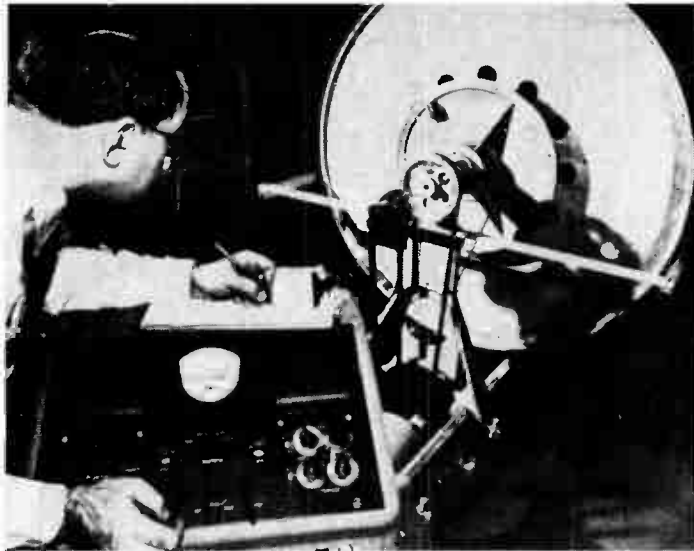

Antenna balancing at International Telephone and Telegraph Corporation's Federal Division employs Model SU-7 Dynamic Balancer in its VORTAC air navigation project. Device determines dynamic balance of rotating portion of VORTAC antenna.

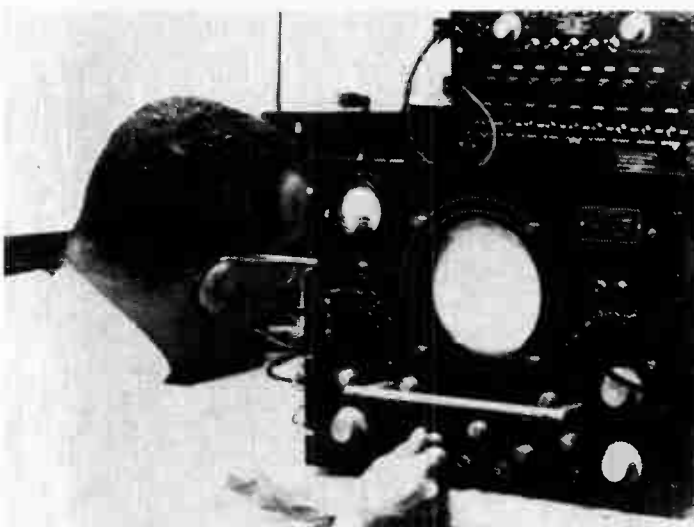

The swept-band transmission measuring set, a new electronic instrument, which facilitates the testing of telephone circuits, determines if there is a defect in a telephone circuit. The signal characteristics are displayed on a Cathode Ray tube which is part of the instrument.



A new 100-watt transistorized two-way radio has been announced by Canadian General Electric Company Limited. It is the first transistorized two-way radio in the 100-watt category to be packaged in a case as small as four inches high, 8 1/2 inches wide, and 15 inches long.



Plugging into a "home made" electronics tester that he built on spare time out of spare parts, Ernie Sweeney of North American Aviation's Los Angeles Division tests products to be used in triplesonic B-70 bomber program. The multi-purpose tester will save hundreds of man hours in development of 2000-mph B-70.



Even a machine can show off its manners — the mechanical hands of the Pye master slave manipulator strikes a match and reaches across to light the cigarette of Miss Vivienne Minchen. This piece of electronic equipment was one of the major attractions at the British Pye Group's own radio, television and electronics show at the Royal Festival Hall, London, recently.

scatter matter

Scanning the international scene

A television camera believed to be the first in the world with an integral zoom lens contained within the camera body has been developed jointly by the BBC Engineering Division and a firm of optical specialists owned by Rank Precision Industries Ltd. It has an unprecedented focal range of 2 ins. to 40 ins. and can zoom from long-shots to a close-up that apparently brings an object 20 times nearer to the viewer. Its development became possible through the revolutionary optical design of the lens. In its more conventional form this lens was first used operationally at Princess Margaret's wedding in Westminster Abbey and was used by the Italians to televize the Olympic Games.

A composite weather map of the entire United States, produced within minutes from more than 100 radar photographs taken simultaneously, and combined and transmitted over a nation-wide facsimile network, is the ultimate goal of a new contract just awarded by the United States Weather Bureau to Alden Electronic & Impulse Recording Equipment Co., Inc.

Under the contract, Alden Electronic will demonstrate the feasibility of its recently-devised plan which promises the simplest, fastest and most economical system of integrating critical radar weather data from coast to coast and ultimately from around the world.

The Alden system would yield a composite weather map within a few minutes after the hundred-plus radar weather centers took their respective photos.

Tense moments of the dramatic 19½ mile jump from the rim of space by USAF Capt. Joseph Kittinger were recorded for leisurely study by U.S. scientists on an airborne magnetic tape recording system specially designed for Capt. Kittinger by a Los Angeles electronic firm, Leach Corporation. The tape recorder, at the time it was built into the Kittinger instrumentation system, was the smallest in the world. It weighs

only 24 ounces and can be held in a child's hand. Since then Leach has produced one half as small, 10½ ounces.

The Kittinger recorder can keep a time-related record of heart beat, respiration, voice, rate of tumble, twists and turns of a falling body, and other data valuable to medical and physical observers, simultaneously on 14 separate magnetic channels.

Use of a TV camera to help a spacecraft land on the moon and a new vehicle called a cross between an airplane and a spacecraft were described by North American Aviation engineers at a meeting of the American Astronautical Society. Robert L. Peterson, a dynamics engineer, said a television camera mounted in a spacecraft also could be used to view the moon enroute to the landing site, to establish the local moon vertical and to send visual data back to a ground control station after the vehicle has landed. In spite of the great distance from the moon to earth, experts claim reception at the ground control station would be as good as everyday reception on a home TV set.

A new type of German milling machine, fitted with a British tape-control system, which anticipates errors and stops the machine before they would have been made, thus eliminating the scrapping of valuable workpieces, was shown publicly for the first time at the German Machine Tool Fair at Hanover from September 11 to 20. The machine — a Droop and Rein FS80 vertical mill — is controlled by the EMICON system, designed and manufactured by E.M.I. Electronics Ltd. This system incorporates a new angle safety unit, which foresees any program error or irregularity in the tape and brings the safety circuits into operation before the cutter arrives at that point. Previously, tape-controlled machines were equipped with a safety system which stopped the machine immediately an error had been made.

RCA offers course on transistors

This course, written by experts in the transistor field, is available to all service technicians, engineers and individuals who have a good basic knowledge of electronics.

The course includes semi-conductor physics, P N junction diodes, transistor principles, transistor equivalent circuits, biasing and DC stabilization, audio frequency amplifiers, transistors at high frequencies, transistor receiver circuits, servicing transistor circuits, switching circuits and many more.

Complete details on this course are available, without obligation, from RCA Institutes, 5581 Royalmount Avenue, Montreal 9, Quebec, Canada.

Shockley Transistor names Adams Engineering Ltd.

Adams Engineering Ltd., of Montreal and Toronto, Canada, has been named engineering sales representative for Shockley Transistor in Eastern Canada.

Announcement of the appointment was made by Frank J. Newman, sales manager for Shockley Transistor Unit of Cleveite Transistor.

Adams Engineering represents many leading electronic engineering and manufacturing firms throughout the area in which they will serve Shockley. Adams maintains headquarters at 1500 St. Catherine Street West, Montreal, Quebec, with another office at 1999 Avenue Road, Toronto, Ont.

The Shockley organization specializes in the development and manufacture of advanced semiconductor products. The Shockley 4-layer diode is a new silicon, semiconductor switch used in electronic instruments, control systems, missiles, computers and communications equipment.

Millie Amp says,
"For Quality
at a low price
buy Gold Brand!"

"Gold Brand"
METERS

STARK

STARK ELECTRONIC SALES COMPANY
AJAX, ONTARIO

For complete details check No. 51

NEW 10.5 db CORNER REFLECTOR

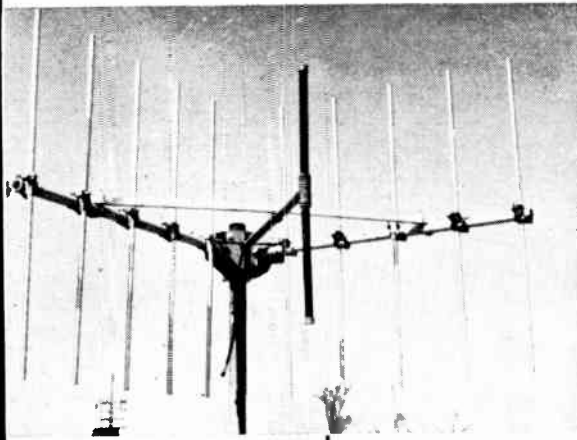

**PLAN
TO
SEE**

The Latest Models
of Antennas —
Duplexers at
Booth No. 44
Queen Elizabeth
Hotel, Nov. 4-5 - 1960

SINCLAIR RADIO LABORATORIES LTD.

Box 179
Downsview
Ontario

For complete details check No. 47 on handy card, page 67

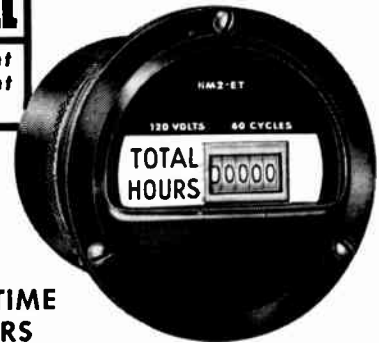

**SEALED
ELAPSED TIME
INDICATORS**

SCHEDULE MAINTENANCE — STUDY PRODUCTIVITY

Glass-to-metal sealed ELAPSED TIME indicators. Compact, low cost, tamper-proof. Standard ASA/MIL dimensions, 2 1/2" and 3 1/2" sizes. Easy to read standard size counter registers 1/10 hour steps to 9999.9 or hour steps to 99999. Hermetically sealed. Shielded. Starts, operates continuously from -55°C to +85°C. For 110-125 or 220-250 volts 60 cycle AC. Bulletin on request. Honeywell Controls Limited, Precision Components Division, Toronto 17, Ont.

Honeywell



For complete details check No. 27 on handy card, page 67

NOW IN SERVICE

**HIGH POWER
STATIC CONVERTERS**

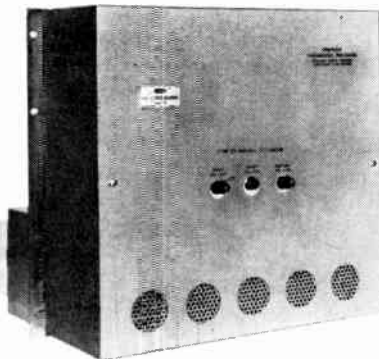

PYLON CX-130/152A

- INPUT 130V OR 152V D.C.
- OUTPUT 130V D.C. AT 6A (ISOLATED OR OPTIONAL GROUND)
- SPECIALLY DESIGNED FOR COMMUNICATIONS SERVICE

Write for further details to:



PYLON ELECTRONIC DEVELOPMENT company, Ltd.

Communication Systems and Equipment
161 CLEMENT ST., LASALLE, MONTREAL 32, QUE.

For complete details check No. 42 on handy card, page 67
ELECTRONICS AND COMMUNICATIONS, October, 1960

ILLUMINATED MAGNIFIERS

designed
for
precision
seeing



OUTSTANDING FEATURES:

- Large precision ground lens.
- Excellent distortion-free, magnification.
- Brilliant shadow-free lighting all around viewing area.
- Luxo's famous PRECISION SPRING-BALANCED ACTION, the magnifying lamp adjusts easily to any position . . . and STAYS PUT!
- Can be mounted anywhere! Table, bench, machine, wall, etc.

PAYETTE RADIO LIMITED

730 ST. JAMES W.

MONTREAL

For complete details check No. 39 on handy card, page 67

PRECISION FILM RESISTORS



MOLDED METAL FILM

Developed by IRC, MOLDED FILM resistors offers:—

1. Low controlled temperature coefficient.
2. Low noise level.
3. Combination of high stability in addition to a low controlled temperature coefficient.
4. Unparalleled reliability, developed as a result of current exacting military and space age requirements.

METAL FILM resistors are ideal for applications where Precision Wirewound resistors are now used.

Available in — $\frac{1}{8}$, $\frac{1}{4}$, $\frac{1}{2}$, 1 and 2 watt sizes.

Performance tests have proved the overall superiority of these advanced precision film resistors.

Write today for catalog B-3.

Leading supplier to manufacturers of electronic equipment



RESISTORS

division of
Renfrew Electric Co. Limited

TORONTO • OTTAWA • MONTREAL • CALGARY

For complete details check No. 29 on handy card, page 67

RACK & PANEL CONNECTORS

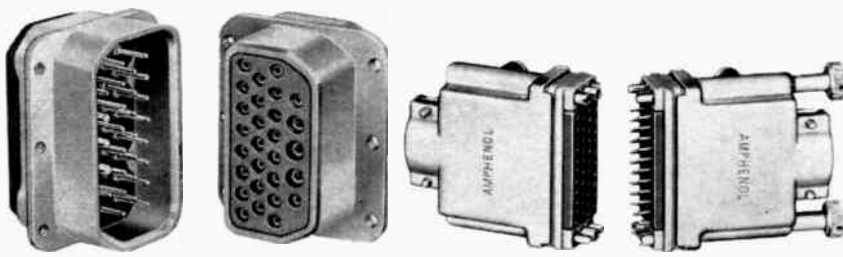

94 SERIES

93 SERIES

both with **POKE HOME** contacts

Meet new additions to AMPHENOL's line of Rack & Panel connectors! The 93 and 94 Series are complete lines of standard connectors providing wide application variety. Both incorporate AMPHENOL'S remarkable Poke-Home contacts that are wired separately from the connector then poked home for assembly. Poke-Home contacts are also removable for fast circuit changes or corrections.

Write For Catalog B-7



CANADA LIMITED

TORONTO • OTTAWA • MONTREAL • CALGARY

For complete details check No. 2 on handy card, page 67

Canada Wire in the Atlantic provinces

The initiation of the manufacture of plastic insulated telephone cables in the Atlantic Provinces is announced by Mr. O. W. Titus, President, Canada Wire and Cable Company Limited.

This will be the result of an immediate substantial enlargement of the present Western Wire and Cable Company plant at Lancaster, N.B., which will now become known as Canada Wire and Cable Company Limited, Atlantic Division.

M. C. Schofield, P. Eng., a native of New Brunswick, formerly the Superintendent of the Western Wire and Cable Company plant, is appointed Plant Manager.

Dialphone appoints quality control supervisor

Appointment of **Gus A. Schutze**, formerly associated with Automatic Electric (Canada) Ltd., as quality control supervisor for Dialphone, was announced recently by Austin M. Elliott, vice-president and general manager of the San Mateo company.

Schutze was associated with Automatic Electric in Canada for four years as quality control technician and telephone test equipment engineer. Prior to joining Dialphone he was with the Rio Tinto Management Services at Elliot Lake, Ontario, as chief instrument technician on uranium extraction operations.

At Dialphone, he will have charge of maintaining high quality standards in the production of the revolutionary automatic dialing instrument that is a companion to the telephone for business or home use.

CCBA annual conference

The ninth annual Central Canada Broadcasters Association Engineering Conference will be held Tuesday, October 25, and Wednesday, October 26, 1960, in the King Edward Hotel, Toronto, Ontario. This conference promises to be bigger and better, and as in the past it will be of direct interest to anyone who has any degree of technical interest in radio or television broadcasting.

Registration will begin at 9 a.m. Tuesday, October 25. Seven technical talks will be delivered during the two days. A tour through the Canadian National and Canadian Pacific Network Television Operating Centers, is scheduled for the second afternoon. The conference will conclude with a reception and banquet at 6.30 p.m. Wednesday, October 26. A very interesting after-dinner speech will be delivered by an engineer from the Bell Telephone Laboratories.

Broad band radio relay equipment

Continued from page 63

quality, or a single TV channel. While it is impossible to describe this equipment in detail in the space available, it may be useful to consider the block diagram of the equipment, in Figure 6, which shows the major features of a repeater equipment. It will be seen that the received rf signal is selected by the receive rf filter, and passed to a low noise crystal mixer, with a noise figure of about 12 db. The local oscillator signal is provided by a crystal controlled frequency multiplier chain. The resulting 70 Mc/s is amplified, and passed to the transmit frequency changer, where it is mixed with the transfer frequency and translated to the output rf frequency. The rf signal is then amplified by two stages of travelling wave tube amplification, and is delivered to the output rf filter at a level in excess of 10 watts. The transfer frequency is derived by mixing the master oscillator signal with the output of a shift frequency oscillator. The shift frequency oscillator, which has a crystal controlled AFC circuit, can be modulated by a traffic signal or a local EOW or supervisory signal. A portion of the IF signal is fed to a wideband demodulator circuit. Thus, drop and insert facilities are available at each repeater, without in any way affecting the through traffic performance.

Figure 7 shows the block diagram of a terminal equipment, and demonstrates how many of the same units used in a repeater are also used in a terminal. Indeed, if the IF connection to the transmit mixer in a repeater is broken, the result is very nearly a terminal equipment. The receiver remains unchanged. In the transmitter, the 70 Mc/s output of a wideband modulator is substituted for the IF signal in the transmit mixer, and the shift frequency is supplied by a crystal controlled oscillator.

Besides the features already discussed, it should be noted that the power supplies in this equipment use silicon rectifiers throughout. Extensive field experience shows that this provision virtually eliminates rectifier faults and replacements. Over a period of some years, no failures of silicon rectifiers have been experienced whatsoever in circuits where the rectifiers were employed at suitable ratings.

On high power tubes such as the N1001 travelling wave tubes, it is necessary to provide external means of cooling; forced air cooling is often used. In the DQ 58B equipment, a single large blower is mounted in the base of each cabinet, and the air supply is distributed to various points throughout the cabinet. This means that a single large long life blower is substituted for a number of small inefficient and unreliable blowers throughout the equipment. Further, the availability of a common air supply enables air to be used for cooling where it would not be used if it meant the addition of a blower. Small amounts of cooling air can be used in this manner to greatly extend the life of critical components. In a station, the air systems of two adjacent cabinets are interconnected in such a manner that one blower will supply air to two cabinets should one blower fail. This avoids virtually all systems failures which could occur because of blower failures.

The DQ 58B is a field proven equipment; it has now been produced in very large quantities on a factory mass production basis. In the laboratory design of radio relay equipment, a great deal of time and care must be devoted to the transfer of a laboratory design

Continued on page 78

FREED VARIABLE TEST VOLTAGE MEGOHMMETER



The Freed Type 1620 Megohmmeter is a versatile insulation resistance measurement instrument with a continuously variable DC test potential from 50 to 1000 volts.

Components such as transformers, condensers, motors, printed circuits, cables and insulation material can be tested at their rated voltage and above, for safety factor.

- Resistance — 0.1 megohms to 4,000,000 megohms.
- Voltage — variable, 50 - 1000 volts.
- Accurate — plus or minus 5% on all ranges.
- Simple — for use by unskilled operators.
- Safe — high voltage relay controlled.
- Self contained — AC operated.

OTHER MEGOHMMETERS AVAILABLE:

Type 1620C MEGOHMMETER — a type 1620 with additional circuitry for testing capacitors.

Type 1020B MEGOHMMETER — a 500 volt fixed test potential. Range 1 megohm to 2 million megohms.

Type 2030 PORTABLE MEGOHMMETER — battery operated, 500 volt test potential. Range 1 megohm to 10 million megohms.

Send for NEW 48 page transformer catalog. Also ask for complete laboratory test instrument catalog.

FREED TRANSFORMER CO., INC.

1716 WEIRFIELD ST., BROOKLYN (RIDGEWOOD) 27, N.Y.

Sales Agents for Canada: CONWAY ELECTRONIC ENTERPRISES
1514 Eglinton Ave. West, Toronto 10, Ontario

For complete details check No. 21 on handy card, page 67

CABLE STRAPPING

can now be done
QUICKLY • PERMANENTLY • ACCURATELY



with P.V.C. or NYLON
NO MORE COSTLY TYING

Send today for samples and catalog

HELLERMANN CANADA LTD.

44 DANFORTH ROAD, SCARBOROUGH, ONT., OX. 1-1131

For complete details check No. 24 on handy card, page 67

ADCOLA

REGD. TRADE MARK

MODERN SOLDERING EQUIPMENT

Illustrated:

Instrument
Cat. No. 70

and

Protective Shield
Cat. No. 68

ADCOLA
PRODUCTS LTD.

Box 103, Weston,
Ont.

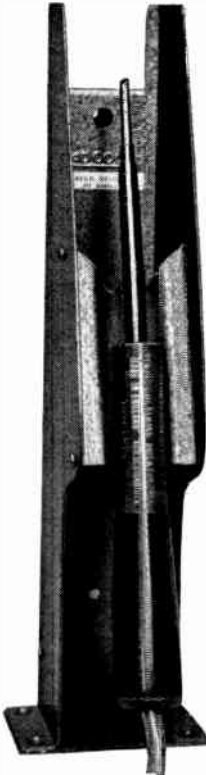

Used on

the transatlantic
telephone
submarine cable
between
Newfoundland
& Nova Scotia
for wiring
the 2-way
submerged
telephone
repeater
amplifiers.

For complete details check No. 1 on handy card, page 67



Shown actual size

**IDEAL FOR
COMPUTER
PATCHWORK
PANELS**

Take your pick from the large selections of CAMBION miniature jacks and plugs. Varying widely in types, these top quality, precision made units are ideal for quick, tight, space-saving patchwork on panel boards.

The jacks make perfect electrical connections, thanks to their special beryllium copper compression springs, floating D keys and solid fronts. Jacks are available in shank lengths for varying panel thicknesses, pin diameters of the plugs are .080", .062" and .045".

Write Cambridge Thermionic Corporation of Canada, Ltd., 2425 Grand Boulevard, Montreal 28, P.Q., for full details on these and other products in the wide line of

CAMBION

The guaranteed electronic components

For complete details check No. 10 on handy card, page 67

Millivoltmeter

Item 629

A new RF millivoltmeter which quickly and accurately measures RF voltages from 1 millivolt to 10 volts at frequencies up to 1,000 MC is available from Hewlett-Packard Company. Readings are virtually free from the temperature effects normally associated with sensitive RF meters.

The new millivoltmeter, Model 411A, includes two linear voltage scales in a 1:3 ratio. These linear scales, an outstanding feature of the instrument, help eliminate scale reading errors and provide maximum voltage resolution. The meter also includes a db scale for readings from -42 to +33 db.

Model 411A is a compact, versatile unit which, according to the manufacturer, provides



greater accuracy than any instrument of its kind. Accuracy from 1 MC to 50 MC is $\pm 3\%$ of full scale; 50 MC to 150 MC, $\pm 6\%$ of full scale, and 500 KC to 1,000 MC, ± 1 db. Because of the millivoltmeter's high temperature stability, accuracy changes are negligible from 10° to 40° C.

Hewlett-Packard Company, 1501 Page Mill Road, Palo Alto, California.

Micropot potentiometer

Item 630

Borg Equipment Division, Amphenol-Borg Electronics Corporation, has announced another addition to their broad line of Micropot potentiometers: the new Borg 205-3T (three-turn) Micropot.

This new Micropot is specifically designed to retain the quality advantages of the well-known Borg 205 ten-turn Micropot. The new three-turn design results in a major reduction of housing length. Over-all housing length is only 1.31/64".

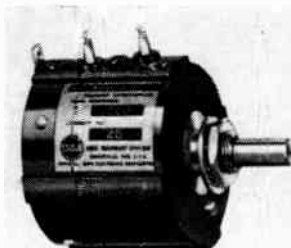

The long (13-1/16") resistance element assures correspondingly high resolution. Terminals are soldered to resistance wire ends, precision positioned and molded integrally with the housing. A stainless steel lead screw guides the moving contact to assure accurate settings, low torque and long life.

Complete information on the new Borg 205-3T Micropot may be had by contacting Atlas Radio Corporation Ltd., 50 Wingold Avenue, Toronto 19, Ontario.

Signal comparator

Item 631

Signal Comparator No. 224-023A is the latest addition to Avien's line of signal comparators. This unit provides go/no-go comparison of a signal voltage with respect to a reference. The comparator is designed for use in ground based systems where 115 volt, 60 cps power is normal or preferred, and where equipment may not be subjected to the environmental extremes encountered by airborne systems. The Comparator features a compact construction, while low power drain permits ready inclusion into automated checkout and similar systems where space is at a premium. Exceptional low hum and noise pickup also assure dependable operation compatible with both military and industrial monitoring requirements.

For further information write the Canadian representative, Brian Engineering Limited, 5275 Van Horne Ave., Montreal, P.Q.

Microminiature variable resistor

Item 632

Ideal for transistor and miniaturized applications such as hearing aids, test equipment and mobile dictating equipment, Centralab Canada Ltd. announce their engineering preview of micro miniature variable resistor, Model 8.

The Centralab Model 8 Rad-ohm is available in production quantities to meet the most stringent space and quality control requirements. The 1/10 watt rating is effectively accomplished by the incorporation of Centralab's exclusive "Inter-fused Composition element".

This ICE construction offers a multitude of advantages, such as — low moisture absorption, voltage and temperature stability,

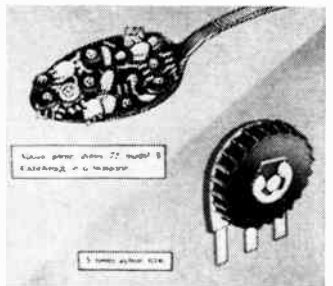

smooth electrical curve, noise-free performance, proven load-life reliability and exceptional wattage dissipation.

Full details and descriptive literature on request. Please write Centralab Canada Ltd., Ajax, Ontario.

TV satellite transmitter

Item 633

Benco Television Association Limited, 27 Taber Road, Rexdale, Ontario, announces a Low Power Television Satellite Transmitter, Model "T-5", with 8.9 watts P.E.P. output (5 watt pedestal level). This transmitter has been designed to meet the requirements of the Canadian Department of Transport, as set forth in the Department's Radio Standards Specification No. 155.

The Model "T-5" is ideally suited to provide television reception for isolated communities when weak television signals are available on a nearby hill or mountain.

The "T-5" is a conversion type unit which translates the distant, wanted VHF television signal into any other wanted VHF television channel. The complete equipment is contained in one weatherproof housing. Simple to install and economical to maintain.

For further information, contact Benco Television Associates Limited, 27 Taber Road, Rexdale, Ontario.

Variable frequency power source

Item 634

A new 50-watt, variable-frequency power source, with better than 0.01 per cent amplitude stability and only 0.1 per cent harmonic distortion, now enables users of AC voltmeters, AC ammeters, and digital meters to calibrate their own instruments to laboratory standards.

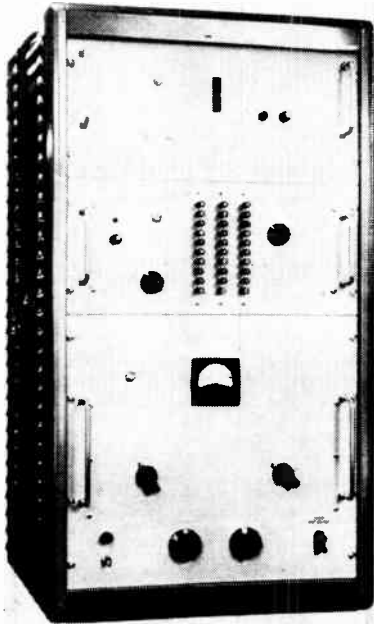

Developed and manufactured by Krohn-Hite Corp., Cambridge, Mass., the Model LDS-1500 power source delivers a continuously-variable wide range of voltage and current — up to 1500 volts, and up to 12 amps, at any frequency between 20 and 2,000 cps.

The complete instrument is housed in a standard cabinet measuring 40" high, 22" wide, and 19" deep.

Further information is available direct from Krohn-Hite Corp., 580 Massachusetts Ave., Cambridge 39, Massachusetts.

Millie Amp says,
"Never before have I
seen such quality
for so little!"



"Gold Brand"
METERS



STARK ELECTRONIC SALES COMPANY
AJAX, ONTARIO

For complete details check No. 48

briefing the industry

■ **In the first half of 1960 equipment manufactured** by Automatic Electric (Canada) Limited has been exported to Pakistan, Australia, El Salvador, Venezuela, Mexico, Dominican Republic, Haiti and Lebanon. Colombia and Ecuador will soon be added to this list. The above equipment is in addition to the apparatus being built and supplied to Canadian independent telephone companies from coast to coast.

■ **J. McK. McLean, vice-president and general manager** of instruments for F. W. Sickles of Canada Limited says that diversification is the answer to foreign competition in Canadian electronics industry. Based on this premise the company has recently announced that it will soon begin production of a new line of semi-conductors at their Waterloo, Ontario plant. At the present time the firm is producing television tuners, deflection yokes, horizontal output transformers, IF transformers and radio coils.

■ **John L. Burns, president of RCA New York** said in Toronto recently that as defense business increases within his company more work will be assigned to RCA Victor Company Limited, RCA's associated company in Canada. Mr. Burns pointed out that already RCA Victor Company Ltd., Montreal, has been awarded a \$2 million contract for equipment for an "electronic skytrack", for use in conjunction with the detection and control system, part of the North American aerial defense system.

■ **Inspectronics Limited is the name of a new underwater inspection television company** which will operate from Brantford, Ont. The company has a capital of 12,500 preferred shares and 100,000 common shares. Plans of the company call for operations from coast to coast in Canada and in the United States.

■ **Canadian National - Canadian Pacific Communications** have introduced to Canada a new and versatile piece of office equip-

ment designed to meet communications needs where instantaneous transmission of material, as written, is required. The new unit, now undergoing tests with several major Canadian firms, is called "Electrowriter". CN-CPC expect the new Electrowriter units will supplement and broaden the already-extensive line of communications equipment offered for private wire service.

■ **Canadians were told recently that they are almost alone** in the world as "an industrialized nation encouraging importation of manufactured goods from nations with lower wages and living standards — to the obvious detriment of its own industries and economy."

George L. Wilcox, president of the Canadian Electrical Manufacturers Association, told the Electrical Day directors' luncheon of the Canadian National Exhibition in Toronto that present importation policies were not wise.

"We have a growing market right here in Canada for the things our secondary industry can produce," he said. "Why then must we ship our raw materials abroad, only to buy them back later in finished form, with the wages of other people and the costs of other producers added?"

■ **On August 17, Dawson City got direct telephone and telegraph service** with the rest of the world for the first time. Prior to the Canadian National Telegraphs' construction of the facilities, which started last September, the only communications service into Dawson City was by wireless telegraph. Telephone calls now placed over the new CNT line are routed to Whitehorse, then to Edmonton where connections are made with the Trans-Canada Telephone System for service to any world point.

■ **Admiral International Corporation** has announced the completion of arrangements for the manufacture of Admiral television receivers in New Zealand. The TV receivers will be produced under license by Collier and Beals Limited of Wellington.

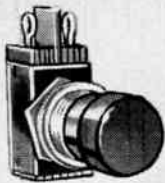

There's a stronger,
more compact

ARROW-HART SWITCH CONTROL
for every job!

Arrow-Hart offers a complete range of quick make and break switches for vacuum sweepers, fans, power tools, radio and electronic equipment.

Send for your copy of the new illustrated Bulletin Z-12 today . . . and ask us for any additional advice or information you may need.



ARROW-HART & HEGEMAN
(CANADA) LIMITED

INDUSTRY STREET, TORONTO 15, ONTARIO
7365 MOUNTAIN SIGHTS, MONTREAL, QUE.

Quality MOTOR CONTROLS • WIRING DEVICES • APPLIANCE SWITCHES

6006-R

For complete details check No. 3 on handy card, page 67

**Broad band radio
relay equipment**

Continued from page 75

into a production design. It is essential to allow adequate margins of performance between that obtained in the laboratory under ideal conditions and expert adjustment, and that which must be achieved on factory built models under field conditions. However, it is an interesting sidelight to note that after a short time in a competent production shop, the performance of DQ 58B equipment being manufactured under mass production conditions, consistently surpasses the performance achieved in the laboratory.

It may be of interest to briefly consider the advances in design of the DQ 58 family of equipments, since the DQ 58B was placed in production. Figure 8 shows a printed circuit modulator unit, Figure 9, a printed circuit demodulator unit. Such units provide improved performance over broader bandwidths, both by the employment of newer components and tubes of higher performance, and by the application of printed circuit techniques to ensure accuracy and reproducibility in the positioning of components and wiring. In physical form, these circuits are in plug in chassis, which provide maximum economy in space and ease in replacement as shown in Figure 10. The provision of such units for all circuits in the equipment provides improvements in both performance and reliability.

Improvements in the design of travelling wave tubes make it possible to eliminate one of the travelling wave tubes in previous equipments, with no degradation in performance. A full rack of operating equipment, constituting a complete single terminal, and incorporating these improvements, is shown in Figure 11.

The advent of new components, such as the varactor and improved microwave ferrite devices, have somewhat simplified some microwave problems, and improved the performance which can be achieved. Units employing the techniques described are now on life test in Canadian Marconi laboratories.

The employment of these new circuit techniques and new and better components, means that future equipments will not only have better performance, but will be much more compact and will consume much less power.

The radio relay design engineer can look forward to providing better equipment for his customer in all respects, performance, economy, and reliability.

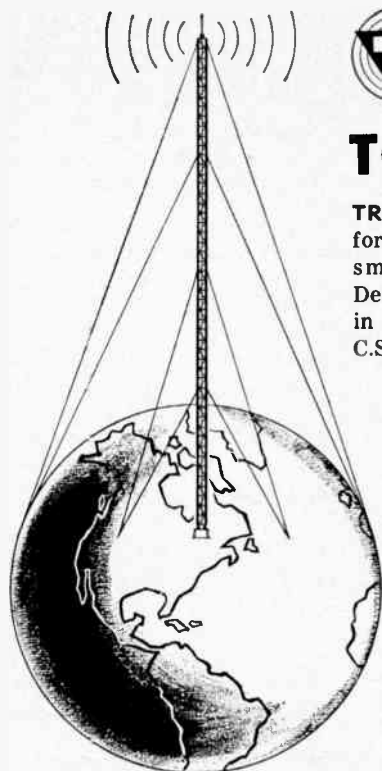

**TRYLON
TOWERS**

TRYLON towers are available for all applications from the smallest to the largest. Designed and manufactured in Canada in accordance with C.S.A. specifications.

TRYLON towers are available for AM, TV, Microwave and Communications Antennas.

TRYLON service also includes design, development, supply, installation and maintenance by expert craftsmen.

The WIND TURBINE Co. of Canada Ltd.

145 Lucan Street
Waterloo, Ontario

For complete details check No. 57 on handy card, page 67



when
design and
purchasing
decisions
are being made
it's
electronics and
communications
buyers' guide
on the

SPOT

Mutual conductance tube tester

Item 635

Outstanding features to be found in the TT-1 include: a constant current heater supply which protects the tester from obsolescence by supplying the correct voltage for any new tube types drawing 300 ma, 450 ma or 600 ma; a life test, which reduces the heater voltage of any tube under test by 10 per cent, thus giving an estimate of its future life; a hybrid test, which not only provides a special low voltage plate supply for testing

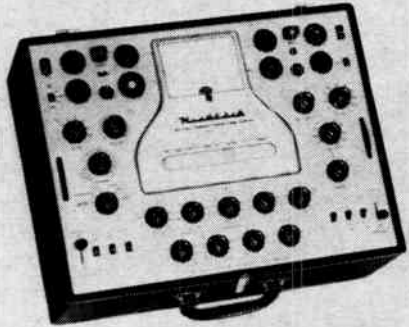

hybrid auto radio tubes, but also features an additional DC supply for the space charge grid permitting mutual conductance tests of space charge tubes in the usual manner; a direct reading leakage testing circuit; and internal calibration circuit, eliminating the need for any standardized tubes, voltmeters or extraneous instruments of any kind; a disconnect switch, which removes all voltage potentials from the selector switches, protecting tubes and tester from possible damage during switching.

Daystrom Limited (Heath Division),
2 Raitherm Road, Toronto 19, Ont.

DEW detector

Item 636

The model 5217 Dew Detector is a new instrument, developed by National Research Council and manufactured by Measurement Engineering Ltd. It is a simple, electronic, high impedance, millivolt relay, coupled with a

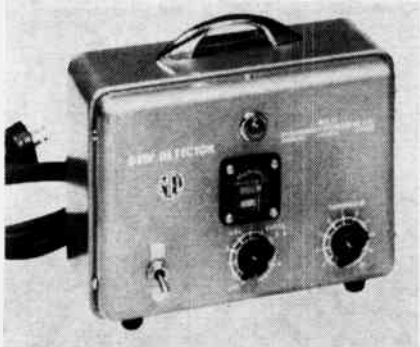

sensor of special design, in such a way that it will detect presence of moisture with a very high order of sensitivity — more so than former dewpoint measuring apparatus, and record the total "time-of-wetness".

For further information contact:
Measurement Engineering Ltd., Arn-
prior, Ontario.

Most Versatile Rectifiers Known!

NEW!

Sarkes Tarzian Modular Silicon Rectifiers

100 to 600 PIV | **500 to 1000 MA**

Compact...Rugged...Low Cost...Easy to Assemble

Modular Silicon Rectifiers can be used individually—as open bridges—or in a variety of circuit combinations, and are designed for printed circuits on terminal strips. Units are enclosed in epoxy-filled phenolic housing and their .032" diameter copper wire leads are silver-plated.

S-5536 thru S-5541

Primarily for use as voltage doubler or center tap.

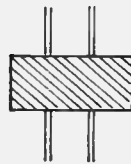

S. T. CODE NUMBER	UNITS USED	INDIVIDUAL DIODE CURRENT RATING	PIV
S-5536	F1	500 MA.	100
S-5537	F2	500 MA.	200
S-5538	F3	500 MA.	300
S-5539	F4	500 MA.	400
S-5540	F5	500 MA.	500
S-5541	F6	500 MA.	600

S-5544 thru S-5549

For connection into 3 phase half wave, or 2 modules into 3 or 6 phase connection.

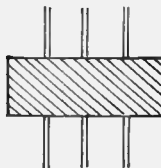

S. T. CODE NUMBER	UNITS USED	INDIVIDUAL DIODE CURRENT RATING	PIV
S-5544	F1	500 MA.	100
S-5545	F2	500 MA.	200
S-5546	F3	500 MA.	300
S-5547	F4	500 MA.	400
S-5548	F5	500 MA.	500
S-5549	F6	500 MA.	600

S-5462 thru S-5468

For use as open bridge for magnetic amplifiers or connected into bridge. Also as half wave sections—individual, series, or parallel.

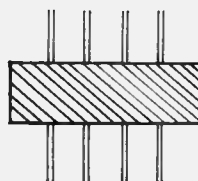

S. T. CODE NUMBER	UNITS USED	INDIVIDUAL DIODE CURRENT RATING	BRIDGE CIRCUIT CURRENT RATING	PIV
S-5462	F1	500 MA.	1000 MA.	100
S-5463	F2	500 MA.	1000 MA.	200
S-5464	F3	500 MA.	1000 MA.	300
S-5465	F4	500 MA.	1000 MA.	400
S-5466	F5	500 MA.	1000 MA.	500
S-5467	F6	500 MA.	1000 MA.	600

For additional information on these three basic styles of modular silicon rectifiers, write Section 5555-G Sarkes Tarzian is a leading producer of semiconductor devices in production quantities, including silicon power rectifiers, silicon tube replacement rectifiers, and selenium rectifiers.



SARKES TARZIAN, INC.

World's Leading Manufacturers of TV and FM Tuners • Closed Circuit TV Systems • Broadcast Equipment • Air Trimmers • FM Radios • Magnetic Recording Tape • Semiconductor Devices

SEMICONDUCTOR DIVISION • BLOOMINGTON, INDIANA

In Canada: 700 Weston Rd., Toronto 9 • Export: Ad Auriema, Inc., New York

For complete details check No. 46 on handy card, page 67

SYNTRON

SILICON RECTIFIERS

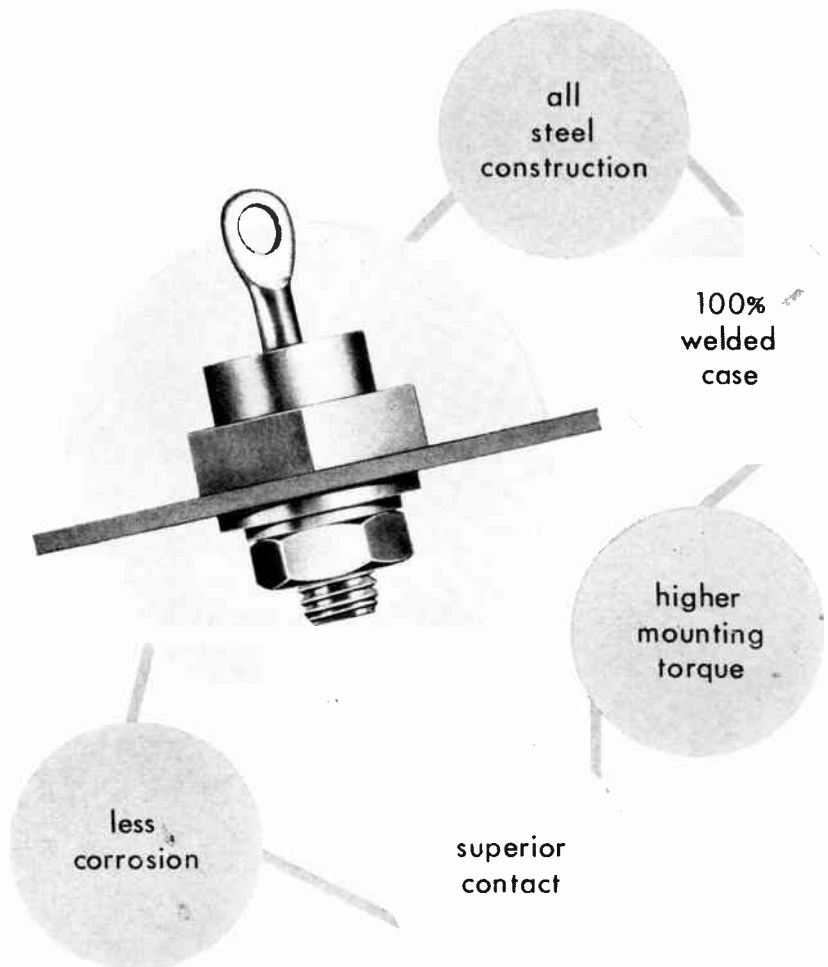

SYNTRON'S exclusive all steel construction provides higher mounting torque, superior contact and reduces corrosion. Maximum mounting torques 50-100 inch #.

Their 100% welded case with no blind solder connections, assures positive contact, greater efficiency and long reliable life.

Write for complete technical data or contact your nearest SYNTRON Sales Engineer.

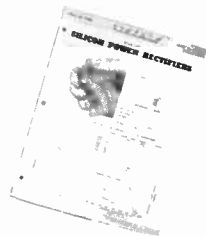

Fluidized bed

Item 637

Using this new technique for insulating and coating metal parts, Hysol 4517 epoxy fluidizing powder has been developed. This material, when applied in a vibra-fluidizer, provides an extremely fast and inexpensive method of building up a substantial thickness (10 mils nominal) of insulation. Good corner coverage is provided.

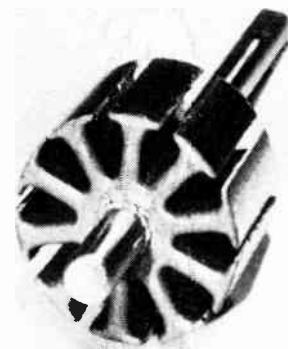

This technique is particularly suited for coating iron cores, meter coils, rotors, stators and other metal parts.

Details on material and equipment, Hysol (Canada) Limited, P.O. Box 53, Station R, Toronto, Ontario.

Temperature compensated power meter

Item 638

The FXR Model B832T Transistorized Temperature Compensated Power Meter is a compactly packaged instrument which will accurately measure either CW or pulsed RF power in five full scale direct reading ranges from 30 microwatts to 3 milliwatts. Values can be read in MW or DBM. The instrument incorporates a unique method of controlling the accuracy and stability

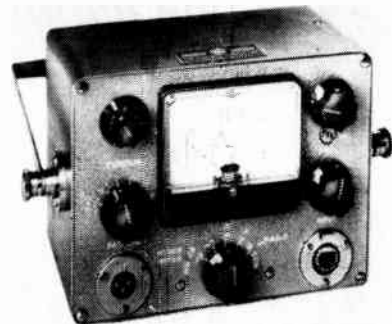

of RF power measurements. Readings are virtually drift free; compensation of ambient temperatures makes the instrument a hundred times more stable than comparable measuring devices, even in the 30 microwatt range. Provision is made to calibrate the DC voltage at all levels and the bridge is self-balancing at 200 ohms. Range switching without recalibration is another advantage.

Radionics Limited, 8230 Mayrand St., Montreal 9, Quebec.

SYNTRON (CANADA) LIMITED

928 Queenston Road

Dept. "K"

Stoney Creek, Ontario

For complete details check No. 52 on handy card, page 67

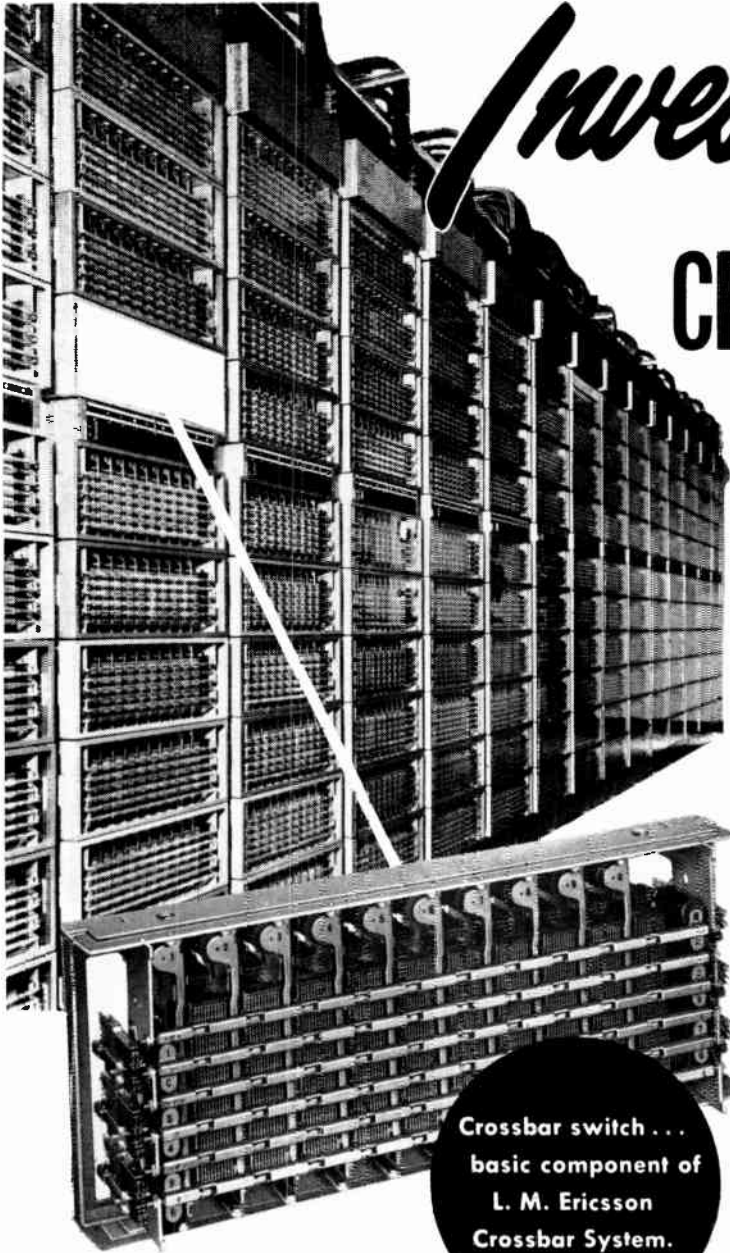

Investigate the **CROSSBAR SWITCH**

by

L.M.ERICSSON

for better economy and service...

Forward looking telephone administrations throughout the world choose the compact L. M. Ericsson Crossbar System for up-to-date trouble-free automatic equipment. For improved faster service for subscribers and reduced maintenance costs now and in the future, look to Ericsson crossbar systems.

L. M. Ericsson crossbar exchanges are currently in operation all over the world and minor design modifications have been incorporated to meet the requirements of Canadian telephone networks. They are economically adaptable to both the expansion of large networks and community dial offices.

Crossbar switch . . .
basic component of
L. M. Ericsson
Crossbar System.

**OTHER L. M. ERICSSON PRODUCTS AVAILABLE
IN CANADA INCLUDE:**

- A wide range of communications equipment for public telephone service.
- Private Automatic and Manual Exchanges and a complete line of inter-communications equipment from the simplest to the most complex.
- Time and Machine Control equipment.
- Precision-built components for the Electronics industry.

Ericsson
LM ERICSSON
TELEPHONE SALES OF CANADA LIMITED

Montreal: 130 Bates Road — Tel: RE. 1-6428 ● Toronto: 34 Advance Road, Etobicoke — Tel: BE. 3-1306

For complete details check No. 20 on handy card, page 67

Industrial
Soldering.

do it
better
with

KESTER SOLDERFORMS

- Immense variety of available shapes
- Quick service on new shapes
- Utmost purity of metals
- Every possible choice of alloy proportions for any purpose, any melting-point, and full choice of resin cores

Will speed up industrial soldering operations.
PLEASE WRITE for sample assortment and full details on Kester Solderforms.

**KESTER
SOLDER**

KESTER
SOLDER COMPANY
OF CANADA, LTD.

KT-1-60

Trade Mark

Dept. E-410, Brantford, Ontario

For complete details check No. 33 on handy card, page 67

Welwyn METOX MINIATURE MOLDED OXIDE RESISTORS

Type F20

- RELIABILITY
- RUGGEDNESS
- STABILITY
- SMALL SIZE
- ECONOMY in PRICE

**Allied in ONE
RESISTOR for
the FIRST TIME**

RELIABILITY — Failure rate is better than one per ten million hours.

STABILITY—Under full load, the stability is better than 2% after 10,000 hours. Subsequent rate of change will not exceed 0.1% per thousand hours.

TEMP. COEF.—Will not exceed $\pm 0.03\%$ per °C.

NOISE—Less than 0.5 $\mu\text{V/V}$ applied.

TOLERANCE — All MIL-R-11C valves at $\pm 5\%$.

SIZE — Same as the Mil Type RC20.

SPECIFICATION — Exceeds materially Mil-R-11C.

PRICE—Related to 5% carbon composition prices.

Type	Rating @ 70°C Ambient	Mil Type	Rated Voltage	Minimum Resistance	Maximum Resistance	Dialectric Strength
F20	½ Watt	RC20	350V	10 Ohms	1.0 Meg.	1000 Volts

For further information write for data sheet WC-1

Welwyn Canada Limited

1255 Brydges Street, LONDON, Ontario

For complete details check No. 56 on handy card, page 67

Sine wave constant voltage transformer

Item 639

Freed Transformer Company, Inc. is now offering for immediate delivery a Sine Wave (7 per cent distortion) constant voltage transformer in 60 and 400 cycle units. With a line variation of 95V to 130V, output of this unit will remain constant to within $\pm 1\frac{1}{2}$ per cent.

The new sine wave constant voltage transformer has a current-limiting feature which prevents excessive fault currents. It can replace non-regulating transformers in step-up or step-down service. Replacement of parts and service are eliminated because the new tubeless constant voltage transformer has no renewable parts. This unit can be hermetically sealed for military application at elevated temperatures.

For further information write to Conway Electronic Enterprises Limited, 1514 Eglinton Avenue West, Toronto 10, Ontario.

Indicator lamp

Item 640

A general purpose relay with a built-in neon lamp as an aid to trouble shooting power circuits has been introduced by Potter & Brumfield Canada Limited.

A neon-indicator lamp is connected in series with a resistor and both components are connected in parallel to the relay coil to provide a positive means of determining current availability. A transparent cellulose acetate dust cover provides operating visibility for lamp and contacts.

This versatile relay, type KRP-N, can be furnished in production quantities by the manufacturer for 6 to 110 volts DC and 6 to 230 volts AC operation. Silver cadmium contacts rated at 10 amperes are standard for both AC and DC models and silver contacts are rated at 5 amperes. Contact arrangements are available up to 3PDT.

Complete specifications may be obtained from the Technical Information Section, Potter & Brumfield Canada Limited, Oxford St., Guelph, Ontario.

Millie Amp says,
"Are you paying
too much for your
meters? Better check
Gold Brand!"



"Gold Brand"

METERS



STARK ELECTRONIC SALES COMPANY
AJAX, ONTARIO

opportunities

These classified advertisements are published to assist those in the trade who have articles for sale, positions available, positions desired, sales agency openings or business opportunities. Charges are 25c per word or figure, not including heading or box number. Minimum charge is \$5.00 payable on submission. No agency commission paid. There is absolutely NO CHARGE for "positions desired" advts.

Send all material to the attention of the advertising manager of ELECTRONICS AND COMMUNICATIONS, 450 Alliance Ave., Toronto 9, Ontario.

CFRB

requires an experienced transmitter maintenance technician. Write:

Mr. Clive Eastwood,
Station CFRB,
37 Bloor Street West,
Toronto 5, Ontario.

ELECTRICAL ENGINEER

of proven supervisory caliber desires position in Southern Ontario. Other locations would be considered. Four years' experience equipment engineering, telephone company. Four years' experience pulp and paper industry. Complete résumé sent with reply.

Box 5045

Electronics and Communications
450 Alliance Avenue, Toronto 9, Ontario

INSTRUMENTATION SALES ENGINEER

required for the Toronto area. An excellent opportunity for a young, aggressive and experienced sales engineer. For local interview apply —

Radionics Limited,
8230 Mayrand Street,
Montreal 9, Quebec.

PURCHASING AGENT

Senior buyer, 33, desires change. Over 12 years' experience, mainly in electronics. Experienced also in material control and production control. Presently employed in Southern Ontario, but willing to re-locate.

Box 5044

Electronics and Communications
450 Alliance Avenue, Toronto 9, Ontario

REPRESENTATIVES WANTED

Sales organizations to handle Canadian manufactured Stedivolt AC line voltage regulators in Eastern and Western provinces of Canada. Must be well-established in electronic, electrical and government circles. Reply giving details of history, size, facilities, coverage and commission expected.

George Kelk Ltd.,
5 Lesmill Road,
Don Mills, Ontario

ELECTRONIC SALES ENGINEER

for Ottawa area required by leading Canadian electronic sales company. Must have technical background suited to application engineering in data handling, communications and test equipment fields. Write to address below, providing a brief outline of education and experience.

Box 5046

Electronics and Communications
450 Alliance Avenue, Toronto 9, Ontario

SENIOR ENGINEER

Professional engineer (electronics), 39, with management experience desires to relocate in Ontario in St. Lawrence River—Eastern Lake Ontario area. Broad experience in nearly all phases of electronic industry including sales, development, installation, product improvement and project management.

Box 5047

Electronics and Communications
450 Alliance Avenue, Toronto 9, Ontario

Millie Amp says,
"I know quality
when I see it!"

"Gold Brand"

METERS

STARK

STARK ELECTRONIC SALES COMPANY
AJAX, ONTARIO

For complete details check No. 50

*Even in high-frequency and
rapid switching types*

**PHILCO offers you
the complete
— and completely
reliable — line
of transistors**

Whatever the type of transistor you require — however demanding the application — you can fill your requirements from the complete, reliably-built line of Philco transistors.

This table shows a typical assortment of Philco transistors. The line also includes high-frequency and rapid-switching types, in the successful development of which Philco engineers have led the industry.

Mail the coupon below for further details

VHF-UHF Microalloy defused base (MADT) types:
2N502, 2N501, 2N499, 2N504

High-frequency Microalloy types:
2N393, 2N599, 2N600

Medium-powered alloy junction types:
2N1125

High-powered alloy junction types:
2N386, 2N387

Philco Corporation of Canada
Don Mills, Ontario.

Please send brochure describing all types of Philco transistors.

Name

Address

60-10-EC

PHILCO CORPORATION OF CANADA
DON MILLS, ONTARIO

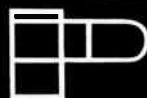

PHILCO government and
industrial division

For complete details check No. 40 on handy card, page 67

4

OUTSTANDING BRIDGES



Type 1650-A Impedance Bridge . . . \$450

For general purpose R/L/C measurements

Ranges: R: 1 m Ω to 10 M Ω
 L: 1 μ h to 1000 h
 C: 1 pf to 1000 μ f
 D: 0.01 to 50 (at 1kc)
 Q: 0.02 to 1000 (at 1kc)

Basic \pm 1% accuracy
 Built-in null detector
 Built-in 1-kc oscillator; bridge useful to 20kc with external sources

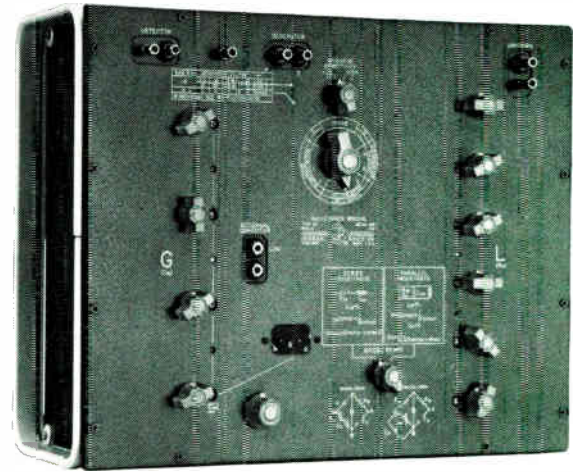

Type 1632-A Inductance Bridge . . . \$950

For precise measurement of inductance

Full-Scale Ranges: L: 111 μ h to 1111 h
 (minimum indication is 0.0001 μ h)

G: 111 μ mhos to 1111 mhos

Basic \pm 0.1% accuracy. Inductors having nearly equal values can be compared to an accuracy of 1 part in 10⁵

Designed for 1-kc measurements. Can be used to at least 10kc with slight decrease in accuracy.



Type 1605-A Impedance Comparator . . . \$800

For rapid measurements of impedance and phase angle without manual balancing

Panel meters indicate percent difference in impedance magnitude and phase angle between unknown and external standard

Ranges: Z: 2 Ω to 20M Ω
 ΔZ : \pm 0.01% to \pm 10%
 $\Delta\phi$: \pm 0.0001 to \pm 0.1 radian

Accuracy: \pm 0.01%
 Built-in 100c, 1kc, 10kc, and 100kc frequency sources.

Write For Complete Information



Type 1607-A Transfer-Function and Imittance Bridge . . . \$1775

For VHF-UHF measurements of transistors, tubes, networks and components

Frequency Range: 25 to 1500 Mc

Biasing Provisions: Built in for use with external d-c sources. Maximum current, 250 ma; maximum voltage, 400 volts.

Measurement	Range	Accuracy (from 150-1000 Mc)
Voltage and current ratios (R)	0-30	$2.5 (1 + \sqrt{R})\% + 0.025$
Transimpedance (Z_{21})	0-1500 ohms	$2.5 (1 + \sqrt{\frac{Z_{21}}{50}})\% + 1.25$ ohms
Transadmittance (Y_{21})	0-600 mmhos	$2.5 (1 + \sqrt{\frac{Y_{21}}{20}})\% + 0.5$ mmho
Impedance (Z_{11})	0-1000 ohms	$2.0 (1 + \sqrt{\frac{Z_{11}}{50}})\% + 1.0$ ohm
Admittance (Y_{11})	0-400 mmhos	$2.0 (1 + \sqrt{\frac{Y_{11}}{50}})\% + 0.4$ mmho

GENERAL RADIO COMPANY

WEST CONCORD, MASSACHUSETTS

Canadian Engineering Office in TORONTO

99 Floral Parkway, Toronto 15, Ontario

Arthur Kingsnorth • Richard J. Provan

Tel: CHerry 6-2171

Repair Service: Bayly Engineering Ltd., Ajax, Ontario

For complete details check No. 22 on handy card, page 67