

**communications
issue**

Courtesy of U.K. Information Office and British General Post Office.

electronics and communications

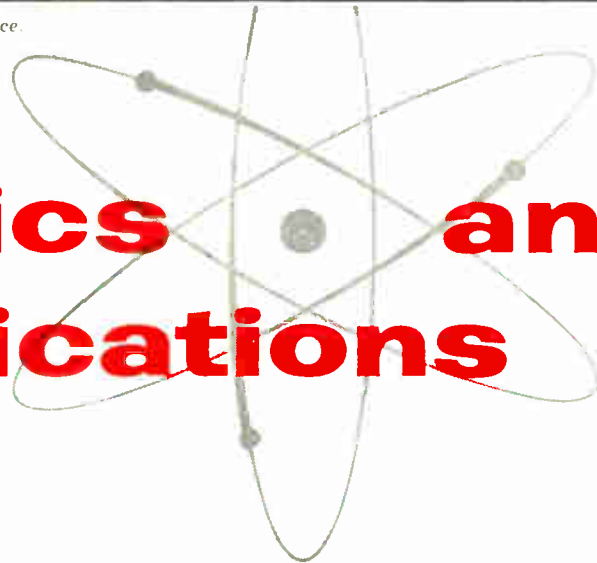

an age publication

JUNE 1959

1211C
DEL
CRC
EPM

MR F W PREZIOSI
8 EASTGATE CRES
SCARBOROUGH ONT



croven

the mark of quality
for the finest in **Crystals** and **Ovens**

SA3 — Accommodates one, two or three HC-6 U crystal holders. Compact size, snap-action thermostat.



Oven type SAS — Single or dual voltages selected by internal switching in wide range of combinations, snap-action thermostat.



Shows conventional Oven. Special markings, various colours available to all requirements.



Crystal type — CR1 (metal holder)



Oven type SA — Incorporates Stevens Snap-action thermostat. Wide range of temperatures.



Crystal types HC-6 U and HC-18 U (miniature).



Oven type RT — Conventional creeper-type thermostat



Oven type SA15 — Holds up to 15 miniature (type HC-18 U) crystals, has snap-action thermostat.



Thanks to our Customers.

You have made us Canada's largest manufacturer of Crystals and Ovens.

Our new factory is fast approaching completion.

Make your Crystal and Oven problems ours. Our staff of engineers are constantly designing new Ovens and Crystals for our Customers both in Canada and in other countries.

Custom Ovens: to fit Crystal filters and transistor requirements.

AN OVEN FOR YOUR EVERY NEED

QUALITY WITH OUR EMERGENCY 24-HOUR SERVICE

Formerly W. Gary Wright Electronics of Canada Ltd.

For complete details check No. 29 on handy card, page 89.



croven LIMITED

628 KENT STREET, P.O. BOX 1420

WHITBY, ONTARIO: MOhawk 8-3325

DIRECT LINE: TORONTO EMpire 6-6012

DIRECT LINE: OSHAWA RAndolph 8-5432

Read what CBC TIMES
and TELEVISION DIGEST
reports say about



MARCONI'S NEW 4 1/2" IMAGE ORTHICON

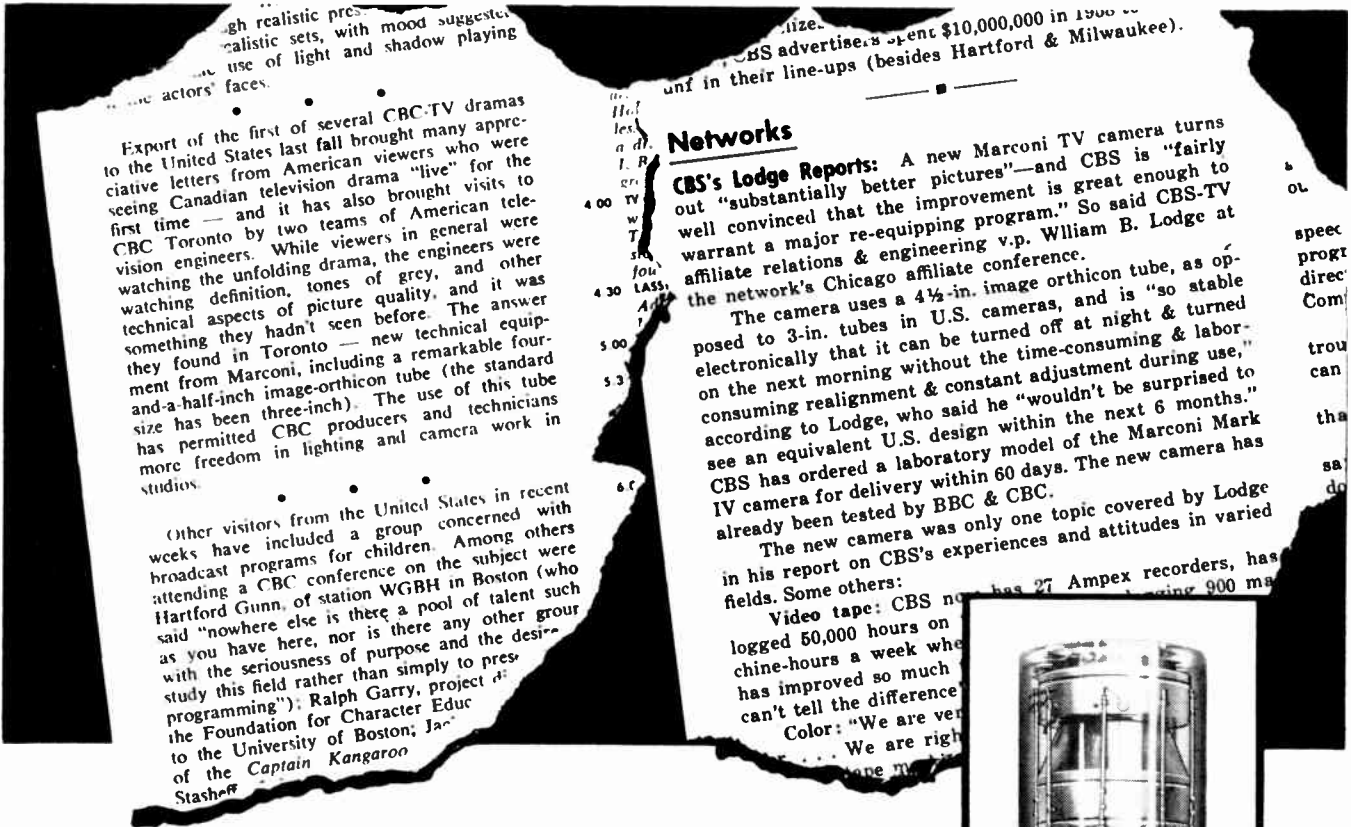

...gh realistic pres...
...alistic sets, with mood suggest...
... use of light and shadow playing
... the actors' faces.

Export of the first of several CBC-TV dramas to the United States last fall brought many appreciative letters from American viewers who were seeing Canadian television drama "live" for the first time — and it has also brought visits to CBC Toronto by two teams of American television engineers. While viewers in general were watching the unfolding drama, the engineers were watching definition, tones of grey, and other technical aspects of picture quality, and it was something they hadn't seen before. The answer they found in Toronto — new technical equipment from Marconi, including a remarkable four-and-a-half-inch image-orthicon tube (the standard size has been three-inch). The use of this tube has permitted CBC producers and technicians more freedom in lighting and camera work in studios.

Other visitors from the United States in recent weeks have included a group concerned with broadcast programs for children. Among others attending a CBC conference on the subject were Hartford Gunn, of station WGBH in Boston (who said "nowhere else is there a pool of talent such as you have here, nor is there any other group with the seriousness of purpose and the desire to study this field rather than simply to produce programming"); Ralph Garry, project director of the Foundation for Character Education at the University of Boston; James Stashoff, of the *Captain Kangaroo*.

Networks

CBS's Lodge Reports: A new Marconi TV camera turns out "substantially better pictures"—and CBS is "fairly well convinced that the improvement is great enough to warrant a major re-equipping program." So said CBS-TV affiliate relations & engineering v.p. William B. Lodge at the network's Chicago affiliate conference.

The camera uses a 4 1/2-in. image orthicon tube, as opposed to 3-in. tubes in U.S. cameras, and is "so stable electronically that it can be turned off at night & turned on the next morning without the time-consuming & labor-consuming realignment & constant adjustment during use," according to Lodge, who said he "wouldn't be surprised to see an equivalent U.S. design within the next 6 months." CBS has ordered a laboratory model of the Marconi Mark IV camera for delivery within 60 days. The new camera has already been tested by BBC & CBC.

The new camera was only one topic covered by Lodge in his report on CBS's experiences and attitudes in varied fields. Some others:

Video tape: CBS now has 27 Ampex recorders, has logged 50,000 hours on chine-hours a week when has improved so much can't tell the difference.
Color: "We are very... We are right...
...one m...

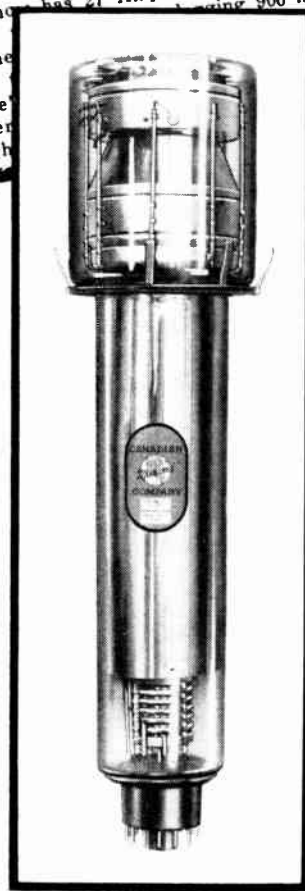

"permits more freedom in lighting
and camera work" ... **CBC TIMES**

"turns out substantially better pictures" ...
CBS vice-president William B. Lodge—
in **TELEVISION DIGEST**

For full data on New 3" and 4 1/2" Field Mesh Image Orthicons write:

ELECTRONIC TUBE AND COMPONENTS DIVISION

CANADIAN **Marconi** COMPANY

830 BAYVIEW AVENUE • TORONTO, ONTARIO

Branches: Vancouver • Winnipeg • Ottawa • Montreal • Halifax • St. John's, Nfld.

For complete details check No. 21 on handy card, page 89.

a new

260

Series III



— with improved sensitivity and added convenience, at a new low price.

For 20 years the famous Simpson 260 has become a by-word in circuit analysis and measurement. Still maintaining its fine reputation for quality and the traditional Simpson care and attention in every detail of design and manufacture — the 260 is now available in a new series to keep up with our changing times. The Series III 260 uses printed circuits for added reliability and ease of service. Increased sensitivities are provided at no sacrifice in reliability; added ranges, and a unique scale layout to improve readability.

Best of all — a new low price making the finest in measurement available to all sizes of pocket books — all made possible only by complete Canadian manufacture.

RANGES:

D.C. Current. From 50 Microamps to 10 Amps in 6 ranges.

D.C. Volts (20000 ohms/volt). From 1/4 volt to 5000 volts in 7 ranges.

A.C. Volts (5000 ohms/volt). From 2.5 volts to 5000 volts in 6 ranges.

D.C. Resistance 0-2000 ohms to 0-20 megohms in 3 ranges.

Polarity reversing switch, volume level (decibel) and DBM ranges.

Price — tax included

\$55.00

The long tradition of fine instrumentation of the Model 260 is now extended to the custom-engineered Model 270, providing increased accuracy, a mirror scale and movement overload protective service, along with full performance data. Write for further details. Priced at **\$63.07**

4-8333



1255 BRYDGES ST.

LONDON, ONT.

IN U.S.A.: SIMPSON ELECTRIC COMPANY, 5200 W. KINZIE STREET, CHICAGO 44, ILLINOIS

For complete details check No. 14 on handy card, page 89.



an age publication

Electronics and Communications

Canada's pioneer journal in the field of electronics and communications engineering

Thomas W. Lazenby, editor
R. C. Poulter, P.Eng., associate editor
D. K. Trowell, editorial assistant
William Bowers, art editor
Guido Milanesio, photo editor

John R. Stocks, publication manager
H. E. Dallyn, advertising manager
Arthur Dixon, assistant advertising manager
Nevill A. Campling, production manager
Paul A. Irwin, circulation manager

Norman G. McHardy, president
L. R. Kingsland, vice-pres. & managing director
K. E. Gould, vice-president

Published by
AGE PUBLICATIONS LIMITED
450 Alliance Avenue, Toronto 9, Ontario
Telephone ROger 2-7225

publishers of
Wine/Beer/Spirits
Restaurants and Institutions
Automatic Heating/Plumbing/Air Conditioning
Air Age
Food Service Equipment Supplier

WEST COAST
Dillenbeck-Galavan, Inc.
226 S. Alexandria Ave.
Los Angeles 4, Calif.

U.K. AND EUROPEAN REPRESENTATIVE
Norman F. Keenan
47 Manchester Street
London, W. 1, England

Subscription Rates:
Canada, U.S.A. and U.K. Possessions \$5.00 a year
Foreign \$10.00 a year

Member Canadian Circulations Audit Board

Authorized as second class mail
by Post Office Dept., Ottawa



contents

JUNE 1959 Vol. 7, No. 6

- 30 Microwave extends facilities of New Brunswick's telephone system
- 31 Alberta telephone system growth continues
- 32 B.C.'s growth forces expansion of west coast telephone companies
- 34 Saskatchewan Government Telephones keeps pace with service demands
- 37 Bell Telephone estimates provide for large construction projects
- 38 Maritime Telegraph & Telephone Company expenditures reach all-time high
- 40 Okanagan Telephone Company completes decade of dial conversion
- 41 Automatic message accounting equipment for DDD
by C. J. Albrechtson
- 43 Remote control of unattended hydro stations
- 45 Cable carrier systems in British Columbia
- 48 World's first UHF scatter system

departments

- 11 EIA Report
- 12 CRTPB Newsletter
- 53 New Products
- 59 Business Briefs and Trends
- 61 News Report
- 73 Book Review
- 98 Editorial



DEPENDABLE POWER



LISTER AIR COOLED DIESEL ENGINES

In every field, Lister engines have proven themselves—setting a high standard of reliability and economy for industry and utilities. They are particularly suited to use in generating assemblies—for continuous running without attention.

Among their varied uses, Lister engines are in use for pumping and construction machinery, generating sets and marine propulsion. Parts and service are available throughout Canada.

Lister HA air cooled range. Direct injection for cold starting and greater economy. 10 BHP per cylinder continuous rating. 1800 RPM. Designed for working under the most varied conditions.

Write us for your free copy of Bulletins LD, SL and HA which describe, in detail, the Lister air-cooled range of Diesel engines 3½—30 BHP. Indicate application.

Lister-Blackstone engines 3½—1400 BHP.

CANADIAN LISTER-BLACKSTONE

1921 Eglinton Ave. E., Scarborough, Toronto 13, Ont. **LIMITED**

VANCOUVER
3135 West Broadway

MONTREAL
25 St. James St., Ville St. Pierre

In the U.S.: Lister-Blackstone, Inc., 42-32 21st Street, Long Island City 1, N.Y.

For complete details check No. 20 on handy card, page 89.

NEW TRANSFER OSCILLATOR

Permits your  524 series Counter to measure to 12.4 KMC with true counter accuracy, "low frequency" convenience!

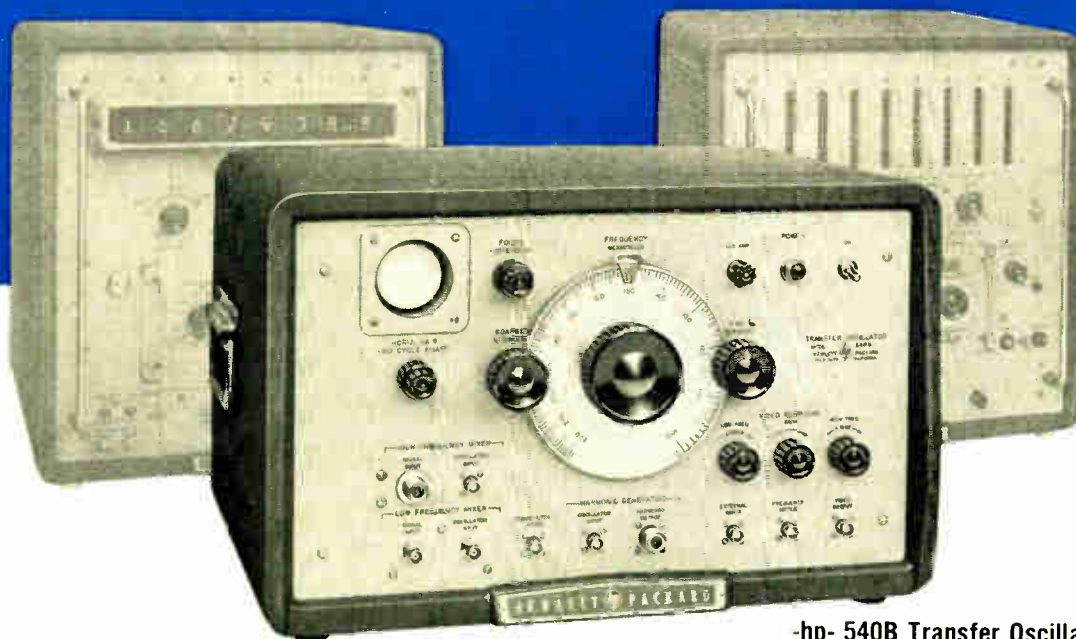



-hp- 540B Transfer Oscillator

Quickly, here's what this new  540B Transfer Oscillator does for you:

Extends frequency counter accuracy far into the microwave region. Permits measurement of pulsed, CW, FM, AM or noisy signals. Provides multiple check for positive accuracy. Measures FM deviation. Requires no external mixer or tuning. Eliminates complex setups.

Measurements such as those listed above are made with a convenience and accuracy heretofore associated

only with much lower frequencies.

Model 540B is an improved version of the popular  540A. It measures frequencies by comparing harmonic output with the unknown and measuring the fundamental on a counter such as  524 series. The instrument has a self-contained oscilloscope detector for comparison with unknown frequencies. A precision tuning control! permits the oscillator harmonic to be locked with the measured frequency.

Specifications:

Frequency Range: 10 MC to 12.4 KMC
Input Signal: CW, FM, AM or pulse
Input Signal Level: Varies with frequency and individual crystals
Accuracy: Depends on input signal. With stable, noise-free CW signal, accuracy approaches that of frequency counters.
Oscillator Frequency Range: 100 MC to 220 MC (fundamental)
 Above 12.4 KMC (harmonic)
Stability: Less than 0.002% change per minute after warmup
Amplifier Gain: Variable to 40 db or more

Bandwidth: Variable. High Freq.: 3 db point adjustable 1 KC to 2 MC. Low Freq.: 3 db point switched from 100 cps to below 10 KC.
Output: 1 v rms maximum into 1,000 ohms
Oscilloscope Frequency Range: 100 cps to 200 KC
Vertical Sensitivity: 5 mv rms/inch at mixer output
Horizontal Sweep: Internal, power supply frequency with phase control; or external, 1 v/inch, 20 cps to 5 KC.
Price: \$750.00 (cabinet) \$735.00 (rack mount)

Data subject to change without notice

HEWLETT-PACKARD COMPANY

Represented in Canada by **ATLAS INSTRUMENT CORPORATION, LTD.**
 50 Wingold Ave., Toronto, Ontario; 106-525 Seymour St., Vancouver, B. C.;
 72 Princess St., Winnipeg, Manitoba



world leader in microwave measuring equipment

For complete details check No. 41 on handy card, page 89.

For ultimate quality in audio amplification

Tung-Sol audio tubes now twin-packed in matched pairs by the manufacturer

Now you can come as close to faultless sound reproduction as the design and circuitry of your hi-fi equipment will permit. Tung-Sol 5881 and 6550 beam-power amplifier tubes are factory-matched to very tight performance limits and twin-packed to help you achieve lowest distortion levels at all volume levels.

Use of Tung-Sol 5881 and 6550 tubes has long been associated with ampli-

fiers of the very finest design. These tubes have always been produced to closest possible tolerances with cathode current ranges held to an absolute minimum.

Now, in twin-packed pairs, they assure the hi-fi enthusiast and the commercial sound engineer of replacement tubes that will provide new standards of performance—a feature of special importance with the newest amplifiers

and loudspeakers, particularly binaural sound equipment.

Service dealers will find the use of these tubes for replacement a source of profitable customer appreciation. Abbey Electronics, Downsview, Ont.

 **TUNG-SOL®**



5881

For service in amplifiers of up to 50 watts.

6550

For service in amplifiers and commercial audio equipment of up to 100 watts.

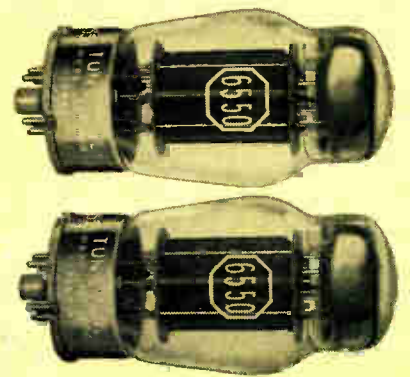

For complete details check No. 75 on handy card, page 89.

NEVER BEFORE-

such flexibility and performance for C.O. and PABX equipment. SIEMENS amazing new EMD motorswitch opens fresh vistas for "years-ahead" planning. Tuned to the future, the EMD motorswitch offers these features today:

UP TO 300 CONTACTS PER SECOND.

INDIVIDUAL MOTOR DRIVE.

SIMPLICITY OF GENUINE DIRECT PULSING AS NUMBER IS DIALED.

SMOOTH RESILIENT MECHANICAL ACTION.

ALLOYED PALLADIUM CONTACTS.

TROUBLE FREE OPERATION.

NO SWITCH CORDS OR COMPLEX SWITCHING MECHANISMS.

MAINTENANCE TIME CUT TO A SMALL FRACTION.

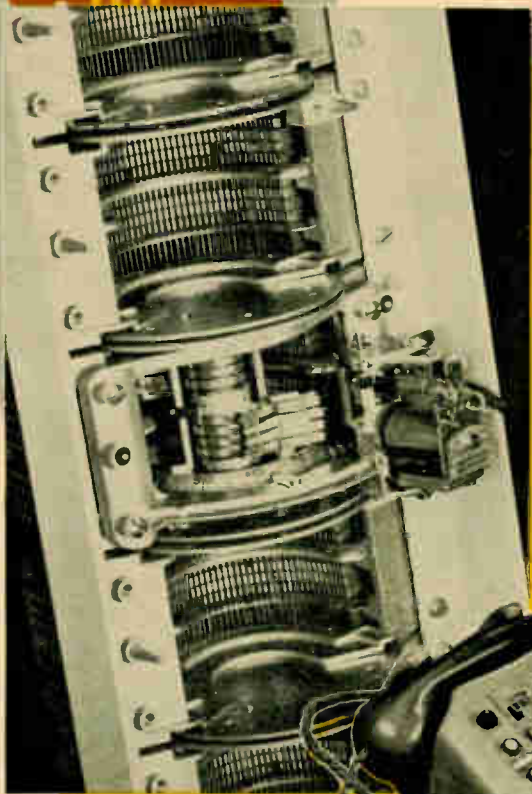

EMD Switch
Smooth noiseless
operation
individually
motor driven

Solderless Multiples

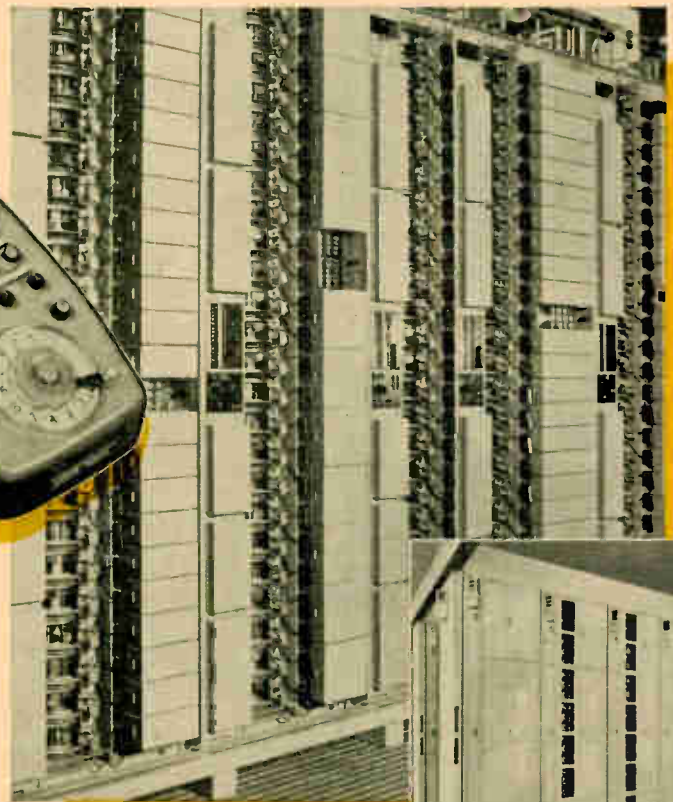

Enclosed in dustproof steel cabinets EMD switches are also suitable for relay rack assembly.

SIEMENS

A&S stands for
Assured Satisfaction



AHEARN & SOPER COMPANY LTD.

QUALITY AND

For standard and sub-miniature applications—From stock or to your specifications—it's **CENTRALAB** for electronic components.



VARIABLE RESISTORS

1/10W. Micro-miniature—For transistor circuits, hearing aids. 0.286" diam. 500 ohms to 10 megs.

1/10W. Ultra-miniature—For computers, hearing aids, transistor circuits. 0.502" diam. 500 ohms to 10 megs.

1/10W. Sub-miniature—For military, communications, computer use. 5/8" diam. 500 ohms to 10 megs.

1/4W. and 1/2W. Sub-miniature—For instruments and military. 43/64" diam. 500 ohms to 2.5 megs.

1/4W. Multiple-miniature—Up to 4 variable and 9 fixed resistors on a 3/4" x 2-1/4" steatite plate. 1000 ohms to 5 megs.

1/2W. Standard—For radio, TV. Single, Twin or dual-concentric. 15/16" diam. 250 ohms to 10 megs.

2.5W. Wirewound—For instruments and TV. Single or dual-concentric. 1-5/32" diam. 1 ohm thru 15K ohms.

Write for Group B bulletins

RELIABILITY



ELECTRONIC SWITCHES

Sub-miniature rotary—15/16" diam. for military and high reliability applications. Rating 0.5 amp. at 6VDC, 100 ma. at 110VAC. Laminated phenolic, steatite, single or multiple sections.

Standard rotary—1-5/16" diam. laminated phenolic or steatite insulation, single or multiple sections. Rating 2 amps. at 15VDC, 150 ma. at 110VAC. (Resistive load.)

Heavy-duty power—For transmitter, industrial control, laboratory testing, military, commercial. 2-13/16" diam. 7-1/2 amp. rating at 110VAC. 25,000 cycles minimum.

Spring return—1-5/16" diam., coil or C-type springs, phenolic, steatite, single or multiple sections.

Specialized—Lever, slide, tone, tuner sections, others.

Write for Group P bulletins.

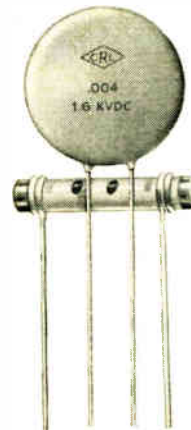

CERAMIC CAPACITORS

Ultra-miniature—3 to 12 VDC, 0.22—2.2 mfd.—for low power factor transistor applications.

Temperature compensating—Discs, tubulars, 150 v to 6,000 VDCW, 1 mmf.—0.1 mf. Capacitance +100 to -3250 ppm.

Bypass—Coupling—Discs, tubulars, 150 v to 6,000 VDCW, 1 mmf.—0.1 mf.

High Voltage—High Accuracy—High Voltage types, up to 30,000 VDCW. High Accuracy types, ± 1% tolerance, 500 VDCW, up to 2,500 mmf.

Trimmer—Tubular or flat. Meet JAN-C-81 specifications. 1 mmf. to 400 mmf. 500 VDCW.

Feed-thru—10—5000 mmf., 500—1,500 VDCW, bushing, shoulder, ring, eyelet, resistor-capacitor combinations.

Specialties—Stand-off, button-shape, potted, other capacitors.

Write for Group D bulletins.

IN ELECTRONICS



PACKAGED CIRCUITS

Complete computer and Radio-TV circuits, amplifiers, oscillators, detector networks, resistor networks—including transistors, capacitors, resistors, wiring and inductance, manufactured to your specific performance limits.

PEC* circuits result in substantial savings in assembly costs. These high reliability packaged circuits can be supplied in a wide variety of terminals for printed circuit board applications.

1/2W. resistors meet applicable MIL-R-11 specifications, 50 ohms to 50 megs. Capacitors up to .01 mmf.

Write for Group Y bulletins.



ENGINEERED CERAMICS

High alumina—85%, 95%, 99%—for high frequency, high temperature applications, close tolerance (± .00025") designs. Jan 1-10-L6A grade.

Grade Jan 1-10-L5A steatite, Grade L2A Corderite, and Grade L2A Electrical Porcelain. For applications where high dielectric and compressive strength, high dimensional stability, low loss and low power factor are required, there is a CENTRALAB ceramic material for the job.

CENTRALAB also specializes in metalizing of ceramics, for hermetic seals or mechanical attachment of other ceramic or metal parts.

Write for Group X bulletins.

YOUR JOB... AND

Centralab's

G-5949 

Centralab Canada Ltd.
669 Bayview Avenue, Toronto 17, Ontario
Affiliated: Centralab, Milwaukee 1, Wisconsin

VARIABLE RESISTORS • ELECTRONIC SWITCHES • PACKAGED ELECTRONIC CIRCUITS • CERAMIC CAPACITORS • ENGINEERED CERAMICS
For complete details check No. 26 on handy card, page 89.

EIA Report

By Basil Jackson, A.R.Ae.S., Tech. M.C.A.I.

New Member of EIA

At a recent meeting of the Components Division of the Electronic Industries Association and later ratified by the Board, the following new member was admitted into membership in the Components Division: Gomard Electronics Ltd., 180 Chatham Street, Hamilton, Ontario. Manufacturers of television deflection yokes, fly-back transformers, small iron-core transformers, and stabilized power supplies. The main representative is Mr. P. Gomard.

U.S. Defense Contracts in Canada

Figures showing the value of United States defense contracts placed in Canada through the Canadian Commercial Corporation and Defense Construction (1951) Ltd. during 1958 indicate that electronics amounted to just over one fifth of the total. Of a total net value of \$68,180,000, electronics and communications equipment amounted to \$12,756,000.

This information was given recently in the House of Commons.

Television in Scheduled Flights

Television has at last taken to the air. On the new Boeing 707 jet airliners flying between Chicago and Los Angeles it is now possible to see a television program on the 600 miles per hour flight. At 35,000 feet altitude a single television station can be seen for about 900 miles, equivalent to one and a half hours of travel. As soon as one network program fades out the same show is tuned in on another station.

Solderability and Printed Wiring Meeting

A joint meeting took place recently between the Components Engineering Sub-Committee on Solderability of Components, and the Engineering Sub-Committee on Sockets and Printed Wiring Boards in Toronto. A most interesting and informative question and answer period took place concerning the soldering techniques for semi-conductor manufacturing, printed circuit soldering, and printed wiring boards. The meeting was under the joint chairmanship of E. Walton, chairman of the Sub-Committee on Solderability of Components and F. H. Edwards, chairman of the Sub-Committee on Sockets and Printed Wiring Boards. Both sub-committees report to the Components Engineering Committee. During the course of the meeting it was noted that a standard was being prepared in the form of a design guide for printed circuit tolerances, and this was very much welcomed by the industry.

Sound Equipment Committee Prepare Specifications

At a recent meeting of the Sound Equipment Committee of the Electronics Division, work commenced on the preparation of specifications for sound system amplifier performance. This was the result of recent meetings held between the Sound Equipment Committee and various professional architectural and engineering organizations. The aim of the committee is to prepare suitable specifications which would be acceptable by the building industry so that original sound equipment of the best quality could be installed at the time of construction.

Speaker for Annual Meeting Announced

The EIA has announced that J. H. Warren, Assistant Deputy Minister, Department of Trade and Commerce, will be the guest speaker at the 30th annual meeting on June 19th at Bigwin Inn, Muskoka, Lake-of-Bays, Ontario. Mr. Warren is in charge of commercial policy in the Department of Trade and Commerce. In talking about the current problems in international trade, Mr. Warren will be requested to discuss the importation problem currently affecting the electronics industry in Canada.

Newsletter

Canadian Radio Technical Planning Board

Who's Who in the Planning Board

No. 15 — Canadian Association of Chiefs of Police

The objectives of the Canadian Association of Chiefs of Police are 1) the promotion of goodwill between all police forces of Canada and other countries, and between the police and the public, in the interests of efficient law enforcement, and 2) the study of modern and progressive practices in the prevention and detection of crime, uniformity of police practices, co-operation for the protection and security of the public.

The association was formed in 1905 under the title of Chief Constables' Association of Canada. However, the name was changed in 1954 to be more representative of the objectives of the association.

The monthly publication of the Canadian Association of Chiefs of Police is "The Canadian Police Bulletin". Annual conferences are held at different cities across Canada; the 1959 annual conference will be held in Regina.

Tropospheric Scatter Committee

Contributing sponsors of the Canadian Radio Technical Planning Board have been asked to vote on the recommendation of the CRTPB Tropospheric Scatter Committee regarding the use of certain frequency bands for scatter communications. These recommendations, which give consideration to the use of scatter systems on the basis of non-interference to existing installations, are in the frequency bands below:

| | |
|---|-----------------|
| 132-174 mc/s (except 156.8 mc/s and 144-148 mc/s) | 4400- 5000 mc/s |
| 450-470 mc/s | 6425- 8500 mc/s |
| 470-890 mc/s | 9800-10000 mc/s |

The results of the ballot on these recommendations on frequency utilization will be known early in June.

New "Constitution and By-Laws" Distributed

The newly approved revised "Constitution and By-laws" of CRTPB were recently circulated to all concerned. Attached to the "Constitution" was a copy of the Executive Committee's comments on the matter of committee membership as resolved at a meeting of the Administrative Committee in Ottawa last December.

Stereo Broadcasting Systems Suggestions

The Stereophonic Standard Sub-Committee of the Broadcasting Committee will be pleased to receive suggestions and comments from any party interested in compatible stereophonic broadcasting systems for AM, FM, and TV. All communications on this subject should be addressed to D. H. Johnston, Secretary of the Stereophonic Standard Sub-Committee, Canadian Radio Technical Planning Board, 200 St. Clair Avenue West, Toronto 7, Ontario.

Over eighteen different methods of stereophonic broadcasting have been suggested to the National Stereophonic Radio Committee in the United States, a watching brief on which is being maintained by the CRTPB Stereophonic Sub-Committee.

FCC and Frequency Allocation Plans

The Federal Communications Commission in the United States and the Office of Civil and Defense Mobilization are conducting joint long range planning to produce an improved pattern of frequency allocations which would be implemented within the next ten to fifteen years. Covering all uses of the Spectrum, the FCC said that, under the program, ways and means will be sought to accommodate expansion and growth in the use of radio, to simplify allocations for the use of radio, including television, and to provide for reasonable transition periods as necessary. This joint study, on a continuing basis, is a new approach in U.S. Government planning for the long-term future in the field of frequency allocations. Before this time such studies had been conducted independently by respective offices with conclusions co-ordinated afterwards. By the new approach, long range planning will be conducted as a joint effort towards a common objective.

Canadian Radio Technical Planning Board
200 St. Clair Avenue West, Toronto 7, Ontario

F. H. R. POUNSETT, President; C. J. BRIDGLAND, Vice-President; R. A. HACKBUSCH, General Co-ordinator;
R. C. POULTER, Director of Public Relations; F. W. RADCLIFFE, Secretary-Treasurer

NEW! CANNON "KWIK-TERM" TERMINALS

EASE OF INSERTION — RELIABLE PERFORMANCE — "TEFLON" INSULATION

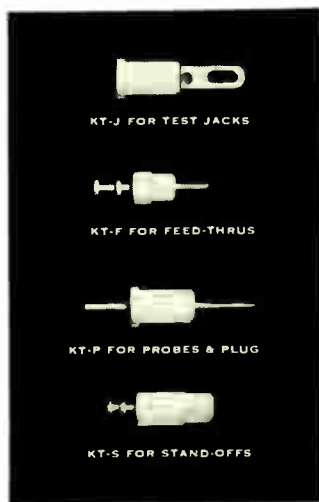

PERMANENTLY INSTALLED IN 4 SECONDS OR LESS by pressing the self-fastening insulator through pre-drilled mounting holes. The resilient properties of the "Teflon" insulation secures the terminal and provides permanent vibration proof installation, with no soldering or screw attachment needed to hold terminal in place. New Cannon "KT" Terminals offer simplified electrical connection especially adapted for circuitry in microwave communications, radar, scientific instrumentation and other crowded space applications. ■ **VOLTAGE RATINGS FROM 2380 V. TO 4250 V.** (Sea Level) depending on size of terminal. Special types are available where higher operating voltages are encountered. ■ **TEFLON BUSHINGS** available in diameters of 0.148" to 0.264." Terminal lengths range from 0.120" to 2.500." Standard pin diameters are 0.040," 0.046," 0.050," and 0.078." Pin material is brass with 0.0003" silver plate. A wide variety of finishes, colors and soldering lugs can be supplied to order. ■ "KT" Terminals are immediately available in a wide variety of sizes and shapes. Cannon also produces special configurations for specific applications: Write for Cannon Catalog KT-1. Cannon Electric Canada Limited, 160 Bartley Drive, Toronto 16, Ontario. Branch Offices in Montreal and Ottawa. Factories also in Los Angeles, Salem, London, Melbourne. Licencees in Paris and Tokyo.



For complete details check No. 25 on handy card, page 89.



MINIFIERS

SUB MINIATURE SELENIUM DIODES

Applications include a broad range of electronic applications: Computers, Electrical Measuring Instruments, Radio and Television, Transistorized Equipment.

- COIL SPRING CONSTRUCTION
- SUB-MINIATURE SIZE
- EXCELLENT MOISTURE AND FUNGUS PROTECTION
- VARIOUS CURRENT AND VOLTAGE RATINGS AVAILABLE.

1 AND 2 CELL TYPES

- Rated Current25 to 1.0 MA
- Typical forward drop at rated current 1.5 to 3.0 volts
- Min. forward current at 1 volt per cell 50 to 200 mili amp.
- Max. reverse current at 26 volts per cell 4 to 16 mili amp.
- Peak inverse voltage 46 to 92 volts

For complete technical specifications write for Catalog M-1.

INTERNATIONAL RESISTANCE CO. LTD.

349 CARLAW AVENUE • TORONTO 8, ONTARIO

SALES OFFICES:

Radiovision Sales Ltd. 492 Somerset St. West 5890 Monkland Ave.
 325 Tenth Ave. West Ottawa Montreal
 Calgary, Alta. Ont. Que.

For complete details check No. 43 on handy card, page 89.

FILTERS

HIGH SELECTIVITY — LOW LOSS

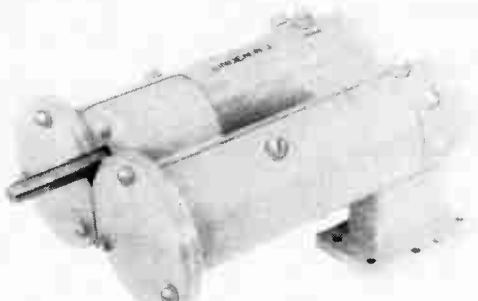

2-SECTION FILTER

These multi element single knob tunable filters were developed by AIRTRON for spectrum control and to reduce interference.

THIS TWO-SECTION PRESELECTOR FILTER OFFERS 7500-8500 mc/s TUNING WITH MINIMUM SIZE AND WEIGHT.

Insertion loss does not exceed 2.0 db for a 25 mc/s bandwidth. Rejection obtained with the characteristics is at least 50 db at $F_0 \pm 60$ mc/s.

WE INVITE YOUR INQUIRIES FOR SIMILAR MICROWAVE RELAY FILTERS.

Airtron CANADA LIMITED

349 CARLAW AVE. TORONTO 8, ONT.

For complete details check No. 5 on handy card, page 89.

RACK & PANEL CONNECTORS

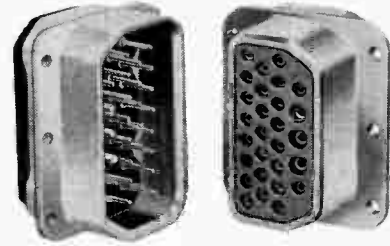

94 SERIES

with poke home contacts 93 & 94 series

Wires are crimped or soldered to contacts then 'poked home' into connector — allows fast circuit changes or corrections if necessary.

94 Series Available With Coaxial Contacts

Write for Catalogs

AMPHENOL CANADA LIMITED

349 CARLAW AVENUE • TORONTO 8, ONTARIO

For complete details check No. 7 on handy card, page 89.



PACK-OF-5

AVAILABLE IN
1/2 WATT TYPES BTS AND GBT-1/2,
1 WATT TYPE BTA RESISTORS

Popular I.R.C. 1/2 and 1 Watt Resistors Available in all Standard E.I.A. Values from 10 ohms to 22.0 megs. $\pm 10\%$ Tolerance.



- Factory Sealed
- Dustproof
- Waterproof
- Convenient Handling

Available at leading distributors across Canada

Suggested Dealer net:

BTS and GBT-1/2 — 40c per pkg.
BTA — 65c per pkg.

INTERNATIONAL RESISTANCE CO. LTD.

349 CARLAW AVE. TORONTO 8, ONT.

SALES OFFICES:

Radiovision Sales Ltd. 492 Somerset St. West 5890 Monkland Ave.
 325 Tenth Ave. West Ottawa Montreal
 Calgary, Alta. Ont. Que.

For complete details check No. 44 on handy card, page 89.



WHY WE BOUGHT COLLINS MICROWAVE

Maritime Telegraph and Telephone Co.
W. A. Logan, Chief Engineer

When the January 1956 sleet storm broke 3,100 of our poles, we found the cost of repairing the open wire lines would be almost as much as installing microwave. After carefully considering costs and system reliability, we chose Collins Microwave and Carrier. We are completely satisfied with the economy, transmission quality and dependability of our Collins system.



COLLINS RADIO COMPANY OF CANADA, LTD., TORONTO, 16, ONTARIO

communications ...today ...tomorrow with S.Q. tubes!

The extension of the application of electron tubes in fixed and mobile communication equipment is enormous and continues to grow steadily. This has created a requirement for tubes with special features which ensure the dependable operation of such professional equipment.

For these professional applications, Rogers offer a range of Special Quality "S.Q." Tubes. Their design and production incorporates the highest standards of the art of tube-making. S.Q. tubes, depending upon the purposes for which they are primarily intended, have special features which measurably increase their desirability.

Reliability is a prime consideration and special measures in design and construction ensure an extremely low failure percentage.

The S.Q. tubes mentioned here have a warranted

These S.Q. tubes Are Recommended

| Spec. Quality Tube Type | E91H | 6463 | E88CC | M8080 | E80CF | E80CC | E80L | M8212 |
|--|-----------------------|---------------|-----------------------|----------------------|----------------|---------------------------------|------------------|--|
| Registered E.I.A. Number | 6687 | 6463 | 6922 | — | — | 6085 | 6227 | |
| Tubes having same basing and comparable electrical characteristics | 5915A 7036 6BE6 | 6350 | 6DJ8 6BQ7A 6BZ7 | 6C4 6C4WA 6100 | 6U8 | 12AU7 ECC82 5814A 6189 | 6677 | 6663 6AL5 6AL5W EAA91 6097 |
| Functional Description | Dual Control Heptode | Double Triode | RF Double Triode | VHF Triode | Triode-Pentode | AF Double Triode | AF Power Pentode | Double Diode |

Recommended S.Q. tube line-ups for

| | Tube 6360 | | Tube 6360 | | Frequency at this point | Frequency at this point |
|-----------|------------------------|------------------------|---------------------------|------------------------|-------------------------|--|
| | 1st section as doubler | 2nd section as doubler | 1st section as multiplier | 2nd section as doubler | | |
| Frequency | 4.81—9.62 | 9.62—19.24 | 19.24—76.96 | 76.96—153.92 | 150 mc/s | 150 mc/s |
| Frequency | 4.81—9.62 | 9.62—19.24 | 19.24—76.96 | 76.96—153.92 | 150 mc/s | 450 mc/s using 6939 as push pull tripler |
| Frequency | 4.81—9.62 | 9.62—19.24 | 19.24—76.96 | 76.96—153.92 | 150 mc/s | 450 mc/s using 6939 as push pull tripler |

Consider the advantages of these 3 recommended tube line-ups . . .

- | | |
|---|--|
| (a) Minimum number of tube types | (f) Tube types available throughout the world |
| (b) Double tetrodes throughout except 250 watt final on 150 mc/s band | (g) Correct and conservative rating in CCS basis with ample safety margin under conditions normally encountered in the field |
| (c) Common system on all bands up to driver stage | (h) Great uniformity tube to tube |
| (d) Tube of comparable quality used in all stages | (i) Reasonable first cost, very low second cost |
| (e) Push pull efficiency at low plate voltage throughout | |

For complete details check No. 64 on handy card, page 89.

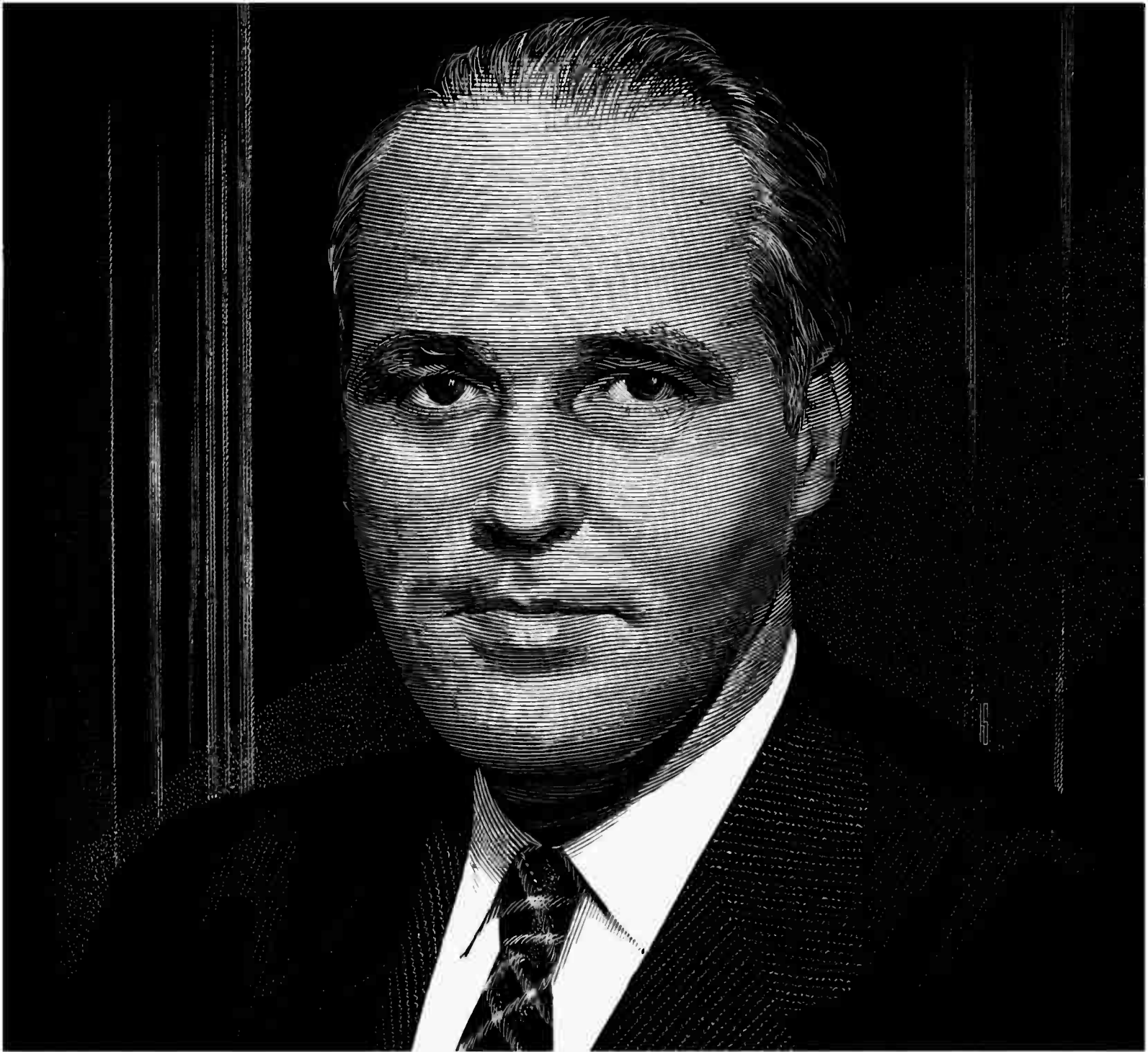

WHY WE BOUGHT COLLINS MICROWAVE

Maritime Telegraph and Telephone Co.
W. A. Logan, Chief Engineer

When the January 1956 sleet storm broke 3,100 of our poles, we found the cost of repairing the open wire lines would be almost as much as installing microwave. After carefully considering costs and system reliability, we chose Collins Microwave and Carrier. We are completely satisfied with the economy, transmission quality and dependability of our Collins system.



COLLINS RADIO COMPANY OF CANADA, LTD., TORONTO, 16, ONTARIO

World Radio History

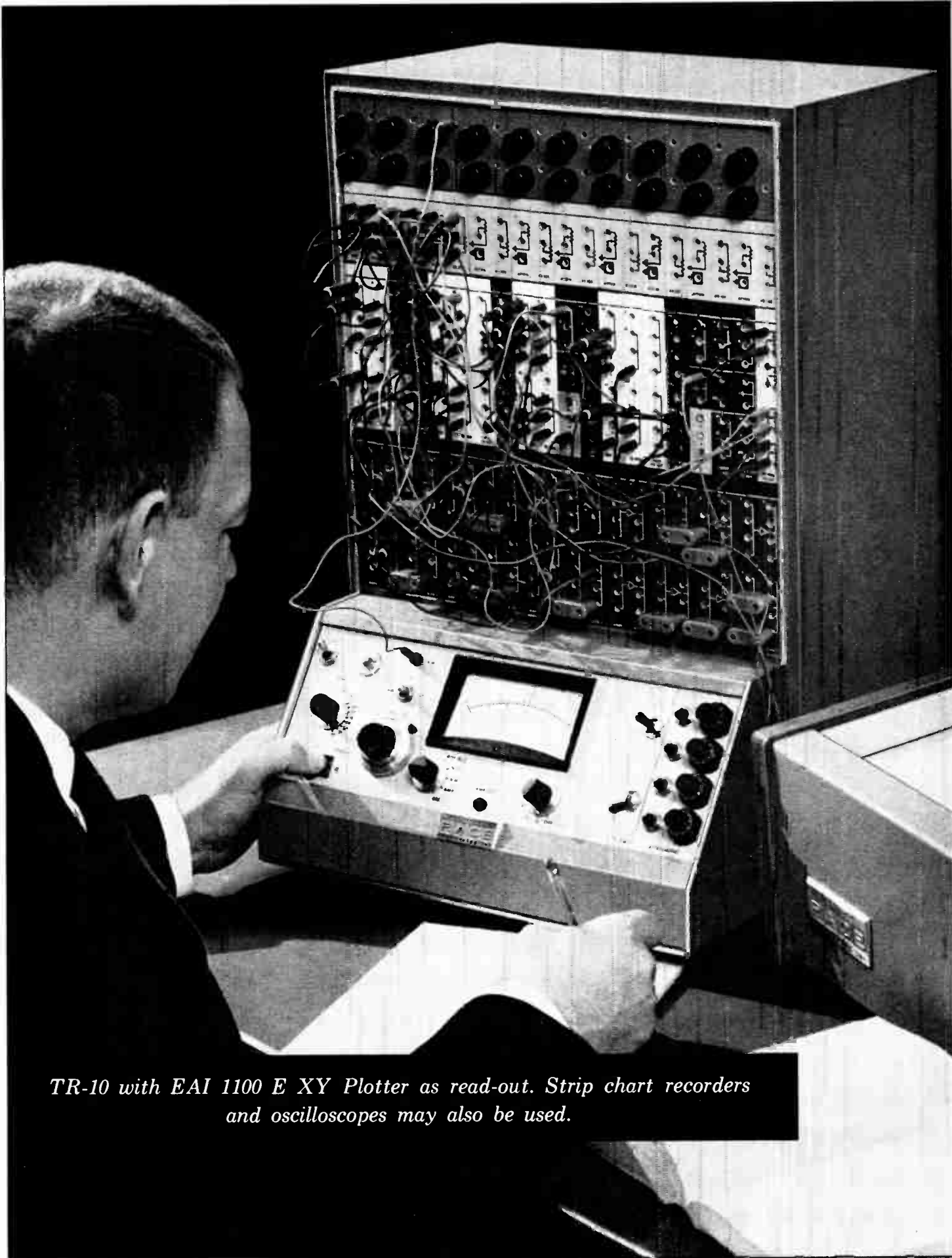

TR-10 with EAI 1100 E XY Plotter as read-out. Strip chart recorders and oscilloscopes may also be used.

THE *FIRST* ALL TRANSISTORIZED ANALOG COMPUTER

— *basic model less than \$4000*

PACE TR-10 Eliminates Drudgery

Gives New Insight Into Engineering Problems

New transistorized computer puts the advantages of analog computation within reach of every engineer. This compact unit, 15" x 16" by 24" high, is powered by 115 volts AC and can provide day-in day-out instant solution of your most vexing engineering problems. Even if you have never seen a computer before, you can learn to operate the TR-10 as easily as you learned to use a slide rule.

Gain New Insight to Complex Problems

Once the problem is set up on your computer, you simply turn a dial to feed in design parameters. The computer provides an instant by instant, dynamic picture of the effect of each change. You can study the inter-related effects of heat, pressure, flow, vibration, torque or any variable. And you can visually compare one with the other. You see problems in a new light — engineering data comes alive — insight into how new designs will work is obtained easier, faster. There's no need for recalculating every time you change a factor — simply turn the dial and see what effect it has on the solution.

Your "Personal Computer" for Higher Creativity

Because of its minimum size and extremely low price, the TR-10 can become your own personal analog computer. It helps to free you from routine drudgery. Permits you to gain first-hand experience with the power of analog techniques, and convert more of your time to *creative engineering*.

Test New Ideas or Designs

New ideas that were too costly to try before are now practical. Any possible combination of factors can be tried. You can design virtually to perfection and have a permanent, visual record of performance. All this can be done before building pilots or prototypes. As a result, "cut and try" expense is drastically reduced.

The same quality workmanship and design that has made Electronic Associates the world's leading producer of precision general purpose analog computers will be found in this new unit. Accuracy to ± 1 per cent. Modular construction allows you to select varying quantities of the following computing functions:

- Summation
- Integration
- Multiplication or Division
- Function generation
- Parameter adjustment
- Logical comparison

For complete engineering data, write for Bulletin TR-10-H.

EAI systems are serving engineers throughout the world. EAI maintains Computation Centers where PACE analog equipment is available on a rental basis. Write for details.



EAI

ELECTRONIC ASSOCIATES, INC. ■ Long Branch, New Jersey

Here's the Complete "Package" for Counting Electrically...

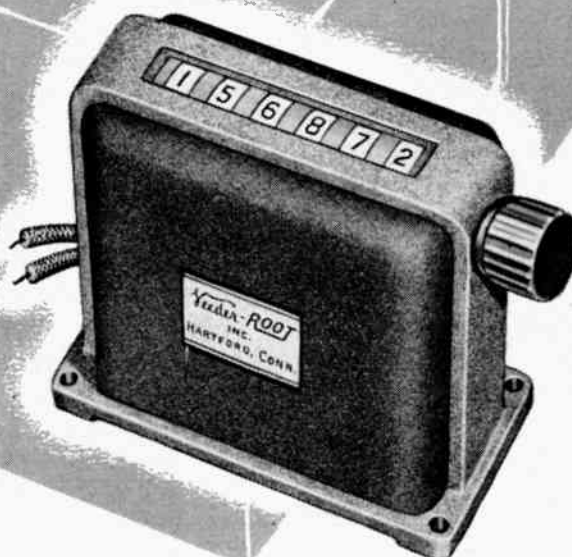

Added Evidence that —

Everyone Can Count on **VEEDER-ROOT**

This Veeder-Root Reset Magnetic Counter (AC or DC) is actuated through electromagnets. And it may be connected in series with any device having a contact arrangement . . . like the specially designed Veeder-Root Electrical Contactor at the left, which insures positive operation of the counter, either in oscillation or connected directly to a revolving shaft . . . with the counter placed at

any distance from the machine or process on which the count is required.

This is another one of the hundreds of Veeder-Root Standard and Special Counting and Computing Devices developed for every conceivable counting duty, in every field from atomics to electronics.

What do you need to count? Just write:

VEEDER-ROOT of CANADA, Ltd.

955 St. James St., Montreal 3

Main Office & Factory: Hartford 2, Conn., U.S.A.
Offices & Agents in Principal Cities



Chicago 6, Ill. • New York 19, N. Y. • Greenville, S. C.
Montreal 2, Canada • Dundee, Scotland
Offices and Agents in Principal Cities

"The Name that Counts"

For complete details check No. 76 on handy card, page 89.

The Old Frontier...



...The New Frontiers

are in science, design, production

The new frontiers are being exploited by companies which like Triplet have worked the frontier of electronics for over 55 years.

Working the frontier means being on the spot with the equipment to develop and maintain this new made world. Triplet has a history of over 50 years of being first with the best in panel instruments and test equipment at a practical cost. Triplet is still working on the frontier of electronics with such innovations as these:

Over 55 years experience in instruments

Burton Browne Advertising



Model 310 a complete miniature V-O-M with single switch selection and the ranges and accuracy of units several times its size. Used with Model 10 clamp-on ammeter plugged in it becomes one of the world's most versatile pieces of test equipment—even measuring current flow without stripping wires.



Model 630-PL V-O-M with such advanced features as an unbreakable clear plastic front for wide range, shadowless, instant vision, polarity reversing switch, single king size knob for selecting both range and circuit, continuous resistance readings from 0.1 ohm to 100 megohms.



Model 690-A, a new Transistor Tester with more Triplet "plus" in accuracy and simplicity, for testing leakage and gain of all low and medium power PNP and NPN transistors. Small, rugged, battery-operated, it measures DC Beta from 5 to infinity. Affords exact tests for shorts, checks forward & reverse leakage of diodes. Features single switch selection of transistor types, positive "off" to prevent accidental battery drain, separate "calibrate" and "gain" buttons eliminate errors, transistor socket and external leads for any basing arrangement.



New Unimeters—a great step forward in increasing meter inventory flexibility while cutting inventory cost. These Select-Your-Range unimeters consist of only two basic meter movements, which can be combined with any one of a number of separate dial-component units for a wide variety of meter ranges. Movements quickly and simply slide onto dial-components and lock together—no soldering, no wiring. Exclusive Triplet Bar-Ring construction for self-shielding, greater accuracy and sensitivity.

TRIPLET

Triplet Electrical
Instrument Company
Bluffton, Ohio

LEN FINKLER, 1794 Avenue Road, Toronto 12, Ont.
C. M. ROBINSON COMPANY, 150 Erin St., Winnipeg;
325 10th Avenue, Calgary, 550 Beatty St., Vancouver.

communications ...today ...tomorrow with S.Q. tubes!

The extension of the application of electron tubes in fixed and mobile communication equipment is enormous and continues to grow steadily. This has created a requirement for tubes with special features which ensure the dependable operation of such professional equipment.

For these professional applications, Rogers offer a range of Special Quality "S.Q." Tubes. Their design and production incorporates the highest standards of the art of tube-making. S.Q. tubes, depending upon the purposes for which they are primarily intended, have special features which measurably increase their desirability.

Reliability is a prime consideration and special measures in design and construction ensure an extremely low failure percentage.

The S.Q. tubes mentioned here have a warranted

These S.Q. tubes Are Recommended

| Spec. Quality Tube Type | E91H | 6463 | E88CC | M8080 | E80CF | E80CC | E80L | M8212 |
|--|-----------------------|---------------|-----------------------|----------------------|----------------|---------------------------------|------------------|--|
| Registered E.I.A. Number | 6687 | 6463 | 6922 | -- | -- | 6085 | 6227 | |
| Tubes having same basing and comparable electrical characteristics | 5915A 7036 6BE6 | 6350 | 6DJ8 6BQ7A 6BZ7 | 6C4 6C4WA 6100 | 6U8 | 12AU7 ECC82 5814A 6189 | 6677 | 6663 6AL5 6AL5W EAA91 6097 |
| Functional Description | Dual Control Heptode | Double Triode | RF Double Triode | VHF Triode | Triode-Pentode | AF Double Triode | AF Power Pentode | Double Diode |

Recommended S.Q. tube line-ups for

| | Tube 6360 | | Tube 6360 | | Frequency at this point | Frequency at this point |
|-----------|------------------------|------------------------|---------------------------|------------------------|-------------------------|--|
| | 1st section as doubler | 2nd section as doubler | 1st section as multiplier | 2nd section as doubler | | |
| Frequency | 4.81—9.62 | 9.62—19.24 | 19.24—76.96 | 76.96—153.92 | 150 mc/s | 150 mc/s |
| Frequency | 4.81—9.62 | 9.62—19.24 | 19.24—76.96 | 76.96—153.92 | 150 mc/s | 450 mc/s using 6939 as push pull tripler |
| Frequency | 4.81—9.62 | 9.62—19.24 | 19.24—76.96 | 76.96—153.92 | 150 mc/s | 450 mc/s using 6939 as push pull tripler |

Consider the advantages of these 3 recommended tube line-ups . . .

- | | |
|---|--|
| (a) Minimum number of tube types | (f) Tube types available throughout the world |
| (b) Double tetrodes throughout except 250 watt final on 150 mc/s band | (g) Correct and conservative rating in CCS basis with ample safety margin under conditions normally encountered in the field |
| (c) Common system on all bands up to driver stage | (h) Great uniformity tube to tube |
| (d) Tube of comparable quality used in all stages | (i) Reasonable first cost, very low second cost |
| (e) Push pull efficiency at low plate voltage throughout | |

For complete details check No. 64 on handy card, page 89.

extended life. Actual practice has shown that their life in general will be much longer than 10,000 hours. It is important to note, in this regard, that to obtain predictable tube life on S.Q. tubes and better tube life on standard tubes, heater voltage must be kept within 5% and bulb temperature must not exceed a maximum of 150°C. Where these conditions do not at present exist, they may be achieved by incorporating voltage regulators for heaters as an additional separate package and by the employment of improved tube shields. The need for the latter may be quickly determined by the use of temperature measuring paints. We would be happy to recommend sources on all these items.

The electrical characteristics of S.Q. tubes remain very stable during life and the uniformity of characteristics from tube to tube is outstanding.

Finally, the S.Q. types of rugged construction for use in mobile equipment can withstand vibrations for a long time. They may even be subjected to incidental shocks of a few hundred g.

Although S.Q. tubes were primarily developed for applications where dependability is of vital importance, either for safety or economical reasons, they are also finding more and more use in other professional equipment. Practice has demonstrated that their initial higher cost is more than compensated by the greater reliability and lower maintenance cost of the apparatus.

Some of the S.Q. tubes with their main data and present and future applications are shown here. We will gladly provide fuller data upon request, both on existing S.Q. tubes and on new developments as they are added.

For Replacement In Present Equipment

| M8196 | E90F | E99F | E81CC | M8137 | EF95 | E91N | M8081 | RT5725 | RT5749 |
|--|------------------------------|--------------------------------------|-----------------------------------|-----------------------------|--------------------------------|-------------------------|-----------------------------|----------------------------|------------------------------|
| — | — | — | 6201 | — | 5654 | 5727 | — | 6AS6W | 6BA6W |
| 6AS6 | 6BH6 6661 6265 | 6BJ6 6662 | 12AT7 12AT7WA ECC81 6679 | 12AX7 | 6AK5 6AK5WA EF95 6096 | 2D21 2D21W PL2D21 | 6J6 6J6W 6099 6101 | 6AS6 | 6BA6 |
| Short Suppressor Base Pentode | R.F. Amplifier Pentode | R.F. Remote Cut-off Pentode | R.F. Double Triode | High mu Double Triode | R.F. Amplifier Pentode | Thyratron Tetrode | Double Triode | Dual Control Pentode | Remote Cut-off Pentode |

150 mc/s, 450 mc/s, 900 mc/s Bands

| Frequency at this point | Power output in load allowing for all losses including filter. All CCS | | | | | |
|--|--|--|---|--|--|---------------|
| | 3-5 watts | 10 watts | 30 watts | 60 watts | 250 watts | |
| 150 mc/s | 6360 push pull Amplifier | 6360 push pull Amplifier | 6360 push pull Amplifier driving a 5894 as push pull Amplifier | 6360 push pull Amplifier driving a 5894 as push pull Amplifier | 6360 push pull Amplifier driving a 5894 as push pull Amplifier driving two 6155 as push pull Amplifiers | 150 mc/s band |
| 450 mc/s | 6939 as push pull Amplifier | 6939 as push pull Amplifier driving a 6252 or 6907 as push pull Amplifier | 6939 as push pull Amplifier driving a 5894 as push pull Amplifier | 6939 as push pull Amplifier driving a 6252 or 6907 as push pull Amplifier driving 5894 as push pull Amplifier | | 450 mc/s band |
| 900 mc/s using 7377 as push pull doubler | 7377 as push pull Amplifier | — | — | — | — | 900 mc/s band |

You are invited to make full use of Rogers Application Engineering Service at any time, on any problem. Just call or drop us a line.

ROGERS

electronic tubes & components

A DIVISION OF PHILIPS ELECTRONICS INDUSTRIES LTD.
116 VANDERHOOF AVE., TORONTO 17, ONTARIO

PUZZLE:

FIND THE POWER BREAK

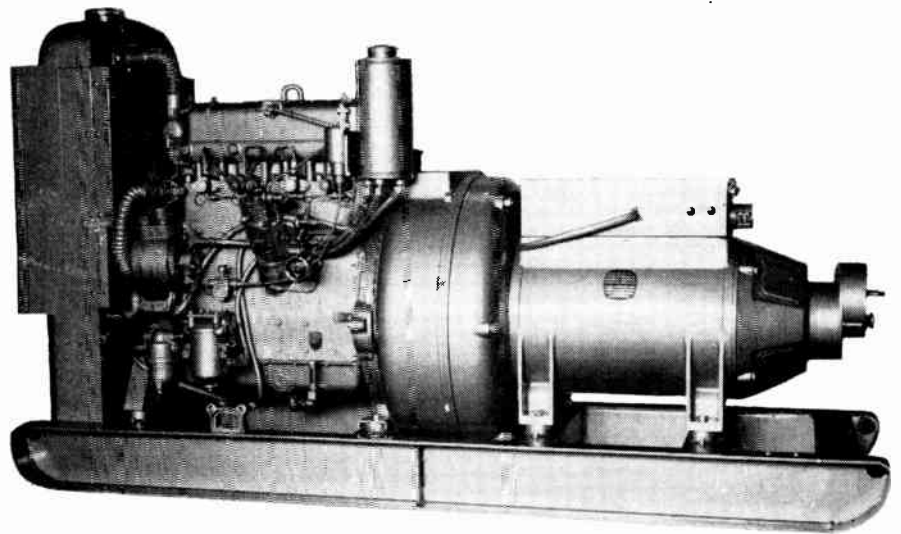

"WE'LL BET YOU DIDN'T FIND IT!" —
*... and you won't!**

THE GRAPH reproduced on this page shows an actual voltage record during a power interruption from normal source — and protected by the new lightweight 10 KW U.S. Motors *DIESEL* "Micro Power" no-break generator.

WHAT IS MICRO POWER? . . . Micro Power is a stand-by or auxiliary power plant for use with equipment that cannot tolerate even a momentary interruption of electrical power. Micro Power provides a constant source of electrical power, despite voltage fluctuations and power failures from prime source, and maintains voltage and frequency output at useable values.

Unlike existing equipment, Micro Power is lightweight and compact in design, weighs only 2,300 lbs., and is just 80½ ins. in length — a definite advantage in simplifying installation on hilltops and other difficult locations where space and weight present a problem.

Micro Power is available with the following engine power options: DIESEL, GASOLINE, NATURAL GAS, and PROPANE, and a full range of electrical ratings. Write for detailed information and specifications.

There are over 50 Micro Power units in use by communication companies in Canada.

* The power break occurred at 3rd line past 6 AM point.

AP 902

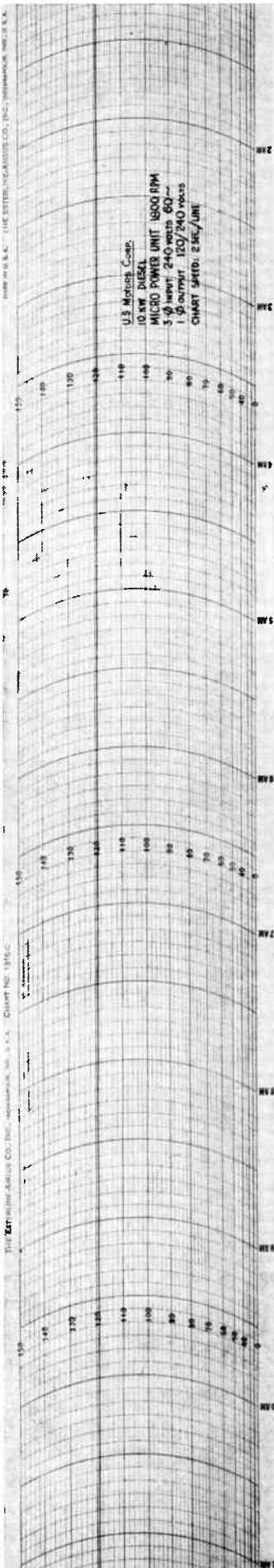

For complete details check No. 10 on handy card, page 89.

Now Made In Canada...

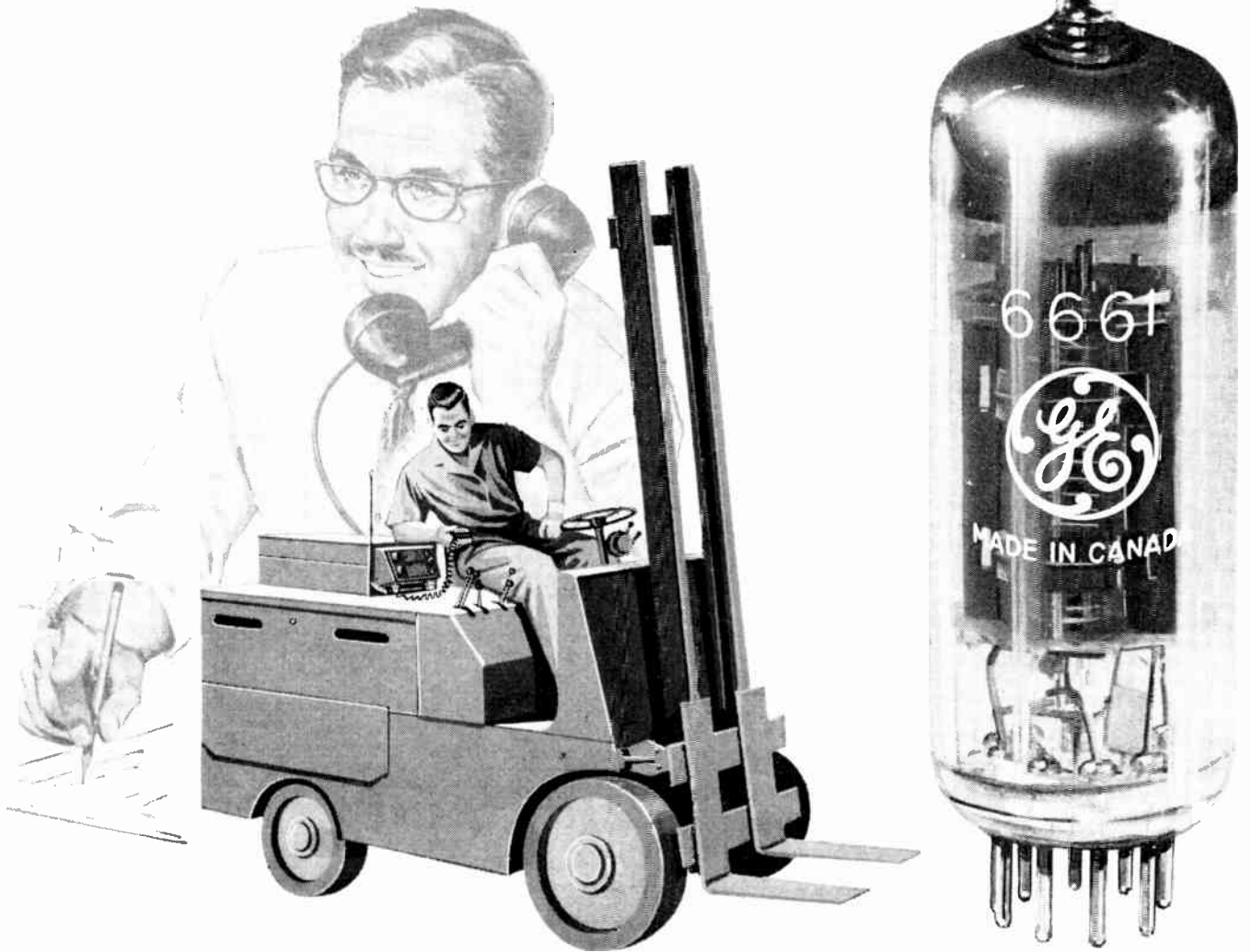

G-E 6600 SERIES TUBES

the low-cost answer for tough communication

Canadian General Electric now manufactures 6600 series tubes, specially designed for mobile communications equipment. In applications where shock, vibration, voltage fluctuations and other factors make standard tube operation unreliable, G-E 6600 Series Tubes are your most economical answer.

COMPARISON CHART:

| | | | | | | | | | | |
|-----------|------|------|------|------|------|------|------|-------|-------|-------|
| TUBE TYPE | 6660 | 6661 | 6662 | 6663 | 6669 | 6677 | 6678 | 6679 | 6680 | 6681 |
| PROTOTYPE | 6BA6 | 6BH6 | 6BJ6 | 6AL5 | 6AQ5 | 6CL6 | 6U8A | 12AT7 | 12AU7 | 12AX7 |

Here's why . . .

Higher Stability: Every tube lot is operated for the minimum period required to assure stable performance.

Tougher Heaters: With a tolerance of — 20% instead of the usual — 10% to accommodate wider voltage fluctuations.

Lower Voltage Operation: Every lot tested for major electrical characteristics at 5.0 volts on the heater instead of the usual 5.5 volts.

Full Interchangeability: With standard prototype tubes.

Canadian manufacture of G-E 6600 Series Tubes means lower cost to you. For full details and new prices, contact your nearest C-G-E Sales Office or authorized G-E tube distributor.



Electronic Tube Section

1683-259

CANADIAN GENERAL ELECTRIC COMPANY LIMITED

For complete details check No. 17 on handy card, page 89.

ELECTRONICS AND COMMUNICATIONS, June, 1959

23

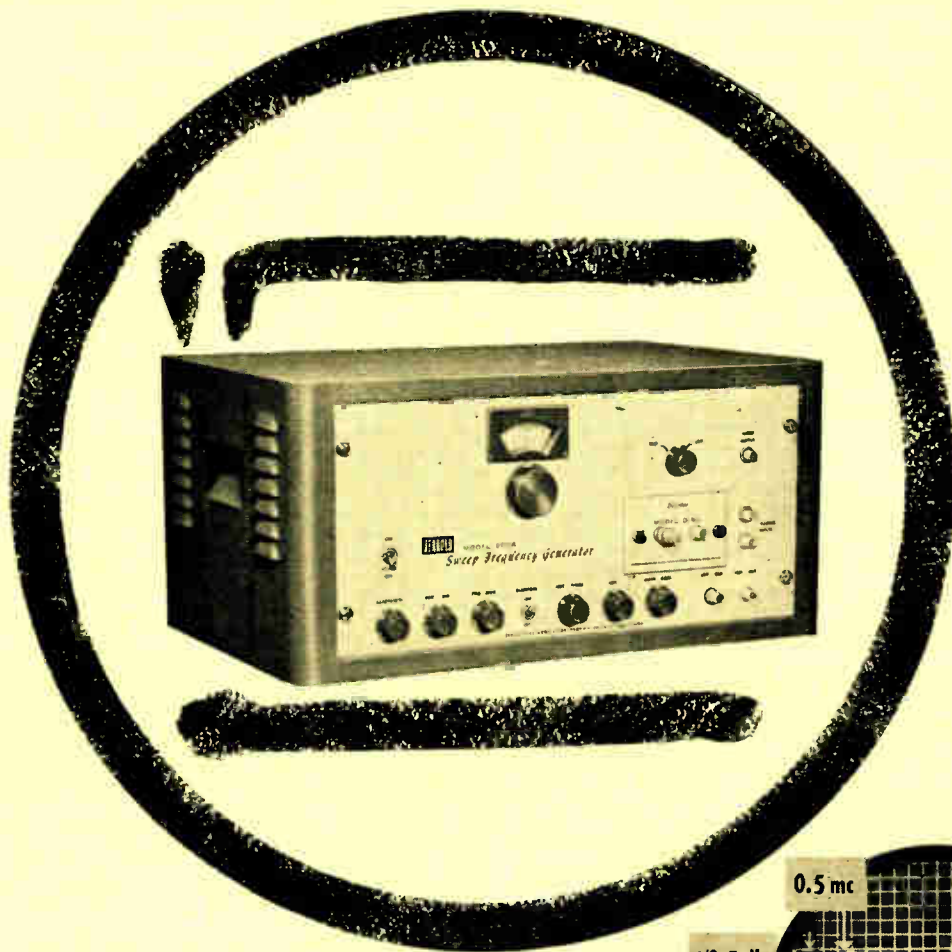

JERROLD'S

versatile new

900A Sweep Generator Covers The Range of Three Regular Instruments!

It's the most *versatile* Sweep Generator in the electronics industry... this one instrument covers *all* your needs from 1/2 MC to 1200 MCS, for **IF's, radar, video, telemetering and communications!**

Specifications: In two ranges—0.5 MC to 400 MC and 275 MC to 1200 MC—the instrument supplies a sweep signal with center at any frequency from 500 KC to 1000 MC and with sweep widths as broad as 400 MC and as narrow as 100 KC. The RF output—carefully monitored by matched, crystal diodes feeding a two-stage, push-pull AGC amplifier—is flat within ± 0.5 db at full sweep width up to 800 MCS and ± 1.5 db from 800 MCS to 1200 MCS. When using sweep widths as narrow as 20 MCS flatness at any center frequency is approximately **\$150000** ± 0.15 db.

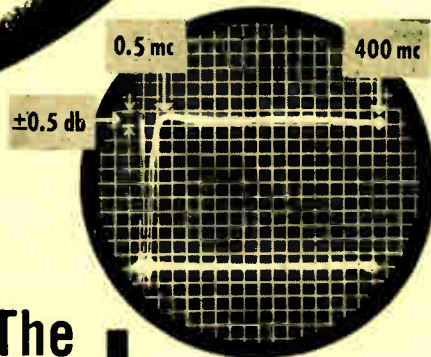

- **HIGH OUTPUT!**

.25 volt RMS on VHF—
.5 volt RMS on UHF!

- **WIDE SWEEP WIDTHS!**

From 100 KC up
to 400 MCS!

- **FLAT OUTPUT!**

Flat to $\pm .5$ db on
widest sweep width!

MODEL 900A IS NOW IN QUANTITY PRODUCTION!

Write today for on the spot demonstration of this versatile instrument!

JERROLD

ELECTRONICS (Canada) LTD.

50 Wingold Avenue, Toronto 19

Jerrold Electronics Corporation, Industrial Products Division
Department 37, The Jerrold Building, Philadelphia 32, Pa.

Export Representative: *Rocke International, New York 16, N.Y.*

For complete details check No. 45 on handy card, page 89.

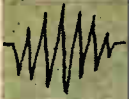

Westinghouse tube engineering...
serving the nation through imagination

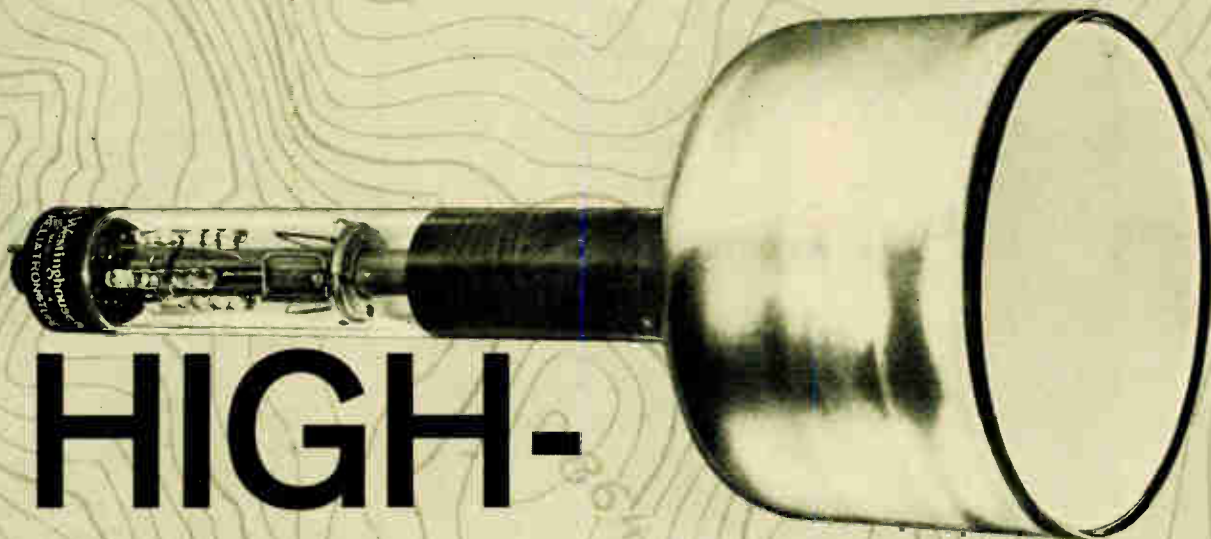

HIGH- RESOLUTION

radar display tube

New cathode-ray tube features electrostatic-focus and offers proven performance in high-resolution radar.

The Westinghouse 5CEP11 is a high-resolution, electrostatic-focus, magnetic-deflection cathode-ray tube primarily designed for presentation of radar displays. It's particularly useful in conjunction with photographic recording systems, such as radar reconnaissance for mapping. The face-plate is optically flat, and employs gray glass for superior contrast. The 5CEP11 will produce a line width not to

exceed 0.0015" at 10 KV anode potential. Line width is measured in production at half amplitude of the light energy distribution of a single line—this is a precise measurement not subject to operator error.

The 5CEP16 is designed for flying spot scanners and also has 0.0015" line width. Sample or production quantities of either 5CEP11 or 5CEP16 are available.

YOU CAN BE SURE...IF IT'S

Westinghouse

59D800

CANADIAN WESTINGHOUSE COMPANY, LIMITED, Electronic Tube Division, Box 510, Hamilton, Ont.

For complete details check No. 23 on handy card, page 89.

ELECTRONICS AND COMMUNICATIONS, June, 1959

Switchboard efficiency to meet your needs!



No. 555

PRIVATE BRANCH EXCHANGE

This is a modern switchboard with the new "plug-in" type units, permitting actual service requirements to be closely met.

Available in capacities of

- 60 and 120 Station Lines
- 14 Central Office Trunks
- 15 Cord Circuits

Two positions may be installed side-by-side to increase the maximum capacity to 240 lines.

The low design makes it convenient for attendant-receptionists to converse with employers' visitors or client over the top of the switchboard.

No. 507

PRIVATE BRANCH EXCHANGE

A small compact switchboard with a capacity of

- 12 Station Lines
- 5 Central Office Trunks
- 5 Connecting Circuits.

Requires about the same amount of space as the average typewriter.

Convenient and simple to operate by an attendant with other duties.

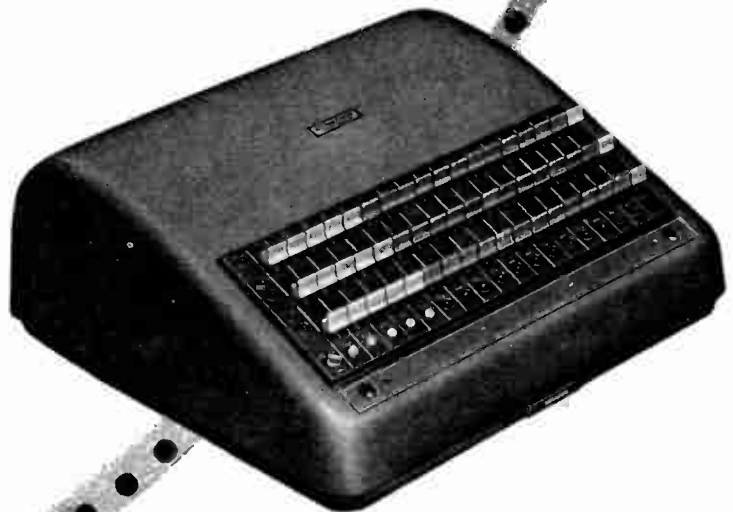

Northern Electric

COMPANY LIMITED

2053-1

44 BRANCHES THROUGHOUT CANADA

For complete details check No. 54 on handy card, page 89.

measured 30 db gain!

30°
330°

20°
340°

10°
350°

350°
10°

340°
20°

330°
30°

40°
320°

50°
310°

60°
300°

70°
290°

80°
280°

90°
270°

100°
260°

320°
40°

310°
50°

300°
60°

290°
70°

280°
80°

270°
90°

260°
100°

250°
110°

240°
120°

230°
130°



the door
to improved
HF
communications
is open

- 1. Simple structures
- 2. Reasonable sizes
- 3. 2/1 Frequency range
- 4. Receiving or Transmitting

*your
enquiries
are
invited*

THE WIND TURBINE COMPANY OF CANADA LTD.

145 LUCAN STREET, WATERLOO, ONTARIO

Subsidiary of: Wind Turbine Company, West Chester, Pa., U.S.A.

140°
220°

150°
210°

160°
200°

170°
190°

190°
170°

200°
160°

210°
150°

18 CHANNELS- IN ONLY 15³/₄" PANEL SPACE

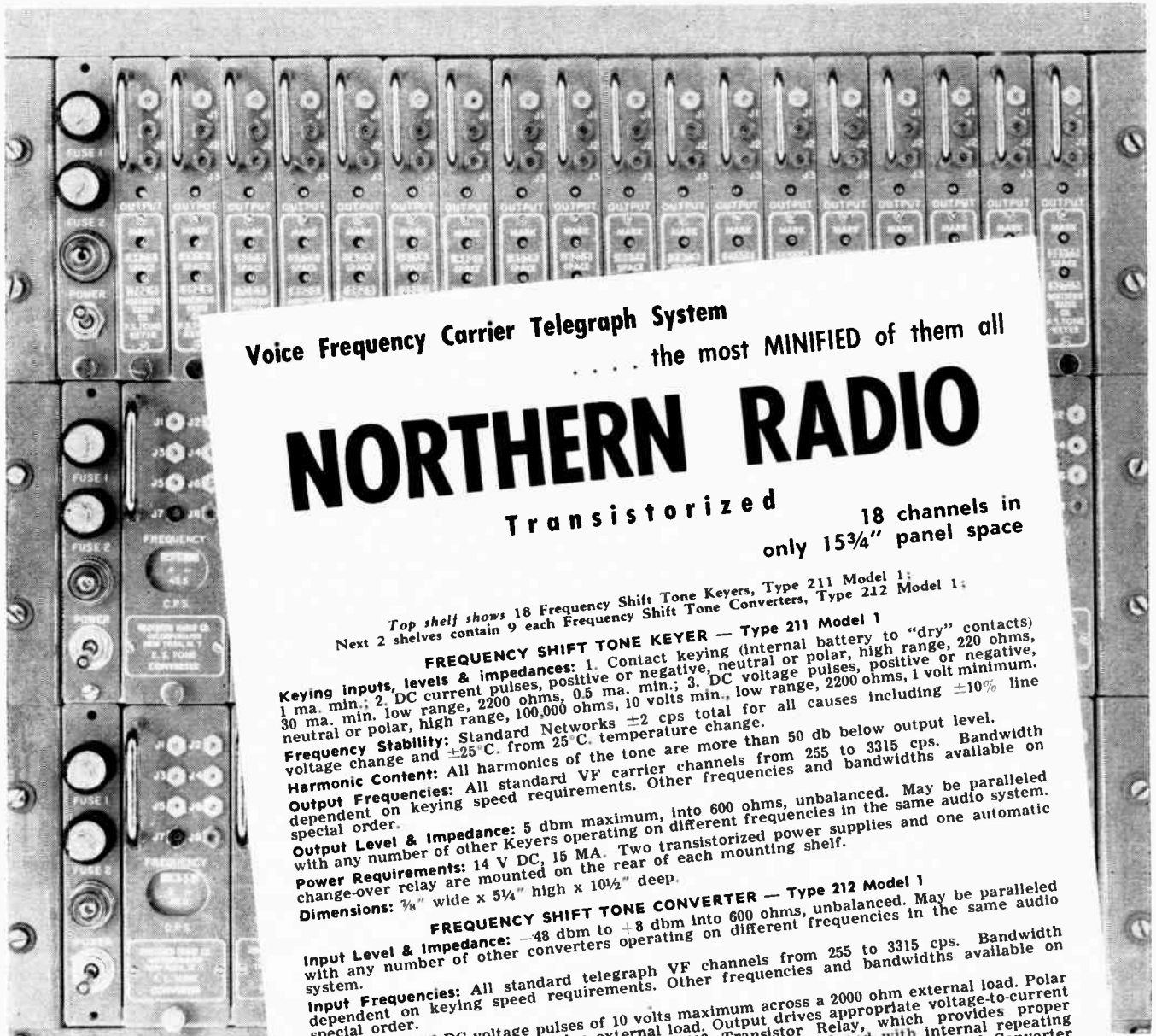

Voice Frequency Carrier Telegraph System
... the most MINIFIED of them all

NORTHERN RADIO

Transistorized

18 channels in
only 15³/₄" panel space

Top shelf shows 18 Frequency Shift Tone Keyers, Type 211 Model 1;
Next 2 shelves contain 9 each Frequency Shift Tone Converters, Type 212 Model 1;

FREQUENCY SHIFT TONE KEYS — Type 211 Model 1

Keying inputs, levels & impedances: 1. Contact keying (internal battery to "dry" contacts) 1 ma. min.; 2. DC current pulses, positive or negative, neutral or polar, high range, 220 ohms, 30 ma. min. low range, 2200 ohms, 0.5 ma. min.; 3. DC voltage pulses, positive or negative, neutral or polar, high range, 100,000 ohms, 10 volts min., low range, 2200 ohms, 1 volt minimum.

Frequency Stability: Standard Networks ± 2 cps total for all causes including $\pm 10\%$ line voltage change and $\pm 25^\circ\text{C}$. from 25°C . temperature change.

Harmonic Content: All harmonics of the tone are more than 50 db below output level.

Output Frequencies: All standard VF carrier channels from 255 to 3315 cps. Bandwidth dependent on keying speed requirements. Other frequencies and bandwidths available on special order.

Output Level & Impedance: 5 dbm maximum, into 600 ohms, unbalanced. May be paralleled with any number of other Keys operating on different frequencies in the same audio system.

Power Requirements: 14 V DC, 15 MA. Two transistorized power supplies and one automatic change-over relay are mounted on the rear of each mounting shelf.

Dimensions: $\frac{7}{8}$ " wide x $5\frac{1}{4}$ " high x $10\frac{1}{2}$ " deep.

FREQUENCY SHIFT TONE CONVERTER — Type 212 Model 1

Input Level & Impedance: -48 dbm to +8 dbm into 600 ohms, unbalanced. May be paralleled with any number of other converters operating on different frequencies in the same audio system.

Input Frequencies: All standard telegraph VF channels from 255 to 3315 cps. Bandwidth dependent on keying speed requirements. Other frequencies and bandwidths available on special order.

Output: Neutral DC voltage pulses of 10 volts maximum across a 2000 ohm external load. Polar pulses ± 10 volts across a 2000 ohm external load. Output drives appropriate voltage-to-current converters, such as Northern Radio Type 213 Transistor Relay, which provides proper teleprinter operating currents. Printers which are already equipped with internal repeating relays may be driven directly from the normal output terminals of the Type 212 Converter when so desired.

Power Requirements: 14 V DC at 30 MA. Two transistorized power supplies and one automatic change-over relay are mounted on the rear of each mounting shelf.

Dimensions: $1\frac{7}{8}$ " x $5\frac{1}{4}$ " x $11\frac{3}{4}$ " deep. For rack mounting a number of these units, a shelf assembly is available accommodating nine (9) units in a panel height of $5\frac{1}{4}$ ".

Write for complete technical data



For complete details check No. 55 on handy card, page 89.

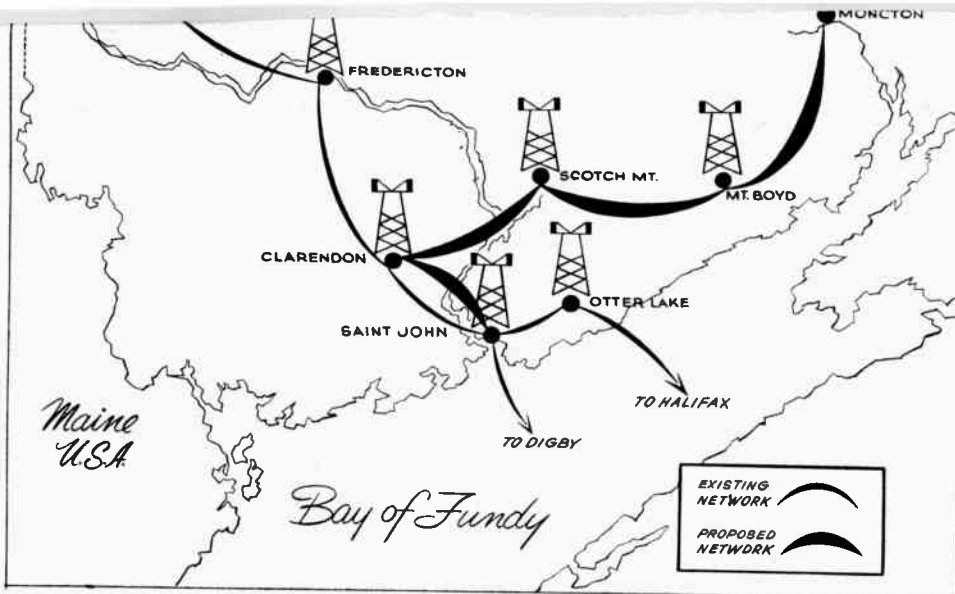

Shown above is the proposed route of a new microwave system to be built by The New Brunswick Telephone Company, Limited between Moncton and Saint John. The new system will cost in the vicinity of \$600,000 and is expected to be in operation by December 1959.

In the year 1958 The New Brunswick Telephone Company Limited completed a work program amounting to more than \$7,300,000 of which over \$6,200,000 was for new construction.

Microwave extends facilities of New Brunswick's telephone system

In the year 1958 The New Brunswick Telephone Company, Limited completed a work program amounting to more than \$7,300,000 of which over \$6,200,000 was for new construction.

Although the degree of growth of The New Brunswick Telephone Company, Limited, during the year was substantially less than the immediately preceding years, nevertheless progress has been made as noted by an increase of 4,231 telephones bringing the company total to 115,649. Of this total over 72 per cent are dial operated. During the year four exchanges — Bathurst, Petit Rocher, Shediac and St. Leonard — were converted to dial and two new dial offices were opened at Millville and Allardville. In addition a major building extension was completed to the Moncton central office.

Toll equipment was added to improve the service and provide additional facilities, all of which was designed to coordinate with the continental dialing plan.

The company completed over 3,990,000 toll messages

during 1958, an increase of three per cent over the preceding year.

In 1959 the company's work program will be in the order of six million dollars (\$6,000,000) which will provide and maintain new and existing services. The proposed construction will provide for a new toll switching office at Newcastle together with the introduction of dial service in that center. This new toll switching center, the first of its kind in the Atlantic Provinces, will be the nucleus of long distance traffic switched automatically to and from the entire north shore area of the Province.

In addition to hundreds of smaller jobs, the 1959 construction program includes the building of a new microwave system between Saint John and Moncton. This new system, which is expected to be in service by December 1959, will relieve this congested toll route and will cost in the vicinity of six hundred thousand dollars (\$600,000).

The new microwave system will operate on a frequency band between 1800-2300 megacycles per second and will be equipped with a regular and a

Reduce size but maintain H.P.

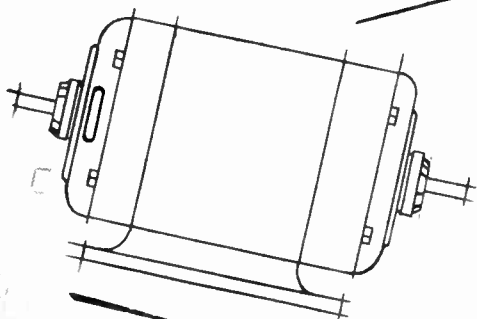

Specify Federal's Isonel Magnet Wire for the windings

**Now available
in square and
rectangular shapes!**

The outstanding thermal properties of Federal's (Polyester) Isonel Magnet wire permit the operation of motors at higher temperatures—suitable for use at Class F (155°C) temperatures. This means the motor size can be reduced for a given horsepower, or greater horsepower can be obtained from a given size.

While having this advantage of higher operating temperatures, Federal's Isonel possesses the excellent heat shock, chemical and abrasion resistant properties of vinyl-acetal magnet wire. It has improved resistance to flow at high temperatures; and it does not craze, giving higher voltage breakdown and better shelf-life.

*Available in Pay-Off Paks
13-23 in 250 and 500 lb.
24-29 in 100 lb. packs.*

5901

Specify Federal . . . for the best in Magnet Wire.

FEDERAL WIRE



& CABLE DIVISION

H.K. PORTER COMPANY (CANADA) LTD.

DIVISIONS: Connors Steel, Delta-Star Electric, Disston, Forge and Fittings, Leschen Wire Rope, Mouldings, National Electric, Refractories, Riverside-Alloy Metal, Thermoid, Vulcan-Kidd Steel, H.K. Porter Company (Canada) Ltd.

For complete details check No. 57 on handy card, page 89.

FEDERAL ISONEL

Solves High Temperature Motor Problems

Reduce size but maintain H.P.

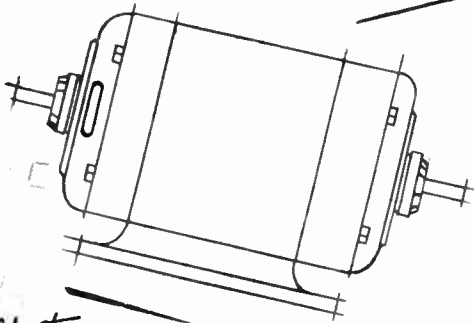

*Specify Federal's Isonel Magnet
Wire for the windings*

**Now available
in square and
rectangular shapes!**

The outstanding thermal properties of Federal's (Polyester) Isonel Magnet wire permit the operation of motors at higher temperatures—suitable for use at Class F (155°C) temperatures. This means the motor size can be reduced for a given horsepower, or greater horsepower can be obtained from a given size.

While having this advantage of higher operating temperatures, Federal's Isonel possesses the excellent heat shock, chemical and abrasion resistant properties of vinyl-acetal magnet wire. It has improved resistance to flow at high temperatures; and it does not craze, giving higher voltage breakdown and better shelf-life.

*Available in Pay-Off Paks
13-23 in 250 and 500 lb.
24-29 in 100 lb. packs.*

5901

Specify Federal . . . for the best in Magnet Wire.

FEDERAL WIRE



& CABLE DIVISION

H.K. PORTER COMPANY (CANADA) LTD.

DIVISIONS: Connors Steel, Delta-Star Electric, Disston, Forge and Fittings, Leschen Wire Rope, Mouldings, National Electric, Refractories, Riverside-Alloy Metal, Thermoid, Vulcan-Kidd Steel, H.K. Porter Company (Canada) Ltd.

For complete details check No. 57 on handy card, page 89.

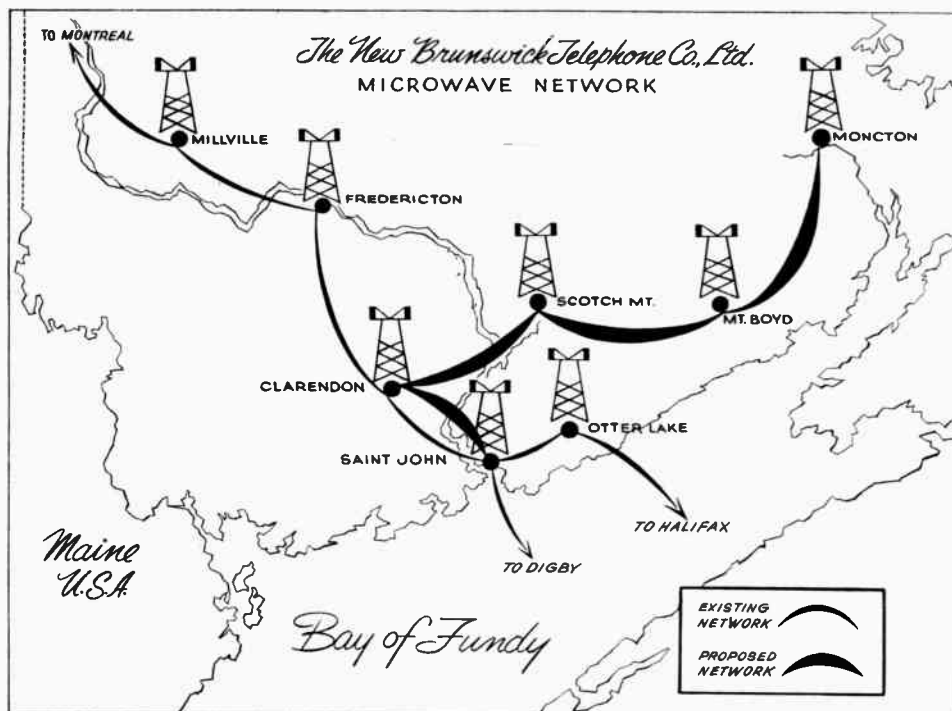

Shown above is the proposed route of a new microwave system to be built by The New Brunswick Telephone Company, Limited between Moncton and Saint John. The new system will cost in the vicinity of \$600,000 and is expected to be in operation by December 1959.

In the year 1958 The New Brunswick Telephone Company Limited completed a work program amounting to more than \$7,300,000 of which over \$6,200,000 was for new construction.

Microwave extends facilities of New Brunswick's telephone system

In the year 1958 The New Brunswick Telephone Company, Limited completed a work program amounting to more than \$7,300,000 of which over \$6,200,000 was for new construction.

Although the degree of growth of The New Brunswick Telephone Company, Limited, during the year was substantially less than the immediately preceding years, nevertheless progress has been made as noted by an increase of 4,231 telephones bringing the company total to 115,649. Of this total over 72 per cent are dial operated. During the year four exchanges — Bathurst, Petit Rocher, Shediac and St. Leonard — were converted to dial and two new dial offices were opened at Millville and Allardville. In addition a major building extension was completed to the Moncton central office.

Toll equipment was added to improve the service and provide additional facilities, all of which was designed to coordinate with the continental dialing plan.

The company completed over 3,990,000 toll messages

during 1958, an increase of three per cent over the preceding year.

In 1959 the company's work program will be in the order of six million dollars (\$6,000,000) which will provide and maintain new and existing services. The proposed construction will provide for a new toll switching office at Newcastle together with the introduction of dial service in that center. This new toll switching center, the first of its kind in the Atlantic Provinces, will be the nucleus of long distance traffic switched automatically to and from the entire north shore area of the Province.

In addition to hundreds of smaller jobs, the 1959 construction program includes the building of a new microwave system between Saint John and Moncton. This new system, which is expected to be in service by December 1959, will relieve this congested toll route and will cost in the vicinity of six hundred thousand dollars (\$600,000).

The new microwave system will operate on a frequency band between 1800-2300 megacycles per second and will be equipped with a regular and a

protection R.F. (Radio Frequency) channel. The R.F. channel is equipped for 36 voice channels initially and each R.F. channel can be expanded to 240 channels as required. The system can be expanded to 6 R.F. channels including the protection channel. Thus a total of 1200 voice channels, with protection, can be attained. The regular R.F. channel will be equipped with automatic switching which will provide automatic transfer to the protection channel in the event of interruption on the voice channels. The equipment was manufactured by General Electric Company of England and will be the first system of its type in Canada for telephone message use.

Building extensions are also planned in 1959 to the

offices in Woodstock and Florenceville and a new central office will be constructed in Hartland in preparation for dial service to approximately 4,000 subscribers. The building additions together with the central office and subscriber's equipment will represent an expenditure of about eight hundred and fifty thousand dollars (\$850,000).

In addition a 50 pair polyethylene insulated cable will be buried between Woodstock and Florenceville, a distance of approximately 25 miles, at a cost of \$200,000. This will be the telephone company's longest underground cable in use in the Province for inter-office trunks.

Continuing enlargement of Alberta Government Telephone System in all spheres reflects industrial growth in the Province of Alberta.

Alberta telephone system growth continues

In these days of expanding economy all across Canada and particularly in Alberta, the responsibility of providing first rate service has fallen heavily upon the public utilities. While Alberta Government Telephones has been expanding and extending its services in the past few years, perhaps few realize the extent of this expansion. For instance: at the end of March 1953 our plant in service at cost was about forty-five and one-half million dollars while at the end of February 1959 it stood at almost one hundred and twenty-eight million dollars, almost tripled in six years. We now have a total of over 200,000 telephones installed throughout the province which does not include the city of Edmonton. The plant investment behind every telephone now amounts to \$645.00. With the production and sale of consumer goods, greater volume generally results in a decrease in the production cost per unit. However the opposite is true of telephone service. The greater the number of telephones in use and the larger the area in which service is provided, the greater the investment necessary behind each telephone. This is because, in order to be of maximum value each telephone must have access if possible to every other telephone on the continent, indeed throughout the world. This of course requires ever increasing complicated and expensive switching and transmission equipment.

Last year from April 1, 1958 to March 31, 1959 a total of twenty million dollars was spent on such equipment. At the end of December 1958 dial exchanges converted to the two letter five number system of numbering included, Banff, Beiseker, Brooks, Calgary, Coaldale, Drumheller, Duchess, Lethbridge, Medicine Hat, Millet, Rosebud, Tilley, and Wetaskiwin. The dial conversion program has now reached 84.9 per cent of the province's telephones. This year our capital expenditures will run around nineteen million. Some of the items included in this figure will be new dial offices at the following points:

Sherwood Park (Edmonton) — 1,000 lines; Edson — 1,200 lines; St. Paul — 1,000 lines; Raymond — 800 lines; Iron Springs — 100 lines (Community Dial Office out of Lethbridge), and Calgary Alpine — 6,800 lines.

Lake Louise exchange and toll line to Banff — (will be Community Dial Office out of Banff). There will be new exchange buildings constructed at the following places: Red Deer, Ponoka, Penhold, Rocky Mountain House, Drayton Valley, Hanna, Cold Lake Airport, White Court, Hinton, Wainwright, Olds, Innisfail, Forest Lawn (Calgary) and St. Albert. There will also be additions made to existing exchange buildings at Lloydminster, Grande Prairie, and Jasper Place.

Including new dial offices and extensions to existing dial exchanges, a total of 19,200 new dial terminals will be installed throughout the province.

In addition the following items of the construction program are of interest:

1. The installation and cutting into service of the Calgary Tandem Crossbar System.
2. Extension of the Edmonton Drayton Valley microwave system to Edson providing twenty-four additional circuits from Edson to Edmonton.
3. Extended area service between Redcliff and Medicine Hat permitting free calling between these centers.
4. Conversion of the General Mobile Radio System to selective calling, assuring a measure of privacy on mobile radio calls.
5. An additional channel on the Trans-Canada microwave system from Calgary to Regina and from Calgary to Lethbridge. This is for television use only and is being installed to permit Regina, Saskatoon and other Saskatchewan points, and Lethbridge to receive programs from the CBC. Time Delay Center at Calgary at the same time as the other centers in the MST zone.
6. Start of a microwave communication system from Peace River to Yellowknife in the Northwest Territories and to Uranium City on Lake Athabasca. (The section from the Alberta - N.W.T. border to Yellowknife will be built by Canadian National Telegraphs).
7. Two million dollar cable extension program in Calgary.

It will be evident from these items what is required by way of capital expenditures to keep abreast of the increasing demand for communication services in the rapidly developing Province of Alberta.



This 12-storey addition to the William Farrell Building in downtown Vancouver will more than double available headquarters space when it is occupied this summer. B.C. Telephone Company departments now housed in 10 different locations will be brought together in the new quarters.

Photo by Rolly Ford Photo Publications Ltd.

Telephone companies serving Canada's western reaches are straining at their fiscal reins in the struggle to keep abreast of British Columbia's growth in the second century of its history.

B.C.'s growth forces expansion of west coast telephone companies

B.C. Telephone Company and its associate, Northwest Telephone Company, have embarked on 1959 expansion plans costing millions of dollars. B.C. Telephone, alone, plans expansion and improvements costing at least \$48,000,000 this year, the biggest chunk of it for new exchange central office equipment.

B.C. Telephone Company's spending program breaks down something like this: \$14,000,000 on exchange central office equipment, most of it for dial conversions and additions; \$8,000,000 on telephones and other subscriber equipment; \$2,390,000 on PBX and PABX equipment; \$8,805,000 on exchange outside cable and wire; \$1,000,000 on long distance cable and wire; \$3,000,000 on central office long distance equipment; \$1,500,000 on radio facilities and \$1,118,000 on office and other miscellaneous equipment.

The company reports that 79 per cent of its tele-

phones are now dial operated and 95 per cent of its 414,934 miles of wire are in cable.

The company has already completed two of its biggest projects of the year — conversion of 110,000 Vancouver telephones to the 2-5 numbering plan and conversion of most toll facilities to operator distance dialing. The Vancouver number change was the largest in Canada's telephone history but it was accomplished March 1 without a hitch. On the same date, two large manual offices in Vancouver were converted to dial, leaving only two manual offices in the city yet to be converted. Automation plans for those two are already well advanced.

Biggest project of 1959 was the conversion to operator distance dialing, a \$10,000,000 undertaking climaxed by a cutover operation on April 4 that linked B.C. with the continent-wide system. New cordless

long distance switchboards and associated intertoll switching machines were placed in operation in Vancouver and Victoria, boards similar in design to that already in use in New Westminster.

The Victoria switchboard has 36 operator positions while the one in Vancouver has 192.

Extended area service, providing for free calling between adjoining exchanges, is being extended in the province, particularly in densely populated sectors such as lower Vancouver Island and the Fraser Valley of the mainland.

The company is devoting a great deal of attention this year to higher grades of service for those who request it, offering one-party service in place of two-party, etc. While the project is not new, it has been accelerated and involves large additions to outside wire and cable plant.

Increased circuits for interior

In the interior of the province, B.C. Telephone is now carrying long distance calls between Vancouver and Kamloops via a Lenkurt 74-A microwave system which provides greatly increased circuit facilities between the two centers.

Operating in the 6000-megacycle common carrier band, the system is 290 miles long and consists of two terminals and eight repeaters which are situated in the mountainous terrain between Kamloops and the coast. All but two of the repeater sites are at elevations of 5000 to 6000 feet above sea level. From the 5830-foot peak of Greenstone Mountain, radio signals are beamed 15 miles directly to a passive reflector one-and-one-half-miles from Kamloops. It then bounces the signals to a receiving antenna alongside the telephone company building in Kamloops. The reflector is a 20- by 24-foot billboard-type structure of aluminum and is the first of its type to be designed and manufactured in British Columbia.

Also being installed at the Vancouver-Kamloops repeater sites is additional equipment for television

transmission. When that system is completed later this year, Kamloops will receive CBC network television by that route and Kelowna will receive the service via a new relay point at Summerland. Key point in the channeling of live television programs to these two centers will be the Trans-Canada microwave system relay station on Lost Horse Mountain near Hedley where additional electronic equipment and antennas are being installed. That is the point from which the Kamloops and Kelowna television chains will branch to the north.

CBC television first reached British Columbia in 1958 when B.C. Telephone completed the western leg of the Trans-Canada microwave system. That was the company's major achievement of 1958.

Nearing completion in Vancouver is the 12-storey addition to the headquarters building of B.C. Telephone Company. It will enable the Company to bring together departments now scattered at 10 different locations.

Also in Vancouver, the company this year will begin construction of a \$3,000,000 purchasing, supplies and repairs building. It will centralize staff and facilities now at 14 locations and, with more than six acres of floor space under roof, will be one of the largest industrial buildings in Vancouver.

In the field of radiotelephony, North-west Telephone Company is an acknowledged pioneer and now operates the largest radiotelephone system of its kind on the North American continent. Its network spans those parts of the province so rugged and mountainous that land lines would have been impractical.

North-west's radiotelephone service now goes to 3324 vessels, 385 land vehicles and 36 aircraft, as well as to 317 fixed toll stations and the company has 31,600 circuit miles of toll facilities.

In North-west's remote service area, expansion is the keynote of the times as much as in the more accessible areas served by B.C. Telephone. North-west's station gain over the two-year period ending January 1 of this year was 5476 to a total of 18,683. About half of that was in the Peace River country with 2700 stations of the total gain.

Radiotelephone for Cariboo country

North-west is building a new microwave radiotelephone system through the Cariboo country to provide additional long distance telephone circuits from Vancouver to Williams Lake, Quesnel and Prince George.

The job includes construction of two new radio relay stations in the Cariboo — one on Timothy Mountain in the Lac La Hache area and one on Dragon Mountain near Quesnel. The 900-megacycle system connects with the B.C. Telephone Company's Vancouver-Kamloops microwave chain at Greenstone near Kamloops and should be in operation by mid-summer.

Starting later this year, long distance telephone calls will be beamed between Prince Rupert and Vancouver by a very high frequency radio system which now extends as far north as the aluminum capital of Kitimat.

Route of the 640-mile radio bridge between Prince Rupert and southern B.C. will be via 11 intermediate relay stations situated on Vancouver Island, Calvert, Swindle and Trutch Islands — in the northern coastal group — and Gray Bay, on Moresby Island in the Queen Charlottes. At present, Prince Rupert communicates with the rest of the province by land lines via Prince George.



Passengers aboard steamers and ferries plying British Columbia's coastal waterways enjoy modern and convenient ship-to-shore telephone service through the facilities of North-west Telephone Company. This station aboard the Princess Elaine is one of thousands serving the coastal fleet of passenger vessels, fishing boats and tugs.

Photo by Williams Bros.

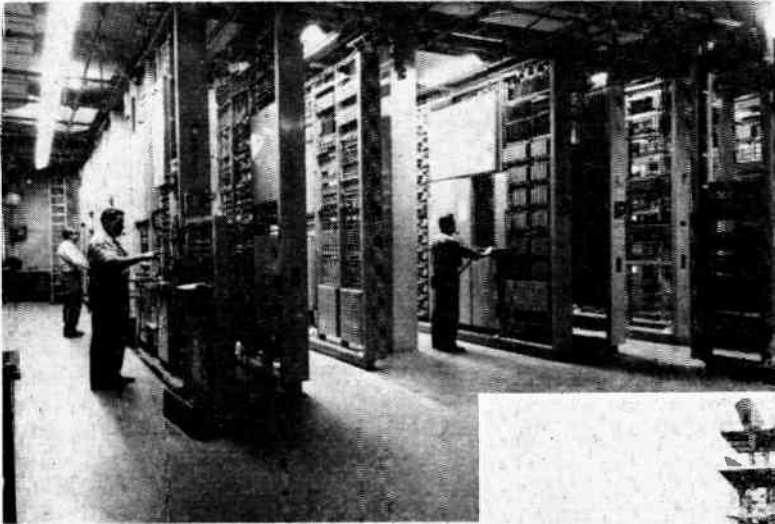

Western Canada's regional center for distance dialing is a crossbar tandem installation in S.G.T.'s main Regina Telephone Building.

S.G.T.'s 12th Avenue Building, Regina, including the offices and the local, long distance, microwave, TV and distance dialing equipment it houses, is valued at over \$10,000,000.



With initial costs of large scale projects behind the system it is expected that financial advantages will begin to be felt during 1959.

Saskatchewan Government Telephones keeps pace with service demands

Now, with the basic phases of two major projects, microwave network and distance dialing installations complete, Saskatchewan Government Telephones is settling down to a period of steady growth in individual customer services. This growth is expected to continue without let-up.

During the last few years, central office equipment was replaced or expanded in S.G.T.'s three largest exchanges at Regina, Saskatoon and Moose Jaw. The Saskatchewan section of the Trans-Canada microwave network was completed and two crossbar machines,

one as Western Canada's regional center for distance dialing, were put in service. Significant strides will be taken to extend these facilities in Saskatchewan in the coming years.

During the five year period, when the major projects were being undertaken, S.G.T. invested more than \$51,000,000 in plant expansion, more than doubling its capital assets (now \$93,829,787). In its 1959 budget, Saskatchewan Government Telephones foresees an expenditure of over \$8½ million for plant extension.

Total revenues for this provincial crown corpora-

tion increased to \$16,670,927 in 1958 from \$15,307,141 in 1957, but net income declined to \$1,178,699 from \$1,888,568. Reasons given for this decline were heavy investment in long term projects, increased interest rates, higher wages, and higher depreciation allowances partially brought about by relatively high capital expenditures. Now that the initial costs of large scale projects are behind the system, it is expected that their financial advantages will begin to be felt in 1959.

With no large scale projects, the construction budget of over \$8,500,000 approximates the amount spent on similar work over the last few years, when great strides were made in system expansion. Of the total budgeted almost \$3,300,000 will be spent on work scheduled to increase the number and quality of long distance circuits feeding into the trans-continental network. Thus the benefits of distance dialing and the microwave system will gradually extend to most parts of the province. It is expected that \$2,750,000 will be spent to install new telephones in the province. This of course includes the necessary central office equipment and local distribution system. New buildings, special services, tools, vehicles and equipment will take up most of the balance of the eight and a half million dollar budget.

Although the Saskatchewan section of the microwave system was completed and in operation in 1957, much work was done to extend this facility. In 1958, over \$800,000 was spent to provide a thin-route system capable of carrying up to 120 telephone conversations between Regina and Yorkton and Regina, Weyburn and Estevan. An extension of the TD-2 network was completed between Saskatoon and Prince Albert for television purposes only in February 1959 and a break-out on the main route for the TV station at Swift Current was provided in October 1958. Work is underway to provide a video break-out at Regina to feed the new Moose Jaw TV station and a microwave extension to connect the Yorkton station to the TV network. This latter extension will be a continuation of the time phase

channel now being installed between Calgary and Regina. Part of the route will make use of existing towers on the main microwave network. The microwave projects now in progress and to be completed this year will cost about \$1,000,000.

In spite of the fact that its waiting list was cut in half during 1958, the system again set a new record for additional telephones, when 12,160 instruments were added to bring the total of local stations to 159,555. (More than doubled in eight years). As proof that the demand for new telephones will continue, is the installation of over 1,300 in January of this year. By the end of February, the last figures available, the total was

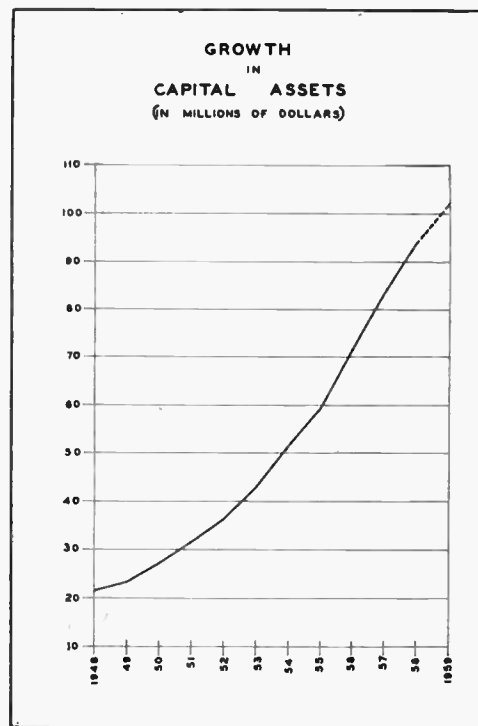
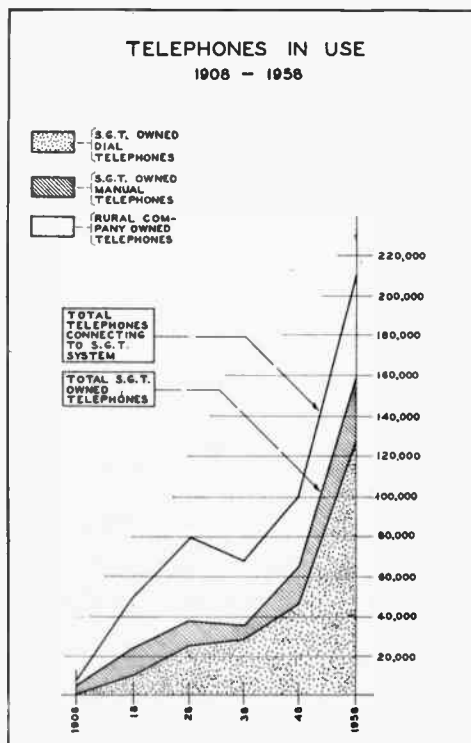
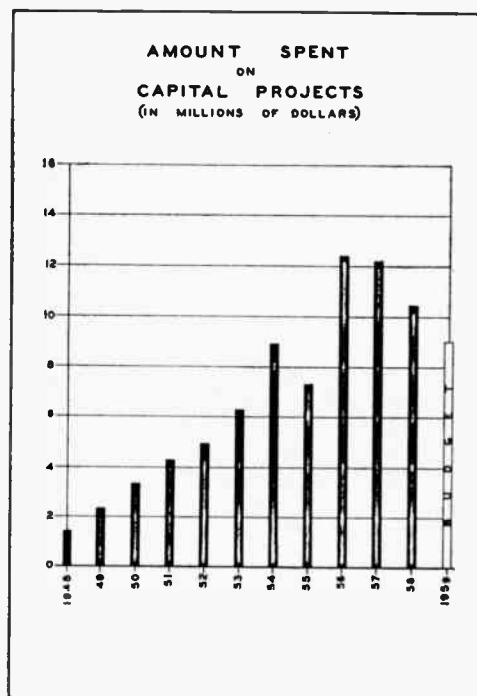

nearing 162,000. In addition to these, some 50,500 rural company owned telephones are switched through system owned offices.

Distance Dialing by 1960

Of the system's telephones in the province over 79.7 per cent are dial operated and connected to 28 automatic offices. During last year, three telephone offices (Wadena, Wynyard and Shaunavon) were converted to dial at an average cost of a quarter of a million dollars each. With the erection of a new central office building at Canora, now complete, installation of automatic equipment by British General Electric will be all but finished by the year end. Canora will go "2-5" numbering and will join the distance dialing network through Regina in the first quarter of 1960. In the latter part of 1960, a 600 line dial extension by Automatic Electric Company in the Yorkton central office will be completed and coincide with the introduction of 2-5 numbering and the joining of Saskatchewan's seventh city to the dialing network. These will be preceded by the completion at Weyburn of a building extension, a dial extension by the British firm, A.T. & E. Co. and a new switchboard by the A.E. Company of Canada. Weyburn will go "two-five" and join the dialing network in late 1959. Even now over fifty per cent of the system's subscribers get full benefit of operator distance dialing.

Other dial conversion tenders are being called for as this is written. Both Meadow Lake, in the northern part of the province, and Outlook, near the location of the South Saskatchewan River Dam project, are well on the way to being a reality. Extension of the tele-

phone building at North Battleford is complete and now awaits an equipment extension of 800 lines plus 800 line replacements by the A.E. Co. of Canada and a new toll switchboard. Cut-over to "2-5" and operator distance dialing are expected in late 1960.

At the time of cutting over the regional switching center in Regina on November 16 last year, the Regina machine was connected directly to 27 points with approximately 350 long distance circuits. These were increased by over 200 when the sectional centers at Calgary and Vancouver opened in April this year. The Regina regional center is connected directly to other regional centers at San Bernadino, Sacramento, Dallas, Denver, Chicago and Montreal. The largest number of circuits to any American point is to Chicago where 35 circuits connect the two cities. Western Canada's first crossbar machine, a No. 5 crossbar, was put into operation in Saskatoon on March 1, 1958, preceding the initiation of the crossbar tandem in the regional center at Regina by eight months.

Throughout its history, Saskatchewan Government Telephones has taken pride in meeting the special needs of its customers. Private lines and teletype service have grown provincially, and, in co-operation with the other member companies of the Trans-Canada Telephone System, nationally for such customers as Trans-Canada Pipeline Company.

In the last few years mobile telephone systems have been installed for oil exploration companies and others, and a private mobile network of the Saskatchewan department of highways to supervise road maintenance has been established. Further expansion of these services can be expected.

Communications for civil defense

Canada's civil defense organization now has a consolidated communications system stretching from St. John's, Nfld., to Victoria, B.C., as a result of circuits established by the communications organizations comprising the Trans-Canada Telephone System.

The new National Attack Warning System was turned over to civil defense authorities on April 1, following a field test of the equipment by civil defense and telephone personnel.

During the successful test, held on the day prior to the turn-over, Maj. Gen. George S. Hatton, deputy civil defense coordinator for Canada, tried out the system from his Ottawa headquarters and called it, "another milestone in our goal to have a well-built, sound and effective civil defense organization for Canada."

The network provides inter-communication between all 10 provincial capitals and 19 other major Canadian cities or target areas, as well as the five air defense command control centers in Canada. A single control officer can give or receive messages to all or any one of the 34 stations on the system.

Maximum service, minimum cost

In order to give maximum communications facilities at minimum cost, the telephone system established the

network so that existing long distance telephone circuits could be utilized when required. When not in use, they serve as regular long distance circuits.

"Such a system," General Hatton told civil defense coordinators throughout Canada during the final field test, "provides the equipment to permit us to flash a warning to you effectively and as rapidly as it unfolds to us."

Key center for the 34-point network is at St. Hubert, Que., where the senior warning control officer works closely with air defense command headquarters. Any alert received by the base is immediately passed on to the civil defense officer who can then order the communications system energized by alerting The Bell Telephone Company of Canada at Ottawa.

Kept abreast of all new developments by the air defense command personnel at St. Hubert, the senior warning control officer can then report detailed information to the coordinators at the provincial capitals or direct to any other city on the network. In the event of a local attack for emergency the coordinator at any point can relay details back to the control center at St. Hubert.

While 34 points were established on the network at the time of the turn-over, the facilities can be easily expanded to other centers virtually anywhere in Canada.



(Left) A Bell Telephone craftsman checks a roll of paper tape on a perforating machine on which are recorded details of long distance calls made via Direct Distance Dialing. These machines are only one of several complex units required for "DDD" service which was introduced at Toronto and Guelph during 1958 and is scheduled for Montreal in 1960.

(Right) Huge discs such as these were required for the tropospheric scatter radio relay system built during 1958 to provide telephone facilities at Goose Bay and help provide for the mining, defense and civil aviation needs of the area in the future. This "over-the-horizon" communications system links up with the coast-to-coast microwave network at Sept Iles, Quebec.

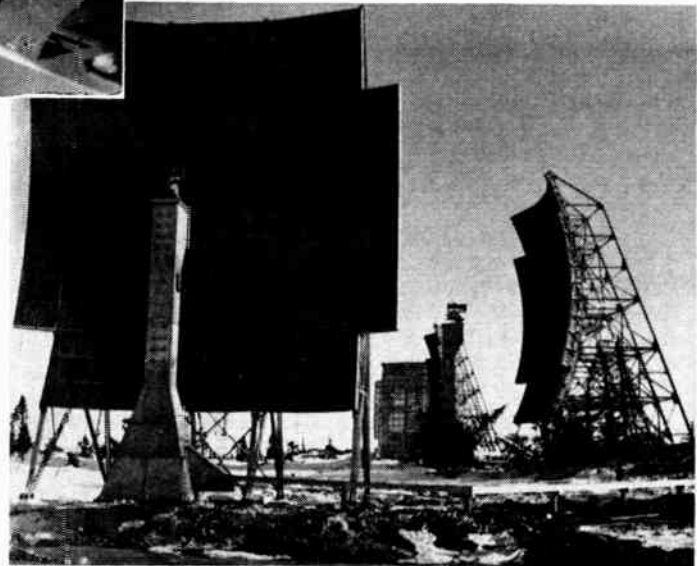

Estimates for 1959-60 indicate greater expenditures with some \$63,000,000 being earmarked for additional land and building projects throughout Bell's territory during this year and next.

Bell Telephone estimates provide for large construction projects

Improvement and expansion of local telephone service in communities throughout Quebec and Ontario, increased development of Direct Distance Dialing for out-of-town calling, and two new microwave radio relay systems will be among the major projects of a record \$200,000,000 construction program for The Bell Telephone Company of Canada in 1959.

This estimated figure follows a previous high of \$183,000,000 for construction expenditures in 1958 when chief projects included the completion of a coast-to-coast microwave system, the inauguration of a tropospheric scatter radio relay network to north-eastern Quebec and Labrador, and the introduction of Direct Distance Dialing for residents of Toronto and Guelph.

Describing 1958 as "a year of substantial progress," and one in which new equipment and operating methods were widely used to enhance efficiency, the Bell showed a net gain of 185,465 telephones at December 31, making a company total of 3,140,349. Outstanding orders for service were reduced to 5,699 and requests for individual in place of two-party lines also decreased to 12,257. Nine out of 10 households in the Bell's Ontario and Quebec territory now have telephone service and 90 per cent of all telephones are dial operated.

This expansion of service to customers was achieved in part through the completion of 38 new central offices, making a year end total of 815. In all, new equipment buildings were opened or existing buildings were

extended in 119 different communities. Estimates for 1959 and 1960 indicate even greater expenditures for land and buildings as some \$63,000,000 has been earmarked for building projects throughout the Bell's territory during this year and next.

Completion of a 3,900 mile microwave radio relay network by the member organizations of the Trans-Canada Telephone System in 1958 was of major importance in providing increased long distance facilities in Canada. Stretching from Sydney, N.S., to Victoria, B.C., the system provides for the transmission of hundreds of long distance calls and two television programs simultaneously. In all, 139 towers, spaced some 30 miles apart, were erected to complete the backbone network which was officially opened on July 1.

Additional towers were built as spurs to the backbone facility and another microwave system to link Montreal with New York was opened late in 1958. This year, two additional microwave systems will be placed in service — one chain of relay stations being erected between Montreal and North Bay and the other from Toronto to London and Windsor, Ont.

Another form of radio relay transmission, known as tropospheric scatter, was inaugurated during 1958 to serve the northern Quebec and Labrador area. Built in cooperation with Quebec Telephone, the new link connects Quebec City with Sept Iles via the regular microwave network and extends from there to Knob Lake and Goose Bay by tropospheric scatter. This "over-the-horizon" system of communication, with relay stations spaced some 200 miles apart, provides initially for 132 voice circuits. The new network is considered

an important step in the provision of communications for mining, defense and civil aviation projects in north-eastern Canada.

During 1958, the Bell also added some 264,000 miles of long distance circuits, increasing its total circuit mileage to 1,451,000 miles. Installation of what is believed to be the longest private line telephone circuit for pipeline operations in North America was also engineered by the Bell in 1958. Early in 1959, the Bell with other Trans-Canada Telephone System organizations established a coast-to-coast "National Attack Warning System" for the nation's civil defense authorities.

As a further move to handle the increased volume of long distance calls efficiently, Direct Distance Dialing facilities were established in Toronto and Guelph during 1958. Requiring special switching equipment and accounting machines, "DDD" first enabled customers of these two cities to dial their own long distance calls to a number of points in Ontario and Michigan. By early 1959, points as far away as New York, Chicago and Miami were added to the calling area and later this year, some cities of western Canada will also be included.

At Montreal, similar equipment is now being installed in a newly erected building and residents there will be given "DDD" service early in 1960 with the completing field to include the points now available to Toronto residents. Eventually, nearly all of the North American continent will be interconnected by "DDD" facilities, so that it will be possible to dial any one of some 60,000,000 telephones in a matter of seconds.

The present view of future operations indicates that 1959 and the years following will see the progress of telephony in Nova Scotia proceeding at an ever-accelerating rate.

Maritime Telegraph & Telephone Company expenditures reach all-time high

The January issue of *Electronics and Communications* carried an article describing the installation of a new Collins Radio Company Microwave Communication System by Maritime Telegraph and Telephone Company, Limited and its affiliate, The Island Telephone Company, Limited.

This article said, in its closing paragraph, "A progressive Company, Maritime has many firsts to its credit: 1941 — Installation of a VHF Radio System to carry Toll Circuits and 1948 — Installation of a commercial PTM system. Also, its leadership can be attested to by the fact that it had Operator Toll Dialing in 1951".

The fifth largest Canadian telephone company, Maritime Telegraph and Telephone Company, Limited was incorporated in 1910, to serve the Province of Nova Scotia. Company policy from the start has been one of planned and progressive expansion, incorporating

into its plant all the improvements, in both techniques and equipment, that develop in the art of telephony.

While the earlier quotation from the January issue of this magazine illustrates the practical application of the company's policy in one instance, the annual report of operations for 1958 shows that this policy is applied generally in all phases of the company's operations.

A member of the Trans-Canada Telephone System, the company provides the Nova Scotia portion of the Trans-Canada Microwave Network, providing message toll facilities and network television channels.

In 1958 the company purchased two portable microwave units which are used to provide remote television pick-up facilities. This equipment was used to carry the first color TV program in the Maritimes, the occasion being a closed circuit program for the Canadian Medical Association.

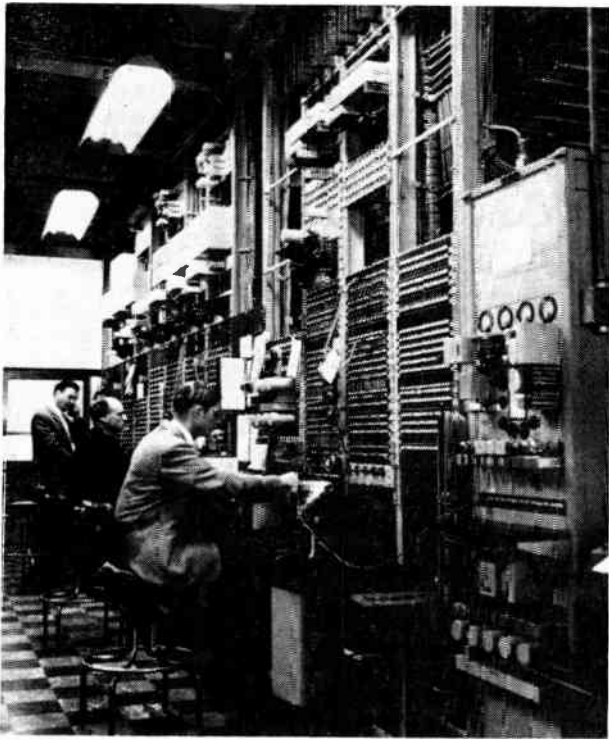

The toll test board in the Halifax Toll Office of Maritime Telegraph and Telephone Company, Limited.

Another dramatic first, made possible by portable microwave, was the pickup of "live" TV coverage of the Springhill disaster. Fed to practically all North American TV Networks, this was the first known use of "live" TV to cover a disaster.

A total of \$6,781,675.00 was spent in 1958 on new construction, one of the heaviest budgets in the company's history. Prominent among the items included in this expenditure were a new toll building in Kentville, heart of the famed Annapolis Valley, and associated toll switching equipment. Early in 1959 Kentville will become the toll switching center for most of the Annapolis Valley.

To provide for this rearrangement of traffic facilities and to meet the ever-growing demand for long distance service, over 5,000 circuit miles were added to the long distance network of Nova Scotia in 1958.

In Halifax a fourth floor was added to the toll building as the first step in the provision of additional toll equipment. Equipment installations are now underway in the new space.

Improvements in local service continue in step with toll improvements. Stewiacke and Canning exchanges were converted to dial. Of 151,192 telephones in service at the end of the year, 80.56% or 121,807 are dial. The dial conversion program will continue in 1959 which will see Pictou, Middleton and Chester exchanges converted to dial.

A milestone in the telephone development of Nova Scotia occurred on December 23rd, 1958 when the 150,000th company telephone in Nova Scotia was installed. A total gain of 7,079 telephones was recorded during the year. Held orders were reduced to only 357 for main service and 516 for higher grades of service.

In Halifax a large dial private exchange was cut into service for H.M.C. Dockyard. Equipped initially for 900 locals, it replaced a manual system which had grown to a 10-position switchboard. Connected by tie trunks to P.A.B.X.'s serving other naval establishments it provides the R.C.N. with a completely integrated dial system connecting 1700 locals.

Looking forward to the future, the company's plans verify that its policy of providing Nova Scotians with the best of telephone service will continue. In 1959 the construction budget will likely exceed that of 1958.

Expansion of long distance facilities will continue. The Halifax Toll Office will receive 24 new operating positions, increasing the number to 78. Additional positions will also be added in Truro, Bridgewater, Digby, Sydney and Shelburne. Multi-channel cable carriers will be installed as well as 12 multi-channel and 18 single channel carrier systems on open wire routes. An additional supergroup on "L" Carrier, equipped for 60 circuits between Halifax and Saint John, will be added to the microwave network.

A heavy construction program is required to serve the new Halifax International Airport. Facilities will be provided over two routes requiring extensive pole line and cable construction. The company will also provide the circuits to operate the Instrument Landing System.

To provide for toll and local installations building extensions will be made to the Truro, Amherst, Kingston and Dartmouth buildings. New buildings will be completed at Barrington, Chester, St. Margarets, Hubbards, Spryfield and Bay Road.

Looking beyond 1959, studies are now underway to determine whether a new microwave route will be necessary between Halifax and Saint John. Also in the offing is the provision, in the Halifax Toll Office, of transit senders to meet the requirements of operator and customer in-dialing.

★ In an effort to obtain a portion of United States defense contracts for Canadian industry the Canadian government is negotiating with American authorities for relaxation of the 26-year-old "Buy American" act. While some relaxation has been made in the past on behalf of Canadian bidders for U.S. defense contracts, orders have been awarded to Canadians on an individual contract basis. Present American legislation sets out that foreign bidders, to be successful in obtaining U.S. defense contracts, must underbid American firms by 12 per cent.

During the year 1959 the Okanagan Telephone Company will spend more than two and a quarter million dollars on its operations. Of this amount \$1,330,218 will be for capital expenditures — the largest in the company's operating history.

Okanagan Telephone Company completes decade of dial conversion

The Okanagan Telephone Company, now in its 52nd year of operation is one of the oldest independent telephone companies in the province of British Columbia.

Today, following a decade of dial conversion and modernization, this telephone company can also claim to have one of the most up-to-date telephone operations in the province. Its present-day system is a far cry from April 1907 when the Okanagan Telephone Company was first incorporated and served some 200 subscribers in its one exchange at Vernon, B.C.

Over the years the Okanagan Telephone Company grew steadily with the Valley it served and mapped a vast modernization plan to meet the post-war demands for telephone service and tremendous system-wide growth and modernization has marked the company's progress from that time — a decade of dial modernization.

From its first "cut-over" in December 1948 the Okanagan Telephone Company has mushroomed from a 9-exchange manual telephone system serving 11,000 subscribers to a 20-exchange dial system serving over 24,000 subscribers. Only one exchange, serving 50 subscribers, remains to "go dial" and within 2 years the company will have an "all-dial system".

Coupled with the growth of telephones in service has been a marked increase in the daily average number of local calls completed. The 1948 figure of 53,447 daily calls has now been more than doubled and in 1958 Okanagan subscribers completed an average of 123,021 local calls each day!

Probably even more noteworthy has been the greatly increased volume of long distance calling throughout the company's system. The first telephone company in B.C. to have Operator Toll Dialing on a system-wide basis, the Okanagan Telephone Company's operators have, since 1953, been able to dial direct to Okanagan system telephones.

The resultant speed-up in service has meant that company operators in four Toll Center offices at Kelowna, Vernon, Penticton and Salmon Arm completed 1,072,799 long distance calls during 1958 — nearly three times the 384,443 calls of ten years ago.

The Okanagan system became part of the continent wide operator distance dialing system when B.C. entered the intertoll network on April 4. In addition, the company is now proceeding with plans for the installation of Automatic Toll Ticketing equipment in its four toll center offices. The first of these installations will be completed this fall and by 1961 will be on a system-wide basis that will permit direct distance dialing of long distance calls by its subscribers.

In the course of carrying out its 10-year modernization plan the company has added to its land, buildings, plant and equipment increasing its 1948 fixed assets figure of \$1,349,223 to a present-day total of \$5,493,956!

Geographically the Okanagan Telephone Company operates 20 exchanges located in the Columbia, Shuswap and Okanagan Valleys, although by charter amendment approved by the B.C. Legislature in 1951 the company now has rights to provide telephone, radio-telephone, radio and television service anywhere within the provincial boundaries of British Columbia.

The company provides radiotelephone service on both a V.H.F. and M.F. basis. V.H.F. radio is used as a Revelstoke-Arrowhead toll line link and M.F. radio-telephone equipment located at Revelstoke and Kelowna provides service to eighteen licensed sets at remotely-located mining and logging operations. In addition the company has just completed the installation of M.F. stations at Penticton, Kelowna and Vernon to provide mobile radiotelephone service.

The company's exchange and toll telephone plant consists of 820 miles of pole line carrying 54,086 miles of wire of which 7,500 miles were added during an extensive construction year in 1958.

Of the company's 19 automatic telephone exchanges, 14 offices are unattended community dial offices while long distance service is provided from 32 positions of toll switchboard located at 5 of the company's larger exchange offices.

Automatic exchange equipment serving the entire Okanagan system consists of 11,400 lines and 24,000 terminals with further extensive equipment additions scheduled for this year.

★ The extension of communication facilities is prevalent from coast to coast in Canada and some indication of the cost of this work is evidenced by the recent statement of Thomas W. Eadie, president of the Bell Telephone Company of Canada, to the effect that telephone plant investment in the Montreal area alone is increasing in the neighborhood of \$40,000,000 a year.

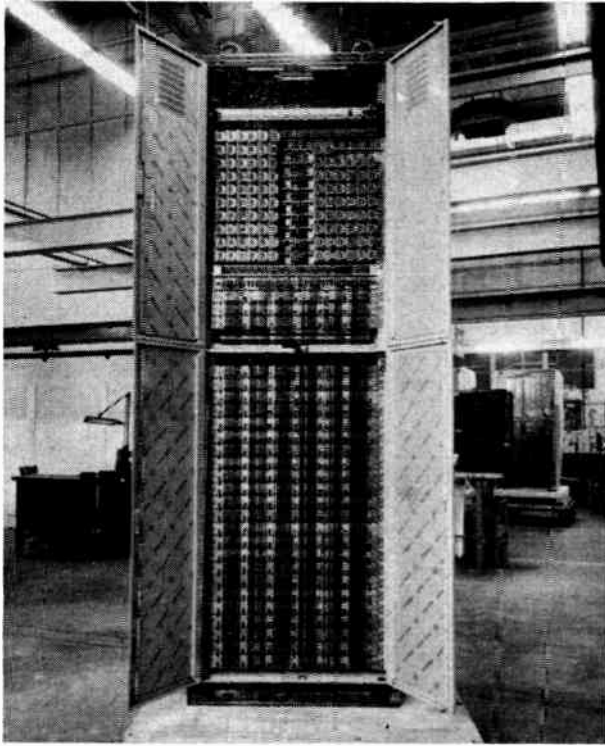

Figure 1. Relay cabinet, part of tape to card converter.

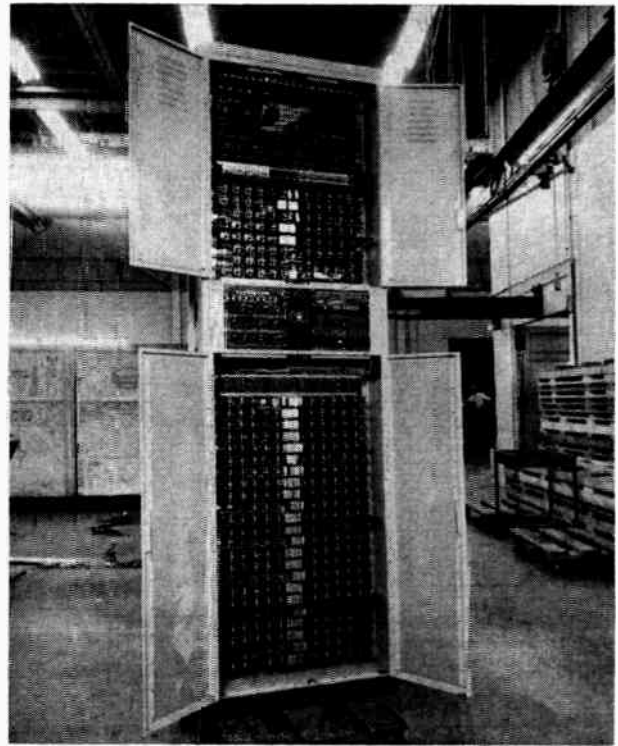

Figure 2. Relay cabinet, part of assembler-computer, containing wire spring relays in the upper part of the cabinet with dry reed relays below.

Rapid advances in the art of direct distance dialing have necessitated the development of . . .

Automatic message accounting equipment for D D D

by C. J. Albrechtson*

The introduction of direct distance dialing to near and distant points requires the addition of equipments in the central office which will automatically record information concerning the calling subscriber and, if required, similar information about who is being called, the time the call begins and the time that it ends. The recording of this data is handled through a Local Automatic Message Accounting System, "LAMA", or a Centralized Automatic Message Accounting System, "CAMA".

All of the information necessary for any of these purposes is perforated on an oil-impregnated tape three inches wide by common "AMA" control circuits. The "AMA" circuits act with such rapidity that no delay is encountered in the normal completion of the call. The tape recorded data is forwarded to a No. 1 Accounting Center for assembly and computing for billing purposes.

The basic unit in the accounting process in both the

central office and the accounting center is the tape perforator. In the central office it records the pertinent information required for each call. In the accounting center it provides new tapes as the information is processed for use in preparing the customers' bills. Essentially, it is a machine with 28 perforating magnets, a drum and a tape advance mechanism. The magnets, each with an armature arm carrying a perforating pin, are mounted on a two-level steel frame. They are divided into four groups of seven each. Seven are mounted on each level on the front edge of the frame, and seven in a similar arc are on the rear edge.

The fourteen magnet operated pins along the front of the frame are lined up over alternate perforating positions in one row. The fourteen magnet operated pins in the rear edge of the frame are similarly lined up over alternate perforating positions in the adjacent row. In "AMA", reference is always made to the infor-

* Northern Electric Company Limited.

mation carried by a "line" of holes; the holes comprising such a line are actually the alternate holes in adjacent rows. The drum on which the paper tape rests while it is being perforated, is made of aluminum tubing 1½ inches in diameter and 3¾ inches long. It has 1232 holes (44 rows of 28 each). The holes are countersunk so as to conform to the conical ends of the perforating pins.

Extreme precision is necessary in the drilling of these holes in order to ensure the proper seating of the perforating pins. The perforated tape is also passed through a reader in the accounting center, the conically shaped holes being required to fit accurately into the holes of the drum of the reader. The space occupied by the line of twenty-eight holes across the tape is used for recording six digits. The first digit requires space for three perforations and each of the other five

The central office output tapes become the input tapes for the first stage in the accounting center. Each machine reads the input tapes, performs its assignments and perforates its output on fresh tapes, the exception being the last machine by which output is recorded on punched cards.

The first step in the accounting center is to take the central office output tapes and feed them into the assembler-computer. The assembler-computer consists of a reader, a relay control circuit and fourteen perforators. Wire spring relays are used in the assembler-computer for general purposes and dry-reed relays for the storage of timing entries. The operating speed of the reader and perforators in the assembler-computer is twenty-five lines per second. Two sets of relays are used alternately in order to match this high speed.

The assembled-computer operations consist of assembling the scattered lines of input entries pertaining to each call, recording this information in the appropriate registers, computing the elapsed time of each call and then perforating an output entry on one of the fourteen perforators. Ten of the perforators are assigned to message unit tapes, one each to toll, service observing, message unit detail and straddle tapes. The straddle tape contains partial or complete records of calls which were recorded on more than one central office tape, and records of over-capacity messages.

The assembler-computer calculates chargeable time by subtracting the time of the answer entry from the disconnect entry and for message unit entries it also calculates the number of message units in a message. It also discards "don't answer", "busy" and mutilated calls.

The assembler-computer includes a large number of input and output tape circuit checking features as do all circuits in "AMA".

A major consideration in the design has been the prevention of over-charging. The output tapes of the assembler-computer are then processed through a converter. The converter is an "AMA" machine which will produce a punched card of commercial design from the "AMA" tapes received from the assembler-computer. It consists of a reader, a punch control contained in three cabinets and a modified IBM reproducing punch.

Through the use of other punched card machines in the billing office, additional information is entered: (a) For toll messages, the charge alphabetical called point and settlement codes (b) for message unit messages, the cards are integrated with those for other message unit usage and the net usage charges and tax are computed.

The message unit detail, service observing, and straddle tapes are processed through the printer-comparer-scanner which is a combined accounting and maintenance machine. It consists of two readers, a relay control circuit and a teletypewriter. This machine is intended primarily for the printing of straddle call records. The scanning functions are used for the analysis of service observing irregularities, checking of billing on customers' inquiries, and for obtaining information to complete billing in cases where processing irregularities have occurred.

The comparer functions are used for testing by means of known input tapes which produce output tapes. When the tapes are inserted in each of the two readers, as long as the line of tape in both readers match, the circuit will advance. If any difference is found, the machine will block.

A DIGIT CODE

| NUMBER RECORDED ON TAPE | HOLE POSITION PERFORATED | APPEARANCE OF A DIGIT | | |
|-------------------------|--------------------------|-----------------------|---|---|
| | | 0 | 1 | 2 |
| 0 | 0 | ● | ○ | ○ |
| 1 | 1 | ○ | ● | ○ |
| 2 | 2 | ○ | ○ | ● |
| 3 | 0, 1 AND 2 | ● | ● | ● |

B TO F DIGIT CODE

| NUMBER RECORDED ON TAPE | HOLE POSITIONS PERFORATED | APPEARANCE OF B, C, D, E AND F DIGITS | | | | |
|-------------------------|---------------------------|---------------------------------------|---|---|---|---|
| | | 0 | 1 | 2 | 4 | 7 |
| 0 | 4, 7 | ○ | ○ | ○ | ● | ● |
| 1 | 0, 1 | ● | ● | ○ | ○ | ○ |
| 2 | 0, 2 | ● | ○ | ● | ○ | ○ |
| 3 | 1, 2 | ○ | ● | ● | ○ | ○ |
| 4 | 0, 4 | ● | ○ | ○ | ● | ○ |
| 5 | 1, 4 | ○ | ● | ○ | ● | ○ |
| 6 | 2, 4 | ○ | ○ | ● | ● | ○ |
| 7 | 0, 7 | ● | ○ | ○ | ○ | ● |
| 8 | 1, 7 | ○ | ● | ○ | ○ | ● |
| 9 | 2, 7 | ○ | ○ | ● | ○ | ● |

Figure 3.

require space for five to make the total of twenty-eight. Each digit represents a single item of information.

Succeeding rows or lines of holes are about one-tenth of an inch apart. Four to six rows of information are required per call. A five element two-out-of-five code used to represent a call is perforated on the tape, as shown in Figure 3. The main elements in call recording are the initial entry, the answer entry, and the disconnect entry. To ensure smooth and accurate accounting of the charge information, many other entries may be perforated on the tape as required.

Collectively, the tapes provide all the information required for billing "AMA" recorded, customer dialed, completed chargeable messages. At the end of each day, the reeled tapes in the recorders are cut. They are sent, periodically, to the accounting center where the machinery performs the data processing tasks peculiar to message accounting. The processing technique is based on putting the central office data in sequence through different machines, each of which has a specific function.

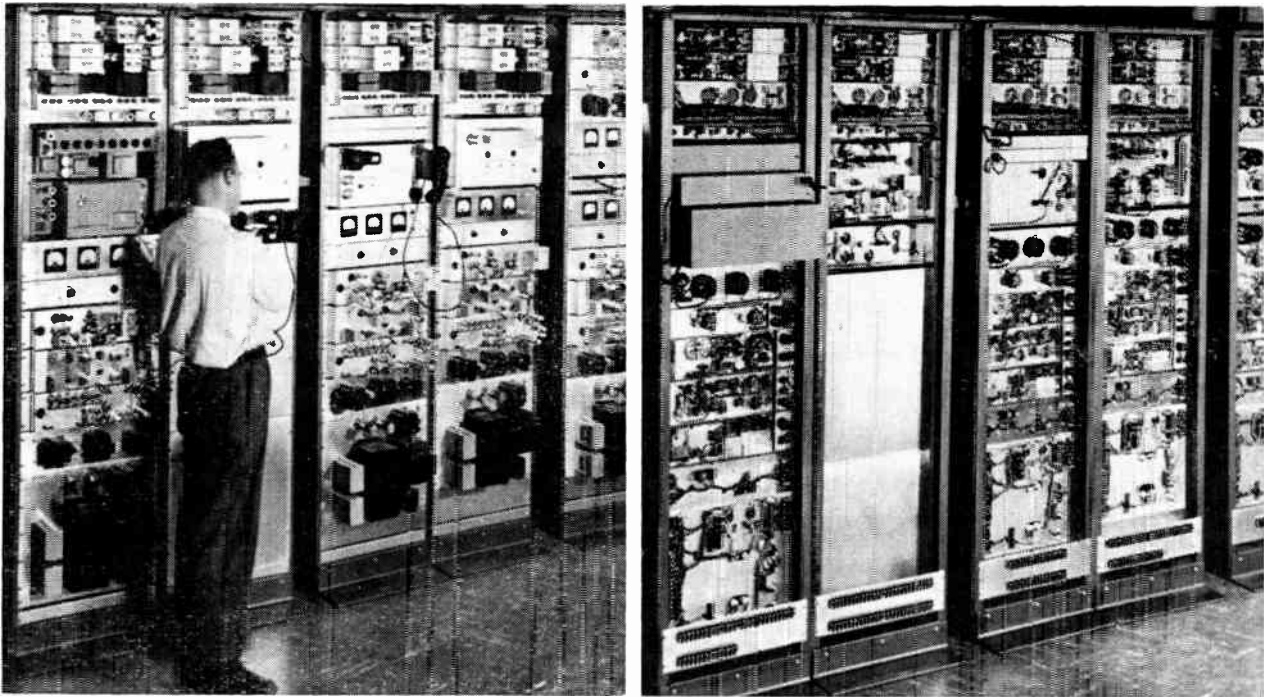

Figure 1. Left: Front view radio relay, multiplex, sub-multiplex, and automatic transfer equipment — as set up for factory system testing. Note frequency shift voice frequency carrier at top of racks. Figure 2. Right: Rear view of equipment shown in Figure 1.

The following article will provide useful suggestions for the design engineer contemplating the use of radio for the . . .

Remote control of unattended hydro stations

While multi-channel radio has been used for years in the common carrier industry (telephone-telegraph), only the forward thinking electric utilities have started to use such radio circuits in Canada. As far as the power utilities are concerned, there are several advantages of this transmission medium.

Such external and unpredictable influences as switching surges, lightning strokes, and station ground rise, do not affect the radio system, and thus no special costly precautions need be taken to overcome these external effects. Radio can provide a virtually unlimited bandwidth, and thus ultra high speed channels can be provided with little difficulty. With good equipment and good system design, it is possible to obtain exceptionally high reliability and so the power engineer is able to turn away from the conventional wire-line systems, their frequency congestion and attendant high total cost. The radio system is a separate entity and thus can supply end-to-end communications when wire-line systems might not be operative. Generally, it is under these conditions that communication is required most urgently.

Such control systems may utilize radio, power line carrier, or voice frequency wire line carrier. Typical systems with a proven service record involve the remote control of an unattended 80,000 horse power water plant using 150 Mc/s relay equipment, and the remote control of two large hydro plants using transistorized frequency shift power line carrier channels. The total capacity controlled in this later example is 160,000 KVA.

The choice of the bearer medium is influenced by such factors as reliability, security, type and quantity of data required, frequency congestion of wire services, speed with which the facility must be established, and last but not least, the economics surrounding the particular project.

Unique system

A recent interesting system supplied to the Hydro Electric Power Commission of Ontario, enables two new unattended 115 Kv transformer stations on a single source transmission line to be remotely controlled from an existing attended transformer station. The controlling station is Blind River T.S. and the controlled

stations Elliot Lake T.S. (18 miles) and Quirke Lake T.S. (28 miles) in the heart of the fast growing community supporting Canada's uranium, mining, and milling industry. Each controlled station is of 45,000 KVA capacity and is used to supply essential power to approximately 10 mines and some 25,000 people.

Figures 1 and 2 show the terminal radio and carrier equipment as set up at the factory for system testing.

One of the requirements to control these stations from Blind River was to provide an independent voice channel to each controlled station for use by service technicians. One channel was applied directly to the baseband and the other used single sideband multiplex. The diagram in Figure 3 shows the operating channel requirements. The supervisory equipment used for controlling the stations required two 3-position party line frequency shift signalling channels in the outbound direction, and one 3-position frequency shift channel in the incoming direction for each remotely controlled station. For telemetering, one 2-position incoming channel was required from each of the controlled stations. Figure 4 shows the way in which the radio baseband was established between the three stations. The scheme employed here was to use one transmitter at Blind River with associated receivers at Quirke Lake and Elliot Lake, on the same frequency. The channel in the return direction from each remote station utilized a separate frequency. The equipment requirements, therefore, resolve into an operating transmitter and receiver at each of the three stations, with an additional receiver at the controlling station. R.F. equipment was duplicated throughout, except at Elliot Lake T.S. where no standby was employed. Nevertheless, provisions were made so that additional R.F. equipment could be added in the future. This arrangement was chosen, since an "operator-technician" would live in the Elliot Lake community and therefore, this station would be partially attended. Radio was an obvious choice as the bearer circuit in this instance, because the Commission specified that all control functions were to be handled on a facility separate from the power transmission line, and because no suitable wire line plant existed in the vicinity.

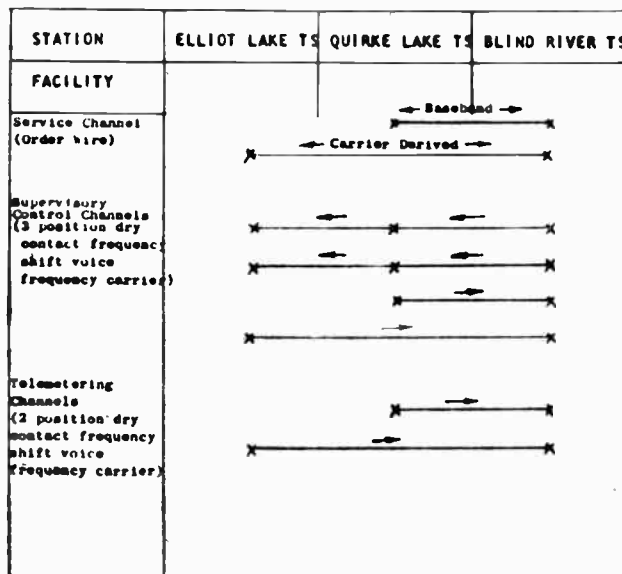

Figure 3. Diagram showing operating channel requirements. Note: X indicates channel terminal or drop. The arrow indicates direction of signal transmission.

Equipment

Radio

Forty watt continuous duty transmitters designed for dependable long term unattended operation were employed, together with low noise figure, double conversion FM receivers. The radio system thus established provided a baseband of 20 Kc. This permitted the use of the frequency shift tone channels directly on the baseband, and allowed adequate space for future expansion. The elimination of additional modulation stages for tone channels improves the system reliability. The equipment is simple to set up, and built-in metering facilitates maintenance. Phase modulation is employed, and the frequency band utilized is 150-174 Mc/s.

Frequency shift tone carriers

The V.F. carriers employed used the frequency shift principle and are suitable for transmission of information, having two or three degrees of freedom. Plug-in adapters allow the equipment to be employed for dry contact, current keying, as well as sine wave modulation up to 35 c/s. The frequency shift is ± 30 c/s and the spacing between adjacent channels is 150 c/s, permitting the use of up to 18 separate channels in the voice range. The frequency shift channels will provide reliable operation when the baseband signal-to-noise ratio drops as low as 1 to 1. Many such systems have service records of 18 months or more without adjustment or interruption. The transmitter and receiver packages are universal in that they can be provided to handle impulse duration, impulse rate, pulse code, or sine wave modulation. Carrier presence and squelch assemblies are provided to initiate transfer from main to duplicate equipment.

Tailoring

System design is very important — a system must be tailored to the user's requirements. Only after close consultation with the user, who has intimate knowledge of the overall requirements, can a good final design evolve. By using logical decision making circuits, such as special sensing devices and memory circuits, together with ancillary hardware, the basic standard equipment packages can be tied together into an operating system.

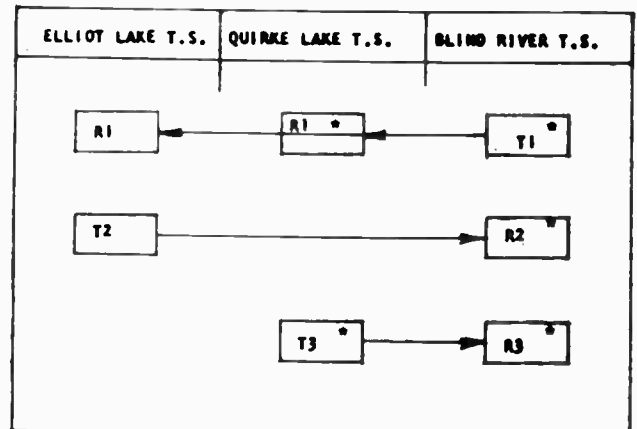
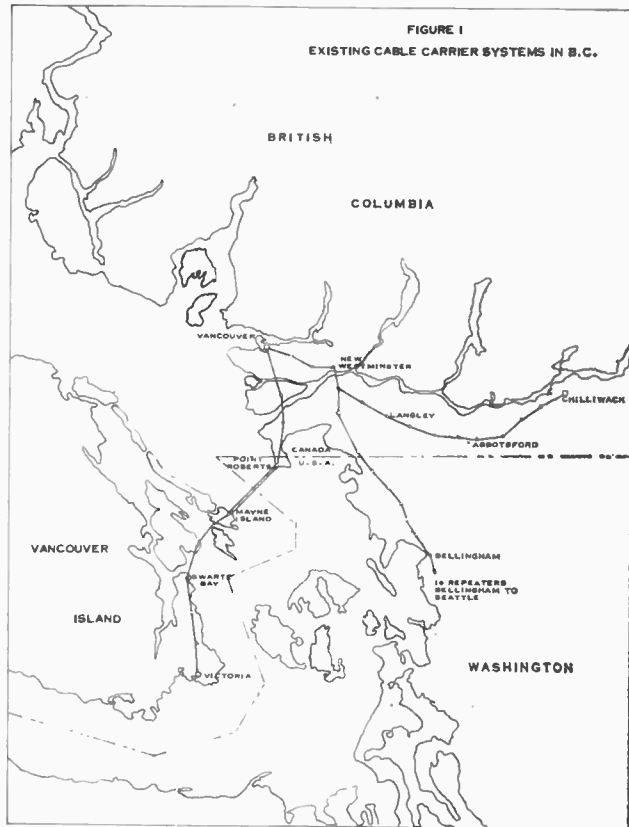

Figure 4. R.F. transmission paths. Note: (1) *Indicates duplication of R.F. equipment including baseband amplifiers and power supplies. (2) Subscripts indicate R.F. frequencies. (3) One antenna and duplexer employed at each station. (4) Arrow shows direction of transmission.

Cable carrier systems offer unique advantages not possessed by other transmission methods. Consequently, when costs and geographical conditions are favorable, system expansion and new installations will keep pace with population growth.

Cable carrier systems in British Columbia



The much publicized term "microwave radio" has tended to obscure the fact that the number of cable carrier installations has grown steadily since the end of the war. In fact, cable systems, very often to the exclusion of other facilities, link metropolitan centers and rapidly growing satellite towns and villages, carry large cross-sections of toll circuits between large cities separated by as much as 300 miles and are designated as alternate routes for SAGE voice and data transmission.

Why has cable carrier been the choice of operating companies sometimes in preference to more widely advertised radio systems? Very often, cost per circuit mile is the criterion when circuits must be dropped off at many points along the route, or when leads to the desired locations already exist. On the other hand, installed cable costs become prohibitive in rough and comparatively inaccessible country. Such is the case in much of British Columbia with the exception of the lower Fraser Valley with its relatively flat terrain. Figure 1 illustrates the geographical layout of British

Columbia Telephone Company's cable carrier systems (Lenkurt Type 45BN) in that area.

General Description — 45BN Cable Carrier System

A complete Type 45BN terminal (Figure 3) transmits 24 toll quality voice and signalling channels over two pairs in toll or exchange cable. Channel and system terminal units (plugged into pre-wired shelves), power supplies and other associated panels can be mounted on one rack as shown. If as many as three complete systems (72 channel capacity) are required, all the panels and shelves can be accommodated on two standard racks.

The building block concept is utilized wherever practicable. For example, the channel units have identical basic chassis into which various channel option sub-assemblies; band pass filters, frequency-shift out of band signalling equipment, and automatic channel regulators may be inserted. Flexibility is the keynote since two-wire operation or any usual four-wire drop arrange-

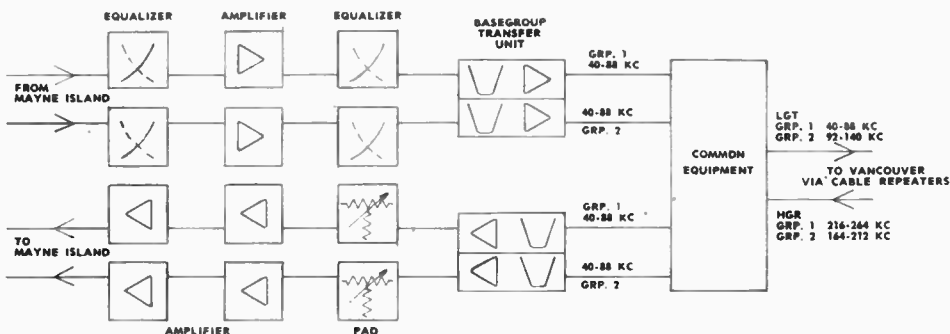

Figure 2. Block diagram of special interconnect equipment at Point Roberts and Mayne Island.

ment can be provided, signalling facilities can be deducted and a wider bandwidth realized merely by interchanging sub-assemblies.

A basic terminal consists in part of six compandor shelves (dynamic noise suppression), two channel equipment shelves (channel units and pregroup units) and a common equipment shelf (base group, synchronizing and line group units). Sets of four specified channel units form a pregroup occupying the frequency spectrum 8 to 24 kcs. Three such pregroups are then modulated to form a basegroup at 40 to 88 kcs. Two basegroups, one of which undergoes an additional group modulation, are combined to yield a 24 channel line group at 40 to 140 kcs — one direction of transmission. For the other direction the 40 to 140 kc group is further modulated for positioning in the 164 to 264 kc spectrum.

In the 45BN repeater, full use is made of transistors to reduce over-all power drain in order that several units in tandem may be fed over simplex circuits from one power point. The net result is that a powered repeater can feed two other repeaters, in tandem, on both sides; that is, a power source is necessary only at every fifth repeater. The Repeater Unit pictured in Figure 4 plugs into its associated Line Equipment Unit. Four such combinations can be accommodated in the Repeater Shelf for mounting on a standard rack or in a weatherproof cabinet (Figure 5) in which satisfactory operation is realized within the temperature range — 40 to 122 degrees Fahrenheit and 90 per cent

relative humidity. An adapter unit is also provided to allow the "BN" repeaters to be plugged into "N" repeater shelves where required.

More specifically, each Repeater Unit and Line Equipment Unit furnishes four-wire repeater facilities for one 24-channel system operating in the frequency range previously indicated. In addition, equalization, amplification, flat-gain regulation, and filtering and modulation for frequency frogging are provided. Here too, flexibility and reduction in spare parts requirements are design features, accordingly simple strapping changes make available either high-low or low-high operation.

The 45BN terminal and repeater assemblies, positioned as they are in the 40 to 140 kc and 164 to 264 kc frequency ranges, are completely compatible with other systems, such as, the Western Electric N and ON which may be on the same cable.

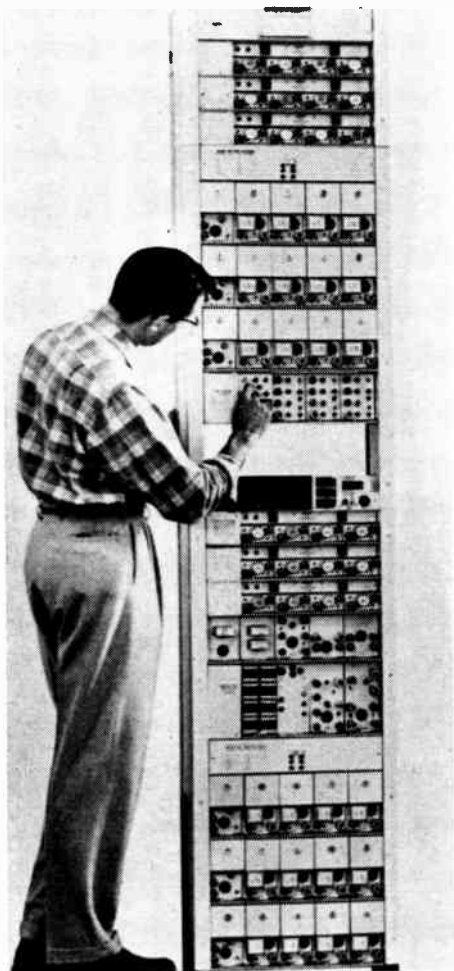

Figure 3. A 24-channel terminal assembly of Type 45BN Cable Carrier System.

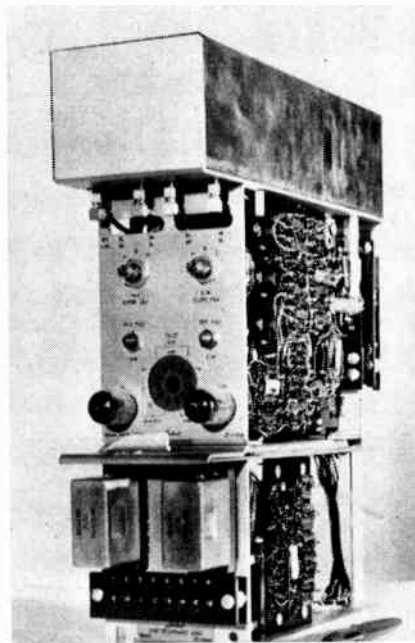

Figure 4. Type 45BN Repeater.

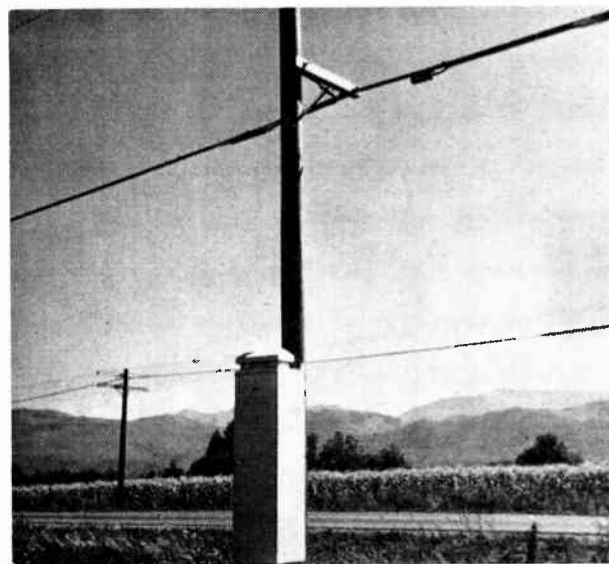

Figure 5. B.C. Telephone Company pole-mounted repeater in weatherproof cabinet located on Sumas Prairie, east of Abbotsford central office. Repeater unit is part of new \$700,000 Vancouver-Chilliwack toll cable.

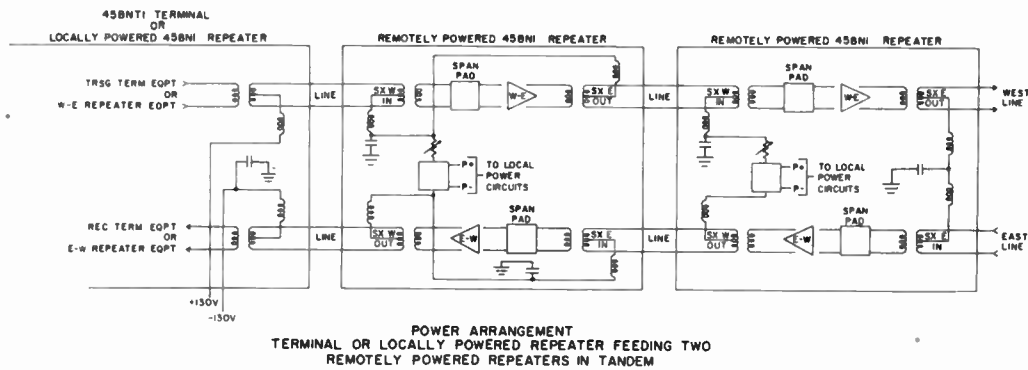

Figure 6.

Vancouver-Victoria Systems

Four 24-channel 45BN systems are in service between Vancouver and Victoria. These systems are believed unique in North America due to the method by which carrier frequencies are successfully transmitted over 14.1 miles of 19-gauge submarine cable between Point Roberts and Mayne Island.

From a basic 12-channel group (40-88 kcs) separate frequency bands, designated low group and high group, are used for each direction of transmission, allowing 24 full duplex channels on the same quad of a toll cable. In the case of a terminal transmitting the low group (LGT), the first 12 channels are derived from the basegroup by modulating a carrier of 180 kcs and, through filters, accepting the lower sideband or 92 to 140 kcs. Thus 24 channels are transmitted from an LGT terminal in the 40 to 140 kcs band. For a high group transmit (HGT) terminal the 40 to 140 kcs band is used to modulate a 304 kc giving a frequency band of 164 to 264 when the lower sideband is used.

Ordinarily, the maximum repeater spacing on 19-gauge toll quadded cable is approximately eight miles. Barring using underwater repeaters, whose cost would be prohibitive, a method had to be devised to allow transmission without repeaters over the 14.1 miles of underwater cable between Point Roberts and Mayne Island. Inasmuch as 45BN circuits may be easily connected on a back-to-back basis at basegroup (40-88 kcs) frequencies, it was decided to break both directions of transmission down to their separate basegroups and take full advantage of lower attenuation at these frequencies. Figure 2 shows in block schematic form the method used.

By means of terminal high frequency interconnect bays, the carrier frequencies (40-140 kc for Low Group transmission and 164-264 kc for High Group transmission) are demodulated into two 12-channel groups between 40 and 88 kc for transmission in each direc-

tion over separate pairs. This allows for more exact equalization of each 12-channel group and reduces transmission path loss.

In order to maintain specified levels over this longer than normal route, additional power amplifiers were provided in the transmitting and in the receiving pairs. The problem of consequent crosstalk was overcome by the use of separate cables for the two directions of transmission. In practice the system proved to be quite satisfactory and is now furnishing 96 toll quality operating circuits.

Vancouver-Chilliwack Systems

Two 24-channel 45BN systems each with 13 repeaters were placed in service between Vancouver and Chilliwack in 1958. This facility provides a backbone route to carry toll traffic from the cities and towns of the Fraser Valley into Vancouver. Being a new toll cable installation, it was possible to take advantage of the tandem feed feature of the 45BN system wherein two repeaters in each direction may be fed power in tandem over the cable pairs from a powered repeater or terminal. The net result was a 50 per cent reduction in the number of powered repeater points.

Figure 6 outlines a schematic of the tandem power feed circuitry. Note that 260 volts is sent out over the transmitting and receiving cable simplexes with power for the first repeater tapped off the series parallel chain.

Vancouver-Bellingham-Seattle Systems

Two 24-channel 45BN systems each with 26 repeaters have been in service for the past two years providing toll quality service between Vancouver and Seattle, Wash. One additional 24-channel system with 11 repeaters is in service between Vancouver and Bellingham. Both Type 45BN and Western Electric N Repeaters are integrated in all three systems.

★ General Charles Foulkes, head of the Canadian Chiefs of Staff committee, has stated that a fully integrated Canadian-American system for the production, procurement and development of defense equipment is imperative. The General said that to solve this situation is one of the greatest problems facing the Canadian-American partnership and suggested that as a solution it may be necessary to revive the war-time Hyde Park Agreement. Unilateral action on the part of Canada to provide the limited equipment required by her defense services was impractical because of the cost and complexity of modern defense equipment.

Collins Radio Company's transhorizon terminal at Red Lake is pictured at right.

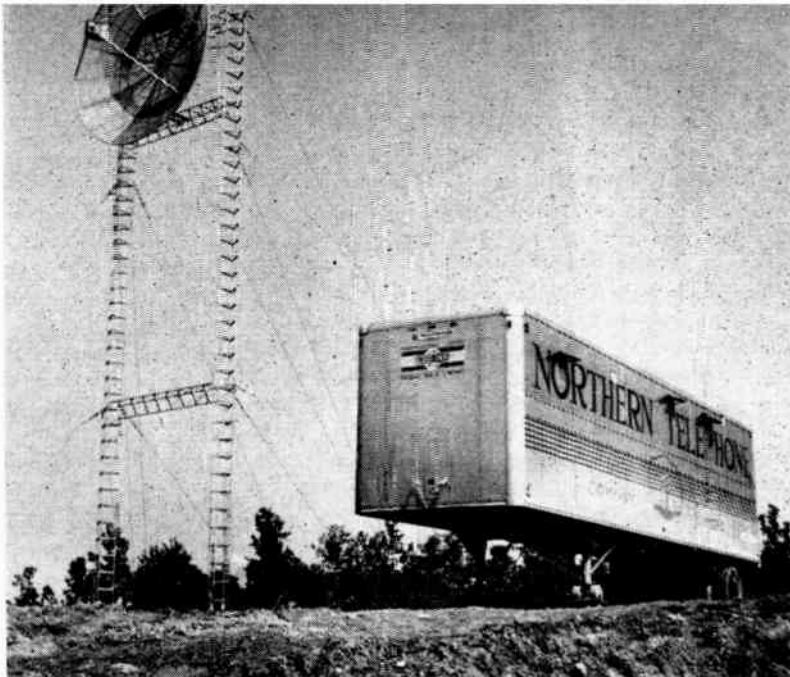

Telephone company provides service to isolated Canadian communities by the installation of the . . .

World's first UHF scatter system

Two 28-foot parabolic antennas were recently installed on the world's first commercially operated Transhorizon (scatter) radio telephone system, which was first put into service on July 9, 1957, by Collins Radio Company for Northern Telephone Company.

The two new antennas, one for each end of the system, which connects Kenora and Red Lake, Ontario, were added to increase potential capability and reliability. It is expected that a telegraph circuit and a radio program channel may be carried over the system in the future.

Kenora, located on the main Trans-Canada routes for railroad, highway and telephone communications, is situated on Lake of the Woods, a popular fishing site. The Red Lake area, whose major industry is gold mining, is composed of several small communities with a total population of approximately 5,000 persons. Red Lake is located 112 miles from the Trans-Canada highway.

The original communication problem was to provide telephone circuits between Kenora and Red Lake which would be practical and economical to operate.

Transhorizon equipment was an obvious choice since the distance could easily be accommodated by only two terminals of equipment. Other systems considered, e.g., line-of-sight microwave or land lines, would have had to follow the highway. Due to the greater distance, twice as far by following the highway compared to air distance, the capital expenditure for land lines would have been far in excess of that for the Transhorizon system.

Servicing of the Transhorizon system is simple compared with land lines or microwaves as there are only two terminals, which are easily accessible to the service personnel of the operating company. The terminals are located on high ground very close to the

service centers of the operating company. Utilizing space diversity, each terminal had two 15-foot antennas. Now each has a 28-foot and 15-foot antenna.

The equipment is housed in two 35-foot semi-trailers, a concept which was pioneered by Collins. The whole system was factory assembled and shipped to the site, where the equipment was connected to the antenna and power lines. This method offers many advantages, which include reducing the time expended in the field in installation of a complete system and reducing the logistics associated with packaging and shipping complete Transhorizon terminals.

The trailers were designed and outfitted at the Toronto plant of the Collins Radio Company of Canada. They were then towed by tractor over 1,300 miles to their respective sites. Included in the vans with the equipment were benches and storage cupboards for spare parts. This means that practically all the servicing of the Collins Transhorizon units can be accomplished in the trailers which, especially in winter, can materially reduce the time expended by the operating company service personnel travelling to and from service centers.

Another feature which contributes to the economical operation of the system is heating of the trailers in winter by heat dissipated by the transmitter. This is sufficient to keep the inside temperature of the trailer at a comfortable level, even when the outside temperature is 40° below zero. In the summer the heat from the transmitter is exhausted to the outside of the trailer.

This system represents an important step in overcoming the problem of serving small isolated communities with reliable communication. It is now possible for telephone companies to provide service in areas where, because of economic or geographic reasons, it was not previously possible.



SELECTION OF **CARRIER EQUIPMENT** is much like chess...

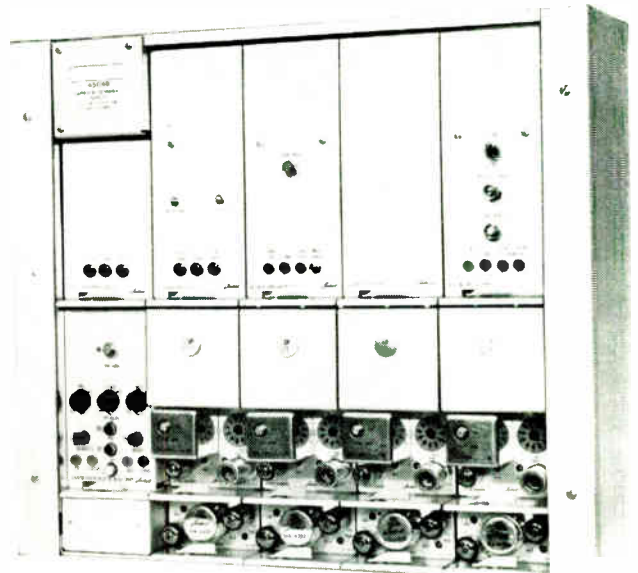

... requiring a working knowledge of all the components plus long range planning. And the news that Lenkurt has added a new range of 45C equipment to their line of carrier systems is important to *your* planning and selection.

The new 45C systems, like the knight, are effective in a wide variety of circumstances and environments. They are compatible with the Western Electric O-class equipments, and interconnectable with the other Lenkurt 45-class systems.

The 45C systems require very little physical power. Common equipment is transistorized, so that the power consumption at terminals is low, and the repeaters operate directly from office battery or any other 48V source—no additional power is required.

Maximum flexibility—a characteristic of the chess queen—is achieved in the 45C systems by making many of the individual plug-in units interchangeable throughout the 45-class equipments. The terminal and repeater common-equipment units are also interchangeable, and spares requirements are reduced to the minimum.

The complete frequency range from 2 kc to 156 kc is covered by the latest Lenkurt carrier telephone equipment. The 45C series, heralded by the widely-acclaimed 45CB1 system, has been expanded to include the 45CA2, 45CC2, and 45CD2 systems. The new design features used in these three systems have also been incorporated into the 45CB1 system, which will now be designated the 45CB2.

Complete information on the Lenkurt 45C carrier systems is yours for the asking; we're quite sure that, given this information, you'll make the right move.

Lenkurt



AUTOMATIC



ELECTRIC



Gardenia White

Forget-Me-Not Blue



Camelia Pink



Turquoise



Sunlight Yellow

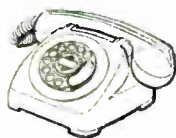

Dawn Grey



Sand Beige



Jade Green

Garnet Red



Classic Ivory

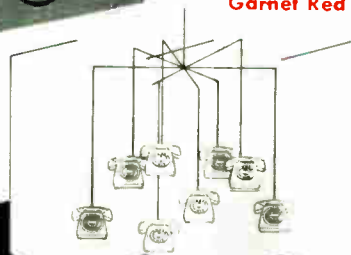

This display is one of many described in the Automatic Electric Do-it-yourself Display Idea Book. All are clearly described. All are easy and economical to build.

to sell **MORE** telephone service
sell **COLOUR!**

You can sell more telephone installations, more extensions . . . when you offer your subscribers 10 harmonizing telephone colours to choose from! In modern homes, stores and offices people use colour to create new dimensions in living. Telephones in decorator colours that blend or contrast with desks, counter tops, kitchens, dens, bedrooms, and living rooms are literally "causing a sensation".

SO TO SELL MORE TELEPHONE SERVICE, SELL COLOUR!

these valuable aids from **AUTOMATIC ELECTRIC** will help you sell the new type 80 Monophone in all ten colours!



COUNTER OR WINDOW STAND-UP DISPLAY

Features the Type 80 Monophone, in full colours. Sells subscribers (when they pay their bills) and passers-by! Available free.



TELEPHONE COLOUR SELECTOR

Outline of Type 80 on clear plastic—with all ten Automatic Electric decorator colours attached. Easily carried in wallet. Price 25¢ each.



DIRECT MAIL LITERATURE

A 4-page brochure in full colour. Lets your subscribers see the complete range of Type 80 Monophones. Available free.



INVOICE STUFFERS

that double as easily-pocketed counter literature. In full colour. Does a strong sales job. Available free.

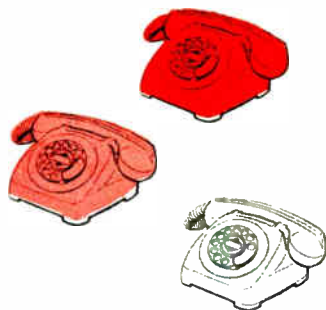

MINIATURE TYPE 80 PHONES

in all ten Automatic Electric Colours—Sand Beige, Garnet Red, Dawn Grey, Sunlight Yellow, Turquoise, Classic Ivory, Jade Green, Gardenia White, Camelia Pink and Forget-Me-Not Blue. Use these miniatures as counter or window display material—or as samples to subscribers who are seriously thinking about coloured units.

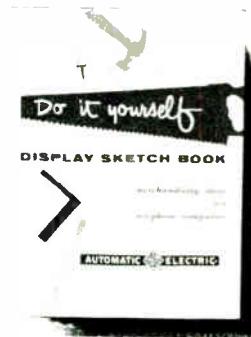

DO-IT-YOURSELF DISPLAY IDEA BOOK

Contains many practical ideas for eye-catching window displays you can build yourself. Available free.

5754-R

For full information about these useful sales aids or the new, coloured Type 80 Monophone, write our nearest branch office. Head Office: Automatic Electric Sales (Canada) Ltd., 185 Bartley Drive, Toronto 16. Branches in Montreal, Ottawa, Brockville, Hamilton, Winnipeg, Regina, Edmonton, Vancouver.

MADE IN CANADA BY



ORIGINATORS OF THE DIAL TELEPHONE



Eliminate taped splices and potting



with the **"RELIABLE" TYPE 400 READY-ACCESS CABLE CLOSURE**

for branch splicing aerial plastic jacketted and insulated conductors

- Designed for use on cables from 1.0" to 2.2" outside diameter.
- Compact and easy to install—does not require a cable splicer.
- Housing of weathertight neoprene—not hermetically sealed.
- Provides entrance for two cables at each end of the closure.
- Available without terminal blocks or with one, two, three, or four 6-pair blocks.
- Has a capacity of 25 loading coils.
- Also available—Types 100, 200 cable terminals, Type 300 cable closure, and the Cook Cable Coat. Terminal blocks of the Cook Cable Coat are interchangeable with the Reliable.

Each unit includes all parts ready for immediate installation. For complete information and literature, write or call

*Automatic Electric Sales (Canada) Limited,
185 Bartley Drive, Toronto 16, Ontario.
Branches in Montreal, Ottawa, Brockville,
Hamilton, Winnipeg, Regina, Edmonton,
Vancouver.*

AUTOMATIC ELECTRIC
SALES (CANADA) LIMITED



For complete details check No. 13 on handy card, page 89.

New Products

New Product specifications published in Electronics and Communications have been briefed for your convenience. If you require further information on any of the items published you may readily obtain such by using our Readers' Service, Page 89. Just mark the products you are interested in on the coupon on Page 89 and the information will be in your hands within a few days.

Gamma dose rate meter

Item 2353

A new gamma dose rate meter, the Model 592B, is announced by The Victoreen Instrument Company of Cleveland, Ohio. According to the manufacturer, the Victoreen Model 592B is an ideal instrument for determination of leakage and true dose rate associated with X-ray installations; for radioisotopes in laboratories, hospitals and industrial plants; and for radiation dosage measurements by certain regulatory agencies.

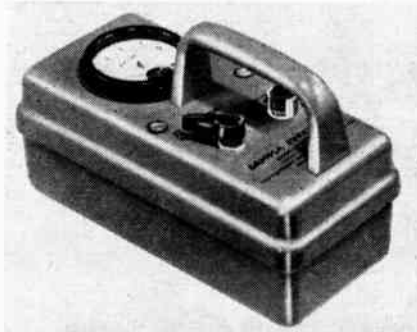

Contained in a light, weathertight case of fiberglass reinforced resin, the Victoreen Model 592B Gamma Dose Rate Meter, measuring 10 x 4 $\frac{3}{4}$ x 6 $\frac{3}{4}$ ins. and weighing only 4 $\frac{3}{4}$ lbs., is reliable and simple to operate. Only two controls, a range switch and a zeroing knob, are required. Zeroing, even in a high radiation field, is fast and sure. The zero knob is protected against inadvertent movement. The large 3-inch meter in easy to read. All high impedance circuitry is hermetically sealed and range switching is performed in the low impedance portion of the circuit, which gives inherent stability and reliability.

The Victoreen Model 592B Gamma Dose Rate Meter features unusually high sensitivity with ranges of: 0-10, 0-100 and 0-1000 mr/hr. Circuit feedback gives rapid response of 90 per cent of final indication in less than 1 second even in the 0-10 mr/hr range. Instrument accuracy is conservatively rated at ± 10 per cent of true dose over the energy range from 50 kev to 1.3 mev.

The battery complement has been reduced to three 1.3-volt batteries and six 22 $\frac{1}{2}$ -volt batteries for lightness and portability. Battery life is conservatively rated at over 250 hours on the 1.3-volt filament supply, over 500 hours on 22 $\frac{1}{2}$ -volt supply.

Full technical details, specification data, prices, etc., on the Victoreen Model 592B Gamma Dose Rate Meter are available on request to The Victoreen Instrument Company, 5806 Hough Avenue, Cleveland 3, Ohio, U.S.A.

Large in-line display

Item 2354

A new, large In-Line Display unit which is approximately four times the size of their standard unit is announced by Industrial Electronic Engineers Inc., North Hollywood, California, manufacturers of a complete line of projection-type readout displays.

The big advantage claimed by the manufacturer is the large numbers and/or characters that appear on the viewing screen, making it possible to view the In-Line Display at a 100' range as compared with the 50' range of the standard model. The size of the character displayed on the new, large, In-Line Display is 3 $\frac{3}{4}$ "

high by 2" wide, as compared with the 1" high by 5 $\frac{1}{8}$ " wide size of the character in the standard in-line display.

It is ideal for use in process, production, and supervisory control panels, annunciation boards, equipment tests, and other types of instruments that call for fast, easy reading of readily identified characters at distances beyond 50 feet.

Other features of this new, large In-Line Display are identical to that of the standard unit. Characters are available in colors, as well as in any style the user desires. This latest In-Line Display also features one-plane presentation. All numbers and/or characters are rear-projected onto the front viewing screen of the unit, and are of uniform size and intensity. In addition to being easier and faster to read, the numbers may be quickly seen from any angle of viewing. Units may be grouped together to make an assembly.

The body case is made of aluminum, and the overall size is 3 $\frac{1}{4}$ " wide, 5 $\frac{1}{4}$ " high, and 1 $\frac{1}{2}$ " long.

For more complete information about this latest large In-Line Display, write direct to the manufacturer, Industrial Electronic Engineers Inc., 3973 Lankershim Boulevard, North Hollywood, California, U.S.A.

Vacuum power switches

Item 2355

Jennings Radio Manufacturing Corp. announce their new line of RH and RL type power class vacuum switches for high voltage interruption.

These new switches are distinguished by much higher voltage and current ratings than previous vacuum switches through the use of larger contacts and improved processing techniques. Individual switches will handle recovery voltages up to 48 kv peak when interrupting 600 amperes rms. They may be used in series for operating voltages up to 230 kv rms.

Jennings RH and RL type switches are available with continuous current ratings up to 600 amps and momentary surge current ratings up to 20,000 amps. These switches also interrupt currents up to 4,000



amps. They are highly resistant to mechanical or electrical damage because vital areas have been encapsulated in specially developed potting compounds.

Vacuum power switches are useful in applications involving capacitor switching, load break switching, fault current interruption, transformer magnetizing current

and inductive switching, and high voltage transmission line dropping. They require no maintenance during the life of the switch and are easily incorporated into existing installations.

Jennings Radio Mfg. Corp., 970 McLaughlin Avenue, San Jose 8, California, U.S.A.

One component epoxies

Item 2356

Hysol (Canada) Limited, a subsidiary of Houghton Laboratories Inc. of New York and California, having recently set up manufacturing facilities in Toronto for the production of epoxy electrical insulating materials, announces that new, single component epoxy compounds are now available for applications in the electrical insulation field. Named the Hysol 6700 Series, these products are developed to reduce handling time and to provide uniform products. Properly applied, 6700 Series Compounds meet the requirements of MIL-T-27B.

Heat resistance exceeds 150°C and types are available for both casting and impregnating. The materials are designed to withstand severe thermal shock, a major

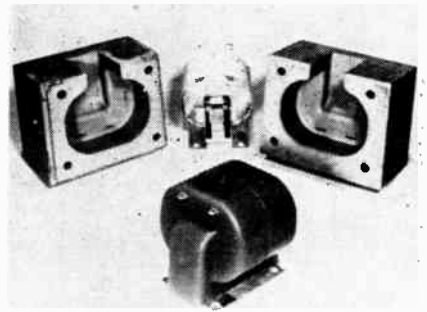

factor in the encapsulation of transformers and other electrical components.

Write for new Technical Data Bulletin 6700-2 to Hysol (Canada) Limited, P.O. Box 53, Station "R", Toronto 17, Ontario.

Dry air supply

Item 2357

Providing clean, dry air for electronic equipment such as pressurized waveguides and enclosed chambers, the new Wells DASR-1030 Dry Air Supply features automatic self-reactivation and continuous duty. The unit supplies 30 psi discharge air at flow rates to four (4) cubic feet per minute.

Manufactured by Wells Industries Corporation, 6880 Troost Avenue, North Hollywood, California, Model DASR-1030 is contained in a weather-proof housing that can be easily removed for routine servicing. The unit is completely self-contained, and is fully equipped with all necessary manifolds, compressors, controls, instrumentation and safety features for field use. Operating controls are conveniently grouped on one sloping panel.

The versatile dry air supply is the newest member of a family of such units manufactured by Wells. These products operate in ambient air from -20° to +140° without sacrifice of efficiency. Model DASR-1030 furnishes clean air with dew point at -100°F. No special tools are required, and all components are standard commercial products to facilitate field maintenance.

Further data on this product is available by contacting Wells Industries Corporation, 6880 Troost Ave., North Hollywood, California, U.S.A.

New Products

Limit switch

Item 2358

Limit Switch Type 274 has been designed by Airmec Limited primarily for use on machine tools where a simple, robust and very reliable limit switch system is essential.

It utilizes a unique principle (patents in relation to which have been applied for) which enables the Contact Assembly to be housed in a sealed portion of the switch and to have no mechanical contact with the plunger. There are thus no metal, plastic or rubber bellows to deteriorate with age and fatigue.

The contact arrangement consists of a rocking magnet on which is mounted a single change-over assembly using silver palladium contacts. The magnet has only two stable positions so that snap action is obtained without the use of highly stressed toggle springs.

The switch is housed in a light alloy die cast case. Three switch connections are brought out through a molded bush housed in a brass collar which is provided with a $\frac{1}{2}$ " standard electric thread. Protected and sealed connections may thus be made to the switch via flexible conduit. Kopex conduit or pyrotenax cable, etc., fitted with a suitable end coupling for screwing on to the switch housing.

The combination of high quality contact material, the complete absence of highly stressed springs and sealing bellows, together with the absolute sealing of the contact assembly, provides an extremely dependable, robust switch of exceptional reliability and long life which may be operated under the most adverse conditions.

Airmec Limited, High Wycombe, Buckinghamshire, England.

UHF TV translator amplifier

Item 2359

The type RA-7 Translator-Amplifier provides 100 watts of peak visual output power in 470-890 mc frequency range when driven by a suitable modulated UHF TV signal. This output power enables communities shielded from originating stations and beyond the range of 10 watt translators to receive TV service.

Features of this broadband amplifier include variable bandwidth, full metering, self-contained power supply, and an exclusive method for adjusting the position of

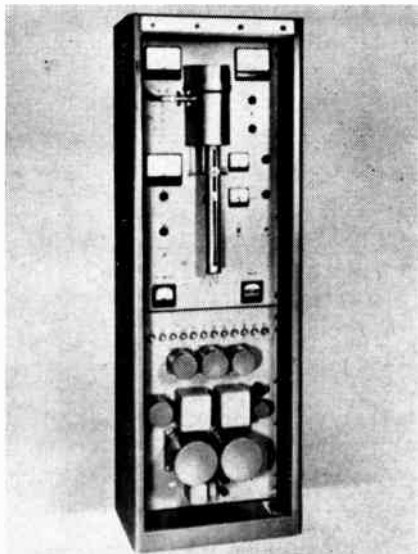

the feed point along the cathode line to insure proper drive impedance and extremely low VSWR.

For further information contact Adler Electronics, Inc., One Lefevre Lane, New Rochelle, N.Y., U.S.A.

Precision phase detector

Item 2360

This instrument is capable of measuring phase angle or time delay with an error of 0.05° or $\pm 1\%$ from 100 kc up to 15 mc. Essentially, it consists of an input cathode follower, two amplifier stages, a step variable delay line, a continuously variable delay line, a differential tuned amplifier, a balanced phase detector and a sensitive output indicator. The continuously variable delay line and the step delay line are used to delay the input signal for a sufficient amount of time in order that the reading on the output phase indicator becomes zero or minimum. The unknown phase angle and time delay is read on the delay line dials, in degrees or microseconds.

This instrument makes possible for the first time a number of measurements which were formerly impossible or very difficult to accomplish by different means. (1) Delay line of an unknown network can be measured with error less than 1 millimicrosecond when used in conjunction with an oscillator with dependable frequency. (2) Phase angle between two voltages can be accurately measured with an error less than 0.05° or $\pm 1\%$. (3) Comparison of time delay or phase angle of an unknown network with respect to a standard can be performed with error less than 1 millimicrosecond. (4) Phase shift of an amplifier can be measured from 100 kc up to 15 mc.

Specifications of the instrument are as follows: The accuracy is better than 0.05° or $\pm 1\%$ of the dial reading. The resolution time is less than 8×10^{-11} sec. for Type 205A1, and 8×10^{-12} sec. for Type 205A2;

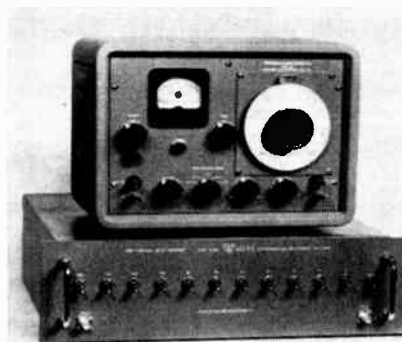

the smallest phase angle in degrees which can be read on the dial is approximately equal to $360 \times$ frequency in cps \times resolution time. The frequency range for both models is 100 kc to 15 mc. The time delay range is continuously variable from 0 to 11 us for Type 205A1, and 0 to 1.1 us for Type 205A2. The indicator sensitivity is 0.05 volt full scale without probe, and 0.5 volt with probe. The input impedance is 1 megohm shunted with 12 uuf with binding posts, and 4 uuf with probes.

Ad-Yu Electronics Lab., Inc., 249 Terhune Ave., Passaic, N.J., U.S.A.

Solid-state 20-watt servo amplifier

Item 2361

Di/An Controls, Inc., announces the availability of the Model AS-20 servo amplifier, specifically designed for use in critical heavy-industry and automation applications, in which long life and ability to withstand abnormal input or output stresses is important. Completely tubeless, using semiconductor circuitry throughout, this moderately-priced unit is mechanically and electrically "ruggedized". For example, a unique input circuit will operate unharmed with continuous input overvoltage of 2,500%. Unlike many conventional solid-state power amplifiers, this amplifier will not be damaged by loss of load, even when driven by the maximum rated input signal.

The electrical characteristics of the Model AS-20 servo amplifier at 60 cps are as follows: input impedance, 20,000 ohms; output impedance, $(750 + j 250)$ ohms; volt-

age gain, 57; power gain, 50 DB; over-all phase shift, less than 10° ; input voltage 2.0 volts RMS (for full 115v RMS output), up to 50 volts RMS without damage; output power, 20 watts max.

The Model AS-20 is designed to operate in any 60 cps servo system, obtaining its input from a synchro control transformer or other similar source, and driving a 20-watt servo motor. Its compact size (4" x 5" x 11") and low weight (10 lbs), together with its inherently-high resistance to shock and vibration, make it ideal for many machine-control or process-control applications.

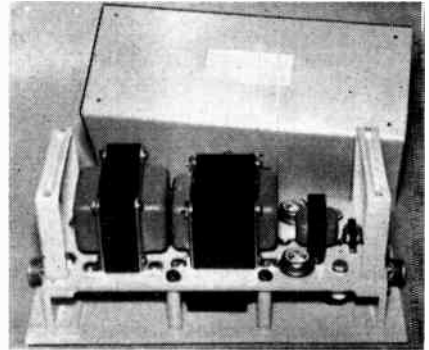

The Model AS-20 will operate at full ratings from -55°C to $+55^\circ\text{C}$, in humidity of 0-100% at 55°C , and is effectively sealed, by its cover construction, against sand and dust. A militarized version (Model AS-20M) is available to meet the requirements of MIL-E-5400. Life expectancy is rated at 10,000 hours for either commercial or military versions.

Complete data is available from the manufacturer, Di/An Controls, Inc., 40 Leon Street, Boston, Mass., U.S.A.

Photomultiplier tubes

Item 2362

A range of eight photomultiplier tubes for scintillation counting and industrial applications is being introduced by Mullard Ltd.

The range comprises one 15-stage, five 11-stage and two 10-stage tubes. All have maximum spectral response in the blue/violet region (4,000 to 4,200Å) and, in addition, two are fitted with quartz windows to allow adequate response to ultra-violet radiation. The tubes are designed for end-on viewing and have caesium-antimony photocathodes, ranging from 20 to 111 mm. in useful diameter, with optically flat nad parallel surfaces.

High current gains have been achieved by the use of precision-mounted solid cathodes machined to carefully controlled shapes and dimensions from specially treated silver magnesium. Solid cathodes have been chosen since they are capable of giving a higher gain per stage than either the sieve or venetian-blind type of electrode; and, in addition, the material itself has excellent secondary emission properties, which remain stable over long periods of time. Another factor contributing to the high gain is the efficiency of the input electron-optical system, which is so designed that over 90 per cent of the photo-electrons reach the first secondary cathode.

The cathodes are mounted linearly in cascade. This arrangement greatly reduces cold emission (since the potentials are divided progressively throughout the tube) and, together with the low thermionic emission of the cathode material, is instrumental in maintaining the dark current at an extremely low level. It also gives maximum insulation between photocathode and anode, thus avoiding feedback.

Besides their uses in scintillation counting these new tubes will also have applications in photometry, pyrometry, and many kinds of industrial counting, control and measurement processes.

Mullard Ltd., Mullard House, Torrington Place, London, W.C. 1, England.

New Products

Digitizer converts analog signal to digital code

Item 2363

The Swartwout Co., Cleveland, Ohio, has announced a new digitizer which translates the analog signal from any Swartwout Autronic transmitter or converter into a digital code. Called the A9M Indicating Digitizer, the new device operates on the 0-0.500 volt AC Autronic signal used by all Swartwout process control instruments. It can be operated in parallel with Swartwout controllers or recorders.

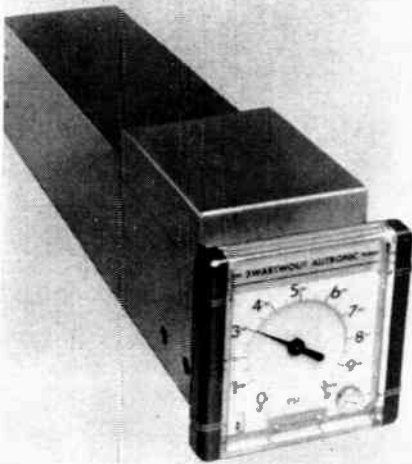

The Autronic signal to the digitizer is amplified and fed to a servo motor driving an analog-to-digital converter. Feedback of the servo's shaft position to the amplifier is accomplished by a differential transformer rather than by slidewire for greater reliability. The output from the digital converter can be used to program tapes or cards for computers, for telemetering, and the like.

The new digitizer is housed in the standard Swartwout case which fits into a five-inch-square panel cutout. The face of the instrument contains a large dial which is directly connected to the encoder; it gives a continuous indication of the process variable. High and low alarm contacts may be incorporated into the digitizer, with a simplified system for accurately setting alarm points.

Provisions are made for locking the rotation of the encoder where required for the specific readout system employed. For complete information, write to the Swartwout Co., 18511 Euclid Ave., Cleveland 12, Ohio, U.S.A.

Cold trap and baffle

Item 2364

Lower liquid nitrogen losses and more effective condensation of backstreaming oil molecules are possible with two new components — an all stainless steel Cold Trap and a nickel plated Baffle — among the 4" Building Block components manufactured by Veeco Vacuum Corp., New Hyde Park, N.Y.

The Veeco CT-400 Cold Trap provides 8-10 hours of continuous operation from one filling (0.6 liters) of liquid nitrogen. A 3" dia. refrigerant bucket is suspended within the trap by a 1" dia. thin-wall filling tube to minimize heat conductance and provide the maximum flow path through the trap, incident with effective trapping. The CT-400 is manufactured from stainless steel (refrigerant bucket, too) because of its chemical inertness, low heat conductance and low out gassing properties. All joints are Microbrazed to insure leak proof welds with stainless steel characteristics.

The Veeco BAF-400 Baffle employs both an internal cooling coil (mounted directly on the baffle disk) and an external coil (mounted on the baffle shell) to condense almost all backstreaming oil molecules before they can enter the vacuum system. And, the fixed angle of the baffle disk carries condensed oil back to the sides of the diffusion pump; so that no oil drops on the hot top jet. The BAF-400 has a solid brass body, copper cooling coils and baffle disk, with all unions silver soldered. The entire assembly is nickel plated to provide non-corroding, vacuum clean surfaces.

Both the CT-400 and the BAF-400 are flanged to mate with any of Veeco's other 4" components.

For additional information, and a copy of Veeco's new brochure on 4" high vacuum Building Block Components and Modular Systems, write: Veeco Vacuum Corp., 86 Denton Avenue, New Hyde Park, L.I., N.Y., U.S.A.

L-band transponder test set

Item 2365

A new ATC L-Band Transponder Test Set is now available from Kearfott Company Inc., Microwave Division, Van Nuys, California, manufacturers of precision microwave components and test equipment.

A unique instrument, this new unit performs all the testing features required to check out L-Band airborne transponders manufactured to ARINC characteristics 532B and ANDB (AMB) 2.3 NAIB. As a completely self-contained unit, it eliminates the need for multi-instrument test set-ups and allows easy portability.

Important among the many special features of this transponder test set are a double pulse generator (with provision for third pulse); strip-transmission line directional couplers; signal generator; calibrated strip-transmission line attenuators; power monitor; pulse spacing network; adaptability to ramp test sets.

As a completely self-contained unit, the new instrument is exceptionally portable with lightweight aluminum chassis and carrying case with handles. It weighs only



59 pounds. Frequency range: 950-1220 mc/sec.; direct reading attenuators; double pulse generator with independent amplitude control. Repetition rates from 15-2000; pulse spacing direct reading, 1-30 microseconds. Dimensions are 21" wide x 12" high x 18" deep. Standard relay racking is provided.

Further information on the new ATC L-Band Transponder Test Set is available on request to Kearfott Company, Microwave Division, 14844 Oxnard Street, Van Nuys, California, U.S.A.

Silicon varactor

Item 2366

Microwave Associates of Burlington, Massachusetts, announces the availability in production quantities of the new silicon varactor. The varactor is a diffused silicon PN junction diode designed to be a variable capacitance with low loss at high frequencies. The unit complies with MIL-E-1 outline 7-1 for cartridge type crystal rectifiers and will fit most standard crystal holders.

In the standard MA-460 series, the pin end of the diode is connected to P-type material on the top of a small "mesa" and the N-side of the silicon element is connected to the base. The reversed polarity unit denoted by the suffix R is also available.

The mechanically reversible MA-450 series may also be ordered with longer delivery time but the single-ended units are generally recommended because they insure placement in holders with the proper end in contact with a heat sink. The minimum cutoff frequencies are graded in 10 kMc steps starting with the suffix A at 20 kMc. Units are currently available as high as 60 kMc.

The varactor is useful in low-noise diode amplifiers (also known as reactance amplifiers or parametric amplifiers), amplifying up-converters, harmonic generators, high-level modulators, frequency dividers, voltage-variable tuners, switches, reactive limiters, and high-speed computers. Low-noise amplifiers have been constructed from 1 mc to 6,000 mc. Harmonics have been generated as high as 100 kMc. At lower frequencies, conversion losses of less than 1 db per harmonic have been observed in many experiments.

More information is available in Microwave Associates, Inc. Catalog 59V obtainable from the Canadian representative, E. G. Lomas, 227 Laurier Avenue West, Ottawa 4, Ontario.

Electronic time delay relays

Item 2367

Substantial increases in durability and reliability are specified for a new line of electronic time delay relays which have been put into production by Voi-Shan Electronics, North Hollywood, California. The new timing devices are built to meet military specifications for use in aircraft, missiles and ground support equipment. The operating scope of the new units is so broad — from 60 milliseconds to 600 seconds — that they could serve to program an entire ground checkout procedure or control the better part of a missile flight. They may be utilized in many control applications not previously possible with electronic units.

The new line is believed to include the smallest size and weight achieved to date for a 600-second timer fitted with a 6PDT, five ampere relay. Over-all size is 2" x 2" x 3". Total weight is 15 ounces. There are two basic models, the TDRA 101, for ground support applications and the TDRA 201, for airborne use.

The Voi-Shan relays are interchangeable with the great bulk of timing devices now in use in aircraft, missile and military electronics applications. They are available with one to six-pole load switches. Standard input is 28 volts DC, but an almost infinite number of variations in specifications can be met.

Because the units were designed specifically for military use, they have been built to withstand severe shock and vibration, and environmental temperatures from -62°C to +125°C. In this environmental range the time delay relays perform to within 5% of specifications. Under optimum conditions, 2% accuracy can be guaranteed.

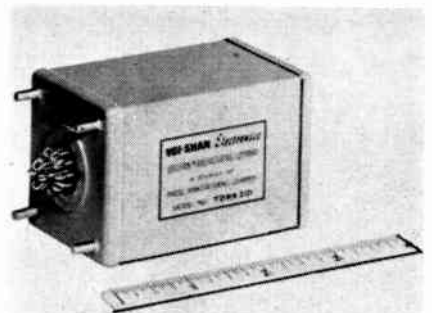

Durability specifications call for a minimum of 100,000 trouble free operations, even under adverse conditions. In optimum situations, relay life will exceed 1,000,000 operations.

For further information, ask for Time Delay Relay Data Sheet; Voi-Shan Electronics, 13259 Sherman Way, North Holly-

New Products

Beckman Magnetic Clutches

Item 2368

Miniature magnetic clutches for electrical control of servo system rotary mechanical functions can now be ordered off the shelf for immediate delivery, from Helipot Division of Beckman Instruments, Inc., represented by R-O-R Associates, Ltd., 1470 Don Mills Road, Don Mills, Ontario.

Two lightweight, compact models are available. Beckman Model 583 is especially suited for small space applications since it is only 1 1/4" in diameter and 2-11/16" long. For more rugged duty there is Model 543, 1 3/4" in diameter and 4 1/8" in length.

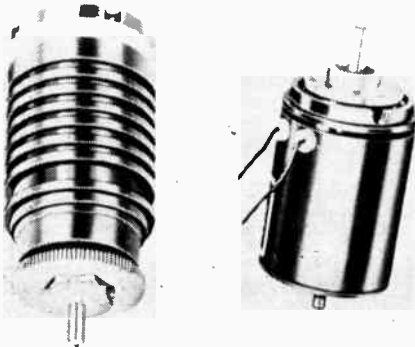

Both models are the dry-disc, fixed-coil type of solenoid controlled clutches which use no slip rings. Inputs of 24 or 48 volts may be specified.

Data on both clutches are included in the following table:

| | BP-543 (with or without brake) | BP-583 (with or without brake) |
|-------------------------------|---|---|
| Maximum speed | 3,600 rpm | 7,200 rpm |
| Coil de-energized | Output to brake (or free) | Output to brake (or free) |
| Coil energized | Input to output | Input to output |
| Total torque (clutch + brake) | 50 oz. in. | 20 oz. in. |
| Time for full engagement | 0.005 to 0.020 sec. | 0.015 to 0.025 second |
| Continuous dissipation | 6 watts | 2.5 watts |
| Output inertia | 10.974 gm. cm. ² | 6.76 gm. cm. ² |
| Input gear pitch | 48 | 48 |
| Number of teeth | 66 | 66 |

A 48-pitch, 1 1/2" pressure angle stainless steel input gear is furnished with each clutch; or special input gears may be substituted.

For further information contact ROR Associates, 1470 Don Mills Road, Don Mills, Ontario.

Modified short coil relay

Item 2369

Potter & Brumfield Canada Ltd. is introducing a modified version of its short coil TS telephone type relay that will feature bifurcated contact arms with as many as twenty arms per relay (ten arms per stack). The new version provides longer and more reliable operating life, permits higher contact loads and requires only 3/8" added to its overall length.

The TS operates on as little as 100 milliwatts per movable arm and can be furnished to operate on voltages up to 110

volts, DC. It will switch up to four amperes at 115 volts, 60 cycle, resistive loads.

This version of the TS is mounted with four tapped #4-40 studs on 3/8" x 3/8" centers. The relay measures 1 3/4" long by 1 1/2" wide x 1 1/8" high (measured from top of 4 pdt relay). It weighs approximately 3 ozs. and can be furnished with pierced solder lugs or taper tabs.

For additional information write the Technical Information Department, Potter & Brumfield Canada Ltd., Guelph, Ontario.

Polyester fibreglas trays

Item 2370

Kennett die-molded polyester fibreglas trays for high temperature and corrosive materials handling applications are available from National Vulcanized Fibre Co.

These low cost, reinforced plastic trays feature outstanding mechanical, chemical and thermal characteristics. Under humid conditions they are dimensionally stable and can be used at temperatures ranging from 45° to 225° without dimensional change or surface damage. Die-molded of polyester fibreglas, the trays are seamless and resistant to most acids, alkalies and chemicals. When empty, these Kennett trays can be nested to conserve storage space.

In size, these polyester fibreglas trays measure 14 in. long by 11 in. wide by 4 in. deep. A lid, that can be used separately as a tray, is also available and measures 15 in. by 12 in. by 1 1/2 in. deep. These Kennett trays are available in any specified color.

Additional information on Kennett polyester fibreglas trays is available from National Vulcanized Fibre Co., 1058 Beech Street, Wilmington 99, Del., U.S.A.

Oscilloscope for high-voltage surge-testing

Item 2371

The Tektronix Type 507 is a specialized oscilloscope, designed primarily for high-voltage surge testing as applied to power transformers, high-voltage insulators, lightning arresters, and their associated designs and acceptance tests.

The Type 507 cathode-ray tube has a vertical-deflection factor of approximately 50 v/cm at 24-kv accelerating potential, and a viewing area of 6 cm by 10 cm. The 10-step input switch selects attenuation of 10% of the input signal per step; has a 72-ohm characteristic impedance. The vertical-input system will withstand crest voltages of 3 kv of the standard 1.5 by 40 μsec surge-testing waveform. Eleven calibrated sweep rates are provided: 20, 50, 100, 200, 500 millimicroseconds/cm, 1, 2, 5, 10, 20, and 50 μsec/cm. The sweep can be

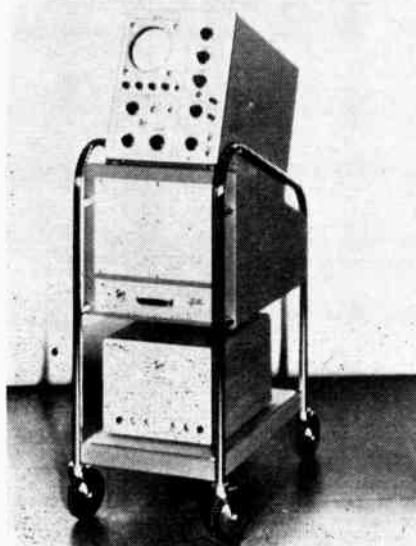

triggered internally or by an external signal and can be operated single-shot for photographic recording. Time markers are available for photographing time references.

Careful design has minimized the effects of ground disturbances on the operation of the Type 507.

The Type 507 consists of three parts: indicator unit, electronically-regulated power supply, and scope-mobile.

For further information write Tektronix, Inc., P.O. Box 831, Portland 7, Oregon, U.S.A.

Active bandpass filters

Item 2372

Active Bandpass Filters are available from T T Electronics, Inc., P.O. Box 180, Culver City, California. These filters consist of a three stage Transistor Amplifier, Twin-T Networks, and a Switching Chassis. The Model A49 Transistor Amplifier shown in the photograph foreground has a voltage gain adjustable to 60 db (1,000 times) or more and a 500,000-ohm input impedance. The output voltage is approximately 3 volts across 10 Kohms. Terminals in the negative feedback loop are available for a Twin-T Network of suitable frequency and impedance. Standard Twin-T Networks shown in the center are available from T T Electronics, Inc. for use with the Amplifier.

In the background is shown the Model F508-R Switching Chassis which accommodates the plug-in Networks and the Amplifier. Any one of 12 filter frequencies can be selected by the panel switch. The panel terminals are for input and output connections. The use of the Switching Chassis is optional for applications requiring rapid frequency changing. Individual Amplifiers and Networks can be applied as plug-in components in any equipment design.

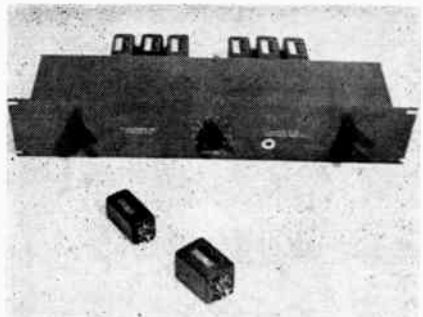

The high input impedance, high gain, and small size of the Transistor Amplifier opens many possible applications for this low frequency filter. Among these are null sensing applications such as required for AC bridges. Another is carrier servo and instrumentation voltage amplification such as servo preamplifiers.

The Amplifier dimensions are 1 1/2 x 1 1/2 x 2 inches. Power required is 22 volts DC at about 1.5MA. This low current drain makes a battery supply practical. An AC power supply can be included on special order. The settable gain control can be mounted on the Amplifier can or on the Switching Chassis control panel as desired.

For further information write T T Electronics, Inc., P.O. Box 180, Culver City, California, U.S.A.

Wire stripping tool

Item 2373

This new tool strips nylon sheathing from plated copperbraid wire (Spec MIL-W-16878C) without scoring the braid. Two high-speed steel blades sharpened to the helix angle of the twisted wire penetrate the nylon to the proper depth. The angle of the cutting blades and the elongated slot in the wire guide induce a spiral motion to the wire as it is drawn over the area to be stripped. The two cuts release tension in the nylon, thus permitting it to be peeled off easily. Previous methods such as razor blades, heat, and make-shift cutters proved unsuccessful, especially in confined work areas, or caused damage to the braid.

A copy of the tool drawing may be obtained free by writing to Stavid Engineering, Inc., Plainfield, New Jersey, U.S.A.

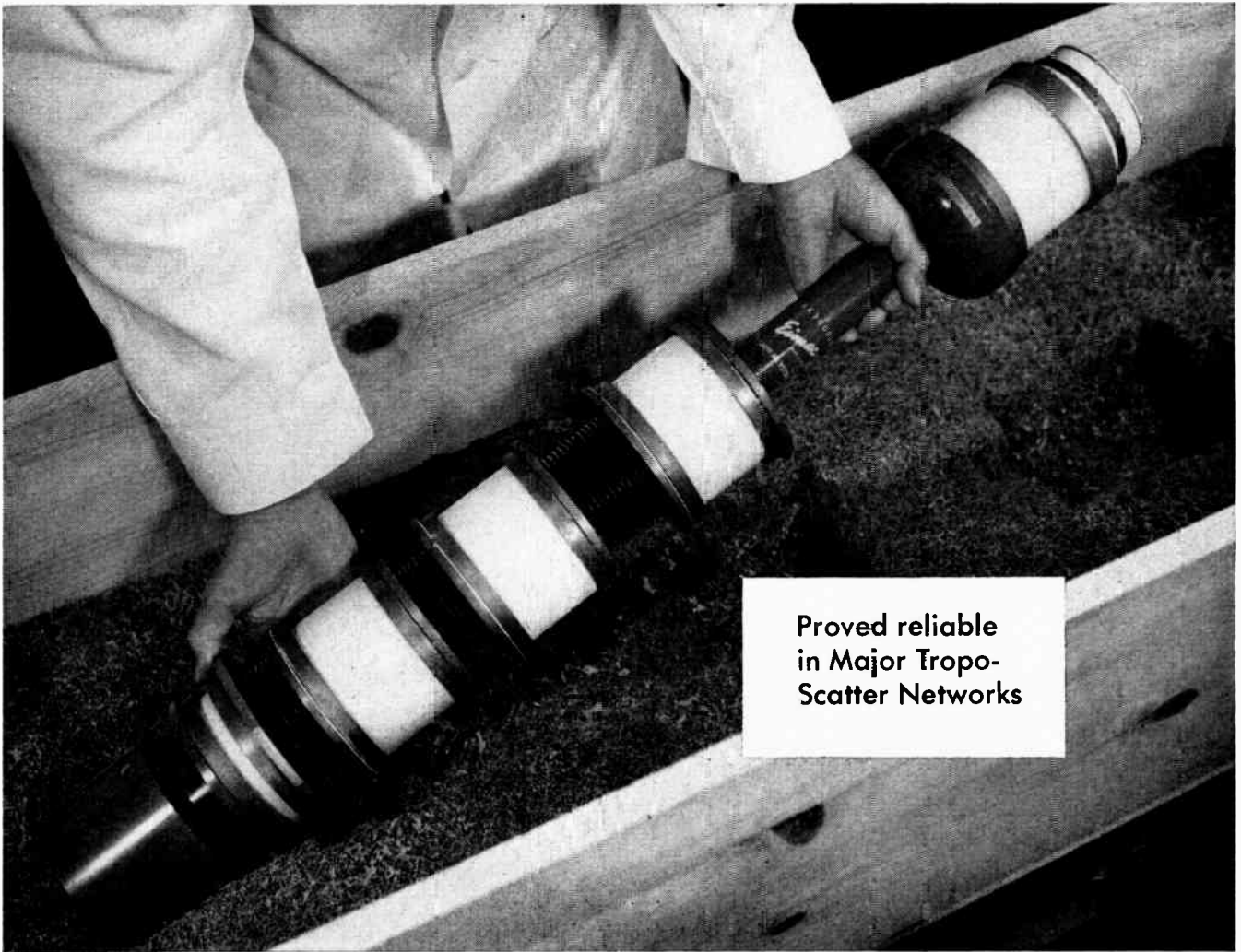

Proved reliable
in Major Tropo-
Scatter Networks

Field experience indicates

**15,000 hours from now, this Eimac
2KW KLYSTRON will still be in service**

After three years of widespread service in such tropo-scatter systems as Dew Line, White Alice and Texas Towers, typical life of Eimac 3K3000LQ klystrons is nearing 15,000 hours and still increasing. Experience with Eimac klystrons in these and other tropo-scatter systems indicates that the 3K3000LQ will easily exceed 15,000 hours typical life. This exceptional record of long life and high performance is the result of Eimac's conservative design and advanced manufacturing techniques.

The Eimac 3K3000LQ is a 2 kilowatt klystron covering the frequency range of 610 to 985 megacycles. It will tune over the entire frequency range with one set of

external cavities and is capable of meeting the bandwidth requirements of modern tropo-scatter systems.

Eimac's external-cavity design permits this wide tuning range and bandwidth, and also eliminates problems inherent in flexible vacuum seals. Systems' operating costs are significantly lowered since tuning circuitry need not be repurchased when tubes are replaced.

The 3K3000LQ is typical of the Eimac family of 1 and 2 kilowatt klystrons. Other tubes in this family, such as the 3KM3000LA, 4KM3000LQ, 3K2500LX and 3K2500SG, cover virtually all the frequencies from 375 to 2400 megacycles. For complete technical data on these exceptional power amplifier klystrons, write the Eimac Application Engineering Department. 5905



Eimac First for high power amplifier klystrons.

EITEL-McCULLOUGH, INC.
SAN CARLOS CALIFORNIA



2036 Prince Charles Road. Ottawa.

New Products

High voltage sparkers

Item 2380

Available for the first time in Canada is the British line of high frequency Sparkers, manufactured by Buckleys (Uvral) of London, England and represented in Canada by Canadian Research Institute, 46 St. George St., Toronto.

Buckley Sparkers generate voltages from 12 kv to 100 kv at frequencies of 200 kilocycles and 2 megacycles. These devices are most useful in the chemical, plastics, and electronic industries for flaw detection.



Producers of glass, plastic, and rubber-lined tanks, plastic wire extruders, neon-sign makers, and radio, TV and electronic tube manufacturers may seem to have little in common, but all use the Buckley Sparker for rapid location of faults and pinholes.

These instruments are stocked and serviced in Toronto by Canadian Research Institute, 46 St. George St., Toronto 5, Ont.

Position-to-digital encoder

Item 2381

Precise, multi-positional reporting can now be accomplished with a new, miniaturized, 10-bit shaft position-to-digital encoder that features high resolution and eliminates ambiguity. Indicating wide application in computer control of automatic machinery, the new encoder translates analog shaft position to true binary digital information. Complemented by auxiliary self-balancing potentiometers or servo equipment, Librascope's encoder is capable of reporting on a wide variety of analog data.

The new encoder is a highly compact instrument. Ten-bit resolution is obtained with only a 3½-inch disc that yields 1,024 discrete position representations per turn. Its design permits, for example, the control of linear machine feeds to within tolerances of 0.001 inch of the total travel. The small size is made possible through use of advanced digital techniques. These techniques have resulted in 10-bit resolution with only 3½-inch diameter disc, less than half the normally required diameter for equivalent resolution. Ambiguity of the shaft position representation is eliminated by incorporating necessary logic in the disc pattern. Another advantage of this disc is the parallel presentation of the data. Control of the transition is accomplished by the combination of a unique disc pattern and a five transistor logic circuit contained in the encoder.

Logic and disc pattern designs, which are significant advances in shaft encoder field, have been accomplished with the aid of the LGP-30 general purpose digital computer. Use of versatile LGP-30 simplifies complex design and production problems and assures accuracy, reliability, long life, and non-ambiguity in the encoder.

The overall size of the encoder is 4½ inches in diameter by 1¼ inches thick. The shaft is fitted with a synchro-type mount to facilitate precise location of the input shaft. Voltage requirements for the

transistors are -6 volts DC. Life of more than one million revolutions can be expected with an input shaft speed of up to 25 rpm. The instrument will operate over a temperature range of -50 to 150 degrees F.

For further information about the Model 740, 10-bit shaft position-to-digital encoder contact Librascope, Incorporated, 808 Western Avenue, Glendale, California, U.S.A.

Temperature sensor

Item 2382

Available immediately from stock in tape-on or self-adhering models, Minco's Thermal-Ribbon provides convenient and accurate sensing of temperature for monitoring or control in airborne, industrial, and instrument applications.

Measuring ¾ inch by 2 inches by .020 inch, the Thermal-Ribbon is thin and flexible for use on flat, curved, or irregular surfaces. It can also be built into equipment and used for temperature monitoring or control while the equipment is operating. Resistance is 676 ohms per degree C at 25°C and varies at a rate of 3.06 ohms per degree at 25°C. Thermal time constant is as small as ½ second - depending on installation.

Each Thermal-Ribbon is shipped complete with installation tape as required and with calibration curve for the operating range of -60° to +160°C. The Thermal-Ribbon may be used with Minco's Thermal-Indicator for direct read-out of temperature.

Request additional information from Minco Products, Inc., 740 Washington Avenue North, Minneapolis 1, Minnesota, U.S.A.

Selective voltmeter (wave analyzer)

Item 2383

A highly selective tunable instrument for measurement of carrier system levels in the range 1 to 400 kc. is announced by Railway Communications, Inc., Raytown, Mo. Variable selectivity from 100 cycles to 10 kilocycles (using crystal filters) for both measuring and monitoring; internal speaker provided. Accuracy ±.5 db from -80 to +32 dbm.

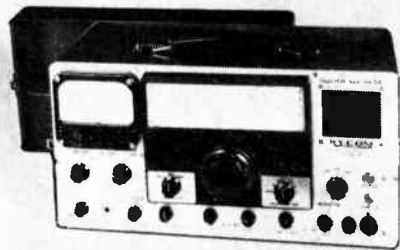

Type 2174 Wave Analyzer is available in both portable (shown) and rack-mounted models and operates from 115 volts 50/60 cycles.

Further details upon application to the Canadian Representative: Tele-Radio Systems Ltd., 3534 Dundas St. West, Toronto 9, Ontario.

Strain gauge recording and plotting system

Item 2384

A new strain gauge recording and plotting system that plots strain vs. load for 24 to 96 strain gauge channels on an exclusively designed continuous paper loop and that can be obtained with a digital readout so that strains can be tabulated on a typewriter, IBM cards or punched tape has recently been developed by B & F Instruments, Inc., 3644 N. Lawrence Street, Philadelphia 40, Pa.

The paper loop system: eliminates folding of chart paper or dumping it into a box; can be supplied with any length of paper to match the specific number of channels

being scanned; is housed under the plotter and enclosed to prevent disturbances from external causes; can be run automatically, without operating the printing mechanism, for quick scanning of results.

Original features are said to include: Individual gauge factor and range selector controls for each channel; polarity is automatically indicated and the full width of the chart paper is utilized to plot tension or compression; scanning switch contacts are not in series with the gauges and contact resistance has no effect on the accuracy; unique method of setting the scale makes reading completely independent of the length of the input cables; overscale channel lights notify the operator when to advance range selector switches; shorting or grounding of a gauge or open circuits does not adversely affect other channels.

Each system includes the required number of 24-channel modules, the recorder or plotter, a regulated power supply and a programmer. Components are enclosed in one or two six-foot racks mounted on casters.

For complete details, write B & F Instruments, Inc., 3644 North Lawrence Street, Philadelphia 40, Pa., U.S.A.

"K" band direct reading noise tube mount

Item 2385

Designed to extend the range of Microwave R.F. Noise Generating equipment, this new "K" Band Direct Reading Noise Tube Mount provides a means of quickly measuring noise figures in systems operating over the frequency range from 18.0 to 26.5 Kmc/sec.

The assembly incorporates a precision calibrated attenuator which is directly marked in noise figure values. The unit is operated in conjunction with either the Waveline Model 2200 or 2200-M Power Units. Fifteen other tube mounts in both standard and direct reading types are available for coverage from 2.60 to 26.5 Kmc/sec.

Further data on this equipment may be obtained from Waveline Inc., Caldwell, N.J., U.S.A.

Propellant-actuated valve

Item 2386

Of normally-closed design, the new Beckman & Whitley Propellant-Actuated Valve houses a laterally moving spool and the explosive cell which drives it. The inlet fitting has a blind end to eliminate the possibility of pre-actuation leakage. When the valve is assembled, the end of this fitting recesses into a counterbore in the spool and actuation results in shearing off the blind end to permit fluid flow past a recess in the spool and to the outlet port.

Metal particles are trapped in the counterbore, and a system of O-ring seals traps the expended combustion gases so that they neither escape from the valve nor contaminate the working fluid.

Design is such as to permit use of a simple reload kit for re-usability in either systems test and check-out activities, or where the valve is used for emergency purposes and must be restored after use.

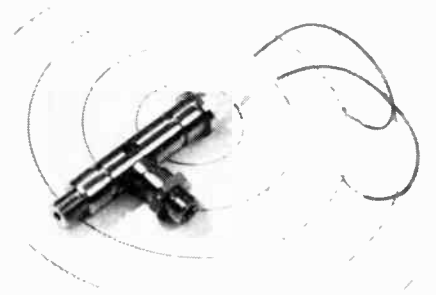

Propellant cells can be provided in either single or dual bridge-wire types to meet reliability or selective-functioning requirements.

Beckman & Whitley, Inc., 985 E. San Carlos Ave., San Carlos, California, U.S.A.

business briefs and trends

★ In the opinion of S. M. Finlayson, president of Canadian Marconi Company, it will be at least two or three years before color television is a part of the Canadian home. "This is not because Canadian manufacturers are unable to deliver color sets," Mr. Finlayson said, "but rather because there is no program of service available now, or likely to be available within the next two or three years for the bulk of the Canadian market."

* * *

★ R. Peter de Karwin, industrial television specialist for Canadian General Electric Company Limited, in addressing a joint meeting of the American Institute of Electrical Engineers and the Institute of Radio Engineers, indicated that recent years had seen a significant breakthrough for closed circuit television on virtually all fronts of industry, education, business and the military services. According to Mr. de Karwin, special attention should be given to stability, reliability, and construction of industrial television equipment selected for bringing a TV picture of remote operations to any desired control point.

* * *

★ Burroughs Corporation of Detroit, Michigan, has subcontracted more than \$300,000 in power supplies for their SAGE data processing equipment to Bogue Electric of Canada, Ltd., Ottawa, according to an announcement by Paul S. Mirabito, general manager of Burroughs' Defense Contracts Organization. The contract is in line with the U.S.-Canadian policy of joint participation in all aspects of North American defense programs affecting the two nations.

* * *

★ A new lightweight, transistorized aircraft servo temperature indicator, capable of giving highly accurate temperature readings under all flight conditions, is being developed for the U.S. Air Force by General Electric. F. T. Dayment, manager, Aviation Equipment Sales for Canadian General Electric Co. Ltd., said recently that the new servo temperature indicators will be available to Canadian manufacturers early in 1960.

* * *

★ Improved radio components which will lead to increased reliability of all electronic equipment, from TV and radio sets to missile guidance systems, were on display at the exhibition of the Radio and Electronic Component Manufacturers Federation held April 6 to 9 in London, England. There were 179 firms exhibiting. Miniaturization was a special feature of the Show.

* * *

★ A purchase order covering more than \$700,000 worth of VOR/ILS systems has been placed with Computing Devices of Canada Limited by the RCAF. The equipment will be supplied by the Radio Division of Bendix Aviation Corporation. These VOR/ILS systems will be installed in de Havilland Comet II's, Canadair-built Convair 540's, Douglas DC-3's, and various other types of aircraft.

* * *

★ C. T. Carson, P.Eng., of Windsor, Ontario, past president of the Association of Professional Engineers of Ontario, in addressing a regional meeting of engineers, said that if Canadian-made goods are to compete successfully in world markets with those produced in Europe and Asia, Canada must continue to increase productivity and at the same time maintain high standards of quality. "In large degree," he said, "responsibility for production standards, efficiency, quality control and unit cost must be assumed by engineers." He added that new machinery, automated procedures, product design, plant layout and other developments, which would contribute to increased efficiency, lay in the engineer's domain.

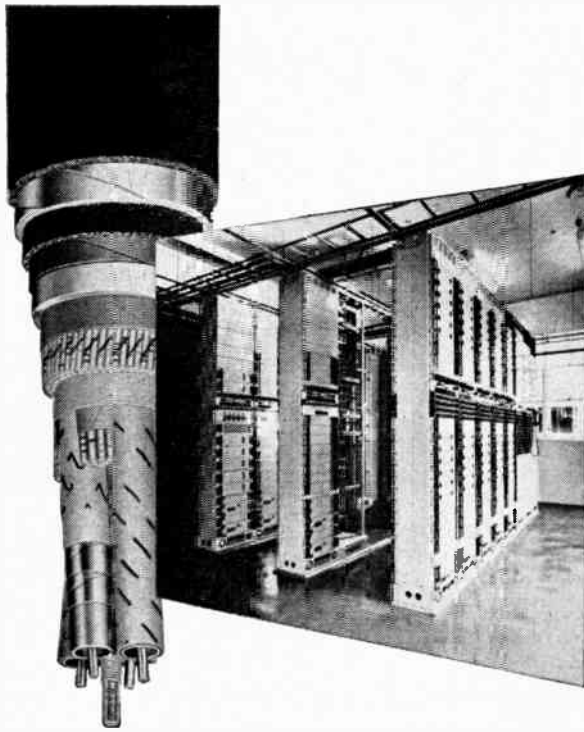

FIRST CO-AXIAL CABLE SYSTEM IN NEW ZEALAND

The first section of the new trunk telephone link in the North Island of New Zealand is now in service with the commissioning of the multi-channel carrier telephone system operating over co-axial cable between Auckland and Hamilton. On this section 240 circuits are to be provided initially; the system is extensible to 960 circuits. A.T. & E. Co. Ltd., were entrusted by the New Zealand Post Office with the supply of all the line transmission and terminal channelling equipment. BICC were responsible for the design, manufacture and installation of the co-axial cable in conjunction with the New Zealand Post Office. This is another example of a joint enterprise by two specialist organisations who undertake complete communication systems anywhere in the World.



**AUTOMATIC TELEPHONE &
ELECTRIC CO. LTD.**

STROWGER HOUSE, 4 RUNDEL ST., LONDON, ENGLAND

REPRESENTED IN CANADA BY AUTOMATIC ELECTRIC SALES (CANADA) LTD., 185 BARTLEY DRIVE, TORONTO 16



**BRITISH INSULATED CALLENDER'S
CABLES LTD.**

21 BLOOMSBURY STREET, LONDON, ENGLAND

For complete details check No. 82 on handy card, page 89.

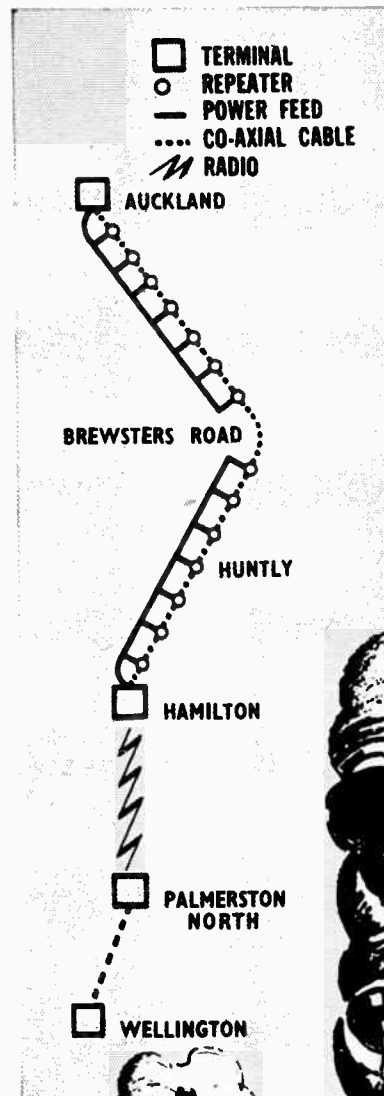

On the second cable link between Wellington and Palmerston North BICC have supplied the Co-axial Cable and ATE are supplying the Transmission equipment.

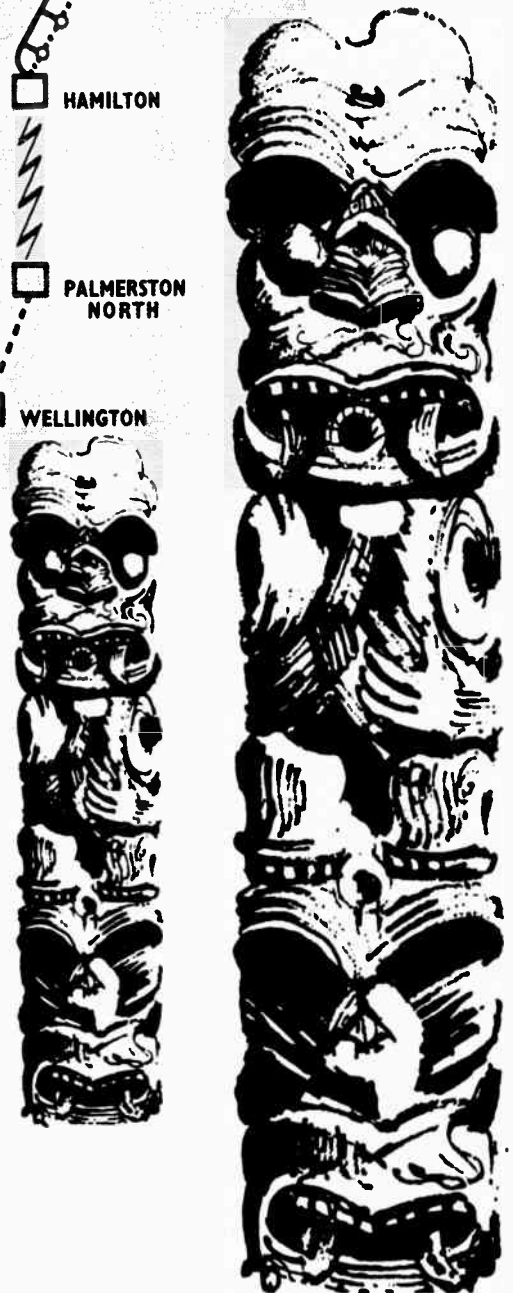

AT 14913

News Report

A monthly roundup of news and personnel changes in the Canadian electronics industry

Sales appointment for Varian's Radiation Division

Paul Corbell will fill the newly created position of sales manager for Varian Associates' Radiation Division, according to an announcement by William McBride, the division manager.



Paul Corbell

Mr. Corbell, who joined Varian in 1952 as applications engineer, Tube Division, was transferred to Canada in 1955 as manager of engineering and sales for the company's newly formed, wholly owned subsidiary, Varian Associates of Canada Ltd. In 1957 he was transferred to head up the firm's New York office, returning to the Palo Alto plant last year as assistant sales manager, Tube Division.

CGE vice-presidents

Robert M. Jennings, W. Frank Wansbrough and Walter G. Ward have been appointed vice-presidents of Canadian General Electric Company Limited. Announcement of the appointments was made by J. Herbert Smith, president, following a recent meeting of the company's board of directors.

Mr. Jennings is general manager of the Small Appliance Department at Barrie, Ontario. He joined CGE in 1930, following graduation in electrical engineering from the University of New Brunswick.

Mr. Wansbrough, who has his offices in the company's major appliance headquarters in Montreal, is general manager of the Appliance and Television Receiver Department. He joined the company in 1929.

Mr. Ward is general manager of the Apparatus Department, with headquarters in Peterborough, Ontario. Mr. Ward is an electrical engineering graduate of McGill University with 28 years' service with Canadian General Electric Company.

Canadian rep for Wayne Kerr instruments

Wayne Kerr Corporation, Philadelphia designers and producers of electronic measuring instruments, are represented in Canada by The Glendon Co., Ltd., 44 Wellington St. East, Toronto, Ontario.

GPL appoints Northern Electric as Canadian TV distributor

The Northern Electric Company Limited has been appointed exclusive Canadian distributor for GPL television equipment, according to an announcement by N. M. Marshall, associate director for sales of the industrial products division, General Precision Laboratory Incorporated, Pleasantville, New York, a subsidiary of General Precision Equipment Corp.

Northern Electric will handle the complete line of GPL closed-circuit television for industrial, institutional and military applications as well as telecine equipment for broadcast studio use.

Sales personnel of Northern Electric will service their territories from a network of zone and district offices located throughout Canada.

IRE Toronto Section holds April meeting

A meeting of the Institute of Radio Engineers, Toronto Section, was held on April 27, in the Mechanical Building, University of Toronto. Dr. Phillip Lapp, of the deHavilland Aircraft of Canada, addressed the meeting on "The Elements of Guided Missiles".

The meeting was arranged through the cooperation of the Canadian Astronautical Society of which Dr. Lapp is the first president.

C.E.W.A. elects new Board of Directors

At the fourth annual meeting and convention of the Canadian Electronic Wholesalers' Association held in the Fort Garry Hotel, Winnipeg, Manitoba, April 13 to 15, the following were elected to the Board of Directors for the ensuing fiscal year: O. L. Bell, of the Big "A" Company Limited, Belleville, Ontario, President; Leo Rosenberg, of Lee Bern & Company Limited, Winnipeg (retiring President), Chairman of the Board, Arnot M. Clark of Western Agencies Limited, Vancouver, B.C., Vice-President. Directors: John Dunn of Hygrade Radio Limited, Vancouver, B.C.; Ralph Bryanton of Radio Supply & Service Limited, Regina, Sask., N. J. Trehub, of Excel Distributing Inc., Montreal, and Alan G. Johnson, of Johnson Electric Supply Limited, North Bay, Ont.

The meeting was attended by the largest number of members from Eastern and Western Canada since the association became a national body

in 1956. The agenda covered a broad range of subjects designed to improve relations between supplier and wholesaler, with the object of stabilizing the business of electronic wholesaling in Canada. A resolution was passed and a wire sent to the Minister of Revenue in the Dominion Government at Ottawa expressing deep concern regarding the disruptive effect upon Canadian trade and unemployment caused by the importation of foreign electronic radio tubes and components. The Government was asked to study the problem and take immediate remedial action.

At meetings held in Toronto and Winnipeg prior to the annual convention the Eastern and Western Divisions elected their respective officers as follows: Eastern Division: Chairman, N. J. Trehub; Vice-Chairman, O. L. Bell. Western Division: Ellison M. Queale, Chairman; Ralph Bryanton, Vice-Chairman.



The newly elected Board of Directors of the C.E.W.A. are left to right: John T. Rochford, secretary-treasurer; Ralph Bryanton, N. J. Trehub, A. M. Clark (vice-president), O. L. Bell (president); Alan Johnson, John Dunn, Leo Rosenberg (chairman of the board).

International Systems marketing managers

International Systems Ltd. of Montreal, Que., announce the appointment of Jack Kingsnorth as manager, Head Office Marketing Division, Commercial Products, and Wally Evan-Jones as manager, Ontario Sales Division.



J. Kingsnorth



W. Evan-Jones

Born and educated in England, Mr. Kingsnorth has been associated with the electronics industry for the past 15 years. He was sales manager for Goodmans Industries Limited, of Wembley, England. He came to Canada in 1955 and joined the Canadian Marconi Company, Montreal, as technical sales representative for VHF radio and microwave communication and allied equipment.

Mr. Kingsnorth will be directing all aspects of the headquarters sales and marketing research operations.

Mr. Evan-Jones in his new position will be in charge of the Toronto branch sales office and will be responsible for the sales promotion activities in the province of Ontario.

Born and educated in Toronto, Mr. Evan-Jones has been actively engaged in the communications and electronics engineering and sales fields for the past 25 years. He has been employed with the Communications Group, Hydro Electric Power Commission of Ontario, Canadian Marconi Company, Canadian Westinghouse Company and RCA Victor Co. Ltd., Montreal, where he was responsible for the sales promotion of Land-Mobile Radio products.

Mr. Evan-Jones holds membership in the IRE and is a member of the Professional Group Vehicular Communications.

Ahearn and Soper add new tube line

The Ahearn and Soper Company Limited now complement their line of tubes by the addition of National Union Electric Corporation of Bloomington, Ill. High voltage amplifier-regulators, digital read-out and magnetic pick-up tubes will be carried in Ottawa stock.

1959-60 officers for IRE Toronto Section

Elected officers of the Toronto Section of the Institute of Radio Engineers for the 1959-60 season are as follows: chairman — R. J. A. Turner, Lake Engineering Co. Ltd.; vice-chairman — K. MacKenzie, McCurdy Radio Industries Ltd.; secretary-treasurer — G. T. Quigley, Philips Electronics Industries Ltd.

Recently appointed standing committee chairmen are: meetings and papers — W. H. Anderson, P.Eng., Ryerson Institute of Technology; membership—F. A. Ford, P.Eng., Canadian General Electric Co., Ltd.; publicity — A. H. Secord, P. Eng., Sinclair Radio Labs. Ltd.; entertainment — J. L. Jordan, North York Hydro Electric Commission; education — C. R. Oakes, University of Toronto; U. of T. Student Branch Representative — Dr. J. L. Yen; Ryerson Institute Student Associate Branch Representative — E. L. Kerridge; section editor, Region 8 Publication — G. G. Armitage, Rogers Electronics Tubes & Components.

The new executive held its first meeting on April 28, at which time plans were laid for the 1959-60 technical program. Two students will be invited to attend each supper meeting which precedes the technical session planned for 7.30 p.m. during this coming season. This year the executive are stressing the value of this social hour and a real effort will be made to attract new people to these dinner meetings.

W. E. Davison retires from Radio Valve

The retirement of W. E. Davison as president of the Radio Valve Company Limited was marked on May 14 last by a testimonial dinner at the Granite Club in Toronto which was attended by business associates and friends. Mr. Davison's retirement ends a career which began with the General Electric Company on October 3, 1910 with which company he was subsequently to serve for a period of 49 years, 37 years of which were in direct association with the Radio Valve Company Limited.

In 1921 Davison was selected by the G.E. Company to come to Canada and set up the Vacuum Tube Division of the Canadian General Electric Company and in 1932 was named as the managing director of this enterprise. During the years of the second world war Davison was given the task of establishing and managing a radar tube plant which achieved a production rate of 500 tubes daily. In 1948

he was appointed president of the Radio Valve Company and remained in this position to see the construction of the modern Rexdale picture tube plant that commenced operation in August 1956.

Over the years of his association with the Radio Valve Company Limited Mr. Davison has been actively connected with the activities of the Parts and Accessories Division of the Radio Manufacturers Association.

DDP contracts awarded in electronics field

Contracts for electronic equipment were awarded by the Department of Defense Production in the first half of April as follows: electronic components — Canadian Charts & Supplies Ltd., Oakville, Ontario, \$316,073; Canadian General Electric Co., Ltd., Toronto, Ontario, \$49,602; R.O.R. Associates Ltd., Don Mills, Ontario, \$11,365; TMC (Canada) Ltd., Ottawa, Ontario, \$21,822; sonar equipment — Edo (Canada) Ltd., Cornwall, Ontario, \$11,264.

S. F. Love to engineering post

The appointment of Sydney F. Love, P.Eng., as supervisor of television engineering for the Electrohome Products Division of Dominion



S. F. Love

Electrohome Industries Ltd., Kitchener, has been announced by David H. Johnston, the division's engineering manager.

Mr. Love, a native of Winnipeg, finished his elementary school education in Cornwall, Ont., and attended secondary school in Toronto. He was graduated from the University of Toronto in 1947 with a B.A. Sc. degree in engineering physics and the next year received his M.A. degree in physics and electronics from the same university.

Following graduation, Mr. Love spent two years as an instructor in the communications laboratory at the University of Toronto. He was with Pye Ltd., Cambridge, England, in 1951 and 1952 when he returned to Toronto to become supervisor of applications engineering for the Radio Valve Company. Mr. Love assumed his present position with Electrohome in April bringing with him 10 years of engineering experience in radio and television.

B.I.C.C. board appointment

The appointment of Sir John N. Dean, B.Sc., A.R.I.C., F.I.R.I., to the board of directors of British Insulated Callender's Cables Ltd. of London, England, has recently been announced.



Sir John N. Dean

Sir John Dean is the chairman (executive) of the Telegraph Construction & Maintenance Company Limited, generally referred to as TELCON, and this announcement coincides with the merger of his company with the B.I.C.C. group.

In Canada recently, Sir John visited the Brockville plant of the Phillips Electrical Co. Ltd., which is the Canadian member of the B.I.C.C. group.

Active Radio Limited named Canadian rep

The appointment of Active Radio and T.V. Ltd., was announced recently by Jacques Ebert, vice-president sales, Chemtronics Inc., 122 Montgomery St., Brooklyn, N.Y., to represent the chemical firm in Canada. Chemtronics manufactures a complete chemical line for the electronics industry, which include: tuner and volume control cleaners, high voltage insulators, cements, glues, tape recorder cleaner and lubricants.

Active Radio, headed by Harold and Mike Rosen, is located at 58 Spadina Ave., Toronto 2B, Ontario.

Appointment by General Instrument - F. W. Sickles

Announcement was made recently by J. McK. McLean, vice-president and general manager of General Instrument - F. W. Sickles of Canada Ltd., Waterloo, Ontario, of the appointment of Ernest A. Thomas as director of engineering, covering all Canadian operations of the company.



E. A. Thomas

This new position has been created as a result of the considerable growth of the company's operations and the addition of a number of new products, including meteorological devices and semiconductors.

Prior to this appointment, Mr. Thomas was chief engineer for the Radio and Television Division of Canadian Westinghouse Company Limited.

Canadian reps for Buchanan Electrical Products Corp.

Buchanan Electrical Products Corporation of Hillside, N.J., a subsidiary of the Elastic Stop Nut Corporation of America, Union, N.J., is represented in Canada by Gasaccumulator Co. (Canada) Ltd., 12 Gower Street, Toronto, Ontario. Gasaccumulator Co., in turn, has local representatives in Calgary, Edmonton, Montreal, Toronto and Vancouver.

Buchanan Electrical Products Corporation produce terminal blocks, fanning strips, snap-on nylon insulators for solderless wire splicing, terminals for solderless wire terminating, and hand and pneumatic tools for installing AN and other solderless types of multi-contact plug and receptacle connectors.

Pedaco Limited announce opening

Pedaco Limited, Box 156, Station "D", Toronto 9, Ontario, incorporated recently, is supplying engineering, development, and manufacturing services in the general area of instrumentation, data handling and industrial electronics.

With extensive design and practical experience in these areas derived from its four member engineering staff, the company is looking forward to a year of consolidation and expansion.

General Radio Co. moves to Concord, Mass.

The General Radio Company, manufacturer of electronic measuring equipment, is in course of moving its headquarters from Cambridge to new offices in West Concord, Massachusetts. The facilities completed this year are part of a long-range plan conceived in 1948 when the company purchased 80 acres of land in Concord.

General Radio maintains a district sales office in Canada (at 99 Floral Parkway, Toronto 15, Ontario) staffed by Arthur Kingsnorth and Richard Provan.

A. C. Wickman represent Micro-Test in Canada

Announcement was made recently that A. C. Wickman Limited of Toronto have been appointed exclusive Canadian representatives for Micro-Test, Inc. of California.

Micro-Test manufacture weldable strain gauges which may be quickly applied to a clean surface by spot-welding. Because of its basic construction, the gauge may be used in

temperatures as high as 1600°F and as low as minus 320°F. Specially calibrated gauges may be supplied with apparent strains of .2 microinch per inch per degree F without the use of a dummy gauge.

Information or advice on specific applications is available from Electronics Division, A. C. Wickman Limited, P.O. Box 9, Station "N", Toronto 14, Ontario.

CGE Industrial Products Dept. appointments

Announcement has been made of the appointment of W. Harry Prevey as manager—Application Engineering and System Sales for the Industrial Products Department of Canadian General Electric Company Limited.

Since joining the company in 1936, Mr. Prevey has had a wide association with engineering and marketing segments of the organization. He brings a broad background of product knowledge and application engineering experience to his new assignment.

Mr. Prevey will make his headquarters at 940 Lansdowne Ave., Toronto 4, Ontario, and will work with the company's district offices from coast-to-coast on the application of distribution equipment to electrical distribution systems of utilities and industries.

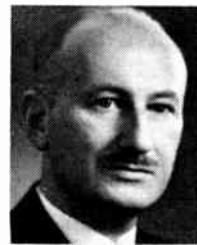

R. M. Love



W. H. Prevey

Robert M. Love has been appointed sales manager — Distribution and Instrument Transformers in the Industrial Products Department of Canadian General Electric.

Mr. Love joined the company in 1917 and has had wide experience in various marketing areas of the company. Since 1954 he has been manager — Ontario District Sales, and prior to that was sales manager — Distribution Transformer and Lighting Equipment of the company's former Supply Dept.

Mr. Love, too, will make his headquarters at 940 Lansdowne Avenue, Toronto 4, and will be closely associated in his new position with the company's country-wide chain of district offices in the sales and planning of distribution transformers, distribution protective equipment and instrument transformers.

Continued on page 66

ATTENTION PLEASE!

The new address of
Electronics & Communications
 is 450 Alliance Avenue,
 Toronto 9, Ontario, Canada.
 All editorial and advertising
 correspondence should be
 directed to this address.



Beatty Telemasts

FOR COMMERCIAL COMMUNICATIONS

Masts to 200 ft.—single, twin-H, and quadruple — designed to CSA specifications. Hot galvanized steel, resistance welded to Canadian Welding Bureau standards, in accurate jigs that insure easy and perfect erection. 10-foot sections completely hot galvanized after all fabrication. Galvanized hinged steel base and complete line of attachment fittings.

BEATTY BROS. LIMITED
 Fergus, Ont. Est. 1874

For complete details check No. 15 on handy card, page 89.

ANOTHER PRODUCT OF CANADIAN INGENUITY:

A truly dependable source of 20 c/s ringing current.

- Independent of A.C. mains.
- No maintenance.
- Accurate frequency for signalling.
- 20 watt capacity.



PYLON ELECTRONIC DEVELOPMENT company, Ltd.
Communications Systems and Equipment
 161 CLEMENT ST., VILLE LASALLE, MONTREAL 32, QUE.

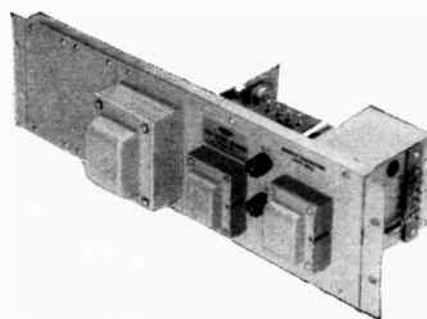

PYLON RINGING GENERATOR
 TYPE RG-1

For complete details check No. 60 on handy card, page 89.



★ RADIO ★ COMMUNICATIONS

Head Office:
 84 Northline Rd., Toronto 16, Ontario



Halifax, Moncton, Montreal,
 Toronto, Winnipeg, Vancouver

now...extremely long life!



TWENTY MILLION snap-actions—yet no bigger than a paper clip!

LICON*

TYPE 11 SNAP-ACTION SWITCH

This new Licon precision snap-action switch design eliminates dead break and provides much greater overload capacity. Constructed to military and industrial standards, it can be obtained in a wide differential movement range from .008 to .030. Licon Type 11, a high electrical capacity snap-action switch, is extremely compact . . . perfect for use where size and dependability are important. Meets MIL S-6743 specifications. Write for Bulletin.

LICON

SWITCHES AND CONTROLS
DIVISION OF
CANADA ILLINOIS TOOLS LTD.
67 Scarsdale Rd.
Don Mills, Ontario

Exclusive Sales Agents

CONSTELLATION
COMPONENTS LTD.

136 Tower Drive, Toronto
17041 Omega Place
St. Genevieve, Montreal

LI-G

For complete details check No. 18 on handy card, page 89.

NEW THE DELHI SPAULDING STRATO-TOWER

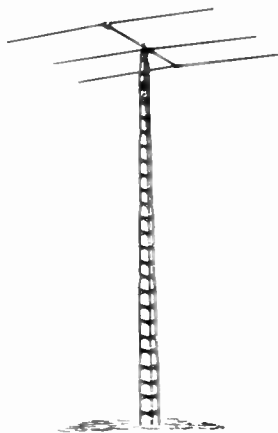

SELF-SUPPORTING
TOWERS UP TO 67 FT!

- Heavily galvanized, all-steel construction
- Riveted joints — no rust-prone welds
- Smart, modern styling
- "X" brace design for greater strength
- Beaded channel leg eliminates twisting
- Quickly, easily erected
- A Product of Canada's leading TV Antenna manufacturer

Your Choice of 4 Bases

The Strato-Tower comes with four different types of base: One for anchoring in concrete; one using a screw anchor; another using a cylinder base; and one to be anchored to the side of a building with ground rods driven through holes in the base.

See the Spaulding Strato-Tower today at any Delhi dealer

ALSO AVAILABLE:

Guyed towers up to 150 ft. in height and an "Erect-Tower" using a crank-up principle to 100 ft.

DELHI METAL PRODUCTS LIMITED
DELHI, ONTARIO

For domestic TV and all types of commercial requirements

For complete details check No. 33 on handy card, page 89.

NEW variable composition resistor

1/2" inch diameter, 1/2 watt. With "moulded in" gold plated solder lugs. Built to meet highest military and industrial requirements.

MADE ENTIRELY IN CANADA

PRECISION ELECTRONIC COMPONENTS (1956) LTD.

50 Wingold Avenue — Toronto 19
RUssell 1-6174

Montreal HU. 9-8495

For complete details check No. 58 on handy card, page 89.
ELECTRONICS AND COMMUNICATIONS. June, 1959

BIG 1959 CATALOGUE FREE!



ONE SOURCE FOR ALL YOUR
ELECTRONIC REQUIREMENTS

Name

Company

Address

City Prov.

WHOLESALE RADIO & ELECTRONICS LTD.
66 Orfus Road - TORONTO 19, ONTARIO - Phone RUssell 7-1271

For complete details check No. 79 on handy card, page 89.

DESIGN ENGINEERS

Select the Right Choke
INSTANTLY!



ESSEX ELECTRONICS

R.F. Choke Kits

Epoxy-encapsulated, High-Reliability R.F. Chokes available in 4 handy kits for design engineers:

| | | |
|-----------|-------------------------------|----------------------|
| RFC - WEE | 0.1 μ H to 1,000 μ H | 0.150 Dia. x 0.375 L |
| RFC - S | 0.1 μ H to 100 μ H | 0.188 Dia. x 0.44 L |
| RFC - M | 1.0 μ H to 1,000 μ H | 0.25 Dia. x 0.60 L |
| RFC - L | 1.0 μ H to 10,000 μ H | 0.31 Dia. x 0.90 L |

Data sheets available on request both for the Choke Kits and for the Essex Electronics Standard Line of Chokes. Both the kits and production quantities of chokes are available from stock.



Chokes • Delay Lines • Coils • Pulse Transformers
ESSEX ELECTRONICS
A DIVISION OF
NATIONAL ELECTRONICS

99 WRAGGE ST., TRENTON, ONTARIO, CANADA
For complete details check No. 37

Canadian Applied Research has new headquarters

Canadian Applied Research Limited and Phoenix Engineered Products Limited have recently been merged by A. V. Roe Canada Limited into a single corporate entity which will continue in the name of Canadian Applied Research Limited.

To take care of this expansion, CARL's Manufacturing, Sales and Service, and Finance Divisions, together with the administrative offices, have moved from 1500 O'Connor Drive to 750 Lawrence Avenue West, Toronto. The Engineering Division will remain at 1500 O'Connor Drive.

Leetronics Inc. appoint local sales rep

Leetronics, Inc. of Brooklyn, N.Y. have announced the appointment of William M. Hummel of Port Credit, Ontario as exclusive sales representative for the Provinces of Ontario and Quebec.

Products consist of special design rotary solenoids for micro-waveguide switching, fail-safe flag signals and position indicators as well as miniature light-weight to heavy duty rotary solenoids for industrial use.

TECHNICAL SALES REP



Roger Desrosiers

The appointment of Roger Desrosiers as technical sales representative is announced by S. E. A. Pinnell, president and sales manager of Pylon Electronic Development Co., Ltd., LaSalle, Quebec. Formerly associated with Stromberg-Carlson, Mr. Desrosiers brings a wide background of experience to serve the growing number of customers for Pylon's electronics engineering facilities.

aluminum alloy

TOWERS

for every application

complete range of:



- TELE COMM. TOWERS
- MICROWAVE
- MOBILE
- BEACON, MARINE AND AIR
- Erection costs lower
- Equal strength of steel
- One third weight of steel
- Ease of handling to site and erection
- No maintenance — no corrosion

Specialists in design and
custom engineered towers

THERE IS A MILLARD TOWER FOR EVERY APPLICATION



MILLARD
ELECTRIC LIMITED
PERTH, ONT., CANADA

For complete details check No. 50 on handy card, page 89.

DIRECT READING OF
FM DEVIATION . . .
25 to 500 mc. At Low Cost!



LAMPKIN 205-A FM MODULATION METER

- Indicates instantaneous peak modulation, plus or minus, an 0-12.5 or 0-25.0 KC scales.
 - Accuracy 10% of full scale.
 - Tunable 25 to 500 MC in one band, with fast and slow controls.
 - Sensitivity 20 millivolts or better throughout range.
 - Speaker for aural monitoring, oscilloscope output for visual monitoring.
 - Meets Department of Transport specs for mobile-radio maintenance.
 - Size only 7" x 12" x 7 1/4". Weight 13 lbs.
 - Price \$240.00 net (does not include duty). Satisfaction guaranteed or money refunded.
- To measure transmitter center frequencies, from 0.1 to 175 MC (to 3,000 MC by checking multipliers), with an accuracy better than 0.0025%, use the LAMPKIN 105-B MICROMETER FREQUENCY METER.

Write today for technical data
on both instruments.

LAMPKIN LABORATORIES, INC.
Dept. 707, Bradenton, Florida, U.S.A.

For complete details check No. 47

ADCOLA

REGD. TRADE MARK

MODERN SOLDERING EQUIPMENT

Illustrated:

Instrument
Cat. No. 70

and

Protective Shield
Cat. No. 68

Canadian Sales
and Service

L. J. LAMB
Box 103
Weston, Ont.
CH. 1-5830

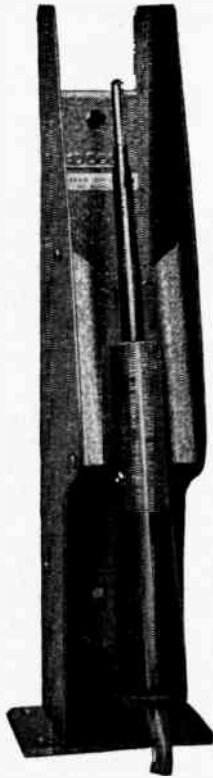

Used on

the transatlantic
telephone
submarine cable
between
Newfoundland
& Nova Scotia
for wiring
the 2-way
submerged
telephone
repeater
amplifiers.

For complete details check No. 1 on handy card, page 89.

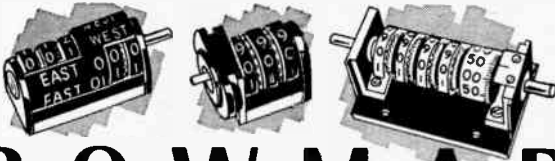

B O W M A R PRECISION COUNTERS

ALL TYPES • ALL SIZES
ALL QUANTITIES



HEADING AND
AZIMUTH
COUNTERS



DECIMAL
COUNTERS



LATITUDE
LONGITUDE
COUNTERS



SPECIAL
ASSEMBLIES
AND INDICATING
DEVICES

Bowmar designs and manufactures precision counting devices and counter packages to all military and customer specifications. Although designs are unlimited, Bowmar is particularly adept in the engineering and production of units in the navigational, ranging, fire control and tracking fields.

Send for data
package 159



AEROMOTIVE ENGINEERING PRODUCTS LTD.
Montreal: 147 Hymus Blvd., Pointe Claire, Que. OX. 7-0810
Toronto: 1912A Avenue Road RU 3-4288

For complete details check No. 2 on handy card, page 89.
ELECTRONICS AND COMMUNICATIONS, June, 1959

SMALLER - LIGHTER - STRONGER ARROW-HART Appliance Switches



A COMPLETE RANGE

For vacuum sweepers, fans, power tools, etc., and radio and electronic equipment.

Send for your free
copy of our new
catalogue Z-10



5906
ARROW-HART & HEGEMAN (CANADA) LIMITED

Industry Street, Toronto 15, Ontario. Phone RO. 2-1101
7365 Mountain Sights, Montreal, Quebec.

Representatives: Cochrane Stephenson (Western) Ltd., Winnipeg, Calgary, Edmonton, Vancouver • George C. Robinson, Saint John, N.B.

QUALITY MOTOR CONTROLS • WIRING DEVICES • APPLIANCE SWITCHES

For complete details check No. 9 on handy card, page 89.

ADAPTABLE FOR ALL APPLICATIONS

Hoyt Panel Meters



Model
No. 661

New series for limited space installations. Front opening — 1 1/2" class — 2% accuracy — standard mounting dimensions — front zero adjustment. In DC ranges from 100 microamps; and self-contained rectifier types, VU, and voltmeters up to 300 v.

Be sure of the highest accuracy, dependability, and readability — plus economy — with HOYT precision electrical instruments. Moving coil, rectifier, and repulsion types available in a wide variety of sizes, ranges, cases, and colors — many with parallax-free, mirror scales . . . the complete Line of matched AC and DC Panel Meters for original equipment or replacement use. Also, custom-designed (including 50-2000+ cycle applications) to meet your most rigid specifications.

Prompt Delivery —
M/A Forms mailed on
day of shipment.

Service Facilities —
strategically located in
Canada.



Write Export Manager — new illustrated literature contains descriptions, engineering data, and prices.



ELECTRICAL INSTRUMENTS

Sales Div.: BURTON-ROGERS COMPANY
42 Carleton Street, Cambridge 42, Mass., U.S.A.

For complete details check No. 16 on handy card, page 89.

Northern Electric Co. sales appointments

H. C. Way was recently appointed manager of the central zone of Northern Electric Company's sales division.

Mr. Way, who joined the company in Toronto in 1930, has served in various capacities in the company's merchandising department and was appointed general merchandising manager in 1946. In 1952 he went to Vancouver as district sales manager, becoming assistant district manager in 1955 and manager of the Pacific district the same year.

Since 1958 Mr. Way has been marketing manager of the sales division with headquarters in Montreal.



F. G. Samis



H. C. Way

F. G. Samis has been appointed marketing manager of the sales division of Northern Electric, succeeding H. C. Way.

Mr. Samis joined the company in 1936, in Toronto. After a number of years in the company's various service departments in that city and in Sudbury, Mr. Samis went to Montreal as priorities supervisor, becoming assistant comptroller of purchasing in 1947, comptroller of purchasing one year later and commercial manager in 1953.

Burndy executive appointments

F. H. McLenaghan, general manager of Burndy Canada Ltd., announces the following top management appointments.

Guy Vandry is appointed general sales manager responsible for all Canadian sales including Burndy sales offices in Montreal, Toronto, Winnipeg, Regina, Calgary and Vancouver. Vandry was previously Eastern district sales manager and utility market manager.



S. G. Ward

Garton Ward is appointed chief engineer. A member of Burndy's top management team since 1952 and well known in the industry as general sales manager of the company, Mr. Ward will now be responsible for expanding its application, development and production engineering departments.

Steuart Holder is appointed plant manager and becomes the member of Burndy's management team responsible for production. Mr. Holder joined Burndy in 1957 after gaining extensive experience in major utility and industrial plants in Quebec and Ontario.

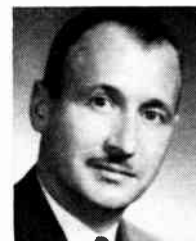

G. Vandry



S. Holder

The appointments follow the promotion of Alan Thomson, previously works manager of Burndy Canada, to an important position in another division of Burndy Corporation and the appointment of Roy F. E. Bunston as an engineering consultant to Burndy Canada Ltd.

Continued on page 70

KAYDON *produced* *this giant bearing*

... an ultra-precision, hardened bearing, 165" O.D. — and regularly produces "tailor made" bearings to 178" O.D. with diameter-tolerances as close as 0.002" on the largest sizes.

Whether your need is for giants like these or for much smaller bearings, call R&M ... KAYDON's Canadian distributors.

R&M offers a full range of KAYDON Special Bearings plus KAYDON's complete line of "Reali-Slim" Standard Ball and Roller Bearings — radial load and thrust types — as small as 4" I.D.

For all applications where minimum weight and thickness of bearing wall — in relation to load capacities — are prime considerations, the unique "slimness" of KAYDON bearings makes them your logical choice.



18

R&M BEARINGS CANADA LTD.

VANCOUVER WINNIPEG LONDON HAMILTON
TORONTO MONTREAL THREE RIVERS QUEBEC CITY

Write to R&M, 1006 Mountain Street, Montreal, for the KAYDON "Reali-Slim" Engineering Catalogue No. 54 or the KAYDON Engineering Data Manual No. 46.

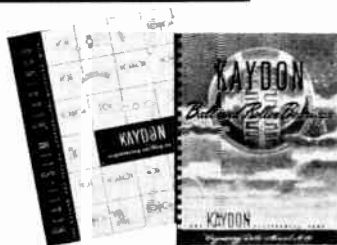

For complete details check No. 61 on handy card, page 89.

FIRST

to test
both
FOREIGN
&
AMERICAN
Tubes



Model 9-66 U

FOREIGN & AMERICAN TUBES

By including permanently wired Foreign Base Type Sockets, in addition to the full quota of American Sockets, the STARK Model 9-66U is capable of testing an exceptionally wide range of tubes (approx. 2500) used by Radio, TV, Hi-Fi, and Industrial Technicians.

DYNAMIC MUTUAL CONDUCTANCE

To assure you of accurate test readings, each tube is thoroughly checked by the patented STARK HICKOK method of Dynamic Mutual Conductance . . . the time-proven method of precise voltage calibration.

ENGLISH & TRUE MICROMHOS

Scale readings are read directly off the 3-range micromho scale (0-3,000; 6,000; 15,000) in both English and True Micromhos. The Tester uses rectifier current to energize both plates and grid. Provision is made for new tube designs. Provides vital life test. Noise test. Incorporates facilities for checking of CRT tube with adaptor.

AUTOMATIC DATA SERVICE

A replacement roll chart service for all Stark Tube Testers, comprising of one chart and three supplements, is supplied annually for the nominal sum of \$4.00 — or — \$9.00 for three years.

MODEL 9-66:

Incorporates all the outstanding features of the Model 9-66U with the exception of foreign base type sockets.

NOW! TEST ALL TUBES

Owners of the Stark Model 9-66 may have their present sets modified to incorporate Foreign Base Type Sockets, permanently wired, at a cost of \$60.00. Send instrument prepaid to:

STARK ELECTRONIC INSTRUMENTS LIMITED
Ajax, Ontario

Radio & TV Technicians

Model 8-77: Every up-to-date requirement in a Radio & TV Technician's Vacuum Tube Tester has been incorporated in this compact 16 lb. portable tester. You can check filament voltages in 18 steps from 0.6 to 117 volts . . . check scale readings directly on the 3-range micromho scale (0-3,000; 6,000; 15,000). Includes such outstanding features as:

- Stark-Hickok Dynamic Mutual Conductance;
- High Speed Short Test (12 times more sensitive!)
- Grid Current Test • Filament Continuity Test
- Reserve Cathode Capacity Test

Exclusive New Socket Design: Snap-in Master Socket Panel slips off easily, exposing new 11-pin socket and saves time in replacing worn-out sockets.

You TEST BEST with STARK

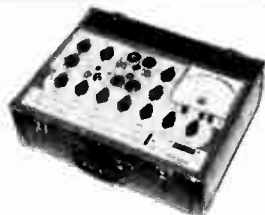

STARK ELECTRONIC INSTRUMENTS LTD.
Factories and Sales Office: Ajax, Ont.
Foreign Representative:
Stark Electronic Instruments Ltd.
13 East 40th St., New York 16
N.Y., U.S.A.

S-592

For complete details check No. 70 on handy card, page 89.
ELECTRONICS AND COMMUNICATIONS, June, 1959



CONTROL KEY SWITCHES

for **LOW VOLTAGE MULTIPLE SWITCHING**

T.M.C. CONTROL KEY SWITCHES, precise in design and of robust construction, are today performing their vitally continuous work in varying apparatus all over the world.

Lever type control switch (Large)

■ Operators feeling the clean and positive "Make and break" action in any of the fifty standard spring combinations forget any fear of failure.

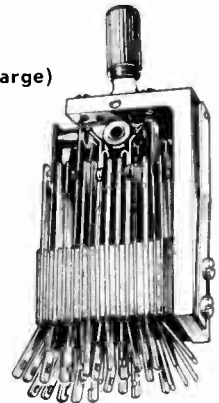

Lever type control switch (Small)

■ The contact springs made of nickel silver operated by hard plastic rollers on steel cams and silver contacts, ensure perfect performance.

Plunger type control key switches

■ Platinum or other metal can be supplied for special operating conditions.



Telephone EM. 6-5314 or write for T.M.C. Control Key Catalogue giving full technical data to:

TELEPHONE MANUFACTURING CO. LTD.
SAXONY BUILDING • 26 DUNCAN STREET
TORONTO, ONT. Telephone EM. 6-5314

For complete details check No. 73 on handy card, page 89.

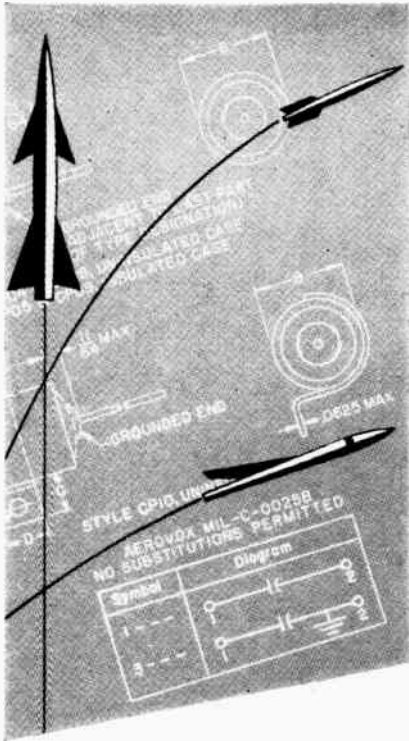

FIRST FROM BLUE PRINT TO BLUE SKY

One source for your
Mil-capacitors for
all airborne electronic
equipment and
missile applications.

For details and expert
technical assistance
on all Mil type
capacitors write or
wire:

AEROVOX
CANADA LIMITED
Hamilton, Ontario

For complete details check No. 3

CGE develops new TV slot antennas

The Canadian General Electric Company Limited has established a new television broadcast antenna test site at Rexdale, on the outskirts of Toronto. Tests at the new antenna site have brought excellent results.

The tallest TV antenna ever built in Canada was unveiled and tested at this site during the winter months. Edgar J. Gareau, broadcast specialist for the Electronic Equipment and Tube Department of CGE, said the antenna is designed for use on the low channels, 4 to 6.

Termed an Ultra-Power slot antenna, due to its high power gain, the device consists of a hollow, constant diameter mast, an RF power feed system, and sleet melting equipment. Wind loading on an antenna is a significant factor in the design of its supporting tower structure, Mr. Gareau explained. The small antenna diameter, as well as the flexibility of guying the antenna, results in less severe structural requirements for towers, thus permitting lower tower prices when G-E Ultra-Power slot antennas are used.

DAYSTROM APPOINTMENT



H. W. Cowan

The appointment of H. W. Cowan as vice-president and general manager of Daystrom Limited was announced recently by Daystrom president, W. H. Westphal. The announcement followed a regular meeting of the company's board of directors. Mr. Cowan has been manager of Daystrom Limited since its establishment in Canada early in 1957.



NEED A CAVITY?

HERE'S A
CAVITY RESONATOR
DESIGNED FOR YOU



Also available
for 30-50 mc.
and 450-470 mc.

TYPE CR-150
152-176 mc.

- Field adjustable over entire band.
- Excellent rejection characteristics.
- Insertion loss 0.5 to 3 db — adjustable without removing loops.
- Temperature compensated.
- Size — 26½" x 6¼"; Weight — 10 lbs.
- Impedance — 50 ohms; Terminations — Type N Female.
- List price — \$225.00 (incl. mounting brackets), F.O.B. Montreal, F.S.T. included.

MADE BY
**DIELECTRIC PRODUCTS
ENGINEERING COMPANY, INC.**

IN CANADA
DAYRAND LIMITED
4612 St. Catherine Street W., Montreal 6, Quebec



For complete details check No. 30

multi-range multi-purpose

automatic cut-out

20,000 ohms/volt d.c.

a.c. & d.c. current ranges

accurate

Model 8 Universal AvoMeter

**ELECTRONICS
RADIO
TELEVISION**

The multi-range instrument with automatic cut-out protection for overload . . . just reset and carry on reading.

OTHER FEATURES:

4 Current Ranges:
100 mA. to 10 Amperes A.C.

7 Current Ranges:
50 μ A. to 10 Amperes D.C.

14 Voltage Ranges:
2.5 Volts to 2,500 Volts
A.C. and D.C.

3 Resistance Ranges:
0.5 Ohms to 20 Megohms

Comprehensive AvoMeter Bulletin
available on request.



5011

Complete factory repair
service with all spares in
stock, available at our
Toronto plant.

R.H. Nichols LIMITED

4544 DUFFERIN STREET, TORONTO

TORONTO MAIL: P.O. Box 500 DOWNSVIEW, Ontario
OTTAWA: P.O. Box 113
VANCOUVER: 624 Vancouver Block 736 Granville Street

For complete details check No. 53 on handy card, page 89.
ELECTRONICS AND COMMUNICATIONS, June, 1959

HUGHES PARAMETRIC AMPLIFIER DIODES

Two rugged, hermetically sealed versions of high performance diodes are now available — priced in same range as good microwave mixer crystals. Use for parametric amplifiers, modulators, frequency convertors, harmonic generators, tuners and switches at h.f. and microwave frequencies. Noise temperatures of 100°K without cooling are readily obtainable.

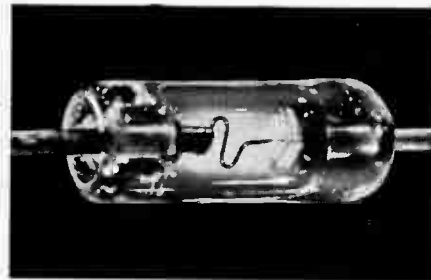

SPECIFICATIONS

TYPE HPA 2800

| Package | Cutoff | V_{κ} min | C | C at 0 bias |
|-----------------------------|--------|------------------|---------|-------------|
| Miniature glass diode style | 70 KMC | 5V | 0.1 uuf | 2.5 uuf |

TYPE HPA 2810

| Package | Cutoff | V_{κ} min | C | C at 0 bias |
|----------------------------|--------|------------------|---------|-------------|
| Microwave reversible diode | 70 KMC | 5V | 0.2 uuf | 2.5 uuf |

Write for full data and prices on Hughes diodes, transistors, rectifiers and Zener diodes.



Hughes diodes are now in stock at our Toronto and Montreal branches.

R-O-R ASSOCIATES LIMITED

1470 DON MILLS RD., DON MILLS, ONT.

TORONTO
Hickory 4-4429

TELEPHONE

MONTREAL
HUNter 1-0700

For complete details check No. 62 on handy card, page 89.

THE NATIONAL SCENE



“Where can flame-retardance improve your product; make it safer . . . function better . . . or sell faster?”

Choose from 11 National Materials—in sheets, tubes, rods, formed shapes, or precision-fabricated parts

Computers, high-voltage switchgear, home appliances, television receivers, radios and radar . . . aircraft and missile instrumentation . . . in fact, with any product where fire is a potential, flame-retardant laminates pay-off in design features and product protection.

The “pay-off” comes in protection of lives and expensive equipment from fire, because these materials are self-extinguishing. As barriers, base plates, terminal boards, support members, printed circuits—National’s family of flame-retardant materials is solving problems of fire containment and those involving *both* fire and electrical insulation.

Surprisingly, *low cost* is a feature of several of these materials. And since they mean more safety and product protection for the user, the “pay-off” also comes in the form of added product sales features.

Write for complete property values on these eleven materials, and let us know what your particular problem is. If you wish samples and price information, drop us a note on your letterhead. National Fibre Company of Canada, Ltd., Dept. O-6, Toronto 3, Ontario,

| Grade | Base | Resin | Extinguishing Time (sec.) UL |
|----------|-------------|-----------|------------------------------|
| PYRONIL | Cellulose | None | <1 |
| X-121 | Paper | Phenolic | 2-4 |
| X-122 | Paper | Phenolic | 1 |
| XX-326 | Paper | Phenolic | 1 ½-2 |
| XXXP-475 | Paper | Phenolic | <1-1 ½ |
| GP-9202 | Glass Mat | Polyester | <1 |
| GP-9204 | Glass Mat | Polyester | <1 |
| G-5-813 | Glass Cloth | Melamine | <1 |
| G-7-832 | Glass Cloth | Silicone | <1 |
| GH-871 | Glass Cloth | Phenolic | <1 |
| EP-491 | Paper | Epoxy | <1 |

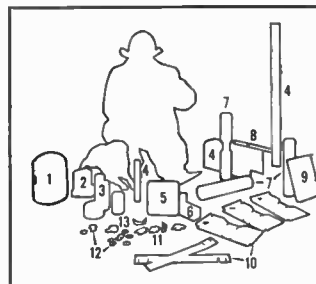

1. Weldor's Shield. 2. Box.
3. Coil Forms. 4. Circuit Breaker
- Parts. 5. Coil Form Base.
6. Film Splicer Housing. 7. High Voltage Bushings. 8. Bus Bar Insulator. 9. Printed Circuit.
10. Portable TV Shields. 11. Switch Shields. 12. Switch Plates. 13. Stand-Off Insulator.

For complete details check No. 52 on handy card, page 89.



CHOOSE FROM THESE MATERIALS...

Vulcanized Fibre: 10 standard grades; many special grades.

PHENOLITE Laminated Plastic: over 80 standard and modified grades; paper, cotton fabric, nylon, asbestos, glass fabric, cotton and glass mat bases; phenolic, melamine, polyester, epoxy, reffon or silicone resins.

PEERLESS Electrical Insulation: coil, strip, corrugated.

Extruded Nylon: 2 grades; rod, strip, pressure tubing, special shapes.

Polyester Glass Mat: 4 standard sheet grades; custom molded shapes.

PHENOLITE Copper-Clad Laminates: 10 standard grades.

Combination Materials: Rubber-PHENOLITE; Rubber-Fibre; Wood-Fibre; Metal-Fibre; Asbestos-Fibre; PEERLESS-PHENOLITE.

BACKED BY THESE SERVICES...

Field Application Assistance
Complete Fabricated Parts Service
Stock Program for Immediate Shipment

BY CALLING THESE OFFICES...

| | | |
|----------------|------------|--------|
| Baltimore | Valley | 3-0393 |
| Boston | TWinbrook | 4-3500 |
| Chicago | Austin | 7-1955 |
| Cincinnati | Garfield | 1-0632 |
| Cleveland | ERievew | 1-0240 |
| Dallas | DAvis | 4-4386 |
| Denver | MAin | 3-2077 |
| Detroit | UNiversity | 3-3632 |
| Griffin, Ga. | | 8-1308 |
| Indianapolis | Walnut | 3-6381 |
| Los Angeles | RAYmond | 3-0291 |
| Milwaukee | BRoadway | 6-6995 |
| New Haven | LOcust | 2-3594 |
| Newark | MITchell | 2-6090 |
| New York | COrtlandt | 7-3895 |
| Philadelphia | SHerwood | 8-0760 |
| Pittsburgh | FAirfax | 1-3939 |
| Rochester | HIllside | 5-0900 |
| St. Louis | PArkview | 5-9577 |
| St. Petersburg | | 5-5505 |
| San Francisco | DAvenport | 6-4667 |
| Seattle | MErose | 2-7298 |
| Wilmington | OLympia | 5-6371 |

IN CANADA:

National Fibre Co. of Canada, Ltd.
Toronto LEnnox 2-3303
Montreal AVenue 8-7536



NATIONAL

FIBRE COMPANY OF CANADA, LTD.
ATLANTIC & HANNA AVENUES, TORONTO
1411 CRESCENT STREET, MONTREAL

Book Review

The Potential Theory of Unsteady Supersonic Flow by John W. Miles, Ph.D., Professor of Engineering, University of California.

This volume is one of a series in the Cambridge Monographs on Mechanics and Applied Mathematics edited by G. K. Batchelor and H. Bondi.

In this monograph Professor Miles gives a systematic and comprehensive survey of the theory of those aerodynamic forces which result from unsteady motion of the structural components of high speed aircraft.

Starting from a full discussion of the basic equations of potential flow in their exact and approximate forms, the author develops the available methods of solution and applies them to typical supersonic wings, slender bodies, and wing-body combinations. Illustrative calculations are given for harmonic motions (such as occur in dynamic stability and flutter problems) and also for transient motions (as in gust entry). There is an appendix dealing with reverse flow theorems, and a bibliography which contains over 300 references.

This monograph will be of interest to all concerned with aerodynamic theory, in universities, government establishments and aircraft companies. It will be especially valuable to those engaged in research into unsteady flow, and to engineers concerned with practical flutter and stability analysis.

The Potential Theory Of Unsteady Supersonic Flow is published by The Macmillan Company of Canada Limited, 70 Bond Street, Toronto, Ontario, contains 220 pages, hard cover bound, price \$7.65.

Principles Of Noise by J. J. Freeman, Lecturer in Electrical Engineering, University of Maryland.

This volume acquaints the reader with enough of the principles, facts, and techniques used in noise analysis to take him to the level where he can read the literature with sufficient ease to use it as a professional tool.

The author deals with such topics as probability, stationary random processes and their transformation, power spectra, noise and factor of various circuits. He explains the relationship of one concept to another, why each concept was created, what its usefulness is, and what its limitations are.

Principles Of Noise is published by John Wiley & Sons, Inc., 440 Fourth Avenue, New York 16, N.Y., contains 300 pages, hard cover bound, price \$9.25.

Sampled-Data Control Systems by Elisha I. Jury, Associate Professor of Electrical Engineering, University of California.

This book provides the first real source of knowledge for the successful treatment of industrial problems related to the basic theory of sampled-data control systems in particular, and circuits, networks, computers and system engineering in general. Augmented with extensive examples and problems, the book describes the theory through a general approach to mixed digital-analog linear systems and a thorough discussion of the z-transform method which can be applied to a wide variety of fields. Problems arising in feedback control systems are solved and discussed by means of application of digital computers. General applications of the z-transform method and the operational solution of linear difference equations are enumerated and clarified.

This study places special emphasis on the organization, integration and extension of material governing industrial control methods.

Sampled-Data Control Systems is published by John Wiley & Sons, Inc., 440 Fourth Avenue, New York 16, N.Y., contains 453 pages, hard cover bound, price \$16.00.

Nonlinear Problems In Random Theory by Norbert Wiener, Professor of Mathematics, Massachusetts Institute of Technology.

This book comprises a series of Dr. Wiener's lectures given at the Massachusetts Institute of Technology for a special group of advanced students. It fills the need for a comprehensive study of nonlinear problems in random theory, and marks the opening of a new field.

The author examines the role of nonlinear processes in physics, mathematics, electrical engineering, physiology, and communications theory. He demonstrates how random processes — in space as well as in time — enter into the study of statistical mechanisms, and so opens new opportunities for research in gas and plasma theory.

Nonlinear Problems In Random Theory is co-published by The Technology Press of M.I.T. and John Wiley & Son, Inc., 440 Fourth Avenue, New York 16, N.Y., contains 131 pages, hard cover bound, price \$4.50.

Circuit Analysis Of Transmission Lines by John L. Stewart, Associate Professor of Electrical Engineering, University of Southern California.

This book offers a short, unified treatment of the science and analysis of ordinary transmission lines. The approach is analytic, although the more important graphical techniques are discussed. Special attention is given to radio frequencies and measurements. The author examines matching devices and the design of resonators and transmission cavities. The text also provides a discussion of the standing-wave ratio and an introduction to the principles and applications of the Smith chart.

The book provides practical applications to communications; offers excellent preparation for study and work with microwaves; includes a relatively thorough coverage of simple transients, including application of transient operation methods; examines the role of economics in power systems.

Circuit Analysis Of Transmission Lines is published by John Wiley & Sons, Inc., 440 Fourth Avenue, New York 16, N.Y., contains 186 pages, hard cover bound, price \$5.50.

Rocket To The Moon by Erik Bergaust and Seabrook Hull.

This is a factual and provocative book about the greatest physical step of all time — escape from the earth, flight to the moon and beyond. More absorbing than space fiction, it brings the reader all the known information, all the significant ideas and assumptions on the conquest of the moon and its results.

The authors, who have devoted their lives to a realistic study of missiles and space flight, face up squarely to our immediate problems — technical difficulties on the one hand, lagging government space programs and outmoded thinking in the military services on the other. Convinced of the importance and the feasibility of reaching the moon, they are openly critical of the space policies of the United States — a view that is upheld by Dr. Wernher von Braun, noted rocket expert, in his informative introduction to the book.

Many complex technical problems face space experts before they can take this giant step. The authors tell how the moon will be approached, first with instrumented probes and then with man himself as a payload. The reader shares all the tension and excitement of the first manned voyage of exploration around the moon, as this incredible adventure is imagined in vivid detail.

Rocket To The Moon is published by D. Van Nostrand Company (Canada) Limited, 25 Hollinger Road, Toronto 16, Ontario, contains 270 pages, hard cover bound, price \$7.00.

1924

1959

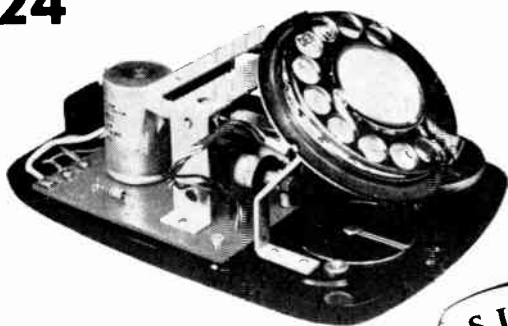

P.A.X.



- No. 65 FOR 25 LINES
- No. 70 FOR 50 LINES
- No. 222 FOR 290 LINES
- No. 17 CUSTOM ENGINEERED FOR LARGE INSTALLATIONS

Prices and Delivery Available on Request

SIEMENS EDISON SWAN (CANADA) LIMITED

(AN A. E. I. COMPANY)
419 NOTRE DAME AVENUE
WINNIPEG 2, MANITOBA.

BRANCH OFFICES: Edmonton, Alberta.
Halifax, Nova Scotia.

For complete details check No. 66 on handy card, page 89.



a new
WELWYN



DEPOSITED CARBON RESISTOR

Welwyn Series N molded resistors employ a thermoplastic insulating material, combining economy with endurance and long term stability.

They meet the requirements specified by MIL-R-10509B and show negligible changes in resistance when subject to several one hour cycles of immersion in boiling water, along with D.C. polarization. Continuous operation at 150°C causes no damage.

The transparent molded insulation has an effective resistance in the order of 10^{13} ohms, and with a thermal conductivity 10 times that of air, vastly improves the load life under conditions of excessive dissipation.

Available in 4 physical sizes and in values of 10 ohms to 10 megohms.

For complete data and specifications write

WELWYN CANADA LIMITED

1255 BRYDGES STREET LONDON, CANADA
H-8349

For complete details check No. 78 on handy card, page 89.

**Northern Electric promotes
Frederic J. Fortier**

Frederic J. Fortier has been appointed commercial manager reporting to the executive vice-president of Northern Electric Company Ltd. of Montreal, Que.

Mr. Fortier joined the company in 1937 and served in various capacities in Montreal before entering the Ottawa district sales department. In 1949 he was appointed government sales specialist for that district and in 1951 proceeded on loan to the Department of Defense Production.



F. J. Fortier

In 1953 Mr. Fortier returned to Northern Electric with the appointment of assistant sales manager of the company's eastern district, becoming assistant manager of organization planning in 1954, sales manager of the eastern district in 1956 and assistant zone manager in 1957.

**Varian's 80% interest in
Bomac formalized**

The acquisition by Varian Associates of Palo Alto, California, of an 80 per cent interest in Bomac Laboratories, Inc., Beverly, Massachusetts, announced January 20, 1959, was formalized by exchange of stock of the two companies at the March meeting of Varian's board of directors held at Bomac.

In making the announcement, H. Myrl Stearns, president of Varian Associates, said the final settlement of all legal and accounting matters had been completed and the acquisition was effective as of January 1, 1959.



H. C. Booth



H. J. McCarthy

Mr. Stearns said that Bomac will continue to operate as a separate unit headed by the founders, Henry J. McCarthy, president, and Harold C. Booth, executive vice-president. Mr. McCarthy and Mr. Booth have joined the Varian board of directors and the latter has been elected a vice-president of Varian Associates.

Continued on page 76



By using the SHF Communications band and new, much smaller components, Westinghouse has developed a powerful yet compact MICROSCATTER system. Two MICROSCATTER components are shown above: The 2 K.W. Klystron Tube (right) and a model of the microwave block.

“Here’s how we put Microscatter on wheels!”

Now, Westinghouse has successfully reduced the size of microwave scatter—by developing an SHF system! And now, all radio equipment for a 5,000 mc. quadruple diversity repeater can be mounted in a 40-foot truck trailer.

For voice, teletype, television, facsimile and raw radar video . . . this advanced MICROSCATTER gives you high quality SHF transmission to points 100 to 200 miles away!

WESTINGHOUSE MICROSCATTER also gives you

HIGH QUALITY TRANSMISSION with an extremely linear, wide band Modulator/Exciter.

LOW COST PER CHANNEL MILE . . . due to minimum operating and maintenance costs . . . and low power consumption.

HIGH RELIABILITY of up to 99.99% . . . with quadruple diversity.

SMALL, NARROW-BEAM ANTENNAS, from 8 ft. to 28 ft. in diameter.



Here's MICROSCATTER on wheels! All radio equipment for a 5,000 mc. quadruple diversity repeater is easily mounted in a standard 40-foot trailer.

For complete information, phone your nearest Westinghouse office. Or write to Canadian Westinghouse Company Limited, Electronics Division, Longwood Road, Hamilton, Canada.

YOU CAN BE SURE...IF IT'S
Westinghouse



WATCH "WESTINGHOUSE DESILU PLAYHOUSE" CBC TV MONDAYS

58C745

HERE'S WHY 14 INTERNATIONAL CARRIERS SELECT

EDO LORAN

FOR JET-AGE LONG RANGE NAVIGATION

- AEROLINEAS ARGENTINAS •
- AIR FRANCE •
- BOAC •
- CUBANA •
- JAPAN AIR LINES •
- KLM •
- LUFTHANSA •
- NORTHWEST-ORIENT •
- PAN AMERICAN •
- QANTAS •
- SABENA •
- SAS • SWISSAIR •
- VARIG •

EDO AIRBORNE LORAN has, to date, been specified by 14 international air carriers for their jet and turbo-prop fleets.

Here are a few reasons why:

- Compact size and total weight of 29 lbs., designed for installation in limited cockpit space.
- Indicator scope, on adjustable swivel base or mounted in standard instrument panel cutout, is easy to read in daylight or artificial light.
- Direct-reading control unit, measuring $5\frac{3}{4}'' \times 4\frac{1}{8}''$, gives pilot or co-pilot instant line-of-position information — no interpolations or special training required.
- Pinpoint position fixes obtained in less than one minute.
- Complete dependability — all-new design featuring miniaturized circuits assures utmost reliability for aircraft operation.
- Fail-safe characteristic rules out possibility of error.
- All-channel availability — Edo Airborne Loran operates on all loran channels, assures world-wide loran coverage.

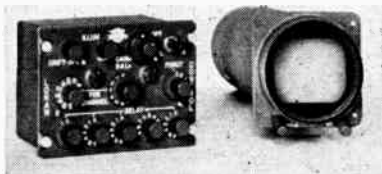

Edo LORAN is designed and manufactured by Edo, a major producer of advanced electronic systems. For complete data on Edo Model 345 Airborne LORAN, send for Technical Manual to Dept. E-6.

For complete details check No. 34 on handy card, page 89.

Edo

(CANADA) Ltd.

CORNWALL, ONTARIO

MORE

**ACTIVE!
EFFECTIVE!**

**KESTER
"RESIN-FIVE"
CORE
SOLDER**



**THE BEST FOR TV-RADIO WORK . . .
EVERYTHING ELECTRICAL** — Kester "Resin-Five" Core Solder is better and faster than any solder ever developed. It has an activated flux-core that does a perfect job on all metals including zinc and nickel-plate. The flux residue is absolutely non-corrosive and non-conductive.

Available in all practical Tin-Lead Alloys; 40/60, 50/50 and 60/40 in diameters of $\frac{3}{32}''$, $\frac{1}{16}''$, $\frac{3}{64}''$, $\frac{1}{32}''$ and others.

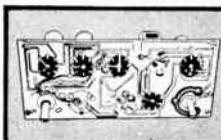

Printed Circuit Soldering
On Copper-etched boards use 60% Tin-40% Lead Alloy . . . for those that are Silver-surfaced use 3% Silver-61½% Tin-35½% Lead

KESTER SOLDER COMPANY

OF CANADA, LTD., Dept. U

Branford, Canada

For complete details check No. 46 on handy card, page 89.

K. G. Thorne named chief engineer

Kenneth G. Thorne, M.I.E.E., M.Brit. I.R.E., P.Eng., has been appointed chief engineer of Computing Devices of Canada Limited, it has been announced by CDC president C. F.



K. G. Thorne

Hembery. He succeeds J. S. Parsons, P.Eng., who recently resigned from the Ottawa electronics and avionics firm.

Thorne was born and educated in England, and graduated from the Polytechnic, Regent St., London.

In his new post Thorne will direct the activities of a creative team of almost 100 highly qualified engineers. Past achievements of this team include development of the well known Position and Homing Indicator, the ANTAC system for the Argus, the Skyline doppler navigation computer, and a variety of special purpose digital and analog computers, and electronic and nuclear test equipment.

E.M.I.-Cossor appoints Ontario sales manager

Harry Clarke, sales manager, E.M.I.-Cossor Electronics Limited, recently announced the appointment of F. J. Martin, M.I.R.E., A.M. Inst. E., as district sales manager for Ontario. Mr. Martin will be located at 72 Grenville Street, Toronto, and will be

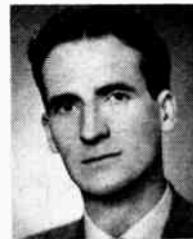

F. J. Martin

responsible for all sales and service in that area.

Mr. Martin has a wide background in the field of industrial electronic instrumentation, having spent five years with Dawe Instruments Ltd., in London, England, both as assistant sales manager and as chief sales engineer for their head office.

Since arriving in Canada, Mr. Martin has been assistant sales manager and customer relations manager for Stark Electronic Sales at Ajax, and for the past year, general sales manager and chief engineer for Conway Electronic Enterprises Reg'd. in Toronto. Mr. Martin also possesses a wide knowledge of communications in all its aspects, having spent some 15 years in the Radio Communication Branch of the Royal Navy.

Continued on page 78



Reliability

ANDREW

The Andrew Product Line covers the related fields of antennas for communication and broadcasting, and transmission lines to connect these antennas to transmitters, receivers or other electronic equipment.

A wide selection of standard models in a complete range of sizes and frequencies is stocked for immediate delivery. Special antennas are designed and manufactured to meet individual requirements.

Installations in all parts of Canada proving Andrew superiority.

Specify Andrew Antennas for your microwave system.

*Designed and
manufactured
in Canada.*

Andrew
A N T E N N A
C O R P O R A T I O N L T D .

606 BEECH STREET - WHITBY, ONTARIO, CANADA

ANTENNAS • ANTENNA SYSTEMS • TRANSMISSION LINES

SYNTRON

SILICON OR SELENIUM RECTIFIERS

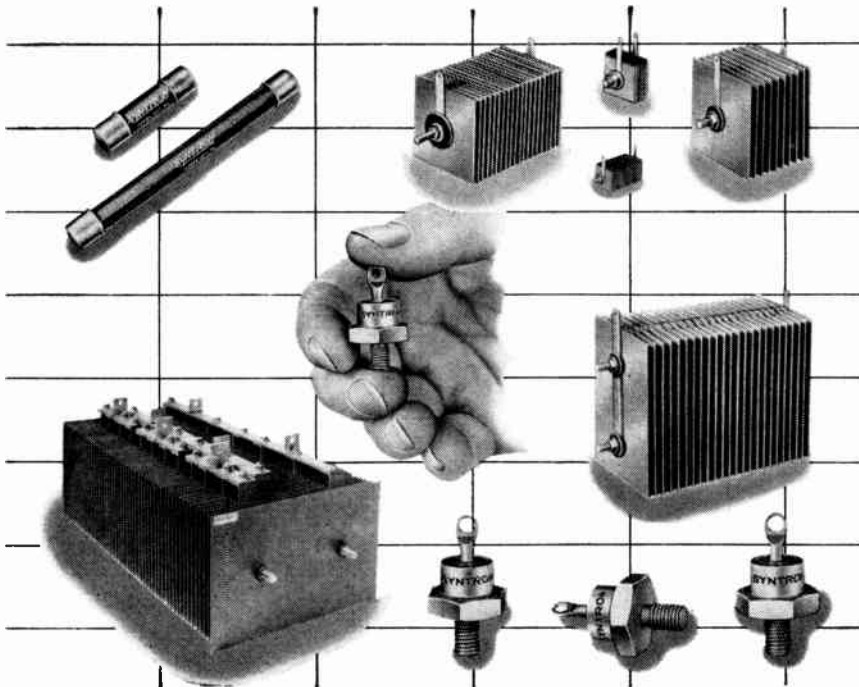

**Efficient, dependable, low cost a-c to d-c conversion
— for all your d-c needs**

SYNTRON provides engineers with the advantages of either silicon or selenium semi-conductor materials.

SYNTRON Vacuum Processed Selenium Rectifiers offer the widest range of cell ratings in the industry.

High Voltage Cartridge Selenium Rectifiers are designed for dependability and long life. With direct current ratings up to 10 ma and 13,200 volts. Hermetically sealed and phenolic tube type.

Industrial Power Rectifiers are light weight, dependable and economical: High efficiency, i.e. — ratio of power output to power input for wide range of loads — low forward drop — high reverse voltages — voltages upward to 52 volt R.M.S. Plate sizes range from 1 inch square to 12 x 16 inches.

Silicon Power Rectifiers are designed for use in intermediate power level applications. Diodes are all-welded construction, hermetically sealed. Exceptional thermal efficiency — less than 2°C per ampere of forward current. Supplied as stud mounted units with rigid positive leads.

The illustration above suggests SYNTRON'S complete line of Selenium and Silicon Rectifiers available for all your d-c needs.

Write for detailed Literature and Specifications

SYNTRON (CANADA) LIMITED
12 MAIN STREET EAST • Dept. K • STONEY CREEK, ONTARIO

For complete details check No. 71 on handy card, page 89.

Executive appointments by H. K. Porter Co. (Canada)

The appointment of Lawrence M. Lake, B.A., C.A., as controller and assistant secretary of H. K. Porter Company (Canada) Limited was recently announced by H. F. Nunn, vice-president and general manager of H. K. Porter Company (Canada) Ltd. At the same time Mr. Nunn announced the appointment of C. W. Leonardi as general manager of the Disston Division of H. K. Porter Company (Canada) Ltd. Both Mr. Lake and Mr. Leonardi will report to Mr. Nunn.



L. M. Lake



C. W. Leonardi

Lawrence M. Lake was formerly secretary treasurer of Barber Die-Casting Co. Ltd. of Hamilton, a post which he held from 1956 until joining H. K. Porter Company (Canada) Ltd. From 1949 to 1956 he was employed by P. S. Ross and Sons.

C. W. Leonardi was secretary treasurer of the Maple Leaf Services organization from 1956 until February 1959 at which time he joined the Porter organization. He established the European operation of Maple Leaf Services in 1955 and was appointed to his former position in 1956. He was also manager of G. A. Touche and Company, professional accountants, in England prior to joining Maple Leaf Services.

A. C. Wickman Ltd. represents Telco Instrumentation

A. C. Wickman Limited, Electronics Division, have announced their appointment as Canadian representative for Telco, of Paris, France.

Telco manufactures intracardiac micromanometers, manometers, pressure sensitive heads, and amplifiers. Telco also offers complete systems, including amplifiers, tape recording facilities, and cathode ray oscilloscope monitoring devices. These systems are in use for surgical procedures as well as catheter investigations.

Further details or assistance in discussing a specific application of any of this equipment may be obtained from A. C. Wickman Limited, P.O. Box 9, Station "N", Toronto 14, Ont.

No interference on Jodrell Bank — moon — Massachusetts radio link

Jodrell Bank experiments on reflection of radio waves from the moon have lead to the successful use of the moon as a reflector of radio waves for long distance radio communication experiments to establish a radio link via the moon between the radio telescope at Jodrell Bank and airforce research center at Massachusetts in U.S.A. A preliminary lunar link has been established this week. Scientific measurements have been carried out using various audio tones. First message via the moon was sent in morse and read as follows "Jodrell Bank to Airforce Cambridge Research Center Massachusetts we'll have no trouble with fishing boats on this circuit". Subsequently intelligible voice transmissions were established. Transmitting and receiving equipment used with the telescope was manufactured by Pye Telecommunications who have been quick to appreciate the commercial possibilities of long distance radio communication with freedom from ionospheric fadeouts and other disturbances.

Widney Dorlec constructional systems

Widney Dorlec means that modern styled cabinets, consoles and control desks of all types can be made quickly without special tools.

New Components permit rapid assembly of standard 19" rack panels. Ask for Bulletin C on telescopic slides.

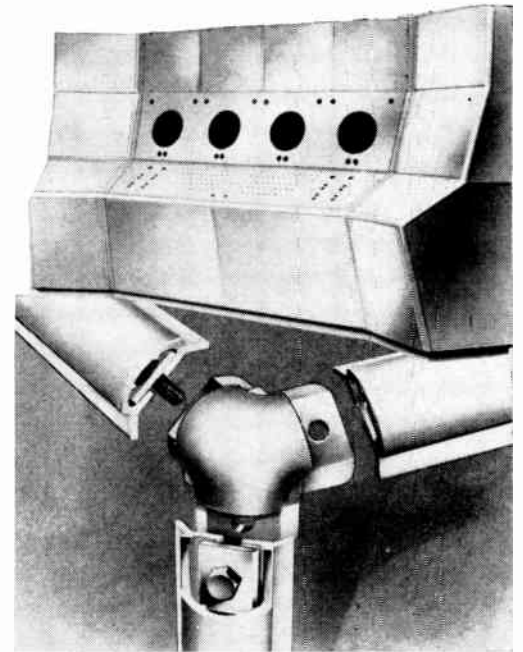

GENERAL COMMUNICATIONS LIMITED

980 O'CONNOR DRIVE

TORONTO 16, ONTARIO

For complete details check No. 39 on handy card, page 89.

97% OF E & C READERS WRITE US WHEN THEY MOVE!

One sure way of finding out what readers think of a publication, is to see how much trouble they will take to make sure they continue receiving copies — regularly. Of every 100 readers of *Electronics and Communications* who change their addresses, 97 make a point of writing a special letter to say so!

Who are our readers? Almost everybody who is anybody in electronics or communications — anywhere in Canada. They're consulting engineers, development engineers, project superintendents, management personnel, etc. Our Sixth Annual Directory and Buyers' Guide is now in preparation. It will go to over 10,000 prospective buyers of *your* products across Canada.

Be sure to be represented. Write for your product check list, advertising rates, etc.

Electronics and Communications
450 Alliance Avenue — Toronto 9, Ont.

FREE! 350 page catalogue

Canada's most complete Buying Guide to electronic equipment for Industry, Communications and Research. Thousands of items listed, illustrated and indexed in this complete reference catalogue. Our experienced staff is always ready to serve and assist you in the selection of the right equipment for your special needs at either of our locations.

Ample free parking.



Name

Company

Address

City Prov.

ALPHA ARACON RADIO COMPANY LIMITED
555 Wilson Avenue, Downsview, Ontario.
Branch Office: 29 Adelaide St. W., Toronto

For complete details check No. 6 on handy card, page 89.

Frequency bridge

The Muirhead D-101-C Frequency Bridge employs the Wien Bridge circuit providing a satisfactory and simple means of measuring audio frequencies, from 100 c/s to 12,100 c/s in two ranges selected by a switch. Measurements to an accuracy $\pm 0.25\%$ are made by means of two decade dials and a continuously variable direct reading dial permitting interpolation between adjacent steps on the second decade. The reading accuracy is always better than 0.05%. The bridge is assembled on a standard panel for rack mounting, provision being made for both jack and binding post connexions.



MADE IN CANADA BY
MUIRHEAD INSTRUMENTS LIMITED
PRECISION ELECTRICAL INSTRUMENT MAKERS
STRATFORD · ONTARIO · CANADA

For complete details check No. 51 on handy card, page 89.

Radio station for Woodstock, N.B.

Soon Woodstock will have its own radio station. While the station call sign has not yet been allocated, this new station will operate on an assigned frequency of 920 kc/s and will become the twelfth radio broadcasting voice in New Brunswick. Canada's Board of Broadcast Governors at their first sitting recently recommended that the station be licensed.

The new station will be completely equipped by Canadian General Electric; in addition to the 1 kw AM transmitter, its electronic equipment also includes the Canadian designed and produced G-E Remote Control Equipment and McCurdy Packaged Master Control System for the studio. The Woodstock station becomes the 16th Canadian station, out of twenty-three, which in recent years has selected the G-E Type BTC-71 1000-watt radio broadcast transmitter.

Woodstock Radio — 920 kc/s — hopes to be on the air in July. Transmitter and studio construction commenced in April.

Aviation Electric Ltd. appoints L. L. Jones

Announcement was made recently that L. L. (Slim) Jones has been appointed manager of Toronto and district sales operations of Aviation Electric Limited.



L. L. Jones

Mr. Jones brings to his position over twenty-five years' experience in flying and marketing aviation products. In the early days he worked as a mechanic on Northern Canadian Bush Operations. He joined the RAF in 1937 and subsequently completed pilot and navigation courses. He served with Coastal Command and Transport Command until 1945 when, with the rank of Wing Commander, he terminated a distinguished service career.

Since returning to civilian life, Mr. Jones has been associated with the Aviation Products Marketing Division of a major oil company and later he became assistant to the general manager, Aircraft Products Division of Bendix-Eclipse of Canada Ltd. In both these positions Mr. Jones was responsible for promoting all Aviation Electric and 'Bendix' aviation and marine products in Toronto and district.

TV transmitter line meets Canadian market need

Canadian General Electric's line of modular television VHF transmitters is being used by an increasing number of TV stations throughout Canada and abroad.

Development of the modular line of TV transmitters and Ultra-Power Slot Antennas was carried on simultaneously, according to Mr. Spence. This was done because no existing equipment of conventional design was capable of meeting the diverse needs of the Canadian broadcaster. He referred specifically to limited audience, distribution and growth rate of population, and shortage of skilled technicians as being significant factors in CGE's solution to a purely Canadian economic problem. The modular construction, Mr. Spence indicated, allowed the broadcaster to build up a complete transmitter from low power to maximum power for both high and low channels, with no obsolescence of any unit.

Mr. Kenneth G. Lund named patents officer

Mr. K. G. Lund has been appointed Patents Promotion Officer dealing with patents in the electrical and electronic fields in the Promotion and Development section of Canadian Patents and Development Limited, as of May 1, 1959.

Mr. Lund was born in Harrow, England in 1932. He attended St. Albans School, and obtained a B.Sc. (Honours Physics) degree in 1954 from the University of Manchester.

He joined the RCAF, in England, in 1954, and served in Canada as a Flying Officer in the telecommunications branch, until 1958. He entered the Graduate School of Business Administration of the University of Western Ontario in September 1958 and came to Canadian Patents and Development upon completing his course.

He is a graduate member of the Institution of Electrical Engineers, and a Professional Engineer of Ontario.

Lake Engineering for Kearfott Company

Lake Engineering Co. Limited, has been appointed by Kearfott Company, Inc., Little Falls, New Jersey, as sole Canadian representative in the field of ferrite components and assemblies. Information concerning Kearfott ferrites may be obtained by writing to Lake Engineering Co. Limited, 123 Manville Road, Scarborough, Ontario.

SECURE **SPACE** NOW
for the Fourth Annual

IRE

CANADIAN CONVENTION AND EXPOSITION

Automotive Bldg., Exhibition Park, Toronto
3 Full Days—October 7, 8, 9, 1959

The Showcase of the Electronics Industry

HERE is your great once-a-year opportunity to expose your products and services to a concentrated audience of more than ten thousand scientists, engineers and technologists.

REMEMBER! Before final decisions are made as to what scientific equipment to buy, and from whom to buy it, these are the men consulted.

Not until next year will you have such a golden opportunity to promote sales and goodwill among these key men of the electronic and nucleonic industries.

DON'T DELAY!

Write, Wire or Phone Today for
Illustrated Brochure and Floor Plan

IRE CANADIAN CONVENTION

1819 Yonge Street, Toronto, Canada

Telephones: HUDson 8-7768 and HUDson 1-3331

Sponsored by the Canadian Sections of the
Institute of Radio Engineers



For complete details check No. 42 on handy card, page 89.

ERIE BUTTON® SILVER-MICA CAPACITORS

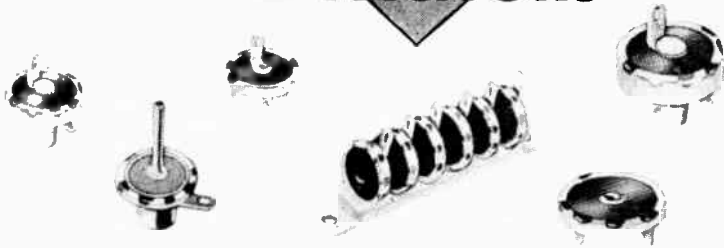

ERIE BUTTON SILVER - MICA CAPACITORS, coated with Button-Tite, exceed the minimum insulation resistance limit specified under MIL-C-10950A, characteristic "D". They still have the same inherent qualities that have made them superior for many years for Military, Industrial, and Commercial applications.

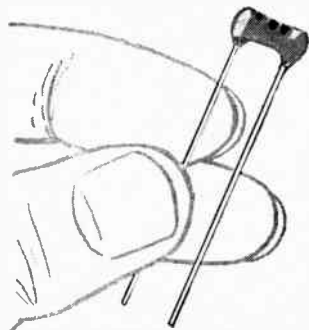

DIPPED PHENOLIC INSULATED

These Radial lead units are dipped in low-loss phenolic material which is baked and vacuum wax impregnated.

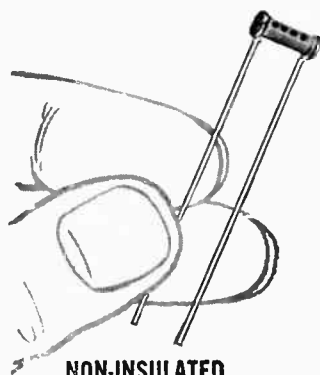

NON-INSULATED

Radial leads soldered to silver electrodes and sealed with moisture impervious coating to withstand humidity.

Write for 16 page
Bulletin 313-2 for description of
ERIE TUBULAR CERAMICONS.
Also ask for our new 8 page
Feed-Thru Ceramicon Bulletin 323.

ERIE TUBULAR and DISC CERAMICONS

AVAILABLE IN 3 TYPES

TEMPERATURE COMPENSATING Disc Ceramicons offer a wide combination of temperature coefficient and capacitance values. They meet all requirements for RETMA REC-107A Class 1 ceramic capacitors. Available in capacity ranges from 1.5 to 2810 mmf at 500 V.D.C.W. and temperature coefficients ranging from P120 through N5600.

GENERAL PURPOSE Disc Ceramicons have low series inductance which assures efficient high frequency operation. Values from 1.5 mmf to .05 mfd. Rated at 500 Volts D.C. Working.

HIGH VOLTAGE Disc Ceramicons employ the same basic diameters and design that have been standardized in 500 volt ceramic capacitors. Conservative voltage rating beginning at 1 KV D.C.W. are based on extensive life test data.

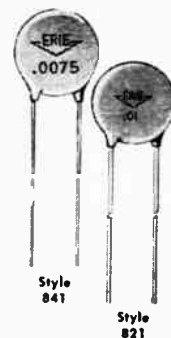

Erie Resistor of Canada Ltd.

Sales Office:

4972 DUNDAS ST. W., TORONTO
Head Office and Factory: TRENTON

Union Carbide adds to directorate

At a meeting of shareholders held in Toronto on April 14, John S. Dewar was elected a director of Union Carbide Canada Limited, according to an announcement by A. A. Cumming, president.



J. S. Dewar

Mr. Dewar, who is vice-president, Operations of the Company, joined Union Carbide's National Carbon Division in 1943 as a chemical sales engineer. After holding a number of senior positions in sales and production, he was appointed vice-president of National Carbon in June 1955, and president a few months later. In September 1956, he was appointed a vice-president of Union Carbide Canada Limited, the position he holds today.

Hoffman scientist addresses Canadian defense group

New design concepts in solar cells were described by Martin Wolf of the Semiconductor Division, Hoffman Electronics Corporation, in an address before the Defense Research Board of Canada on May 1 at Montreal, Que.

A leading authority on solar cells, Mr. Wolf was one of a group of Hoffman Semiconductor Division scientists who pioneered the commercial development of silicon solar cells and silicon Zener devices.

R. C. Kahnert Sales Limited announces appointments

In line with the expansion plans in the industrial and communications field, Roland C. Kahnert announces



J. H. Noble

the appointment of Aurele Desjardins as vice-president and director. Mr. Desjardins will be responsible for sales in the Quebec province and the Ottawa area.

To further assist in the company's increased activities, Jim Noble has been appointed sales director. Formerly sales manager of Antiference Canada Ltd., Mr. Noble brings with him several years' experience both in the manufacturing and distributor fields.

For complete details check No. 36 on handy card, page 89.

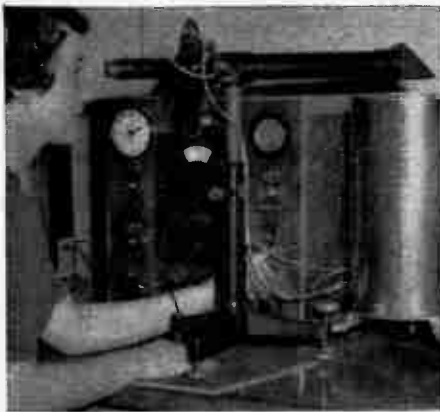

tough tests for incoming material

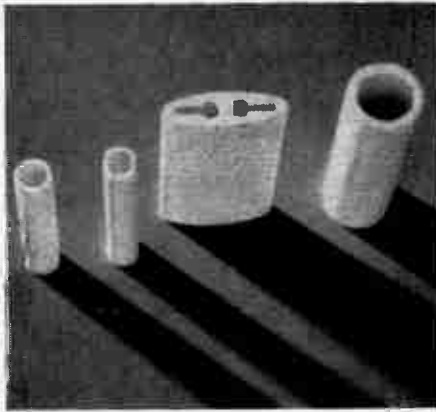

specially selected ceramic core materials

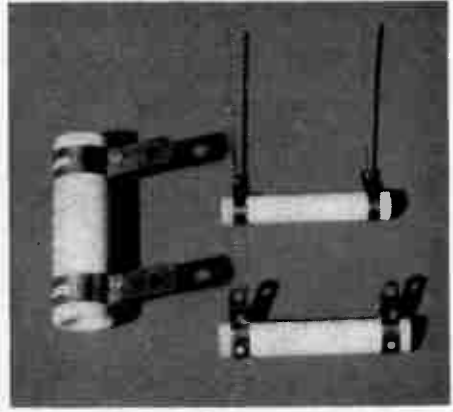

rigid, low resistance terminals

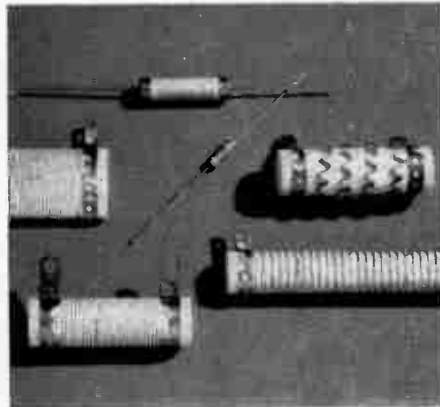

finest alloy resistance wire

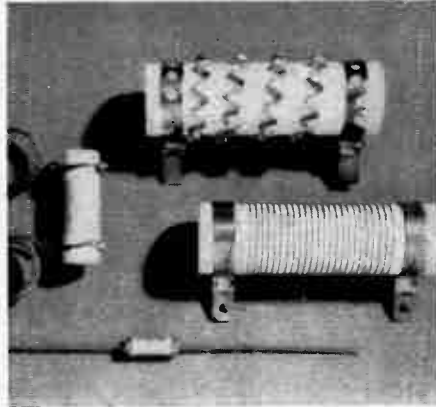

spot welded or silver brazed junctions



**THIS IS A
RESISTOR
YOU CAN
STAKE YOUR
REPUTATION ON**

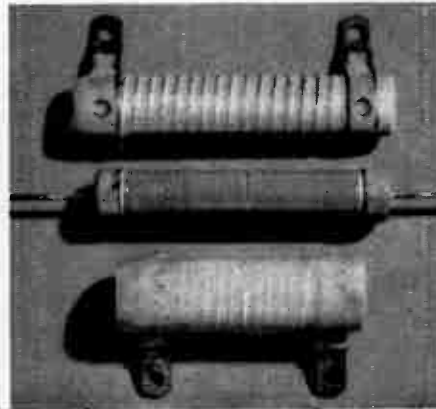

our own VITROHM enamel, first coat . . . and final coat

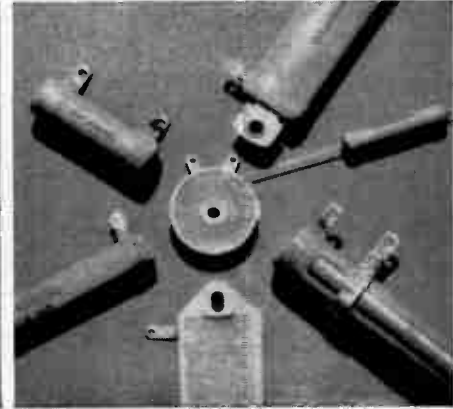

Built-in VITROHM reliability, from core to final vitreous enamel, lets you solder these resistors in and forget 'em

They come in a tremendous variety of sizes, shapes and ratings, but all Ward Leonard VITROHM resistors have one thing in common: they're built for maximum reliability! Take just one point — ceramic cores, for example: made by Ward Leonard to exacting specs, the cores feature low-porosity, high-dielectric-strength ceramic for maximum moisture exclusion and good electrical insulation. What's more, the thermal coefficient of linear expansion of ceramic is specially selected to make the core compatible with resistance wire, enamel and terminals . . . to prevent cracking, crazing, peeling, or layer separation.

And there's the same meticulous care with all the other elements that go to make up a finished VITROHM resistor: terminals, spot welded or brazed junctions, resistance wire, and last but not least, W/L VITROHM enamel, formulated and manufactured in our own modern enamel smelting plant . . . provides complete electrical and mechanical protection. To ensure reliability in your product . . . specify VITROHMS. Write for data packed catalogue #15: Ward Leonard of Canada Limited, 1070 Birchmount Rd., Toronto 16, Ontario.

LIVE BETTER...Electrically

Result-Engineered Controls Since 1892



RESISTORS | RHEOSTATS | RELAYS | CONTROLS | DIMMERS

5907 Resistors • Rheostats • Relays • Motor Controls • Dimmers • Loadbanks • SAFT Batteries • Barkelew Switches • Kenco Pumps

For complete details check No. 77 on handy card, page 89.

ELECTRONICS AND COMMUNICATIONS, June, 1959



WARD LEONARD
OF CANADA LIMITED

1070 BIRCHMOUNT ROAD TORONTO 16

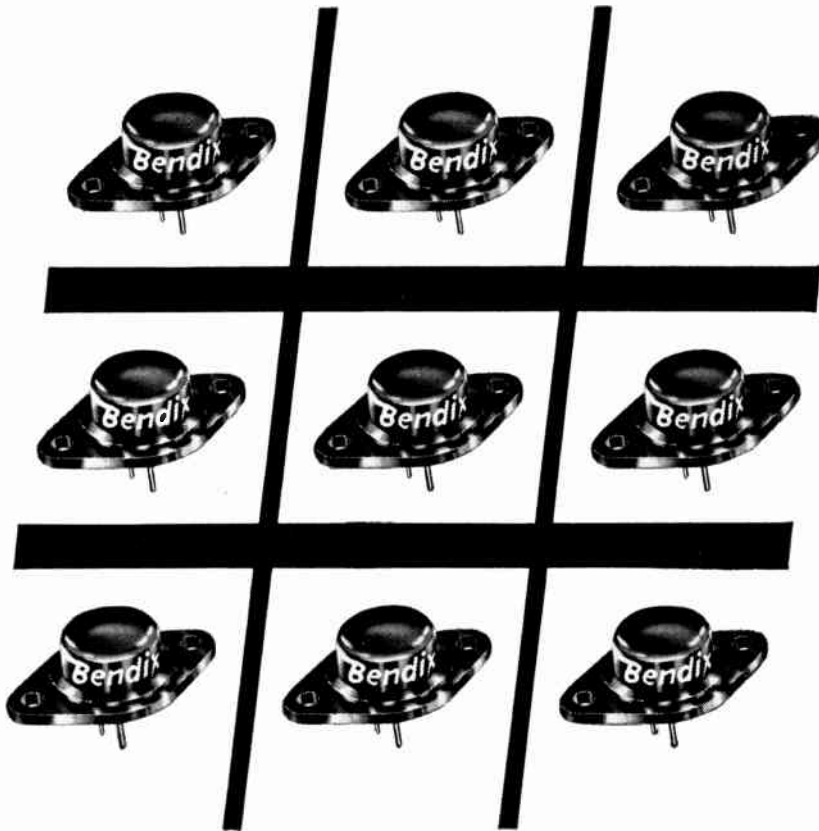

You win whichever way you go . . . with

NEW BENDIX SWITCHING TRANSISTORS

Now the new Bendix series of nine Power Switching Transistors lets designers select exactly the transistor they need to design each circuit for maximum efficiency and economy.

Especially engineered as high current switching devices for DC-DC converter circuits and DC-AC inverter circuits, these transistors are capable of switching up to 250 watts. Available in three current gain ranges for optimum matching, the transistors also have three voltage breakdown ratings to eliminate burn out. Easy to design into circuits, easy to mount, Bendix Power Switching Transistors come in the *standard transistor "package"*. Some other common applications are: relay replacements, drivers for relays, magnetic clutches,

solenoids, and other loads requiring high current.

For a wide choice in performance and price to meet your transistor needs exactly, select Bendix Power Switching Transistors. Write for further information to

COMPUTING DEVICES OF CANADA LIMITED

Head Office:
P.O. Box 508, Ottawa, Ontario
Western Office:
712 8th Ave., S.W., Calgary, Alberta
Toronto Office:
164 Eglinton Ave., Toronto, Ontario

| Current Gain At 3 Adc | Collector-to-Emitter Voltage | | |
|--------------------------|------------------------------|--------|--------|
| | 40 | 70 | 80 |
| 15-30 | 2N639 | 2N639A | 2N639B |
| 20-40 | 2N638 | 2N638A | 2N638B |
| 30-60 | 2N637 | 2N637A | 2N637B |



COMPUTING DEVICES OF CANADA LIMITED

5807

For complete details check No. 28 on handy card, page 89.

OPPORTUNITIES

These classified advertisements are published to assist those in the trade who have articles for sale, positions available, positions desired, sales agency openings or business opportunities. Charges are 25c per word or figure, not including heading or box number. Minimum charge is \$5.00 payable on submission. No agency commission paid.

There is absolutely no charge for "positions desired" advts. Send all material to the attention of the advertising manager of ELECTRONICS AND COMMUNICATIONS, 450 Alliance Avenue, Toronto 9.

POSITIONS AVAILABLE

SALES ENGINEER

with Communications Systems Engineering background for position in antenna and transmission line field. Salary open.

Andrew Antenna Corporation Ltd.
606 Beech Street
Whitby, Ontario.

SEASONED SALES ENGINEER

required by instrumentation organization with good technical background. Salary open. Car essential. Widely recognized products. Career opportunity for right man. Replies held in strictest confidence.

Conway Electronic Enterprises
1514 Eglinton Ave. West, Toronto 10
Russell 3-6576.

ELECTRICAL ENGINEER

for design of electronic supervisory control systems. Must have experience in or with Canadian power utilities. For new company.

Box 5010
Electronics and Communications
450 Alliance Avenue, Toronto 9, Ont.

OPPORTUNITIES

PARTNERSHIP AVAILABLE

Small expanding business in the communications and signalling field. Some commercial experience desirable but not essential. Write for appointment to:

Box 5007
Electronics and Communications
450 Alliance Avenue, Toronto 9, Ont.

SALES AGENCY

U.S. Company requires Canadian sales agency for engineered line of relays of the following types: coaxial, differential, hermetically sealed, impulse, keying, latching, mercury contact polarized, power control and overload sensitive, stepping. Subminiature, telephone, time delay contactors, solenoids, dry circuit and crystal can size.

Box 5011
Electronics and Communications
450 Alliance Avenue, Toronto 9, Ont.

SALES REPRESENTATIVE

In Toronto and district wanted for established company. Must be familiar with all phases of electronic instrumentation. Late model car necessary. Remuneration includes salary, expenses, commission, fringe benefits as well as opportunity to invest in growing company. Reply in first letter, giving all details of qualifications and salary expected. All replies held strictly confidential.

Box 5012
Electronics and Communications
450 Alliance Ave., Toronto 9, Ont.

NEW DUAL BEAM

TYPE 502 OSCILLOSCOPE



Dual display on linear time base.

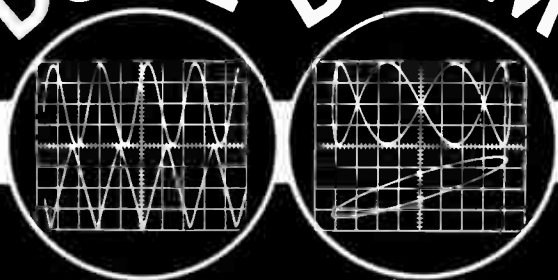

Dual display for X-Y curves.

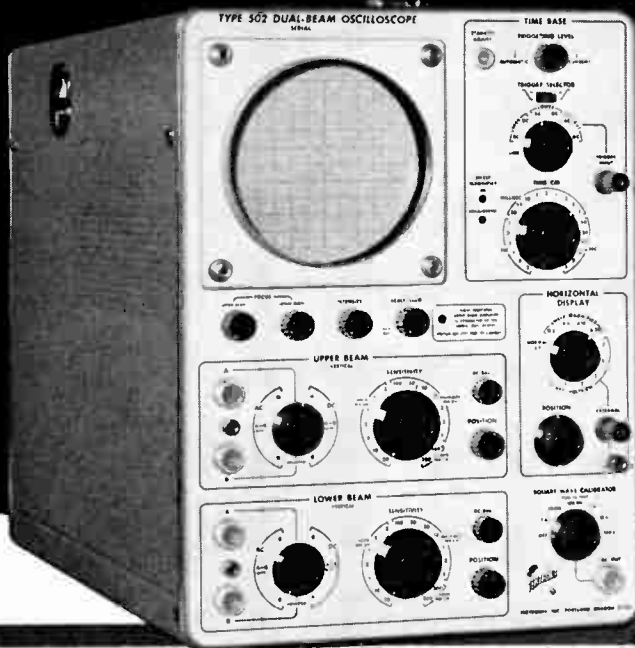

TWO-GUN CATHODE-RAY TUBE.

200 $\mu\text{v}/\text{cm}$ SENSITIVITY, BOTH BEAMS.

DIFFERENTIAL INPUT, ALL SENSITIVITIES.

2, 5, 10, and 20 TIMES SWEEP MAGNIFICATION.

X-Y CURVE TRACING with TWO BEAMS—(horizontal input sensitivity to 0.1 v/cm).

SINGLE-BEAM X-Y CURVE TRACING at 200 $\mu\text{v}/\text{cm}$, BOTH AXES.

EXTRA FEATURE—Both amplifiers have transistor-regulated parallel heater supply.

TYPE 502 CHARACTERISTICS

HIGH-GAIN AMPLIFIERS

200-microvolts/cm deflection factors, both dc-coupled and ac-coupled. 16 calibrated steps from 200 $\mu\text{v}/\text{cm}$ to 20 v/cm.

Passbands—dc-to-100 kc at 200 $\mu\text{v}/\text{cm}$, increasing to dc-to-200 kc at 1 mv/cm, dc-to-400 kc at 50 mv/cm, and to dc-to-1 mc at 0.2 v/cm.

Differential Input, Both Channels—Rejection ratios: 1000-to-1 at 1 mv/cm or less, 100-to-1 at 0.2 v/cm, 50-to-1 at 5 to 20 v/cm.

Constant Input Impedance, 1 megohm, 47 μpF , both channels.

WIDE-RANGE SWEEP CIRCUIT (Common to both beams)

Single-knob control for selecting any of 22 accurately-calibrated sweep rates from 1 $\mu\text{sec}/\text{cm}$ to 5 sec/cm.

Sweep Magnification—2, 5, 10, and 20 times, accurate within the maximum calibrated sweep rate.

Automatic Triggering—fully automatic, or preset with amplitude-level selection when desired. Sweep can also be operated free-running.

X-Y CURVE TRACING OPERATION

Horizontal-input amplifier permits curve-tracing with both beams simultaneously at sensitivities to 0.1 v/cm. For curve-tracing at higher sensitivities (to 200 $\mu\text{v}/\text{cm}$) with one beam, one of the vertical amplifiers can be switched to the horizontal-deflection plates.

OTHER FEATURES

Amplitude calibrator, 1 mv to 100 v in decade steps—square wave, frequency about 1 kc.

3-kv accelerating potential on new Tektronix 5" dual-beam crt. 8-cm by 10-cm linear-display area, each beam, 6-cm overlap.

Electronically-regulated power supplies.

Price **\$825**
f.o.b. factory

Here are a few uses for the Type 502:

IN ELECTRONICS—Use the Type 502 as a general-purpose oscilloscope and also to show simultaneously the waveforms at any two points in a circuit, e.g. input and output, opposite sides of a push-pull circuit, trigger and triggered waveform, etc.

IN MECHANICS—Display, compare, and measure outputs of two transducers on the same time base; plot one transducer output against another—pressure against volume or temperature for instance; measure phase angles, frequency differences, etc.

IN MEDICINE—Display, compare, and measure stimulus and reaction, or the outputs of two probes, on the same time base; use differential input to cancel out common-mode signals, or to eliminate the need for a common terminal; use in routine investigations, etc.

IN ALL FIELDS—The Type 502 can save you more than its cost in time—in as little as one application!

Tektronix, Inc.

P. O. Box 831 • Portland 7, Oregon
Phone CYpress 2-2611 • TWX-PD 311 • Cable: TEKTRONIX

CANADIAN FIELD OFFICE:

3 Finch Avenue East, Willowdale, Ontario
Phone: Toronto, Baldwin 5-1138

For complete details check No. 72 on handy card, page 89.

Forget the Amplifier

Boost feeble input signals
with compact ultra-sensitive

WESTON *Sensitrol*[®] relays



If your design utilizes an amplifier to boost a minute signal for relay operation — or, if you have “shelved” some new product idea because the cost, space requirement and other drawbacks of amplifiers made the design impractical — Sensitrol relays are for you. For these tiny, ultra-sensitive relays, which operate direct on input signals as slight as 1 millivolt or ½ micro-ampere, and handle substantial wattage at 110 volts, entirely replace amplifiers, vacuum tubes and auxiliary power supplies. They are available with single or double contacts, fixed or adjustable, manual or solenoid reset. For engineering assistance in adapting Sensitrol relays to present products, or new problems you have in mind, call your nearest Weston representative, or write for the Sensitrol bulletin B-25-B . . . to Daystrom Limited, 840 Caledonia Road, Toronto 10, Ontario; 5430 Ferrier Street, Montreal, Quebec, a subsidiary of Daystrom, Incorporated. Or any office of Northern Electric Co. Ltd.

5706

WESTON

Instruments



For complete details check No. 32 on handy card, page 89.



You can get more hours of work done per day by separating “outside” and “inside” calls with two phones! Your private second phone lets you step up daily output . . . and saves money to boot! Automatic Fanon Fones need no operator; equipment is not rented thus no monthly bill. Minimizes rented equipment needed for external calls and discourages “personal calls”, where necessary, by confining other than management staff to communication within the office or plant.

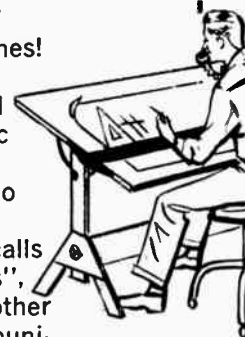

OUTSIDE PHONE means **business for you . . .**
Regular “outside” phone (rented from telephone company) communication with customers, etc

FANON FONE means **getting it through . . .**
“Inside” FANON FONES (owned by your company) for rapid communication within the plant, expediting orders, production, etc.

FANON FONE Private Automatic Telephone Systems

- Accelerates inside calls split-second connections.
- Relieves switchboard congestion, allows better service on outside calls.
- Fully automatic service 24 hours per day.
- No more “have to call you back”. Hold outside call while you check information on your private automatic phone.
- Paging facilities . . . automatic busy signals available.
- Executive priority to cut into busy line if emergency prevails.



GET THE FACTS! WRITE TODAY!
Complete specifications are now available on the new Fanon PAX systems. Fanon communication engineers can serve your every need.

OTHER FANON SYSTEMS:

Ask about the complete line of Fanon Fones from two phones and up. Loud speaker intercom systems also available.

FANON
ELECTRONICS OF CANADA, LTD.
431 King Street West Dept. P-1 Toronto 2B, Ontario

For complete details check No. 38 on handy card, page 89.

another communications advance...

the STC 4-WIRE TERMINATING SET



Advanced design techniques and the use of high quality components have resulted in another STC advance in the field of telecommunications!

The STC four-wire terminating set meets with the high balance requirements necessary for the operation of high grade toll trunks.

The many advanced features — plus the low cost of equipment — make it ideal for use in two-wire switching offices where a balance of 27 db or more must be maintained.

The equipment is miniaturized. Four units occupy only 3½ inches of vertical space on a 19 inch rack. The units may be extended for inspection and testing without interrupting service.

Brief Performance Specifications:

Network building-out capacitance in 0.005 mfd steps . . . up to 0.075 mfd

Transhybrid loss — with balance network and two-wire side terminated in matching resistors more than 50 db

Plug-in pads supplied rotatable (2)
0 to 0.75 db in 0.25 db steps

**Standard Telephones and Cables
Mfg. Co. (Canada) Ltd**



9600 St. Lawrence Blvd., Montreal 12, Que.
Products for Industry... the world over!



NOW...

RADIO RELAY EQUIPMENT

can be tailor-made to
your telephone requirements
with

MARCONI'S

NEW DQ48B

**DESIGNED, DEVELOPED AND
MANUFACTURED IN CANADA**

The DQ48B is a compact medium haul radio relay equipment operating in the 900 Mc/S band with a maximum capacity of 132 telephone channels. This equipment offers all the facilities of our well known DQ48A at lower cost and has many new features which provide the sort of flexibility which results in a 'custom' designed system to meet your special requirements.

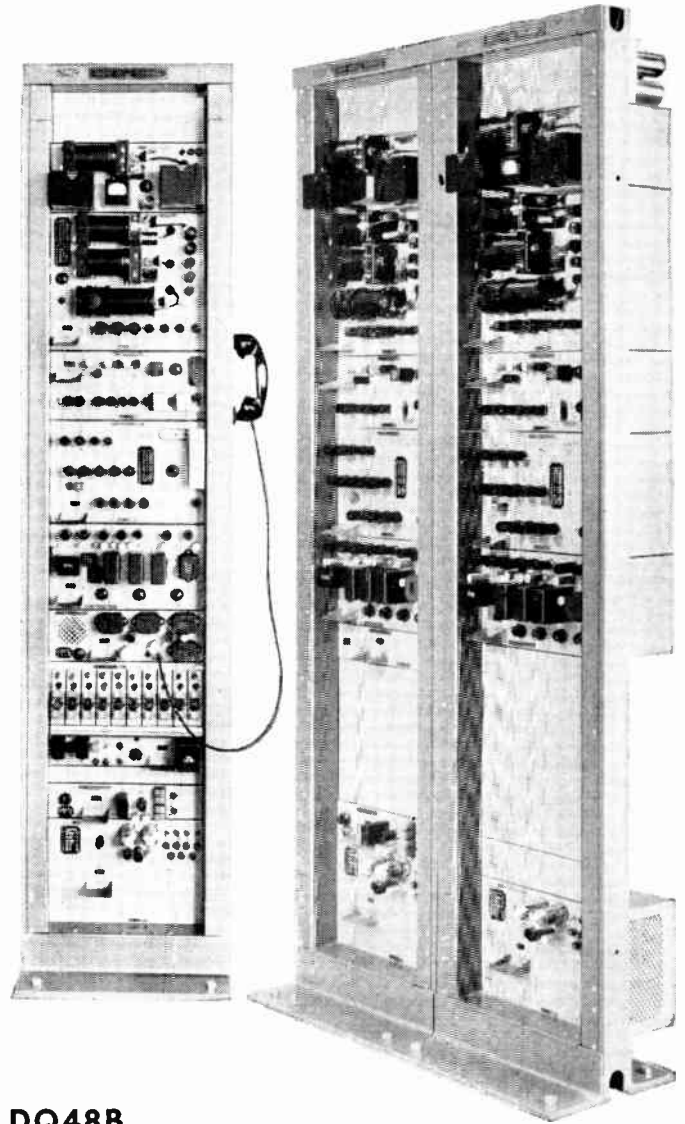

Some of the Features of the DQ48B

1. Output Power: 5 or 20 watts (optional)
2. Compact but highly accessible equipment completely mounted in one standard rack.
3. Receiver of narrow bandwidth for small channel requirements. (optional)
4. Compact built-in Fault Alarm offering up to 5 functions from each of 10 remote stations. (optional)
5. All panels, metered.
6. Automatic change-over units, hot or cold standby. (optional)
7. Plug-in Order Wire telephone unit. (optional)
8. Twin-path facilities and baseband diversity combiner. (optional)
9. 2000 Mc/s RF heads (3 to 5 watts). (optional)
10. Full channel drop and insert facilities at all stations.

You can see that the range of optional features allows you to build every station in your system to meet your precise requirements. This is very important because it minimizes your capital outlay and running costs.

We are at your service

Should you require further information regarding our range of equipments please write to one of the offices listed below.



CANADIAN MARCONI COMPANY

Radio Relay Department,
970 McEachran Avenue, Montreal 8, Canada
Tel: CR. 6-3627

SALES OFFICES FROM COAST TO COAST:

| | | | | |
|--|--|--|--|--|
| 830 Bayview Ave. Tel. HU. 1-5221 TORONTO | 5394 Main Street Tel. TR. 6-4174 VANCOUVER | 1710 3rd Street N.E. Tel. CR. 7-7571 CALGARY | 572 Barrington St. Tel. 3-1325 HALIFAX | 20 Barnes Road Tel. 2881 ST. JOHN'S, Nfld. |
|--|--|--|--|--|

For complete details check No. 22 on handy card, page 89.

APPLICATION FOR FREE SUBSCRIPTION

INDEX TO ADVERTISERS

Page number is on the right.
Key number for use with
READER SERVICE CARDS is
on the left.

| Key No. | | Page No. |
|---------|--|----------|
| 1. | Adcola Products Ltd. | 67 |
| 2. | Aeromotive Engineering Products Ltd. | 67 |
| 3. | Aerovox (Canada) Ltd. | 70 |
| 4. | Ahearn & Soper Co. Ltd. | 9 |
| 5. | Airtron Canada Ltd. | 14 |
| 6. | Alpha Aracon Radio Co. Ltd. | 79 |
| 7. | Amphenol Canada Ltd. | 14 |
| 8. | Andrew Antenna Corp. Ltd. | 77 |
| 9. | Arrow-Hart & Hegeman (Canada) Ltd. | 67 |
| 10. | Atlas Polar Co. Ltd. | 22 |
| 11. | Automatic Electric Sales (Canada) Ltd. | 49 |
| 12. | Automatic Electric Sales (Canada) Ltd. | 50-51 |
| 13. | Automatic Electric Sales (Canada) Ltd. | 52 |
| 14. | Bach-Simpson Ltd. | 4 |
| 15. | Beatty Bros. Ltd. | 64 |
| 16. | Burton-Rogers Co. | 67 |
| 17. | Canadian General Electric Co. Ltd. | 23 |
| 18. | Canada Illinois Tools Ltd. | 65 |
| 19. | Canada Illinois Tools Ltd. | 92 |
| 20. | Canadian Lister-Blackstone Ltd. | 6 |
| 21. | Canadian Marconi Co. | 3 |
| 22. | Canadian Marconi Co. | 88 |
| 23. | Canadian Westinghouse Co. Ltd. | 25 |
| 24. | Canadian Westinghouse Co. Ltd. | 75 |
| 25. | Cannon Electric (Canada) Ltd. | 13 |
| 26. | Centralab Canada Ltd. | 10 |
| 27. | Collins Radio Co. | 15 |
| 28. | Computing Devices of Canada Ltd. | 84 |
| 29. | Croven Ltd. | 2 |
| 30. | Dayrand Limited | 70 |
| 31. | Daystrom Limited (Heath Div.) | 92 |
| 32. | Daystrom Limited (Weston Div.) | 86 |
| 33. | Delhi Metal Products Ltd. | 65 |
| 34. | Edo (Canada) Ltd. | 76 |
| 81. | Eitel-McCullough Inc. | 57 |
| 35. | Electronics Associates Inc. | 16-17 |
| 36. | Erie Resistor of Canada Ltd. | 82 |
| 37. | Essex Electronics of Canada Ltd. | 66 |
| 38. | Fanon Electric Co. Inc. | 86 |

(Continued overleaf)

Please ADD my name to receive ELECTRONICS & COMMUNICATIONS.

Please CHANGE my address for mailings.

NOTE — Card must be completed in full to be valid.

My Name (Please Print)

Mail copies to my home, or business address as noted below.

Street

City Zone Prov.

If you have recently CHANGED your address please note former address here:

Company Nature of Business
(State, when applicable, whether electronic equipment or components are manufactured, sold, or used in manufacturing, etc.)

Signature Position
IF YOU ARE AN ENGINEER, PLEASE SO STATE — when it is not included in your job title.
6-59

PLEASE SEND FURTHER INFORMATION ON THE FOLLOWING NEW PRODUCT ITEMS AS NUMBERED BELOW — USE PRODUCT ITEM NUMBERS

- | | | | | | | | | | |
|-------------------------------|-------------------------------|-------------------------------|-------------------------------|-------------------------------|-------------------------------|-------------------------------|-------------------------------|-------------------------------|-------------------------------|
| <input type="checkbox"/> 2353 | <input type="checkbox"/> 2354 | <input type="checkbox"/> 2355 | <input type="checkbox"/> 2356 | <input type="checkbox"/> 2357 | <input type="checkbox"/> 2358 | <input type="checkbox"/> 2359 | <input type="checkbox"/> 2360 | <input type="checkbox"/> 2361 | <input type="checkbox"/> 2362 |
| <input type="checkbox"/> 2363 | <input type="checkbox"/> 2364 | <input type="checkbox"/> 2365 | <input type="checkbox"/> 2366 | <input type="checkbox"/> 2367 | <input type="checkbox"/> 2368 | <input type="checkbox"/> 2369 | <input type="checkbox"/> 2370 | <input type="checkbox"/> 2371 | <input type="checkbox"/> 2372 |
| <input type="checkbox"/> 2373 | <input type="checkbox"/> 2374 | <input type="checkbox"/> 2375 | <input type="checkbox"/> 2376 | <input type="checkbox"/> 2377 | <input type="checkbox"/> 2378 | <input type="checkbox"/> 2379 | <input type="checkbox"/> 2380 | <input type="checkbox"/> 2381 | <input type="checkbox"/> 2382 |
| <input type="checkbox"/> 2383 | <input type="checkbox"/> 2384 | <input type="checkbox"/> 2385 | <input type="checkbox"/> 2386 | | | | | | |

PLEASE SEND FURTHER INFORMATION ON THE FOLLOWING ADVERTISEMENTS AS NUMBERED BELOW — USE KEY NUMBERS

- | | | | | | | | | | | | |
|-----------------------------|-----------------------------|-----------------------------|-----------------------------|-----------------------------|-----------------------------|-----------------------------|-----------------------------|-----------------------------|-----------------------------|-----------------------------|-----------------------------|
| <input type="checkbox"/> 1 | <input type="checkbox"/> 2 | <input type="checkbox"/> 3 | <input type="checkbox"/> 4 | <input type="checkbox"/> 5 | <input type="checkbox"/> 6 | <input type="checkbox"/> 7 | <input type="checkbox"/> 8 | <input type="checkbox"/> 9 | <input type="checkbox"/> 10 | <input type="checkbox"/> 11 | <input type="checkbox"/> 12 |
| <input type="checkbox"/> 13 | <input type="checkbox"/> 14 | <input type="checkbox"/> 15 | <input type="checkbox"/> 16 | <input type="checkbox"/> 17 | <input type="checkbox"/> 18 | <input type="checkbox"/> 19 | <input type="checkbox"/> 20 | <input type="checkbox"/> 21 | <input type="checkbox"/> 22 | <input type="checkbox"/> 23 | <input type="checkbox"/> 24 |
| <input type="checkbox"/> 25 | <input type="checkbox"/> 26 | <input type="checkbox"/> 27 | <input type="checkbox"/> 28 | <input type="checkbox"/> 29 | <input type="checkbox"/> 30 | <input type="checkbox"/> 31 | <input type="checkbox"/> 32 | <input type="checkbox"/> 33 | <input type="checkbox"/> 34 | <input type="checkbox"/> 35 | <input type="checkbox"/> 36 |
| <input type="checkbox"/> 37 | <input type="checkbox"/> 38 | <input type="checkbox"/> 39 | <input type="checkbox"/> 40 | <input type="checkbox"/> 41 | <input type="checkbox"/> 42 | <input type="checkbox"/> 43 | <input type="checkbox"/> 44 | <input type="checkbox"/> 45 | <input type="checkbox"/> 46 | <input type="checkbox"/> 47 | <input type="checkbox"/> 48 |
| <input type="checkbox"/> 49 | <input type="checkbox"/> 50 | <input type="checkbox"/> 51 | <input type="checkbox"/> 52 | <input type="checkbox"/> 53 | <input type="checkbox"/> 54 | <input type="checkbox"/> 55 | <input type="checkbox"/> 56 | <input type="checkbox"/> 57 | <input type="checkbox"/> 58 | <input type="checkbox"/> 59 | <input type="checkbox"/> 60 |
| <input type="checkbox"/> 61 | <input type="checkbox"/> 62 | <input type="checkbox"/> 63 | <input type="checkbox"/> 64 | <input type="checkbox"/> 65 | <input type="checkbox"/> 66 | <input type="checkbox"/> 67 | <input type="checkbox"/> 68 | <input type="checkbox"/> 69 | <input type="checkbox"/> 70 | <input type="checkbox"/> 71 | <input type="checkbox"/> 72 |
| <input type="checkbox"/> 73 | <input type="checkbox"/> 74 | <input type="checkbox"/> 75 | <input type="checkbox"/> 76 | <input type="checkbox"/> 77 | <input type="checkbox"/> 78 | <input type="checkbox"/> 79 | <input type="checkbox"/> 80 | | | | |

Name Position

Company Nature of Business

Street City Prov.
6-59

PLEASE SEND FURTHER INFORMATION ON THE FOLLOWING NEW PRODUCT ITEMS AS NUMBERED BELOW — USE PRODUCT ITEM NUMBERS

- | | | | | | | | | | |
|-------------------------------|-------------------------------|-------------------------------|-------------------------------|-------------------------------|-------------------------------|-------------------------------|-------------------------------|-------------------------------|-------------------------------|
| <input type="checkbox"/> 2353 | <input type="checkbox"/> 2354 | <input type="checkbox"/> 2355 | <input type="checkbox"/> 2356 | <input type="checkbox"/> 2357 | <input type="checkbox"/> 2358 | <input type="checkbox"/> 2359 | <input type="checkbox"/> 2360 | <input type="checkbox"/> 2361 | <input type="checkbox"/> 2362 |
| <input type="checkbox"/> 2363 | <input type="checkbox"/> 2364 | <input type="checkbox"/> 2365 | <input type="checkbox"/> 2366 | <input type="checkbox"/> 2367 | <input type="checkbox"/> 2368 | <input type="checkbox"/> 2369 | <input type="checkbox"/> 2370 | <input type="checkbox"/> 2371 | <input type="checkbox"/> 2372 |
| <input type="checkbox"/> 2373 | <input type="checkbox"/> 2374 | <input type="checkbox"/> 2375 | <input type="checkbox"/> 2376 | <input type="checkbox"/> 2377 | <input type="checkbox"/> 2378 | <input type="checkbox"/> 2379 | <input type="checkbox"/> 2380 | <input type="checkbox"/> 2381 | <input type="checkbox"/> 2382 |
| <input type="checkbox"/> 2383 | <input type="checkbox"/> 2384 | <input type="checkbox"/> 2385 | <input type="checkbox"/> 2386 | | | | | | |

PLEASE SEND FURTHER INFORMATION ON THE FOLLOWING ADVERTISEMENTS AS NUMBERED BELOW — USE KEY NUMBERS

- | | | | | | | | | | | | |
|-----------------------------|-----------------------------|-----------------------------|-----------------------------|-----------------------------|-----------------------------|-----------------------------|-----------------------------|-----------------------------|-----------------------------|-----------------------------|-----------------------------|
| <input type="checkbox"/> 1 | <input type="checkbox"/> 2 | <input type="checkbox"/> 3 | <input type="checkbox"/> 4 | <input type="checkbox"/> 5 | <input type="checkbox"/> 6 | <input type="checkbox"/> 7 | <input type="checkbox"/> 8 | <input type="checkbox"/> 9 | <input type="checkbox"/> 10 | <input type="checkbox"/> 11 | <input type="checkbox"/> 12 |
| <input type="checkbox"/> 13 | <input type="checkbox"/> 14 | <input type="checkbox"/> 15 | <input type="checkbox"/> 16 | <input type="checkbox"/> 17 | <input type="checkbox"/> 18 | <input type="checkbox"/> 19 | <input type="checkbox"/> 20 | <input type="checkbox"/> 21 | <input type="checkbox"/> 22 | <input type="checkbox"/> 23 | <input type="checkbox"/> 24 |
| <input type="checkbox"/> 25 | <input type="checkbox"/> 26 | <input type="checkbox"/> 27 | <input type="checkbox"/> 28 | <input type="checkbox"/> 29 | <input type="checkbox"/> 30 | <input type="checkbox"/> 31 | <input type="checkbox"/> 32 | <input type="checkbox"/> 33 | <input type="checkbox"/> 34 | <input type="checkbox"/> 35 | <input type="checkbox"/> 36 |
| <input type="checkbox"/> 37 | <input type="checkbox"/> 38 | <input type="checkbox"/> 39 | <input type="checkbox"/> 40 | <input type="checkbox"/> 41 | <input type="checkbox"/> 42 | <input type="checkbox"/> 43 | <input type="checkbox"/> 44 | <input type="checkbox"/> 45 | <input type="checkbox"/> 46 | <input type="checkbox"/> 47 | <input type="checkbox"/> 48 |
| <input type="checkbox"/> 49 | <input type="checkbox"/> 50 | <input type="checkbox"/> 51 | <input type="checkbox"/> 52 | <input type="checkbox"/> 53 | <input type="checkbox"/> 54 | <input type="checkbox"/> 55 | <input type="checkbox"/> 56 | <input type="checkbox"/> 57 | <input type="checkbox"/> 58 | <input type="checkbox"/> 59 | <input type="checkbox"/> 60 |
| <input type="checkbox"/> 61 | <input type="checkbox"/> 62 | <input type="checkbox"/> 63 | <input type="checkbox"/> 64 | <input type="checkbox"/> 65 | <input type="checkbox"/> 66 | <input type="checkbox"/> 67 | <input type="checkbox"/> 68 | <input type="checkbox"/> 69 | <input type="checkbox"/> 70 | <input type="checkbox"/> 71 | <input type="checkbox"/> 72 |
| <input type="checkbox"/> 73 | <input type="checkbox"/> 74 | <input type="checkbox"/> 75 | <input type="checkbox"/> 76 | <input type="checkbox"/> 77 | <input type="checkbox"/> 78 | <input type="checkbox"/> 79 | <input type="checkbox"/> 80 | | | | |

Name Position

Company Nature of Business

Street City Prov.
6-59

BUSINESS REPLY CARD
No Postage Stamp Necessary if Mailed in Canada

5c POSTAGE WILL BE PAID BY

ELECTRONICS AND COMMUNICATIONS

450 Alliance Avenue

Toronto 9, Ontario



BUSINESS REPLY CARD
No Postage Stamp Necessary if Mailed in Canada

5c POSTAGE WILL BE PAID BY

ELECTRONICS AND COMMUNICATIONS

450 Alliance Avenue

Toronto 9, Ontario



BUSINESS REPLY CARD
No Postage Stamp Necessary if Mailed in Canada

5c POSTAGE WILL BE PAID BY

ELECTRONICS AND COMMUNICATIONS

450 Alliance Avenue

Toronto 9, Ontario



INDEX TO ADVERTISERS

(Continued)

| Key No. | | Page No. |
|---------|--|----------|
| 39. | General Communications Ltd. | 79 |
| 40. | General Radio Co. | 100 |
| 41. | Hewlett-Packard Co. | 7 |
| 42. | IRE Convention | 81 |
| 43. | International Resistance Co. Ltd. | 14 |
| 44. | International Resistance Co. Ltd. | 14 |
| 45. | Jerrold Electronics Corp. | 24 |
| 46. | Kester Solder Co. of Canada Ltd. | 76 |
| 47. | Lampkin Laboratories Ltd. | 66 |
| 48. | Mechron Engineering Products Ltd. | 91 |
| 49. | Mel Sales Ltd. | 97 |
| 50. | Millard Electric Ltd. | 66 |
| 51. | Muirhead Instruments Ltd. | 80 |
| 52. | National Fibre Co. of Canada Ltd. | 72-73 |
| 53. | Nichols Ltd., R. H. | 71 |
| 54. | Northern Electric Co. Ltd. | 27 |
| 55. | Northern Radio Mfg. Co. Ltd. | 28 |
| 56. | Philco Corp. of Canada Ltd. | 96 |
| 57. | Porter (Canada) Ltd., H. K. | 29 |
| 58. | Precision Electronic Components | 65 |
| 59. | Pye Canada Ltd. | 64 |
| 60. | Pylon Electronic Development Co. Ltd. | 64 |
| 61. | R & M Bearings Canada Ltd. | 68 |
| 62. | R.O.R. Associates Ltd. | 71 |
| 63. | Racal (Canada) Ltd. | 99 |
| 64. | Rogers Electronic Tubes & Components (Div., Phillips Electronic Industries Ltd. | 20-21 |
| 65. | Sanborn Co. | 95 |
| 66. | Siemens Edison Swan (Canada) Ltd. | 74 |
| 67. | Snelgrove Co. Ltd., C. R. | 94 |
| 68. | Sola Electric (Canada) Ltd. | 93 |
| 69. | Standard Telephones & Cables Mfg. Co. (Canada) Ltd. | 87 |
| 70. | Stark Electronic Instruments Ltd. | 69 |
| 71. | Syntron (Canada) Ltd. | 78 |
| 72. | Tektronix, Inc. | 85 |
| 73. | Telephone Mfg. Co. Ltd. | 69 |
| 74. | Triplett Electrical Instrument Co. | 19 |
| 75. | Tung-Sol Electric Inc. | 8 |
| 76. | Veeder-Root of Canada Ltd. | 18 |
| 77. | Ward Leonard of Canada Ltd. | 83 |
| 78. | Welwyn Canada Ltd. | 74 |
| 79. | Wholesale Radio & Electronics Ltd. | 65 |
| 80. | Wind Turbine Co. Canada Ltd. | 27 |

**special
diesel
generating
equipment to
customer
requirement**

Mechron automatic no break and primary power diesel generating equipment

Installation and Field Maintenance Service Available

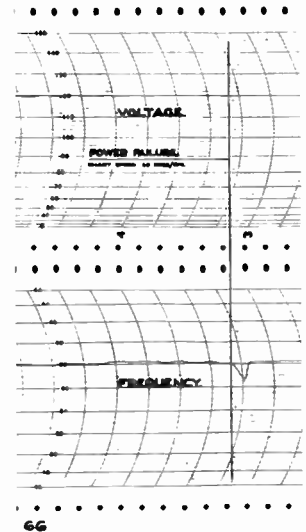
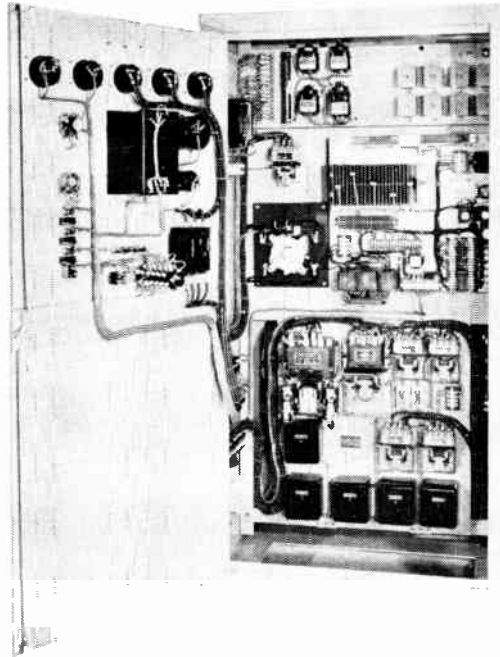
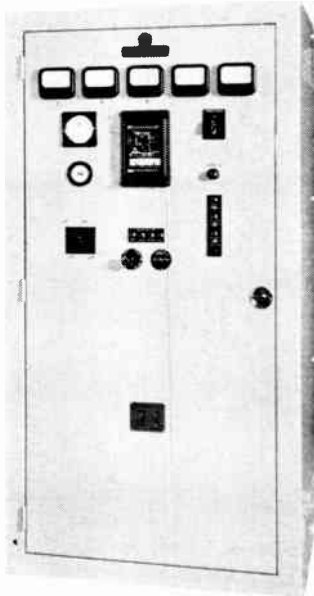

Mechron primary power equipment

is used by various Government Departments. These include D.O.T., D.N.D., Northern Affairs, etc.

Major Communications companies also rely on

Mechron equipment

to ensure a continuous source of reliable power.

Mechron designed no break

Equipment maintains the voltage constant with negligible frequency drop when primary power fails

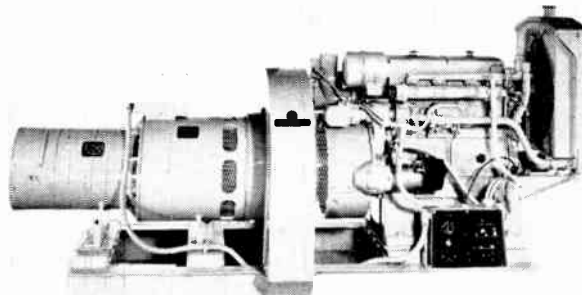

*Designed and produced
in Canada by*

MECHRON ENGINEERING PRODUCTS

LTD.

MONTREAL

OTTAWA

TORONTO

For complete details check No. 48 on handy card, page 89.

You've
never seen a
SUB-MINIATURE
switch
as mighty
as this

BIG switch performance in sub-miniature size

Rated 10 amps 30 V.d-c. inductive
(L/R- .026). Consistently more
than 20,000,000 cycles

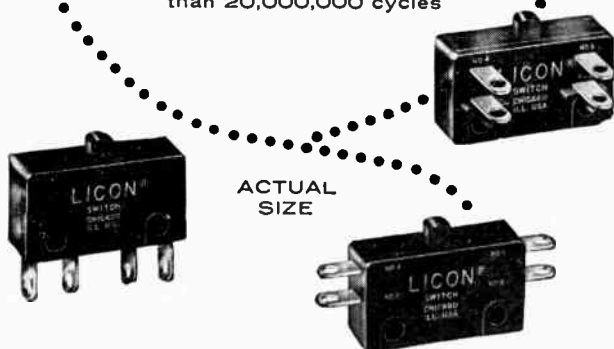

NEW LICON® TYPE 16 SWITCH measures only 25/32" long and 1/4" thick but packs quality and dependability never before achieved in sub-miniatures. With characteristics found only in much larger precision switches, the Licon Type 16 is ideal for aircraft safety applications, has performance and size vital to guided missiles. Passes Navy 1300 G shock test . . . exceptionally shock and vibration resistant even near the trip point. Its new switch mechanism with stainless steel springs avoids early fatigue and provides the advantages of double break contacts with wiping action in a wide range of movement differentials and operating forces.



**WRITE FOR
FREE LICON TYPE 16
SWITCH BULLETIN**

Engineering data, characteristics, modifications . . . write for complete information on the new Licon Type 16 Sub-miniature Switch today.

NOW MADE IN CANADA

L I C O N

SWITCHES AND CONTROLS

DIVISION OF
CANADA ILLINOIS TOOLS LTD.

67 Scarsdale Road
Don Mills, Ontario

Exclusive Sales Agents

**CONSTELLATION
COMPONENTS LTD.**

136 Tower Drive, Toronto
17041 Omega Place
St. Genevieve, Montreal

LI-A

For complete details check No. 19 on handy card, page 89.



SAVE ON TEST EQUIPMENT

with easy-to-build HEATHKITS



RF GENERATOR KIT

Model LG-1 \$67.95

Ideal for the design and development laboratory, or for general service. Checks RF and IF stage gain, overall circuit sensitivity, demodulator performance, selectivity. Meter switch selects output in microvolts or percent of modulation, on accurately calibrated 200 microamp panel meter.

AUDIO SIGNAL Generator Kit

Model AG-9A \$40.95

Tune frequencies within $\pm 5\%$ accuracy with distortion of less than .1 of 1% between 20 CPS and 20,000 CPS. Frequency can be varied in steps of 1 CPS from 10 to 100 CPS and a four-position multiplier switch provides an overall range of 10 to 100,000 CPS.



AUDIO WATTMETER KIT

Model AW-1 \$34.95

Five power ranges cover 0.5 mw, 500 mw, 5 w, and 50 w full scale. Db ranges cover -10db to +30db. Frequency response is ± 1 db, from 10 CPS to 250 kc. Non-inductive load resistors are built in for 4, 8, 16 or 600 ohms impedance.



DAYSTROM LIMITED

2 RAITHERM ROAD, TORONTO 19, ONT.

Distributors of Heathkits in Canada

5919

For complete details check No. 31 on handy card, page 89.

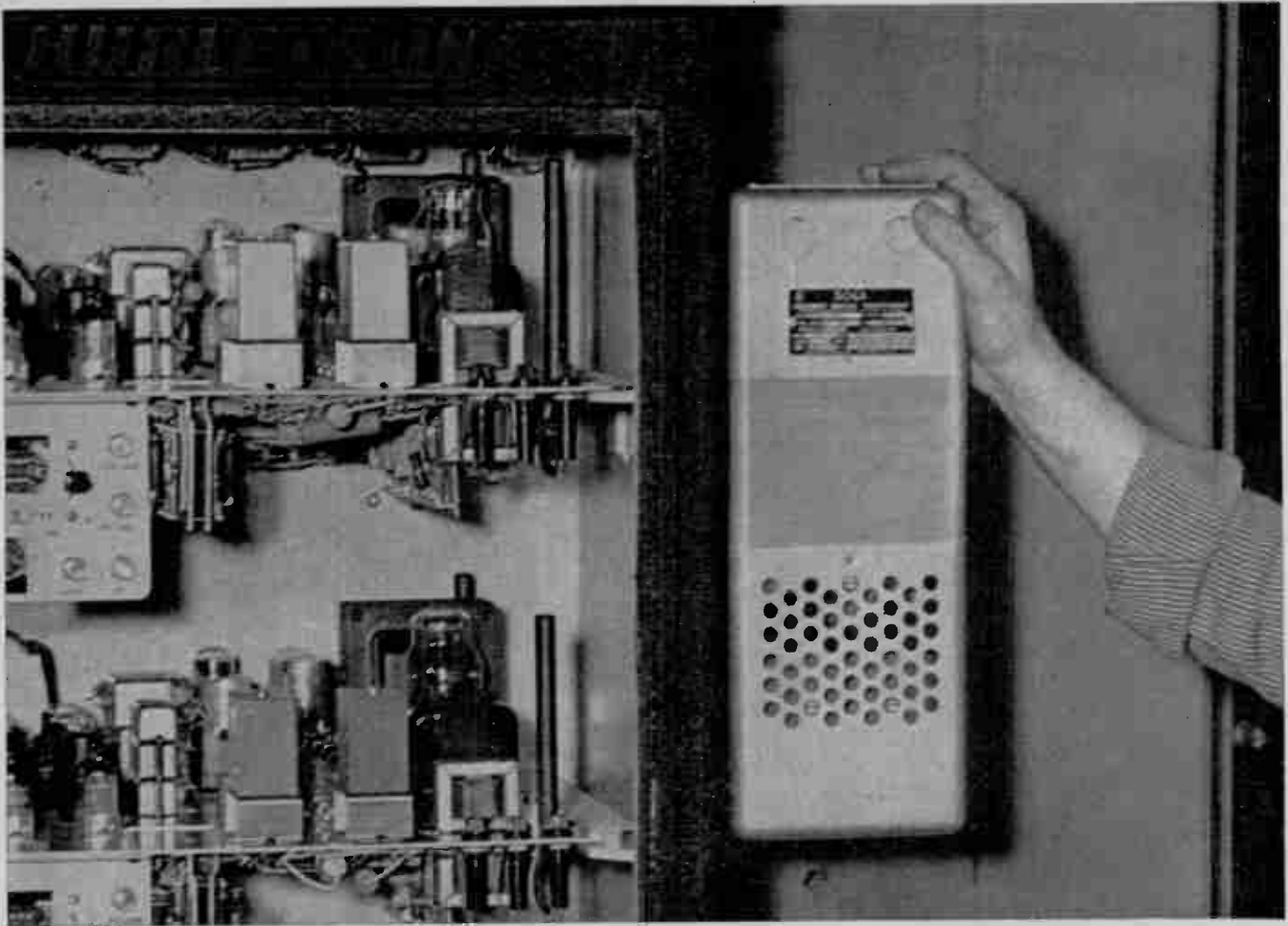

Sola's Standard-type Constant Voltage Transformer, mounted at right of control cabinet, supplies regulated input voltage for dependable operation of Hurlertron printing register control.

Equipment delivers full-efficiency performance with input voltage Sola-regulated within $\pm 1\%$

Built in or added as an accessory, Sola Constant Voltage Transformers permit voltage-sensitive equipment to operate at full efficiency. Variations in line voltage as great as $\pm 15\%$ are stabilized to within $\pm 1\%$ of equipment nameplate voltage. This eliminates performance variations and failures caused by irregular voltage—highs, lows, or most transients. Sola-regulated input voltage also gives tubes and other components the correct electrical environment for full life.

The Sola Constant Voltage Transformer is a static-magnetic regulator whose action is automatic and virtually instantaneous—it responds to variations in input

voltage within 1.5 cycles. It has no tubes or moving parts and requires no manual adjustments or maintenance.

The Standard-type CV illustrated is only one of a complete line of Sola voltage regulators having wide application in electrical and electronic devices. Such special types as harmonic-free, filament, plate-filament, and adjustable harmonic-free transformers all provide the benefits of regulated input voltage. More than 40 models of these economical, compact regulators are available from stock. Sola also manufactures custom-designed units (in production quantities) to meet special needs.

For complete data write for Bulletin 32F-CV-170.

SOLA ELECTRIC (CANADA) LTD., 24 Canmotor Avenue • Toronto 18, Ontario • Phone: CLifford 1-1147
In The United States, Sola Electric Co., Chicago 50, Illinois, A Division of Basic Products Corporation

SOLA



CONSTANT VOLTAGE TRANSFORMERS

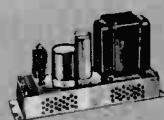

REGULATED DC POWER SUPPLIES



MERCURY LAMP TRANSFORMERS



FLUORESCENT LAMP BALLASTS

For complete details check No. 68 on handy card, page 89.

STABILITY

... the oldest
all-Canadian company
manufacturing
frequency control components



In this era of rapid advancement in radio communication techniques, STABILITY in frequency control is essential to the achievement of closer tolerances.

STABILITY is also the keynote of the long and successful operation of the C. R. Snelgrove Co. Limited* — of its personnel and of its policies with regard to quality, reliability and service. The only changes at Snelgrove are those of expanding facilities designed to meet the growing demands of customers who also know the value of quality, reliability, service and ... STABILITY.

C. R. **SNELGROVE**

COMPANY LIMITED

DON MILLS, ONT. HI. 4-1107-8

*Canadian owned and operated — the oldest company in Canada solely devoted to the manufacture of precision low drift quartz crystals, crystal ovens and other associated frequency control devices.

When you must have recording range out to 150 cps . . . immediately visible, permanent traces in rectangular coordinates . . . a large number of channels in the limited space of a mobile van or control room . . . and the flexibility of a variety of economical preamps—a Sanborn 850 system is the *one* most practical answer to *all* these requirements. In aircraft and missile telemetering facilities, computer installations, test stand work and similar multi-channel recording applications, the ‘850’ is proving its unique adaptability and practicality.

You can unplug and change ‘850’ preamplifiers in seconds to record a wide range of variables. Select

by pushbutton any of nine electrically-controlled chart speeds from 0.25 mm to 100/sec. Observe and make notes on the convenient 8” vertical chart display. Reload charts quickly and easily from the front. Every operating feature *you want* is backed up by the performance specifications *you need*—for the greatest possible recording usefulness.

DC Coupling and Phase Sensitive Demodulator preamplifiers are now available. Carrier and Basic Chopper preamplifiers are now being prepared for production. A rack-mounted Master Oscillator Power Amplifier (MOPA) to supply Carrier and Chopper excitation is also in preparation.

THE ONLY

6- or 8-CHANNEL DIRECT WRITER

THAT OFFERS YOU

**Response to 150 cps
... 0.5% LINEARITY**

**Wide choice of
ECONOMICAL PREAMPS**

**INKLESS traces
-RECTANGULAR coordinates**

24½" panel space

Your local Sanborn Sales-Engineering representative can give you the complete ‘850’ facts and specifications. Contact him now.



**SANBORN
COMPANY**

Industrial Division
175 Wyman Street Waltham 54, Mass.

R.O.R. Associates, 1470 Don Mills Road, Don Mills, Ontario, Canada



SANBORN
850
SERIES

For complete details check No. 65 on handy card, page 89.

An Important Announcement to Electronics Equipment Buyers . . .

PRICES REDUCED



UP TO 20%

ON ALL PHILCO

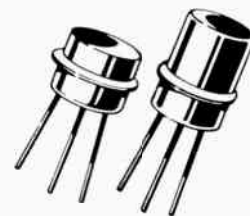

TRANSISTORS

SAVE MONEY ON WORLD'S FINEST QUALITY TRANSISTORS

Now, you can specify Philco Transistors — and build extra quality and performance into your products — at savings up to 20%.

For further information on this important price news from Philco — plus a copy of our free booklet “Transistor Types from Philco” — mail this coupon today.

PHILCO CORPORATION
OF CANADA LIMITED,
Don Mills, Ontario

Please send me booklet “Transistor Types from Philco” and facts on reduced transistor prices.

Name

Firm

Address



Distributor enquiries are invited.



PHILCO CORPORATION OF CANADA LIMITED, DON MILLS, ONTARIO
For complete details check No. 56 on handy card, page 89.

THE **TOP** NAMES IN

COMMUNICATIONS and MICROWAVE TEST EQUIPMENT

Arizona Telemetry Corporation

Boonton Electronics Corp.

Communication Measurements Laboratory

The Digitran Co.

Endevco Corporation

Frequency Standards Inc.

Instrument Development Laboratories

International Radiant Corp.

Kay Electric Co.

Krohn-Hite Export Corp.

Ling Electronics Corp.

Measurement Engineering Ltd.

Narda Microwave Corp.

Narda Ultrasonics Corp.

Polarad Electronics Corp.

The Reflectone Corp.

Sanders Associates Inc.

Sensitive Research Instrument Corp.

Servo Corporation of America

Trad Electronics Corp.

Technology Instrument Corp.

Weldmatic, Division of Unitek Corp.

ARE REPRESENTED IN CANADA BY:



MEL SALES LIMITED

ARNPRIOR, ONTARIO

For complete details check No. 49 on handy card, page 89.

editorial

Communications—sheet anchor of electronics industry

Notwithstanding the broad use of electronics that has developed in Canada over the past fifteen years, it may reasonably be said that the real backbone of the electronics industry in Canada has been in the sphere of commercial communications. Taken by itself it perhaps ranks as the highest dollar spender in the Canadian industry and although the extension and improvement of communications facilities have been carried on apace since the end of the war, there is still much to be done in the matter of new construction to keep up with the rapid industrial development that has highlighted the Canadian scene in recent years.

Canadian communications facilities rank second to none and the particular geographic problems and the isolated pockets of population that are characteristic of the Canadian development pattern have in many instances presented singular problems both in economics and engineering, the solution of which by Canadian communications companies have added stature to their accomplishments.

If any assurance should be required with regard to the continuing economic soundness of the Canadian electronics industry, it can well be found in the phenomenal expansion of communications systems in Canada that has taken place in recent years and the wide gaps that must yet be bridged in order to meet the needs of this country's growing industrial developments. In this respect it is significant to note that extensions of communications facilities not only require large financial outlays in capital equipment, but, by the nature of the apparatus used, also require continuing maintenance and the consumption of large quantities of maintenance materials. This, in turn, of course, means a continuing high rate of employment both in the manufacture of capital equipment and for maintenance purposes.

Communications, therefore, may be regarded as the sheet anchor of the Canadian electronics industry, especially during such uneasy phases as the industry has recently weathered and which to a large extent were brought about by defense contract cancellations.

It is further interesting to note that, with the advent of jet aircraft on Canadian airways, a vast and specialized segment of Canadian communications will be required to be overhauled and modernized — a task which, in many areas, has already begun.

In recognition, therefore, of the strength that is lent to the Canadian electronics industry through commercial communications, *Electronics and Communications* presents this special Communications Issue which, it is hoped, will convey some idea of the magnitude of the work that is being carried on by this segment of the Canadian electronics industry. While the reports carried in this issue only cover some of the larger communications systems in Canada, they may be taken as indicative of the activity currently being engaged in by the largest to the smallest companies in Canada.

Communications, unlike other large segments of the electronics industry such as the manufacture of defense equipment, are not subject to the vicissitudes and vagaries of defense requirements. Communications are constituted of the needs of an expanding economy and are therefore by the nature of their necessity a stable enterprise. There can be little doubt, then, that so long as the Canadian economy continues to grow, communications will grow likewise, providing a solid foundation for the Canadian electronics industry as a whole.

FULLY Compatible

Single Sideband or Double Sideband Radio Telephone

TRA.55

Transportable

.5, 1 and 5 Kw transmitters and linear amplifiers, with receiving and remote equipment. Now available. Also mobile units.



ABRIDGED SPECIFICATION

| | |
|------------------|---|
| Frequency range: | 3-15 Mc/s |
| Channels: | 4 crystal controlled |
| Output power: | 60 watts P.E.P. continuous rating |
| Aerial: | (a) 75 ohm for tuned aerials (b) single-ended output for long wire untuned aerials |
| Finish: | High grade tropical standard for ambient temperatures of 40°C. |
| Power supply: | AC or DC |
| Dimensions: | Width 20½ inches (52 cms) Height 24½ inches (62½ cms) Depth 20½ inches (52 cms) |
| Weight: | Approx. 160 lbs. (72.6 Kg) |

- ★ 4 pre-set crystal controlled channels
- ★ Frequency range: 3-15 Mc/s in 2 bands
- ★ 60W P.E.P. continuous rating
- ★ Extreme simplicity of operation
- ★ Transportable
- ★ May be used for CW operation
- ★ Extreme simplicity of maintenance

The enormous effective gain in power obtained by SSB transmission is now available in compact and economical form, especially suited to the needs of government communications authorities, geological survey teams, meteorological services, mining companies, oilfields, civil aviation and forestry operators.

The TRA.55 is tropicalized and designed for use by unskilled personnel, the transmitter and receiver being tuned simultaneously to 4 pre-set channels, selected by a single switch. The R T transmit switch is incorporated in the handset handle. North American type tubes and connectors are used throughout.

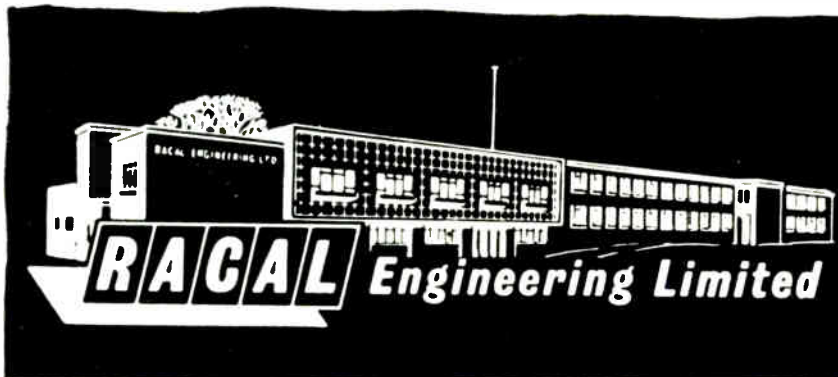

BRACKNELL, BERKSHIRE

Telephone Bracknell 941
Cables/Grams. Racal Bracknell Berks

Agents in Canada:
INSTRONICS LTD.
P.O. Box 100
Stittsville, Ontario

For complete details check No. 63 on handy card, page 89.

METERED



for every work bench

- ★ Indicate the exact amount of load voltage and either load current** or power† drawn.
- ★ Ideal for measuring power consumption.
- ★ Provide a convenient means for determining the effects of reduced or increased line voltage on a-c operated equipment; for example, cutoff points of voltage-regulator circuits are readily determined.
- ★ Useful for tracking down circuit troubles that are intermittent with normal line voltage, but which can be made to occur more frequently or fail altogether at either low or high line-voltage.



▲ Type W5MT3A** Metered Variac, \$85
... reads load volts and amperes



▲ Type W5MT3W† Metered Variac, \$110
... reads load volts and watts

The new General Radio Metered Variac[®] autotransformers are everyday tools needed in laboratory test setups and engineering work areas. These continuously adjustable a-c supplies are available in two types. Each model consists of a W5 Variac with Duratrak[®] brush contact surface, a current transformer, the necessary switches, a voltmeter, and either an ammeter (W5MT3A) or a wattmeter (W5MT3W).

Output voltage range is from 0 to 135 volts. Dual ranges are provided for maximum accuracy: 0-1 and 0-5 amperes for the volt-ammeter; and 0-150 and 0-750 watts for the volt-wattmeter. Meters are magnetically shielded to yield an overall accuracy of 3% despite the Variac's stray field. A double-pole off-on switch disconnects the instrument from both sides of the line. The output circuit has two fuses mounted on the front panel to protect both the Variac and its meters from overload.

*Patent Applied For

Write For Complete Information

GENERAL RADIO COMPANY

Canadian Engineering Office in TORONTO

99 Floral Parkway, Toronto 15, Ontario
Arthur Kingsnorth • Richard J. Provan
Tel.: CHerry 4-6221

Repair Service: Bayley Engineering Ltd., Ajax, Ontario

For complete details check No. 40 on handy card, page 89.