



ELECTRONICS

AND

COMMUNICATIONS

NO 7 & PAGES 1081
P. EASTGATE CRES
TORONTO ONT

RFM
CRC
DEL
1811C

A Communications Feature Issue

Mass-Produced De-Twinning of Quartz Crystals

By Anthony E. Lofting

What! Another Engineering Change

By George L. King, P.Eng.

The Application of Miniaturized Order Wire
Equipment To Radio Systems

By E. V. Hird, P.Eng.

An Air-Portable UHF Transhorizon
Communication Terminal

MAY 1958

AN AGE PUBLICATION
TORONTO, CANADA

DEVELOPED FOR
APPLICATIONS ...

... beyond today's horizons

New HEIGHTS
OF PERFORMANCE
Achieved by
advance-design
**ASTRON CAPACITORS
AND R.F. FILTERS**

Today's design requirements foreshadow tomorrow's revolutionary applications ... Imposing critical new areas of performance on electronic components.

The vexing problem of efficient capacitor and R. F. filter operation under these ultra-severe conditions of extreme heat, cold, moisture and vibration challenges the imagination of the component manufacturer ... truly he must create "something completely new under the sun"!

A foremost pioneer in the exacting development of advance-design components, to cope with these requirements, is Astron ... leader in miniaturization, manufacturer of industry's widest variety of types, whose experience, ability and creative far-reaching point of view produces the significant, highly-engineered designs pictured here ... proof of a dedication to progress.

The types and styles illustrated are but a few of the many available ... for complete technical and application information on all Astron products, please request catalog AC-4.

R. F. Noise Suppression Filters. Complete noise suppression "Packaged" service—Definition of requirements • Engineering analysis • Efficient solutions • Advance-type components • Quality production.

A complete stock is maintained in Pointon's Toronto warehouse.

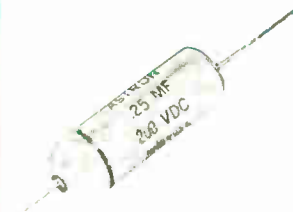

Blue • Point™ Molded Plastic Paper Capacitors

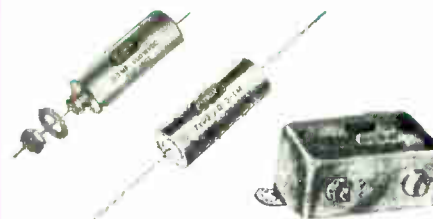

Meteor® High Temperature Miniaturized Capacitors



Series "X"™ Mylar Plus Capacitors

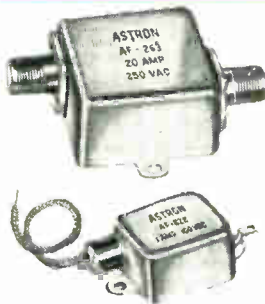

Comet* Molded Plastic Metallized Paper Capacitors

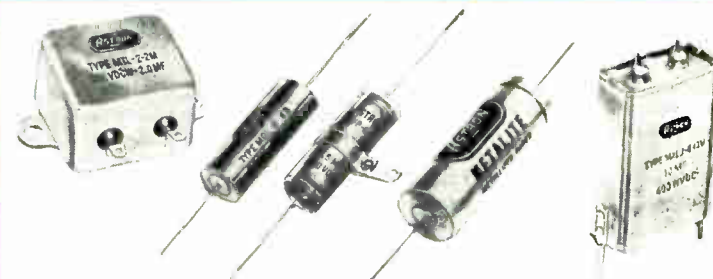

Metalite® and Hy-Met* Sub-Miniature Metallized Paper Capacitors



Safety Margin "SM"™ Miniature Electrolytic Capacitors



Safety Margin "SM"™ Twist-Prong and Cardboard Cased Electrolytic Capacitors

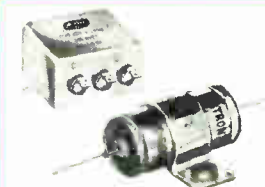

MIL-Type Hermetically Sealed Paper Capacitors



ASTRON
CORPORATION
255 GRANT AVENUE EAST NEWARK, N. J.

⑤ Big Advantages with MARCONI 110° Picture Tubes



⑤ advantages

- * 5½" shorter than the conventional 90° tube, opening new scope for cabinet design.
- * Available with 90° faceplate allowing for conversion to 110° without retooling the mask.
- * No ion trap required—you save on the cost of an ion trap and the labour for adjusting it.
- * Integral glass button base eliminates any possibility of loose base-pin connection.
- * Small neck allows 110° deflection with only slightly more power than is required for a 90° tube.
- * Approximately one pound lighter.

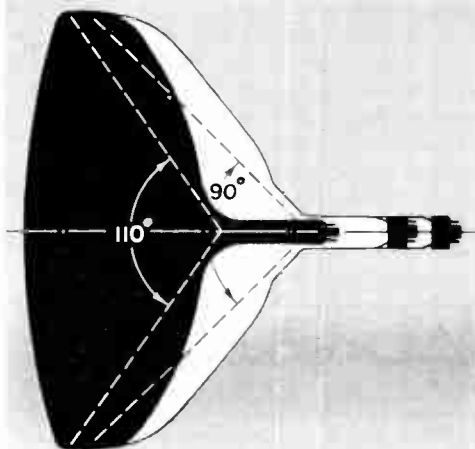
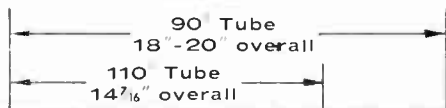

As always Marconi is ready to supply the industry's latest needs. Marconi 110° tubes are now available from Canadian production to customer's specifications.

ELECTRONIC TUBE AND COMPONENTS DIVISION

CANADIAN **Marconi** COMPANY

830 BAYVIEW AVENUE, TORONTO, ONTARIO

BRANCHES: Vancouver • Winnipeg • Montreal • Halifax • St. John's, Nfld.

Now! Westinghouse **WL-6198A** Vidicon Tube ends flicker effect!

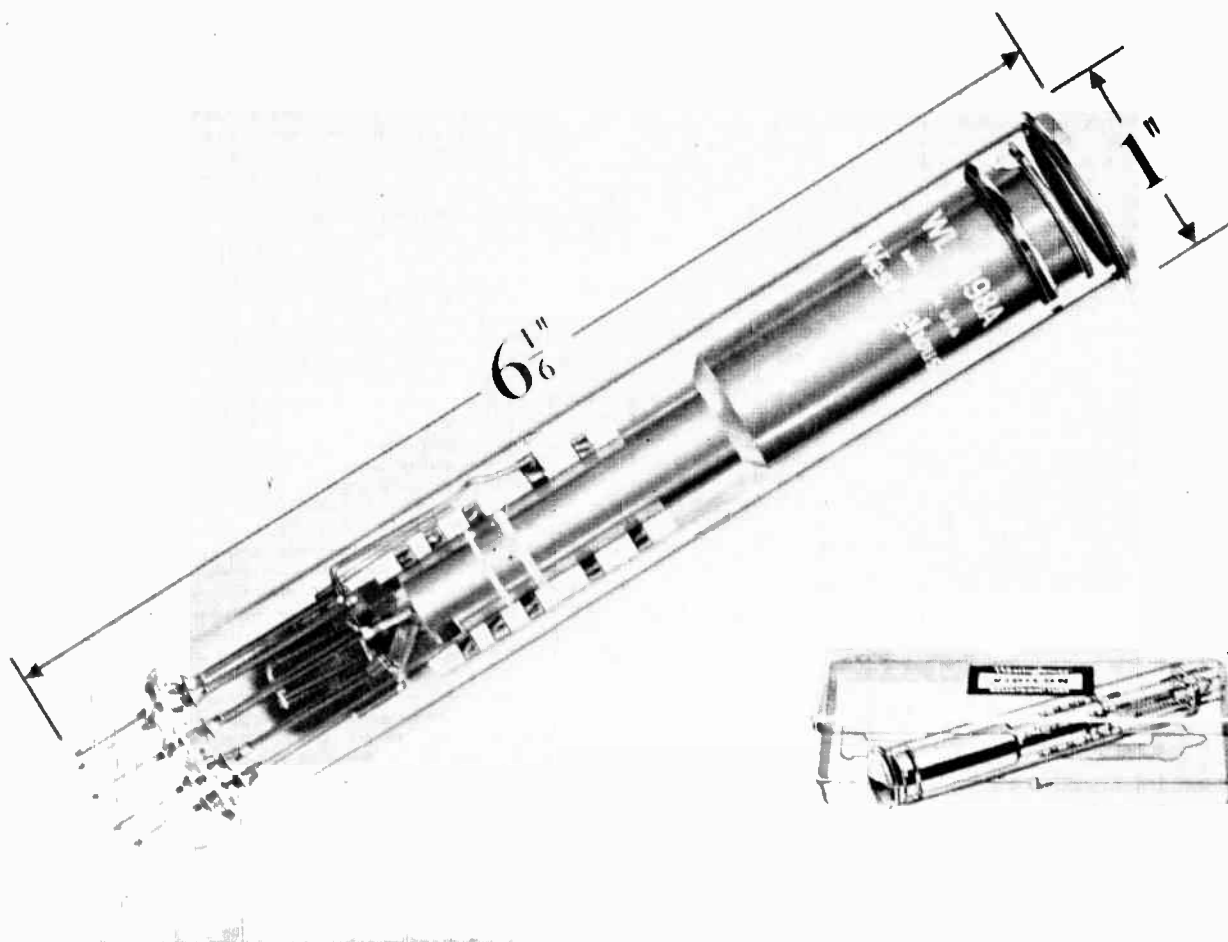

IMPROVED DESIGN OFFERS TELEVISION CAMERA DESIGNERS OPTIMUM VIDEO CHARACTERISTICS

Four big new advantages are now yours with the Westinghouse WL-6198A Vidicon . . .

For military and industrial television cameras, you'll find the Westinghouse WL-6198A the most advanced Vidicon you can use. Here's why.

YOU CAN BE SURE...IF IT'S

Westinghouse

- 1.** It eliminates flicker effect due to beam instability.
- 2.** It can be operated at optimum video strength, thanks to good uniformity of dark current.
- 3.** It's ideal for automatic video control because of narrow spread of signal electrode voltage.
- 4.** It's the first Vidicon Tube with electropolished gun, thus eliminating picture blemishes caused by contaminating particles from gun.

Electronic Tube Division

Hamilton, Ontario

For further data on advertised products use page 81.

Electronics And Communications

VOLUME 6

MAY, 1958

NUMBER 5

FEATURES

Mass-Produced De-Twinning Of Quartz Crystals	24
by Anthony E. Lofting	
What ! Another Engineering Change	30
by George L. King, P.Eng.	
Infra-Red Spectrometry For Analytical And Organic Chemistry	34
Miniaturized Order Wire Equipment In Radio Systems	35
by E. V. Hird, P.Eng.	
A Portable UHF Transhorizon Communication Terminal	38
Tropospheric Scatter System For Northern Quebec-Labrador	40
by H. G. Owen	
A Secode Dial System For The Aircraft Industry	42
Measuring Gamma Emitting Radioactive Samples	43

DEPARTMENTS

Editorial	9
RETMA Report	11
C RTPB Newsletter	12
Business Briefs And Trends	15
New Products	49
News Report	54
Book Review	80

President, Norman G. McHardy; Vice-President, Secretary-Treasurer, L. R. Kingsland; Editor, Thomas W. Lazenby; Consulting Technical Editor, Leslie Hill, Ph.D. Eng.; Editorial Assistant, D. K. Trowell; Advertising Manager, H. E. Dallyn; Assistant Advertising Manager, Arthur Dixon; Production Manager, Nevill A. Campling; Business Manager, Clifford A. Sparks; Circulation Manager, Paul A. Irwin; Art Editor, Wm. McReynolds; Photo Editor, Guido Milanesio. United Kingdom and European Representative, Norman F. Keenan, 47 Manchester Street, London W. 1, England. West Coast Representative, Dillenbeck-Galavan, Inc., 266 South Alexandria Ave., Los Angeles 4, Calif. Montreal Representative, Keith Edgar, 116 Rue de Flandre, Montreal 23 (Preville), Quebec. Telephone: OR. 1-2020. All business and editorial correspondence should be addressed to the Toronto office.

PUBLISHED BY AGE PUBLICATIONS LIMITED

Founded in 1923 by Norton W. Kingsland

Publishers of Heating, Plumbing and Air Conditioning AGE • Restaurants and Institutions
Automatic Heating • Wine, Beer and Spirits in Canada • Industrial Aeronautics

31 - 35 Willcocks Street, TORONTO, ONT., CANADA. Tel. WALnut 2-3115.

SUBSCRIPTION RATES: Canada, U.S.A. and British Possessions - \$5.00 per year • Foreign - \$10.00 per year.

Contents copyright by Age Publications Limited. No part of this periodical may be reproduced without the consent of the publisher.

Authorized as second class mail. Post Office Department, Ottawa.



Member Canadian Circulations



Audit Board, Inc.

PRINTED IN CANADA

60

**ALL UNDER
ONE ROOF
IN CANADA**

PRODUCTION

TOOLING

ENGINEERING

DESIGN

Panel Measuring Instruments
Portable Measuring Instruments
Electronic Instrumentation

A complete, Canadian facility for instruments or instrumentation is at your disposal — complete, from the creative to the production stage, all under one roof.

If you'd prefer Canadian manufacture of the instrument side of your equipment, or if all you have is the idea, let us demonstrate the unique combination of skills we can offer.

A CANADIAN COMPANY

Bach-Simpson
LIMITED

1255 Brydges St. London, Ontario

H6954

For further data on advertised products use page 81.

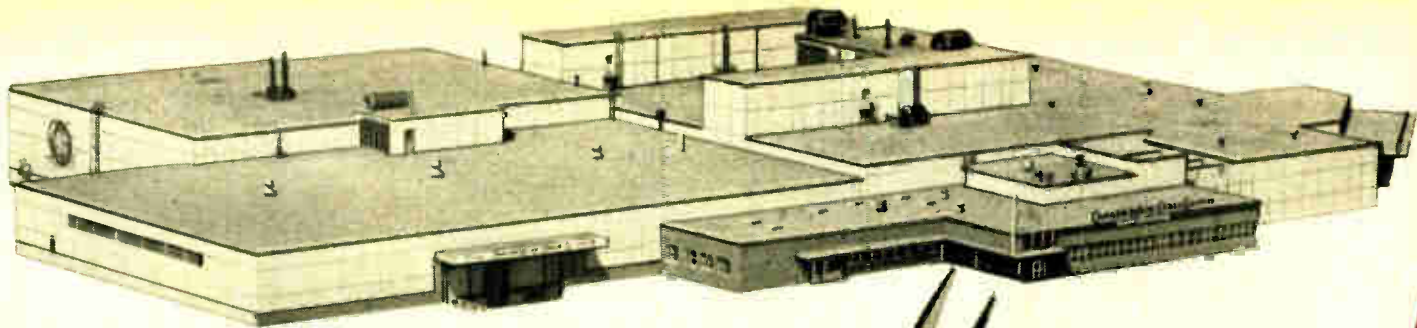

... another great

Canada Wire plant

MAGNET WIRE DIVISION, SIMCOE, ONTARIO—engineered from the ground up to produce the finest quality magnet wires modern technology can create.

20th Century progress demands magnet wires of superbly high quality in an almost endless range of sizes and insulations. Now, at this new, 113,000 square foot Simcoe Magnet Wire Division plant, Canada Wire is equipped with the finest drawing and annealing equipment, and enamel ovens, capable of meeting industries' needs for magnet wires, no matter how demanding. Thicknesses from No. 9 to No. 50. Fifty-four kinds of insulations to meet the most exacting operating requirements. And the unique standards of quality and service by which these magnet wires are produced will benefit every user; some are described here. Your local Canada Wire Sales Office will be pleased to provide full details on the magnet wire products now available from Simcoe.

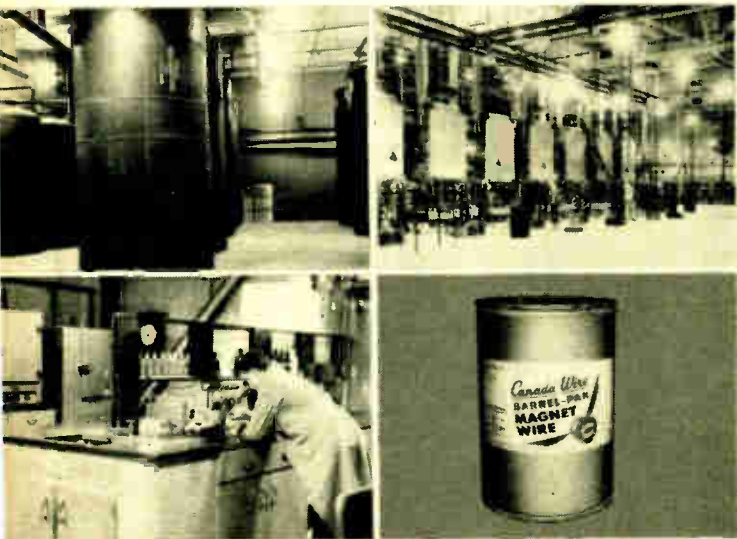

Above left—The only magnet wire plant in Canada with facilities for storing 30,000 gallons of wire coating enamels. Eliminates the variations found from batch to batch in using drum type shipments.

Above right—Production is completely automatic. Air-conditioning system removes all dust from the air to protect enamel insulation during production.

Below left—New inspection and laboratory test equipment to thoroughly evaluate all raw materials and finished products. Forward-thinking research to pace the staggering rate of progress in electronics, flight and other fields.

Below right—Magnet wire customers may now have their requirements shipped in new "Barrel-Paks" of 80 up to 600 pounds of Magnet Wire. More economical to handle. Sealed against dust—protected against damage.



TRADE MARK REGISTERED

Pacing progress with forward-thinking cable research

Canada Wire and Cable Company Limited

A Canadian Company Manufacturing and Selling Coast to Coast

Blueprinting The Future...

Today, the changing face of Canada no longer mirrors the shallow blemish of the axe and plow alone.

Today, the deeper bite of industry prevails . . . punctuating the prairie's sparseness with the geometric symmetry of tapered oil rigs . . . splintering the brittle silence of the tundra with the thin, metallic whine of meshing gears . . . tapping the bubbling, frenzied energy of a thousand teeming streams . . . turning seasoned stands of timber into newsprint, corrugated cartons, paper cups.

For this is Canada today—eager, energetic, vital . . . pulsating with the potent throb and beat of countless newborn industries and skills.

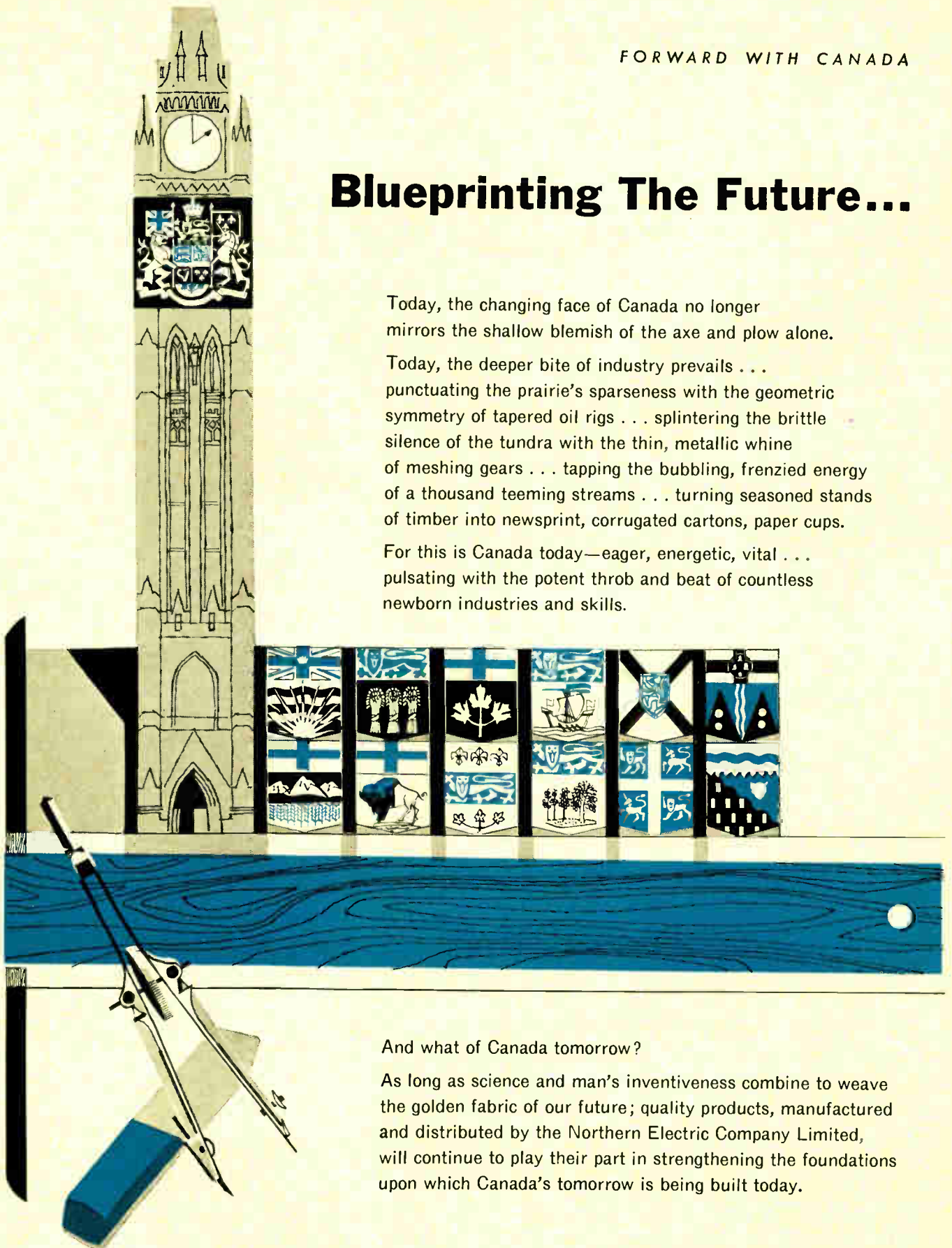

And what of Canada tomorrow?

As long as science and man's inventiveness combine to weave the golden fabric of our future; quality products, manufactured and distributed by the Northern Electric Company Limited, will continue to play their part in strengthening the foundations upon which Canada's tomorrow is being built today.

Northern Electric
SERVES YOU BEST

For further data on advertised products use page 81.

6658-3

Electronics And Communications

Volume 6

May, 1958

Number 5

A Matter Of Perspective

“CANADA’S engineering profession heavily infiltrated by foreign specialists is facing complete domination by the United States as technical personnel flee the recession in their own country for employment in Canadian subsidiaries of U.S. firms . . .”

The above, reported in the first of a series of articles dealing with the Canadian engineering profession, was published recently in a Toronto newspaper.

A first reaction to this statement may be the impression that the engineering situation in Canada is radically changed from what it was two years ago when we were continually hearing of the drain-off of Canadian engineers to the United States. Before anybody gets excited about this seemingly alarming statement, however, it might be well to ascertain what kinds of engineers are flowing in what direction and the reasons that make them flow as they do.

To begin with, if one examines the various technical journals in the United States it will be readily evident that many American firms are still seeking engineers and other qualified technical personnel through an unabated and strenuous advertising campaign. This is surely positive proof that there still exists a severe shortage of engineers in the United States despite the talked-about recession.

The only other interpretation that could be placed upon the continuing advertising schedules of the many American companies whose advertisements appear month after month in United States periodicals is that they are anxious to rid themselves of hard-earned dollars.

The correct interpretation, of course, is that there still is a shortage of certain types of engineers in the United States, such as electronic engineers, aeronautical engineers and mechanical engineers as well as physicists with experience in these lines of endeavor. Because of this shortage and because American firms are having difficulty in filling these positions from the ranks of their own citizens, it is reasonable to presume that many Canadian engineers with the required qualifications are still migrating to the United States, especially so when the opportunities available to them for the application of their particular skills is practically non-existent in Canada.

On the other hand it is quite apparent why other types of engineers should be flowing in the opposite direction, that is, from the United States to Canada. Here, of course, we have in mind those types of engineer who come within the category of civil engineering, structural engineers, highway specialists, specialists in hydraulics and power plant design who, by reason of the major construction projects taking place in Canada, are influenced to migrate here in search of the work for which they are trained. That such a situation should exist is unfortunate for Canadian engineers of similar training who could well carry out the work involved. However, before we condemn this situation too thoroughly it may be well to further determine how many of these engineers coming into Canada come as employees of American firms who are carrying out various projects in this country. Chances are that a goodly number of American engineers in Canada

are, indeed, employed under these circumstances — a situation which then resolves itself to the point where we should not become too concerned about the presence of American engineers as such in Canada, but rather the circumstances that bring them here.

While there is much to be thankful for in the investment of American capital in the development of Canada, it would seem that the time may be drawing very close when official sources should study carefully the advisability of safeguarding the interests of Canadian engineering firms insofar as providing that they be employed to a fuller extent as the engineering agents for any future American financed construction projects in Canada.

Such a proviso would help to assure employment for Canadian civil engineers and engineering firms rather than prolong the present day paradox of having several major engineering projects underway in Canada with a roster of unemployed Canadian civil engineers of varying specialties.

On the basis of the foregoing reasoning it is evident that there exists a two-way flow of engineers between Canada and the United States and it would appear that the United States is getting the best of the deal. While Canadian engineers with electronic, aeronautical and mechanical training are migrating south of the border, they are not usurping the employment rights of American engineers in these categories by reason of an existing American shortage of such personnel. On the other hand American civil engineers coming into Canada as employees of American firms are, to some extent, infringing on what would appear to be the rightful employment opportunities of Canadian civil engineers.

To state, however, that the Canadian engineering profession is facing complete domination by the United States by reason of the entry of technical personnel from that country is, we think, somewhat on the imaginative side of reasoning. If membership figures of the Association of Professional Engineers of Ontario can be taken as a criterion of the number of American engineers in Canada, there would not appear to be any danger of American domination.

Of the 16,714 engineers registered with the Association, 1,700 are United States citizens. This amounts to approximately 9.8 per cent which seems to be reasonably far removed from the point of domination by the United States.

On the whole, the ups and downs of the Canadian engineering profession over the past ten years — the expressed alarm over shortages — their migration to the United States — the considerably publicized investigation into the salaries paid them by Canadian employers — and the post-Sputnik outcry as to whether their academic training is of a calibre adequate to serve them and their employers in this space age and the efforts of engineering societies to establish a firmer professional recognition for the engineer has all tended to place the significance of the engineer in truer perspective in the public eye. Let us hope that this perspective will not be distorted by reports that the Canadian engineering profession is becoming dominated by the United States.

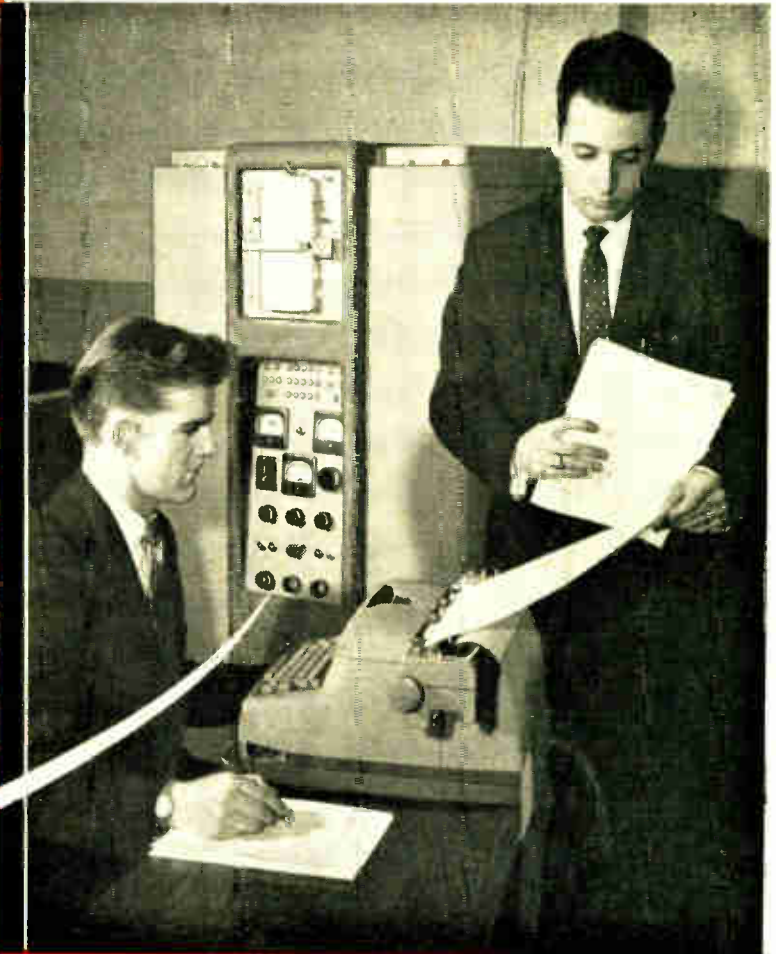

**LOWER
COSTS**

in highway design

That was the objective of Western Computing Co. Ltd. when they chose the Bendix G15D Computer to free the engineers of their group from the tedium of routine earthwork and bridge design computation.

They achieved their objective — and more — because savings extend far beyond design computation. For instance: greater precision in computation, a more realistic safety factor and the ability to explore additional alternatives enable this leading civil engineering design and survey group to produce even better and more economical final designs.

Time savings of 30 to 1 in earthwork computations and even greater savings in stress calculations for bridges have enabled the Bendix G15D Computer to more than double the engineering productivity of Western Computing Co. Ltd.

Versatile G15D digital computers are in everyday use for such things as photogrammetric data reduction; highway pay quantity calculations; traffic studies; pipeline, hydraulic and structural design calculations; and many other applications.

REDUCE COSTS - SAVE TIME - INCREASE EFFICIENCY WITH THE BENDIX G 15 D

COMPUTING DEVICES OF CANADA LIMITED
P. O. BOX 508 • OTTAWA • CANADA

5803



For further data on advertised products use page 81.



JENSEN *Capacitors*

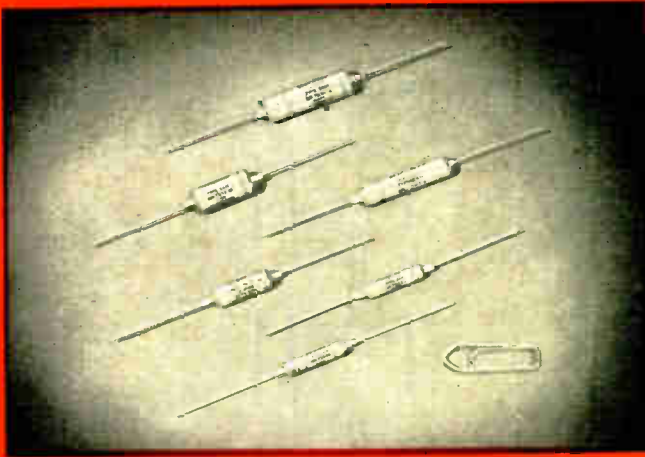

Jensen type EAH Subminiature Electrolytics

These capacitors feature extremely low leakage current from max. 10 to 120 microamperes, depending upon capacity value and voltage rating. Type EAH are hermetically sealed, have long service and shelf life and are suitable for tropical use. The container is supplied with a plastic insulating sleeving.

100 standard values are available in 14 voltage ranges from 3 to 350 V.D.C.W. Capacities up to 200 μ F. at 3 volts, 100 μ F. at 12 volts, 50 μ F. at 25 volts, 25 μ F. at 50 volts, 8 μ F. at 150 volts and 3 μ F. at 250 volts. A 8-page bulletin (EAH No. 32) listing all available standard values with max. leakage current, and other technical data, is available upon request.

Jensen type EAR Electrolytics

These capacitors are available in 20 standard container sizes from 7/16" x 13/16" to 1 3/8" x 3". Single, dual or triple units can be supplied in 16 voltage ranges from 2 to 500 V.D.C.W.

High purity aluminum construction hermetically sealed in aluminum containers with neoprene faced laminated phenolic end disc, together with low leakage current and power factor ensures long shelf and service life.

Polarized or non polarized types with etched or plain foil construction for continuous operation at temperatures up to 85°C are described in a 6-page bulletin (EAR No. 12). Special non-polarized capacitors for cross-over network applications with plain foil construction for long life and current handling capacities up to 3 amps, are described in a 4-page bulletin (EAR No. 51).

The above literature available upon request.



Jensen type EAT Twist-prong Electrolytics

These capacitors are supplied in standard 1" and 1 1/2" diameters with height from 1 1/2" to 5 1/2" in single, dual, triple and quadruple units in 18 standard voltage ranges from 3 to 600 V.D.C.W.

High purity aluminum construction, hermetically sealed in aluminum containers with a heavy molded bakelite base and neoprene gasket, together with low leakage current and power factor, ensures long shelf and service life. A positive acting safety vent is located in the top of the container. The extra heavy tab on the aluminum cathode, welded directly to the cathode mounting ring, ensures true low impedance connection. Cadmium plated steel or linen based phenolic mounting plates are available. Polarized or non-polarized types with etched or plain foil construction for continuous operation at temperatures up to 85°C are described in a 6 page bulletin (EAT No. 26) available upon request.



Associated Electronic Components

37 ROSELAWN AVENUE

• HU. 1-0144 •

TORONTO 12, ONTARIO, CANADA

IN U.S.A. 29480 Magnolia Drive, Flat Rock, Detroit, Michigan. Sterling 29884.



It's telephone wire, son— *Phillips* TELEPHONE WIRE

"I like to work with wire that's light and easy to handle . . . wire that uncoils smoothly without tangling, pulls easily and strips easily. And I like to know that the wire I use is dependable; that the installations I make will give years of reliable telephone service."

Earl Walkley, Maintenance Superintendent for the Port Hope Telephone Company, Newtonville, is an old hand in the telephone business. Like most experienced linemen, he *knows* what makes high quality telephone wire.

Recognizing that their products are proved *on the job*, Phillips engineers are constantly modifying specifications to meet the standards set by the men who work with them. The result—better communications for Canada with better telephone wire from Phillips!



Earl Walkley, Maintenance Superintendent, Port Hope Telephone Company, Newtonville.



Phillips Electrical Company Limited. Head Office—Brockville, Ontario. Branches—Montreal, Ottawa, Toronto, Hamilton, Winnipeg, Regina, Edmonton, Vancouver. The Canadian affiliate of the British Insulated Callender's Cables Group. Phillips Telephone Wires & Cables are also distributed throughout Canada by Automatic Electric Sales (Canada) Ltd.

5813

For further data on advertised products use page 81.

RETMA Report



By Basil Jackson, A.R.Ae.S., Tech. M.C.A.I.

New Engineering Committee Being Formed

At a recent Board of Directors' meeting it was announced that a new engineering committee is in process of formation entitled "Prime Contractors Electronic Components and Materials Committee". This committee, when operating, will have CAMESA representation on it. The Components Engineering Committee has appointed its Vice-Chairman, F. H. Edwards, to serve on the new committee with additional representatives to be appointed if desired. This new committee will report to W. J. Cheesman, the Electronics Division's Engineering Panel Representative. The committee will meet soon to appoint a chairman and draw up terms of reference.

Recent RETMA Meetings

On April 14 the RETMA Board of Directors met in Toronto. Under discussion were the reports of the three divisions together with reports from committees which report to the Board including the Government Liaison Committee, Government Acts and Regulations Committee, Industrial Relations Committee, Tariff Advisory Committee Report, and the Public Relations and Publicity Committee. The budget for the fiscal year 1958-1959 was also reported on by the Budget Committee, and later accepted by the Board. The Director of Engineering reported to the Board on activities of the engineering committees and Canada's position in world radio frequencies allocations.

The three divisions also met, separately, in Toronto during April. The Components Division met on April 16. Reports of the various committees were presented and discussed in detail, including a report from the Components Engineering Committee. The Electronics Division met on April 15 and discussed engineering and commercial reports together with a report by the Director of Engineering and the Government Relations Representative. The Receiver Division received reports presented by, among others, the Receiver Engineering Committee, and the Service Committee, and discussed these in addition to excise taxes, tariff matters, and radio receiver importations.

Recent Engineering Committee Meetings

The Components Engineering Committee met in Toronto on April 9. The Sub-Committee chairmen reported, and business referring to technical matters of components was discussed, including standard proposals and standards for the industry.

The Receiver Engineering Committee met on April 16, at Toronto. Chairmen-Observers on the various EIA (U.S.) engineering committees presented reports of the activities of these committees, while the adoption of standard proposals and standards was discussed in addition to other items of business relating to the technical aspects of radio and television receivers.

The Sound Equipment Committee of the Electronics Division met on May 15 to review its terms of reference and objective. The latter was stated as an attempt to interest architects and consulting engineers in proposed RETMA engineering standard specifications for sound equipment and installations, thereby raising the standard of equipment and installations used in Canada. Plans were adopted for putting this main objective into effect within the next few months.

Transformer Engineering Sub-Committee Meeting

The Transformer Engineering Sub-Committee transformed the Collins Hotel, Dundas, Ontario into a technical meeting house on Tuesday, May 13. During the morning a regular meeting was held while during the afternoon a technical session was held at which K. A. Alexander, Magnet Wire Engineer, Canada Wire and Cable Company Limited, spoke on "Recent Developments In Magnet Wire".

Newsletter

Canadian Radio Technical Planning Board

WHO'S WHO IN THE PLANNING BOARD

No. 4 — The Railway Association of Canada

The Railway Association of Canada is a non-profit organization representing Canada's railway industry. It was originally established on October 23, 1917, on the suggestion of the Federal Government, at a conference of railway executives as the Canadian Railway War Board. It was renamed the Railway Association of Canada on November 8, 1918 for the purpose of co-ordinating the various activities of the railways and in particular those relating to operating matters. In 1952 it was incorporated.

The Association consists of twelve Members and nine Associates, its principal function being to carry out liaison between its member lines and Government Departments and agencies, in particular the Board of Transport Commissioners for Canada. It is administered by six standing committees, dealing with such matters as Operations, Traffic, Law, Accounting, Finance and Economics. Each of these committees has a number of sub-committees consisting of representatives of the members. One of the six standing committees is the Operating Committee which is responsible for all matters relating to the safety and efficiency of railway operation. One of its numerous sub-committees is a Communications Sub-Committee, responsible for matters pertaining to the work of the Canadian Radio Technical Planning Board. This sub-committee is composed of seven members representing Canada's five principal railways—Algoma Central and Hudson Bay Railway, Canadian National Railways, Canadian Pacific Railway Company, Ontario Northland Railway and the Quebec North Shore and Labrador Railway. A permanent staff headed by the General Secretary, W. G. Scott, has its headquarters in Montreal. The Railway Association is very interested in, and is affected by, the work of the Canadian Radio Technical Planning Board. — W. G. Scott, RAC representative on the CRTPB.

Executive Committee Meeting

The Executive Committee met in Toronto on April 25. Under discussion were the following items:— Effective date and amortization date of DOT Specifications 116, 107, 108, 109, 112, and 122. A report from the Microwave Committee was discussed at length, while the minutes of the April 21 meeting of the Aeronautical Committee were also dealt with. The agenda also included considerable general business.

Fixed Land and Maritime Mobile Committee

The Fixed Land and Maritime Mobile Committee met on April 2 and again on April 14.

Radio Frequency Spectrum Management

A few copies are still available of the paper entitled "A Canadian Point of View on Radio Frequency Spectrum Management" by C. M. Brant, Chief of Technical Co-ordination, Department of Transport.

Applications for copies, which are free, should be addressed to the Canadian Radio Technical Planning Board, 200 St. Clair Avenue West, Toronto 7, Ontario.

New FCC Commissioner

John Storrs Cross, the new FCC commissioner, who replaces Richard A. Mack, is an electrical engineer. The new commis-

sioner was recommended for the position by President Eisenhower, and he is a graduate of Alabama Polytechnic Institute.

In 1935 he was chief of all electrical and radio design with the United States Department of Interior, was a naval captain from 1942 to 1946, and was with the Telecommunications Division of the State Department from 1946 until the present time. He has been connected at first hand with international agreements on radio frequency allocations and has been in contact with the Federal Communications Commission regularly.

New DOT Appointment

Promotion of P. D. McTaggart-Cowan, MBE, Assistant Director of the Meteorological Branch of the Department of Transport to the position of Associate Director, was announced recently by the Civil Service Commission with the concurrence of Transport Minister George Hees. Mr. McTaggart-Cowan will be Associate Director with Andrew Thomson, Dominion Meteorologist and Director of the Branch.

A graduate of the University of British Columbia, Mr. McTaggart-Cowan joined the Canadian Meteorological Service in 1936. He was largely responsible for developing trans-Atlantic weather forecasting during the early days of World War II which helped to make possible the ferrying of aircraft from Canada to the United Kingdom. He has been active in the formation and operation of the World Meteorological Organization, particularly as a member of the Commission for Synoptic Meteorology.

DOT Installing VOR

The Very High Frequency Omni-Range system, or "VOR", for aircraft navigation, is being put into increasing use across Canada by the Department of Transport as another forward step in development of Canadian aviation and air navigational electronic aids. Already it is in use from Montreal westerly across southern and south-western Ontario.

By the end of the year it is expected to be operative from Kenora to Lethbridge and from Lethbridge to Calgary and Edmonton. In addition, sites have been selected for installations at Fredericton, Moncton, Charlottetown, Halifax, Yarmouth, Sydney and Gander to enable an extension eastward from Montreal.

All the equipment is in duplicate, so that temporary breakdown of any unit will not affect the serviceability of the system. Checking of the ground installations is carried on constantly by technicians to ensure proper operation.

The older navigational aid, the low frequency radio range, is still in use across Canada but aviation is converting rapidly to the use of the "VOR" system, which is less subject to interference and much more accurate in use.

With the "VOR" the pilot does not have to fly around to locate an audible signal that will help him find an airway. He merely turns a switch on his new equipment and a needle on a dial indicates the direction of the "VOR" transmitter station. He makes the necessary changes in course until the needle indicates that he is heading in the right direction. With the new system he can follow a much more sharply-defined course than is possible with the older "radio range". With the older system, poor radio conditions might make the range signal inaudible.

Canadian Radio Technical Planning Board
200 St. Clair Avenue West, Toronto 7, Ontario

F. H. R. POUNSETT, President; C. J. BRIDGLAND, Vice-President; R. A. HACKBUSCH, General Co-ordinator;
R. C. POULTER, Director of Public Relations; F. W. RADCLIFFE, Secretary-Treasurer

business briefs and trends

★ Contracts to the value of over \$36 million were awarded in the latter half of March by the Defense Production Department and Defense Construction (1951) Ltd.

* * *

★ According to the State Department in Washington, D.C., the United States is prepared to give 150 scientists from abroad two years of intensive training, commencing September next. Acting on behalf of the State Department, the National Academy of Sciences in Washington will act as a clearing house in screening applications from overseas scientists and in giving consideration to requests from groups in the United States, particularly universities, who may be seeking scientists from abroad.

* * *

★ The 54th annual report of the Canadian Westinghouse Company Limited, submitted to its shareholders recently, revealed that sales in the year 1957 had established a record volume of over \$150 million. This figure represents a 15 per cent gain over the previous high of \$130 million in 1956. The company looks forward to another year of continued progress in 1958.

* * *

★ Pushbutton dispatching of trains between Toronto and Smiths Falls will eliminate written orders to engineers and conductors when the Canadian Pacific Railway has completed the installation of a \$2 million electronic control system in the next two years. Every switch on the 200 odd miles of track will be mechanically controlled from the control room in the Union Station, Toronto. An emergency plant can immediately be put into operation in the event of a power failure.

* * *

★ The first Canadian oil company to order an IBM "705" giant computing unit is Imperial Oil Limited, who will install the \$2½ million computer in its new office building in Toronto on a rental basis from International Business Machines. The company has organized an employee training program, not only for those who will be specifically engaged in writing programs for the unit, but also to provide a general orientation scheme for the entire staff to acquaint them with the effect of the computer on current procedures. The installation will be completed by the summer of 1959.

* * *

★ A microwave system bringing the latest in modern communication facilities to one of Canada's most promising new industrial areas has been completed. The system links Birch River, The Pas, Cranberry Portage and Flin Flon in Northern Manitoba. The system was supplied and installed by RCA Victor Company, Ltd., on behalf of the Manitoba Telephone System.

* * *

★ Regina airport is installing surveillance radar equipment which will make visual spotting of aircraft from the ground possible for the first time at that location. Because of the increasing air business out of Regina, radar spotting devices have come to be considered a necessity in order to improve air traffic control and keep lanes free from congestion. Similar long-range radar equipment is being introduced into airports all across Canada.

* * *

★ Canadair, Ltd. of Montreal, who will be producing the Sparrow II air-to-air missile for the R.C.A.F., is planning to erect a million dollar missile test center at Ville St. Laurent, Que., for experimental developments. Environmental chambers will be installed, providing opportunities for testing ultra-low temperature and extremely low pressure altitudes.

* * *

★ The National Science Foundation in Washington, D.C., has prepared a study which shows that of the highly-skilled or professionally-qualified immigrants entering the United States annually from all countries since 1953, 25 to 30 per cent of the total have come from Canada. In actual figures this means, according to the Foundation's study, that Canada has lost to the United States every year some 3,500 to 5,000 expert skilled workers.

(Continued on page 44)

AUTOMATED
.....

HYFEN

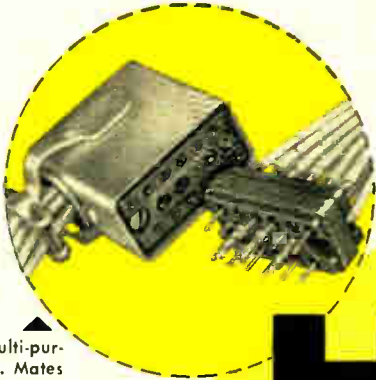

15 contact, multi-purpose connector. Mates with, or replaces existing solder connectors.

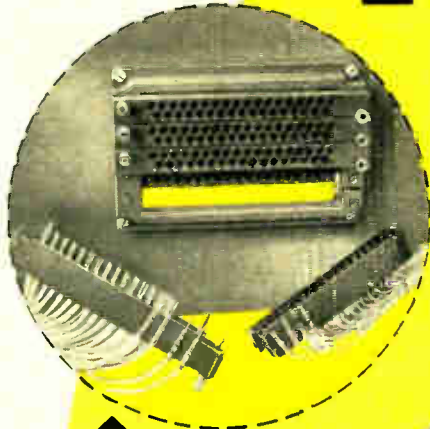

Feed-thru, modular design, multiple insert connector. 35 contact inserts, can be removed from frame for easy contact insertion or removal. 5 or 8 insert frames available.

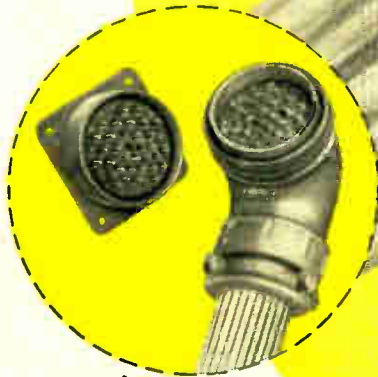

AN-type HYFEN connector, showing HYFEN method adapted to round design.

HYFEN types illustrated are typical of those already supplied to the Industry by Burndy. HYFEN connectors are engineered to meet specific requirements. For other types and sizes, contact Burndy.

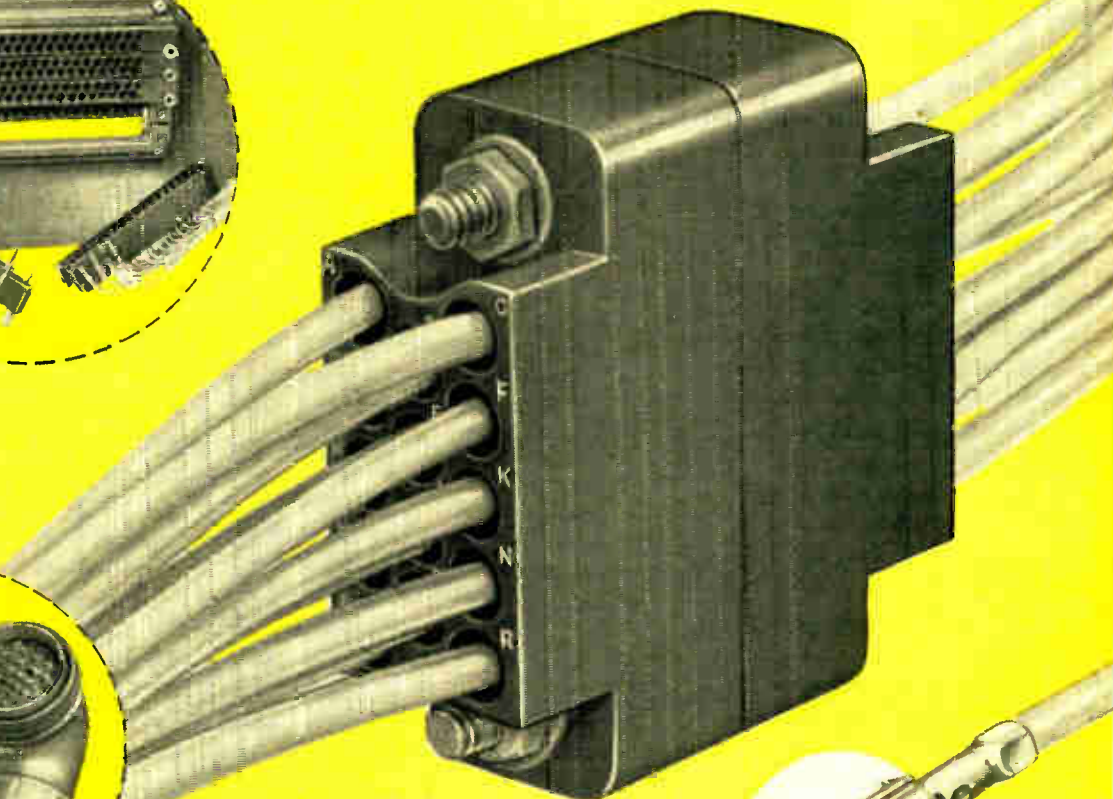

MINIATURE MS-type HYFEN
three times actual size



CLOSED-ENTRY SOCKET—prevents probe damage... protects contact springs from overstress.

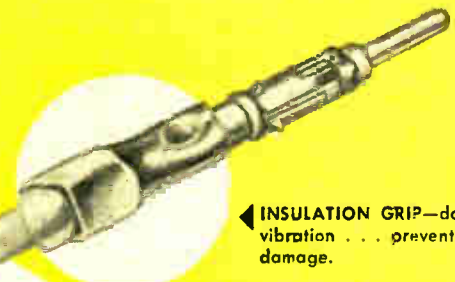

INSULATION GRIP—dampens vibration... prevents wire damage.

OMATON
DIVISION



For detailed information, send for Bulletin HYF-7. Write or Wire BURNDY, 1530 Birchmount Rd., Toronto, Scarborough

For further data on advertised products use page 8E.

COMPRESSION-INSTALLED CONNECTORS

3
Simple
Steps to
Install



CRIMP pins or sockets on wire

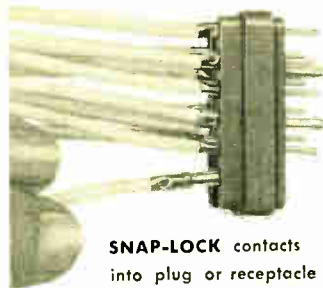

SNAP-LOCK contacts
into plug or receptacle

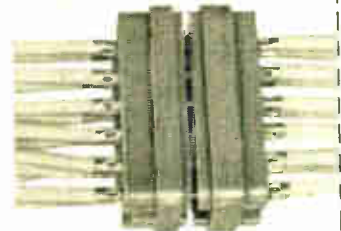

MATE with HYFEN or equivalent
solder types

3
Points of
Contact

HYFEN connectors have the minimum number of contact resistance points; wire-to-pin, pin-to-socket, socket-to-wire

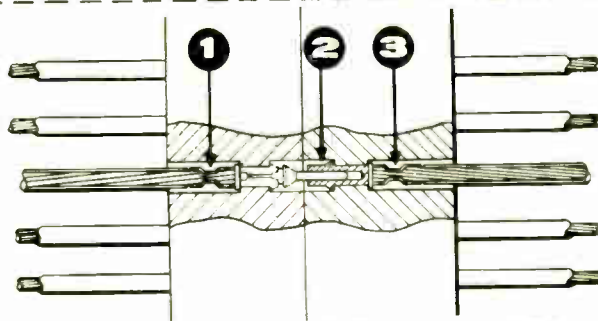

3
Compression
Installation
Tools



Hand Actuated —
Ratchet Controlled

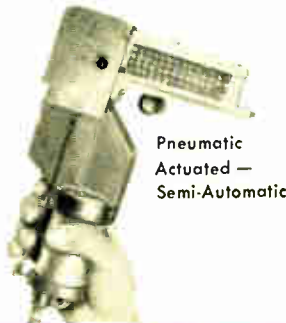

Pneumatic
Actuated —
Semi-Automatic

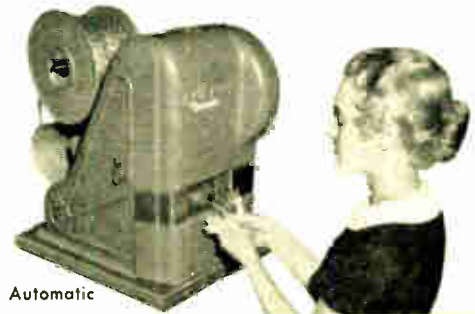

Automatic

HYFEN SAVES WEIGHT - SAVES SPACE - AND SAVES TIME

Burndy's HYFEN method brings added Reliability and Versatility to the connector field, allowing the design of lighter and more compact equipment . . . saving space, weight and time. Pins and Sockets can be bench-installed on the wire and can be snap-locked in place even after the Plug and Receptacle have been mounted on the equipment. 35 years experience designing solderless connectors, developing crimping techniques and companion tooling, provide the necessary engineering "know-how" for this logical step toward

complete automation. Designed to replace or mate with virtually all existing connectors, including AN, MS, and other Miniature types, the HYFEN meets or exceeds MIL specs for voltage drop, dielectric strength, contact engaging and retention force, resistance to corrosion, and pull-out values. The HYFEN method assures increased dependability — providing quick visual check of crimping depth — ending the high rejection rate inherent with the use of solder . . . especially important in today's continuing trend toward miniaturization.

BURNDY

5806

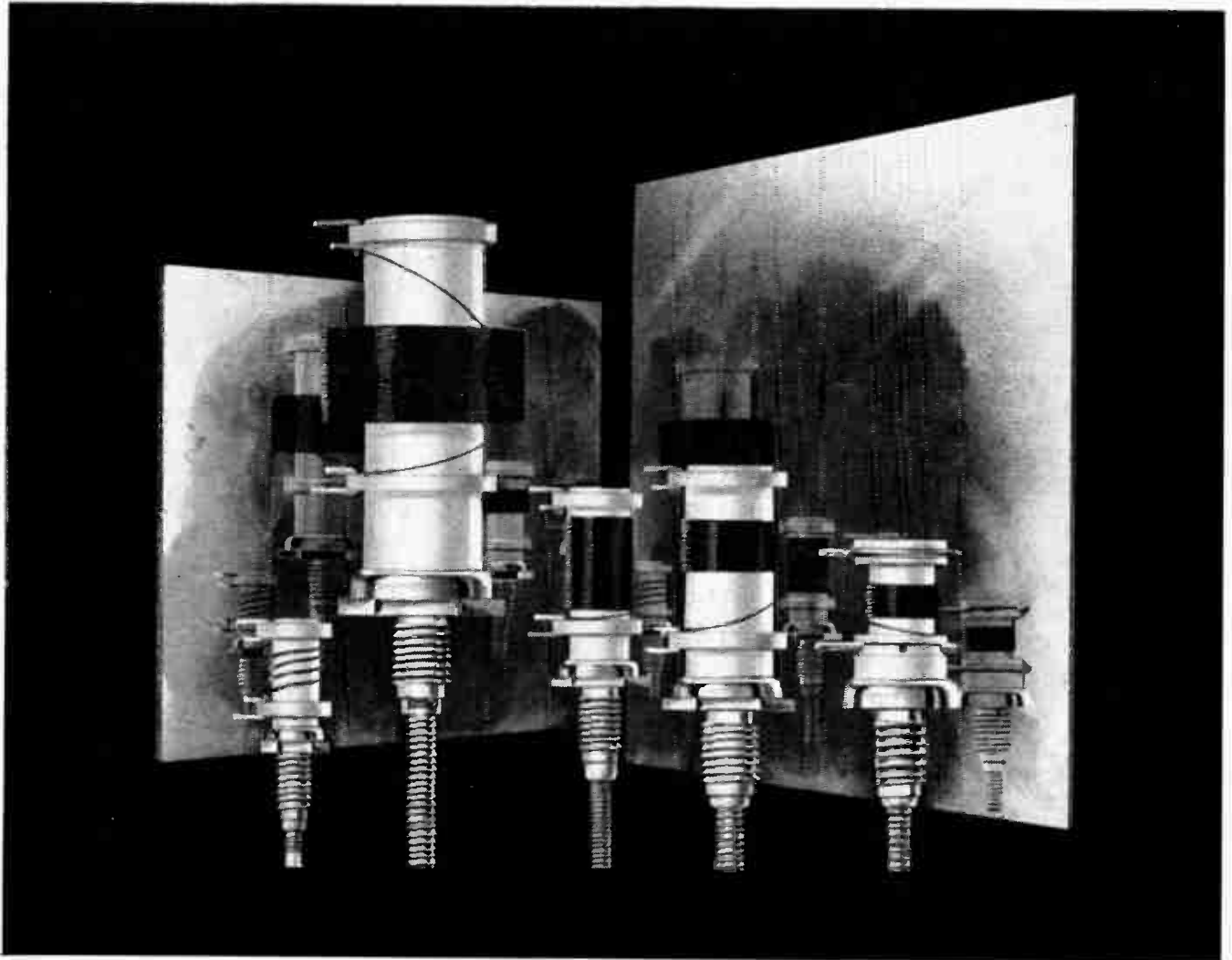

Cambion® coil forms with Perma-Torq® Tensioning Device are designated PLST, PLS-6, PLS-5, PLS-7, PLS-8 and are factory assembled to mounting studs. The units are completely interchangeable with Cambion's LST, LS-5, LS-6, LS-7 and LS-8.

Reliability is their family resemblance

Here's a reliable family of coil forms ready to meet your specifications. These Perma-Torq Tensioning Devices on Cambion coil forms allow locking of tuning cores while still tunable — and you can depend upon them to do their job well.

This built-in dependability is a result of Cambion's unique design plus quality control — that meets or betters government specifications.

Perma-Torq is a compression spring of heat treated beryllium copper, that has a very high resistance to fatigue and keeps coils tuned as set — even under extreme vibration and shock. The device also allows for immediate readjustment — without removal or loosening of any mounting nut or locking spring.

Quality control and features like the above are just two of the reasons why Cambion can offer you guaranteed standard or custom electronic components — whose performance you can rely upon.

Cambion researchers and practical experts are always available to help you

solve your component problems. For all specifications and prices, write Cambridge Thermionic Corporation, 420 Concord Avenue, Cambridge 38, Mass. West Coast stocks maintained by E. V. Roberts and Associates, Inc., 5068 West Washington Blvd., Los Angeles 16, and 1560 Laurel St., San Carlos, Calif.

Cambion's new printed circuit coil forms are ideal for high temperature work and horizontal mounted panels. Equipped with Perma-Torq locking device for set tuning, the tuning core is affixed to the form at one end through a brass housing, thus eliminating internally threaded forms and cores and resulting in a more precise element with finer tuning. The coils, 2550, 2540, 2530 and 2525, are ceramic units with silicone fiberglass collars which have terminals for mounting on printed circuit boards.

*Patent pending.



CAMBRIDGE THERMIONIC CORPORATION
GAMBION®



Makers of guaranteed electronic components, custom or standard

For further data on advertised products use page 81.

Concerned with microwave test equipment?

Only NARDA offers you these

exclusive features!

TURRET ATTENUATORS

Only Narda offers you a UHF-only attenuator. This represents a considerable savings in cost for applications in this frequency range. Each of three models offers the Designer or Development Engineer 12 steps of attenuation from d.c. to 1,500 mc with a VSWR of 1.25. Designed for bench use or mounting into test equipment packages.

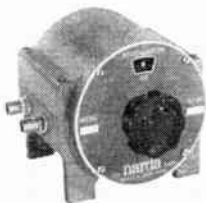

One unit can give a maximum of 30 db attenuation; two units can be used in series to provide a wide range of control in small steps.

- Model 705—0, 3, 6, 9, 12, 15, 20, 25, 30 db
- Model 706—0, 1, 2, 3, 4, 5, 6, 7, 8, 9, 10, 20 db
- Model 707—0, 3, 6, 9, 12, 15, 18, 21 INF db

ALL MODELS . . . \$275 each

COAXIAL DIRECTIONAL COUPLERS



10, 20 and 30 DB . . . 225 to 4,000 mc.

Only Narda offers coaxial directional couplers in 10 and 30 db values, as well as 20 db. In addition, all models offer such advantages as these:

1. Flat Coupling—values with 1 db of nominal over a full octave frequency range, with calibration provided to ± 0.2 db accuracy.
2. Machined from solid blocks of aluminum—hence, more rugged.
3. Directivity exceeding 20 db.
4. Frequency Ranges: 225-460, 460-950, 950-2000, 2000-4000 mc.

Write for complete specifications.

\$100 to \$225



S to X BAND FREQUENCY METER

Narda offers the only single instrument covering this complete band of frequencies—2,350 to 10,500 mc. In addition, no combination of other meters can cover these frequencies at a comparable price!

An easy to read nomograph type calibration chart, mounted in the lid, converts digital counter readings to frequency in megacycles—to the rated accuracy of 0.2%. No calculations or interpolations are needed.

The unit is completely self contained, with built-in detector and indicating meter. A sensitivity control allows use with strong signals; for signals below 5 mw., the external meter jack may be connected to an amplifier or oscilloscope.

Model 802B . . . \$785



UHF FREQUENCY METER DETECTORS . . . Direct Reading

The only direct reading frequency meter detectors available for the UHF range—and they're from Narda, of course! Absorption type meters, with 0.2 db insertion loss, each includes a resonant cavity, coaxial switch, crystal detector, current meter, sensitivity control and type N terminals.

SPECIFICATIONS

Frequency (mc)	Accuracy	Loaded Q	VSWR	Sensitivity for full scale deflection	NARDA Model	Price
200-500	0.5 mc	500	1.15	0.2 mw	804	\$375
500-1500	1 mc	700	1.15	0.2 mw	805	375
1500-2400	2 mc	500	1.25	0.5 mw	806	375

Complete Coaxial and Waveguide Instrumentation for Microwaves and UHF — including:

- | | | |
|----------------------|---------------|----------------------|
| DIRECTIONAL COUPLERS | TUNERS | ATTENUATORS |
| TERMINATIONS | ECHO BOXES | STANDARD REFLECTIONS |
| FREQUENCY METERS | SLOTTED LINES | BOLOMETERS |
| HORNS | BENDS | THERMISTORS |

MAIL COUPON TODAY FOR FREE CATALOG AND NAME OF NEAREST REPRESENTATIVE

The Narda Microwave Corporation
160 Herricks Road
Mineola, N. Y.
Dept. EC-2.



NAME

COMPANY

ADDRESS

CITY..... ZONE..... PROV.



the narda
microwave corporation

160 HERRICKS ROAD, MINEOLA, N. Y. • PIONEER 6-4650

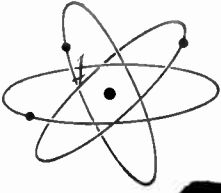

ACT NOW

for space at the

I R E CANADIAN CONVENTION AND EXPOSITION

ELECTRONICS and NUCLEONICS

*your finest opportunity to show your products
to the finest prospects—*

For three full days, you can display and demonstrate your products and services at low cost, to a concentrated audience which you cannot meet again for a year.

Your audience will be eager to see all it can, learn all it can, and above all, be receptive to your message.

During those three days you and your representatives will meet the key men who make or influence buying decisions about your products.

Act NOW! to reserve space. Write to-day for illustrated brochure.

**OCTOBER
8-9-10**

1958



AUTOMOTIVE BUILDING., C.N.E., TORONTO

Office—1819 YONGE STREET, HUDSON 8-7768

Sponsored by the Canadian Sections of the Institute of Radio Engineers

For further data on advertised products use page 81.

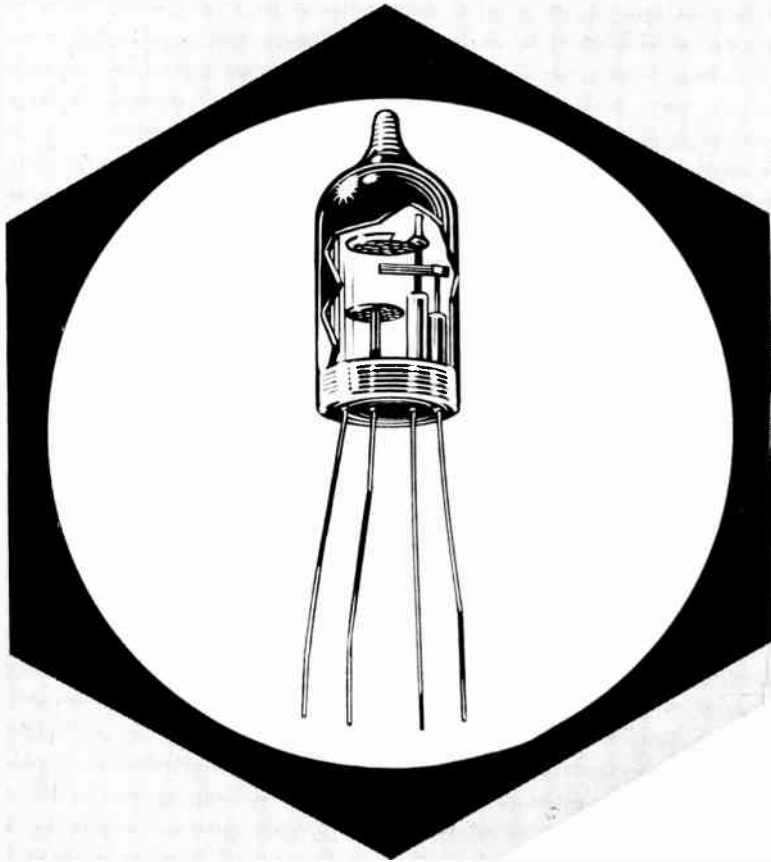

The Philips Z 70 U is a cold cathode trigger tube of sub-miniature construction. It has a special primer electrode which operates in complete darkness without ignition delay. Its small size (1" x 0.4"), long life and narrow tolerances makes this Special Quality* tube particularly suitable for counting, switching, relay and "on-off" applications up to 5,000 operations per second. During the entire life of the tube the anode to cathode burning voltage remains between the limits of 113 to 121 volts. The Z 70 U has a continuous cathode current rating of 3 mA and a peak cathode current rating of 12 mA. The tube has flying lead connections making it suitable for printed wiring applications.

**Rogers Special Quality tubes are finding more and more applications in all types of professional equipment. The greater reliability and lower maintenance cost of the apparatus in which they are used more than compensates for the higher initial cost.*

ROGERS

electronic tubes & components

A DIVISION OF PHILIPS ELECTRONICS INDUSTRIES LTD.
116 VANDERHOOF AVENUE, TORONTO, ONTARIO / BRANCHES: MONTREAL, WINNIPEG, VANCOUVER

★ Rogers Electronic Tubes are sold through Canada's Independent Electronic Parts Distributors

for **THAT NEW IDEA**

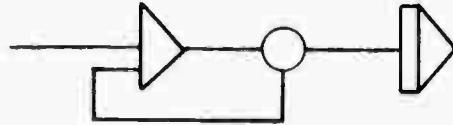

IN ANALOG COMPUTING



IN ANALOG PLOTTING

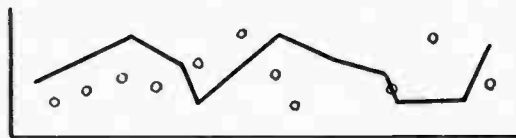

IN DIGITAL PLOTTING

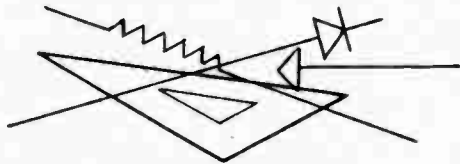

IN CONTROL SYSTEMS ENGINEERING

Write Dept. EC-5

Detailed information can be obtained by mail, wire or telephone

Electronic Associates, Inc.

Manufacturers of **FACE** Precision Analog Computing Equipment

LONG BRANCH, NEW JERSEY

TEL. CAPITOL 9-1100

For further data on advertised products use page 81.

A
F
V
H
F



**EIMAC
FIRST**

**Covering the Spectrum
with Reliable Ceramic Tubes**

U
H
F



From audio into super high frequencies, Eimac covers the RF spectrum with modern ceramic tubes. This incomparable ceramic electron tube family—more than one-third of the Eimac line—includes reflex and amplifier klystrons, negative grid tubes, rectifiers, pulse modulators, and receiving tubes. The tubes illustrated are typical of more than 40 Eimac ceramic tube types that are being selected by leading equipment manufacturers for use in all types of applications— from tropo-scatter to industrial heating, from single sideband to pulse. The advantages of reliable Eimac ceramic tubes include: resistance to damage by impact, vibration, and heat; smaller size; and better processing techniques.

S
H
F

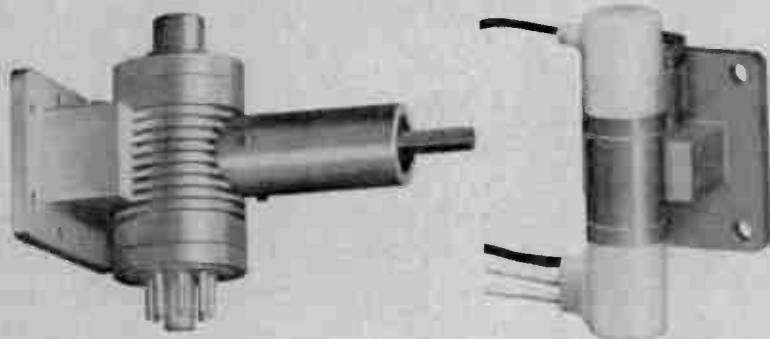

EITEL-McCULLOUGH, INC.
SAN BRUNO - CALIFORNIA
Eimac First with ceramic tubes that can take it

PRODUCTS DESIGNED AND MANUFACTURED BY EIMAC
Negative Grid Tubes
Reflex and Amplifier Klystrons
Ceramic Receiving Tubes
Vacuum Tube Accessories
Vacuum Switches
Vacuum Pumps

Includes the most extensive line of ceramic electron tubes

The World's Largest Manufacturer of Transmitting Tubes
Canadian Representative:
R. D. B. SHEPPARD
2036 Prince Charles Road, Ottawa 3, Canada

Quartz-Crystals, Used In The Manufacture Of Carrier-Telephony Filter Elements, Frequently Occur With Large Volumes Of Unsuitable Material — Twinning. The Nature Of This Defect Is Described In This Article Together With Its Close Relation To The Mother Crystal. Early Observations Of Induced Twinning And Subsequent Investigations For Controlled Twinning Are Related. Correlation Of Theory To A Practical Process For Reclaiming This Expensive Raw-Material Is Discussed. Details Of Some Inspection And Manufacturing Procedures Are Given To Assist In Understanding The Subject.

Mass-Produced De-Twinning Of Quartz Crystals

By Anthony E. Lofting *

SILICON dioxide, otherwise known as quartz, occurs in abundance throughout the world. Crystalline quartz is more rare, as its conditions of formation were infrequently obtained in nature. Subsequent disturbances have destroyed much crystalline matter, leaving few profitable mining areas.

The principal quartz-crystal deposits are located in Brazil, four regions yield the usable material which is gathered from open-cast mines at depths around 30 meters¹. There is considerable effort associated with this method of mining, large quantities of earth and non-crystalline material have to be excavated to reveal clean crystal. The ratio of usable to extraneous material averages 1 to 2000. Inspection, air-transportation, customs duty and handling procedure increase the price to make quartz-crystal a most expensive raw material. The natural size distribution favours smaller stones which have little value to manufacturers of resonant-units. Preferred size ranges are from 500-1000 grams, and these comprise only 15 per cent of all mined crystals.

These factors of rarity, remote location and highly selective demand raise to \$35. per pound the final cost of such material.

Natural quartz-crystal frequently occurs with regions of twinning. In fact it is a rarity of nature for single crystalline quartz to occur. The inhomogeneity termed 'twinning' can be of three distinct major types. Optical, called also Brazilian, twinning is the most easily detected, as light rays are affected differently by the two contiguous volumes. It should be noted that Brazilian twinning is somewhat rare in stones mined in that country. Electrical twinning is more abundant, harder to detect, and consequently the more troublesome variety. Electrical twinning is also called Dauphine twinning due to its occurrence in the Alps of that name.

Two regions of optical and electrical twinning in a mother crystal can overlap, thereby constituting the third major type namely, compound-optical twinning.

In production it is necessary to detect such regions in each crystal. Evasive cutting techniques can be employed in many cases provided early knowledge of the extent and location of the twin is obtained. This condition is hard to achieve in a production shop for many reasons. A consideration of the methods involved for detecting

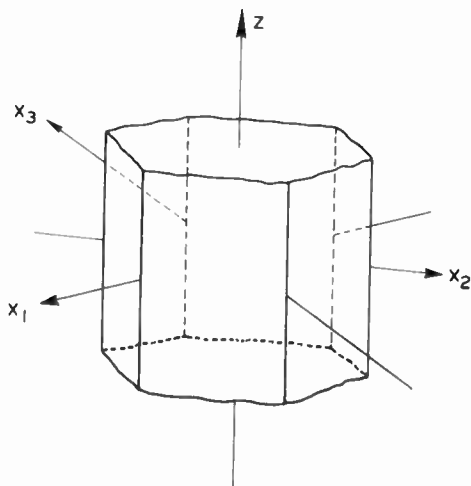

● Fig. 1. — Relationship between Z and X axes of quartz crystal.

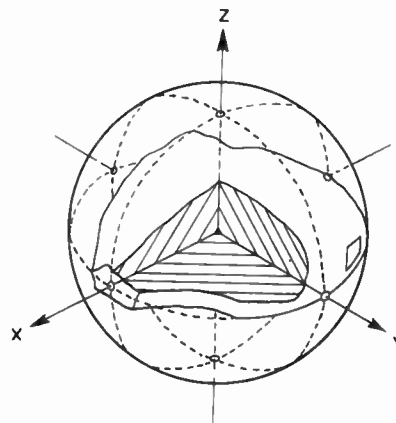

● Fig. 2. — Effect of prolonged etching of quartz crystal sphere.

* Anthony E. Lofting, a native of London, England, came to Canada in 1956. Since then he has worked in Montreal for the Northern Electric Company Ltd. as a development engineer in the manufacturing methods department.

Mr. Lofting is a graduate of the Institute of Electrical Engineers and was educated at the Polytechnic in London. Before coming overseas, he was a research engineer in interference suppression and, more recently, worked in the technical advertising field. He also served in the R.A.F. between 1947 and 1950, and was stationed at Cranwell for this duration.

the more elusive electrical-twinning may illustrate the difficulty. Optical means are not applicable for observing the twinned regions as optical activity is the same for both. Electrical activity however is different and the twins can be designated 'positive' and 'negative'. By obtaining a sample slice of preferred orientation it is possible to observe the piezoelectric effect using an electrometer. Squeezing the plate by finger pressure produces an observable deflection on the instrument. Direction of swing will indicate polarity, transferring the meter probe across a twin boundary as indicated by reversal of electrometer reading.

Much shunting of the probe across the quartz face would be necessary to evaluate effectively the twinning boundaries. Another method is fortunately available which has the advantage of providing more accurate results and of indicating all types of twinning.

The principle involved concerns the preferential etching along certain crystallographic axes.

Quartz crystal possess a trigonal symmetry (as will be shown later) about the major Z axis. Three identical axes, X_1, X_2, X_3 lie on a plane perpendicular to Z, Fig. 1. In relation to the external faces of a symmetrical crystal, an X-axis will pass through the inter-facial edge. (The solubility is greatest along the negative and a minimum along the positive X-axis. At any intermediate point the solubility will be correspondingly different.)

Fig. 2 shows the effect of etching for 7 weeks a sphere of quartz in relation to the crystallographic axes.⁸ A close examination of the surface, such as that made by W. L. Bond² reveals local differences between neighbouring etch-pit shapes. These shapes are related to the orientation on the sphere, hence are reproducible and afford a quick means for determining orientation.

Examination of individual etch-pit shapes is not necessary, a pin-hole oriascope provides a means of

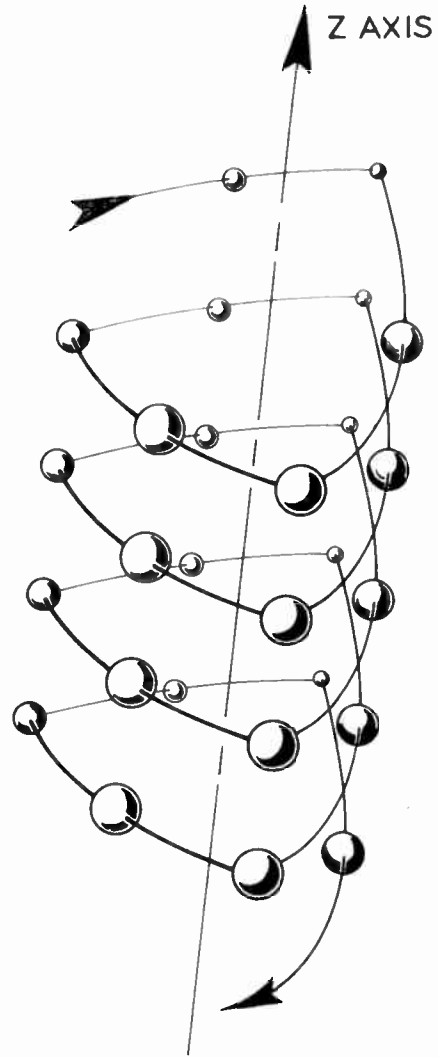

● Fig. 4. Helical structure of silicon atoms in quartz-crystal.

quickly observing the pit in terms of a characteristic light pattern.

Etching therefore provides a means for determining orientation of a quartz plate. If it can be shown that twinning is a case of changed orientation then this method will be applicable.

The piezoelectric effect is made evident if a pressure be applied along one of the X-axes when a potential will be produced between the points of pressure. In the figure

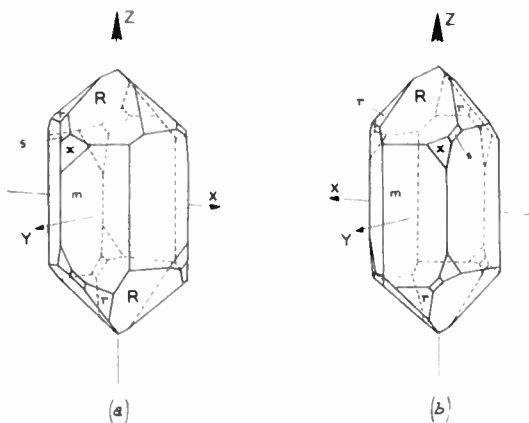

● Fig. 3. Quartz-Crystal Twins.

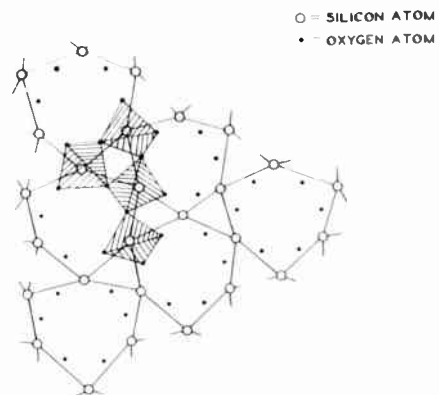

● Fig. 5. Atomic construction of quartz-crystal.

shown a positive potential will appear at the apex where an arrow emerges, a negative potential will obtain at apexes 60° from these when pressure is applied across.

As mentioned previously, an electrical twin is characterized by a reverse in potential. We can now further say that such a twin is equivalent to a rotation of the considered volume by 60° about the Z axes with respect to the parent crystal.

All three considered cases of twinning lend themselves to detection by etching techniques.

In practice an etch period of one half an hour is sufficient to identify orientation of parent and twinned portions of a plate. However, it is not convenient to wait this long after having cut a test slice before proceeding with subsequent cuts. Also the information provided by etching one plate from one side of a crystal is not complete. Production practice is to slice the complete crystal, to etch all slices and to mark twinned regions which must be avoided in subsequent cutting operations.

The process proposed in this article is to remove such regions if they are of the electrical type of twinning. Twinning removal would simplify the described manufacturing procedures and save raw material. Further, the extensive use of this process would permit quantities of cheap raw material to be utilized which by various indications is known to be fully electrically twinned and therefore of little market value³.

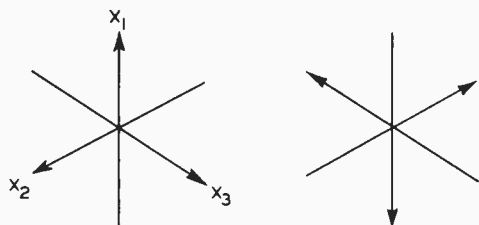

● Fig. 6. Electrical Twins.

Crystal Structure

It was briefly explained that twinning is a change in orientation. Before qualifying this theory it will be necessary to dwell upon crystal structure and to elaborate upon the piezoelectric effect.

Quartz crystals are formed as hexagonal prisms with pyramidal terminations. At first sight the appearance of the regular six-sided crystal suggests a hexagonal or six-fold symmetry. Closer inspection reveals certain differences between adjacent faces on both the prism and pyramid. Alternate faces are noticed to be similar in

character, shape and surface condition. A number of minor faces may be present, located at boundaries between prism and pyramid. These minor faces occur at corners 120° apart about the Z axis. From this evidence we may class the crystal as having trigonal symmetry, i.e. it must be rotated 120° about the Z axis to present a similar face or intersection. Fig. 3 shows the two perfect forms that a quartz crystal may take. Minor faces are shown as 'x' and 's' between the prism and pyramid faces 'm' and 'R' or 'r' respectively. The two forms both have trigonal symmetry, but the minor faces are located differently. In figure 3 (a) the faces 'm, x, s' and 'r' are arranged as a right-handed screw. In 3 (b) they form a left-handed screw. These configurations correspond to a basic structural difference, one being the mirror image of the other. Quartz therefore belongs to the enantiomorphous class, possessing neither plane nor center of symmetry. Its crystalline growth is progressive producing a helical structure. The direction of helical rotation along a growth axis determines the 'hand' of a crystal. Fig. 4 is a simplified view of constituent silicon atoms and demonstrates the helical arrangement about the major, optic, axis. Light rays travelling parallel to the major axis experience a rotation the direction of which is governed by the helical construction and classifies the crystal handedness.

It is the occurrence of two contiguous regions with opposite handedness which constitutes optical twinning. Associated with the reversed optical activity there is a reversal of electrical polarity being a result of the molecular dual-orientation. A crystal plate cut across an optical twinning boundary will produce potentials in opposition when set in vibratory motion. The natural frequency of vibration is modified by the presence of optical twinning due to differences in frequency constant. The twinned region will be of supplementary orientation to the parent crystal with corresponding characteristics.

A more detailed view of the molecular structure viewed along the major axis is shown in Fig. 5. The large circles represent silicon atoms, oxygen atoms are shown as solid dots. By drawing imaginary lines between associated oxygen atoms we confine a system of tetrahedra linked together throughout the crystal, detail shown shaded in Fig. 5. This concept will immediately indicate that the figure represents an end view of atoms in different planes. It will be seen that the arrangement is assymmetric about the major axis, three axes of similarity are drawn as X₁, X₂, and X₃. These being termed the electric axes.

To reiterate, a pressure applied along an X-axis produces a charge with its potential along the same axis. Using I.R.E. convention a positive charge is produced towards outgoing axis shown in Fig. 6. The two figures

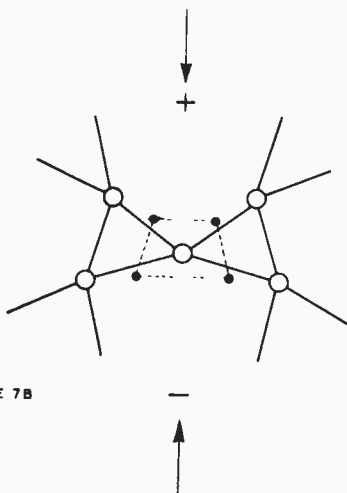

● Fig. 7. Small rearrangement of atoms necessary to reverse polarity of quartz.

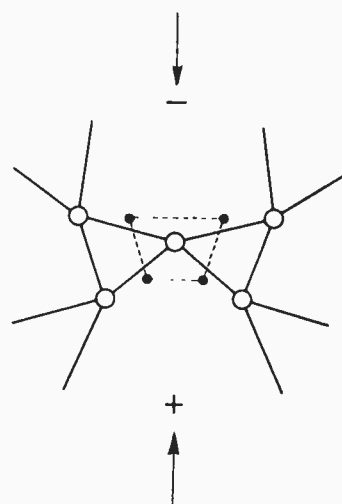

● Fig. 7A. An enlarged partial view of Fig. 5.

represent electrical twins, having opposite polarity, or an equivalent rotation of 60° . Optical twinning may exist. The second figure in that case would have its axes marked X_1, X_2, X_3 , in a clockwise direction.

To understand the piezoelectric effect at microscopic level, consider Fig. 7, 7(a) being an enlarged partial view of Fig. 5.

Deformation under pressure will produce potentials as indicated. Two charge center of gravity movements take place, of oxygen and silicon atoms, both in the same direction. Oxygen atoms move a greater distance and thereby produce the external electric charge. As deformation of the super-imposed triangles formed by the constituent atoms is responsible for the piezoelectric effect, then a rotation of the atoms to Fig. 7(b) for example, can be expected to produce a reversed external charge as the center of gravity can be seen to move in the opposite direction. The atomic re-arrangement has not required a rupture of any bond, the magnitude of movement corresponds to little more than thermal vibration at room temperature.

It is the practicability of externally influencing a crystal plate such that the atoms of a twinned region revert to the arrangement of the parent region which has been the object of our investigation.

Much of the matter so far presented has been verified by X-ray spectroscopy and the observance of the piezoelectric effect in relation to crystal forms. Atomic differences between electrical twins was understood, it was also realized by crystallographers that provided no atomic bonds were disrupted it was possible to re-orient certain molecules. However the two were not connected, and it was left for accident to indicate the possibility of externally induced twinning. Although Zinzerling⁴ and Frondel⁵ observed migration in twinning under certain conditions.

Early Discoveries

Some of the processes involved in producing crystal-vibrators require treatment at elevated temperature, sometimes with small stresses applied, for example with holding jaws. A number of units were observed to be electrically unsatisfactory due to the presence of electrical-twinning, (hereafter 'twinning' shall be taken to mean electrical-twinning), which was created at the high temperature operations. An investigation⁶ was sponsored to see just how much the twinning could be controlled at a time when hostilities made quartz supply uncertain. The result of this investigation showed that when a certain system of stresses was applied to a crystal-plate of a chosen orientation at an elevated temperature then some modification of the twin boundary position was possible. Bending, compressing, twisting and temperature gradients were the methods investigated which applied the desired stresses. Twisting provided the most consistent results, due in part to the ease of applying a well defined stress, and volumes of twinning could be induced and removed by this process. The ease of control for a given method was found to be a function of plate orientation. Fig. 8 indicates the degree of twinning control to be expected for a particular plate orientation with stresses applied as a torque about the major plate axis. Other systems of stress will revolve this figure about the orthogonal axes, possibly with additional modifications. A vector, normal to major surface of the plate, drawn on the curves will indicate by its intercept this degree, the figure drawn being called that of 'piezorescence', from 'growth out of pressure'.⁷

As indicated on Fig. 8, the cuts most favourable for de-twinning are the rotated-Y, such as AT, GT, DT, etc. According to these same figures the most popular cut, for crystal filter applications, the X-cut is not applicable to this method.

Outline Of Present Study

Our investigation of the de-twinning principle and its application to mass production of crystal units required planning of tests to answer certain basic questions. A

simple method was required to remove twinning from X-cut plates in a short period of time at temperatures permitting the use of conventional materials.

To provide details of torque, temperature, rate of temperature increase and time-cycling a comprehensive tool was designed. (Fig. 9) A torque of from 0 to 20 Kg-cm. can be applied to plates up to $2\frac{1}{2}$ inches long and $\frac{1}{4}$ inch thick. Two blocks of steel were slotted to receive the crystal plate ends, one block was fixed, the other rotated about on axis normal to the slot length. A torque-arm was connected by a lever mechanism to this moving block, weights of various sizes could be moved along the graduated arm. All bearings were accurately machined from high-temperature metals. Materials were used throughout for use up to 1000°F . and provision was made for fitting a second torque-arm.

Based upon the figure of piezorescence (Fig. 8) it was decided to attempt first the de-twinning of DT plates. Fig. 10 shows the two X-cut blocks which were subsequently cut into DT plates for this experiment, and indicates clearly the extent of electrical twinning. The random distribution of twinning, such as that shown, is the type previously found⁶ most conducive to de-twinning processes. The type of twinning distribution is related to the impurity which assists the condition for twinning, distribution other than the random type will be discussed later.

The piezorescence figure was constructed by calculation utilizing several assumptions. This was necessary due to the complex relations between stress and strain for it would be a big task to determine the effect of each modulus of elasticity in such an anisotropic material. A qualitative guide can be made by the piezorescence figure, and we shall consider it in this role.

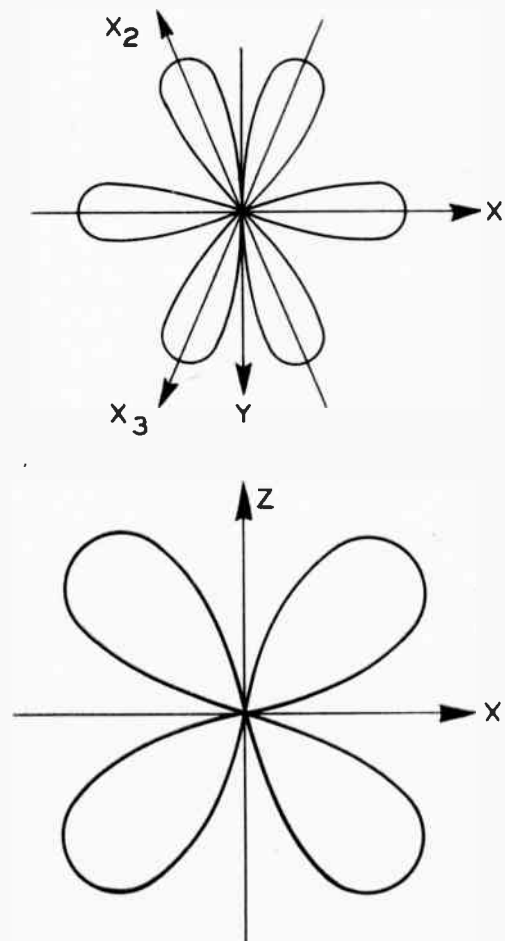

● Fig. 8. Figure of Piezorescence.

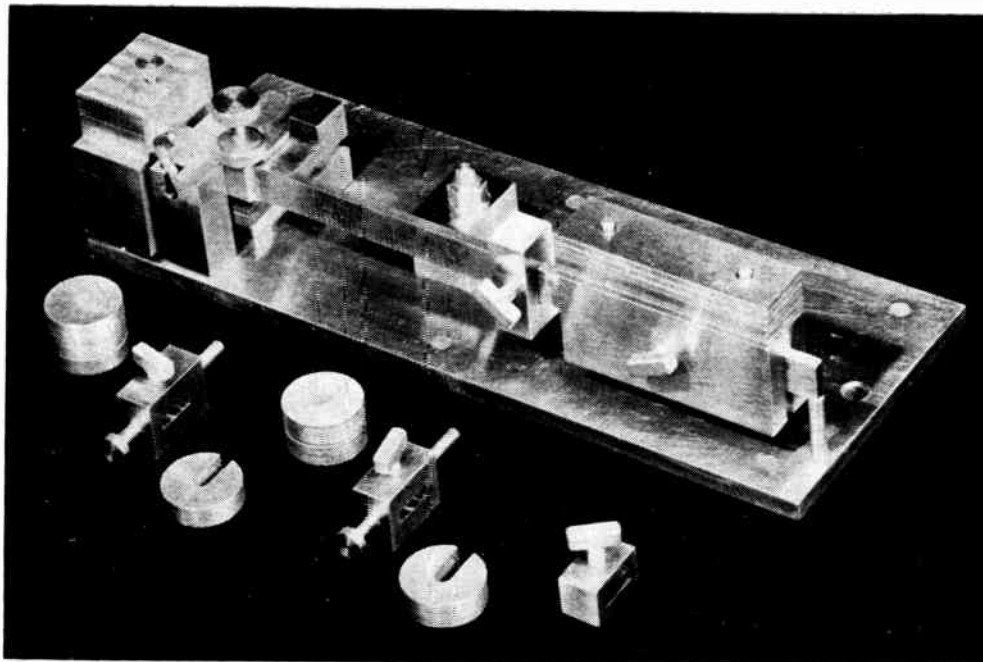

● Fig. 9. Tool to provide details of torque, temperature, rate of temperature increase and time-cycling.

New Observations

A number of DT plates were treated and in every case some twinning boundary movement was observed. The extent of movement or clearance depended upon the torque applied and final temperature reached. If the torque was too large then plate fracture occurred during treatment, however some degree of de-twinning was always achieved before fracture. Transient high torques were applied due to floor vibrations in the experimental area, also the bearing resistance opposed restoration of the plate to its low temperature position. Allowances were made for these effects and certain expedients adopted to eliminate them where possible after which plates were largely de-twinned without breakage. Further experiments soon indicated the torque and temperature required for success.

Figure 11 indicates examples of quartz before and after treatment. The residual twinned volumes are observed to be on the periphery of treated plates, a location where its effect is a minimum upon the performance of most crystal vibrator units.

A new tool was designed, founded upon the early results obtained. Reduced size, and more simple construction were sought to facilitate mass-production procedures. This new design, shown illustrated in Fig. 12, applies the stress in terms of an angular twist about the wafer crystal-plate axis. Effects of vibration and bearing resistance are eliminated due to absence of moving parts during treatment. Physical size was reduced so that at 1.1" high the arrangement can be passed through a small tunnel furnace having a short through-time. Stress is applied by clamping the plate against two steel surfaces, one of which is tilted with respect to the other. The angle of tilt depends principally upon the type of cut and dimensions of plate, and has been determined experimentally.

During the initial proving-in of this tool a large quantity of DT plates were lost due to fracture. As mentioned, stress applied to the plate was variable, and fractures were resulting from incorrect settings. As a measure to avoid this expensive loss, and yet provide guidance information it was decided to treat the more readily available X-cut plates. This decision resulted in an important discovery, namely that X-cut plates may be directly treated, successfully. At first sight this apparently anomalous result casts doubt upon the piezocrescence

figure. But it will be remembered that this figure, Figure 8, only applies for one system of stresses, namely pure torque about the major crystal-plate axis. If the stress system is modified, then the piezocrescence figure will suffer a redistribution and be revolved about the crystallographic axes, X, Y and Z. A stress induced by temperature gradient will bring about such a change. Due to the physical constants of quartz it only requires a few

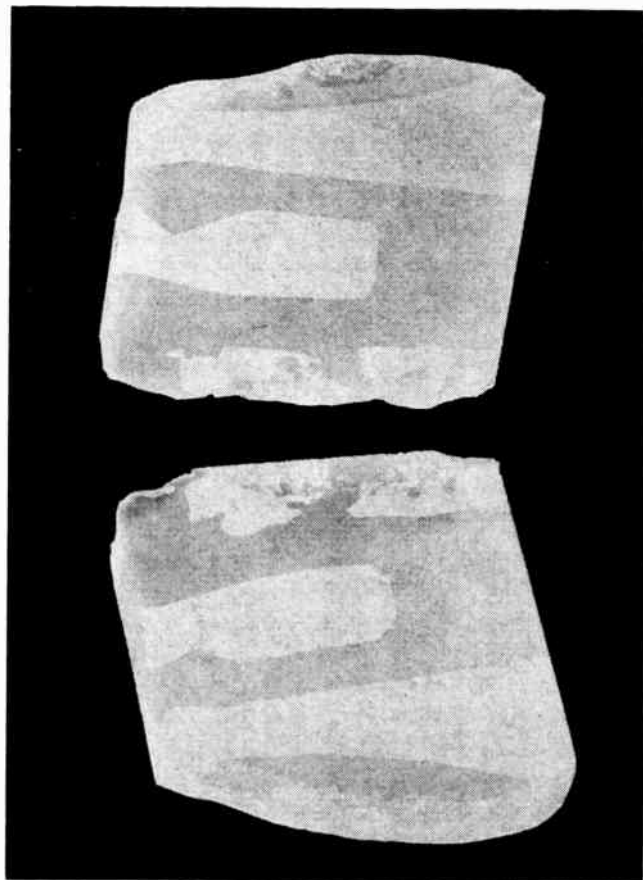

● Fig. 10. Showing two X-cut blocks to be cut into DT plates.

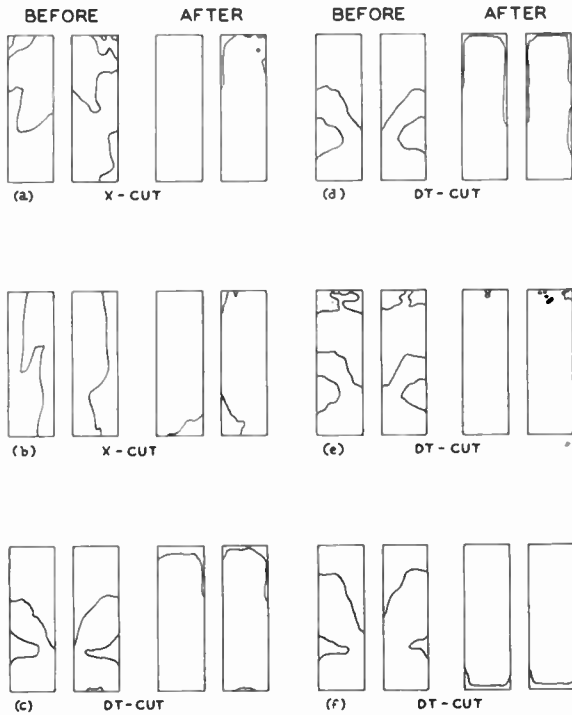

● Fig. 11. Showing examples of quartz before and after treatment.

degrees of temperature-gradient to provide sufficient stress for de-twinning. Such a gradient was induced along the crystal-plate during its travel through the tunnel furnace.

The de-twinning of X-cut plates was repeated, but with varying degrees of success. Certain patterns of twinning lent themselves to the process better than others. The previously mentioned random or irregular distribution of twinning was the most easily treated. A more common distribution has nearly straight boundaries and is suspected to be related to Tyndall effect, which may support conditions for the existence of twinning. Other inhomogeneities in quartz which support twinning may extend their influence even when the otherwise suitable conditions for de-twinning exist. This would

appear to be so from the results obtained, for not all plates required the same torque, or number of treatments, and some were particularly reluctant to de-twin.

Present And Future Applications In Industry

It was the object of these investigations to provide a simple effective means whereby twinned quartz could be rendered suitable for the manufacture of resonant units. The company sponsoring the investigation, Northern Electric Co. Ltd., use quantities of quartz for telephone carrier systems. Carrier filter units employ low-temperature co-efficient and low frequency X-cut crystal plates. Therefore the object can be re-stated as a means to provide a de-twinning process for the X-cut. At the planning stage of this investigation it was envisaged that the de-twinning of 0° , Θ° , 0° bars (using I.R.E. convention) would be employed. By cutting plates to final dimensions from such bars at 30° , 90° , Θ° . The purpose would be achieved. Further study was required into methods for cutting plates directly to such exact dimensions and orientation, as lapping was prohibited by the small size. Fortunately the direct de-twinning of X-cuts will bypass this additional development and only slightly modify present production procedure. However a number of factors must first be evaluated before full-scale use be made of X-cut de-twinning.

For example the exact effect of crystal inhomogeneities and assessment of their extent prior to any cutting operations. The Tyndall-effect referred to previously can be detected as a light-blue haze within the stone when a beam of light passes through. An "inspectoscope", consisting of an oil-bath with additional light sources, is the instrument used for this inspection. Other defects may be easily determined which adds but little extra effort to the quartz processing.

REFERENCES

- ¹Geology of Quartz Crystal Deposits. *Stoiber, Tolman & Butler. Am. Min. 30 pp. 245-268.*
- ²Etch Figures of Quartz. *W. L. Bond Z. Kristallogr. 1938 pp. 488-498.*
- ³The Inspection & Grading of Quartz. *Samuel G. Gordon. Am. Min. 30 pp. 269-288.*
- ⁴Zinzerling, E. V., Collected works, Vol. 2. p. 149.
- ⁵FrondeL, C. Secondary Dauphiné Twinning in Quartz. *Am. Min. 1945. p. 447.*
- ⁶The Control & Elimination of Electrical (Dauphiné) Twinning in Quartz. *Wooster, Wooster, Rycroft and Thomas. Jour. I.E.E. 1947. pp. 927-938.*
- ⁷Ibid. pp. 930, 934.
- ⁸Dana—A system of mineralogy.

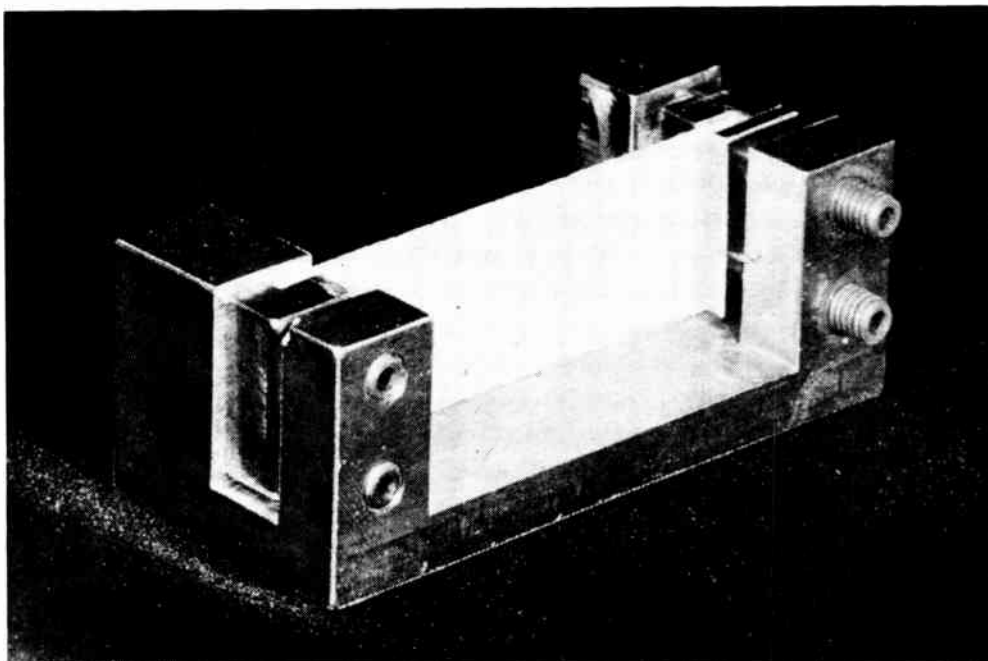

● Fig. 12. Tool designed to facilitate mass production procedures.

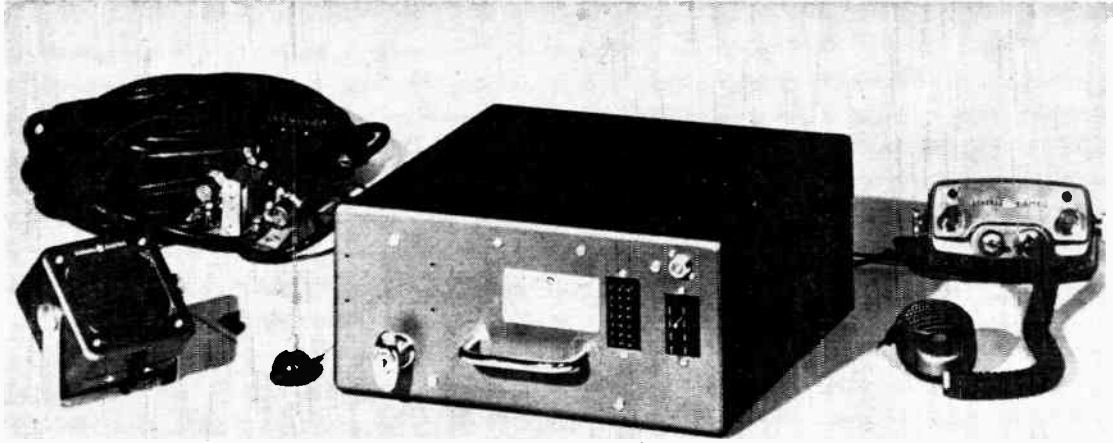

● Figure 1

It Is The Intention To Show That Any Commercial Product Undergoes Continual Evolution In Order To Keep Abreast Of Technological Advances And To Assure The Manufacture Of A Truly Competitive Product. It Is Stressed That Changes Are Not Aimed At Speeding Obsolescence, But Are Honest Efforts To Market A Continually Improved Product, Both Technically And Economically.

What! Another Engineering Change

By George L. King, P.Eng. *

THIS statement is sometimes spoken in jest, but more often in all honesty. The fact that it is often made is significant. This article describes changes and reasons for these changes to an electronic equipment along with their impact on Marketing and Manufacturing during a production period of some two years.

Engineering changes may be divided into several broad categories.

First: Changes due to errors — These will not be dealt with other than to say that engineers are only human and, therefore, capable of committing errors and omissions. The cost of such changes and the necessity to minimize such situations is recognized by all.

Second: Changes to facilitate or simplify assembly and test of the equipment.

Third: Changes to improve the operation of the equip-

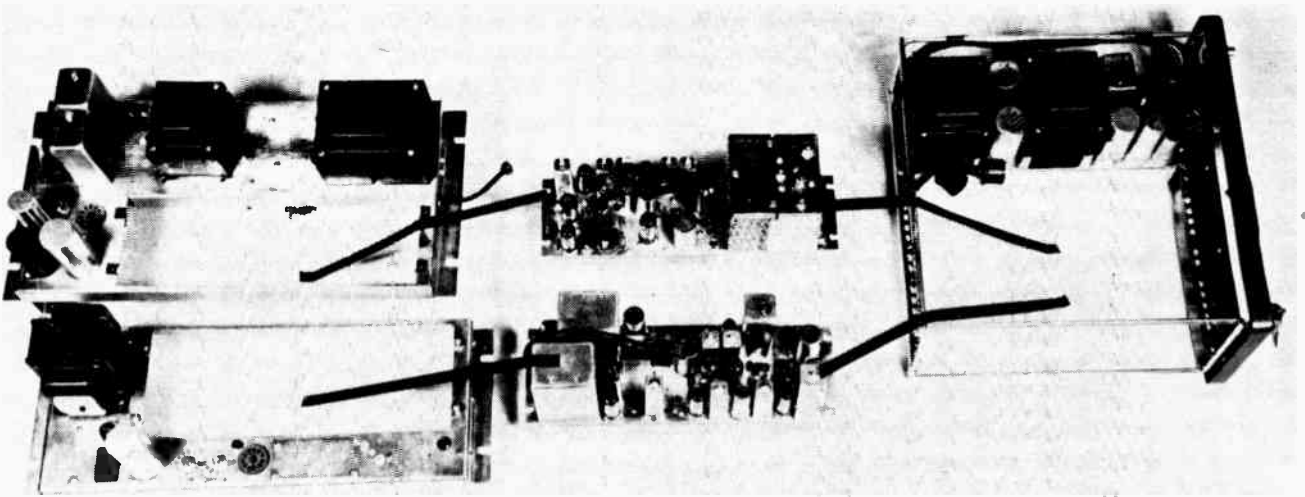

● Figure 2

** George L. King, P.Eng., graduated from Queen's University, Kingston, Ontario, with a B.Sc. in 1947 in Electrical Engineering. After serving as an instructor in the Department of Electrical Engineering at Queen's until 1951, he joined Canadian General Electric Company. He has been active in various phases of Mobile Radio Engineering work from 1953 until the present date.*

ment brought about by techniques new to the industry, or new to the suppliers. This type will also be commented upon.

Fourth: Future changes. An active value analysis program and a product improvement plan will result in continuing changes to ensure a truly competitive product.

Before proceeding with specific examples of such changes, an introduction to the equipment considered is necessary. The product involved is the General Electric "Progress Line Mobile Radio", which was designed by General Electric in the United States and produced there for sometime before production was started in Canada. This is a fully integrated family of equipment. A mobile or a station combination consists basically of a transmitter, a receiver and a power supply.

Flexibility has been provided by designing these components so that they are interchangeable with other units of their type.

Figure 1 shows a complete set of equipment for mobile applications. Here are seen the power and control cables, the speaker, the antenna, the mobile combination, the control unit, and the microphone.

Figure 2 shows the flexibility of the equipment. The same transmitter and receiver can be mounted in either the mobile case or in their respective station power supplies. Electrical connections are made to the units by plugging the terminated cables into the sockets in the station power supplies or in the mobile case into sockets on the power supply cable.

The station power supplies have standard 19" rack dimensions and mount in a cabinet the size and shape of a two drawer filing cabinet.

Figure 3 shows one of the eight power supplies which fit into the mobile case. This particular one is the 6/12 volt dc 50 watt power supply. These power supplies are available for 6, 12 or 24 volts dc operation and 117 vac operation.

Figure 4 shows the 14" and 17" cases. A 20" case is

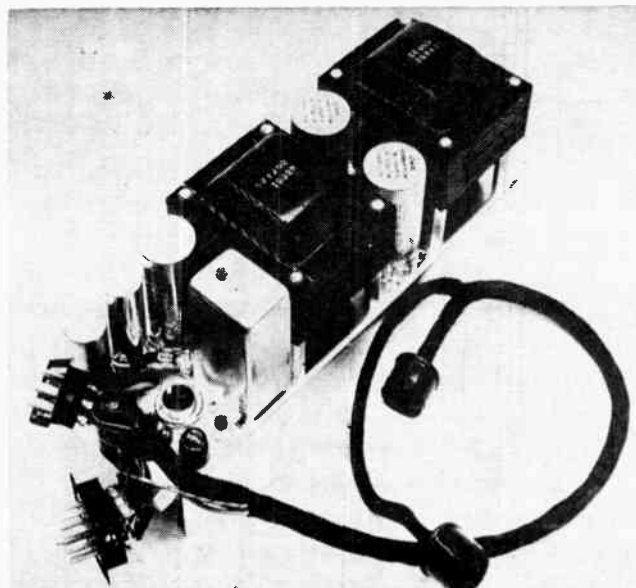

● Figure 3

also available. The 14" case is standard, while the 17" case allows for a 3" option panel, and the 20" case has sufficient space for a telephone type selector. These then, are the basic equipments on which changes have been made, or will be made.

Figure 5 is a drawing of the case, with some internal points of interest shown. The original case as produced in the United States posed manufacturing problems for a limited production. It was not practical to make drawn front and rear panels nor to use the faster box dies for forming the covers and the bases. The front and rear panels were purchased from General Electric and all forming was done with standard V dies, which required slight changes to some dimensions and bend radii.

The reinforcing gussets which also served as a guide for the rack were found to be equally effective when only half the original length was used. The two springs used to lock the cover onto the rear panels were replaced by one spring. The springs on the case which bear against the frame were replaced by rubber bumpers. Difficulty was experienced in minimizing the spot weld marks on the cover for the reinforcing channels, and if someone wanted to stand on the case, the cover would buckle anyway. For these reasons, the reinforcing was removed. This had a double savings. By removing the channels, the clearance above the transmitter was sufficient for a standard toggle switch to be used on the P.A. housing in place of the special short-shank switch at a considerable reduction in cost.

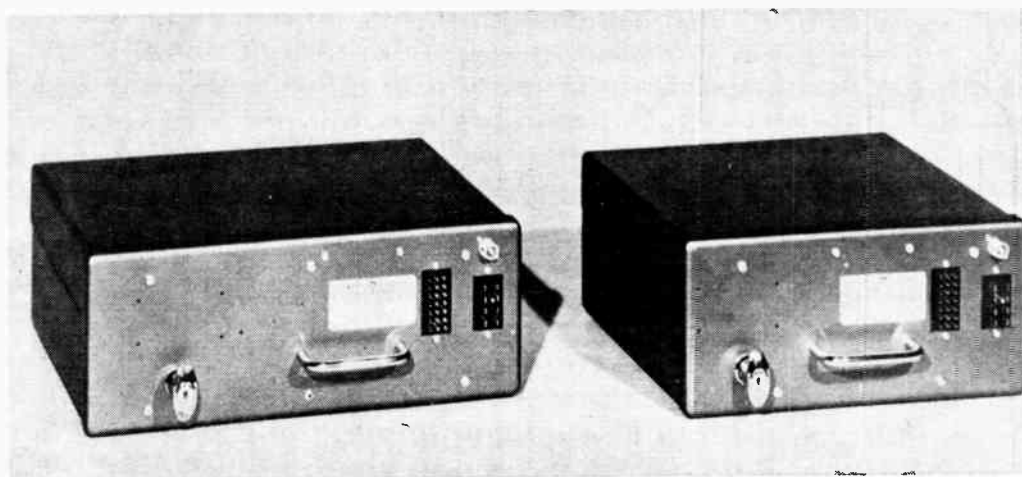

● Figure 4

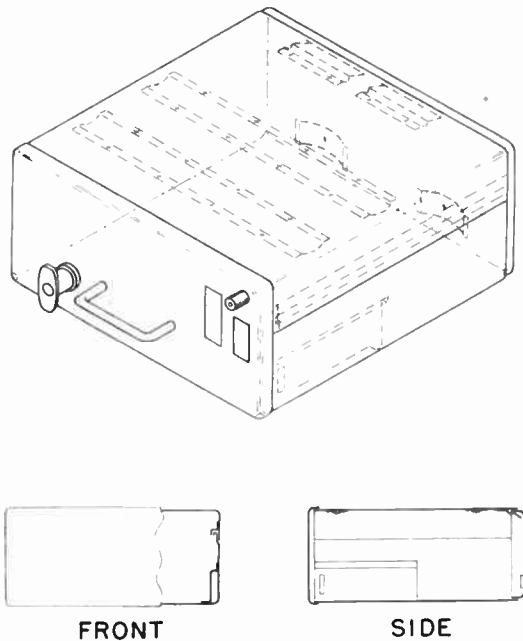

● Figure 5

\$10,000 Annual Cost Reduction

Figure 6 shows a collection of items which have been changed, some of the items look alike while others have no physical similarity. However, they have one thing in common and that is equal or improved operation at reduced overall cost.

Item 1. These test jacks, because of their brittle composition could not be properly tightened without fear of breakage. If broken, replacement was costly procedure. If not sufficiently tight, the nuts worked loose. A spin-on nylon jack is now used, resulting in no breakage, faster assembly and no loosening.

Item 2. This machined aluminum thumb nut was replaced by a standard cap nut.

Item 3. These knobs look alike, but one is a set screw type and the other is a push on type. The original costs are the same, but assembly time is reduced.

Item 4. This laminated vibrator socket was replaced by a molded type reducing the possibility of breakage.

Item 5. These two coils are similar in appearance but one has more uniform characteristics, takes less assembly time, and has a four fold improvement in reject rate, through the use of litz wire with solder soluble insulation.

Item 6. These four test jacks were replaced by a four pin socket — a catalogue part.

Item 7. This fabricated wire clamp was replaced by a standard nylon clamp.

Item 8. The assembly of this by-pass capacitor required a spin on eyelet and the capacitors pressed into this eyelet. Replacing these with the screw on type speeded assembly time and made replacement much simpler. A probable future change is the use of new ceramic capacitors recently made available which have good power factors at the higher frequencies, thus allowing a lower capacitance to be used.

Item 9. This speaker grill with small rectangular perforations has been replaced by an expanded metal grill. The price differential about 4 to 1.

Item 10. The termination of the co-ax shield to the connector was made by wrapping with wire and then soldering. This has been improved both in operation and appearance by the use of a crimp-on collar.

Item 11. Originally these cables were supplied by a vendor with all leads of equal length, stripped and tinned. However, for assembly the leads had to be different lengths. A considerable savings was effected by obtaining these from the vendor already cut to length. Because of the savings in wire, the vendor was also able to give a better price. The items considered above represent a total cost reduction after subtracting the cost of making the changes of some \$10,000 on an annual basis.

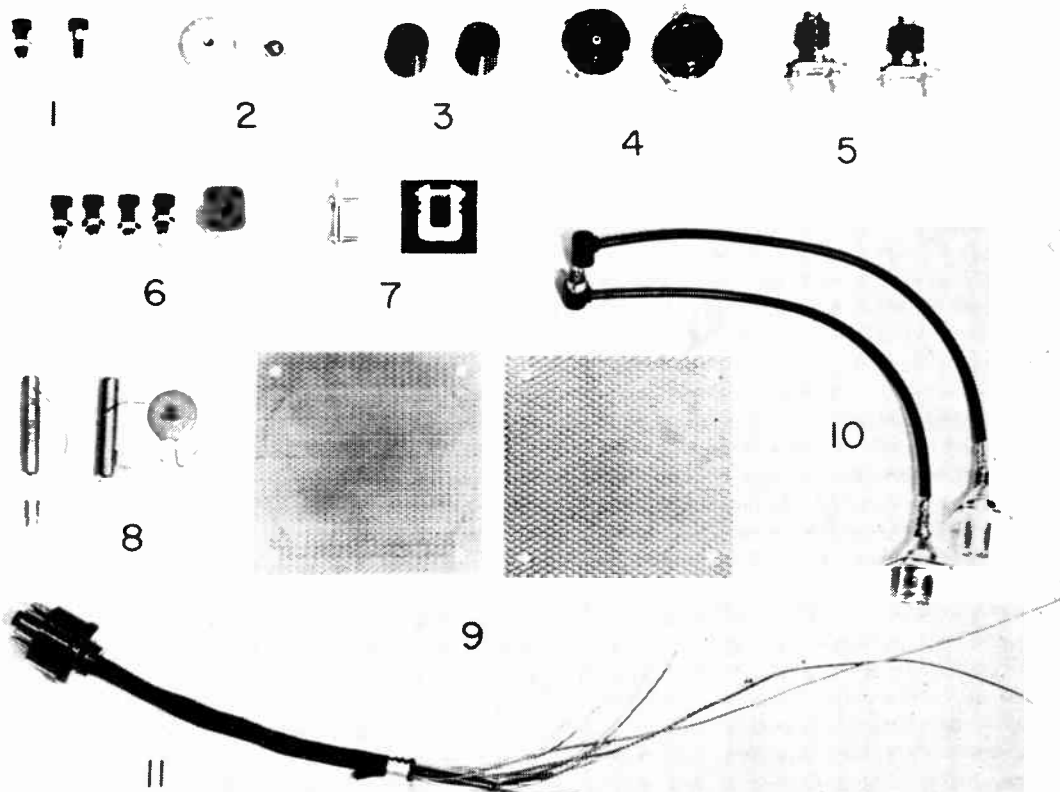

● Figure 6

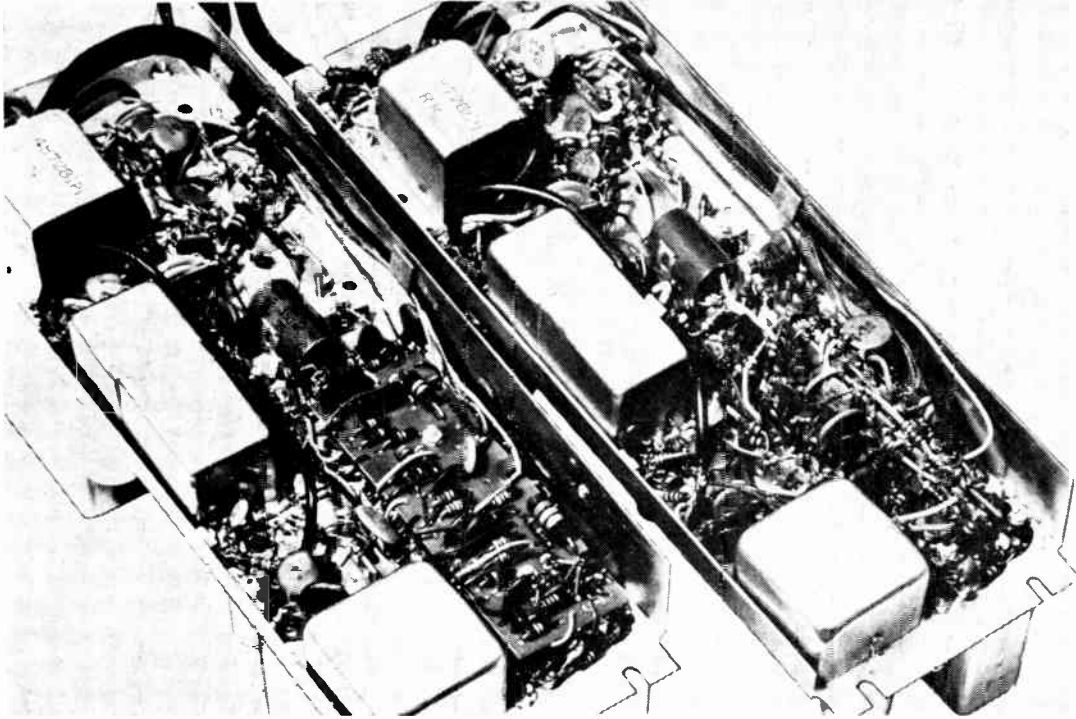

● Figure 7

Circuit Improvements

Figure 7 shows the comparison between two receivers. The one on the right contains a sub-assembly that has been nick-named the "rats nest". This has since been replaced by a printed board as shown on the receiver to the left. The results are fewer errors during manufacture, less breakage and better appearance. To someone not familiar with this printed board, circuit tracing may be more tedious, but once familiar, trouble shooting is simplified because of the more orderly arrangement of components. The board can be lifted from its mounting and tilted so that both surfaces are accessible.

Figure 8 shows the circuit in the old and new version of the receiver first audio amplifier, and the d-c amplifier of the squelch circuit. To reduce the maximum possible audio output and to improve the performance of the squelch circuit, changes were made as shown. A is the original circuit, and B the revised circuit.

The audio gain was reduced by the addition of R1. The squelch was improved by changing the B plus feed to the d-c amplifier and the cut-off voltage feed to the audio control grid. The d-c amplifier was further stabilized by reducing its filament voltage. To avoid the tendency for the audio grid to "float", its impedance to ground was

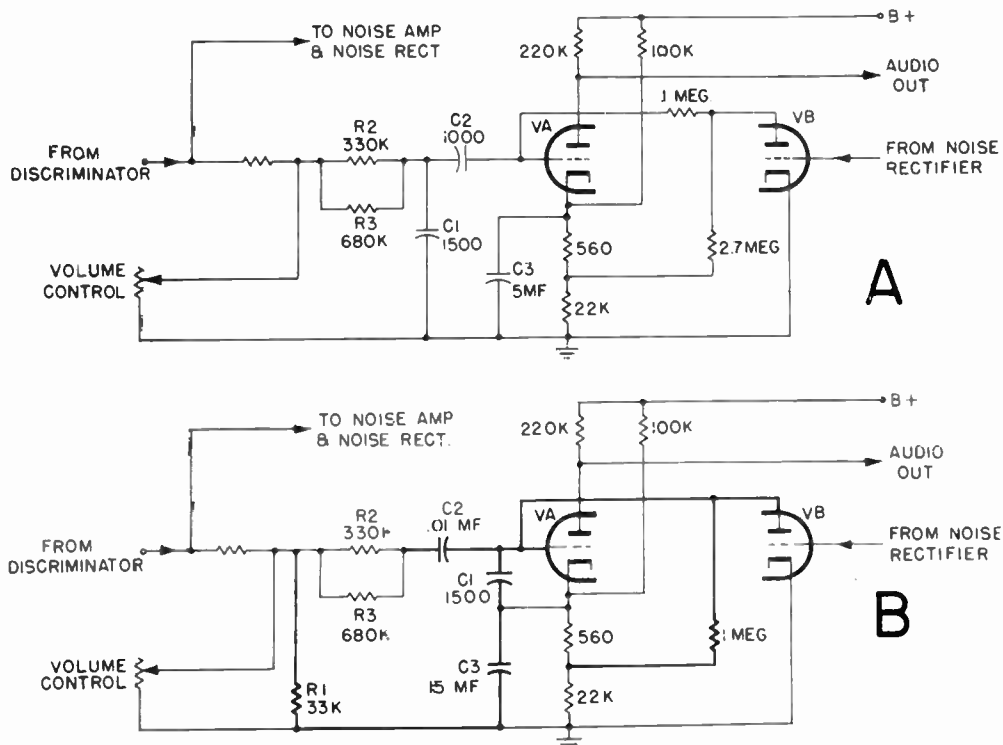

● Figure 8

decreased by placing C1 on the grid side of the coupling capacitor C2. In order that the de-emphasis network R2 R3 C1 operate as previously, C2 was increased.

This increase resulted in a squelch opening delay which cut out the first portion of a received signal. The reason for this delay is as follows:

On receipt of a signal, the cut off bias is removed from the audio grid, allowing C2 and C3 to charge.

Due to the circuit time constants the original smaller C3 would charge faster than C2 thus maintaining the cut-off voltage on the audio amplifier grid for approximately one second, sufficient to chop off the start of a transmission. This was cured by increasing C3.

These changes by no means represent all the changes that have been made during the two year span. A few of the others are: Improved receiver muting by switching B plus instead of audio switching, improved oscillator activity in the transmitters by increasing the feed back capacitance, and the use of a modified tuning procedure for the low i-f transformers.

At this point you may very well ask "Are any changes contemplated for the future?" The answer is an emphatic yes!

Among such changes, the major ones will be a receiver with even better desensitization performance and equal sensitivity and selectivity with fewer tuned circuits, transistorized power supplies, and dual voltage crystal ovens which do not require separate changeover when changing voltage.

Changes may not be made indiscriminately but must be properly timed. The onus of making changes may not be entirely in the hands of engineering, because the initial requirement for a change may come from Marketing. However, to minimize strained relations, frequent reports regarding the possibility of a change should be forwarded to Manufacturing. For example, if the expediting crew has contacted several vendors in procuring a part on a rush basis and the scheduling crew has worked overtime to gear production to meet commitments, they will hardly be pleased to receive an unexpected engineering notice substituting another part.

The effects on Marketing are not quite as measurable as is the possibility of unused components and idle time in Manufacturing, but are nevertheless every bit as important. The printing of an accurate instruction manual, the stocking of the proper replacement parts and the assurance that delivery will not be delayed are all factors which must be carefully considered.

Conclusions

It has been the intention to show that Progress Line Mobile Radio specifically, and any commercial product generally, undergoes continual evolution in order to keep abreast of technological advances and to assure the manufacture of a truly competitive product. It is stressed that changes are not aimed at speeding obsolescence, but are honest efforts to market a continually improved product both technically and economically.

Infra-red Spectrometry In Chemistry

A new type of automatic recording infra-red spectrophotometer — an easy-to-operate and inexpensive instrument — is expected to give considerable impetus to infra-red analysis.

Though infra-red spectroscopy has been a valuable tool in analytical chemistry for more than a decade, the ultra-violet spectrophotometers in use today outnumber the infrared units in operation 10 to 1. Infra-red is potentially a more fertile field for research than the ultraviolet, but until recently, the high cost and complexity of infra-red spectrophotometers has deterred many would-be users of these instruments.

Now, engineers have developed what they call the IR-6 expressly for the analytical and organic chemist. The instrument is so easy to operate and so inexpensive initially that even the small-budget laboratory can afford it.

This unique spectrophotometer was commissioned by Beckman and designed by Dr. John U. White and his associates of the White Development Corporation. Dr. White is well-known for his contributions to infra-red spectroscopy and to IR instrumentation. His latest achievement — the IR-6 — initiates a new era in infra-red. Recording linearly in transmittance and wavelength, the IR-6 meets the needs of many chemists for a "work-horse" instrument. It offers excellent accuracy and resolution for most analytical work.

The designers of the IR-6 eliminated several "nice but non-essential" features in order to emphasize extreme ease of operation and to minimize cost. Scanning speed, for example, is fixed; the speed chosen is the one most often used on expensive adjustable-speed instruments. The slit program, chart expansion, source current, and time constant also are fixed. These operating parameters were chosen for optimum performance at that scanning speed.

Performance of the IR-6 is not as high as that expected from the more expensive infra-red spectrophotometers, but the instrument offers excellent resolution for the majority of infra-red applications in the chemical laboratory. For a 16-minute scan, such performance is comparable to that of many expensive instruments.

Quantitative Work

While the IR-6 was designed primarily for the qualitative analysis that constitutes the majority of infra-red research activities, the instrument also is capable of accurate quantitative work whether by scanning or by using the cell-in cell-out technique. A special densitometer accessory is available for applications where extreme accuracy is desired.

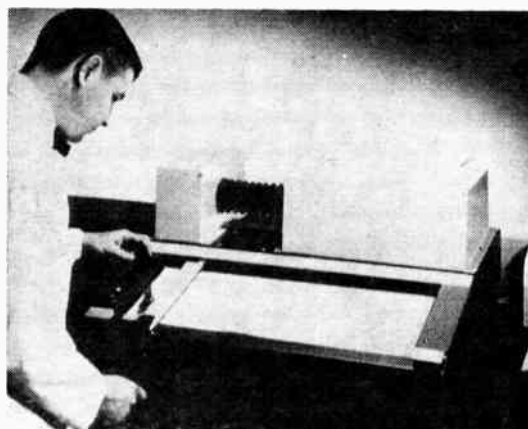

● Design simplicity of the IR-6 Infra-red Spectrophotometer a feature contributing to its ease of operation is evident in the above photograph of the instrument.

Operation of the IR-6 is so simple that all laboratory personnel can produce rapid, accurate spectra. The instrument has only five operating controls: start and stop buttons, selector switch and the customary zero and 100 per cent adjust knobs. The entire 2-16 micron spectrum can be scanned in 16 minutes; the scan may be stopped at any time by pushing the stop button.

The IR-6 has a flat-bed recorder. The entire spectrum, traced on preprinted, file-size charts, is visible at a glance.

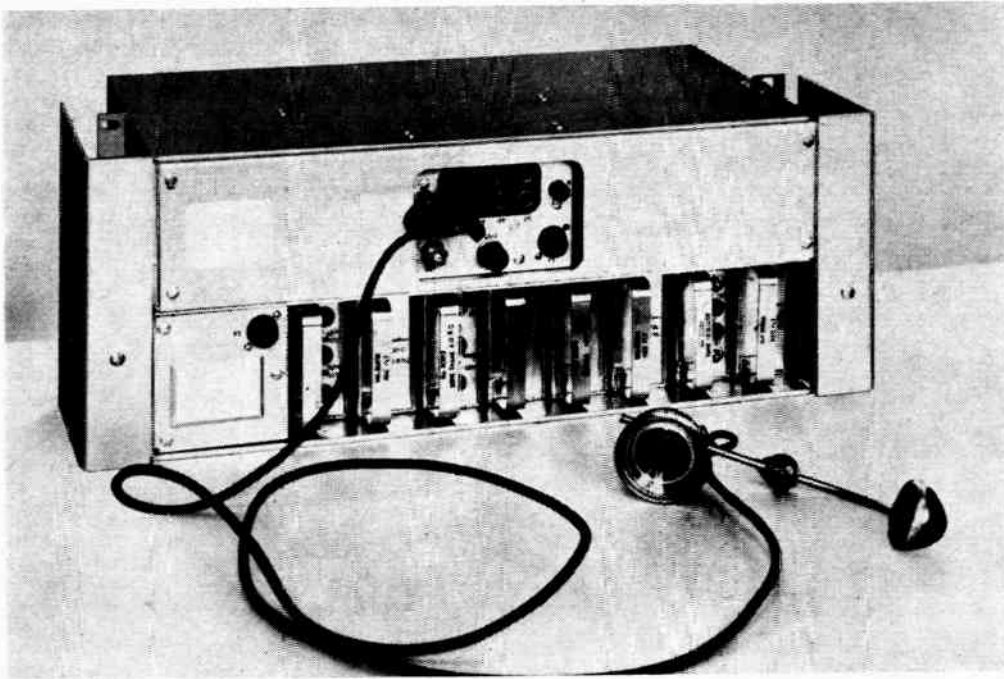

● Fig. 1. A typical application of order wire equipment at a three-way turning point.

**The Use Of A Separate Order Wire Greatly Assists
Maintenance Personnel During Emergencies,
In Trouble Shooting And In Regular Maintenance Lineup
And Testing Of Radio Equipment**

Miniaturized Order Wire Equipment In Radio Systems

By E. V. Hird, P.Eng. *

EXPERIENCE has shown that to keep outage time of point-to-point microwave radio systems to an absolute minimum, a separate order wire should be provided for the exclusive use of maintenance personnel. Such radio systems are usually capable of carrying 120, 240, or greater numbers of multiplexed voice channels; thus with such heavy channel loading the cost of the maintenance order wire becomes economical.

Many microwave radio systems utilize back to back radio terminals at repeater locations. This offers the advantage of being able to drop and insert carrier channels into the radio baseband. Spur radio systems may also be bridged onto the main system at these locations, thus creating a three way or four way radio turning point.

The interconnection of the radio basebands is commonly solved by the use of a four way four wire resistance bridge. The radio order wire requires a similar bridge plus amplifiers and two way voice and signalling equipment to provide adequate facilities for maintenance use. A typical application of order wire equipment at a three

way turning point is shown in Figure 1.

Order Wire Equipment

The 53A Order Wire System was developed initially for use with the 6000 mc Lenkurt 74A Radio System, the equipment being miniaturized and transistorized, with optional plug-in subassemblies to meet almost any conceivable order wire application. All equipment operates from 48 volts d.c. with optional power supply panels available to permit operation from 130 volts d.c. or 115 volts 60 cycle a.c.

Figure 2 illustrates a typical 53A order wire assembly. Equipment panels utilize 45 class mechanics and conform to standard telephone practice, mounting on 19" relay racks with 5" front and 2" rear projection. The circuitry of each plug-in subassembly is enclosed in a metal can $3\frac{1}{8}$ " high, $1\frac{1}{2}$ " wide and $7\frac{1}{4}$ " deep as shown in Figure 3. The front face of the can contains level adjustments and test points if required, with a handle

* Mr. E. V. Hird is Applications Engineer for the Lenkurt Electric Company of Canada Limited, Vancouver, B.C.

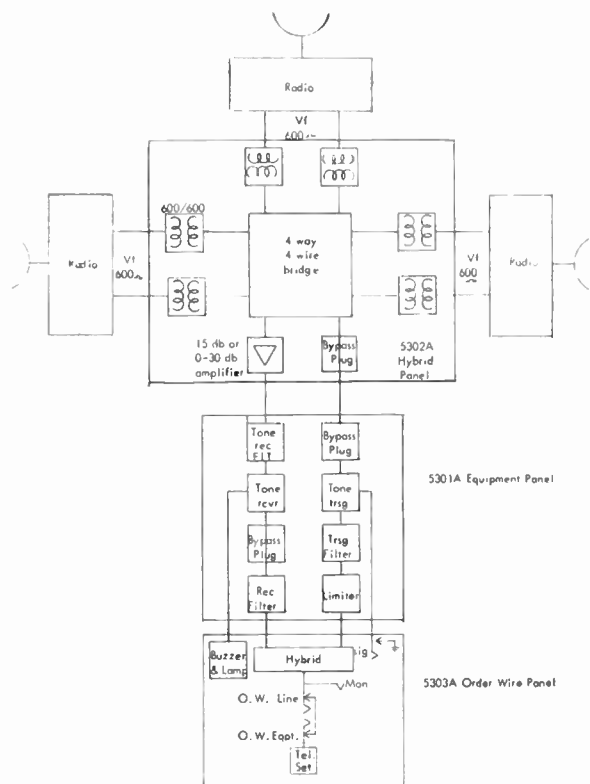

● Fig. 2. Illustrates a typical 53A order wire assembly.

for removing the subassembly from its mounting. The back face has an 11 pin plug, which mates with an 11 pin receptacle in the panel mounting position.

The following is a brief description of each panel in the 53A order wire assembly:

(a) 5302A Hybrid Panel

The 5302 Hybrid Panel consists of a 600 ohm balanced four-way four-wire resistance hybrid, plus receptacles for 8 plug-in subassemblies. A schematic of the panel and

subassemblies is shown in Figure 4. Any of the seven optional subassemblies may be plugged into each receptacle as desired for a specific application. These optional subassemblies include a bypass plug; 600 ohm terminations for any unused sides of the resistance hybrid; 600/600 ohm or 600/135 ohm line balancing or impedance matching transformers; a three stage transistorized amplifier with a variable 0-30 db gain and a maximum output level of +12 dbm, or a single stage transistorized amplifier of 15 db gain and maximum output level of 0 dbm. Both amplifiers operate from 48 volts d.c., drawing 20 MA and 10 MA respectively.

Frequency response for all units is within ± 1 db from 300 cycles to 12 kc. The resistance hybrid provides a trans hybrid balance of 80 db from 300 cycles to 50 kc with an insertion loss of 15 db.

(b) 5301A Equipment Panel

The 5301A Equipment Panel provides mounting positions for eight individual plug-in subassemblies. Mounting positions P1 to P4 are wired in series and are normally used for transmitting branch circuits. The optional plug-in subassemblies normally serve to provide a two-way speech-plus signalling system with a voice band of 1.8 kc or 3 kc and optional signalling tones of 2.1, 2.34 or 4 kc.

Figure 5 illustrates a typical application of the panel in which voice frequency signals from the radio equipment are accepted by the low pass 1.8 or 3 kc filter and passed to the order wire panel. A tone receive filter tuned to 2.1, 2.34 or 4 kc is bridged on to the incoming line and is connected to the two stage transistorized tone receiver. Incoming tone signals are amplified, then rectified and applied to an additional transistor, the latter operating as an electronic switch to place 48 volt signal battery on the E lead to the order wire panel. Voice signals from the order wire panel are fed into a transistorized limiter circuit to suppress all output speech peaks above +5 dbm, then passed to a 1.8 or 3 kc low pass TRSG filter, thence to the radio order wire. Ground placed on the M lead from the order wire panel controls a transistorized keyer circuit in the 2.1, 2.34 or 4 kc tone transmitter, the output of which is bridged across the TRSG outline of the panel.

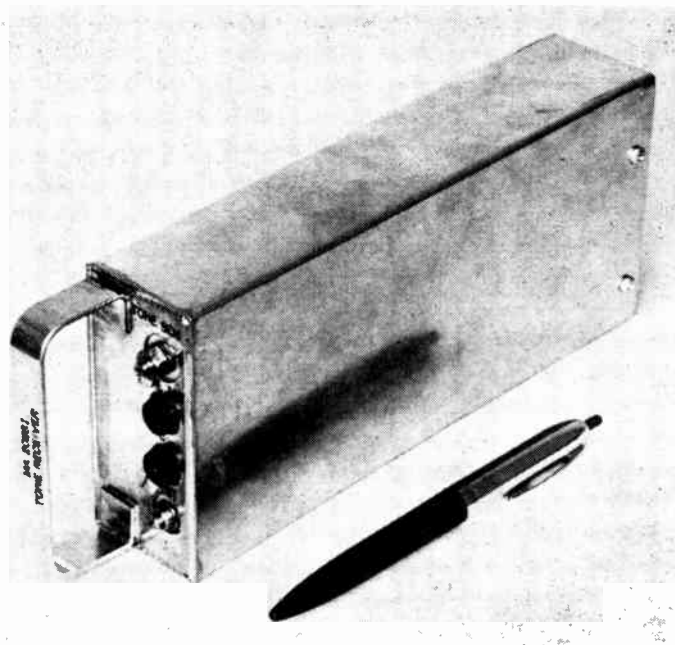

● Fig. 3. Typical plug-in sub-assembly.

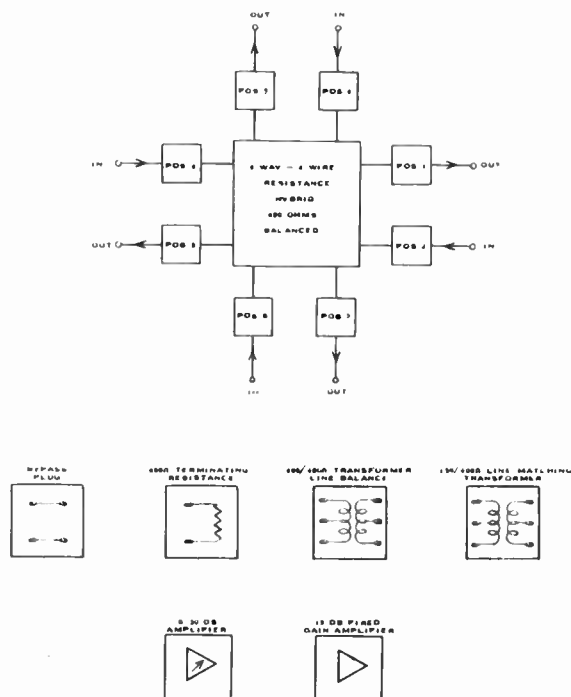

● Fig. 4. Schematic 5302A hybrid panel and plug-in subassemblies.

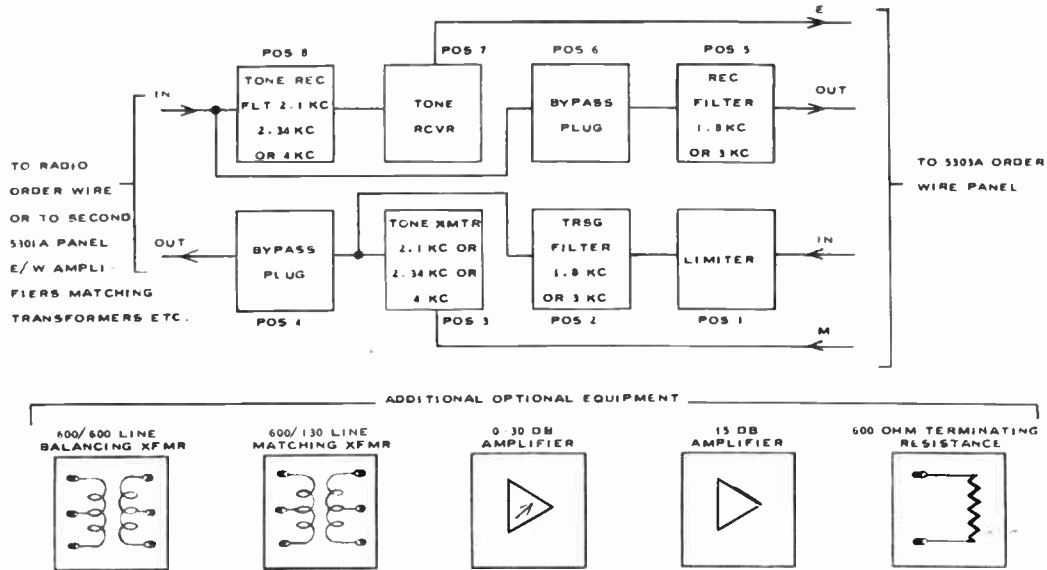

● Fig. 5. Typical schematic 5301A equipment panel.

If additional gain or impedance matching is required such as over an open wire or cable extension to the radio site, a second 5301A Equipment Panel may be placed in series with the first panel and line matching transformers, 15 db or 0-30 db transistorized amplifiers equipped as required.

Frequency response of the voice frequency section of the panel is within ± 1 db from 300 to 1.8 or 3 kc. The tone receive filters provide 20 db rejection between adjacent signal tones.

(c) 5303A Order Wire Panel

The 5303A Order Wire Panel is shown schematically in Figure 6. A coil type hybrid with a receive gain adjustment allows the panel to operate with a four-wire voice frequency drop, or the panel may be connected directly to a two-wire vf drop. The two-wire telephone set circuit has provision for an external loudspeaker to be connected, the latter being removed from the circuit and terminated in 600 ohms whenever the operators headset is inserted into the telephone set jacks or whenever the optional extension common battery telephone is used. A call lamp

lights and a buzzer sounds whenever ground is placed on the E lead as when signalling from the far end order wire equipment. A strapping option on the panel permits continuous or momentary operation of the buzzer and call lamp as desired. The SIG key is depressed to signal out on the M lead to the far end equipment.

The panel will operate from positive or negative 48 volts d.c. and requires 195 ma.

(d) 5304A Power Distribution Panel

The 5304A Power Distribution Panel contains a transistorized shunt regulator circuit, which supplies up to 400 ma at +48 volt d.c. from a +130 volt d.c. source and is designed to be used at a location where 48 volts d.c. or 110 volts a.c. power is not available.

(e) 5064A Power Supply Panel

The 5064A Power Supply Panel provides a filtered 48 volt d.c. output from a 115 volt 60 cycle a.c. source, with an adjustable output current range from 0.1 to 1.3 amp. A dry disc rectifier bridge is used with the output voltage remaining within ± 1.25 volts for a line voltage variation of up to 10%.

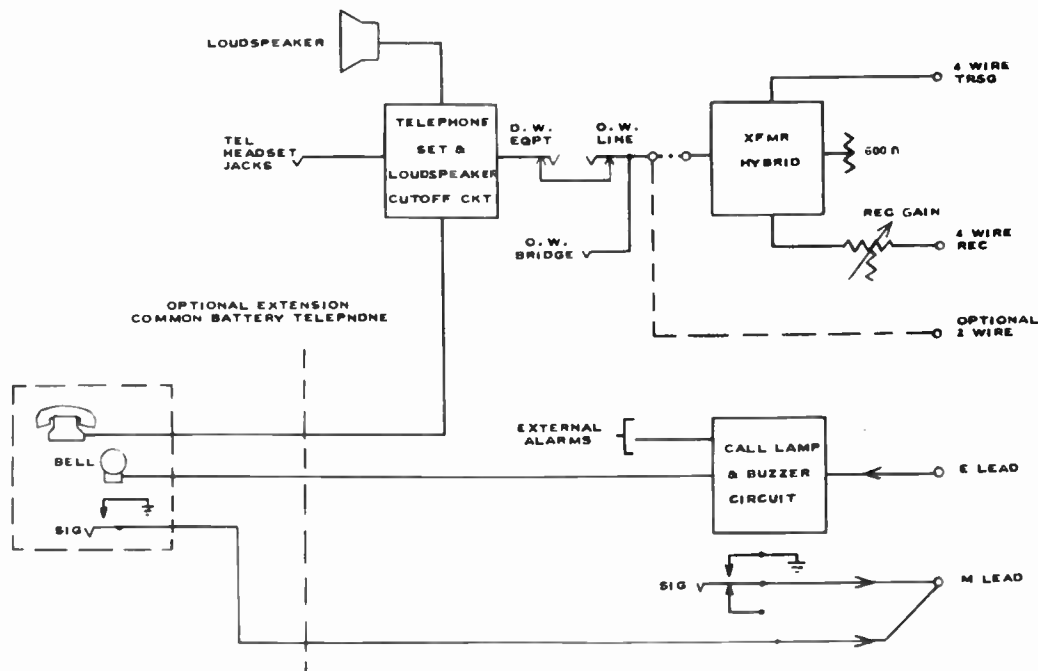

● Fig. 6. Schematic 5303A order wire panel.

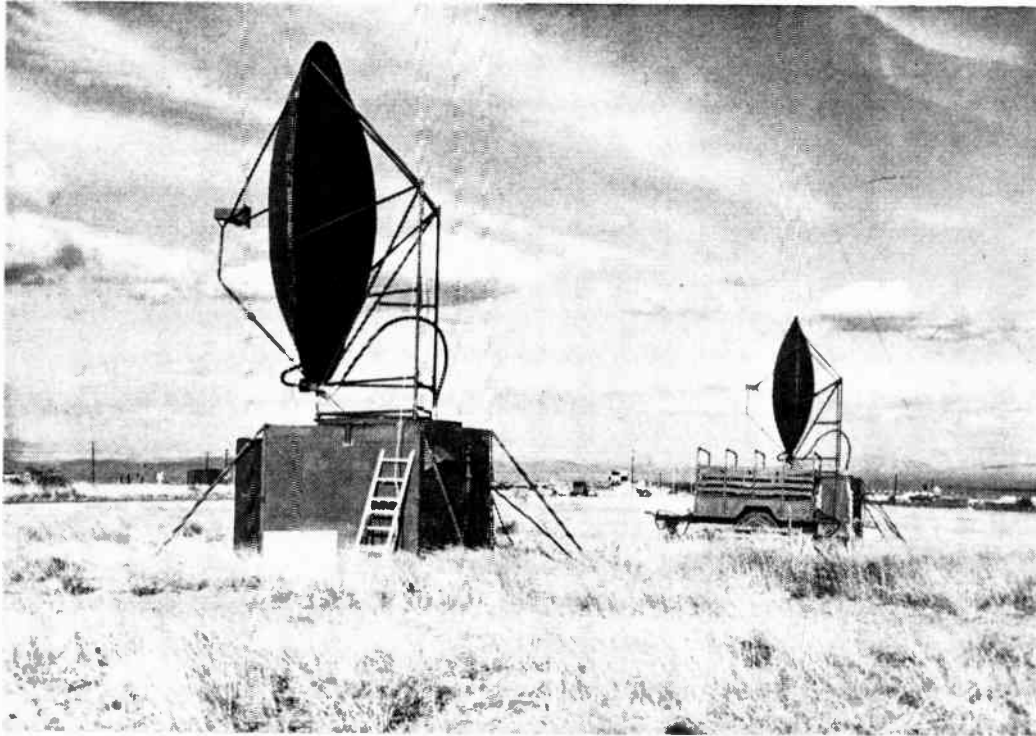

● Air-inflated antennas are mounted directly on the shelter roofs of the communication terminal. The reduced weight and storage requirements of this advanced antenna design help make the terminal the most easily transported of its type for highly reliable UHF communication over ranges of 50-150 miles with many simultaneous voice channels.

A Portable UHF Transhorizon Communication Terminal

A COMPACT, air-transportable UHF Transhorizon communication terminal with inflatable antenna, capable of being completely packed in the two metal "huts" that serve as shelters when the station is erected, provides the greatest mobility available today for this type of communication system. Such mobility could greatly improve the effectiveness of fast-moving army tactical units requiring communication to points beyond the horizon.

The two huts can be easily carried by transport aircraft as well as by truck, and placed in operation by a few men in a very short time.

The transhorizon terminal employs tropospheric scatter propagation to achieve extremely reliable multi-channel communication for ranges of 50-150 miles without intermediate relays. Operation of this terminal is in the 1000 mc band.

Two 15-foot parabolic reflector antennas are utilized to provide space diversity. The reflector consists of two fabric sections of a vinyl-coated plastic material clamped to a ring girder hoop to form an enclosed envelope. The inside surface of the rear fabric section is coated with aluminum and a protective mylar film. This serves as the reflector, while the front section is transparent to RF energy.

A motor-driven centrifugal blower inflates the antenna in about 12 minutes, maintaining the desired pressure afterward by on-off cycling. The inflated antenna is designed to withstand winds up to 70 miles an hour without distortion of the parabolic reflecting surface, and it has, in fact, easily weathered 50 mph winds at the test site.

The feed horn is of the open ended waveguide type, making it a broadband device, with a flared end that improves the VSWR to less than 1.3 to 1 over the 755-985 mc range, eliminating the need for an antenna tuner. The reflector has a 6-foot focal length, and the feed provides a 10-db illumination taper with approximately 29 db gain with respect to an isotropic antenna. This performance is equal to that of conventional 15-foot metal paraboloids.

The inflatable antenna is one of the keys to the portability of the terminal because of the reduced weight, ease of erection and storage, and lessened supporting tower requirements. The complete antenna assembly, including tower, weighs about 400 pounds, compared to 1350 pounds for equivalent conventional metal antenna and tower. The complete inflatable antenna assembly can be dismantled and stored in a space about three feet by two feet by seven and a half feet while the major part of a 24-foot trailer is required for only two conventional metal antenna assemblies.

The two equipment enclosures are "hut" shelters measuring roughly seven feet by seven feet by 8 and a half feet. One of the shelters houses the exciter, a Collins 310K-3; dual diversity Collins 50G-2 or -3 Receivers, and waveguide-type bandpass filters and diplexer. When the terminal is set up for operation, there is a work table opposite the equipment racks, complete with spare parts and test equipment cabinets. By itself, this nucleus shelter could be used for 25-watt operation.

Full 1-kw operation is provided by the second "hut" containing a 1-kw power amplifier — a repackaged Collins 240E-2. The three-cavity, air-cooled klystron is located on the left side of the shelter, together with blower assemblies, work table and storage chests. The power supply cabinet is located on the opposite side of the shelter. Repackaging of the transmitter and integrating its cabinet with the shelter walls has shaved approximately 500 pounds off the equipment's weight.

When the terminal is erected, adequate space in the shelters remains for placing Signal Corps AN/TCC-3 4- or AN/TCC-7 12-channel multiplex equipment for use with the transhorizon equipment.

In transit, the receiver-exciter shelter carries the folded antenna fabrics and dismantled towers for both antennas, transmission lines, blower cables and a 70-foot power cable. An example of the weight-saving packaging features is the use of a single set of uprights for supporting the cable during transit and for supporting the work table after terminal erection.

Shelters are supplied with detachable dolly wheels for movement over short distances, such as exact placement at the site. A portable jack may be operated by four men to hoist a shelter to the proper height so a truck may be backed under the shelter for loading.

All of the equipment making up the complete terminal is shipped in the shelters except the primary power source. A compact, transportable military PE-95 generator is available for this purpose, however.

At the new location, the tower, consisting of tubular aluminum members with telescoping joints, is easily assembled on the ground, together with the ring girder and the antenna fabric sections. Only a few men are required to erect the completed assembly. Antenna siting is made less critical during the erection stage because elevation and azimuth adjustments can be made afterward. Elevation may be varied over a $\pm 3^\circ$ range by a turnscrew which raises or lowers the ring girder. Azimuth may be adjusted $\pm 5^\circ$ by loosening rear leg locks and guys and pivoting the tower about the front leg.

Although the towers supplied place the feed axis at 22 feet, 4 inches above the ground, this height may be varied by omission or addition of tower sections, with a maximum height of 40 feet.

Another terminal being supplied to the Signal Corps by Collins has the antennas mounted directly on the

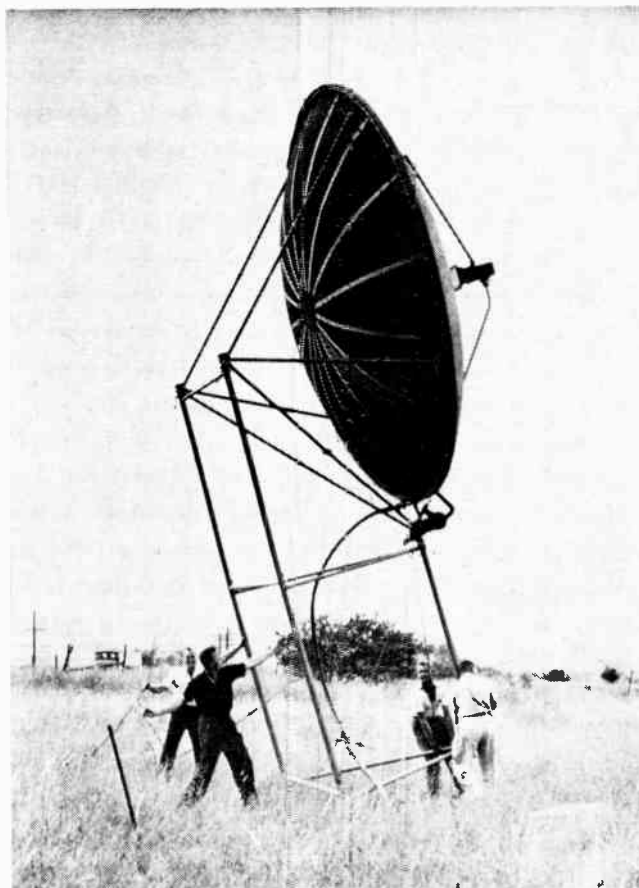

● One of the keys to the portability of the new UHF transhorizon terminal is an air-inflatable antenna. It may be easily erected or dismantled at the station site by only a few men.

shelter roofs. Outriggers on the shelters give the necessary support to the shelters. This terminal includes several refinements. Among them are more even distribution of weight between the two shelters (3100 pounds for the receiver-exciter shelter, 3320 for the transmitter) and a pressure regulation system for the antenna using a blower which stalls out when the proper level is reached.

Tests of the original air-transportable terminal, run side-by-side with a Collins-fitted 31-foot trailer terminal and conventional metal antennas, indicate the new air-transportable system matches the performance of the time-tested trailer systems. The development of the air-transportable terminal is an independent project sponsored by Collins Radio Company.



● Complete UHF transhorizon radio communication terminal, including two air-inflatable antennas, can be dismantled and shipped in the two enclosures that serve as shelters for receiving and transmitting equipment.



● Evaluating the air-transportable terminal for UHF transhorizon radio communication. The terminal includes two air-inflatable antennas, a receiver-exciter shelter (left) and a transmitter shelter.

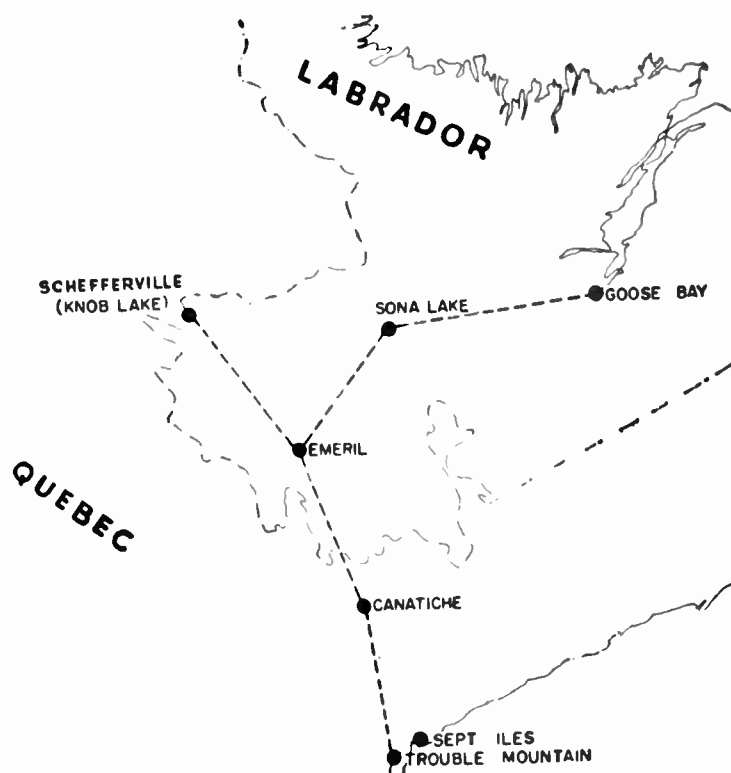

● Route Of The "Tropospheric Scatter" Radio Relay System Built By The Bell Telephone Company of Canada and Quebec-Telephone To Serve The Quebec-Labrador Mining Area. It Is Scheduled For Service June 1.

Tropospheric Scatter System For Northern Quebec-Labrador

By H. G. Owen

Bell Telephone Co. of Canada

Dialing '110' for operator, a telephone user in the new exchange at Goose Bay, scheduled for service June 1, will signal the operator in Quebec City, 670 airline miles away.

This communications system linking that remote air force station with the national telephone system — and the world — is not being built merely to serve an exchange of 2,000 telephone lines. It's a voice highway erected to help open up the vast resources of northern Quebec and Labrador for development.

A strange phenomenon known as "tropospheric scatter" makes economically possible the provision of scores of telephone channels north to such remote centres as Schefferville (Knob Lake) and Goose Bay.

200-Mile Leaps

Ordinary microwave-radio transmission requires relay points an average of 30 miles apart — in "line of sight" with one another. Tropospheric scatter permits relay stations to be located up to 200 miles apart — "over the horizon" from each other.

At Goose Bay, the new dial office will serve several hundred members of the Royal Canadian Air Force and of the Department of Transport, as well as residents of the neighbouring Labrador community of Happy Valley. These

people, and several thousand members of the United States Air Force stationed there, will now have regular commercial long distance telephone service for the first time.

Because the new exchange is not readily accessible to telephone maintenance men from a larger centre, as would be the case with most offices of its size, the company has had to build permanent living quarters for 20 men, a garage for six vehicles, and a storehouse and workshop — just to maintain Goose Bay's service alone.

Linked To Trans-Canada System

From Quebec City, conversations will travel along a section of the Trans-Canada Telephone System's coast-to-coast microwave network to St. Athanase, Que., then switch over to a new microwave relay link being built by Québec-Téléphone to carry the signals east to Trouble Mountain, 15 miles from Seven Islands — rail gateway to the vast iron-ore mining territory.

At Trouble Mountain is located the first station, operated by Québec-Téléphone, of the tropospheric scatter system. Relay stations have been under construction through the past winter at Canatiche and Emeril on the Quebec North Shore Railway, and at Sona Lake near the famed Grand Falls on the Hamilton River. From Trouble

Mountain to Goose Bay is 460 miles by the tropospheric scatter route.

At Emeril another leg of the system reaches 118 miles north to Schefferville in the Knob Lake mining district. The dial telephone exchange at Schefferville is served by La Compagnie de Téléphone d'Ungava, a subsidiary of the Iron Ore Company. Long distance service is already available to telephone users in Schefferville, but the microwave link will provide additional facilities as required.

Work Force Totals 600

Through the summer of 1957 and winter of 1957-8, as many as 600 men at one time have labored on the tropospheric scatter stations, including the terminals at Goose Bay and Trouble Mountain. They have built roads and airstrips, moved big diesel generators, tons of structural steel for the towering antennas, masses of electronic equipment, and thousands of gallons of fuel oil into the sites, and built temporary and permanent structures for themselves and the intricate apparatus.

In spite of storms which disrupt air freight schedules, temperatures of 40 below, and the long wait for "freeze up" in the fall and "break up" in the spring, the work is on schedule.

At one period, Asiatic 'flu — which might be followed by pneumonia — loomed as a serious threat to men far from hospitals, but fortunately only a few cases occurred.

First In World

The first tropospheric scatter system in the world for actual telephone service was built in Canada by the Bell Telephone Company in 1954 for defence purposes. Research on the principle of "scatter" was carried out by the Bell Telephone Laboratories and other agencies in the United States. The Quebec-Labrador System is capable of providing up to 200 channels of telephone circuits, some of which may be used to provide teletype facilities.

To produce the necessary high power for hops of more than 100 miles, 10,000-watt ultra-high-frequency transmitters are used. One repeater station may require as much power as a small town with a population of 1,000.

To ensure good reception, two receiving antennas are used, and a combined signal obtained from the output of the two. The biggest "dishes" are 60 feet across and weigh 70 tons. The structures are designed to withstand winds up to 120 miles an hour and ice loads three inches thick.

The entire system will require more than 2,000 vacuum tubes — roughly equivalent to 150 television sets, about 50 miles of wire, and more than a quarter of a million soldered connections.

Over The Horizon

Although ultra-high-frequency radio waves have the characteristics of light and travel in straight lines, beyond-the-horizon transmission depends upon the fact that a very small portion of a microwave signal is reflected or scattered at a height of five miles or less in the troposphere — where weather occurs.

Thus, while most of the signal energy travels in a straight line out into space, a tiny fraction is deflected. With a powerful originating signal and huge antennas as much as 60 feet across, this faint signal can be picked up as far as 200 miles away from the originating station. Picked up at a relay station, it is amplified to its original strength and transmitted to the next station in the same manner.

Scattering is believed to be due to a bending effect resulting from the signal passing through masses of air with differing densities and water content.

Although not practical in built-up areas of the country, beyond-the-horizon transmission is particularly suitable in remote regions where construction and maintenance of the more numerous repeater stations needed for ordinary transmission would be exceedingly costly, and where "scattering" will not interfere with other radio systems.



● View of antenna installation in the Quebec-Labrador "tropospheric scatter" radio relay system which will provide commercial long distance telephone service to Goose Bay and the Labrador mining area.

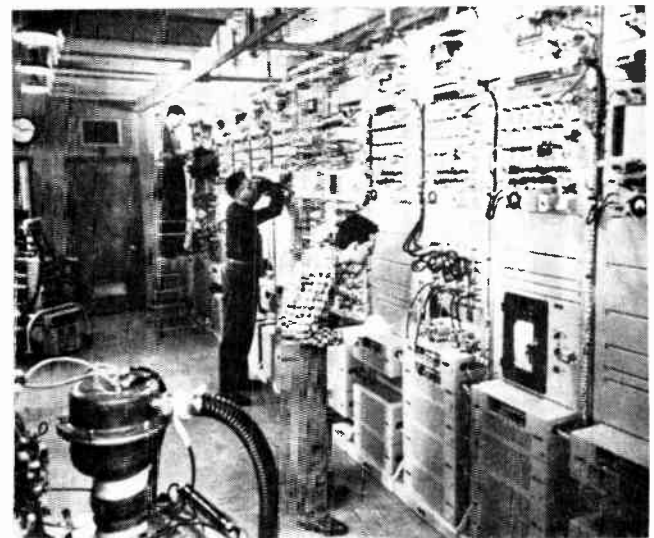

● Interior view of an operating point in the Quebec-Labrador "tropospheric scatter" radio relay system, showing some of the intricate equipment in use.



● A general view of an antenna complex and administration center at Emeril, Labrador, from which one leg of the system reaches east to Goose Bay and another north to Schefferville (Knob Lake), Que.



- By means of the dial the pilot can signal a specific base station, report his identity and location and even control lights at unattended air strips.

The Load On Voice Radio Communications Channels Can Be Reduced By 80 Per Cent By The Use Of

A Secode Dial System For The Aircraft Industry

A dial signalling system for the aviation industry the purpose of which is to eliminate pilot fatigue is being developed by Electrical Communications Incorporated, designers and manufacturers of the Secode decoder. The new system proposed by the designers will utilize techniques similar to those used in their mobile radio selective calling units.

As mentioned the purpose of the system is to eliminate pilot fatigue caused by continuous monitoring of radio during flight because specific planes may be singled out to receive particular communications through simple dial signalling. Also, the Secode system will enable pilots to make routine reports instantaneously, such as plane or flight number or position, by dialing a series of numbers instead of using voice communications. Further, when the dialed or voice information is received at the desired ground station, acknowledgment and transmission of receipt of the message automatically back to the plane may be permitted by the system.

This technique will obviously reduce the load on the presently busy voice radio channels. Since the coded transmissions consist of digital tone pulses, they will

consume less radio band space than voice traffic.

Through the use of this system ground radio station operators may communicate with a specific plane by dialing the flight number or other designating number. When the desired plane intercepts this coded signal, a lamp or other indicator advises the pilot to tune his radio to a specified frequency. It is also possible to provide apparatus that will automatically switch the radio in the aircraft to the desired frequency without any effort on the part of the pilot. Upon receiving the signal, the pilot uses his radio to carry on voice communication with the ground station operator.

The use of the Secode 49HS Decoder as the basic component of the system permits the use of flight numbers instead of a permanently assigned number, since the code to which a decoder will respond can be changed in less than one minute . . . and without tools. While it is possible to use a plane's registration number or Air Force number as the calling code, which requires ground station operators to determine which plane is assigned to a specific flight, it is easy to set the decoder before each flight so that it will respond to the flight number.

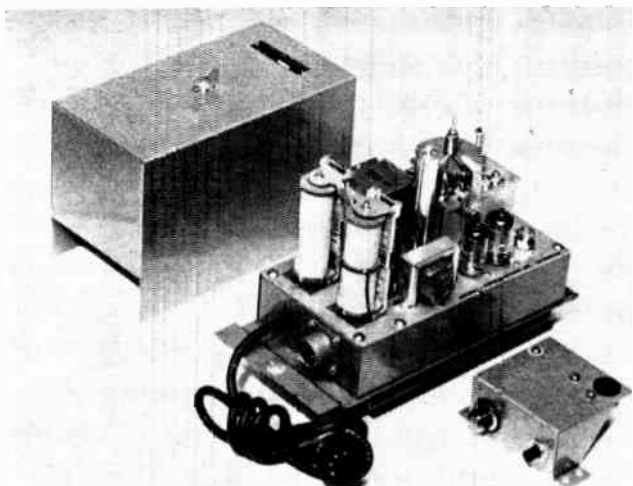

● *Above:* Experimental model of the Secode decoder unit. The new types will be half the size and much lighter in weight.

● *Right:* The Secode 49HS decoder, the heart of the new aviation dialing system, which responds to digital pulses. It may be set to respond to any of over 500,000 dial-coded pulses. The code to which it will respond can be changed in less than one minute without tools of any kind.

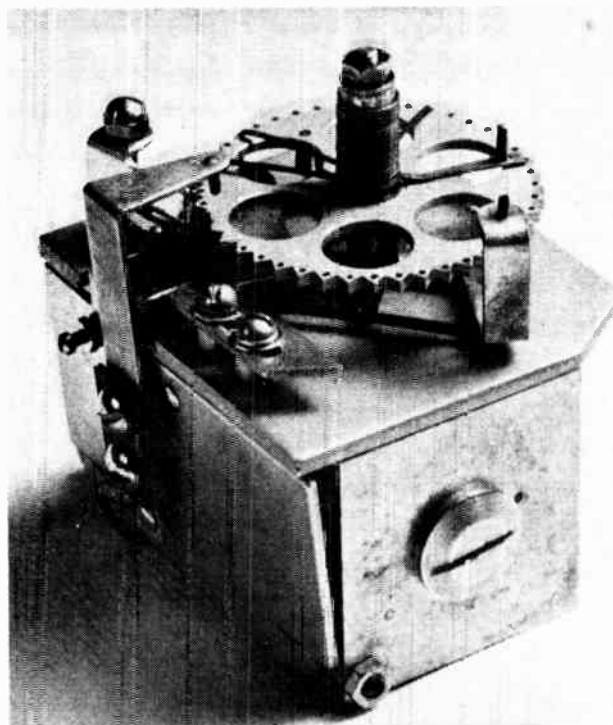

Reduce Complexity

The typical airport control tower and traffic control center is a bee hive of activity and it is sometimes difficult for a pilot to raise a specific station due to the density of radio communications traffic. The use of Secode dial signaling can reduce the complexity of air-to-ground communications. Calls from pilots will actuate signals at ground stations which will advise ground station operators that a plane is trying to make contact. Calls from several planes can be stored and answered by ground stations when time permits. By using automatic recording and acknowledging equipment, the need for a manual response from a ground station can be eliminated in many instances.

Equipment can be installed at unattended landing strips which will permit pilots to dial a specific number to turn on landing lights, another number to turn them off, still another number to open hangar doors, etc.

According to company officials the load on voice radio communications channels can be reduced by 80% by

using dial signaling.

Since the Secode system is compatible with the national dial telephone system, it is possible to integrate aviation communications with the telephone system.

The system proposed by Electrical Communications makes use of tone pulses formed by an ordinary telephone dial. These pulses are intercepted by a radio receiver and fed to a decoder unit which contains a Secode 49HS Decoder. When the number and sequence of the tone pulses match the setting of the decoder, a pair of electrical contacts is closed. The decoder can be set to any of over 100,000 different combinations and the code to which a decoder will respond can be changed in less than one minute without tools.

The decoder unit developed by Electrical Communications is believed to be smaller and lighter than any other airborne decoder yet developed for this purpose, weighing less than six pounds. Early demonstrations of the Secode aviation dial signaling system are being planned.

Measuring Gamma Emitting Radioactivity

A Scintillation Well Counter for high efficiency measurement of gamma emitting liquid or solid radioactive samples is a new instrument that contains a number of features not previously available in radiation detectors of this type. These include: (1) an exclusive "scaler-spectrometer" circuit which permits use of the detector with any scaler, ratemeter, or gamma-ray spectrometer system; (2) more than two inches of lead shielding surrounding the sodium iodide well crystal to reduce cosmic ray and other background to a minimum; (3) a position lock at the side of the lead shield to enable the operator to move the detector to any height; (4) and a unique detector which can be removed from the lead shielding to permit substitution of alpha, beta, or solid gamma sensitive crystals for the

well crystal.

Since radioactive samples may be introduced directly into the well of the crystal, measurement of very weak sources is practical with high statistical counting accuracy. The generous amount of shielding combined with the tremendous sensitivity of the well scintillation crystal permits accurate measurement of gamma sources with activities as low as 10^{-5} microcuries. The overall sensitivity of the instrument is approximately 50%. Background counting rate when used with a scaler or ratemeter is approximately 300 counts-per-minute and is reduced to 20-30 counts-per-minute when used with a gamma-ray spectrometer system. Count rate is independent of sample volume up to 5 milliliters.

business briefs and trends

★ Canadian Admiral Corporation of Port Credit, Ontario, has displayed an optimistic outlook for its operations by investing the sum of \$5 million in new equipment, tools and dies for its 1958 lines of merchandise.

* * *

★ The Canadian Marconi Company has reported a net loss in 1957 of almost \$1½ million, compared with a net loss of less than \$200,000 in the previous year's operations. The net loss was arrived at after writing off forward engineering expenditure totaling \$1,300,000 in addition to making allowance for depreciation and inventory reserves. An amount of approximately \$600,000 for engineering development outlay incurred in 1957 was carried forward into 1958. In making his annual report, Stuart M. Finlayson, president of the company, stated that, based on forward engineering and careful planning for the future, there was reason to expect much improved operating results in 1958.

* * *

★ The Radio and Electrical Engineering Division of the National Research Council of Canada reports experimentation on various projects which include the development of a reading machine for the blind; a photoelectric detector to enable a blind operator to use a standard platform balance; and tests carried out on a 22-ft. diameter polyfoam radome at S- and X-band frequencies.

* * *

★ A conference was recently held in Atlantic City, N.J., to discuss the hazards of microwave radiation as related to public health. An intensive study of the effects of nuclear and electromagnetic radiation on the human body is being conducted for all three branches of the service under the sponsorship of the United States Defense Department. Factual data is expected to emerge in about twelve months' time.

* * *

★ RCA Victor Company, Ltd., reports that radio stations, no longer afraid of the television bugaboo, appear to be riding one of the biggest booms in their history. In every part of Canada radio stations have been improving and enlarging their facilities recently at a rate unmatched in several years. In addition, many entirely new outlets have made their debut on the air, thus proving that TV's older cousin is very much alive and active.

* * *

★ Winnipeg's first commercial closed-circuit television program was screened recently to bring a boxing match before an audience of some 3,000 persons. This marked the first time closed-circuit pay-as-you-see TV had been used in Winnipeg and it was felt that it might be the forerunner to home pay-TV.

* * *

★ In the latter part of April the 1958 Instruments, Electronics and Automation Exhibition was held in London, England, supported by British firms in the instrumentation and electronics field and by a good representation of exhibitors from overseas. Some fifty U.S. manufacturers took space to display their products.

* * *

★ Radio set sales continue to boom in Canada, despite the competition of television. Since 1925 Canadians have spent an estimated one billion dollars on radio receivers for their homes and their cars. At an average of \$77 a set, they will spend another \$57,750,000 in 1958, it is estimated. Manufacturers are turning their attention to ways and means of putting radios not only in every home, but in virtually every room of the home and in all manner of other unexpected places.

* * *

★ A new Central Quebec television station known as CKTM-TV recently began operations from a studio located at Mount Carmel, between Three Rivers and Shawinigan Falls. The new station has a video power of 6,000 watts and an audio power of 3,000 watts. It will provide service for a possible audience of 400,000 through an estimated 56,000 TV sets in the area.

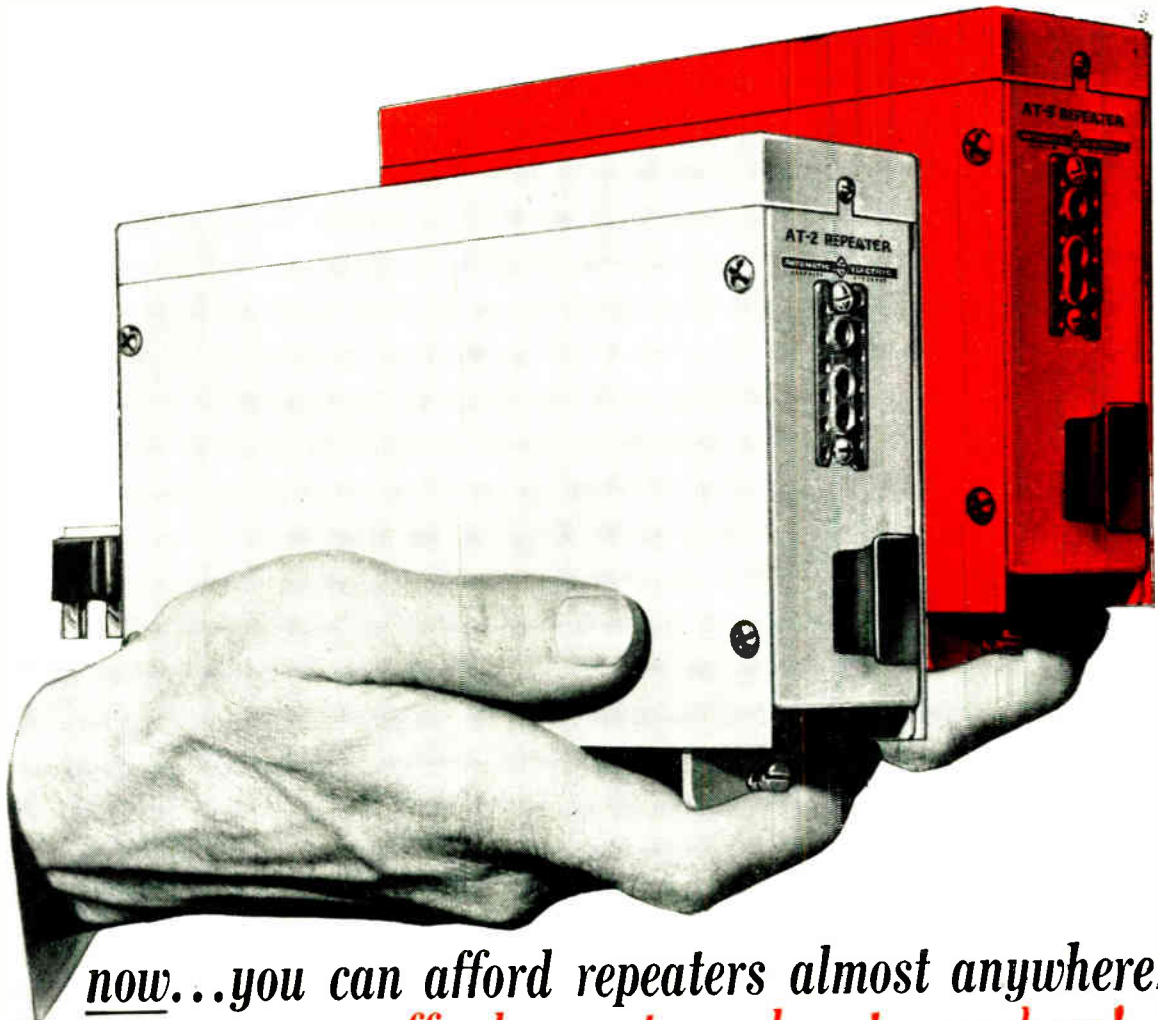

now...you can afford repeaters almost anywhere!
now...you can afford repeaters almost anywhere!

Automatic Electric's new Type AT-2 and AT-3 Voice Frequency Repeaters can improve transmission on many trunks or long lines where the cost of conventional repeaters and other methods are prohibitive. AT Repeaters end the need for costly cable loading — or the use of heavier gauge cable to raise transmission level. Outside plant costs can be reduced on new installations by using smaller gauge cable with these repeaters.

AT-2 and AT-3 Repeaters provide, for the first time, all the benefits of the negative-impedance principle (economic voice frequency amplification on marginal trunks, special service circuits and foreign exchange lines), plus all the space saving, long life advantages of transistorized circuits. Initial cost is low; only 1/10th as much current used as conventional repeaters, and use of transistors instead of tubes practically eliminates maintenance.

Complete data on this fully tested equipment available in Circular 1844-A. Write for your copy today. *Automatic Electric Sales (Canada) Limited, 185 Bartley Drive, Toronto 16, Ontario. Branches in Montreal, Ottawa, Brockville, Hamilton, Winnipeg, Regina, Edmonton, Vancouver.*

5613-R

AUTOMATIC  **ELECTRIC**

ORIGINATORS OF THE DIAL TELEPHONE



now-let

Lenkurt

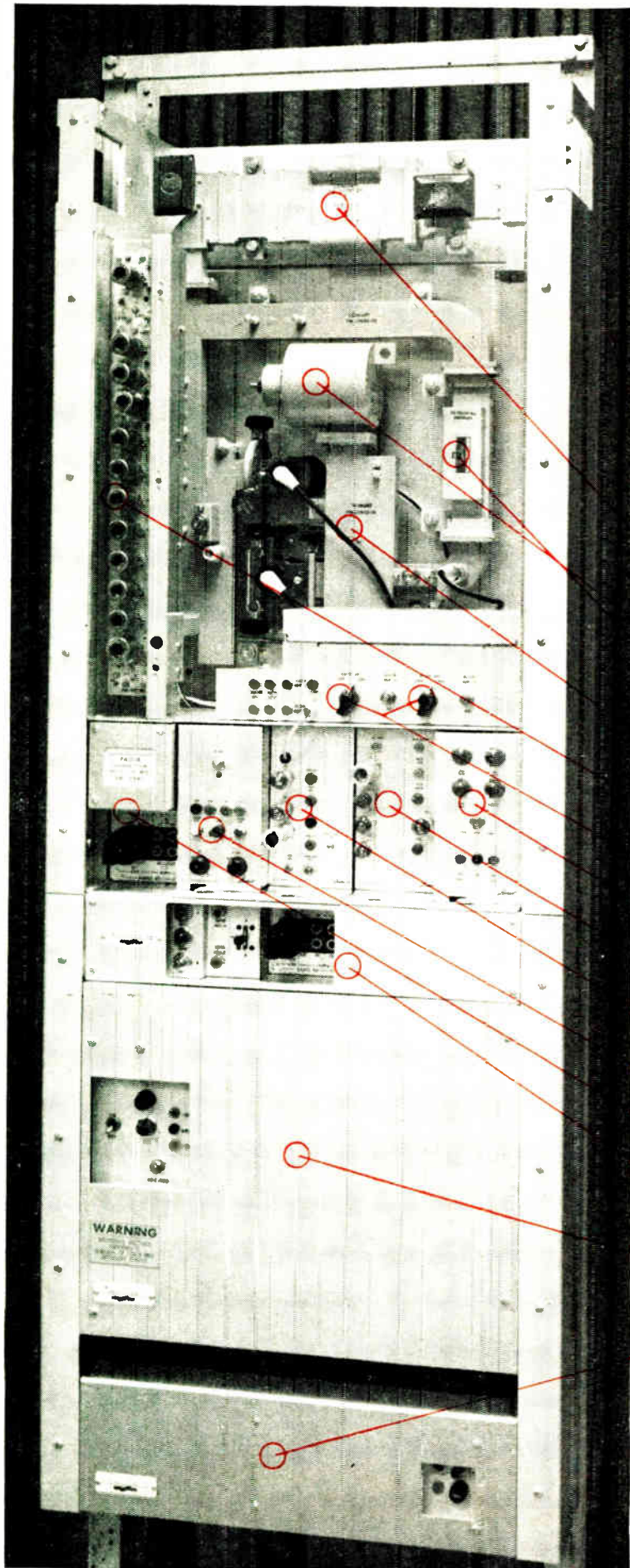

- 1 CIRCULATOR PANEL
- 2 REFERENCE CAVITY
- 3 FERRITE ISOLATOR
- 4 A. F. C. DISCRIMINATOR
- 5 I. F. STRIP
- 6 A. F. C. CONTROLS
- 7 FAULT INDICATING UNIT
- 8 TRANSMITTER BASE-BAND AMPLIFIER
- 9 RECEIVER BASE-BAND AMPLIFIER
- 10 POWER DISTRIBUTION AND ALARM
- 11 BASE-BAND JACK FIELD
- 12 FREQUENCY DIVERSITY COMBINER PANEL
- 13 KLYSTRON POWER SUPPLY
- 14 LOW VOLTAGE POWER SUPPLY

THE BASIC TYPE 74A MICROTEL

Let's take a look inside

microtel

NEW MICROWAVE EQUIPMENT

for the 6000 mc. band

FEATURES YOU CAN'T SEE—

- **POWER OUTPUT**—Transmitting klystron output is 700 milliwatts nominal.
- **POWER CONSUMPTION**—fuel standby terminal 115 volts, 60 cycle only 340 watts.
- **A. F. C. REFERENCE CAVITY** zero temperature coefficient invar metal reference cavity assures a stable transmitter frequency control without the use of ovens.
- **LONG KLYSTRON LIFE** is assured by the use of a heat sink which maintains a relatively low operating klystron temperature.
- **FERRITE ISOLATOR** provides 40 db isolation between the antenna and the transmitting klystron which allows longer waveguide runs.
- **EASE OF MAINTENANCE** is accomplished by using Lenkurt's familiar plug-in type construction.
- **CIRCULATOR PANEL** allows 2 or more 74A terminals to be connected to a common antenna.

For complete information write or call your nearest Automatic Electric office.

AUTOMATIC ELECTRIC SALES (CANADA) LIMITED, 185 Bartley Drive,
Toronto 16, Ontario. Branches in Montreal, Ottawa, Brockville, Hamilton, Winnipeg,
Regina, Edmonton, Vancouver.

AUTOMATIC  **ELECTRIC**

ORIGINATORS OF THE DIAL TELEPHONE



*Extend your areas of operation
quickly, easily, economically
with PHILLIPS
URBAN, SUBURBAN, RURAL
distribution cables*

In cities or in expanding outlying communities, Phillips distribution cable, from Automatic Electric, provides the *fast, economical* way to extend open wire lines and cable plant.

On new construction these cables can be attached directly to the pole. For increasing existing pole line capacity, they can be attached to the underside of a cross-arm or directly to the pole. Long cabling lays permit easy attachment of support wire to the pole. The steel support wire of each cable has a breaking strength of 1800 lbs. and is polyethylene insulated.

The conductors and weather-proof insulation vary with each cable:

URBAN — 16 pair only

Size 24 AWG solid annealed uncoated copper insulated with colour-coded polyvinyl chloride compound.

SUBURBAN — available in 6, 11, 16 pairs

Size 22 AWG annealed uncoated copper insulated with polyethylene, and protected with colour-coded PVC jacket.

RURAL — available up to 18 pairs

Size 19 AWG annealed uncoated copper insulated with high grade polyethylene. A tough, colour-coded polyvinyl chloride (PVC) jacket protects the polyethylene against damage during installation.

In addition to the cables, Automatic Electric can supply a complete range of pole line hardware and associated supplies.

Call your nearest AE representative *today* for complete information.

*Automatic Electric Sales (Canada) Limited, 185
Bartley Drive, Toronto 16, Ontario. Branches in
Montreal, Ottawa, Brockville, Hamilton, Winnipeg,
Regina, Edmonton, Vancouver.*

AUTOMATIC ELECTRIC

SALES (CANADA) LIMITED

5539

For further data on advertised products use page 81.

New Products

New Product specifications published in *Electronics and Communications* have been briefed for your convenience. If you require further information on any of the items published you may readily obtain such by using our Readers' Service, Page 81. Just mark the products you are interested in on the coupon on Page 81 and the information will be in your hands within a few days.

Instrument For Measuring Machinery Speeds

Item 1944

A low cost, reliable stroboscope for the study of rotating, vibrating and reciprocating machinery in slow motion, and the rapid measurement of machinery speeds, is available from Dawe Instruments Limited, of Ottawa. Known as the Strobominor, the instrument is only 5" by 9" high, and weighs only 6½ lbs. It measures machinery speeds up to 50,000 rpm.

Operation is simple. The lamp of the stroboscope illuminates the rotating or vibrating part with very brief flashes of light. The frequency and length of the flashes can be accurately adjusted. When the light flashes create the illusion that the moving part has stopped, the correct number of rpm can be read on the calibrated scale.

Accuracy is normally better than plus or minus 5 per cent, and with careful calibration, can be substantially increased. The scale covers the range 600 to 7200 rpm. Higher speeds — up to 50,000 rpm — are measured by using multiples of the flashing speeds.

For complete information on the Strobominor — and on other Dawe Instruments for measuring rotation, vibration, etc. — write to **Dawe Instruments Limited, 1654 Bank Street, Ottawa, Ontario.**

Klystron Power Unit

Item 1945

The Klystron Power Unit Type 1856 has been designed by Airmec Limited, telecommunication and electronic engineers, of High Wycombe, Bucks., England, to operate low voltage Klystron Oscillators with a high degree of frequency and power stability. The Power Unit will operate Klystrons either singly or in pairs (as signal source and local oscillator). Separate controls are provided to facilitate the operation of two valves simultaneously and completely independently of each other.

It may be used as a general purpose stabilized power supply having a very low output impedance with internal oscillators providing sawtooth and square wave modulation. Provision is also made for pulse modulation to be applied from an external source via an input plug and switch on the front panel.

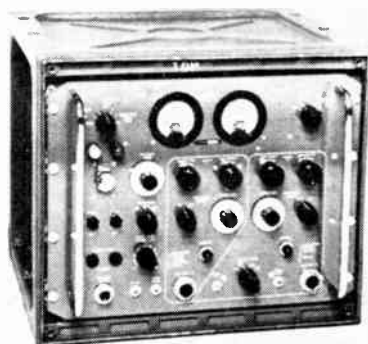

The Power Unit produces a fixed negative going synchronization pulse and a time base voltage variable in amplitude for external use, both of which are derived from the sawtooth oscillator and brought out to separate plugs on the front panel.

This unit conforms to the requirements of Inter Services Specification for tropicalization and climatic durability.

For further information apply to the Canadian agents: **Radio Communications Equipment and Engineering Ltd., 850-5th Ave., Lachine, Montreal 32, Que.**

Parallel Groove Clamps

Item 1946

The A. B. Chance Company of Canada Ltd. is offering a new line of Two- and Three-Bolt Parallel Groove Clamps that covers No. 6 through 477 MCM in just four clamp sizes. Cast of high-strength, heat-treated aluminum alloy, for use on ACSR or all-aluminum conductors, they are designed to withstand high mechanical and electrical stress.

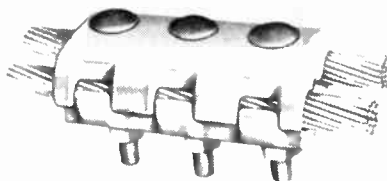

These thick-bodied clamps have the massive construction and high resiliency to stay tight under all load and temperature conditions. Clamp body is contoured to make the bolts self-aligning and self-centering — to apply equal pressure on both main and tap lines. Conductor grooves support and contact all outside conductor strands.

"Bright dipping" and a coating of compound assure low-resistance contact surfaces. Available with either aluminum or steel hardware.

For further particulars, write direct to **A. B. Chance Company of Canada Ltd., 100 Howden Road, Box 10, Toronto 13, Ontario.**

Canadian-Developed Static Control System

Item 1947

A new static control system, designed to aid in the automation of various low power control operations, has been announced by Canadian General Electric Company's Apparatus Department. This static control system is a completely Canadian development carried out in the company's apparatus engineering laboratory at Peterborough, Ontario.

The system makes available to CGE engineers a new automation tool in the form of one basic universal logic element supported by twelve ancillary and amplifier elements for use in designing completely automatic control systems for applications ranging from steel mills to conveyor systems. Functional packaging has been developed which incorporates industrial requirements and allows optimum organization of the system for design, installation and maintenance purposes. Each logic unit contains several logic elements and each unit plugs into its own base to which input and output connections are made with "slip-on" connectors. No wire connections are made to the logic unit itself.

The heart of the universal logic element is a transistor switch designed for ideal digital "ON-OFF" operation. The life of these switches is independent of the number of operations, while the speed is such as to allow operation in excess of 50 kilocycles per second. This gives increased scope for information handling and transmittal in industrial applications. Simple

rules have been developed for the universal transistor switch which allows the use of conventional logic.

The ancillary static units include a permanent memory, a capacitor time-delay, for normal applications, a magnetic time-delay when precision is required, an isolated input unit, transistor pre-amplifier for incorporation into static regulating systems, and an AC amplifier with considerably improved performance. The logic supply voltages are DC and thus no special test equipment is required to check the signal voltages. Functional lighting will be employed which will permit easy sectionalizing of the system for both operational and maintenance purposes.

For further information apply to **Apparatus Department, Canadian General Electric Company Ltd., 214 King St. W., Toronto, Ontario.**

Miniature Push Button Switch

Item 1948

This versatile switch, Type OE, can be supplied with various numbers of keys. Two types of keys are available: (a) Interlocking type where each new key depressed will release the previously depressed key; (b) Self-releasing keys where a second push will release the already depressed key.

Any contact combination up to 6pdt per key can be supplied. A combination of the two key types is available in the same assembly. Various types of standard solder lugs or lugs for printed circuit boards are available. Shielding plate between front and rear contact set can be supplied.

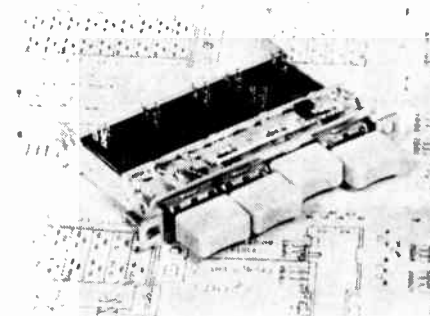

Approximate dimensions are: Mounting depth 1¼", height ¾", length depending upon the number of keys supplied. Width of each key is 1¼" plus ⅜" to give overall body length.

Prices are attractive and detailed specifications can be supplied upon request from **Associated Electronic Components, 37 Rose-lawn Ave., Toronto 12, Canada.**

Slide Rule Type Calculator

Item 1949

A valuable slide rule type calculator, providing complete electrical and mechanical specifications on all standard series Continental Connectors, is now available to engineering personnel who specify these components in their work. The 3" x 8½" wide pocket size makes it a convenient reference tool that can be carried easily.

On the reverse side of the rule is a Body Molding Comparator that provides values of various properties of plastic compounds used in molding Continental Connectors.

For a free copy, write to **Electronic Sales Division, DeJur-Amsco Corporation, 45-01 Northern Boulevard, Long Island City, N.Y.** and indicate your job title and company affiliation.

New Products

Cam Switch

Item 1950

A low cost, miniaturized Cam Switch for counting and control applications has been developed by Tech Laboratories, Inc., Palisades Park, N.J. Designated Type 8A, the cam switch is available in both six and ten-position models for use as a decimal-to-binary converter switch, a control switch or a decade switch.

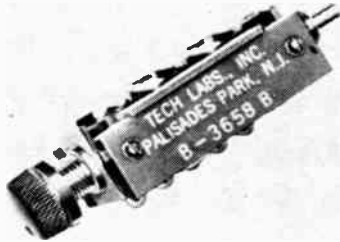

Considered to be the least expensive and smallest switch of its kind, it has been life tested in excess of 40 million breaks with no evidence of failure. Type 8A is rated at one-amp., 110 volts AC, and has a breakdown rating of 1500 volts. Available in single and double-ended designs for clockwise and counter-clockwise operations.

Complete information is available on request from A. Deskin Sales Co., 6875 Fielding Avenue, Montreal, Quebec, sole Canadian representatives.

Electronic Go-No-Go Gage

Item 1951

An electronic "go-no-go" gage for speed and rate control has been developed by Computer-Measurements Corporation, North Hollywood, California, manufacturer of high speed counting, timing, and frequency measuring equipment.

The new instrument monitors any control or limiting situation that can be stated in terms of frequency. In operation, an unknown frequency generated by one of the many types of transducers on the market is applied at the input on the instrument. Upper and lower frequency limits are selected by setting the control knobs on the front panel. Any two frequencies falling between 1 and 40,000 cps can be selected in 1 cycle increments. If the unknown frequency falls below the lower preset limit, a clearly visible red lamp marked "LOW" is lighted. For input frequencies equal to or above the higher preset, another red lamp marked "HIGH" is illuminated. If the unknown frequency is equal to or greater than the lower limit and less than the upper limit, a green lamp marked "IN LIMITS" lights. Relay contact closure for external control is available for each lamp condition. In all cases, the actual input frequency is displayed on decades for visual monitoring.

Many types of production line tests and processing controls are possible with the new instrument known as the Model 620A. For instance, relatively unskilled workers can tune oscillator circuits with great accuracy. As a material flow controller, the device could be used in a steel mill to keep the output in tune with the input preventing line buckle and stretch-out. In the chemical and petroleum processing industries, the instrument can serve as a pressure or liquid flow regulating-indicator system. As a motor speed controller, the instrument keeps the speed within pre-selected limits. Frequency stability and comparison checks can be quickly and easily made.

For further information, specifications, price and delivery, please address Computer-Measurements Corporation, 5528 Vine-land Avenue, North Hollywood, California, U.S.A.

New Miniaturized Relay

Item 1952

A new miniature telephone-type relay which, while weighing only two to three ounces, incorporates the best of the high quality and long life features of its famous Class B Relay predecessor, has been announced by Automatic Electric Sales (Canada) Limited, Toronto, Ontario. From 100-million to 200-million operations can be expected during the service life of this relay.

Known as the Class E Relay, this unit is intended for applications where savings in space and weight are desirable, but quality must not be sacrificed. This relay can be used advantageously in portable electrical circuit analyzers, data processing equipment, and similar applications where savings in weight, space, and floor loading are important.

One of the service-life-lengthening features of this relay is Automatic Electric's exclusive armature bearing assembly which employs a heavy duty stainless steel pin turning in a sintered-metal, lubrication-retaining type of bearing yoke. A unique square-staked bearing pin remains tight in the armature throughout the longer service life. Heavy thickness armature arms, previously available in larger relays only, will not "sag off" in service. Thus, the arms retain their proper stroke, even under heavy loading, or severe operating conditions. Broken and worn out backstops are eliminated by the basic design of the Class E Relay. A portion of the heelpiece has been formed to provide a permanent backstop. A non-magnetic residual backstop-button presents a resting surface for the armature arms in the unoperated position.

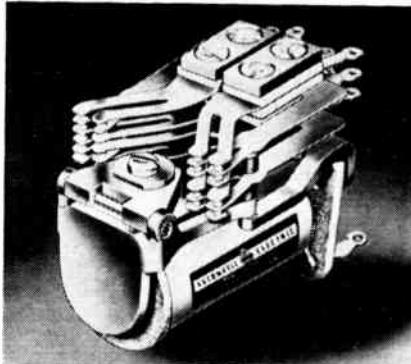

Another feature taken from the Class B Relay is the use of sturdy stock in the heelpiece to insure stability of adjustment. In addition, the extra thickness makes the relay slightly more sensitive — a characteristic which improves contact pressure per given amount of power consumed by the coil.

This relay has been designed for up to 150V DC and 220V AC operating voltages. Dimensions of the unit are: length, 2 1/4"; width, 1 1/8"; and height, varying from 1 1/16" for a unit with a minimum of two springs, to 1 3/32" when 10 springs are employed.

This relay is available in the following series: EQA (quick acting); ESO (slow-operate); ESR (slow-release); ESA (slow-acting (slow-operate and slow-release)); EFA (alternating current); and EMS (snap-action contacts). Various mountings include octal-plug type, eight and 20 pin, and strip mounting with or without dust cover. Relays with dust covers have a maximum of 10 springs per pileup. The relay is also available in a hermetically sealed unit with a maximum of six springs per pileup.

Automatic Electric Sales (Canada) Ltd., 185 Bartley Drive, Toronto 16, Ontario.

Silicon Rectifiers

Item 1953

The Taylor-Leslie Mining & Engineering Corporation Limited of Toronto announces, through its president, Grant A. Taylor, diffused high current silicon rectifiers with the following advantages:

High Power Rating — for power supply applications to 400 amperes at 350 volts

peak inverse. To 5,000 amperes in stacked combinations.

High Efficiency — up to 99 per cent, depending on application.

Excellent Regulation — forward drop of less than 1 volt per cell.

Reliability — operates from -65°C. to 150°C. without derating.

Lowest Reverse Leakage — in micro-amperes at rated peak inverse.

For further particulars contact Taylor-Leslie Mining & Engineering Corporation Limited, P.O. Box 312, Terminal "A", Toronto, Ontario, Canada.

Photodrawings Aid Engineering Visualization

Item 1954

"Photodrawings" is the title of the Kodak publication describing the modern technique of using photographs to convey engineering drawing information in an easy-to-visualize form. The 12-page illustrated booklet has been prepared in answer to the requests of draftsmen, engineers, and industry production men who have expressed great interest in the procedure. Previously such requests were answered by mimeographed information and drawings.

The technique is simple. Photographs are reproduced on a translucent material on which engineering detail and superimposed sketches can be added. From this master photodrawing, work prints can be made by the conventional processes. This results in a saving of time and money over other methods.

The booklet discusses two different methods of preparing photodrawings for use in various areas of industry including assembly, inspection, and engineering. Included are sections on making the picture negative, equipment and materials needed, making the master photodrawing, direct process reproduction, halftone methods, continuous tone methods, composite methods, blueprint reproduction, and lithographic reproduction.

"Photodrawings" (P-22) is available without charge by writing Canadian Kodak Sales Limited, Toronto 9, Ontario.

Plastic Film Capacitors

Item 1955

The low losses, high insulation resistance and high stability of these Jensen Type TTH Miniature Stabilized Plastic Film Capacitors make them suitable for very critical applications such as found in filtering network, and high quality oscillator and amplifier circuitry. No contact failure exists at very low r.f. voltages (below 1 millivolt) and no inherent noise is measurable.

They are available from stock in all standard values and in tolerances to ±2%.

Temperature coefficient of capacity is 150 p.p.m. which makes type TTH suitable for temperature compensation when placed in parallel to oscillator and tuning coils.

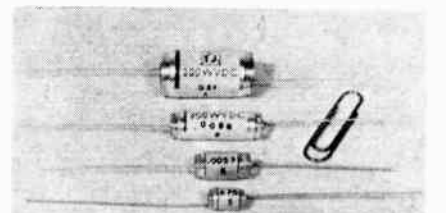

Insulation resistance at a maximum relative humidity of 60% is in excess of 500,000 megohms. Temperature rating for full working voltage is maximum 70°C (158°F). They may be operated at 85°C (185°F) at 50% of the rated working voltage.

Capacitors with a length of .395" will withstand r.f. current of 0.3 Amp. Larger units will withstand 1 Amp r.f. current. AC rating is equal to 50% of DC rating. Available with 100, 200, 400 and 600 volts W. DC.

Detailed technical data available upon request from Associated Electronic Components, 37 Roselawn Ave., Toronto 12, Canada.

New Products

Solderless Connectors And Compression Tooling

Item 1956

An entire new line of solderless HYFEN connectors, and related crimp-type installation tooling, is announced by Burndy Canada Ltd.

The new connector line is designed to speed the wiring of electronic and missile harnesses and add greater dependability by utilizing crimped pins and sockets that snaplock into a plug or receptacle. Elimination of solder provides greater reliability and speeds production time, with the application of the HYFEN principle allowing the design of lighter and more compact equipment.

HYFEN types include a 15 contact, multi-purpose plug and receptacle connector; a feed-through, modular design, multiple insert connector with inserts removable from frame for easy contact insertion or removing; an AN-type; and an MS miniature type. As the HYFEN principle is not limited to either size or number of contacts, variations can be engineered to meet specific requirements.

Also offered is an entirely new line of compression tooling, especially designed for the installation of HYFEN connectors. A new TERMATIC machine that automatically crimps HYFEN pins and sockets to individual wires or complete harnesses will be available. Also a new semi-automatic, pneumatic hand or bench tool that holds complete magazines of pins and sockets for rapid installation; a pneumatic hand tool; and a single-stroke, ratchet-controlled hand tool.

Particulars on these products may be obtained by writing to **Burndy Canada Ltd., 1530 Birchmount Road, Scarborough, Ont.**

Tape-Programmed Circuit Tester

Item 1957

Capable of push-button operation by an unskilled worker, a new, high-speed, high-accuracy circuit tester performs complex tape-controlled measurements on electronic and electrical equipment. Production and maintenance tests, including measurements of impedance, a-c and d-c voltage, resistance, leakage, and continuity, are performed on a go/no-go basis according to the sequence, value, and tolerance information punched into a standard, 1-inch paper or paper-mylar tape.

Designated as the CTI Supertester® Model 180, the new, tape-operated unit embodies principles proved in use by the earlier Model 100B during the past four years. The device can be programmed to energize equipment under test, provide warm-up delay periods, stop when the operator is to perform a manual operation, and can be supplied with an accessory printer to provide a permanent record of rejected tests.

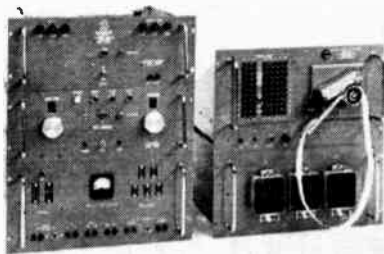

For each measurement, any two test points designated on the tape are selected from 300 test leads by a crossbar Switching Unit. The combinations of test points, sequence, and number of tests are virtually unlimited. Where more than 300 test points are available in the equipment to be tested, additional Switching Units can be added in series. A parallel arrangement allows the selection of four or more test points at a

time, two usually being used for the measurement, and the others available for such operations as controlling relays or providing signal voltages to the unit under test.

Bridges are used to compare the circuit under test to standards selected from four precision decades located within the tester. Accuracies of the bridges are ± 1 per cent for impedance and a-c voltage, $\pm 1/2$ per cent for resistance and d-c voltage. Ranges are: impedance, 10 ohms to 1 megohm; resistance, 10 ohms to 10 megohms; d-c voltage, 1 volt to 1000 volts; a-c voltage, 2.5 volts to 750 volts; continuity, 0.5 ohms with 100-ma test current; leakage, 10 megohms to 500 megohms with 100, 250, or 500 volts d-c applied. By employing special techniques in conjunction with combinations of the basic measurements provided, ranges can be extended and more involved tests made, including frequency, gain, frequency response, current, high voltage, r-f, etc.

The unique Tape Reader, capable of providing up to 80 simultaneous bits of information for each test, is also available separately for other tape-programming or data-handling applications. Supplied as accessories are an electrically-operated Tape Punch and a Tape Duplicator to co-ordinate the Punch with the Reader for automatic copying or rapid editing of tapes.

California Technical Industries division of **Textron Inc., 1446 Old County Road, Belmont, California, U.S.A.**

Flexible Waveguides With Silicone Rubber Jackets

Item 1958

Low and high temperature resistant silicone rubber molded Flexaguide has been made available by Airtron, Inc., Linden, N.J. Designed to operate over a temperature range of -100°F to plus 300°F , higher for short periods, the silicone rubber jacketed Flexaguide assemblies retain complete flexibility, with a minimum bending radius identical to that of neoprene molded flexible waveguides.

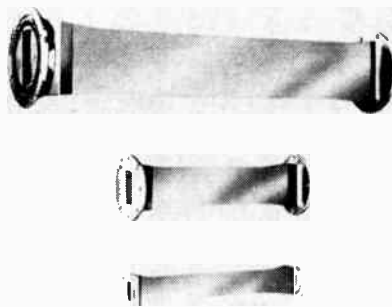

Available in all waveguide sizes from WR-284 to WR-28, the new assemblies may be obtained with standard military type or RETMA type, brass or aluminum flanges in all combinations for both pressurized and non-pressurized applications.

The new low and high temperature assemblies are particularly beneficial for applications in the missile field where extremely high ambient temperatures cause severe environmental operating conditions. The internal surface of these assemblies is silver covered for good electrical performance and the outer surface is suitably protected against corrosion.

For further information on the silicone rubber molded Flexaguide, write to **Airtron, Inc., 1096 West Elizabeth Avenue, Linden, N.J., U.S.A.**

"Firewire" Inspection Equipment

Item 1959

This instrument employs a beta-ray transmission technique for showing that there is no discontinuity in the semi-conductive layer within a co-axial element. It has been developed by Isotope Developments Ltd. in collaboration with the Gravier Manufacturing Company, Limited.

The "firewire" consists of a stainless steel tube 0.080" diameter, with a co-axial centre

wire of Nichrome 0.018" diameter. These are separated by a layer of glass which acts as a semi-conductor.

In the beta-ray inspection technique the "firewire" is held in a jig between a suitable beta source and a probe containing a Geiger Muller tube. The result of the inspection is displayed on a standard rate-meter and recorded on a strip chart.

Isotope Developments Ltd., Benham Grange, Aldermaston Wharf, near Reading, Berkshire, England.

Dead Reckoning Indicator

Item 1960

A Pilot's Dead Reckoning Indicator is available for the first time from Daystrom Limited, 840 Caledonia Rd., Toronto.

The new Dead Reckoning Indicator is a display device intended for use as a short range aircraft navigational aid which may

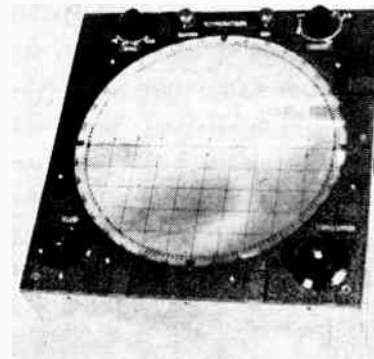

be portable or permanently mounted vertically or horizontally. It features a translucent screen scribed with a grid of coordinates and a compass rose. A lamp holder or "bug" is driven beneath the screen by three servo-motor systems to position the "bug" at any point or locus of points while the third servo-motor system rotates the "bug" through 360°. The location of the "bug", an arrow image, and its alignment relative to the grid represent the possible position of the aircraft and its heading in the area covered by the screen.

Range scales available are 2.5, 5 and 50 miles.

Additional data on this device and other new developments may be obtained upon writing to **Daystrom Limited, 840 Caledonia Rd., Toronto, Ontario, Canada.**

Corrosion Voltmeter

Item 1961

A convenient and simple outfit for field use, to detect and measure existing potentials between a buried structure and the surrounding medium, is announced by R. H. Nichols Limited. Such voltages give rise to corrosion, which is basically an electrochemical action, and corrosion is costly. By measuring the electric potential between the structure and its environment, it is possible to obtain an accurate estimate of the location and extent of corrosive action taking place.

To obtain absolute values of such small potentials, it is necessary to use an instrument that takes no current from the circuit. The Cambridge Corrosion Voltmeter incorporates a potentiometer that, in effect, feeds on EMF to the structure-soil circuit that is equal and opposite to the corrosion voltage. The potentiometer is adjusted until the voltmeter reading is zero, and this "backing-off" voltage is measured, which represents the equivalent of the corrosion voltage. The instrument is self-contained and has two ranges, 0-1.2 and 0-5 volts.

Another valuable aid for cathodic protection measurements and investigations is the Cambridge Corrosion Test Set. It combines a highly sensitive voltmeter and a milliammeter, self-contained in a carrying case for field use. Ranges covered are 0-0.15 to 150 volts in 7 ranges, 0-0.5 to 500 ma in 7 ranges and 0-1.5 to 15 amps in 3 ranges.

R. H. Nichols Limited, 2781 Dufferin St., Toronto, Ontario.

New Products

Transistorized Power Supply

Item 1962

A new dc power supply designed especially for use in transistor circuit development and other low voltage applications is now available from the Hewlett-Packard Company.

The instrument, Model 721A, is a compact, completely transistorized power supply with an output of 0 to 30 volts, continuously variable. Regulation, no load to full load, is 0.3% or 30 mv, whichever is greater. This high regulation insures that the fixed parameters remain stable during tests regardless of line or load variations. This feature, plus the 721A's low ripple voltage (less than 130 microvolts), assures high accuracy of experimental results achieved with the new power supply.

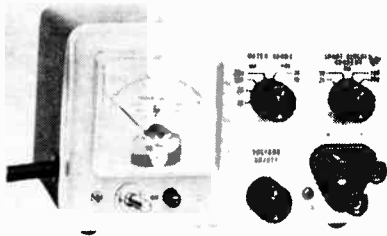

Protective features on Model 721A include a front panel switch which sets the maximum current that can be drawn, even with the output short circuited. This prevents damage to transistors in case of accidental overloads. There are also no damaging surges of high voltage when the 721A is turned on or off.

A three terminal output on the new supply makes it possible to connect the ground to either + or - terminal or to "float" the 721A on top of another voltage, thereby providing maximum versatility. A 2-inch panel meter is arranged to indicate several ranges of either voltage level or current, eliminating the need for auxiliary instruments.

Model 721A, equipped with a floating chassis, weighs only 4 pounds. It is 7 inches wide, 4.3 inches high and 3 inches deep.

Hewlett-Packard Company, 275 Page Mill Road, Palo Alto, California.

Cement Sampler Kit

Item 1963

A cement sampler kit containing 14 different types of special cements has been made available by General Cement Mfg. Co., Rockford, Illinois. It is said that the 14 different cements offer solutions to a wide assortment of surface joining problems in research, development and production.

According to Russell Gawne, vice president and general sales manager, this new cement sampler kit presents the research, development and production engineer with a handy assortment of the most desired cement formulas. Each kit contains 2 oz. bottles of Service, Pli-O-Bond, Acrylic, Plastic, Bakelite, Vinylite, Grille Cloth, Model, Wood, Rubber-to-Metal, Electrical-&Resistor, Neoprene, Label and Vinyl Cements. Each bottle has its own applicator in the lid.

G. C. Cement Sampler Kit No. 345 is available through local electronics distributors.

Further information and a copy of the latest G. C. Electronic Chemical Bulletins may be obtained by writing direct to General Cement Mfg. Co., Adhesive Division (division of Textron Inc.), 400 South Wyman Street, Rockford, Illinois, or their Canadian representatives, Charles W. Pointon Ltd., 6 Alcina Avenue, Toronto 10, Ontario.

Vibristor

Item 1964

A development of Vibration Research Laboratories Inc., of Tuckahoe, N.Y., the Vibristor is an electrical and mechanical equivalent for the conventional vibrator as used in communications applications.

Transistors perform the interrupter function, thereby eliminating all moving parts. In addition to almost unlimited life, DC to DC conversion efficiency is raised to over 85 per cent, resulting in lower battery drain for the same output. Electrical and mechanical noise is non-existent.

Models are available to replace any non-synchronous, synchronous or split-reed vibrator, without wiring or circuit changes, and with ratings up to 120 watts at nominal 6 or 12 volts, 78 watts at 24-28 volts. Models are also available for constant-frequency inverter applications (60 cycles). While standard Vibristors operate at 115 cps., other frequencies up to 100 kc. can be supplied. Conventional vibrator cans (1½" x 3¾") and bases are employed.

For further information write the Canadian representative: Tele-Radio Systems Ltd., 3534 Dundas St. West, Toronto 9, Ontario.

V.H.F. Receiver Pre-Amplifier

Item 1965

Where weak signals are encountered, there are many ways of improving quality with higher towers, lower loss coaxial cable, higher antennas, or higher power at the transmitter. However, doubling signal power can be a very expensive matter at 50 mile range. In these circumstances, Model BP-1, a product of Pylon Electronic Development Company, Ltd. is well worth considering as a means of adding db.s to present signal-to-noise-ratio.

As an example of the improvement to be expected, measurements were taken on a fully serviceable receiver of well known make, which has a stated 20 db quieting point of less than 0.8 microvolts. The best sensitivity that could be achieved without the pre-amplifier was 0.6 microvolts for 20 db quieting. However, with the pre-amplifier, the quieting point dropped to 0.22 microvolts, an improvement of 8 db. Paralleling the pre-amplifier output with a 50 ohm dummy load to represent a second receiver, the quieting point rose only to 0.24 microvolts.

An improvement of at least 3 db in signal-to-noise ratio can be obtained with the most sensitive type of receiver commercially available.

The unit employs an extremely docile and reliable circuit, with one simple tuning adjustment. A quartz trimmer capacitor assures high stability and permits narrow bandwidth. Installation is simple as the unit mounts on a standard relay rack and is operated directly from the AC mains.

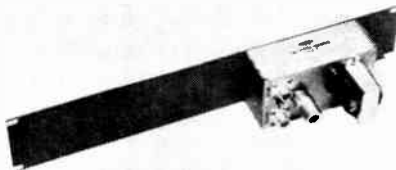

Further particulars are available from Pylon Electronic Development Company, Ltd., 161 Clement St., Ville LaSalle, Montreal 32, Que.

Fan Designed For The Electronics Industry

Item 1966

A special-purpose fan, designed for mounting flange down in the base of electronic racks or cabinets, with full utilization of the "dead space" at the bottom of most standard racks, is being marketed by the Kooltronic Fan Company of Princeton, New Jersey.

The Kooltronic K650S or K800S, so mounted, gives the preferred type of installation with pressurization of the rack for maximum cleanliness, plus minimum intrusion on valuable panel space.

Motor—For commercial application and minimum cost, a precision type shaded pole motor with sleeve bearings can be provided. Generally preferred, however, is a ball bearing, permanently lubricated motor of similar design, carried in stock. Motors are extremely cool-running, manufacturer's tests showing motor temperature rise at 30°C. and 36.5°C. for the 6½" and 8" fans respectively.

Fan Blade — Specially formed, deep pitched, aluminum. Accurately hand-set to track properly, run quietly and without vibration, during final assembly of unit.

Super-Thin Model — Since space limitations are often more critical with regard to unit depth than fan diameter, the K650ST fan can frequently be substituted for 4½" or 5" fans normally specified. The larger fan blade diameter allows a larger motor diameter, with considerable economy over the cost of smaller units which require the expensive miniature types of motor. Overall depth of this unit: just three inches!

The Canadian sales representative is E. E. Whittaker, P.O. Box 3255, Arnprior, Ontario.

Tube Voltmeter

Item 1967

A sensitive electronic voltmeter for the measurement of true R.M.S. values of complex voltage waveforms from 300 microvolts to 300 volts at frequencies between 5 c/s



and 500 Kc/s is announced by Dawe Instruments Ltd. (Canadian Division), Ottawa. Unlike the usual vacuum tube voltmeters, which are average or peak reading instruments calibrated to read R.M.S. values, the Type 612 True R.M.S. Vacuum Tube Voltmeter also measures accurately the effective value of waveforms other than sinusoidal. Accurate R.M.S. readings can be obtained for voltages or currents associated with non linear devices or circuits.

A true R.M.S. Vacuum Tube Voltmeter is essential for the measurement of voltages and currents associated with saturated reactors, rectifier ripple, noise generated in transistors, tubes and resistors, acoustic and vibration tests, and intermodulation and harmonic distortion determinations. With a known load resistor the R.M.S. Vacuum Tube Voltmeter can be used to determine true audio frequency power output for non sinusoidal signals. In addition the wide range and frequency coverage make the instrument particularly suitable for general laboratory measurements at power, audio, and low radio frequencies. An output jack is provided to monitor the signal or to enable the instrument to be used as a high gain amplifier.

Thirteen voltage ranges are provided with full scale deflection of 300 microvolts on the lowest range, and 300 volts on the highest. Accuracy is ±3% from 15 c/s to 150 Kc/s, and ±5% from 5c/s to 500 Kc/s.

Dawe Instruments Ltd., 1654 Bank Street, Ottawa 1, Ontario.

New Products

Subminiature Relays

Item 1968

Associated Electronic Components take pleasure in announcing the availability of new Zettler subminiature relays type AZ210.

These relays are designed for high reliability, high contact rating and long life. Low capacity between contact stacks, from contact to frame and between open contacts, allows switching in high frequency circuits. Pull-in time from 4 to 20 mS depending upon the number of contacts and operating conditions for coil. Release time from 2 to 10 mS.



Standard contact arrangements are 2pdt or 4pdt with coils for operation on 6, 12, 24 and 48 V. DC., are available from stock. Coils for other voltages are available. Contacts are designed for high reliability and a life of up to 10 million operations. Maximum contact rating for non-inductive loads are 250 V. AC. or 100 V. DC., 1 Amp for AC or DC., 150 Watt AC or 50 Watt DC.

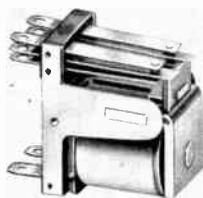

Relay is mounted with one screw only and has a 'snap-on' aluminum dust cover.

Dimensions, (including dust cover): Mounting height 29/32", width 9/16", length 15/16" for 2pdt or 1-3/32" for 4pdt.

Further technical details are available from **Associated Electronic Components**, 37 Roselawn Ave., Toronto 12, Canada.

Transistor Driver And Output Transformers

Item 1969

Microtran Company, Inc. of Valley Stream, N.Y., announces the availability of its line of transistor driver and transistor output transformers in molded construction.

These transformers are designed to meet the requirements of MIL-T-27A Class R and S Grade 2 or 4. Reliable life is 10,000 hour minimum. High temperature epoxy is used in the molding of these units to provide protection against extremes in temperature. Mounting is by means of standard channel ears, threaded studs, or inserts. Terminal pins are arranged for use with dip soldered printed circuitry.

Catalog is available, listing electrical ratings in which these molded units may be obtained, from the Canadian Representative — **Hudson Randall International**, 123 Manville Road, Toronto 13, Ontario.

Calibrating Oscillator

Item 1970

The calibration of oscilloscopes is only one of the numerous laboratory uses for which the compact (5" x 4" x 3½"), light (2 lbs.) and inexpensive dry cell operated, transistorized new Danbridge Calibrating Oscillator Type CO1 has been designed.

It supplies output frequencies of 1 kilocycle and of 10 kilocycles $\pm 2\%$ in no load condition with a maximum direct output of 10 volts to 5 kilohms. Both square wave and sine wave output is available with output voltages of 1-3-10-30-100-300 millivolts-1-3 volts $\pm 2\%$ with the former and 1-3-10-30-100-300 millivolts-1-3-10 volts rms $\pm 5\%$ with the latter. Wire wound resistors are used for the attenuator which has a good stability and an accuracy of $\pm 1\%$.

The square wave output is limited by a zener diode which supplies a known amplitude for calibrating purposes. The sine wave output may be adjusted by comparison with the square wave and separate

check positions of the attenuator switch are provided for this purpose. The output is set separately on each frequency by two potentiometers. The output voltage can be varied by the calibrated step attenuator, and facilities are provided for using the attenuator separately. The tuned circuit not in use is isolated from the oscillator circuit and connected to two of the terminals so that it may be used as a filter in external circuits.

A low output power transistor is employed in the oscillator. A Hartley circuit is used with ferrite core coils and polystyrene capacitors as tuning elements. Adjustable trimming cores in the inductors allow exact adjustment of frequency at any time, if necessary.

The instrument is supplied with four dry cells "Penlight" as power supply, but mercury batteries Mallory RM-522 may be substituted.

For more particulars write to **The J. W. Ellis Industries**, 42 Lombard Street, Toronto, Ontario, Canada.

Measurements UP TO 1000 Mc/s

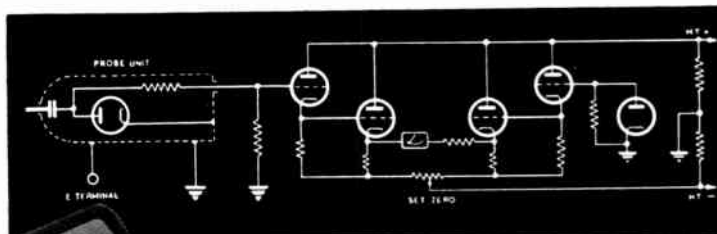

with Marconi Vacuum Tube Voltmeter TF 1041A

Accuracy

- $\pm 2\%$ of full scale ± 0.01 volt
- $\pm 3\%$ of full scale for inputs greater than 100 volts

Marconi's new vacuum tube voltmeter gives you these added advantages:

- frequency response flat from 20 c/s to 1000 Mc/s
- 6 ranges for a.c. voltages — 0 to 300 volts
- 7 ranges for d.c. voltages 0 — 1000 volts
- 7 ranges for resistance between 0.2 ohm and 500 megohms

Marconi Voltmeter TF 1041A has a large mirror scale meter for fast and precise reading. A specially designed probe makes point contact with the a.c. circuit under test. For d.c. potentials there are a movement-reversing switch and a three-lead rubber moulding fitted with either prods or alligator clips.

Marconi



CANADIAN MARCONI COMPANY

MONTREAL 16, QUE.

Canada's
Largest
Electronic
Specialists

News Report

A monthly roundup of news and personnel changes in the Canadian electronics industry

New Agency Agreements Announced By CDC

Selection of new agency lines to enable CDC to offer a complete range of equipment for data acquisition, data conversion, data transmission, data reduction, and data processing, has resulted in the signing of exclusive sales agreements for Canada with five foreign firms in the past six months, it was recently announced by W. S. Kendall, Marketing Director of Computing Devices of Canada Limited.

The new agency agreements are with Epsco Incorporated, Traid Corporation, Flight Research Incorporated, Reeves Instrument Corporation, and O.M.I. Corporation of America.

Most recent of new CDC agencies are Ottico Meccanica Italiana, of Rome, Italy, and the O.M.I. Corporation of America, suppliers of what is claimed to be the widest assortment of photogrammetric instruments made by a single manufacturer. High quality photomappers, photostereographs, and stereocomparators are the most important instruments in the line.

Dayrand Ltd. Represents Two Electronics Firms

D. S. Wilson, President of Dayrand Limited of Montreal, P.Q. announces the appointment of the company as

representative for two electronics firms: C. R. Snelgrove Co. Limited, manufacturer of quartz crystals, frequency standards and crystal ovens; and Dielectric Products Engineering Company Inc. of Raymond, Maine, manufacturer of transmission line, antennas, diplexers and dehydrators. Dayrand will represent C. R. Snelgrove in the province of Quebec, and will handle Dielectric Products for Canada and part of the northeastern United States.

Mr. Wilson, formerly with RCA Victor Company, Ltd. as Manager of Mobile Communications and as Government Contracts Administrator, states that Dayrand Limited was formed in 1957 for the purpose of providing specialized technical representation for a small number of Canadian and American electronics manufacturers. The head office of the company is at 901 Victoria Square, Montreal.

Newly Graded Technicians Hold First Meeting

The first meeting of engineering technicians and technologists was held at the Queen Elizabeth Building, Canadian National Exhibition grounds, Toronto, on May 12.

Some 200 members attended the dinner meeting which was addressed by J. Herbert Smith, P.Eng., president of Canadian General Electric Company Ltd.

Elcom Marketing Assists Parts Distributors

The formation of Elcom Marketing Limited has recently been announced in Toronto, Ontario. This firm has been formed to provide an experienced service to manufacturers of electronic components designed for industrial applications. A concentrated effort will be made to assist electronic parts distributors interested in this growing market.

As marketing manager, "Elcom" has appointed E. E. "Ted" Thompson who has previously held senior positions with Automatic Radio Co. of Canada Ltd., Hallicrafters Canada Limited, and Philips Industries Ltd.

Elcom Marketing Limited has leased office space at 767 Warden Avenue, Scarborough, with telephone OXFord 8-3691.

Industrial Sales Rep For CESCO

M. I. Rosenthal, president of Canadian Electrical Supply Co. Ltd. of Montreal, announces the addition of Danny Fitzmorris as industrial sales representative for the company's Industrial Division.

Mr. Fitzmorris has been associated with the electronics industry for the past fourteen years. He is well known to the industry, having previously been connected with the Century Electric Company and Canadian Marconi Company.

AUTOMATIC ELECTRIC SALES STAFF CHANGES



R. B. IRWIN



R. W. ROBB

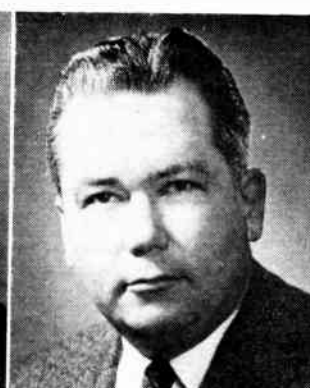

G. S. BALLANTYNE



M. M. GOODWIN

● Automatic Electric Sales (Canada) Limited, Toronto, announce the following staff changes to augment their sales operations in Western Canada. Shown above (left to right) are: Robert B. Irwin, B.Sc., who has been transferred from the Engineering Department at Brockville to become Staff Assistant to the Telephone Sales Manager at Toronto; Robert W. Robb, District Manager at Winnipeg, who has moved to Edmonton, and continues in his present position in charge of all sales operations in the Western District, covering Alberta, Saskatchewan, Manitoba and Head of the Lakes; Gordon S. Ballantyne, B.Sc., Sales Engineer at Edmonton, who has been appointed Carrier and Radio Sales Engineer for the Western District, remaining at Edmonton; Malcolm M. Goodwin, Staff Assistant to the Telephone Sales Manager at Toronto, who has been transferred to Winnipeg as Sales Representative in charge of that office.

News Report

Astronautical Society Sets Ambitious Program

The Canadian Astronautical Society held its second general meeting in Toronto on April 23 at the main plant of the de Havilland Aircraft of Canada, with over one hundred members attending.

In his presidential address, Dr. P. A. Lapp reviewed the rapid progress made by the Society since its inception last year, and indicated that the experimental and theoretical activities were proceeding well in the several specialist sections.

The president's address was followed by a short talk by A. B. Barnes, Propulsion Group Leader, who described the recent static rocket firings and illustrated these by means of a color movie taken at the time.

Guest speaker was Professor Patterson of the Institute of Aerophysics, University of Toronto, who delivered an illustrated lecture concerning the physics of the atmosphere and high-speed, low density phenomena.

The Society is guided by fourteen

objectives, the comprehensiveness of which may be judged by the first objective which reads: to investigate and promote the advancement of all branches of scientific study comprising the field of astronautics, including such areas as: (a) Propulsion and Space Travel; (b) Flight Dynamics and Structural Design; (c) Instrumentation and Automatic Control; (d) Communications and Telemetry; (e) Navigation and Geodetics; (f) Astronomy and Astrophysics; (g) Space Medicine and Psychology; (h) Space Law.

Enquiries regarding the constitution and activities of The Canadian Astronautical Society may be addressed to the secretary, A. E. Maine, c/o The de Havilland Aircraft of Canada, Guided Missile Division, Downsview, Ontario.

Retirement Of Arrow-Hart Sales Manager

W. E. (Bill) Lemon, for the past fourteen years sales manager of Arrow-Hart & Hegeman (Canada) Limited, retired recently after more than twenty years of service in the company's sales force. Mr. Lemon was well known in the electrical industry.

CANADA WIRE OPENS SIMCOE PLANT

The Hon. Leslie M. Frost, Prime Minister of Ontario, officially opened Canada Wire and Cable Company's new magnet wire division plant at Simcoe, Ontario on Thursday, May 8.

This automatically-operated factory for producing all sizes of enamelled and textile-covered magnet wire is located on 13½ acres of ground and is centrally-located to supply by road or rail the principal markets of magnet wires in Toronto, Hamilton and St. Catharines as well as throughout Canada.

In the opening address of the ceremony, O. W. Titus, president of Canada Wire, stated that the company believes in decentralization and operating wherever possible in units not exceeding 200. "We now stand equipped," said Mr. Titus, "to supply practically all kinds of basic requirements for the electrical needs of Canada, namely wires and cables from the finest hairline enamelled wires to the highest voltage insulated cables in the world."



● Photographed at the official opening of the Canada Wire & Cable Company's new Simcoe plant are, left to right: Leonard G. Lumbers, vice-president, O. W. Titus, president, and The Hon. Leslie M. Frost, who officially opened the new plant. The new facilities contain some of the most modern, automatically-controlled wire-extruding equipment on the North American continent and will be used for the manufacture of all sizes of enamelled and textile-covered magnet wire.

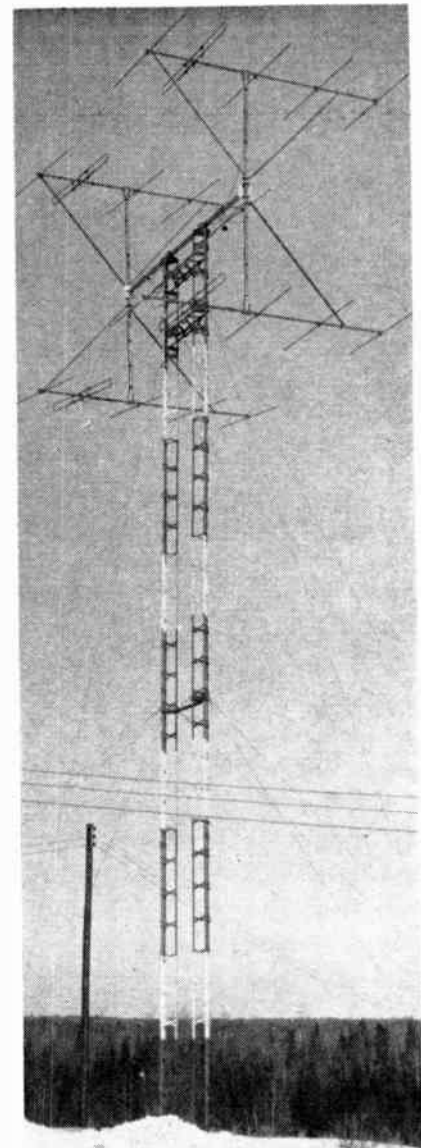

JANET SYSTEM
ANTENNA

ANTENNAS AND DUPLEXERS

FOR RADIO TELEPHONE
TROPOSPHERIC AND
METEOR SCATTER
AIRCRAFT RADIO
RADAR

OUR PRODUCTS ARE
DESIGNED AND MADE
IN CANADA

**SINCLAIR RADIO
LABORATORIES LIMITED**
70 SHEFFIELD STREET
TORONTO 15, CANADA

**CRAMPED
FOR SPACE?**

**Component Density
221,000 per cubic foot
in Centralab®**



vs. 55,000 per cu. ft.
with conventional
components

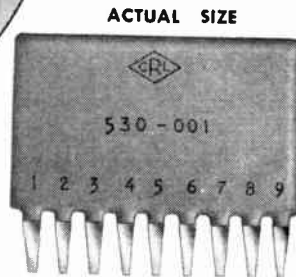
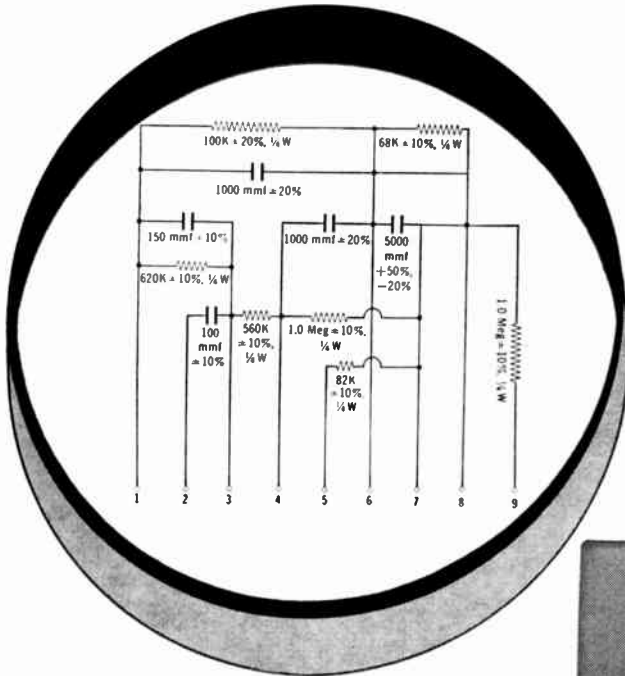

This complex circuit is produced in its entirety in the unit shown here actual size. This almost unbelievable component density is achieved routinely by Centralab. The same basic component/cu. ft. ratio can be maintained where larger or smaller numbers of resistors and capacitors are involved. Centralab **PEC** circuits are your most sensible way to achieve ultra-miniaturization with superior reliability. You gain many other advantages by using **PEC** circuits in your equipment design.

- Reduces assembly costs and weight
- Eliminates wiring errors and testing
- Simplifies inventory and purchasing procedures
- Frequently costs less than individual components

A **PEC** circuit can be designed to incorporate capacitors (printed or attached), resistors (fixed or variable) plus inductors, sockets and other components. They are supplied with plug-in terminals for printed wiring or wire leads for metal chassis.

For the best solution to your miniaturization and assembly problems, contact Centralab's packaged circuit engineers now . . . or write for Bulletin 42-227 containing detailed design information.

Y-5831

Centralab Canada Ltd. 804 MT. PLEASANT ROAD TORONTO 12, ONTARIO
 Affiliated: CENTRALAB • MILWAUKEE 1, WISCONSIN
 VARIABLE RESISTORS • SWITCHES • PACKAGED ELECTRONIC CIRCUITS
 CERAMIC CAPACITORS • ENGINEERED CERAMICS • SEMI-CONDUCTOR PRODUCTS

News Report

**CEWA Annual Convention
Elects 1958-59 Executive**

In addressing the 3rd Annual National Meeting of the Canadian Electronic Wholesalers Association held at the Sheraton Brock Hotel, Niagara Falls, Ontario, on May 15th last Joseph A. DeMambro, president of the National Electronic Distributors Association of the United States pointed out the many benefits that may be derived from trade associations and emphasized some of the guide posts that trade associations should follow if they were best to serve the interests of their members.

"A well defined trade association," Mr. DeMambro said, "should provide and be designed to: protect you from monopoly; help fight your battles with government; tell you about better business methods, such as cost accounting procedure and the like; furnish you with accurate statistics to gage your growth or decline; provide you with better tools for merchandising your products; inform you of better manufacturing and distributing techniques and teach you something of fair and unfair methods of competition as defined by our statutes and court decisions."



J. A. DeMambro

Executive officers elected to the Canadian Electronic Wholesalers Association for the year 1958-59 were: Leo Rosenberg, president; O. L. Bell, vice president; and directors, L. M. Poole, the retiring president, M. I. Rosenthal, Ted Sacker and John Dunn.

Prior to the National Convention the Western Division of the Association held their annual meeting at the Royal Alexandra Hotel, Winnipeg at which the following were elected to the executive of the Western Division: John Dunn, chairman; Leo Rosenberg, vice chairman; with directors Ted Sacker, A. D. Burneski, W. Cowley and A. Clark.

John T. Rochford of Toronto, was appointed secretary treasurer of the Western Division.

For further data on advertised products use page 81.

THE NATIONAL SCENE

TEN-TO-ONE THE Copper Clad Laminate YOU WANT IS HERE!

From these ten basic PHENOLITE® Grades, you can select the base material, resin, properties and price to fit your present printed circuit need.

If your problem is finding a suitable cold-punch material, try samples of XXXP-470-1. It's designed for use in automated production equipment. If you are looking for higher heat resistance, check Grades G-10 and G-11.

Out of National's research laboratories come new advances every day. See your National Representative about new products and applications. He can keep you posted on the full line of PHENOLITE Laminated Plastic, Vulcanized Fibre and National Nylon for electronic applications across-the-board. In the meantime, write for our new "PHENOLITE Copper Clad Data" folder. Address Dept. O-5.

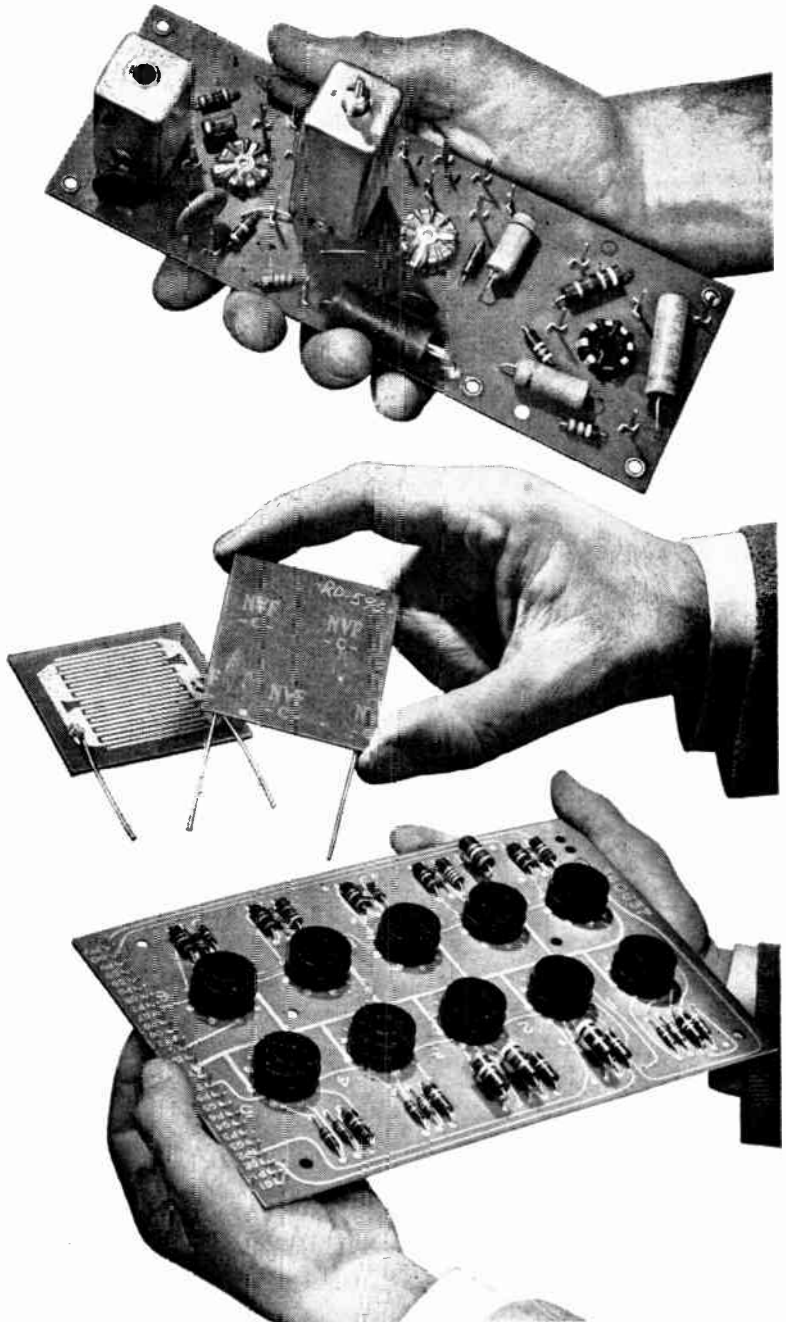

NATIONAL

FIBRE COMPANY OF CANADA, LTD.

Atlantic & Hanna Aves., Toronto • 1411 Crescent St., Montreal

SEE THESE PRODUCTS ON DISPLAY AT
THE I.R.E. SHOW, BOOTH 4419-21.

TYPICAL TEST VALUES ON COPPER CLAD PHENOLITE

GRADE	PROPERTIES OF BASE MATERIAL					COPPER CLAD PROPERTIES				RELATIVE COST Based on XXXP on Arbitrary Scale of 1
	Dielectric Constant	Dissipation Factor	Moisture Absorption	Flexural Strength	Maximum Operating Temperature	Copper Bond Strength		Hnt Sold.r Resistance	Surface Resistance	
						Pounds to Pull 1" Strip				
						10 ⁶ Cycles	10 ⁶ Cycles	1/16", % 24 Hrs	Psi	
P-214-B-1	5.3	.040	2.20	18,000	250	8	11	> 10 @ 475°F	100,000	.81
XXP-209-G-1	4.6	.037	1.30	17,000	250	8	11	> 10 @ 475°F	200,000	.92
XXP-239-1 PHENOCLAD	4.2	.035	0.67	15,500	250	8	11	> 10 @ 475°F	200,000	.92
XXXP-219-C-1	4.5	.030	0.70	15,500	250	8	11	> 10 @ 475°F	500,000-1,000,000	1.00
XXXP-455-1	4.0	.026	0.55	23,500	250	8	11	> 10 @ 475°F	1,000,000-1,500,000	1.00
XXXP-470-1	3.7	.027	0.48	14,000	250	8	11	> 10 @ 475°F	300,000-500,000	1.00
N-1-852-1	3.3	.030	0.20	16,000	165	8	11	> 10 @ 450°F	2,000,000	2.69
G-5-813-1	6.8	.018	1.00	55,000	300	8	11	—	—	2.98
G-10-865-1	5.2	.012	0.13	60,000	250	10	15	> 30 @ 500°F	1,500,000-2,000,000	3.49
G-11-861-1	4.9	.015	0.17	60,000	300	10	15	> 30 @ 500°F	2,000,000	3.55

QUARTZ CRYSTALS

MAY LOOK ALIKE AND

INITIALLY

TEST ALIKE

BUT* - -

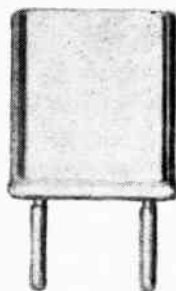

THAT'S WHERE SIMILARITY ENDS

Unfortunately, the purchaser buys a finished product in which the important components are hermetically sealed from view.

The only tangible guarantee of quality and performance is the reputation of the crystal manufacturer.

Reputation rather than high pressure selling has made SNELGROVE a purchaser's guide when ordering crystals and crystal ovens. The C. R. SNELGROVE CO. LIMITED has successfully expanded their business because their quality products are the direct results of careful development, sound design and engineering and precision manufacturing in Canada's largest plant devoted solely to the manufacture of quartz crystals.

*Canada's largest crystal users make it perfectly clear — crystals from SNELGROVE.

Snelgrove—Canada's Frequency Control Specialist. Licensed under Bell System Patents.

C. R. SNELGROVE CO. LIMITED

DON MILLS (TORONTO), ONT.

HI. 4-1107-8

News Report

Muirhead & Co. Wins Official Design Approval

Muirhead & Co. Limited, of Beckenham, Kent, England, have been design approved by the Ministry of Supply for the whole range of the following classes of equipment: synchros, resolvers, linear variometers (linvars), servo motors, tacho generators, servo motor-tacho generators.

It should further be noted that the company is also design approved for synchro test equipment as well as the elements themselves.

Muirhead & Co. Limited is represented in Canada by Muirhead Instruments Limited of Stratford, Ontario.

New CESCO Appointment

Canadian Electrical Supply Co. Ltd., of Montreal, P.Q., through its president, M. I. Rosenthal, announces the addition of Roy Hawker to the company's staff as purchasing agent for the Toronto branch.

Mr. Hawker has been in the electronics jobbing industry as purchasing agent and industrial sales manager over the past several years, and has a total of 27 years in the radio business.

Electro Sonic Supply Expands Premises

Electro Sonic Supply Co. Ltd. have announced a new expansion to their present buildings at 543 Yonge St., Toronto. Approximately 110% more space will be added to facilitate greater and easier handling of both wholesale and retail facets of their business.

Electro Sonic have purchased the buildings next to their present quarters for this expansion and construction will begin almost immediately.

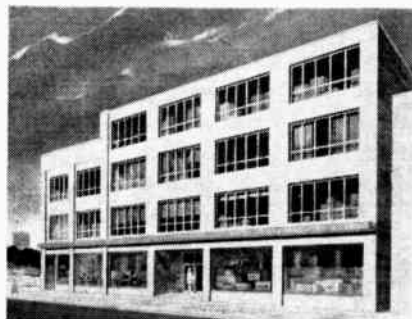

It is the hope of Electro Sonic that, with this extra addition, a greater diversification of products will now be handled to serve all industries using electrical and electronic components. Shipping facilities will be improved to uphold their present motto of same day delivery as orders are taken.

greater **VERSATILITY...RELIABILITY...COMPACTNESS**

MODEL 450-1100 CARRIER PREAMPLIFIER

Carrier Freq. — 2400 cps (std.); 600, 1200, 4800 cps optional
 Carrier Exc. — approx. 4.5-5 volts, depending on transducer imped.
 Transducer Imped. — 100 ohms min. - 1000 ohms max.
 Input Imped. — approx. 2500 ohms, incl. zero sup. ckt.
 Sensitivity — 100 uv rms from transducer (output imped. 1000 ohms or less) gives 1 volt at output under max. output loading
 Output — preferred circuit: between one active cathode and one reference cathode
 alternate circuit: between active cathode and ground
 Output Voltage Capabilities — (a) ± 3 volts into 2200 ohms min. load
 (b) ± 6 volts into 5000 ohms load
 (c) ± 7.5 volts open ckt
 Output Linearity — better than 0.2% for (a) above
 Output Impedance — approx. 1000 ohms, preferred ckt., 500 ohms alternate output ckt.
 Freq. Response — 3 db at 20% of carrier freq.
 Zero Suppression — can suppress 0 to 100% of transducer output (either sense via switch)
 Power Req. — 115 volts, 50-400 cps, approx. 30 watts
 All data subject to change without notice.

SANBORN 450 SERIES UNIT PREAMPLIFIERS

... FOR DRIVING OPTICAL OSCILLOGRAPHS

... TAPE RECORDERS

... 'SCOPES

Here is amplifier design that gives you *wider* usefulness, *improved* performance and a *choice* of packaging, in reduced size and weight. Individually in portable cases, or as four-unit modules for standard 19" racks, with their own power supplies, Sanborn "450" Preamplifiers can be used with a variety of popular optical oscillographs, tape recorders, oscilloscopes or other indicating devices. The 450-1100 is a carrier amplifier-demodulator with calibrated zero suppression, for measuring strain, pressure, velocity, flow, temperature, displacement, etc. with a strain gage bridge, resistance or reactance transducer, or differential transformer. For differential input measurements, the 450-1800 provides the wide range of an AC amplifier and DC stability of a chopper, in a design featuring low noise, low drift and high gain. The 1800's usefulness is increased by a choice of models: 1800, with high current output amplifier (± 2.5 v, ± 50 ma), position control, and zero suppression; 1800A, same as 1800 but without zero suppression; 1800S, with single-ended output amplifier, delivers ± 2.5 volts at ± 1 ma, linearity 0.1% full scale, 30 kc bandwidth, zero suppression and position controls; 1800SA, same as 1800S except without zero suppression.

Investigate the many exclusive advantages these and other Sanborn "450" Preamplifiers offer your work. Call your local Sanborn Engineering Representative or write the Industrial Division in Waltham.

SANBORN COMPANY

Industrial Division

175 Wyman Street, Waltham 54, Mass.

Canadian Representative: R-O-R ASSOCIATES, 1470 Don Mills Road, Don Mills, Ontario

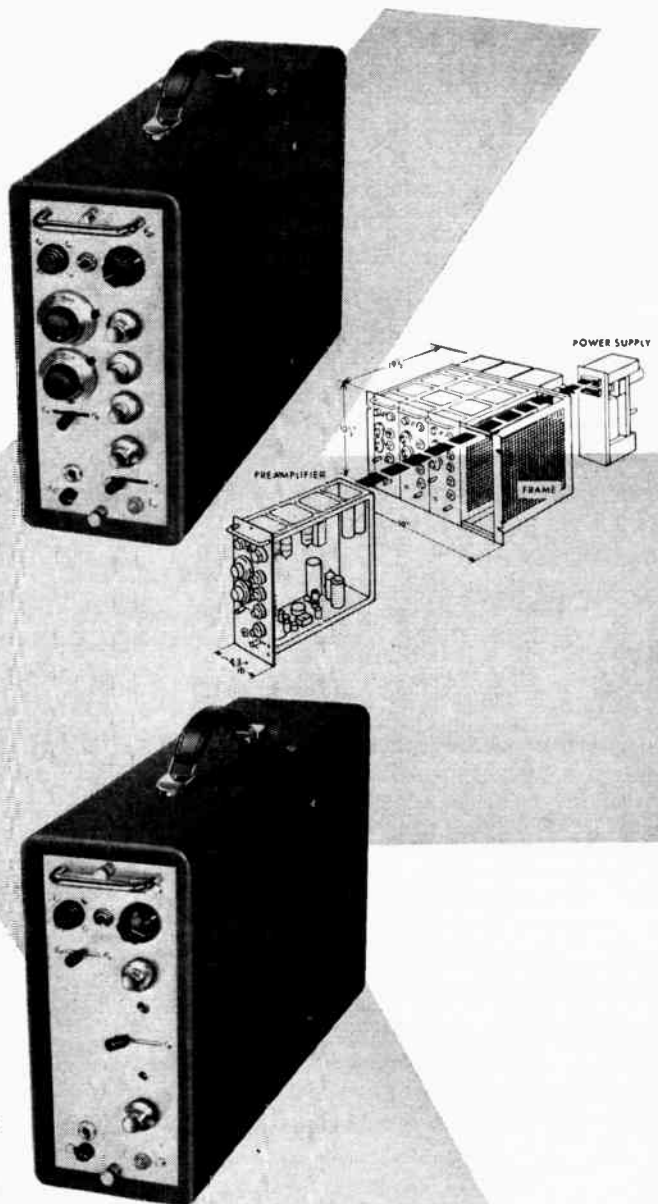

MODEL 450-1800 TRUE DIFFERENTIAL DC PREAMPLIFIER

Input — Impedance: 200,000 ohms differentially between terminals (balanced) or 100,000 ohms each input lead to gnd. (single-ended)
 Common mode rejection: at DC, 100 db; to 60 cps, 94 db;
 400 cps, 80 db.
 Equiv. input drift: ± 2 uv for 24 hours
 Equiv. input noise: 5 uv peak to peak (0-10 cps), 20 uv (0-1000 cps),
 50 uv (0-30 kc)
 Zero suppression: polarity, pos. or neg. Ranges 0-100 mv and 0-1 volt.
 Accuracy 1% of full scale range.

Output — Low Power Circuit: (in all models)
 Output appears between two cathodes as true push pull signal.
 Common mode level of cathodes ± 0.2 volts with respect to ground.
 Output capability: ± 3 volts into 5000 ohms
 ± 10 volts open circuit
 Zero position control not active for this output
 Freq. response: 3 db down at 30 kc
 Linearity: 0.1%
 Gain: Fixed steps 1000, 500, 200, 100, 50, 20
 Gain Accuracy 0.5% for D.C.
 Smooth gain control covers range between fixed steps
 High Power Circuit: (1800 and 1800A)
 Output appears between two emitters as true push pull signal.
 Common mode level of emitters ± 2.5 volts with respect to ground.
 Preferred load: 50 ohms
 Output: ± 2.5 volts, ± 50 ma
 Freq. response: 3 db down at 15 kc
 Linearity: 0.5%
 Zero position control is operative for high power output ckt.
 Single-ended Output Circuit: (1800S & 1800SA)
 Output appears as single-ended signal between emitter and amplifier chassis.
 Load 2200 ohms, min.
 Output ± 2.5 volts
 Freq. response: 3 db down at 30 kc
 Linearity: 0.1%

Power Req. — 115 volts, 60 cps, approx. 50 watts

NOTHING BUT THE BEST!

Marsland Servo System Components are expertly engineered with the best of materials: silicon diodes, tantalum capacitors, nylon and teflon insulations. Manufactured in Canada. Second to none in their precision manufacture, dependability, and enduring Marsland quality.

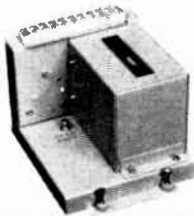

Transistor Servo Amplifier, Mod. AM-103.
Application: Single channel, 400 c. synchronous positioning servo loop. Up to size 18 Bu. Ord. motor, with built-in 400 c. power supply and feed-back damping control.

Transistor Servo Amplifier, Mod. AM-102.
Application: Two channels, 400 c. precision positioning servo loop, (i.e. Resolver). Up to size 18 Bu. Ord. motor, built-in 400 c. power supply, transfer input network, feed-back damping and stick-off voltage controls.

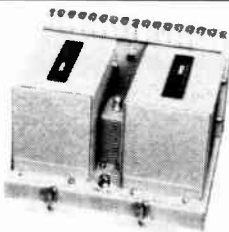
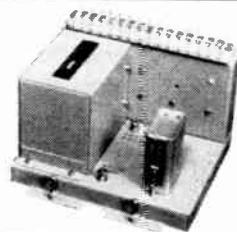

Transistor Servo Amplifier, Mod. AM-101 (AM-104 + AM-105).
Application: High gain, 400 c. synchronous amplifier for highest accuracy velocity integrating servo-loop, using up to size 18 Bu. Ord. motor/tachometer generator. Built-in: power supplies, null voltage suppressor, tachometer generator phasing network, speed adjustment and quadrature rejection circuit.

Transistor Amplifier, (Pre-Amplifier) Mod. AM-104, Class A, all transistor voltage and low power amplifier combined.
Voltage gain between rated impedances is adjustable between 50 and 150 V. Built-in power supply, 400 c. (Power Amplifier AM-105 packages in same manner: Class B, all transistor synchronous power amplifier-application as positioning and integrating servo amplifier.)



Differential, Model M-134.
Body & Mounting: Similar to size 18 Bu. Ord. motor. All ball bearings. Application: Servo mechanisms and computers.
Speed/Torque: symmetrical mechanical differential max. speed of any shaft 4000 r.p.m.; max. torque output 10 oz. inch.



Magnetic Clutch, Model M-134.
Body & Mounting: Similar to size 18 Bu. Ord. motor. All ball bearings. Max. speed 4000 r.p.m. Application: Servo mechanisms and computers. Energizing Power: 24 V.D.C., 3 watts. Min. Torque: 35 oz. inch.

MARS LAND
ENGINEERING LIMITED
KITCHENER, ONTARIO, CANADA

News Report

A. Deskin Sales Co. Named Canadian Rep

A. Deskin Sales Co. of 6875 Fielding Avenue, Montreal, P.Q., has recently been appointed Eastern Canadian sales representative for Valor Instrument Inc. of Gardena, California, manufacturer of constant delay lines, miniature pulse transformers, custom-built shift regulators, solid state regulated power supplies for transistors and other low voltage applications.

In addition A. Deskin Sales Co. has become the Quebec and Eastern Ontario sales representative for Carling Electric, Inc. of West Hartford, Conn., manufacturers of toggle and push-button switches for every application.

CSA Dielectric Committee Led By University Professor

John Hart, B.Sc., Ph.D., associate professor of physics at Carleton University, Ottawa, has been appointed chairman of a Canadian Standards Association committee on dielectrics.

The committee has been established to provide a forum for discussion and facility for the standardization of electrical insulating materials on a national basis; to provide a base for the standardization of A.I.E.E. No. 1; to provide for the establishment of electrical insulating material standards consistent with the needs of the Canadian economy; to provide for the development of new or for the concurrence of existing electrical insulating material test methods with the object, where desirable, of establishing C.S.A. test standards suited to the needs of the Canadian economy.



Dr. J. Hart

Other members of the special committee are: F. Ashworth, manager, Product Control Dept., Canada Wire and Cable Co. Ltd.; F. A. Goba, Research and Development Laboratories, Canadian Westinghouse Co. Ltd.; W. G. Hoyle, Division of Radio and Electrical Engineering, National Research Council; D. C. King, C.S.A. Testing Laboratories; Prof. A. J. Kravetz, Electrical Engineering Department, University of Toronto; M. Kurtz, Hydro Electric Power Commission of Ontario; J. T. Madill, Aluminum Company of Canada Ltd.; L. P. Mahon, Canadian General Electric Co. Ltd.; Prof. K. C. Mann, Department of Physics, University of British Columbia.

For further data on advertised products use page 81.

**NEW
PERFORMANCE
FEATURES**



**NEW
OPERATING
CONVENIENCE**

**TYPE 543
DC-to-30 MC
OSCILLOSCOPE**

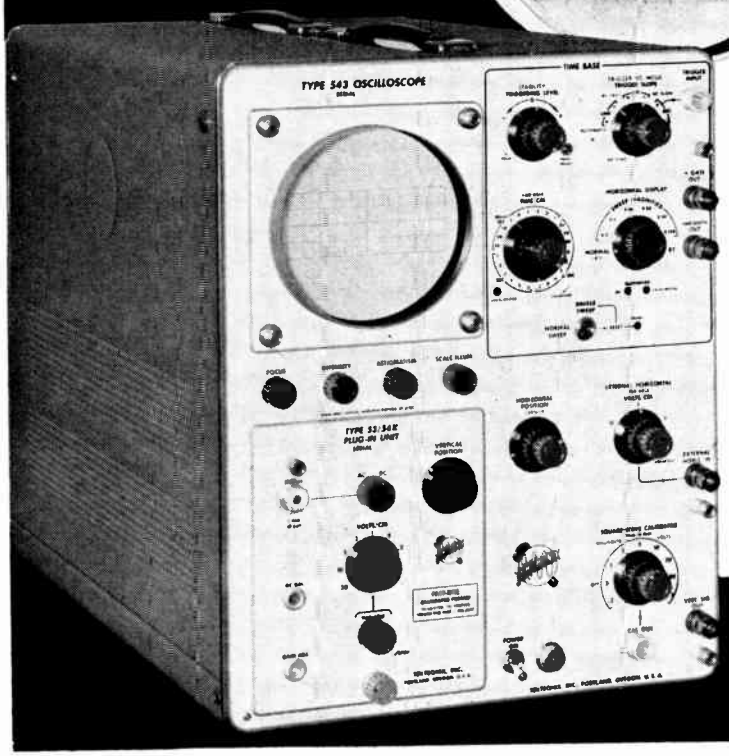

This new fast-rise oscilloscope with the Tektronix Plug-In Feature is extremely versatile and easy to operate. With a single Type 53/54 fast-rise plug-in pre-amplifier the Type 543 handles the usual applications in the DC-to-30 MC range. Many other inexpensive plug-in units are available for the more-specialized jobs, including one for transistor rise, fall, delay and storage time testing.

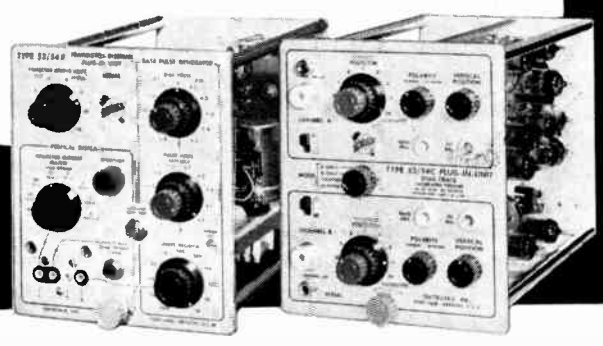

MAIN CHARACTERISTICS

VERSATILITY

Nine Available Plug-In Preamplifiers—Wide Band, Dual Trace, Low Level, Differential, and others for specialized applications.

HIGH PERFORMANCE

DC to 30 MC with fast-rise plug-in units.
DC to 24 MC with dual-trace plug-in unit.
0.02 μ sec/cm to 15 sec/cm sweep range.

EASY OPERATION

24 Calibrated Direct-Reading Sweep Rates.
Sweep Magnification—2, 5, 10, 20, 50, and 100 Times.
Preset Triggering—Eliminates triggering adjustments in most applications.
Single Sweep Operation—Lockout-Reset Circuitry for one-shot recording.

HIGH WRITING RATE

250 cm/ μ sec. 10-kv accelerating potential assures bright trace for operation in single-sweep applications, and with low sweep repetition rates.

TYPE 543 PRICE, without plug-in units \$1200

- Type 53/54K Fast-Rise Unit \$125
- Type 53/54C Dual-Trace Unit \$275
- Type 53/54R Transistor Test Unit \$300

Prices f.a.b. factory.

Please call your Tektronix Field Engineer or Representative for complete specifications and, if desired, to arrange for a demonstration at your convenience.

CANADIAN FIELD OFFICE:

3 Finch Avenue East, Willowdale, Ontario
Phone: Toronto, Baldwin 5-1138

ADD SWEEP LOCKOUT to your Tektronix Type 531 and 541 Oscilloscopes—order Modification Kit K531 Sweep Lockout, Tek. 040-118 \$25

for Type 532
K532 Sweep Lockout, Tek. 040-147 \$25

Tektronix, Inc.

P. O. Box 831 • Portland 7, Oregon

Phone CYPRESS 2-2611 • TWX-PD 311 • Cable: TEKTRONIX

For further data on advertised products use page 81.

More
features
in new
**STROMBERG
-CARLSON**
voice frequency
repeaters

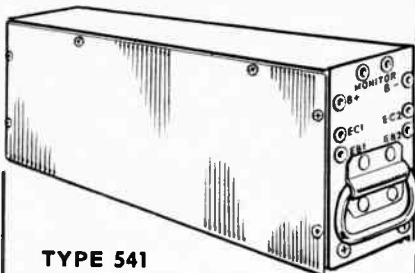

TYPE 541

**NEGATIVE IMPEDANCE
REPEATER**

- Compact 19" shelf holds 8 of these 100% TRANSISTORIZED voice repeaters, which takes only 3½" of vertical rack space.
- LOW POWER DRAIN—less than one watt per repeater from existing 48 V battery.
- Use of Semiconductors and printed wiring assures years of trouble free service.

**TYPE 551 — 2 WIRE
HYBRID REPEATER**

- for terminal use.
- for intermediate use.

Ask for complete data

**HACKBUSCH
ELECTRONICS**

LIMITED

23 PRIMROSE AVENUE
TORONTO 4, ONTARIO

News Report

**Manager For F. J. Stokes
Co. of Canada**

Announcement was made recently of the appointment of Fred Y. Walters, Jr., P.Eng., as manager of F. J. Stokes Company of Canada Ltd., 4198 Dundas Street West, Toronto.

Mr. Walters joined Stokes of Canada as a sales engineer in 1955. His previous experience was gained through association with Vickers, Inc., Gutta Percha & Rubber Ltd., and Northern Electric Co. Ltd.

F. J. Stokes Company of Canada Ltd. is a subsidiary of the F. J. Stokes Corporation in Philadelphia, Pa.

**Northern Radio Represents
McLean Engineering**

Northern Radio Manufacturing Company Ltd. of 1950 Bank St., Ottawa, announces that it has been appointed Canadian agent for McLean Engineering Laboratories, designers and manufacturers of fans and blowers for electronic applications.

McLean Engineering is a pioneer in the field of rack mounted package type electronic cooling and pressurizing equipment. Fans and blowers are specifically designed to fit standard electronic racks — small packaged units that pressurize the cabinet with cool, filtered air, preventing dust from entering through cracks and joints.

PSC COMMERCIAL MANAGER



W. A. DYMOND

• The appointment of Mr. W. A. Dymond as Commercial Manager of The Photographic Survey Corporation is announced by Mr. W. H. Godfrey, General Manager of the Toronto company. Mr. Dymond has been with PSC since 1946 and has a broad background in the technical, sales and administrative activities of the company.

% STILL
OPERATING

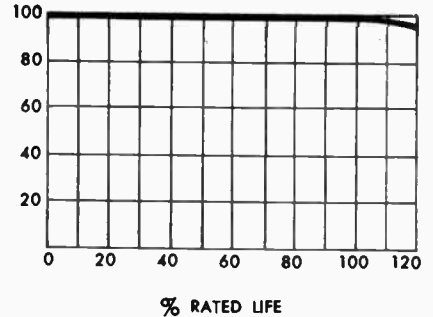

**If you want
reliable transformers**

...don't overlook this old solution

Right now, you demand more from transformers than ever before. You must have high reliability, even at extreme altitudes, and you need smaller lighter units.

Used, and *proved*, for decades, oil-encased transformers should not be forgotten in a search for new methods.

Everyone knows the advantages: effective convection of heat, excellent insulating properties, complete insurance against hidden leaks. Oil-sealed types (with a nitrogen bubble) are good, light, high-altitude transformers. Gas-free oil-filled types (with a bellows to allow for heat expansion) withstand very high voltage stresses. Except in the smallest sizes, they save space, too.

You can place several high voltage units close together in a single oil-filled case, and save case weight. Those connections moved inside the case no longer need large insulators. Even the units themselves can be smaller. This all adds up—particularly in high altitude service—to interesting savings in space and weight.

We make all sorts of transformers and special assemblies for the communication industry: encapsulated, cast in epoxy or foam, and just potted in pitch. But oil transformers still have an important place.

Whatever type you need, we'll be glad to hear from you. Our facilities in design, production, and quality control are at your service. Our experience, too.

CALEDONIA

ELECTRONICS AND TRANSFORMER CORPORATION

Dept. EC-5, Caledonia, N.Y.

In Canada: Hackbusch Electronics, Ltd.
23 Primrose Ave., Toronto 4, Ontario

For further data on advertised products use page 81.

ELECTROLYTIC CAPACITORS

Type PC heavy gauge steel case with screw terminals and mounting lugs. High reliability under extreme conditions. Full range of capacities and voltages.

Canadian Sales Representative

WM. T. BARRON

939 Lakeshore Road — Toronto 14, Ont.

Daly Capacitors Limited

FORMERLY DALY-ARROW LIMITED
Manufacturers of Electrolytic Capacitors
140 KENDAL AVE., TORONTO 14, ONT.



NEW BRITISH ELECTRONIC INSTRUMENTS

- Automatic Frequency Monitors
 - Electronic Counters
 - Capacitance and Inductance Bridges
 - Square Wave and Pulse Generators
 - Adjustable Phase Correction Units
- made by Cinema-Television Ltd., and available in Canada throughout Dawe Instruments.

For an illustrated catalogue with full details of this equipment, write today to:

DAWE INSTRUMENTS LIMITED

CANADIAN DIVISION: 1654 Bank Street, Ottawa, Ontario
5802

are your RELAY COSTS HIGH?

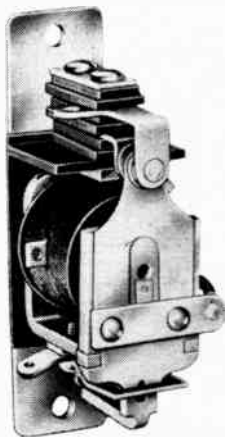

215XAX

Cut costs with Struthers-Dunn Frame 215 relays!

215 Relays are:

- compact
- dependable
- inexpensive
- insulated

Coils—up to 230 volts, 60 cycles AC up to 125 volts DC.

CONTACT RATINGS

Volts	24	115
AC AMPS	15	13
DC AMPS	15	1/4

For further information write Dept. 11

RELAY DIVISION J.R. LONGSTAFFE CO. LTD.

300 CAMPBELL AVE., TORONTO, ONTARIO

WHAT DO YOU WANT IN A TESTING METER



The
MODEL
8

AvoMeter

GIVES YOU . . .

- Automatic cutout protection
- 20,000 ohms per volt movement
- 4 ac current ranges to 10 amps.
- 7 dc current ranges to 10 amps.
- 14 ac-dc voltage ranges to 2500 v.
- 3 resistance ranges zero to 20 megohms
- 4 easy-to-read scales
- polarity reversing button
- anti-parallax mirror
- external accessories for increased ranges.

ACCURATE • PORTABLE • LIGHTWEIGHT

For detailed bulletin write to Dept. EC5

542A

R.H. **Nichols** LIMITED

4544 DUFFERIN STREET • TORONTO

Address Mail To Box 500, Downsview, Ont.

Before you buy
any capacitor
checker see
and try the

ALL-NEW MODEL 97 AEROVOX LC-CHECKER



\$89.95

The all-new Model 97 LC-Checker represents the ultimate in r-f circuit and component testing. In a single instrument it covers the widest range of checking functions. It's the only instrument that will test for capacitance without disconnecting capacitors from the circuit. Incorporates latest printed-circuit techniques.

THE ALL-NEW MODEL 97 LC-CHECKER CAN DO ALL THESE JOBS . . .

- 1—Measure capacitance and relative "Q" of capacitors.
- 2—Measure capacitor insulation resistance.
- 3—Align r-f and i-f circuits.
- 4—Check super-het oscillator tracking with set "hot-or-cold."
- 5—Align i-f channels in FM receivers and independent alignment of i-f transformers.
- 6—Determine resonant absorption points.
- 7—Locate resonant points in unused portions of coil assemblies in multi-range oscillators.
- 8—Align video and sound i-f systems in TV sets.
- 9—Precise alignment of 4.5 mc intercarrier sound i-f channels.
- 10—Determine natural resonant points of r-f chokes.
- 11—Determine natural period of antennas and transmission lines.
- 12—Measure fundamental crystal frequencies and operation at harmonic levels.
- 13—Measure transmitter buffer, amplifier and tank circuits for parasitic current loops with power off.
- 14—Measure correct wave-trap and filter tuning.
- 15—With a standard plug-in crystal, can be used as an accurate signal generator for signal substitution and precise signal sources.

5801

Write for descriptive literature

**AEROVOX
CANADA LIMITED
HAMILTON, CANADA**

WESTERN SALES

Chas. I. Thompson, Vancouver, B.C.

U.S.A.

AeroVox Corporation, New Bedford, Mass.

News Report

Raytheon Canada Ltd. Changes Ownership

Raytheon Manufacturing Co. of Waltham, Massachusetts, has recently acquired the interest in Raytheon Canada Ltd. previously held by Dominion Electrohome Industries Ltd. of Kitchener since 1955.

Raytheon Canada Ltd. has offices in Waterloo and a factory in Kitchener where work is being carried out in behalf of the Federal Department of Transport in connection with air traffic control radar equipment.

Carl A. Pollock, president of Dominion Electrohome, will be chairman of the board of directors of Raytheon Canada Ltd. and two other executive members of Electrohome, J. G. Tufts and D. S. Sykes, will remain as officers of the Canadian affiliation of Raytheon.

C. W. Pointon, Jr. Visits Principals In England

Charles William (Bill) Pointon, the junior member of the firm of Charles W. Pointon Limited, of Toronto, manufacturers' representatives, is now in England working with one of his organization's principals, the Garrard Engineering and Manufacturing Co. — manufacturers of Garrard equipment — at Swindon, Wiltshire.

This is the first manufacturer of products represented by Charles W. Pointon Limited with whom Mr. "Bill" Pointon will spend time while in England. Following his return to this continent, he will in turn spend time and become acquainted with companies in the United States represented by his firm.

C.G.E. DIRECTOR



J. A. BELAND

● J. Alexandre Béland of Louiseville, P.Q., has been elected to the Board of Directors of Canadian General Electric Company Limited.

If it's
TOWERS you
need, check
ROHN
FIRST!

AMERICA'S FINEST
COMMUNICATIONS
TOWER OF ITS KIND
... WITH EXCLUSIVE
BUILT-IN ECONOMY

Reduce Costs

— by getting a tower specifically for your job. These towers are suitable for use up to 300 feet guyed—or self supporting to 50-60 ft.! ROHN towers are in daily use for microwave, radio and dozens of all type communications requirements throughout the U.S. — at big savings — yet more than do the job! Can be used for a multitude of jobs.

Proven Design

— get full engineering data to prove superiority. Gleaming, hot-dipped galvanized finish available — stays shiny and new—no painting needed. Design fully tested — proved by thousands of installations. Easily shipped and inexpensively installed. Cross pieces form natural ladder for servicing.

Special Towers

— you're invited to submit your requirements. Towers will be built to your specifications if practical. Let us know your needs — ROHN can satisfy them BEST when it comes to towers of this type.

Shown here is a Rohn No. 30 tower used for radio communications by Central Illinois Light Co. Note slim, sleek appearance—takes little space—yet places antenna high into air for good communications.

FREE



Send for new "Specifications & Price" catalog for Rohn Communications Towers. Your inquiry will receive prompt attention. Rohn representatives are coast-to-coast to serve you. Write — phone — wire

ROHN Manufacturing Co.

116 Limestone, Bellevue
Peoria, Illinois

"Pioneer Manufacturers of TV and Communication Towers of All Kinds."

For further data on advertised products use page 81.

SEE IT NOW

... the first complete industrial television system, completely installed and serviced by a local contractor.

Now you can have a "live" demonstration, where you want it, when you want it, with no obligation on your part. See for yourself what Du Mont Industrial Television can do for you . . .

TC-100 Camera. Completely self-contained. Connects directly to TV receiver or monitor.

Complete remote control facilities for pan, tilt, focus, lens change.

TC-200 Camera. Extra-fine performance for extra-critical applications. Extremely compact.

8" and 17" high definition monitors.

COMPLETELY FLEXIBLE CLOSED CIRCUIT TV DESIGNED BY DUMONT

The complex problem of designing a new line of flexible and economical closed circuit TV equipment has been solved by the Allen B. Dumont laboratories. Two basic cameras suitable for all industrial and educational applications have been produced. These two cameras feature a full line of accessories and remote controls that can be added in the field where required.

The type TC-100 Television Camera, complete in one unit observes any scene and produces an appropriate television signal for viewing on either a video monitor or standard receiver. No external power supply or control unit is required. Bright clear pictures are produced with light levels as low as ten or fifteen footcandles, and useable pictures with even less light. Crystal-controlled scanning produces "rock-steady" pictures. A three-lens turret is included. The camera measures 5" wide, 7½" high, 12" long and weighs 12 pounds.

For added flexibility these accessories are available for this model: remote focus, turret and iris drives, remote camera control, voltage regulator and interlace adapter kit.

The type TC-200 Television Camera equipment consists of a miniature vidicon camera and a separate control unit. These produce a high resolution, 2:1 interlace television signal. Conservative design and rugged construction make this equipment excellent for the extra tough industrial TV applications. This extremely small camera, ideal where space is at a premium, can be operated up to 2,000 feet from the TCC-200 Television Camera Control. The TCC-200 Television Camera Control contains four separate removable sub-units: Sync Generator, Deflection Amplifier, Video Amplifier and Power Supply. The unit also contains controls for operation of camera and all remote drives - these are located on a small, completely enclosed panel which is removable where space is important. The TC-200 Television Camera is 3" wide, 3½" high, 10" long and weighs only 3 pounds.

For complete flexibility these accessories can be added: remote drive housing, remote focus drive, remote turret drive and a remote iris drive.

A full line of monitors especially designed for CCTV are also available. The monitors employ wide band video amplifiers and are designed for continuous duty even under adverse temperature and humidity conditions.

Dumont closed circuit TV and the Dumont mobile communications equipment line is distributed in Canada by Electronic Service Supply Company. Full engineering assistance in systems planning is available. Electronic Service Supply was established in Western Canada in 1947 and have completed many difficult assignments in electronic control and communications systems across Canada.

Eastern Canada Sales Representatives are Tele-Radio Systems Ltd., Toronto.

Electronic Service Supply Company's specialists are anxious to help you with any closed circuit TV problem - System layout, design of control consoles, housings, any problem from basic planning to a complete and operating TV system, are obtainable from this one reliable source of supply.

DUMONT®

Canadian Distributor

ELECTRONIC SERVICE SUPPLY COMPANY

210 - 9th Avenue East
Calgary, Alberta

Branches or Representatives in most
Canadian Cities

INDUSTRIAL
TELEVISION DEPARTMENT
ELECTRONIC SERVICE SUPPLY
COMPANY

210 - 9th Ave. East Calgary, Alberta

- I'm interested in a demonstration.
Please tell me more.
- Send me Industrial Television Handbook.

NAME _____

COMPANY _____

ADDRESS _____

MORE *ACTIVE! EFFECTIVE!*



**THE BEST FOR TV-RADIO WORK . . .
EVERYTHING ELECTRICAL**—Kester "Resin-Five"
Core Solder is better and faster than any solder ever
developed. It has an activated flux-core that does a perfect job on
all metals including zinc and nickel-plate. The flux residue
is absolutely non-corrosive and non-conductive.

Available in all practical Tin-Lead
Alloys; 40/60, 50/50 and 60/40 in
diameters of $\frac{3}{32}$ ", $\frac{1}{16}$ ", $\frac{3}{64}$ ", $\frac{1}{32}$ " and
others.

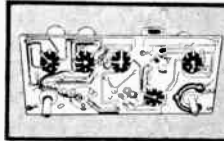

Printed Circuit Soldering
On Copper-etched boards
use 60% Tin - 40% Lead
Alloy . . . for those that
are Silver-surfaced use
3% Silver-61½% Tin -
35½% Lead

KESTER SOLDER COMPANY
OF CANADA, LTD., Dept. U Brantford, Canada



**FOREMOST IN
SONAR**
UNDER WATER ACOUSTIC DETECTION
AND RANGING EQUIPMENT

Edo

(CANADA) Ltd.

CORNWALL, ONTARIO

News Report

H. L. Pollock Represents Electronic Components Group

Philips Electronics Industries Ltd., 116 Vanderhoof Ave., Toronto 17, announces the appointment of Harvey L. Pollock, P.Eng., to the position of sales engineer in the Aviation & Electronic Components Group.

Mr. Pollock is a graduate of the University of Manitoba in Engineering Physics and holds the M.Sc. degree from that University also. He has previously been associated with Canadian Aviation Electronics Ltd., Winnipeg, in charge of systems engineering for maintenance of the Pine Tree Radar Line. Recently, he has been associated with Avro Aircraft Ltd. and was responsible for co-ordination of the Technical Design Department's interest in the Arrow electronics systems.

In his new position, Mr. Pollock will be responsible for marketing of electronic components and systems for government and industry across Canada. These include the products of the A. W. Haydon Company, Analogue Controls, Servonics, Inc., and Ebert Electronics.

Rear Admiral Adams Joins Canadian Westinghouse

Rear Admiral Kenneth F. Adams, who retired recently from the Royal Canadian Navy after a distinguished



Admiral K. F. Adams

33-year career, has been appointed Commercial Development Manager at the Canadian Westinghouse Company, Hamilton.

Rear Admiral Adams graduated in 1922 from the Royal Naval College of Canada. After six years with the merchant marine, he joined the permanent force RCN as a lieutenant and served for several years on cruiser and destroyer duty. At the outbreak of World War II he was executive officer of the RCN barracks at Halifax.

Following sea and shore establishment commands, including a period in command of HMCS Iriquois on the perilous convoy run to Murmansk, he was promoted to the rank of captain. With the formation in 1953 of a new establishment at Hamilton to administer Canada's 22 naval reserve divisions, he became Commanding Officer Naval Divisions and was promoted to rear admiral in 1955.

Rear Admiral Adams will make his headquarters in Hamilton.



NEW

FOR THE LATEST IN
**ELECTRONIC
 INSTRUMENTS**

CALL ON
**ATLAS INSTRUMENT
 CORPORATION LTD.**

EXCLUSIVE CANADIAN SALES AND SERVICE REPRESENTATIVES FOR THESE OUTSTANDING MANUFACTURERS OF ELECTRONIC MEASUREMENT EQUIPMENT:

ELECTRO PRODUCTS — Magnetic pick-up probes.

GERTSCH — Frequency measuring equipment and ratio transformers.

HEWLETT-PACKARD — Comprehensive line of electronic test equipment DC through micro wave.

INDUSTRIAL TEST EQUIPMENT — Impedance and phase measuring equipment, power oscillators, Hi-pot testers.

WEINSCHEL ENGINEERING — Coaxial attenuators, terminations and transmission loss measurement equipment.

KINTEL (KAY LAB) — Wide range of DC instrumentation and closed circuit television.

LINDGREN — R.F. screen rooms.

SIERRA — Transmission line test equipment.

TEL INSTRUMENT — Voltage regulators and vibration calibrators, TV test equipment.

ATLAS INSTRUMENT CORPORATION LTD.

50 Wingold Ave., Toronto 19, Ontario. RU. 1-6174

Branches in: Montreal - Winnipeg - Vancouver

American Beauty

ELECTRIC SOLDERING IRON



NEW!

TINY TIP FOR MINIATURE, SUBMINIATURE AND MICRO-TYPE CONNECTIONS.

The slim, new American Beauty "T-12" iron with its plug-in transformer is especially built to solder today's tiny connections easily, accurately and dependably.

This NEW tip-element (about the size of a kitchen match) with its 3/32" tip is built for fast, hot, production-line use—day after day.

Here is the quality-built, economical answer to YOUR miniature soldering problems! Write for literature and prices.

AMERICAN ELECTRICAL HEATER COMPANY

171-14

DETROIT 2 MICHIGAN



RELIABLE, LIGHTWEIGHT, PORTABLE POWER

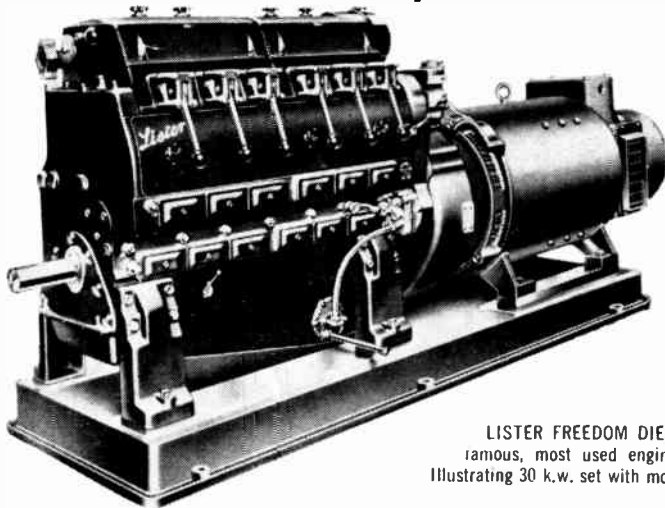

LISTER FREEDOM DIESELS—the most famous, most used engines in industry. Illustrating 30 k.w. set with model FR6 Engine.

Built in a tradition of reliability, Lister-Blackstone engines incorporate the very latest improvements in Diesel design. The full line includes engines from 3½ to 1300 h.p. and there are models for every purpose. Ease of maintenance and economical operation are assured when you specify Lister-Blackstone. Service and spare parts are available from coast to coast.

Write us for the name of your nearest Distributor.

CANADIAN LISTER-BLACKSTONE

LIMITED

1921 EGLINTON AVE. E., TORONTO 13 • 3135 WEST BROADWAY, VANCOUVER
25 ST. JAMES ST., VILLE ST. PIERRE, MONTREAL

In the U.S. — Lister-Blackstone Inc., 42-32, 21st St., Long Island City 1, N.Y.

DISTRIBUTORS: B.C. Equipment Co. Ltd., 551 Howe Street, Vancouver; Bruce Robinson Electric (Edm.) Ltd., 10056-109th Street, Edmonton; Medland Machinery Limited, 576 Wall Street, Winnipeg; Russel-Hipwell Engines Ltd., Owen Sound; Consolidated Engines & Machinery Co. Ltd., 5645 Pare Street, Town of Mount Royal, P.Q.; Russell-Hipwell Engines Ltd., 1298 Barrington Street, Halifax; Clayton Construction Co., Ltd., P.O. Box 118, Muir Bldg., St. John's, Nfld.

For further data on advertised products use page 81.

News Report

Clevite Transistor Products Appoint Canadian Rep

The Glendon Company Limited, of 44 Wellington St. East, Toronto 1, Ontario, have been appointed sales representatives for Clevite Transistor Products for Quebec and Ontario.

The Clevite line includes PNP germanium alloy junction power transistors and high frequency power transistors. Clevite also manufacture gold bonded subminiature germanium glass diodes for application in the military, computer, high temperature, high resistance, high conductance, and general purpose fields.

R. C. Griffin Of CNT Receives Promotion

John R. White, general manager of Canadian National Telegraphs, has announced the promotion of R. C. Griffin, formerly assistant general equipment engineer, to the position of general equipment engineer.

Mr. Griffin, who graduated from Nottingham University in England in 1933 with a degree in electrical engineering, first joined Canadian National Telegraphs in 1948 as assistant engineer. Prior to his appointment as assistant general equipment engineer in 1957, Mr. Griffin occupied several engineering positions, primarily in the equipment field of Canadian National Telegraphs.

RCA VICTOR DIRECTOR



J. D. HOULDING

● Election of John D. Houlding as a Director of RCA Victor Company, Ltd. at the annual meeting held at its Head Office in Montreal on April 24, was announced by P. J. Casella, President. As Vice-President, Technical Products of RCA Victor, Mr. Houlding has under his direction, research, tube manufacturing, commercial and industrial electronics and defense activities of the company.

OPERATION "SNOW WHITE"



Special-purpose tube assembly takes place in a fully air-conditioned, dust and lint-free room. Before entering, all personnel must don nylon or dacron, lint-free smocks and

scrape their shoes on a dust-removing, air-suction grating. All assemblers are highly trained, class "A" operators with at least 4 years experience on electronic tube manufacture.

Now Canadian General Electric Manufactures Special-Purpose and 5-Star Tubes in Canada!

Military and industrial users of special-purpose receiving tubes will be the first to benefit from a new manufacturing facility—recently established by Canadian General Electric. Operation Snow White . . . launched to meet the ever-increasing demand for high-reliability tubes . . . is a typical example of how C.G.E. research and manufacturing keeps abreast of changing conditions. Just three years ago, tubes of G-E 5-Star quality were virtually unknown in Canada. Today, demand not only warrants domestic production but is expected to double by 1961.

Features of G E 5-Star and other high-quality receiving tubes are: Slotted, double, mica supports; Cathoretically coated heaters; Exceptionally close grid, cathode and heater tolerances. Their production requires: A dust and lint-free atmospheric condition; Microscopic inspection of all parts and assemblies; Extra and particularly severe testing methods; and finally, a full 48 hour burn-in to stabilize characteristics and weed out possible early failures.



All assembly takes place under glass. Latex finger gloves, changed every hour, are worn to prevent contaminating finger prints. Each assembler is required to give her work area a thorough cleansing twice daily.

The following are some of the types which will be produced initially: 5654/6AK5W, 5840, 6136/6AU6WA, 5726/6AL5W, 5902, 5749 6BA6W, 6021, 5718, 6201-12AT7WA, 6J4WA.

The 5654/6AK5W, produced to MIL-E-1/4A specification, is already in production and others will soon follow. For up-to-date details on the availability and new low prices of these Canadian-made high-reliability receiving tubes, contact: Electronic Tube Section, Canadian General Electric Co. Ltd., 189 Dufferin St., Toronto, Ontario.



**GENERAL ELECTRIC
INDUSTRIAL AND
MILITARY TUBES**

ELECTRONIC EQUIPMENT AND TUBE DEPARTMENT

1452-158

CANADIAN GENERAL ELECTRIC COMPANY LIMITED

ELECTRONICS & COMMUNICATIONS, MAY, 1958

For further data on advertised products use page 81.

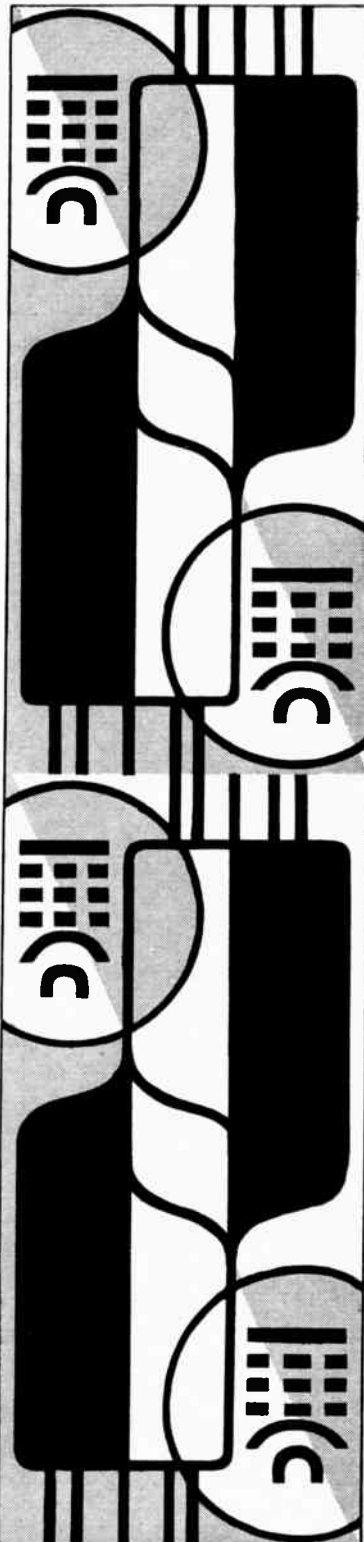

ERICSSON

TELEPHONE SALES
OF
CANADA LIMITED

AVAILABLE FROM STOCK!

L M ERICSSON

MINIATURE, LONG-LIFE
ELECTRONIC TUBES

- 10,000 hours warranty with much higher life expectancy for most types.
- Mechanical properties far superior to international standards.
- Ruggedized and specially tested for stability, vibration output, glass strain, etc.

some of the Ericsson tubes now available:

TWIN TRIODES

2C51/396A, 407A, 5842/417A

H.F. PENTODES

5590/401A, 5591/403B,
5847/404A, 6028/408A

POWER AMPLIFIER PENTODES

6760, 6761, 6AQ5L, etc.

- For complete Electronic Tube Data Sheets, sign and mail this coupon with your letterhead today!

ERICSSON TELEPHONE SALES OF CANADA LIMITED

MONTREAL: 130 Bates Road — REgent 1-6428

Please send data sheets on your long-life electronic tubes to:

Name: _____

News Report

Westinghouse Engineer Awarded Special Honor

A life membership in the Canadian Welding Society was recently awarded to Harry Thomasson of the Canadian Westinghouse Company Limited of Hamilton, Ontario. It was the third such honor conferred in the 20 year history of the organization.

Making the presentation, James Scott, president of the Canadian Welding Society, commended the assistance rendered by Mr. Thomasson, who worked on the educational programs sponsored by the society.

Formerly manager of the mechanical-metallurgical section of the Westinghouse Research and Development Laboratories, Mr. Thomasson has more recently been appointed as consulting engineer for the Canadian Westinghouse Company, in which capacity he will be engaged in special technical assignments and available to all divisions of the company.

A. C. Wickman Extends Electronics Service

Further expansion of the Electronics Division of A. C. Wickman Limited, 1425 Queensway, Toronto 14, Ontario, has recently been announced.

The company is marketing in Canada products of Dynamic Instrument Company, of Cambridge, Massachusetts. These products include a complete range of strain gage pressure transducers, flow meters and force transducers.

This addition will permit the company to offer complete instrumentation systems for Canadian users.

Closed-Circuit TV For CARTB

Bruce Emonson, Operations Manager of TelePrompter of Canada Ltd., went to Montreal recently to attend a session with the executives of the new Queen Elizabeth Hotel and representatives of the Canadian Association of Radio and Television Broadcasters.

The meeting was held in connection with the forthcoming Broadcasters' convention to be held in Montreal this month.

Plans were made for the setting up of a miniature TV studio to demonstrate live and film commercials that will be fed by closed circuit to a GPL television receiver-projector to be viewed on a 9x12 screen by an advertising audience.

The Canadian General Electric Company will supply the camera set-up and the technical operation will be handled by TelePrompter of Canada Ltd., a division of S. W. Caldwell Ltd.

For further data on advertised products use page 81.

TELE-RADIO SYSTEMS LTD.

are pleased to announce their appointment, effective immediately as official representatives for the

BUDELMAN ELECTRONICS CORPORATION

Stamford, Conn.

manufacturers of a complete line of low cost rural telephone carrier and microwave equipment and accessories. Budelman equipment is already familiar to many Canadian telephone companies and other users for its high quality and reliability. Budelman products are:

Subscriber carrier (CB, dial and magneto).

Private line carrier — the lowest cost carrier ever offered.

E & M and ringdown trunk carrier.

Pole mounted cabinets.

Single and multi-channel point-to-point radio links for voice, telegraph, supervisory control and telephone trunk service using Budelman telephone carrier for multiplexing.

Wireless microphones, frequency deviation meters, antenna duplexers, emergency power panels for carrier systems, special carrier transformers and filters, gas protector panels.

Tele-Radio Systems Ltd.

Telephone and Radio Communications

A comprehensive communications service with regard to the supply of fixed, mobile and point-to-point radio, telephone equipment, carrier power equipment, telephone wires, closed circuit television, antennae and accessories of all kinds.

We welcome enquiries dealing with special products and applications.

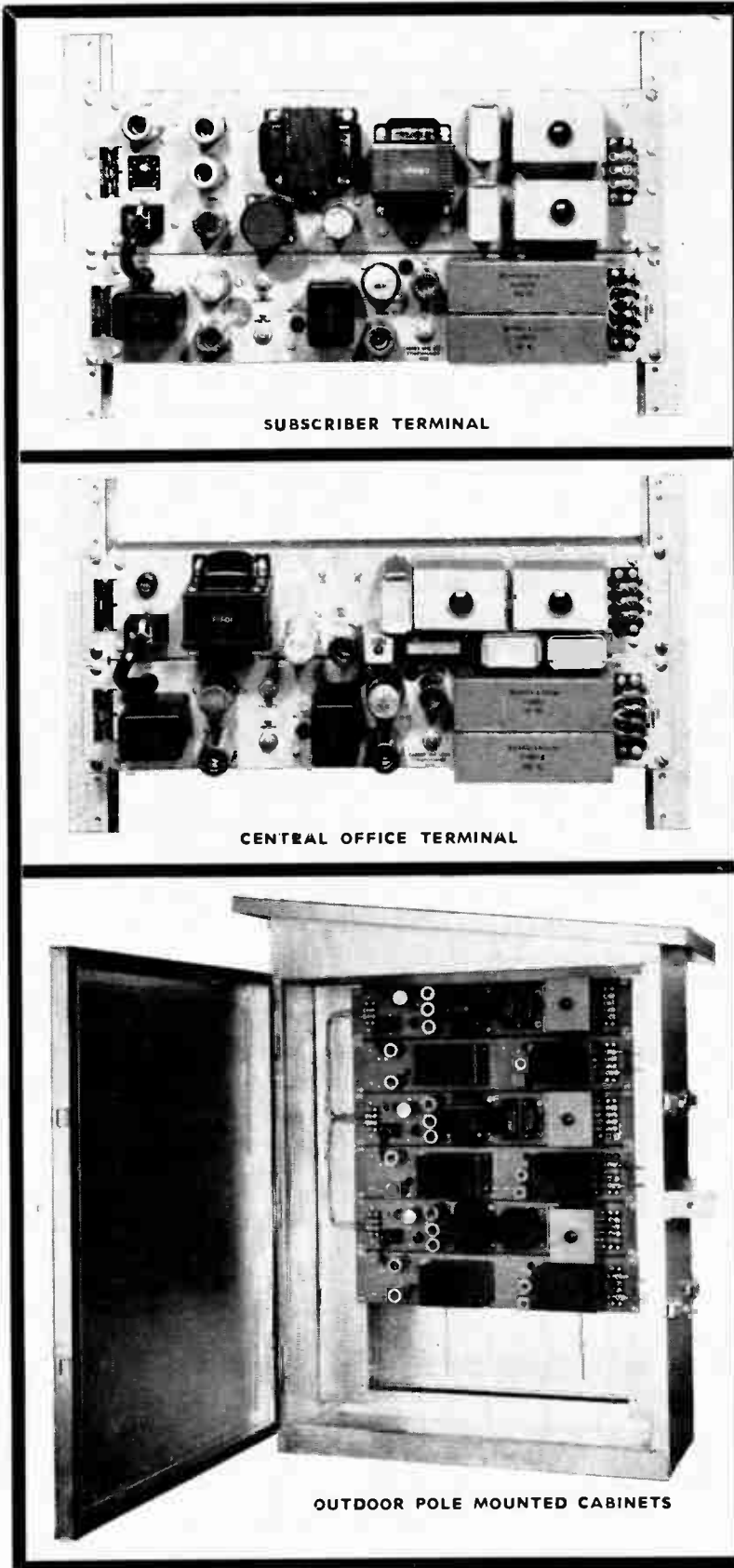

"If it's for communications, we'll supply it".

**3534 Dundas St. West
Toronto 9, Ontario, RO. 2-8224**

MUIRHEAD

TACHOMETER GENERATORS AND SERVOMOTORS

EXACTLY to BuOrd Spec

Mark 1 Mod 1 TACHOMETER GENERATOR (Size 15)



MUIRHEAD

Supply	115V	400c/s
Generated Voltage per 1000 rev/min	3.1V	
Phase Shift at 3000 rev/min	5°	lagging
Residual Voltage at 0 rev/min		
R.M.S.	0.013V	Fundamental 0.008V
Weight	7oz	200g

Mark 12 Mod 0 SERVOMOTOR (Motor Tachometer Size 15)



MUIRHEAD

Supply	to Phase 1	115V	400c/s
	to Phase 2	115V	400c/s or 57.5V 400c/s

MOTOR PERFORMANCE

Torque at Stall (minimum)	1.45oz in	104g cm
Torque at 2500 rev/min (maximum power output)	0.8oz in	58g cm
No Load Speed (minimum)	4500 rev/min	
Weight with Generator	14oz	400g

The Generator figures are the same as for Mark 1 Mod 1 above

Mark 16 Mod 0 SERVOMOTOR (Motor Tachometer Size 18/15)



MUIRHEAD

Supply	to Phase 1	115V	400c/s
	to Phase 2	115V	400c/s or 57.5V 400c/s

MOTOR PERFORMANCE

Torque at Stall (minimum)	2.35oz in	170g cm
Torque at 2500 rev/min (maximum power output)	1.5oz in	110g cm
No load speed (minimum)	4500 rev/min	
Weight with Generator	19oz	540g

The Generator figures are the same as for Mark 1 Mod 1 above

Servomotors can also be supplied with various low impedance control windings.
Write stating your requirements.

Data sheets giving full information on the above and a handy reference sheet
on our full range of Synchros and Servomotors are available on request.

MUIRHEAD INSTRUMENTS LIMITED
STRATFORD · ONTARIO · CANADA Telephone: 3717 & 3718

333/3Ca

News Report

Hi-Fi Exposition For Montreal In Fall 1958

R. C. Kahnert, president of the Dominion High Fidelity Association, announced at a recent meeting of its members held in Toronto, that the second industry-sponsored hi-fi exposition will be held in the Windsor Hotel, Montreal, P.Q., from October 29 to November 1 inclusive.

Over forty rooms and salons have been reserved on the first floor on the Dorchester and Stanley Street frontages of the hotel, and additional adjacent space is under option if required.

The show will be under the management of John T. Rochford, who handled the successful effort which the Dominion High Fidelity Association staged in Toronto last Fall.

Hon. Frank M. Ross Elected To Boards Of Directors

At the annual general meeting of Canada Wire and Cable Company Limited held recently, The Hon. Frank MacKenzie Ross, Lieutenant Governor of British Columbia, was elected to the board of directors of the company.

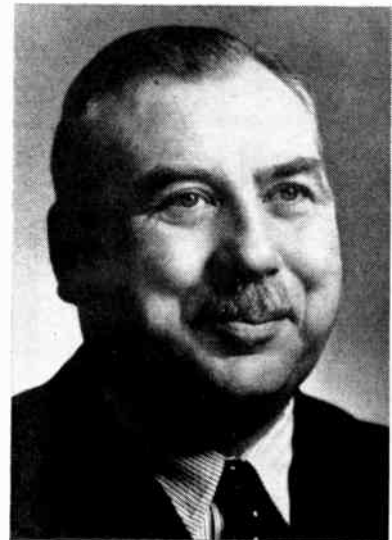

HON. FRANK M. ROSS

The Hon. Frank M. Ross is chairman of the board of Canadian Dredge and Dock Co. Ltd., International Paints (Canada) Ltd., Western Bridge and Steel Fabricators Ltd., Vancouver Iron Works Ltd., and Vancouver Machinery Depot Ltd. He is president of McCord Street Sites Ltd., Red Barge Lines Ltd., Columbia Paper Co., Ltd., Lafarge Cement of North America Ltd., West Coast Shipbuilders Ltd., Pioneer Gold Mines of B.C. Ltd. and a director of a number of companies.

For further data on advertised products use page 81.

Here's the Complete "Package" for Counting Electrically...

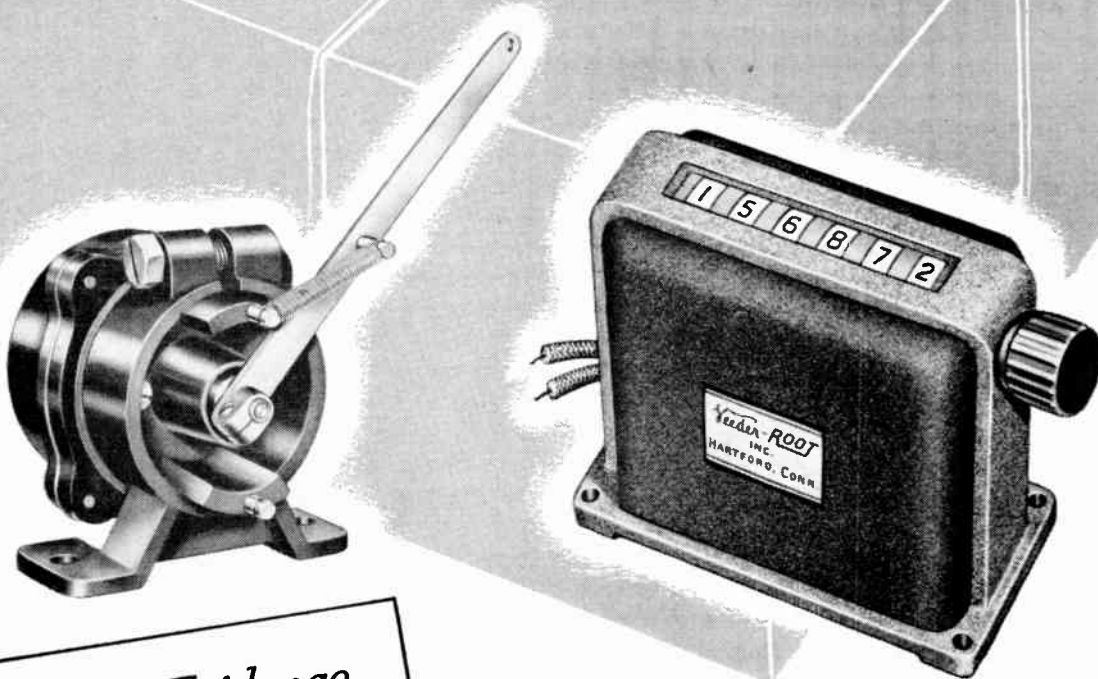

Added Evidence
that —

Everyone Can Count on VEEDER-ROOT

This Veeder-Root Reset Magnetic Counter (AC or DC) is actuated through electromagnets. And it may be connected in series with any device having a contact arrangement . . . like the specially designed Veeder-Root Electrical Contactor at the left, which insures positive operation of the counter, either in oscillation or connected directly to a revolving shaft . . . with the counter placed at

any distance from the machine or process on which the count is required.

This is another one of the hundreds of Veeder-Root Standard and Special Counting and Computing Devices developed for every conceivable counting duty, in every field from atomics to electronics.

What do you need to count? Just write:

VEEDER-ROOT of CANADA, Ltd.

955 St. James St., Montreal 3

Main Office & Factory: Hartford 2, Conn., U.S.A.
Offices & Agents in Principal Cities



Chicago 6, Ill. • New York 19, N. Y. • Greenville, S. C.
Montreal 2, Canada • Dundee, Scotland

Offices and Agents in Principal Cities

"The Name that Counts"

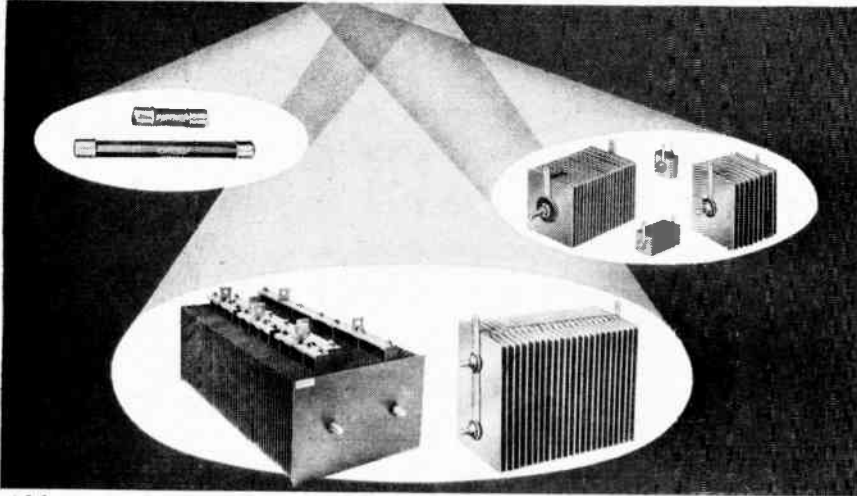
SYNTRONQuality Control
Vacuum Process**SELENIUM RECTIFIERS**provide quality performance,
dependability and longer life**Plus** the widest range of cell sizes in the industry

For all your d-c power needs — SYNTRON Selenium Rectifier cells are manufactured by a unique vapor deposit vacuum process and quality control method to provide rectifiers of extreme uniformity, long life and stability.

Years of successful industrial and commercial application have proven their dependability and quality.

SYNTRON Selenium Rectifiers are noted for these outstanding characteristics that make them consistently out-perform and out-last similarly rated rectifiers—lowest voltage drop, lowest leakage current, lowest temperature rise, longest life, greater uniformity from cell to cell and greatest voltage ratings.

SYNTRON builds rectifier stacks for every application—from Industrial Power Stacks with 12" x 16" cells, largest in the industry, down to low current, high voltage hermetically sealed cartridge type stacks.

SYNTRON Selenium Rectifiers provide high efficiency, low maintenance and longer life to every application.

E 658

Other SYNTRON Equipment

designed to increase production,
cut production costs, improve products

Vibrators (bins, hoppers, chutes)	Rectifiers (Silicon and Selenium)
Vibratory Feeders	a-c to d-c Selenium Rectifier Units
Vibratory Screens	Electric Heating Panels
Shaker Conveyors	Electric Heating Elements
Vibratory Elevator Feeders	Sinuated Wires
Weigh Feeders	Shaft Seals
Packers and Jolters	Electric Hammers
Hopper Feeders	Concrete Vibrators
Lapping Machines	Paper Joggers

Our representatives will be glad to work with you in selecting the proper equipment for your operation.

Call your nearest Syntron representative

For more information write for complete catalog . . . *Free*

**SYNTRON (CANADA) LIMITED**

Dept. K

12 MAIN ST. EAST

• STONEY CREEK, ONT.

News Report**Automatic Electric Train
RCCS Operators**

The Royal Canadian Corps of Signals, which operate and maintain a large number of fixed PBX systems for the Canadian Army, both in Canada and overseas, are currently faced with the task of converting these installations from manual to automatic operation.

Preparing service personnel for this task, the Signal Corps have used the Automatic Electric Training School

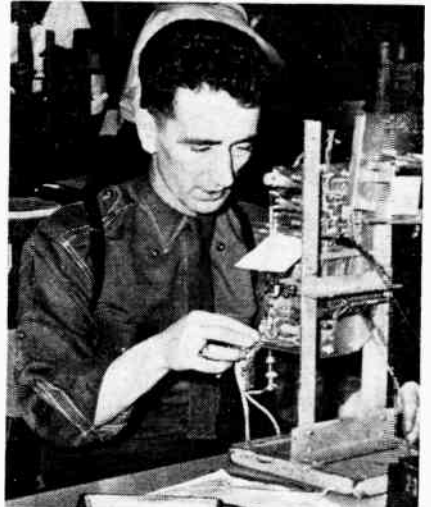

as a means of acquainting personnel in the basic principles of automatic telephony.

On completion of the course, students are assigned to maintenance of existing Army PABX systems of the Strowger type. Shown in the accompanying photograph is Sergeant L. M. King working with a 2-5 selector, on which he spent a portion of his time, effort and study in the 11-week training course of the Automatic Electric Company at Northlake, Illinois. Sergeant King attended the training school in line with the policy of the Royal Canadian Corps of Signals to keep its personnel well informed on the latest developments in the field of telephony.

**Nat. Industrial Service Assn.
Has Canadian Vice-President**

H. C. Blenkhorn, president of Blenkhorn & Sawle, Ltd., of St. Catharines, Ontario, was elected vice-president of the National Industrial Service Association, Inc., at its 25th annual convention held on May 13 in New Orleans, La.

The N.I.S.A. is a trade organization of 1,600 electric motor, generator and transformer service and sales shops in the United States and Canada.

The 1959 convention of the Association will be held in Montreal, May 17-20, at the Queen Elizabeth Hotel, the first convention to be held in Canada.

For further data on advertised products use page 81.

Profit with

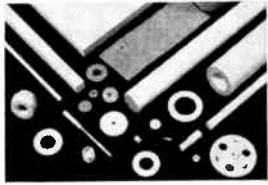

POLYPENCO®

Industrial Plastics

for improved product design

- Highest Quality • Controlled Physical Properties
- Wide Range of Stock Sizes—easily machinable for component parts

- ... **NYLON**—rod, tubing, tubular bar, strip, plate, discs
- ... **TEFLON***—rod, tubing, spaghetti tubing, tape, sheet, thin wall tubing
- ... **NYLAFLOW®** Flexible Nylon Pressure Tubing—up to 2500 P.S.I., for pneumatic, gas and liquid lines
- ... **Q-200.5** Cross-Linked Polystyrene—rod and plate
- ... **K-51** Chlorinated Polyether—rod, tubular bar, strip
- ... **NYLATRON® GS** Nylon Molding Powders
- ... **NYLASINT®** Finely Divided Nylon Powders for cold pressing and sintering

• Write for latest data

Distributors and Sales Engineers:

Peckover's Limited: 115 McCormack St., Toronto
2052 St. Catherine St. W., Montreal

C. M. Lovsted & Co. (Canada) Ltd.: Vancouver · Edmonton · Calgary
POLYPENCO, INC., 2150 Fairmont Ave., Reading, Pa., U.S.A.



The Right ATTENUATION...



...in a JIFFY!

- Useful to 1500 Mc/s
- Other types available
- Write for free catalog



PYLON ELECTRONIC DEVELOPMENT company, Ltd.

Communications Systems and Equipment

161 CLEMENT ST., VILLE LASALLE, MONTREAL 32, QUE.



A resilient insert rack and panel connector

Here is the new and improved Bendix Type SR rack and panel electrical connector with outstanding resistance to vibration. The low engagement force of this connector gives it a decided advantage over existing connectors of this type.

Pressurization is easily accomplished. The resilient inserts press firmly against the shell wall holding the contacts in exact position. Insert patterns are available to mate with existing equipment in the field.

Adding to the efficiency of this rack and panel connector is the performance-proven Bendix "clip-type" closed entry socket.

Here, indeed, is another outstanding Bendix product that should be your first choice in rack and panel connectors.

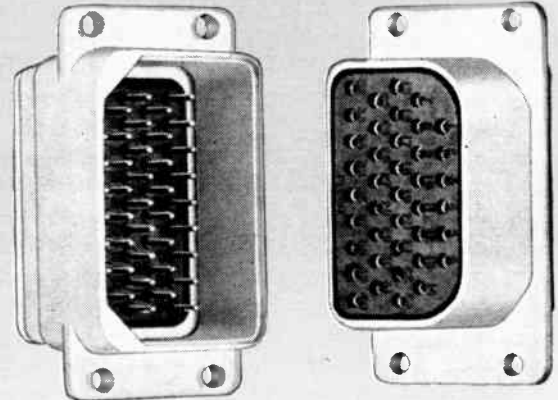

OUTSTANDING FEATURES

Resilient Insert • Solid Shell Construction • Low Engagement Forces • Closed Entry Sockets • Positive Contact Alignment Contacts—heavily gold plated • Cadmium Plate—clear irridite finish • Temperature range -67° to $+250^{\circ}$ F. • Easily Pressurized to Latest MIL Specifications.

SCINTILLA DIVISION of
SIDNEY, NEW YORK



Export Sales and Service: Bendix International Division, 205 East 42nd St., New York 17, N. Y.

Canadian Affiliate: Aviation Electric Ltd., 200 Laurentien Blvd., Montreal 9, Quebec

FACTORY BRANCH OFFICES:

117 E. Providencia Ave., Burbank, Calif. • Paterson Building, 18038 Mack Ave., Detroit 24, Mich. • 545 Cedar Lane, Teaneck, N. J. • 5906 North Port Washington Rd., Milwaukee 17, Wisc. • Hulman Building, 120 W. Second St., Dayton 2, Ohio • 2608 Inwood Road, Dallas 19, Texas • 8425 First Ave., South, Seattle 8, Washington • 1701 "K" Street, N.W., Washington 6, D. C.

ELECTRONICS & COMMUNICATIONS, MAY, 1958

For further data on advertised products use page 81.

CPI's NEW DESIGN

SUPER HIGH TEMPERATURE THERMAL SWITCH

- ...SENSITIVE TO TEMPERATURE CHANGE ONLY
- ...UNAFFECTED BY VIBRATION OR OTHER ENVIRONMENTAL CONDITIONS

Here is a new super high temperature thermal switch designed for extremely high temperature applications where very high, close temperature calibration is required with repeated operations. And, its rugged, compact construction provides high resistance to vibration.

Providing a fast, accurate response under extreme service conditions, this *new design* switch has a temperature range for continuous operation from as low as minus 20°F to as high as 1750°F with safe momentary overshoots to 2200°F. It is constructed of special stainless steel alloys with single or two wire leads, and has a resistive rating of 1½ amperes at 28 volts D.C. This lightweight (it weighs only two ounces) switch is available with contacts normally open or normally closed.

Investigate this CPI super high temperature switch — applicable to such uses as jet engines, gas turbines, rocket motors, after burner control — in fact, anywhere that high temperature control is a problem.

New catalog gives engineering data.
Ask for Catalog EL

When temperatures are high (or low), specify CPI.

Control products, inc.

HARRISON, N. J.

News Report

Radiotelephone Coverage Of Trans-Provincial Highway

Mobile radiotelephone coverage of the Southern Trans-Provincial Highway will extend from Vancouver to the Alberta border before the end of the year.

B.C. Telephone Company will spend more than \$100,000 this summer establishing radio terminals at many of the sites which make up the B.C. portion of the Trans-Canada microwave system. Situated on such mountains as Blackwall, Santa Rosa and Phoenix in the southern half of the province, the radio terminals will form an interlocking network providing radiotelephone service to any point on the highway.

The system will also be used in the operation and maintenance of the microwave relay chain which is scheduled to go into service on July 1.

Vehicles equipped with radiotelephones will be able to keep in close touch with home and office when traveling through southern B.C. Signals transmitted from cars or trucks will be picked up by the nearest mountain terminal and relayed directly to a nearby telephone office. There, the local operator will be able to connect the caller to any number he requires.

At the present time, mobile service is given throughout the Lower Mainland to approximately 20 miles east of Hope. Dog Mountain, one of the most spectacular of the Trans-Canada microwave relay sites, is already providing radiotelephone coverage to vehicles in the Hope area.

ORRadio Opens Half Million Dollar Plant

Announcement is made of the completion of a new half million dollar plant in Opelika, Alabama, by ORRadio Industries, Inc., for the manufacture of magnetic recording tape.

Senator John Sparkman, principal speaker on the occasion of the formal opening of the plant, referred to the company as having pioneered in the recording tape industry in America. "Its video tape is helping revolutionize the television industry," he said. "Its instrumentation tape is in demand by the government for use in the missile and rocket program. Its computer tape is widely used in the most modern calculating equipment and the fabulous 'electronic brains'. Its geophysical tape is used by science and industry in subterranean explorations."

ORRadio Industries, Inc. is represented in Canada by Atlas Radio Corporation Ltd., 50 Wingold Avenue, Toronto, Ontario.

TRIPLETT

Reliability...

through 15,631 accepted types

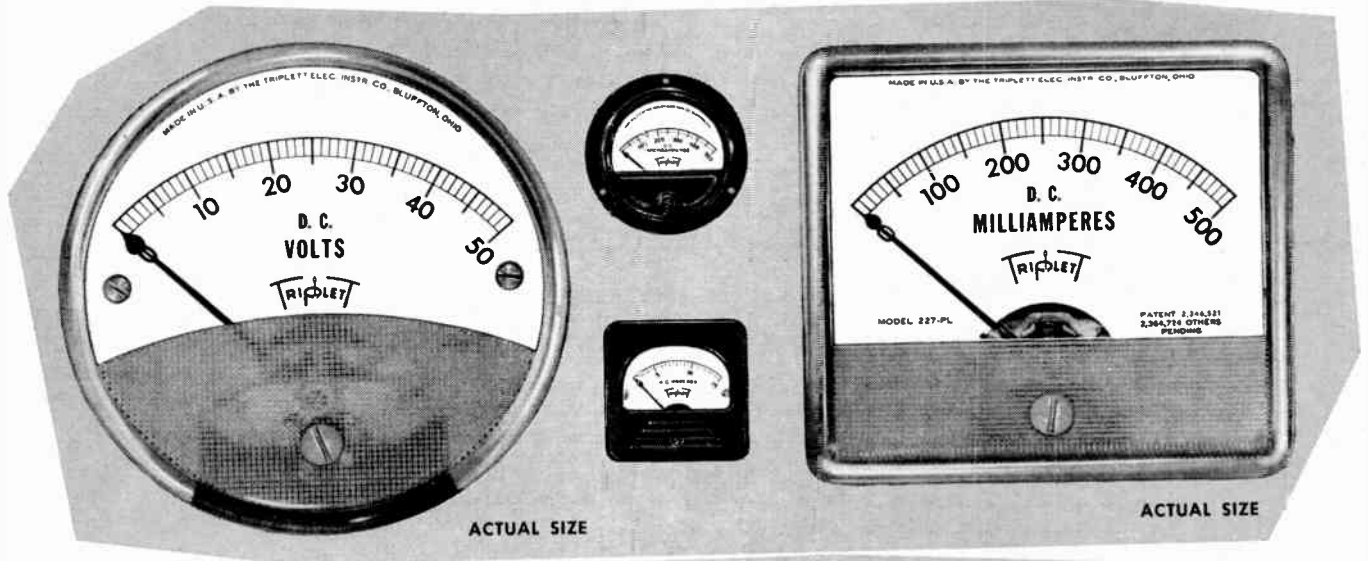

ACTUAL SIZE

ACTUAL SIZE

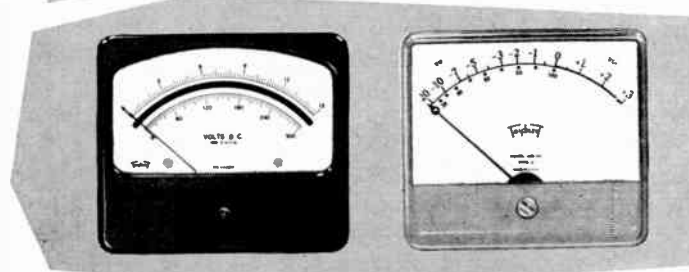
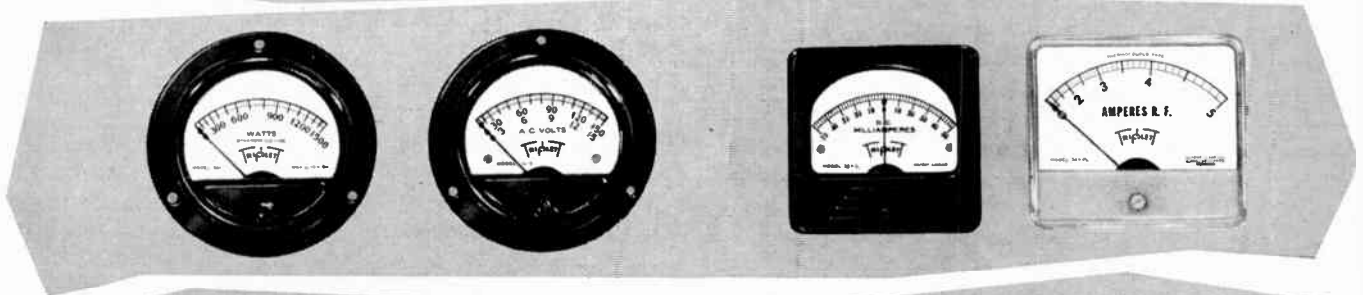

Clear plastic (PL) meters feature;

- Longer scale length
- Visibility unlimited
- Light unobstructed—no shadows
- Interchangeability—universal
- Appearance revolutionized

UNIQUE FEATURES AND CHARACTERISTICS

These guarantee superior quality in *all* TRIPLETT meters:

- High torque to weight ratio for extra rugged movement. Specially developed bearings withstand severe vibration and reduce friction to a minimum.
- Bearings are microscopically graded not only for depth and radius, but also for *polish*. Only best quality jewels are used.
- Unique hardening method assures uniformly hard pivots.
- High flux scientifically aged alnico magnets for greatest permeability. Micrometrically balanced all metal frame construction protects bearings against vibration from any direction.
- Simplicity of frame construction assures easy, accurate alignment in servicing.
- Dials are all metal—no paper dials are ever used—will not become abrasive, warp, crack or discolor under normal conditions. (Printing presses in Triplet's own plant allow fast, inexpensive service on special dial requirements.)
- Extra strong ribbed pointers precisely balanced with triple "slide and lock" adjusting weights.
- Insulations provide extra allowance for breakdown voltages.
- All metal parts processed, all molded parts pre-cured to eliminate distortions from stresses and strains.

BURTON BROWN ADVERTISING

TRIPLETT ELECTRICAL INSTRUMENT COMPANY • 52 years of experience • BLUFFTON, OHIO

Triplet design and development facilities are available for your special requirements for meters and test equipment.

LEN FINKLER & CO.
330 Adelaide Street West
Toronto 2B, Ontario
EMpire 8-5222

C. M. ROBINSON COMPANY
189 Market Street, Winnipeg
325 10th Avenue, Calgary
550 Beatty Street, Vancouver

News Report

Lake Engineering Working Agreement With Elcom Marketing

An agreement has been signed between Lake Engineering Co. Limited and Elcom Marketing Limited — both of Toronto — which will enable these firms to provide a more complete marketing service to their principals and the Canadian electronics industry. This agreement effectively merges the application engineering background of "Lake" and the marketing experience of "Elcom" to provide a complete electronic component service to the industrial consumers.

Included in the products concerned are those of Dialight Corporation, Federal Telephone, Grayhill Inc., Kemtron Electron Products Inc., Stanwyck Coil Products Ltd., Hawkesbury Wire Co. Ltd., Stegg Electric Ltd., Wirt Co., James Knights Co., Siemens Halske and Telefunken.

Expansion Of Canada's Precision Instrument Industry

Further indication of the rapid expansion of Canada's growing precision instrument industry came recently with the announcement by Canadian Applied Research Limited of Toronto that its now-famous R-Theta Navigation Computer System had been chosen by the Belgian Air Force

for installation in its Canadian-built CF-100 jet interceptors.

Under joint Canada-U.S. mutual aid arrangements 53 of the Avro Aircraft CF-100's are being supplied to the Belgian Air Force. Delivery of the aircraft by RCAF aircrew has already begun, and it is expected the order will be completed this summer.

While the amount of the R-Theta contract has not been disclosed, it is expected to be approximately one million dollars.

In making the announcement, J. M. Bridgman, vice-president and general manager of Canadian Applied Research Limited, stated: "This is one of the largest orders for Canadian designed and manufactured electro-mechanical instrumentation equipment ever secured outside Canada in peacetime."

W. F. Souch Western Rep For Caldwell

M. M. Elliott, President of Caldwell A/V Equipment Co. Ltd. of Toronto, has announced that W. F. Souch will act as Western Representative for the firm.

"Doc" Souch is well-known in the radio and television industry, particularly among broadcast engineers in Western Canada. Prior to forming his own company — W. F. Souch and Associates, with headquarters in Winnipeg — he was with the Canadian Marconi Company for over twenty years.

Mr. Souch will handle a complete line of cameras, projectors, film hand-

ling equipment, educational and industrial television equipment along with tape recording equipment manufactured by Stencil Hoffman. Mr. Souch will call on radio and television stations, advertising agencies and industrial accounts in Manitoba, Saskatchewan and Alberta.

Power Industry Computer Application Conference

The first International Conference held on this continent dealing specifically with digital computer applications in the power industry will be held in the King Edward Hotel, Toronto, from September 15 to 17 inclusive.

The conference, under the auspices of the American Institute of Electrical Engineers, will be divided into the following five sections, with well known speakers in this particular field: (1) Design of Rotating Machinery; (2) Design of Non-Rotating Machinery; (3) Electric Power System Analysis and Design; (4) Power System Operating Problems; (5) Power System Economic Studies.

Interesting inspection trips will be made to visit typical computer installations in the Toronto area.

For further information, registration or hotel accommodation, write J. R. Leslie, c/o Ontario Hydro, 620 University Avenue, Toronto 2, Ontario, Canada.

For Best Returns Use
Electronics and Communications



F. V. TOPPING • *Electronics Ltd.*

DESIGN - PRODUCTION - ELECTRONICS

- RADIO FREQUENCY CONTROL EQUIPMENT
- COMMUNICATIONS ACCESSORIES
- CAREFUL CUSTOM PRODUCTION
- TRANSISTORIZED EQUIPMENT
- DC CONVERTERS
- STABLE AIRBORNE AC SUPPLIES

A CANADIAN COMPANY WITH NEW IDEAS

94 LAIRD DRIVE

HU. 9-4325

TORONTO 17, ONTARIO



Beatty Telemasts

FOR COMMERCIAL COMMUNICATIONS

Masts to 200 ft.—single, twin-H, and quadruple — designed to CSA specifications. Hot galvanized steel, resistance welded to Canadian Welding Bureau standards, in accurate jigs that insure easy and perfect erection. 10-foot sections completely hot galvanized after all fabrication. Galvanized hinged steel base and complete line of attachment fittings.

BEATTY BROS. LIMITED
Fergus, Ont. Est. 1874

WANTED

SALES MANAGER with extensive electronic and electro-mechanical background. Responsibilities will include active promotion of several component lines, supervision of distributor programs, sales forecasting and maintenance of good customer and principal relationships. \$5,000-\$8,500.

Box No. 1003
Electronics and Communications
31 Willcocks St. - Toronto 5, Ont.

**YOU'RE AHEAD with
Jensen
AUTHENTIC HI-FI**



**"RED CENTRE LINE"
NEW UNAX, DUAX and
COAXIAL SPEAKERS**

- Jensen's finest line of new advanced-design loud-speakers.
- The most complete range of types and sizes ever available.
- Deliver better sound.
- Higher efficiency.
- Lower cost.

SPECIFICATIONS

Model No.	Type	Size	Frequency Range	Power Rating	Magnet Weight	Canadian User Net
CX-255	3-element	15"	30-15,000 cps	27 w.	1 3/4 lbs.	\$88.00
CX-150	3-element	15"	30-15,000 cps	22 w.	1 lb.	76.50
CX-225	3-element	12"	30-15,000 cps	25 w.	1 3/4 lbs.	68.50
CX-120	3-element	12"	30-15,000 cps	20 w.	1 lb.	57.00
DX-150	2-element	15"	40-13,000 cps	22 w.	1 lb.	41.00
DX-120	2-element	12"	40-13,000 cps	20 w.	1 lb.	29.50
UX-120	Single element	12"	40-12,000 cps	14 w.	1/2 lb.	22.50
UX-80	Single element	8"	50-12,000 cps	12 w.	1/2 lb.	16.75
CK-110	Coaxial 2-way	12"	45-14,000 cps	14 w.	1/2 lb.	22.75

For further information write to Dept. 9

SPEAKER DIVISION J.R. LONGSTAFFE CO. LTD.
300 CAMPBELL AVENUE TORONTO, ONTARIO



Sir Isaac Newton
1642-1727

*"When the time is short
and the pressure's frightening,
They serve my systems
with the speed* of lightning!"*



BECKMAN / BREADBOARD PARTS
For the standard parts
to breadboard your system,
Send for catalog 55E,
where we show 'em and list 'em.

**Within 3 days of order!*

Beckman / Helipot Corporation, Newport Beach, Calif.
a division of Beckman Instruments, Inc.
Canadian Factory: No. 3 Six Points Rd., Toronto 18, Ont.
Sales Representative: R-O-R Associates, Ltd.
1470 Don Mills Road, Don Mills, Ont.

1206

ADCOLA
CADDOUS LIMITED
REGD. TRADE MARK

**MAKERS OF HIGH QUALITY SOLDERING
INSTRUMENTS, HAND PYROMETERS, ETC.**

**Soldering Instruments Available With
1/8", 3/16" and 1/4" Tips**

All Voltages Supplied

List No. 64
3/8" Detach Bit

CSA Approved
Canadian,
British and
Foreign Pats.,
Reg. Designs,
Etc.

Canadian Rep: **L. J. LAMB**
Box 103
Weston, Ont.

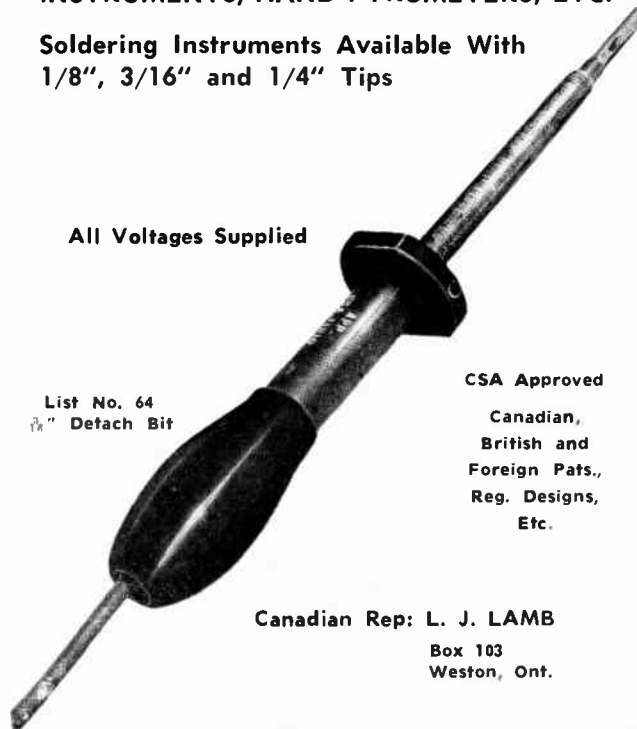

with field proven

G-V THERMAL SENSING RELAYS

G-V Sensing Relays operate contacts when current or voltage to their heaters exceeds or drops below the operating point. They can be selected with a response rate paralleling the action of the equipment. These relays operate quickly on heavy changes but tolerate slight changes until they become dangerous.

Meets military requirements

Write for Engineering Assistance and complete technical Data. Ask for Publication 70.

G-V G-V CONTROLS INC.
54 Hollywood Plaza, East Orange, N.J.

Represented in Canada by:
LEONARD ELECTRIC, LTD., 346 Bering Ave., Toronto 18

Looking for a "POT"?

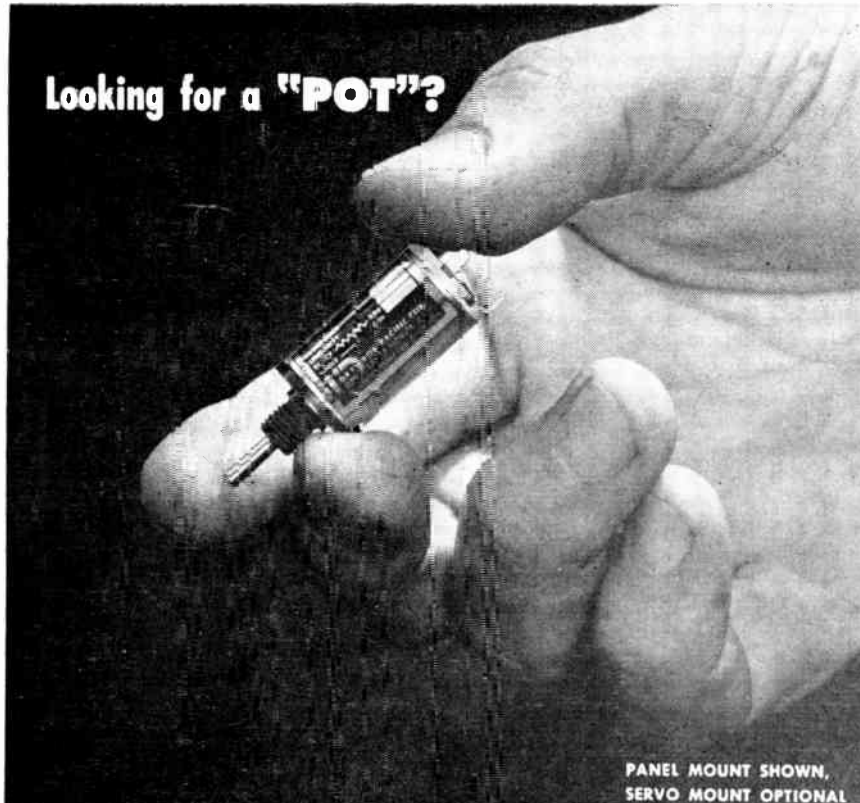

PANEL MOUNT SHOWN,
SERVO MOUNT OPTIONAL

ACTUAL SIZE

SERIES 341 TEN-TURN PRECISION POTENTIOMETER

Smaller in diameter than a fountain pen — no longer than a shriveled up Gryllidae Gryllus*, this tiny "pot" offers ultimate precision in the smallest package on the market.

Check some of the standard specifications of this precision-built, wire-wound, ten-turn potentiometer:

SIZE:	0.55" x 1.02"
WEIGHT:	10 gms. max.
BACKLASH:	Essentially zero
PHASE SHIFT:	Less than 0.1° at 400 cps
VIBRATION:	20gs to 200Q cps (3 attitudes)
POWER:	2.5 watts at 40° C, 0 watts at 140° C

* also known as a cricket

STANDARD MODELS AVAILABLE IN PRODUCTION QUANTITIES NOW . . . SPECIAL REQUIREMENTS CAN USUALLY BE MET. WRITE TODAY FOR COMPLETE INFORMATION CONCERNING THIS AND OTHER MINIATURE WIRE-WOUND, PRECISION POTENTIOMETERS.

Openings exist for highly qualified engineers

WRITE TODAY FOR DETAILS

ACTUAL SIZE

DAYSTROM

LIMITED

840 Caledonia Rd.,
Toronto 19, Ontario
or 5430 Ferrier St.,
Montreal, Quebec.
A Subsidiary of
Daystrom Incorporated.



One-turn, Wire-wound,
Precision
Potentiometer.
LOW COST
HIGH PERFORMANCE

5810

Book Review

Television In Science And Industry by V. K. Zworykin, E. G. Ramberg and L. E. Flory.

The authors point out in the Preface to the book that television, from the angle of mere home entertainment, exhausts only a small fraction of its potentialities. In the book they have endeavored to explore the function of television as an extension of human sight, variously called closed-circuit or industrial television to distinguish it from the more specialized broadcast function, and to describe the tools which have been developed to realize it.

After a brief historical introduction in the first chapter, Chapter 2 proceeds to outline the principal fields of application of television in industry, research, medicine, education, commerce, military affairs, and home and farm.

Chapter 3 describes in detail the equipment which has been developed for closed-circuit television.

Chapter 4 seeks to give a general view of the status of closed-circuit television in 1957.

In Chapter 5 an attempt is made to forecast the future development of closed-circuit television.

Television In Science And Industry is published by John Wiley & Sons, Inc., 440 Fourth Avenue, New York 16, N.Y., contains 300 pages, hard cover bound, price \$10.00.

Industrial Control Circuits by Sidney Platt (Cat. No. 202).

A fundamental knowledge of electronics is all that is required to gain complete familiarity with the basics of this volume. The author looks at the subject through the eyes of a person with little or no knowledge of this field, explaining the circuits that govern the initiation, processing and finishing stages of industrial electronic equipment in a straight-forward, easy-to-understand manner.

Specific industrial applications are used to graphically describe the problems of industrial control. Every phase of control circuits is discussed, including electronic relay control and timing circuits, photoelectric control, power controls and industrial control instrumentation.

Industrial Control Circuits is published by John F. Rider Publisher, Inc., 116 W. 14th St., New York 11, N.Y., and may be obtained through the Canadian representative — Charles W. Pointon Limited, 6 Alcina Avenue, Toronto 10, Ontario. The book contains 194 pages, paper cover bound, price in Canada \$4.10.

Techniques Of Magnetic Recording by Joel Tall with foreword by Edward R. Murrow.

This volume is a unique contribution to a fast developing field. It translates the complexities of a science into practical, easy-to-follow techniques. It is a book for the professional who wants new ideas, new standards of excellence, and a book for the amateur just introduced to magnetic recording.

Beginning with a description of Poulsen's invention of magnetic recording, the author presents a condensed history of developments since 1900. Then he treats the many problems that arise in magnetic recording. Individual chapters are devoted to recording in such areas as medicine, education, and public entertainment and advertising.

The inclusion of descriptions written by the originators of various techniques, extensive quotation from the laboratory notes of pioneers, an extensive glossary, and a comprehensive bibliography make the book invaluable to the amateur and to the professional.

Techniques of Magnetic Recording is published by Brett-Macmillan Ltd., 25 Hollinger Rd., Toronto 16, Ontario, contains 472 pages, hard cover bound, price \$7.95.

(Continued on page 88)

For further data on advertised products use page 81.

ATTENTION CIRCULATION MANAGER

INDEX TO ADVERTISERS

Page number is on the right. Key number for use with READER SERVICE CARDS is on the left.

Key No.	Page No.
1. Adcola Products Ltd.	79
2. Aerovox (Canada) Ltd.	64
3. American Electrical Heater Co.	68
4. Amperite Co.	90
5. Amphenol Canada Ltd.	87
6. Arrow-Hart & Hegeman (Canada) Ltd.	85
7. Associated Electronic Components	13
8. Atlas Instrument Corp. Ltd.	67
9. Automatic Electric Sales (Canada) Ltd.	45
10. Automatic Electric Sales (Canada) Ltd.	46-47
11. Automatic Electric Sales (Canada) Ltd.	48
12. Bach-Simpson Ltd.	6
13. Beatty Bros. Ltd.	78
14. Bell Telephone Co. of Canada, The	88
15. Bendix Aviation Corp.	75
16. Burndy Canada Ltd.	16-17
17. Burton-Rogers Co.	85
18. Caledonia Electronics & Transformers Corp.	62
19. Cambridge Thermionic Corp.	18
20. Canada Wire & Cable Co. Ltd.	7
21. Canadian General Electric Co. Ltd.	69
22. Canadian I.R.E. Convention	20
23. Canadian Lister-Blackstone Ltd.	68
24. Canadian Marconi Co.	3
25. Canadian Marconi Co.	53
26. Canadian Westinghouse Co. Ltd.	4
27. Centralab Canada Ltd.	56
28. Computing Devices of Canada Ltd.	10
29. Control Products, Inc.	76
30. Daly Capacitors Ltd.	55
31. Dawe Instruments Ltd.	63
32. Daystrom Ltd.	80
33. Edo (Canada) Ltd.	66
34. Eitel-McCullough Inc.	23
35. Electro Sonic Supply Co. Ltd.	87
36. Electronic Associates Inc.	22
37. Electronic Service Supply Co.	65
38. Ericsson Telephone Sales of Canada Ltd.	70
39. Freed Transformer Co. Inc.	85
40. G-V Controls Inc.	79
41. General Radio Co.	92
42. Hackbusch Electronics Ltd.	62
43. Hammond Manufacturing Co. Ltd.	84
44. Helipot Corp.	79

(Continued overleaf)

Please ADD my name to the mailing list for **ELECTRONICS & COMMUNICATIONS** (no obligation).

My Name (Please Print)

Mail copies to my home, or business address as noted below.

Street

City Prov.

If you have recently **CHANGED** your address for receiving copies of **E & C** please note former address here:

Company Nature of Business

Signature Position

5-58 (For card to be valid it must be completed in full, including signature)

PLEASE SEND FURTHER INFORMATION ON THE FOLLOWING NEW PRODUCT ITEMS AS NUMBERED BELOW — USE PRODUCT ITEM NUMBERS

- | | | | | | | | | | |
|-------------------------------|-------------------------------|-------------------------------|-------------------------------|-------------------------------|-------------------------------|-------------------------------|-------------------------------|-------------------------------|-------------------------------|
| <input type="checkbox"/> 1944 | <input type="checkbox"/> 1945 | <input type="checkbox"/> 1946 | <input type="checkbox"/> 1947 | <input type="checkbox"/> 1948 | <input type="checkbox"/> 1949 | <input type="checkbox"/> 1950 | <input type="checkbox"/> 1951 | <input type="checkbox"/> 1952 | <input type="checkbox"/> 1953 |
| <input type="checkbox"/> 1954 | <input type="checkbox"/> 1955 | <input type="checkbox"/> 1956 | <input type="checkbox"/> 1957 | <input type="checkbox"/> 1958 | <input type="checkbox"/> 1959 | <input type="checkbox"/> 1960 | <input type="checkbox"/> 1961 | <input type="checkbox"/> 1962 | <input type="checkbox"/> 1963 |
| <input type="checkbox"/> 1964 | <input type="checkbox"/> 1965 | <input type="checkbox"/> 1966 | <input type="checkbox"/> 1967 | <input type="checkbox"/> 1968 | <input type="checkbox"/> 1969 | <input type="checkbox"/> 1970 | <input type="checkbox"/> 1971 | <input type="checkbox"/> 1972 | <input type="checkbox"/> 1973 |

PLEASE SEND FURTHER INFORMATION ON THE FOLLOWING ADVERTISEMENTS AS NUMBERED BELOW — USE KEY NUMBER

- | | | | | | | | | | | | |
|-----------------------------|-----------------------------|-----------------------------|-----------------------------|-----------------------------|-----------------------------|-----------------------------|-----------------------------|-----------------------------|-----------------------------|-----------------------------|-----------------------------|
| <input type="checkbox"/> 1 | <input type="checkbox"/> 2 | <input type="checkbox"/> 3 | <input type="checkbox"/> 4 | <input type="checkbox"/> 5 | <input type="checkbox"/> 6 | <input type="checkbox"/> 7 | <input type="checkbox"/> 8 | <input type="checkbox"/> 9 | <input type="checkbox"/> 10 | <input type="checkbox"/> 11 | <input type="checkbox"/> 12 |
| <input type="checkbox"/> 13 | <input type="checkbox"/> 14 | <input type="checkbox"/> 15 | <input type="checkbox"/> 16 | <input type="checkbox"/> 17 | <input type="checkbox"/> 18 | <input type="checkbox"/> 19 | <input type="checkbox"/> 20 | <input type="checkbox"/> 21 | <input type="checkbox"/> 22 | <input type="checkbox"/> 23 | <input type="checkbox"/> 24 |
| <input type="checkbox"/> 25 | <input type="checkbox"/> 26 | <input type="checkbox"/> 27 | <input type="checkbox"/> 28 | <input type="checkbox"/> 29 | <input type="checkbox"/> 30 | <input type="checkbox"/> 31 | <input type="checkbox"/> 32 | <input type="checkbox"/> 33 | <input type="checkbox"/> 34 | <input type="checkbox"/> 35 | <input type="checkbox"/> 36 |
| <input type="checkbox"/> 37 | <input type="checkbox"/> 38 | <input type="checkbox"/> 39 | <input type="checkbox"/> 40 | <input type="checkbox"/> 41 | <input type="checkbox"/> 42 | <input type="checkbox"/> 43 | <input type="checkbox"/> 44 | <input type="checkbox"/> 45 | <input type="checkbox"/> 46 | <input type="checkbox"/> 47 | <input type="checkbox"/> 48 |
| <input type="checkbox"/> 49 | <input type="checkbox"/> 50 | <input type="checkbox"/> 51 | <input type="checkbox"/> 52 | <input type="checkbox"/> 53 | <input type="checkbox"/> 54 | <input type="checkbox"/> 55 | <input type="checkbox"/> 56 | <input type="checkbox"/> 57 | <input type="checkbox"/> 58 | <input type="checkbox"/> 59 | <input type="checkbox"/> 60 |
| <input type="checkbox"/> 61 | <input type="checkbox"/> 62 | <input type="checkbox"/> 63 | <input type="checkbox"/> 64 | <input type="checkbox"/> 65 | <input type="checkbox"/> 66 | <input type="checkbox"/> 67 | <input type="checkbox"/> 68 | <input type="checkbox"/> 69 | <input type="checkbox"/> 70 | <input type="checkbox"/> 71 | <input type="checkbox"/> 72 |
| <input type="checkbox"/> 73 | <input type="checkbox"/> 74 | <input type="checkbox"/> 75 | <input type="checkbox"/> 76 | <input type="checkbox"/> 77 | <input type="checkbox"/> 78 | <input type="checkbox"/> 79 | <input type="checkbox"/> 80 | <input type="checkbox"/> 81 | <input type="checkbox"/> 82 | <input type="checkbox"/> 83 | <input type="checkbox"/> 84 |

Name Position

Company Nature of Business

Company Address City Prov.

5-58

PLEASE SEND FURTHER INFORMATION ON THE FOLLOWING NEW PRODUCT ITEMS AS NUMBERED BELOW — USE PRODUCT ITEM NUMBERS

- | | | | | | | | | | |
|-------------------------------|-------------------------------|-------------------------------|-------------------------------|-------------------------------|-------------------------------|-------------------------------|-------------------------------|-------------------------------|-------------------------------|
| <input type="checkbox"/> 1944 | <input type="checkbox"/> 1945 | <input type="checkbox"/> 1946 | <input type="checkbox"/> 1947 | <input type="checkbox"/> 1948 | <input type="checkbox"/> 1949 | <input type="checkbox"/> 1950 | <input type="checkbox"/> 1951 | <input type="checkbox"/> 1952 | <input type="checkbox"/> 1953 |
| <input type="checkbox"/> 1954 | <input type="checkbox"/> 1955 | <input type="checkbox"/> 1956 | <input type="checkbox"/> 1957 | <input type="checkbox"/> 1958 | <input type="checkbox"/> 1959 | <input type="checkbox"/> 1960 | <input type="checkbox"/> 1961 | <input type="checkbox"/> 1962 | <input type="checkbox"/> 1963 |
| <input type="checkbox"/> 1964 | <input type="checkbox"/> 1965 | <input type="checkbox"/> 1966 | <input type="checkbox"/> 1967 | <input type="checkbox"/> 1968 | <input type="checkbox"/> 1969 | <input type="checkbox"/> 1970 | <input type="checkbox"/> 1971 | <input type="checkbox"/> 1972 | <input type="checkbox"/> 1973 |

PLEASE SEND FURTHER INFORMATION ON THE FOLLOWING ADVERTISEMENTS AS NUMBERED BELOW — USE KEY NUMBER

- | | | | | | | | | | | | |
|-----------------------------|-----------------------------|-----------------------------|-----------------------------|-----------------------------|-----------------------------|-----------------------------|-----------------------------|-----------------------------|-----------------------------|-----------------------------|-----------------------------|
| <input type="checkbox"/> 1 | <input type="checkbox"/> 2 | <input type="checkbox"/> 3 | <input type="checkbox"/> 4 | <input type="checkbox"/> 5 | <input type="checkbox"/> 6 | <input type="checkbox"/> 7 | <input type="checkbox"/> 8 | <input type="checkbox"/> 9 | <input type="checkbox"/> 10 | <input type="checkbox"/> 11 | <input type="checkbox"/> 12 |
| <input type="checkbox"/> 13 | <input type="checkbox"/> 14 | <input type="checkbox"/> 15 | <input type="checkbox"/> 16 | <input type="checkbox"/> 17 | <input type="checkbox"/> 18 | <input type="checkbox"/> 19 | <input type="checkbox"/> 20 | <input type="checkbox"/> 21 | <input type="checkbox"/> 22 | <input type="checkbox"/> 23 | <input type="checkbox"/> 24 |
| <input type="checkbox"/> 25 | <input type="checkbox"/> 26 | <input type="checkbox"/> 27 | <input type="checkbox"/> 28 | <input type="checkbox"/> 29 | <input type="checkbox"/> 30 | <input type="checkbox"/> 31 | <input type="checkbox"/> 32 | <input type="checkbox"/> 33 | <input type="checkbox"/> 34 | <input type="checkbox"/> 35 | <input type="checkbox"/> 36 |
| <input type="checkbox"/> 37 | <input type="checkbox"/> 38 | <input type="checkbox"/> 39 | <input type="checkbox"/> 40 | <input type="checkbox"/> 41 | <input type="checkbox"/> 42 | <input type="checkbox"/> 43 | <input type="checkbox"/> 44 | <input type="checkbox"/> 45 | <input type="checkbox"/> 46 | <input type="checkbox"/> 47 | <input type="checkbox"/> 48 |
| <input type="checkbox"/> 49 | <input type="checkbox"/> 50 | <input type="checkbox"/> 51 | <input type="checkbox"/> 52 | <input type="checkbox"/> 53 | <input type="checkbox"/> 54 | <input type="checkbox"/> 55 | <input type="checkbox"/> 56 | <input type="checkbox"/> 57 | <input type="checkbox"/> 58 | <input type="checkbox"/> 59 | <input type="checkbox"/> 60 |
| <input type="checkbox"/> 61 | <input type="checkbox"/> 62 | <input type="checkbox"/> 63 | <input type="checkbox"/> 64 | <input type="checkbox"/> 65 | <input type="checkbox"/> 66 | <input type="checkbox"/> 67 | <input type="checkbox"/> 68 | <input type="checkbox"/> 69 | <input type="checkbox"/> 70 | <input type="checkbox"/> 71 | <input type="checkbox"/> 72 |
| <input type="checkbox"/> 73 | <input type="checkbox"/> 74 | <input type="checkbox"/> 75 | <input type="checkbox"/> 76 | <input type="checkbox"/> 77 | <input type="checkbox"/> 78 | <input type="checkbox"/> 79 | <input type="checkbox"/> 80 | <input type="checkbox"/> 81 | <input type="checkbox"/> 82 | <input type="checkbox"/> 83 | <input type="checkbox"/> 84 |

Name Position

Company Nature of Business

Street City Prov.

3-58

BUSINESS REPLY CARD
No Postage Stamp Necessary if Mailed in Canada

5c POSTAGE WILL BE PAID BY

ELECTRONICS AND COMMUNICATIONS

31 - 35 Willcocks Street

Toronto 5, Ontario



BUSINESS REPLY CARD
No Postage Stamp Necessary if Mailed in Canada

5c POSTAGE WILL BE PAID BY

ELECTRONICS AND COMMUNICATIONS

31 - 35 Willcocks Street

Toronto 5, Ontario



BUSINESS REPLY CARD
No Postage Stamp Necessary if Mailed in Canada

5c POSTAGE WILL BE PAID BY

ELECTRONICS AND COMMUNICATIONS

31 - 35 Willcocks Street

Toronto 5, Ontario



INDEX TO ADVERTISERS

Key No.	(Continued)	Page No.
45.	Hughey & Phillips Inc.	86
46.	International Resistance Co. Ltd.	85
47.	Kester Solder Co.	66
48.	Electronic Research Laboratories	86
49.	Longstaffe Co. Ltd., J. R.	79
50.	Longstaffe Co. Ltd., J. R.	63
51.	Magnetics Inc.	89
52.	Marsland Engineering Ltd.	60
53.	Muirhead & Co. Ltd.	72
54.	Narda Corp., The	19
55.	National Fibre Co. of Canada Ltd.	57
56.	Nichols Ltd., R H.	63
57.	Northern Electric Co. Ltd.	8
58.	Phillips Electrical Co. Ltd.	14
59.	Pointon & Co., Charles W.	2
60.	Polypenco Inc.	75
61.	Pylon Electronic Development Co. Ltd.	75
62.	Rogers Electronic Tubes & Components (A Div. of Phillips Industries Ltd.)	21
63.	Rohn Manufacturing Co.	64
64.	Salon International De La Piece Detachee Electronique	84
65.	Sanborn Co.	59
66.	Siemens Brothers (Canada) Ltd.	86
67.	Sinclair Radio Laboratories Ltd.	55
68.	Snelgrove & Co. Ltd., C. R.	58
69.	Sprague Electric International Ltd.	86
70.	Syntron (Canada) Ltd.	74
71.	Tektronix Inc.	61
72.	Tele-Radio Systems Ltd.	71
73.	Telephone Mfg. Co. Ltd.	87
74.	Topping Electronics Ltd., F. V.	78
75.	Triplet Electrical Instrument Co., The	77
76.	Tung-Sol Electric Inc.	83
77.	Veeder-Root of Canada Ltd.	73
78.	Ward Leonard of Canada Ltd.	91

ACTIVE CIRCULATION

It costs us a lot of active dollars annually to keep our circulation lists up-to-date and it's important enough to us that we have them audited every year by CCAB (Canadian Circulations Audit Board Inc.)

Advertisers trust CCAB audited figures so we get more advertisers and YOU get the high standard of editorial you have always wanted to read.

ELECTRONICS and COMMUNICATIONS

is a



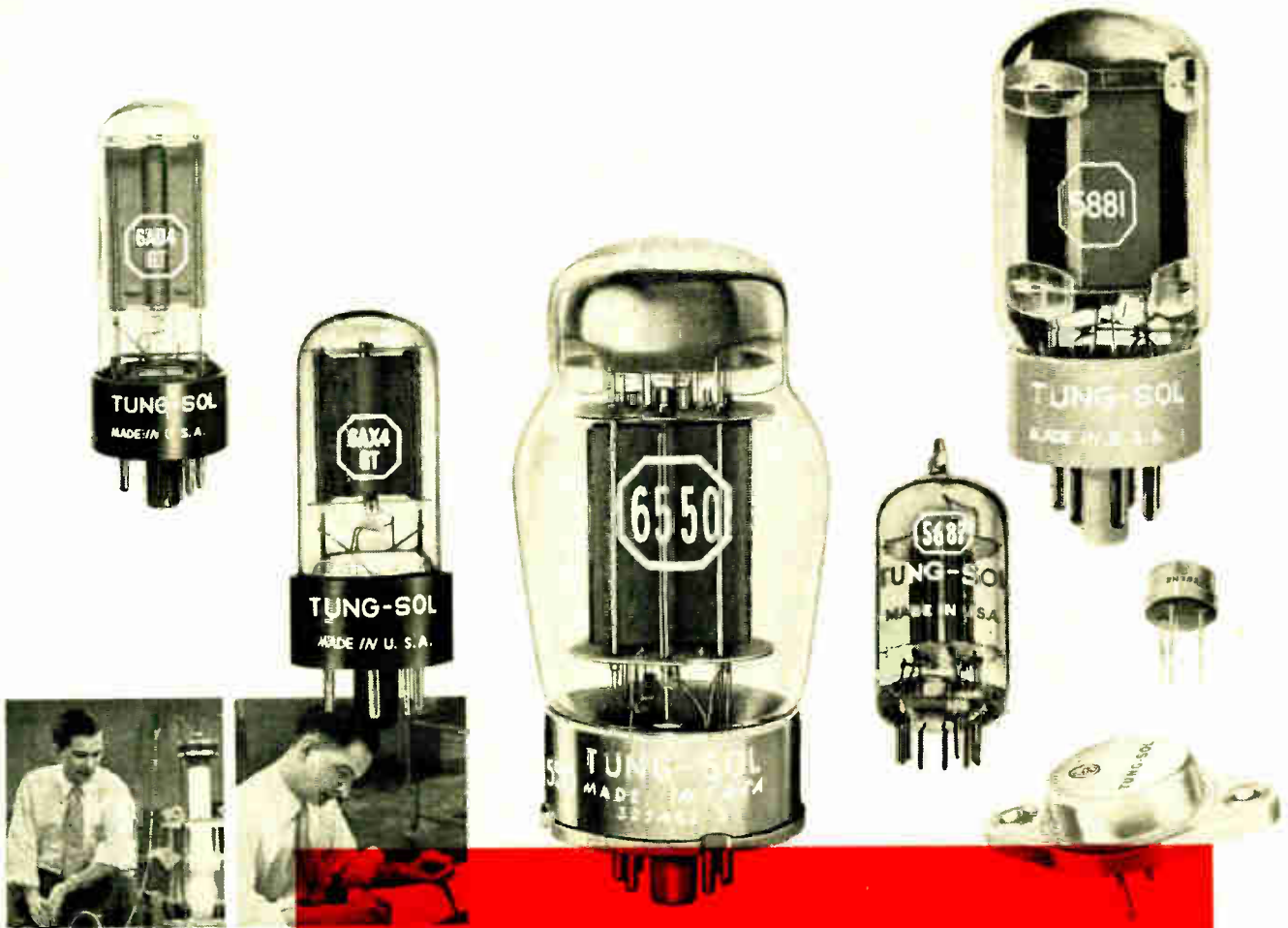

**RESEARCH, DESIGN, DEVELOPMENT
AND QUALITY PRODUCTION IN VOLUME**



TUNG-SOL®

ELECTRON TUBE DIVISION TUNG-SOL ELECTRIC INC., NEWARK 4, N. J.
IN CANADA: ALPHA ARACON RADIO CO., LTD., TORONTO, ONT.

Ready for Industry!

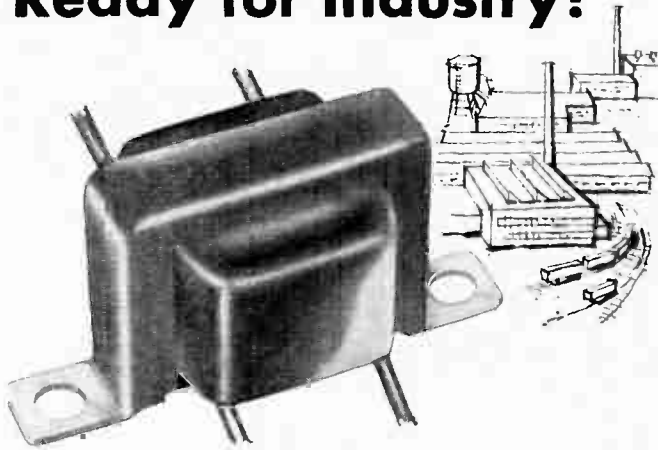

HAMMOND TRANSISTOR TRANSFORMERS

Over the past few years Hammond has developed numbers of miniature transformer prototypes for use in the communications, aviation, and instrumentation industries. Now . . . thoroughly tested and proven in use . . . Hammond presents:

the New "44 THOUSAND SERIES" featuring

- encapsulation
- low insertion loss
- low distortion
- wide frequency response
- four different mountings
- a core size for each power level
- 56 impedance ratios from stock

Complete electrical and mechanical specifications available with cross reference guide to exact equivalents of currently popular American types. Write for Bulletins 5200/5202/5203.

SOME HAMMOND (MINIATURE) SPECIALS



"clinch lug" mounting for production use.



for printed circuit work under adverse environmental conditions.



for printed circuit applications.

Let Hammond undertake the design, development, and precision manufacture of your Audio . . . Power . . . Pulse . . . and High-Frequency Transformers. If your requirement is not met by a stock item the factory will build a "transformer" to your specifications. Enquiries for large or small quantities are invited.

STANDARD ITEMS STOCKED BY JOBBERS COAST TO COAST

HAMMOND MANUFACTURING COMPANY LIMITED

H/57/8

GUELPH, ONTARIO, CANADA

Since 1927 - Canada's Transformer Specialists

20 th. June / 26 th. June.

PARIS

SALON INTERNATIONAL DE LA PIÈCE DÉTACHÉE ÉLECTRONIQUE

INTERNATIONAL
EXHIBITION
OF ELECTRONIC
COMPONENTS.

The largest technical display
in the world
in the field
of electronics.

EXHIBITION PARK
PORTE DE VERSAILLES
PARIS
FRANCE



For all enquiries, apply to :
"Commissariat Général
du Salon de la Pièce Détachée"
23, rue de Lübeck, PARIS-16^e
Téléphone : PASSy 01-16

For further data on advertised products use page 81.

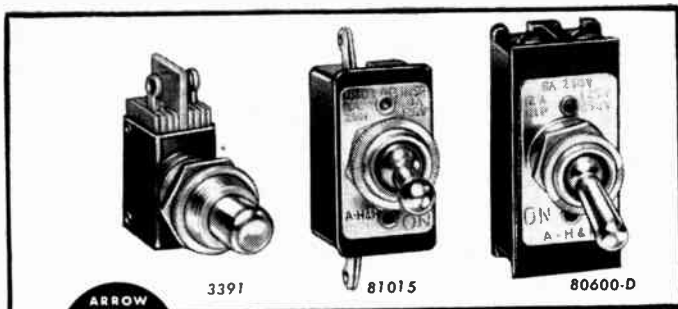

**NEW
ARROW-HART**

Switch Controls

Stronger . . . More Compact

A complete new range of one-hole mounting, quick make and break switches for vacuum sweepers, fans, power tools, etc., and radio and electronic equipment.

Send for your copy of the new illustrated Bulletin Z-2, today. Ask us for any additional advice and information you may need.

ARROW-HART & HEGEMAN
(CANADA) LIMITED
Industry Street, Toronto 15, Ontario, RO. 2-1101
7365 Mountain Sights, Montreal, Que.



Representatives:
Cochrane Stephenson (Western) Ltd., Winnipeg, Calgary,
Edmonton, Vancouver; George C. Robinson, St. John, N.B.

5703

SPECIFY Hoyt METERS



No. 653 illustrated

FOR
EVERY
APPLICATION

NOW! 2 1/2, 3 1/2, 4, 4 1/2 inch, anti-static treated, AC or DC meters with clear polystyrene cases for modern installations. Feature standard or matched colors on lower frosted panel for appearance and functional identification.

Be sure of the highest accuracy, dependability, and readability PLUS economy with HOYT precision AC and DC instruments — the complete line of Panel Meters. Moving coil, rectifier, and repulsion types available in a wide variety of sizes, ranges, cases, and colors. Also, custom-designed (including 400-800+ cycle applications) to meet your most rigid specifications for a quality instrument.

Write Export Manager — new illustrated literature contains descriptions, engineering data, and prices.



Prompt Delivery —
M/A Forms mailed
on day of shipment.

Service Facilities —
strategically located in
Canada.



ELECTRICAL INSTRUMENTS
Sales Div.: BURTON-ROGERS COMPANY
42 Carleton Street, Cambridge 42, Mass., U.S.A.

FREED VARIABLE TEST VOLTAGE MEGOHMMETER



NO. 1620

The Freed Type 1620 Megohmmeter is a versatile insulation resistance measurement instrument with a continuously variable DC test potential from 50 to 1000 volts.

Components such as transformers, condensers, motors, printed circuits, cables and insulation material can be tested at their rated voltage and above, for safety factor.

- Resistance — 0.1 megohms to 4,000,000 megohms.
- Voltage — variable, 50 - 1000 volts.
- Accurate — plus or minus 5% on all ranges.
- Simple — for use by unskilled operators.
- Safe — high voltage relay controlled.
- Self contained — AC operated.

OTHER MEGOHMMETERS AVAILABLE:

Type 1620C MEGOHMMETER — a type 1620 with additional circuitry for testing capacitors.

Type 1020B MEGOHMMETER — a 500 volt fixed test potential. Range 1 megohm to 2 million megohms.

Type 2030 PORTABLE MEGOHMMETER — battery operated, 500 volt test potential. Range 1 megohm to 10 million megohms.

Send for NEW 48 page transformer catalog. Also ask for complete laboratory test instrument catalog.

FREED TRANSFORMER CO., INC.

1716 WEIRFIELD ST., BROOKLYN (RIDGEWOOD) 27, N.Y.



DO YOU HAVE A HIGH TEMPERATURE PROBLEM ?

IRC have designed the Pyrolytic Alloy resistor Type PVX which can operate in high ambient temperatures with improved high voltage load stability.

APPLICATIONS

- high voltage bleeders
- TV high voltage circuits
- Cathode ray tube circuits
- Protective equipment for high voltage circuits
- Photo-electric cell applications
- Ionization chambers
- High voltage transformer enclosures
- X-ray equipment
- High voltage meter multipliers
- Ambient temperature of up to 150° C.
- Precipitrons
- High range moderate cost resistor applications



For further information write to:

INTERNATIONAL RESISTANCE CO. LTD.

349 CARLAW AVE.

TORONTO 8, ONT.

Radiovision Sales Ltd.
325 Tenth Ave. West
Calgary, Alta.

SALES OFFICES:
492 Somerset St. West
Ottawa
Ont.

1500 St. Catherine St. West
Montreal
Que.

NEW!
DOUBLE OBSTRUCTION LIGHT
 ... Side Conduit Entrance Type

**HIGH QUALITY — LIGHT WEIGHT
 SIMPLE — POSITIVE LATCH
 FOR EASIER MAINTENANCE**

In accordance with
 DEPT. of TRANSPORT SPECS.

MODEL OB24 DOUBLE OBSTRUCTION LIGHT

SIDE conduit entrance type to facilitate installation on horizontal conduit runs. Available in 3/4" or 1" conduit tap.

MODEL OB22 DOUBLE OBSTRUCTION LIGHT

BOTTOM conduit entrance type to facilitate installation on vertical conduit runs. Available in 1" conduit tap.

MODEL KG 114 300MM BEACON

Complete with two Aviation Red Color Filters. For two 500 (or 620) watt lamps. Ventilated Dome to improve lamp life. Available in 3/4" or 1" conduit tap.

Request Descriptive Literature

HUGHEY & PHILLIPS, INC.

Manufacturers of
 300MM Beacons, Obstruction Lights, Photo-Electric Controls, Beacon Flashers, Special Junction Boxes, Microwave Tower Light Control & Alarm Systems, Remote Lamp Failure Indicator Systems, and Complete Kits for: Tower Lighting, Sleet-melter Power & Control.

3200 NORTH SAN FERNANDO BLVD.
 BURBANK, CALIF.

In Canada BEECHEY ENTERPRISES
 290 Lawrence Avenue West
 Toronto 12, Ontario, Canada



SURFACE-BARRIER TRANSISTORS

Sprague is a major source for reliable surface-barrier transistors for high frequency and computer applications.

CANADIAN MANUFACTURING REPRESENTATIVE

Micarta Fabricators Limited
 18 Toronto Street
 Toronto, Ontario
 Phone EMpire 8-4251

**WANTED:
 SALESMAN**

Sales Engineer required by leading representative organization to sell components to industrial accounts in the Toronto area. Send complete details to

Box No. 341

Electronics and Communications

**31 Willcocks Street
 Toronto 5, Ont.**

THE CENTENARY NEOPHONE

IN ITS HUNDREDTH YEAR OF OPERATIONS

SIEMENS EDISON SWAN LIMITED

INTRODUCE THE FIRST TELEPHONE INSTRUMENT EMPLOYING A PRINTED CIRCUIT

OTHER FEATURES INCLUDE:

- 3 CASE COLOURS
- 7 HANDSET COLOURS
- LIGHTEST HANDSET (7 OZS.)
- NYLON CORDS

FURTHER DETAILS, PRICE, AND DELIVERY AVAILABLE ON REQUEST

SIEMENS BROTHERS (CANADA) LIMITED

419 NOTRE DAME AVENUE
 WINNIPEG 2 - MANITOBA

BRANCH OFFICES: EDMONTON, ALBERTA
 HALIFAX, NOVA SCOTIA

STOCK DELIVERY

SYNCHROS PRECISION
 RELAYS POTENTIOMETERS
 TUBES SERVO MOTORS
 DIODES SYNCHRONOUS MOTORS
 METERS PULSE TRANSFORMERS
 TRANSISTORS

LABORATORY TEST EQUIPMENT
 MICROWAVE EQUIPMENT

*Listed Below Are Typical Values
 From Our 16 Page Bargain Catalog
 (Available Upon Request)*

WINSLOW model 5G-1000 MEGOHMMETER — Insulation Resistance Test Set — hand cranked generator — Range 0-1000 megohms at 500 VDC \$129.50

GENERAL RADIO Type 715AE DIRECT CURRENT AMPLIFIER in portable Esterline Angus case \$250.00

SOLA #30710 2KVA CONSTANT VOLTAGE TRANSFORMER — Pri — 95-125/190-250 V 50 or 60 cy. Sec—115 V ±1% regulation 2000VA \$125.00

BOSTON Cat. #UD-48 GEAR REDUCTORS — Ratio 48 to 1—0.25 HP at 1800 RPM \$ 32.50

HELIPOT Mod. B PRECISION POTENTIOMETERS — 10K ohms, 15 turns, 10 watts, linearity 0.02% \$24.50

VANDYKE PRECISION POTENTIOMETERS—50K ohms, 10 turns, linearity 0.5%, hermetically sealed \$ 8.50

115-Volt 60-cy Synchros

Type 1G Generators \$37.50
 Type 1F Motors 37.50
 Type 1CT Control Transformers 37.50
 Type 1DG Differential Generators 45.00
 Type 3HG Generators 62.50
 Type 3F Motors 62.50
 Type 3HCT Control Transformers 62.50
 Type 3D Differential Motors 62.50
 Type 3HDG Differential Generator 62.50

MANY OTHER STANDARD TYPES
 IN STOCK

ELECTRONIC RESEARCH LABS
 718 Arch Street Phila. 6, Pa.
 Phone — MArket 7-6771

ELMENCO CAPACITORS

FOIL MICA SILVERED MICA
DUR-MICA (Dipped Mica)

All types available from stock.
Government release notes if required.

For Catalogue and Price List

call WA 4-9301
write
ELECTRO SONIC
SUPPLY CO. LTD.
Industrial Sales Division

543 YONGE ST., TORONTO 5
your one stop for
automatic control components



AMPHENOL
manufacture coaxial cable
in Canada and are
fully equipped

- ... to TEST cable to specifications JAN-C-17A, MIL-C-17B & JCNAAF-C-55;
- ... to SWEEP & TEST all polyethalene dielectric coaxial cable with officially calibrated equipment.

Test Certificate accompanies all Amphenol Cable Shipments.

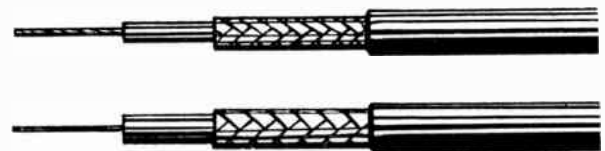

For further information write to Dept. 10

AMPHENOL CANADA LIMITED
300 CAMPBELL AVE.
TORONTO - ONTARIO

"better to hear you with"

In the rural areas of Canada, T.M.C. Magneto Telephone Equipment has been keeping open vital communications for almost a decade. Suppliers to many of the world's major telephone users for over forty years, T. M. C. equipment has the features for which you are seeking. Rugged construction, stylish appearance, easy maintenance, highly competitive initial cost. Telephone EM. 6-5314 or call at our showroom to discuss your problems with our engineers.

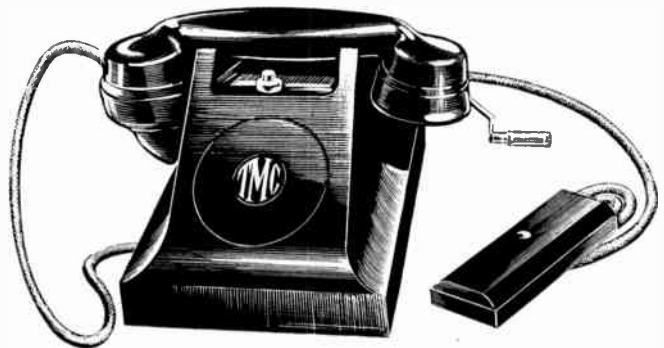

Magneto Telephone Switchboards

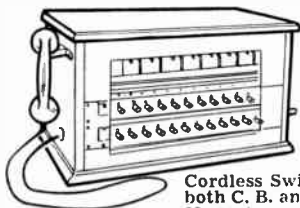

Cordless Switchboards both C. B. and Magneto

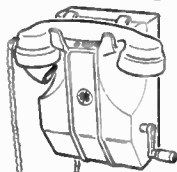

Magneto Wall Telephone



MAGNETO TELEPHONES

TELEPHONE MANUFACTURING CO. LTD.
Saxony Building, 26 Duncan Street, Toronto

Write For Technical Details
To Department EC

Book Review

(Continued from page 80)

Power System Communications edited by E. Openshaw Taylor has seven contributing lecturer-authors.

This is the third book dealing with a particular aspect of Power System operation based on a series of advanced lectures given at the Heriot-Watt College, Edinburgh, Scotland.

The lectures were intended to bring modern developments to the notice of practising engineers and their success led to requests for their publication in book form. The two previous books have dealt with "Power System Transients" and "Power System Plant."

The present volume covers a branch of the subject that has hitherto been thought rather specialized but which now forms an essential part of the power engineer's knowledge and experience.

Separate chapters are devoted to the following subjects: Communication Circuits; Apparatus; Post Office Plant; Carrier-Current Equipment; Radio and Television Equipment; Supervisory Control; Telemetry; and Intertripping.

An Appendix of Graphical Symbols for telecommunication equipment completes a book which will be invaluable to all engineers who require reliable information on practical developments and applications in the field of power system communications.

Power System Communications is published by British Book Service (Canada) Ltd., 1068 Broadview Avenue, Toronto 6, Ontario, contains 304 pages, hard cover bound, price \$7.50.

The Ultra High Frequency Performance Of Receiving Tubes by W. E. Benham and I. A. Harris.

This is a detailed and easily-understood theoretical account of the behavior of radio receiving tubes at ultra high frequencies. The book supplies a thorough explanation of the interaction between tube and circuit and an appreciation of the advantages and limitations of space-charge control tubes.

In line with the increasing use of vhf and uhf bands, the treatment is aimed solely toward the uhf properties of ordinary tubes (chiefly triodes) which show promise of outstanding performances as low noise amplifiers, as oscillators, and to a lesser extent, as mixers.

The theory of the conventional tube is presented as a circuit element, enabling linear circuit analysis to be applied to the problem of tube amplifiers for small signals at ultra high frequencies.

A simple yet detailed account of the electronic processes in a tube forms a basis for the uhf theory of the tube and also provides a sound introduction to the transit time theory of thermionic devices.

The book is commended to those who are seeking to understand principles, particularly in relation to the part played by valves as circuit elements.

The Ultra High Frequency Performance Of Receiving Tubes is published by McGraw-Hill Company of Canada Limited, 253 Spadina Road, Toronto 4, Ontario, contains 173 pages, hard cover bound, price \$7.50.

Keep
vehicles
busy...

save
time and
money...

with a BELL 2-WAY RADIOPHONE SYSTEM

Today, business and industry are increasing efficiency through direct communication with vehicles. Bell can provide such a system at surprisingly low cost. You don't buy any equipment—your private mobile facilities are engineered, installed and serviced by Bell with no cost to you for investment... upkeep... or obsolescence.

Call your Bell Business Office.

IN ACTION (see photos left)

- helping contractors cut costly delays
- helping police, fire and other departments
- speeding work of lift trucks and freight vehicles
- saving time on railroads
- cutting costs in petroleum and gas industries



THE BELL TELEPHONE COMPANY OF CANADA

Plan To Attend The
IRE CONVENTION

Exhibition Park - Toronto
October 8-9-10, 1958

For further data on advertised products use page 81.

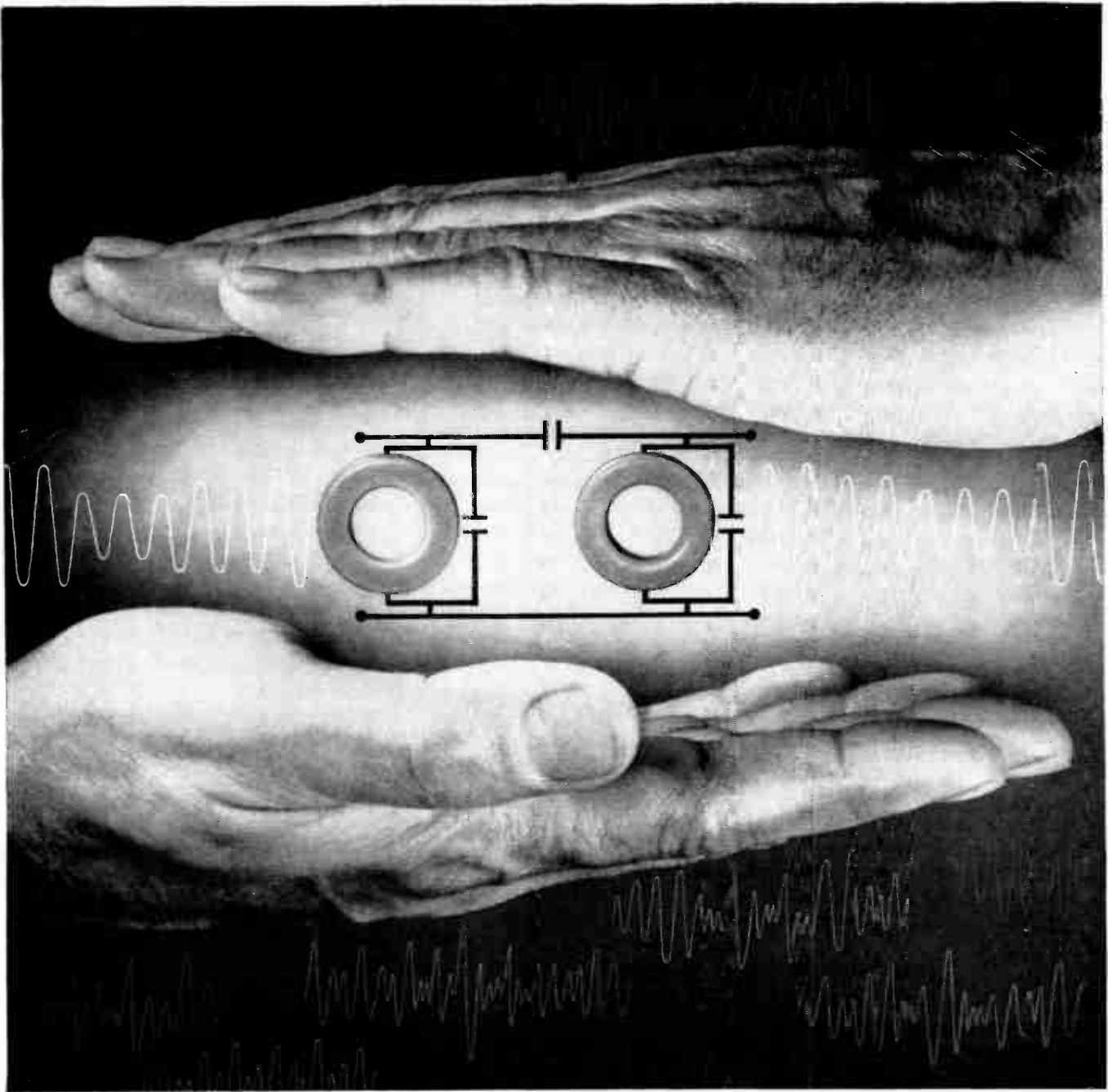

Now—guaranteed practical inductance limits for regular and frequency-stabilized permalloy powder cores

Call them frequency-stabilized or temperature stabilized, the important thing about these new molybdenum permalloy powder cores made by Magnetics, Inc., is our *guarantee* of core inductance within realistic limits. You can write—right now—for these guaranteed limits.

Filter circuit designers will take note that these guaranteed limits for permalloy powder cores are far tighter than those published before. Note also that they are guarantees on inductance which is the parameter of chief concern to the core user rather than on permeability.

This can save you dollars on your production line—by cutting down on adjustment of number of windings on coils.

And you know, too, that temperature stabilization eliminates difficult compensation problems.

But did you know that we guarantee these new inductance limits for all of our permalloy cores, whether stabilized or not? For all the facts, write us at *Magnetics, Inc., Dept. EC-47, Butler, Pennsylvania.*

MAGNETICS inc.

AMPERITE PREFERRED

by design engineers—because they're
MOST COMPACT • SIMPLEST • MOST ECONOMICAL
HERMETICALLY SEALED



Also — Amperite Differential Relays: Used for automatic overload, under-voltage or under-current protection.

PROBLEM? Send for Bulletin No. TR-81

BALLAST REGULATORS

Amperite Regulators are designed to keep the current in a circuit automatically regulated at a definite value (for example, 0.5 amp.) ... For currents of 60 ma. to 5 amps. Operate on A.C., D.C., or Pulsating Current.

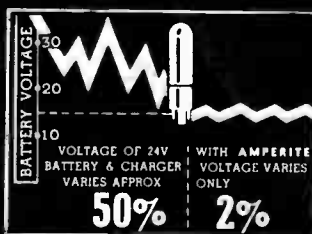

Hermetically sealed, they are not affected by changes in altitude, ambient temperature (-55° to $+90^{\circ}$ C.), or humidity. . . Rugged, light, compact, most inexpensive. . . . List Price, \$3.00.

Write for 4-page Technical Bulletin No. AB-51



AMPERITE CO. Inc., 561 Broadway, New York 12, N. Y.

Telephone: CAnal 6-1446

In Canada: Atlas Radio Corp., Ltd., 50 Wingold Ave., Toronto 10

TECHNICAL PERSONNEL AVAILABLE

Technical Personnel Available classified ads are offered as a service by Electronics and Communications to those seeking employment in the electronics and communications or allied industries. You are invited to send particulars of your qualifications to the editor.

MANAGER. P.Eng., age 39. Bus. Adm. Graduate. Available for responsible position in general management or marketing. Background: Communications, Automotive Batteries, Electrical Appliances, Industrial Electronics. Experience: Production Engineer, Product Sales Manager, Administrative Assistant, Marketing Manager, Commercial Research Manager-Market Research and Industrial Development. Reply to Box 518, Electronics and Communications.

ELECTRONIC TECHNICIAN — age 26. Received from the Ryerson Institute of Technology an Electronic Engineering Technicians diploma on completion of three-year course. Has had experience in field of Geophysics in Edmonton, Alberta, where duties involved the completion of Gamma-Ray and Neutron Logs on semi-completed oil wells. Also worked with Toronto firm in field of Aeronautics, servicing and testing the Altitude Controller and the Airspeed Compensator for the Auto-Pilot system of the CF-100 fighter aircraft. Reply to Box 520, Electronics and Communications.

ELECTRONIC ENGINEER — member IRE, versed in radar, radio and telephone communications, systems facilities, in development, installation and maintenance, sales, supervisory-managerial phases. Especially strong in field or application work. Security clearance up to secret. Desires responsible, challenging position with progressive firm. Reply to Box 521, Electronics and Communications.

INDUSTRIAL EDITOR and WRITER: age 43, ten years as editor of production management and chemical magazines, plus a year and a half as advertising manager of electrical manufacturer. Personal interest tends toward public and industrial relations, B.A. (mainly in science), (R.C.A.F. as navigator). Reply to Box 522, Electronics and Communications.

ADVERTISING AND SALES Promotion Manager, age 25; experience in industrial and consumer advertising, marketing, sales promotion and merchandising. Capable of handling entire department. Experience extends to radio and TV, also conventions, sales meetings, public relations, catalogue preparation and agency liaison. Familiar with Communications, Telephone, Television, Scientific Instruments and Domestic Products. Ryerson graduate. Reply to Box 523, Electronics and Communications.



VITROHM RESISTORS



VITROHM RING RHEOSTATS

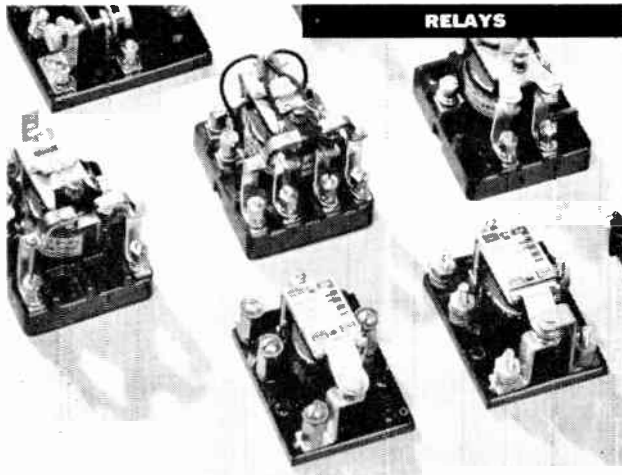

RELAYS

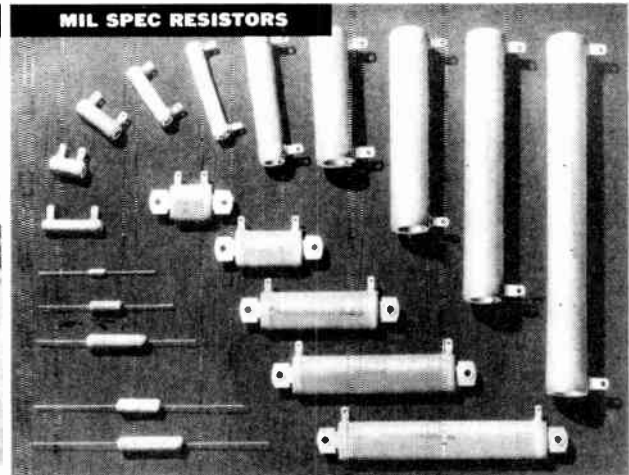

MIL SPEC RESISTORS

4 tips for design engineers

VITROHM® Resistors, stock and made to order

FORM	WATTS		RESISTANCE VALUES (ohms)	
	Stock	Made to Order	Stock	Made to Order
VITROHM: Fixed	5 to 200	5 to 218	1 to 250,000	0.2 to 1,750,000
Adjustohm	10 to 200	10 to 218	1 to 150,000	0.3 to 525,000
STRIPOHM	20 to 75	20 to 75	1 to 65,000	0.1 to 115,000
AXIOHM	3, 5, 10	3, 5, 10	1 to 50,000	0.25 to 50,000
NON-INDUCTIVE	35 to 160	10 to 160	1 to 1,000	0.86 to 14,000
PLAQOHM	25 to 150	25 to 150	1 to 10,000	0.5 to 86,400
DISCOHM	24	24	1 to 4,000	1 to 5,760
RIBFLEX	Not Available	75 to 550	Not Available	0.04 to 66

VITROHM Ring Rheostats

25 W, 1 min to 5,000 max ohms
 50 W, 1 min to 10,000 max ohms
 100 W, 1 min to 10,000 max ohms
 150 W, 1 min to 10,000 max ohms
 300 W, 1 min to 2,500 max ohms

Relays

Sensitive—2 amp, 125v, a.c. max
 Midget—6 amp, 125v, a.c. max
 Heavy duty midget—15 amp, 125v, a.c. max
 Multi-pole—10 amp, 125v, a.c. max
 Heavy duty—25 amp, 125v, a.c. max

Mil Spec Resistors

All styles, all sizes, all characteristics and all resistance values listed in Military Specification MIL-R-26C. Ask for BULLETIN 12

5814

LIVE BETTER...Electrically



Write for a complete listing and specifications on Ward Leonard Resistors, Relays or Rheostats
 Ward Leonard of Canada Limited, 1070 Birchmount Road, Toronto 16.



**WARD LEONARD
 OF CANADA LIMITED**

1070 BIRCHMOUNT ROAD TORONTO 16

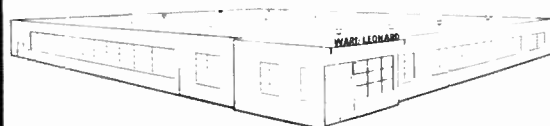

CANADIAN FACTORY AND HEAD OFFICE

Resistors • Rheostats • Relays • Motor Controls • Dimmers • Switchboards • SAFT Batteries • Berkeley Switches • Kinco Pumps

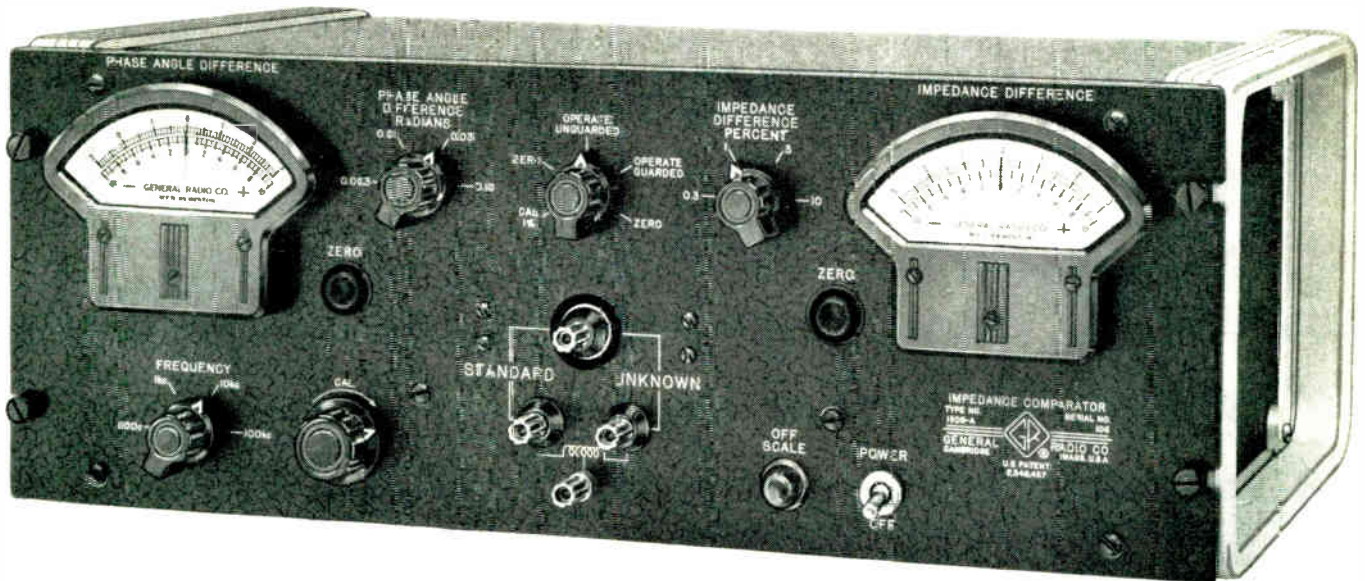

A Measurement Once Every Second with the IMPEDANCE COMPARATOR

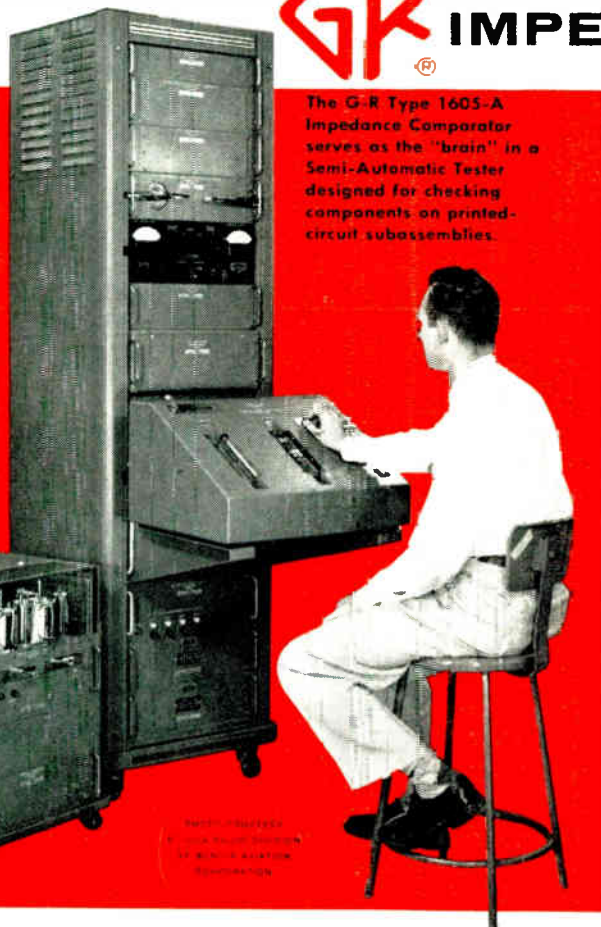

The G-R Type 1605-A Impedance Comparator serves as the "brain" in a Semi-Automatic Tester designed for checking components on printed-circuit subassemblies.

The Comparator indicates directly on two panel meters the differences in magnitude and phase angle between unknown and standard impedances. No manual balancing is required.

As used with the Semi-Automatic Tester, the Comparator's panel meters are disconnected. Comparator metering voltages, proportional to impedance-magnitude difference (in per cent) and phase-angle difference (in radians), are amplified by the Tester and compared against d-c reference voltages which correspond to allowable tolerances. Printed-circuit components which produce voltages in excess of pre-set tolerances are automatically rejected.

Relays have been added in the Tester so that Comparator impedance ranges can be switched automatically by a remote punched-card programmer. Since programs are switched every second, three continuously running oscillators are used as fixed-frequency sources for the Comparator.

The Unit was constructed by Bendix Radio Division under sub-contract for IBM and the United States Air Force.

Why The Impedance Comparator Was Selected For Automatic Sorting:

- ★ Indicates *both* impedance magnitude and phase angle without knob manipulation.
- ★ D-C voltages proportional to percentage deviation from standard are provided.
- ★ No excess switches or complex controls.
- ★ Excellent guard circuitry permits long cable runs, which are usually necessary in automatic equipment.
- ★ Wide impedance range, high measurement accuracy.
- ★ Constructed for long, reliable service.
- ★ Practical size and weight.

COMPARATOR SPECIFICATIONS

Wide Range of Internal-Test Frequencies:
100, 1000, 10,000, and 100,000 cps.

Impedance Ranges

Resistance: 2 ohms to 20 megohms
Capacitance: 40 μf to 500 μf
Inductance: 20 μh to 10,000 μh

Direct-Reading Meter Ranges

Impedance-Magnitude Differences:
0.3%, 1%, 3%, and 10% of full scale.
Phase-Angle Differences:
0.003, 0.01, 0.03, 0.1 radians full scale.

Over-All Accuracy

3% of full scale (0.01% over-all accuracy on 0.3% impedance magnitude range).

Price: \$790

WE SELL DIRECT. Our District Sales Offices are staffed by engineers especially trained to help you in the selection of instruments and measuring systems best suited to your needs. We welcome your inquiries — will help solve your problems.

GENERAL RADIO Company

Cambridge, Massachusetts, U.S.A.

Canadian Office: 99 Floral Parkway, Toronto 15, Ontario

Arthur Kingsnorth

Richard J. Provan

Repair Service:
Bayly Engineering, Ltd.,
Ajax, Ontario

Telephone: CHerry 6-2171

