

# Electronics Today

\$3.75  
MM70924

June 1987

Canada's Magazine for Electronics & Computing Enthusiasts

## The VME Bus

## Hot Industrial Computers

## Digital IC Tester

## Current Tracer

## 8088 Animation

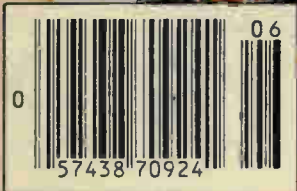
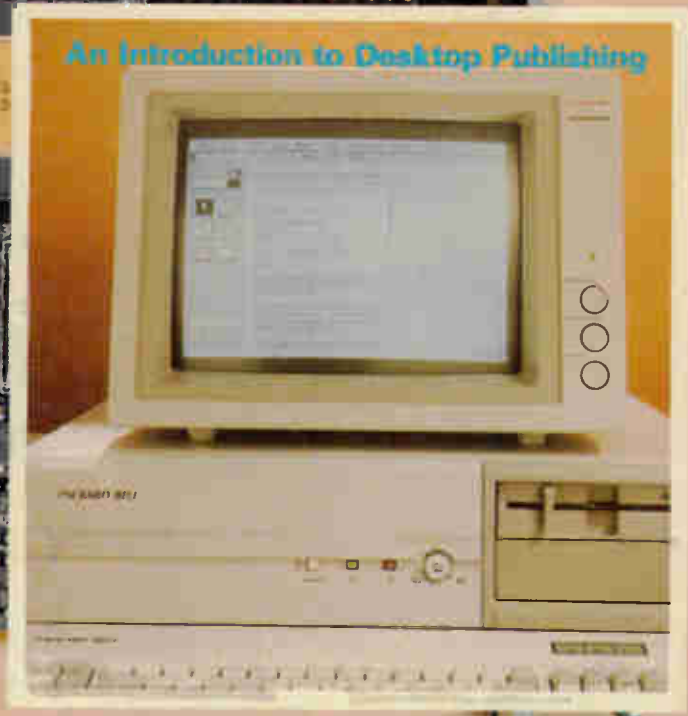



# BEST Computers

## Designed & Made in Canada

### IBM PC, XT & AT Compatible

#### NEW AVX-386

**Standard Features:** Based on the 80386-16 processor running at a speed of 16MHz, software selectable to 8MHz. Two 5.25" disk drives (one 1.2 Meg, one 360K), 10 expansion slots, presocketed for 287 or 387 math coprocessor, one serial and one parallel port, real time clock/calendar, game port, colour graphics OR monochrome video board, hardware reset button, high quality extended AT style keyboard, keyboard lock and status panel. CSA approval.

**Configuration 1:** Standard features with 2 Meg on-board memory using 41256K DRAMs:

**\$5695.00**

N.B. Configuration 1 on-board memory cannot be expanded beyond 2 Megabytes since the 256K DRAMs are a different physical size and pin configuration than the 1 Megabyte DRAMs.

**Configuration 2:** As above with 8 Megabytes of on-board memory, using 1 Meg DRAMs:

**\$8695.00**

	Configuration 1	Configuration 2
30 Meg 39ms Fast stepping hard drive	\$ 6995.00	\$ 9995.00
40 Meg 39ms Fast stepping hard drive	\$ 7195.00	\$10195.00
70 Meg 39ms Fast stepping hard drive	\$ 8185.00	\$11195.00
115 Meg Fast stepping hard disk drive	\$11695.00	\$14695.00



### Warranty

We have such confidence in the reliability of our BEST systems that we offer a full ONE YEAR WARRANTY. This far exceeds the 90 day industry standard. On-site service plan is available across Canada at extra cost through 3M of Canada Ltd.

#### Features common to the BEST Mk III and Mk IV

- Superb IBM PC & XT Compatibility
- Canadian Designed and Made
- 256K RAM Standard minimum (uses 41256K RAM Chips)
- Expandable on-board to 640K RAM
- Parallel Port (for printer)
- Serial Port (for communications)
- Real Time Clock/Calendar (with battery backup)
- Presocketed for optional co-processor such as 8087 Math Processor
- High Quality enhanced AT style Keyboard with separate cursor pad and numeric keypad
- Reset Switch
- Phoenix BIOS as used in many major brand IBM compatible systems
- 150 Watt Power Supply which will handle a Hard Drive without upgrade
- 7 Slots
- Flip-Top Case
- 2 Slimline CS,DD 5-1/4" Disk Drives
- Colour Video (RGB and Composite) Board or Hi-Res Monochrome Card (customer choice)
- Disk Drive Controller
- CSA Approved

#### Super Fast BEST Mk IV

All the features mentioned above plus speed selectable: 4.77 and 8MHz (most software will run on the higher speed); uses 8088-2 processor. TRUE 16-bit machine, based on 8086-2 processor with 16-bit bus on-board architecture, with speed more than twice as fast IBM XT yet maintaining 8-bit I/O channel bus for IBM hardware and software compatibility.



**\$1795**

With 640K RAM ..... \$1895.00  
**As Basic Configuration with HD:**  
 With 20 Meg HD, 1 Flp.640K ..... \$2595.00  
 With 40 Meg HD, 1 Flp.640K ..... \$3395.00  
 With 70 Meg HD, 1 Flp.640K ..... \$4395.00  
 Note: 40 and 70 Meg Hard Drive Systems are Fast Stepping and include SpeedStor Software Valued at \$150.00

#### BEST Mk III

Two 360K DS/DD disk drives serial and parallel ports, real time clock/calendar, Phoenix BIOS, using the 8088-2 processor, full specifications given above.



**\$1595**

With 640K Memory ..... \$1695  
**As Basic Configuration with HD:**  
 With 20 Meg HD, 1 Flp.256K ..... \$2295  
 With 40 Meg HD, 1 Flp.640K ..... \$2395  
 With 70 Meg HD, 1 Flp.640K ..... \$4195  
 Note: 40 and 70 Meg Hard Drive Systems are Fast Stepping and include SpeedStor Software Valued at \$150.00

#### BEST COMPACT 88

8086-2 CPU, runs at 4.77 & 8MHz, true 16-bit on-board architecture with superb IBM XT compatibility though runs in excess of twice the speed. Compact packaging - approx 60% narrower than the XT case with 7 slots of which 5 are full size and two are short-board slots, 150 W power supply, provision for 5.25" disk drive, 20 Meg slimline hard drive and a 3.5" disk drive. Basic package with 256K RAM, expandable to 640K, with one 360K disk drive; and colour or monochrome video board:



**\$1595**

With 640K Memory ..... \$1695  
**As Basic Configuration with HD:**  
 With 20 Meg HD, 1 Flp.256K ..... \$2395.00  
 With 20 Meg HD, 1 Flp.640K ..... \$2495.00  
 With 40 Meg HD, 1 Flp.640K ..... \$3295.00

#### AVT10-286

Superb IBM AT Compatibility, Phoenix IBM AT Compatible BIOS, clock speed 20MHz (10MHz CPU), selectable to 6/8/10MHz system speed. 7 expansion slots, presocketed for 80287 math coprocessor, real time clock/calendar, 2 high quality disk drives (one 1.2 Meg and one 360K) optional 3.5" high density drives available; parallel port, 2xserial ports, choice of monochrome or colour graphics adaptor, hardware reset button, high quality AT compatible extended keyboard with separate cursor and numeric keypad; heavy duty power supply (over 200W), keyboard lock. CSA approved.

**Configuration 1:** 640K RAM on-board

**\$3495.00**

Configuration 1 on-board memory cannot be expanded beyond 1 Megabyte as the 256K DRAMs are a different physical size and pin configuration than the 1 Meg DRAMs. The full 16 Megabytes of Direct addressable memory is still available using memory expansion cards.

**Configuration 2:** 2 Megabytes on-board memory expandable to 4 Megabytes on board:

**\$3995.00**

As Basic Configuration with Hard Drives:	Configuration 1	Configuration 2
20 Meg 78ms FastStepping HD	\$4195.00	\$4695.00
30 Meg 39ms Fast stepping HD	\$4795.00	\$5295.00
*40 Meg 39ms Fast stepping HD	\$4995.00	\$5495.00
*70 Meg 39ms Fast stepping HD	\$5995.00	\$6495.00
*115 Meg Fast stepping HD	\$8495.00	\$9995.00

(\*40, 70, and 115 Meg Hard Drive Systems include SpeedStor Software Valued at \$150.00).

#### BEST Compact 286

Superb IBM AT Compatibility, Phoenix AT BIOS, 16MHz clock (8MHz CPU), 80286 processor, 640K of on-board memory, one 360K 5.25" drive, colour or monochrome video board, high quality AT style keyboard, compact packaging - similar to that of PC XT, 150W power supply, 7 expansion slots (5 x AT bus standard, 2 x PC/XT bus standard). CSA approved.

**\$2295.00**

**BEST COMPACT 286 configurations**

20 Meg 78ms Stepping hard disk drive	\$2995.00
30 Meg 39ms Fast stepping hard drive	\$3595.00
40 Meg 39ms Fast stepping hard drive	\$3795.00
70 Meg 39ms Fast stepping hard drive	\$4795.00

(Note 40 and 70 Meg Hard Drive Systems include SpeedStor Software Valued at \$150.00).

#### Additional Drives and Cards

**Additional Floppy Disk Drives**  
 360K 5.25 inch Floppy Disk Drive . \$150.00  
 720K 3.5 inch High Density Drive . \$199.00

**BEST EGA Video Display adapter** ..... \$199.00  
**ATI Graphics Solution** ..... \$199.00  
**Genoa Spectrum** ..... \$199.00

**Video Display adapters**  
 (substitution prices for standard BEST CGA or Monographic card)

**Leasing and Rental Plans**  
 Available for all BEST Systems.

# Exceltronix

Toronto Store: 319 College Street, Toronto (416) 921-8941  
 Ottawa Store: 217 Bank Street, Ottawa (613) 230-9000  
 Mississauga Showroom, Pickup Counter and Mail Orders:  
 6315 Keele Road, Mississauga, Ont., L5T 1S4  
 Long Distance Orders: 1-800-387-8995, Local Orders: (416) 673-5111

## Spectacular Gang EPROM Programmer & Emulator



Totally self-contained (has its own display, entry keypad and power supply).

Based on the Z-8 microprocessor.

Can program up to 8 EPROMs simultaneously (anywhere from one to 8 EPROMs at the same time with the Information In Its own memory or master EPROM).

The Gang Programmer can handle a wide selection of EPROMs: 2716, 2732, 2732A, P2732A, 2532, 2764, 27128, 27128A and optionally upgradeable to handle 27256, 27512, 2758 and 2724.

Complete package with EPROM Emulator, 8 ZIF sockets, Gang Programmer with 16Kx8 of RAM and RS232. **\$995.00**

Gang EPROM Programmer with 8 ZIF sockets, 16Kx8 RAM and RS232, without Emulator. **\$695.00**

EMPROM Programmer with only one ZIF socket, 16Kx8 RAM and RS232, without Emulator. Able to do all the functions describe but can handle only one EPROM at a time **\$499.00**

## MONITORS

### Special on TTL Monitors TTX TTL

Monitor requirements are dependent upon computer outputs. Please contact Exceltronix for your monitor needs.

#### TTX Model 1202A TTL Amber Monitor

720 x 348 Resolution • 12" Anti Glare Viewing Area

**\$169.00**

#### Zenith ZVM 1240

12" diagonal screen • glare amber display • PC monochrome input (TTL) • 25 lines x 80 characters • 720 x 350 pixels • IBM PC & compatibles.

**\$229.00**

## MONOCHROME

#### Zenith ZVM1230A

12in. diagonal screen • non-glare green display • composite input • 25 lines x 40/80 characters

**\$125.00**

#### Zenith ZVM 1220A

12in. diagonal screen - non-glare amber display • composite input • 25 lines x 40/80 characters

**\$129.00**

## COLOUR

#### Zenith ZVM 1330 RGB Colour Monitor

640 x 200 Resolution  
13" Anti Glare Viewing Area **\$599.00**

#### Thomson 4120 RGB/Composite Colour Monitor

560 x 240 Resolution  
Green/Full Colour Switch  
13" Anti Glare Viewing Area **\$499.00**

#### Thomson CM3638251 RGB Colour Monitor

640 x 240 Resolution  
14" Antiglare Viewing Area  
Green/Amber/Full Colour Display Switch... **\$599.00**

**Call or write for our Brand New FREE Summer 1987 24-page catalogue or see it in the May Issue of Computing Now!**

## The BEST EGA - Enhanced Graphics Adapter

The BEST EGA card has several modes of video operation available on one card: 100%, IBM EGA compatible 640 x 350 pixels in 16 colours on the enhanced colour display.

It supports functions of the IBM Colour graphics video adaptor and IBM monochrome display adaptor, 320 x 200 and 640 x 200 16 colour graphics on the colour graphics monitor, 640 x 350 four shade graphics on the monochrome display (black normal intensified and blank), flicker free display, split alphanumeric mode screen display, bit mapped graphics in four planes up to 512 characters that can be user defined.

The BEST EGA card comes standard with 256K memory for flicker free, text and bit mapped graphics

**\$299.00**

## NIC Network Interface Card

The BEST NIC card allows any PC/XT or AT compatible system to operate in a network environment that supports the ArcNet topology. The BEST NIC uses the Standard Microsystems single chip ArcNet controller and LAN Transceiver chip to conform to all ArcNet protocol requirements.

The NIC Card can be used with many versions of Advanced Novell Netware, as well there is space on the card for user installed firmware, which allows the card to work in a Waterloo Port environment. The User installed firmware can also eliminate the need for floppy drives in the workstations, with the use of a Boot Prom.

The BEST NIC card has 3 LEDs mounted on the rear bracket to indicate network, and token passing activity. Also accessible from the rear of the system are network address selection switches, which allows the network address to be changed without opening the system case.

**\$599.00**

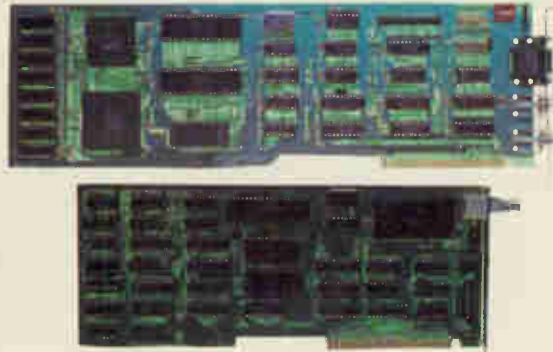

## EPROM PROGRAMMER (IBM COMPATIBLE)

### MAIN EPROM PROGRAMMER CARD (WITH SOFTWARE)

With 2 standard EPROM sockets **\$ 99.00**

### EPROM PROGRAMMER WITH ZIF SOCKETS (WITH SOFTWARE)

With one 24-pin, ZIF socket and one 28-pin ZIF socket with provision for serial port **\$139.00**

### EXTERNAL CARD

Ready to plug into the main EPROM Card (includes one 24-pin and 28-pin ZIF socket and cable). Saves you from opening the computer each time you want to program your EPROMS **\$ 69.00**

## BEST MODEM

The BEST modem is a smart 1200/300 direct connect modem. It can either be a stand alone unit in which case it requires a small wall adaptor, or it plugs in one of the IBM slots. When used as a stand alone unit, the modem looks like a Hayes 1200 Smart Modem, that is, it emulates the same instruction set. When it is used in the IBM, it looks like an intelligent serial communications port which also supports a superset of the Hayes instruction set.

The modem supports auto-dial, auto-answer and auto-speed select directly from software control. The modem also has a speaker so that aural monitoring of the call is possible. There are also LED monitors so that the status of the modem can always be known. These LEDs are: Modem Ready, Auto-Answer enabled, Carrier Detected, Transmitting, Receiving, Data Set ready.

Software packages such as Crosstalk, PC-talk and Hayes' Smartcom II also will run with this modem.

### The BEST IBM AT Compatible 4 Meg Memory Card

In order to take advantage of the memory addressing capabilities of the IBM AT or the BEST AVT-286 business computer, we developed a memory card for the user up to 4 Megabytes of dynamic RAM. The memory card will run at speeds up to 16MHz, which is fast enough to meet the needs of any 80286 microprocessor on the market today. The design uses state of the art (256K x 9) memory arrays to allow for maximum memory in the smallest physical space. The ninth bit is used as a parity bit to insure the validity of the data. The card is available in memory sizes from 512K to 4 Megabytes in steps of 512K. Boundaries are switch selectable above 1 Meg in blocks of 512K.

With 512K Regular **\$ 895.00** Special **\$348.00**  
With 1 Meg Regular **\$ 895.00** Special **\$498.00**  
With 2 Meg Special **\$ 735.00**  
With 4 Meg Regular **\$1995.00** Special **\$1295.00**

### Memory and Parts

4164 (150ns)	<b>\$ 2.49</b>
41256 (150ns) (quantity discounts available)	<b>\$ 4.99</b>
2764	<b>\$ 5.95</b>
27128	<b>\$ 6.95</b>
27256	<b>\$ 8.95</b>
6116	<b>\$ 3.99</b>
6264	<b>\$ 6.95</b>
V20 (5MHz)	<b>\$ 13.00</b>
V20 (8MHz)	<b>\$ 18.00</b>
SP0256 (sound chip)	<b>\$ 25.00</b>
3087	<b>\$245.00</b>
30287	<b>\$450.00</b>

## POWER SUPPLIES

150W CSA approved, IBM PC/XT compatible **\$129.95**  
200W CSA approved, IBM PC/XT compatible **\$199.00**

## DISK DRIVES

### NEW SILENT JU455 Shugart/Panasonic

5.25" slimline DS/DD Disk Drive with 360K

Ideal for IBM Computers **\$149.00**

### JU475 Shugart/Panasonic

5.25" slimline Disk Drive with 1.2Meg

Ideal for AT Compatibles **\$199.00**

### Hard Drives

Seagate 20 Meg with controller **\$799.00**

Special: Toshiba 80Meg hard drive with controller **\$2495.00**

### AT Compatible

High Speed Seagate Hard Drives with controller

20Meg **\$1295.00**

30Meg **\$1495.00**

40Meg **\$1995.00**

## Star Micronics Printers

### NP-10

100 c.p.s. draft, 25 c.p.s. NLQ **\$299.00**

### NX-10

120 c.p.s. draft, 30 c.p.s. NLQ. Easy to use from panel controls **\$349.00**

### NX-15

As NX-10 but 15" carriage **\$659.00**

### NB24-15

180 c.p.s. draft, true letter quality at 60 c.p.s. 24 wire head **\$1295.00**



300/1200 Baud **\$249.00**  
300/1200 Baud, Stand-Alone Unit, Attractively Packaged **\$299.00**

## Copal Printers

• Epson Compatible • Supports both IBM and Apple systems • Centronics Parallel Interface • Both Draft and Near Letter Quality (NLQ) modes.

**SC1200 \$349.00**

- 120 cps draft quality
- 24 cps NLQ
- NLQ available in all print sizes
- 11 inch carriage
- Pin and friction feeds
- One Year Warranty

**SC1500 \$499.00**

- 180 cps draft quality
- 36 cps NLQ
- 3K Buffer

**SC5500 \$699.00**

- 15 inch carriage
- 3K Buffer

# Exceltronix

Toronto Store: 319 College Street, Toronto (416) 921-8941  
Ottawa Store: 217 Bank Street, Ottawa (613) 230-9000  
Mississauga Showroom, Pickup Counter and Mail Orders:  
6315 Kestrel Road, Mississauga, Ont., L5T 1S4  
Long Distance Orders: 1-800-367-6995, Local Orders: (416) 673-5111





**NEW  
REDUCED  
PRICES**

# Price/Performance With Real Scope<sub>s</sub>

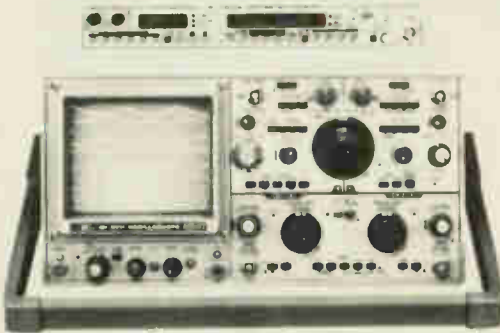

The SS-5710 and SS-5711 can be provided with exclusive counters and digital multimeters.

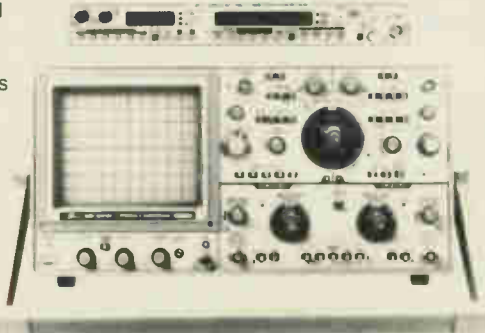

## SS-5711 Reliability resulting from superb basic characteristics DC-100 MHz

- Typical frequency of from DC to 120 MHz, -3 dB, thereby having a 20 MHz margin over the specified frequency response
- Highly precise and stable deflection factor and sweep rate
- Reliable time difference between channels
- Jitterless circuitry for stable triggering
- Superb linearity
- 3 year warranty

**\$2319**

## SS-5710 4-input, 8-trace Portable Oscilloscope DC-60 MHz

- Typical frequency of from DC to 70 MHz, -3 dB, thereby having a 10 MHz margin over the specified frequency response
- Highly precise and stable deflection factor and sweep rate for a wide range of temperatures
- Superb linearity
- Reliable time difference between channels
- Built-in TV sync separator
- 3 year warranty

**\$1718**



## SS-5705 3-input, 6 trace Portable Oscilloscope, DC-40MHz

- 3-Input, 6-Trace
- 12KV Accelerating Voltage
- Versatile trigger capability with TV-SYNC
- Jitter-free circuitry and variable Hold-off
- High accuracy for V and H ( $\pm 2\%$ )
- Accurate calibrator (Amplitude:  $\pm 1\%$  and Frequency  $\pm 1\%$ )
- 2 year warranty

**\$1271**

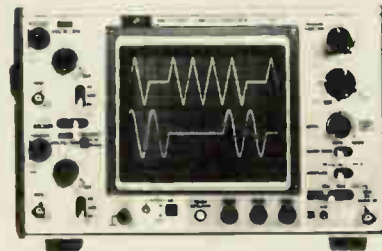

## SS-5702 2-input, 2-trace Oscilloscopes, DC-20 MHz

- Compact and lightweight; low power consumption
- 6-inch rectangular parallax-free CRT with internal graticule
- Variable sweep length and dual X-Y operation facilities
- 1 mV/div-10 V/div deflection factor  
0.1  $\mu$ s/div-0.2 s/div sweep rate
- TV-V trigger mode
- 2 year warranty

**\$741**



**Allan Crawford Associates Ltd.**

Toronto 416-890-2010 Montreal 514-731-8564 Ottawa 613-596-9300  
Calgary 403-295-0822 Vancouver 604-988-2195

Prices are suggested Canadian list.  
FST Extra. Subject to change without notice.

### Available from:

**ELECTROSONIC**  
Toronto, Ontario  
(416) 494-1666

**ELECTRONIC WHOLESALERS  
CANADA LTD.**  
Montreal, Quebec  
(514) 769-8851

Ottawa, Ontario  
(613) 746-4413

**PRODUIT ELECTRONIQUE**  
Ste.-Foy, Quebec  
(418) 651-5356

**NCC ELECTRONICS**  
Windsor, Ontario  
(519) 969-4363

**PROJEAN INSTRUMENTS**  
Montreal, Quebec  
(514) 273-8331  
**ITT & RAE INDUSTRIAL  
ELECTRONICS**

Burnaby, BC  
(604) 291-8866  
Calgary (For Iwatsu Only)  
(403) 251-5888

Dartmouth, Nova Scotia  
(902) 465-2350

Edmonton, Alberta  
(403) 451-4001

Moncton, New Brunswick  
(506) 857-8011

St. Laurent, Quebec  
(514) 331-0960

Saskatoon, Saskatchewan  
(306) 933-2888  
Concord, Ontario  
(416) 736-1144

Winnipeg, Manitoba  
(204) 786-8401  
**RIDEOUT TOOL & SUPPLY**  
St. Johns, NFLD  
(709) 754-2240

## Our Cover



The photo of the single-board MVME133 VME computer is courtesy of Motorola Microcomputer Division; the desktop publishing photo is by Ed Zapletal.

Electronics Today is Published 12 times a year by: Moorshead Publications Ltd.  
1300 Don Mills Road,  
North York, Toronto, Ont. M3B 3M8  
(416) 445-5600

Editor: William Markwick  
Assistant Editor: Edward Zapletal  
Director of Production: Erik Blomkwist  
Production Manager: Dolph Loeb  
Circulation Manager: Sharon Cernecca  
Advertising Account Manager: David Stone

Publisher: H.W. Moorshead; Executive Vice-President: V.K. Marskell; Vice-President - Sales: A. Wheeler; Vice-President-Finance: B. Shankman; General Manager: S. Harrison; Production: Kevan Buss; Naznin Sunderji; Accounts: P. Dunphy; Reader Services: N. Jones, K. Parkinson, R. Cree, K. Barkwell; Advertising Services: H. Brooks.

Newsstand Distribution:  
Master Media, Oakville, Ontario

Subscriptions:  
\$22.95 (one year), \$37.95 (two years).  
Please specify if subscription is new or a renewal.

Outside Canada (US Dollars) U.S.A. add \$3.00 per year. Other countries add \$5.00 per year.

Postal Information:  
Second Class Mail Registration No. 3955.  
Mailing address for subscription orders, undeliverable copies and change of address notice is:  
Electronics Today, 1300 Don Mills Rd.,  
Toronto, Ontario, M3B 3M8

Printed by Heritage Press Ltd., Mississauga  
ISSN 07038984.

Moorshead Publications also publishes Pets Magazine, Computing Now!, Computers in Education, and Government Purchasing Guide.

Circulation Independently Audited  
by MURPHY & MURPHY  
Chartered Accountants.

# Electronics Today

Canada's Magazine for Electronics & Computing Enthusiasts

June 1987

Vol. 11 No. 6

## Features

The VME Computer	29
Perspective On Audio Sampling	49

## Technology

An Introduction to Desktop Publishing	16
Electric Boats	27
Ultrasonic Testing	38
Tracing The Causes of Acid Rain	40

## Projects

Computer Buffer	10
Current Tracer	18
IC Tester	33

## Series

For Your Information	6
8088 Programming: Animation	22
Designer's Notebook: Motor Drives, Part 3	42

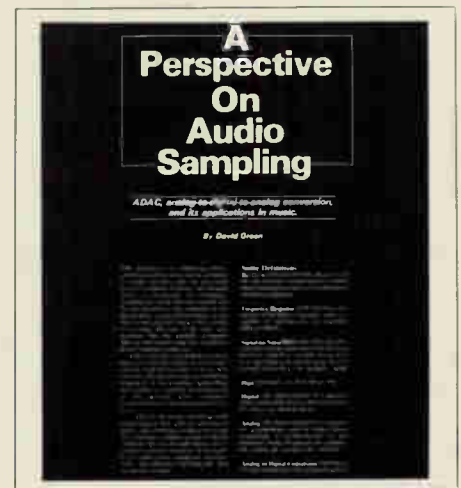

## Columns and Information

Market Place	9	Subscriptions	46
Next Month	12	Classified	48
Books	14	Advertisers' Index	53
Order Form	45		

# For Your Information

## The Editor's Corner

By Bill Markwick

IN THE coming months, we will be expanding the editorial coverage of *Electronics Today* to reflect the growing interest in science and high technology. The new format is energetic and exciting, covering as it does a wider range of topics than before: computing, general science, physics, new products, new techniques in science and manufacturing and more. We will continue with our how-it-works approach, providing

lucid explanations of technology for a wide reader base.

Editorial contributions and subject ideas are welcomed. Some of the many article topics we will be including are: new techniques and discoveries in general science, avionics, space, earth sciences, physics, music, computing, electronics projects (beginning and advanced), microchips, industry, communications, aeronautics, automotive technology, and how-it-works articles on the various technologies that surround us daily. While we plan to be interna-

tional in scope, Canadian content will receive priority.

Canada has a healthy, growing, but little-publicized hi-tech industry, and we hope to be part of the effort to bring Canadian accomplishments to a wider public.

We are not discontinuing our hands-on approach to electronics circuitry; articles and projects for both beginners and advanced experimenters will be included in the new format. However, we will begin increasing the coverage of general technology immediately

and continue until the fall of 1987; at this time the content will be about two-thirds general technology and one-third electronics.

We hope to have an all-glossy format with more colour pages, a more comprehensive News section, and multiple-subject covers reflecting the change in content.

We know you'll enjoy reading the new format as much as we enjoyed creating it.

## Double Play



Have you ever wished that you could watch two channels at once, or that you could scan up and down the channels without missing your favorite show?

Rabbit Systems Inc. has announced its Double Play entertainment device that enables TV viewers to enjoy more than one television program on a single TV screen, at one time.

Equipped with its own wireless remote control the unit allows viewers to:

- Auto-scan through TV channels on the Double Play mini-screen to make selections without interrupting the show they're watching.

- Freeze the image on the mini-screen.

- Switch programs back and forth between the primary screen and mini-screen with the press of a button.

- Monitor a videotape while viewing a live broadcast on either the primary or mini-screen.

- Move the mini-screen to any corner of the TV's primary screen.

Designed to compliment existing audio/video components, the unit comes in a metallic black finish and is completely compatible with existing televisions and VCRs.

For more information contact: Rabbit Systems Inc., 233 Wilshire Blvd., Santa Monica, CA 90401 USA. (213) 393-9830.

Circle No. 4 on Reader Service Card

September 28th to October 3rd has been declared the second annual Canadian High Technology Week by the Ministry of State for Science & Technology and the Department of Regional Industrial Expansion.

The Canadian High Technology Show and the Canadian Electronics Production, Packaging & Design Exhibition are the focal points for the week. With almost

1000 booths, these shows form the largest exhibition of electronic components, test equipment, production equipment, CAD/CAM products, supplies and services for the industry.

The shows will take place at the Coliseum Building at Exhibition Place, Toronto. We'll keep you posted over the next couple of months.

## Custom Cobra



Doug MacCorkindale (extreme left), auto teacher at Toronto's Overlea Secondary School, has assisted Moorshead Publications in building special photo props, and we thought you'd like to see

the pride and joy of his students, a Cobra replica with a Chevrolet 350 V-8. One thousand hours of labour went into the construction of the 135mph car, valued at \$30,000.

**Oooooops!** A number of readers have contacted us regarding what appears to be a problem with the page numbering in the May '87 issue of *Electronics Today*.

**Fear not, those articles affected can be found on the following pages:**

Satellite Feed Chart - page 58  
VHF Scanners - page 60  
Linking Computers With Light - page 54  
The Listening Computer - page 71  
The C64 Power Hack - page 62  
The C64 Kernal Upgrade - page 65

We apologize for any inconvenience which may have resulted from this disaster. As we approached press time, the Vice-President in charge of page numbering was not available for comment.

**Copyright** — all material is subject to worldwide copyright. PCB designs are copyright and may not be sold without permission.

**Liability** — no responsibility whatever is accepted for failure of projects to perform for any reason, and no responsibility is accepted for any injury or damage caused by any fault in design.

**EDITORIAL QUERIES** — written queries must be accompanied by a stamped, self-addressed envelope, relate to recent articles and must not involve research.

*We cannot answer telephone queries.*

**PCB Suppliers** — we do not supply PCBs or kits or keep track of stocks. Please contact the following:

K.S.K. Associate, P.O. Box 266, Milton, Ont. L9T 4N9.

B—C—D Electronics, P.O. Box 6326, Stn. F., Hamilton, Ont. L9C 6L9.

Wentworth Electronics, R.R. No. 1 Waterdown, Ont. L0R 2H0.

Danocinths Inc., P.O. Box 261, Westland MI 48185 USA.

Spectrum Electronics, 14 Knight wood Crescent, Brantford, Ontario N3R 7E6



# Slow or fast ... Store it with these.

## HAMEG



### HM205

**The outstanding oscilloscope  
with digital storage**

This remarkable new concept combines a general purpose oscilloscope with a full functioned digitizing oscilloscope to meet today's rapidly increasing demand for measurement versatility.

In addition to its feature-packed analog operating modes, it provides very practical digitized waveform processing for slow events between 0.1ms and 50s total duration. Key features are:

- 20MHz-realtime bandwidth, 10kHz sampling rate
- Input sensitivity 2mV/div - 20V/div
- Digital timebase 1ms/div - 5s/div
- Memory 2x1k Byte with 8-bit resolution
- Analog timebase 0.5us/div - 0.2s/div
- Triggers to more than 40MHz at 0.5 div
- Active TV-Sync-Separator
- Variable Hold-Off Time
- Built-in component tester, fast-risetime calibrator

**\*\$1,395.00**

In many applications the HM205 can easily replace considerably more expensive digital storage and long persistence instruments, or perform display functions of chart recorders.

This is one of the really outstanding and money-saving innovations on the scope market today!

\*FOB Downsview - FST included - Subject to change.



### HM208

**The high-tech storage scope  
with 20 MHz sampling rate**

This is a state-of-the-art storage oscilloscope specially designed to capture fast single events with 8-bit resolution and up to 2000 points record length.

Providing both digital storage and analog mode, the HM208 combines 20MHz bandwidth, 20MHz sampling rate, and sensitivity to 1mV. Up to 4 sets of data can be stored in 2 independent 2k Bytes memories. Features include:

- Digital timebase from 10us/div - 50s/div
- Image expansion to 1us/div
- Refresh, Roll, Single, and X-Y modes
- 256 points (8 bit) vertical resolution
- 1024 or 2048 points horizontal resolution
- 25 - 50 - 75 - 100% pre-trigger
- X-Y recorder output with penlift
- Linear Dot Joiner
- Options: IEEE-488 bus Interface; memory backup.

**\*\$3,795.00**

In realtime operation, the HM208 features excellent low-level signal triggering to more than 40MHz, and maximum timebase resolution of 20ns/div.

The HM208 is Western Europe's most popular DSO, is truly affordable and backed by a company with 30 years experience in innovative oscilloscope design.

Circle No. 6 on Reader Service Card

980 Alness Street, Unit 7  
Tel: (416) 661-5585

**BCS**  
ELECTRONICS  
LIMITED

Downsview, Ontario, M3J 2S2  
Telex: 065-28169

# IF YOU WANT TO GET INTO PC SERVICING, YOU HAVE TO GET INTO A MICROCOMPUTER!

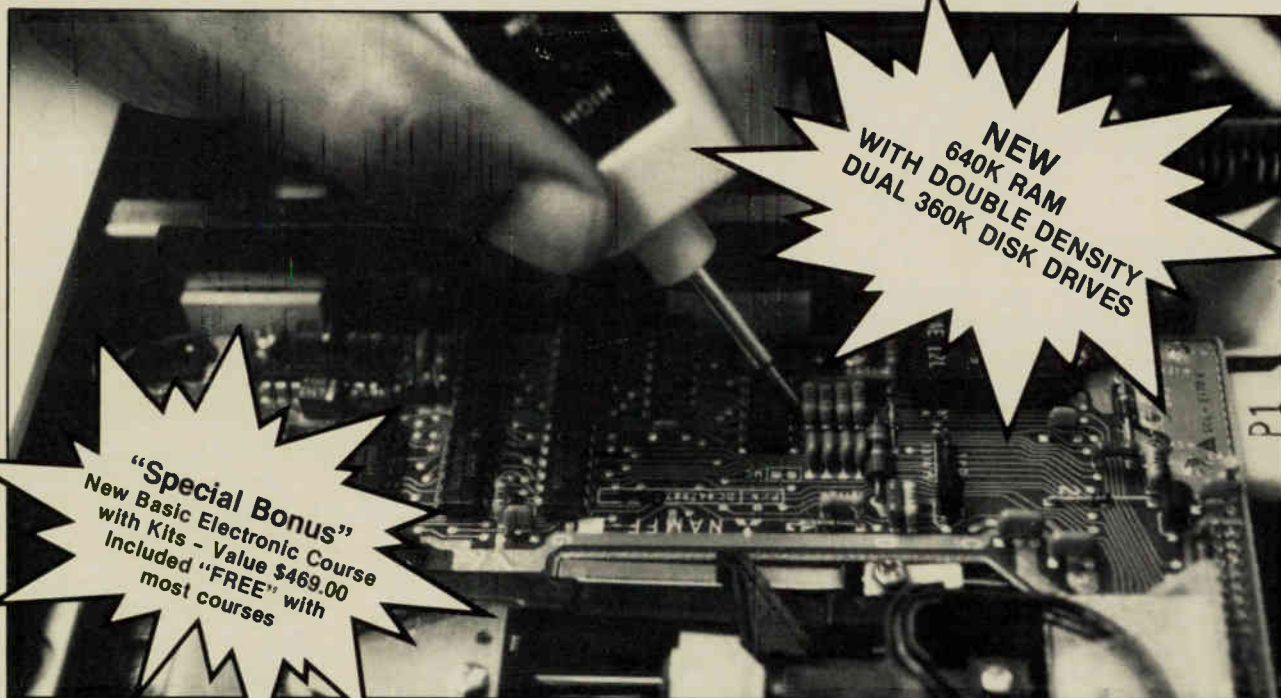

**"Special Bonus"**  
New Basic Electronic Course  
with Kits - Value \$469.00  
Included "FREE" with  
most courses

**NEW**  
WITH DOUBLE RAM  
640K RAM  
WITH DOUBLE DENSITY  
DUAL 360K DISK DRIVES

## Learn PC Servicing By Building Your Own Desk-Top Computer!

NTS Intronic Home training gets you right down into the heart of computer circuitry. Learn how microprocessors function, how they operate and are used to solve problems. Your program includes a wide variety of tests and projects you perform as you build your own PC, circuit board by circuit board unit by unit.



SEND FOR "FREE COLOUR CATALOGUE"

## Hand-On Training With Your (IBM Compatible) PC-XT Puts You At The Leading Edge Of Technology!

This remarkable desk-top PC is the most powerful and versatile ever offered in any home study course. Advanced features of this PC-XT include:

- 16 Bit 8088 microprocessor for IBM compatibility
- 640 K RAM for high speed performance
- 8 expansion slots
- 135 watt power supply
- Dual 360K double density floppy disk drives
- Color graphics/printer adapter card
- Operating system included: MS-DOS with GW Basic

## NTS Offers Many Additional Courses in Electronic and Other Fields:

- Robotics
- Video Technology
- TV & Radio Servicing
- Industrial Technology & Microprocessor
- Basic Electronics
- Transportation Technology (Auto and Diesel)
- Climate Control Technology (HVAC)



National Technical Schools  
Canadian Office  
517 Bohemia Crescent  
Oakville, Ontario L6J 2K7  
(416) 842-8383



IBM is a Registered Trademark of International Business Machine Corp  
MS is a Registered trademark of Microsoft Corp



# MARKET PLACE

## A STEP INTO ROBOTICS

Here is your opportunity to enter the exciting world of Robotics and Automation.

With Lincom's intelligent stepper motor controller, high efficiency chopper drive that handles up to 5000 steps/second and powerful 150 oz/inch stepper motor.

High level instructions such as:

Initialize, Absolute location, Slope of acceleration/deceleration, Number of steps, Rate of stepping, RS-232 Control Port.

Documentation and simple initialization and set up instructions supplied on MS-DOS\* compatible diskette.

Introductory Offer.....\$495.00

Send cheque or money order.  
Quebec residents, add 9% PST.

**LINCOM RESEARCH INC.,**  
3127 De Miniac, St-Laurent, Quebec H4S 1S9,  
Tel: (514) 334-5039, Fax: (514) 334-4711.

\*MS-DOS is a trademark of Microsoft

## ARE YOU?....

- Antenna or TVRO Installer?
- Hobbyist?
- Small Cable System Operator?

## WE...

Have been in the Antenna Business for 15 years.

- Manufacture our own Amplifiers, Filters, Traps etc.
- Sell TV & VCR Accessories at lowest prices in Canada
- Sell LNB's and Channel Modulators
- Project low cost transmitters up to 6 watts.
- Stock TV and Professional Antennas
- Supply a whole range of RF Components and hard to find parts.

But most of all: We are **Honest, Reliable** and have the **Best Price in Town.**

## ANTECO®

(The First Exclusive Antenna Business in Canada)

877 Alness St. Unit 20 Downsview  
(Toronto) Ont. M3J 2X4

Phone: (416) 738-8610 Telex: 06-964566 EUROANT TOR.



## AD-PCM method solid state Tapeless tape recorder Kit

- Max. recording time 128 sec (at 8KBps) with 256K x 4 pcs D-Ram controlled by new technological 60 p in CPU
- 500mW audio Amp and 600ohm/10Kohm MIC Amp built-in
- Host computer control available

Complete Kit (without SP, MIC) ..... \$90.00

## Voice (speech) recognition 5CH (Max. 20CH) control SW Kit

- Can control 5 relays on/off with your voice
- State-of-the-art special 60pin CPU control
- With additional circuit can extend more 15CH
- Your voice memory backed up by S-Ram and battery

Complete Kit with 5 relays ..... \$149.00

## Digital Capacitance Meter Kit

- 3 digit large size LED display 9V battery operation
- Wide range 10pF to 999uF, Accuracy 2%

Complete Kit (without case) ..... \$39.00

## Max. 500MHz 8-digit Frequency Counter Kit

- 10Hz to 500MHz, 6 combination measurements
- Large size high bright 8-digit LED
- Up to 10MHz 30mV, 10MHz to 500MHz 100mV. Accuracy 0.005%

Complete Kit (without case) ..... \$145.00

## 12CH (MAX. 32CH) Infrared Tx, Rx Remote-control switch Kit

- Max. control distance 40 feet indoor
- 38KHz modulated and 16 bit serial coded signal
- 86dB high gain Amp. with IR sensor and band-pass filter
- Special function CPU control

Complete Kit ..... \$87.00

## Stepping motor driver Kit come with mini motor

- Good for driving small motor. Max. 12V 1.2A, 3000 pps
- Manual control or computer control are selectable.

15% Special price ..... \$68.00

## Product Mart

### CLASSIFIED ADVERTISING FORM

**Rates:** The basic one time insertion rate is \$1.50 per word (Minimum 25 words). The rate of \$3.50 per word allows your advertisement to run in all three publications (Computing Now!, Electronics Today, and Computers in Education) Headings, logos and reverse advertisements are available for an additional \$30.00

Special discount rates are available for multiple insertions. They are as follows:

- 25% for 12 consecutive insertions
- 15% for 6 consecutive insertions
- 10% for 3 consecutive insertions

These rates apply only to the prepayment of the entire sum

Send a cheque (deduct applicable discounts) along with this order form

#### Classification:

#### Copy:

1	2	3	4	5
6	7	8	9	10
11	12	13	14	15
16	17	18	19	20
21	22	23	24	25
26	27	28	29	30
31	32	33	34	35
36	37	38	39	40
41	42	43	44	45
46	47	48	49	50

Name \_\_\_\_\_

Address \_\_\_\_\_

Postal Code \_\_\_\_\_

Phone \_\_\_\_\_

Mastercard  Visa  American Express  Card Number \_\_\_\_\_ Expiry Date \_\_\_\_\_

Signature \_\_\_\_\_



Please contact **Moorshead Publications**  
1300 Don Mills Rd., Don Mills, Ontario M3B-3M8  
**(416) 445-5600**

## High Speed EP-Rom erasing UV 1 amp Kit

- High Intensity type. To erase 20 pcs Rom in 5 to 10 minutes
- Also P.C. Board exposing UV lamp sold by K.E.M.

1 set ..... \$35.98 1 set with timer ..... \$38.98

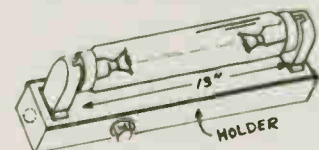

\$5.00 for shipping. Plus PST for B.C. residents. Plus C.O.D. fee, if required. No invoice order acceptable.

## K.E.M. Electronics Ltd.

Mall to Box 69126, Station (K),  
Vancouver, B.C. V5K 4W4  
Office 879E, Hastings, Vancouver  
Tel: (604) 251-1514

# Computer Buffer Interface

***A simple output port buffer with eight 50V, 500mA channels.***

***By R.J. Evans***

The user port on most microcomputers can supply only a small amount of output current. It is first priority when using these outputs to buffer them. This applies not only when using the outputs for interfacing to other equipment, but also when using long transmission lines. Buffering also has a third function, to protect the computer.

This article describes a buffer/interface "module" which can be used in a variety of ways to overcome many problems encountered with computers, peripherals and logic circuits. The basic ways in which it can be used are:

(1) As described here, an interface for the user port suitable for experimentation,

(2) As above, but fitted with 4mm sockets,

(3) As a line driver - the circuit board is built into a small box on the cable to overcome transmission or network problems for logic circuits.

(4) As a module used on home-constructed peripherals to avoid building special circuits each time.

The unit uses only one PCB. The circuit is reliable, rugged, and inexpensive to build.

## Specifications

The unit has up to eight channels per board and draws 0.3mA from the computer when the input is high, giving out up to 500mA (a gain of over 1600). The Acorn BBC and Commodore 64 can provide up to 1mA in the high state.

The output is an open-collector type which can have a voltage across it of up to 50V, though the LED resistors will need to be changed to higher values when operating at voltages over 8V.

The board does not provide pullup resistors; these are unnecessary for an interface anyway because the load is sufficient. The channels can be chained together to provide larger maximum currents.

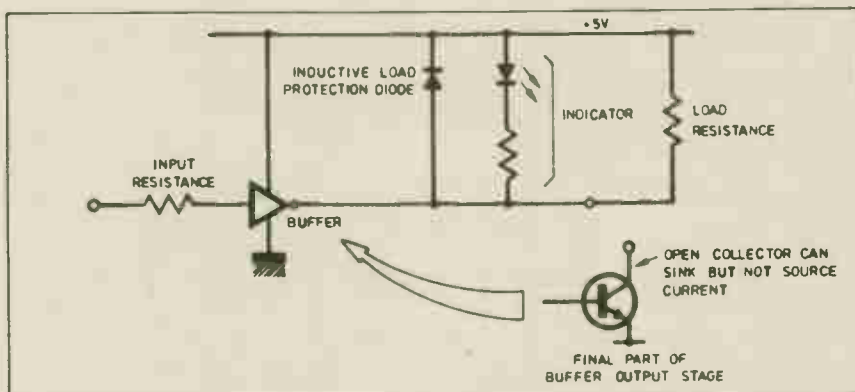

Fig. 1. Single channel arrangement for the buffer/interface.

## The Circuit

The circuit is based on the ULN2000 series buffer/driver ICs as shown in Fig. 2. The ULN2001 and 2003 provide seven channels and the ULN2803 provides eight. The circuit board can be used with any of these. The indicators are optional and can be omitted if desired.

Resistors R1 and R8 are input current limiting resistors and C1 is an optional reservoir capacitor.

## Construction

Construction is exceptionally simple; all the components fit on the one PCB, which is shown in Fig. 3. Starting with the

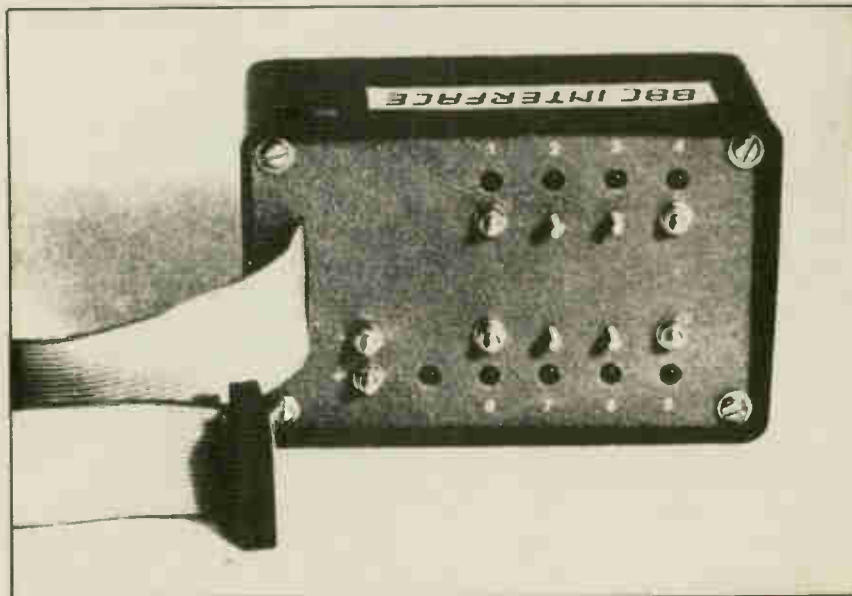



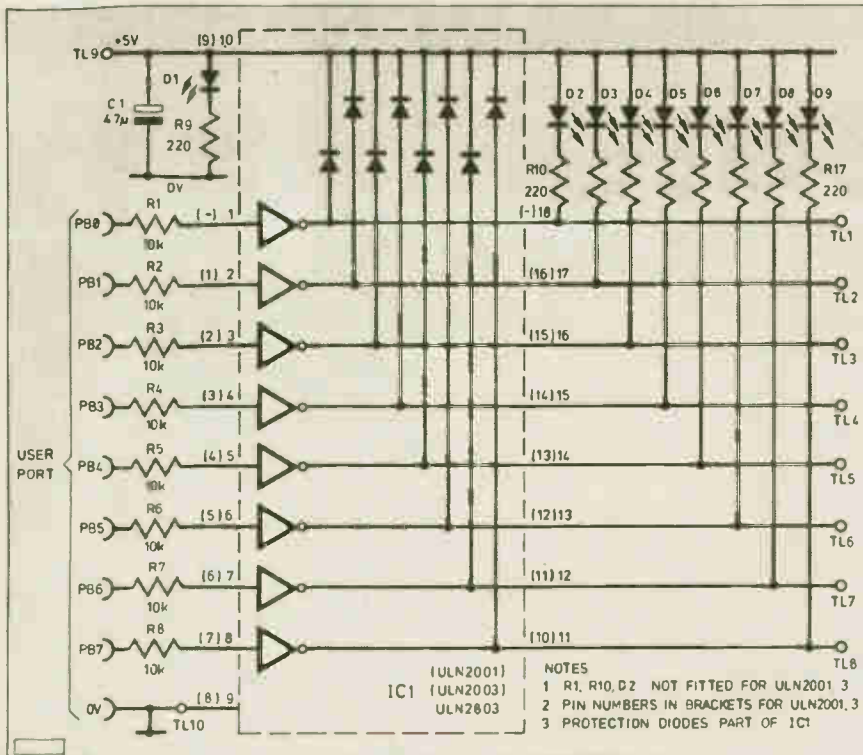

Fig. 2. The complete circuit diagram for the buffer/interface.

low-profile components on the PCBs, the best order is resistors, IC socket, LEDs and terminals. The terminals are made from small bolts, such as 4-40 machine screws, and although crude, are simple, cheap and satisfactory for semi-permanent connections using solder tags or spade terminals.

After the board is assembled, check the polarity of the capacitor and LEDs. The flat on the case of an LED represents the cathode. Fit IC1 into its socket.

The cable to the computer can be made up of suitable multi-conductor cable or ribbon cable, terminated in a connector to suit the computer. The connections can be obtained from the computer manual, and should be doublechecked by plugging the socket into the computer and measuring the output voltages for various output settings.

### Testing

In order to test the circuit, connect 5V across the power terminals. The power LED should light. If it doesn't, check the polarities of the power leads and the

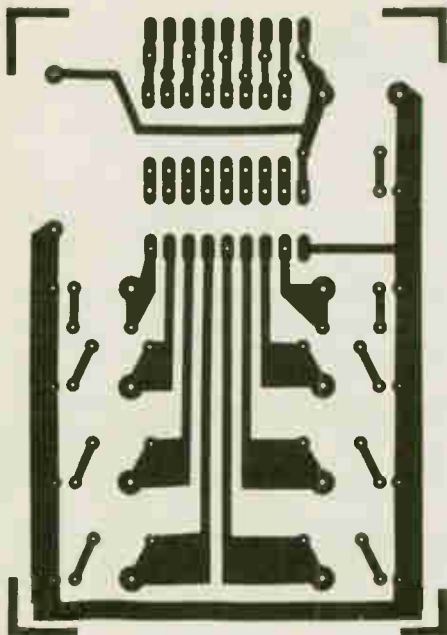
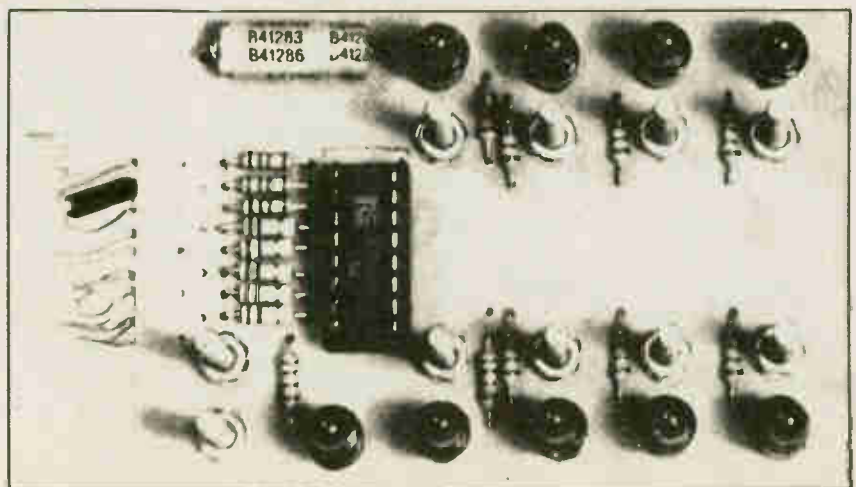
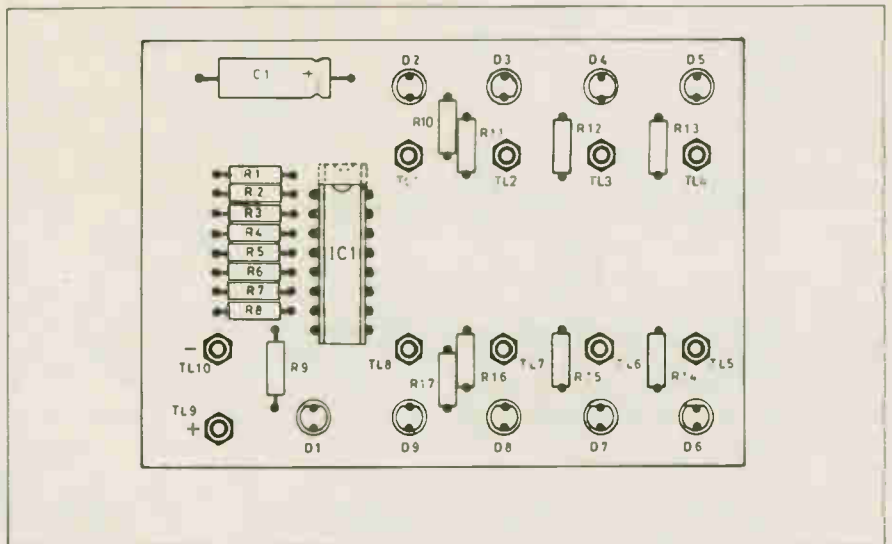

Fig. 3. The printed circuit board and component layout.



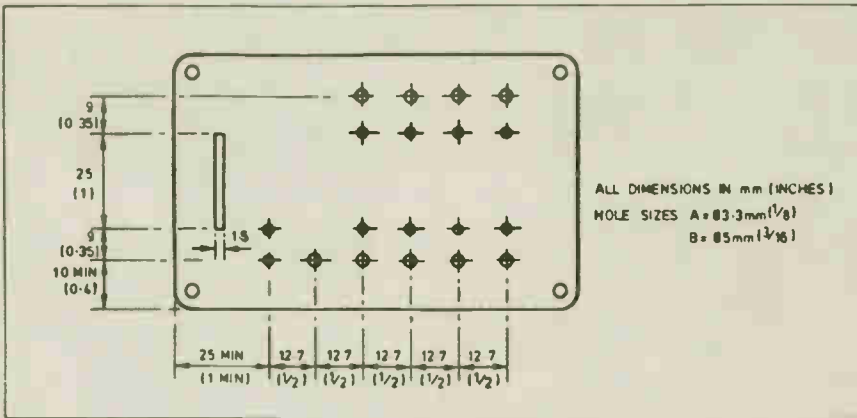

Fig. 4. The front panel drilling details.

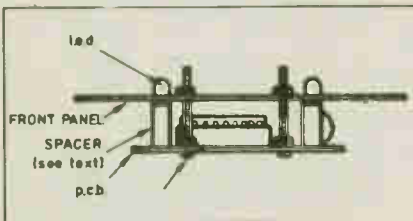

Fig. 5. The method of mounting the circuit board on the rear of the front panel.

## PARTS LIST

### Resistors

R1 to R8 ..... 10k (total 8)  
R9 to R17 ..... 220 (total 9)

### Capacitor

C1 ..... 47 $\mu$  25V electrolytic

### Semiconductor

IC1 ..... ULN2001 or ULN2003  
(for 7 channels)  
ULN2803 (for 8 channels)

### Miscellaneous

Suitable ribbon cable and connectors, 16-pin socket for 7-channel version or 18-pin socket for 8-channel version, utility box, mounting bolts, PCB, etc.

The ULN buffers are carried by Active Components.

LEDs themselves. Then, using another piece of wire, apply 5V to each input in turn; the associated LED should light.

Writing to the user ports should be done according to the computer manual's instructions. In general, the indicators will light in a binary pattern, where a Zero equals *not lit* and a One equals *lit*. ■

# NEXT MONTH IN Electronics Today

## OUR ANNUAL TEST EQUIPMENT SPECIAL!

- It's time once again for our yearly roundup of what's new for the well-equipped testbench. We'll be looking at the latest in oscilloscopes, meters, and lots more general-purpose and specialized test equipment.
- **Precision Audio Design, Part 2.** In this second article, we examine hum and noise caused by ground loops, and how to avoid the pitfalls thereof.
- **Connectors!** A special article on connectors, why they're reliable (or not) and how to select them.

Plus added features on technology.

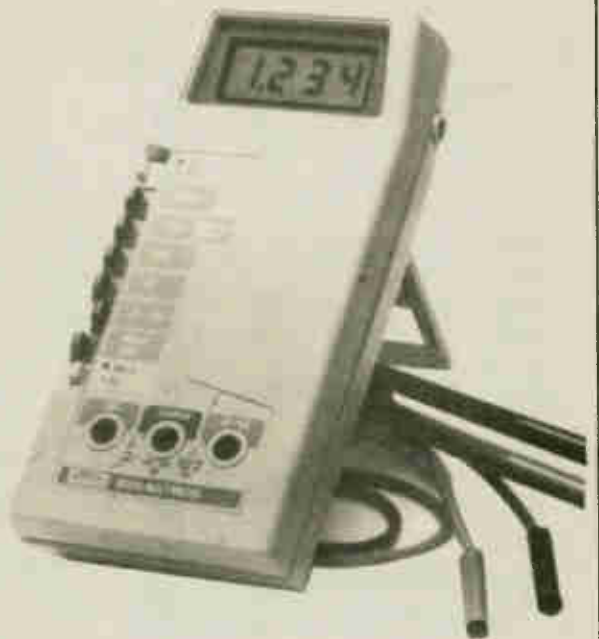

For Advertising and Subscriptions  
Call (416) 445-5600



# ALMOST FREE PC SOFTWARE VOLUME XXIII

**ARCE** A really tiny archive utility, this thing will extract members from ARC files without tying up half a disk for itself.

**BABY** An extremely warped game, this thing is engaging and fairly challenging none the less. It involves catching babies who are leaping out of a burning building.

**CHMOD** This is a useful utility for reading and changing the bits in the DOS mode flag.

**CITYDESK** This is a really elegant fancy printing program that allows you to do some desktop publishing functions with a dot matrix printer.

**DOG** A disk organizer, Dog will defragment the files on your disks to make them quicker to access.

**FPR** This is a printing program written in C. It's not compiled... you can change it to suit your needs. Requires a C compiler.

**THRILL** There is little to say about this program. It's a beautiful example of high resolution PC graphics, and was too good to ignore even if it is wholly useless. It's also a bit naughty.



This edition of our almost free PC software is an especially good value... it features two disks for the price of one and a half. We've expanded it in order to be able to include the latest version of the phenomenal PC-Write word processor, a package which outperforms just about everything else in creation... and costs a great deal less. We've also come up with a powerful collection of utilities and a very strange game. These two disks include some really splendid software, things that you'll probably wonder how you survived without once you get into using them.

All of this profound software, plus its attendant documentation and support files, is available for a mere

## \$29.95

plus seven percent Ontario sales tax.  
from

### MOORSHEAD PUBLICATIONS

1300 Don Mills Road, North York (Toronto),  
Ontario M3B 3M8 or you can order by phone. Call

## 1(416)445-5600

Have your MasterCard, Visa or American Express card ready.  
MAKE PAYMENT PAYABLE TO MOORSHEAD PUBLICATIONS

**Fine Print:** This software has been collected from public access bulletin boards and is believed to be in the public domain. We have checked this software carefully to insure that it functions as it should. However, we cannot assist you in adapting it to your specific applications. Moorshead Publications warrants that these programs will be readable when you get them. However, magnetic fields, cosmic rays, truck tires or the bends may adversely affect your disk in transit. If it doesn't function properly when you receive it please contact us for a prompt replacement.

Our latest software catalogue lists a variety of interesting, low cost programs. Circle reader service card number 100 for a free copy.

**MIDI-IO** This is the source file for the interrupt driven MIDI communication module from the April 1987 edition of Computing Now! Requires MASM to assemble and a language compiler to use... preferably C.

**PC-WRITE** The latest version of this phenomenal word processor, this thing is enough to turn you off any other word processing package on the planet. Even if you only write ribald lime-ricks in pig latin once every four years you owe it to yourself to try PC-Write.

**EDWIN** This is a decent windowing program editor written in Turbo Pascal. It's not terribly fancy, but it's fast and very much like WordStar.

#### PLEASE NOTE

This volume has been compressed in order to get all this software onto two disks. It will uncompress out to three floppies. This isn't terribly weird... there's a batch file to handle all the work for you... but plan to spend a while watching it run before you can use your software. When you get this disk set, place the first disk in drive A: of your PC and type INSTALL B, for example, to unpack the files onto a floppy in drive B:



**NEW & REVISED**

# BABANI BOOK OFFER

Exclusively available in Canada from  
**Moorshead Publications.**

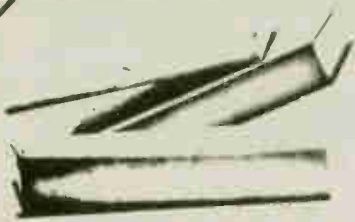

**NEVER BEFORE  
ADVERTISED**

## PROJECTS

**BP50: IC LM3900 PROJECTS** \$4.25  
The purpose of this book is to introduce the LM3900 to the Technician, Experimenter and Hobbyist. It provides the groundwork for both simple and more advanced uses and is considerably more than just a collection of simple circuits or projects.

**BP75: ELECTRONIC TEST EQUIPMENT CONSTRUCTION** \$5.25  
This book covers in details the construction and use of a wide range of test equipment for both the electronics hobbyist and radio amateur. The projects are fairly simple to build and the components are inexpensive and easily obtainable.

**BP76: POWER SUPPLY PROJECTS** \$7.50  
This book gives a number of power supply designs including simply unregulated types, fixed voltage regulated and variable voltage stabilised designs. The information in this book should also help the reader to design his own power supplies.

**BP92: ELECTRONICS SIMPLIFIED - CRYSTAL SET CONSTRUCTION** \$5.25  
This is a book written especially for those who wish to participate in the intricacies of electronics.

**BP101: HOW TO IDENTIFY UNMARKED IC'S** \$1.95  
An unusual and fascinating chart that is highly recommended to all those interested in electronics and which will hopefully pay for itself many times over, by enabling the reader to use IC's that might otherwise have been scrapped.

**BP121: HOW TO DESIGN AND MAKE YOUR OWN PCBs** \$5.85  
The purpose of this book is to familiarise the reader with both simple and more sophisticated methods of producing printed circuit boards. The emphasis of the book is very much on the practical aspects of printed circuit board design and construction.

**BP185: ELECTRONIC SYNTHESIZER CONSTRUCTION** \$9.00  
With this book a relative beginner should be able to build, with the minimum of difficulty and at a reasonably low cost, a worthwhile monophonic synthesiser and also learn a great deal about electronic music synthesis in the process.

## COMPUTERS

**BP61: BEGINNERS GUIDE TO DIGITAL TECHNIQUES** \$2.85  
It is the object of this book to cover the essential areas of basic digital techniques, and it is hoped that the material contained therein will help in better understanding and contribute to more enjoyment in using these incredible devices.

**BP72: A MICROPROCESSOR PRIMER** \$5.25  
In an attempt to give painless approach to computing, this inexpensive book will start by designing a simple computer and then the shortcomings of this simple machine will be discussed and the reader is shown how these can be overcome. A glossary of microprocessor terms is at the end of the book.

**BP78: PRACTICAL COMPUTER EXPERIMENTS** \$5.25  
The aim of this book is to enable the reader to simply and inexpensively construct and examine the operation of a number of basic computer circuit elements and it is hoped gain a fuller understanding of how the mysterious computer "chip" works.

**BP86: AN INTRODUCTION TO BASIC Programming Techniques** \$5.85  
This book is based on the authors own experience in learning BASIC and also in helping others, mostly beginners to programming, to understand the language.

**BP115: THE PRE-COMPUTER BOOK** \$5.85  
Aimed at the absolute beginner with no knowledge of computing, this entirely non-technical discussion of computer bits and pieces and programming is written mainly for those who do not possess a microcomputer but either intend to one day own one or simply wish to know something about them.

**BP135: SECRETS OF THE COMMODORE 64** \$5.85  
This book is intended as a beginner's guide to the Commodore 64. You will be getting masses of useful information and programming tips.

## CIRCUITS

**BP1: FIRST BOOK OF TRANSISTOR EQUIVALENTS AND SUBSTITUTES** \$4.50  
Shows alternatives and equivalents to many popular transistors made in Great Britain, U.S.A., Europe, Japan and Hong Kong.

**BP14: SECOND BOOK OF TRANSISTOR EQUIVALENTS AND SUBSTITUTES** \$5.25  
Companion Volume to BP1. An invaluable addition to the library of all those interested in Electronics be they amateur or professional.

**BP42: 50 SIMPLE L.E.D. CIRCUITS** \$5.85  
Contains 50 interesting and useful circuits and applications, covering many different branches of electronics, using one of the most inexpensive and freely available components.

**BP85: INTERNATIONAL TRANSISTOR EQUIVALENTS GUIDE** \$9.00  
This book is designed to help the user find possible substitutes for a popular user-orientated selection of modern transistors and includes devices produced by over 100 manufacturers.

**BP140: DIGITAL IC EQUIVALENTS AND PIN CONNECTIONS** \$15.00  
Shows equivalents and pin connections of a popular user orientated selection of Digital Integrated Circuits. Includes European, American and Japanese devices.

## RADIO AND COMMUNICATIONS

**BP51: ELECTRONIC MUSIC AND CREATIVE TAPE RECORDING** \$5.85  
This book sets out to show how Electronic Music can be made at home with the simplest and most inexpensive equipment. It describes how the sounds are generated and how these may be recorded to build up the final composition.

**BP70: TRANSISTOR RADIO FAULT-FINDING CHART** \$2.85  
The author has developed this chart by drawing on many years of experience in repairing transistor radios and, used properly, should enable the reader to trace most common faults reasonably quickly.

**BP79: RADIO CONTROL FOR BEGINNERS** \$5.25  
The aim of this book is to provide a practical introduction to radio control for newcomers to this fascinating hobby. A number of constructional projects are included and in many cases complete board layouts are given to help the beginner who is inexperienced in electronic construction techniques to simply and successfully build up the circuits.

**BP100: AN INTRODUCTION TO VIDEO** \$5.85  
This is a book for the person who has just, or is about to buy or rent some video equipment but is not sure what it is all about.

**BP125: 25 SIMPLE AMATEUR BAND AERIALS** \$5.85  
This book describes how to build 25 amateur band aerials. The designs start with the simple dipole and proceed to beam, triangle and even a mini-rhombic.

**BP155: INTERNATIONAL RADIO STATION GUIDE** \$9.00  
The tables show the station site, country, frequency and/or wavelength as well as the effective radiation power (ERP) of the transmitter and in some cases, the station's call sign.

**BP53: PRACTICAL ELECTRONICS CALCULATIONS AND FORMULAE** \$11.80  
A book that bridges the gap between complicated technical theory and the "cut and try" method. A good reference book.

**BP136: 25 SIMPLE INDOOR AND WINDOW AERIALS** \$7.00  
People living in apartments who would like to improve short-wave listening can benefit from these instructions on optimising the indoor aerial.

**BP147: AN INTRODUCTION TO 6502 MACHINE CODE** \$10.00  
The popular 6502 microprocessor is used in many home computers: this is a guide to beginning assembly language.

**BP225: A PRACTICAL INTRODUCTION TO DIGITAL ICs** \$7.00  
This book deals mainly with TTL type chips such as the 7400 series. Simple projects and a complete practical construction of a Logic Test Circuit Set are included as well as details for a more complicated Digital Counter Timer project.

**BP47: MOBILE DISCOTHEQUE HANDBOOK** \$7.80  
Divided into six parts, this book covers such areas of mobile "disco" as Basic Electricity, Audio, Ancillary Equipment, Cables and Plugs, Loudspeakers, and Lighting. All the information has been considerably sub-divided for quick and easy reference.

**BP131: MICRO INTERFACING CIRCUITS - BOOK 2** \$9.00  
Intended to carry on from Book 1, this book deals with practical applications beyond the parallel and serial interface "Real world" interfacing such as sound and speech generators, temperature and optical sensors, and motor controls are discussed using practical circuit descriptions.

**BP141: LINEAR IC EQUIVALENTS AND PIN CONNECTIONS ADRIAN MICHAELS** \$23.80  
Find equivalents and cross-references for both popular and unusual integrated circuits. Shows details of functions, manufacturer, country of origin, pinouts, etc., includes National, Motorola, Fairchild, Harris, Motorola, Intersil, Philips, ADC, AMD, SGS, Teledyne, and many other European, American, and Japanese brands.

**BP156: AN INTRODUCTION TO QL MACHINE CODE** \$10.00  
The powerful Sinclair QL microcomputer has some outstanding capabilities in terms of its internal structure. With a 32-bit architecture, the QL has a large address range, advanced instructions which include multiplication and division. These features give the budding machine code programmer a good start at advanced programming methods. This book assumes no previous knowledge of either the 68008 or machine code programming.



# BABANI BOOKS

**BP59: SECOND BOOK OF CMOSIC PROJECTS** \$7.80  
This book carries on from its predecessor and provides a further selection of useful circuits, mainly of a simple nature. The book will be well within the capabilities of the beginner and more advanced constructor.

**BP32: HOW TO BUILD YOUR OWN METAL & TREASURE LOCATORS** \$7.80  
Several fascinating applications with complete electronic and practical details on the simple, and inexpensive construction of Heterodyne Metal Locators.

## ELECTRONIC THEORY

**BP144: FURTHER PRACTICAL ELECTRONICS CALCULATIONS AND FORMULAE** \$5.00

This book covers many aspects of electronics where a knowledge and familiarity of the appropriate formulae is essential for a fuller understanding of the subject. An essential addition to the library of all those interested in electronics be they amateur, professional or student.

**ELEMENTS OF ELECTRONICS — AN ON-GOING SERIES**  
F.A. WILSON, C.G.I.A., C.Eng.  
**BP62: BOOK 1. The Simple Electronic Circuit and Components** \$11.70

**BP77: BOOK 4. Microprocessing Systems And Circuits** \$11.80

Although written especially for readers with no more than ordinary arithmetical skills, the use of mathematics is not avoided, and all the mathematics required is taught as the reader progresses.

Each book is a complete treatise of a particular branch of the subject and, therefore, can be used on its own with one proviso: that the later books do not duplicate material from their predecessors, thus a working knowledge of the subjects covered by the earlier books is assumed.

**BOOK 1** This book contains all the fundamental theory necessary to lead to a full understanding of the simple electronic circuit and its main components.

**BOOK 2** This book continues with alternating current theory without which there can be no comprehension of speech music radio, television or even the electricity utilities.

**BOOK 3** Follows on semiconductor technology leading up to transistors and integrated circuits.

**BOOK 4** A complete description of the internal workings of microprocessor.

**BOOK 5** A book covering the whole communication scene.

## PROJECTS

**BP37: 50 PROJECTS USING RELAYS, SCR'S & TRIACS** \$7.80  
F.G. RAYER, T.Eng.(CEI), Assoc.IERE

Relays, silicon controlled rectifiers (SCR's) and bidirectional triodes (TRIACS) have a wide range of applications in electronics today. This book gives tried and practical working circuits which should present the minimum of difficulty for the enthusiast to construct. In most of the circuits there is a wide latitude in component values and types, allowing easy modification of circuits or ready adaptation of them to individual needs.

**BP71: ELECTRONIC HOUSEHOLD PROJECTS** \$7.00  
R.A. PENFOLD

Some of the most useful and popular electronic construction projects are those that can be used in or around the home. The circuits range from such things as 2 Tone Door Buzzer, Intercom, through Smoke or Gas Detectors to Baby and Freezer Alarms.

**BP90: AUDIO PROJECTS** \$7.80  
F.G. RAYER

Covers in detail the construction of a wide range of audio projects. The text has been divided into preamplifiers and mixers, power amplifiers, tone controls and matching and miscellaneous projects.

**BP44: IC 555 PROJECTS** \$10.00  
E.A. PARR, B.Sc., C.Eng., M.I.E.E.

Every so often a device appears that is so useful that one wonders how life went on before without it. The 555 timer is such a device. Included in this book are Basic and General Circuits, Motor Car and Model Railway Circuits, Alarms and Noise Makers as well as a section on the 556, 558 and 559 timers.

**BP82: ELECTRONIC PROJECTS USING SOLAR CELLS** \$7.80  
A collection of simple circuits which have applications in and around the home using the energy of the sun to power them. The book deals with practical solar power supplies including voltage doubler and tripler circuits, as well as a number of projects.

**BP49: POPULAR ELECTRONIC PROJECTS** \$10.00  
R.A. PENFOLD

Includes a collection of the most popular types of circuits and projects which, we feel sure, will provide a number of designs to interest most electronics constructors. The projects selected cover a very wide range and are divided into four basic types: Radio Projects, Audio Projects, Household Projects and Test Equipment.

**BP94: ELECTRONIC PROJECTS FOR CARS AND BOATS** \$7.80  
R.A. PENFOLD

Projects, fifteen in all, which use a 12V supply are the basis of this book. Included are projects on Windscreen Wiper Control, Courtesy Light Delay, Battery Monitor, Cassette Power Supply, Lights Timer, Vehicle Immobiliser, Gas and Smoke Alarm, Depth Warning and Shaver Inverter.

**BP95: MODEL RAILWAY PROJECTS** \$7.80  
Electronic projects for model railways are fairly recent and have made possible an amazing degree of realism. The projects covered include controllers, signals and sound effects, strobeboard layouts are provided for each project.

**BP93: ELECTRONIC TIMER PROJECTS** \$7.80  
F.G. RAYER

Windscreen wiper delay, darkroom timer and metronome projects are included. Some of the more complex circuits are made up from simpler sub-circuits which are dealt with individually.

**BP84: DIGITAL IC PROJECTS** \$7.80  
F.G. RAYER, T.Eng.(CEI), Assoc.IERE

This book contains both simple and more advanced projects and it is hoped that these will be found of help to the reader developing a knowledge of the workings of digital circuits. To help the newcomer to the hobby the author has included a number of board layouts and wiring diagrams. Also the more ambitious projects can be built and tested section by section and this should help avoid or correct faults that could otherwise be troublesome. An ideal book for both beginner and more advanced enthusiast alike.

**BP99: MINI—MATRIX BOARD PROJECTS** \$7.60  
R.A. PENFOLD

Twenty useful projects which can all be built on a 24 x 10 hole matrix board with copper strips. Includes Doorbuzzer, Low-voltage Alarm, AM Radio, Signal Generator, Projector Timer, Guitar Headphone Amp, Transistor Checker and more.

**BP103: MULTI-CIRCUIT BOARD PROJECTS** \$7.80  
R.A. PENFOLD

This book allows the reader to build 21 fairly simple electronic projects, all of which may be constructed on the same printed circuit board. Wherever possible, the same components have been used in each design so that with a relatively small number of components and hence low cost, it is possible to make any one of the projects or by reusing the components and PCB all of the projects.

**BP107: 30 SOLDERLESS BREADBOARD PROJECTS — BOOK 1** \$9.00  
R.A. PENFOLD

A "Solderless Breadboard" is simply a special board on which electronic circuits can be built and tested. The components used are just plugged in and unplugged as desired. The 30 projects featured in this book have been specially designed to be built on a "Verobloc" breadboard. Wherever possible the components used are common to several projects, hence with only a modest number of reasonably inexpensive components it is possible to build, in turn, every project shown.

**BP106: MODERN OP-AMP PROJECTS** \$7.80  
R.A. PENFOLD

Features a wide range of constructional projects which make use of op-amps including low noise, low distortion, ultra-high input impedance, high slew-rate and high output current types.

## CIRCUITS

**How to Design Electronic Projects** \$9.00  
BP127

Although information on standard circuit blocks is available, there is less information on combining these circuit parts together. This title does just that. Practical examples are used and each is analysed to show what each does and how to apply this to other designs.

**Audio Amplifier Construction** \$2.25  
BP122

A wide range of circuits is given, from low noise microphone and tape head preamps to a 100W MOSFET type. There is also the circuit for 12V bridge amp giving 18W. Circuit board or strip board layout are included. Most of the circuits are well within the capabilities for even those with limited experience.

**BP98: POPULAR ELECTRONIC CIRCUITS, BOOK 2** \$9.00  
R.A. PENFOLD

70 plus circuits based on modern components aimed at those with some experience.

**BP179: ELECTRONIC CIRCUITS FOR THE COMPUTER CONTROL OF ROBOTS** \$12.00

The main stumbling block for most would-be robot builders is the electronics to interface the computer to the motors, and the sensors which provide feedback from the robot to the computer. The purpose of this book is to explain and provide some relatively simple electronic circuits which bridge the gap.

**BP39: 50 (FET) FIELD EFFECT TRANSISTOR PROJECTS** \$7.00  
F.G. RAYER, T.Eng.(CEI), Assoc.IERE

Field effect transistors (FETs) find application in a wide variety of circuits. The projects described here include radio frequency amplifiers and converters, test equipment and receiver aids, tuners, receivers, mixers and tone controls, as well as various miscellaneous devices which are useful in the home.

This book contains something of particular interest for every class of enthusiast — short wave listener, radio amateur, experimenter or audio devotee.

**BP88: HOW TO USE OP AMPS** \$11.80  
E.A. PARR

A designer's guide covering several op amps, serving as a source book of circuits and a reference book for design calculations. The approach has been made as non-mathematical as possible.

**BP65: SINGLE IC PROJECTS** \$6.00  
R.A. PENFOLD

There is now a vast range of ICs available to the amateur market, the majority of which are not necessarily designed for use in a single application and can offer unlimited possibilities. All the projects contained in this book are simple to construct and are based on a single IC. A few projects employ one or two transistors in addition to an IC but in most cases the IC is the only active device used.

**223: 50 PROJECTS USING IC CA3130** \$5.00  
R.A. PENFOLD

In this book, the author has designed and developed a number of interesting and useful projects which are divided into five general categories: I — Audio Projects II — R.F. Projects III — Test Equipment IV — Household Projects V — Miscellaneous Projects.

**BP102: THE 6809 COMPANION** \$7.80

Written for machine language programmers who want to expand their knowledge of microprocessors. Outlines history, architecture, addressing modes, and the instruction set of the 6809 microprocessor. The book also covers such topics as converting programs from the 6800, program style, and specifics of 6809 hardware and software availability.

**BP118: PRACTICAL ELECTRONIC BUILDING BLOCKS — Book 2** \$7.60  
R.A. PENFOLD

This sequel to BP117 is written to help the reader create and experiment with his own circuits by combining standard type circuit building blocks. Circuits concerned with generating signals were covered in Book 1, this one deals with processing signals. Amplifiers and filters account for most of the book but comparators, Schmitt triggers and other circuits are covered.

**BP83: VMOS PROJECTS** \$7.80  
R.A. PENFOLD

Although modern bipolar power transistors give excellent results in a wide range of applications, they are not without their drawbacks or limitations. This book will primarily be concerned with VMOS power FETs although power MOSFETs will be dealt with in the chapter on audio circuits. A number of varied and interesting projects are covered under the main headings of Audio Circuits, Sound Generator Circuits, DC Control Circuits and Signal Control Circuits.

## RADIO AND COMMUNICATIONS

**BP177: AN INTRODUCTION TO COMPUTER COMMUNICATIONS** \$7.80

Connecting up an ordinary home computer to the telephone system via a modem opens up a new world of possibilities: talking to other computers, databases, networks, radio links, etc. An explanation of basic principles and practicalities in simple terms.

**BP176: A TV-DIXERS HANDBOOK** \$18.00

This book will be a practical guide for the beginner and a source of reference for the established TV-DXing enthusiast. The possibilities and problems of receiving television signals over long distances and resolving of such pictures with the minimum of distortion is discussed. Also included are many units and devices which have been designed by experienced enthusiasts.

# An Introduction to Desktop Publishing

## Our initial experiences with two of the available DTP systems.

By Bill Markwick

The latest bit of software to stir up excitement is the desktop publishing system, said to be the electronic equivalent of the Gutenberg printing press. Here is a very brief sampling of our experiences with two of these systems, the Aldus Pagemaker and the Xerox Ventura system. We also have DTP software for the Macintosh, but I didn't get time to examine it closely enough to include it before press date.

This isn't meant to be a product review, but a quick summary of what the new user faces when learning DTP.

### What You Can Do

You can type text into the computer screen page or load it from a word processor disk, move it around, change the type size and style, add rules and boxes, load pictures from certain computer drawing programs, and flow the text around them.

When you have the page or pages filled, you can adjust here and there for a more pleasing balance, change headlines and subheadings to bold, italic or another typeface, and save the whole thing to a disk.

Now you can print out the pages on your laserprinter. The quality of the type at 300 dots per inch is somewhat less crisp than a proper typesetter at 600/1200DPI, but it's adequate for

most purposes and infinitely better looking than even a good typewriter.

### What You Need

The bare minimum that you need for MS-DOS DTP is an IBM or compatible with 512K and preferably 640K, a hard disk with at least two megabytes of room on it, a mouse, and a laserprinter. The type of monitor isn't too important; a TTL type with a Hercules card would be nice, but we get along with a standard Colour Graphics Card and monochrome monitors.

If you already have a standard 4.7MHz PC, you'll find it irritatingly slow, depending on your patience level. The next step up is an 8MHz Turbo version, with an AT or compatible being much better.

The mouse can be almost any type; we use the SummaMouse and it always installs without a fuss, even if you use a Mouse Systems driver.

We've recently acquired a Packard-Bell system with an AT compatible and their own brand of laserprinter; the package arrived complete with a scanner and Ventura software. The printer isn't yet equipped with a Postscript interface; Postscript is a page-description coding that allows any DTP software that can write the required file to work with any laserprinter that has the interface. At the moment we can only print out Ventura files through the Packard Bell system.

Incidentally, both systems can be configured to print on an Epson printer as well. It's slow, and the quality is a bit sketchy, but it's handy for checking your work when the laserprinter is tied up.

### Installation

Both Ventura and Pagemaker require

a lengthy disk-swapping procedure to load the files into the hard disk, and you have to do it all over again if you decide to change anything. Pagemaker also requires Microsoft Windows, a file-handling, windowing system that comes with it. Some computer users may find Windows convenient for general use as well, though I prefer my DOS lean- and-mean. One advantage to the Windows approach is that it comes with a paintbox program that's compatible with Pagemaker.

The mouse will occupy one serial port, and another will be required for the laserprinter. You'll probably have to buy more hardware to add a second port.

### Tryout

Both systems come with extensive documentation which is fortunately subdivided into main and quick-reference books. Load the program and have a go at typing something in or loading a textfile. You'll probably find that they're very easy to use at first, with most operations guided by pull-down menus that are fairly straightforward.

Changing the typeface is just a matter of tagging the specific text with the cursor and selecting the type from a menu. The view you'll have will either be a reduced view in which the full page appears on the screen, or the normal view of about half a column; the view can be moved over the page with the cursor. The result of enlarging the text is not always what you'd expect; sometimes the larger text will be forced all over the place until you reduce its size or start over.

The text-handling capabilities of the DTP systems are limited; they aren't really meant to be word processors, but a methods of doing simple text or corrections quickly.



Ventura uses a system of frames, in which the user draws a semi-transparent box on the screen to mark the desired location for text or pictures to be loaded. Pagemaker lets you load the text first, then set its size with the cursor. Text can be moved around in both systems; it's fairly easy with Pagemaker's cursoring, and fairly complicated with Ventura's cut-and-paste. Cutting is no problem, but if you don't do things in the right order, you may end up emptying the buffer or altering its contents.

### Fuzzy Wuzzy WYSIWYG

What You See Is What You Get is an admirable goal for the publishers of these systems, but it's some distance away yet. One particularly annoying thing is that timesteps may change here and there for no apparent reason. No doubt the problem (and its cure) is explained somewhere in the manual, but it's frustrating at first. A more serious problem for those of us who aren't layout artists is the difference in size and proportion between the screen image and the final printed page. What looks good onscreen is often airy and spindly (or all jammed up) when transferred to the printed page. Someone said once that DTP is going to result in more bad artwork than the invention of Letraset.

The answer, besides reading the manual thoroughly, is to spend a lot of time at it. I found that even my meagre layout skills began to improve with practice, though I still find that it takes more time to make the fine adjustments than it does to create the basic file.

### Graphics

Both systems have a very simple graphics function for adding straight lines and boxes. Both are somewhat cumbersome to use; sometimes you draw a line and it ends up drawn on every page because it's hard to tell which function is a one-time and which is a repeater.

The graphics can be expanded most easily with Pagemaker; the Windows filehandler has a good paintbox program whose files are directly compatible with the DTP. Just draw what you want using the comprehensive menus, inhale the resulting file into Pagemaker and size the drawing to

suit. It's a little more complex with Ventura.

### Style Sheets

It's possible to set up the format you like and transfer these characteristics to a template that can be called up for each editing session. This saves a great deal of time when it comes to ruler lines, timesteps, and so on.

### File Loading

There isn't much of a problem with word processor files; the programs can decipher most of the popular processor textfiles. When it comes to loading pictures, however, you're in for some complex file conversions, particularly with Ventura. This system uses the GEM format, which makes the PC screen somewhat like a Macintosh with pulldown menus and so forth. This means that any drawing files must be converted to the GEM format, and the means for doing this are limited.

For example, I have to be able to load schematics done with AutoCAD. First, the AutoCAD file has to be sent to the disk in the DXF format using AutoCAD's internal utilities. Then the DXF file has to be converted to a GEM file using a utility that comes with Ventura. It's very time-consuming and doesn't always work reliably. AutoCAD also seems to be the only CAD program that can write in the required format.

On the other hand, once your drawing is loaded into Ventura, sized and scaled, and printed out on the laserprinter, there's nothing like it, not even the best of printouts from the best of plotters. Furthermore, you can use the DTP program to add real text and labels instead of the rickety

characters that come with AutoCAD.

### The New Gutenberg?

Journalists and DTP salespeople have let fly the idea that DTP is an invention rivalling the invention of the printing press. In a way, it is: production problems are vastly simplified for both small and large publishers, and people who find page layout to be intimidating will be encouraged to go ahead.

But it only solves problems in one small area, that of page layout production. This is not the main hurdle to getting your book or magazine published; the problem is getting into the proper distribution and retail markets.

On the other hand, I suppose you could store your magazine or newsletter as a Postscript file, send it to other DTP users in other cities via modem, and have them get a limited number of copies printed and distributed locally. Painless nationwide distribution for the basement newsletter.

To sum up, the systems can be frustrating to learn and use; to some extent they program you instead of the other way around. Still, they open up a new world of possibilities to anyone involved with any type of publishing, and when you surmount the problems, they're enormously rewarding. ■

*This article was typeset with Ventura and the Packard Bell laserprinter.*

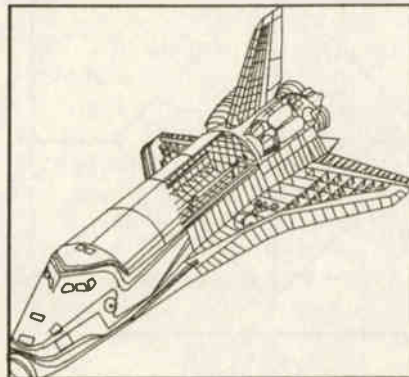

*The ubiquitous AutoCAD shuttle.*

# Current Tracer

*Keep on the right track with this low cost tester*

*By Mike Tooley*

THIS SIMPLE current tracer provides a means of sensing and indicating the relative magnitudes of the currents present in printed circuit board tracks without having to break the circuit in order to insert a conventional current measuring instrument. The instrument described is capable of sensing current levels of as little as a few milliamps and can be either direct coupled or AC coupled to the circuit under test.

Commercial current tracers operate on one of two principles: either sensing the small voltage dropped along a printed circuit track carrying a current or by employing a Hall effect device to sense the magnetic field in the immediate vicinity of a printed circuit track carrying a current.

Generally speaking, Hall effect current tracers are superior since they require no direct contact with the printed circuit tracks and the uncertainty for making an effective contact with the track is eliminated. Unfortunately, such instruments are extremely expensive and the technique is therefore inappropriate for a low-cost home-built item.

## Circuit Description

The complete circuit diagram of the Current Tracer is shown in Fig. 1. The unit senses the small voltage drop present along a printed circuit track (typically a few hundred microvolts) and comprises a single inverting operational amplifier IC1.

To cope with the wide range of input voltage levels (from a microvolt to several hundred millivolts) the op-amp is used in a configuration which ensures a logarithmic characteristic where the voltage gain provided by the circuit falls markedly as the level of the input signal increases.

Switch S1 provides selection of AC or DC coupling at the input of IC1 while potentiometer VR1 provides additional manual gain (sensitivity) control. The bridge rectifier arrangement formed by the diodes D1 to D4 ensures that the signal presented to the meter is of the correct polarity regardless of the polarity of the input. Diodes D5 and D6 provide "last ditch" protection of the meter movement

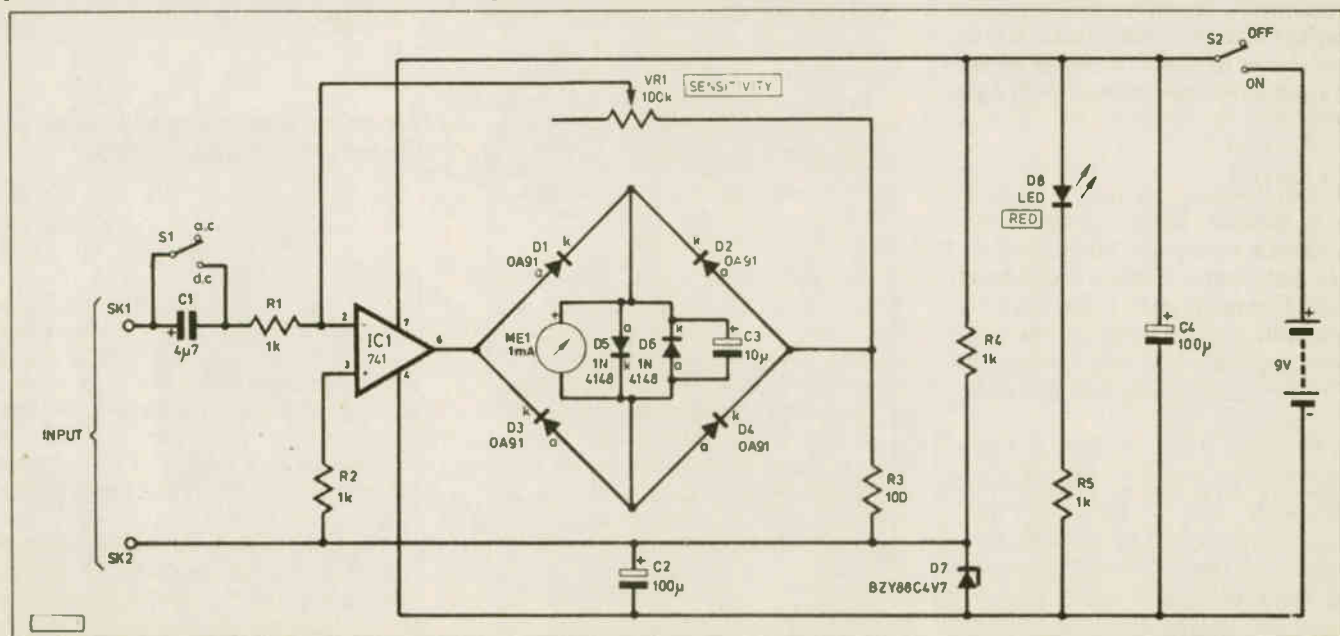

Fig. 1 Complete circuit diagram for the Current Tracer.



while capacitor C3 determines the time constant of the meter display.

A nominal half-supply rail for the op-amp inputs is provided by means of a simple shunt Zener diode D7. Capacitors C2 and C4 provide decoupling while the LED D8 indicates that the instrument is switched on.

## Construction

The Current Tracer is extremely simple to construct. With the exception of the battery connector, meter, probe socket, and front panel controls, all components are mounted on a standard size matrix board comprising 24 strips of 23 holes.

The stripboard component layout is shown in Fig. 2. Please note that four track breaks in the copper strips are required under the IC holder and these should be made using a spot face cutter or sharp drill bit of the appropriate size.

After the board has been assembled and thoroughly checked, it should be mounted horizontally in the base of the case using four short insulated stand-off pillars. The IC should then be inserted into its socket, again taking care to ensure correct orientation.

The meter movement, controls and probe connectors are mounted on the front panel according to the photographs and rear panel wiring (Fig. 3). Before finally mounting the front panel components, the fascia can be lettered according to the photographs. Links to the front panel mounted components should be made using short lengths of insulated wire, following the wiring diagram shown in Fig. 3.

## Testing

When complete, carefully check the internal wiring of the Current Tracer, taking particular care to check the wiring of the battery connector and meter. The 9V battery may then be connected and the unit can be switched on.

The LED D8 should be illuminated, indicating the presence of the DC supply, and a multimeter switched to the 10VDC range should be used to check that the voltage developed across the Zener diode D7 is in the range of 4.5V to 5V. If this is not the case, carefully check the internal wiring and component board layout.

Two probes should then be purchased (or built) bearing in mind that the equipment requires a very effective connection to the track of the printed circuit under test. Each probe should be fitted with an insulated connecting lead terminated with a 2mm plug. The probes should then be used to link the Current Tracer to the test circuit shown in Fig. 4 which provides voltage drops of approximately 100uV, 1mV, and 100mV respectively.

Electronics Today June 1987

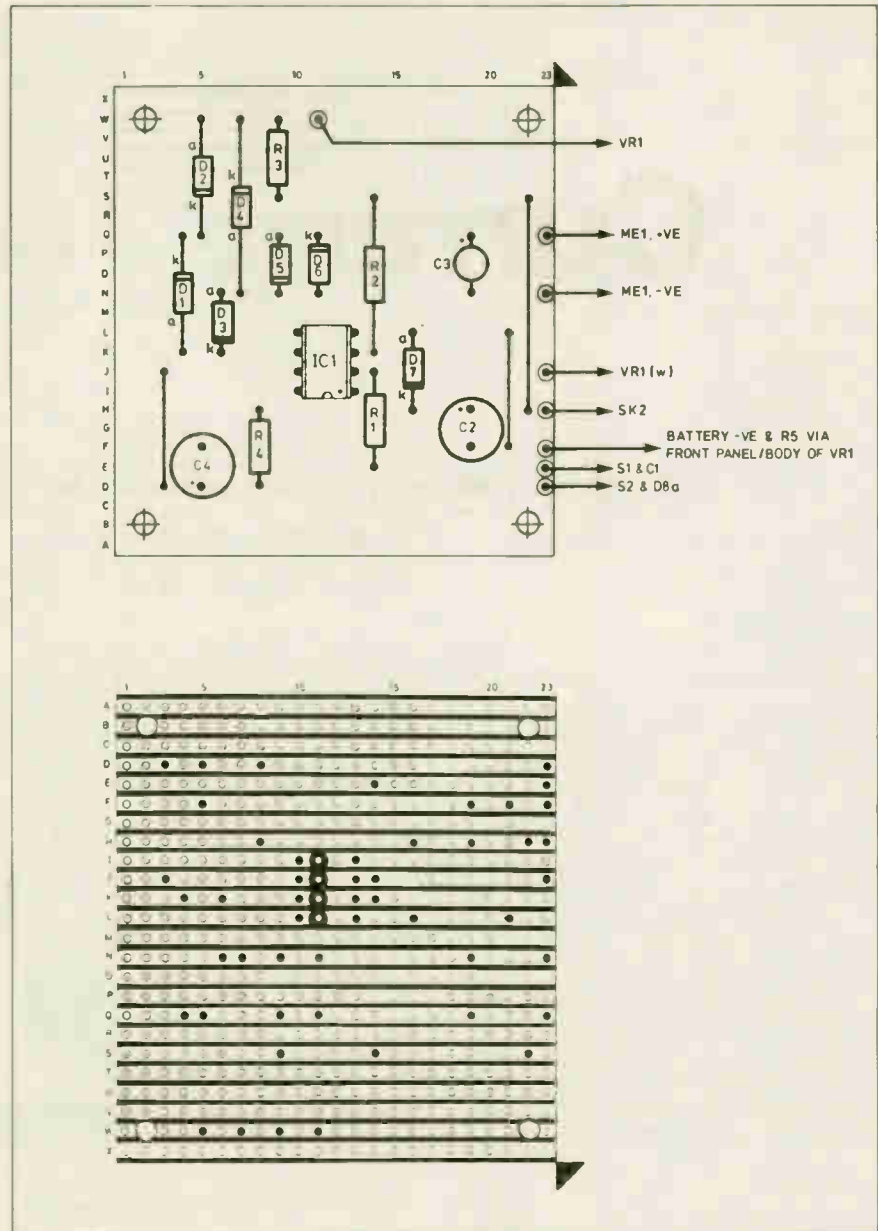

Fig. 2 Circuit board component layout, details of breaks to be made in the underside copper tracks and wiring details to the front panel. The VR1 lead marked with a "w" should be taken to the wiper or center tag of the potentiometer.

The Current Tracer's Sensitivity control, VR1, should be set to maximum (fully clockwise) and the probes applied to points A and D of the test circuit. This should produce a full-scale indication on the meter, of approximately 1mA.

The probes should then fall to approximately 0.6mA. Finally, the probes should be applied to points C and D. In this position, a reading of approximately 0.3mA should be produced.

It should be noted that since the Current Tracer is not "polarity conscious", the polarity of the input connections is not important.

## In Use

Having confirmed that the Current Tracer is operating correctly, it is spending a little time familiarizing yourself with its use. It will, of course, be necessary to find a suitable PC board with which to do this. The board you select should ideally be populated with a variety of TTL devices and should be connected to its normal supply.

The Current Tracer's probes should be applied at various points along the printed circuit tracks which convey the supply and the indications produced should be carefully observed. A probe separation of

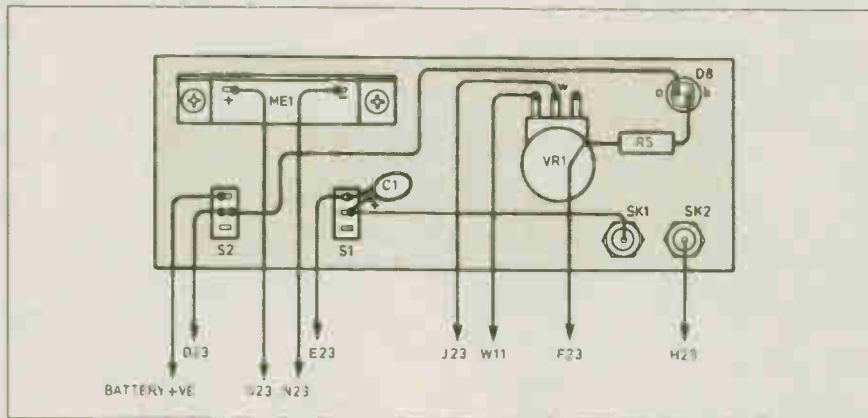

Fig. 3 Interwiring between the front panel mounted components. Note that resistor R5 is soldered to the metal body of potentiometer VR1.

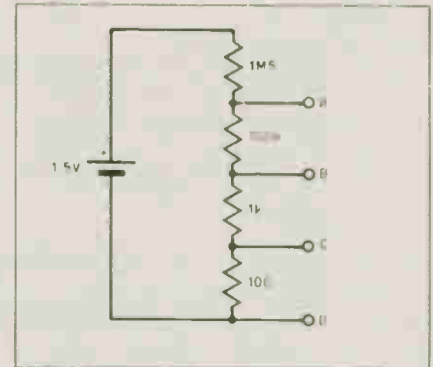

Fig. 4 Current Tracer test circuit.

10mm will produce a discernible deflection on a printed circuit track carrying the normal supply current associated with a standard TTL device.

Increasing the separation of the probes will, of course, increase the indication

produced. With practice, it should be possible to make a meaningful assessment of the relative supply current for each chip present.

Finally, the probe can also be used to detect faults in connectors (simply connect the probes on either side of similarly numbered pin connections and observe the indication produced), dry or "high resistance" joints, and inadequate

decoupling. In this latter application, the instrument should be used in the AC mode and the probes connected between the positive supply rail and 0V.

### Parts List

#### Resistors

R1	.....	1k
R2	.....	1k
R3	.....	100R
R4	.....	1k
R5	.....	1k

All 0.25W, 5% carbon

#### Potentiometer

VR1	.....	100k lin. carbon
-----	-------	------------------

#### Capacitors

C1	.....	4u7 tant. 35V
C2	.....	100u p.c. elec. 16V
C3	.....	10u p.c. elec. 16V
C4	.....	100u p.c. elec. 16V

#### Semiconductors

D1-D4	.....	1N34
D5,6	.....	1N4148
D7	.....	.4V7 Zener
D8	.....	red LED w/bezel
IC1	.....	741 op-amp

#### Miscellaneous

ME1	.....	1mA edgewise meter
S1	.....	SPDT min. toggle
S2	.....	SPDT min toggle
SK1	.....	.2mm socket (red)
SK2	.....	.2mm socket (black)

8-pin low-profile DIL socket; case to suit approx. 205 x 140 x 110mm; 0.1in matrix stripboard (24 tracks x 23 holes); single-sided 1mm terminal pins (8); insulated threaded mounting pillars (4); mounting bolts, nuts, knob, 9V battery and connector, and probes.

Note: The edgewise panel meter (e.g. Shurite 350 series) is available from Electro Sonic Inc., 1100 Gordon Baker Rd., Willowdale, Ontario, M2H 3B3. (416) 494-1555.

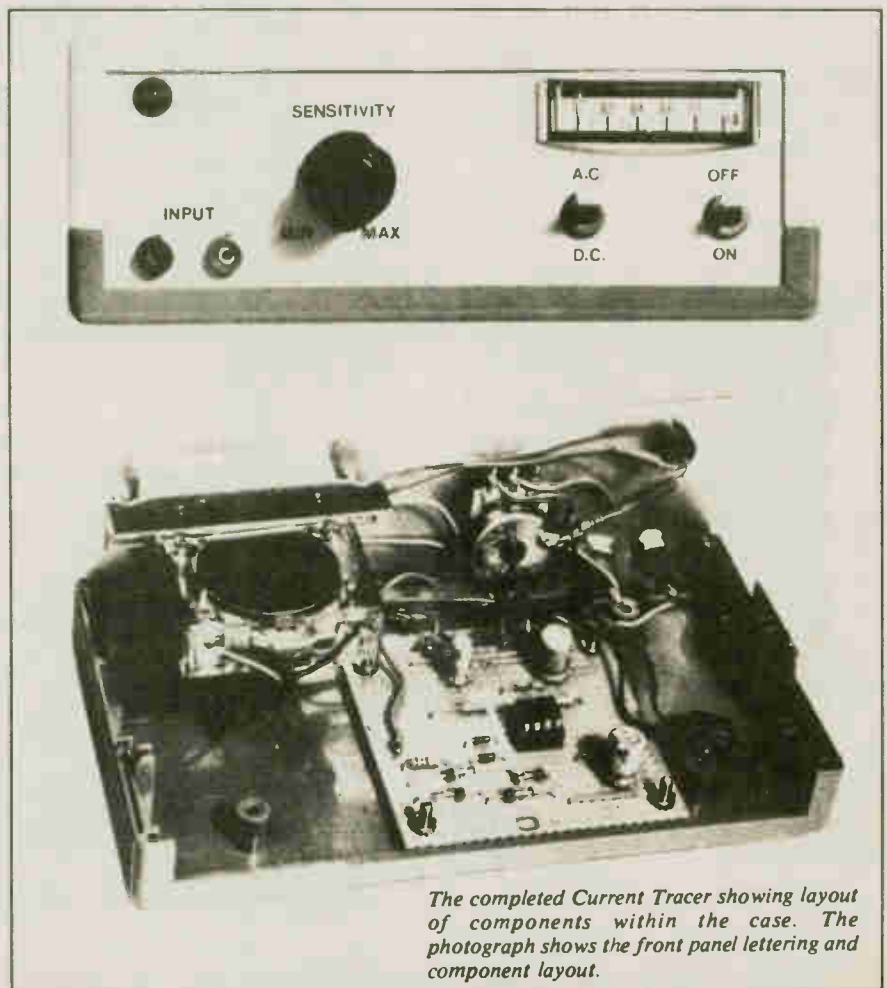

The completed Current Tracer showing layout of components within the case. The photograph shows the front panel lettering and component layout.



## IBM Speech Recognition System

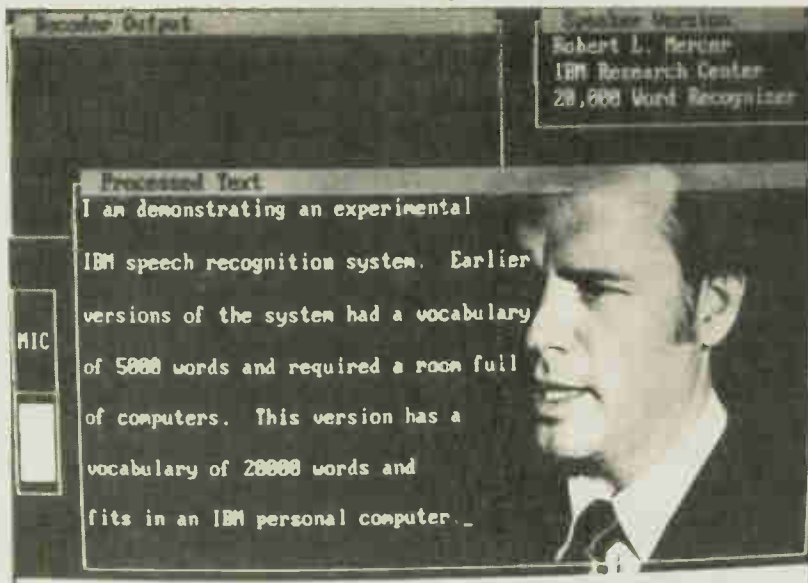

Computer recognition of human speech has moved dramatically forward with the demonstration by IBM scientists of a 20,000-word vocabulary for their experimental speech-recognition system.

Speech-recognition research at the IBM T.J. Watson Research Center has led the field with a series of milestones, including the first experimental 5000-word system and more recently the first PC-based system with a vocabulary of that size. Only a few years ago a room filled with computer equipment was required for the 5000-word system.

This latest achievement of 20,000 words in a desk-top system marks another leap forward for the project. The 20,000-word vocabulary includes 97% of all the words a speaker is likely to use in business.

The system is easy to use. Speech is uttered into a small microphone, with brief pauses between words, and the result appears almost instantly on a computer screen. Documents can subsequently be edited either by voice or keyboard, stored, printed or transmitted.

Since the system is "speaker

dependent", it requires a preliminary 20-minute session in which the user trains the computer by reading a special document. The system uses the information it collects in this way to characterize and remember the individual's unique way of speaking.

Although one of the major drawbacks at this stage is the necessity for pauses between words, efforts to achieve the recognition of continuous speech, without pauses, will accelerate. This advance in technology is expected to even further increase the computing power in PC-based systems.

Circle No. 7 on Reader Service Card

## Logic Lab

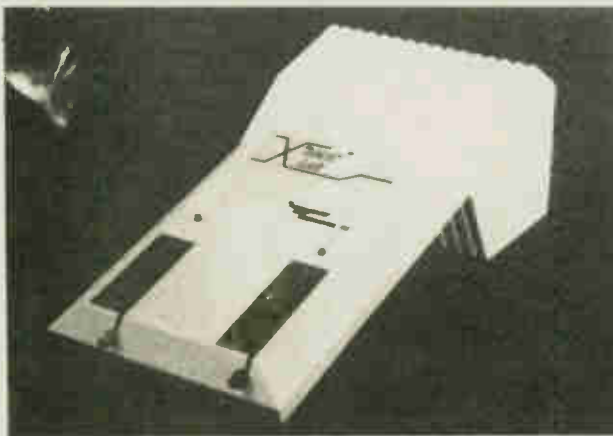

The Logic Lab from Programmable Logic Technologies Inc. is a complete programmable logic development system which connects to the IBM PC, XT, AT or compatibles.

The Logic Lab is a generic programmable logic development system which is designed to be used by engineers developing logic for

implementation in standard programmable logic devices. The unit features the Fast Map software assembler to convert logic equations into the standard JEDEC format fuse map; other assemblers producing the JEDEC format can also be used. The file is then downloaded from the PC to the hardware programmer using a

RS-232 serial link set to 9600 baud. Electrically erasable and reprogrammable GAL devices which are included with the system may be programmed to any one of 42 standard PLD configurations and substituted in the circuit for prototype evaluation. Priced at \$479.00US, the system includes the Logic Lab hardware programmer, 2 GAL devices, and the GAL handbook.

For more information and/or a demonstration disk send \$1US to: Programmable Logic Technologies, Inc., Box 1567, Longmont, Colorado 80501.

Circle No. 8 on Reader Service Card

At a recent meeting of the International Solid-State Circuits Conference (ISSCC) in New York, Mitsubishi Electric Corporation of Tokyo announced that it had recently completed the technical development of a 4-megabit dynamic random access memory (DRAM) chip that can be housed in a 300-mil-wide dual in-line package, the same size used for 1M DRAMs.

As of July 1st, 1987, the federal tax on VCRs, microwave ovens, and televisions will taken off at the wholesale level rather than at the manufacturers level. This, as a result of Finance Minister Michael Wilson's last budget.

How much more imported VCRs, microwaves, and televisions will cost as a result is a question mark, says Syd Goldstein, Vice Chairman of Mitsubishi Electric Sales Canada Inc. Shifting the federal tax from the manufacturer to the wholesale level and defining importers as manufacturers means the tax will be levied at a higher rate, explains Mr. Goldstein. "Right now, importers pay the 12 per cent tax at the point of entry - on the value of the imported product - plus import duty. Levying the tax at the wholesale end means we'll be paying the tax after freight, promotion costs and our mark-up have figured into the equation. Our margins right now are too small to absorb that kind of price increase. We'll have no choice but to pass it on to the consumer," he predicts.

Ontario Minister of Industry, Trade, and Technology, Hugh O'Neil, recently participated in the co-signing of Canada's first National Science and Technology Policy. The policy is the result of discussions among the 13 federal, provincial, and territorial ministers comprising the Council of Science and Technology Ministers established in December, 1986.

"We recognize the vital role of science and technology in safeguarding the economic future of Canada," Mr. O'Neil said. "Ontario is pleased to be able to lend its support to a National Policy on Science and Technology, and I am certain that we all recognize the need for such a policy."

In addition he also pointed out that although the policy is a step in the right direction, a tough task lies ahead. There's truth in them thar words.

The Science and Technology Foundation of Japan has announced that Dr. Theodore H. Maiman, inventor of the first laser, will receive the 1987 Japan Prize for his accomplishments in the field of electro-optics.

Described by the foundation as the "Nobel Prize of the East", the Japan Prize is awarded annually under the supervision of the Prime Minister's office and includes a \$326,000 cash award.

A physicist, Dr. Maiman developed the first ruby crystal laser in 1960, at the age of 33.

---

# IBM High Resolution Animation

---

*Have you ever wondered how arcade graphics are animated on a computer? Find out one way as we wrap up this feature.*

---

*by John Rudzinski*

SINCE THIS is the last installment of *8088 Programming*, we're going to cover something all the books I've read on 8088 assembler seem to be missing from their collective tables of contents. I'm not at all sure why this is -- high resolution animation is considerably easier than 32-bit division, and yet nobody wants to touch it. Strange.

Text animation on any micro is simple. Either POKE or print a character to the screen, wait a bit, POKE or print a space over it, then move the character to the next location in the direction you want it to go. For the most part, though, text animation has gone out of vogue. When, using high resolution graphics, you can make a bug-eyed monster *look* like a bug-eyed monster, shooting down menacing 'Q's with your valiant 'A' loses any appeal it may have had. On many micros, high resolution animation is handled the same way. The computer's character set is redefined into bug-eyed monster body parts, then assembled on the hi-res screen by grouping the appropriate redefined characters together. Crude, yes, but it works. One problem using this method is that bit-by-bit animation, where shapes move smoothly across the screen, is generally not accomplished. Instead, the shapes are blanked out using spaces, then placed at the next location to give the impression of movement. Problem is, eight bits have been skipped, so the animation is jumpy, at best.

## A Smooth Shave

Before we look at one way of accomplishing smooth hi-res animation in 8088 assembler, it's best we get acquainted with the addressing modes of the IBM's 640 by 200 screen.

The IBM CGA card (an acronym for Color Graphics Adaptor) has 16K of RAM on it, more than the first two computers I owned combined. Each hi-res line on the 640 by 200 pixel screen consists of 80 bytes, and 80 multiplied by 200 gives you 16,000 with 384 bytes in reserve. So far, so good.

If all 200 lines had consecutive addressing (00H, 50H, A0H, FOH, etc.) then animation calculations would be a snap. Unfortunately, few hi-res screens have consecutive addresses, and IBM's is no exception. Line one, expectedly, begins at address B800:0000, where B800 is the segment of the CGA card's RAM. Line two, however, begins at B800:2000. Actually, rather than blabbering on about it, here's how the first bytes on the first eight lines are addressed:

```
B800:0000
B800:2000
B800:0050
B800:2050
B800:00A0
B800:20A0
B800:00F0
B800:20F0
```

This pattern continues to the bottom of the screen. All the bytes in any given line are consecutive, but there is either a 2000H addition or 1FB0H subtraction as you move down a line, and either a 2000H subtraction or 1FB0H addition as you move up. So, POKEing a shape onto the screen isn't quite cut and dried.

## Playing Squash with Owls

The code from listing one, *ANIMATE.COM*, displays one method of handling the screen addressing. Actually, the code from the labels POKE0: through L0: can slap a shape of *any* length and width onto the screen, so long as you have the finger agility to type it in. Place the number of lines the shape occupies into AL and the number of bytes across into CX and you're off and running.

With the present settings, the three byte by five line shape at LN1 gets POKEd, something that looks oddly enough like a squashed owl. My apologies to any naturalists out there. The fun begins with the routines starting at L0:, which meet our objective: smooth animation.

Yes, the shape *can* be animated by taking onscreen byte contents and moving them to other onscreen bytes, erasing the previous ones, but for reasons previously mentioned, that method doesn't become arcade-style animation. So ... just how do we do it?

The people at Intel, who lovingly crafted the 8088 microprocessor, gave us a

Electronics Today June 1987





## Listing 1 continued

```

T4:   CLC
      MOV     CX,4           ;4 bytes
      MOV     DI,LIN5       ;5th line
S5:   MOV     AL,ES:[DI]
      RCR     AL,1           ;move bits right
      MOV     ES:[DI],AL
      INC     DI             ;next byte
      LOOP   S5
T5:   DEC     TEMP
      CMP     TEMP,0        ;Have we rotated 1 full byte?
      JE      T6
      JMP     L0
T6:   CALL    KEY           ;Check if viewer's had enough.
      INC     LIN1
      INC     LIN2
      INC     LIN3
      INC     LIN4
      INC     LIN5         ;Increment screen addresses by one.
      MOV     TEMP,8       ;Want to do eight full rotates of each byte
      DEC     ACROS        ;One less screen address to move across
      CMP     ACROS,0      ;Reached the end of the screen?
      JE      B0           ;Yep. Start moving left.
      JMP     L0           ;No. Continue moving right.

BYE:  MOV     AH,0
      MOV     AL,2
      INT     10H          ;Back to 80x25 text mode
      POP     DX,CX,BX,AX  ;Get all registers back
      INT     20H          ;and exit.

B0:   MOV     LIN1,0004FH
      MOV     LIN2,0204FH
      MOV     LIN3,0009FH
      MOV     LIN4,0209FH
      MOV     LIN5,000EFH ;Set line addresses to right edge
      MOV     TEMP,8       ;Reset bit counter and
      MOV     ACROS,77     ;byte counter for another sweep.
L1:   CALL    PAWS         ;Procrastinate, somewhat.
      CLC
      MOV     CX,4         ;4 bytes
      MOV     DI,LIN1      ;1st line
S6:   MOV     AL,ES:[DI]   ;Get byte from screen
      RCL     AL,1         ;move bits right
      MOV     ES:[DI],AL  ;and drop it back onto the tube.
      DEC     DI           ;Point to previous byte 'til all four
      LOOP   S6           ;rotated.
      CLC
      MOV     CX,4         ;4 bytes
      MOV     DI,LIN2      ;2nd line
S7:   MOV     AL,ES:[DI]   ;move bits right
      RCL     AL,1
      MOV     ES:[DI],AL
      DEC     DI
      LOOP   S7
      CLC
      MOV     CX,4         ;4 bytes
      MOV     DI,LIN3      ;3rd line
S8:   MOV     AL,ES:[DI]   ;move bits right
      RCL     AL,1
      MOV     ES:[DI],AL
      DEC     DI           ;next byte
      LOOP   S8
      CLC
      MOV     CX,4         ;4 bytes
      MOV     DI,LIN4      ;4th line
S9:   MOV     AL,ES:[DI]   ;move bits right
      RCL     AL,1
      MOV     ES:[DI],AL
      DEC     DI           ;next byte
      LOOP   S9
      CLC
      MOV     CX,4         ;4 bytes
      MOV     DI,LIN5      ;5th line
S10:  MOV     AL,ES:[DI]   ;Get screen byte
      RCL     AL,1         ;move bits right
      MOV     ES:[DI],AL  ;POKE byte back
      DEC     DI           ;next byte
      LOOP   S10
      DEC     TEMP
      CMP     TEMP,0
      JE      T7
      JMP     L1
T7:   CALL    KEY           ;Check if exit requested.
      DEC     LIN1
      DEC     LIN2
      DEC     LIN3
      DEC     LIN4
      DEC     LIN5         ;Subtract 1 from addresses.
      MOV     TEMP,8       ;Do another eight bits
      DEC     ACROS        ;one less screen address to go
      CMP     ACROS,0      ;Reached end of screen?
      JE      B1           ;Yes, move right.
      JMP     L1           ;No. Keep moving left.

B1:   MOV     LIN1,00000H
      MOV     LIN2,02000H
      MOV     LIN3,00050H
      MOV     LIN4,02050H
      MOV     LIN5,000A0H ;Reset all address on track,

```

03H is subtracted from that number because DI already has three in it from its previous increments. The code then repeats what was done before, though it LOOPS at POKE2. When all three bytes are placed onscreen on that line, 01H is again SUBtracted from AL, as another line has successfully been POKEd. Again, if AL equals zero, it jumps to the animation code at L0:, but if not, 01FB3H is subtracted from DI (01FB0H ' 03H) to accommodate the address of the next line down. The code then JuMPs backup the POKE0:, where the process repeats 'til all five lines are POKEd.

L0: starts with a stall. A time-delay loop spends a bit of time doing nothing before RETURNing from its CALL. I put that there because the squashed owl moves too fast otherwise. If you don't believe me, take it out. When a number of shapes are moving onscreen, however, it'll be rather redundant.

Now that the shape is onscreen, the animation starts. The carry is cleared so that a zero is rotated into the byte, and CX is loaded with four, because four bytes in a given line will be rotated ... three holding the shape, and one for the excess bits from byte three. DI points to the first screen address, the byte that DI points to is placed into AL, AL is Rotated with Carry Right once, and the byte in AL is then replaced back onto the screen. The onscreen pointer, DI, is incremented, and the program then LOOPS back to S1: 'til all four bytes are rotated. This process continues down to T5:, by which time all the bytes of the shape, including the five extra bytes, have been RCRed once.

At T5:, the value in TEMP is decremented. It originally held the value of eight. If TEMP equals zero, it means the program's rotated all the shape's bits eight times, moving the entire shape one byte right. If not, though, the program JuMPs back to L0: until this objective has been accomplished.

If TEMP *does* equal zero, the program picks up at T6:, where a quick CALL to check the status of the keyboard is made. You can only look at an ambulatory compressed owl for so long. If a key has been hit, the program terminates with a JuMP to BYE:. If not, the screen address lines are incremented, TEMP is restocked with the value of eight, and the byte at ACROS is decremented. ACROS keeps tabs on how many bytes remain for us to move either left or right. If ACROS equals zero, a change of direction is definitely in order. If not, the program JuMPs back to L0: to continue the process until 77 screen locations have been covered. The reason we can't move 80 locations is because the shape itself takes up three bytes and would overlap the screen.



**NEW**

# Only NRI gives you a 27" high-resolution stereo color TV you build to prepare you for today's video servicing careers.



## You Build a 27" Stereo TV

During the assembly process of your state-of-the-art Heath/Zenith 27" TV, you learn to identify and work with components and circuits as they actually appear in commercial circuitry. Then through tests, adjustments, and experiments you quickly master professional troubleshooting and bench techniques.



## Inside Your TV

The Heath/Zenith 27" TV has all the features that allow you to set up *today* your complete home video center of the future. Flat screen, square corners, and a black matrix to produce dark, rich colors . . . even a powerful remote control center that gives you total command of video and audio operating modes.

NRI has purposely designed your training around equipment that has the same high-tech circuitry you'll encounter in commercial equipment. That means your training is real-world training.

## Your NRI Training

### Has Another Special Element

Also built into your NRI training is the enormous experience of our development specialists and instructors. Their long-proven training skills and personal guidance come to you on a one-to-one basis. Always available for consultation and help, these instructors ensure your success both during your training and after graduation.

## Step Into the Future Today

The richest reward gained from your NRI Video/Audio training is a firm grip on the future. Now is the time to act. Send the post-paid card to us today. You will receive our 100-page catalog free. It's a fascinating explanation of our training methods and materials. (If someone has used the card, write to us at the address below.)

**NRI School of Electronics**

McGraw-Hill Continuing

Education Center

330 Progress Avenue

Scarborough, ON M1P 2Z5

Canada



Become one of America's most sought-after technicians . . . put your talents and spare time to work for you in the "explosive-growth" world of home entertainment electronics.

Train in state-of-the-art video/audio servicing and become a fully qualified service professional the uniquely successful NRI way. It's hands-on training, at home . . . designed around the latest electronic equipment you build and keep as part of your training.

## The High-Tech Revolution in the Home Is Just Starting

Sweeping changes are taking place in our homes, changes brought about by the phenomenal growth of home entertainment electronics. Already available are high resolution TV, TVs with stereo sound, simultaneous multi-channel viewing, projection TV, Camcorders, 8 mm video cassettes, and compact disc players.

And the revolution has spread to the business sector as tens of thousands of companies are purchasing expensive high-tech video equipment used for employee training, data storage, even video conferencing.

## Join the Future or Be Left Behind

Today the consumer electronics industry represents a whopping \$26 billion opportunity for the new breed of consumer electronics technician.

Today's consumer electronics revolution is creating huge servicing and repair mar-

kets that are just starting to boom.

Here is your chance to become a fully qualified professional the way tens of thousands have trained with NRI.

## Totally Integrated Hands-On Training

Since NRI training is built around "learn by doing," right from the start you conduct important experiments and tests with your professional digital multimeter. You assemble the remarkable NRI Discovery Lab and perform a complete range of demonstrations and experiments in the process.



NRI's commitment to you goes beyond providing you with equipment appropriate to the latest technology. Best of all, we ensure that in the learning process you acquire the very skills that will make you a professional service technician on the job.

```

MOV     TEMP,8           ;the bit counter and
MOV     ACROS,77        ;the byte counter, and
JMP     LO              ;do it all over again.

; PAWS
PROC
XOR     BX,BX           ;Time delay routine
BXINC:  INC     BX       ;Clear BX
        ADD     BX,1     ;Add 1 to BX
        CMP     BX,160  ;Is BX 160?
        JE      POOT    ;Yep. Branch to return
        JMP     BXINC   ;Nope. INC BX again.
POOT:   RET
PAWS:   ENDP
; KEY
PROC
MOV     AH,0BH         ;Keyboard scan routine
INT     21H           ;Check for character
CMP     AL,OFFH       ;Key pressed?
        JE      B2     ;Yep. Quit.
        RET          ;Else, go back.
B2:     JMP     BYE
KEY:    ENDP
; CODE
DATA   ENDS
        ENDS
END
    
```

Listing 1 continued

The code for moving left is virtually the same, except the screen addresses are changed to point the program to the right side of the screen, and we Rotate Carry Left instead of RCRing the shape bits onscreen.

That's essentially how it works. What you actually see when you type ANIMATE after assembling the code is a squashed owl moving smoothly back and

forth on the 640 by 200 graphics screen. This code will assemble nicely on the public domain A86 Assembler, and probably ChASM, but you'll need to properly set up the PROCedures and SEGments if you're using MASM.

Say G'night, Gracie  
BlortII.COM, a game I wrote using the above principles and put into the public

domain is available on the larger IBM bulletin boards. It's much like Blort!, which appeared in *Computing Now!* a bit back, though there're a few added bells, whistles, and high resolution animation added to beef it up somewhat. Its source code is available, too, but see the game for more information.

I've enjoyed adding what I could to this section of *ET* with Bill Markwick and Ellery Henn, and I hope we didn't confuse you too much. We've gone from the basics of 8088 assembler, through on-disk textfile encryption to high resolution animation. We hope you enjoyed *8088 Programming* as much as we did bringing it to you. ■

COMPUTER PARTS GALORE INC.

316 COLLEGE STREET, TORONTO, ONTARIO M5T 1S3  
SALES, SERVICE AND CUST. SUPPORT (416)-928-2161  
TOLL FREE 1-800-387-1385 - ORDERS ONLY PLEASE.

MAIL ORDERS: We take VISA, MC and AMEX CARDS Cheques (2Weeks for non-certified) C.O.D.\$4.00 extra. Min.Order \$25.00. Delivery & handling 5% (min \$5.00) for surface del. Heavy items may cost more. Premium del. service of your choice may be used at extra cost. All prices are subject to change without notice. All items are subject to prior sale. rma needed for returns. 20% restocking fee. 90 day warranty on all items unless otherwise stated. ELECTRONIC INQUIRIES - FAX: (416) 924-0292 ENVOY100 ID: CPG BBS: (416)368-2069 (NO USER FEE) DEALER INQUIRIES WELCOME

AT SYSTEMS

ATTAK-286 BASIC SYSTEM Includes:  
512K RAM -1.2M AND 360K FLOPPY DRIVES  
16 BIT HARD/FLOPPY CONTROLLER  
8-16 BIT AT SLOTS 2-8 BIT XT SLOTS  
COLOR OR MONO/GRAPHICS ADAPTER  
200W POWER SUPPLY -5080 AT KEYBOARD  
AT FLIP TOP CASE W/ ALL CABLES  
IN-DEPTH MANUAL AND SCHEMATICS  
4 DISKS OF FREE PUBLIC DOMAIN SOFTWARE  
ALL FOR ONLY \$2399.95

OPTIONS: ADD TO BASIC SYSTEM PRICE

- (A) 10 MHZ MOTHERBOARD UPGRADE \$149.95
- (B) UPGRADE TO 230W CSA PS \$29.95
- (C) BOTH DRIVES 1.2M FLOPPIES \$49.95
- (D) 612K 180NS RAM (FOR 8MHZ) \$79.95
- (E) 512K 120NS RAM (FOR 10 MHZ) \$85.95
- (F) UPGRADE TO RT101 STYLE KYBD \$39.95
- (G) EGA W/256K VIDEO RAM \$119.95
- (H) AT I/O W/SERIAL/PARALLEL/GAME \$119.95
- (I) 30 MEG AT TYPE 40MS HDRIVE \$999.95
- (J) 44 MEG AT TYPE 28MS HDRIVE \$1199.95
- (K) 72 MEG AT TYPE 28MS HDRIVE \$1499.95
- (L) TTL HI-RES MONO MONITOR \$189.95
- (M) RGB COLOR MONITOR \$59.95
- (N) EGA HI-RES COLOR MONITOR \$799.95
- (O) NEC MULTI-SYNCH MONITOR \$1045.95
- (P) 80287-5 (5MHz) \$325.95 80287-8 (8MHz)\$449.95
- (Q) MS-DOS 3.2 (special price system only) \$99.95
- (R) AT 2MEG EMS/EXTENDED RAMCARD \$8299.95

300 DAY WARRANTY ON ALL SYSTEMS  
QUANTITY PRICING AVAILABLE CALL\$\$\$

ATTAK-286 MOTHERBOARDS

CHIPS & TECHNOLOGY LSI CMOS chipset. USA built 4 layer board, robot assembled/tested for highest reliability.  
(A) Wired, tested, w/manual, schematic 8MHz \$849.95  
(B) Wired, tested w/manual, schematic 10MHz \$999.95  
(C) Bare PCB, parts list and instructions \$160.95  
(D) Detailed manual and schematic \$39.95  
(E) PHOENIX ROM BIOS Includes setup program \$99.95  
(F) PHOENIX KEYBOARD BIOS \$39.95  
(G) CHIP & TECH LSI Set 8 MHZ \$189.95  
(H) 80286 Processor 8 MHZ \$129.95  
(I) 80287 Co-Processor 5 MHZ \$324.95  
(J) 80287 Co-Processor 8 MHZ \$449.95  
(K) AWARD AT BIOS \$89.95  
(L) AT HARD/FLOPPY CONTROLLER \$339.95  
QUANTITY PRICING AVAILABLE

XT SYSTEMS

The latest in clone technology. 100% compatible. Legal BIOS. Fully tested. Burned-in.  
BASIC SYSTEMS INCLUDE:  
256K Ram Installed on 640K 8 Slot Motherboard  
1 DSDD High Quality 360K Floppy and Controller  
AT/XT 5000 autoswitch keyboard  
Color or Mono/Graphic video adapter  
8 slot Steel flip-top Case with 150w Power Supply  
4 FREE Disks of PUBLIC DOMAIN SOFTWARE

- SYSTEM #1: XT 4.77 MHZ. STD. MB. \$749.95
- SYSTEM #2: XT 84.77 MHZ. 4LAYER PCB \$874.95
- SYSTEM #3: XT 104.77 MHZ. 4LAYER PCB \$949.95

OPTIONS: ADD TO BASIC SYSTEM PRICE:

- (A) CLOCK/CAL SERIAL PARALLEL .....\$99.95
- (B) UPGRADE MEMORY TO 640K .....\$74.95
- (C) ADD 2ND 360K FLOPPY DRIVE .....\$144.95
- (D) 20 MEG HDISK/CNTRL .....\$589.95
- (E) 30 MEG RLL HDISK/CNTRLR .....\$689.95
- (F) UPGRADE TO EGA VIDEO ADAPTER .....\$225.95
- (G) TTL HI RES MONITOR .....\$189.95
- (H) RGB COLOR MONITOR .....\$549.95
- (I) EGA HI RES COLOR MONITOR .....\$799.95
- (J) NEC MULTI SYNCH MONITOR .....\$1045.95
- (K) 8087-3 (5MHz) -\$199.95 8087-2 (8MHz) -\$299.95
- (L) MS-DOS 3.2 (special price w/system only) \$99.95
- (M) ROLAND PR1012 DOT MATRIX PRINTER \$359.95

300 DAY WARRANTY ON ALL SYSTEMS.  
QUANTITY PRICING AVAILABLE CALL\$\$\$

CASES AND POWER SUPPLIES

- (A) XT Flip-top case (side or back switch) \$64.95
- (B) XT Flip-top case (AT aspect, XT fit) \$99.95
- (C) XT Slide case Strong, shielded, secure \$79.95
- (D) AT full size case, slide out type \$159.95
- (E) AT Flip-top case full size \$179.95
- (F) Mini-AT Flip-top case (for baby AT) \$199.95
- (G) 150W Side or Back switch XT PS \$134.95
- (H) 180W CSA Side switch XT PS \$189.95
- (I) 180W Side Switch XT PS \$189.95
- (J) 200W AT PS \$229.95
- (K) 230W CSA AT PS \$259.95
- (L) Apple Clone PS \$49.95
- (M) NTC Open frame +5-4A, +-12-1A, 5-1A \$19.95
- (N) BURROUGHS Open frame +5-6A, +-12-3A \$34.95
- (O) EXTERNAL HDISK CASE: w/fan, switch, fuse, 65W PS, AC plug, 5ft Hdisk Cables \$189.95

XT 640K MOTHERBOARDS

FULLY TESTED. LEGAL BIOS, ZEROK RAM, MANUAL INCLUDED.  
(A) 4.77 MHZ, std 640K unit Bare PCB and assembly data and manual \$34.95  
(B) 8/4.77 MHZ Hard/Soft switch 2 layer turbo Bare PCB and assembly data and manual \$229.95  
(C) 8/4.77 MHZ Hard/soft switch 4 layer turbo BARE PCB and assemble data and manual \$39.95  
(D) 10/4.77 MHZ Hard switch 4 layer turbo \$299.95

WIRED XT PERIPHERAL CARDS

All cards are wired and tested, manual included. Bare PCB's are still available. ASK for prices. All cards are ZeroK and have no disks except where noted.  
(A) COLOR GRAPHICS w/rgb, composite, grayscale outputs \$94.95  
(B) MONO/GRAPHICS- Hercules clone w/par. port \$119.95  
(C) ENHANCED GRAPHICS ADAPTER Chips & Tech VLSI \$639.95  
(D) PRINTER Std parallel interface \$44.95  
(E) RS-232 Std serial w/one port \$49.95 w/two ports \$69.95  
(F) I/O + 2 serial/click/par/game w/disk \$99.95  
(G) MULTI I/O w/2 floppy cntrlr/serial/click/par/game w/disk \$129.95  
(H) DISC CONTROLLER Std. 1 to 4 drives \$44.95  
(I) 676K Ram Card OK-\$74.95 256K-\$114.95 384K-\$144.95 576K \$169.95  
(J) GAME Std 2 joystick ports \$39.95  
(K) CLOCK/CALENDER w/disk \$44.95  
(L) KRAM 2MB -J-RAM2 clone w/disk and manual ZeroK \$179.95  
(M) RAMBANK 2MB EMS card w/disk ZeroK \$189.95  
(N) EPROM PROGRAMMER 2716-27512A w/disk, one socket \$179.95  
(O) EPROM PROGRAMMER as above 4 socket model \$289.95  
(P) PAL PROGRAMMER programs most standard pals \$445.95  
(S) 8748 MICRO PROGRAMMER programs 8748 and 8740's 355.95  
(T) I.C. TESTER tests most 74 series and CMOS chips \$199.95  
(U) XT or AT 1.2M / 360K Floppy Controller \$139.95  
(V) 384K MULTI-FUNCTION CARD Ser,Par,Game w/disk ZeroK \$129.95

BABY AT MOTHER BOARDS

Full feature 6/8 Mhz AT Motherboard. w/CHIPS & TECH chip set. 6-16 bit slots, 2-8 bit slots. This board will fit in a standard XT case and run all standard XT cards. An excellent way to upgrade your system to get the performance you require. Legal Bios  
BABY AT MOTHERBOARD ZEROK RAM \$795.95  
LOW PROFILE AT 16 BIT floppy/hard disk controller \$349.95

FEWARE - CATCH THE WAVE

PUBLIC DOMAIN SOFTWARE: Our library contains 150+ titles ranging from ACAD Support to WORD PROCESSING with spelling correction. Individual disks are available for \$5.00 per disk/\$4.00 per disk if you order 10 or more disks. Catalogs of our library are available for \$4.00 / free with a purchase of \$25.00 or more. The catalog contains many low priced solutions to what could be expensive problems  
JOIN OUR FEWARE CLUB: Just \$99.95 and you receive one disk a month for one year of TORONTO'S NEWEST HOTTEST UPLOADS.  
12 DISKS IN TOTAL FOR \$59.95



# Electric Boats

Latham, proprietor of the company, realized the full potential of electric boats, both for the environment and the commercial operator. He invested in designing and building new mould tools for glass fibre low energy hull forms necessary to operate electric boats successfully.

The first production electric boat to be commercially available in Britain for at least 60 years was given an overall length of 6.4 m, a beam of 1.7 m and a draught of only 28 cm. Traditionally styled with a graceful counter stern, it is called the Frolic class. The second boat produced some three months later, measures 6 m overall length, has a 1.8 m beam and a draught of 46 cm. Of more modern styling with a red cabin top, it is named the Mystic class.

Both hulls have a fine entry at the bow, increased buoyancy amidships to accommodate half a tonne of battery and a shallow displacement stern to reduce transom drag. These design characteristics provide a low wash hull of considerable manoeuvrability, capable of a speed that compares favourably to conventional higher powered diesels.

In addition to hull design, great attention has been paid to the interiors. Battery compartments provide an easy answer to seating arrangements and the absence of an engine box gives a clean, uninterrupted central zone. A complex mould tool produces the interior as a single piece glass fibre moulding.

Close cooperation with leading battery, controller and motor manufacturers has resulted in a totally reliable system with remarkably low energy consumption.

## Eight Years Operation

There are 16 lead acid monobloc traction batteries of 48 V with an expected operating life of around eight years. Semi-traction units are available that are quite adequate for limited usage and would be especially appropriate to private owners. In either case the batteries can be left in situ all year round with no winter lay-up procedure required. Whatever the weather conditions the turn of a key will guarantee an instant start.

The batteries provide energy through a solid state controller to a 1.4 kW series wound dc motor, totally enclosed in a cylinder measuring 30 cm long by 23 cm in diameter and weighing just 65 kg. This unit is housed just forward of midships under the floor.

It has been specially developed to produce maximum torque at 900 rev/min, allowing direct drive to a conventional propeller shaft and eliminating the need for a belt drive reduction box. The propeller is a three bladed manganese bronze unit of 35.5 cm diameter with 25.4 cm pitch.

It was not until 1983 that The Steam & Electric Launch Company of Hoveton, in eastern England, already well known for its elegant early 20th century style steam launches, produced its first all-electric boat for a private customer seeking a quiet mode of water transport from his tranquil riverside property on the edge of the local Norfolk Broads waterways.

Even at this early stage of development, the boat was fitted with the latest electric control equipment, providing exceptional handling and economy in energy.

## New Mould Tools

With the experience gained, Rupert

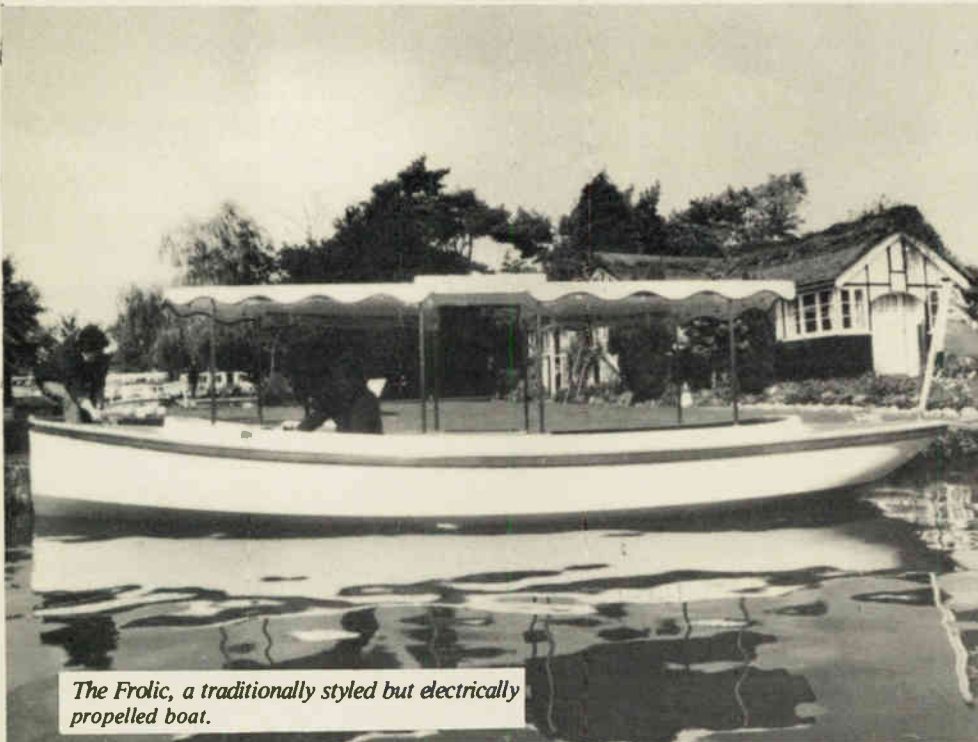

*The Frolic, a traditionally styled but electrically propelled boat.*

***An economical and non-polluting way to cruise the waterways.***

***By Kevin Desmond***

IT IS a sad fact that motorized traffic using the world's inland waterways and lakes tends to erode and pollute the terrain, frightening off the more timid wildlife. However a boat that will help to alleviate this problem is now being manufactured in eastern England. Totally non-polluting, virtually silent in operation, and lacking vibration, it is also extremely economical to refuel.

Electric boats are not new. At the turn of the century, there were hundreds of battery powered boats in regular use on rivers and lakes. But the heaviness of their batteries, motors and timber hulls did not render them as viable an option as the gasoline or diesel engine or its lighter outboard equivalent.

In the case of overloading, due for instance, to propeller fouling, a thermistor is fitted which detects overheating and automatically limits the current supply, slowing the speed of the boat. After the cause has been rectified the motor can be restarted once normal working temperature has been regained.

The instrument panel is conveniently situated near the helm position and comprises security key switch, hand speed controller to provide Stop and variable speed in either direction, and a battery condition indicator. The motor direction can be reversed from full ahead to full astern in one quick movement, an action not recommended for conventional power units.

The panel cable is harnessed to the control module in the forward compartment, and the wheel is fitted with a teleflex steering system.

**Maintenance Free**

The whole system is virtually maintenance free. Once a week the batteries will require an electrolyte level check and of course recharging after each use.

Recharging is simple. The launch is

provided with a special socket to take the charger cable and the charger can either be on board or on shore and has an insulated power supply.

Batteries can be fully recharged from a fully discharged state in about ten hours. Depending on the customer requirement, the boat can be fitted with different battery and motor packs. For example, 350 Ah batteries will provide a speed of 10.5 km/h continuously for eight hours with nearly 20% battery capacity still in reserve.

Both the Frolic and Mystic boats have been developed with the commercial operator in mind. The marginally large initial investment is more than offset by the low operating cost.

The Steam & Electric Launch Company has sold some 28 electric boats to both commercial and private owners in Britain, Sweden and the United States,

**Stringent Test**

Recently one Frolic and one Mystic underwent stringent tests involving some 24 hours of continuous running around the Norfolk Broads without recharging bat-

teries. Half the route was run against the tidal flow and half with it, but an average speed of 7 km/h was maintained which enabled each boat to cover 160 km.

Most remarkable of all, the total cost of fuel for the journey worked out at only about \$1.25 for each boat. ■

**SUBSCRIBE TODAY!  
RECEIVE AN ALMOST  
FREE SOFTWARE DISK  
VALUE AT \$19.95  
SEE ORDER FORM  
PAGE!**

**GET OUR FAMOUS HIGH TECH CATALOG FREE**

Your guide to everything that's new in electronics, computers and technical education. Over 400 items. Discover fascinating bits to build, enjoy and learn with... as well as assembled high tech products for home, business and hobby.

**Heathkit**  
Heath Company

A completely mobile, programmable, electromechanical robot, HERO-2000 is capable of interacting with its environment free of external control.

Heath Company  
1020 Islington Ave.,  
Toronto, Ont. M8Z 5Z3

MAIL COUPON TODAY and receive the latest issue of the Heathkit Catalog free of charge.

Name \_\_\_\_\_  
Address \_\_\_\_\_  
City \_\_\_\_\_ Prov. \_\_\_\_\_  
Code \_\_\_\_\_  
EU-0687



# The VME Bus

INSTRUMENTATION and process control computers are as common in industry as the desktop micro is everywhere else, and one of the most popular standards is the VME bus system. The 32-bit computer system consists of circuit cards that plug into a 19-inch rackmount enclosure, giving the user a wide choice of CPUs, memory expansions, and interfaces.

The standard originated when European manufacturers proposed modifications to Motorola's Versabus system, and in 1981, Mostek, Motorola and Signetics/Philips produced the VME; in 1983, it was introduced as a complete system, with the original VME bus, 80Mb memory extension, serial bus, etc. The actual meaning of the initials is rarely mentioned in documentation; one explanation is that it stands for *Versatile Module, European*.

## Hardware

The bus is constructed on a multilayer board; in 16-bit versions, a 96-way con-

necter, the P1, is used for connecting add-on card modules to the 16-line data bus and 29-line address bus. In the full 32-bit version, there are two 96-way connectors, the P1 and P2, carrying a 32-line data bus and 37-line address bus.

In addition, there is a 38 line control bus for data transfer (at up to 48MB/sec), synchronization, etc. A total of 64 lines are provided as user-defined in/out connections, and the remainder of the pins used for power and ground lines.

The unit is powered by bipolar 5 and 12-volt supplies. Signal levels correspond to TTL levels, with outputs being the usual totem-pole, open-collector, or tri-state types.

## CPUs

The most popular CPU is the 68000-series 32-bit microprocessor. In recent years the operating speed of both processors and memory chips has been increasing; for instance, Force Computers has released a 25MHz 68020 with no wait states (a delay

---

***A look at the VME computer, as important to industry as MS-DOS is to the office.***

---

***By Bill Markwick***

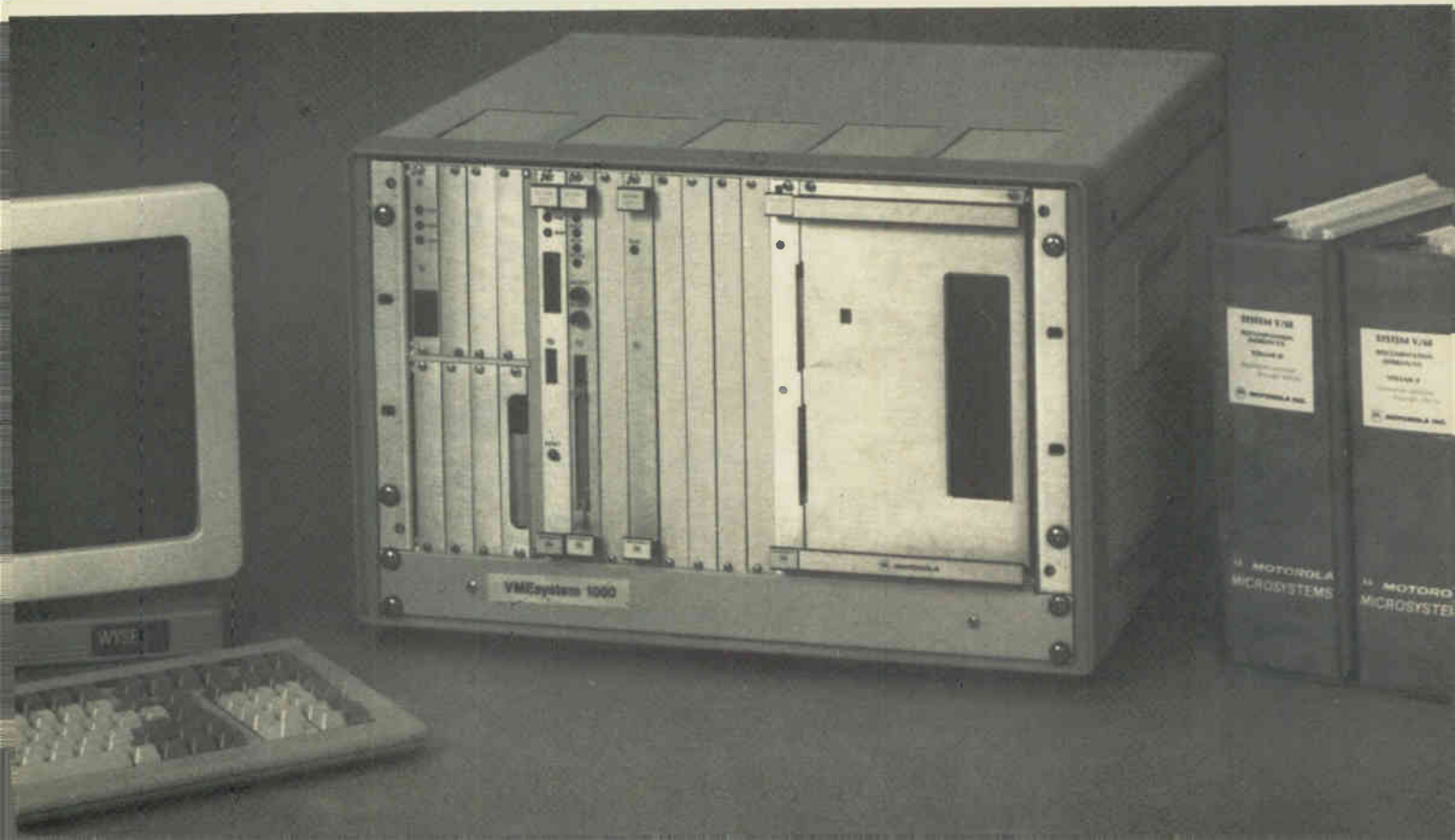

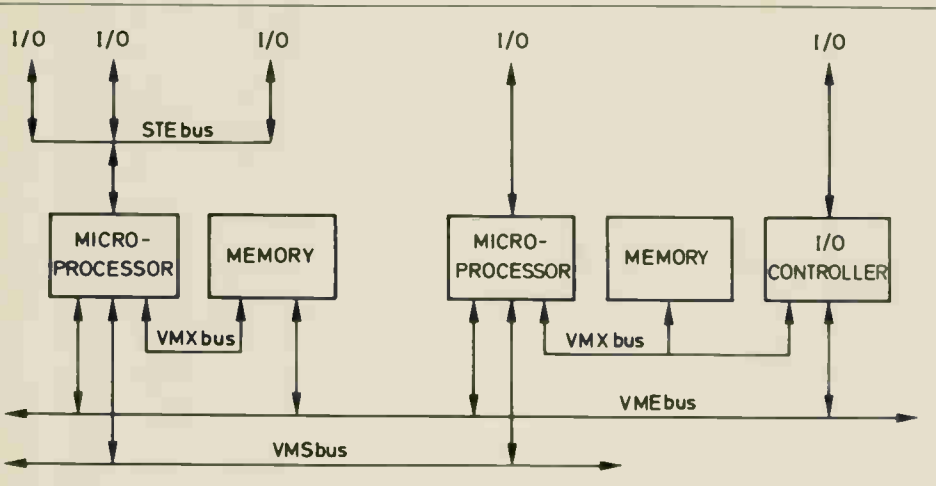

Fig. 1. The architecture of a typical VME bus system.

while the slower memory chips catch up). This gives the user the equivalent of a midi or small mainframe computer, and it all fits in a rackmount case.

With advances in getting more circuitry into fewer microchips, it's possible to have the entire VME microcomputer on one plug-in card, freeing up lots of room for peripheral cards. For instance, the Heurikon HK68/V2F shown in Fig. 2 is available with operating speed of up to 25MHz using a 68020, has up to 4Mb of on-board memory, 128K of EPROM and all sorts of options such as math coprocessors and real-time clocks.

Motorola's MVME133A, shown on the cover, is another monoboard micro. It features a 68020 at 20MHz, 1Mb of RAM, serial ports, three timers, seven-level interrupt handler, and a math coprocessor. It's being offered as the ideal controller for

robotics, machine and numerical control, image processing, and other demanding applications, and lists for \$4250US.

The high-speed performance and flexibility of the VME system doesn't come inexpensively, with most systems getting into the mini-computer price range.

Examples of the operating systems sup-

plied with the systems are Motorola's System V/68 or Unix System V. This allows the VME bus to become a full-fledged computer, running any of the popular programming languages, such as C, FORTRAN or Pascal.

## Graphics

Far from being just a glorified relay controller, the VME bus color graphic adapters allow CAD, image enhancement, high-speed simulation, etc. For instance, the Motorola MVME390A provides 1024 by 1024 pixel resolution, bit-mapped 384K RAM, three planes producing eight colors out of a palette of 4096, or alternatively, eight gray scale levels out of 16 for monochrome displays. The Matrox VG-640 features 640 by 480 pixel resolution, 256 colors out of 262,144, and a drawing speed of 35,000 vectors/second, and the Matrox VIP-1024 real-time digitizer adds real-time image acquisition and display to a VME system. With a 1024 by 1024 image buffer and 8 bits/pixel, it enables the computer to be used in robotic vision, medical display, image archival work and industrial arts.

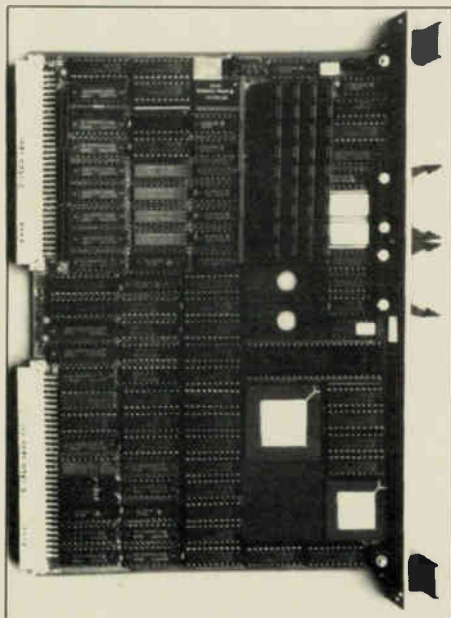

Fig. 2. Heurikon's HK68/V2F single-board VME computer.

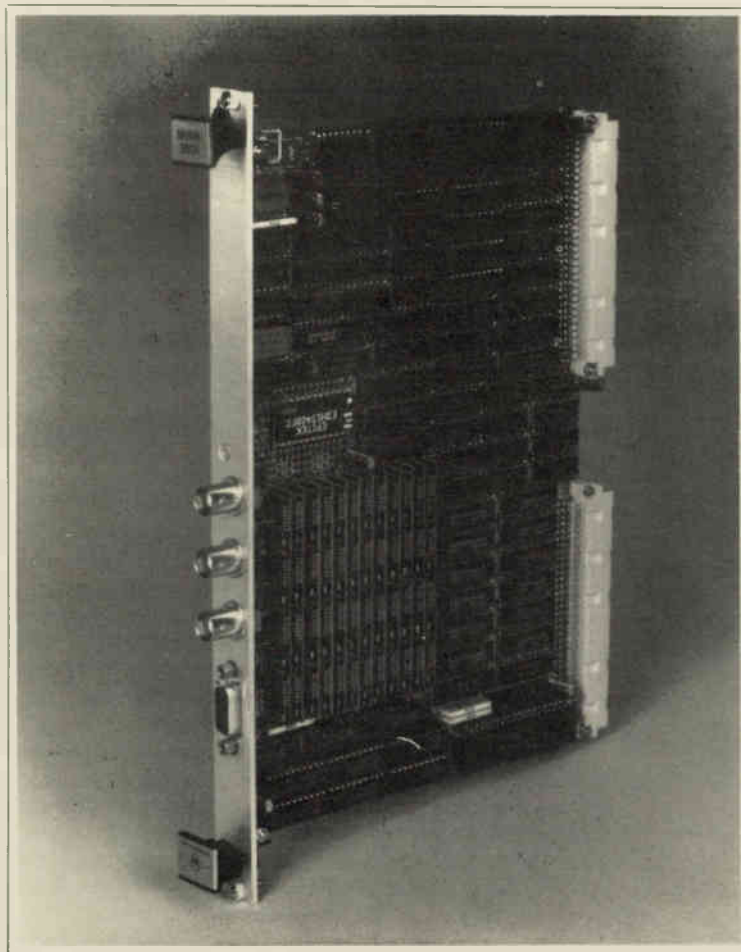

Fig. 3. Motorola's colour display adapter.



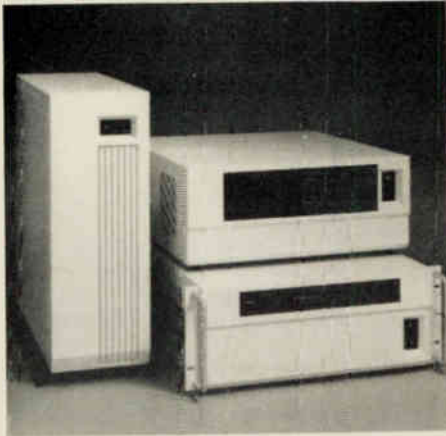

Fig. 4. Three VME packaging styles from Electronic Solutions.

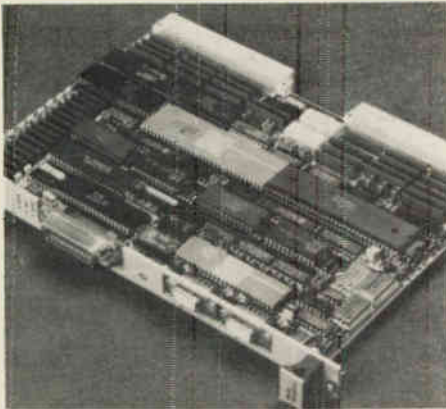

Fig. 5. Plessey's PME 68-14 single board computer with GPIB interface.

### Packaging

The standard 19-inch wide rackmount box simplifies adding modules to the system, but it doesn't mean that the computer has to look like an industrial machine. Elegant boxes and panels are available from such suppliers as Vector, Electronic Solutions, and Augat, and the familiar horizontal tab-mount rack can also be replaced by desktop units available in horizontal or vertical formats.

### Getting the Signals In

Industrial applications naturally require a number of ways of transmitting data to and from process equipment or products under test, and this is where the flexibility of the VME bus makes it so popular.

When it comes to monitoring, recording and processing data from test equipment, the GPIB (General Purpose Instrument Bus) is an industry standard, using the IEEE 488 bus format. There are modules available for interfacing the VME bus to the GPIB, such as the National Instruments GPIB-1014P, but one way of doing it with a single board is the Plessey PME 68-14. It consists of a 68000 or optional 68010 10MHz CPU, up to

Electronics Today June 1987

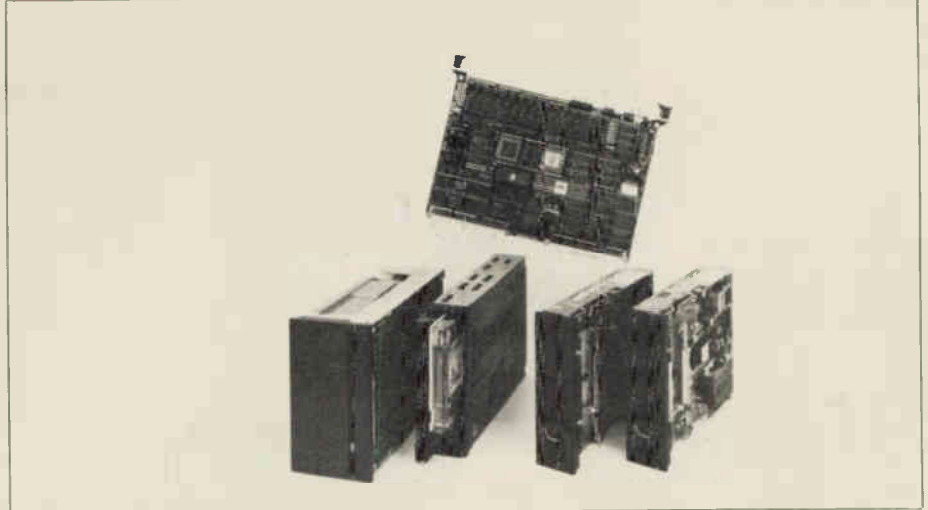

Fig. 7. A wide range of mass storage devices are available for the VME system, such as hard disk, tape drives and floppy drives.

2MB of RAM, serial communications interface, three counter/timers and more. The GPIB is interfaced with an on-board IEEE 488 Talker, Listener, and Controller.

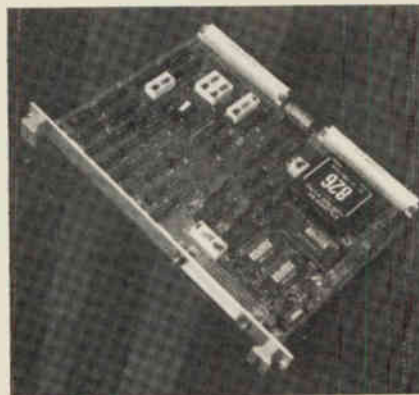

Fig. 6. Burr-Brown's MVP901 analog I/O board.

When the computer has to look at analog signals, Burr-Brown is a leader in supplying analog I/O cards for the VME bus. Their MPV901 series of General Purpose I/O cards, for instance, feature 12-bit resolution, 32 single or 16 differential inputs, a gain range of 1000:1 and a throughput time of 70us. The MPV911 high performance series has 16-bit resolution and sample times as low as 1.4us.

### Build Your Own?

Well, you *could*, but the construction would largely consist of buying a backplane such as the Vector VME J1/J2 monolithic type, and plugging in the available cards to suit just about any purpose you could come up with. The cost of the various modules would probably exceed the cost of a 386-type MS-DOS desktop micro, though you'd have yourself a high-speed ultra-flexible unit for sure.

While the VME bus is largely limited to industrial and instrumentation applications, it's an interesting approach to very high computing power.

### Sources mentioned:

**Force Computers**  
Tracan Electronics,  
1200 Aerowood Drive,  
Units 3 and 4,  
Mississauga, Ontario L4W 2S7,  
(416) 625-7752.

**Heurikon Corporation**  
3201 Latham Drive,  
Madison, WI 53713,  
(608) 271-8700.

**Motorola Microcomputer Division**,  
PO Box 20912,  
Phoenix, Arizona 85036,  
(602) 438-3501.

**Matrox, Electronic Solutions, National Instruments, Burr-Brown**  
Allan Crawford Associates,  
5835 Coopers Ave,  
Mississauga, Ontario L4Z 1Y2  
(416) 890-2010.

**Vector**  
Electronic Packaging Systems,  
PO Box 481,  
613 O'Connor Drive,  
Kingston, Ontario K7L 4W5,  
(613) 384-1142.

**Augat Electronics**,  
1081 Meyerside Drive,  
Unit 15,  
Mississauga, Ontario L5T 1M4,  
(416) 677-1500.

# EGAWONDER™

## Any Software. Any Monitor. Any Time.



Any Software on  
an EGA Monitor



Any Software on a  
TTL Monochrome Monitor



Any Software on an RGB  
Color Monitor<sup>3</sup>

### Upgrade to EGA without an EGA Monitor

The unique ATI EGA WONDER allows upgrade to the new EGA graphics standard without the purchase of an expensive EGA monitor. EGA WONDER runs EGA, CGA, MDA, Hercules and 132 column software on EGA Color, RGB Color, TTL Monochrome and Composite monitors. Extremely flexible, EGA WONDER maintains downward compatibility to both existing software and existing monitors. On the internal monitor of a Compaq PC Portable, EGA WONDER displays EGA, CGA, MDA and Hercules software via an optional expansion module.<sup>2</sup> For EGA monitor users, the ATI EGA WONDER improves the display of CGA software by producing high resolution 8x14 text and double scanned graphics. Old CGA software

is now displayed with EGA quality. Completely compatible to IBM's EGA, ATI's EGA WONDER performs smooth scrolling, pixel panning and windowing. No memory modules are required because 256K of video memory is a standard feature. EGA WONDER is the only card able to display EGA software on the internal monitor of both the IBM PC Portable and the Compaq PC Portable. EGA WONDER provides an NTSC Composite signal for interface to a Polaroid Palette.

### SoftSense Automatic Mode Switching

User friendly and easy to use, the ATI EGA WONDER has built-in SoftSense Automatic Mode Switching. It is actually able to sense and automatically switch between EGA and CGA color modes or between EGA, MDA and Hercules monochrome modes. The ATI EGA WONDER is compatible at the hardware level to the IBM Enhanced Graphics Adapter, the IBM Color/Graphics Adapter, the IBM Monochrome Display Adapter and the Hercules Graphics Card to minimize software incompatibilities.

EGA WONDER is now available from all major computer stores, call us today at (416) 477-8804 for more information.

**\$635 (Cdn)**  
Suggested retail price

The price in the EGA Wonder Advertisement in the April issue of Computing Now! from EMJ Data Systems Ltd., is in US funds.

Trademarks IBM PC Portable - EGA - CGA - MDA - International Business Machines - Compaq - Compaq Computer Corporation - Hercules - Hercules Computer Technology - Polaroid Palette - Polaroid Corporation.

- 1 Any Software, Any Monitor, Any Time applies to IBM graphics, standards, monitors, software
- 2 Optional Compaq Expansion Module (no 132 Columns) Suggested list price \$99 [US]
- 3 EGA, MDA, Hercules software displayed via interlacing. Flickering effect of interlacing reduced with purchase of anti-glare screen filter.

Circle No. 11 on Reader Service Card



**EMJ** Data Systems Ltd.

HEAD OFFICE BRANCHES  
GUELPH Toronto Montreal Vancouver Winnipeg  
(519) 837-2444 (416) 454-2940 (514) 849-4171 (604) 732-7268 (204) 475-7825  
TOLL FREE (Ont., Que., N.B., N.S., P.E.I., Man. 1-800-265-7212) (B.C., Alta. 1-800-663-9048)



# Digital IC Tester

**Do you have a batch of TTL or CMOS chips of questionable quality? Remove the guesswork with this low cost tester.**

**By Mike Tooley**

THIS UNIT provides a means of testing many of the most commonly used TTL and CMOS logic gates without having to remove them from the circuit in which they are connected. The instrument described has been designed for 14-pin DIL devices having "standard" supply connections (i.e. pins 7 and 14 connected to 0V and + 5V respectively). If desired, the design may be readily modified for other supply connections or for 16-pin devices.

spending a little time explaining how the device operates. By duplicating the logical function of the device under test (using a known functional device of the same type) and then comparing the output produced by the suspect device with that produced by the functional device, we can establish whether, or not, the device is faulty.

The comparison may be carried out using nothing more than an exclusive-OR gate. When the inputs of an exclusive-OR gate are similar (i.e. both high or both

clip onto the chip in question. The test clip is connected to the tester by way of a short length of ribbon cable which terminates at a 15-pin D-type connector, SK2. The pins on which logical signals may be found (pins 1 to 6 and 8 to 13) are connected to a bank of single-pole switches (S1 to S13 excluding S7). Note that these switches have been numbered to correspond with the pin numbers in question.

The switches facilitate direct connection of the pins of the suspect device with the corresponding pins of the known device which is inserted into a 14-pin DIL socket, SK1. It is important to note that, in normal use only the input pins are linked by means of the "connect" switches. When testing a 7400 quad two-input NAND gate, for example, the following switches should be placed in the "on" position: 1, 2, 4, 5, 9, 10, 12, and 13.

The pins used for comparison purposes are selected by means of S14 ("external") and S15 ("internal"). When testing a 7400 device, for example, these should both be switched, in turn, to: 3, 6, 8 and 11. The result of the comparison is indicated by means of D1. This LED is illuminated whenever the output of IC1d goes low. This low state output results from an identical input condition and thereby serves to indicate that the two devices are performing in a similar manner.

Switch S7 provides a means of interrupting the power to the unit while a second LED, D2, serves to indicate that power is being received from the unit under test. C1 provides local decoupling of the + 5V rail.

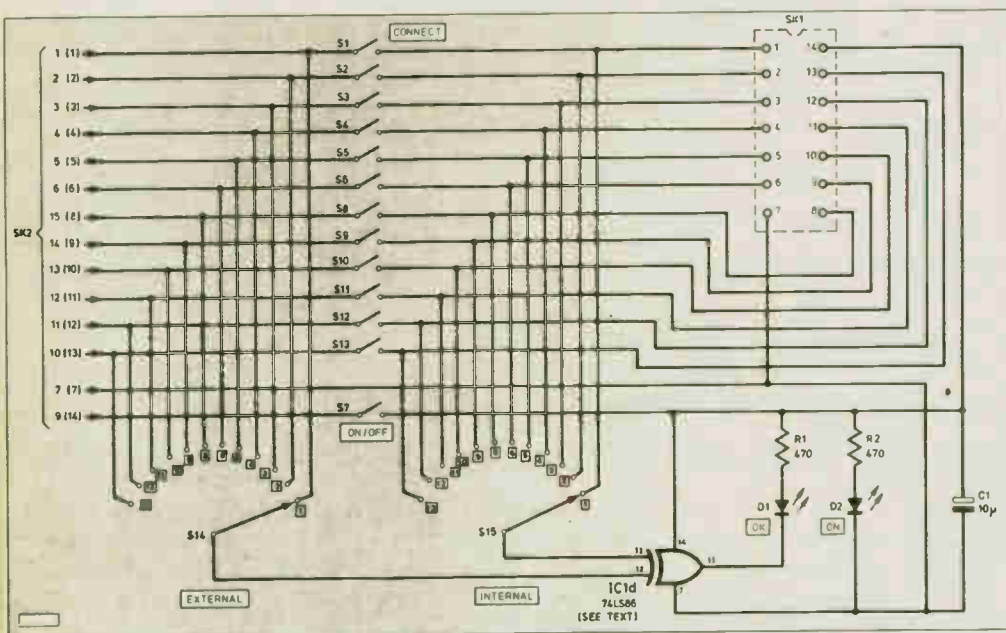

Fig. 1 The complete circuit diagram for the Digital IC Tester. The numbers inside the squares around the switches S14 and S15 refer to the front panel labels and pin selection of the test socket SK1.

In order to test a given IC, all that is required is a functional device of the same type and a knowledge of the pin connections of the chip in question.

## Circuit Description

Before describing the circuit, it is worth

low) the output of the gate will be low. Conversely, where there is a difference in the logical states of the gate's inputs the output of the gate will go high.

The complete circuit of the IC Tester is shown in Fig. 1. Inputs from the suspect device are obtained by placing an IC test

## Construction

The IC Tester is quite simple to construct; all the parts necessary are readily available. Furthermore, it is worth marking out the front panel, drilling and mounting the various controls and LEDs before starting on the circuit itself. SK1, in particular, should be mounted on an

off-cut of stripboard which in turn should be mounted using double-ended threaded pillars so that it protrudes through a small rectangular hole cut in the front panel. The IC socket should be soldered in place and the links between opposite sides cut and the various links made to the switches as shown in Fig. 3.

Components IC1d, R1, R2, and C1 are mounted on a small piece of matrix board comprising 19 strips of 17 holes. The stripboard component layout is shown in Fig. 2. Note that seven track breaks are required and these should be made using a spot face cutter. If such a tool is not available to you, a sharp drill bit of appropriate size may be used.

Once the board has been assembled and thoroughly checked, it should be mounted directly below SK1 using the other ends of the two threaded pillars. IC1 can then be inserted into its socket, taking care to ensure correct orientation. Finally, the remainder of the wiring can be completed as shown in Fig. 3.

The IC test clip should be wired to a 15-pin cable mounting D-type socket using a 500mm length of stranded ribbon cable. The pins should be connected according to Fig. 4.

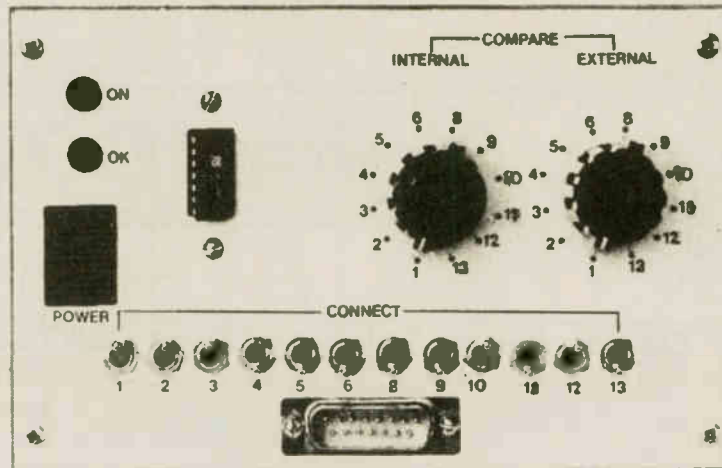

Front panel lettering and component layout of the tester.

### TEST CLIP WIRING

#### I.C. test clip 15-way D-connector

1	1
2	2
3	3
4	4
5	5
6	6
7	7
8	15
9	14
10	13
11	12
12	11
13	10
14	9

(Note: Pin-8 of the D-connector is unused)

Fig. 4 Details of the test clip wiring.

Short lengths of heat-proof sleeving should be used to insulate the connections made at the test clip. Furthermore, to assist in identification, the use of color-coded ribbon cable is highly recommended.

### Testing

In order to test the instrument it will be necessary to enlist the use of a functional item of equipment which uses a commonly available 14-pin DIL IC having conventional pin connections. Furthermore, it will be necessary to have a known functional example of the same device at hand. The circuit selected should preferably be a low-frequency one; complications may arise in the case of high-speed logic due to the stray capacitive reactance introduced by the tester and its associated ribbon cable.

Assuming that a 7400 device is available for use in the initial testing process, insert the known chip into SK1, switch the

power off in the circuit concerned and then connect the test clip. Now link the inputs using the "connect" switches (using the information given earlier) and then restore power to the circuit. Switch S7 to its "on" position and check that D2 is illuminated. If D2 doesn't light, switch the power off and check the wiring, including

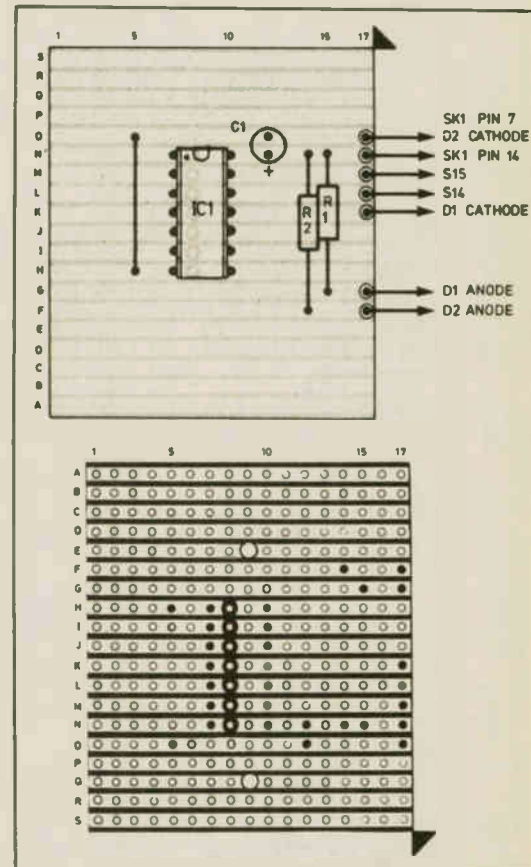
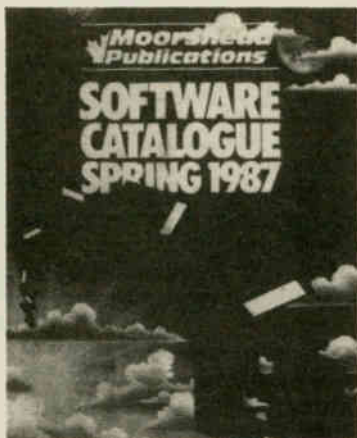

Fig. 2 Circuit board component layout and details of breaks to be made in the underside copper tracks.

## DID YOU RECEIVE YOUR COPY?



This catalogue is a comprehensive description of the Almost Free Software available from Moorshead Publications.

If you would like a copy of this catalogue, please mail your request to:

**Moorshead Publications  
Software Services**  
1300 Don Mills Road  
Toronto, Ontario  
M3B 3M8



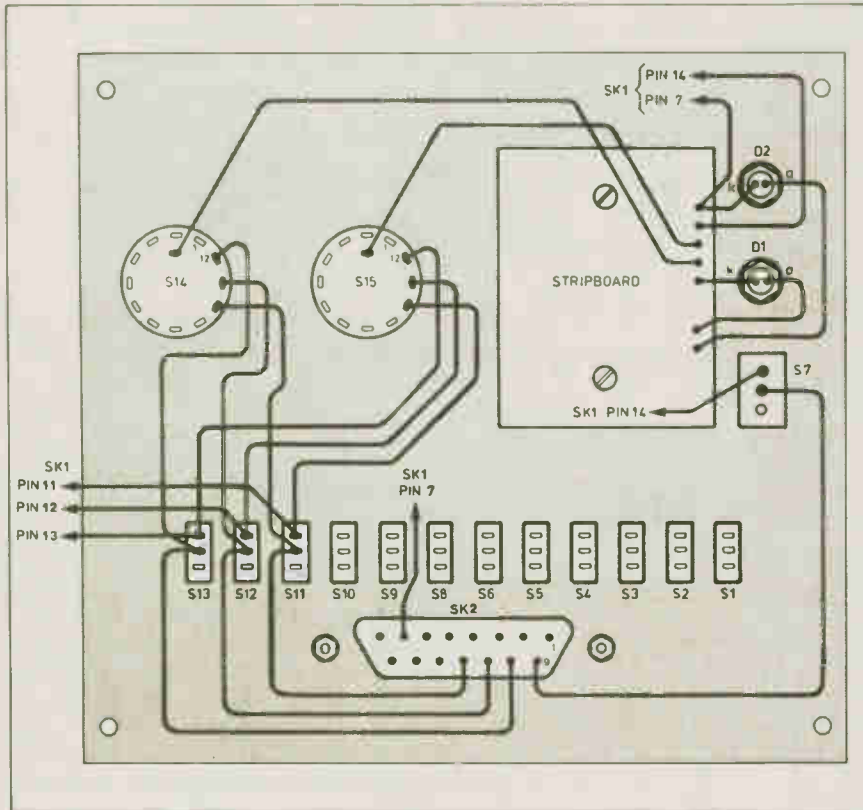

Fig. 3 Interwiring between the front panel mounted components and the circuit board. The remainder of the "connect" and "compare" switch wiring follows the pattern shown.

the ribbon cable, connector and test clip.

Having checked that the power is being received by the tester, turn both "compare" switches to position 3 (the output of the first NAND gate). Check that D1 is extinguished or is flashing. This indicates that one or the other of the integrated circuits is faulty. Repeat the procedure for all four gate outputs by turning the two compare switches to positions 6, 8 and 11 and check that all four NAND gates give the same result.

The tester may also be used in reverse; where a "loose" chip (one not in a circuit) is to be tested it may be inserted in SK1 and the IC test clip fitted to a functional device in a working circuit. The procedure for use is otherwise exactly the same as before.

### Parts List

Resistors	
R1	.....470R
R2	.....470R

Both 0.25W, 5% carbon

### Capacitor

C1	.....10u elect. 16V
----	---------------------

### Semiconductors

IC1	.....74LS86
D1	.....red LED w/bezel
D2	.....green LED w/bezel

### Miscellaneous

S1 to S6 and S8 to S13	.....miniature SPDT toggles
S7	.....SPDT rocker switch
S14, S15	.....1-pole, 12-way rotary switches
SK1	.....14-pin low-profile DIL socket
SK2	.....15-pin D-type chassis mounting plug
PL1	.....15-pin D-type cable mounting socket

14-pin IC test clip; 14-pin low-profile DIL sockets (2); 500mm length of 14-way ribbon cable; case approx. 205 x 140 x 110mm; stripboard, 0.1" matrix measuring 95 x 63mm; single-sided 1mm terminal pins (7); insulated threaded mounting pillars (2); mounting bolts (6); mounting nuts (2); knobs (2).

## Subscribe now to Computing Now!

Computing Now! is from the publishers of Computers in Education and Electronics Today and offers full coverage of what's happening in Canadian microcomputing. Get the most out of your micro with:



### Listings!

From the CP/M to MS DOS; programs for business use or just for fun.

### Reviews!

The newest computers, the latest peripherals. Software, book reviews, and interesting gadgetry.

### Programming!

Articles and discussions on how to solve those programming bottlenecks.

### Systems!

If you're looking for a business system, you'll find information that lets you find the most efficient, most economical equipment for your needs.

### Subscribe now:

\$22.95 for one year (12 issues) or \$37.95 for two years (24 issues).

### Special Offer Page 46



1300 Don Mills Road,  
North York,  
Toronto, Ontario  
M3B 3M8  
Telephone (416) 445-5600

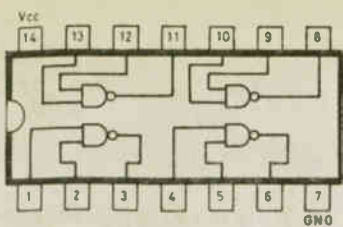

**A**

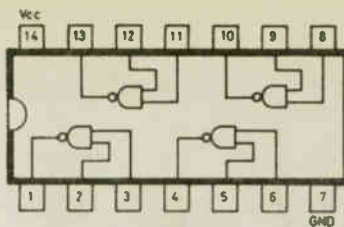

**B**

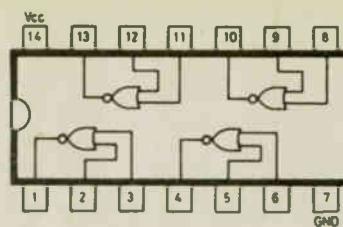

**C**

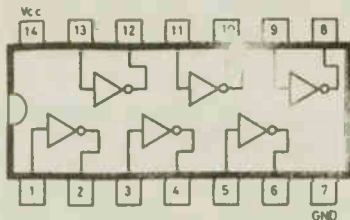

**D**

COMMON I.C. PIN CONNECTIONS	
I.C. type	Pin-out reference
7400	A
7401	B
7402	C
7403	A
7404	D
7405	D
7406	D
7407	Q
7408	E
7409	E
7410	F
7411	F
7412	F
7413	H
7414	D
7415	G
7416	D
7417	Q
7420	I
7421	J
7422	J
7427	K
7428	A
7430	L
7432	M
7433	C
7437	A
7438	A
7440	J
7474	N
7486	O
74107	P

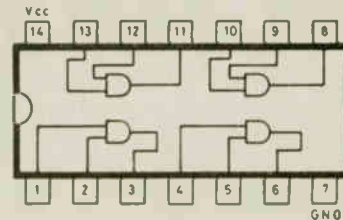

**E**

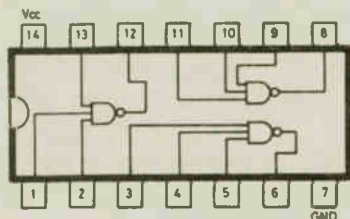

**F**

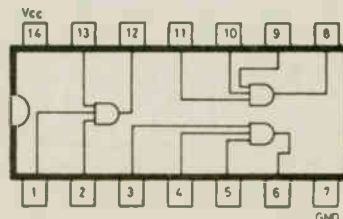

**G**

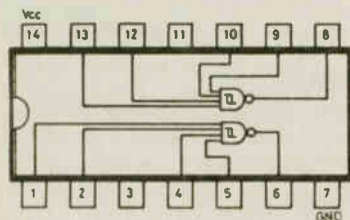

**H**

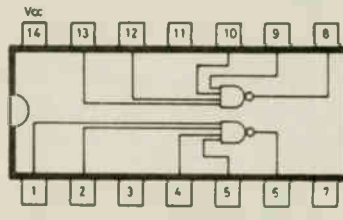

**I**

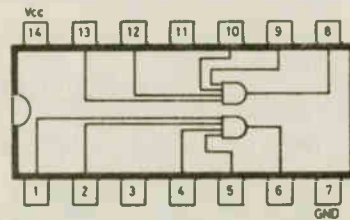

**J**

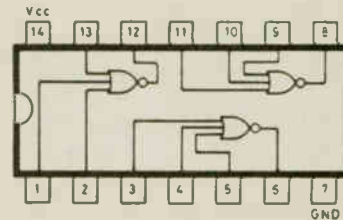

**K**

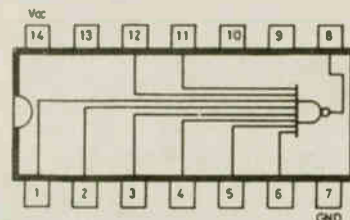

**L**

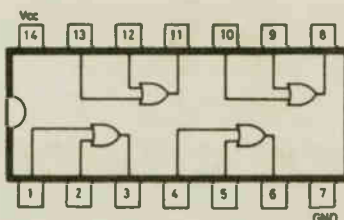

**M**

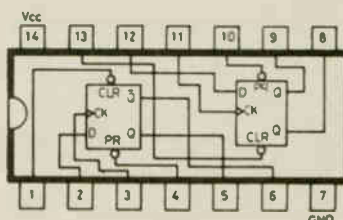

**N**

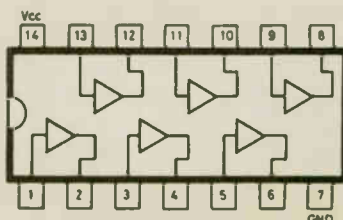
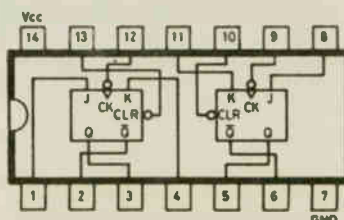
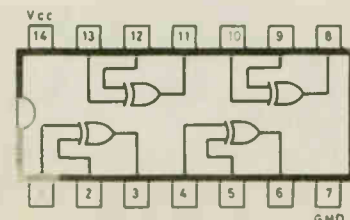



# ALMOST FREE PC SOFTWARE VOLUME XXIV

**AC** This is a very small area code program... give it a three digit area code and it will tell you where it is. The C source is also included.

**ASC** This is a memory resident utility that pops up a window with an ASCII character chart.

**ATTR** This utility lets you meddle with the attribute bits of your files.

**BAC** This is a disk backup utility that's a lot less frightening than the one that comes with DOS.

**BACKSCRL** This recalls stuff that has scrolled off your screen. It's neat if you can't seem to reach the Num Lock key in time.

**CAT** This is a collection of disk utilities in one program.

**CLOCK** One of the nicest screen clocks we've seen, this has a built in alarm function among other things.

**COVER** This is a sorted disk directory that prints out all the files on a floppy in a form suitable for sticking to the sleeve.

**CWEEP** This is a menu driven file mover... saves typing the word COPY over and over again.

**DDIR** Yet another directory utility, this does a two column directory similar to the regular single column DOS version.

**DELZ** This wipes out files so that they can never come back... kills the sectors as well as the directory entry.

**DISKCAN** This one checks your disks for bad sectors... get 'em before they get you.

**DOORS** This lets you flip between multiple monitors without rebooting your system.

**EQUIP** This program tells you what hardware your system thinks it has... very often providing you with the answers to all sorts of software problems.

**FASTDISK** If your floppies seem a bit tedious you might want to zap 'em with this speed up program.

**FDATE** This changes the time and date stamps of files.

**FLIP** This one sets a number of otherwise tedious parameters under DOS.

**FREE** This returns the amount of free space on a disk without having to watch the whole directory scroll by.

**GERM** This is a memory resident interrupt driven telecommunications terminal.

**IBMSHELL** This allows you to fool your system into loading COMMAND.COM from other places.

**KBBUFF** This is a keyboard buffer extender. No home should be without one.

**KEYFAKE** This allows you to "stuff" keyboard characters into an application to get past tedious introductory screens and menus.

**LC** This counts the number of lines in a text file.

**LOCATE** This scans through subdirectories checking all the files for specific text strings.



## Little Programs of the Gods

This is one of the most useful disks we've ever done. It has no phosphor monsters, no pinball games, no spreadsheets and no unspeakably complex three way menu driven cranial capacity measurement programs. In their place, we've collected a plethora of utilities and bits of code. These little guys are classics... every one of them designed to make your PC a bit more useful.

There are enough DOS assistants here to create a whole new operating system, and a sufficient assortment of memory resident trolls to account for most of the alternate key combinations on your keyboard. There are a number of things here that no enlightened user should be without. Some of these programs are updated versions of things on earlier almost free PC software disks.

Despite the enormity of this list, all of this profound software... plus its attendant documentation and support files... is available for a mere

# \$19.95

plus seven percent Ontario sales tax.

from

## MOORSHEAD PUBLICATIONS

1300 Don Mills Road, North York (Toronto),  
Ontario M3B 3M8 or you can order by phone. Call

# 1(416)445-5600

Have your MasterCard, Visa or American Express card ready.

MAKE PAYMENT PAYABLE TO MOORSHEAD PUBLICATIONS

**Fine Print:** This software has been collected from public access bulletin boards and is believed to be in the public domain. We have checked this software carefully to insure that it functions as it should. However, we cannot assist you in adapting it to your specific applications.

Moorhead Publications warrants that these programs will be readable when you get them. However, magnetic fields, cosmic rays, truck tires or the bends may adversely affect your disk in transit. If it doesn't function properly when you receive it please contact us for a prompt replacement.

Our latest software catalogue lists a variety of interesting, low cost programs. Circle reader service card number 100 for a free copy.

**LOCK** This is a file encryptor. Also includes UNLOCK.

**MOVE** This moves files between subdirectories with less typing than COPY would entail.

**NDOSEDIT** An updated version of regular DOSEDIT, this is a resident DOS command line editor that actually makes DOS decent to work with Indispensible.

**NO** This is a strange little wild card exception thing. It allows you to create more complex file specifications than does DOS all by itself.

**NPAD** This is a simple memory resident note pad.

**PCUTIL** This is a collection of add-ons to DOS.

**PINHEAD** This is the tiny printing press program from the June 1987 edition of Computing Now! It can get up to sixteen kilobytes of text on a single page. Includes the C language source... works on an Epson compatible printer.

**POPCAL** This is a memory resident utility which will bring up a calendar for any month of any year you like.

**PR** This is a handy formatted printing utility.

**PUSHDIR** Primarily used in batch files, this allows you to change subdirectories, do something and then return to the previous directory.

**REBEEP** A replacement for PAUSE... this is a noisy batch file utility to attract attention when a task has been completed.

**RENDIR** This renames subdirectories.

**SCRN** This is a screen saver... it blanks all the monitors attached to your system after a specified number of minutes of inactivity to keep your phosphor from getting fried.

**SETPRN** This allows you to painlessly set up your printer from DOS.

**SETUP** This is a memory resident utility that will allow you to set up an Epson compatible printer from within any application.

**SIZE** This returns the number of allocation clusters a file occupies on a disk.

**SOUND** This makes weird noises to attract attention from within a batch file.

**SP** This is a really nice little print spooler.

**SWEEP** This allows you to execute a command in every subdirectory on your disk.

**UNDEL** This recovers accidentally deleted files. You may not need it now but you sure will sooner or later.

**VDL** This requests verification before it deletes files so you won't need UNDEL quite as often.

**VOLSER** This changes the volume name of a disk.

**WAITN** This pauses for a specified time while executing in a batch file.

**WHEREIS** This finds files in subdirectories. It includes the C source code from the June 1987 edition of Computing Now!

**XDEL** This is a menu driven file deletion utility.

# Ultrasonic Testing

*Sound pulses probe the hidden flaw.*

*By Jack Blitz*

MACHINE and material structures that break down can cause death, injury or serious financial loss in many industries, so it is essential to eliminate or reduce the chances of this happening by testing any equipment. In the cases of air transport and nuclear energy, for example, tests need to be 100% effective, even if this means the cost of testing exceeds the production cost of the machinery itself.

It is just as important that such testing should not impair a system's usefulness. Non-destructive testing (NDT) has been labour intensive in the past, but recent advances in automatic tests, involving robotics and data processing, have drastically reduced labour costs as well as human error in observing and recording data. Savings on large-scale installations and components are considerable.

A principal method of NDT is ultrasonic testing, which lends itself neatly to automation. High frequency sound waves (typically between 0.5 and 10 MHz) are propagated through the machine or material being examined, and the subsequent behaviour of these waves indicates any changes in dimensions and structure.

Potentially dangerous defects such as cracks in regions liable to fatigue can be detected and measured. Short pulses of ultrasound are generated by a probe and passed through the test object. To ensure maximum transmission of energy the two are coupled by a liquid.

## Received Signal

The pulses are reflected at any defects present and also at geometrical boundaries. They are eventually received either by the same probe or another, located in a convenient position. Since the speed of ultrasound through the object can be determined by means of an initial calibration, the time between the transmission of the

*The method of automated ultrasonic testing used by CNS Electronics Ltd. for the detection of voids in a steel drum filled with a mixture of nuclear waste and concrete.*





pulse and its arrival at the receiving probe indicates the position of the defects as well as the boundaries of the object.

The size of the received signal provides an estimate of the extent of the defect. The signals are usually displayed on the screen of a cathode ray tube, but they may also be stored and processed.

For manual testing, the operator scans the test piece by sliding the ultrasonic probe across the surface of the component, and observes the screen for defect echoes. This can be laborious and sometimes uncertain, especially if the operator's experience is limited. However, for automatic testing, the work is totally immersed in a tank containing water, and scanning is achieved by moving either the probe or the test object by means of a motor.

The probe is either moved systematically along one of three dimensions with the object stationary, so covering a complete area, or it is fixed in position with the object rotating. Alternatively both methods may be combined.

### Scans in 3-D

Typically, a probe can perform a C-scan, where it moves systematically over a whole horizontal plane above the sample, producing complete information about positions of reflecting surfaces and strengths of reflections. This information is fed into a microprocessor, which makes it possible to obtain and build up visual images, similar to X-rays, of the test sample's internal structure.

Three-dimensional information can be obtained, which is not possible with X-rays, but the resolution of the "pictures" is usually less than those obtained with X-rays.

Much progress has been made in the design of automatic testing equipment, often with computer control for both scanning and information gathering. For example, recent cooperation between HMK Technical Services Ltd. which specialises in computer control devices, and Wells-Krautkramer Ltd. long known for ultrasonic equipment and scanning devices, has produced a method for the automatic defect testing of high quality nickel-based alloy discs, designed to be forged and machined into hubs for jet aircraft engines. Both companies are UK-based.

Since these engines operate at extreme ranges of pressure and temperature, a high standard of testing had to be specified, to eliminate any risk of failure.

Each disc was mounted on a turntable in a water-filled tank 3.5 m x 1.35 m x 1.2 m. A 10 MHz probe providing a high degree of defect resolution could be moved in three dimensions, as could the turntable, under computer control.

Electronics Today June 1987

The disc was scanned horizontally above its upper surface along concentric circles and, for each position of rotation, vertically along the side. Images containing the collected information could be displayed on chart recorders and monitored on a visual display unit.

### Other Uses

This method could be employed to a less exacting standard in testing, say, of plastic car bumpers as a check that a production line was under control. Here failure would obviously be less serious than with an aircraft engine.

Ultrasonic testing is also widely used for the inspection of large structures, including concrete ones such as dams and barrages. Ultrasonic path lengths of up to 20 meters are possible.

CNS Electronics Ltd. is a well established British manufacturer of equipment, sold under the name of Pundit, for this type of application. Its products have been used successfully for testing carbon and graphite electrodes, molten glasses and metals, and ceramics, and for the inspection of timber for rot. The company's Japanese agents have constructed scan-

ning rigs to carry out inspection for voids on 182 litre steel drums filled with a mixture of nuclear waste and concrete.

Another British company using ultrasonic scanning techniques is Mecasonics Ltd. which is concerned with computer operated scanning of aircraft components. An ultrasonic C-scan of such a component produces a colour display which indicates variations in the strength of the received signals over a horizontal plane. This in turn indicates variations in structure and appearance of any defects. ■

**SUBSCRIBE TODAY!  
RECEIVE AN ALMOST  
FREE SOFTWARE DISK  
VALUE AT \$19.95  
SEE ORDER FORM PAGE!**

## Electronics Today

## Subscribe Now!

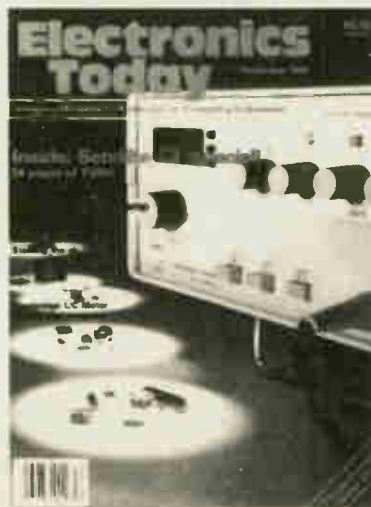

Electronics Today is from the publishers of **Computers in Education and Computing Now!**

We supplied the hobbyist and technician with a superb collection of:

### Projects:

Build you own test equipment, audio gear, computer add-ons, and games.

### Computers:

Reviews, listings, and how-it-works articles.

### Technology:

Articles on the latest in hi-tech.

### Tech Tips:

Handy hints for the testbench.

### Price is Only:

\$22.95 for one year (12 issues) or \$37.95 for two years.

**SPECIAL OFFER PAGE 46**

### Moorshead Publications

1300 Don Mills Road, North York, Toronto, Ontario M3B 3M8  
Telephone (416) 445-5600

# Tracing the Causes of Acid Rain

*A report on acid rain testing methods used in Europe.*

By Graham Bell

Although man-made atmospheric pollution has been with us for decades, public awareness and concern intensified only when the cause of the catastrophic smogs in Britain in the early 1950s, for example, and the continuing Los Angeles smog were explained. These were clearly linked to coal and petroleum combustion. Suddenly conditions that were formerly tolerated as "facts of life" became issues about the basic quality of life.

Public pressure ensured government action. In Britain, the Clean Air Act passed in 1956 removed the longterm likelihood of a repeat of the smogs, but in the late 1960s increasing scientific evidence of the presence of airborne pollutants once more aroused public concern. The national and international environmental organiza-

tions which emerged at the time were also provided with a term that has since dominated media headlines and the titles of countless scientific papers: acid rain.

## The Questions

A Briton, Robert Smith, first used the term acid rain in 1872 and unlike most scientific shorthand used by the media, this one is accurate. Rain is made acidic by the reaction within it of man-made pollutants before it reaches the ground. How is it produced? How much of it is there? What damage does it do? These were the questions to which scientists working in North America and Europe addressed themselves.

In the United Kingdom, research was started by, among others, scientists working in the Natural Environment Research Council (NERC) who, in the last ten to 15 years, have begun the process of clarifying what immediately became apparent as a complex issue. What was clear was that the sulphur dioxide and nitrogen oxides that originate from the burning of fossil fuels in power stations and

from industrial sources were the root cause of acid rain formation.

It was also shown that whereas some of the gaseous pollutants were deposited close to their source as dry deposition, much contributed to the formation of acid rain which could be deposited hundreds of kilometres from that source.

## Higher Altitudes

Reports that streams, rivers and lakes in Scandinavia, Scotland and the English Lake District were becoming more acidic had already indicated that the problem was not confined to industrial areas. One of the first things to be done was to collect rain at rural as well as urban sites to discover just how acidic it was.

In Scotland, NERC scientists working at the institute of Terrestrial Ecology (ITE), discovered that the rain was more acidic on the east coast than the west, but that as there was more rainfall at higher altitudes, the total amount of acidity reaching mountains was greater, wherever the mountains were. Already, then, other factors - in this case altitude - were seen to be im-



portant in terms of working out how much acid was reaching the ground.

A greater understanding of the distribution of acid rain has resulted from these studies. They now include projects examining the input of acidity from other forms of precipitation. Low cloud, or mist, has been shown to be up to ten times more acidic than rain-water collected at the same site. Swirling mist droplets need to be trapped before reaching the ground, and the fine needles of conifers grown in upland areas appear to be ideal nets in gathering the droplets.

It is a measure of the progress in the study of acid rain that recently a week-long conference was organized by the ITE in Edinburgh to study acid deposition processes at high elevation sites, where scientists from North America, France, Austria, Sweden, West Germany, the Netherlands and Italy discussed the results of their studies with their British counterparts.

### Streamwater Chemistry

Snow is a further source of the acid input, particularly to uplands. Scientists at another NERC research body, the Institute Of Hydrology, have shown massive increases in acidity in upland streams during the springtime snowmelt. When snow melts, the first meltwater appearing at the bottom of the snow column contains many of the pollutants accumulated in the snow over the winter. This is because the impurities are concentrated on the surface of the ice grains and in the liquid water held between them, and may be easily removed from the snow by the first meltwater percolating through.

The study the change in streamwater chemistry is clearly of paramount importance in gaining an understanding of the effects of acid precipitation, whether rain, mist or snow, on freshwater systems. It is these changes that ultimately become a matter of life and death to the flora and fauna of rivers and lakes.

The Institute of Hydrology scientists, while monitoring these changes, have recognized the importance of the type of vegetation, soil and underlying bedrock, all of which are known to have an effect on the acid precipitation that ultimately reaches the stream draining a particular catchment. The planting of conifers on soils that are

normally acidic in nature has been shown to increase the acidity of the waters entering streams and often causes the release of particular chemicals such as aluminum, which is deleterious to fish.

Hydrologists working for the NERC's British Geological Survey are also studying the effects of acid deposition on aquifers (water-bearing rock formations) and their contained water or groundwater. The latter is continuously entering the waterways. The researchers have found that although most aquifers in Britain are sufficiently calciferous to remove the threat of acidification problems (calcereous compounds are alkaline and neutralize acid), some could be affected and the water coming from such sources may be significantly acidified. Studies into these interactions between water and rock are currently in progress.

### Climatic Effect

Although the term acid rain as originally conceived is still useful, unfortunately it has come to be used in an all-encompassing sense to include any and all atmospheric pollution. It has become clear in recent years that the problems of air pollutants are many and complex and are very different within continents, particularly Europe.

The primary pollutant gases, sulphur dioxide and the oxides of nitrogen are, in fact, mixed with several secondary pollutants including ozone. Ozone occurs naturally, but its concentration in the air is enhanced in sunny conditions by a photochemical reaction between hydrocarbons from petroleum combustion and the oxides of nitrogen.

*Continued on page 48*

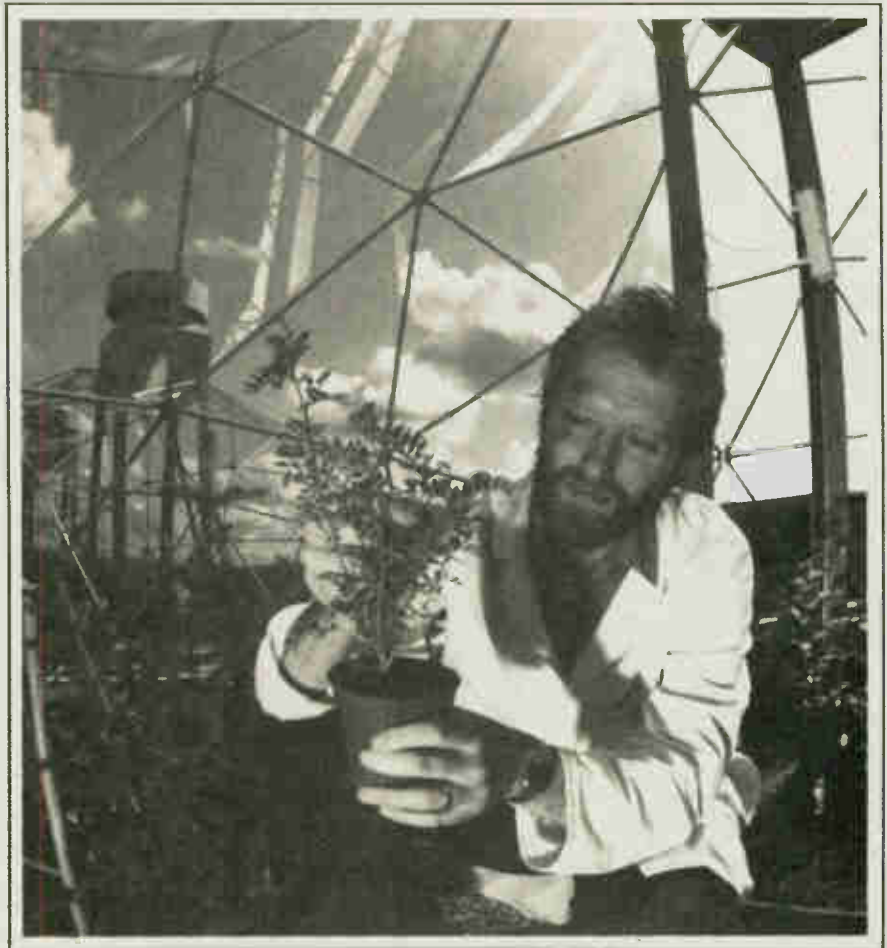

*At the University of Lancaster in northwest England, a variety of crops and trees in dome-shaped greenhouses are being continually treated with pollutants at levels found in the atmosphere over much of Europe. The project involves temperature controls, and cold air is being blown into two of the greenhouses, simulating conditions of severe frost during winter nights.*

# Electric Motor Drives Part III



*The technology of supersynchronous drives as motor controllers.*

**By Dr. H.R. Virani**



THERE ARE a large number of high power drive applications which benefit from being operated at speeds between 2000 and 10000 r/min. Most of them are fans, pumps and compressors where the higher speeds enable their sizes to be reduced and their efficiency of operation to be increased. Any pump or compressor of a particular power and flow capability will reduce in size as the speed is increased and it is possible to obtain higher pressure per stage, thus reducing the number of stages.

Such drives are used widely, in power stations for feedwater pumps, in the chemical industry as gas compressors, in gas and oil pipelines which now convey these materials over many thousands of miles and on large refrigeration compressors for cold stores and the air conditioning of large buildings such as airports. They frequently range from 500 to 20000 KW.

Up to now the only way of directly driving these machines, without using intermediate gear boxes, has been to use steam or gas turbines and in the past this approach had the additional advantage of using process steam or gas which was a cheap by-product of the main chemical process.

Electric motors have been used for such drives, but with step-up gear boxes because the motor speed has been limited by the frequency of the electric supply available. With 50 or 60 Hz utility power supplies, AC motors can only be made to operate at up to 3000 or 3600 r/min. respectively and the majority of designs are for 1500 or 1800 r/min.

The position today is much different and is continuing to change rapidly. The reduction in the price of power electronic equipment, which has been taking place for many years now, means that frequency conversion, even on very large powers, is now economic, and this means that power supply frequencies of up to 200 Hz can be obtained quite easily. High power converters can change the main power supply at 50 or 60 Hz into a much higher frequency and can do it very efficiently.

**Benefits of high speed drives**

The widespread use of electrical drives for the majority of mechanical machinery is the result of the simplicity, reliability, flexibility and lower lifetime costs compared to other methods and the same reasons are behind their application to high speed pumps, blowers and compressors.

Electrical energy can be transmitted over long distance with only small losses and it is much more flexible in use. It can also be converted statically into other forms and converted into mechanical

power very efficiently.

Converter fed drives also have the very significant benefit of being variable speed systems and they can be used as the means of plant control. In most other pumps or blowers, control over the flow of the gas or liquid is carried out by using dampers, vanes or valves which absorb considerable amounts of power, which is usually wasted by heating up the material being transported - be it air, gas or water. Very large energy savings can be made by using the variable speed feature of these drives, which operate at high efficiency over the whole of the speed range.

Fig. 1 is an example of the magnitude of financial savings which can be made in many cases; this particular one is a large boiler fed pump drive of 8000 KW output operating at up to 600 r/min. The use of direct drive to the high speed machine has

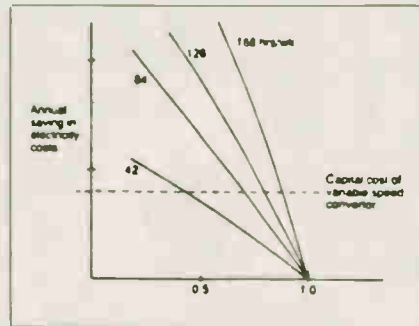

Fig. 1. Annual savings on electrical costs when variable speed drives are used.

the advantage of simplicity and the avoidance of a gearbox, which can be an additional source of maintenance problems and power losses. Its most obvious effect is that the size of the motor is very much smaller than its lower speed equivalent, and this can be an important advantage in the cost and layout of the rotating equipment.

**The overall design**

Although converter fed induction motor systems are available for lower powers,

the most suitable system for high speed, high power is the syncdrive. A synchronous machine makes it possible to use a more economic converter system, and as there is considerable use of turbo type synchronous machines at up to 4000 r/min, this forms a sound basis for development up to higher speeds.

A typical circuit diagram of a high speed drive is shown in Fig. 2 and illustrates the main features of such schemes. Two converters form the basis of the scheme, one connected to the supply and the other connected to the motor and operating at motor frequency. The DC link reactor isolates the two converters from each other and allows them to operate independently.

With AC motors there is no particular limit to the level of voltage on the stator windings, and it is sensible to match the converter and motor voltages so as to avoid use of output transformers, which complicate the system during starting as well as adding cost to the drive system. In general, DC link voltages between 4 and 8 KV are used for these high power drives, and motor windings voltages from 2 to 6 KV are chosen, depending on the size and circuit configuration. This synchronous motor AC drive application has, therefore, led to new designs of converters becoming available to suit these voltage levels.

The DC link reactor in these systems achieves its purpose of isolating the two converters from each other by smoothing the DC link current. The result of this is to make the AC currents in the supply and the motor into non-sinusoidal, quasi-square waveforms containing a relatively high level of harmonics. The situations can be considerably improved by splitting the converters into sections and phase displacing the sections so as to reduce the overall level of harmonic effects produced. In the example of Fig. 2, the splitting of the supply side converter into two halves fed from the phase displaced trans-

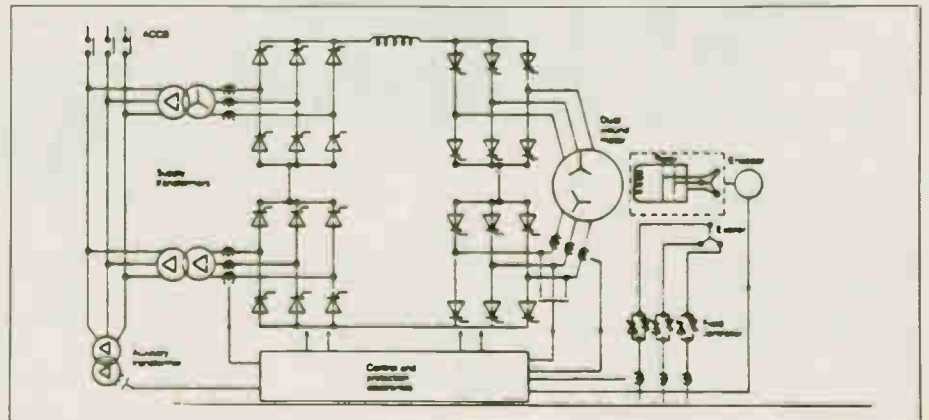

Fig. 2. Typical circuit diagram of a high speed motor drive.

Continued on page 47

**New Battery Back-Up System**



Tripp Lite of Chicago has introduced a new 325 watt battery back-up system to their line of emergency power supply systems.

The BC-325 features complete protection against power failures as well as full brown-out protection and a built-in filtering network that guards against transient spikes and line noise when operating on AC power.

The unit also features a maintenance free gel cell battery, regulated battery charger, alarm with reset and it's all housed in an attractive cabinet that will fit into

any environment. Hassle-free, it requires no special hook-ups; just plug it in.

The BC-325's 26 amp-hour battery supplies 60 minutes of emergency power at half load, and 25 minutes of power at full load, allowing for the safe shutdown of your computer system.

Tripp Lite also offers 200, 450, 675, 1000, and 2000 watt units.

For addition information contact: Tripp Lite, 500 North Orleans, Chicago, IL 60610.

Circle No. 12 on Reader Service Card

**IBM Braille Mouse**

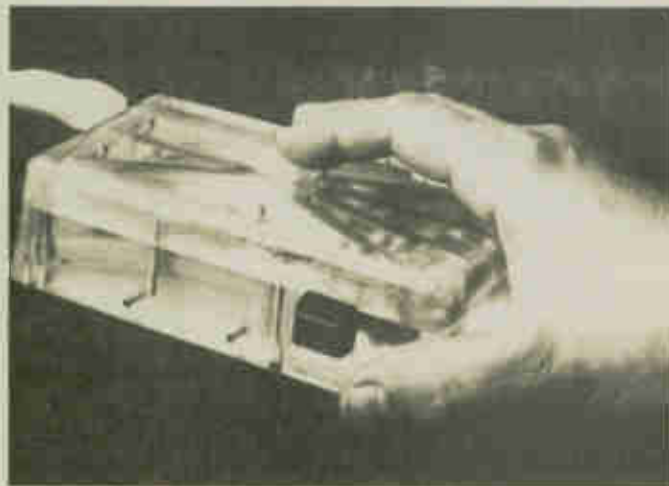

Thanks to some ongoing research by IBM scientists, the blind may soon be able to easily read computer screens with a braille "mouse".

The experimental mouse works by raising tiny "pistons" at a user's fingertip as the mouse is moved across a desk-top tablet, spelling out in braille the characters, words and symbols on the screen. A person moving the cursor around the screen with the mouse can therefore feel the characters like a printed braille page beneath his or her finger and easily conceive a mental image of the screen.

No special software or training is required to use the device, provided the user can read braille. In fact, it could be used to teach braille, according to IBM scientists.

The mouse, a special PC adapter card and a tablet plug into the PC system's chassis. The adapter card converts any character pointed to by the cursor into braille. The tablet

provides an operating surface for the mouse and a frame of reference for the user. Two levels of braille are possible for the user: Grade 1 Braille (which includes all 26 English letters, 11 common punctuation marks and numbers) and Computer Braille (which consists of the upper and lower case alphabet, numbers zero through nine and over 50 programming symbols).

To make reading easier the mouse can track each line on the display. Rows and columns are engraved on the tablet in braille as a quick location guide, and a fingertip switch lets the user "ask" where the cursor is on the screen. The row and column information is then passed on to the user in braille form.

Advantages of the experimental device include its accuracy and ability to "read" spaces and computer symbols and its potentially low cost of manufacturing.

**Smaller Lasers**

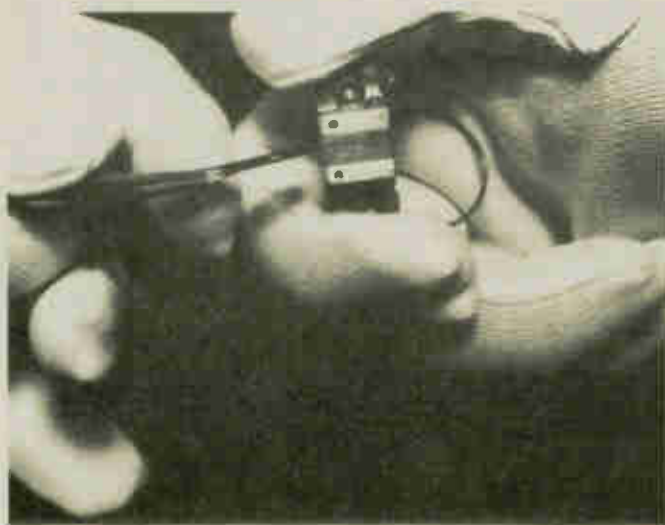

A McDonnell Douglas engineer stacks a monolithic laser diode bar array (in tweezers) with other arrays to form a laser diode optical device, or "pump" (right). These solid-state laser diode bar arrays have generated a peak output level of 114 watts per centimeter, which is the highest level of power reported to date for such devices.

This technological breakthrough could result in smaller, yet more powerful, durable and energy-efficient lasers. The bar arrays, which are less than 1.2cm long and 0.01cm thick, were fabricated and tested at McDonnell Douglas Astronautics Company facilities in St. Louis.

Circle No. 13 on Reader Service Card

**New 10 Amp Schottky Rectifiers**

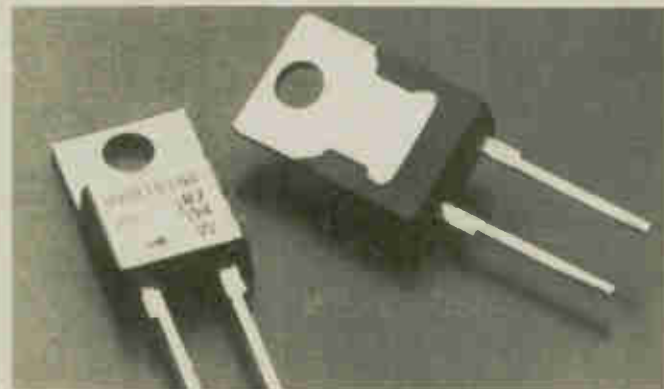

Motorola has expanded its series of Schottky Barrier Rectifiers with the introduction of a family of 10 Amp, 60V through 100V rectifiers.

This new family of rectifiers is designed to give energy efficient operation with low forward voltage at 10 Amps and low power

dissipation at 10 Amps DC of only 5 watts. The devices are available in the cost-efficient TO-220AC plastic UL compliant package.

Clark Moreland, Motorola Inc., Semiconductor Products Sector, P.O. Box 52073, Phoenix, Arizona 85072.

Circle No. 14 on Reader Service Card



# ANNOUNCING PROJECTS BOOK NO. 3

Hobby Projects was first published in the summer of 1980 and contained 25 Electronics Projects reprinted from Electronics Today magazine. It was a sell out and was followed in January 1981 by Projects Book No.2 and in the summer of 1983 by 50 Top Projects, both of which were also virtually sell outs.

Projects Book No.3 has now been compiled and is off press and available for order by telephone or mail. Cost is \$3.95 (plus \$1.00 postage). Bulk rates on requests.

Projects Book #3 contains over 35 of the most popular projects which have appeared in Electronics Today since 1983. Emphasis this time is on test equipment and audio, as well as several other projects in a variety of applications. This long-awaited best seller is a must for project fanatics.

To order, telephone (416) 445-5600 with credit card details or write:  
**Moorshead Publications**, 1300 Don Mills Road, North York  
(Toronto), Ontario M3B 3M1.

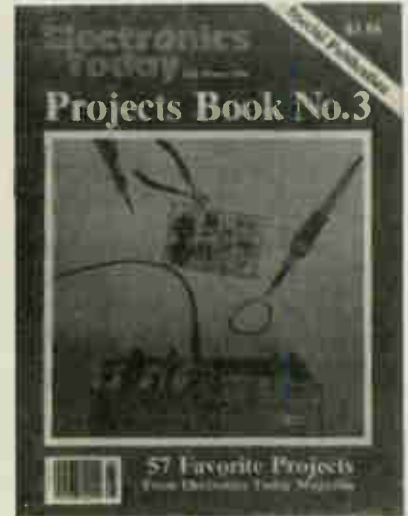

## Electronics Today Order Form

### Subscriptions:

Please complete reverse side of order form to start or renew a subscription.

### SPECIAL PUBLICATIONS

ITEM	QTY	AMOUNT
Book of Computer Music \$4.95	.....	\$ .....
Project Book No. 3 \$3.95	.....	\$ .....

### BOOKSHELF — Order Form

Code (e.g. BP12)	Title (Short-form is O.K.)	Price
.....	.....	\$ .....
.....	.....	\$ .....
.....	.....	\$ .....
.....	.....	\$ .....
.....	.....	\$ .....

### SOFTWARE — Order Form

.....	\$ .....
.....	\$ .....
.....	\$ .....
<b>Sub Total</b>	\$ .....
<b>Tax (Ontario Residents)</b>	\$ .....
<b>Postage \$1.00</b>	\$ .....
<b>Total Enclosed</b>	\$ .....

Orders from the Bookshelf are tax exempt. Please add \$1.00 for postage. Remember to put your name and address on reverse side. See over for mailing details. Specials and Software add 7% PST.

Back issues: \$4.00 each; Ontario residents add 7% sales tax.  
Please circle issued desired.

1977	1978	1979	1980	1981
Feb. July	May June Sept. Nov. Dec.	Jan. Mar. April May July Aug. Sept. Oct. Nov.	Jan. Mar. May June Nov. Dec.	Jan. Feb. March April June July Aug. Sept. Oct. Nov. Dec.
1982	1983	1984	1985	1986
Jan. March April May June July Aug. Oct.	Jan. Feb. March April Aug. Oct. Dec.	Jan. Feb. March April May June July Aug. Sept. Oct. Nov. Dec.	Jan. Feb. March April May June July Sept. Oct. Dec.	Jan. Feb. March April May June July Aug. Sept. Oct. Nov. Dec.
1987				
Jan. Feb. Mar. April	May			

Binders:  Moorshead Publications, Electronics Today  
\$9.75 each plus 7% P.S.T.

## Announcing a special Electronic Test Equipment review in the July issue of Electronics Today!

The Editor of Electronics Today has announced plans for a special addition to the July issue of the magazine.

The editorial environment is Test Gear, oriented to let readers know what the well-stocked testbench is wearing in 1987. Plans include a lineup of **oscilloscopes, meters, power supplies and other test gear** that makes troubleshooting and measuring easier and faster.

The feature will be essential reading for everyone who wants to keep abreast of changes and development in this important aspect of electronics.

Regular readership of Electronics Today will be expanded by increased newsstand sales, making the issue a unique advertising opportunity. Those marketing in this field can aid the preparation of this supplement by forwarding information to the Electronics Today editorial team.

Contact David Stone at (416) 445-5600 for space reservations and to discuss a marketing plan.

Cover Date: July, 1987 - Copy Close: May 26, 1987

# Electronics Today

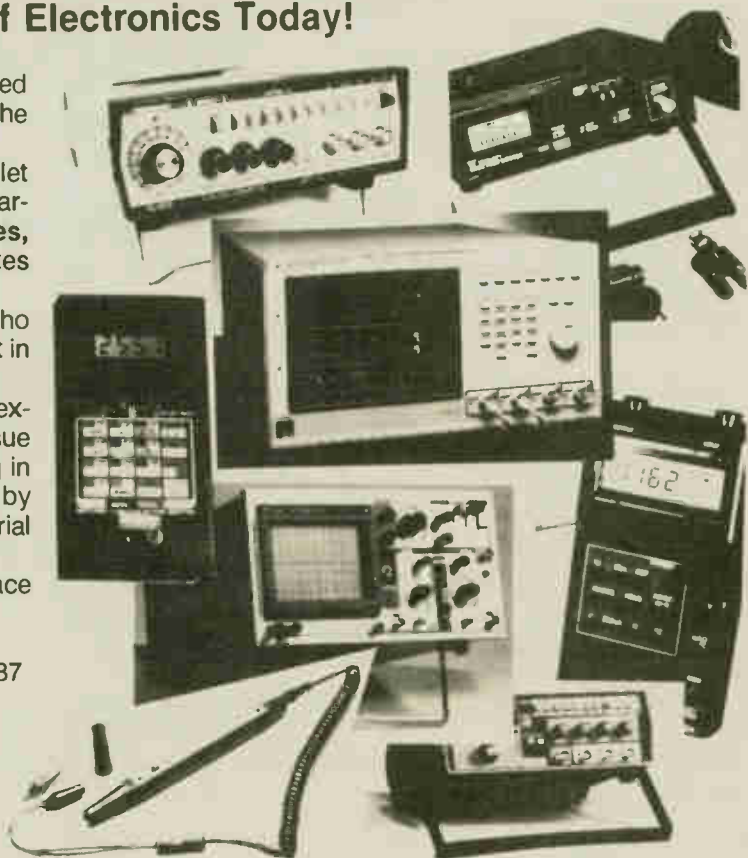

**BE SURE OF YOUR ISSUE EACH MONTH. SUBSCRIBE TODAY.**

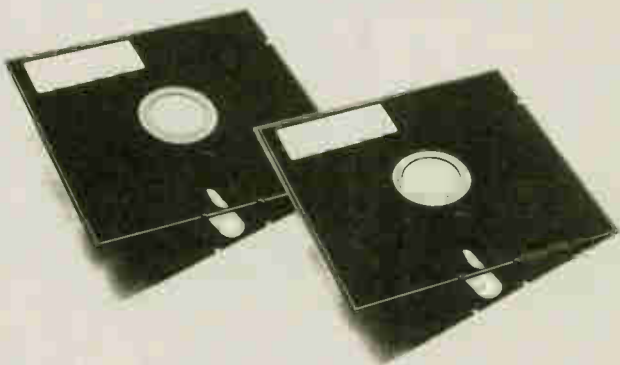

## Bonus! Almost Free Software Sample Disk

Subscribe today and receive a sampler disk filled with great public domain software programs (IBM PC/MS DOS format only). This disk contains great games like Pango and Pitfall, as well as a fantastic Chess program and some great DOS utilities. See what you've been missing!

**Regular value: \$19.95**

### Moorshead Publications

1300 Don Mills Rd., North York, Toronto, Ont. M3B 3M8.

MERCHANDISE ORDER  Please fill out form overleaf  
SUBSCRIPTIONS:  NEW SUBSCRIPTION  RENEWAL

#### Electronics Today

One year (12 issues) \$22.95  Two years (24 issues) \$37.95

#### Computing Now!

One year (12 issues) \$22.95  Two years (24 issues) \$37.95

#### Computers in Education

One year (10 issues) \$25.00  Two years (20 issues) \$45.00

Outside Canada (US Dollars)

For U.S. please add \$3.00 per year  Other countries add \$5 per year

NAME \_\_\_\_\_

ADDRESS \_\_\_\_\_

TOWN/CITY \_\_\_\_\_ PROVINCE/STATE \_\_\_\_\_

CODE \_\_\_\_\_ DATE \_\_\_\_\_

POSTAL CODE \_\_\_\_\_

Cheque enclosed DO NOT send cash

Mastercard Account No. \_\_\_\_\_

Visa Account No. \_\_\_\_\_

American Express Account No. \_\_\_\_\_

Expiry Date \_\_\_\_\_

Signature \_\_\_\_\_



former secondary winding, cancels out the 5th and 7th harmonics in the power supply system.

### High speed motor

The design of a high speed synchronous motor is derived from turbine generator practice. Both the rotor and stator have basically the same construction as their generator counterparts, but special design features are required to accommodate the harmonics in the supply current and to ensure smooth running throughout the operating speed range.

### Mechanical design

The round rotor is machined from an alloy steel forging which has been given stringent non-destructive tests at the supplier's forge to guarantee its physical properties. Radial slots are milled in the rotor body for the field winding, and each field coil is retained by single-piece Duralumin wedges which enclose the full length of each slot without any break. The rotor end windings are supported by non-magnetic steel end-bells which are shrunk onto the rotor body and over the ends of the slot wedges.

The centrifugal stresses in high speed motors are no higher than those in the largest 2 pole generator rotors now in service because the maximum surface velocity is kept within the same limits in both cases. This factor, together with restraint in maximum rotor body length restricts the maximum output of 2 pole synchronous motors at the present time to the typical range of output shown in Fig. 3.

Turbine generators may pass through one, two or more lateral critical speeds during start-up, before running continuously at a steady speed which is subject to only minor variations caused by small changes in system frequency. It can be demonstrated by test that a properly designed motor will perform within acceptable vibration limits throughout the operating speed range both when the rotor is in a balanced condition and when it is unbalanced by a permissible amount. It is also possible to demonstrate by special impulse tests that the bearings have an adequate stability margin against shaft whirl and high speeds.

### Electrical design

The design of the motor windings is affected by the almost square waveform of the current supplied by the convertor. The magnitude and order of the current harmonics in the stator windings are tabulated in Fig. 4 with the magnitude varying inversely with the order. It is necessary, therefore, to subdivide each stator conductor into extra thin strips to reduce the

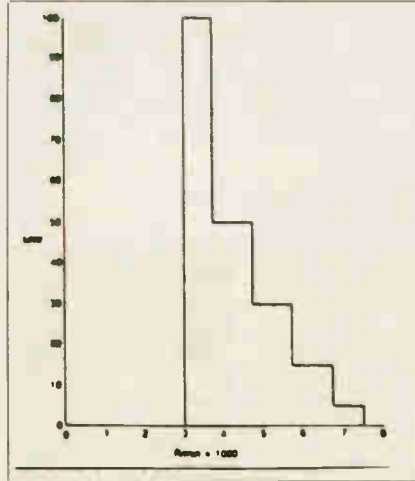

Fig. 3. Typical range of output vs. rotor body length.

eddy current loss caused by the harmonic currents. This can be carried out readily without changing the basic construction and the standard method of conductor transposition. The effect to the stator current harmonics on the rotor surface loss is much more significant. For example, the magnetic field produced by the 5th harmonic rotates in the opposite direction to the rotor and it induces a 6th harmonic current in the rotor surface.

The magnetic field produced by the 7th harmonic stator current rotates in the same direction as the rotor and it also induces a 6th harmonic current in the rotor. The resultant of the two 6th harmonic currents is tabulated in Fig. 4 together with the resultant 12th, 18th and 24th harmonic currents which are produced in a similar manner. The harmonic losses and heating of the rotor surface can be reduced by providing a low resistance path in the shape of damper windings. A further benefit can be achieved by connecting the stator winding to form two separate three-phase windings with 30° displacement between the phases. When the two stator windings are supplied with current which is also phase displaced by 30° the net result is the elimination of the 6th and 18th rotor current harmonics and a major reduction in the harmonic losses.

The use of a double three-phase winding requires extra terminals but does not otherwise complicate the stator construction. The magnitude of the 12th harmonic losses distributed over one pole pitch of the rotor circumference can be calculated by using the finite element technique already developed to investigate negative phase heating in large generator rotors. The increased loss at high speed is due to the skin effect in the aluminium wedges.

### Brushless exciter

The motor requires a source of excitation at standstill to provide torque for starting and accelerating the load. A conventional rotating exciter cannot produce useful output at low speeds and a special design is needed for this purpose. A three-phase stator winding energized from a thyristor-controlled supply induces current in the three-phase rotor winding by transformer action. The output from the rotor winding is rectified by a standard diode bridge to provide excitation for the motor field.

When the motor accelerates, additional electromotive force is generated by the rotation and the input from the supply is reduced to maintain normal flux in the motor. By this means a completely brushless system of excitation is provided which

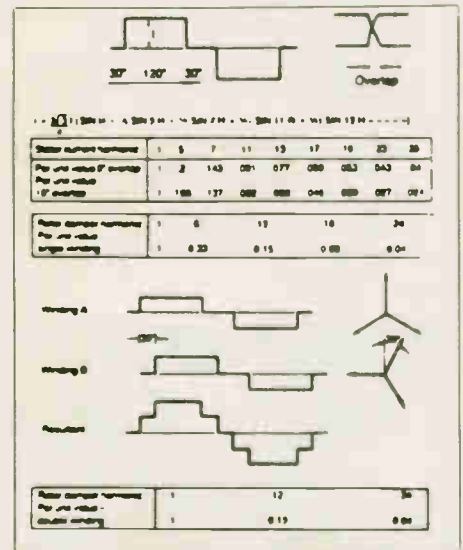

Fig. 4. The order and magnitude of the current harmonics in the stator windings.

eliminates all brush maintenance which is particularly suitable for motors which operate in a hazardous gas area. Two 100% duty diodes are connected in series to provide back-up in the unlikely event of a diode failure and eliminates the need for diode fuses.

### Conclusion

There is no doubt that high speed direct electric drives will be an increasing part of the future industrial scene. As the technology involved in this is directly based on existing experience, their introduction is likely to proceed very smoothly with few operational difficulties. ■

It was formerly considered unlikely to cause direct damage to British ecosystems because the climate was considered insufficiently sunny. However, evidence now exists to show that ozone can cause damage to plants in Britain as well.

Scientists now believe, therefore, that they are dealing with a "cocktail" of pollutants and there is a need to understand the effects of pollutant mixtures. Experiments performed at the University of Lancaster in northwest England and Imperial College in London, among other places, have shown that the influence of one pollutant has been found to be unaffected by that of others in some cases, while elsewhere damage caused by mixtures exceeds that of the individual pollutants.

Scientists from West Germany, the Netherlands and Britain are currently engaged in a European Community funded project concerned with the combined effects of different pollutant inputs and a possible connection with damage to trees in central Europe. IN an attempt to

*Six sites from Scotland to southern Germany will be monitored in an attempt to detect early warning signs of forest decline.*

determine whether it is possible to recognize early symptoms of forest decline by a range of tests, including biochemical analysis, six sites have been selected, stretching from Scotland to southern Germany. Each suffers different concentrations of, among others, sulphur dioxide and oxides of nitrogen, and different frequencies of ozone episodes, which are periods of high concentration, as well as different acid inputs.

It is through such international collaborative programs, where the expertise of scientists from different scientific disciplines and from countries experiencing different problems, that many of the remaining questions con-

cerning acid rain and the pollutant "cocktail" will be answered. ■

*Graham Bell works for the Natural Environment Research Council's Institute of Terrestrial Ecology at Penicuik, near Edinburgh, Scotland.*

# Product Mart *Where Buyers Find Sellers*

**ORIGINAL** Exact Parts, Board and power supply for Jan/87 Tri-Mode cable TV descrambler article in Radio Electronics. Complete set \$89.95 postpaid. **GENIE**, P.O. Box 522, Montreal H3S 2V3.

**ORIGINAL** Exact Parts, Board, power supply and reprint for Feb/84 SB3 cable TV descramble article in Radio Electronics. Complete set \$69.95 postpaid. **GENIE**, Box 522, Montreal H3S 2V3.

**ELECTRONIC SURPLUS INDUSTRIES LIMITED**, we sell used industrial/military test instruments, including oscilloscopes by HP Tektronix, Philips; Signal generators, meters, components, tubes, etc. 1191 Lawrence Avenue West, Toronto, Ontario M6A 1E2 416-787-1837.

**PC SOFTWARE** — hundreds of disks, thousands of programs. All disks \$5.00 each. Send \$3.00 for a directory disk to: **RJS SOFTWARE SYSTEMS**, Box 13013, Kanata, Ontario K2K 1X3.

**EXCITING** Surprise pack of Electronic Parts \$6.00, plus \$1.50 shipping. New catalogue 2-36c stamps. **MP2 SCIENTIFIC**, 1547 Venables St., Vancouver B.C. V5L 2G8. BC residents please add 7% Sales Tax.

**CABLE TV DESCRAMBLING TECHNIQUES**. 56 pages. \$13.95. Channel 3 notch filter \$39.95. Amazing see-in-the dark infra-red night viewer kit \$295. SCA background music kit \$49.95. Catalogs \$1. **OCTE(J)**, Box 173, Montreal, H3X 3T4. 514-739-9328.

**BUGGED? WIRETAPPED?** Find out fast! Countermeasures equipment catalog \$1. **OCTE**, Dept ET, Box 173, Montreal H3X 3T4.

## PRODUCT MART

WHERE BUYERS  
FIND SELLERS

For more information call:  
(416) 445-5600



# A Perspective On Audio Sampling

*ADAC, analog-to-digital-to-analog conversion,  
and its applications in music.*

*By David Green*

THE popularity of synthesized music, combined with the power of the computer to handle numbers and the decreasing price of computer memory, has brought about a revolution of computer-manipulated sound. This first started with the introduction to the consumer of the digital delay, a dedicated computer system that records and plays back a short sample of a sound. The next in the series were machines like the Fairlight Computer Musical Instrument and the Synclavier digital sampling synthesizer.

Unless you were a Top-40 musician or had a very friendly banker, it was doubtful you could afford either of these. Now with the introduction and overwhelming popularity of the Compact Audio Disk, and inexpensive sampling keyboards such as the Roland S-10, computer manipulated audio has become quite common.

One of the biggest problems with digital audio is that a person who doesn't understand computers is expected to grasp the even more complex concept of digital sampling. This has brought about a lot of confusion among consumers about quality of sound versus equipment specifications. The following will hopefully shed an amount of light.

## **Some Definitions**

Before we proceed into any discussion of the specifications and parameters of both digital and analog audio, a few definitions should be explained.

**Frequency Response:** from the lowest frequency to the highest frequency a device is capable of reproducing; for example, 20Hz to 20kHz.

**Signal-to-Noise Ratio:** the difference between the average audio level and the noise level (i.e., tape hiss, circuitry noise, etc.). It is specified as being the noise level in decibels below 0VU; for example, -60dB.

**Digit:** In binary, a 1 or 0; On or Off.

**Digital:** the representation of a quantity expressed in individual or discrete integers or values; see Analog below.

**Analog:** the representation of a quantity by a continuous scale of values whose magnitude is proportional to the parameter being measured; for example, the reading on a needle-type voltmeter.

**Analog to Digital Conversion:** the process of representing precisely (if not exactly) a

## A Perspective On Audio Sampling

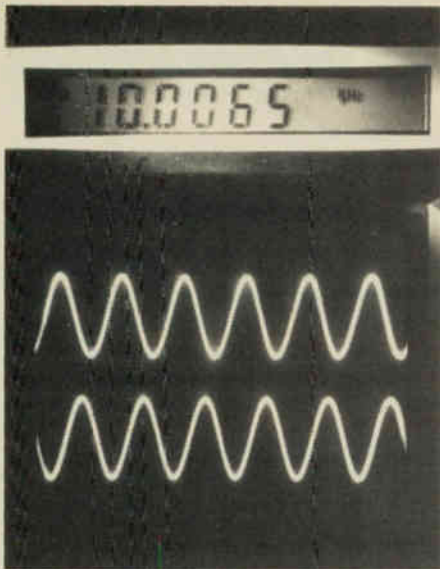

Fig. 5. A 12-bit 10kHz filtered tone. The output is still a copy of the input.

squarewave or complex wave beyond its upper frequency specification. The only thing the specs tell us is that the higher harmonics are past the -3dB reference point.

3. The dynamic range is equal or proportional to the data conversion size: 8-bit, 12-bit, etc.

Fact: the dynamic range is defined as the range in dB between the lowest AC voltage and the highest. The low voltage is determined by the system noise, and the highest is determined by the supply voltage available as well as a reference voltage applied to the converter IC.

Thus you can "stretch" the dynamic range to any desired value, but the distortion will naturally increase because you have the same number of bits sampling a greater range.

The dynamic range is only proportional to the bit count for a given distortion value.

4. The signal-to-noise (S/N) ratio is extremely good, and distortion is non-existent.

Fact: the signal-to-noise ratio is only as good as the rated specifications of the components used in the analog and digital circuitry: the linear ICs, transistors, and passive components.

All digital/analog converters are susceptible to errors, usually in the area of 1/2 to 2 least-significant-bits (LSB); this is

equivalent to up to 1.17 percent with 8-bit converters and up to 0.0046 percent with

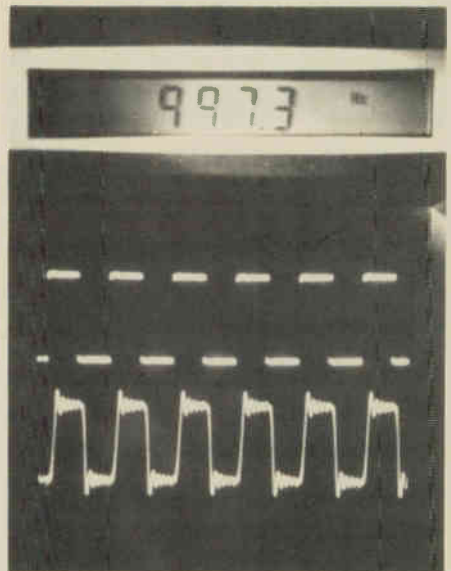

Fig. 6. A 12-bit filtered 1kHz square wave. The upper harmonics that make the square wave square are missing. The upper and lower tones would sound different due to the missing harmonics.

## LEASING

### INSTRUMENT RENTALS CANADA

will provide lease terms for your electronic equipment valued from \$5,000 to \$250,000.

Lease terms available from 1 to 4 years.

Leasing protects your capital and lets you pay for equipment as it earns you money.

For details and quotes call:

IRC Equipment Leasing

(800) 387-3411 (Ontario, Quebec)

(800) 268-4928 (throughout Canada)



IRC Equipment Leasing Inc.  
6815 Rexwood Rd., Unit 6,  
Mississauga, Ontario L4V 1S4



NOW AVAILABLE  
IN TWO CAPACITIES

## FUNCTION GENERATORS

**KZ-1404A:** • Seven frequency ranges 0.05 Hz to 1 MHz  
• Continuously variable voltage output 0-10V • Accuracy  $\pm 3\%$  • DC offset: -5V to +5V • Input voltage; 115/220V AC  $\pm 10\%$  50/60 Hz • Dimensions: 3.5" high, 12" wide, 13" deep **\$349.**

**KZ-1405:** • 8 frequency ranges: 0.01 Hz to 10 MHz, gated with phase control • 20 volt open load; 50 ohm output • DC offset variable within  $\pm 10V$  **\$895.**

Plus \$10 for shipping and handling.

Ontario residents add 7% P.S.T. Order by phone or mail.



**KB ELECTRONICS**

355 Iroquois Shore Road, Oakville, Ont. L6H 1M3  
(416) 842-6888 Telex: 06-982396 (KBEL OKVL)



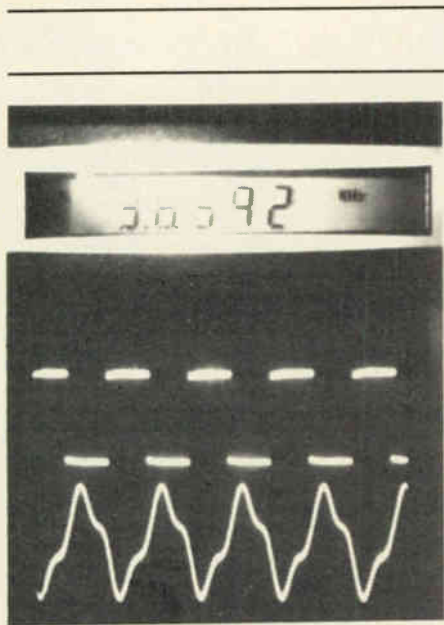

Fig. 7. A 12-bit filtered 3.8kHz squarewave. The squarewave is now reduced to a fundamental with one harmonic.

16-bit converters, plus the distortion from the analog circuitry. This amount will be doubled because the same errors occur on both the recorded sample and the playback sample.

Distortion also results from quantization error. This occurs at very low signal levels because there are only a few bits available to represent the signal voltages; the digital code has inherent difficulty in quantizing small signals near the low end of the dynamic range. This can often be seen in distortion readings for compact disk players, at least in reviews where the available equipment was capable of taking readings 50 to 80 dB below OVU. ■

### Advertisers' Index

Allan Crawford & Associates Ltd. ....	4
Anteco Communications .....	9
BCS Electronics Ltd. ....	7
Broadcasting Radar Terminal Board ...	55
Canara Technologies .....	56
Computer Parts Galore .....	26
Digital Research Computers .....	51
ECG Canada Inc. ....	53
EMJ Data Systems Ltd. ....	32
Exceltronix .....	2, 3
Gentek Marketing Inc. ....	51
Heath Company .....	28
Instrument Rentals .....	52
Kaientai Electronic Merchants Ltd. ....	9
KB Electronics .....	52
Lincom Research Inc. ....	9
McGraw Hill .....	25
National Technical Schools .....	8
Orion Electronics .....	54
R.P. Electronic Components Ltd. ....	54
Solen Electronics Ltd. ....	53

For Advertising Information  
Call 445-5600

## Announcing

### low-cost, high-quality test instruments from Philips ECG...

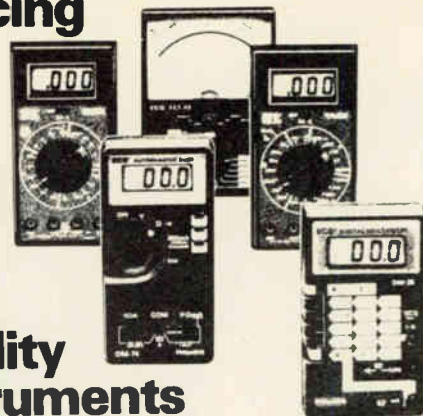

We have been selected to bring you the advanced line of electronic test instruments just developed by Philips ECG. This high quality, low cost line includes four handheld digital multimeters, an FET input analog meter, a switchable oscilloscope probe, and accessories for these units.

Philips ECG multimeters feature high accuracy and easy use, and all come with top quality safety test leads. The digital models offer auto polarity, overrange indication, overload protection and 3 1/2 digit liquid crystal displays, the analog model provides excellent reliability, many measurement ranges, high input impedance and superior values.

Philips ECG oscilloscope probe offers 200 MHz bandwidth and five foot flexible cable. It fits most popular oscilloscope models.

Make the most of these new test instruments from Philips ECG. Put us to the test!

### ECG CANADA INC.

A North American Philips Company

#### Electronic Components and Systems

1928 St. Regis Blvd., Dorval, Quebec H9P 1H6 (514) 685-5800

Circle No. 18 on Reader Service Card

# SPEAKERS DRIVERS IN CANADA

vifa



FOTAL

DYNAUDIO®

## CROSSOVER, SPEAKER COMPONENTS

### SOLE CROSSOVERS

Custom Computer Design  
Passive Crossover for Professional, Hi-Fi and Car Hi-Fi  
Application, Power up to 1000 Watt.

### SOLE INDUCTORS

Perfect Lay Hexagonal Winding Air Cored  
Values from .10 mH to 30 mH,  
Wire Sizes from #20 AWG to #10AWG

### CHATEAUROUX CAPACITORS

Metallized Polypropylene (Non-Polarized)  
Values from 1.0 mfd to 200 mfd,  
Voltage Rating: 250 VDC / 150 VAC

### CROSSOVER, SPEAKER PARTS

Mylar Capacitors, Power Resistors, Crossover Terminals,  
Nylon Ty-Wrap, Binding Post, Banana Plugs, Speaker Terminals,  
Grill Cloth, Plastic Grill Fast Snap, Neoprene Gasket, Misc. Parts.

### COMPUTER AIDED DESIGN FOR ENCLOSURE AND CROSSOVER AVAILABLE TO CUSTOMER

Product specifications and prices available upon request.



**SOLE IN INC.**  
5851 Cousineau Blvd.,  
St. Hubert, Que.  
J3Y 7P5 Canada

**ORDERS**  
Tel: (514) 656-2759

Circle No. 19 on Reader Service Card

## High Tech Photography

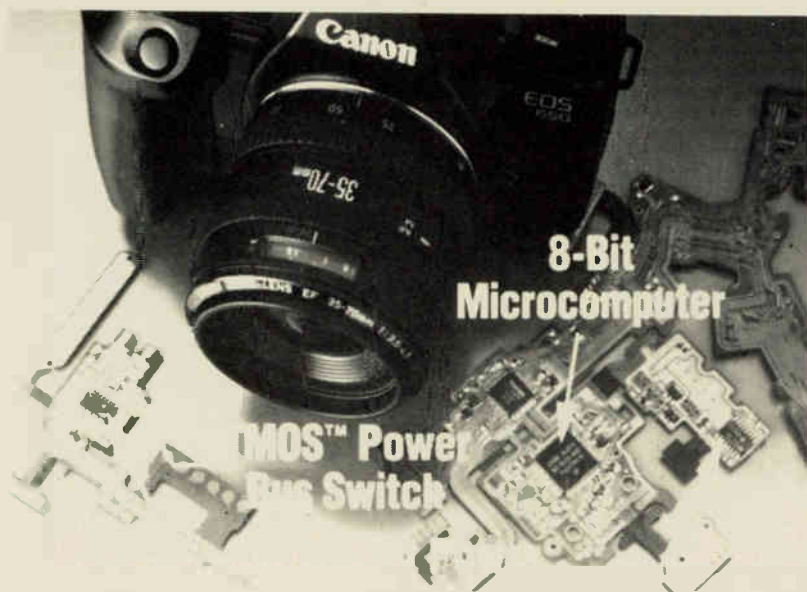

Three different types of Motorola devices have been incorporated into the new Canon EOS 620 and 650 line of 35mm cameras.

The MC68HC11 MCU is the camera's primary microprocessor

used to significantly enhance Canon's EOS metering programs. For power control, two MPC1710 devices and one SFX10 device are used. One MPC1710 rewinds the spring for the shutter, and the

other performs the film advance and rewind functions. The SFX10 is incorporated to control the camera's power bus.

In addition to these cameras, the MC68HC11 has been designed into

automotive, industrial control, portable communications, and many other applications. The MPC1710 motor controller has a wide range of applications in DC servo motor drives, including usage in computer peripherals, toys, and battery-operated appliances.

For more information on these and other Motorola microcomputer ICs contact: Jack Takesuye, Motorola Inc., Semiconductor Products Sector., P.O. Box 52073, Phoenix, AZ 85072

Circle No. 20 on Reader Service Card

According to the Ontario Waste Management Corporation, miniaturized, printed circuit manufacturing operations using ion beam etching instead of the conventional acid process eliminate the pollution hazard associated with copper sulphate waste.

## SERVING VANCOUVER FOR 25 YEARS... ...WE NOW GO NATIONAL "Our Best Sellers"

5Hz-500MHz Frequency Counter  
**GLOBAL MAX-500**  
\$269.95



- 8 digit display
- switchable gate times
- low cost & easy to use
- ideal for hobbyist & technicians
- 1 year warranty

Large Purchase of Computer Grade Capacitors  
"Thousands Available"



Examples:	1 - 9	10 +
30,000 u/130V	\$ 9.00	\$ 6.00
50,000 u/15V	6.00	4.50
1400 u/200v	8.00	5.60
100,000/15V	10.00	8.00
600 u/25V	2.00	1.50
48,000 u/50V	15.00	11.00

Phone for other values and special prices

We purchase many close-out and overstock inventories... therefore we have available many unique products available at low clearance prices. Large and small quantities available. Please call or write for stock information.

"WE HAVE IT ALL UNDER ONE ROOF"



**R.P. ELECTRONIC COMPONENTS LTD.**  
2113 West 4th Ave., Vancouver, B.C. V6K 1N7  
Phone: (604) 738-6722 Fax: (604) 738-3002

Please order by phone or mail. We accept Credit cards, Money orders, certified cheques and bank transfers include 5% for Shipping/Handling. BC residents: add 6% PST. Nothing to order this time? Send us your name and address and we'll include you on our mailing list!

3 1/2 DIGIT Multimeter  
w/Capacitance test  
METEX 3630  
\$139.95



- Test:
- dc to 1000V ± 0.3%
  - ac to 750V ± 0.8%
  - 20 Amp - AC & DC
  - Transistor HFE
  - Capacitance to 20uf
  - Large LCD Display
  - Rugged/compact case
  - 1 year warranty

Ever wondered where to get those hard to get tubes?



Well we probably have them. We stock over 2000 DIFFERENT types of receiving and industrial tubes.

Phone us for your requirements.

Examples:	Price
6CA7	\$16.50
6L6GC	10.75
12AX7A	7.50
6922	10.50

# COMPUTERS

**ORION 5AT**  
Only **\$1995**

with 1 meg dual clock mother board.  
Includes:  
• 640K memory • 200 watt power supply • 1-2 meg floppy driver • combined floppy drive controller • AT Keyboard • 80286 based system  
**100% IBM™ Compatible**  
OPTIONS: 2nd Drive.....\$169  
Hires Monitor.....\$149

**LASER 128**  
PERSONAL COMPUTER  
LOOKS LIKE A/C - RUNS LIKE A/C  
APPLE COMPATIBLE  
INTRODUCTORY PRICE  
**\$699**  
128K RAM ON BOARD

**20 MEG MB**  
HARD DISK SYSTEM  
Includes Hard Disk Controller, Cables and instructions. All drives are pre-tested and come with a one year warranty.  
**\$599**

**1200 BAUD MODEMS**  
• EXTERNAL DESIGN • INTERNAL DESIGN  
• WITH POWER SUPPLY • 10 INCH CARD  
• LED STATUS INDICATORS • SERIAL PORT INCLUDED  
MAYES COMPATIBLE, AUTO-DIAL, AUTO-ANSWER, AUTO-RE-DIAL ON BUSY, POWER-UP SELF TEST, FULL ONE YEAR WARRANTY  
**\$249**

**ORION 5XT**  
100% IBM™  
Compatible with  
640K motherboard **\$799**

**8 MEG TURBO BOARD**  
Includes • 256K Memory • 8 Expansion Slots • One 380K DS/DD Disk Drive • 150W Power supply • Disc Controller Card • Choice of Colour or Monochrome Card • Will run 1-2-3 Flight Simulator Base II TM Super Calc, Vis Calc and others

**IBM COMPATIBLE BOARDS**

• 1F02 348K MULTIFUNCTION (S/P/C/O)-OK.....	\$175
• 1F03 384K RAM VER 11-OK.....	\$ 75
• 1F03 512K RAM Ver 11-OK.....	\$ 78
• 1F05 Color Graphic.....	\$119
• 1F06 Monochrome.....	\$119
• 1F07 Mono-Graphic with printer port.....	\$169
• 1F09 UO - II - (S/P/C/O).....	\$115
• 1F11 Parallel Printer (Cable extra).....	\$ 35
• 1F12 Serial - RS232C.....	\$ 49
• 1F13 Game.....	\$ 29
• 1F14 Floppy Drive Controller - Cable.....	\$ 78
• 1F15 Clock Card.....	\$ 59
• 1F16 Serial & Clock Card.....	\$ 79
• 1F17 E Prom Burner.....	\$149
• 380K DS/DD Disk Drive.....	\$149
• XT Compatible Mother Board OK.....	\$225

**50 DISC HOLDER**  
Reg. \$19.95 NOW **\$9.95**

**NO NAME**  
DISCS DSDD **\$5.99**

**ORION DISKETTES**  
100% error free and lifetime warranty.  
SSDD **\$12.99** DSDD **\$14.99**

**ORION ELECTRONICS SUPPLIES INC.**  
40 Lancaster St. W., Kitchener (519) 576-9902  
Electronic Distributor Industrial - Commercial - Educational



# When Choosing Perfection, **BRTB** has the Connection



**Coaxial  
Connectors  
UHF, N, BNC Series  
Microphone  
Connectors  
Twinax Connectors  
Fuse Clips  
Solder Terminals  
and Teflon Terminals**

**Lamp Holders  
Sub Miniature Connectors**

**B**ROADCASTING  
**R**ADAR  
**T**ERMINAL  
**B**OARD  
(Canada Inc.)

181 Bentley St. Unit 9  
Markham Ont. L3R 3Y1  
Tel: (416) 475-8903



**S**ales Canada Inc.  
4087 Harvester Rd.,  
Unit 10, Burlington, Ont.  
L7L 5M3  
1(416) 333-1344

# MONITORing

The world's largest manufacturer of monochrome tubes, proudly introduces to the Canadian Computer Industry the technology of flat screen tube. It minimizes distortion and reflected light, giving

a high-resolution quality display.

The ergonomic design with built-in "tilt-and-swivel" feature adds a touch of class. All models meet the world safety standards, including CSA. Various models available.

## ...The World Standard



**SAMSUNG**

Electron Devices

Synonymous With Quality The World Over



**Canara Technologies Inc.**  
5560 Kennedy Rd.,  
Mississauga, Ont.  
L4Z 2A9

Tel: (416) 890-2525  
Telex: 06-960271  
Fax: (416) 890-0410

4026 Bois Franc  
St. Laurent, P.Q. H4S 1A7  
Tel: (514) 332-6550  
Fax # 832-2107



**Sterling Microsystems Inc.**  
#1-3531-Jacobs Road,  
Richmond (Vancouver), B.C.  
Canada V6V 1Z8  
Tel: 604-270-3233  
Fax: 604-273-1330  
1-800-863-4167  
Telex: 04-508428

EXCLUSIVE CANADIAN DISTRIBUTORS

Circle No. 24 on Reader Service Card