

Electronics Today

\$3.75
MM70924

July 1986

Canada's Magazine for Electronics & Computing Enthusiasts

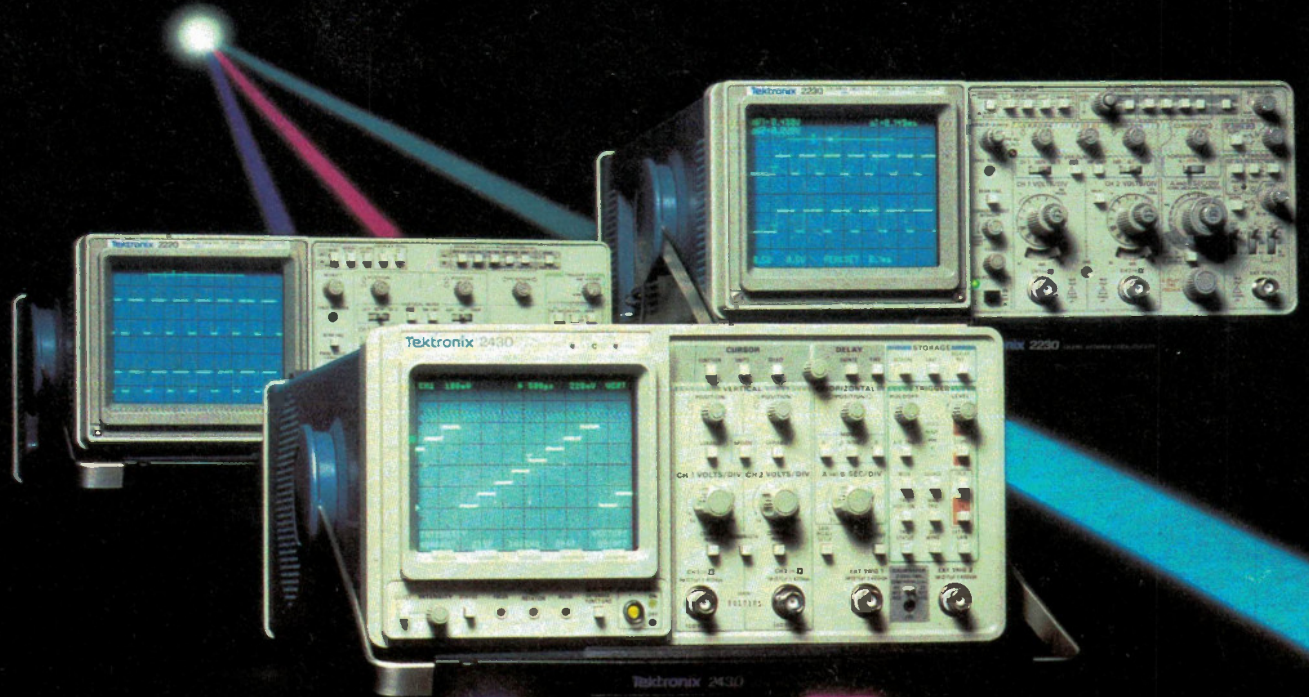

Test Equipment Special!

What's new for the testbench

Stereo TV
How It Works

Bit Detector Project
Finding stray bytes

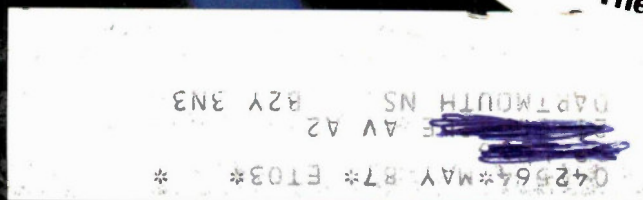

BEST Computers

Made in Canada, IBM PC, XT & AT Compatible

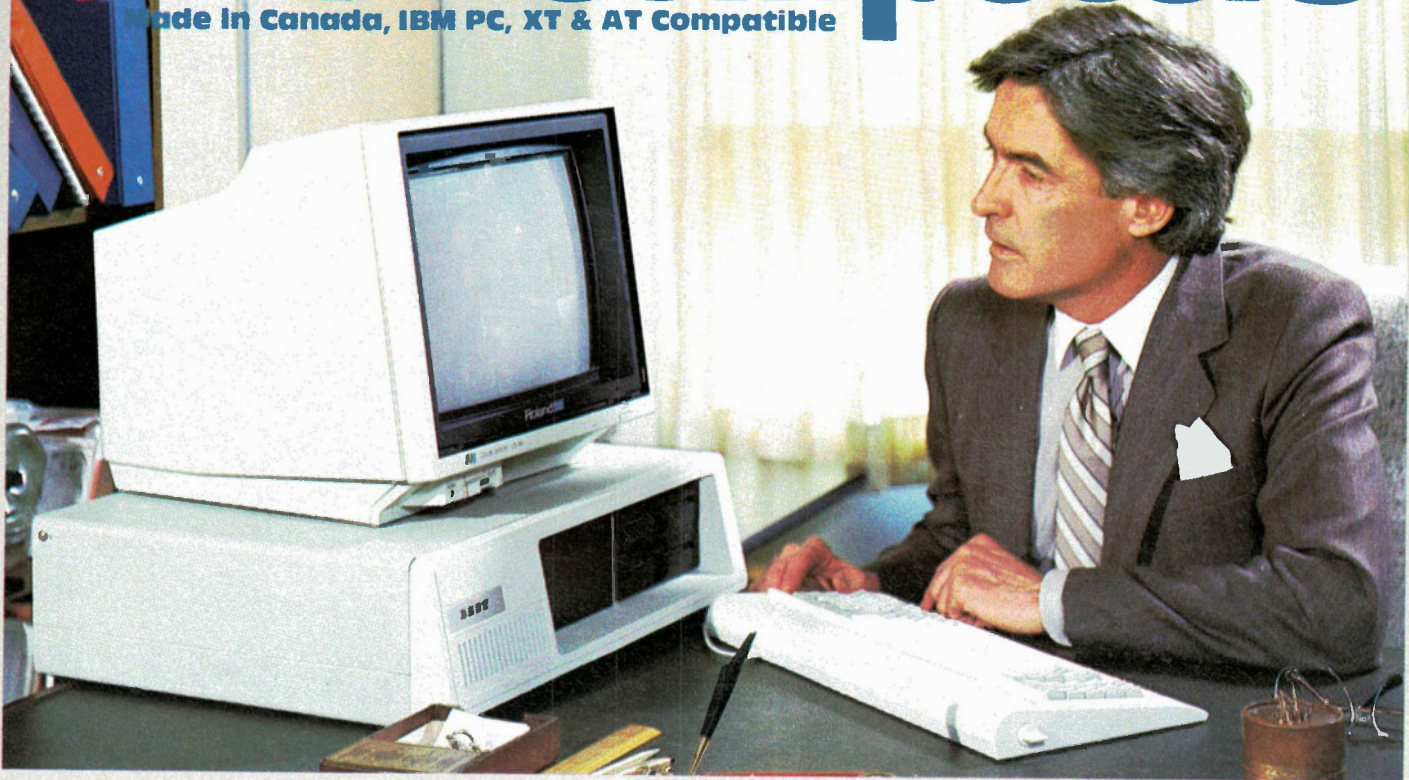

Monitor not included. IBM, IBM PC, IBM XT and IBM AT are registered trademarks of IBM Canada Ltd.

Features common to BEST MK II, MK III & MK IV

- Superb IBM PC & XT Compatibility
- Canadian Made
- 256K RAM Standard minimum (uses 41256K RAM chips)
- Expandable on board to 640K RAM
- Parallel Port (for printer)
- Serial Port (for communications)
- Real Time Clock/Calendar (with Battery Backup) Presocketed for optional co-processor — such as 8087 Math Processor
- IBM Compatible Keyboard
- Reset Switch
- Phoenix BIOS as used in many major brand IBM compatible systems.
- 150 Watt Power Supply which will handle a Hard Drive without upgrade.
- 7 Slots
- Flip top case
- 2 Slimline DS,DD 5¼", 360K Disk Drives
- Colour Video (RGB & Composite) Board or Hi-Res Monochrome Card (customer choice)
- Disk Controller Board

Warranty

We have such confidence in the time tested reliability of the BEST that we offer a ten (10) month warranty which is way above the industry standard. On-site service plan available at extra cost Nation-wide through 3M of Canada Ltd.

BEST MK II. Regular \$1695. This Month:

Two 350K DS,DD disk drives, Serial and Parallel Ports, Real Time Clock, Phoenix BIOS, uses 8088 processor — full specifications given above.

\$1595⁰⁰
TEN MONTHS WARRANTY

Other Configurations:

With 640K RAM	\$1695
With 10 Meg Hard Drive/1 Floppy/256K ..	\$2495
With 10 Meg Hard Drive/1 Floppy/640K ..	\$2595
With 20 Meg Hard Drive/1 Floppy/256K ..	\$2795
With 20 Meg Hard Drive/1 Floppy/640K ..	\$2895

4.77/8MHz
DUAL
SPEED

The FAST BEST MK III

As BEST MK II plus speed selectable: 4.77 and 8MHz (most software will run on the higher speed), uses 8088-2 processor.

\$1895⁰⁰
TEN MONTHS WARRANTY

Other Configurations:

With 640K RAM	\$1995
With 10 Meg Hard Drive/1 Floppy/256K ..	\$2795
With 10 Meg Hard Drive/1 Floppy/640K ..	\$2895
With 20 Meg Hard Drive/1 Floppy/256K ..	\$2895
With 20 Meg Hard Drive/1 Floppy/640K ..	\$2995

SPECIAL

SUPER-FAST BEST MK IV

As BEST MK III plus TRUE 16-Bit machine, 8086-2 processor, IBM compatible 8-Bit I/O channel bus, even faster than MK III due to 16-Bit architecture. With 256K standard.

REGULAR \$2400
\$2095⁰⁰
TEN MONTHS WARRANTY

Other Configurations:

With 640K RAM	\$2195
With 20 Meg Hard Drive/1 Floppy/640K ..	\$3195

The BEST Mk IV Main board processes data approx. 2.1 times faster than the IBM PC/XT or BEST Mk II.

IBM
AT
Compatible

AVT-286

Superb IBM AT compatibility, 640K RAM, Two 5.25 in disk drives (one high density 1.2 Megabyte, one standard 360K), serial and parallel ports high quality keyboard, keyboard lock and status monitor.

\$3495⁰⁰
TEN MONTHS WARRANTY

With 20 Megabyte fast stepping Hard Disk and Controller:

\$4950⁰⁰

40 Megabyte systems also available at reasonable prices.

Exceltronix 319 College Street, Toronto, Ont. M5T 1S2
(416) 921-8941. Order line only 1-800-268-3798
Ottawa. 217 Bank Street (613) 230-9000
Visa, Mastercard and American Express accepted.

Not the Cheapest — Just the BEST!

The flood of Far Eastern IBM Clones has brought about significant price reductions in the market. These new low price levels may make us seem uncompetitive but before you make a judgement based solely on price, we ask you to make a fair comparison; we believe that this will still show the BEST is the BEST value.

• We have been offering a 300 day (ten month) warranty for a long while now yet we know of no clone that has moved to equal or better this. Why? We can do this because we manufacture and test to a very high standard and stand behind our products.

• Take just one example of quality — we could shave the price noticeably by using cheap internal connectors, we can buy at a fraction of the price of the products we use because we know of the problems that can occur.

• Our floppy drives are either Panasonic or Toshiba, truly well made, quality drives that last — again, we could reduce our price by using cheaper drives that are engineered to lower standards.

• We use Seagate hard drives: they stand behind their products so that we can. We could reduce the price of a hard drive system literally hundreds of dollars by using the cheapest available but your information is important and reliability here is something we do not want to compromise on.

• All BEST systems undergo a 40 minute manual test followed by a 48 hours automatic continuous test where the hard and floppy drives and memory are tested for hundreds of cycles. When this is completed a further 40 minutes of manual tests are made — all so that the customer is unlikely to experience the problems which would not surface without this expensive testing.

• We use the latest chip technology. For example 41256 memory chips — several systems cannot handle anything bigger than a 4164.

• This attention to detail and quality runs through the entire engineering and production of the BEST range. This quality does not show on the outside — it shows in the repeat and recommended business we receive. We have been around a lot longer than most of our competitors and will be around when many of them have gone. We have to stand by our products — and we do.

Eugen F. Hutka

Eugen Hutka
President

Call or Write for our Full Colour Catalogue

Our Spring 1986 catalogue gives full specifications on our IBM AT and XT compatibles, AVT-286, MK II, Mk III and MK IV computers plus detailed specifications, with prices on our other products, made or distributed by us.

BEST MK II Package Deal

- BEST MK II 256K (as on opposite page at \$1595)
- Copal Printer (SC1200L) 120 c.p.s., 80 columns
- ZVM1220 or ZVM1230 Monitor
- Printer and Video cables

Limited Time Offer. Special price applies to this package only.

\$1895.00

A \$200 saving

BEST MODEM

The BEST modem is a smart 1200/300 direct connect modem. It can either be a stand-alone unit in which case it requires a small wall adaptor, or it plugs in one of the IBM slots. When used as a stand-alone unit, the modem looks like a Hayes 1200 Smart Modem, that is, it emulates the same instruction set. When it is used in the IBM, it looks like an intelligent serial communications port which also supports a super-set of the Hayes instruction set.

The modem supports auto-dial, auto-answer, and auto-speed select directly from software control. The modem also has a speaker so that aural monitoring of the call is possible. There are also LED monitors so that the state of the modem can always be known. These LEDs are: Modem Ready, Auto-Answer enabled, Carrier Detected, Transmitting, Receiving, Data Set ready.

Software packages such as Crosstalk, PC-talk, and Hayes' Smartcom II also will run with this modem.

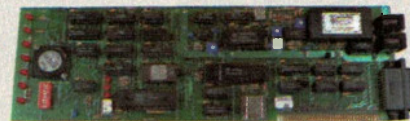

Board not exactly as illustrated.

- 300 Baud **\$179.00**
- 300/1200 Baud . **\$249.00**
- 300/1200 Baud, Stand-Alone Unit, Attractively Packaged **\$299.00**



Colour Monitor

- TVM Model MD-3A
 - 14 Inch
 - Multi-Display Amber/Green/ Full Colour
 - Compatible with PC/XT/AT using RGBI TTL level
 - 640x400 interlace
 - One Year Warranty
- Only \$599.00**

- Epson Compatible • Supports both IBM and Apple systems
- Centronics Parallel Interface • Both Draft and Near Letter Quality (NLQ) modes

SC1200

- 120 cps draft quality
- 24 cps NLQ
- NLQ available in all print sizes
- 11 Inch carriage
- Pin and friction feeds
- One Year Warranty

\$329.00

SC1500 \$499.00

- 180 cps draft quality
- 36 cps NLQ
- 3k Buffer

SC5500 \$699.00

- 15 inch carriage
- 3K Buffer

Exceltronix

319 College Street, Toronto, Ont. M5T 1S2
(416) 921-8941. Order line only 1-800-268-3798
Ottawa, 217 Bank Street (613) 230-9000
Visa, Mastercard and American Express accepted.

Toronto Computing Centre Inc.

Formerly Surplustronics

**8088 Computer Systems
with 90 day Warranty**



From \$995

Includes:

- 8088 motherboard
- High quality legal Bios
- One DS,DS 360K Drive
- Power Supply with Fan
- Keyboard
- Flip-Top case
- Disk Controller
- With plenty of spare slots
- All you need for complete System is Video Board

\$339 8088 motherboard with 256K (expandable on board to 640K) Fully assembled and tested with legal Bios, Flow soldered provision for 8087.

AT Compatible Motherboard call for Best Price.

256K Memory

41256 (150nS) Please call
Set of 9 Please call

64K Memory

4164 (150nS) Please Call

Set of 8088, 8255A-5, 8237A-5, 8288, 8284, 8253A-5, 8259A \$45.00

IBM Compatible Keyboards

Maxiswitch \$135.00
Keytronics 5151 \$195.00
IBM & Apple Compatible \$149.00

Printers

Copal SC550001
180 cps, 132 column \$699.00
Copal SC1500T
180 cps, 80 column \$499.00
Copal SC1200L
120 cps 80 column \$329.00

IBM Peripheral Cards

Colour Video Board \$159.00
Monochrome Video Board \$159.00
Floppy Controller with RS232 \$139.00
Floppy Controller \$ 99.00
Modem 300 Baud \$179.00
Multifunction Floppy Board \$199.00
Multi I/O card with cables \$175.00
384 MF-FL \$289.00
384 MF W-OK \$155.00
Parallel and Game Port Card \$ 59.00
Cable and connector extra.

Hard Drives
Half-height, with Controller and Cables
10 Meg \$639.00
20 Meg \$975.00

Disk Drives for IBM Computers

Toshiba, 5 1/4" slimline, DD, DS 360K, 40 track \$169.95

Monitors

Zenith ZVM1230 Green and ZVM1220 Amber . . . \$135.00
Tatung, TTL, Hi-Res, 22MHz \$199.00
Tatung Colour Switchable to green or amber . . . \$649.00
JIL 14in, composite RGB and NTSC \$549.00

Complete 6502 Board

- Assembled and fully tested (flow soldered)
- 64K, 80 x 24 video with soft-switch, floppy controller.
- System comes with blank EPROM's on board, does not come with any proprietary software or Basic \$239.00

Complete System

- Using 6502 board above in IBM style flip-top case, using powerful 75 watt power supply with fan, programmable serial keyboard adaptor, IBM style keyboard

As above with one built in disk drive \$699.00
As above with two drives \$879.00

6502 Power Supply

For 6502 Case. CSA Approved 5V, 5A, + 12V 2.5A, -5V 0.5A, -12V 0.5A. \$69.00

Kepco Power Supply

5V 5A,+ 12V 2.8A,+ 12V 2A, -12V 0.5A, Open Frame \$38.95



SALE ITEM

Panasonic Printers — Sale

Open Frame \$29.95
Ideal for experimenters. No warranty.

We have changed our name. We felt our previous name of Surplustronics did not properly describe our line of quality products. Service and prices are still the best available to which we now add warranties on most products.

IBM Style Power Supply

150W \$149.00
220W \$249.00

Power Bars with Surge Protectors \$34.00

Apple Cards

Assembled, flow-soldered/cleaned and 100% tested
16K RAM Card \$ 49.00
80 x 24 video card \$ 69.95
Z80A Card \$ 59.00
Parallel Printer Card (cables extra) \$ 49.00
Parallel Printer Card with cable \$ 69.00
128K RAM Card with 128K \$ 99.00
EPROM Programmer with Software (programs 2716, 2732, 2732A, 2764) \$ 79.00
Z80/64K Card \$119.00
Serial Card (cable extra) \$ 79.00
Floppy Controller \$ 42.00
Prototyping Board \$ 14.95

Modem Bargain!

Apple Compatible plug-in Autoanswer, Autodial, Touch Tone or Pulse Dial. Excellent for use with most Bulletin Boards. 300 Baud. Final Sale as is \$39.95

Apple Compatible Slimline

Disk Drives 5-1/4" \$179.00

Apple Compatible Modem

\$159.00



Plugs into your Apple or compatible computer, Direct connect, 300 Baud, Autodial, Autoanswer, Touch Tone/Pulse Dial, complete with documentation.

IBM Style Case Suitable for 8088 or Apple Boards

\$75.00

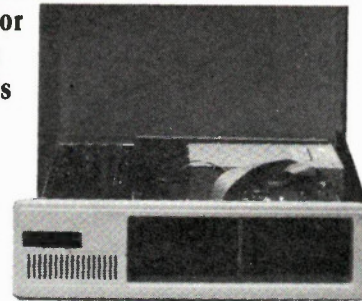

AT Style Case \$169.00

Mail Orders add \$7.50 minimum for shipping & handling. Ontario residents add 7% P.S.T. Visa, Mastercard and American Express cards accepted: send card number, expiry date, name of bank and signature. Send certified cheque or money order, do not send cash. All prices on this page are final sale. No warranty. No returns. No refunds but HUGE savings. Warranties available at extra cost.

More lines to serve you better **(416) 960-1350**

Toronto Computing Centre Inc. 310 College Street, Toronto, Ontario M5T 1S3



Our Cover

Highlighting our Test Equipment Special, our cover photograph this month was provided courtesy of Tektronix Canada Ltd.

Electronics Today

July 1986
Vol. 10 No. 7

Canada's Magazine for Electronics & Computing Enthusiasts

Electronics Today is Published by:
Moorshead Publications Ltd.
(12 times a year)
1300 Don Mills Road,
Don Mills, Toronto, Ont. M3B 3M8
(416) 445-5600

Editor: William Markwick
Assistant Editor: Edward Zapletal
Director of Production: Erik Blomkwist
Production Manager: Douglas Goddard
Production: Naznin Sunderji
Dolph Loeb
Circulation Manager: Lisa Salvatori
Advertising Account Manager: Marlene Dempster

Publisher: H.W. Moorshead; **Executive Vice-President:** V.K. Marskell; **Vice-President - Sales:** A. Wheeler; **General Manager:** S. Harrison; **Controller:** B. Shankman; **Accounts:** P. Dunphy; **Reader Services:** M. Greenan, J. Fairbairn, R. Cree, L. Robson, N. Jones; **Advertising Services:** H. Brooks; **Advertising Telemarketing:** Rod Macdonald.

Newsstand Distribution:
Master Media, Oakville, Ontario

Subscriptions:
\$22.95 (one year), \$37.95 (two years).
Please specify if subscription is new or a renewal.

Outside Canada (US Dollars) U.S.A. add \$3.00 per year. Other countries add \$5.00 per year.

Postal Information:
Second Class Mail Registration No. 3955.
Mailing address for subscription orders, undeliverable copies and change of address notice is:
Electronics Today, 1300 Don Mills Rd., Toronto, Ontario, M3B 3M8

Printed by Heritage Press Ltd., Mississauga
ISSN 07038984.

Moorshead Publications also publishes Computing Now!, Computers in Education, and Pets Magazine.

Circulation Independently Audited by MURPHY and MURPHY Chartered Accountants.

Advertiser's Index see page 6

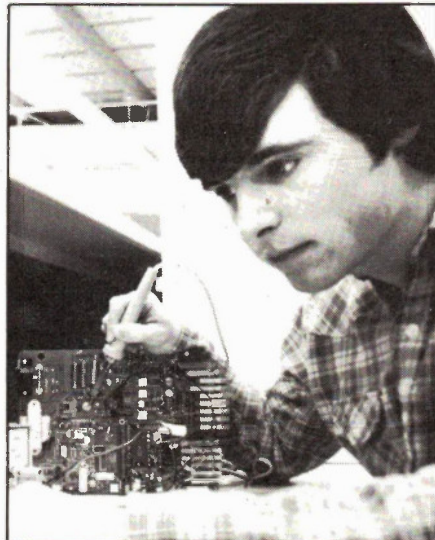

Test Equipment page 26



Stereo TV page 49

Features

Laminated RF Shielding	10
Test Equipment Special	26
Stereo TV	49
Creating The Science Environment	62

Projects

Rotation Sensor	14
Bit Detector	20

Series

For Your Information	6
Beginner's Bench: Part 3: Semiconductors	57

Columns and Information

Marketplace	9	Product Mart	51
Circuit Ideas	12	Order Form	51
Software	18	Subscriptions	52
Next Month	24	Binders	52
Computing Now! This Month	24	Books	54

For Your Information

Advertisers' Index

ABAC Electronics Enterprises	41	Interfax Systems Inc.	65, 67
All-Crystal Displays	37	Kaientai Electronic Merchants	48
Allan Crawford Associates	68, 69	KB Electronics	48
Armaco Electronics Ltd.	38	Kitronics International Ltd.	9
Atlas Electronics Ltd.	71	Lasco Montreal Inc.	9
BCS Electronics Ltd.	27, 46, 66	Len Finkler & Co.	70
Brunelle Instruments Inc.	43	Masuko International Corporation	46
BV Engineering	33	McGraw Hill	25
Computer Parts Galore	30	Meints-Shuster	36
Daetron	45	Patron Components	33
Duncan Instruments	9, 46	Philips Electronics Ltd.	72
EIL Instruments Canada Ltd.	70	Ram-X Electronics	9
Exceltronix	2, 3	RCC Electronics	39
Hammond Manufacturing Co. Ltd.	70	Soltech Industries Inc.	40
Heathkit/Zenith Educational Systems	70	Sunix Inc.	38
Hitachi Denshi, Ltd. (Canada)	35	Tektronix	70
Hobbitt Electronics	9, 41	Toronto Computing Centre	4
Information Unlimited	37	Varah's Direct	7
Innovage Microsystems Inc.	70		

For Advertising Information
Call 445-5600

Versatile Differential Amp

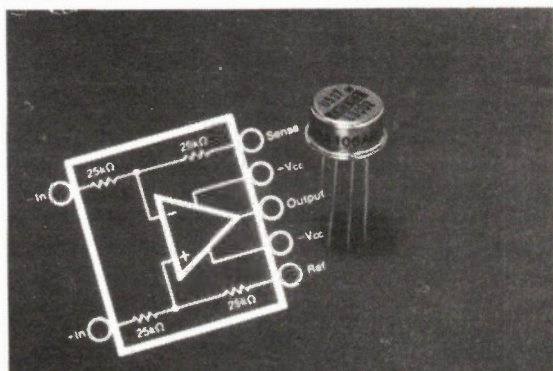

Looking for an accurate, low-cost solution to the analog design problems associated with unity-gain amplifiers? Well, look no more. The Burr-Brown INA105 is ideally suited for a wide variety of analog circuit designs such as differential amps, unity-gain inverters, absolute value and summing amplifiers, just to mention a few.

The INA105 combines a premium op amp and a precision low-drift resistor network on a single IC, hermetically sealed inside a compact metal TO-99 package. Laser trimming assures total ac-

curacy (gain, nonlinearity, offsets, and CMR) of better than +0.015% eliminating the need for external adjustments and pots in the circuit. It can drive 20mA from the positive supply, greatly simplifying 4-20mA current source and transmitter designs, has fast microsecond settling time to 0.01%, and low 2mA maximum quiescent current.

Contact Mrs. Rose Monk, Allan Crawford Associates Ltd., System Products Division, 5835 Coopers Ave., Mississauga, Ont., L4Z 1Y2. (416) 890-2010.

Circle No. 51 on Reader Service Card.

Scientists at the Institute for Perception Research, a joint research organization in the Netherlands run by Philips Research and Eindhoven University of Technology, are working toward a more natural-sounding synthetic speech. The usual method of making computers speak is to put words together from phonemes, or basic units of speech sound. The resulting sound is somewhat artificial because of

the difficulty in joining the phonemes smoothly; in natural speech, each phoneme is subtly influenced by its neighbours. One way out of this is to compose speech from diphones, or transitions between successive phonemes. These can be automatically extracted from natural speech and stored in computer memory. When retrieved and reconstructed, the diphones produce better quality and intelligibility.

Sales of home telephones will reach a stable annual growth of eight percent per year, creating a North American market of \$4.2 billion by 1990, according to a release by a NY research firm called Packaged Facts. There was a huge growth in home phones over

the last few years, largely due to the breakup of AT&T, the major supplier of telephone equipment. Most of the brands introduced soon after the breakup came and went quickly as consumers discovered the poor quality of the low-cost phones.

New Signal Conditioners



The new Daytronic 3000 series of stand-alone, single-channel signal-conditioners and digital indicators produce high-level analog output; accommodating virtually all types of transducers and signal sources encountered in electromechanical testing and control operations.

Ideal for use in bench-top, panel-mount, or rack-mount applications, these instruments have built-in regulated excitation, selectable low-pass active filtering, and internal reference calibration

standards.

Options include: local digital display; automatic dual limit monitoring; manually controllable peak capture operation; 12 VDC battery or 230 VAC operation; 4-20 mA current output; internal control relays, and more.

For more information or a free catalogue, contact: Stuart Vanderpluis, Durham Instruments Ltd., P.O. Box 426, Pickering, Ont., L1V 2R7.

Circle No. 52 on Reader Service Card.

TRANSFER 5 BILLION BITS/SECOND

The transfer of five billion bits per second on a data communication local area network has been achieved with the aid of fibre-optic methods by researchers at the Chalmers Institute of Technology in Gothenburg, Sweden. Within a few years, it is stated, there will be a great need for transfer speeds in this range in order to facilitate the exchange of information between "electronic" offices, automated industries, global data banks and satellites, for instance.

Five billion bits per second is thought to be one hundred times faster than the fastest transfer time hitherto obtained. This would make it possible to transfer the entire text of the Encyclopaedia Britannica between two word processors in different locations in less than one-third of a second, or connect 50,000 computers via a common cable without any loss of transfer speed.

High-speed data transfer on local area networks is a relatively new science, which makes possible communication between computers, word processors, automatic industrial units, via a common cable in small, limited geographic areas such as an industrial plant or university.

- David Dempster

The recommended cures: Canadian companies must unite in the development of base computer technologies, a major commercial microchip foundry must be established in Canada, and computer technology must be seen as a strategic industry, all-important to our survival as an industrial power.

The recommendations aren't surprising, coming from a manufacturer of computers, but it's difficult to say that he isn't right.

The president of Control Data Canada, T.S. Dudley Allan, told a meeting of Canadian aerospace companies that Canada has a "pretend" electronics industry. Despite its achievements, he says, we're dabblers, doing a little here, a little there. Not many companies use computer-aided technologies but are waiting to see what will happen. Another problem is that Canada is dependent on the US and Japan for computer microchips.

Continued on page 8

Copyright

All material is subject to worldwide copyright protection. All PCB patterns are copyright and no company can sell boards to our design without our permission.

Liability

While every effort has been made to ensure that all constructional projects referred to in this magazine will operate as indicated efficiently and properly and that all necessary components are available, no responsibility whatsoever is accepted in respect of the failure for any reason at all of the project to operate efficiently or at all whether due to any fault in the design or otherwise and no responsibility is accepted for the failure to obtain component parts in respect of any such project. Further no responsibility is accepted in respect of any injury or damage caused by any fault in design of any such project as aforesaid.

Editorial Queries

Written queries can only be answered when accompanied by a self-addressed, stamped envelope. These must relate to recent articles and not involve the staff in any research. Mark such letter Electronics TodayQuery. *We cannot answer telephone queries.*

Binders

Binders made especially for Electronics Today (ETI) are available for \$9.75 including postage and handling. Ontario residents please add provincial sales tax.

Back Issues and Photocopies

Previous issues of Electronics Today Canada are available direct from our office for \$4.00 each; please specify by month, not by feature you require. See order card for issue available.

We can supply photocopies of any article published in Electronics Today Canada; the charge is \$2.00 per article, regardless of length. Please specify both issue and article.

Component Notation and Units

We normally specify components using an international standard. Many readers will be unfamiliar with this but it's simple, less likely to lead to error and will be widely used everywhere sooner or later. Electronics Today has opted for sooner!

Firstly decimal points are dropped and substituted with the multiplier: thus 4.7uF is written 4u7. Capacitors also use the multiplier nano (one nanofarad is 1000pF). Thus 0.1 uF is 100nF, 5600pF is 5n6. Other examples are 5.6pF = 5p6 and 0.5pF = 0p5.

Resistors are treated similarly: 1.8Mohms is 1M8, 56kohms is the same, 4.7kohms is 4k7, 100ohms is 100R and 5.6ohms is 5R6.

PCB Suppliers

ETI magazine does NOT supply PCBs or kits but we do issue manufacturing permits for companies to manufacture boards and kits to our designs. Contact the following companies when ordering boards.

Please note we do not keep track of what is available from who so please don't contact us for information PCBs and kits. Similarly do not ask PCB suppliers for help with projects.

K.S.K. Associates, P.O. Box 266, Milton, Ont. L9T 4N9.

B—C—D Electronics, P.O. Box 6326, Stn. F., Hamilton, Ont. L9C 6L9.

Wentworth Electronics, R.R. No. 1 Waterdown, Ont. L0R 2H0.

Danocinths Inc., P.O. Box 261, Westland MI 48185 USA.

Arkon Electronics Ltd., 409 Queen Street W., Toronto, Ont., M5V 2A5.

Spectrum Electronics, 14 Knightswood Crescent, Branford, Ontario N3R 7E6.

Interface with Varah's Direct

— RS-232 Products & Accessories —

DATATRACKER: The Best in Breakout Boxes!

The Dataracker was designed with simplicity in mind. It's the most easily used, informative breakout box on the market today. The Dataracker monitors every single available line on the interface (50 total, 25 on either side) for high, low, off and clocking signals. As well, it tests cables for their complete configuration in less than 30 seconds. This breakout box is unsurpassed in performance. By eliminating guesswork, the Dataracker pays for itself again and again.

The Dataracker's extended test points, 25 clearly marked switches in a "no-nonsense" configuration, automatic 2/3 reversal, and highest quality mini clip leads are just some of the reasons it's so popular.

Included with the Dataracker are a 4-ft extension cable, 4 mini clip leads, a comprehensive step-by-step interfacing guide, and a padded carrying case. An optional cable test adaptor is also available to allow single-ended cable testing of installed cables.

You were first introduced to the Dataracker in the March *Electronics Today* "For Your Information" section. Now *Varah's Direct* proudly brings *The Dataracker* directly to you!

Dataracker: Stock # 62760 \$495.00

Cable test Adapter: Stock # 62761 \$59.95

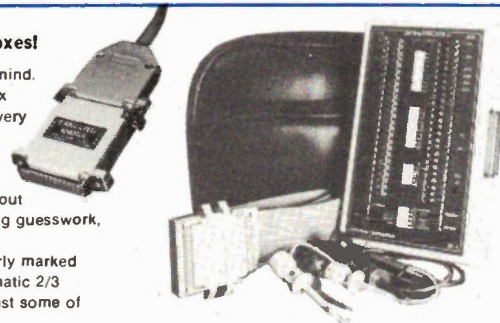

MINITRACKER: Pocket Performance!

The Minitracker is a miniature RS-232 signal monitor which is quick and easy to use. Its 16 LEDs display the status of the 8 most commonly used lines: 2, 3, 4, 5, 6, 8, 11, and 20. A red light indicates a high signal and a green means low. When both are flashing, it tells you that data is transmitting.

The Minitracker's passive design means no batteries are required. That's convenience. And everything you need fits easily into your pocket. *That's performance!*

Minitracker: Stock # 62765 \$79.95

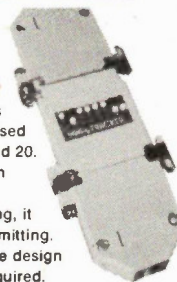

MICROPATCH: Timesaver Plus!

The Micropatch is the smallest, most effective RS-232 adapter available. Its unique design allows easy on-site custom wiring without custom cables or soldering. Sixty high quality mini-spring sockets are arranged with 25 to each DB25 connector. 10 serve to bus common connections together.

Included are 25 re-useable 2" jumper wires which insert easily into the socket's self-healing silicone rubber membrane for excellent dust and moisture-free connections.

The Micropatch is enclosed in a snap-apart cover so it can be used as a temporary or a permanent solution. Either way, custom interfacing has never been easier!

Micropatch (Male-Female): Stock # 62750 \$69.95



ACCESSORIES:

Gender Changers: only \$14.95

Solves mismatched ends ...

Connects Male-to-Male, Stock # 43270

Connects Female-to-Female, Stock # 43272



Pre-assembled Cable Specials:

6-ft IBM Centronics to 25-pin D-Sub

• Reg. \$42.90 now \$29.95

8-ft RS-232 Serial Assemblies:

Male-to-Male, Male-to-Female,

Female-to-Female.

• Reg. \$41.80 now \$29.95

8-ft Modem Cables:

Standard: (1 through 8, 20, 22)

• Reg. \$32.50 now \$27.95

Null Modem: (1-1, 2-3, 3-2, 6-20,

7-7, 20-6)

• Reg. \$35.20 now \$28.95



RS-232 Connectors:



25-pin D-Subs

Male: \$3.10 each, 5 / \$13.95

Female: \$3.55 each, 5 / \$14.95

25-pin Hoods:

Click together: \$2.75

Data Phone Shell: \$3.45

Metal Shielding: \$3.95

9-pin D-Subs:

Male: \$2.10 Female: \$2.40

15-pin D-Subs:

Male: \$2.65 Female: \$3.00

37-pin D-Subs:

Male: \$4.95 Female: \$6.60

50-pin D-Subs:

Male: \$6.20 Female: \$8.25

Click Together Hoods:

9-pin: \$2.25 15-pin: \$2.50

37-pin: \$2.85 50-pin: \$2.95

Contact *Varah's Direct* for your RS-232 accessories. Call Us at (416) 842-8833 from 8:00 to 6:00 E.S.T. (Mon. - Fri.), or Write Us at the address listed below. We accept VISA, Mastercard, Money Orders or Cheques. And don't forget, our 1986 catalogue is still available and it's free. Simply indicate you need one and we'll send it along with your order!

Varah's direct

OUTLETS:

Vancouver
Edmonton
Calgary
Winnipeg
Oakville
Nepean

WRITE:

Varah's Direct, 504
Iroquois Shore Rd.
Oakville, Ontario
L6H 3K4
(please include
your postal code)

CIRCLE

Reader Service
No. for this ad
OR CALL:
(416) 842-8833
Mon. to Fri.
8:00-6:00 E.S.T.



Member Canadian
Direct Marketing
Association

NEW SOLID STATE INSTRUMENTATION HELPS SCIENTISTS STUDY LIGHTNING

Scientists have undertaken an intensive research project this summer to learn more about how thunderstorms spawn lightning, a phenomenon that causes an estimated \$260 million (U.S.) in property damage and kills or injures about 350 persons a year in the U.S. each year, according to a recent report from the National Science Foundation (NSF). The problem is considered so important that hundreds of meteorologists and atmospheric scientists from all parts of the world held a six-day conference in June to discuss various aspects of atmospheric electricity.

The research project, six weeks long, started July 14th in New Mexico and involved at least 19 research groups from nine institutions, including five universities. Funded by the NSF's Division of Atmospheric Sciences, the study used a jet airplane, two sailplanes, at least 20 balloon flights, six radars and several rockets. New Mexico Institute of Mining and Technology's Langmuir Laboratory for Atmospheric Research was the site for the project, a complex of buildings and instruments atop the 10,000-foot South Baldy Peak in the Magdalena Mountains near Socorro.

Dr. William P. Winn, a New Mexico Tech physicist and one of the organizers of the project, said the site was especially good for such experiments because the mountains heat the surrounding air at high altitudes, causing convection and the development of electrically active and isolated thunderstorms over the laboratory.

How clouds become electrified has remained a puzzle and the scientists want answers. They

think the presence of ice and water particles play an important role, but details of necessary interactions remain unresolved. Efforts to learn about lightning have been going on for some time, according to Dr. Winn. However, the availability of light-weight solid-state integrated circuits open a lot of possibilities for better instrumentation which means better data, he said. Many new instruments have microcomputers built in, making some kinds of measurements of storms possible today that were not economically feasible five years ago.

The researchers hope to understand the role precipitation particles such as rain, hail and ice play in generating electric charges in thunderclouds. They also hope to learn more about winds and air movements which carry such charges from one place to another. Six radars were to be used to get information about the motions of water and ice particles. And the jet was slated to fly around storms to measure the flow of air into and out of the clouds as they develop. One sailplane had a special camera for photographing precipitation particles and both sailplanes were equipped with electric field meters.

Balloon-borne measurements of electric fields also were made. Small rockets trailing grounded wires were launched to trigger lightning when conditions appeared right. One of six radars used was designed and developed by New Mexico Tech scientists to scan an entire thunderstorm every 20 seconds, a rate about 10 times faster than ordinary radars. Its purpose—to help sort out the relationships between electric charge, precipitation and lightning.

Also planned to be used was a unique instrument called a very high frequency interferometer to provide a three-dimensional "x-ray" view of the lightning channels within a thunderstorm cloud.

AVALANCHE SYSTEM DEVELOPED

An electronic avalanche rescue system for saving lives of mountaineers and downhill skiers buried in snow has been developed by researchers at the Royal Institute of Technology, Stockholm. Called Recco, and marketed by Recco Co., also of Stockholm, it consists of self-adhesive stickers which are attached to each ski boot. These stickers reflect microwave signals emitted from a search antenna used by the rescue team.

How effective is the system in deep snow? According to the developers, the signals penetrate through 10 meters of snow and are clearly reflected by the stickers and pin-pointed by the rescuers. The stickers, which require no energy source, feature a miniature antenna and a diode, harmless electronic components. An alternative version of the sticker can be sewn into trousers, this model being suitable for ski touring. The detection equipment includes a transmitter and receiver (carried on a packframe if the rescue team is

land-based) weighing about 12 kg, headphones, and a hand-held scanning antenna. When the latter is pointed at the avalanche victim's reflector sticker the rescuer hears a high-pitched tone in his headphones.

Avalanche victims can be located without difficulty, it is claimed, with an accuracy of 0-30 cm. Depending on outside temperatures, the detection equipment operates for up to two hours with fully-charged batteries. Batteries can be replaced in less than a minute.

Persons located under an avalanche within 10 minutes have an 80 percent chance of survival, it is stated. After two hours, their chances of survival are only 20 percent; thus, rapid location is of the utmost importance. In this respect, the Recco system is best utilized by a helicopter team.

DATA HIGHWAY AT CHALK RIVER

At Chalk River Nuclear Laboratories, Chalk River, Ontario, a task force has been set up to overcome a communications problem created by the incompatibility of various disk formats. In that, they are not alone; but they are doing something about it. This incompatibility limits the efficient use of their word processors because text prepared on one machine can only be read by, edited or updated on another machine of the same make. This problem is further complicated by the fact that facilities to transfer text from one operator to another are virtually non-existent.

As a result, the Electronics branch of CRNL receives frequent requests from staff to reformat disks or transfer technical information. However, there is hope on the horizon. The task force, composed of Gerry Lynch, Electronics branch, and Jim O'Byrne, Office Services branch, has implemented a pilot text transfer system. For a six month period secretaries will gather data for the task force to get a better idea of CRNL's requirements for a permanent system in the future. The pilot system uses the newly-installed INTRAN CATV cables as a "data highway" to connect the Computing Centre, five AES and MICOM word processors and the typesetter in Printing Services section. Secretarial staff participating in the test are now able to transfer text to each other as well as off-site via the AES communication link. In addition, Bell Canada's DataPac System offers an alternate route outside through the INTRAN cable and the Computing Centre.

"We've recognized the problems caused by the lack of communication between different word processors for some time," says Gerry Lynch. The pilot system uses existing hardware and technology and overcomes the lack of standardization in internal storage of text by using international standards for data communication. Word processors involved have required only mini-

mum modifications to be compatible with the network. To get a better idea of how the system operates in actual office situations, it is being used by secretarial staff rather than technical personnel. Gerry Lynch says that the main aim of the experiment is to discover appropriate specifications and practical guidelines for establishing a permanent text transfer system at CRNL in the future.

It was the responsibility of George Gilks and Ed Nicholson of the Electronics branch to get the system operational. Ed Nicholson supervised the installation of the cable connecting buildings and machines, while George Gilks made necessary modifications to enable the word processors to communicate with each other. Secretaries are being trained by George Gilks and he will also give them technical advice during the trial period. It is now possible for secretarial staff to share workloads, store and receive data from the Computing Centre and have easy access to specialized output equipment such as the typesetter. Report from various sources can be assembled by transferring partial texts to one source for final formatting.

Yvonne Rawlingson, Electronics branch secretary, who represents the secretaries involved in the test, has been using the existing system for the past year. According to her, it has been a major time-saver for both secretarial and professional staff.

In the past, monthly highlights for progress reports were typed on different word processors. Because of machine incompatibility, it meant a major retyping job for the branch secretaries and more proofreading for the branch heads. That problem is now history. Now, each secretary transfers her part of the report to Rawlingson's machine and within minutes it's assembled and ready to go. After the trial period the pilot text transfer system will be disassembled. The task force will then make long-term proposals to improve CRNL's interbranch and off-site data communications.

CONSISTENCY METER MEASURES SUSPENSIONS WITH DIODES

From Sweden comes news of a consistency meter which uses light-emitting diodes to transmit infrared pulses for measuring the concentration of particles in suspensions in process industries and water treatment and sewage plants. The developer of the device, Cerlic Controls AB, of Solna, Sweden, has named the instrument the ACM and they state that it can be easily calibrated to measure consistencies from 0.005 percent to 4 percent with extreme accuracy and sensitivity.

It is able to operate for long periods of time with zero due to the absence of mechanical parts and its self-cleaning design. It is claimed that it is unaffected by changes in temperature, velocity and viscosity and because of its versatility, paper mills will be able to build control systems around

screens, cleaners and fourdriniers. Said to be highly efficient, yet simple and inexpensive, the ACM consists of a transmitter and a signal processing unit joined by a 10-metre cable. The transmitter, which weighs only 3.5 kilograms, detects particles by means of infrared light generated by diodes. The display on the signal processing unit presents a percentage value that corresponds to the measured consistency. The equipment can measure white water consistency as well as suspended solids in liquors and waste water.

The ACM is said to supercede virtually all other types of consistency meters, both mechanical and optical, within the 4 percent range. The self-cleaning design diminished clogging, even pitch-clogging, giving months of uninterrupted operation under severe working conditions, according to Cerlic.

— David Dempster

Continued on page 13

MARKET PLACE

KITSTRONIC INTERNATIONAL LTD.

4051 Sheppard Ave., E, Agincourt, Ont., M1S 1S8

Your source for Japanese and American Components and Computers N.E.C., Fujitsu, Hitachi, Oki, Asuka

- XT/AT Keyboards and peripherals
- 4164, 41256
- 2716, 2732, 2764, 27128, 27256
- 8087, 80287
- V20, V30
- Panasonic and Fujitsu disk drives
- Newtech XT/AT systems

- Legal bios with 30% faster format time

Call Now **416-298-3280**

FAX: **416-298-2093**

Stock Available for Prompt Delivery

STATIC RAMS

WITH THIS COUPON

**μPD4364
8,192 x 8-BIT
STATIC MIX-MOS RAM**

4⁹⁵ each.

MINIMUM ORDER
2 PCS.



150ns

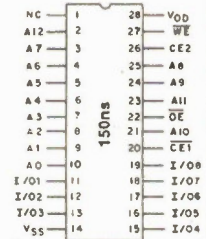

Send cheque or money order plus \$2.00 for postage/handling. Que residents add PST.



HOBBIT



7454 LANGELIER ST-LEONARD QUE. H1S 3B7
(514) 259-5581.

RAM-X Electronics Introduces the 8K RAM Memory Modules



\$49.95 ea. cdn.
Easy to install
3 step instructions

MODEL-100 Users

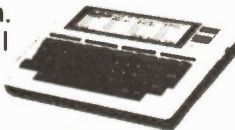

For your
Radio Shack
Model-100
computer

SAVE \$300 when you fully upgrade to 32K bytes. WE HAVE 1000's IN STOCK! We can ship anywhere in Canada FREE! Send cheque or money order for \$49.95 per module to:

RAM-X Electronics

33 Centre Street
Orangeville, Ont.
L9W 2X3

Dealer inquiries invited, or call 1-519-941-1610

*TRS-80 MODEL-100 is a trademark of the division of Radio Shack Tandy Corp.

★ ★ ★
★ ★ ★

FREE

3½ Digit Multimeter
- \$100.00 Value -
with every oscilloscope
Offer good to August 31, 1986

Attach this coupon with your order



DUNCAN INSTRUMENTS CANADA LTD.

121 Milvan Drive
Toronto, Ontario M9L 1Z8

Telephone: (416) 742-4448

Toll Free: 1-800-387-7418

★ ★ ★
★ ★ ★

**WHY PAY MORE?... to support the middle man
WHY NOT PAY LESS?... buy direct from the importer... WE CAN OFFER...**

System I

- Choice of Colour or Monochrome Display Card
- 640K
- 8088 Main Board with 8 Slots
- 512K Ram on Board
- 360K Half Height Floppy Disc Drive with Controller Card
- 135 Watt Power Supply with Side Switch
- Cabinet that can House 4 Half Drives

for only **\$899.00**

System II

- As System I but with...
- Full 640K Ram on Board
- Two 360K Half Height Floppy Disc Drives
- System Clock with Battery Back Up
- Two RS-232 Serial Ports
- Parallel Printer Port
- Game Port

for only **\$1199.00**

All our systems carry a full warranty of 300 days. We have many configurations, parts and peripherals to offer you. Why not send for our free brochure..... **We promise to look after you.**

Mail Order Certified cheques or money order only — No cash please. Add \$15.00 for shipping and handling. Quebec residents please add 9% PST. FST included in prices. All prices are subject to change without notice.

LASCO Montreal Inc. established importers of electronics since 1976
785 Plymouth, T.M.R., Quebec, Canada. H4P 1B3 (514) 341-4222

Laminated RF Shielding

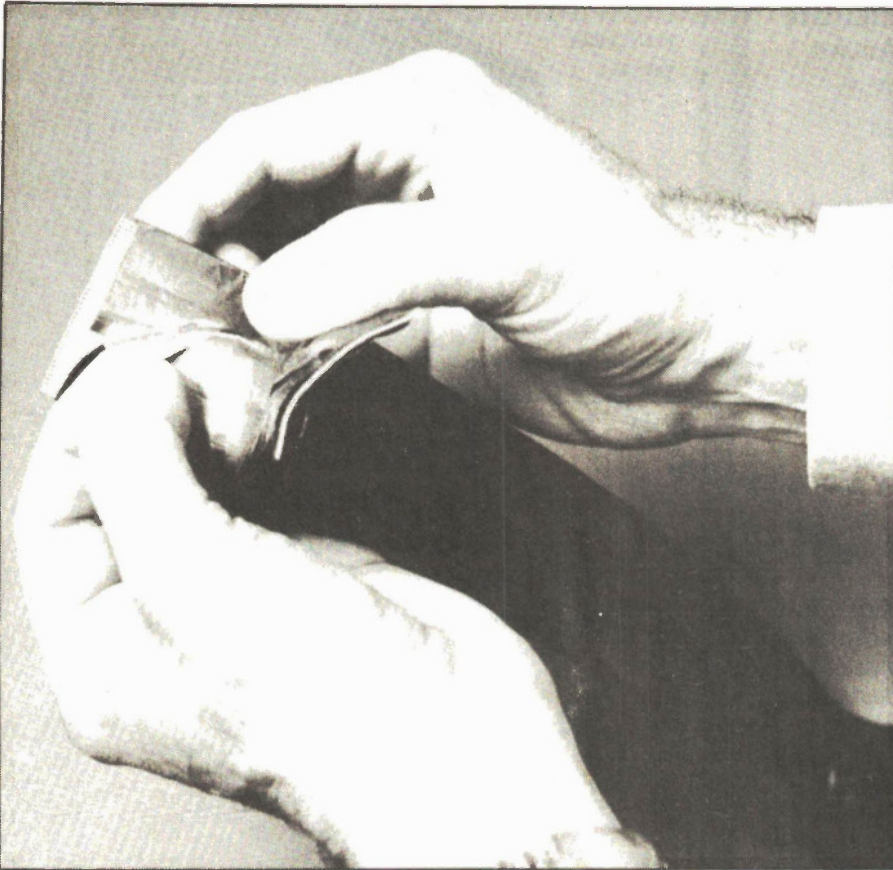

*By Wayne Morrow, Laminates Division
Keene Corporation, Providence, RI.*

IT'S no secret that more and more OEM electronic products need more and better EMI/RFI shielding. And in more and more cases, the material of choice is composite EMI/RFI shielding. That's the foil-coated sheet-type material which is most often applied like wallpaper or contact paper to create the barrier.

The question then becomes: which composite shielding? The decision can get complicated, since there are literally hundreds of choices within the generic category of composite shielding. However, the right choice can make a big difference in the device you're designing. It affects electronic performance, weight and space, FCC compliance and overall serviceability. Also affected are material and manufacturing costs.

This article will discuss the options available, and offer some guidelines for

narrowing down the selection. It also will discuss some of the myths that have arisen about EMI/RFI shielding.

Why Composite?

First, however, why shield in the first place, and why go with composite shielding rather than metal sprays or conductive plastics? The answer to the first part isn't as obvious as it sounds. There are always the very obvious FCC type 15 emission regulations to contend with. Less obvious, though, is the performance reliability of your product. Susceptibility of your device to incoming interference could be a bigger problem than emissions, so the design should be looked at from both the emission and susceptibility standpoints. In fact, there is some talk about regulations for susceptibility as well as emissions.

Why composites rather than metal sprays? They are cleaner to apply than metal sprays, so they pose no OSHA or EPA issues. And they don't impair structural integrity of the enclosure, as do some conductive plastics or additives. Moreover, there is greater assurance against voids in the barrier due to incomplete spray coverage or resin mixing. However, composites usually require an extra, essentially manual, production step.

A VCR Rescue

Recently, a major VCR manufacturer found that composite EMI can also serve a 'rescue' function. Some 8,000 of its ready-to-ship units were emitting out-of-compliance EMI levels.

The original zinc spray-on shielding inside the enclosure wasn't containing the emissions well enough, so the company was faced with finding a 'fix'. There wasn't enough internal clearance to accommodate overspraying the original coating with another 5 mil of zinc. Also, masking for an after-the-fact spray operation would have been prohibitively expensive. In addition, there was no certainty that more of the same would solve the problem. The VCR manufacturer came to Keene to explore whether some type of composite shielding might work.

At first, they considered a two-part system. First, apply a polyester film, coated on both sides with adhesive. Next, apply copper foil to the film surface.

A one-step, 2-mil foil/adhesive construction was tried, using much less expensive aluminum foil instead of copper. The VCR manufacturer die-cut the shielding to fit the cabinet walls, including all holes and wiring lead entries. This was done on the same dies that trim the original plastic enclosure, and allowed the manufacturer to retrofit the cabinets very inexpensively. Thus, about \$1,600,000 worth of 'bad' product was salvaged.

Composite Shielding Choices

There are four basic types, or constructions, of composite EMI shielding. Each can usually be supplied with or without pressure-sensitive adhesive backings:

- adhesive coated foils, usually in copper or aluminum
- foil/film laminates, with or without adhesive
- foil/paper laminates, with or without adhesive
- specialty composites

The specialty composites include:

- foils with special adhesives that are fire retardant, or conductive to provide grounding paths.
- margin laminates, where the foil shield doesn't completely cover the backing

areas. Margin laminates are available with center laminate (two edges free of foil), butt laminate (one edge free of foil) and ship-lap laminate for shielding cylindrical shapes.

Silver, copper, aluminum, zinc, nickel and steel are used as the conductive material. Most requirements, however, are filled by either copper or aluminum.

Performance Characteristics

Since EMI shielding is largely a matter of surface reflection from the conductive foil, theoretically the foil can be as thin as desired; i.e., a consistent, uninterrupted layer one atom thick would fulfill the electronic function.

However, mechanical conditions relative to handling, forming, die-cutting, stress and abrasion resistance usually determine the backing material and total thickness. The backing, for example, electrical grade kraft paper, can be selected to add the necessary thickness, shape retention and other mechanical properties specified.

Environmental factors also influence the choice of backing. For example, polyethylene film backing has good chemical and humidity resistance while electrical grade kraft paper retains its shape after folding, and has some handling 'heft' to it. But where service temperatures exceed 90C, aramid fiber, which withstands temperatures up to 220C, might be the better backing choice.

Aluminum or Copper?

The widespread concern about EMI is relatively new, but EMI shielding already has its myths. The most pernicious one is that copper shielding is always preferable to aluminum. Not so! If you believe copper is 'the only way', you are likely to pass up some good savings in product cost and weight. The fact is, aluminum is perfectly adequate for the vast majority of applications, and costs about two-thirds less than copper. It's also much lighter.

Where the relative costs of the composites are ranked, 0.003-in. thick copper with pressure sensitive adhesive coating is the most expensive, the least expensive being 0.002-in. thick aluminum with pressure sensitive adhesive coating. The striking weight difference between the two materials becomes especially important in avionics.

For instance, 0.003-in. copper shielding (one ounce rolled, annealed copper foil with 0.001-in. adhesive) yields 1.56 sq. yd. per lb. By contrast, the aluminum composite (0.001-in. aluminum foil with 0.001-in. adhesive) yields 5.125 sq. yd. per lb., four times more. One of the lighter-weight aluminum composites (0.00035-in. aluminum foil with 0.0005-in. polyester film for a total thickness of only 0.001-in.)

yields 9.637 sq. yd. per lb.

Despite the weight and cost advantages, aluminum-based composite shielding more than fulfills FCC regulation 15J, Class A and Class B.

Aluminum

As indicated in the curves, RF attenuating copper foil is superior to aluminum at lower frequencies, but the gap diminishes at higher frequencies. Moreover, both metals well exceed FCC code requirements (as well as NEMA 101 requirements). In fact, a product may well be over-engineered when copper shielding is specified.

Exception: one situation favoring copper over aluminum is the requirement to solder something to the conductive surface, such as a ground wire.

Copper

Sometimes, copper's superiority may also be important in near-field situations. To understand why, it's important to see how shielding works fundamentally.

Attenuation of radiated interference waves by conductive barrier has three components. The first is reflection by the outer surface of the shielding metal, by far the largest. Next is absorption within the metal layer and, lastly, is re-reflection by the inner surface of the metal. The closer and more powerful the source, the greater the influence of the absorption and re-reflected components.

By nature, copper has proportionately better absorption and re-reflection properties than aluminum. So, where the emitter is powerful and near-field, copper foil does have a slight edge.

Volume Production

With regard to costs, the greater the volume of shielding material required, the more it pays to find the least expensive shielding material that fills requirements. Approach the question with awareness that the entire area of shielding materials is in a state of change. The best solution a year ago may not be the best today.

If the final decision is to specify composite laminate, ascertain that the supplier you contact for advice offers all four basic types of composites. This should include the specialty margin laminates. That way, application engineers at the supplier can be totally objective.

Consider the Source

Before specifying EMI shielding, or even making an inquiry of a supplier, be sure you know these electronic parameters specifically:

- the nature of the interference: the strength, frequency, and relative proportions of electric fields and magnetic fields (impedance);

the proximity of the emitter to the shielding (near field vs far field).

For instance, if the interference is a combination of electronic and magnetic emissions, both electrical conductivity and magnetic permeability of the shielding must be considered. Of the six commonly used shielding metals, only nickel and 1045 steel have appreciably poorer magnetic permeability.

Tailor the Need

Another factor to consider is the required mechanical strength and rigidity to withstand fabrication and end-use service. If the shielding is to be applied like wallpaper, characteristics of the adhesive rather than the strength or rigidity of the backing material may be the chief concern. However, often the shielding will be constructed into a self-supporting mini enclosure. In that case, formability and amenability to assembly or die-cutting may be paramount. If MIL specs are entailed, the application engineer will apply a different set of criteria. Fire resistance requirements also call for a custom approach to selecting adhesives and backing laminates or coatings. The supplier must, of course, be fully informed on all aspects of the shielding problem to help the design engineer find the best solution. ■

DID YOU RECEIVE YOUR COPY?

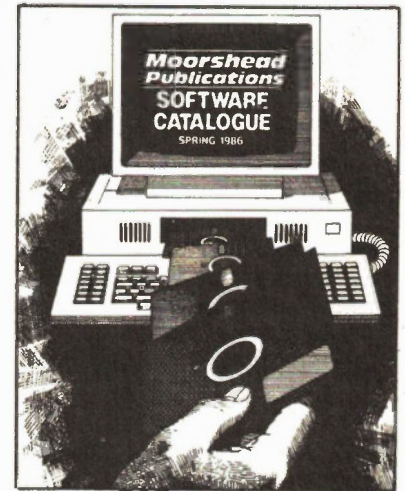

This catalogue is a comprehensive description of our Almost Free Software Volumes I through VII.

If you would like a copy of this catalogue, please circle the Reader Service Card Number or mail your request to:

**Moorshead Publications
Software Services**
1300 Don Mills Road
Toronto, Ontario
M3B 3M8

Stepper Motor Controller

By S.A. Baker

THIS CIRCUIT is designed for use with any computer with an eight line TTL compatible output port, e.g. VIC20, or Commodore 64. It is ideal for controlling a turtle as it operates two stepper motors.

Some recommended dimensions for this turtle are 61.1mm diameter wheels and 229mm between the wheels. These dimensions mean that with both motors running in the same direction, the turtle will move 2mm forwards/step. (The motor's step is 7.5 degrees). If the motors are stepped in opposite directions, the turtle will turn through 1 degree/step.

To make motor ME 1 step forwards, the output port should be poked with 255-(1,5,4,6,2,10,8,9). To make the other motor step forwards, the port should be poked with 255-16(1,5,4,6,2,10,8,9).

The 255- compensates for the inverters

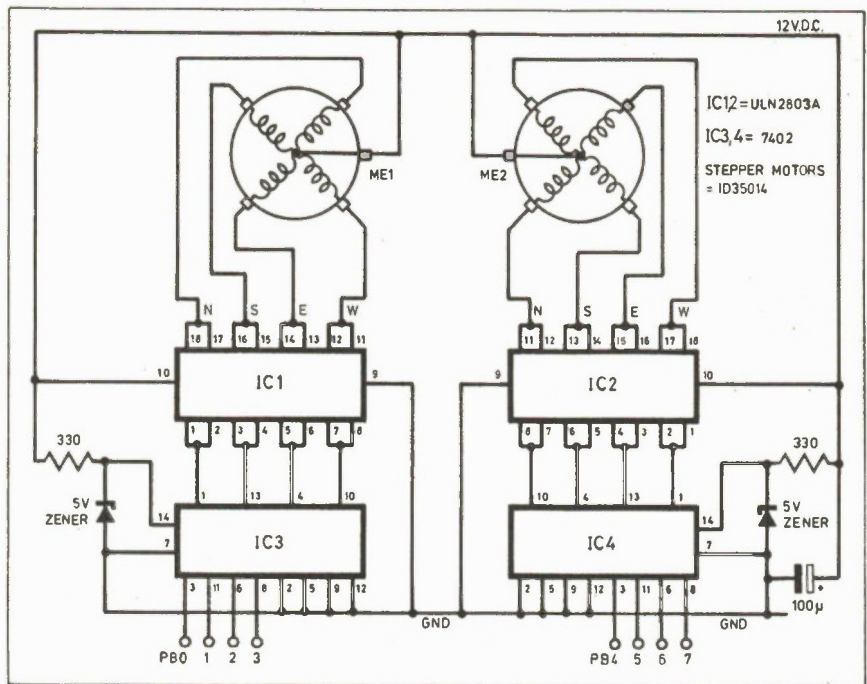

in the circuit. The inverters are NOR gates with one input grounded. They are present to ensure that the ULN 2803A, which is a Darlington amplifier, receives 5V

whatever the inverter's input voltage.

The power supply must be 10-15V and capable of supplying 2A.

Electronics Today

Offers advertisers the opportunity to increase their sales and profits in the electronic field. Over \$200 million is spent annually for both electronics and micro-computer products by Electronics Today readers.

Each year Electronics Today delivers thousands of sales leads processed through our Reader Service Card Program. These sales leads are qualified with name, address and title of respondent.

For advertising information call
(416) 445-5600

Simple Pushbutton Codelock

By David Cox

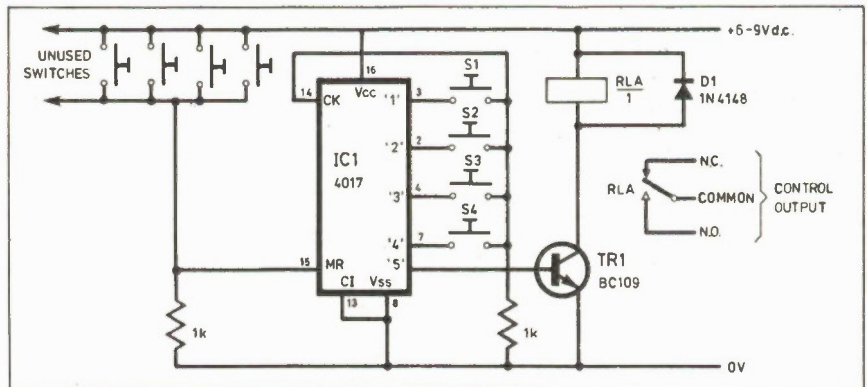

THE CIRCUIT below operates around just one chip, a 4017 counter. When power is first supplied, the first output of IC1 goes high.

If the first coded switch S1 is pressed, the counter would be allowed to clock on one count. If any other switch is pressed, nothing would happen. Now that the IC's second output is high, the second button may be pressed, allowing the counter to clock one again.

Now if one of the unused switches is pressed, the counter will be reset. This goes on until the counter reaches the fifth

output. At this point, the output is carried to the base of Q1, allowing the relay to operate. The resistance of the relay coil should be greater than 100 ohms in order to avoid damage to the transistor.

Up to nine switches may be used in the code, and if more than the four shown here are required, simply connect the extra switches between the next output and the clock input pin. The base of Q1 should be connected to the output after the last switch. Any extra 'unused' switches should be wired in parallel with those already shown.

Water-Soluble Solder Mask

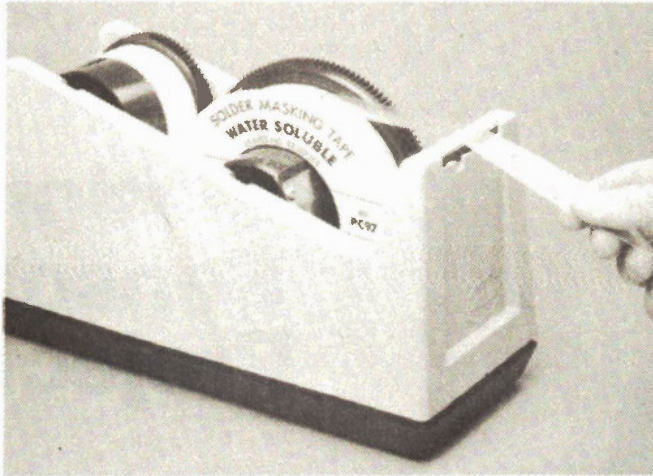

For all you electronic environmentalists out there searching for a biodegradable, water-soluble solder mask, rest easy. Ersin Multicore Canada has introduced its PC97 tape.

Both the tape and its adhesive are completely removed using plain hot water or water containing saponifiers. It can also be removed simultaneously with flux residues in aqueous in-line or batch cleaning systems.

Available as a tape or preformed dots in various sizes, PC97 is static free, has a shelf life of over one year, and requires no set-up or

drying time. The tape is furnished in 60 yard (54 meter) rolls, and comes in a variety of widths. The dots are available in blue and packaged in rolls of 10,000, with standard diameters of .7, 5/8, 1/2, 3/8, 5/16, and 1/4 inches.

For more information (and to find out the meaning of saponifiers) contact: Robert Gauthier, Ersin Multicore Canada Inc., 3525 Robert Chevalier, P.A.T., Montreal, Quebec H1A 3R7 (514) 642-4095 or (416) 278-7323.

Circle No. 54 on Reader Service Card.

Rogers Cable TV has a new service for subscribers who own personal computers. Called XPress, it is a 24-hour-a-day information service featuring news, business, finance, weather, sports and entertainment data from more than 30 international sources, such as AP, CP, SportsTicker, etc. The service will initially be offered in Toronto, Brampton and Mississauga.

The one-way service originates in Boulder, Colorado and is sent by satellite to cable companies. The subscriber only needs an IBM-PC or compatible, an Apple IIc or IIe or a Commodore 64 or 128. No modem is required. The service costs \$24.95 per month with a one-time hookup fee of \$59.95 for IBMs and Apples, \$69.95 for Commodores.

Zentronics is now carrying a new line of STD BUS power supplies from Power-One. The initial selection is three standard models designed to the popular STD specs. They're available in rackmount, stand-alone and surface-mount, all in three levels of power with single or triple outputs. For more information, contact Zentronics, 8 Tilbury Court, Brampton, Ontario L6T 3T4, (416) 451-9600.

Circle No. 56 on Reader Service Card.

A patented new technology for producing a colour cathode ray tube with a perfectly flat faceplate was announced by the Zenith Electronics Corporation in Illinois. The "flat tension mask" (FTM) offers reflection-free viewing, high resolution, and up to 70 percent increased contrast ratio compared to conventional displays. The first model will be a 14-inch monitor for computers, with deliveries beginning in 1987.

The Ontario Government plans to create a Premier's Council to "steer Ontario into the forefront of economic leadership and technological innovation". The 20-member council will establish broad priorities, encourage the most effective investment in basic research, and maximize the effectiveness of the government's investment in technology centres. The council will oversee a \$1 billion, ten-year technology fund, half of which is new funding.

If you're into robots, the Robotic Society of America is soliciting new members. For \$15 (US) for individuals or \$25 (US) for companies, you get a membership in a group that appeals to professionals and hobbyists alike, dealing with robots that work on their own or in conjunction with computers. As an incentive, new members will receive a copy of the Robotic Sourcebook, a description of commercially available robots and sources of books, kits, industrial robots, etc. They're at PO Box 54 H, Scarsdale NY 10583.

GMFCanada Limited has opened a new headquarters in Mississauga, Ontario, for the marketing of industrial robots. The 18,000 square-foot facility houses all of the marketing operations, training, demonstration areas and a systems assembly area. GMF is the largest robotics company in the world, manufacturing industrial equipment and machine-vision systems.

Control Data has installed \$23 million worth of made-in-Canada Cyber 180 computers at California State University, bringing the total number of Control Data systems at CSU to 36, of which about 60 percent are Canadian-made or designed.

The press release then goes on to say that the computers "serve more than 325,000 students and thousands of faculty members and administrators." Fawly Ivory Towers?

We regret that the Multi-Use Printed Circuit Board, Part II, scheduled for this month was delayed due to production difficulties. We'll have the second part for you as soon as possible.

Also, our regular feature, Designer's Notebook, will resume next month.

Sound Level Meter

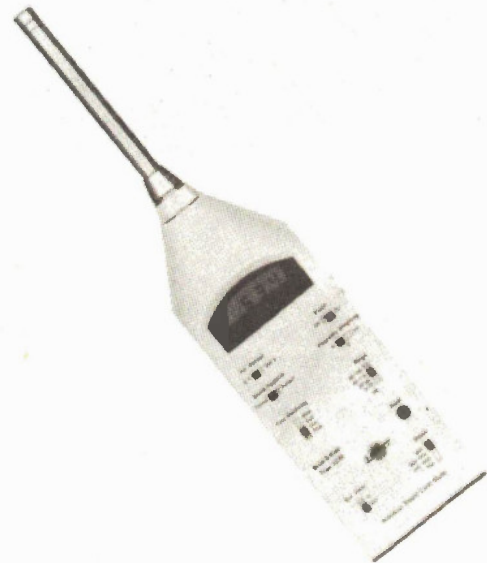

The Bruel and Kjaer Type 2235 sound level meter is suitable for a wide range of applications including: building acoustics, audiometer calibration, and frequency analysis.

The hand-held portable device has a wide range and is capable of measuring sound level pressures from 24 dB to 130 dB; this can be further extended to 150 dB with the addition of a 20 dB attenuator (Type ZF 0020). It is also capable of measuring maximum or instantaneous sound pressure level with automatic or manual reset in accordance with IEC standards. Measurements are displayed with 0.1 dB resolution on a digital

display indicating both overload (measurement is suppressed) and battery conditions. AC and DC outputs are provided for chart or tape recordings and audio monitoring of measurements. Optional filter sets can be added, providing 1/3 or 1/1-octave frequency analysis of sound pressure, and with an external optional microphone the unit becomes ideal for audiometer calibration.

Windeyer Associates, Andy McKee, 3460 Simpson Street, Suite 306, Montreal, Quebec H3G 2J4. (514) 695-8225.

Circle No. 55 on Reader Service Card.



Rotation Sensor Project

An electronic tachometer for checking the speed of rotating shafts.

By Mike Feather

TECHNIQUES for measuring the shaft speed of, for example, an electric motor have traditionally relied upon the use of some form of mechanical tachometer, in which the speed is displayed directly on an analog scale.

These devices provide a useful check on the speed of large motors, but the speed of smaller motors is likely to be considerably reduced if tachometers are coupled up to them.

Other methods employ a small DC generator coupled directly to the motor shaft. The output of the generator can be made to vary directly with the motor speed and a voltmeter may be used to provide an indication of this. Once again, the arrangement is really only suitable for use with large motors.

Electronic Methods

Most electronic methods employ some form of arrangement in which a sensor of one type or another picks up the shaft speed without the necessity for any mechanical coupling to it.

Such sensors include magnetic, slot optical and photo-reflective types and these are described later in this article.

Each of these sensors provides a pulsed output, the pulse frequency being proportional to the shaft speed, so that the task of speed measurement becomes one of determining the frequency of the sensor output pulses. Frequency meters, both analog and digital, are available, but they tend to be rather expensive instruments and this month's practical project describes the theory and construction of a frequency meter/tachometer unit based on the inexpensive 2917 tachometer IC.

The completed unit provides a calibrated analog output voltage which varies directly with the frequency of the input signal. For shaft speed measurement, any of the sensors described may be used.

The 2917 Tachometer Chip

The 8-pin tachometer DIP IC is a frequency-to-voltage (F/V) converter. It employs a charge pump technique in which the input frequency produces a directly proportional DC output voltage. The pinout and internal circuitry of the chip are shown in Fig. 1 and Table 1.

The first stage consists of a differential amplifier, one input of which is grounded

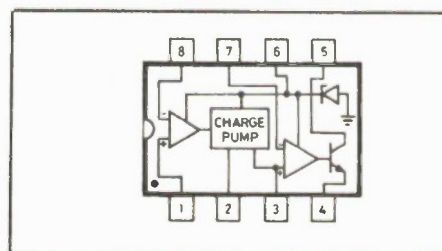

Fig. 1. Internal circuitry of the 2917 tachometer IC.

Pin	Function
1	Frequency input
2	Timing capacitor
3	Filter capacitor/resistor
4	Output transistor emitter
5	Output transistor collector
6	V _{cc}
7	Bias current
8	Ground

Table 1: Pinout details of the 2917 IC.

while the other serves as the signal input. The signal voltage required for correct operation is typically 250mV peak, but the

input is protected for voltage swings of up to 28V.

If the frequency of higher voltages is to be determined, e.g., the contact breaker pulses of a car engine, then some form of potential divider network must be used.

The next stage comprises the charge pump circuitry. An external capacitor and resistor determine the DC output voltage for a given pulse input frequency. The output of the charge pump is applied to an operational amplifier which can be used in the op amp or comparator mode, so allowing either proportional or speed-switched outputs.

The final stage consists of a floating NPN transistor which can be used to drive a variety of loads, the maximum sinking current being approximately 50mA.

The chip includes an internal zener diode which, with the addition of an external dropping resistor, allows operation from unregulated power supplies.

As mentioned, three basic speed sensing arrangements are employed with the tachometer unit: magnetic, optical switch, and photo-reflective sensors.

Magnetic Sensors

The arrangement of the magnetic sensor type of pick-up is shown in Fig. 2. Rotating of the toothed ferrous wheel (e.g., a gear wheel) adjacent to the pole of the pick-up develops an alternating voltage at the output terminals of the device. The frequency of this AC output is proportional to the speed of rotation of the wheel. The clearance between wheel teeth and pick-up pole should not be greater than 2.5mm for correct operation of the sensor.

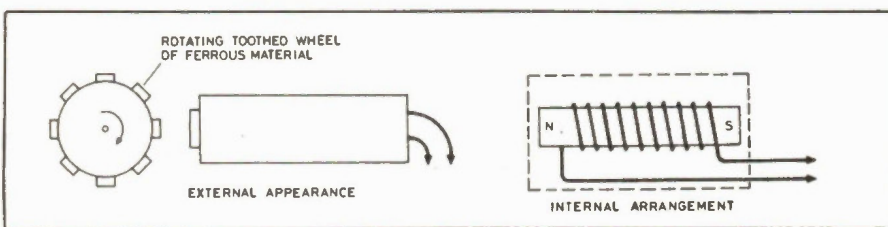

Fig. 2 Magnetic pick-up used for speed sensing.

Slotted Optical Switch Sensor

A typical slotted opto-switch is shown in Fig. 3. The device consists of an infrared LED and a phototransistor sensor mounted in a slotted plastic housing.

A rotating opaque disc with holes or slots around its circumference may be situated in the slot and the phototransistor can be used to provide a pulsed output voltage, the frequency of which varies directly with the speed of the disk. Fig. 5 shows the circuitry used with this type of sensor.

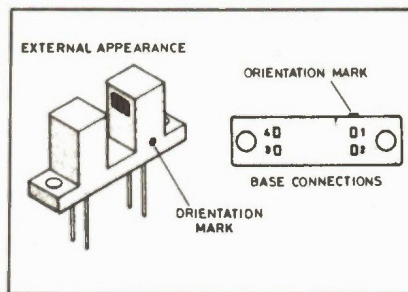

Fig. 3. Details of the slotted optical switch sensor.

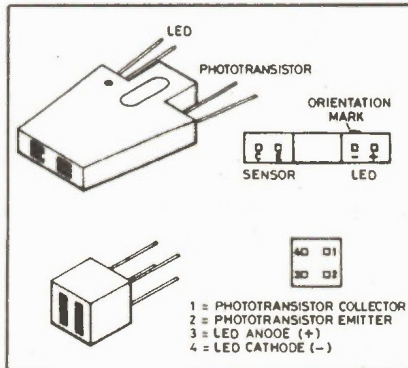

Fig. 4. The diffuse scan photo-reflective sensor: top, the large type is shown and, above, the miniature version.

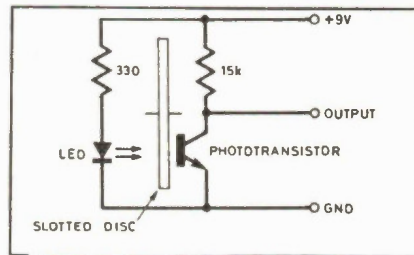

Fig. 5. Basic circuit for opto-switches.

Infra-Red

Photo-reflective sensors also use an infra-red LED/phototransistor combination, but the phototransistor responds to reflected radiation from objects placed close to the device. Two types are commonly available and these are shown in 4.

For shaft- or wheel-speed sensing applications, a small piece of bright aluminum foil makes a suitable reflecting surface. The optimum sensor/reflector distance is approximately 5mm for the larger device and 1.2mm for the miniature

Subscribe now to Computing Now!

Computing Now! is from the publishers of Computers in Education and Electronics Today and offers full coverage of what's happening in Canadian microcomputing. Get the most out of your micro with:



Listings!

From the ZX81 to CP/M to MS-DOS; programs for business use or just for fun.

Reviews!

The newest computers, the latest peripherals. Software, book reviews, and interesting gadgetry.

Programming!

Articles and discussions on how to solve those programming bottlenecks.

Systems!

If you're looking for a business system, you'll find Information that lets you find the most efficient, most economical equipment for your needs.

Subscribe now:

\$14.95 for one year (12 issues) or \$27.95 for two years (24 issues).

(Time Limited Offer)

Computing Now!

1300 Don Mills Road,
Don Mills,
Toronto, Ontario
M3B 3M8
Telephone (416) 445-5600

version.

The associated LED/phototransistor circuit arrangement is the same as that used for the slotted opto-switch sensor shown in Fig. 5.

The Frequency/Tachometer Transducer Unit

The circuit of the main unit is shown in Fig. 6. The design provides two ranges of speed and frequency measurement: 0-500Hz and 0-5000Hz. For direct measurement of the frequency of pulse trains or alternating voltages, no transducers are required and the unit may be used as it stands. A 5V DC voltmeter is used for indicating the frequency.

The signal from the sensor is applied to the input of the 2917 IC via C2. A 5-pin DIN socket is used for the input connector. The frequency range is selected by S1 which switches the appropriate capacitor into the charge pump circuitry. R1 determines the charge pump output voltage and a 100k resistor is used in this application.

The op amp/comparator is used in the linear mode and the output voltage from the device is taken between pin 4 (the transistor emitter) and ground. VR1 is a potential divider circuit which allows variation of the output voltage for calibration purposes. R2 is the dropping resistor for the Zener diode circuitry. The LED and its series resistor provide a visual "on" indication for the unit.

Note the connection from the +9V supply line to the input DIN plug. This is used for providing a supply for opto-probes. The current drain of the circuit is small and a 9V battery will allow long periods of continuous operation.

Construction

Construction of the circuit is very straightforward. The PCB design and component overlay diagrams are shown in Fig. 7, although the circuit could be constructed on a small piece of Veroboard.

Connection pins should be inserted and soldered into the PCB at the points shown. Other components can now be inserted and soldered on to the board.

The front panel of the case should now be drilled and its components mounted as indicated in the photograph. Connections between the front panel and the p.c.b. pins can now be made using 7/0.2mm insulated wire. Care should be taken to ensure that the connections to the panel LED are the right way around. The battery connector is soldered to the on/off switch, again noting carefully the polarity. Finally, the 2917 IC is inserted into its socket in the correct orientation.

If an optoelectronic sensor is to be used in combination with the unit, this should now be constructed. Fig. 8 shows a pro-

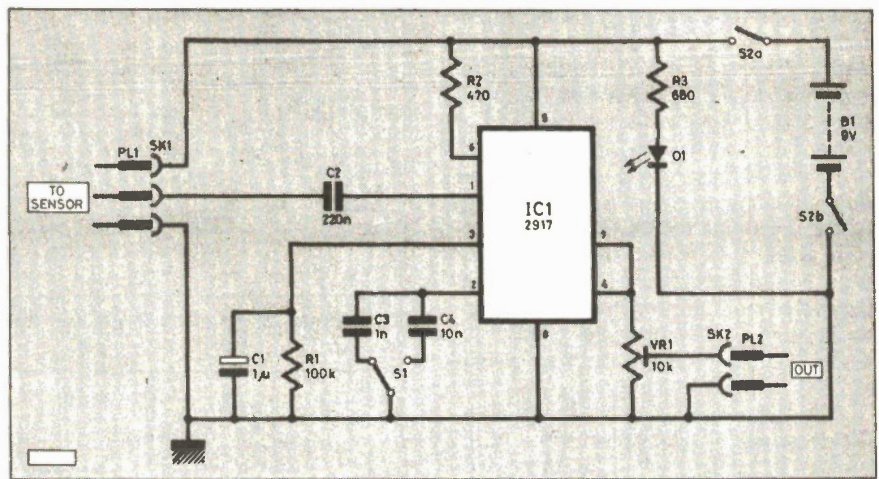

Fig. 6. Circuit diagram for the frequency measurement/tachometer unit.

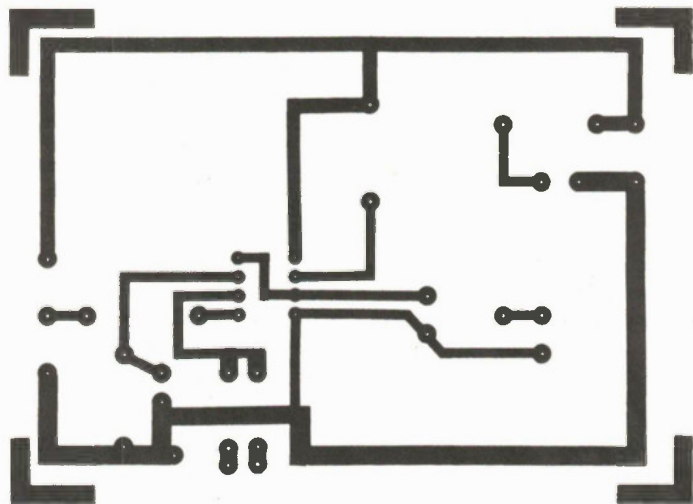
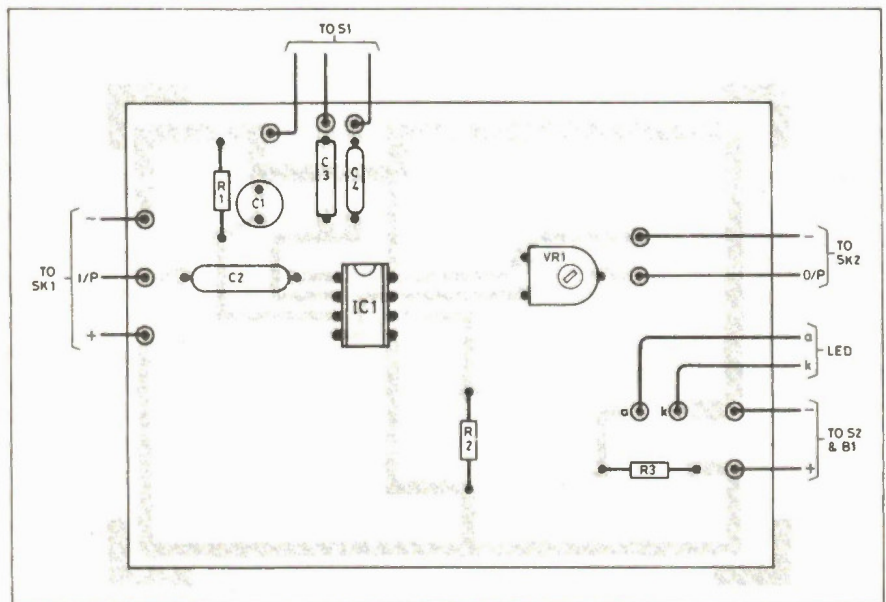

Fig. 7. the component overlay for the frequency measurement/tachometer unit and the PCB.

Continued on page 48

ANNOUNCING

Computers in EDUCATION 86

Hands-on Show and Conference

**Arts Crafts Hobbies Building
Exhibition Place, Toronto
October 23rd, 24th, and 25th, 1986
Thursday and Friday 10:00 - 9:00
Saturday 10:00 - 5:00**

- A professional show for Canadian educators emphasising personal hands-on evaluation of educational software.
- A huge number of programs covering the entire educational spectrum will be available for private examination in the Computer Lab Facility.
- Computer Lab Facility will comprise over 100 educational microcomputers for unpressured personal testing of either the software or hardware.
- Demonstrations of the latest educational hardware.
- Wide range of classroom-orientated peripherals on show.
- Full programme of educational computing seminars.

For Exhibitor Information contact:

Arthur Nagels

**1300 Don Mills Road, Don Mills, Ontario, M3B 3M8
(416) 445-5600**

Almost Free PC Software

Volume IX

The premise that good software ought to be cheap isn't one that the microcomputer industry as a whole seems to embrace, what with most programs costing several hundreds of dollars... and usually being copy protected, infested with bugs or poorly documented when you finally do get them. We think that cheap software is almost as fundamental as clean water and classic Coke.

This ninth volume of our popular almost free PC software represents another superb collection of programs for the IBM PC and compatible systems. Whether you're into games, business, hacking or just being in the same room as a microcomputer, this disk will enhance the usefulness of your PC at a cost that won't even dent your wallet, let alone blow it out of the sky as most applications packages can.

Small C If you've ever wanted to try writing programs in the C language, this compiler will fascinate you. It's a restricted implementation of C, producing code which is compatible with Microsoft's MASM and LINK programs... you'll need these to get it going.

Map is an interesting little utility which will check how DOS is situated in the memory of your computer and tell you a number of things about it. It's a useful programming tool, especially helpful if you're debugging software which interacts directly with DOS.

Note is the source file for the memory resident note pad that we ran in the March 1986 edition of Computing Now!. It requires MASM and LINK to use. It will create a resident memo page that you can call up from within any application.

Pango is one of the wildest games we've come across for the PC. While its premise is a bit improbable, it's fast and weird and more fun than a stoned house cat.

PC-Spell is a pretty decent spelling checker written in BASIC. Despite its pedestrian sounding origins, it's fast, accurate and easy to use. It can be listed if you want to see how it works, and comes with a large dictionary file and a utility to assist you in customizing it.

Peacock is a memory resident program which allows you to change the colours of your screen with alternate function keys. It's useful, for example, if you run software which insists on changing the screen to something loathsome.

Recover is a utility to assist you in getting data back from damaged files. It lets you look at your files one sector at a time and put the pieces back together.

SDB is a small relational database. It isn't dBASE III, but it also doesn't cost quite as much. It's still pretty powerful and is eminently suitable for many business applications. It features on line help.

Tally is a program which accurately counts the number of characters, words and lines in a file... all within your lifetime.

Xeno edits the tracks and sectors of your disks in a user friendly format... or, at least, one that doesn't lunge for your throat every time you boot it. You can use it to explore DOS, fix trashed disks, unerase files and do all the other low level magic that sector editors are renowned for.

All of this profound software... plus its attendant documentation and support files... is available for a mere

\$19.95

plus seven percent Ontario disk tax
from

**Moorshead Publications
1300 Don Mills Road
Toronto, Ontario
M3B 3M8**

or you can order by phone and frustrate Canada Post. Call

1 (416) 445-5600

Have your Master Card, Visa or American Express card ready.

Fine Print: This software has been collected from public access bulletin boards and is believed to be in the public domain. We have checked this software carefully to insure that it functions as it should. However, we cannot assist you in adapting it to your specific applications.

Moorshead Publications warrants that these programs will be readable when you get them. However, magnetic fields, cosmic rays, truck tires or the bends may adversely affect your disk in transit. If it doesn't function properly when you receive it please contact us for a prompt replacement.

```

0000 43 50 43 20 20 20 20 - 45 50 45 20 00 00 00 00  CPC  EXE
0010 00 00 00 00 00 00 E5 79 - 00 00 02 00 00 99 00 00  ey
0020 44 49 43 54 49 4F 4E 41 - 20 20 20 20 00 00 00 00  DICTIONA
0030 00 00 00 00 00 00 E5 79 - 00 00 29 00 00 83 00 00  ey }
0040 40 41 50 20 20 20 20 20 - 43 4F 4D 20 00 00 00 00  MAP  COM
0050 00 00 00 00 00 00 E5 79 - 00 00 4A 00 00 27 00 00  ey J
0060 40 41 50 20 20 20 20 20 - 44 4F 43 20 00 00 00 00  MAP  DOC
0070 00 00 00 00 00 00 E5 79 - 00 00 54 00 00 05 00 00  ey T
0080 50 41 4E 47 4F 20 20 20 - 45 50 45 20 00 00 00 00  PANGO  EXE
0090 00 00 00 00 00 00 79 03 - 21 00 56 00 00 74 00 00  y ! V t
00A0 50 43 2D 53 50 45 4C 4C - 42 41 53 20 00 00 00 00  PC-SPELLBAS
00B0 00 00 00 00 00 00 E5 79 - 00 00 74 00 00 05 00 00  ey t
00C0 50 43 2D 53 50 45 4C 4C - 44 4F 43 20 00 00 00 00  PC-SPELLDOC
00D0 00 00 00 00 00 00 E5 79 - 00 00 76 00 00 0D 00 00  ey v
00E0 50 43 2D 53 50 45 4C 4C - 53 4F 52 20 00 00 00 00  PC-SPELLSOR
00F0 00 00 00 00 00 00 E5 79 - 00 00 7A 00 00 02 00 00  ey z
    
```

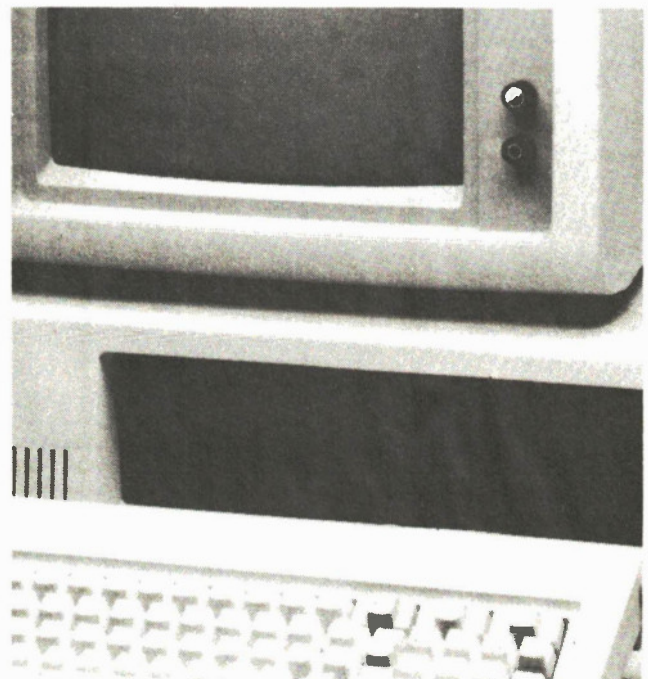
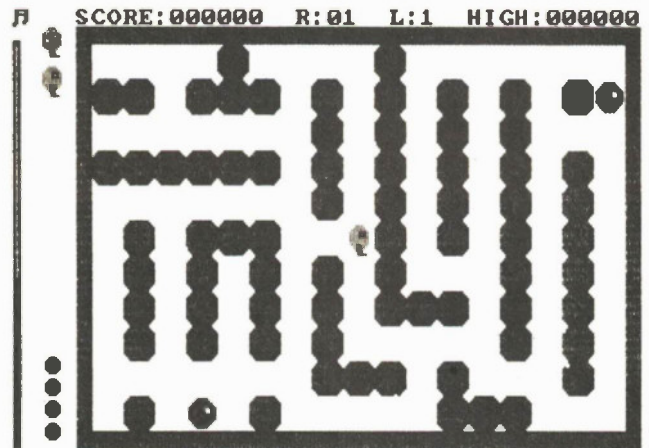

Almost Free PC Software

Volume X

In human terms, the number ten is rather magical. It's the number of digits we have, the number before which everything can be dealt with with one character and the legal drinking age on Baffin island. At least, this is what people say. In computer terms, ten is minor inconvenience, and nothing to get excited about. The real party starts at sixteen.

In a software sense, ten is rather special as it's the number we've assigned to a decidedly better than splendid collection of public domain programs for the IBM PC. This stuff is supremely special, as befits a number of such obvious significance. While the actual number of programs on this disk is rather smaller than in the past, the programs themselves are rather larger and more sophisticated. They'll blow the socks clear off your computer if you've left any on top of it, and make you forget about data base management, spreadsheets and all the other pedestrian nonsense that usually lives on disks.

It's software so good that anyone else would have copy protected it.

Monopoly is the first working implementation of the classic board game that we've come across... and we've had several that bombed pretty colourfully. This one is great, though, with fast and occasionally sarcastic play, a graphic board display and pretty good sound effects.

D20 is the latest version of Steve's sorted directory program. This one uses DOS two calls and handles subdirectories.

Edit is largely what it says, a public domain text editor. Once again, we've had to dig through quite a few efforts along these lines to find one that didn't crash and burn every time someone had the audacity to sneeze in the same room as it. This is a lightning fast full screen editor, ideal for editing program source files, dBASE stuff or other ASCII phenomena.

Banner takes mere text and prints it sideways on your printer... in gargantuan block letters that can be read from miles away if you have a good set of binoculars. It's not the sort of thing that you'd want to publish a book with, but it's a good trip for signs.

Mortgage is another utility to help you understand just what you've gotten yourself into. It's one of the nicest mortgage programs we've seen so far... lifelong debt and ruination has never been so well formatted.

Quick speeds up your PC quite a bit. It hooks into the video and makes it run a great deal faster, eliminating at least some of the glacial slowness that makes an IBM what it is.

Speech is a rather remarkable little germ of code. It talks through the PC's internal squeaker speaker. The voice quality isn't exactly human, but it's understandable on most machines. This is a really interesting bit of work, one that can be accessed from within other programs to create talking applications. It's great if the tube in your monitor burns out.

PC-AR is an accounts receivable package for the PC. While not the equal of some of the commercial software that handles this function, it will take care of the records for a small or medium sized business quite well.

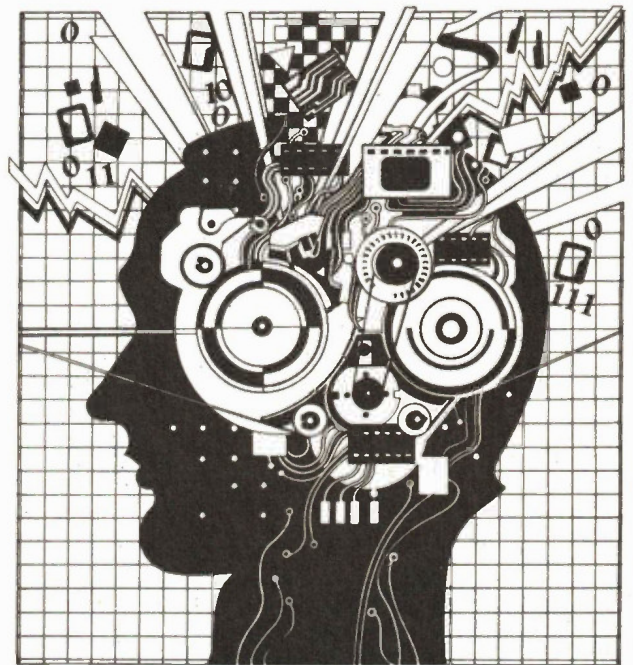

All of this profound software... plus its attendant documentation and support files... is available for a mere

\$19.95

plus seven percent Ontario oxide tax

from

Moorshead Publications
1300 Don Mills Road
Toronto, Ontario
M3B 3M8

or you can order by phone and help bankrupt Canada Post. Call

1(416) 445-5600

Have your Mastercard, Visa American Express card ready.

Fine Print: This software has been collected from public access bulletin boards and is believed to be in the public domain. We have checked this software carefully to insure that it functions as it should. However, we cannot assist you in adapting it to your specific applications.

Moorshead Publications warrant that these programs will be readable when you get them. However, alien carpet salesmen, lost X ray machines from Atlantis, bricks of no fixed address or disembodied dwarfs may adversely affect your disk in transit. If it doesn't function properly when you receive it please contact us for a prompt replacement.

Bit Pattern Detector

Hunting for bytes? This project lights up when it detects specific serial or parallel data.

By Neale Hancock

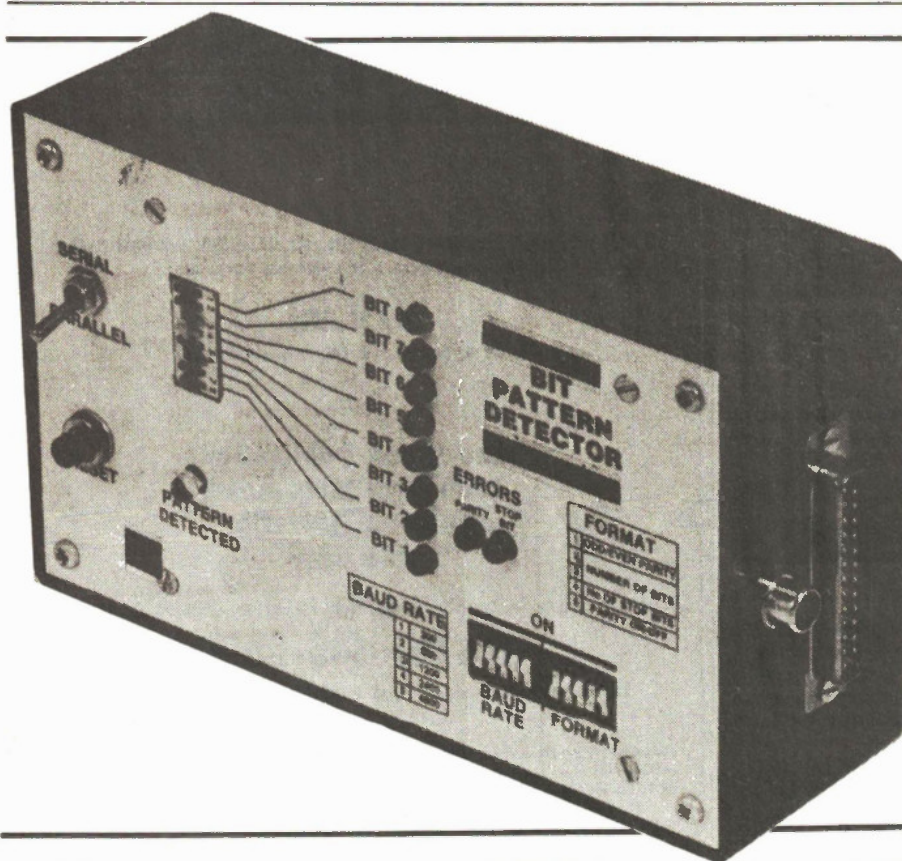

THIS project gives you a simple and economical way to detect and display specific bytes of data. It may be used on both parallel and serial data paths, or just on parallel data paths if you want to save yourself the cost of a UART.

Two methods used to indicate the presence of a specific data byte are possible, Method 1 and Method 2.

Method 1 is used to search a stream of data for a specific byte, then simultaneously illuminate an LED and send out a trigger pulse when the byte is detected. When this method is being used, the byte to be searched for is set on a bank of switches. Every byte which travels down the data path is compared with this byte and when the two are the same an LED illuminates.

Method 2 requires a single byte to be sent down the data path from a terminal or a bit pattern generator. The bit pattern is set up on the switches and detected in the same way as in Method 1; it is also displayed on the eight LEDs on the front panel.

When the bit pattern detector is used on serial data paths, either Method 1 or 2 can be used to detect bytes of data. Method 1 is best used to determine whether a specific byte has reached the desired destination, and is convenient when troubleshooting RS232 links. In this case one can determine whether or not a peripheral is responding correctly to the data being sent to it.

Method 2 is best used to check whether or not the serial link is transmitting data without errors. If there is an error in the transmitted data you can identify which bits are incorrect.

Parallel data paths are a common way of routing data around a PC board. Therefore the bit pattern detector is ideally suited to checking inputs and outputs on data and address buses (providing that they are no greater than 8 bits wide). In parallel mode, Method 1 is used to trigger an event when the byte set by the programming switches occurs. This is ideal for microprocessor circuits when you need to trigger an interrupt line. Method 2 is best used for checking data flow through a circuit.

Circuit Synopsis

The basis operation of the circuit is as follows. The incoming serial data is converted to TTL levels to enable it to be received in a form acceptable to the General Instruments AY-3-1015D universal asynchronous receiver-transmitter (or UART for short).

The UART primarily converts serial data into parallel data, it also removes start, stop and parity bits from the serial signal. The speed at which the UART runs is set by the baud rate generator.

The buffer is used to select between data from the UART or the parallel input, to be sent to the comparator. The comparator is used to compare the incoming data with the settings on the programming switches. When the incoming data is the same as the settings on the switches the 'pattern detected' LED is illuminated.

The buffered display shows the byte present on the data path on a row of LEDs. These LEDs are driven by non-inverting buffers to reduce loading.

Construction

If you only require the bit pattern detector to operate in parallel mode you can omit a number of components. These components are IC1, IC2, IC8, Q1, D1, R1, R2, R3, R4, C1, C2, C3, C8, C9, C10, C11, LED1, LED2, SW1, SW2, SW3 and the 2.457 MHz crystal.

Before you commence construction examine the PC board for defects such as bridges and broken tracks. Also take note of the components which should be mounted on the copper side of the PC board. These components are marked in colour on the overlay. The reason for components being mounted there is because there is not enough clearance for them between the PC board and the front panel.

The resistors and capacitors should be mounted first. Take note of the orientation of the electrolytic capacitors C2 and C12, and remember that all the capacitors are mounted on the copper side of the PC board.

Next mount the diodes, but first check their orientation. Try to keep the spacing between LEDs 3 to 10 as consistent as possible, keeping in mind that they have to be aligned with the front panel. Also mount the three banks of DIP switches. The crystal, the regulator and the transistor can then be mounted on the copper side of the PC board.

Next mount the integrated circuits. All the ICs are CMOS except for IC1 which is NMOS so treat them all with respect. Remember NMOS and CMOS chips are static sensitive; they do not like having their legs touched, only pick them up by their ends.

When soldering in the integrated circuits, try not to overheat them by soldering rows of successive pins. This is especially important in the case of IC1 for which it is best to solder the pins from opposite ends, eg, pin 1 then pin 21, pin 2 then pin 22 etc. This prevents the chip from being excessively heated in one area and saves it from possible damage.

There are mercifully few flying leads to connect in this project, as the majority of the switches and all the LEDs are mounted on the PC board. Take note of the connections to the serial/parallel switch, the DB 25 socket and the 9 volt in-

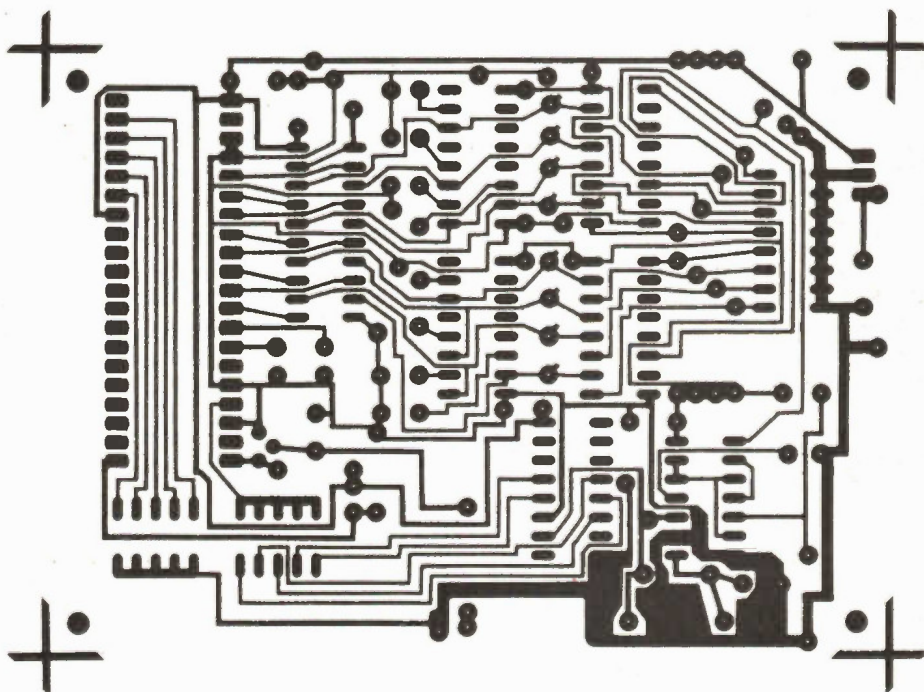
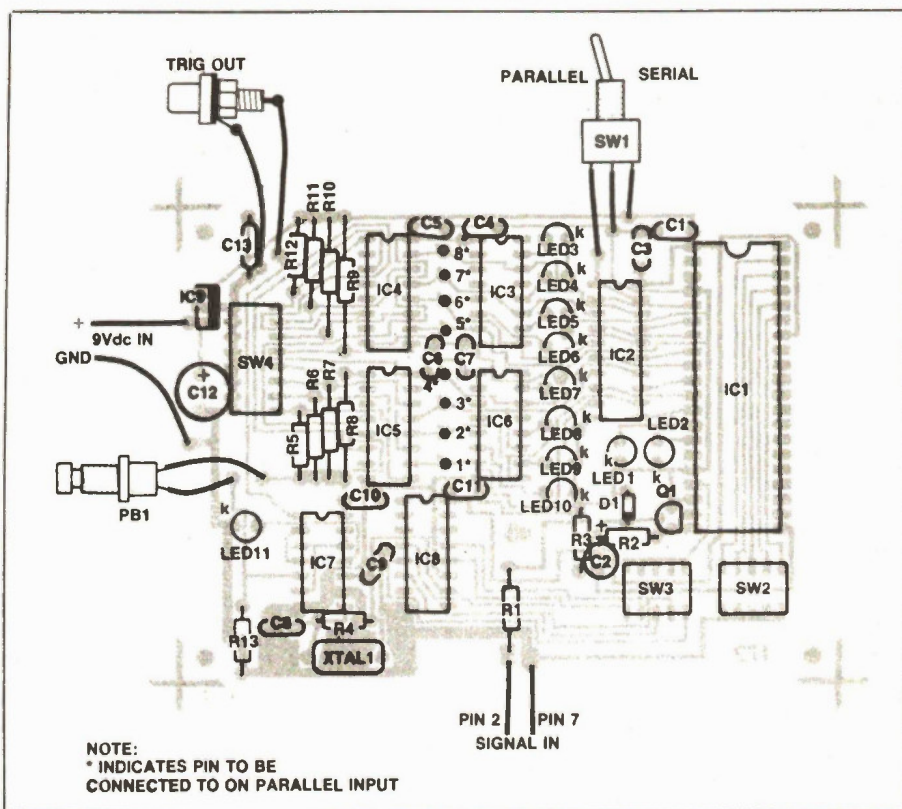

TABLE 1. DB 25 CONNECTIONS

Pin on DB 25 plug	14	15	16	17	18	19	21	22
Pad on pc board	1	2	3	4	5	6	7	8

put socket. The DB 25 socket is also used to access the parallel data input. Table 1 shows the recommended connections. However, as RS232 connectors can be configured in different ways on different computers, check that these lines are not used in your particular case. If they are, you may get false data entering ICs 4 and 5. If some of the recommended lines are used, connect the parallel data input lines to unused pins on the connector.

To allow all the LEDs and DIP switches to poke neatly through the front panel requires some careful drilling. To assist in this check the drilling diagram. By accurately aligning this diagram over your front panel, it can be used as a drilling template. When you have it in position, lightly punch the centres of all holes. To make the centres more accurate it may help to have a hard surface under the front panel when you are punching it. The outlines for the DIP switches can be marked by cutting through the diagram with a sharp blade or scalpel. This will transfer all the required markings on to the metal.

When you are drilling the 5mm diameter holes it is advisable to drill a pilot hole first, using a 3mm drill. Now use the 5mm drill where required. The edges of these holes can be cleaned using a large drill bit. The rectangular holes for the DIP switches can be cut using a nibbling tool or by drilling a series of holes and filing between them.

The circuit board can now be mounted behind the front panel using four nuts and bolts. Some 5mm spacers should provide adequate clearance between the front panel and the PC board. With a bit of wiggling the LEDs and the DIP switches should protrude through the front panel. If you have difficulty in getting the DIP switches through, file the holes gradually until they do. If the LEDs give you difficulty, twist them until they are evenly spaced so that they can be located in the holes.

Before you connect in the plugpack carefully examine the PC board for solder bridges; also check that all the components are located and oriented correctly on the board. Now connect the 9 volt plugpack, and check that the voltage rails are within 500mV of 5 volts. If not, disconnect the plugpack and check for short circuits on the PC board in the vicinity of the 5 volt supply rails.

To test the bit pattern detector set the 8-bit programming DIP switches to '0' and the pattern detected LED should light up. Switch any of the DIP switches to the '1' position and press the RESET button. The PATTERN DETECTED LED should go out. If this does not occur, recheck the board for shorts, broken tracks or dry joints.

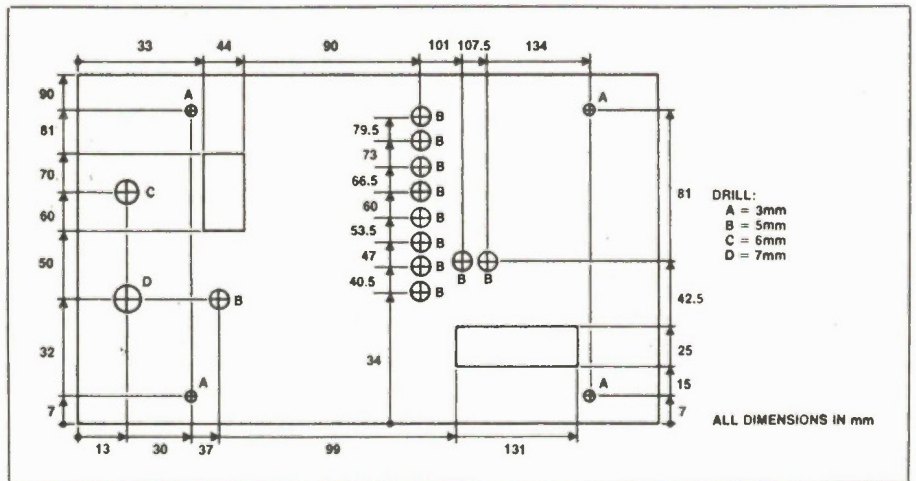
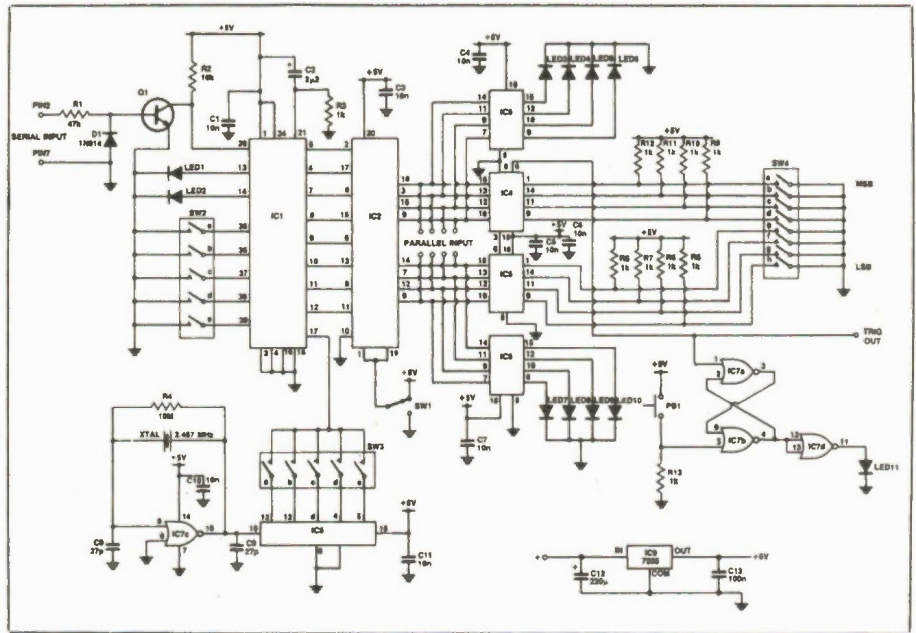

PARTS LIST

Resistors (All 1/4 W, 5%)
 R147k
 R210k
 R3, R5-R131k
 R410M

Capacitors
 C1, C3-C7, C10, C1110n
 C22u2 25 V electro
 C8, C927p
 C12220u 25 V electro
 C13100n greencap

Semiconductors

D11N914
 LED 1, 2, 11red 5 mm
 LED 3-10green 5 mm

Q12N5818
 IC1AY-1015D UART
 IC274HC244
 IC3, 64050
 IC4, 574HC85
 IC74001
 IC84020
 IC97805

Miscellaneous

SW1SPDT
 SW2, 35-way DIP switch
 SW48-way DIP switch
 PB1pushbutton switch

DB 25 plug; 2.457 MHz crystal; case 160 mm x 95 mm x 50 mm; RCA socket; 3.5 mm phono socket;

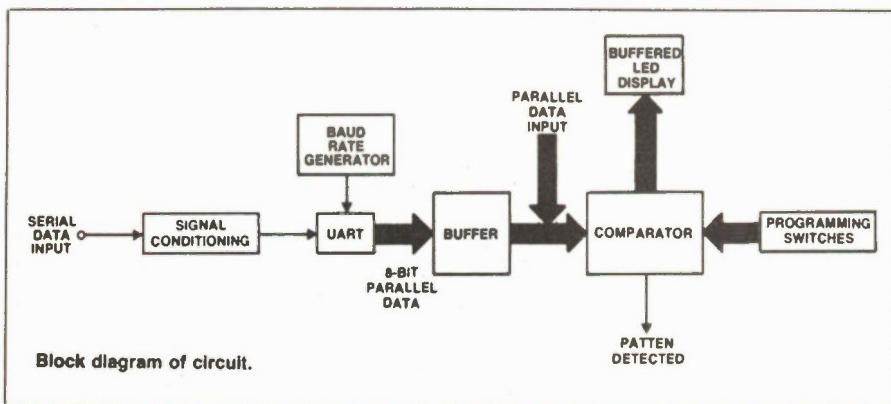

TABLE 2. FORMAT SWITCH SETTINGS

Switch No.			
1	on = odd parity		off = even parity
2,3	2	3	no of bits
	on	on	5
	off	on	6
	on	off	7
	off	off	8
4	on = 1 stop bit		off = 2 stop bits
5	on =		off =

Using It

When detecting bytes on a serial line first set up the BAUD RATE and FORMAT DIP switches to suit the serial port. Table 2 shows the settings for these switches. Next set the binary value of the byte to be detected on the eight DIP switches next to the SERIAL/PARALLEL switch. The top switch (bit 8) is the most significant bit and the bottom one (bit 1) is the least significant bit. Now send the data stream or the specific byte to be detected from this port. If either of the ERROR LEDs light up, check that the FORMAT or BAUD RATE DIP switches are set correctly.

To detect bit patterns or bytes on a parallel data bus, firstly flip the SERIAL/PARALLEL switch to the PARALLEL position and connect the relevant pins on the DB 25 connector (listed in Table 1) to the relevant lines on the parallel data bus. The eight LEDs should indicate the state of these lines. If a particular pattern is to be detected set its binary value on the DIP switches and the PATTERN DETECTED LED should light up when it appears on the data bus.

How It Works

Some serial signals are 'non return to zero' (NRZ) meaning that a high state is represented by a positive voltage and a low state is represented by a negative

voltage. The diode D1 is used to convert any NRZ signals to 'return to zero' signals and the transistor Q1 is used to set the signal level at 5 volts. The resultant signal output from Q1 will comply to TTL standards, that is, 5 volts as a high level and 0 volts as a low level. This signal conditioning is performed because the UART (IC1) requires TTL input signals.

The oscillator circuit consisting of the crystal, the NOR gate (IC7c), R4, C8 and C9 oscillates at a frequency of 2.457MHz. This signal is divided down by the 7-bit ripple counter, IC8, to provide five different baud rates. These rates are switched to the UART by the bank of DIP switches, SW3.

The UART removes start and stop bits from the incoming serial bit stream and converts the serial data into parallel data. SW2 is used to set up the UART for the correct parity, and correct number of data and stop bits. LEDs 1 and 2 indicate errors with parity and stop bits respectively.

After the serial data has been converted into parallel data, it is compared with the settings on the DIP switches (SW4) via ICs 4 and 5. When the bit pattern is the same as the switch settings, pin 6 of IC4 goes low. However, this output goes high again when a bit pattern different from the switch setting occurs. To latch this output an R-S flip-flop is used. This consists of NOR gates IC7a and IC7b. IC7d is

used to invert the latched signal to a high level and thus switch on LED11 to indicate that the bit pattern has been detected.

IC2 is an octal tristate buffer which is used to select between serial and parallel incoming data by SW1. When SW1 is in the serial position, the data output from the UART is connected to the comparators. When this switch is in the parallel position the data output from the UART is disabled from the rest of the circuit, isolating the outputs of IC1 from incoming data. Otherwise this data would be fed into the outputs of the UART.

LEDs 3 to 10 display the incoming data in a binary form. They are driven by the non-inverting buffers IC3 and IC5. Thus the loading on IC2 is reduced when the circuit is examining serial data. The loading of the source of the parallel data is reduced when the circuit is examining parallel data.

The 10nF capacitors connected between the Vcc pin of the integrated circuits and ground remove transients and any other undesirable ac signals which may be picked up by the Vcc rail. On the PC board, these components are located next to the Vcc pins of each integrated circuit. Capacitors C12 and C13 perform the above mentioned task for the incoming dc supply.

Electronics Today

Offers advertisers the opportunity to increase their sales and profits in the electronic field. Over \$200 million is spent annually for both electronics and micro-computer products by Electronics Today readers.

For advertising information
Call (416) 445-5600

NEXT MONTH IN Electronics Today

Home Controllers!

Tame that unruly house with a CPU. A roundup of the computer control systems available; build yourself the world's most expensive lamp dimmer.

Industrial Controllers!

How these tiny microcomputers mind the store, replacing racks of relays or paper tapes.

Versatile Power Supply!

A miniature unit with both constant current and constant voltage modes, ideal for the testbench or as a battery charger.

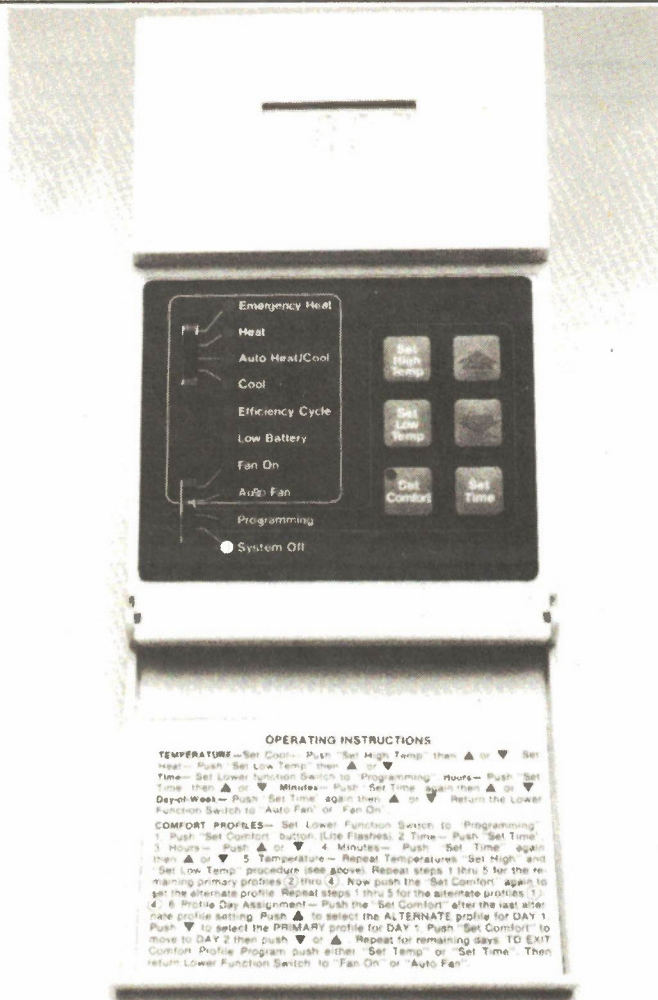

This Month in

Computing! Now!

Serial Telecommunications in C

Get your modem up and running with telecom software written in C.

The Absolutely Last WordStar Patch - Maybe

By now your WS should have more patches than a pair of farmer's coveralls.

Everything You Wanted To Know About PC Memory

A look at the ins and outs of the PC's memory structure. Don't forget to check it out.

Software For The Atari 520ST

A look at what's available in software for the increasingly popular 520ST.



For Subscription or Advertising Information Call (416) 445-5600

GET THE KNOW-HOW TO REPAIR EVERY COMPUTER ON THIS PAGE.

Learn the Basics the NRI Way—and Earn Good Money Troubleshooting Any Brand of Computer

The biggest growth in jobs between now and 1995, according to Department of Labor estimates, will occur in the computer service and repair business, where demand for trained technicians will actually *double*.

You can cash in on this opportunity—either as a full-time corporate technician or an independent service-person—once you've learned all the basics of computers the NRI way. NRI's practical combination of "reason-why" theory and "hands-on" building skills starts you with the fundamentals of electronics, then guides you through advanced electronic circuitry and on into computer electronics. You also learn to program in BASIC and machine language, the essential languages for troubleshooting and repair.

Total Computer Systems Training, Only From NRI

No computer stands alone... it's part of a total system. To really service and repair computers, you have to understand computer *systems*. And only NRI includes a complete computer system as part of your training, preparing you for the real world of computer servicing.

You start with the step-by-step assembly of the highly rated, IBM compatible Sanyo 550 Series computer. You install and troubleshoot the "intelligent" keyboard. Then you assemble the power supply, install the disk drive and extra memory to give you a powerful 256K RAM system.

Finally, you interface the high-resolution monitor and dot-matrix printer and begin to use the \$1,000 worth of software that's included. You're learning about, working with, servicing and troubleshooting an entire



IBM is a Registered Trademark of IBM Corporation.

Epson is a Registered Trademark of Epson America, Inc.

Apple and the Apple logo are Registered Trademarks of Apple Computer, Inc.

Compaq is a Registered Trademark of COMPAQ Computer Corporation.

© 1985 AT&T Technologies, Inc.

personal NRI instructor and the NRI technical staff, ready to answer your questions and help you when you need it. You get it all from NRI!

100-Page Free Catalog Tells More

Send the postage-paid reply card today for NRI's big 100-page color catalog on NRI's electronics training, which gives you all the facts about NRI courses in Microcomputers, Robotics, Data Communications, TV/Audio/Video Servicing, and other growing high-tech career fields.

If the reply card is missing, write to the address below.

AND MORE.

computer system—monitor, keyboard, computer, disk drive, power supply, and printer—all the essentials you'll meet every day as a professional computer service technician.

No Experience Needed, NRI Builds It In

This is the kind of practical, hands-on experience that makes you uniquely prepared, with the skills and confidence you need for success. You learn at your own convenience in your own home. No classroom pressures, no night school, no need to quit your present job until you're ready to make your move. Your training is backed up by your



Your NRI course includes the • IBM PC compatible Sanyo computer with memory expansion to 256K RAM • high-resolution monitor • double-density/double-sided disk drive • "intelligent" keyboard • dot-matrix printer with near-letter-quality mode • NRI Discovery Lab® to teach circuit design and operations • digital multimeter • logic probe • spread sheet • word processing software—and more.

NRI SCHOOLS
McGraw-Hill Continuing Education Center
330 Progress Avenue
Scarborough, Ontario MIP 2Z5
or telephone 416-293-8787
We'll Give You Tomorrow.

HAMEG 20MHz

Digital Oscilloscope

In addition to providing the impressive features of a well-designed 20 MHz real-time oscilloscope, the new HM 205 permits storage and display of slow-occurring signals and events (from 50 sec to 0.1 msec). None of the usual problems associated with long-persistence screens, such as trace flicker, streaking, and relatively short view time (max. 10 sec in Single-Shot mode) due to unavoidable loss of brightness, are present in the HM205.

HM205 LIST \$1250

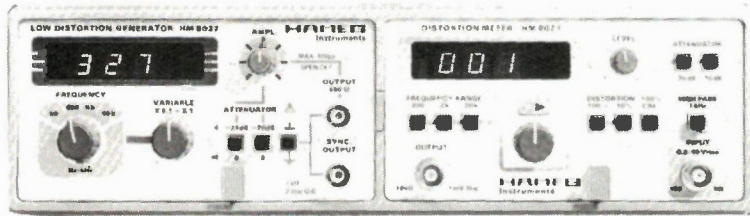
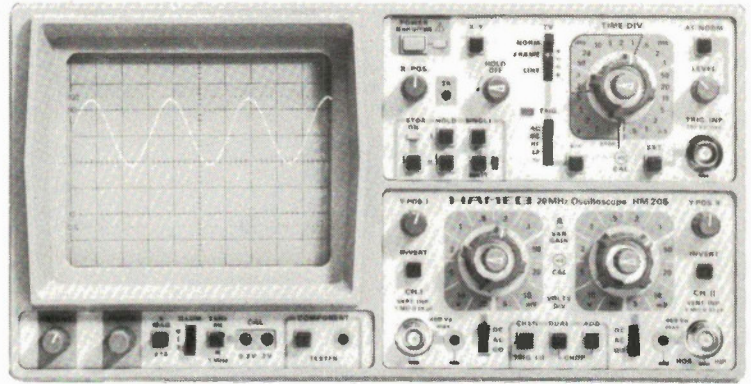

HM8001 WITH HM8037 & HM8027 MODULAR SYSTEM

DISTORTION METER & AUDIO GENERATOR

Ideally suited to fit under either of these Oscilloscopes and other Hameg Models

Analog Oscilloscope

The HM 203 Vertical Amplifiers incorporate variable gain controls and maximum input sensitivity is 2MV/cm over the full band width. Triggering up to 40 MHz is possible along with LINE, HF, DC and TV Sync. The instrument also has a component test built in.

HM 203-5 LIST \$770

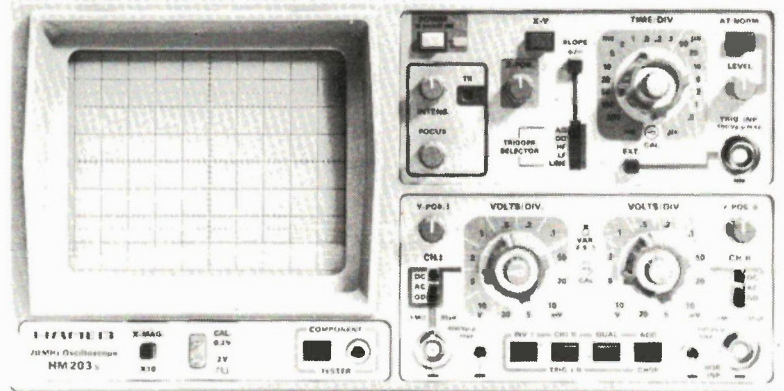

Complete audio distortion measurements are now economically possible with the new BCS-DATE* our date* system is a low cost 4 unit system from 5HZ to 50KHz and includes our H980 probes and interconnecting cable set.

HM 203 DATE*

**\$1895.00
COMPLETE**

HM 205 DATE*

**\$2395.00
COMPLETE**



**980 Alness St. Unit 7,
Downsview, Ontario.
M3J 2S2
(416) 661-5585
TELEX 065-28169**

Mon-Fri 8-5 pm, Sat 10 am-1 pm

*Distortion, Audio Test Equipment

Circle No. 5 on Reader Service Card

Electronics Today

Test Equipment

What's new in the test equipment lineup, plus ideas on applications and use.

By Bill Markwick

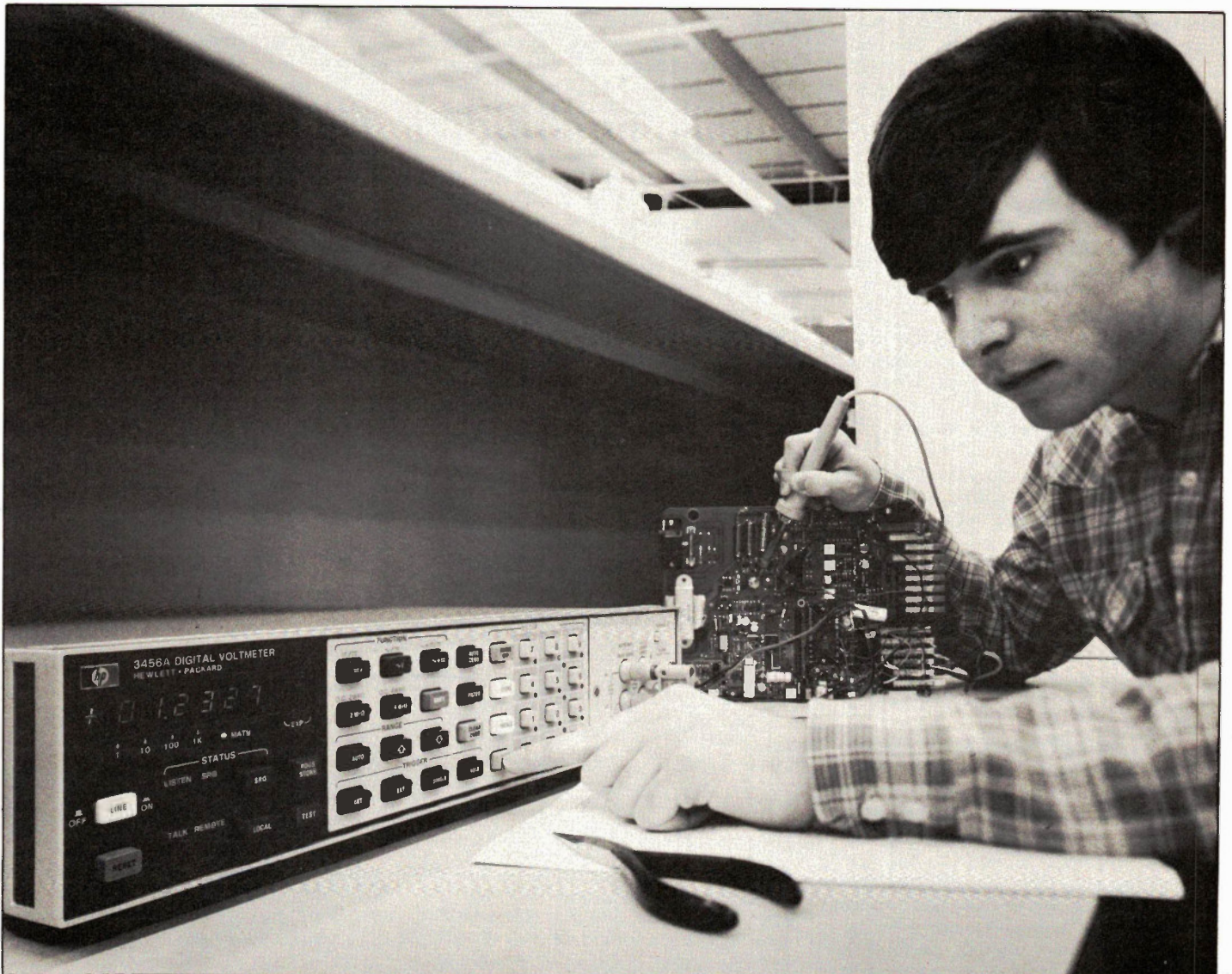

ONCE again it's time for a look through some of the test equipment available. Most of the items selected are aimed at the small to medium testbench, although of course they have universal applications. Occasionally we stray into the area of equipment with huge price tags, if only to see what can be done.

Not surprisingly, there are more and more microprocessors and special ICs being used in test gear. The result has usually been any or all of: a lower price, a smaller size, more features, better precision or extended test capabilities. The credit-card Digital Multimeter is now an inexpensive reality. Another advantage is that one unit can do the job of several, such as scopes with built-in voltmeter and frequency counter readouts.

The savings in price and size often mean that you can afford other, specialized units such as troubleshooting aids, power analyzers and so on.

Maybe its time to retire that great old tube scope that's given years of service, or replace that huge signal generator with one that's now a fifth the size. Here are just a tiny sampling of the many models available. If you don't see what you want, don't give up: every representative of every product in this article has a much wider range of models and types than we could possibly hope to show. And, of course, we apologize to anyone inadvertently omitted, or anyone whose product line couldn't be fully represented because of space restrictions.

Oscilloscopes

The scope is probably the first major piece of test gear that anyone considers buying. It's difficult to overemphasize its role as the heart of any testbench, or overstate the usefulness of a portable scope in field work.

When choosing a scope, there are three main possibilities: the analog, the analog storage, and the digital storage. If you use the scope primarily for looking at steady-state signals, particularly if you need maximum bandwidth (or maximum economy), then the analog scope is the winner. If you have a need to capture transient signals, those pesky voltages that only happen sometimes, then the choice is between an analog or a digital storage system.

It's a tad harder to make the decision about storage types. If you only need a capture facility once in a while, perhaps price would be the determining factor. However, if you require high performance, it boils down to this: the microprocessor, now turning up in most test equipment, allows the digital storage scope to have multiple memories for image storage and on-screen readouts of voltage and time parameters via movable

cursors. The tradeoff is speed; digital scopes work by taking high-speed samples of the trace and assigning a digital value to each sample. This digital value is then stored in RAM. Obviously, there will be some loss of speed compared to the analog scope; the signal scanning is interrupted for a small but finite time period to allow sampling and conversion. To speed things up, digital scopes often let the signal build up for several repetitions to give the equivalent of extremely high-speed sampling; this works well for repetitive waveforms, but not for one-time transients. If high-speed transient signals are your thing, especially at 10MHz or above, the analog scope may have the edge. If you deal in low frequencies, say below 1MHz, the choice is yours.

Naturally, everyone would like to have everything all in one box, and at a good price. How close can we come to this? Surprisingly close, in fact. I'd pick one of the newer digital storage scopes in the under-\$5000 range as being the all-around winners for versatility.

It's interesting to consider resolution and noise for a moment. The analog scope is not particularly concerned with either one; resolution is as good as the phosphor coating, and low-level noise, being random in nature, generally doesn't stick around long enough to make the phosphor glow. With digital scopes, however, the resolution is determined by the sampling method, usually an 8-bit system with a vertical resolution of 256 points vertically and 1024 horizontally (this varies with make and model). At low frequencies, the display looks fine. As the frequency increases, the display make look a bit coarse.

In addition, the low-level noise voltages are sampled along with the signal, and if displayed, give a jagged line and the impression of very low resolution indeed. Most scopes use signal averaging to eliminate this; a number of signal repetitions are sampled and the average value is computed by the microprocessor. The result can be superior to an analog scope: each time the number of samples is doubled, the apparent signal-to-noise is doubled. An averaged sample of 128 passes, for instance, suppresses noise on a repetitive signal by 21dB. Try holding the tip of an analog scope's probe between your fingers. The result will usually be a very blurry display of 60Hz noise. Try the same thing with the signal-averaging of a digital scope, and all the fur and fuzz drops away, revealing a much cleaner 60Hz noise voltage.

You might want to look into cursoring functions. Dots or lines on the CRT are set to bracket any desired amplitude or time period, and the value can be read directly from a digital display at the borders of the screen. They're sometimes available on analog scopes, though they're more naturally found on the digital storage types.

And one last point: before you dismiss digital storage models as too expensive, consider that the units with comprehensive cursoring facilities can also replace (or add) a voltmeter, frequency counter and elapsed-time counter. Besides, they're a delight to use!

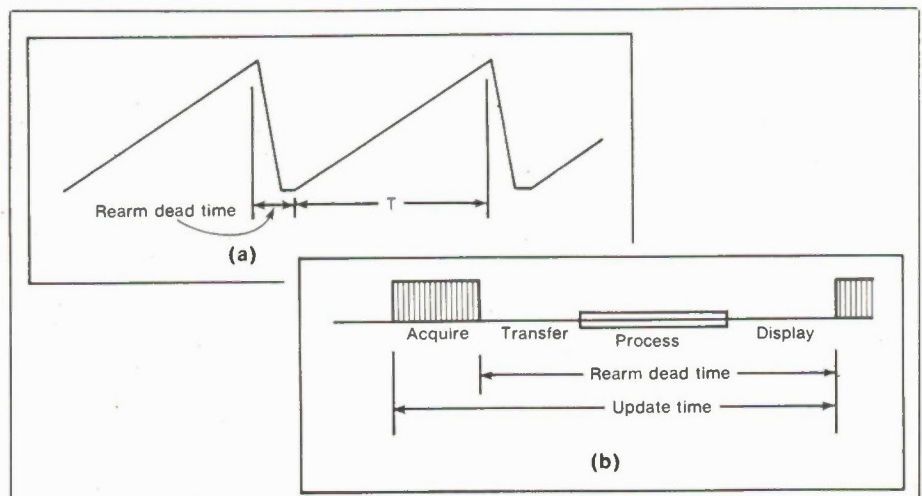
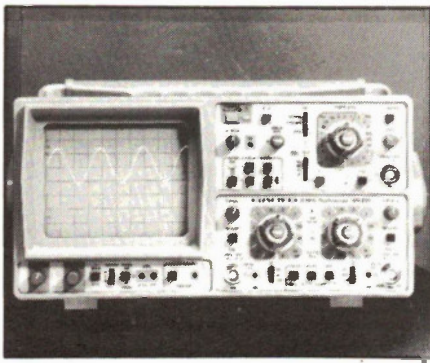

Fig. 1. An analog scope captures nearly all waveform changes because its trace is active most of the time (a). The inactive time, or rearm dead time, is only about 10 to 20 percent of T , the active display time.

A digital storage scope, however, has a long-rearm dead time (b) because of sampling and conversion operations (Courtesy of Tektronix).



The Hameg HM205 is a 20MHz dual-channel digital storage scope with 2mV/div sensitivity and triggering up to 40MHz. Our work with Hameg scopes has always pointed up their fine triggering amplifiers, and the 205 is no exception, with an active video trigger for viewing noisy or distorted TV signals. Other features include a built-in component tester and a 1kHz/1MHz calibrator. Signals stored in the single-shot mode are kept in memory, even if the real-time mode is used.

BCS Electronics Ltd., 980 Alness St., Unit 7, Downsview, Ontario M3J 2S2, (416) 661-5585. Circle No. 34

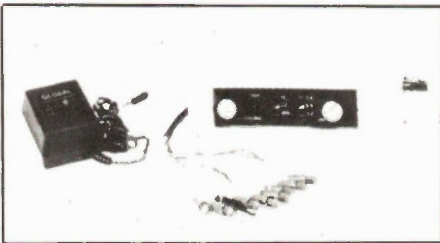

If you'd like to look at multiple signals, but aren't up to buying an expensive multi-input scope, the Global MX-8 Multiplexer is ideal for feeding up to eight analog or digital signals into any single or dual-channel scope. It features 40V peak-to-peak input range to accommodate CMOS, a frequency range to 5MHz and overvoltage protection to 100V. Probes and an AC adapter are included.

Distributor: Len Finkler and Co., 80 Alexdon Rd., Downsview, Ontario M3J 2B4, (416) 630-9103. Circle No. 35

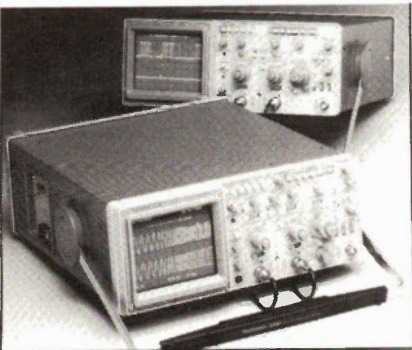

As one of the world's leading manufacturers of test equipment, Tektronix has a comprehensive lineup of analog and digital oscilloscopes. The 2220 dual-channel has a bandwidth of 60MHz, a 4K memory, averaging, a plotter output and an optional RS232/GPIB output. The 2230 has the same, plus 100MHz bandwidth, 3 memories, battery backup option, and a cursor measurement system. Stored waveforms can be expanded, compressed or repositioned. Various modes such as trigger parameters and display settings can be tailored by the user with a menu system.

Tektronix Canada Inc., PO Box 6500, Barrie, Ontario L4M 4V3, (705) 737-2700. Circle No. 36



The Heath ID-4850 Digital Memory Oscilloscope Kit will turn any IBM PC or compatible computer into a 50MHz digital storage scope with a risetime of 7ns. It can also be used with any single-channel oscilloscope that has at least 5MHz bandwidth and an external trigger input. The supplied software allows full control of the oscilloscope functions from the keyboard of the computer. The computer displays the dual traces on an 8 by 10 graticule. Waveform displays can be stored on disk for later reference or waveform averaging. Also available assembled as the SD-4850.

Heathkit Centres, or the Heath Company, 1020 Islington Ave., Toronto M8Z 5Z3, (416) 232-2686. Circle No. 37



The Samick-505 is a low-cost general purpose scope for the hobbyist or student. It features a bandwidth of DC to 4.5MHz, a vertical sensitivity of 20mV/div, a horizontal input from DC to 250kHz, phasing up to 140 degrees for frequency sweep and horizontal deflection circuits.

H.W. Cowan Canada Ltd., 99 Coons Rd., PO Box 268, Richmond Hill, Ontario L4C 4Y2, (416) 773-4331.

Circle No. 38

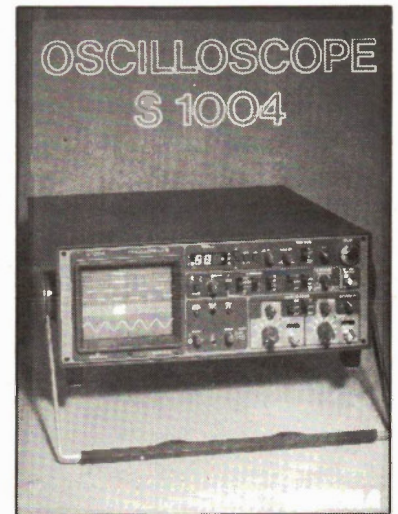

The Hewlett-Packard 54110D Colour Digitizing Oscilloscope is only one of many in HP's vast lineup of test equipment. It features a 1GHz repetitive bandwidth and adds full colour capabilities to the features of the 54100 scope introduced in 1984. 4,096 colours are available, of which any nine can be displayed at once. This simplifies viewing the rapidly changing environment of logic and data signals, differentiating between overlapping, superimposed or similar waveforms and helping to associate displayed information with corresponding data or waveforms. The 54110D measures frequency, period, pulse width, transition times, peak-to-peak amplitude, top and base voltage levels, preshoot and overshoot. A multiplexing input is available for multiple probes. At \$31,749, they aren't for fixing the family TV, but what a way to work with logic.

Hewlett-Packard (Canada) Ltd., 6877 Goreway Drive, Mississauga, Ontario L4V 1M8, (416) 678-9430. Circle No. 39

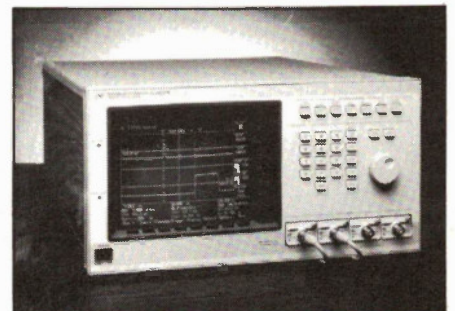

An Austrian line of scopes is represented by the Norma S 1004 dual-channel oscilloscope. One of its specialities is an auto-focussed beam with an internal

COMPUTER PARTS GALORE INC.
316 College St. Toronto, Ontario M5T 1S3

KEYBOARDS

- (A) 5150 Style, 83 Keys, Std Layout, uses the long lasting Cherry Sw, IBM® Comp. \$ 99.95
- (B) 5151 Style, 105 Keys, Keytronic 5151 layout. Cherry Sw. IBM® Compatible \$139.95
- (C) 5160 Style, AT® compatible, with 83 keys by Cherry, 5150 layout \$159.95
- (D) 5161 Style, AT com, but 5151 layout \$189.95
- (E) AES DATA Keyboard, Par ASCII and Serial but not IBM. Runs Apples® very good general use ASCII keyboard \$ 24.95
- (F) APPLE NUMERIC BASIC FUNCTION, II+ \$ 89.95
- (G) APPLE STANDARBASIC FUNCTION, II+ \$ 89.95
- (H) APPLE DETACHED II+, NUMERIC FUNC. \$149.95
- (I) FOX 2001 Internal keyboard, Iie \$ 69.95
- (J) FOX 2001 External keyboard, Iie \$139.95

POWER SUPPLIES

- (A) 150 Watt, Back/Side Switch, with +5v-15Amp, +12V-5.5Amp, -5,12V-½Amp, A good quality, hydro approved unit. \$139.95
- (B) 150 Watt, CSA approved unit, for the very highest system reliability, +5v-15Amp +12v-5.5Amp, -5,12V-½Amp, Side Sw \$159.95
- (C) APPLE II+, or FOX 2001 Iie, power supply, +5v-5Amp, +12v-2.5Amp, -5, 12V-½Amp Very high quality \$ 79.95
- (D) OPEN FRAME Northern Telecom switcher as widely sold, +5v-4A, ± 12V-1Amp and -5 at 1 Amp, very good deal \$ 18.95
Power cord for (D) above \$ 3.50
- (E) IBM OPEN FRAME, came from the defunct NCR compatible, +5v-7Amp, +12v-3Amp, -5, 12v-½Amp, runs the whole thing \$ 59.95

V-20 CHIP

You may have heard of the NEC V-20 chip. It is an upgraded 8088 that can run programs up to 50% faster (depending on code). It also can run Z-80 code, allowing it to be used for Z-80 development. Especially good for Video when using code using it's features. A hot and hard to get CHIP at (5 Mhz) \$24.95
Faster version runs at 8 Mhz \$44.95

HARD DRIVE BOX



This nicely made box is ideal for externally mounted hard or floppy drives. It has space for one full height or two half height drives and power supply space at rear. This is a well made and rugged units for only \$59.95.

Toll Free Orders Only 1-800-387-1385 (416) 928-2161

CASES

XT® CASE WITH AT® LOOK

- (A) Standard 8 slot hinged case XT® case. Fits side or back power supply (Specially) Has much heavier metal than competitors for stability, takes 1-4 ½ sized drives and fits very well \$79.95
 - (B) Same as above, but the front looks like an AT case, with switch for KB and LEDs on front (picture) \$89.95
 - (C) ABS numeric case for II+ \$49.95
 - (D) ABS case for FOX 2001 \$49.95
 - (E) Hard drive box, holds 1 full sized or two ½ sized hard drives, good for portable tape backups as well \$59.95
- 40 Watt power supply for the above \$59.95
60 Watt power supply for the above \$79.95

DRIVES QUME

- (A) Yes we have the drives that IBM bought for their own use, complete with the IBM® logo right on them. Brand new DS/DD ½ Height drives \$129.00
- (B) Panasonic drives, very quiet, as above but no logo, DS/DD ½ Height \$165.00
- (C) Toshiba drives, noiser than above, but cheaper, no logo, DS/DD ½ Height \$159.00
- (D) Seagate 20 Meg hard drive with Controller, ½ height \$699.00
- (E) Seagate 20 meg drum only \$549.00
- (F) Controller only \$169.00

GRAY SCALE ADAPTER

As you know the IBM colour graphics card does not look very good on a monochrome monitor. This is because often two colors look the same on monochrome so you cannot read red print on a blue background or some such. This little gray scale proportionately scales each color into a different intensity allowing easy viewing on amber, green or white monitors. We sell it as a kit for only (with cable) \$19.95
or wired and tested (with cable) \$24.95

RIBBONS

- Gemini 10X \$ 3.95
- Gemini 15X \$ 3.95
- Centronics 739 \$ 6.95
- Centronics 150 \$ 7.95
- LX80 \$11.95
- Olympia \$ 8.95
- MX-80 \$ 8.95
- TTX \$ 7.95
- Diabolo \$ 6.95
- CITOH imag Wr \$ 6.95
- QUME IV \$ 8.95
- Tally 1000 \$ 7.95

MODEMS

- GVC INTERNAL 300/1200 \$325.00
- GVC EXTERNAL 300/1200 \$325.00
- SMARTMODEM 300 \$249.00
- SMARTMODEM 1200 \$649.00
- SMARTMODEM 2400 \$995.00

CABLES

- Disc Drive cable (3 Con & twist) \$12.95
- IBM Parallel printer cable \$14.95
- IBM serial printer cable \$14.95
- IBM 6' Keyboard extension (curly) \$ 9.95

* Note: The terms, IBM, XT, AT, PC are registered trademarks of International Business Inc.

WIRED CARDS FOR IBM®

- (A) 384K RAM card, ¾ size for 384K of 64K DRAM. Wired and tested with OK \$ 79.95
Bare PCB and assembly data \$ 19.95
- (B) 578K RAM card, ¼ size for 576K of 256K DRAM. Wired and tested with OK \$ 59.95
Bare PCB and assembly data \$ 14.95
- (C) KRAM card, a clone of the JRAM card for 2 MBYTE of 256K DRAM. Runs all software 100% compatible, W & T with OK \$139.95
Bare PCB and assembly data \$ 29.95
- (D) COLOR GRAPHICS, A PERSYST clone, runs all software and our one has grey scale O/P & color comp and TTL RGB, W & T \$125.00
- (E) MONO GRAPHICS, A hercules clone, runs all software and has parallel centronics printer as well, W & T \$139.95
Bare PCB and assembly data \$ 24.95
- (F) 384K/MULTIFUNCTION card, exact copy of AST SIXPACK, Ser, Par, Clock, Cal, Game I/O with software and ports, W & T. OK \$169.95
Bare PCB and assembly data \$ 24.95
- (G) DISC CONTROLLER, runs 1-4 drives has newest 9216 data separator with cables wired and tested \$ 59.95
Bare PCB and assembly data \$ 12.95
- (H) DISC + I/O CARD, A very nice new card with disc controller plus AST sixpack on board without any RAM. Ideal for the new 640K motherboards, Ser, Par, Clock, Cal, Game, software and ports, W & T \$189.95
- (I) 10+2, An AST SIXPACK with no RAM, has Ser, Par, Clock, Cal, Game and software and ports, W & T \$129.95
Bare PCB and assembly data \$ 19.95
- (J) PRINTER, Centronics, Std parallel printer, ¼ size, W & T \$ 49.95
Bare PCB and assembly data \$ 12.95
- (K) SERIAL, std serial card, two ports ½ sized, W & T \$ 44.95
Bare PCB and assembly data \$ 12.95
- (L) CLOCK/Calendar, A ¼ sized card for these two functions, with battery \$ 49.95
Bare PCB and assembly data \$ 12.95
- (M) GAME, card, A ¼ sized card with 2 std game ports on it, W & T \$ 39.95
Bare PCB and assembly data \$ 12.95
- (N) EXTENDER, and 6" extender board for easy access for service Olympia \$ 14.95
- (O) PROTOTYPE, full sized with all WW area and a DB25, DB9 footprint \$ 24.95
- (P) RAM/PROTOTYPE, Full size with 256K/1M RAM area for 64K/256K DRAM at end with DB25 and DB9 footprint \$ 29.95

CENTRONICS CONNECTORS

- 36 Pin solder cable male \$4.95
- 36 Pin Flat cable male IDC \$4.95
- 36 Pin Flat cable female \$4.95
- S-100 Edge Connectors \$.99

PRINTERS

- ROLAND PR1212A \$575.00
- PR1011 \$375.00
- PR2022 \$645.00
- OLYMPIA NP \$425.00
- RO \$475.00
- CITIZEN MSP 10 \$450.00

IBM COMPATIBLE SYSTEMS

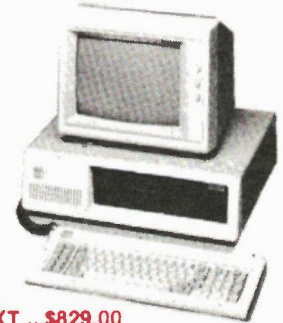

XT ...\$829.00

What a deal, the nicest systems of all at the lowest price for good merchandise. The basic system has the following. For \$829.00

- 640K Motherboard
 - 1 DS/DD 360K ½ Ht.DD
 - 1-4 DD Controller
 - Keyboard
 - Colour Graphics Card
 - Free software
 - 256K RAM on board
 - 8 XT slots
 - Flip top case
 - 150 Watt power supply
 - All cabling & 24 hr. Test and burn-in
- To upgrade the system to your choice please select from these options.
- Monochrome graphics card . Add \$ 49.00
 - Ser/Par/game/clock/calendar Add \$110.00
 - Printer card Add \$ 45.00
 - Serial card Add \$ 49.00
 - Second drive Add \$150.00
 - KRAM CARD, OK Add \$139.00

640K XT MOTHERBOARDS

We now have several types of 640K motherboards with all the standard attributes of the "REAL" thing as well as some new ones. All have 8 XT slots, XT size, and 8087 socket and have 100% compatibility. The extra features are the use of 256K RAM to get 640K on the mother board plus the new desirable "TURBO" feature. The "TURBO" has two speeds, the basic 4.77 and either 6.67 or 8.00 Mhz. The 6.77 uses the -3 or standard 8000 chip set and RAM, the 8.00 needs the -2 high speed version and 120Ns RAM. The speed advantage is the ratio of 6.67/4.77 = 1.39 or 39% faster and 8.00/4.77 = 1.67 or 67% faster, all other things being equal. Of course timing loops will be changed so that any real time output will be faster by the ratio unless the loop is fixed. The largest saving is in CAD programs with a lot of number crunching, smallest savings are disc intensive programs.

- SME-XT, wired with OK 3 hr burn-in \$199.00
- SME-XT, wired with no IC's at all \$ 99.00
- SME-XT, bare pcb, book parts list \$ 34.95
- TURBO 6.67 MHZ VERSION
- SME-XT A Wired, 3 Hr burn In, OK \$229.00
- SME-XT A Wired, no IC's at all \$129.00
- SME-XT A Bare PCB, book, parts list \$ 39.00

TURBO 8.00 MHZ VERSION

- SME-XT B, wired, 3 hr burn In, OK \$249.00
 - SME-XT B, wired, no IC's at all \$139.00
- All boards come with book and parts list, the wired with OK have BIOS included.

APPLE WIRED CARDS

- Applecard \$149.00
- 16K \$ 39.95
- 80 Column \$ 59.00
- 128K(OK) \$ 55.00
- 80 Column with softswitch \$ 69.00
- 128K(64) \$ 99.00
- 128K(128K) \$149.00
- Grappier \$ 49.00
- Drive Cont. \$ 49.95
- Cable above Z-80 \$ 45.00
- \$ 19.95

graticule for sharp, parallax-free viewing. The timebase is also automatic, setting itself to display 1.5 to 5 cycles of signal, plus manual control.

A second timebase employs an adjustable delay. Norma is represented by H.W. Cowan Canada Ltd. (mentioned above), and by:

Mesurina Ltd., 57 Hyde Park, Beaconsfield, Quebec H9W 5L7, (514) 697-6581. Circle No. 40

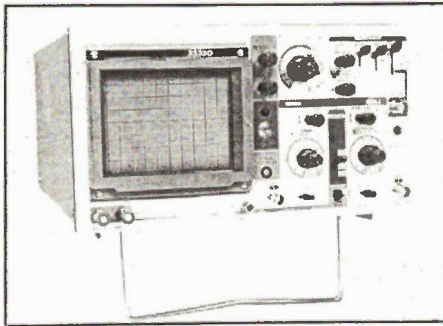

The **Model 33330** from KB is a 20MHz dual-trace scope with a 20MHz bandwidth aimed at general-purpose use. The vertical sensitivity is 5mV/div in 12 ranges, and the horizontal range is 0.2 μ s to .5s per division. A component tester is included, providing up to 9V and 2mA to any components inserted into the front panel jacks. An intensity modulation (Z-axis) input is provided.

KB Electronics, 355 Iroquois Road, Oakville, Ontario L6H 1M3, (416) 842-6888. Circle No. 41

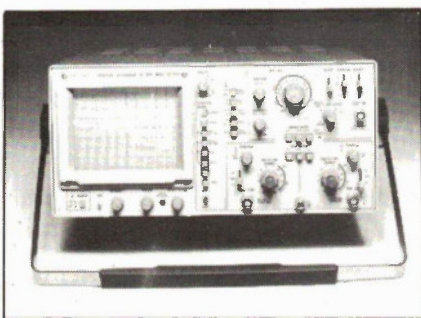

The **Meguro MSO-1270A** scope is a digital dual-channel with 20MHz bandwidth. It features a 2-kiloword 8-bit A/D converter for each channel, enabling high-density monitoring. The pre and post trigger functions, along with the split memory function, provide for easy comparison of two or four waveforms. The time axis is capable of 160 times magnification.

RCC Electronics, 310 Judson St., Unit 6, Toronto, Ontario M8Z 5T6, (416) 252-5094. Circle No. 42

Electronics Today July 1986

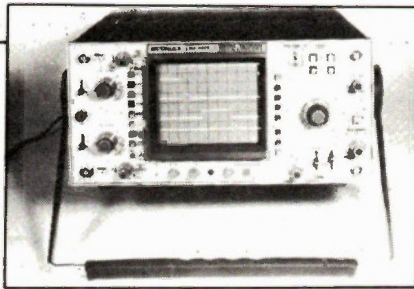

The **Leader LBO 5825** is a 35MHz real time oscilloscope, providing up to 500kHz of digital storage with dual channel capability. The memory for each channel permits four waveforms on two channels to be stored and displayed simultaneously, and if a waveform in the real time mode is included, six waveforms may be viewed. The waveforms can be stored for up to two weeks with the power off via a battery backup. An XY output for recorders is provided.

Omnitronix Ltd., 2410 Dunwin Drive, Unit 4, Mississauga, Ontario L5L 1J9, (416) 828-6221. Circle No. 43

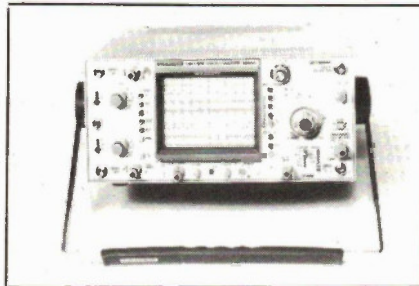

The **Leader LBO 516** is a low-cost 100MHz two-channel scope. Like the Norma, it features a high-voltage tube and an internal graticule for parallax-free viewing. Alternate sweep on the main and delayed timebases, a 2ns/div sweep speed and trigger view make this scope ideal for servicing, R&D or teaching. A channel-1 output is provided for frequency measurements.

Omnitronix (see above)

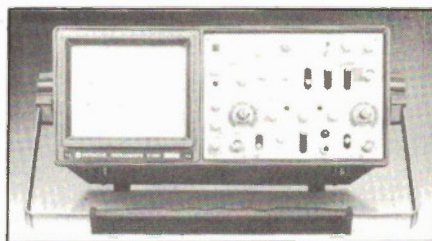

The **Hitachi V680** oscilloscope is a digital storage scope with full cursoring capability. It features 5mV/div vertical sensitivity, an adjustable delay line, a 60MHz bandwidth, and a third channel for viewing up to six traces. The cursors measure frequency, time and voltage as well as displaying the status of various controls.

The **V680** was reviewed in last month's *Electronics Today*.

Hitachi Denshi Ltd. (Canada), 65 Melford Drive, Scarborough, Ontario M1B 2G6, (416) 299-5900. Circle No. 44

Generators

The signal generator is as necessary as the oscilloscope, but rarely gets much attention. Although it's easy enough to make a circuit oscillate, as we all know when that pet circuit takes off and makes smoke, it's quite a challenge to make one that has both amplitude and frequency stability over a wide range. Plus, of course, low harmonic distortion. The lowly audio oscillator may not seem like much next to its regal cousin, the 100MHz synthesized RF generator, but it's an engineering challenge nonetheless.

If you're looking for a standard audio oscillator, any unit will do as a starter, but you'll find certain features very useful. A squarewave output is handy, as is a 50-ohm output; an stepped output attenuator switch is great in addition to the usual level knob. If you don't have the ability to attenuate signals down to the millivolt level, you'll have to build or buy an attenuator anyway. The function generator has some nice features, particularly for R&D: various waveforms, very wide range, and (usually) voltage control of the output frequency and amplitude.



The **Samick 705** is a low-cost general-purpose audio oscillator, suitable for small testbenches, servicing, instructional purposes, etc. Its range is 20Hz to 2MHz in 5 ranges; the output is 600 ohms, with sine and squarewaves switch-selectable. The distortion is less than 0.5 percent from 200Hz to 20kHz. The output sine voltage is 7V RMS open circuit and the squarewave output is 7V p-p.

H.W. Cowan Canada Ltd. (see under Oscilloscopes) Circle No. 45

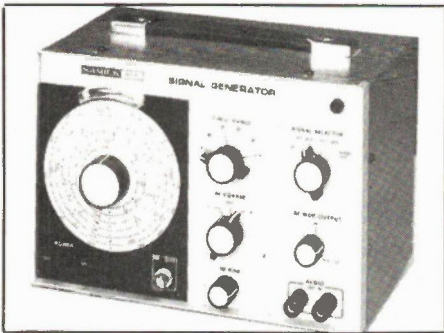

The **Samick 605** is a low-cost RF generator with a range of 100kHz to 70MHz in 6 ranges. The frequency accuracy is plus-or-minus 2.5 percent, and the output voltage is more than 30mV RMS into 50 ohms. A 3-step attenuator provides 40dB of attenuation, and a 400Hz audio signal is generated internally.



The **Beckman Circuitmate FG2** is a function generator with sine, square, triangle and TTL pulse outputs. Frequency range is 0.2Hz to 2MHz. The duty cycle of the signal can be set to any desired value and a DC offset voltage can be added to the output for applications requiring bias. A 20dB attenuator switch is standard. \$279.

Lenbrook Electronics, Unit 1, 111 Esna Park Drive, Markham, Ontario L3R 1H2, (416) 477-7722.

Circle No. 46



The **Fluke 6060A** is a synthesized signal generator for testing a wide variety of RF receivers, filters, amplifiers and mixers. It covers a frequency range of 0.1 to 1050MHz with 10Hz resolution and has a switching speed typically less than 100ms. Non-harmonic spurious products are -60dBc and harmonics are less than -30

32

across the entire range. Amplitude levels are selectable from -137dBm to +13dBm with 0.1dB resolution.

Allan Crawford Associates Ltd., Test and Measurement Division, 6503 Northam Drive, Mississauga, Ontario L4V 1J2, (416) 678-1500.

Circle No. 47

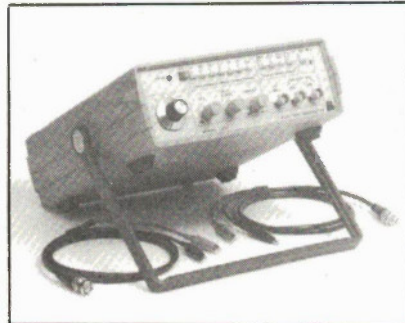

From Brunelle Instruments' wide range of test equipment comes the **Model 3020 Frequency Generator**. The output waveforms are sine, square, triangle, pulse and ramp, from .2Hz to 2MHz in seven ranges. Three decades of range can be controlled with a 0-10V control signal. DC offset of 10 volts can be added to the output. It's also available with an internal frequency counter as the Model 3030.

Brunelle Instruments, 73-6th Range South, St. Elie d'Orford, Quebec J0B 2S0, (819) 563-9096.

Circle No. 48

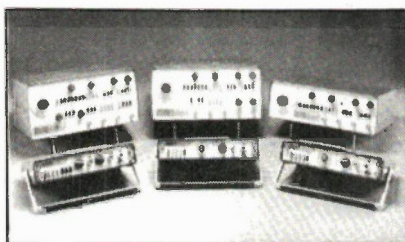

A new series of generators is available from **OK Industries**. The Model 205 is a 5MHz function generator, the Model 206 is a 5MHz sweep/function generator, and the Model 207 is a 5MHz pulse/function generator. All models offer sine, triangle, square and haversine waveforms, a TTL output, a 20V 50-ohm output, variable symmetry, switchable attenuation, and external sweep and trigger/gate modes. The 206 has both linear and log sweep, with a 10,000:1 range on the log sweep, plus a full marker function.

Len Finkler and Co. (see under Oscilloscopes).

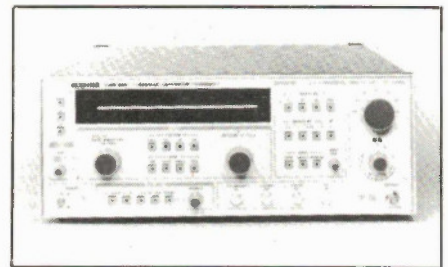

The **Leader LSW 359** is a wideband sweep marker generator suitable for R&D, lab inspection, alignment of communications equipment, etc. It covers the frequency range from 1-1500 MHz in 3 bands. Each band has sweep speeds varying from 10ms-100s in four ranges, plus a manual sweep function. 1, 10, 50, and 100MHz markers are standard, as well as a variable marker.

Omtronix Ltd. (see under Oscilloscopes)

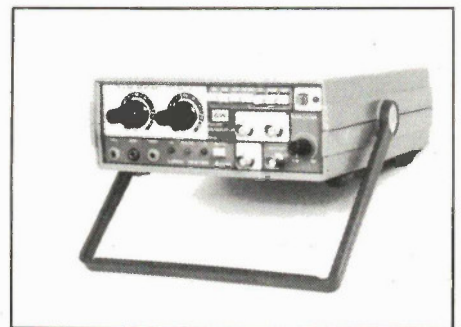

The **Goodwill Instruments GPG8018** is a pulse generator with a logic tester function for use with CMOS or TTL. The frequency range is 0.5Hz to 5MHz, and the pulse period range is 100ns to 0.1s. It can be used with an oscilloscope for adjustable sweep delay, or for testing counter circuits and shift registers, or for logic testing of TTL, CMOS and related logic families.

Duncan Instruments Ltd., 121 Milvan Drive, Toronto, Ontario M9L 1Z8, (416) 742-4448.

Circle No. 49

The **King Instruments FG-2512F** is a 0.2 to 2MHz function generator with sine, square, pulse, triangle and ramp waveforms. With variable width and repetition rates, it becomes a pulse generator as well. It also has external voltage control and a DC offset voltage can be added to the output.

RCC Electronics (see under Oscilloscopes)

LCR Meters

Not something that the average tech spends his time daydreaming about, the LCR meter is indispensable to quality control, production testing and R&D departments. The ability to read the value of components quickly and accurately is no small thing, particularly when it comes to capacitors and inductors. In general, they work by placing the unknown component in one leg of a bridge and then applying a calibrated test tone. Balancing the bridge then produces a readout of the component value. Naturally a micro-processor takes care of the details, eliminating much knob-twiddling and nulling of meters. The older manual models always seemed quite willing to null, even at three or four different values that didn't make sense.

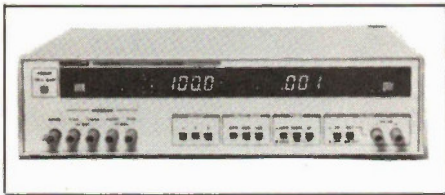

The Leader LCR 745 is a digital LCR meter featuring automatic and manual ranging. This CPU-controlled meter is designed to measure capacitance, inductance, resistance, dissipation factor and quality factor. The accuracy is plus or minus 0.35 percent of the reading. Test frequencies of 1kHz and 120Hz are switch selectable.

Omnitronix Ltd. (see under Oscilloscopes)

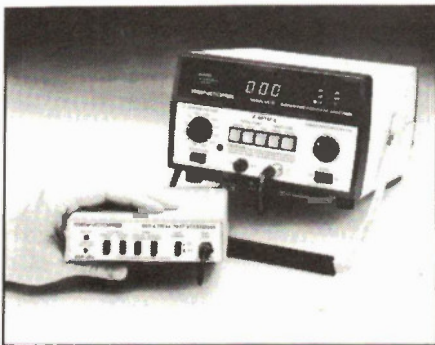

The Sencore Model LC75, also known as the Z Meter, is said to have high speed when checking capacitors and inductors due a larger charge current than previous models. It also tests for ESR (Equivalent Series Resistance), an important parameter for capacitors in switching PSUs, etc. Included in the capacitor test are leakage and dielectric absorption. An optional accessory, the SCR 250, allows the

Electronics Today July 1986

unit to test SCRs and triacs. Full autoranging.

Duncan Instruments (see under Generators).



The Wayne Kerr LCR Meter 4220 is designed for the production line, and features not only auto-ranging, but detection of the type of component inserted. Capacitors, inductors and resistors can be tested over 8 decades of range. The component fixture is a 4-wire type which effectively cancels errors caused by contact resistance and contact lead impedance.

Wayne Kerr Inc., 600 West Cummings Park, Woburn, MA 01801, (617) 938-8390.

Circle No. 50

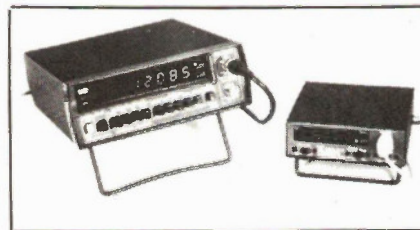

The Triplet 7000 Series frequency counters cover a wide range of frequencies. The Model 7200, a compact version, counts from 5Hz to 160MHz with a variable gate time. The 7500 (10Hz to 150MHz) and the 7700 (dual channel, 10Hz-100MHz and 50MHz-550MHz) feature period and RPM measurement.

Len Finkler and Co. (see under Oscilloscopes)

Not as exotic as it might seem, the Novasina Dewpoint Transmitter indicates the dewpoint temperature and ambient temperature of air or other gas. That's the temperature at which condensation forms, for those who haven't struggled with pink fiberglass insulation during renovations. Typical applications are DP measurements in cold storage rooms, dry-

FREE
CATALOG
AND
APPLICATIONS GUIDE

**RECORDING
ENGINEERING
SOFTWARE**

PCDOS • MSDOS • CP/M • TRDOS

PDP — Plotter Driver Program For multi and single pen plotters	\$72.95
XFER — Transfer Function Synthesis Transfer functions → Electronic circuits	\$72.95
TEKCALC — Scientific Calculator Program Screen graphics/Statistics/Programmable	\$72.95
COMCALC — Communications Design Spreadsheet Communications budget calculator	\$72.95
RIGHTWRITER — Report Proofreader Program Version 2 — Applies 2,200 rules of English	\$97.95

ACNAP — AC Network Analysis	\$72.95
DCNAP — DC Network Analysis	\$72.95
SPP — Signal Processing Program	\$72.95
PLOTPRO — Scientific Graph Printing	\$72.95
PCPLOT — High Resolution Graphics	\$72.95
LOCIPRO — Root Locus Analysis	\$72.95
ACTFIL — Active Filter Design	\$72.95
STAP — Static Thermal Analysis	\$72.95
MATRIC MAGIC — Matrix Manipulation	\$72.95

Circle No. 29 on Reader Service Card

BV Engineering
Professional Software



2200 Business Way, Suite 207, Riverside, CA 92501 U.S.A.
(714) 781-0252 All price U.S. \$ include S&H

PC/XT EXPANSION PRODUCTS

	Retail Price
Main Board 8 slot (256K)	\$240.00
Colour Graphics Card	\$100.00
Multifunction Card (384K) & Cable	\$230.00
512 RAM Card (OK)	\$ 80.00
Disk Controller Card & Cable	\$ 75.00
135 W Power Supply	\$130.00
Monochrome Display/Printer Card	\$111.00
Monographics Printer (Herc.Comp.)	\$130.00
360K DSDD Drive from	\$140.00
Asuka Drive (for Apple)	\$160.00
Keyboard for IBM	\$105.00
Segate (20MB) Hard Disk & Controller	\$750.00
Flip-top XT Computer Case	\$ 70.00
High Resolution TTL Monitor from	\$185.00
High Resolution Display Monitor from	\$140.00
SmarteAM modem (1200 Baud)	\$325.00
PC/XT Eprom Write Card	\$220.00
Apple Eprom Write Card	\$ 89.00
Panasonic Printer (KX 1091)	\$450.00
EGA Card	\$630.00
V20 Turbo CPU	\$ 15.00
I/O Plus II	\$120.00
Multi I/O	\$160.00
8087-3	\$179.00

AT/XT COMPATIBLE SYSTEMS

Please call for details

RAMS		EPROMS	
4116 150	\$1.00	2716	\$ 3.00
4164 150	\$1.50	2732	\$ 4.00
4128	\$9.50	2764	\$ 4.50
41256	\$4.50	27256	\$14.00

Note: Prices subject to change without notice. FST extra for all IC's.

Computer Parts, I.C. & Memories Specialist
Dealers Inquiries welcome — price lowest in town

PATRON COMPONENTS INC.

4002 Sheppard Ave. E. Suite 506,
Toronto, Ontario M1S 1S6
Tel. (416) 299-7731
Telex: 065-25256 PATRON TOR
FAX NO. (416) 298-4569

Circle No. 28 on Reader Service Card 33



The **Hioki 3601** is a counter with lots of features all in one box, including period, frequency ratio, time interval, pulse width, duty cycle, totalize and RPM. Three ranges cover 10Hz to 160MHz, and the reciprocal counting method can be used to improve resolution. Averaging and difference measuring minimize the effect of noise. The unit can be connected to a GPIB (General Purpose Instrument Bus), enabling computer control and data acquisition.

RCC Electronics (see under Oscilloscopes).



The **Goodwill GFC8010F** is a 120MHz counter using two ranges, eight digits and LSI technology to shrink the size. The 1 megohm input impedance likes to see about 10 to 30mV depending on the frequency. Gate times of 0.1s, 1s, and 10s are switch selectable.

Duncan Instruments Ltd. (see under Generators).

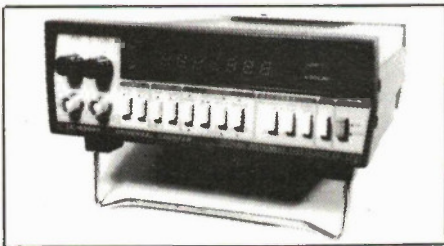

If you need a two-channel counter, the **King Instrument KI6304A Universal Counter** has, indeed, two. It can measure frequency, period, time interval and ratio. It can totalize measurements. It has a range of 10Hz to 10MHz and 1MHz to 100MHz prescaled on A. It has a range of 2.5MHz direct on B. It has seven digits. It comes from:

RCC Electronics (see under Oscilloscopes).

Digital Multimeters

The DMM is now so inexpensive and so full of features that they're replacing the standard moving-coil multimeter as the basic bench meter. Maybe they'll even get to the point where they'll replace that \$20 needle meter that you have in your toolbox.

Once manufacturers get a custom chip to make their meters go, it's not abig step to design in extra features, such as diode testers or HFE measurement.



The **Brunelle 4060 DMM** has 3 1/2 digits, full-scale DC and AC volts from 200mV to over 750V, DC and AC current from 200uA to 10A, resistance from 200 ohms to 20M, a diode tester and HFE from 0 to 1999. DC accuracy is 0.25 percent and AC accuracy is 0.5 percent. The Brunelle line includes many other types of meters.

Brunelle Instruments (see under Generators)



If you prefer rotary switches to the side-buttons, the **Norma D1216** has what you want. It features DC and AC volts and amps, and a diode tester similar to the Brunelle 4060. DC accuracy is 0.2 percent and AC accuracy is 0.75 percent to 400Hz, 2.5 percent to 5kHz. A range of accessories is available for HF and HV measurements. Other styles of bench and handheld meters are available from the Norma line.

H.W. Cowan Ltd. (see under Oscilloscopes).

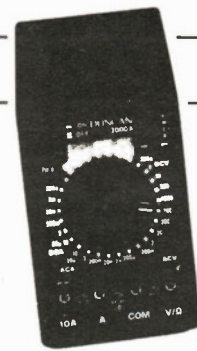

More good old rotary switches in the **Duncan Model 3000A**. Besides the usual, the 3000A reads DC and AC current to a remarkable 20uA FSD and HFE to 1000. A continuity beeper and diode tester are included.

Duncan Instruments (see under Generators).



The **Triplet Model 4750** has some unusual features. Besides the usual DMM scales, it has dBm, autoranging, temperature, data hold, peak hold, and true RMS measuring for AC. A reading can be stored as a zero reference point for making relative measurements. Basic DC accuracy is 0.04 percent. A wide range of adapters and accessories is available.

Len Finkler and Co. (see under Oscilloscopes).



The **Fluke Model 37** is a benchtop multimeter that incorporates some of the features found in Fluke's very successful 70-series DMMs. The digital display has the analog bargraph for ease in reading changing signals, a storage compartment

★★★★★ **FIVE** ★★★★★

STAR PERFORMANCE FROM HITACHI



DIGITAL + ANALOG STORAGE SCOPES

Whether recording lightning strikes, crash impact data or heartbeats, these digital and analog storage scopes will capture them all.



HIGH PERFORMANCE CRT READOUT DISPLAY

If top of the line is what you demand, these outperformers will top your list with features such as cursors, DVM, programmable on screen text, etc.



VIDEO WAVEFORM + VECTOR MONITORS

In the studio or on location, the versatility and performance of these instruments will steal the show.



PERFORMANCE PROVEN GENERAL PURPOSE

From 20 MHz to 100 MHz Hitachi's price/performance combination is second to none.



TOUGH MINI SCOPES

These rugged ultra-portables will take it, wherever the job takes them.



Call us for Performance Proven Electronics



Hitachi Denshi, Ltd. (Canada)

Head Office:
65 Melford Drive
Scarborough, Ontario M1B 2G6
Tel: (416) 299-5900
Toll Free: 1-800-268-3597
FAX: 1-416-299-0450
Tlx: 065-25324

Ottawa Office:
159 Colonnade Road, Unit 3
Nepean, Ontario K2E 7J4
Tel: (613) 727-3930
FAX: 1-613-727-3955
Tlx: 053-4533

Eastern Office:
8096 Route Trans Canadienne
St. Laurent, Quebec H4S 1M5
Tel: (514) 332-6687
FAX: 1-514-335-1664
Tlx: 0582-4768

Western Office:
3433-12th Street N.E.
Calgary, Alberta T2E 6S6
Tel: (403) 291-4388
FAX: 1-403-250-1634
Tlx: 03825-861

Circle No. 26 on Reader Service Card



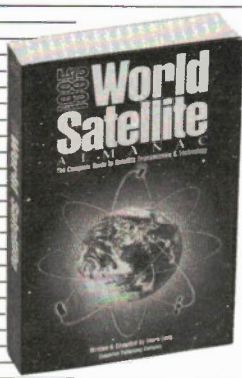

1985 World Satellite Almanac

\$56.95

more than 500 pages
over 350 maps,
charts & tables

NOW... ALL THE WORLD'S SATELLITES ILLUSTRATED, FOOTPRINTED, INDEXED AND ANALYZED IN ONE AUTHORITATIVE SOURCE.
Technical Data
Never Before Seen in Print

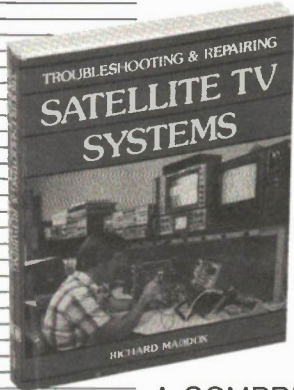

Troubleshooting & Repairing Satellite TV Systems

\$27.95

400 pages
351 Illustrations

A COMPREHENSIVE SERVICING GUIDE ON SATELLITE SYSTEMS FOR PROFESSIONAL TECHNICIANS AND OWNERS.
Schematics and Repair
Tips on 43 Different Model Devices

Meints-Shuster

400 BOUL. ROGER PILON
DOLLARD-DES-ORMEAUX
QUEBEC CANADA H9G 2K2



YES! please send me:

- _____ copies of the 1985 World Satellite Almanac
- _____ copies of the Troubleshooting & Repairing Satellite TV Systems

NAME _____ POSITION _____

COMPANY _____

ADDRESS _____

CITY _____ PROV. _____ POSTAL CODE _____

AMOUNT ENCLOSED \$ _____ (ADD \$3.00/BOOK FOR SHIPPING)
MAKE CHEQUE OR MONEY ORDER (CDN. FUNDS) PAYABLE TO:

Meints-Shuster

400 BOUL. ROGER PILON,
DOLLARD-DES-ORMEAUX
QUEBEC CANADA H9G 2K2 ALLOW 3 WEEKS FOR DELIVERY

**SORRY
UNABLE TO BILL**

Test Equipment

in the rear holds test leads and accessories, the unique Touch Hold feature captures readings for hands-free operation, and autoranging with manual selection is standard. Both min/max and relative measurements can be made. Under \$360.

Allan Crawford Associates (see under Generators)

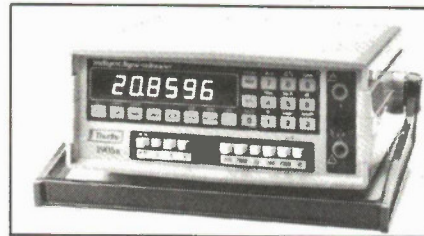

If you need more digits and computing power with your DMM, the Thurlby 1905A has that indeed. The display has 5 1/2 digits, and the micro inside can handle functions such as linear scaling with offset, percentage deviation, limits comparison, offset zero, decibels and so forth. Basic accuracy is 0.015 percent. Input impedance is selectable as 10M or an unusually high 10,000M. A data logging facility can record up to 100 readings in memory.

EDG Electronics, 3950 Chesswood Dr.,
Downsview, Ontario M3J 2W6, (416)
636-9404.

Circle No. 57

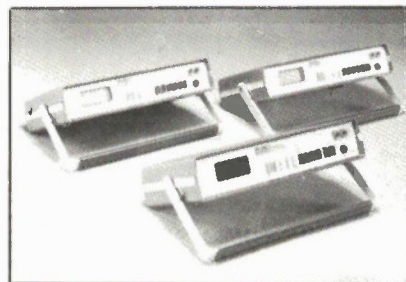

A new series of portable and benchtop DMMs is the OK 600 Series. The three models feature 29 ranges, 0.1 percent basic accuracy, 3 1/2 digits, and AC/battery power. They also have a diode checker, overrange indication and high common mode rejection.

Len Finkler and Co. (see under Oscilloscopes).



The new **Hioki 3217** is the smallest DMM available so far: a bit larger than a credit card, it fits nicely in a shirt or coat pocket. It features 3 1/2 digits, AC and DC volts to 450, resistance to 2M, an instantaneous continuity checker with a beeper and over-voltage protection, and a diode checker. Autoranging is standard. Complete with leads, battery and case.

RCC Electronics (see under Oscilloscopes).

Troubleshooting Aids

There are so many troubleshooting aids that we've started collecting them for a future issue. In the meantime, here are a few items that will ease the problem of trying to find an escaped byte or a dead volt.

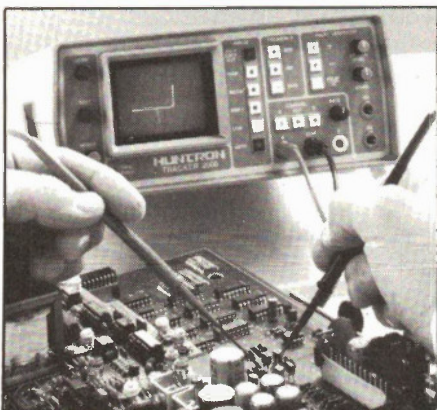

The **Huntron Tracker 2000A** and the **I Interface** from Cyprus Products can do in-circuit or out-of-circuit testing of ICs, analog circuits, digital circuits, etc. A wide range transistors and other reactive devices can be checked. The interface has two channels for test instruments, such as the Tracker on one channel and a meter on the other. A known good circuit can connect to one output and the device under test to the other, allowing comparison checking. The 2000A has automatic sequential switching and three test frequencies; a variable pulse generator allows testing of devices such as triacs and SCRs.

Circle No. 58

Cyprus Products, 7648 Heather St., Vancouver, BC V6P 3R1, (604) 327-8814.

Electronics Today July 1986

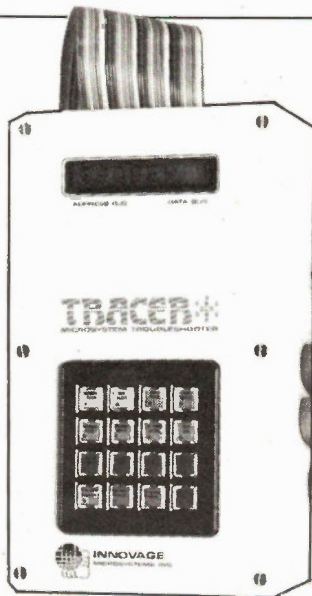

The **Tracer 100XT** from Innovage is designed for troubleshooting computers and logic systems. It connects to the CPU and allows you to operate it during testing. You can set breakpoints, test memory cells, examine or change memory contents, trigger a scope and more. Built-in diagnostics give you lots of information about the circuit under test. A Tracer is slated for a product review in an upcoming issue. The basic unit is \$1750.

Innovage Microsystems Inc., 5-6125 12 Street SE, Calgary, Alberta T2H 2K1, (403) 255-9590.

Circle No. 59



If your production models are plagued with stray electromagnetic emissions, the **Emscan** from Bell Northern Research reads EMI and displays the results on a colour monitor. All you do is place your gadget on the scanner, and its EMI emission is converted to an electronic fingerprint and displayed over the layout of the components, which is stored in the BNR computer-aided design system. Not the kind of thing you'll find at the corner milk store; there's no word yet about production quantities.

Bell Northern Research, PO Box 3511, Station C, Ottawa, Ontario K1Y 4H7, (613) 727-2958.

Circle No. 60

LIQUID CRYSTAL DISPLAYS

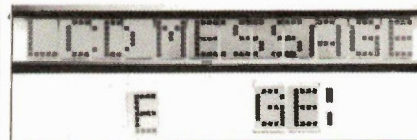

- Large 45x57mm character size 5x7 Dot Matrix LCD single digit display unit, built-in driver with memory, Serial Data Input/Output, can be cascaded into row configuration, available in various colours. . . \$19.95
- Programmable LCD moving message display board \$399.00



- Standard and custom design LCD's available with fast lead time for prototype and production runs. Our engineering facility provides technical support to interface LCD's into your products.

For more information please call or write:

ALL-CRYSTAL DISPLAYS

237 Lauzon Road, Windsor, Ontario, N8S 3L7

Tel: (519) 948-7225 Telex: 064-77624 WND

Circle No. 24 on Reader Service Card

AMAZING SCIENTIFIC and ELECTRONICS DEVICES

PLANS — All Parts Available in Stock.

- LCS BURNING CUTTING CO2 LASER \$20.00
- RUB3 RUBY LASER RAY PISTOL 20.00
- BTC5 1.5 MILLION VOLT TESLA COIL 15.00
- GRAI - GRAVITY GENERATOR 10.00
- MAGNETIC CANNON/PROJECTOR 10.00
- LRG3 SOLID STATE LASER RIFLE 10.00

KITS — Includes Plans and Parts

- LHC2K SIMULATED RED/GRN/YEL LIGHT LASER 34.50
- BTC3K 250,000 VOLT TESLA COIL 159.50
- IOG1K ION RAY GUN 109.50
- PSP3K PHASOR SHOCK WAVE PISTOL 49.50
- STG1K - STUN/PARALYZING GUN 39.50
- INF1K INFINITY TRANSMITTER 134.50
- MFT1K 2-3 MILE RANGE FM VOICE XMTR 49.50

ASSEMBLED AND TESTED PRODUCTS

- LGU30 RED 1MW PORTABLE HENE LASER 315.00
- TCL30 SOLID STATE TESLA COIL 35KV 74.50
- IPG50 POCKET PAIN FIELD GENERATOR 64.50
- BLS10 BLASTER DEFENSE WEAPON 89.50
- ITM10 - 100KV SHOCK AND STUN GUN 99.50
- PPF10 PHASOR PAIN FIELD PORTABLE 249.50
- SNP20 SECURITY PHONE LISTNER 99.50

• CATALOG CONTAINING DESCRIPTIONS OF ABOVE PLUS HUNDREDS MORE AVAILABLE FOR \$1.00 OR INCLUDED FREE WITH ALL ABOVE ORDERS.

PLEASE INCLUDE \$3.00 PH ON ALL KITS AND PRODUCTS PLANS ARE POSTAGE PAID. SEND CHECK, MO, VISA, MC IN US FUNDS.

INFORMATION UNLIMITED

P.O. Box 715, DEPT ET, AMHERST, NH 03031

Circle No. 25 on Reader Service Card 37

Miscellaneous Equipment

A grab-bag of goodies that do specialized jobs. Not everyone would like a wattmeter, for instance, but when you need one, you really need it.

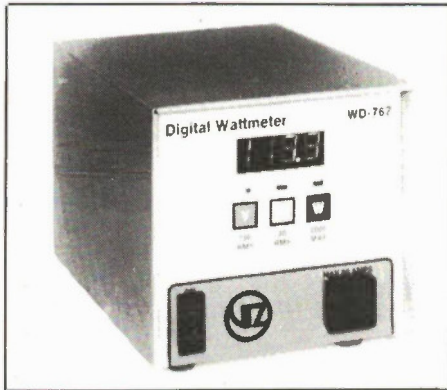

The Viz WD767 Wattmeter will display true RMS volts, true RMS current up to 20 amperes, and the true power level up to 2kW. The power factor can be determined by noting the difference between the displayed true power and the product of the displayed volts and amps. A unit is on the way for a product review, wherein we'll attempt to unravel the mystery of true versus apparent power in reactive cir-

cuits. In the meantime, should you want to measure true power within one percent, contact:

H. W. Cowan Canada Ltd. (see under Oscilloscopes).



The Daetron MC300 is a capacitor checker *par excellence*. It can test everything you've ever wanted to know about capacitors, plus some things you never thought of. A review of the unit appeared in the February, 1986 issue of *Elec-*

tronics Today. Test capacitance, dielectric absorption, leakage, insulation, cable length, sort capacitors in different modes, test transistors and zener diodes and more. All for \$149.95 and it's made in Canada.

Daetron, 935 The Queensway, Box 641, Toronto, Ontario M8Z 5Y9, (416) 255-9701. Circle No. 61

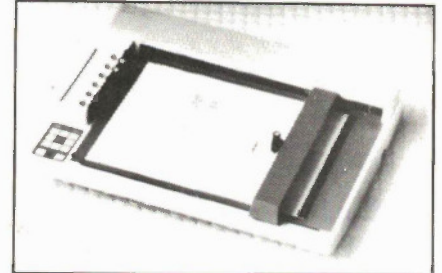

If you're hatching a plot, the Sekonic A3 Plotter is six pen digital unit; with appropriate software it is capable of high-quality engineering and business graphics. It's compatible with most computers and features Centronics or RS232 inputs. Plotting speed is up to 300mm/sec with a maximum resolution of .025mm and an accuracy of 0.2mm.

Omnitronix Ltd. (see under Oscilloscopes).

8088 SYSTEM \$699.00

(Major Boards made in Japan)

- 256K Memory ● One DSDD Disk Drive
- Controller Card
- Flip-Top Case and Keyboard
- Heavy Duty Power Supply ● 180 Day Warranty

(All you need for complete system is Video Card and Monitor)



COMPLETE 640K SYSTEM \$1250.00

- Two DSDD Disk Drive ● Controller Card
- Colour Graphic Card or Monochrome Display Card
- Real Time Clock ● Serial, Parallel and Game Ports
- Flip-Top Case and Keyboard ● Heavy Duty Power Supply ● 180 Day Warranty

(All you need to get the system ready to use is a Monitor)

MAIL ORDER: Cheque, Money Order, Certified Cheque plus \$20.00 for shipping and handling. Ontario residents add 7% P.S.T. (Prices subject to change without notice).

SUNIX INC. 578 MARLEE AVE. (At Glencarm Subway) Toronto, Ontario M6B 3J5
 Telex: 06-217736 SUNIX TOR. Tel: (416) 781-3263
 In Calgary, (403) 239-1813

sanwa LD Series DIGITAL MULTIMETERS



FEATURING:

- basic DC volt accuracy $\pm 0.5\%$
- auto or manual ranging
- audible continuity test
- 12 amp AC/DC current measurement
- up to 750 AC and 1000 DC volt measurement
- overload protected
- 1 year warranty

LD510 — Basic Model

LD520H — HFE Measuring Range

LD530F — Capacity Measuring Ranges

Optional units expand functions to temperature HFE, capacity and circuit check capability.

Free catalogue available upon request.

ARMACO Electronics Ltd.

224 West 5th Avenue, Vancouver, B.C. V5Y 1J3
 Telephone: (604) 876-4131 Telex: 04-53490

Precise Measurement From

RCC ELECTRONICS



FEATURES HIGH ACCURACY, KC 535B (SIMULTANEOUS AND EXTERNAL CONTROL.)

- switchable frequencies of 100, 120 and 1KHz
- auto or manual ranging
- external bias and offset adjustment for stray capacitance
- displays either C or L or D or Q simultaneously
- measure semiconductor capacitance
- options include I/O board, BCD output and GP-IB interface

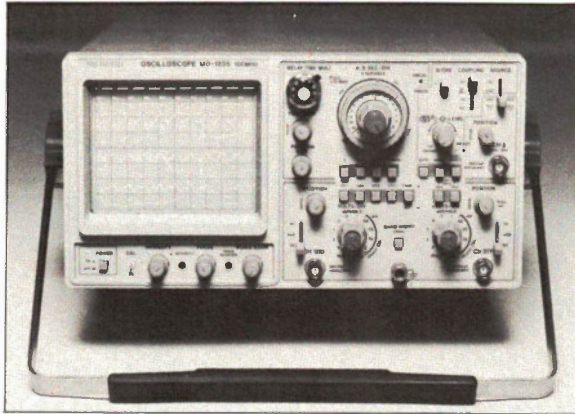

MEGRO MO-1225 – 'SCOPE FOR 100 MHz, EXCEPTIONALLY EASY TO OPERATE

- 3 channels and 8 traces
- alternate sweep
- 6-inch rectangular high luminance internally calibrated CRT
- wide dynamic range and 2-channel X-Y operation
- TV sync. separator circuit
- 20 MHz bandwidth limiter

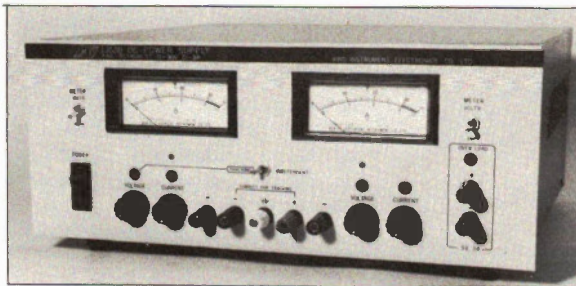

KING INSTRUMENT MODEL KI-1353B DUAL DC POWER SUPPLY

- A general purpose constant voltage/current limit supply.
- provides 3 types of output, 2-0-30V 3A variable, and a 5V 3A fixed
- employs an integrated circuit driven series transistor circuit to achieve high efficiency, excellent regulation, low ripple and noise, fast recovery
- voltage and current controls allow the voltage and current outputs to be varied from zero to the maximum rated value
- overload protection switches operate automatically from constant voltage operation to constant current operation when the load current exceeds the value established by the current control settings.



MEGURO MLA-3300 – LOGIC ANALYZER

MLA-3300 is a compact, light-weight logic analyzer with 16-channel data input and 100 ns maximum resolution (at 10 MHz). The liquid crystal display gives the analyzer very low power dissipation in logic circuits, making possible battery-powered operation (AC can also be used) where no other power source is available. The analyzer is designed to measure timing, state and signature and can be used in many applications from hardware to software.

With 256 Bit/Channel Acquisition Memory & 256 Bit/Channel Reference Memory, comparative acquisition are easily made. Combines three functions: Timing, Analyzer, State Analyzer & Signature. Analyzer in one unit.

Call or write for more information from the RCC office nearest you.

RCC ELECTRONICS

310 JUDSON ROAD, UNIT 6, TORONTO M8Z 5T6 (416) 252-5094

Montreal: 6600 Trans Canada Highway, Suite 750, Point Claire, Quebec, H9R 4S2, Telephone: (514) 694-6080, Telex: 05-821762

Vancouver: 119-255 West 1st Street, Unit 3, North Vancouver, B.C., V7M 3G8, Telephone: (604) 985-4065, Telex: 04-352841

Moncton: P.O. Box 921, Moncton, N.B., E1C 8N8, Telephone: Toll Free 1-800-361-2909

Quebec & Maritimes Toll Free 1-800-361-2909

ET-286 Plus

HyperSpeed SuperComputer

As artificial intelligence and expert systems become more the rule than the exception in personal computer software, and as office automation takes on larger and larger tasks, superior machines will emerge with attributes that support faster speed, massive memory and more extensive storage. Naturally, the drive to communicate will also stimulate a variety of networking applications.

In the OEM Marketplace, just such a superior machine already exists: The ET-286 plus. The ET-286 plus pushes back the envelope in personal computer performance without sacrificing compatibility with more conservative products.

The ET-286 plus is an IBM AT compatible singleboard computer from SOLTECH INDUSTRIES INC., designed for the most demanding applications in networking, office automation, CAD/CAM and high performance workstations. The ET-286 plus conforms to both the software and hardware compatibility requirements of the AT. It has the same form/fit characteristics, 6 full expansion slots, 2 PC/XT expansion slots, matching keyboard and power supply connectors plus high speed and high performance characteristics that set it apart from IBM and all the rest.

It isn't enough to be merely compatible... be the best

- 6/8/10 MHz 1 Wait State
- 6MHz 0 Wait State
- 12.5MHz Architecture
- 4 Meg On-Board Memory
- 6 Full AT Expansion Slots
- 2 PC/XT Expansion Slots
- 3 Serial Ports (Switchable)
 - RS-232
 - RS-422
- 2 Centronics Parallel Ports
- Built-In Clock/Calendar
- IBM AT Compatible BIOS

Also available: the standard for IBM PC/XT Compatibility, The ACS-1000 Super Computer.

- 1 Megabyte On-Board Memory
- Built-in Disk Controller
 - up to 4 Floppies
- 54 KB User Definable ROM
- Switchable: 4.77 or 8 MHz
- Built-in Multifunction Board
 - Parallel Printer Port
 - 2 Serial Ports
 - Time-of-day Clock

Seize Control of Your Hardware
Destiny

If you are using board level microcomputers you can have greater power, versatility and reliability by using ET-286 plus or the ACS-1000 Singleboard Supercomputers. These products have been designed for the serious OEM.

To order or for more details call

604-888-2606 or write
Soltech Industries Inc.
9274 - 194th Street
Surrey, B.C. V3T 4W2

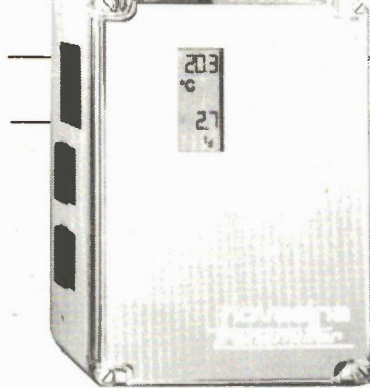

ing processes, or other industrial processing.

Alexander D. Smart Ltd., 351 Steelcase Road W., Unit 3, Markham, Ontario L3R 4H9, (416) 474-0550. Circle No. 63



When it comes to testing wire insulation, the old ohmmeter doesn't make it. You need a device with a high-voltage generator inside, and the Kyoritsu 3111 is an insulation tester that fills the bill, converting its battery voltage to 500 and 1000V. Current is limited to 500uA. There's also a continuity function with a 2 ohm mid scale. The word *earth* at the top of the dial means that you can plant flowers in it.

Omnitronix Ltd. (see under Oscilloscopes).



The convenience of the handheld digital thermometer means that they're replacing the glass bulb type. The Fluke Models 51 and 52 feature 0.1 degree C resolution, K or J thermocouples, internal compensation for ambient temperature, and a Hold button so you can run indoors and warm up before reading the liquid-crystal display. The Model 52 has two inputs, and will read either one or the difference between them.

Allan Crawford Associates (see under Generators).



After you've bought every single piece of test equipment in this article, you'll want to get some labels so you'll know which is which. The Brady Write-On labels are available pretitled; just write, peel off and apply. They're furnished on dispenser cards that flex easily for typewriter use. Custom labels available on request.

W.H. Brady Inc., 10 Marmac Drive, Rexdale, Ontario M9W 1E6, (416) 675-2112. Circle No. 64

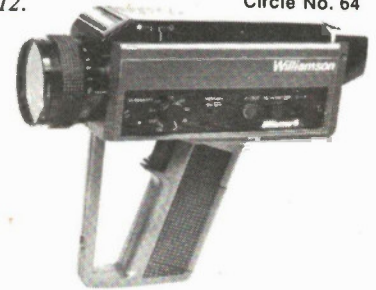

Yet another thermometer is the Thermostar 21DS. It's advantage is that it's a non-contact type that uses infrared optics and electronic processing. Single lens reflex optics allows simultaneous viewing and measuring of the target, and a filtering system lets the operator look safely at very high temperature objects. Analog and digital outputs are available for recorders or loggers.

Alexander D. Smart Limited (see above).



If you're interested in optical measuring and related test equipment the Optikon company has sent us the most amazing collection of catalogs and product sheets. Included are precision lens elements, prisms, mirrors, filters, fibre optics, lasers, every conceivable type of fibre optic generator and test set, spectral analyzers, photometers, radiometers, and more. They're also the representatives for Micro-Controle, a firm specializing in computer- or manually-controlled mounting devices and servomotors for optoelectronics, microscopy, microelectronics, etc.

Optikon Corporation Ltd., 410 Conestogo Road, Waterloo, Ontario N2L 4E2, (519) 885-2551. Circle No. 65

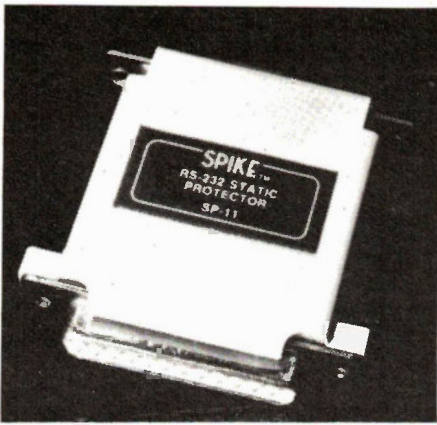

Now that more and more test units are becoming fairly intelligent, they communicate amongst themselves using one of several methods. If you're using the common RS232 serial communications links, you might be interested in the **RS232 Static Protector**. It comes complete with in and out connectors and installs between a piece of equipment and its cable. Metal oxide varistors snip off over-voltage spikes, and where's a better place to find overvoltage spikes than a testbench?

Home Base Inc., 60 Nably Court, Scarborough, Ontario M1B 2K9, (416) 293-4488. Circle No. 66



The **TestWriter** is a software product designed to reduce the time and money involved in developing guided fault isolation (GFI) programs for digital circuit testing. It's used with an IBM or IBM compatible computer in conjunction with the Fluke 9020A microsystem troubleshooter. Fault trees are automatically generated and displayed from information supplied by the user, such as component type and interconnections. The operator makes selections from menus, guided by prompts and graphics.

Allan Crawford Associates (see under Generators)

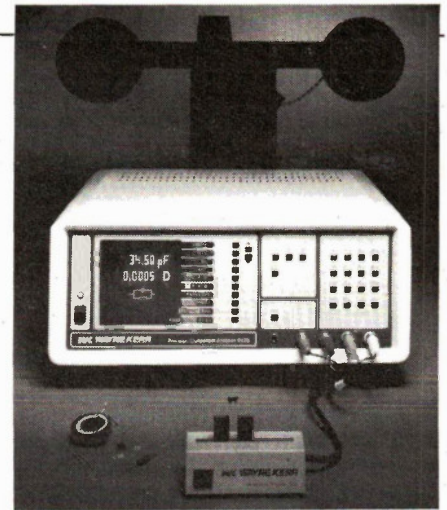

A colour brochure is available describing the **6425 Component Analyzer** from Wayne Kerr. It measures the usual LCR values, plus phase angle, dissipation factor, impedance, Q, and more. The display is a 7-inch CRT which shows values plus the schematic representation of the component or components being tested. The main menu (index) lets the user enter various limits for batch testing.

Wayne Kerr Instruments (see under LCR meters).

LASER 128

PERSONAL COMPUTER
128K RAM
ON BOARD



APPLE COMPATIBLE
INTRODUCTORY PRICE
ONLY \$789.95

ONE FULL YEAR WARRANTY RUNS LIKE //e, LOOKS LIKE A //c

HOT NEW item for '86

Built In Features

- 5 1/4" Disk Drive & Controller
- Z-80 Co-Processor RUNS CP/M
- Mouse & Joystick Port Interface
- Serial Printer Port Interface
- Parallel Printer RS-232 Interface
- Modem Port Interface
- 128K on board RAM — 32K ROM
- Expansion Slot (Apple @ Cards)
- Volume Control & Ear Jack
- Numeric Key Pad & 10 Funct. Keys
- Switchable to Divorak Keyboard
- LCD Display & Battery (Optional)
- RGB Runs Double Hi-Res, 16 Color Background, Backdrop & Text Graphics Resolution 560H x 384V

Optional Accessories

- External Drive \$207.00
- 256K Expand Ram Call
- Mouse \$113.95
- Serial Cable \$ 29.95
- Parallel Cable \$ 32.95
- Modem \$152.00
- RGB Cable \$ 29.95
- Joystick \$ 21.95
- LCD Display Call
- Battery Pack Call

Apple Peripherals

- Technico Drive \$174.95
- Z-80 Card \$ 39.95
- //e Numeric Key Pad \$ 49.95

Call for other peripherals

AB&C ELECTRONIC ENTERPRISES

P.O. BOX 662, THUNDER BAY, ONTARIO P7C 4W6
TELEPHONE (807) 623-6111
Dealer Enquiries Invited

Ont. Res. add 7% P.S.T. Cert. Cheque or Money Order, Visa & Mastercard accepted. Allow three weeks for delivery. Full refund if returned within 15 days. Add \$5.00 for shipping & handling. Prices subject to change without notice. Apple //e, //c are registered trademarks of Apple Computer Inc.

Circle No. 31 on Reader Service Card.

ELECTRONIC LOVERS WANTED

IF you're a Student and you Love our Discounts

IF you're a Small Business and you Love our Services

IF you Love our Choice of Parts

IF you Love our Prices and you Love Electronics

Then

HOBBILT is the Place You'll Love

HOBBILT

7454 Langelier St. Leonard, Quebec H1S 3B7
(514) 259-5581

Your Name, Address and \$1.50 Gets You Our Current Catalogue

Circle No. 32 on Reader Service Card.

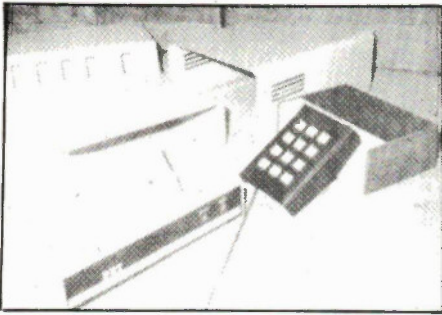

If you're thinking of making test equipment or other electronic products for yourself or for resale, you might want to contact **Canadian Computer Designers Mfg.** of Mississauga, Ont. They specialize in custom prototyping and new product design and development. Available are custom cabinets, computer cabinets, rack enclosures, custom heatsinks, bezels, brackets, etc.

Canadian Computer Designers Mfg., 7150 Torbram Rd., Unit 10, Mississauga, Ontario L4T 4B5, (416) 673-7773.

Circle No. 67



The **Alnor 8525 Thermoanemometer** has a digital readout, a hold button and an automatic averaging feature. Temperature can be measured from 0-70 degrees C (32-158 F), and air velocity can be measured from 20 to 2000 feet per minute. Some applications include air measurement in fume hoods, spray booths, air handling ducts, clean rooms, etc.

Alnor Instrument Company, 7555 N. Linder Ave., Skokie, Illinois 60077, (312) 647-7866.

Circle No. 68

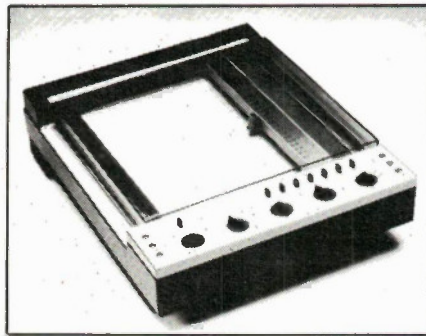

The **J.J. Lloyd PL 4** is an XY/t flat bed recorder that's easily transportable. Both input amplifiers have high-Z inputs and 18-step attenuators with maximum sensitivity of 25uV/mm. The electronically controlled chart drive has 9 speeds from 2mm/min to 20mm/sec. Calibration accuracy is greater than 0.2 percent.

Omnitronix (see under Oscilloscopes).

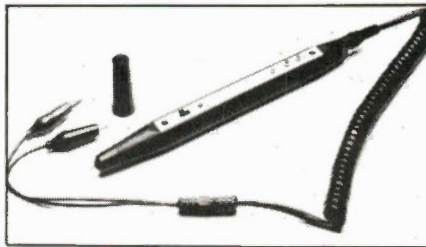

A digital logic pulser that helps performs in-circuit diagnosis is the **OK PLS-500**. The handheld pulser injects a signal into the circuit node so the response can be observed using a logic probe. This eliminates the need to desolder the device from the circuit board. The pulser is also capable of triggering or being triggered by another instrument. Pulse duration is 2us, long enough for accuracy and short enough to prevent damage to the device under test.

Len Finkler and Co. (see under Oscilloscopes).

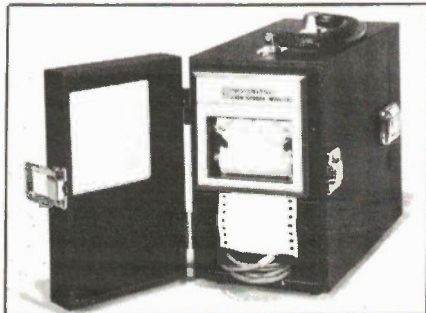

Another recorder is the **Kyoritsu 5350**. It's portable, loads by cassette, and its major feature is its ease of operation. There are three speeds, plus the capability of recording continuously for 33 days, measuring

temperature, voltage, current, etc. It can also panel-mount.

Omnitronix (see under Oscilloscopes).

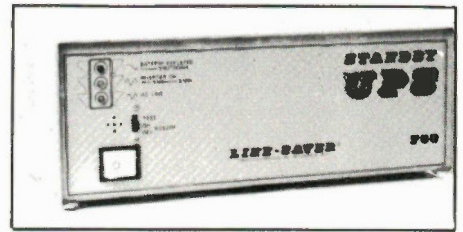

If you have a whole testbench full of computerized equipment, you know how annoying a power outage can be, particularly if you lose a lot of preselected settings. One cure is an uninterruptible power system, and one example of those is the **LS750 Line-Saver** by Kalglo. The 36V sealed rechargeable battery inside is converted to 750W worth of output, available in 120/240V, 50/60Hz. The output voltage is regulated by pulse-width modulation for best efficiency. Backup time is 5-10 minutes at full load, 35-40 minutes at one-third load.

Duncan Instruments (see under Generators).

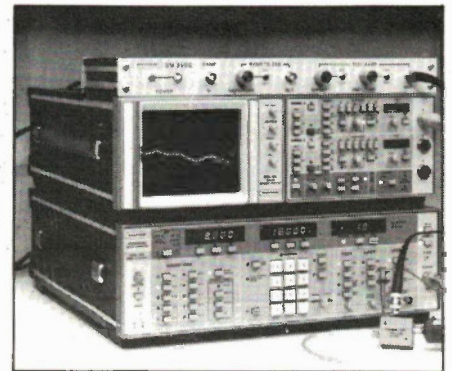

The **Wiltron SM3500** ramp generator is designed specifically for testing voltage controlled devices. Used in conjunction with the Wiltron 5600 analyzer, it simplifies the testing and analysis of devices whose characteristics vary due to an applied voltage. Loss or gain can be displayed over a 71dB range with 0.01dB resolution. The test ramp output can be adjusted for peak to peak voltages over a plus or minus 13V range.

Wiltron Instruments Ltd., Unit 102, 215 Stafford Road, Nepean, Ontario K2H 9C1, (613) 726-8800.

Circle No. 69

The **Marcland uC 2000** is a low-cost microcomputer-based temperature controller. The overall accuracy is 0.25 percent, and it can accept both J and K type thermocouples. Setpoint limits are set with the front panel membrane switches. The unit's tiny size make it ideal where space is at a premium.

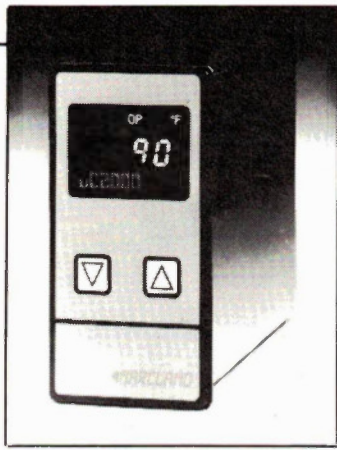

Marcland Instrument Services Inc., 156 St. Denis, St. Lambert, Quebec J4P 2G2, (514) 866-4607. Circle No. 70

If you have to calibrate equipment or components to specific AC voltages, the CDC-32 is an AC calibrator for meters, A/D converters, amplifiers, RMS converters, AC gain control circuits, etc. The output range is 10VAC RMS, with an accuracy of 0.06 percent of the setting. Output frequencies are 50, 60 and 400Hz. \$995US.

Electronic Development Corporation,

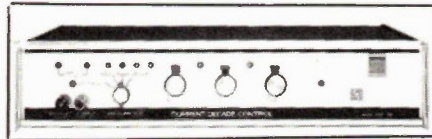

11 Hamlin St., Boston, MA 02127, (617) 268-9696.



Inadvertently omitted from the section on oscilloscopes was the Philips PM3055. A 50Mhz scope, it features microprocessor control of just about everything. All parameters can be set instantly at the touch of one button, and an LCD panel reads out the settings. Automatic up/down buttons replace the usual stepped switches, and multifunction softkeys simplify the front panel layout. Other scopes in the 3050 series include a

100MHz model, IEEE computer hookup, etc. \$1825.

Philips Electronics Ltd., S&I Division - Test and Measurement, 601 Milner Ave., Scarborough, Ontario M1B 1M6, (416) 292-5161. Circle No. 71

Catalogs

Here are just a few of the many catalogs we receive from distributors, and as usual, our apologies to those who had to be omitted due to space restrictions.



B&K Dynascan is represented by Atlas Electronics, 50 Wingold Ave., Toronto M6B 1P7, (416) 789-7761. The immense B&K line includes scopes, meters, generators, analyzers, and you name it.

When Accuracy Counts... You Can Count On Us... Since 1977

THE BRUNELLE Commander SERIES

Model 4070 - 4½ Digit Multimeter

\$189.00

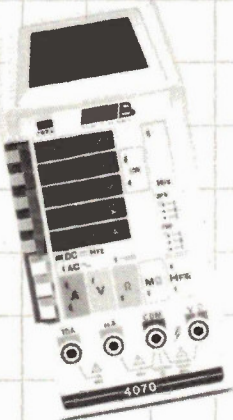

- 4½ digit LCD Display
- .05% basic DC Accuracy
- Overload Protection
- Audio and Visual Continuity Function
- Diode Test Function
- Transistor Test Function
- 10A AC/DC Current Measurement
- Up to 1000 Volts DC Measurement
- Safety Designed Input Jacks And Test Leads
- One (1) year warranty
- ClampOn Ammeter, Temperature Adaptor, HV Probes, Carrying Case, etc. (OPTIONAL)

Model 3020 - Function Generator

\$274.99

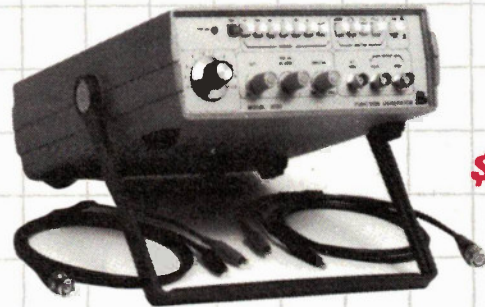

- .2HZ to 2MHZ (7 ranges)
- Wave Forms: Sine, Triangle, Square, Ramp and Pulse
- Output Level: ▶ 20VP.P Open Circuit
- VCF: 0 to 10V (1000:1)
- Attractive Styling
- Two (2) Year Warranty

• Quality + Price + Service = **BRUNELLE**



Brunelle Instruments Inc.
73-6th Range South
Saint Elie D'orford, Quebec, J0B 2S0
Tel: 1-819-569-1408 Telex: 05-836266

Mail Order: Certified Cheque, Money Order, COD's FOB St-Elie, Quebec Residents add 9% P.S.T.

OR

CALL COLLECT: 1-819-569-1408

1986 Catalog of Testing & Measuring Instruments for the Professional



The AEMC line from Boston is represented by Duncan Instruments, 121 Milvan Drive, Toronto M9L 1Z8, (416) 742-4448. They make bridges, cable equipment, multimeters, add-on modules for varied functions, current testers, power meters, light meters, etc.

Product Guide

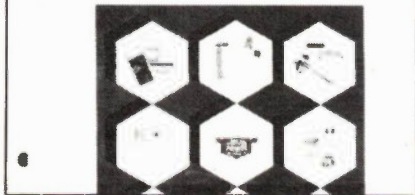

Cardinal Industrial Electronics supply western Canada with components, test equipment, cabinetry, audio equipment, chemicals and more. They have outlets in Calgary and Saskatoon, with the head office at Box 12000, Edmonton, Alberta T5J 2P4, (403) 483-6266. Circle No. 72



EICO the well-known manufacturer of test equipment in both kit and assembled form, is represented by H.W. Cowan Canada Ltd., 99 Coons Rd., P.O. Box 268, Richmond Hill, Ontario L4C 4Y2, (416) 773-4331. Circle No. 73

In the market for a chart recorder? The CR600 from J.J. Lloyds has a chart width of 250mm and two fully overlapping pens offering versatility as well as precision and linearity. The unit has an accuracy of bet-



ter than 0.25%, linearity of 0.25%. Chart drive speeds range from 0.01mm/sec to 10mm/sec with a writing speed of 600mm/sec. The instrument also has switched calibrated ranges from 5uV/mm to 500uV/mm with a variable span control providing a complete overlap precision voltage source for calibration. Useful chart widths of up to 2 meters are possible using standard roll chart or Z-fold paper. Other features include: reverse direction, external speed, pen lift, and optional rack mounting hardware for operation in a vertical plane.

Omnitronix Ltd., 2410 Dunwin Dr.
Unit 4, Mississauga, Ont., L5L 1J9. (416)
828-6221 Circle No. 74



If it's a weight indicator you're looking for, the Bofors E1-TAD Digital Weight Indicator is state of the art, designed to meet current and future user needs. In addition to normal weighing functions, its three microprocessors allow future communication to larger integrated systems. The unit may be operated from the front panel keyboard or via the Full Duplex 20mA serial loop. RS232c, RS422 and RS423 interfaces are optional.

Standard features of the E1-TAD are: zero-track, motion detection, 5 selectable tare modes, error messages from continuous diagnostics, a watchdog timer, remote control, and adjustable display brightness.

Options include analog outputs, BCD @ 5V or 24V levels, Setpoint Relays, and a real time clock. Various software options are available for batching, flow measurement, peak value display, manual tare, and accumulation.

Alexander D. Smart Ltd., 351 Steelcase Rd. W., Unit 3, Markham, Ontario L3R 4H9. (416) 474-0550 Circle No. 75

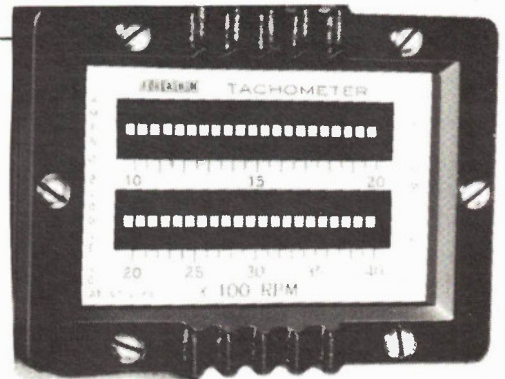

Checking the speed of your shaft is easy with Frahm Vibration Reed Tachometers. Handheld or permanently mounted, these tachs do not require direct contact with the rotating shaft or moving parts. No maintenance is required since there are no moving parts to wear or lubricate, and no power is required since tuned steel reeds are natural resonant indicators responding to machine vibration frequencies.

The instruments are not affected by ordinary temperature changes, stray negative fields or operating position and they will operate indefinitely under normal conditions with no discernible drift in natural frequency. Accuracy retention is within 0.3% of the rated vibration frequency. Standard and miniature types are available and all popular ranges are also available. Circle No. 76

Biddle Instruments, 510 Township Line Rd., Blue Bell, PA 19422. (215) 646-9200.



Get a grip on the situation with the Brunelle Model 6000 digital clamp-on volt-ammeter and insulation tester module. The unit features 7 functions: AC/DC volts, AC amps, resistance, diode check, continuity test and insulation tester with the optional Module Model 6001.

Capabilities include DC voltage measurement up to 1000 V, AC current up to 1000 A from 50 to 500Hz, and resistance from 0 to 2MOhms.

The Module Model 6001 insulation tester is a direct plug-in unit featuring two ranges, 0 to 20MOhms and 0 to 200MOhms, and it delivers an output voltage of 500 VDC. Both units are covered by a complete two year warranty.

Brunelle Instruments Inc., 69, 6th Range S., St-Elie D'Orford, Quebec, J0B 2S0. (819) 569-1408 Telex: 05-836266

Circle No. 77

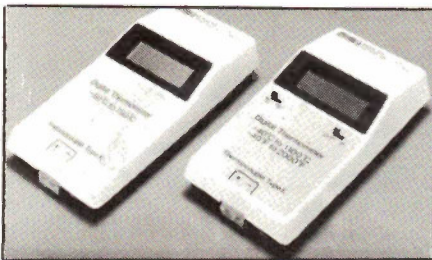

The Series 400 digital thermometers from O.K. Industries Inc. feature large, readable LCD displays and compact 'calculator' style enclosures suitable for a wide range of applications.

These low-cost devices are capable of measuring -50 to 750 degrees Celsius with a one degree resolution (Model 401) and -40 to 1100 degrees Celsius with a 0.1 degree resolution. Both units feature switchable C/F displays, operate on a single 9V battery, and accept any K-type thermocouple. Naked bead thermocouples and batteries are also supplied.

Len Finkler & Co. (see under Oscilloscopes).

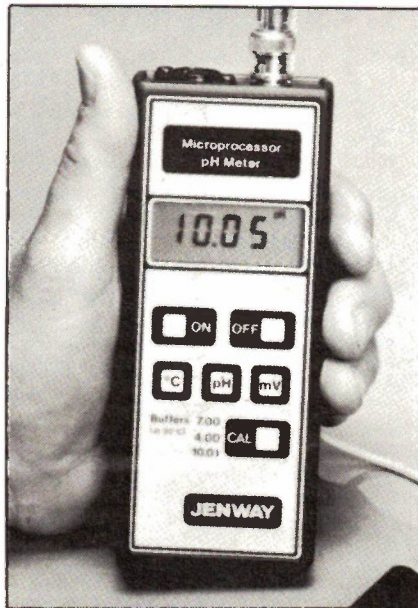

Claimed to be the world's smallest pH meter, the Model 3100 from Jenway, in Britain, is a handheld unit capable of measuring pH in the range of 0 to 14, as well as temperature and mV measurement from -30 to 150 degrees Celsius and from 0 to plus or minus 1999 mV.

Contained within the 150 x 60 x 26 mm, 140g case, is a bevy of microprocessor-based circuitry including: integral buffer-comparison memories, back-up memories which retain all data after powering down, and a microprocessor which controls all measurement functions and performs automatic calibration.

Included with the unit is a gel-filled combination electrode, automatic temperature compensator/measurement probe, a pack of 4 and 7 pH buffer powders, and a 9V battery.

Duncan Instruments Ltd. (see under Generators).

DOES YOUR DIGITAL CAPACITANCE METER DO THIS?

FULL 4 DIGIT 0.5 INCH LCD DISPLAY COMPLETELY AUTORANGING WITH 10 RANGE MANUAL CAPABILITY

AND THIS

RANGE OF 0.0 pF to 1 FARAD (999.9 mF)
0.5% BASIC ACCURACY UP TO 100 uF

AND THIS

READS DIELECTRIC ABSORPTION

AND THIS

EXTENDED PSEUDO 5 DIGIT
RESOLUTION ON SOME RANGES ONLY

AND THIS

ABILITY TO ZERO LARGE CAPACITANCE
VALUES UP TO 99.99 uF

AND THIS

CALCULATES TRUE CAPACITANCE
IF CAPACITOR IS LEAKY

AND THIS

DIODE CLAMP AND FUSED
PROTECTED INPUT.
DISCHARGE RESISTOR IN OFF
POSITION AT TERMINAL INPUTS.
POWERED BY 9V BATTERY

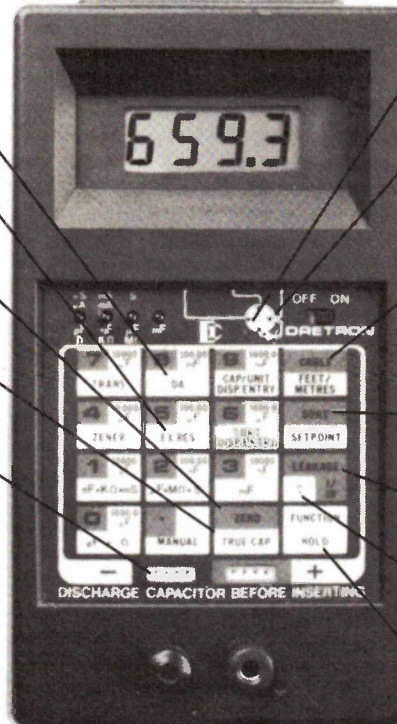

AND THIS

IDENTIFIES TRANSISTORS (NPN, PNP)
AND THEIR LEADS (E, B, C, ETC.)

AND THIS

TESTS ZENER DIODES AND RECTIFIERS.
UP TO 20V ZENER WITH AC ADAPTOR,
ZENER VOLTAGE WITH 9V BATTERY
DEPENDS ON ITS CONDITION

AND THIS

AUTOMATICALLY CALCULATES LENGTHS
OF CABLES IN FEET, METRES, MILES,
KILOMETRES (THEORETICAL RANGE
OF 9,999 MILES)

AND THIS

ABILITY TO SORT CAPACITORS IN
MANY DIFFERENT MODES

AND THIS

ABILITY TO READ LEAKY CAPACITANCE
(INSULATION RESISTANCE OR CURRENT)

AND THIS

CALCULATES TIME CONSTANTS WITH
USER DEFINED RESISTANCE VALUES

AND THIS

HOLD FUNCTION FREEZES DISPLAY

ONE YEAR PARTS & LABOUR WARRANTY

FOR ONLY THIS

\$169.95



MODEL MC300

Approx. Size
7" x 4" x 1 1/4"

DAETRON
A DIVISION OF BERGERON
TECHNOLOGIES INC.
935 THE QUEENSWAY
BOX 641
TORONTO ONTARIO M8Z 5Y9
(416) 263-9701

DEALER ENQUIRIES INVITED

MADE IN CANADA

PLEASE SEND ME

____ (QUANTITY) MC300(s) @	\$169.95	\$ _____
CARRYING CASE	\$19.95	\$ _____
AC ADAPTOR	\$11.00	\$ _____
ONTARIO RESIDENTS ADD 7% PST		\$ _____
SHIPPING AND HANDLING @ 5.00 per instrument		\$ _____
<input type="checkbox"/> I ENCLOSE CHEQUE <input type="checkbox"/> MONEY ORDER <input type="checkbox"/> BILL MY VISA		\$ _____
<input type="checkbox"/> VISA CARD NO. _____		
EXPIRY DATE _____	SIGNATURE _____	
NAME _____		
ADDRESS _____		
CITY _____	PROV. _____	POSTAL CODE _____

Circle No. 20 on Reader Service Card



DUNCAN INSTRUMENTS CANADA LTD.

ELECTRONIC INSTRUMENT SPECIALISTS
121 MILVAN DRIVE,
TORONTO, ONTARIO M9L 1Z8 TELEX: 065-27271

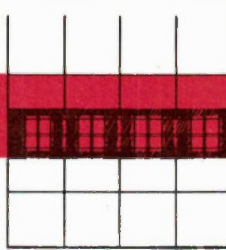

TOP LINE OSCILLOSCOPES. BOTTOM LINE PRICES.

FOR FULL DESCRIPTIVE BROCHURES: (416) 742-4448
Toll Free Number 1-800-387-7418

MODEL 6035 \$955.00

DUAL TRACE 35 MHz OSCILLOSCOPE

- 35MHz bandwidth (—3dB)
- Delayed trigger sweep
- Sensitivity 1mV
- 6" rectangular tube
- 10 ns rise time
- X-Y operation

MODEL 9100 \$2595.00

- Three Channel 100 MHz Oscilloscope
- Delayed Sweep
- Dual Time Base
- Fastest Horizontal Sweep to 2ns/DIV.
- Channel 1 Output
- TV Sync Separator
- Linear Focus
- Trigger Level Lock
- Dual-Trace

MODEL 6022 \$595.00

DUAL TRACE 20MHz OSCILLOSCOPE

- 6" CRT with internal graticule
- 20MHz bandwidth (—3 dB)
- Stabilized power supply
- Trace rotator
- Low power consumption
- X-Y mode; Add/Subtract; 5 trigger modes
- Built-in component tester

FREE

3½ Digit Multimeter \$100.00 value with every oscilloscope.
Refer to this Ad when ordering. Offer good to August 31, 1986

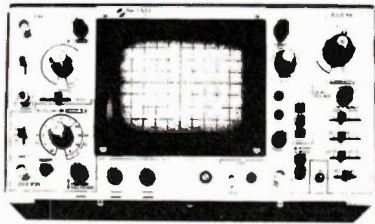

Circle No. 6 on Reader Service Card

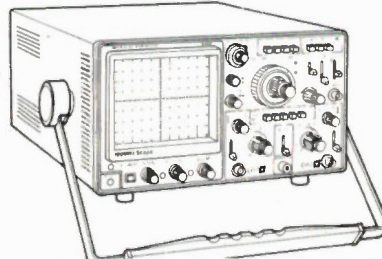

Circle No. 7 on Reader Service Card

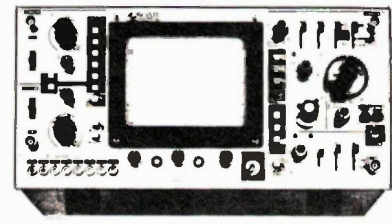

Circle No. 8 on Reader Service Card

PROBES & TEST/LEAD CLEARANCE

Model Number	Description	Regular Price	Sale* Price
1P20	X1 Probe, 20 MHz 1.5m Long	\$24.05	\$17.95
P100	X10 Probe, 100 MHz 1.5m Long	\$24.93	\$19.95
2P150	X10 Probe, 150 MHz 2.0m Long	\$26.82	\$18.95
TL 1000	Meter Test Leads	\$13.13	\$10.95
126074	BNC-Banana Patch Cord 1.0m Long	\$12.17	\$ 9.95
126083	BNC-CROC Patch Cord, 1.5m Long	\$10.74	\$ 8.95

Prices valid on current stock only. Some quantities are limited. Sale ends June 30th 1986.

Your Canadian Coline Sales
and Stocking Source.

Please add \$2 for shipping and handling.
Ontario residents please add 7% P.S.T.



980 Alness St. Unit 7,
Downsview, Ontario,
M3J 2S2
(416) 661-5585
TELEX 065-28169

Store Hours:

Monday to Friday 8:00 am to 5:00 pm.
Saturday: 10:00 am to 1:00 pm.

Circle No. 9 on Reader Service Card

Performance to Cost Ratio Second to None!

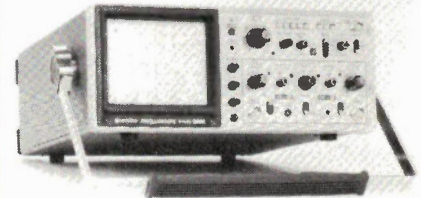

Hitachi Denshi

V1070A 100MHz, 4 channel, delay, CRT readout	\$3398.00
V1050 100MHz, 2 trace, delay	\$2460.00
V650 60MHz, 2 trace, delay	\$1878.00
V423 40MHz, 2 trace, delay	\$1619.00
V223 20MHz, 2 trace, delay	\$1283.00
V422 40MHz, 2 trace, DC offset	\$1497.00
V222 20MHz, 2 trace, DC offset	\$1107.00
V212 20MHz, 2 trace	\$ 938.00
V680 60MHz, 3 channel, delay, cursors ..	\$2525.00

Prices subject to change without notice. F.O.B. Woodbridge, F.S.T. included, shipping extra.

10% Off With This Coupon

Catalogues available upon request.

Mail Order: Cheque, Money Order, Certified Cheque, Visa. Ontario residents add 7% PST.

Credit Card Orders: Include card no., name on card, expiry date, signature.



Maruko International Corporation
ELECTRONICS DIV

50 Alex Avenue, Unit 2, Woodbridge, Ontario L4L 4K6
416-851-7764, 1-800-387-5881

Circle No. 10 on Reader Service Card



Synergy for Hire

Computers are what you make of them. We make them into instruments. We make 'em rock, we let 'em sing and we send 'em back into time and to play the music that has touched the souls of human beings for centuries. We're into MIDI, of course.

Computer based musical instruments can release the music in you that has thus far been battered into submission by the really boring bits of playing music. They can give you the freedom to compose without hassling over sheet music, the joy of arranging with several thousand players on tap... none of whom will ever want to take breaks... and the sublime ecstasy of playing with as much of the band as you want to have right at the ends of your arms.

The Book of Computer Music is a clear, easy to understand map through the tangle of patch cords, interfaces, software packages and other paraphernalia that has grown up around MIDI. It will make MIDI Music attainable for whatever you're up for. It gets into everything from a basic introduction, to choosing hardware and software, to composing, to code hacking and construction. And every word of it has been written by players for players. It's the single most encompassing, most comprehensible work on MIDI to date.

It's also home grown.

The Book of Computer Music will be available on the stands and at selected computer and music stores... the natural laws that govern the breaking of guitar strings during solos and the dropping of uninsured rented amplifiers by roadies will invariably see it sold out by the time you go to get one. You can assure yourself of a copy by sending \$4.95 to

Moorshead Publications
1300 Don Mills Road
Toronto, Ontario
M3B 1M8

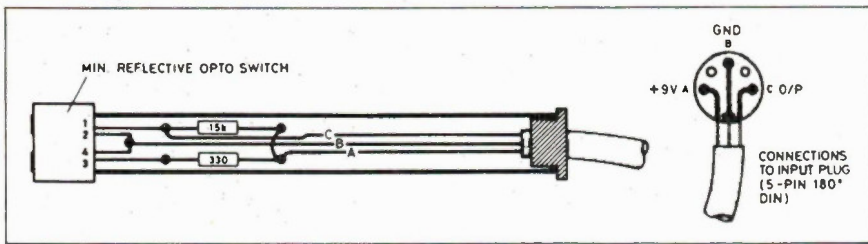

Fig. 8. The photo-reflective probe assembly and suggested method of construction.

prototype probe arrangement which uses the miniature photo-reflective switch device.

Testing and Calibration

The PCB and all external connections should be checked for dry joints, solder bridges and other wiring faults.

An audio signal generator (20Hz-20kHz) and a 5V DC voltmeter are required for calibrating the unit. The fre-

quency range switch is set to select the 0-500Hz range (the 1n capacitor is in circuit). Connect up the signal generator to the input and set it to 500Hz, 1V p/p output. VR1 can now be adjusted to give a 5V indication on the meter.

Adjust the signal-generator to other frequencies within the 0-500Hz range and check the linearity of the unit. The frequency range should now be switched to

0-5kHz and this range checked against the signal generator. ■

Electronics Today

Each year Electronics Today delivers thousands of sales leads processed through our Reader Service Card Program. These sales leads are qualified with name, address and title of respondent.

For advertising information call

(416) 445-5600

K.E.M.

We make your Prototype Plate - thru P.C. Board in only 5 days!



Business Items

- Hardware, software design
- Custom circuit design
- P.C. board design and films
- Proto-type P.C. board (not for mass production)
- Technical consultancy
- Electronic parts

Price Quotation Example:

4" x 5" PTH Board with 200 holes
\$145.00/for 2 pcs.

.....Ask for detailed price quotation list.....

K.E.M. Electronics Ltd.

Mail to Box 69126 Station (K), Vancouver, B.C. V5K 4W4
Office 879E. Hastings St., Vancouver, B.C. Tel: (604) 251-1514

MULTI-FUNCTION
COUNTER

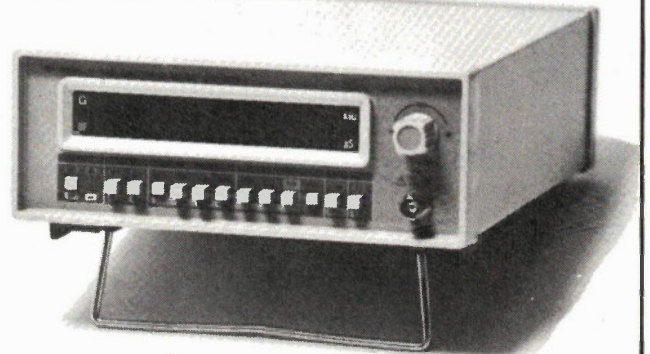

GREAT FEATURES, SUPER PRICE!

Here's a compact, lightweight 10 Hz to 100 MHz counter with four function performance. The unit features eight digit LED display, low power consumption circuit with functions for frequency, period, totalize and self check. Dimension are 3" x 8" x 10-1/2"

MODEL HCF-100

\$225

Order by phone or mail. VISA, money order, cert. cheque or C.O.D. Add \$10 for shipping and handling. Ontario residents add 7% PST.

KB ELECTRONICS

355 Iroquois Shore Road, Oakville, Ont. L6H 1M3
(416) 842-6888 Telex: 06-982396 (KBEL OKVL)

IF YOU'VE been shopping around lately for a new television set, you've probably heard the words Multichannel Television Sound being thrown about quite a bit. What it all means is that stereo television is now a reality. More importantly it means that broadcasters will be able to offer separate audio channels for things such as second language broadcasts as well as a professional channel for transmitting programming and non-programming materials to other stations.

Until recently, television has remained pretty much the same as it was from the outset with respect to sound quality - mediocre. Oh they added extra speakers here and there, and maybe some bass and treble controls, but these were only band-aid solutions to the problem.

Enter, the Federal Communications Commission, the Electronic Industries Association, and the Broadcast Television Systems Committee (EIA's TV industry watchdog), three very important players on the stereo TV stage.

The MTS Success

With the spectre of AM stereo lurking off

Stereo TV

An industry-wide standard and our hunger for quality TV sound has made stereo TV a reality.

By Edward Zapletal

in the shadows, the TV broadcasters and equipment manufacturers were eager to avoid a similar fiasco by offering to the FCC, a stereo transmission system that would be accepted as the industry-wide standard.

In case you're not familiar with AM stereo, it never really got off the ground because the FCC threw the marketplace open, hence, manufacturers of the transmission systems couldn't agree on a single standard. This left the consumer electronics manufacturers and broadcasters in a confused state as to which of the systems to endorse. As a result of this, AM stereo, and AM radio in general, remain in critical condition to this very day.

After having reviewed the various sub-

missions and suggestions from the manufacturers and broadcasters, the BTSC held a vote to select the best overall system. The system selected and given to the FCC for recommendation was developed by the Zenith Corporation, and in addition to this, a noise reduction system developed by dbx Corporation was also selected as the standard for NR.

Other systems were submitted by Telesonics and EIA (Japan), as well as noise reduction systems from CBS and Dolby.

In the late Spring of 1984, the FCC handed down a favorable decision on MTS along with new very general technical rules which allow the television aural baseband to be used for more than just monophonic broadcasting. The frequency range of 0 to 120 KHz, which was restricted to audio-only in the range of 50 Hz to 15 KHz for the main channel, was opened up for use in television



stereophonic sound, second language programming and any other broadcast or non-broadcast use.

It should be noted here that our own Department of Communications and the CRTC have gone along, in principle, with the U.S. rules and regulations regarding MTS. Various draft versions of broadcast

basic features such as L + R main channel, L-R sub-channel and the pilot tone were derived from its FM stereo cousin.

In the BTSC television main channel, the aural carrier modulation consists of a L + R audio signal with a pre-emphasis of 75 microseconds. The frequency range of this channel remains unchanged (50 Hz to

a frequency of $5f_H$ (78.670 KHz) and is frequency locked to $5f_H$ in the absence of modulation. The SAP audio signal is subjected to level encoding which is identical to that of the L-R sub-channel. The resulting SAP modulating signal is bandlimited to 10 KHz and frequency modulates the SAP subcarrier to a peak deviation of 10 KHz.

Although it is not in wide use as of yet, some experimentation is being done in areas close to the American-Mexican border, as well as in the Los Angeles area. At present, no licenses for SAP have been issued in Canada as the CRTC has not yet made an exact decision on just how to implement it.

Pro Channels

Imbedded amongst all this talk about MTS is its third and least apparent feature, the professional channel. It lives way up in the $6\frac{1}{2}f_H$ area of the baseband and is used primarily by the broadcasters for relaying voice or data information to crews in the field, or to other stations.

The maximum modulation frequency for voice signal is 3.4 KHz and for data is 1.5 KHz. While there is 150 microseconds of pre-emphasis applied to the voice signal there is none applied to the data signal. The total aural carrier peak deviation for this channel is 3 KHz.

Noise Reduction

Audio signal processing is not new to the broadcasting industry and whether it is used or not is up to the particular broadcaster. However, should noise reduction be implemented, the mandatory system to be used is the dbx Companding System, which is based on complementary audio processing at both the transmitter and receiver ends. The block diagram in Fig. 2 outlines the basic operation of the dbx encoder system used on the L-R and SAP sub-channels.

In order to maintain monophonic (L + R) compatibility, companding is not used on the main channel, however, it is provided on the stereo sub-channel. This is necessary because most of the noise is introduced in the sub-channel.

The system includes separate stereo difference and SAP compressors on the transmitting end, and a single expander for both stereo and SAP in the receiver. Stereo separation will be strongly influenced by the degree to which compressor and expander processing are complementary.

MTS Decoding - How It Works

The following description of the Zenith MTS Decoder is based on the unit used by Zenith during the EIA field tests. The block diagram is shown in Fig. 4.

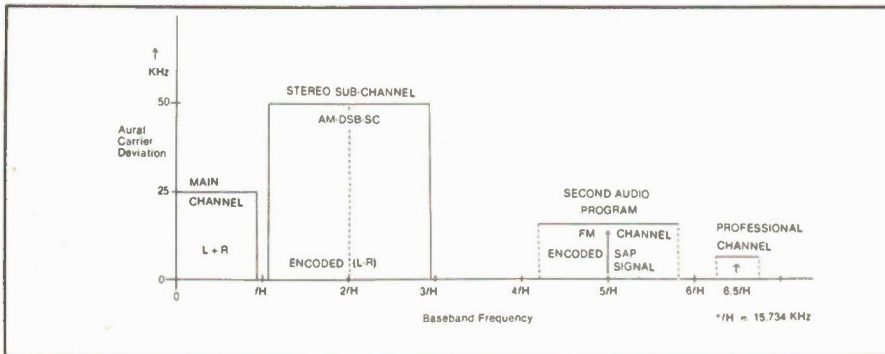

Fig. 1 A graph showing the layout of the baseband frequency vs. aural carrier deviation.

Signal Specifications								
Service or Signal	Modulating Signal	Max Mod Freq KHz	Audio Proc. or Pre-emph.	Sub-carrier Frequency	Sub-carrier Mod. type	Sub-carrier Dev. KHz	Aural Carrier Peak Dev. KHz	
Monophonic	L + R	15	75us				25*	
Pilot				f_H			5	
Stereo	L-R	15	dbx encoding	$2f_H$	AM DSB SC		50*	
SAP		10	dbx encoding	$5f_H$	FM	10	15	
Prof. Ch.	Voice Data	3.4 1.5	150us	$6\frac{1}{2}f_H$	FM FSK	3	3	
* Total does not exceed 50 KHz							Total	73

Table 1 Transmission standards for the BTSC system.

specifications, procedures, and information circulars are available, and no licensing of any kind is being done at this time. Any of the handful of television stations currently broadcasting in stereo, in Canada, are doing it purely on an experimental basis after filing their intent to do so with the D.O.C.

BTSC Stereo

The heart of the BTSC system lies in its pilot tone, located at 15734 Hz. The pilot tone allows receivers to recognize that transmissions are in stereo and to switch to that mode. To ensure compatibility and to prevent BTSC type receivers from falsely detecting other MTS formats, the FCC protected that frequency for use only in the BTSC system. Fig. 1 shows a chart of the complete audio baseband as it is now allowed to exist with provisions for the Second Audio Program and Professional channels. Table 1 is a summary of the signal specifications.

The concept of television stereo sound is not a completely new one; some of the

15 KHz) allowing older, non-stereo, television sets to receive the monophonic signal as they normally would.

The new TV L-R sub-channel, however, is subjected to level encoding (Fig. 2) which is part of the dbx Companding System. This level encoding in turn causes double-sideband, suppressed carrier amplitude modulation of a subcarrier at twice the horizontal picture scanning frequency (15734 Hz). The audio bandlimits of both the pre-emphasized L + R and encoded L-R channels are 50 Hz and 15 KHz.

Second Audio Program

One of the more innovative aspects of the BTSC system is the provision for simultaneous broadcasting of a second audio program or SAP. Put more simply, it means that a program broadcast in English, could also be received in another language such as French by merely switching the MTS decoder on your TV to the SAP position.

The subcarrier for the SAP channel has

Product Mart *Where Buyers Find Sellers*

TV GENIE channel 14 transmitter \$99.95. Cable TV Descrambling Techniques. 56 pages. \$13.95. Amazing see-in-the-dark Infra-Red night viewer kit \$295. Catalogs \$1. **CROSLEY(J)**, Box 173, Montreal, Canada H3X 3T4.

LUSCIOUS surprise pack of electronic parts \$6.00. 100% money back guarantee! Catalog 2-34¢ stamps. **MP2 SCIENTIFIC**, 33255 S. Fraserway, Suite 472, P.O. Box 8000, Abbotsford, B.C. V2S 6H1. BC residents please add 7% Sales Tax.

6502 MICROCONTROLLER

THE 6502 for your projects. 2 or 8k static ram, 2, 4, 8, 16, or 32K EPROM, 3 6522 VIA's, 1 or 2 Mhz clock, 65C02 hardware Compatible, small 8" x 4.5", **AGGA ELECTRONICS** a Division of RTP, P.O. Box 1848, Kelowna, BC, Canada, V1Y 8P2. Bare PCB with doc. \$44.95. BC Orders add 7% PST. U.S. orders add \$2.00 shipping.

**DO SMALL
ADVERTISEMENTS
ATTRACT ATTENTION?
WELL, THIS ONE DID!**

WHERE BUYERS FIND SELLERS

For more information Call:
(416) 445-5600

PRODUCT MART

LED...LED...LED.... Always in stock for immediate delivery by return mail. (5mm diffused) Red. \$0.10 - Green \$0.12 - Yellow \$0.12 - Amber \$0.14 - Orange \$0.14 - 2 pcs Holder \$0.4. Minimum order 100 each. Add \$2. for postage. Free sample and selection guide on your letterhead. To **SURPLUS ELECTRO QUEBEC**, 2264 Montee Gagnon, Blainville, P.Q. J7E 4H5.

J&J ELECTRONICS LTD., Box 1437E, Winnipeg Manitoba R3C 2Z4. Surplus and Semiconductor Specialists. Do you get our bargain flyer? Send \$1.00 to receive the current literature and specials and to be placed on the mailing list for future publications.

COMPUTRONIKS, 35 Queen St. E, Brampton, Ont. L6W 2A7. Visit or call us at 416-453-1166 for best "VALUE", IBM PC XT/AT compatible hardware and software for all computers.

Electronics Today Order Form

Subscriptions:

Please complete reverse side to start or renew a subscription.

Back Issues: \$4.00 each; Ontario residents add 7% sales tax.
Please circle issues desired.

1977	1978	1979	1980	1981
Feb. July	May Sept. Nov. Dec.	Feb. April May July Aug. Sept. Oct. Nov.	Jan. May June Nov. Dec.	Jan. Feb. March April June July Aug. Sept. Oct. Nov. Dec.
1982	1983	1984	1985	1986
Jan. March April May June July Aug. Oct.	Jan. Feb. March April Aug. Sept. Oct. Nov. Dec.	Jan. Feb. March April May June July Aug. Sept. Nov. Dec.	Jan. Feb. March April May June July Sept. Oct.	Jan. Feb. March April May

Binders: Electronics Today Computing Now!
 Moorshead Publications
\$9.75 each plus 7% P.S.T.

SPECIAL PUBLICATIONS

ITEM	QTY	AMOUNT
Book of Computer Music \$4.95	\$
Project Book No. 2 \$3.95	\$
50 Top Project \$4.95	\$
Your First Computer \$3.95	\$
Computers in Small Business \$3.95	\$

BOOKSHELF — Order Form

Code (e.g. BP12)	Title (Short-form is O.K.)	Price
.....	\$
.....	\$
.....	\$
.....	\$
.....	\$

SOFTWARE — Order Form

.....	\$
.....	\$
.....	\$
Sub Total	\$
Tax (Ontario Residents)	\$
Postage	\$1.00
Total Enclosed	\$

Orders from the Bookshelf are tax exempt. Please add \$1.00 for postage. Remember to put your name and address on reverse side. See over for mailing details. Specials and Software add 7% PST.



**ELECTRONICS TODAY
PRESENTS
MISTER BINDERHEAD!**

**ENJOY HOURS OF FUN MAKING
YOUR OWN FACES AND FEATURES!**
(Face peripherals not included)

IF you think we're scraping the bottom of the barrel this month for ideas to sell binders, you're right. This is probably one of the stupidest things we've done yet. And on top of all that, you have to go out and buy your own eyes, nose, moustache, etc.

In fact, we're almost on the edge of apologizing for coming up with nonsense like this.

What we don't apologize for, however, are our fine quality magazine binders, available with either **Electronics Today** or **Moorshead Publications** imprinted on the spine.

They each hold twelve issues with spring rods that eliminate cutting or punching, and these are spaced apart to prevent the magazines from bunching up or bending. Pages lie flat without removing the issue.

To order yours, specify the desired imprint and send \$9.75 (Ontario residents add 7% sales tax) to:

**Binders
Moorshead Publications
1300 Don Mills Rd.,
Don Mills, Ontario M3B 3M8**

**BE SURE OF YOUR ISSUE EACH
MONTH. SUBSCRIBE TODAY.**

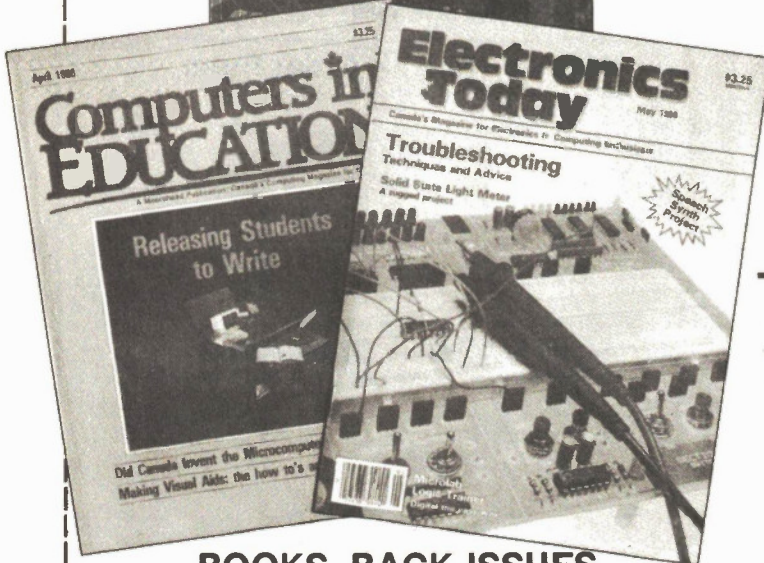
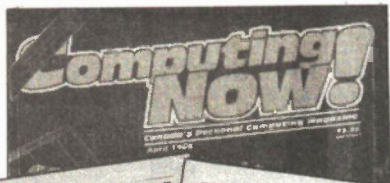

**BOOKS, BACK ISSUES,
SPECIAL PUBLICATIONS, BINDERS
— SEE OVER**

Moorshead Publications

1300 Don Mills Rd., Don Mills, Toronto, Ont. M3B 3M8

MERCHANDISE ORDER Please fill out form overleaf
SUBSCRIPTIONS: NEW SUBSCRIPTION RENEWAL

Electronics Today
 One year (12 issues) \$22.95 Two years (24 issues) \$37.95
Computing Now!

One year (12 issues) \$14.95 Two years (24 issues) \$27.95

Computers in Education

One year (10 issues) \$25.00 Two years (20 issues) \$45.00

Outside Canada (US Dollars)

For U.S. please add \$3.00 per year other countries add \$5 per year

NAME _____

ADDRESS _____

TOWN/CITY _____ PROVINCE/STATE _____

CODE _____ DATE _____

POSTAL CODE _____

Cheque enclosed DO NOT send cash

Mastercard Account No. _____

Visa Account No. _____

American Express Account No. _____

Expiry Date _____

Signature _____

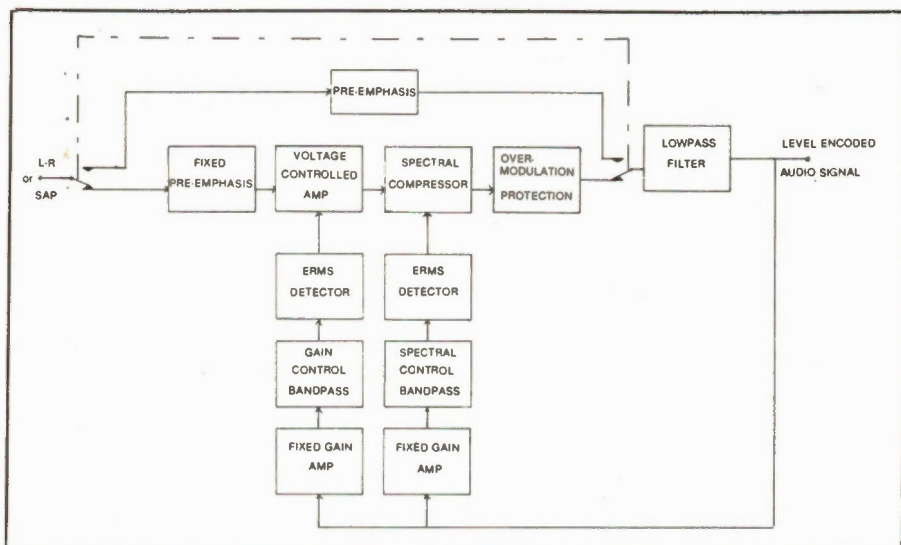

Fig. 2 Block diagram of the dbx Encoder system.

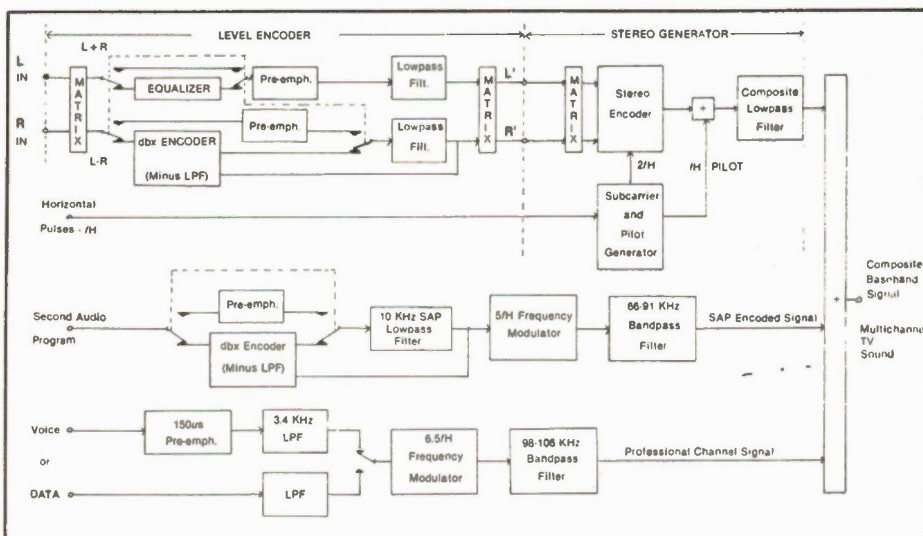

Fig. 3 MTS composite baseband signal generation system.

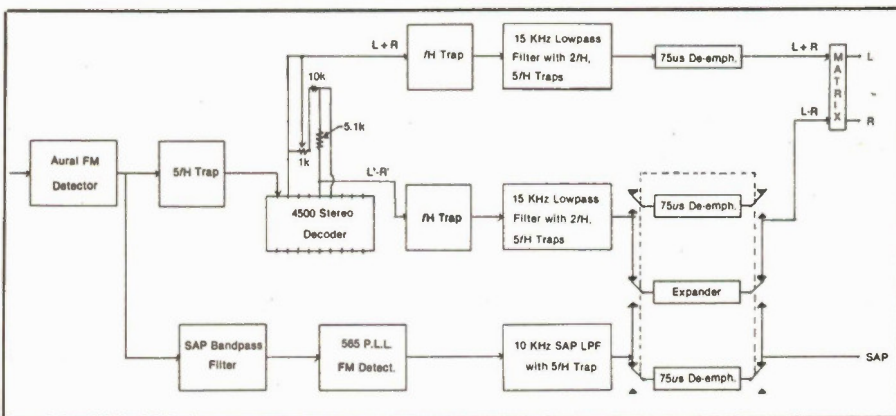

Fig. 4 Block diagram of the Zenith MTS decoder system with associated filters and traps.

The output of the aural FM Detector consists of the entire composite baseband (0 - 120 KHz). The 4500-type Stereo Decoder has inherent 5/H rejection

neither in the pilot path nor in the stereo sub-channel path. For this reason, a 5/H trap circuit precedes the Stereo Decoder. The unit is designed for L and R outputs

but L+R and L-R are needed for the companding process. In addition, no de-emphasis is required at the outputs of the 4500.

The dbx encoded L-R signal has to be bandlimited in order not to mislead the Expander Control circuits. The decoder has unwanted inherent outputs at f/H , $2/H$, $3/H$, $4/H$, and $7/H$ (SAP) and at all sidebands of those, except at f/H . For this reason the lowpass filter has traps at some of these frequencies. If high precision, high stereo separation expansion is desired, a compensating circuit may be included in the L+R path to duplicate that part of the Expander amplitude and phase response that is due to parasitics and to deliberate bandlimiting. This is similar to the process used in the Level Encoder of Fig. 3.

The L+R path includes a lowpass filter identical to the one in the L-R path assuring identical response in both, and thus good separation.

The SAP path includes, first, a bandpass filter arrangement. This is followed by a 565-type integrated circuit phase-locked loop FM detector. Next in the sequence is a 10 KHz lowpass filter intended to eliminate spurious signals above 10 KHz that might influence expansion control in a non-complementary manner. The fixed de-emphasis constituting the last stage in the Expander keeps the spurious signals out of the audio.

The block diagram also illustrates the use of a single switchable Expander for L-R and SAP. Whichever signal is not expanded has a 75 microsecond de-emphasis network instead. Two expanders are desirable for station monitoring - one for stereo and one for SAP.

What's Available

There probably isn't a major manufacturer of television sets out there who isn't producing something in the way of stereo products. Component TV has become extremely popular in recent years and although the initial outlay of cash may be slightly higher, upgrading your set is less difficult if you only want to change the tuner or the monitor separately.

VCRs have progressed steadily as well: first with stereo, then true Hi-Fi, and now they're available with built-in MTS decoders as well. With this kind of set-up, all you need to do is hook up to your component stereo and speakers and you're away.

Now that the manufacturing industry has the sound problem worked out for the most part, it looks as though they are concentrating on redesigning the picture tube to make it more space efficient. All that's left to do now is pressure the programming folks into giving us some real quality TV to watch on these high-tech sets. ■

NEW & REVISED

BABANI BOOKS

Imported from England and exclusively available in Canada from Moorshead Publications.

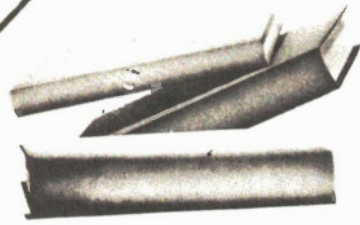

BP53: PRACTICAL ELECTRONICS CALCULATIONS AND FORMULAE \$11.75
A book that bridges the gap between complicated technical theory and the 'cut and try' method. A good reference book.

BP136: 25 SIMPLE INDOOR AND WINDOW AERIALS \$6.65
People living in apartments who would like to improve short-wave listening can benefit from these instructions on optimising the indoor aerial.

BP147: AN INTRODUCTION TO 6502 MACHINE CODE \$7.75
The popular 6502 microprocessor is used in many home computers; this is a guide to beginning assembly language.

BP150: AN INTRO. TO PROGRAMMING THE SINCLAIR QL \$7.75
Helps the reader make the best use of the Sinclair QL's almost unlimited range of features. Complements the manufacturer's handbook.

BP225: A PRACTICAL INTRODUCTION TO DIGITAL ICs \$6.65
This book deals mainly with TTL type chips such as the 7400 series. Simple projects and a complete practical construction of a Logic Test Circuit Set are included as well as details for a more complicated Digital Counter Timer project.

BP130: MICRO INTERFACING CIRCUITS - BOOK 1 \$8.55
Aimed at those who have some previous knowledge of electronics, but not necessarily an extensive one, the basis of the book is to help the individual understand the principles of interfacing circuits to microprocessor equipment.

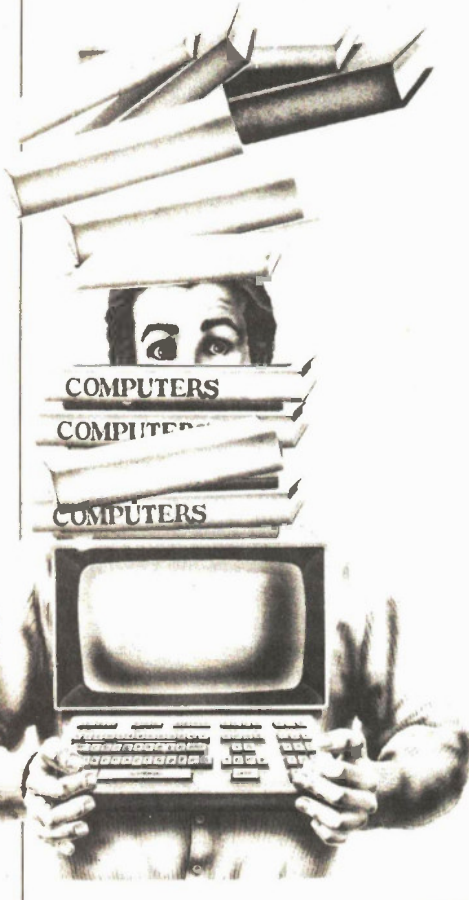

BP131: MICRO INTERFACING CIRCUITS - BOOK 2 \$8.55
Intended to carry on from Book 1, this book deals with practical applications beyond the parallel and serial interface. "Real world" interfacing such as sound and speech generators, temperature and optical sensors, and motor controls are discussed using practical circuit descriptions.

BP111: AUDIO \$13.25
This one is ideal for readers who want to really get into sound. A wide range of material is covered from analysis of the sound wave, mechanisms of hearing, room acoustics, microphones and loudspeakers, amplifiers, and magnetic disc recording.

BP141: LINEAR IC EQUIVALENTS AND PIN CONNECTIONS ADRIAN MICHAELS \$21.95
Find equivalents and cross-references for both popular and unusual integrated circuits. Shows details of functions, manufacturer, country of origin, pinouts, etc.; includes National, Motorola, Fairchild, Harris, Motorola, Intersil, Philips, ADC, AMD, SGS, Teledyne, and many other European, American, and Japanese brands.

BP156: AN INTRODUCTION TO QL MACHINE CODE \$7.75
The powerful Sinclair QL microcomputer has some outstanding capabilities in terms of its internal structure. With a 32-bit architecture, the QL has a large address range, advanced instructions which include multiplication and division. These features give the budding machine code programmer a good start at advanced programming methods. This book assumes no previous knowledge of either the 68008 or machine code programming.

BP47: MOBILE DISCOTHEQUE HANDBOOK \$5.25
Divided into six parts, this book covers such areas of mobile "disco" as: Basic Electricity, Audio, Ancillary Equipment, Cables and Plugs, Loudspeakers, and Lighting. All the information has been considerably sub-divided for quick and easy reference.

BP59: SECOND BOOK OF CMOS IC PROJECTS \$7.75
This book carries on from its predecessor and provides a further selection of useful circuits, mainly of a simple nature. The book will be well within the capabilities of the beginner and more advanced constructor.

BP32: HOW TO BUILD YOUR OWN METAL & TREASURE LOCATORS \$7.75
Several fascinating applications with complete electronic and practical details on the simple, and inexpensive construction of Heterodyne Metal Locators.

ELECTRONIC THEORY

ELEMENTS OF ELECTRONICS - AN ON-GOING SERIES
F.A. WILSON, C.G.I.A., C.Eng.

BP62: BOOK 1. The Simple Electronic Circuit and Components \$11.70

BP63: BOOK 2. Alternating Current Theory \$ 8.55

BP64: BOOK 3. Semiconductor Technology \$18.55

BP77: BOOK 4. Microprocessing Systems and Circuits \$11.70

BP89: BOOK 5. Communication \$11.70

The aim of this series of books can be stated quite simply — it is to provide an inexpensive introduction to modern electronics so that the reader will start on the right road by thoroughly understanding the fundamental principles involved.

Although written especially for readers with no more than ordinary arithmetical skills, the use of mathematics is not avoided, and all the mathematics required is taught as the reader progresses.

Each book is a complete treatise of a particular branch of the subject and, therefore, can be used on its own with one proviso, that the later books do not duplicate material from their predecessors, thus a working knowledge of the subjects covered by the earlier books is assumed.

BOOK 1 This book contains all the fundamental theory necessary to lead to a full understanding of the simple electronic circuit and its main components.

BOOK 2 This book continues with alternating current theory without which there can be no comprehension of speech, music, radio, television or even the electricity utilities.

BOOK 3 Follows on semiconductor technology, leading up to transistors and integrated circuits.

BOOK 4 A complete description of the internal workings of microprocessor.

BOOK 5 A book covering the whole communication scene.

PROJECTS

BP48: ELECTRONIC PROJECTS FOR BEGINNERS \$ 7.75
F.G. RAYER, T.Eng.(CEI), Assoc.IERE

Another book written by the very experienced author — Mr. F.G. Rayer — and in it the newcomer to electronics, will find a wide range of easily made projects. Also, there are a considerable number of actual component and wiring layouts, to aid the beginner.

Furthermore, a number of projects have been arranged so that they can be constructed without any need for soldering and, thus, avoid the need for a soldering iron.

Also, many of the later projects can be built along the lines as those in the 'No Soldering' section so this may considerably increase the scope of projects which the newcomer can build and use.

BP37: 50 PROJECTS USING RELAYS, SCR's & TRIACS \$ 7.75
F.G. RAYER, T.Eng.(CEI), Assoc.IERE

Relays, silicon controlled rectifiers (SCR's) and bi-directional triodes (TRIACS) have a wide range of applications in electronics today. This book gives tried and practical working circuits which should present the minimum of difficulty for the enthusiast to construct. In most of the circuits there is a wide latitude in component values and types, allowing easy modification of circuits or ready adaptation of them to individual needs.

BP221: 28 TESTED TRANSISTOR PROJECTS \$5.00
R. TORRENS

Mr. Richard Torrens is a well experienced electronics development engineer and has designed, developed, built and tested the many useful and interesting circuits included in this book. The projects themselves can be split down into simpler building blocks, which are shown separated by boxes in the circuits for ease of description, and also to enable any reader who wishes to combine boxes from different projects to realise ideas of his own.

BP71: ELECTRONIC HOUSEHOLD PROJECTS \$ 7.20
R. A. PENFOLD

Some of the most useful and popular electronic construction projects are those that can be used in or around the home. The circuits range from such things as '2 Tone Door Buzzer', Intercom, through Smoke or Gas Detectors to Baby and Freezer Alarms.

BP73: REMOTE CONTROL PROJECTS \$ 8.10
OWEN BISHOP

This book is aimed primarily at the electronics enthusiast who wishes to experiment with remote control. Full explanations have been given so that the reader can fully understand how the circuits work and can more easily see how to modify them for other purposes, depending on personal requirements. Not only are radio control systems considered but also infra-red, visible light and ultrasonic systems as are the use of Logic ICs and Pulse position modulation etc.

BP90: AUDIO PROJECTS \$ 7.60
F.G. RAYER

Covers in detail the construction of a wide range of audio projects. The text has been divided into preamplifiers and mixers, power amplifiers, tone controls and matching and miscellaneous projects.

BP 174: MORE ADVANCED ELECTRONIC MUSIC PROJECTS \$19.95

Complementing Book BP74, "Electronic Music Projects", BP174 provides more advanced projects, such as a flanger, a phaser, mini-chorus and ring modulators, percussion synth, etc. Each project has an introduction, circuit diagram and constructional notes.

BP74: ELECTRONIC MUSIC PROJECTS \$ 7.20
R.A. PENFOLD

Although one of the more recent branches of amateur electronics, electronic music has now become extremely popular and there are many projects which fall into this category. The purpose of this book is to provide the constructor with a number of practical circuits for the less complex items of electronic music equipment, including such things as a Fuzz Box, Waa-Waa Pedal, Sustain Unit, Reverberation and Phaser-Units, Tremelo Generator etc.

BP44: IC 555 PROJECTS \$ 7.75
E.A. PARR, B.Sc., C.Eng., M.I.E.E.

Every so often a device appears that is so useful that one wonders how life went on before without it. The 555 timer is such a device. Included in this book are Basic and General Circuits, Motor Car and Model Railway Circuits, Alarms and Noise Makers as well as a section on the 556, 558 and 559 timers.

BP82: ELECTRONIC PROJECTS USING SOLAR CELLS \$ 7.75

A collection of simple circuits which have applications in and around the home using the energy of the sun to power them. The book deals with practical solar power supplies including voltage doubler and tripler circuits, as well as a number of projects.

BABANI BOOKS

BP49: POPULAR ELECTRONIC PROJECTS \$ 7.75 R.A. PENFOLD

Includes a collection of the most popular types of circuits and projects which, we feel sure, will provide a number of designs to interest most electronics constructors. The projects selected cover a very wide range and are divided into four basic types: Radio Projects, Audio Projects, Household Projects and Test Equipment.

BP94: ELECTRONIC PROJECTS FOR CARS AND BOATS \$7.60 R.A. PENFOLD

Projects, fifteen in all, which use a 12V supply are the basis of this book. Included are projects on Windscreen Wiper Control, Courtesy Light Delay, Battery Monitor, Cassette Power Supply, Lights Timer, Vehicle Immobiliser, Gas and Smoke Alarm, Depth Warning and Shaver Inverter.

BP95: MODEL RAILWAY PROJECTS \$7.60 F.G. RAYER

Electronic projects for model railways are fairly recent and have made possible an amazing degree of realism. The projects covered include controllers, signals and sound effects; striboard layouts are provided for each project.

BP93: ELECTRONIC TIMER PROJECTS \$7.60 F.G. RAYER

Windscreen wiper delay, darkroom timer and metronome projects are included. Some of the more complex circuits are made up from simpler sub-circuits which are dealt with individually.

BP113: 30 Solderless Breadboard Projects-Book 2 \$8.85 R.A. Penfold

A companion to BP107. Describes a variety of projects that can be built on plug-in breadboards using CMOS logic IC's. Each project contains a schematic, parts list and operational notes.

BP104: Electronic Science Projects \$8.85 Owen Bishop

Contains 12 electronic projects with a strong scientific flavour. Includes Simple Colour Temperature Meter, Infra-Red Laser, Electronic clock regulated by a resonating spring, a Scope with a solid state display, pH meter and electrocardiograph.

BP110: HOW TO GET YOUR ELECTRONIC PROJECTS WORKING \$7.60 R.A. PENFOLD

We have all built circuits from magazines and books only to find that they did not work correctly, or at all, when first switched on. The aim of this book is to help the reader overcome just these problems by indicating how and where to start looking for many of the common faults that can occur when building up projects.

BP84: DIGITAL IC PROJECTS \$7.60 F.G. RAYER, T.Eng.(CEI), Assoc.IERE

This book contains both simple and more advanced projects and it is hoped that these will be found of help to the reader developing a knowledge of the workings of digital circuits. To help the newcomer to the hobby the author has included a number of board layouts and wiring diagrams. Also the more ambitious projects can be built and tested section by section and this should help avoid or correct faults that could otherwise be troublesome. An ideal book for both beginner and more advanced enthusiast alike.

BP67: COUNTER DRIVER AND NUMERAL DISPLAY PROJECTS \$7.05 F.G. RAYER, T.Eng.(CEI), Assoc. IERE

Numeral indicating devices have come very much to the forefront in recent years and will, undoubtedly, find increasing applications in all sorts of equipment. With present day integrated circuits, it is easy to count, divide and display numerically the electrical pulses obtained from a great range of driver circuits.

In this book many applications and projects using various types of numeral displays, popular counter and driver IC's etc. are considered.

BP99: MINI-MATRIX BOARD PROJECTS \$7.60 R.A. PENFOLD

Twenty useful projects which can all be built on a 24 x 10 hole matrix board with copper strips. Includes Doorbuzzer, Low-voltage Alarm, AM Radio, Signal Generator, Projector Timer, Guitar Headphone Amp, Transistor Checker and more.

BP103: MULTI-CIRCUIT BOARD PROJECTS \$7.60 R.A. PENFOLD

This book allows the reader to build 21 fairly simple electronic projects, all of which may be constructed on the same printed circuit board. Wherever possible, the same components have been used in each design so that with a relatively small number of components and hence low cost, it is possible to make any one of the projects or by re-using the components and P.C.B. all of the projects.

BP107: 30 SOLDERLESS BREADBOARD PROJECTS — BOOK 1 \$8.85 R.A. PENFOLD

A "Solderless Breadboard" is simply a special board on which electronic circuits can be built and tested. The components used are just plugged in and unplugged as desired. The 30 projects featured in this book have been specially designed to be built on a "Verobloc" breadboard. Wherever possible the components used are common to several projects, hence with only a modest number of reasonably inexpensive components it is possible to build, in turn, every project shown.

BP106: MODERN OP-AMP PROJECTS \$7.60 R.A. PENFOLD

Features a wide range of constructional projects which make use of op-amps including low-noise, low distortion, ultra-high input impedance, high slew-rate and high output current types.

CIRCUITS

How to Design Electronic Projects \$8.95 BP127

Although information on standard circuit blocks is available, there is less information on combining these circuit parts together. This title does just that. Practical examples are used and each is analysed to show what each does and how to apply this to other designs.

Audio Amplifier Construction \$8.95 BP122

A wide circuits is given, from low noise microphone and tape head preamps to a 100W MOSFET type. There is also the circuit for 12V bridge amp giving 18W. Circuit board or strip-board layout are included. Most of the circuits are well within the capabilities for even those with limited experience.

BP80: POPULAR ELECTRONIC CIRCUITS — BOOK 1 \$7.75 R.A. PENFOLD

Another book by the very popular author, Mr. R.A. Penfold, who has designed and developed a large number of various circuits. These are grouped under the following general headings: Audio Circuits, Radio Circuits, Test Gear Circuits, Music Project Circuits, Household Project Circuits and Miscellaneous Circuits.

BP98: POPULAR ELECTRONIC CIRCUITS, BOOK 2 \$8.85 R.A. PENFOLD

70 plus circuits based on modern components aimed at those with some experience.

BP39: 50 (FET) FIELD EFFECT TRANSISTOR PROJECTS \$6.75 F.G. RAYER, T.Eng.(CEI), Assoc.IERE

Field effect transistors (FETs) find application in a wide variety of circuits. The projects described here include radio frequency amplifiers and converters, test equipment and receiver aids, tuners, receivers, mixers and tone controls, as well as various miscellaneous devices which are useful in the home.

This book contains something of particular interest for every class of enthusiast — short wave listener, radio amateur, experimenter or audio devotee.

BP162: COUNTING ON QL ABACUS \$7.60 R.A. PENFOLD

This book is designed to introduce the beginner to the use of spreadsheets in general and Abacus on the Sinclair QL in particular. It assumes no previous experience in computing or spreadsheets. Practical examples show the calculations for domestic, small business and technical applications.

BP87: SIMPLE I.E.D. CIRCUITS \$5.40 R.N. SOAR

Since it first appeared in 1977, Mr. R.N. Soar's book has proved very popular. The author has developed a further range of circuits and these are included in Book 2. Projects include a Transistor Tester, Various Voltage Regulators, Testers and so on.

BP24: 50 PROJECTS USING IC 74* \$6.75 R.A. PENFOLD

A unique book on projects that can be simply constructed with an op amp and a few components. Originally published in Germany, this book will be an valuable asset to any hobbyist.

BP88: HOW TO USE OP AMPS \$8.85 E.A. PARR

A designer's guide covering several op amps, serving as a source book of circuits and a reference book for design calculations. The approach has been made as non-mathematical as possible.

BP65: SINGLE IC PROJECTS \$6.05 R.A. PENFOLD

There is now a vast range of ICs available to the amateur market, the majority of which are not necessarily designed for use in a single application and can offer unlimited possibilities. All the projects contained in this book are simple to construct and are based on a single IC. A few projects employ one or two transistors in addition to an IC but in most cases the IC is the only active device used.

223: 50 PROJECTS USING IC CA3130 \$5.00 R.A. PENFOLD

In this book, the author has designed and developed a number of interesting and useful projects which are divided into five general categories: I — Audio Projects II — R.F. Projects III — Test Equipment IV — Household Projects V — Miscellaneous Projects.

BP117: PRACTICAL ELECTRONIC BUILDING BLOCKS BOOK 1 \$7.60

Virtually any electronic circuit will be found to consist of a number of distinct stages when analysed. Some circuits inevitably have unusual stages using specialised circuitry, but in most cases circuits are built up from building blocks of standard types.

This book is designed to aid electronics enthusiasts who like to experiment with circuits and produce their own projects rather than simply follow published project designs.

The circuits for a number of useful building blocks are included in this book. Where relevant, details of how to change the parameters of each circuit are given so that they can easily be modified to suit individual requirements.

BP102: THE 6809 COMPANION \$7.60

Written for machine language programmers who want to expand their knowledge of microprocessors. Outlines history, architecture, addressing modes, and the instruction set of the 6809 microprocessor. The book also covers such topics as converting programs from the 6800, program style, and specifics of 6809 hardware and software availability.

BP118: PRACTICAL ELECTRONIC BUILDING BLOCKS - Book 2 \$7.60 R.A. PENFOLD

This sequel to BP117 is written to help the reader create and experiment with his own circuits by combining standard type circuit building blocks. Circuits concerned with generating signals were covered in Book 1, this one deals with processing signals. Amplifiers and filters account for most of the book but comparators, Schmitt triggers and other circuits are covered.

BP24: 50 PROJECTS USING IC741 \$6.75 RUDI & UWE REDMER

This book, originally published in Germany by TOPP, has achieved phenomenal sales on the Continent and Babani decided, in view of the fact that the integrated circuit used in this book is inexpensive to buy, to make this unique book available to the English speaking reader. Translated from the original German with copious notes, data and circuitry, a "must" for everyone whatever their interest in electronics.

BP83: VMOS PROJECTS \$7.70 R.A. PENFOLD

Although modern bipolar power transistors give excellent results in a wide range of applications, they are not without their drawbacks or limitations. This book will primarily be concerned with VMOS power FETs although power MOSFETs will be dealt with in the chapter on audio circuits. A number of varied and interesting projects are covered under the main headings of: Audio Circuits, Sound Generator Circuits, DC Control Circuits and Signal Control Circuits.

RADIO AND COMMUNICATIONS

BP96: CB PROJECTS \$7.60 R.A. PENFOLD

Projects include speech processor, aerial booster, cordless mike, aerial and harmonic filters, field strength meter, power supply, CB receiver and more.

BP222: SOLID STATE SHORT WAVE RECEIVER FOR BEGINNERS \$47.60 R.A. PENFOLD

In this book, R.A. Penfold has designed and developed several modern solid state short wave receiver circuits that will give a fairly high level of performance, despite the fact that they use only relatively few and inexpensive components.

BP117: AN INTRODUCTION TO COMPUTER COMMUNICATIONS.

Connecting up an ordinary home computer to the telephone system via a modem opens up a new world of possibilities: talking to other computers, databases, networks, radio links, etc. An explanation of basic principles and practicalities in simple terms.

BP91: AN INTRODUCTION TO RADIO DXing \$7.60

This book is divided into two main sections one to amateur band reception, the other to broadcast bands. Advice is given to suitable equipment and techniques. A number of related constructional projects are described.

BP105: AERIAL PROJECTS \$7.60 R.A. PENFOLD

The subject of aeriels is vast but in this book the author has considered practical designs including active, loop and ferrite aeriels, which give good performances and are reasonably simple and inexpensive to build. The complex theory and math of aerial design are avoided.

OTHER PUBLISHERS

PH121: HARDWARE INTERFACING WITH THE TRS-80
J. UFFENBECK (1983) \$19.45
 TRS-80 Model I and Model III users now have a book to help them understand their personal computers to monitor and control their interfaces between the computer and the industrial environment. Contains 14 hands-on experiments using BASIC.

SB22026 POLISHING YOUR APPLE® \$7.45
 Clearly written, highly practical, concise assembly of all procedures needed for writing, disk-filing, and printing programs with an Apple II. Postively ends your searches through endless manuals to find the routine you need! Should be in the hands of every new Apple user, regardless of experience level. Ideal for Apple classrooms too!

A BEGINNER'S GUIDE TO COMPUTERS AND MICROPROCESSORS — WITH PROJECTS.
TAB No. 101S: \$14.45
 Here's plain English introduction to the world of microcomputers — its capabilities, parts and functions... and how you can use one. Numerous projects demonstrate operating principles and lead to the construction of an actual working computer capable of performing many useful functions.

TAB1370: A MASTER HANDBOOK OF IC CIRCUITS \$21.95
 A circuit for every occasion. You'll find all the circuits you're looking for in this 512-page book. The 932 circuits are broken down into 12 functional categories and in six categories. It's a veritable cornucopia of ideas, projects, and designs that you can build now.

TAB1544: ELECTRONIC PROJECTS FOR PHOTOGRAPHERS \$21.95
 This book gives you needed tips on the principles of electronics and building techniques... how to set up a work area, and much more. Includes a wide variety of practical accessories for your camera, studio, or darkroom with this helpful guide.

SB22361: INTRODUCING THE APPLE MACINTOSH \$20.95
 A wealth of information on hardware, software etc. for the Mac. Included are such topics as: making your desktop more efficient, improving your productivity with the Mac, getting the most from your mouse, how the 68000 microprocessor works and much, much more.

PH131: ZAP! POW! BOOM! ARCADE GAMES FOR THE VIC 20
T. HARTNELL & M. RAMSHAW (1983) \$17.45
 Move through the maze eating dots with MAZEMAN. Sail through space zapping the ASTEROIDS. Outshoot the fastest draw in town GUNFIGHT. Owners of the VIC 20 can now play these games — and more — simply by following the programs outlined in this handy guide.

THE BASIC COOKBOOK.
TAB No. 105S: \$10.45
 BASIC is a surprisingly powerful language... if you understand it completely. This book, picks up where most manufacturers' documentation gives up. With it, any computer owner can develop programs to make the most out of his or her machine.

HANDBOOK OF MICROPROCESSOR APPLICATIONS
TAB No. 1203 \$16.45
 Highly recommended reading for anyone who are interested in microprocessors as a means of accomplishing a specific task. The author discusses individual microprocessors, the 1802 and 1801, and how they can be put to use in real world applications.

MICROPROCESSOR INTERFACING HANDBOOK: A/D & D/A
TAB No. 1271 \$16.45
 A useful handbook for computer users interested in using their machine in linear applications. Topics discussed include voltage reference, data conversion, analogue switching and much more.

HOW TO BUILD YOUR OWN WORKING MICROCOMPUTER
TAB No. 1200 \$16.45
 An excellent reference or how-to guide for building your own microcomputer. Hardware and software are developed as well as many practical circuits.

PH180: 1984 CANADIAN BUSINESS GUIDE TO MICROCOMPUTERS
K. DORRICOIT \$11.95
 Written by the managing director of Deloitte, Haskins & Sells, a Canadian partnership of public accountants and other professional advisors to management, this book is one of the most complete comprehensive guides to microcomputers available. Starting with a general overview of microcomputers and their business applications, the author helps you assess your computer needs, compares and evaluates computer systems and application packages, and gives you tips on "doing it right". A must for anyone thinking of purchasing a microcomputer for business.

COMPUTER PROGRAMS IN BASIC
AB01 \$15.45
 A catalogue of over 1,600 fully indexed BASIC computer programs with applications in Business, Math, Games and more. This book lists available software, what it does, where to get it and how to adapt it to your machine.

PH217: BASIC COMPUTER PROGRAMMING FOR KIDS
P. CASSIDY & J. CLOSE \$16.45
 Fully illustrated with photographs and drawings, this book teaches the reader how to use computers and computing and gently introduces them to mathematics and the basic theory of computer work. Written in an easy, conversational tone.

PH51: PASCAL FOR THE APPLE
IAIN MACCALLUM \$34.20
 A step-by-step introduction to Pascal for Apple II and Apple II Plus users. The package of text and software diskette provides readers with worthwhile and interesting programs which can be run immediately and the results studied. Includes over 200 exercises with full solutions. Book/Disk Package.

PH52: APPLE GRAPHICS GAMES
PAUL COLLETTA \$40.95
 Contains 10 arcade-style games written especially for Apple II, including Spider, Piano, Pairs and Poker, as well as education, math, and designing games. Book/Disk Package.

PH57: START WITH BASIC FOR THE COMMODORE VIC 20
D. MONRO \$33.45
 This book/cassette package shows the reader how easy it really is to create programs using the full capacity of the machine. Includes helpful exercises and step-by-step instructions to put the full power of the VIC 20 at the user's fingertips. Book/Cassette Package.

SB21822: ENHANCING YOUR APPLE® II — VOLUME 1
D. LANCASTER \$25.50
 Who but Mother Nature or Don Lancaster could successfully enhance an Apple? YOU can, with help from Volume 1 in Don's newest series for Sams. Among other things, you'll learn (1) to mix text, LORES, and HIREX together anywhere on the screen in any combination. (2) how to make a new-wire modification that will open up whole new worlds of 3-D graphics and other special effects, plus (3) a fast and easy way to tear apart and understand somebody else's machine-language program. Other goodies abound!

PH106: PROGRAMMING TIPS AND TECHNIQUES FOR THE APPLE II
J. CAMPBELL (1983) \$23.45
 An advanced exploration of the intricacies of structures programming. Further develops the skills necessary to solve programming problems. Special chapter on sound and graphics which discusses both high and low resolution graphics for the Apple II.

HB131: THE BEGINNER'S GUIDE TO BUYING A PERSONAL COMPUTER \$6.45
 Written for the potentially interested computer buyer, in non-technical language, this affordable book explains the terminology of personal computers, the problems and variables to be discussed and discovered while making that initial buying decision. The book does not make recommendations, but does present a great deal of information about the range of hardware available from the largest personal computing manufacturers. Readers discover the meaning and impact of screen displays, tape cassette storage and disk storage, graphics and resolution, and much more. Comparison charts clearly define standard and optional features of all the current mass market personal computers.

DESIGNING MICROCOMPUTER SYSTEMS
HB18: \$18.95
POOCH AND CHATTERGY
 This book provides both hobbyists and electronic engineers with the background information necessary to build microcomputer systems. It discusses the hardware aspects of microcomputer systems. Timing devices are provided to explain sequences of operations in detail. Then, the book goes on to describe three of the most popular microcomputer families: the Intel 8080 Zilog Z-80, and Motorola 6800. Also covered are designs of interfaces for peripheral devices, and information of building microcomputer systems from kits.

S100 BUS HANDBOOK
HB19: \$26.00
BURSKY
 Here is a comprehensive book that exclusively discusses S-100 bus computer systems and how they are organized. The book covers computer fundamentals, basic electronics, and the parts of the computer. Individual chapters discuss the CPU, memory, input/output, bulk-memory devices, and specialized peripheral controllers. It explains all the operating details of commonly available S-100 systems. Schematic drawings.

110 THYRISTOR PROJECTS USING SCRs AND TRIACS
MARSTON \$13.45
HB22
 A grab bag of challenging and useful semiconductor projects for the hobbyist, experimenter, and student. The project range from simple burglar, fire, and water level alarms to sophisticated power control devices for electric tools and trains. Integrated circuits are incorporated wherever their use reduces project costs.

PH104: ACCOUNTANT'S BASIC PROGRAMMING FOR THE APPLE II
A PARKER & J. STEWART (1983) \$20.45
 Shows the reader how to program the Apple II to perform a variety of accounting functions, such as payroll, accounts payable, accounts receivable, tax, inventory, customer statements, and more.

HOW TO PROFIT FROM YOUR PERSONAL COMPUTER: PROFESSIONAL, BUSINESS, AND HOME APPLICATIONS
LEWIS \$18.95
HB01
 Describes the uses of personal computers in common business applications, such as accounting, managing, inventory, sorting, mailing lists, and many others. The discussion includes terms, notations, and techniques commonly used by programmer's. A full glossary of terms.

AN INTRODUCTION TO MICROPROCESSORS EXPERIMENTS IN DIGITAL TECHNOLOGY
HB07 \$18.95
SMITH
 A "learn by doing" guide to the use of integrated circuits provides a foundation for the underlying hardware actions of programming statements. Emphasis is placed on how digital circuitry compares with analog circuitry. Begins with the simplest gates and timers, then introduces the fundamental parts of ICs, detailing the benefits and pitfalls of major IC families, and continues with coverage of the ultimate in integrated complexity — the microprocessor.

MICROCOMPUTERS AND THE 3 R'S
DOERR \$16.45
HB09
 This book educates educators, on the various ways computers, especially microcomputers, can be used in the classroom. It describes microcomputers, how to organize a computer-based program, the five instructional application types (with examples from subjects such as the hard sciences, life sciences, English, history, and government), and resources listings of today's products. The book includes preprogrammed examples to start up a microcomputer program; while chapters on resources and products direct the reader to useful additional information. All programs are written in the BASIC language.

HB107: GRAPHICS COOKBOOK FOR THE APPLE WADSWORTH \$15.95
HB107
 Learn how to use your Apple II to "paint" shapes, objects, and letters in low-resolution graphics. The author provides a library of microcomputer graphics including such multicoloured illustrations as robots and flying saucers, trees, sailboats, and colourful picture backgrounds. Contains complete annotated Applesoft BASIC programs to draw all the pictures described in the book as well as suggestions for improving programming techniques.

HB116: THE BASIC CONVERSIONS HANDBOOK FOR APPLE™, TRS-80™, and PET™ USERS
BRAIN BANK \$14.50
 A complete guide to converting Apple II and PET programs to TRS-80, TRS-80 and PET programs to Apple II, and TRS-80 and Apple II programs to PET. Equivalent commands are listed for TRS-80 BASIC (Model I, Level II), Applesoft BASIC and PET BASIC, as well as variations for TRS-80 Model III and Apple Integer BASIC. Also describes variations in graphics capabilities.

SARGON: A COMPUTER CHESS PROGRAM
SPRACKLEN \$27.50
HB12
 "I must rate this chess program an excellent buy for anyone who loves the game." Kilobaud
 Here is the computer chess program that won first place in the first chess tournament at the 1978 West Coast Computer Faire. It is written in Z-80 assembly language, using the TDI macro assembler. It comes complete with block diagram and sample printouts.

BASIC COMPUTER PROGRAMS FOR BUSINESS: STERNBERG (Vol. 1)
HB13 \$21.50
 A must for small businesses utilizing micros as well as for entrepreneurs, volume provides a wealth of practical business applications. Each program is documented with a description of its functions and operation, a listing in BASIC, a symbol table, sample data, and one or more samples.

AUDIO AND VIDEO INTERFERENCE CURES
KAHANER \$8.95
HB21
 A practical work about interference causes and cures that affect TV, radio, hi-fi, CB, and other devices. Provides all the information needed to eliminate interference. Schematic wiring diagrams of filter types of receivers and transmitters are included. Also supplies simple filter diagrams to eliminate TV interference caused by noisy home appliances, neon lights, motors, etc.

PH107: APPLE LOGO PRIMER
G. BITTER & N. WATSON (1983) \$19.95
 A pictorial starter book that will make LOGO easy for anyone. Includes easy to follow examples and reference tables. Also included is a workshop outline for teachers and leaders who want to train others.

SB22047: 26 BASIC PROGRAMS FOR YOUR MICRO \$17.45
MICRO
 Features 26 previously unpublished, simple-to-complex games you can run on almost any brand of microcomputer as long as you have enough RAM on board. Most take between 500 and 5000 bytes, with the highest taking 13K. Conversion charts that let you key them into your Radio Shack, TRS-80, Apple II, TImex/SInclair 1000 (ZX81), Spectrum, Atari, or PET are included. Also features notes on program techniques and structures.

Beginner's Bench, Part 3: Semiconductors

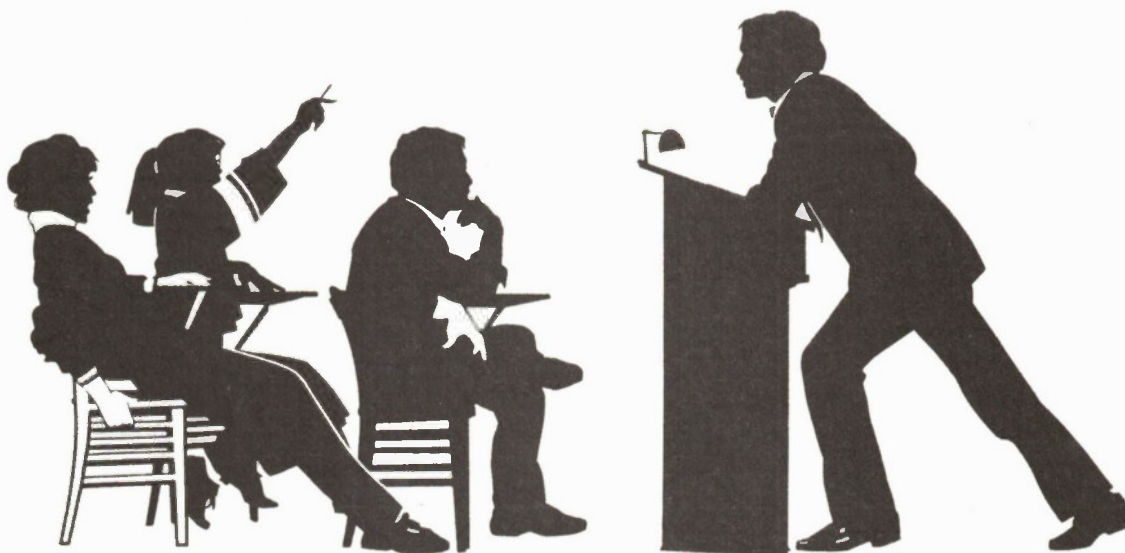

A review of the basic action of diodes and transistors.

By Michael Tooley and David Whitfield

IN electronics, we often categorize materials as either conductors (e.g., copper or aluminum) or insulators (e.g., mica or polystyrene). There is, however, a third category of material upon which the whole of our modern solid-state technology depends: the semiconductor.

The controlled diffusion of impurities into the crystal lattice structure of materials such as silicon or germanium (which would both be normally classified as insulators in the pure form) allows us to produce materials which are neither conductors nor insulators. These materials are semiconductors and their electrical conductivity is a function of the amount of impurity present. (For the curious, the level of impurity is usually less than one part per billion).

Due to superior characteristics at high temperatures, the majority of modern semiconductors are fabricated from

silicon (Si) rather than germanium (Ge). There are still, however, a few applications in which germanium devices may be preferred (as we shall see later) but, for the purpose of our explanation of semiconductor action, we will confine our discussion to silicon, and its atomic structure.

The nucleus of a silicon atom is surrounded by three distinct electron shells. The inner shell contains two electrons, the middle shell contains eight electrons, as shown in Fig. 1. Since these four outer (valence) electrons are available for bonding with adjacent atoms, silicon is said to exhibit a valency of four (i.e., it is tetravalent).

Bearing in mind that the number of protons (+) in the nucleus is exactly equal to the number of orbiting electrons (-), we can simplify the atom as shown in Fig. 2. Only the four protons which balance the

valence electrons are shown.

In pure silicon each one of the four valence electrons is shared between adjacent atoms, as shown in Fig. 3. The result is a crystal lattice in which electrons from covalent bonds and, since there are no "free" electrons available to carry charge, the material behaves like a near-perfect insulator.

If we now introduce a number of impurity atoms, each having a valency of five (pentavalent), into the regular crystal lattice of silicon atoms it will then contain a number of "free" electrons which are not involved in the bonding process and which are therefore available to take an active role as charge carriers (see Fig. 4). It should, however, be noted that the material will still be electrically neutral (i.e., the total number of positive charges will exactly balance the total number of negative charges).

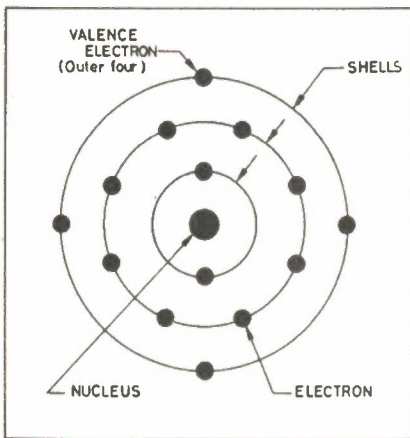

Fig. 1 Model of a silicon atom.

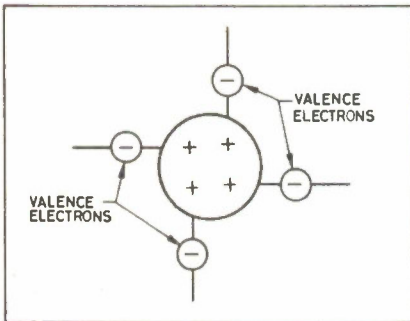

Fig. 2 Simplified silicon atom.

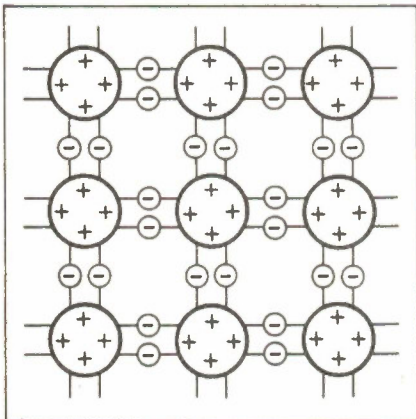

Fig. 3. Lattice structure of pure silicon showing covalent bonds.

Since the pentavalent element produces a surfeit of electrons, we call it a "donor" impurity. The semiconductor material produced is said to be n-type as the majority charge carriers present are negatively charged electrons.

If, on the other hand, we now introduce an impurity element which has a valency of three (trivalent) into the regular crystal lattice, we will produce a material which again is electrically neutral but which now has a number of incomplete bonds known as holes (see Fig. 5). These holes are simply gaps into which electrons can be fitted; as electrons travel within the lattice other holes will be created so we

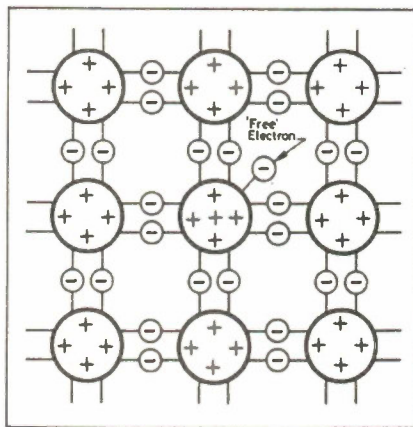

Fig. 4. Effect of introducing a pentavalent impurity.

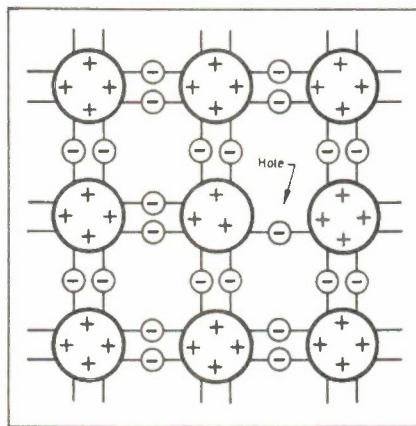

Fig. 5 Effect of introducing a trivalent impurity.

can think of the holes as being mobile positive charge carriers.

Since the trivalent element produces a shortage of electrons we call it an "acceptor" impurity. The semiconductor material is said to be p-type as the majority charge carriers are holes.

The process of introducing impurity elements into pure semiconductor material is known as "doping". Suitable impurities are phosphorus, P, or arsenic, As (both pentavalent) and boron, B, or aluminium, Al (both trivalent).

By means of a sophisticated manufacturing process in which both types of impurity are employed, regions of n-type and p-type material can be produced within the same slice of silicon. The result is called a p-n junction.

The P-N Junction

When a p-n junction is formed, some of the free electrons within the n-type material diffuse across the junction into the p-type region and recombine with some of the vacant holes. Conversely, some of the holes within the p-type region diffuse across the junction and recombine with free electrons in the n-type region.

This process (illustrated in Fig. 6) results in the creation of a region either

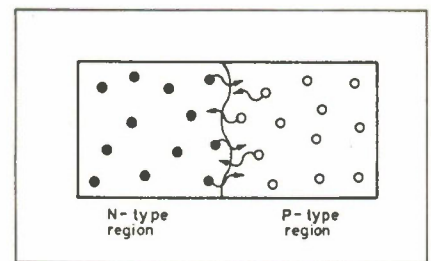

Fig. 6. Diffusion of electrons and holes within a p-n junction.

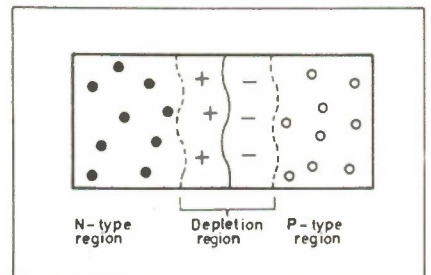

Fig. 7. The depletion region.

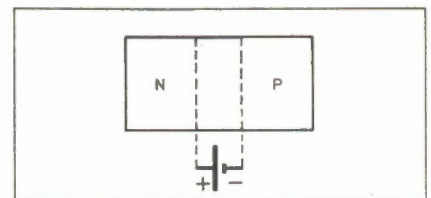

Fig. 8. Equivalent potential associated with the depletion region.

side of the junction boundary in which no free charge carriers exist (i.e., it contains no free electrons or vacant holes). For this reason it is known as the depletion region or depletion layer.

The process of diffusion across the junction boundary continues until equilibrium is eventually reached. At this point the p-type material has acquired a small negative charge and the n-type material has acquired an equally small positive charge, as shown in Fig. 7. This difference of charge can be considered as equivalent to a small internal voltage source, as shown in Fig. 8.

In order to remove the depletion region it is necessary to apply an external potential to the junction which is exactly equal but of opposite polarity to that which results from the junction's own internal charge, as shown in Fig. 9. This potential effectively negates the internal charge imbalance and reduces the width of the depletion region to zero. Thereafter, and with increasing applied potential, charge carriers are able to move across the junction boundary; electrons freely moving from the n-type region into the p-type region. This is known as the forward biased condition and an appreciable value of conventional current will flow from the p-type region (anode) to the n-type region (cathode).

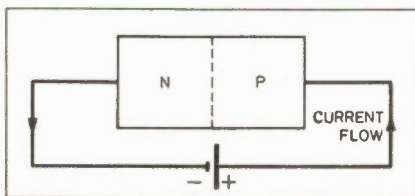

Fig. 9. Forward biased p-n junction.

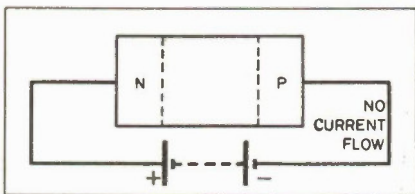

Fig. 10. Reverse biased p-n junction.

If the external potential is applied with the same polarity as that which results from the junction's own internal charge, the depletion region widens and movement of charge carriers across the junction is further inhibited (see Fig. 10). The symbol for a diode is shown in Fig. 11. Readers should note that the arrow of the symbol shows the direction of conventional current flow.

Diode Characteristics

The properties of any particular diode are best described by means of characteristic graphs showing current plotted against applied voltage. Typical characteristics for low power silicon and germanium diodes are shown in Fig. 12 and Fig. 13 respectively. The following general points should be noted:

1. For clarity, different scales have been used for the forward and reverse voltage and current axes of both graphs. In particular it should be noted that the forward current has been shown in milliamps whereas the reverse current scale has been shown in microamps.

2. Since the voltage axis is horizontal and the current axis is vertical, the steepness (or slope) of the graph provides an indication of the equivalent resistance of the device. Readers should note that, steepness of the graphs vary according to the applied voltage. The steeper the characteristic the lower the equivalent resistance will be.

Readers should now devote some time to comparing the characteristics of the two types of diode and should note the following specific points:

1. Silicon diodes do not start to conduct until the forward voltage reaches approximately 0.6V. Beyond this point the current rises rapidly.

2. Germanium diodes do not start to conduct until the forward voltage reaches approximately 0.2 V. The increase of current beyond this point is somewhat less rapid than for the silicon type.

3. Silicon diodes consume very much less reverse current and can generally withstand very much higher reverse voltages than their germanium counterparts.

4. Silicon diodes have steeper forward characteristics and can generally withstand higher forward currents than their germanium counterparts. Although the significance of the forward voltage drop (0.6V approx. for silicon and 0.2V approx. for germanium) may not at this stage be apparent, readers should bear these values in mind for future reference. As an example of their significance we shall now briefly consider the functioning of a simple diode checker.

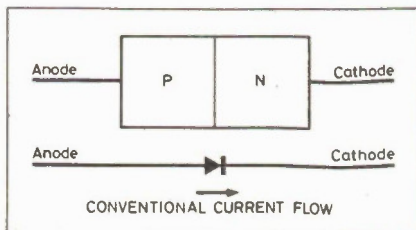

Fig. 11. Diode symbol.

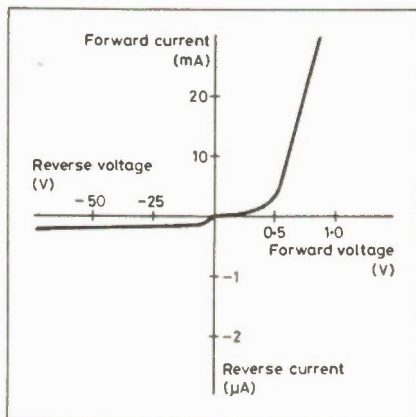

Fig. 12. Typical silicon diode characteristic.

Simple Diode Checker

The type and functional state of a diode may be easily checked if we simply measure the voltage drop that appears across it in the forward and reverse biased conditions. A forward voltage drop of between 0.1V and 0.3V would indicate that the device was a functional germanium type whereas an indication of between 0.5V and 0.7V would indicate a functional silicon type.

Since a functional diode should consume negligible current in the reverse biased condition, the reversed voltage drop

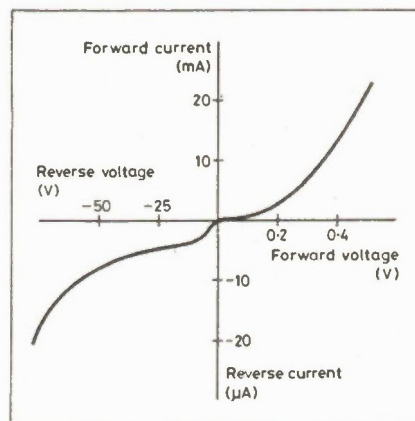

Fig. 13. Typical germanium diode characteristic.

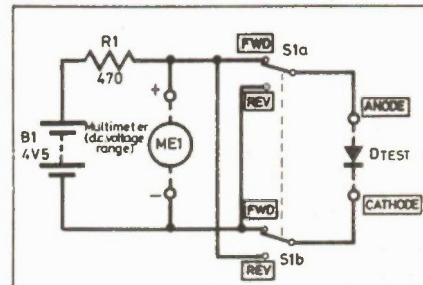

Fig. 14. A simple diode checker.

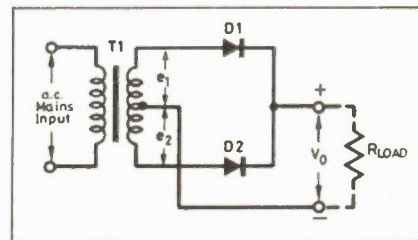

Fig. 15. Bi-phase rectifier arrangement.

should be virtually the same as the supply voltage. Any other indication, or deviation from the expected forward biased voltage, would be suspect.

A simple diode checker based on these principles is shown in Fig. 14. A forward current of less than 10mA is applied to the diode and the forward and reverse voltage drops are then measured using a multimeter. Some typical indications for the diode checker are given in Table 1.

Unfortunately, "in circuit" diode testing is not quite so simple unless one can be certain the conditions within the circuit remain static and the diode remains in a continuously forward biased state. It is, therefore, usually safer to remove a diode from the circuit before testing it.

Peak Reverse Voltage

Readers have already seen in Figs. 12 and 13 how an appreciable reverse voltage may be applied with only negligible reverse current flow. However, if the reverse voltage is increased beyond a certain point, the

reverse current rapidly increases and the diode breaks down due to excessive power dissipation. (The power dissipated by the diode being equal to the product of the reverse voltage and the reverse current).

The maximum reverse voltage which can safely be applied to a diode is known as the peak reverse voltage, or simply PRV. (Note that some books refer to this as the "peak inverse voltage", or PIV). Germanium diodes have typical PRV ratings in the region 30V to 100V whilst their silicon counterparts have typical PRV ratings of between 40V and 800V.

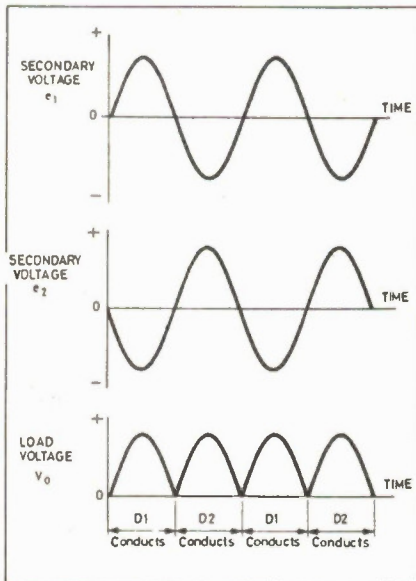

Fig. 16. Waveforms for the bi-phase rectifier.

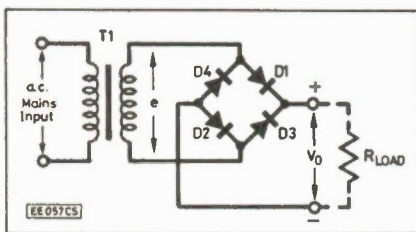

Fig. 17. Bridge rectifier arrangement.

The Bi-Phase Rectifier

The efficiency of our simple power supply can be greatly improved by positive, half cycles of the incoming AC supply. This can be achieved using the "bi-phase" rectifier arrangement shown in Fig. 15. Here a split (or "centre-tapped") secondary winding is used.

The alternating voltages at either end of the secondary winding are said to be in "anti-phase"; i.e., when the voltage at one end goes positive with respect to the centre-tap the voltage at the other end goes negative. The two diodes thus conduct alternately, as shown in Fig. 16. The net result of all this is that the charge lost by a reservoir capacitor can be replenished at twice the rate (i.e., about every 8ms

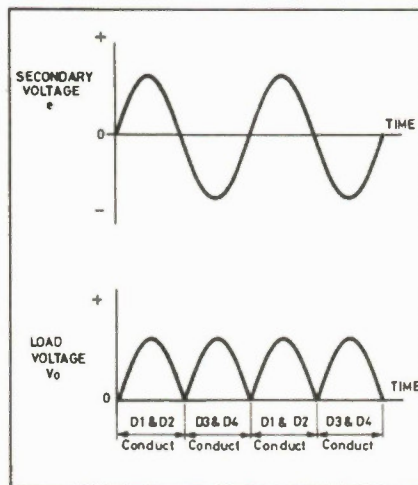

Fig. 18. Waveforms for the bridge rectifier.

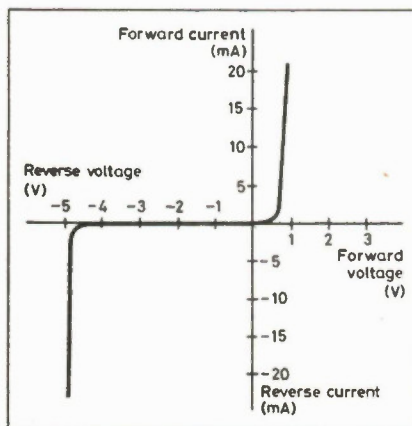

Fig. 19. Typical characteristic for a 4.7V [zener] diode.

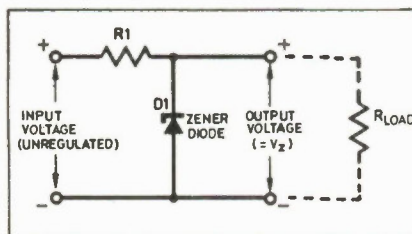

Fig. 20. Simple zener diode voltage regulator.

rather than every 16ms when the supply is at 60Hz). This, in turn, leads to more effective smoothing and so the output contains less ripple.

The Bridge Rectifier

An alternative to the bi-phase rectifier arrangement is the use of a bridge rectifier, as shown in Fig. 17. Here four diodes are used with opposite pairs of diodes conducting on alternate half cycles of the AC input, as shown in Fig. 18.

The bridge rectifier arrangement obviates the need for a split secondary winding and often makes use of a specially encapsulated rectifier (in which all four diodes are contained within an epoxy resin block).

The Zener Diode

Whereas reverse breakdown is an unpleasant fact of life when designing rectifier circuits it can be quite useful in other areas. Silicon diodes can be manufactured so that they exhibit a controlled reverse breakdown and, provided the current is limited to a safe working value, the diode will not suffer permanent damage. Devices of this type are called zener diodes and can be purchased with accurate breakdown voltages from 2V7 to over 100V.

A typical characteristic for a 4V7 zener is shown in Fig. 19. Once the reverse zener voltage has been exceeded, the voltage drop across the diode remains substantially constant. The zener can thus be used to provide and accurate voltage source; all we need to do is to supply an appropriate value of current using a series resistor connected from a higher potential supply.

Fig. 20 shows a simple zener diode regulator. Provided the load current does not exceed a critical value, the output voltage remains close to the nominal zener voltage regardless of moderate load current and input voltage variations. Finally, Fig. 21 shows how our enhanced power supply can be modified to incorporate a regulated output.

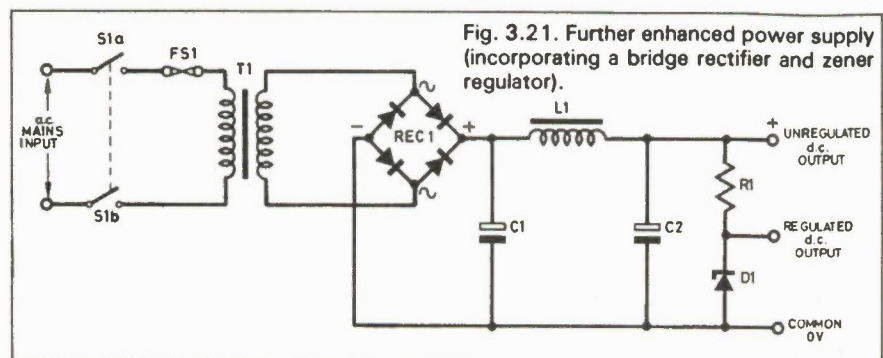

Fig. 21. Further enhanced power supply (incorporating a bridge rectifier and zener regulator).

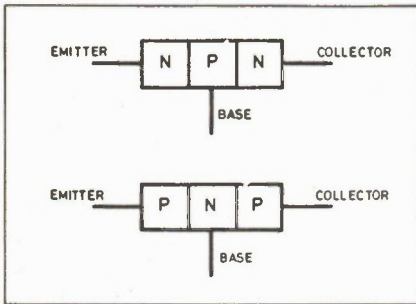

Fig. 22. Basic construction of NPN and PNP transistors.

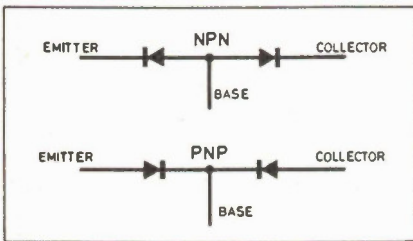

Fig. 23. Diode equivalent models for NPN and PNP transistors.

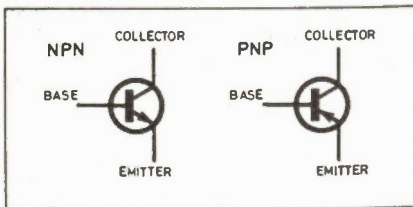

Fig. 24. Symbols used for NPN and PNP junction transistors.

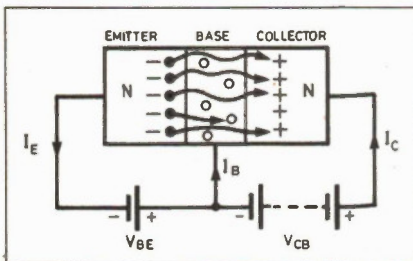

Fig. 25. Bias voltages and currents within an NPN transistor.

The Transistor

Whereas diodes have only one junction, transistors comprise two semiconductor junctions fabricated on a single slice of germanium or silicon. Two varieties are possible; NPN and PNP as shown in Fig. 22. In either case, the junctions are formed between the emitter-base and collector-base. This allows us to develop the simple diode models of NPN and PNP transistors shown in Fig. 23.

The symbols used for NPN and PNP transistors are shown in Fig. 24. Readers should take particular note of the direction of the arrow at the emitter which indicates the direction of conventional current flow.

Electronics Today July 1986

In normal use, the base-emitter junction is forward biased whilst the collector-base junction is reverse biased. Fig. 25 shows the biasing arrangement for an NPN transistor. Electrons present at the emitter will move into the base region where they become "minority carriers". Some electrons will recombine with holes in the base region but, since the base is made very narrow and the collector is positively charged, the greater proportion of electrons leaving the emitter are swept across into the collector region.

The emitter and collector currents are thus almost equal, the difference between them being equal to the base current (i.e., that which results from recombination of electrons and holes within the base region). We can, therefore, establish the following relationship between the currents in a transistor:

$$I_e = I_b + I_c$$

Typical currents for a small silicon transistor would be:

$$I_e = 2\text{mA}, I_c = 1.98\text{mA}$$

and

$$I_b = 20\mu\text{A} \text{ (i.e., } 0.02\text{mA)}$$

Transistor Characteristics

Since transistors have three terminals, their characteristics are somewhat more difficult to show graphically than was the

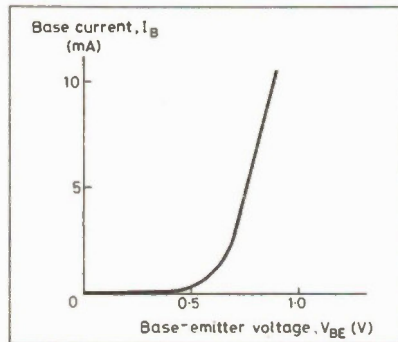

Fig. 26. Typical input characteristic for a silicon transistor (V_{CE} constant).

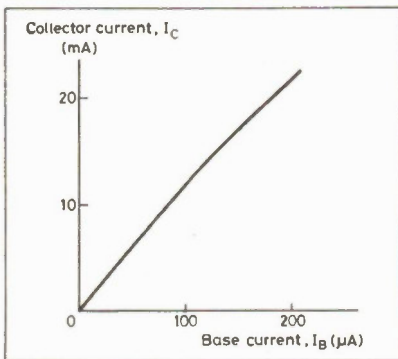

Fig. 27. Typical transfer characteristic for a silicon transistor (V_{CE} constant).

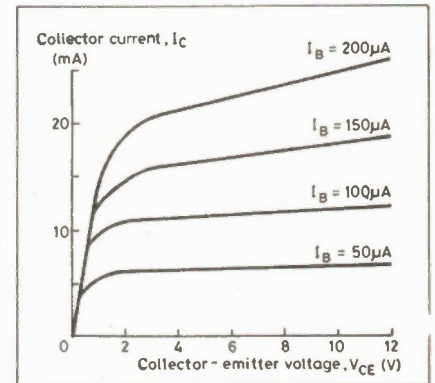

Fig. 28. Typical output characteristic for a silicon transistor (I_B constant).

case with diodes. In most cases we can adequately specify a transistor's characteristics using just three graphs:

- the input characteristic; I_b plotted against V_{be} with V_{ce} held constant.
- the transfer characteristic; I_c plotted against I_b with V_{be} held constant.
- the output characteristic; I_c plotted against V_{ce} with I_b held constant.

We have shown a typical set of characteristics for an NPN silicon transistor in Fig. 26 to 28. Readers should note that the input characteristic is simply that of a forward biased junction diode and that the transfer characteristic is substantially linear (i.e., doubling the value of base current results in a doubling of the value of collector current, and so on). This latter effect is important since it leads to the concept of "current gain"; a small change in input current at the base of a transistor results in a corresponding, but very much larger, current change at the collector.

Thus, assuming that we input current to the base of a transistor and take our output current from the collector of the transistor, current gain can be defined as:

$$\text{Current gain} = \frac{\text{Collector Current}}{\text{Base Current}}$$

$$= I_c / I_b$$

Typical values for the current gain of small silicon transistors range from around 100 to over 300.

Next month: Some practical transistor circuits that demonstrate the previous theories. ■

Computing Now! Microcomputer Directory

Finding the hardware or software one wants for one's microcomputer applications is very often an exercise in finding out what exists. Following this, one must locate what one has chosen, often through a labyrinth of dealers and suppliers. Conventional magazine directories and surveys can help with all of this... somewhat... but to date a comprehensive useable directory of what's available in Canada has yet to be published.

Most directories are constructed so as to be easy to compile. This one has been designed to be easy to use. Rather than selecting arbitrary categories, the items in the directory will be classified by system and within each system, in a tree structure dividing them into subclassifications.

This will result in a large directory with a lot of duplication in it. However, it will be a reference highly valued by its readers because of its resulting ease of use. It will be the essential reference work for anyone involved in microcomputers, from single system end users to small and mid-sized businesses. For advertising information contact Denis Kelly at (416) 445-5600 immediately.

Cover Date: September 1986

Copy Close: July 20th 1986

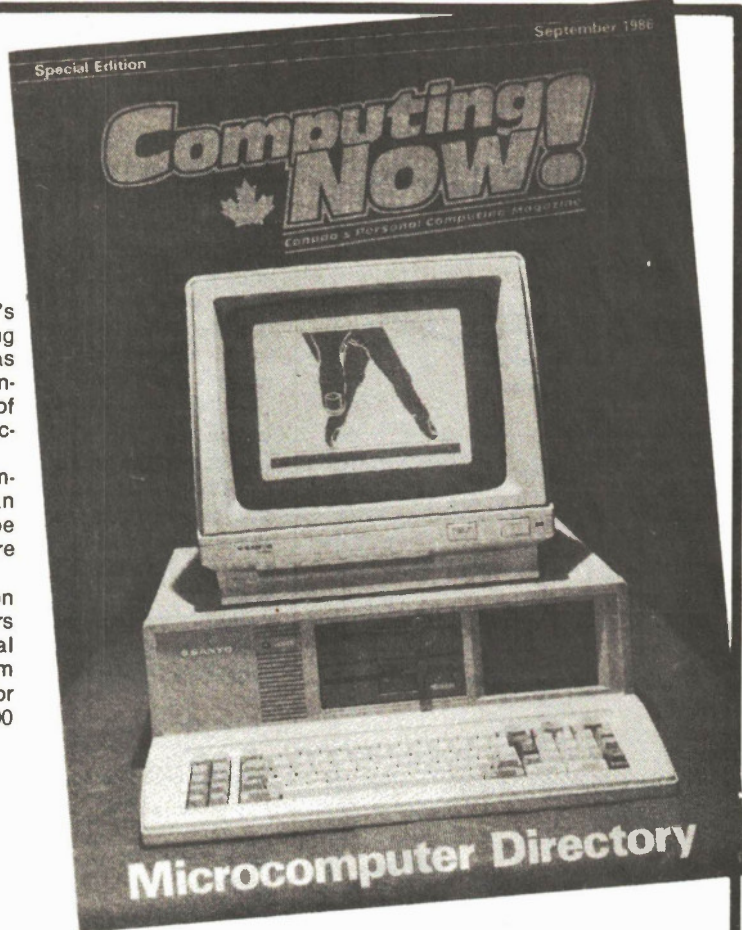

ANNOUNCING PROJECTS BOOK NO. 3

Hobby Projects was first published in the summer of 1980 and contained 25 Electronics Projects reprinted from Electronics Today magazine. It was a sell out and was followed in January 1981 by Projects Book No.2 and in the summer of 1983 by 50 Top Projects, both of which were also virtually sell outs.

We have been asked when the next edition will be published and planning has thus started on Projects Book No. 3 which will go to press in August with a Fall 1986 cover date.

The contents of Projects Book No. 3 will be approximately 25 of the most popular projects which have appeared in Electronics Today since 1983. In addition, there will be new projects not yet seen by our readers. This edition will be in demand by previous purchasers of earlier editions and by other Electronics Today readers for the new projects.

It will be of especially great interest to: a) recent readers, b) casual readers, and c) non readers of Electronics Today which will mean that your advertising message will be seen by a slightly different readership.

For complete details on this unique advertising opportunity please make immediate contact with Marlene Dempster at (416) 445-5600.

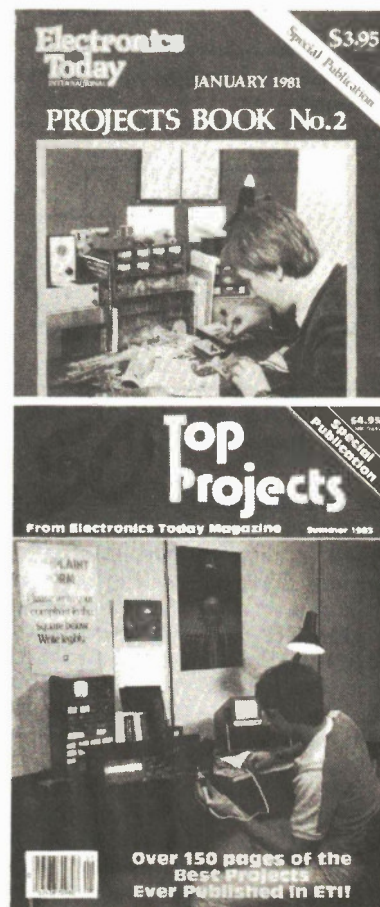

Creating The Science Environment

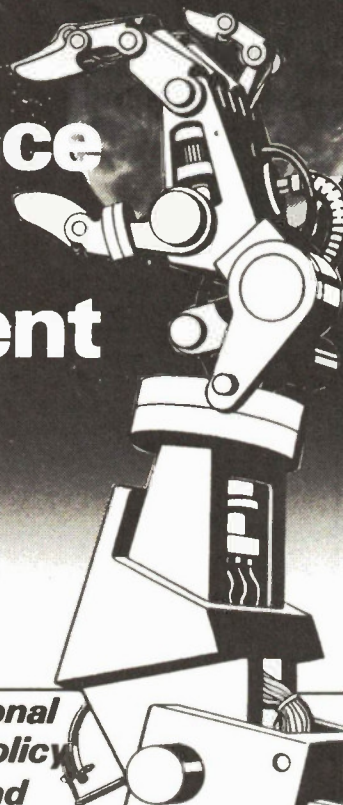

Canada needs a new national science and technology policy to stimulate innovation and research, according to this report by the Electrical and Electronic Manufacturers Association of Canada.

Editor's Preface: In general, the technical journalist tends to perceive the Canadian electronics industry as a warehousing venture. There are a few outstanding and successful innovations, but for the most part Canada does not have the environment to stimulate, encourage and support original design and manufacture.

Mention to anyone in the industry that you've invented the better mousetrap and plan to produce it, and you'll get a lengthy list of reasons why it isn't likely to succeed. Components cost too much, assembly is cumbersome, funding is difficult, taxes are crippling, you can't compete with imports, etc.

It isn't surprising that our outlook on designing new products is so negative, varying from doubt to outright defeatism. Without a support structure, an individual company is left on its own to do the best it can with piecemeal assistance. It would be interesting to see a study investigating the differences between Canadian entrepreneurial attitudes and those of say, Taiwan, Japan, or the USA.

Perhaps we'd find that other countries have an environment as stimulating to industry as Europe was to musicians and composers in the 17th and 18th centuries. For example, an encouraging atmosphere, a vast market, and a large established peer group produced the flood of world-class composers for which Germany is famous.

It isn't quite that way here. If you decide to start a company, there's the faintest suspicion in the air that you're up to something, and so you're put through a trial-by-ordeal just to see if you're serious. Little or no information is easily available to the small entrepreneur concerning legalities, taxes, accounting, and so on. The difficulty in getting venture capital is a story in itself, and government financial assistance comes and goes with each new budget.

Of course, the required information, support and finances for new companies or new products can be found somewhere, waiting to be unearthed by some brave undaunted soul who is dedicated to making a go of it. And, of course, we shouldn't say that hard work isn't called for, or that some rigorous filtering isn't required, or that the system should back any scheme no matter how flimsy. It's just that we're cutting off far too many ideas and talents through the lack of a proper strategy.

The Electrical and Electronic Manufacturers Association of Canada (EEMAC) recognizes that the job of coordinating all this falls to the government. On May 7, 1986, they presented a

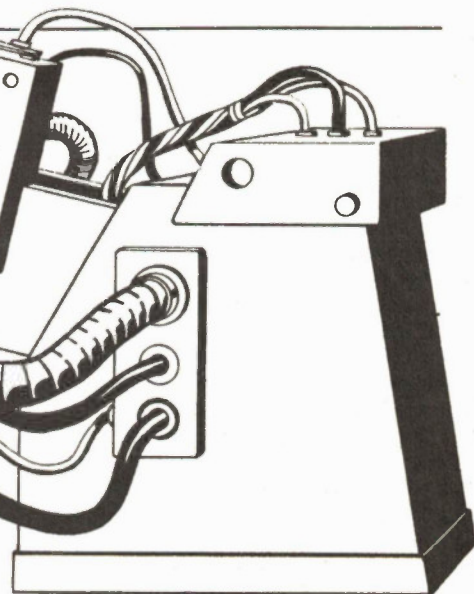

brief to the federal government, entitled *Creating The Science Environment*. The majority of the text of the report is reproduced with their kind permission.

— Bill Markwick

Introduction

In 1944 Dr. C.J. Mackenzie, President of the National Research Council, said that "the inherent material strength of any modern country is directly correlated with the strength of its resources and activities in science, technology and research". In 1983 Dr. P. McGeer, then BC's Minister of Science and Technology, wrote in reference to Canada, that "one of the most severe penalties a country can impose on itself in today's world is to have inferior policies towards engineering and science".

Sad to report, in the forty years between those similar observations, little has been done in Canada in recognition of this principle which so many other industrialized nations have taken to heart. We are therefore highly supportive of any steps taken to create and implement a Science Policy for Canada.

Today, the competition for world trade relies heavily on industrial skills in engineering and science. As a major trading nation, we neglect these at our peril. EEMAC's objectives are:

1. To see an improved climate for science and engineering both at the legislative level and in the population at large,
2. to see education reform that gives all students an appreciation of the importance of science and engineering in the modern world,
3. to restore the capability of the educational system to provide a larger portion of our gifted people the opportunity to study engineering and science,
4. to increase the interaction between universities and industry,
5. to increase the amount of publicly-funded research and development performed by industry.

The federal government's Science Policy, and its commitment to a policy, is a crucial concern of industry. Strong support and representation at the highest level is needed to create the emergence of Canadian engineering and science as a driving force in the economy.

A Science Policy should not address itself solely to pure research. The directions taken in industrial research and development will be crucial to Canada's international trade performance.

Increasingly, Canada's economic well-being and the standard of living of our people will depend not only on our declining natural resources, but our ability to compete both at home and abroad in technology and knowledge-based industries.

Since this is the area that EEMAC knows well, the following pages detail our concerns and recommendations. They form an integrated proposal designed to create an environment which will encourage successful R&D in Canada.

Industrial R&D

Research and development is not an end in itself, but a process and activity by which advanced nations compete for industrial economic advantage. Research and development (R&D) triggers a risky, expensive process which allows industry to create new jobs, new products, expand imports and replace imports, generating new wealth.

The lack of growth in Canada's

manufacturing industry, and in the Electrical and Electronic sector in particular, indicates that industrial development has been inadequate. The failure of the electronics manufacturing industry to benefit from world-wide innovation is particularly disturbing because it is a key industry which affects many others.

The Electrical and Electronic Sector is a heavy R&D spender relative to most industries, but obviously its expenditure is still not enough to ensure its own future health. In 1984 many companies in the

before the product can be brought to market. Successful R&D requires additional cash flow for a host of start-up activities, including market development, tooling, plant expansion, inventory, additional staff, and extensive retraining.

An effective R & D strategy must be comprehensive and must complement the entire manufacturing and marketing process. Industrial R & D must be market-driven, constantly evolving to satisfy ever-changing international and domestic requirements.

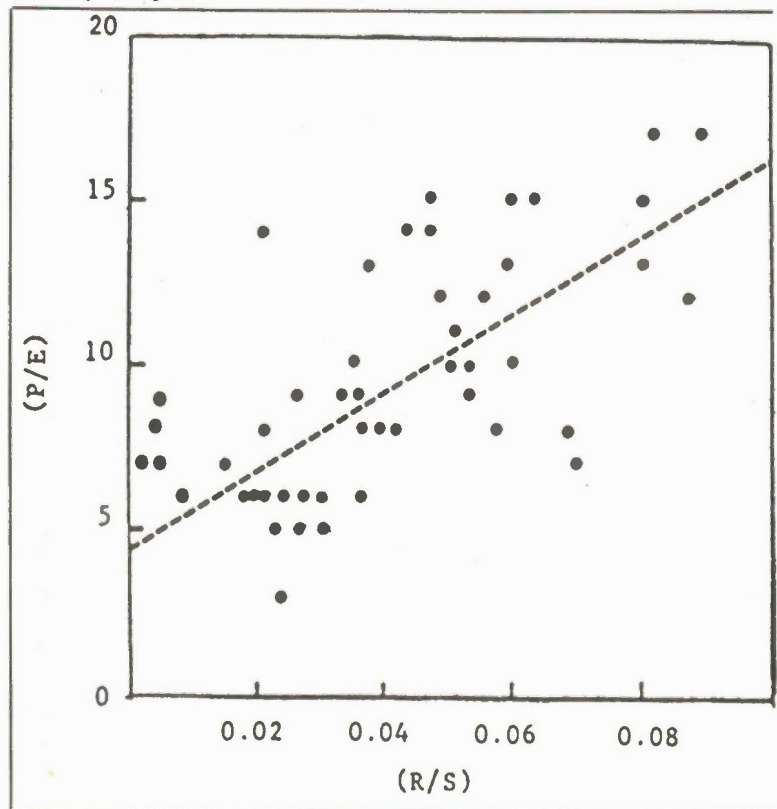

1978 Price/earning ratio for 50 American companies as a function of R&D to sales.

sector spent over 4 percent of gross revenue on R&D, more than triple the national average. Other companies in this sector experiencing strong growth are spending in excess of 5 percent and up to 20 percent of gross revenue. To bring R&D spending even up to the 5 percent level across the sector is not realistically possible without substantial public support, particularly in enabling technology contracts (where the only deliverable product is a demonstration of technological capability). The enabling technology contract is an attractive solution, since it could be coupled with a redistribution of government R&D expenditures.

Under the best conditions, R&D is an expensive, high-risk proposition. R&D started today will not begin to yield results for some years, and most successful innovations require large amounts of capital

Canada's R & D strategy must endeavour to:

- Create entire new industries and jobs which do not exist in Canada today;
- Nurture, strengthen and expand the nucleus of dynamic companies in their struggle for success in the international high-technology marketplace;
- Expand investment in Canada by multinational companies with particular emphasis on world product mandates;
- Help retool existing industry, utilizing computer-aided manufacturing, computer-aided design and other innovations which foster competitive product development intervals, boost productivity, and improve product quality;
- Retrain the work force to understand and master the pervasive force of new technologies and tools.

Training and retraining of manpower is

a two to six year endeavour, not including the time required to expand facilities and staff. The time requirement to implement tax reform, new investment procedures and technological interaction is also in the order of five years. The evolutionary cycle of a product is also measured in years. These realities dictate that long-term commitment is required from industry, education, labour, and government for change to be effected.

Enabling Technology

One of the main reasons that government support to industrial development is lower in Canada than in some other industrialized countries is because major products are not developed under government contract where the development of industrial capability is seen as a major and necessary component of the investment. In other industrial countries with which we compete, non-tax support represents as much as 33 percent of industrial R & D. In Canada, it is about 12 percent.

This is clearly an opportunity that we are missing in Canada. Government contracts are often placed on a very competitive basis where no allowance can be made for the substantial development costs that may be required to create that particular manufacturing capability in Canadian industry. The funding of these kinds of development costs under such major contracts is widely practiced in other countries, does not attract the attention that grants or tax incentives do, and is not considered unfair competition.

For whatever reason, the government has tended to favour "buy" in the make/buy decision, seeming to overlook the industrial benefits of manufacturing advanced products.

The relationship of funding by governments, industry, and university is not particularly out of line in Canada. What is out of line is the division of R & D performed by those three sectors. It is clear that governments in Canada are not directing sufficient funds to R & D in industry particularly by the procurement mechanism. To become comparable to the U.S.A., an additional \$1 billion should have been spent in industry in 1982. At the same time, \$680 million less should have been spent in intramural government laboratories and \$340 million less in university laboratories. This simply underlines the size of the distribution distortion that exists in Canada.

(1) Recommendation: Defence and other government purchases should be used to build greater technical capability in industry, particularly in design.

(2) Recommendation: Move development work out of government labs and procure

from industry where there is more likelihood of commercial development. Award technology contracts to industry, not government labs.

Incentives, Procurement, and Grants

About 16 cents of every industrial sales dollar is deposited in government coffers in the form of Federal sales tax, income tax, and corporate tax, whereas secondary manufacturing industry, on average, retains earnings of about 4 cents. With such an uneven partnership, industry depends heavily on government to take a significant part in its ongoing development, particularly in respect to research activities and the application of scientific development, particularly in respect to research activities and the application of scientific developments. Such government participation is widely practiced in the OECD countries but has yet to achieve these levels in Canada.

As part of government's cooperative role with industry, we believe that this assistance can be provided in four ways:

A. Through contracts for the provision of technological capability. This is an area

where Canada is one of the few industrialized nations in the world that does nothing. This is commented on in Government procurement below.

B. By direct grants. We believe that the level of granting in Canada is adequate on the surface at present although the process is too bureaucratic.

Since the taxation of grants was introduced in the 1985 federal budget, this financing method is less attractive. It is also hampered by its use as a regional development tool. Imposing regional economic imperatives on R & D funding is a destructive philosophy. Industrial research is more likely to succeed in proximity to universities and other industrial research.

For small-sized companies, government grants are a necessity but, in general, selective tax incentives are the most efficient method of increasing industrial cash flow. This then stimulates indigenous R & D and the cash flow needed to turn R & D into jobs and exports. Any revenue foregone by government will be recovered in the long term through increased employment and expanded industrial activity.

C. By providing tax incentives for

40 MHz 3 MODELS FROM \$950

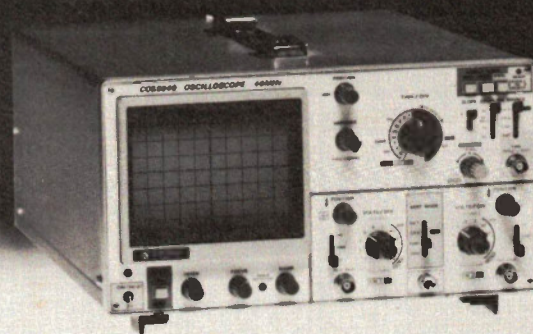

5% discount when you call Tom and order direct.

- | | |
|---|---|
| ■ 3 CH, Alternate Time Base
Simultaneous Trigger View
..... \$1,215 | ■ 2 CH, Single Time Base
..... \$950 |
| ■ 2 CH, Delayed
Sweep \$1,075 | ■ P-P Auto Trigger |
| | ■ Nationwide Sales and
Service |

interfax

KIK

514-336-0392
416-671-3920

613-726-8888
604-430-1410

research and development. Here again, we believe that the level of tax incentive is adequate and that recent steps to remove the limits on the application of such incentives are positive. However, these incentives will be of no help unless they are in fact delivered to industry at the level intended. Nor indeed will they be helpful if they introduce any degree of uncertainty in the administration of R & D costs by the performer.

Unfortunately, incentives are not as beneficial as they seem. While R & D expenditures attract a 20 percent credit (except where companies with revenues below \$200,000 are eligible for a 35 percent rate) the actual value may only be in the region of 7 percent. This occurs because the credit is considered income and taxed. This reduces the effective credit typically to 13 percent; further, the provinces do not recognize the federal credit and their taxation creates an additional reduction to about 10 percent. The credit is only applied to costs "all or substantially all" of which are attributable to R & D.

Only stand-alone R & D facilities avoid the problem of attribution. Such facilities are rare in industry in Canada, and the

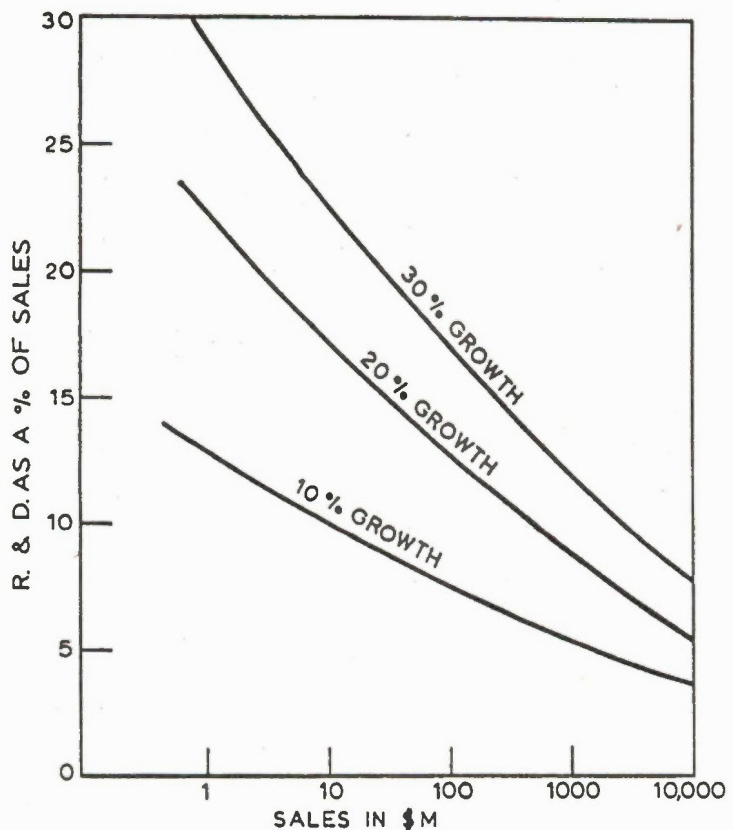

Average performance of 15 American technology companies 1977-1982.

LOGIC PROBES FOR LOGICAL PEOPLE

CHOOSE THE PERFORMANCE YOU NEED FROM THE NUMBER ONE CANADIAN SOURCE FOR PROBES AND TEST LEADS

SPECIFICATION	PROBE LP10A	PROBE LP25	PROBE LP50	PULSER PR41	PULSER PG-1K
Frequency	17MHz	25MHz	50MHz	0.5/400Hz	1000Hz
Pulse Width	30nS	30nS	20nS	10uS	2uS
Input Limits	200V AC/DC	200V AC/DC	40V		
Fused Input	No	No	Yes		
TTL Levels 1/0	2.3/0.8	2.3/0.8	2.0/0.8		
CMOS Levels 1/0	70%/30%	70%/30%	70%/30%		
Input Impedance	1M	1M	1M/20pf		
Readout Display	3-led	3-led	7 segment		
Pulse Memory	Yes	Yes	No		
Tone Generator	No	Yes	No		
Illuminated Tip	No	No	Yes		
Replaceable tip	No	No	Yes	No	Yes
Output Cur.(max)				100mA	400mA
Variable pulse rate				No	1-50 pps
Single pulse				No	Yes
SYNC Input				Yes	No
Price*	\$33.00	\$71.50	\$203.50	\$82.50	\$181.00

PROBES AND PULSERS COMPATIBLE WITH TTL AND CMOS

*Includes F.S.T. Add \$2.00 for shipping. Ontario orders add 7%.

BCS Store Hours:
Mon-Fri 8 to 5, Sat. 10 to 1.

VISA & MASTERCARD accepted



980 Alness St. Unit 7,
Downsview Ontario
M3J 2S2 (416) 661-5585
TELEX 065-28169

difficulties of technology transfer dictate the integration of R & D and manufacturing.

These two factors, the taxation of credits and attribution, reduce the original tax credit of 20 percent to about 7 percent. This tax incentive is not the significant positive factor that public utterances would lead us to believe.

(3) **Recommendation:** That changes be made in the Income Tax Act so that the R & D performer realizes the full value of the tax incentive. Specifically, allow "attributable" current expenditures (based on generally accepted cost accounting methods) rather than the debatable "all or substantially all" present requirement of the Act.

(4) **Recommendation:** Federal grant programs be maintained at the same relative levels which exist today (about 17 percent), not to exceed 20 percent of all R & D conducted in industry in Canada so as not to provoke countervailing action. For maximum efficiency, granting programs be simplified and streamlined. Tax reform must make the value of these programs fully realizable, and their value must be independent of geographic location.

(5) **Recommendation:** Provincial governments to relinquish their taxing of federal R & D incentives or alternately provide some offsetting benefits to R & D performers in their province.

The new federal measure which introduces a 100 percent tax credit for some companies on the first \$2 million of R & D tax expenditure is an important development. It will be a real stimulus to smaller private companies. While encouraged by this move, EEMAC cannot accept ownership criteria in this legislation. Such discriminatory requirements are contrary to the Government's well established position on foreign investment and inhibiting to the creation of world product mandates.

(6) Recommendation: That ownership criteria be excluded from any legislation intended to promote and encourage research and development in Canada.

D. Government Procurement. Government procurement should be a tool for technology development. Government departments should look for opportunities to be the first buyer of new products. Money for this purpose should flow through departmental budgets to ensure that each procurement satisfies a real need in the right time frame. The risks of such activities must be accepted and failure in a product development does not mean failure in the associated technology development.

(7) Recommendation: In every practical case, government should be an early purchaser of new Canadian products. Early sales provide needed cash flow, encourage the solution of production start-up problems, bring down unit costs and accelerate the development of market skills.

E. Mechanisms directed to companies which are not sufficiently profitable to realize tax credits.

This is particularly important for small start-up operations and for other companies that may be temporarily unprofitable. The new measure offering 100 percent tax credit, though only applicable to some companies, is a positive move.

Investment Capital

To achieve substantial industrial growth in the next decade, industry requires large amounts of investment capital from corporations and individuals.

It is often said that there is an attractive pool of capital in Canada but coupling to it for technology development has not had noticeable success. We believe that some steps must be taken to make such investments practical and popular.

The recent granting of a lifetime exemption of \$500,000 of capital gains from taxation is a positive step to improving the availability of capital. However, since this measure is not directed at industry, we are

not convinced that it will benefit the high risk, R & D based enterprises that are seeking funds.

A mechanism is needed to encourage small-investor participation in technology-related activity.

The need for this capital generating device is that Canadian companies raise less than a third of their capital by equity, mostly using debt instruments. This compares with U.S. figures of over a half by equity.

To be attractive for buyers to take on high-risk investments, a substantial tax write-off is needed, adjusted for the degree of risk as indicated by the level of assets in a company.

(8) Recommendation: Adopt a national stock savings plan with a sliding scale of tax write-off for investors ranging from 150 percent for small developing companies to 50 percent for large companies.

Manpower Development

The federal government directly funds postgraduate development through the Natural Sciences and Engineering Research Council (NSERC). It also substantially supports education through credits and transfer payments to the provinces.

In the recent past, Canadian industry could look to the universities for leadership on many technical issues. The universities often had access to the best equipment and staff who were working at the forefront of science applicable to industry. This is no longer true and, given the relatively static buying power of the new NSERC budget, is unlikely to change.

The high rate of technical change has accelerated obsolescence and has, in many instances, radically increased the cost of state-of-art equipment. University staff, perforce spending less than full time on research, cannot remain at the forefront of specific industrial problems given the current rate of change. Thus, a new covenant must be struck between the university and business. The basis for the new covenant should be the provision of industrial experience for university staff, university exposure for industrial staff, and a reemphasis of the fundamentals in university education.

(9) Recommendation: In cooperation with the provincial Ministers of Education a strategy for education and skilled manpower development be determined that is consistent with the National Science Policy.

100 MHz

3 CHANNELS...\$1,995

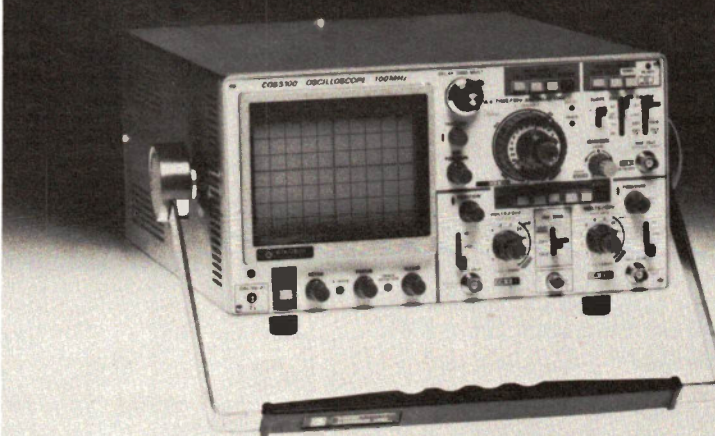

- Alternate Time Base
- Simultaneous Trigger View
- 2 ns/div, Max Sweep

- Multimode Display
- P-P Auto Trigger
- 60 MHz . . . \$1,550

interfax

514-336-0392
416-671-3920

KIK #3 in scope sales

613-726-8888
604-430-1410

Creating The Science Environment

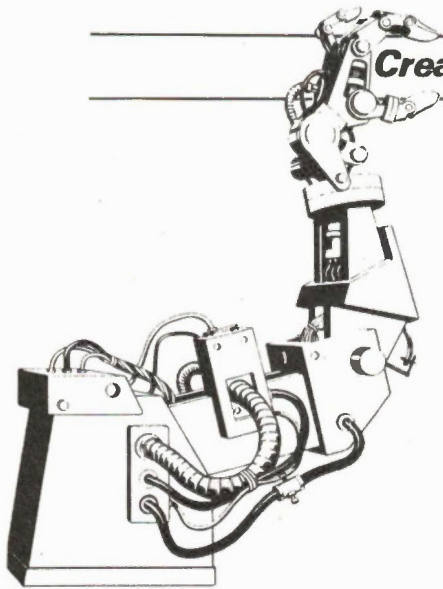

The post-secondary component of education must not be considered in isolation; primary and secondary education, and all the factors which come into play at those levels, must also be considered.

(10) Recommendation: To implement a strategic planning approach to education reform.

Provincial governments should play a leading role in focussing ongoing discussion of post-secondary education matters between government departments, industry and the educational institutions.

(11) Recommendation: Create an accelerated turnover of 2 percent per year of existing faculty and hire 1 percent per year new faculty in strategic areas and increase capital expenditure in key areas. Faculty salaries to be brought closer to industry levels.

(12) Recommendation: Allocate new resources in staff, equipment, and space to engineering and computer science faculties and introduce industrial experience into university courses.

In our opinion, the distribution of resources within the universities is a very serious problem. Clearly the governing boards of these institutions must revise their distribution criteria to produce some correspondence to the needs of society in the context of its future intellectual and economic well-being.

(13) Recommendation: Institute a five-year plan of renewal for universities to provide adaptability and move to a market-influenced system with funding by individuals, business and industries.

We believe that there is a level of technological illiteracy, with its roots in the high schools, being propagated through the university system.

In an age of rapidly increasing technological complexity, where no one is

unaffected, society on the whole has been reactionary. So too have our institutions of learning. While science programs usually call for competence in Arts and Humanities, the reverse is sadly not true.

(14) Recommendation: Establish uniform high school graduation standards and reduce technological illiteracy with required Science content in schools and universities.

Government/Industry/University Interaction

The human technical resources of Canada must be fully marshalled to effect rapid growth in secondary industry. To this end, interaction and transfer must take place linking government bodies, universities and industry.

For the electrical and electronic industries, which perform close to one quarter of Canada's industrial research and development, the transfer of technology is recognized to be of such difficulty that research and development must be done as intimately as possible with the manufacturing function.

(15) Recommendation: The staffs of government research laboratories should be encouraged to spend periods of time working in industry through a system of mutually rewarding incentives.

(16) Recommendation: To encourage university researchers to work with industry they must get full credit for this during performance evaluation at their university.

There should also be a great deal of encouragement for policies and programs that encourage the interchange of personnel between university/industry/government laboratories. A new program for industry with specific financial incentives for becoming involved with universities at the working level would be an appropriate incentive.

For any further information on this report, contact EEMAC, One Yonge St., Suite 1608, Toronto M5E 1R1, (416) 862-7152. ■

Where to Buy

FLUKE

Handheld DMMs

Victoria, B.C. Queale Electronics	604-388-6111
Vancouver, B.C. Instrument Service Lab RAE Industrial Electronics	604-278-4511 604-291-8866
Vernon, B.C. Interior Electronics	604-545-2394
Kelowna, B.C. Interior Electronics	604-860-0585
Kamloops, B.C. Interior Electronics	604-374-5002
Calgary, Alta. Cardinal Industrial Electronics	403-259-6817
Edmonton, Alta. Cardinal Industrial Electronics Instrument Service Labs RAE Industrial Electronics	403-483-6266 403-463-7488 403-451-4001
Saskatoon, Sask. Armatek Controls Cardinal Industrial Electronics RAE Industrial Electronics	306-477-0717 306-934-3443 306-933-2888
Regina, Sask. Radio Supply & Service	306-352-8642
Winnipeg, Man. RAE Industrial Electronics WES Electronics Ltd.	204-786-8401 204-632-1260
Windsor, Ont. C.M. Peterson	519-253-1161
Sarnia, Ont. Armatek Controls C.M. Peterson	519-332-0100 519-344-3382
London, Ont. C.M. Peterson	519-434-3204
Kitchener, Ont. C.M. Peterson	519-745-0981
Hamilton, Ont. C.M. Peterson	416-528-0151
Toronto, Ont. Armatek Controls C.M. Peterson EIL Instruments Inc. Electro Sonic RAE Industrial Electronics	416-251-3111 416-247-6667 416-624-6660 416-494-1666 416-736-1744
Oshawa Weesco-Oshawa	416-683-6586
St. Catharines, Ont. C.M. Peterson	416-685-7377
Peterborough, Ont. Weesco-Peterborough	705-745-2493
Sudbury, Ont. Sonic Northern	705-674-0764
Ottawa, Ont. Electronic Wholesalers	613-746-4413
Montreal, Que. Electronic Wholesalers Franklin Electric ProJean Instruments	514-769-8851 514-341-6260 514-273-8331
Chicoutimi, Que. Franklin Electric	418-545-8313
Moncton, NB RAE Industrial Electronics	506-857-8011
Halifax, NS RAE Industrial Electronics Weesco-Maritimes	902-465-2350 902-465-3730
St. John's, Nfld. Rideout Tool & Supply	709-754-2240

How to beat the high cost of cheap meters.



You get what you pay for.
So get the Fluke 70 Series.

You'll get more meter for your money, whether you choose the affordable 73, the feature-packed 75 or the deluxe 77.

All of them will give you years of performance, long after cheaper meters have pegged their fishhook needles for the last time.

That's because they're built to last, inside and out. So they're tough to break. They don't blow fuses all the time. You don't even have to replace batteries as often.

And they're backed by a 3-year warranty. Not the usual 1-year.

Of course, you may only care that the world-champion 70 Series combines digital and analog displays with more automatic features, greater accuracy and easier operation than any other meters in their class.

You may not care that they have a lower overall cost of ownership than all the other "bargain" meters out there.

But just in case, now you know.

FROM THE WORLD LEADER
 IN DIGITAL MULTIMETERS.



FLUKE 73	FLUKE 75	FLUKE 77
\$134*	\$162*	\$231*
Analog/digital display	Analog/digital display	Analog/digital display
Volts, ohms, 10A, diode test	Volts, ohms, 10A, mA, diode test	Volts, ohms, 10A, mA, diode test
Autorange	Audible continuity	Audible continuity
0.7% basic dc accuracy	Autorange/range hold	"Touch Hold" function
2000+ hour battery life	0.5% basic dc accuracy	Autorange/range hold
3-year warranty	2000+ hour battery life	0.3% basic dc accuracy
	3-year warranty	2000+ hour battery life
		3-year warranty
		Multipurpose holster

* Canadian price. FST extra. Subject to change.
 ** Patent pending.

Contact your local authorized distributor now for immediate delivery.
 Or for more information, call the ACA office nearest you.

aca **Allan Crawford Associates Ltd.**
 TEST & MEASUREMENT DIVISION

Toronto: (416) 890-2010 Ottawa: (613) 596-9300 Vancouver: (604) 294-1326
 Montreal: (514) 731-8564 Halifax: (902) 463-8640 Calgary: (403) 295-0822

Electronics Today

LITERATURE REVIEWS



TRACER * 100XTR

A multi-purpose, handheld microsystem tool for hardware and software development, manufacture test and field service.

The TRACER provides advanced diagnostics and microsystem real-time monitor capabilities not found in any other test instrument. The TRACER supports all phases of microprocessor system development and hardware debug.

An RS232 port provides exciting alternatives to ATE, and emulation and logic analysis methods.

Circle No. 84 on Reader Service Card

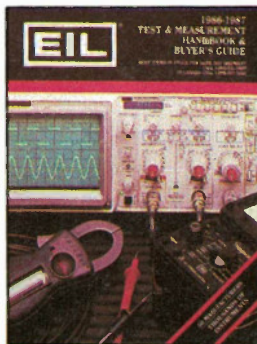

EIL

EIL INSTRUMENTS is one of the largest network of sales/service-centres for test, measurement and control instruments. The company distributes, customizes and services analog and digital panel meters, electrical testing and measuring equipment. EIL has made available to you at no additional cost our EIL Test and Measurement Hand Book and Buyer's Guide 1986/87, just call 1-416-624-6660 or toll free 1-800-387-3344.

Circle No. 85 on Reader Service Card

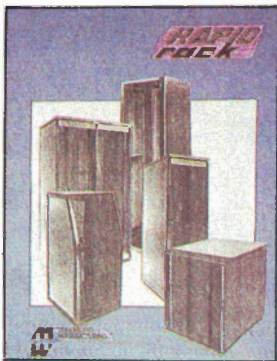

HAMMOND RAPID RACK

This new Hammond Rapid Rack Catalog features a new line of 19" Environmental Racks. These racks are available from stock in a standard NEMA 12 design or in an EMI/RFI shielded design. The catalog also contains a new, broader range of pre-assembled available-from-stock 19" Rapid Racks and accessories. New offerings include double ganged racks; sloping console racks and data terminal desks and racks. HAMMOND MANUFACTURING COMPANY LIMITED, 394 Edinburgh Road North, Guelph, Ontario N1H 1E5, (519) 822-2960.

Circle No. 86 on Reader Service Card



HEATHKIT'S SUMMER '86 CATALOGUE

Heathkit's Summer '86 Catalogue is available now. Packed with over 400 do-it-yourself kits, the Heathkit catalogue also has a full line of assembled products. See our new line of Assembled Oscilloscopes, EPROM Programmers and Erasers are also available. There are numerous PC-Comptible computers in both assembled and kit form from under \$1600. New courses in Fibre Optics, Lasers and Computer Servicing, round out the field.

Circle No. 87 on Reader Service Card



LENLINE TOOLS AND TOOL CASES

If you're a technician on the go, a well stocked tool kit is a must. Len FINKLER & CO. carry a wide range of tool kits, well stocked with standard and hard to get secondary tools. The cases are made by Platt from tough, durable industrial materials. Lenline is flexible too. Because you know what tools you need to get the job done, you can design the tool kit that is best suited to your needs, from student to professional engineer.

Circle No. 88 on Reader Service Card

LIT-REVIEWS

MOVE YOUR SALES LITERATURE INTO BUYER'S HANDS

Quick...

who makes the scopes that out-tech the competition?

NEW
150MHz
1596

NEW
100MHz
1590A

80MHz
1570A

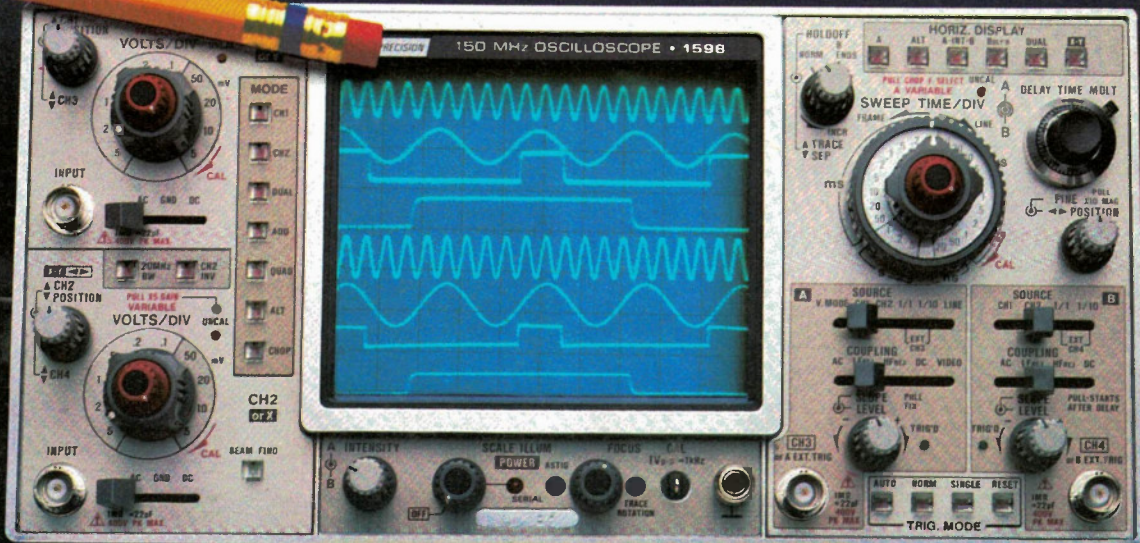

Now... up to 150 MHz
Compare these features and performance specifications.

Bright 20kV display
(12kV on 1570A)
with illuminated
graticule.

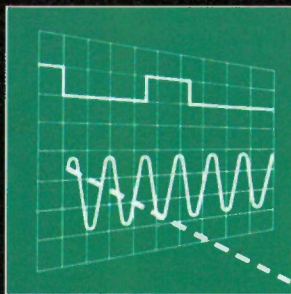

1mV
TRUE
SENSITIVITY

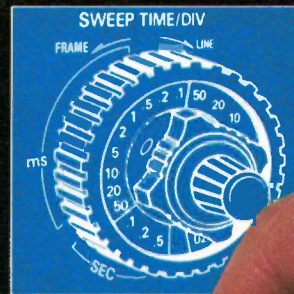

Dual
independent
timebase*



Four vertical inputs
with 8-trace display

- $\pm 2\%$ VERTICAL AND HORIZONTAL ACCURACY
- V-MODE DISPLAYS FOUR UNRELATED SIGNALS
- SOFT-TOUCH, LIT CONTROLS
- 500 μ V CASCADE SENSITIVITY
- CHANNEL 1 BUFFERED OUTPUT

Five times more
sensitive than
most competitors.

Circle No. 17 on Reader Service Card

Compare all of the features and performance benefits
with any scopes in their price range. See your local
stocking distributor or contact

*Not on 1570A



ATLAS ELECTRONICS LIMITED ... Achieving Excellence

50 Wingold Avenue
Toronto, Ontario M6B 1P7

Telephone 416-780-7761 Telex 069-69538

BK PRECISION

**DYNASCAN
CORPORATION**

THE SMART SCOPE



The new face of 50 MHz 'scope technology

\$1825.00
Duty & FST included

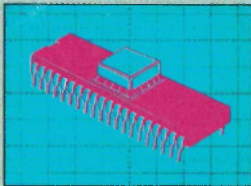

Autoset. PM 3050's green button gives you instant, fully automatic setting of all scope parameters – amplitude, timebase and triggering – for any input signal.

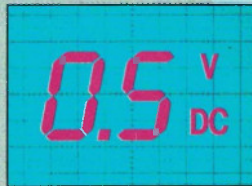

LCD panel. Gives clear indications of instrument settings, parameter values and selected control key functions at a glance, right next to the CRT screen.

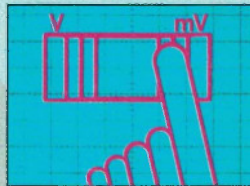

Up/down controls. Today's technology for fast, convenient input of amplitude (V/div.) and time (s/div.) settings. Fingertip operation – just press one way for up, and the other for down.

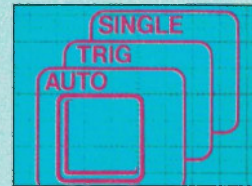

Softkey function selection. Multifunction softkeys simplify the front panel layout, and make operation clearer and more logical. An instantly accessible menu shows all available functions.

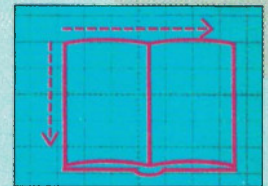

All-new front-panel design. The all-new front-panel design makes operation clearer and simpler. Control sequence is left to right, and top to bottom – just like reading a book!

Philips' all-new PM 3050 family are the smart scopes – in more ways than you'd think! First, they're smart in *performance*. With an advanced-technology 16 kV CRT, versatile triggering functions up to 100 MHz, and fast computer hook-up via an IEEE option.

And they're smart in *simplicity*, with Autoset, right-every-time micro-computer control and full modular design for fast, easy service.

But most of all they're smart in *price*, thanks to 'Philips unbeatable combination of design know-how and manufacturing technology. So check our PM 3050 family for yourself.

And make a smart move to the new technology in 50 MHz 'scopes!

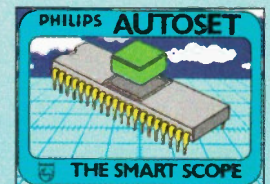

Philips PM 3050 family:
setting the
new standard



Test & Measurement

For full information about the PM 3050 scopes family, contact Philips Electronics LTD, S & I Division-Test & Measurement, 601 Milner Avenue, Scarborough, Ontario M1B 1MB, Tel: (416) 292-5161.

Circle No. 18 on Reader Service Card

PHILIPS