

# Electronics Today

\$3.25  
MM70924

January 1986

Canada's Magazine for Electronics & Computing Enthusiasts

## Heatsinks

Simple calculations for reliability

Transistor Stage Design

Discrete lives!

Millifaradometer Project

For large capacitors

Vibration Amp Project





# BEST Computers

Made in Canada, IBM PC, XT & AT Compatible

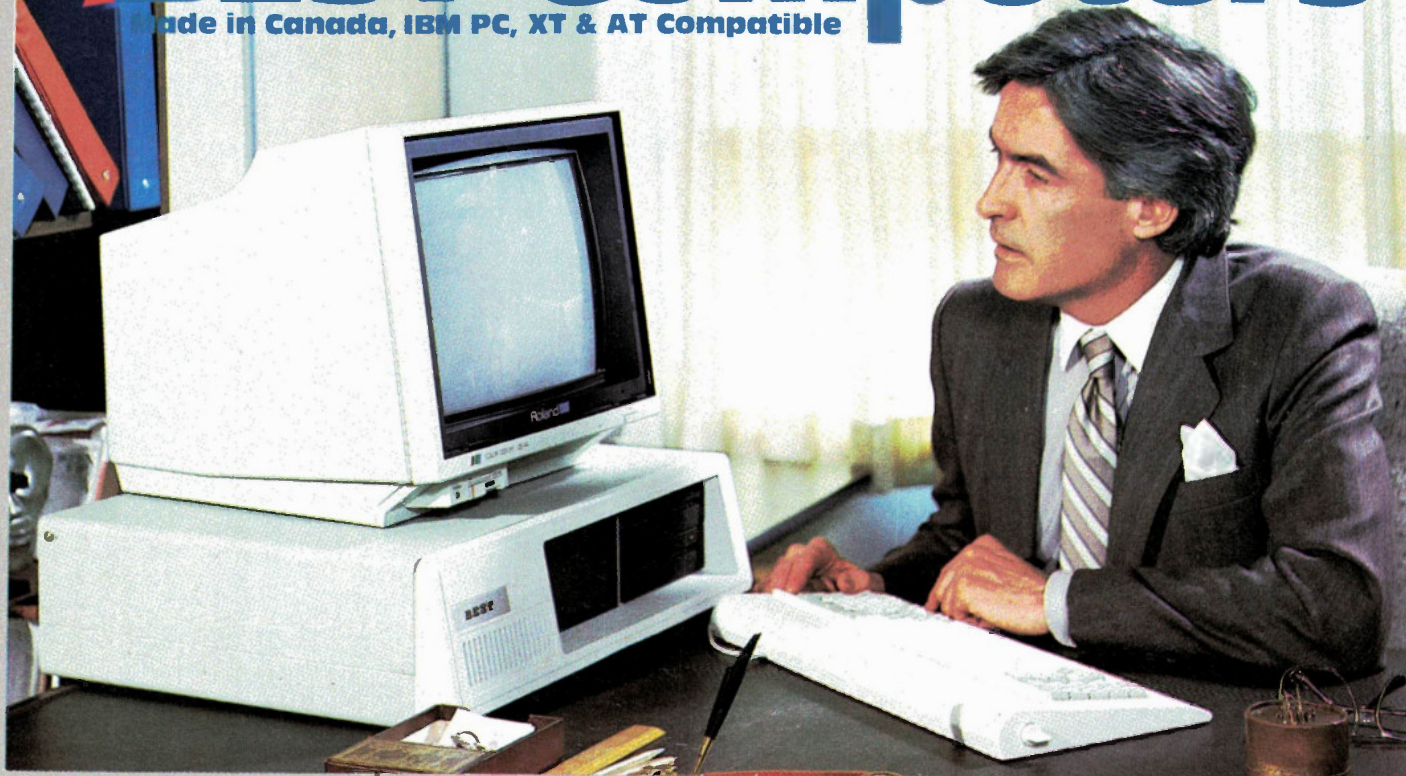

Monitor not included. IBM registered trade mark of IBM Canada Ltd.

## Features common to BEST MK II, MK III & MK IV

- Superb IBM PC & XT Compatibility
- Canadian Made
- 256K RAM Standard minimum (uses 41256K RAM chips)
- Expandable on board to 640K RAM
- Parallel Port (for printer)
- Serial Port (for communications)
- Real Time Clock/Calendar (with Battery Backup)
- Presocketed for optional co-processor — such as 8087 Math Processor
- IBM Compatible Keyboard
- Reset Switch
- Phoenix BIOS as used in many major brand IBM compatible systems.
- 150 Watt Power Supply which will handle a Hard Drive without upgrade.
- 7 Slots
- Flip top case
- 2 Slimline DS,DD 5 1/4", 360K Disk Drives
- Colour Video (RGB & Composite) Board or Hi-Res Monochrome Card (customer choice)
- Disk Controller Board

### Warranty

We have such confidence in the time tested reliability of the BEST that we offer a 300-day warranty, way above the industry standard.

Please Note: Don't be put off by our spectacularly low price; this is due to the fact we do not deal with middlemen and our volume buying power of parts. All BESTs are manufactured in Canada to the highest quality standards using prime, guaranteed components by our sister company. All systems are pretested (burnt-in) for about 48 hours before shipping. Hundreds of happy customers report excellent reliability and compatibility.

### BEST MK II. Regular \$1695. This Month:

Two 360K DS,DD disk drives, Serial and Parallel Ports, Real Time Clock, Phoenix BIOS, uses 8088 processor — full specifications given below.

# \$1595<sup>00</sup>

Other Configurations:

With 640K RAM .....	\$1695
With 10 Meg Hard Drive/1 Floppy/256K ...	\$2495
With 10 Meg Hard Drive/1 Floppy/640K ...	\$2595
With 20 Meg Hard Drive/1 Floppy/256K ...	\$2795
With 20 Meg Hard Drive/1 Floppy/640K ...	\$2895



### The FAST BEST MK III

As BEST MK II plus speed selectable: 4.77 and 8MHz (most software will run on the higher speed), uses 8088-2 processor.

# \$1895<sup>00</sup>

Other Configurations:

With 640K RAM .....	\$1995
With 10 Meg Hard Drive/1 Floppy/256K ...	\$2795
With 10 Meg Hard Drive/1 Floppy/640K ...	\$2895
With 20 Meg Hard Drive/1 Floppy/256K ...	\$3095
With 20 Meg Hard Drive/1 Floppy/640K ...	\$3195



### SUPER-FAST BEST MK IV

As BEST MK III plus TRUE 16-Bit machine, 8086-2 processor, IBM compatible 8-Bit I/O channel bus, even faster than MK III due to 16-Bit architecture. With 640K standard.

# \$2500<sup>00</sup>

Other Configurations:

With 10 Meg Hard Drive/1 Floppy/640K ...	\$3395
With 20 Meg Hard Drive/1 Floppy/640K ...	\$3695



### AVT-286

Superb IBM AT compatibility, 640K RAM, Two 5.25 in disk drives (one high density 1.2 Megabyte, one standard 360K), serial and parallel ports high quality keyboard, keyboard lock and status monitor.

# \$3495<sup>00</sup>

With 20 Megabyte fast stepping Hard Disk and Controller:

# \$4950<sup>00</sup>

40 Megabyte systems also available at reasonable prices.



# New Year Printer Special Spectacular Savings

## New from Star Micronics SG-10 Printer



### Ideal for Text & Graphics

- Dual Mode - NLQ/draft standard (NLQ = near letter quality) • 120 CPS and 20% faster throughput • Bidirectional, logic/seeking • 2K buffer (expandable to 6K with optional buffer interface) • 100% IBM PC or Star standard control codes-switch selected • Friction and tractor standard • full 1 year warranty • 10" wide carriage • Standard parallel interface (serial optional) ..... **\$379.00**

### SG-10 C for Commodore Computers

All the same features as the SG-10 but includes built-in interface which plugs directly into Commodore computers.

**\$389.00**

## Star Micronics SG15

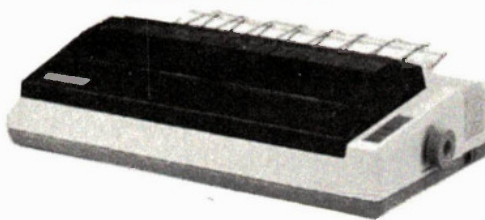

Same specifications as the SG-10 except with 15in. carriage and standard 16K buffer.

**\$599.00**

### SR-15

- 200 cps and 20% faster throughput • IBM PC or Star standard control codes switch selected • Dual Mode - NLQ/draft standard • Friction/tractor and automatic single sheet feed - standard • 15" carriage • 16K buffer • Bidirectional, logic seeking • Price/performance leader • Parallel port standard, serial optional • Full 1 year warranty. **\$995.00**

## Star Micronics — Power Type daisywheel printer Letter Quality



18 c.p.s., Bi-directional, Logic-seeking. 110, 132 or 165 columns. 100 Typefaces available, Proportional Spacing.

**\$535.00**

**Call or write for our  
1986 catalogue**

## Save Money — Time Limited Specials

Please note: These unbelievably good prices are due to a bulk purchase  
Prices good while stocks last.

### Star Micronics Gemini 10X Ideal for Text and Graphics

- 120 c.p.s., • 816 characters print buffer, option 4K or 8K • standard parallel optional RS232C • tractor & friction feed. **Super Special \$279.00**



### Star Micronics Gemini 15X PC IBM Compatible

Same as Gemini 10X PC but with 15in. carriage.

**\$399.00**

### Delta 15 PC IBM Compatible

160 c.p.s draft, 40 c.p.s Near Letter Quality, Friction and Tractor feed, 8K Buffer, Serial and Parallel Interfaces. 15in. carriage. Ultra-High Resolution.

**\$499.00**

### Delta 10 PC IBM Compatible

As above but 10in. carriage.

**\$399.00**

### Radix 15 PC IBM Compatible

200 c.p.s draft, 50 c.p.s. NLQ, Friction and Tractor Feed, Serial and Parallel Interfaces, 16K Buffer. 240 x 144 Ultra High Resolution.

**\$689.00**

### Radix 10 PC IBM Compatible

**\$549.00**

### ND-04D and ND-04DE-G 5 1/4" 360K DS/DD

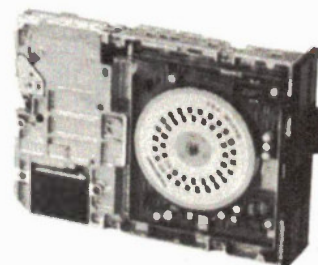

For your IBM PC/XT or compatible. Grey or black available.

**\$169.00**

### Memory Special

**41256 ..... \$4.39!**  
Large Quantity Discounts  
Available

**Check our catalogue for  
other spectacular  
memory pricing**

### Star Micronics Gemini 10X PC

All the above features but IBM Compatible.

**\$279.00**

**Check out our catalogue for  
prices of Monitors, Disk  
Drives, Print Supplies and  
Printer Cables**

**We have excellent pricing  
on 10 and 20 Megabyte  
Hard Drives and Controllers**

# EXCELTRONIX

319 College Street, Toronto, Ont. M5T 1S2  
(416) 921-8941. Order line only 1-800-268-3798  
Ottawa, 217 Bank Street (613) 230-9000  
Visa, Mastercard and American Express accepted.





# Will they still be your friends if you say no?

Jerry's a good driver. But this time he's had one too many and the thought of him behind the wheel makes you nervous. Can the gang persuade you to get in the car anyhow or will you stick by your guns and say no?

Nobody who's had too much to drink should ever be on the road. So speak up. Suggest that you or one of the others drive

instead. Better still, Jerry should leave the car parked then everyone could share a cab home.

If your friends are really your friends they'll thank you, not put you down, for pointing out the dangers of drinking and driving. What you're really doing is caring about their safety as well as your own. And isn't that what a friend is for?

## Seagram

*We believe in moderation and we've been saying so since 1934.*

*Do you know how much alcohol you can safely handle? Write to us and we'll send you a valuable free chart on drinking limits. P.O. Box 847, Station H, Montreal, Quebec. H3G 2M8*





### Our Cover

Our advice on heat-sink applications appears on page 30; photo by Bill Markwick.

Electronics Today is Published by:  
**Moorshead Publications Ltd.** (12 times a year)  
 1300 Don Mills Road,  
 Don Mills, Toronto, Ont. M3B 3M8  
 (416) 445-5600

Editor: **William Markwick**  
 Assistant Editor: **Edward Zapletal**  
 Director of Production: **Erik Blomkwist**  
 Production Manager: **Douglas Goddard**  
 Production: **Naznin Sunderji**  
**Dolph Loeb**  
 Circulation Manager: **Lisa Salvatori**  
 Advertising Account Manager: **Marlene Dempster**

Publisher: **H. W. Moorshead**; Executive Vice-President: **V. K. Marskell**; Vice-President - Sales: **A. Wheeler**; General Manager: **S. Harrison**; Controller: **B. Shankman**; Accounts: **P. Dunphy**; Reader Services: **M. Greenan, J. Fairbairn, R. Cree, L. Robson, N. Jones**; Advertising Services: **H. Brooks**.

Newsstand Distribution:  
 Master Media, Oakville, Ontario

Subscriptions:  
 \$22.95 (one year), \$37.95 (two years). Please specify if subscription is new or a renewal.

Postal Information:  
 Second Class Mail Registration No. 3955. Mailing address for subscription orders, undeliverable copies and change of address notice is: Electronics Today, 1300 Don Mills Rd., Toronto, Ontario, M3B 3M8

Printed by Heritage Press Ltd., Mississauga  
 ISSN 07038984.

Moorshead Publications also publishes Computing Now!, Computers in Education, and Pets Magazine.

Circulation Independently Audited by MURPHY and MURPHY, Chartered Accountants.

### Advertisers' Index

BCS Electronics Ltd.	21, 63
Canada Remote Systems	26
Computer Parts Galore	28, 29
Daetron	62
EDG Electronics Distributors	57, 59, 61
Electronic Control Systems	26
Electronic Supplies Inc.	40
Electronic Supply Parts	26
Exceltronix	2, 3
Information Unlimited	39
Interfax Systems Inc.	31, 33
Kaientai Electronics Merchants Ltd.	26
KB Electronics	22, 40
Metermaster	58
McGraw Hill	25
Parts Galore	21, 28, 29
Patron Components Inc.	39
Philips Electronics Ltd.	34, 35
Seagram	4
Soltech Industries Inc.	38
Surplustronics	36
The Software Link Inc.	64
The Electronic Book Club	27
Transpac Trading Corp.	8
Varah's Direct	7

Call 445-5600

# Electronics Today

January 1986  
 Vol. 10 No. 1

Canada's Magazine for Electronics & Computing Enthusiasts

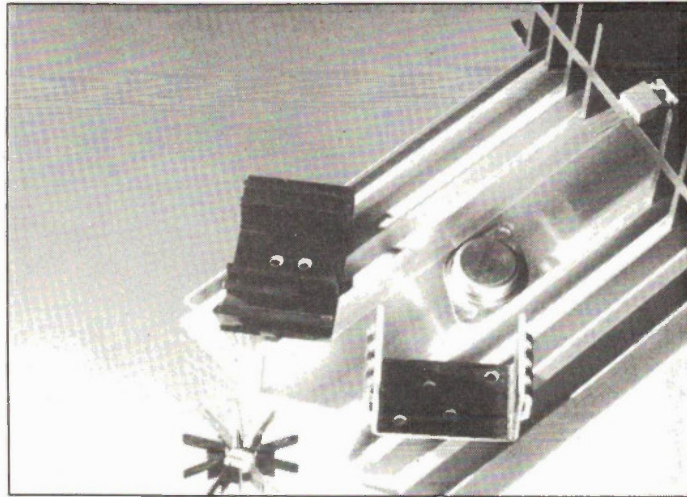

Heatsinks p. 30

## Features

Index To 1985	16
Heatsinks	30
Designing Transistor Stages	49

## Review

Apron Bugbuster	56
-----------------	----

## Projects

Logical Lock	9
Millifaradometer	32
Vibration Amplifier	47

## Series

Computing Today: RISC Chips	18
Electronics From The Start, Part 7	43
Designer's Notebook: ATE	52

## Columns and Information

For Your Information	6	Product Mart	55
Next Month	10	Order Form	45
Computing Now! This Month	11	Subscriptions	46
Software	22	Circuit Ideas	55
Almost Free Software	23, 24		



# For Your Information

## Phone Loop Tester



The Triplet Model 5 performs all sorts of performance checks on telephone lines: power influence, circuit noise, circuit loss, line milliamps, etc., plus having a volt-ohmmeter and multitone generator. Field measurements can be done by one person. Overload

protection is provided throughout; it's complete with batteries and test leads. Distributed by Len Finkler and Company, 80 Alexdon Rd., Downsview, Ontario M3J 2B4, (416) 630-9103.

Circle No. 3 on Reader Service Card

## Milliohm Meter

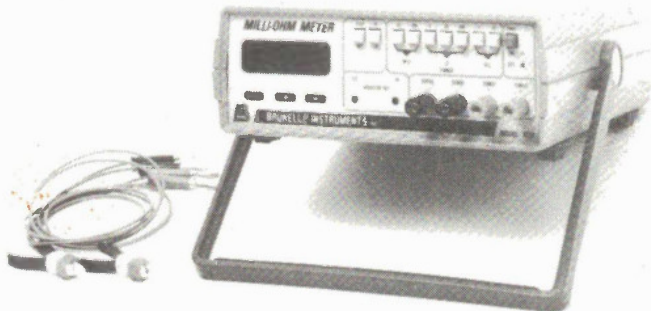

Brunelle's newest addition to their Commander series of test instruments is the BTL 1820 milliohm meter. It has a resolution of 0.05 milliohms, and is especially designed for the testing the contact resistance of switches, relays,

plugs, connectors, etc. All low valued resistors can also be measured. From Brunelle Instruments, 826 Belvedere St. S., Sherbrooke, Quebec J1H 4B8, (819) 563-9096.

Circle No. 4 on Reader Service Card

## Instrumentation UPS



A series of uninterruptible power supplies to provide continuous power to sensitive or important equipment during power failures or brownouts has been introduced by Triton Technology Inc. Canadian designed and manufactured, the series is ideally suited for computers, instrumentation, word pro-

cessors, medical equipment, etc., and features line conditioning, voltage regulation, line isolation and emergency power in one unit. From Allan Crawford Associates, Test and Measurement Division, 5835 Coopers Ave., Mississauga, Ontario L4Z 1Y2, (416) 890-2010. Circle No. 5 on Reader Service Card

## Starting Switch

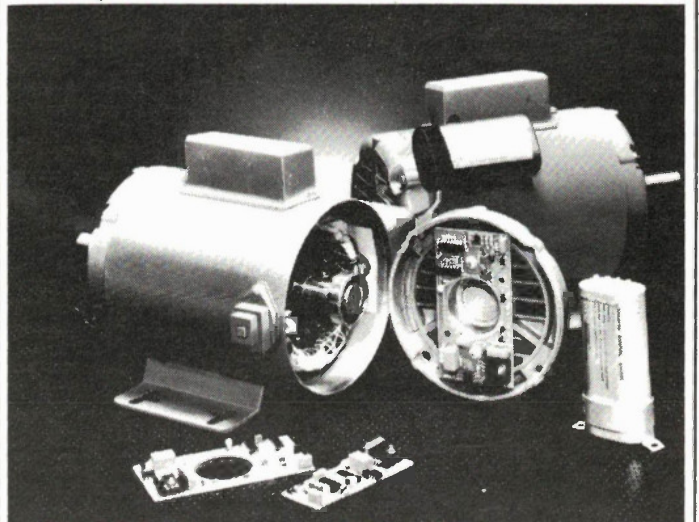

A new electronic starting switch, the SINPAC series from the Stearns Division of PT Components, performs all the functions of centrifugal actuator switches without the disadvantages of electromechanical designs. It is speed-sensitive, and will engage the starting winding on momentary overloads to ensure maximum torque. It is not coupled to the motor

shaft in any way, simplifying assembly, operation and repair. No additional components or changes in the starting capacitor are required. Available for various sizes and types of motors. Contact Rumble Equipment Ltd., 25 Baywood Road, Rexdale, Ontario M6V 3Y8, (416) 743-8711.

Circle No. 33 on Reader Service Card.

If you're looking for long or short term rental of test equipment, including HP, Tektronix, DEC, etc., Electro Rent Corporation has a huge assortment with various plans available, including rent-to-purchase. They also have a quarterly catalogue that lists used equipment

for sale. Contact them at 1110 Kamato Road, Unit 1-2, Mississauga, Ontario L4W 2P3, (416) 624-6132, or at their outlets in Ottawa, Montreal and Vancouver.

Circle No. 6 on Reader Service Card



#### Copyright

All material is subject to worldwide copyright protection. All PCB patterns are copyright and no company can sell boards to our design without our permission.

#### Liability

While every effort has been made to ensure that all constructional projects referred to in this magazine will operate as indicated efficiently and properly and that all necessary components are available, no responsibility whatsoever is accepted in respect of the failure for any reason at all of the project to operate efficiently or at all whether due to any fault in the design or otherwise and no responsibility is accepted for the failure to obtain component parts in respect of any such project. Further no responsibility is accepted in respect of any injury or damage caused by any fault in design of any such project as aforesaid.

#### Editorial Queries

Written queries can only be answered when accompanied by a self-addressed, stamped envelope. These must relate to recent articles and not involve the staff in any research. Mark such letter Electronics TodayQuery. *We cannot answer telephone queries.*

#### Binders

Binders made especially for Electronics Today (ETI) are available for \$9.75 including postage and handling. Ontario residents please add provincial sales tax.

#### Back Issues and Photocopies

Previous issues of Electronics Today Canada are available direct from our office for \$4.00 each; please specify by month, not by feature you require. See order card for issue available.

We can supply photocopies of any article published in Electronics Today Canada; the charge is \$2.00 per article, regardless of length. Please specify both issue and article.

#### Component Notation and Units

We normally specify components using an international standard. Many readers will be unfamiliar with this but it's simple, less likely to lead to error and will be widely used everywhere sooner or later. Electronics Today has opted for sooner!

Firstly decimal points are dropped and substituted with the multiplier: thus 4.7uF is written 4u7. Capacitors also use the multiplier nano (one nanofarad is 1000pF). Thus 0.1 uF is 100nF, 5600pF is 5n6. Other examples are 5.6pF = 5p6 and 0.5pF = 0p5.

Resistors are treated similarly: 1.8Mohms is 1M8, 56kohms is the same, 4.7kohms is 4k7, 100ohms is 100R and 5.6ohms is 5R6.

#### PCB Suppliers

ETI magazine does NOT supply PCBs or kits but we do issue manufacturing permits for companies to manufacture boards and kits to our designs. Contact the following companies when ordering boards.

Please note we do not keep track of what is available from who so please don't contact us for information PCBs and kits. Similarly do not ask PCB suppliers for help with projects.

K.S.K. Associates, P.O. Box 266, Milton, Ont. L9T 4N9.

B—C—D Electronics, P.O. Box 6326, Stn. F., Hamilton, Ont. L9C 6L9.

Wentworth Electronics, R.R. No. 1 Waterdown, Ont. L0R 2H0.

Danocinths Inc., P.O. Box 261, Westland MI 48185 USA.

Arkon Electronics Ltd., 409 Queen Street W., Toronto, Ont., M5V 2A5.

Spectrum Electronics, 14 Knightswood Crescent, Brantford, Ontario N3R 7E6.

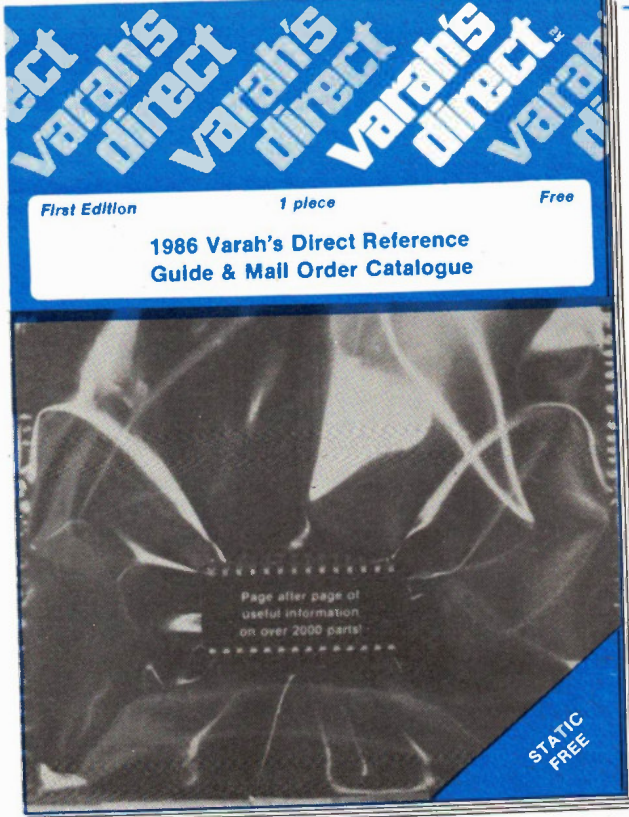

# It's a direct hit!

## The Varah's Direct catalogue is a bestseller. And it's free!

The first printing just couldn't accommodate all the requests, so now we offer you a second printing *hot off the press*. Contact us today!

#### Here's a sample of the comments so far:

*"Excellent catalogue and reference guide"*

Jack Henderson  
Burlington, Ontario.

*"Helps us out of the jungle of part numbers. Send more order forms!"*

Ray Palmer  
Summerland, B.C.

*"Got to be a winner"*

Norm Frieden  
Hamilton, Ontario

#### For everything that you need:

semiconductors • capacitors • resistors  
educational kits • test equipment  
tools • literature • and much more!



Member Canadian  
Direct Marketing  
Association

#### Locations:

Vancouver  
Edmonton  
Calgary  
Winnipeg  
Oakville  
Nepean

#### Write:

Varah's Direct  
504 Iroquois Shore Rd  
Oakville, Ontario  
L6H 3K4  
(please include your  
return postal code)

#### Circle:

The reader service  
number for this ad  
Or Call:  
(416) 842-8833  
Monday to Friday  
8 00 - 6 00. E S T



# Super Subscription BONUS!

## Three Special Publications — worth \$12.85 — FREE!

# ONE MONTH ONLY

**Electronics Today** is moving to new larger premises shortly and we're like everyone else, we are taking this opportunity to clear out storage. We have a number of *Special Publications* that we thought we would offer readers rather than move with us.

Subscribe now and we will send you **THREE** of these as a 'Thank you': **50 Top Projects, Projects Book No.2 PLUS** either **Electronic Circuit Design or Circuits File** (we do not have enough of either of the last two to guarantee a choice). Mostly these are in perfect condition but a few are slightly dog-eared; after all, this is a genuine clear-out!

Offer applies to both one and two year subscriptions. Not valid with any other bonuses or discounts. Offer expires January 31st, 1986; 'Bill me' subscriptions must be paid by that date to qualify.

**WHAT YOU DO:** Use the card in this issue (or any other card in *Electronics Today* after March 1985) and write in the central long box in the centre of card 'Specials offer' — we'll do the rest.

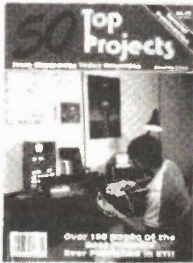

• 50 Top Projects  
156 Pages

\$4.95  
Fifty all-time best projects from ETI magazine packed into one giant 156 pages special. There are projects for the beginner to the more advanced builder, including: Semiconductor Tester, Universal Counter, LED Level Meter, AM radio, and much, much more.

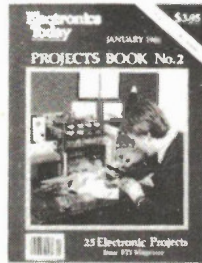

• Projects Book No. 2  
100 pages

\$3.95  
Contains 25 of the best projects from recent issues including the High Performance Series 4000 Amplifier (including Preamps and Power Supply), Rumble Filter, Dynamic Noise Filter, Logic Probe, Cable Tester, Function Generator, Rain Alarm, Digital Tacho, Two Octave Organ, Light Chaser, Shutter Speed Timer, Ni-Cad Charger and more. First published January 1981.

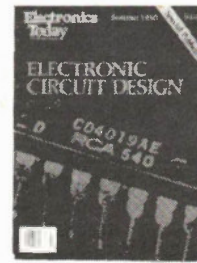

• Electronic Circuit Design  
92 pages

\$3.95  
A collection of major articles on various aspects of circuit design including CMOS, Audio Amplifiers, Power Supplies, SCR's, Op-Amps, Using the 3080 and Temperature Control. A large number of useful circuits are given but the emphasis is on guidance and how to design for yourself.

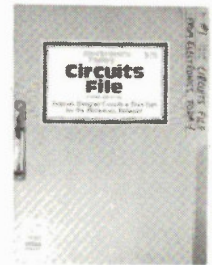

• Circuits File  
100 Pages

\$3.95  
A huge collection of circuits and tech tips for the experimenter. Includes hifi, alarm circuits, power control, electronic music, and lots of testbench accessories. Most of the circuits have not been previously published.

# Electronics Today

Offer expires January 31st 1986



# Logical Lock Project

*An electronic method of operating a security lock.*

*By Phil Walker*

THIS lock will not make your house burglar-proof; however, it should do away with the need to hide keys. All you need to persuade your family to do is to remember a five-figure number. All the digits in the number must be different; for example, you couldn't use the code 9999, but they can be in any order, and the code can be changed if your number should get a little too widely known.

Although both the system diagram, Figure 1, and the circuit diagram are relatively large, the unit uses comparatively few components, just six integrated circuits and a handful of other components to do all the clever stuff. We expect that the actual control unit itself will be relatively cheap to build; however, the solenoid-operated lock will probably be the main expense, although there may be ways around this, as we shall see.

## How It Works

Switches SW1 to 10 make up the keypad. Of these, SW1 to 5 are all connected in parallel; these are the "wrong digits". Pushing any of these switches makes current flow through R1, down through the switch and then through R2 (a little current flows out of the input to IC1a, but this is small enough not to take account of). Capacitor C1 is present to ensure that the rise in voltage across R2 is smooth. When fairly inexpensive switches close, they don't just close cleanly, but make and break their contacts (bounce) several times before finally making firm contact; C1 prevents the fluctuations that occur from reaching IC1a's input.

IC1a is a Schmitt trigger with an inverted output. What this means is that it has a very precisely defined voltage at which it will turn on, and once it has turned on, the voltage at its input must be reduced to a much lower level than that which turned it on to get it to turn off. Because the output is inverted, the output voltage is actually a logic low when the input is turned on. Schmitt triggers are often used to clean up logic signals, and that is exactly what these are being used for here.

Resistors R1 and R2 form a potential divider while one of switches SW1 to 5 is

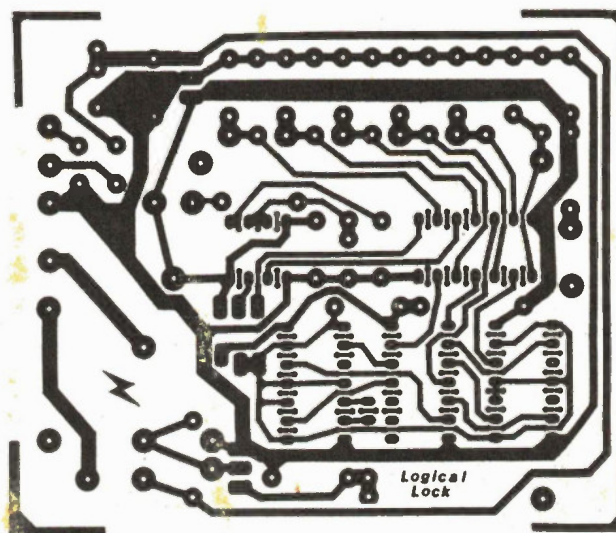

Fig. 1 The printed circuit.

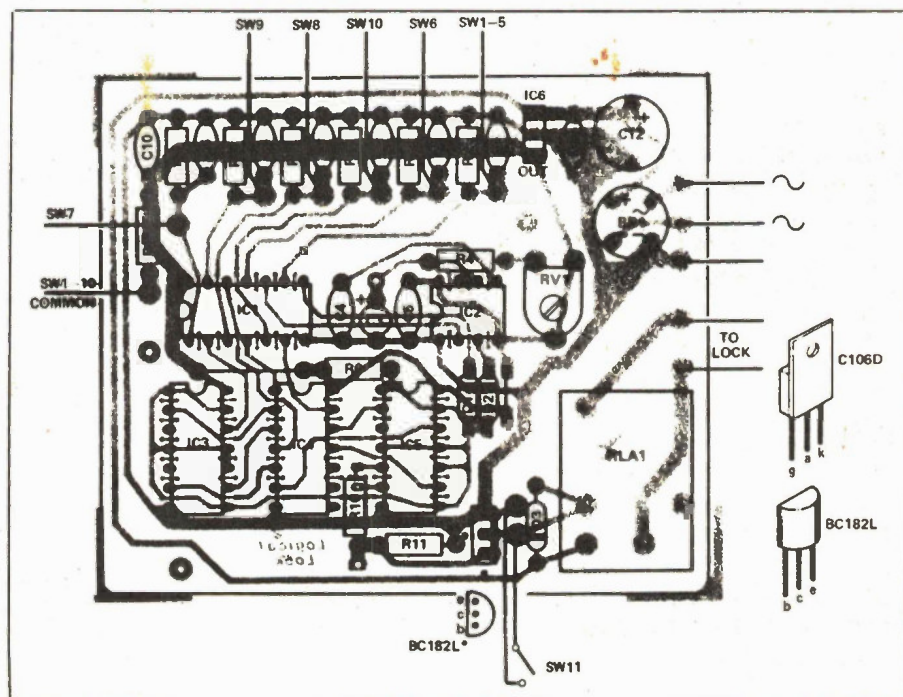

Fig. 2 The parts overlay.



**Assembly**

All the components for the project, except the keypad, transformer and fuse are mounted on a PCB. The prototype was built using Veroboard; however, there were so many links that we were easily convinced that a PCB would make life very much easier.

We did find it necessary to use one or two links on the PCB, so the first task in assembly should be to insert all the links. One hint: all the links run parallel to the edge of the board. If you have one which doesn't, you've got it wrong. closed. The voltage at their junction point (via the closed switch) at the input of IC1a is just enough to trigger the input of the IC, as already discussed. If any of the switches SW6 to SW10 are closed, then R2 will be effectively in parallel with the resistors attached to the lower ends of the (other) switch which is closed (R3 or R5 or R6 or R7 or R8), so the voltage at the input to IC1a or any of the Schmitt triggers (the other sections of the IC discussed later) cannot reach the voltage needed to turn on the Schmitt triggers. This prevents our prospective intruder from trying to cheat by pressing more than one key at a time, as this will have no effect.

The output from IC1a will, therefore, go low if any of switches SW1 to 5

are pressed. This low signal is passed via D2 to the reset line to the ICs in the decoder section; these will be discussed quite soon.

SW6 is the first of the "right" switches that has to be pressed. As with IC1a, pressing SW6 takes the input of IC1b high and its output low. This low signal is fed

to IC2, which is a 555 timer IC. The 555 timer is very useful, and for this reason is a very common integrated circuit that can do a great variety of timing jobs in electronic circuits. We won't go into the details of its operations here, except to say that it is wired as a monostable. What this means is that the circuit has only one

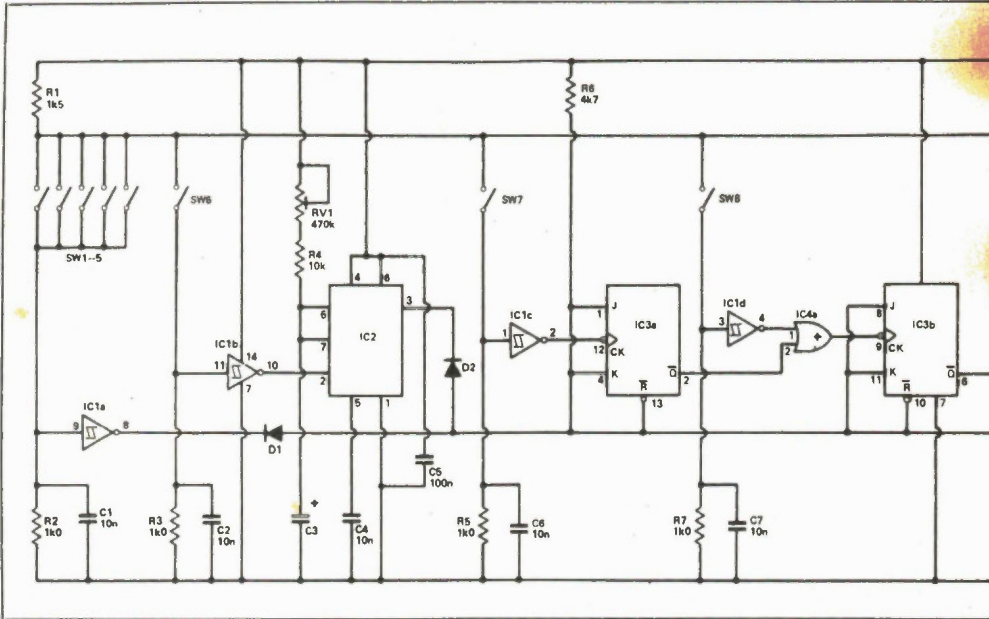

**NEXT MONTH IN Electronics Today**

**MOSFETS!**

We look at the device that may eventually replace the bipolar: the MOSFET. It's about as close as you can get to a voltage-controlled power transistor with no thermal problems. We include circuits and application notes.

**More Transistor Design!**

We continue with the second part of Designing Transistor Stages - the discrete bipolar is not dead yet. Next month we feature a recap of the most common configurations of the single transistor.

**Pulse Generator Project!**

An easy-to-build pulse generator board with various types of outputs, variable rate including external sync, and variable width. Ideal for experimenting with logic circuits.

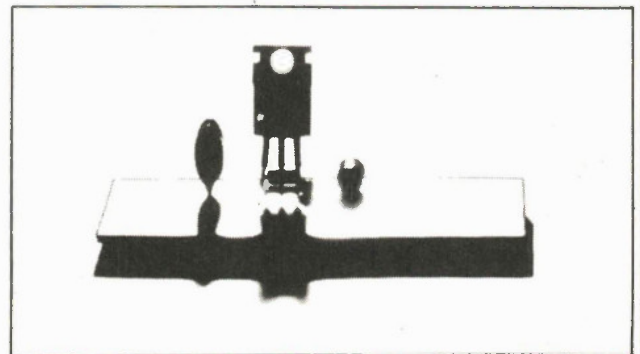

For Subscription or Advertising Information Call (416) 445-5600



stable state (as opposed to the flip-flops that we shall meet shortly). A trigger pulse, such as it will receive from SW6 via IC1b, will make it go into its second, unstable state for a period of time which is controlled by capacitor C3 and potentiometer RV1, after which it will revert to its first, stable state.

In its unstable state, the output from the 555 timer IC, which is pin 3, is taken high. When it returns to its stable, first state, the output is taken low, which takes the reset line to the decoder via D2.

One incidental point to note here is that D1 and D2 are both germanium diodes. Germanium diodes have a lower

voltage drop across themselves when they are conducting, so they are less likely to let a low logic signal get too high in voltage and fail to be recognized as a low.

### Decoder

The next section of the circuit is the decoder, which is based on IC3 and 5 a and b, with associated ancillary logic

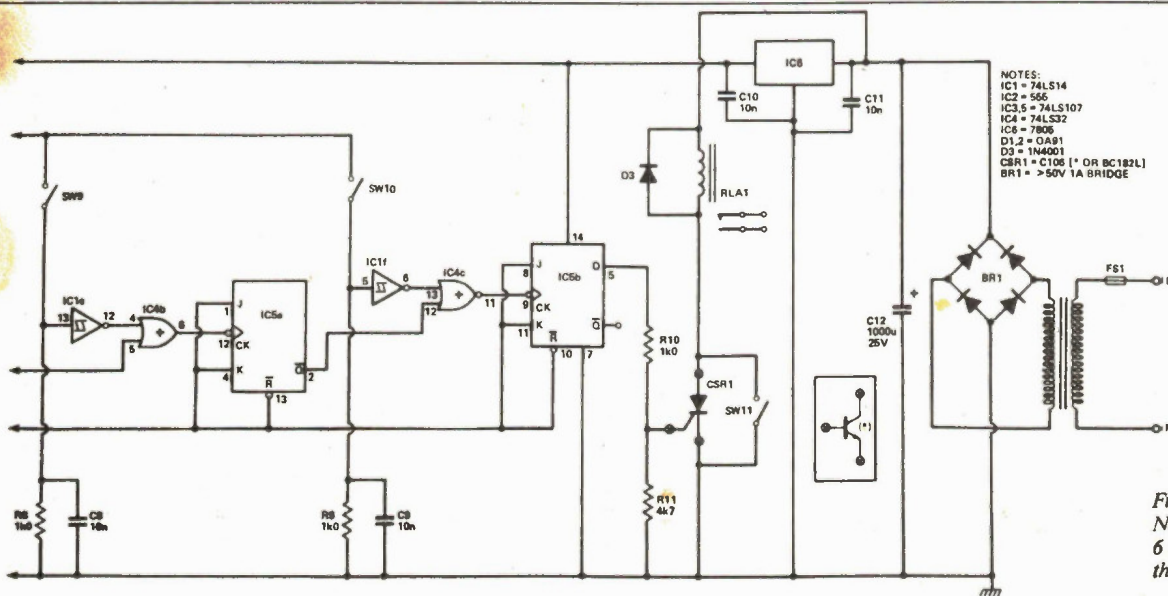

Figure 3. The circuit. Note that it switches 6 to 10 which control the actual combination.

# This Month in

## Computing! Now!

### The First of the AT Compatibles

The powerful features of this newest generation of business computers, and some of the useful things to look for when you actually think about buying one.

### A Hard Drive for Next To Nothing

A hard disk system can transform your computer into a really astounding, powerful machine. With ingenuity and this article, you can implement a hard drive for hundreds of dollars less than they usually cost.

### Apple CP/M RTTY Decoder

Turn on your shortwave radio, plug in your computer, and decode the beeps and bops. Check out news transmissions, amateur radio, and a host of other data in the sky.

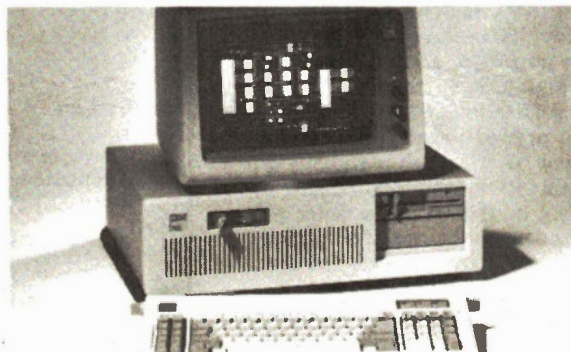

For Subscription or Advertising Information Call (416) 445-5600



gates. The first switch which must be pressed is SW7 (this is after SW6 has been pressed). This takes the output of IC1c low. This output is fed to the clock input of IC3a. IC3a and 3b, 4a and 4c, are flip-flops. These are devices which have two stable states: when they are put into one or other of their stable states, they will stay there until caused to "flip" to the other state, and they can then be made, by another stimulus, to "flip" into the first state.

There are many different types of flip-flops, and we could (and will, one day) spend an entire article talking about them. So let us just say that the type here is a J-K flip flop which is negative edge triggered. In English, this means that with the two inputs J and K wired to logic high, as they are here, the outputs will flip from low to high or vice-versa) depending on which stable state the flip-flop was in) as the clock input goes from positive to negative.

In practical terms, that means that as the output of IC1s goes from high to low, the output Q will change from either low to high or from high to low, depending on which state it was in just before IC1a's output changed. However, we know that state the output was in, because before SW6 was pressed, the reset line was low. This has, curiously enough, the effect of resetting all the flip-flops in the decoder, output Q will be high (incidentally, the inverted output Q, not used here, will be high), so it will then have gone to low (Q will go to high). This takes one input to the OR gate, IC4a, to low.

Like all OR gates, IC4a will let its output go low when both its inputs are low. Before SW8 is pressed, IC1d's input will be held low by R5, and its output will be high, so one input to IC4a is still high and its own output is also high. However, as soon as SW8 is closed, IC1d's input is taken high and its output goes low, taking IC4d's output low with it. This positive-to-negative transition is exactly what the clock input of IC3b needs to make this IC flip its outputs taking the Q output from high to low which will in turn take the Q output of IC4b high (exactly as with IC4a).

Again, closing the switch (SW9, this time) takes the other input the OR gate (now IC4b) low (via IC1e), again giving the flip-flop (IC5a here) the positive-to-negative transition, again the Q output goes from high to low, etc.

Let it suffice to say that if the switches are all pressed in the correct order, the Q output of IC5b will eventually go high; this will last for only a short space of time, because by this time, the timer will probably be near to the end of its period, and it will then take the reset line low, turning off all the flip-flops.

However, this is where the latch part of the circuit comes in. This makes use of a very useful component indeed, a silicon controlled rectifier (sometimes called a

thyristor). In the normal reverse direction, the direction in which no diode will conduct, the SCR will not conduct either. However, in the other direction, the forward direction, the SCR will conduct only after a suitable voltage pulse has been applied to the gate terminal. After this pulse has been applied, the SCR will continue to conduct, whatever happens at the gate terminal, so long as the current flowing through the main terminals of the SCR remains above a certain, holding value.

In this circuit, the SCR makes a very good choice for the latch, because, besides latching on and staying on, the SCR also can pass relatively high currents with very little voltage drop and so relatively small heat dissipation. The only way to turn off SCR1 is by shorting it out briefly, so removing all the current through it; this can be done using SW11.

The SCR is used to provide power to the relay RLA1, which has contacts which are capable of taking the mains, at low current. More about this in the wiring-up section.

The final section of the circuit is the power supply, which is absolutely standard. T1 takes the line voltage and transforms it down to a much lower one; BR1 rectifies this and C12 smooths out the voltage; IC6 regulates this down to a steady 5 volts; C10 and C11 protect against high frequency instability causing problems in the regulator IC6.

#### Parts List

##### Resistors (All 1/4W 5% carbon)

R1	.....	1k5
R2, 3, 5, 7, 8, 9, 10	.....	1k0
R4	.....	10k
R6, 11	.....	4k7

##### Capacitors

C1, 2, 4, 6-11	.....	10n	ceramic
C3	.....	axial electro	
C5	.....	100n	ceramic
C12	.....	1000u	regulator

##### Semiconductors

IC1	.....	74LS14
IC2	.....	555
IC3, 5	.....	74LS107
IC4	.....	74LS32
IC6	.....	7805
D1, 2	.....	1N34
D3	.....	1N4001
SCR1	.....	C106
BR1	.....	any 1A 200V bridge.

##### Miscellaneous

SW1-11	.....	any suitable arrangement of panel-mounting single-pole push-to-make momentary switches or keypad
RLA1	.....	12VDC relay
T1	.....	9V miniature transformer, 3VA (minimum)
FS1	.....	1A fuse and panel-mounting holder

PCB; cases for keypad and main unit; ribbon cable; wire solder, etc.

The keypad is assembled in its own case, and how you do this is very much a matter of personal choice, as is the keypad itself. For a ten-digit keypad you need eleven wires in total (ten digits and common). The reset switch must be inside the protected building as it will open the door when operated. You may find it useful to have more than one keypad; there is no problem provided the switches are wired in parallel, and also provided that only one pad is operated at a time.

Using a solenoid-operated door catch which uses 115VAC (not all do), the contact on RLA1 will have to be wired appropriately. You will have to work out the exact details for yourself according to the lock you are using; if you are not confident, don't use a line-operated lock.

#### Installation

The keypad has to be installed outside the door, with the rest of the installation on the inside. It is convenient to mount the reset button near the door, either with the main box or separately, but make sure that the reset (and the rest of the works) are more than an arm's length away from any breakable window, and preferably that the reset button is protected with a cover when not in use. If the reset button is away from the mains box, the wires should not be either too long or too thin. The action of the switch depends on the current path through it being at a lower resistance than the path through the SCR. If the wires are too long or thin, a sizeable current will continue to flow through the SCR, holding it on. Better to mount the whole assembly away from the lock in this case.

Most electronically-operated locks operate from the keeper (doorpost) side. Some specifically combine electrical operation with an ordinary night-latch lock so that they can be operated either electrically or with a key. ■



# BABANI BOOKS

Imported from England and exclusively available in Canada from Moorshead Publications.

**BP53: PRACTICAL ELECTRONICS CALCULATIONS AND FORMULAE** \$11.75

A book that bridges the gap between complicated technical theory and the 'cut and try' method. A good reference book.

**BP136: 25 SIMPLE INDOOR AND WINDOW AERIALS** \$6.65

People living in apartments who would like to improve short-wave listening can benefit from these instructions on optimising the indoor aerial.

**BP147: AN INTRODUCTION TO 6502 MACHINE CODE** \$7.75

The popular 6502 microprocessor is used in many home computers; this is a guide to beginning assembly language.

**BP150: AN INTRO. TO PROGRAMMING THE SINCLAIR QL** \$7.75

Helps the reader make the best use of the Sinclair QL's almost unlimited range of features. Complements the manufacturer's handbook.

**BP225: A PRACTICAL INTRODUCTION TO DIGITAL ICs** \$6.65

This book deals mainly with TTL type chips such as the 7400 series. Simple projects and a complete practical construction of a Logic Test Circuit Set are included as well as details for a more complicated Digital Counter Timer project.

**BP130: MICRO INTERFACING CIRCUITS - BOOK 1** \$8.55

Aimed at those who have some previous knowledge of electronics, but not necessarily an extensive one, the basis of the book is to help the individual understand the principles of interfacing circuits to microprocessor equipment.

**BP131: MICRO INTERFACING CIRCUITS - BOOK 2** \$8.55

Intended to carry on from Book 1, this book deals with practical applications beyond the parallel and serial interface. 'Real world' interfacing such as sound and speech generators, temperature and optical sensors, and motor controls are discussed using practical circuit descriptions.

**BP111: AUDIO** \$13.25

This one is ideal for readers who want to really get into sound. A wide range of material is covered from analysis of the sound wave, mechanisms of hearing, room acoustics, microphones and loudspeakers, amplifiers, and magnetic disc recording.

**BP141: LINEAR IC EQUIVALENTS AND PIN CONNECTIONS ADRIAN MICHAELS** \$21.95

Find equivalents and cross-references for both popular and unusual integrated circuits. Shows details of functions, manufacturer, country of origin, pinouts, etc.; includes National, Motorola, Fairchild, Harris, Motorola, Intersil, Philips, ADC, AMD, SGS, Teledyne, and many other European, American, and Japanese brands.

**BP156: AN INTRODUCTION TO QL MACHINE CODE** \$7.75

The powerful Sinclair QL microcomputer has some outstanding capabilities in terms of its internal structure. With a 32-bit architecture, the QL has a large address range, advanced instructions which include multiplication and division. These features give the budding machine code programmer a good start at advanced programming methods. This book assumes no previous knowledge of either the 68008 or machine code programming.

**BP47: MOBILE DISCOTHEQUE HANDBOOK** \$5.25

Divided into six parts, this book covers such areas of mobile 'disco' as: Basic Electricity, Audio, Ancillary Equipment, Cables and Plugs, Loudspeakers, and Lighting. All the information has been considerably sub-divided for quick and easy reference.

**BP59: SECOND BOOK OF CMOS IC PROJECTS** \$7.75

This book carries on from its predecessor and provides a further selection of useful circuits, mainly of a simple nature. The book will be well within the capabilities of the beginner and more advanced constructor.

**BP32: HOW TO BUILD YOUR OWN METAL & TREASURE LOCATORS** \$7.75

Several fascinating applications with complete electronic and practical details on the simple, and inexpensive construction of Heterodyne Metal Locators.

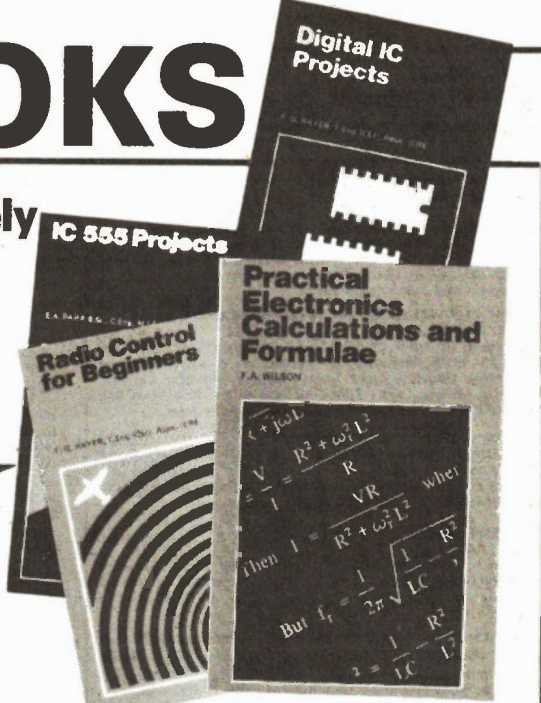

## ELECTRONIC THEORY

**ELEMENTS OF ELECTRONICS - AN ON-GOING SERIES**

F.A. WILSON, C.G.I.A., C.Eng.

**BP62: BOOK 1. The Simple Electronic Circuit and Components** \$11.70

**BP63: BOOK 2. Alternating Current Theory** \$ 8.55

**BP64: BOOK 3. Semiconductor Technology** \$18.55

**BP77: BOOK 4. Microprocessing Systems And Circuits** \$11.70

**BP89: BOOK 5. Communication** \$11.70

The aim of this series of books can be stated quite simply — it is to provide an inexpensive introduction to modern electronics so that the reader will start on the right road by thoroughly understanding the fundamental principles involved.

Although written especially for readers with no more than ordinary arithmetical skills, the use of mathematics is not avoided, and all the mathematics required is taught as the reader progresses.

Each book is a complete treatise of a particular branch of the subject and, therefore, can be used on its own with one proviso, that the later books do not duplicate material from their predecessors, thus a working knowledge of the subjects covered by the earlier books is assumed.

**BOOK 1:** This book contains all the fundamental theory necessary to lead to a full understanding of the simple electronic circuit and its main components.

**BOOK 2:** This book continues with alternating current theory without which there can be no comprehension of speech, music, radio, television or even the electricity utilities.

**BOOK 3:** Follows on semiconductor technology, leading up to transistors and integrated circuits.

**BOOK 4:** A complete description of the internal workings of microprocessor.

**BOOK 5:** A book covering the whole communication scene.

## PROJECTS

**BP48: ELECTRONIC PROJECTS FOR BEGINNERS** \$ 7.75

F.G. RAYER, T.Eng.(CEI), Assoc.IERE  
Another book written by the very experienced author — Mr. F.G. Rayer — and in it the newcomer to electronics, will find a wide range of easily made projects. Also, there are a considerable number of actual component and wiring layouts, to aid the beginner.

Furthermore, a number of projects have been arranged so that they can be constructed without any need for soldering and, thus, avoid the need for a soldering iron.

Also, many of the later projects can be built along the lines as those in the 'No Soldering' section so this may considerably increase the scope of projects which the newcomer can build and use.

**BP37: 50 PROJECTS USING RELAYS, SCR'S & TRIACS** \$ 7.75

F.G. RAYER, T.Eng.(CEI), Assoc.IERE  
Relays, silicon controlled rectifiers (SCR's) and bi-directional triodes (TRIACs) have a wide range of applications in electronics today. This book gives tried and practical working circuits which should present the minimum of difficulty for the enthusiast to construct. In most of the circuits there is a wide latitude in component values and types, allowing easy modification of circuits or ready adaptation of them to individual needs.

**BP221: 28 TESTED TRANSISTOR PROJECTS** \$5.00

R. TORRENS  
Mr. Richard Torrens is a well experienced electronics development engineer and has designed, developed, built and tested the many useful and interesting circuits included in this book. The projects themselves can be split down into simpler building blocks, which are shown separated by boxes in the circuits for ease of description, and also to enable any reader who wishes to combine boxes from different projects to realise ideas of his own.

**BP71: ELECTRONIC HOUSEHOLD PROJECTS** \$ 7.20

R. A. PENFOLD  
Some of the most useful and popular electronic construction projects are those that can be used in or around the home. The circuits range from such things as '2 Tone Door Buzzer', Intercom, through Smoke or Gas Detectors to Baby and Freezer Alarms.

**BP73: REMOTE CONTROL PROJECTS** \$ 8.10

OWEN BISHOP  
This book is aimed primarily at the electronics enthusiast who wishes to experiment with remote control. Full explanations have been given so that the reader can fully understand how the circuits work and can more easily see how to modify them for other purposes, depending on personal requirements. Not only are radio control systems considered but also infrared, visible light and ultrasonic systems as are the use of Logic ICs and Pulse position modulation etc.

**BP90: AUDIO PROJECTS** \$ 7.60

F.G. RAYER  
Covers in detail the construction of a wide range of audio projects. The text has been divided into preamplifiers and mixers, power amplifiers, tone controls and matching and miscellaneous projects.

**BP74: ELECTRONIC MUSIC PROJECTS** \$ 7.20

I.R.A. PENFOLD  
Although one of the more recent branches of amateur electronics, electronic music has now become extremely popular and there are many projects which fall into this category. The purpose of this book is to provide the constructor with a number of practical circuits for the less complex items of electronic music equipment, including such things as a Fuzz Box, Waa-Waa Pedal, Sustain Unit, Reverberation and Phaser-Units, Tremelo Generator etc.

**BP44: IC 555 PROJECTS** \$ 7.75

E.A. PARR, B.Sc., C.Eng., M.I.E.E.  
Every so often a device appears that is so useful that one wonders how life went on before without it. The 555 timer is such a device. Included in this book are Basic and General Circuits, Motor Car and Model Railway Circuits, Alarms and Noise Makers as well as a section on the 556, 558 and 559 timers.

**BP82: ELECTRONIC PROJECTS USING SOLAR CELLS** \$ 7.75

A collection of simple circuits which have applications in and around the home using the energy of the sun to power them. The book deals with practical solar power supplies including voltage doubler and tripler circuits, as well as a number of projects.



# BABANI BOOKS

## BP49: POPULAR ELECTRONIC PROJECTS \$7.75

R.A. PENFOLD

Includes a collection of the most popular types of circuits and projects which, we feel sure, will provide a number of designs to interest most electronics constructors. The projects selected cover a very wide range and are divided into four basic types: Radio Projects, Audio Projects, Household Projects and Test Equipment.

## BP94: ELECTRONIC PROJECTS FOR CARS AND BOATS \$7.60

R.A. PENFOLD

Projects, fifteen in all, which use a 12V supply are the basis of this book. Included are projects on Windscreen Wiper Control, Courtesy Light Delay, Battery Monitor, Cassette Power Supply, Lights Timer, Vehicle Immobiliser, Gas and Smoke Alarm, Depth Warning and Shaver Inverter.

## BP95: MODEL RAILWAY PROJECTS \$7.60

Electronic projects for model railways are fairly recent and have made possible an amazing degree of realism. The projects covered include controllers, signals and sound effects: striboard layouts are provided for each project.

## BP93: ELECTRONIC TIMER PROJECTS \$7.60

F.G. RAYER

Windscreen wiper delay, darkroom timer and metronome projects are included. Some of the more complex circuits are made up from simpler sub-circuits which are dealt with individually.

## BP113: 30 Solderless Breadboard Projects-Book 2 \$8.85

R.A. Penfold

A companion to BP107. Describes a variety of projects that can be built on plug-in breadboards using CMOS logic IC's. Each project contains a schematic, parts list and operational notes.

## BP104: Electronic Science Projects \$8.85

Owen Bishop

Contains 12 electronic projects with a strong scientific flavour. Includes Simple Colour Temperature Meter, Infra-Red Laser, Electronic clock regulated by a resonating spring, a 'Scope with a solid state display, pH meter and electrocardiograph.

## BP110: HOW TO GET YOUR ELECTRONIC PROJECTS WORKING \$7.60

R.A. PENFOLD

We have all built circuits from magazines and books only to find that they did not work correctly, or at all, when first switched on. The aim of this book is to help the reader overcome just these problems by indicating how and where to start looking for many of the common faults that can occur when building up projects.

## BP84: DIGITAL IC PROJECTS \$7.60

F.G. RAYER, T.Eng.(CEI), Assoc. IERE

This book contains both simple and more advanced projects and it is hoped that these will be found of help to the reader developing a knowledge of the workings of digital circuits. To help the newcomer to the hobby the author has included a number of board layouts and wiring diagrams. Also the more ambitious projects can be built and tested section by section and this should help avoid or correct faults that could otherwise be troublesome. An ideal book for both beginner and more advanced enthusiast alike.

## BP67: COUNTER DRIVER AND NUMERAL DISPLAY PROJECTS \$7.05

F.G. RAYER, T.Eng.(CEI), Assoc. IERE

Numeral indicating devices have come very much to the forefront in recent years and will, undoubtedly, find increasing applications in all sorts of equipment. With present day integrated circuits, it is easy to count, divide and display numerically the electrical pulses obtained from a great range of driver circuits.

In this book many applications and projects using various types of numeral displays, popular counter and driver IC's etc. are considered.

## BP99: MINI-MATRIX BOARD PROJECTS \$7.60

R.A. PENFOLD

Twenty useful projects which can all be built on a 24 x 10 hole matrix board with copper strips. Includes Doorbuzzer, Low-voltage Alarm, AM Radio, Signal Generator, Projector Timer, Guitar Headphone Amp, Transistor Checker and more.

## BP103: MULTI-CIRCUIT BOARD PROJECTS \$7.60

R.A. PENFOLD

This book allows the reader to build 21 fairly simple electronic projects, all of which may be constructed on the same printed circuit board. Wherever possible, the same components have been used in each design so that with a relatively small number of components and hence low cost, it is possible to make any one of the projects or by re-using the components and P.C.B. all of the projects.

## BP107: 30 SOLDERLESS BREADBOARD PROJECTS - BOOK 1 \$8.85

R.A. PENFOLD

A "Solderless Breadboard" is simply a special board on which electronic circuits can be built and tested. The components used are just plugged in and unplugged as desired. The 30 projects featured in this book have been specially designed to be built on a "Verobloc" breadboard. Wherever possible the components used are common to several projects, hence with only a modest number of reasonably inexpensive components it is possible to build, in turn, every project shown.

## BP106: MODERN OP-AMP PROJECTS \$7.60

R.A. PENFOLD

Features a wide range of constructional projects which make use of op-amps including low-noise, low distortion, ultra-high input impedance, high slew-rate and high output current types.

## CIRCUITS

### How to Design Electronic Projects

BP127

\$8.95

Although information on standard circuit blocks is available, there is less information on combing these circuit parts together. This title does just that. Practical examples are used and each is analysed to show what each does and how to apply this to other designs.

### Audio Amplifier Construction

BP122

\$8.95

A wide circuits is given, from low noise microphone and tape head preamps to a 100W MOSFET type. There is also the circuit for 12V bridge amp giving 18W. Circuit board or strip-board layout are included. Most of the circuits are well within the capabilities for even those with limited experience.

## BP80: POPULAR ELECTRONIC CIRCUITS - BOOK 1 \$7.75

R.A. PENFOLD

\$7.75

Another book by the very popular author, Mr. R.A. Penfold, who has designed and developed a large number of various circuits. These are grouped under the following general headings; Audio Circuits, Radio Circuits, Test Gear Circuits, Music Project Circuits, Household Project Circuits and Miscellaneous Circuits.

## BP98: POPULAR ELECTRONIC CIRCUITS, BOOK 2 \$8.85

R.A. PENFOLD

\$8.85

70 plus circuits based on modern components aimed at those with some experience.

## BP39: 50 (FET) FIELD EFFECT TRANSISTOR PROJECTS \$6.75

F.G. RAYER, T.Eng.(CEI), Assoc. IERE

\$6.75

Field effect transistors (FETs), find application in a wide variety of circuits. The projects described here include radio frequency amplifiers and converters, test equipment and receiver aids, tuners, receivers, mixers and tone controls, as well as various miscellaneous devices which are useful in the home.

This book contains something of particular interest for every class of enthusiast - short wave listener, radio amateur, experimenter or audio devotee.

## BP87: SIMPLE L.E.D. CIRCUITS \$5.40

R.N. SOAR

\$5.40

Since it first appeared in 1977, Mr. R.N. Soar's book has proved very popular. The author has developed a further range of circuits and these are included in Book 2. Projects include a Transistor Tester, Various Voltage Regulators, Testers and so on.

## BP24: 50 PROJECTS USING IC 741 \$6.75

A unique book containing 50 projects that can be simply constructed using an op amp and a few components. Originally published in Germany, this book will be an valuable asset to any hobbyist.

## BP88: HOW TO USE OP AMPS \$8.85

E.A. PARR

\$8.85

A designer's guide covering several op amps, serving as a source book of circuits and a reference book for design calculations. The approach has been made as non-mathematical as possible.

## 3P65: SINGLE IC PROJECTS \$6.05

R.A. PENFOLD

\$6.05

There is now a vast range of ICs available to the amateur market, the majority of which are not necessarily designed for use in a single application and can offer unlimited possibilities. All the projects contained in this book are simple to construct and are based on a single IC. A few projects employ one or two transistors in addition to an IC but in most cases the IC is the only active device used.

## 223: 50 PROJECTS USING IC CA3130 \$5.00

R.A. PENFOLD

\$5.00

In this book, the author has designed and developed a number of interesting and useful projects which are divided into five general categories: I - Audio Projects II - R.F. Projects III - Test Equipment IV - Household Projects V - Miscellaneous Projects.

## BP117: PRACTICAL ELECTRONIC BUILDING BLOCKS BOOK 1 \$7.60

R.A. PENFOLD

\$7.60

Virtually any electronic circuit will be found to consist of a number of distinct stages when analysed. Some circuits inevitably have unusual stages using specialised circuitry, but in most cases circuits are built up from building blocks of standard types.

This book is designed to aid electronics enthusiasts who like to experiment with circuits and produce their own projects rather than simply follow published project designs.

The circuits for a number of useful building blocks are included in this book. Where relevant, details of how to change the parameters of each circuit are given so that they can easily be modified to suit individual requirements.

## BP102: THE 6809 COMPANION \$7.60

\$7.60

Written for machine language programmers who want to expand their knowledge of microprocessors. Outlines history, architecture, addressing modes, and the instruction set of the 6809 microprocessor. The book also covers such topics as converting programs from the 6800, program style, and specifics of 6809 hardware and software availability.

## BP118: PRACTICAL ELECTRONIC BUILDING BLOCKS - Book 2 \$7.60

R.A. PENFOLD

\$7.60

This sequel to BP117 is written to help the reader create and experiment with his own circuits by combining standard type circuit building blocks. Circuits concerned with generating signals were covered in Book 1, this one deals with processing signals. Amplifiers and filters account for most of the book but comparators, Schmitt triggers and other circuits are covered.

## BP24: 50 PROJECTS USING IC741 \$6.75

RUDI & UWE REDMER

\$6.75

This book, originally published in Germany by TOPP, has achieved phenomenal sales on the Continent and Babani decided, in view of the fact that the integrated circuit used in this book is inexpensive to buy, to make this unique book available to the English speaking reader. Translated from the original German with copious notes, data and circuitry, a "must" for everyone whatever their interest in electronics.

## BP83: VMOS PROJECTS \$7.70

R.A. PENFOLD

\$7.70

Although modern bipolar power transistors give excellent results in a wide range of applications, they are not without their drawbacks or limitations. This book will primarily be concerned with VMOS power FETs although power MOSFETs will be dealt with in the chapter on audio circuits. A number of varied and interesting projects are covered under the main headings of: Audio Circuits, Sound Generator Circuits, DC Control Circuits and Signal Control Circuits.

## RADIO AND COMMUNICATIONS

## BP96: CB PROJECTS \$7.60

R.A. PENFOLD

\$7.60

Projects include speech processor, aerial booster, cordless mike, aerial and harmonic filters, field strength meter, power supply, CB receiver and more.

## BP222: SOLID STATE SHORT WAVE RECEIVER FOR BEGINNERS \$47.60

R.A. PENFOLD

\$47.60

In this book, R.A. Penfold has designed and developed several modern solid state short wave receiver circuits that will give a fairly high level of performance, despite the fact that they use only relatively few and inexpensive components.

## BP91: AN INTRODUCTION TO RADIO DXING \$7.60

This book is divided into two main sections one to amateur band reception, the other to broadcast bands. Advice is given to suitable equipment and techniques. A number of relevant constructional projects are described.

## BP105: AERIAL PROJECTS \$7.60

R.A. PENFOLD

\$7.60

The subject of aeriels is vast but in this book the author has considered practical designs including active, loop and ferrite aeriels, which give good performances and are reasonably simple and inexpensive to build. The complex theory and math of aerial design are avoided.



**Spin-off**

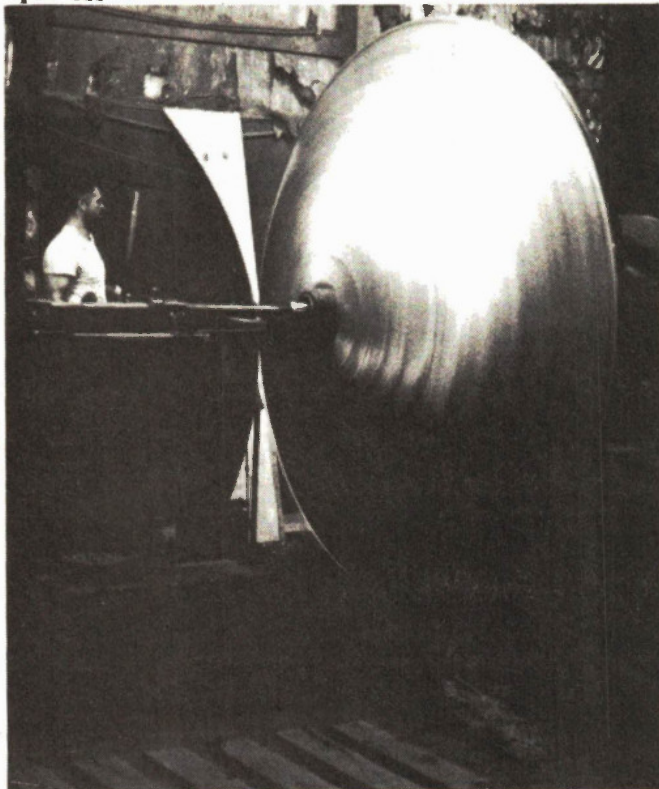

The photograph is from a release from Reynolds Aluminum of Richmond, Virginia, showing how one-piece satellite dishes are formed. The aluminum disk is spun at 250 RPM and the operator forms it

to the mold in about three minutes. The factory in the photo, DH Satellite of Wisconsin, can produce 1500 dishes a day.

**Strip Sockets**

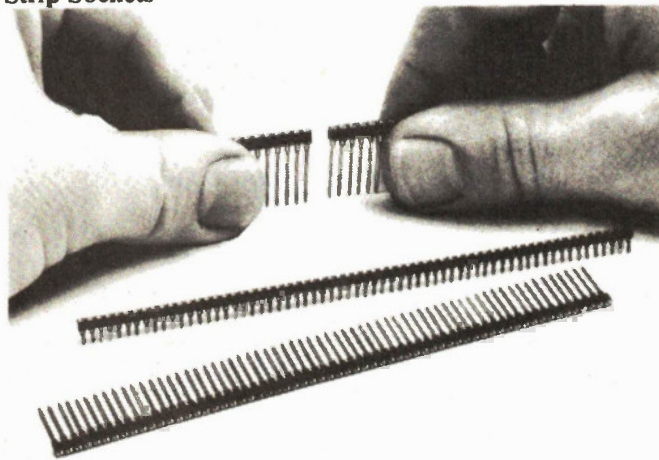

The Robinson Nugent company offers IC sockets that are guaranteed to break. Huh? The contacts are in 64-pin strips that can be snapped off to form sockets of the exact pin count needed; the insulator is 0.1" wide for easy side stacking and use as quad-inline

sockets. Both solder and wirewrap versions are available. From Weber, a division of DGW Electronics Corporation, 85 Spy Court, Markham, Ontario L3R 4Z4, (416) 475-8500.

Circle No. 36 on Reader Service Card.

**New Computer**

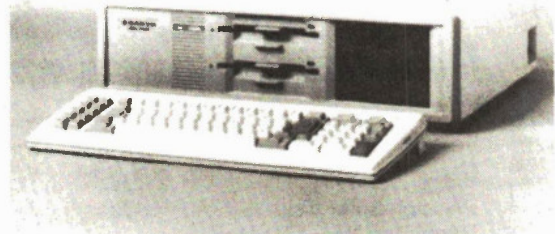

Sanyo Business Systems has expanded the MBC 880 series of IBM PC-compatible computers to offer increased storage space. All units have 256K, seven slots and a video display card; various configurations of floppy disks and hard disks are available. Clock speeds are 4.77 and 8.0MHz. Software in-

cluded is MS-DOS, GW-BASIC and WordStar. From Sanyo PC-compatible computers to offer increased storage space. All units have 256K, seven slots and a video display card; various configurations of floppy disks and hard disks are available. Clock speeds are 4.77 and 8.0MHz. Software in-

Circle No. 34 on Reader Service Card.

**Multi-user Computer**



Tandy introduces the 3000, an MS-DOS computer that uses the Intel 80286 CPU for multi-tasking and multi-user applications. It can run Xenix 5.0, an operating system designed for high processing speeds with multiple users. Using Tandy's ViaNet networking

system, resources on the network are available to each user. 512K of RAM is standard, as is a 1.2M floppy disk; a 20M hard disk is available. From Radio Shack Computer Centres.

Circle No. 35 on Reader Service Card.



# 1985 Electronics Today Index

Features	Mnth	Page	Errata
Index 1982-1984	Jan	16	
Plasmon Solar Cells	Jan	26	
Hammond Radio Museum	Jan	38	
High Definition Tv	Feb	13	
Best From Your Scope II	Feb	18	
Alexander Graham Bell	Feb	21	
Logic Analyzers	Feb	35	
First Look, ACS-1000	Mar	7	
Computer Power Supplies & Filters	Mar	11	
Home Computer Survey	Mar	22	
Making Schematics	Apr	14	
Signal Generators II	Apr	20	
Silkscreening for Electronics	Apr	38	
ZX81 RAMpack Extender	Apr	46	May 59
Designing With Microprocessors	May	12	Jul 17
Troubleshooting Guide	May	30	
Communications Satellites	May	53	
Supercomputers	Jun	29	
Satellite Reception	Jun	32	
NAPLPS for Microcomputers	Jul	8	
Computer Contest	Jul	18	
Magnetic Permanence	Jul	32	
ZX-EPRoM	Jul	52	Sep 7
Kodak's DX Coding	Aug	9	
Time Domain Analysis	Aug	10	
Circuit Special	Aug	34	
Fundamentals of Hearing	Aug	44	
CSA Certification	Sep	10	
Cellular Telephones	Sep	30	
Error Correction In RAM	Oct	14	
What's New In Oscilloscopes	Oct	34	
A Guide to Transformers	Oct	38	
Automatic Test Equipment	Nov	12	
Radar Supremacy in WWII	Nov	20	
Tools For Electronics	Nov	32	
Camera Contest	Nov	11	
Impedance	Dec	18	
Surface Acoustic Waves	Dec	27	
Electronics In Photography	Dec	37	

Reviews	Mnth	Page	Errata
Cosmic Printer/Plotter	Jan	10	
Tech-Sketch Light Pen	Jan	13	
EMP 1200A Modem	Jan	24	
ECS6 Portable Computer	Jan	34	
ACNAP Circuit Design Software	Jan	58	
Mouse Graphics System	Feb	26	
Radio Shack Color Computer II	Feb	55	
Sanyo 550-Series Computer	Mar	42	
Best Computer	Apr	23	
Alphacom VP42 Printer	Apr	36	
ACS-1000 Computer Board	May	36	
Tandy 1000 Computer	May	49	
Centronics GLP Printer	May	56	
MTHS-80 Interface	Jun	26	

Commodore 16 Computer	Jun	36	
Commodore Plus 4 Computer	Jul	49	
Micro Cap II Circuit Software	Sep	47	
Zopan Function Generator	Nov	44	

Projects	Mnth	Page	Errata
Analog Capacitance Meter	Jan	22	
RS232 Breakout Box	Jan	45	
EPROM Emulator	Feb	45	
CMOS Tester	Feb	58	
9V Power Supply	Mar	14	
Visu-Writer	Mar	45	
Universal Relay Driver	Apr	26	
Cymbal Synthesizer	Apr	40	
ZX81 RS232	May	20	
Darkroom Timer	May	34	Jul 17
Distortion Meter	Jun	13	
Timed Nicad Charger	Jun	22	
Anti Phaser	Jun	55	
Distortion Meter, Part 2	Jul	23	
Dual Tracking Power Supply	Jul	35	
RS232 For Commodores	Aug	23	
Sound Effects	Aug	32	
Noise Gate	Sep	13	
Voltage Probe	Sep	28	
Switching Plugpack	Sep	19	
Digital Scoreboard	Oct	22	
Crystal Radio	Oct	50	
Audio Mixer	Oct	54	
Battery Checker	Nov	9	
Direct Injection Box	Nov	38	
Audio Frequency Generator	Nov	55	
ET Photoflash	Dec	10	
Heat Pen	Dec	43	
FET Amplifier	Dec	47	

Series	Mnth	Page	Errata
Des. Notebook: Customised ICs	Jan	20	
Computing Today: Projectile Motn.	Jan	30	Apr 12
Configurations: Multivibrators	Jan	50	
Computing Today: 68020 CPU	Feb	8	
Configurations: Sawtooth Gen.	Feb	30	
Des. Notebook: Speech ICs	Feb	40	
Des. Notebook: Noise Calcs	Mar	17	
Configurations: Op Amps	Mar	33	
Computing Today: Apple Copy Programs	Mar	52	
Configurations: Heatsinks	Apr	16	
Computing Today: Circuit Programs	Apr	59	
Configurations: Power Supply Dsgn	May	9	
Computing Today: Single Chip MPUs	May	26	
Des. Notebook: Audio Design	May	38	
Electronics From the Start Pt. 1	Jun	9	



NAME  
NOM

NO.

**Another year has passed us by and it's time once again to release the list of lists — the index of Electronics Today articles and projects for 1985.**

Configurations: Optoelectronics	Jun	16
Computing Today: Z80 Design		
Pt. 1	Jun	39
Des. Notebook: Power Amps	Jun	42
Configurations: Logic Gates	Jul	13
Computing Today: Z80 Design		
Pt. 2	Jul	27
Des. Notebook: Fibre Optics	Jul	58
Electronics From the Start Pt. 2	Aug	14
Electronics In Canada: Soltech	Aug	17
Des. Notebook: 7800 Regulators	Aug	26
Computing Today: Z80 Design		
Pt. 3	Aug	38
Des. Notebook: PSU Noise	Sep	25
Computing Today: Z80 Design		
Pt. 4	Sep	39
Electronics In Canada: ILP		
Transf	Sep	41
Electronics From the Start Pt. 3	Sep	58
Computing Today: Z80 Design		
Pt. 5	Oct	8
Electronics From the Start Pt. 4	Oct	9
Des. Notebook: Transistor Summary	Oct	60
Des. Notebook: Digital Sampling	Nov	22
Computing Today: Z80 Design		
Pt. 6	Nov	42
Electronics From the Start Pt. 5	Nov	49
Des. Notebook: Diodes	Dec	54
Electronics From the Start Pt. 6	Dec	58
Computing Today: Data Encryption	Dec	25





# Computing Today:

## Reduced Instruction Set Computers

THE most visible trend in the development of microprocessor technology since the release of 4-bit processors in the early 1970s is a continual increase in the width of the data bus, a factor which is commonly used as a broad classification of processors. Today 8-bit is the accepted type for home computers, 16-bit tends to be used for small business machines and 32-bit is found in scientific machines.

Hand in hand with this development has been an increase in the complexity of the instruction set. The earlier 4 and 6-bit devices could only carry out simple logic and arithmetic functions such as AND, OR, ADD and SUBTRACT, various branches and subroutine calls and limited memory access consisting of LOAD and STORE instructions. As 8-bit development continued, the number of addressing modes increased as did the complexity of the arithmetic functions. Multiply is included on the 6809, for example, this being an 8-bit processor which also offers some limited 16-bit instructions. With 16 and 32-bit processors multiply and divide are the accepted norm and many other advanced instructions such as loop constructions and block moves are to be found. It goes without saying that increasing execution speeds accompanied the foregoing trends.

A few figures will help to illustrate these trends. The number of basic instruction types on the 8080, the first popular 8-bit processor launched in the mid 1970s, is 30. The later 6502, also an 8-bit device and extensively used in home computers, has a similar number, whereas the 6809, one of the latest and most advanced 8-bit micros released about 1979, has 43. The 68000, a typical 16-bit processor, has 61. Comparing numbers of instructions between processors is not easy, as one processor may have as different instructions what are merely different addressing modes of the same instruction on another device. The numbers above are not necessarily the numbers of instructions claimed by the manufacturers but would, for example, class all conditional branches as a single instruction.

What probably gives a more accurate picture of the complexity of the chip is a count of all the op-codes, a figure which gives a measure of the number of combinations of instructions and addressing modes. When these numbers are considered we see about 200 for the 8080, 266 for the 6809 and over 1,000 for the 68000.

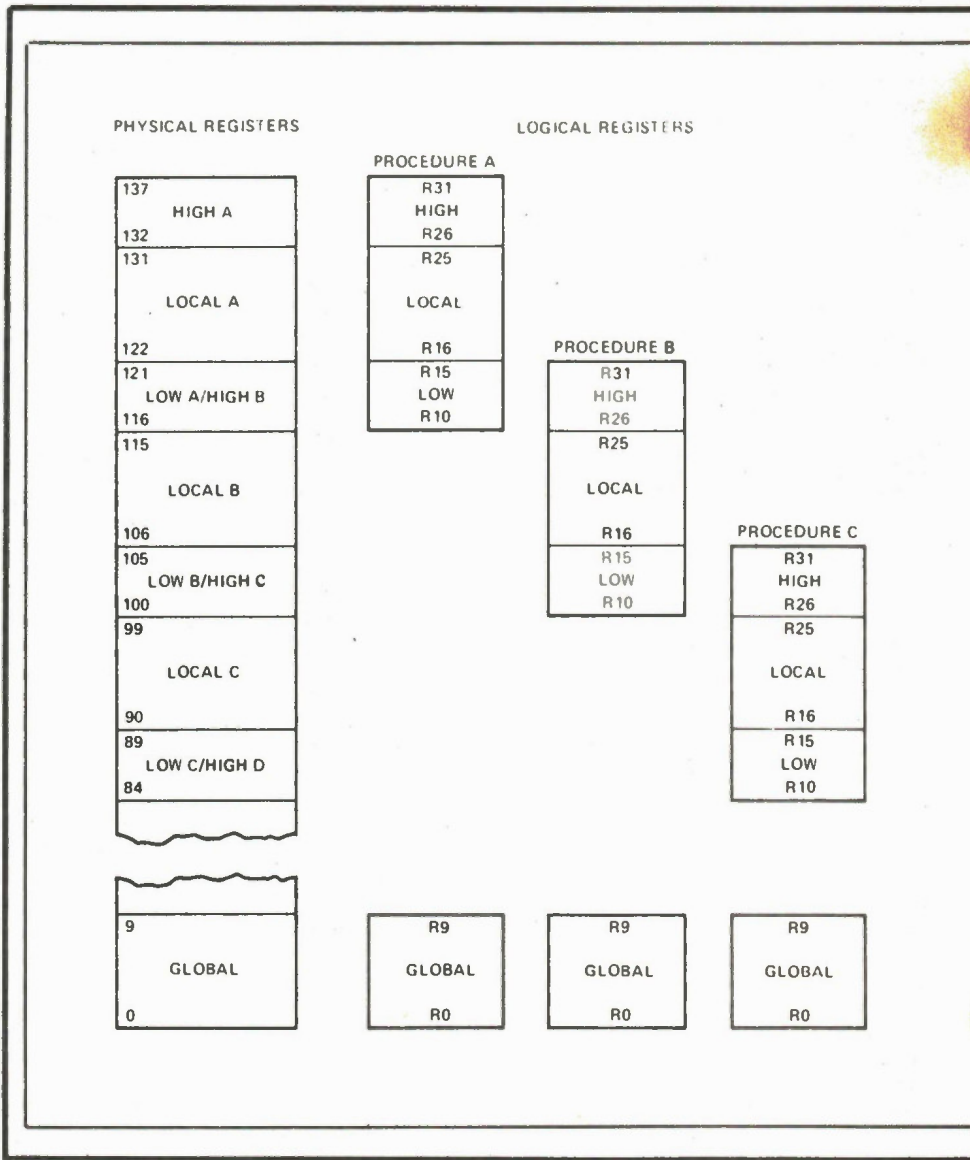

**A look at RISC chips, an efficient architecture for CPUs.**

**By Mike Bedford**



Comparing performance numerically is once again difficult, but it is quite clear that the 6809 is considerably faster than the 8080 or the 6502 and that the 68000 probably gives a 3 fold speed increase over the 6809.

Even a quick glance at the above figures would lead to the conclusion that complicated instruction sets are necessary to achieve high processing speeds, and indeed this has traditionally been the point of view throughout the development of computer architecture. The argument for this link is that if a particular function is not available as a processor instruction it will have to be replaced by a series of simpler instructions. For example, if multiply is not available it has to be replaced by a routine carrying out multiple additions and/or shifts, a process which will usually be much more time consuming than a hardware implementation of the function.

Recent developments suggest that this trend of increasing complexity in microprocessors may be reversed. The RISC or Reduced Instruction Set Computer offers the possibility of very high speeds coupled with an extremely simple yet innovative architecture.

### Development of RISC

It has been suggested that by the end of the decade virtually all computers for engineering applications, from PCs to multi-user minicomputers, will employ some degree of RISC architecture. Some advocates of RISC would indeed go as far as to suggest that all computers of the late 1980s will include RISC processors. Before going on to describe such a processor and how a simple approach can achieve impressive speeds, it will be useful to outline the development of this type of architecture.

The project which is generally considered to represent the first work carried out on a RISC type architecture is the IBM-801, the design of a simplified instruction set being a result of statistical indications that the most commonly encountered instructions are simple ones such as LOAD, STORE, branches and simple arithmetic. Although this project has not, as yet, yielded a commercial product, preliminary results suggest that it has a performance comparable to the IBM 370/168 mainframe at almost 2 MIPS (million instruction per second) while other reports have claimed speeds as high as 10 MIPS. In view of the fact that the 801 is essentially a mini computer rather than a mainframe, this is a very impressive figure.

Another large company engaged in RISC research is DEC who are reported to have two such projects, codenamed Nautilus and Titan. Once again, no commercial product has yet evolved and few details have been published. From those snippets of information that are available,

we can say that Nautilus is intended as a general purpose machine which fits somewhere between the VAX and the System 10/20 machines and has a speed of about 10 MIPS, whereas Titan is an engineering workstation with some degree of VAX compatibility which should yield speeds in the region of 2 MIPS.

Other large computer companies are known to be carrying out research in this field but so far only two RISC machines are on the market, both manufactured by smaller companies. The Pyramid 90x is a general purpose machine intended for both commercial and engineering applications. It is clearly intended to compete with the DEC VAX 11/780 and is claimed by its manufacturers to give 8-10 times the performance of a similar machine with conventional architecture. The Ridge 32, on the other hand, brings the power of a VAX to an engineering workstation for applications such as CAD and solid modelling. The claims for this machine are that it executes I/O faster than the VAX 780 and can execute linear equations faster than a VAX 750 with a floating point accelerator.

Although it is interesting to see the impact made by RISC in the realm of minicomputers, the area which will be of most interest to readers of this article will be the development of RISC microprocessors. The first such device, RISC 1, was completed in 1982 by a team of staff and graduate students at the University of California in Berkeley. (3). The team, led by Professor David A. Patterson, designed the chip from initial discussion to first silicon in a near record time of only 19 months. The fact that such timescales could be achieved and speeds in excess of those of commercial devices such as the 68000 could be demonstrated by a team with little previous knowledge of VLSI design can be attributed primarily to the simplicity of the architecture. Since impressive performance is possible with minimal design effort, we have the promise of microprocessors with a much increased speed to cost ratio in the not too distant future. In the following description of RISC architecture the discussion will be based on the Berkeley RISC 1 and later RISC II chips, although most of what is said could be applied to any machine using RISC philosophy.

### Minimal RISC

The most obvious question to tackle first is how a simplified instruction set can lead to high processing speeds. To put this another way, where is the fallacy in the usual argument that incorporating increasingly complex functions into the hardware decreases execution time by removing software overheads?

One problem with this conventional argument is that very often a single advanced processor function of a modern microprocessor may not be all it seems.

Instead of a complex instruction being implemented fully in hardware, the situation is that such features are actually translated to a series of micro-instructions, these being a low level of instruction within the device.

An implication of this is that single instructions on modern microprocessors can often take many cycles to execute. For example, on the 68000, the signed multiply instruction can take up to 42 cycles, 122 cycles are required for signed divide and even a commonly encountered instruction such as return from exception (interrupt return) can take 110 cycles. A closely related point is that, even for simple instructions, if a processor has a number of different variants and/or addressing modes the internal circuitry must be configured to suit each different requirement. This switching of gates is once again carried out by micro-coded instructions with the inevitable speed reduction.

The RISC I and RISC II processors are not micro-programmed and, with a couple of exceptions, are able to execute all instructions in a single cycle. Table 1 shows the RISC I instruction set. It will be noticed that there are only 31 instructions and, in contrast to most modern 16 and 32-bit micro-processors, the device is totally devoid of the more esoteric instructions. Coupled with the fact that there are only two addressing modes, it is not difficult to see how all functions can be hard-wired, hence obviating the need for micro-coding.

The RISC philosophy is that memory should only be accessed by LOAD and STORE instructions (these being the exceptions which take two machine cycles to execute) all processing being carried out from register to register internally. This limited memory access means, for example, that in order to add two memory locations together into a third, the processor would need to load the contents of the first two memory locations into registers, add the two registers together and finally carry out a store from the register containing the result into the third location.

An implication of this approach is that a large number of internal registers is essential. In fact, the register organisation is quite innovative and will be described shortly. Conveniently, it is because of the simplicity of the processor ALU and control logic (about 6<sup>4</sup> of RISC I compared to about 50<sup>4</sup> on many commercial processors) that it is feasible to devote a large area of the chip to the registers required by RISC architecture.

One possible argument against the approach outlined above is that, although it appears able to provide impressive speeds at a reasonable cost, the limited instruction set means that a much greater programming effort will be required. Since the programming time generally represents the greatest part of the cost of a system containing both hardware and



software, this could be a considerable disadvantage. It would undoubtedly limit the attractiveness of RISC processors if programming had to be carried out in assembler language, but RISC I is designed to be programmed in a high level language. Under these circumstances the limited instruction set is quite transparent to the applications programmer, being of concern only to the writers of the compilers.

The use of high level languages does not merely mask a possible disadvantage: indeed, the RISC I processor was designed with high level languages very much in mind, PASCAL and C being the languages considered. As part of the initial design, statistical data on the frequency of occurrence of various constructions together with the corresponding numbers of machine instructions were analysed. The results led the Berkeley team to the conclusion that the most time consuming parts of high level language programmes are concerned with subroutine calls and handling of local variables. As we shall see, the RISC register of architecture addressed both these points, reducing their execution times considerably.

### Registers

It has already been stated that the RISC I processor offers a large number of general

purpose registers. The organisation of these registers and the way in which they greatly contribute to the fast execution of subroutine calls will now be described.

A conventional microprocessor has a relatively small number of internal registers. For example, the 6809 has only two general purpose data registers and two index registers; even the more advanced 68000 has only eight data registers and seven address registers. This means that, on entering a subroutine, all registers which are going to be used by that routine for its internal working must be saved on entry and restored on return to the calling code. This saving and restoring is carried out by means of a stack in memory, this also being the method used for passing parameters to and from the subroutine. It is the need for these PUSH and PULL instructions which so much slows down subroutine calls on conventional processors.

RISC I obviates the need for this time consuming process by using 137 registers which are arranged as a number of overlapping register windows. This scheme is illustrated in Figure 1. The left hand bank shows the internal numbering of the registers in the processor whereas the three banks on the right represent three separate register windows which map physically onto the total pool of 137

registers. Any subroutine has access to one window of 32 registers which are always referred to as RO-R31 irrespective of which physical registers they are mapped onto.

It will be noticed that each register window is split into four segments referred to as global, low, local and high. The global registers are used for values which are likely to be accessed by a number of different procedures since these are common to all windows. The local registers are used for local working within a particular routine. Whenever a subroutine call or a return is executed, a new window is automatically selected and the local registers used by the calling routine became accessible, thereby obviating the need to save their contents on a stack.

As far as the passing of parameters is concerned, this is where the low and high registers are used. Since the low registers of one window overlap the high registers of a neighbouring window, the means of passing parameters to a procedure is to place them in low registers prior to issuing the call. Conversely, the called procedure will pick up the parameters passed to it in its high register area - once again removing the need for a stack.

Clearly this philosophy places a limit on the depth of subroutine calls which may be nested since there are only a finite number of registers from which to create new windows. To cope with this problem the RISC I processor recognises overflow and underflow conditions. Under these circumstances a trap takes place to a software routine which stacks the registers in memory in the conventional manner. If this condition were to happen frequently, the performance would clearly suffer. Research has shown that in average programs, such conditions occur relatively infrequently - if 8 windows are available it is suggested that overflows only happen on about 1% of subroutine calls.

### Conclusions

It is difficult to know how to conclude an article on an aspect of micro electronics which is still in its infancy. Clearly the "keep it simple" approach to microprocessor design has much to commend it, offering high speed processing at a potentially low cost. RISC advocates predict a rosy future for this type of processor and there is no reason to question the basis for their optimism. Nothing is certain in the electronics industry, however, as a look at the predictions made in the late 1970s regarding bubble memories makes clear. The reduced instruction set computer may be another dream that will never come to fruition or it may be a major factor shaping the future. ■



## ONLY FEW LEFT

## 50% OFF LIST PRICE:

### SINGLE FUNCTION PRECISION METERS — BENCH/PORTABLE

### 2% ACCURACY — MIRRORED SCALE

### FOR EDUCATION — INDUSTRY — HOBBYIST

<h2 style="margin: 0;">\$28.85</h2> <h3 style="margin: 0;">EACH</h3> <p style="margin: 0;">WHILE THEY LAST</p>	<p>Model 6000 AC Milliammeter 0-5/25/100/250/1000mA</p> <p>Model 6001 AC Ammeter 0-1/5/10/25A</p> <p>Model 6003 DC Microammeter 0-50/100/250/500/1000uA</p> <p>Model 6005 DC Ammeter 0-1/5/10/25A</p> <p>Model 6007 DC Volymeter 0-1/2.5/5/10/25/50/100/250/500/1000V</p>	
--	---	--

---

#### PRECISION WATTMETERS:

120/240/480V Scales. 0.5 and 1 A ranges, 1% accuracy

**NOW ONLY \$85.00 each** — less than half original price.

MANY OTHER INSTRUMENTS — ONE OF KIND, DEMOS ETC. TOO NUMEROUS TO LIST!

Circle No. 37 on Reader Service Card.



## KB ELECTRONICS

Phone: 416-842-6888  
355 Iroquois Shore Rd. Oakville, Ont. L6H 1M3 Telex: 06-982396 (KBEL)



# It's fast, simple to operate and will fit any oscilloscope

# SHACKMAN 7000

## oscilloscope camera

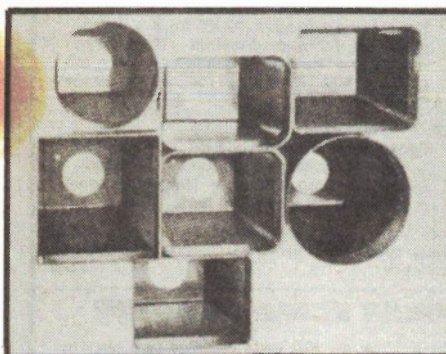

### CAMERA HOODS

Picture quality from the Model 7000 is excellent with virtually no distortion. The oscilloscope mountings are arranged so that all the displayed information appears on the print.

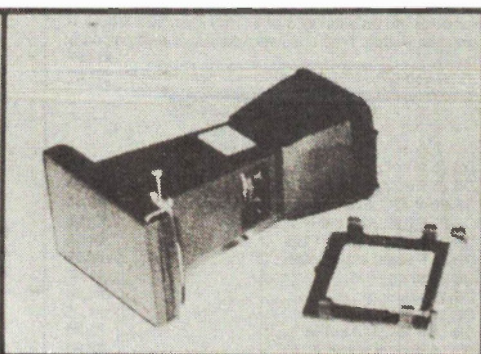

Exposures can be accurately controlled with a high quality fully speeded shutter and continuously variable aperture control.

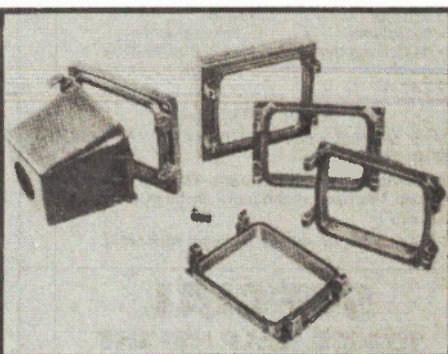

### BEZEL ADAPTERS

By selecting the correct hood, you have a hand-held camera which fits quickly and easily to a number of oscilloscopes.

### Specification

- Camera Body:** High quality ABS moulding with attached Polaroid 101 series film back.
- Lens:** Moulded two element f3.5 70mm focal length with aperture control down to f32.
- Shutter:** Self cocking, mounted between lens. Speeds from 1 second to 1/125th inclusive, with 'B' for time exposures. Built in 'X' contact for event triggering. Shutter actuated by cable release.
- Focus:** Fixed by method of mounting for correct distance.
- Object to Image Ratio:** Up to 8 x 10cm displays 1.085 fixed  
10 x 13cm displays 1.065 fixed
- Film:** Polaroid Black and White 8 exposure film packs  
Type 107C 3000 ASA  
Type 665 75 ASA Pos./Neg.
- Hoods and Spacer Bodies:** High Quality ABS Mouldings

Polaroid is a Registered Trade Mark of the Polaroid Corp. U.S.A.

**Camera Hoods  
are available for  
practically all  
makes of scopes.**

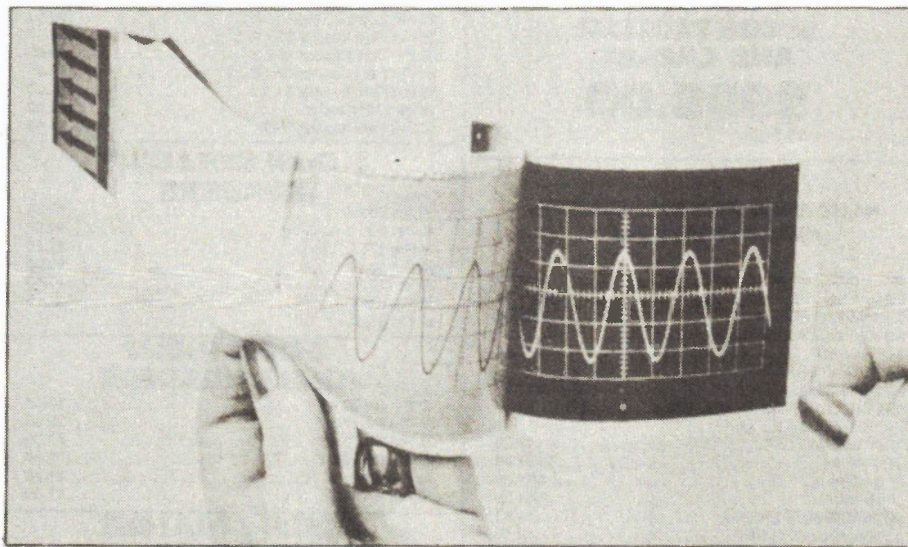

990 Alness St. Unit 7,  
Downsview, Ontario  
M3J 2B2  
(416) 661-5586  
TELEX 066-29189

Mon-Fri 8-5 pm

**COMPLETE  
TO FIT MOST  
MAKES AND  
MODELS OF OSCILLOSCOPES**

**\$470<sup>00</sup>**

F.O.B. Downsview, Ont. FST Incl'd.

Circle No. 38 on Reader Service Card.



# January Savings

COMPUTER  
**PARTS GALORE INC.**  
316 College St.  
Toronto, Ontario M5T 1S3

1-416-928-2161

1-800-387-1385

## APPLE + NEW LOW BARE PCB PRICES\*

### GROUP 1 \$7.00 each

- Real time clock
- Rana 4 drive
- 9 V Music
- Disc Controller
- Disc Controller (Shamrock)
- PIA card
- EPROM
- WILD CARD
- SAM TALKS

### GROUP 2 \$9.00 each

- Gripper
- 80 Column
- 80 Column Soft Switch
- Z-80
- COMMUNICATIONS
- RGB
- Sprite graphics
- APPLICARD 128K ADD ON

### GROUP 3 \$11.00 each

- SSM MODEM
- APPLICARD
- APPARAT EPROM PROG
- 16K
- 128K

All boards come with a parts list and placement diagram. We have all the parts of the PCB's just ask for them.

\*Prices so low we require payment with order.

## SPECIAL 10 MEG HALF HEIGHT HARD DRIVE W/CONTROLLER AND CABLES \$645.00

## 25 MEG HALF HEIGHT HARD DRIVE W/CONTROLLER AND CABLES \$995.00

## ASSORTED SEMICONDUCTRS AND OTHER STUFF

(A) RED LED S/M/L	10/\$1.00
(B) GREEN LED S/M/L	8/\$1.00
(C) AMBER LED S/M/L	8/\$1.00
(D) PIN PHOTODIODES, INFRA-RED	2/\$1.00
(E) PHOTO TRANSISTOR, NPN VISIBLE	2/\$1.00
(F) LDR (LIGHT DEP RESISTOR)	\$1.00
(G) FET ELECTRET MIKE, TINY 10MM	\$2.00
(H) 1N4001	10/\$1.00
(I) 1N4004	8/\$1.00
(J) 1N4007	6/\$1.00
(K) 25AMP-600V BRIDGE	\$2.95
(L) 25AMP-600V BRIDGE	\$3.50
(M) 6AMP-200V BRIDGE	\$1.50
(N) 3AMP-200V BRIDGE	\$1.00
(O) DIODE 3AMP-600V	3/\$1.00
(P) 1N914/1N4148 Silicon diode	10/\$1.00
(Q) 7805 1AMP-5V regulator	2/\$1.00
(R) 7812 1AMP-12V regulator	\$0.75
(S) 78M12 1/2 AMP-12V regulator	2/\$1.00
(T) LM317 Variable 1AMP regulator	\$1.50
(U) LM323 5V 3AMP regulator	\$2.95
(V) LM350 Variable 3AMP reg.	\$3.95
(W) 2 1/2" 80hm mini speaker	\$1.50
(X) MINI TOGGLE SWITCH SPDT	\$1.95
(Y) MINI PUSH BUTTON SWITCH, NO	\$0.50

## DISC DOUBLER

Just that, it doubles your discs by cutting another write protect notch on the other side of the Apple SSDD diskette so the other side can be used, doubling your storage space. Note, almost all diskettes are good on both sides and the diskette packagers just label them SS or DS and sell the DS for 25% more. So spend \$8.95 and save hundreds later on.

## MODULATOR

This modulator was made for the TI 99-44 that is now dead as a doornail. We bought a bunch and are selling em for... \$14.95. They are a very good quality modulator for use on 12 Volts DC and have both sound and video inputs and are for color use on channel 3 or 4. They also have a built in antenna switch. They are a very good unit professionally built. **\$14.95**  
Video cable, RCA-RCA 6 feet **\$1.00**

## CONNECTORS DB SERIES

DB-25 M solder	\$1.95
DB-25 F solder	\$1.95
DB-25 M IDC, Flat cable	\$5.95
DB-25 F IDC, Flat cable	\$5.95
DB-25 M Right angle PCB	\$4.95
DB-25 F Right angle PCB	\$4.95
DB-25 Shell	\$1.00
DB-15 M solder	\$1.35
DB-15 F solder	\$1.35
DB-15 F IDC, Flat cable	\$3.95
DB-15 M right angle PCB	\$2.95
DB-15 F right angle PCB	\$2.95
DB-15 Shell	\$1.00
DB-9 M solder	\$1.35
DB-9 F solder	\$1.35
DB-9 M right angle PCB	\$2.50
DB-9 F right angle PCB	\$2.50
DB-9 Shell	\$0.75

## FLAT CABLE DRIVE CONNECTORS

50 Pin Edge C, 8" drive	\$5.95
40 Pin Edge C,	\$4.95
34 Pin Edge C, 5-1/4" drive	\$5.95
20 Pin Edge C, Hard drive	\$4.95
34 Pin Fem header 17 x 2	\$3.50
26 Pin Fem header 13 x 2	\$3.00
20 Pin Fem header 10 x 2	\$2.00
16 Pin Fem header 8 x 2	\$2.00
16 Pin DIP header	\$2.00
10 Pin Fem header 5 x 2	\$1.00

## 2 ROW STRAIGHT HEADERS

50 Pin 25 x 2	\$3.00
40 Pin 20 x 2	\$2.50
34 Pin 17 x 2	\$2.20
26 Pin 13 x 2	\$2.00
20 Pin 10 x 2	\$1.50
16 Pin 8 x 2	\$1.00
10 Pin 5 x 2	.50

## 2 ROW RIGHT ANGLE HEADERS

40 Pin RA 20 x 2	\$3.50
34 Pin RA 17 x 2	\$3.00
26 Pin RA 13 x 2	\$2.50
20 Pin RA 10 x 2	\$2.00
16 Pin RA 8 x 2	\$1.50
10 Pin RA 5 x 2	\$1.00

## 1 ROW STRAIGHT HEADERS

Gold	\$5c per pin
Tin	\$4c per pin

## 1 ROW RIGHT ANGLE HEADERS

Gold	\$5c per pin
Tin	\$4c per pin

## CENTRONICS CONNECTORS

36 Pin solder cable male	\$6.95
36 Pin Flat cable make IDC	\$6.95
36 Pin Chassis female	\$6.95
S-100 Edge Connectors	\$2.50

## SOCKETS AMP IC SOCKETS

As you know AMP makes the best IC sockets. With a double wipe action and a very wide open target for easy insertion, the best.

6, 8, 14, 16, 18, 20, 24, 28, 40  
Pin in stock at only

1.5c PER PIN

## FEEWARE

FeeWare??, It is public domain software that we have collected into volumes and are offering out at a fair price considering the gathering effort. You can do what you like with it, set up your own resale operation in your area etc. What we offer is two sets of 4 diskettes with each set covering a general area of interest.

SET A — Communication oriented.

Full Modem package 1200/300 Baud + Word processor + Keyboard Macros + Desktop environment + Help + DOS utilities + Copy programs + Many other small routines too detailed to list here.

SET B — Data Base package.

Spreadsheet + Printer utilities + File utilities + Help + Games + Data Base + "C" Compiler + Language utilities + Many other small routines too detailed to list here.

Price ..... for each set **\$24.95**  
Please specify package A or B Catalog (refundable on purchase) **\$2.00**

## GRAY SCALE ADAPTER

As you know the IBM color graphics card does not look very good on a monochrome monitor. This is because often two colors look the same on monochrome so you cannot read red print on a blue background or some such. This little gray scale proportionately scales each color into a different intensity allowing easy viewing on amber, green or white monitors. We sell it as a kit for only (with cable)

**\$19.95**  
or wired and tested (with cable) **\$24.95**

## V-20 CHIP

You may have heard of the NEC V-20 chip. It is an upgraded 8088 that can run programs up to 50% faster (depending on code). It also can run Z-80 code, allowing it to be used for Z-80 development. Especially good for Video when using code using its features. A hot and hard to get CHIP at (5 Mhz) **\$28.95**  
Faster version runs at 8 Mhz **\$44.95**

Note, this chip is also rebranded and sold as the 88000 by others, be warned.

## Dual Trace Bench/ Portable Scope

Featuring at no extra cost ... 'The Component Tester'

- 20 Mhz (—3dB)
- Trace Rotator
- Bandwidth
- 5 mV Vertical
- 6" CRT Display
- Sensitivity
- Fully Automatic
- HF Rejection
- Triggering

We have a lot of these 20 Mhz scopes that are sold elsewhere for up to \$699.00. Well we sell em a lot cheaper, only **\$475.00**  
Dual probe set ..... per probe **\$34.95**

## SOLAR CELLS

SOLAR CELLS. These square polycrystalline silicon solar photo-voltaic cells have many uses from car top battery chargers, sony walkman power supplies, calculators, radios, nicads, etc. Each cell has an open circuit potential of 0.5 volts that is area independent, and a short circuit current that is area dependent, see list. We have been playing with them here and they are lots of fun, we are going to make up a few large banks of cells as an emergency lighting system. Note can also be used for the ETI solar powered night light. Each order comes with a data sheet and instructions on how best to use the cells.

- High Efficiency (a) 1" x 4", 1/2 Amp. **\$3.95**
- Polycrystalline (b) 2" x 2", 1/2 Amp. **\$3.95**
- Antireflective Coating (c) 2" x 4", 1 Amp. **\$6.95**
- Fine Collector Grid (d) 4" x 4", 2 Amp. **\$6.95**
- High Area Factor Square Cells



# Almost Free PC Software

## Volume Five

We've ventured once more into the phone lines, scouring the public domain for the cream of its software. Distilled from several megabytes of code, this disk represents the best of what's floating around on the bulletin boards of the continent. It wasn't easy, and a lot of disks bit the dust in the process of creating this collection.

Whether you are interested in business programs, games, hardcore hacking or just making your computer a more productive tool, you'll find something of interest on this disk.

**AREACODE** is a useful tool if you use the telephone a lot. Give it an area code and it will tell you what city it corresponds to.

**D** is another sorted directory program. However, this one emulates the CP/M style D, which is arguably a lot more useful for most applications.

**FRACTALS** This is an amazing implementation of the Mandelbrot microscope, generating unearthly fractal images on the tube of your system. Mere words fail to describe them.

**FROGGER** is an implementation of the classic arcade game. Just try not to get the highway littered with frog guts.

**HIDE** is a package of utilities which allow you to create, enter and remove invisible DOS directories. This allows you to set up a hard drive system with areas that are only available to users that know about them.

**LAR** This library utility allows you to concatenate several small files into a library to save on disk overhead and then extract the individual files when you need them. It saves a lot of space when it's used with files you don't use often.

**MAIL1** is a mailing label utility in BASIC.

**MORERAM** This is an assembler program . . . you need MASM and LINK to make it work. It lets you do a number of things to the memory settings on your motherboard, including using more than 640 K and allowing for four floppies to facilitate RAM disks. It will also allow you to set the switch settings of your motherboard for 64 K so things will boot up quicker and then change the RAM setting after booting.

**MORTGAGE** generates amortization charts. Read 'em and weep.

**MXSET** lets you control the parameters of Epson compatible printers from the command line. It's a lot easier than LPRINTing characters from BASIC every time you want to change modes.

**NUSQ** unsqueezes files that have been previously compressed to save space. It's primarily of use to BBS types . . . but it's extremely small.

**PARCHK** This is an assembler program . . . you need MASM and LINK to get it going. It installs a trap for parity errors in your computer so that they don't hang your system and helps you locate where the funky RAM is.

**PCBOSS** This is a more user friendly working environment than is MS-DOS. It makes your whole system menu driven, with absolutely no command names to remember. If IBM were dead it would be rolling in its grave over this.

**VDEL** This is a delete with verify program. You could type VDEL \*.ASM and it would show you the name of every .ASM file in the current directory and ask you if you want it deleted.

**WHEREIS** finds files in a complex hard disk system.

**ZAXXONPC** This is a highly decent implementation of the game. Run it and rip.

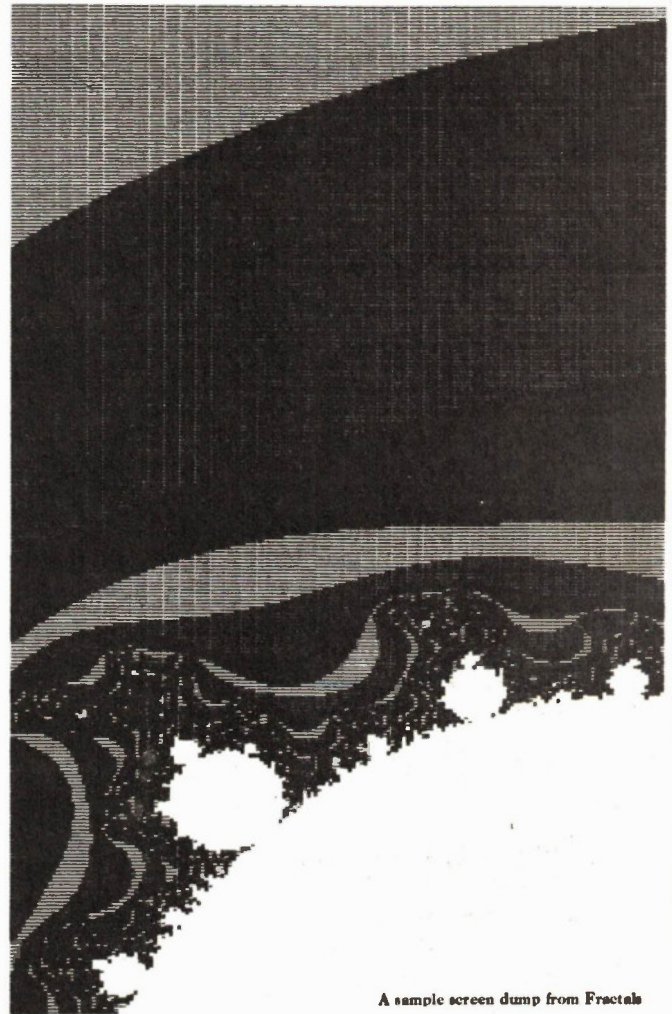

A sample screen dump from Fractals

The disk, with all the programs listed here plus the appropriate documentation files is available for a mere

**\$19.95**

plus seven percent Ontario sales tax

**Almost Free Software  
Moorshead Publications  
1300 Don Mills Road,  
Don Mills, Toronto, Ontario  
M3B 3M8  
1-416-445-5600**

during business hours. Have your VISA, Mastercard or American Express card handy

**Fine Print:** This software has all been collected from public bulletin boards and is believed to be in the public domain. The fee charged for it is to defray our cost in collecting it, testing it and putting this collection together, and for the cost of the media and its handling.

While we have endeavoured to make sure that this software does what it says it does, and while it has exhibited no bugs while we were using it, it is possible that some of it may not function properly on some PC compatible system. We are unable to assist you in modifying the software for your applications.

Moorshead publications warrants that the disk you receive will be readable. However, the post office may have other plans. If you are unable to read your disk please return it to us for replacement.



# Almost Free PC Software

## Volume 6

### Special Two Disk Set

Five hundred years ago you could have been called a witch for having software like this.

The IBM PC public domain is one of the most lively aspects of micro computers just now. While actual paid for software companies are cheerfully flipping over and floating to the surface all around us, public domain authors seem to be everywhere. Some of them are brilliant, and some of the software that one finds out there is profound beyond mere words.

In volume six of our almost free PC software you'll come upon some of the larger applications that have been released in recent months. We've tried to get a fairly decent blend of both serious business stuff and good wholesome bloody video games. There is also some first rate code for computer hackers.

**3-Demon** is one of the most interesting variations on Pac-Man in the known universe. Rather than simply looking at a map of a maze, this program shows you a three dimensional view of it. You wander through endless corridors munching out on either food pellets or granola bars... your choice... and avoiding the deadly ghosts.

**DU** was one of the most powerful CP/M based disk utilities ever envisioned. This version for the PC captures much of its power and flexibility. It allows you to see what the tracks and sectors of your disks look like, recover erased or damaged files and meddle with the system tracks.

**General Ledger** This is a complete general ledger accounting package in BASIC. It's exceedingly well written and comprehensive. It'll do most of what the very expensive packages will do without laying an endless licencing agreement on you. An enormous documentation file is included.

**PC-Chess** is a pretty slick chess program for the PC. It features colour graphics... if you have a colour tube... and a running chess clock. While not as lively as Asteroids, chess has been around longer.

**RAMDISK** is the assembler source code for a memory disk program. If you've always wanted to know how these things work... or want to write some sort of variation on this useful utility... here's your chance.

**VFILER** is a file management utility without equal. It shows you all the files in a directory and allows you to copy them, type them, execute them, mass move them... in short, it does almost everything DOS does but it's user friendly.

**QModem** is unquestionably the best telecommunications package in existence. This is the most recent version of it, replete with windowing, multiple protocols, function keys and unspeakably well debugged code throughout. A modem without this software is like IBM without ties.

**ARC** is a very sophisticated file archiving package. It not only libraries multiple small files into one larger one, but it analyses each file and applies compression to it in the best of four ways to use up the least amount of disk space.

**ZAPLOAD** is a utility for programmers to handle Intel standard HEX files. It's seethingly fast and well documented.

**SOPWITH** lets you fly a World War One biplane around and blow up things. If you're not quick enough you may become one of the things. The graphics are superb and the carnage is no where near as bad as a moderately good news day.

**JSB** is another BASIC music program. You have to troll through a lot of these things to find the ones that don't make your ears fall off. This one plays a Bach sonata.

**STAR** is exceedingly stupid but fun to look at and very small. It draws... yes, you've guessed it... stars.

**SURFACE** draws the often seen and tediously reproduced "hat" function. It takes a very long time to do this, which proves that the task is very complex and thus well worth doing.

**OP** is the operator program we ran in the November edition of Computing Now!. It's very useful... even more so if you don't have to type in the source.



The complete volume six almost free PC software package... two disks for the price of two disks... is available for

**\$24.95**

plus 7% Ontario sales tax

We'll swap relatively worthless money for priceless software at

**Moorshead Publications**

1300 Don Mills Road,  
Don Mills, Toronto, Ontario  
M3B 3M8

or you can phone us at

**(416) 445-5600**

during business hours. Have your Visa, Mastercard or American Express card handy.

**Fine print:** All of this software was obtained from public bulletin boards and is believed to be in the public domain. Some of it is freeware... its authors would like you to send them some money if you decide you like it. This is between you and your credit limit.

Please note that we aren't charging you anything for this software, but rather, for the cost of our downloading, sorting and assembling it and for the cost of the media and postage to get it to you.

We've tested this software thoroughly and it all appears to be working properly. Some of it, like the resource editor, will require a degree of expertise to use fully. Be prepared to experiment a bit. We are unable to assist you with adapting this software to your specific applications.

If you are unable to read the files on this disk contact us. We can jointly swear at the post office and we'll replace your disk.

This disk is provided without a system and will not boot. You will have to copy the files onto a bootable disk to use them.



# Only NRI Gives You This Kind of Training and Equipment. Only NRI Gives You So Much Professional Preparation For a TV/Audio/Video Servicing Career.



Learn how to diagnose problems using a professional 3½-digit multimeter.

Exclusive NRI Action Audio instructions.

Get complete instruction in TV, VCR, video disc players, audio equipment, home video cameras, and more with 68 easy-to-digest bite-size lessons.

Build this 25" Heath/Zenith color TV with infrared remote control and in-set space phone.

Perform state-of-the-art experiments using your NRI Discovery Lab®.

Learn servicing with remote control videocassette recorder and NRI Action Video tapes.

Only NRI gives you so much of this kind of practical training with equipment you learn on and keep. Learn by doing. That's the way to make it interesting, that's the way to make it enjoyable, that's the way to get the hands-on experience and know-how you need.

## Hands-On Training For Real Bench Experience and Priceless Confidence

You start with experiments and demonstrations on the unique NRI Discovery Lab. You learn basic circuit wiring and soldering techniques, and then quickly move on to more advanced concepts as you come to understand electronic theory, solid-state devices, digital systems, and microprocessors. You learn by actually building and observing the action of circuitry you'll be working with in real-life situations.

## Exclusive NRI Training on VideoTape

In addition to profusely illustrated lessons, you get NRI's Action Audio cassette to "talk" you through the use and operation of the professional digital multimeter you receive as part of your equipment. Even more exciting are your NRI Action Video cassettes... videotaped lessons that show you graphic presentations of electronic systems, vivid closeups of servicing techniques and professional "shortcuts" to study and replay as often as you want.

## You Get a TV, VCR, DMM and More Equipment To Keep

You also build your own 25" Heath/Zenith color TV, a state-of-the-art unit that includes infrared remote control, a Time Control Programmer and the incredible Advanced Space Phone that lets you telephone from your chair. Using the videocassette recorder that's included as part of your training, you learn how to adjust, service and repair these fast-selling units. Your front-loading VCR features up to 6-hour recording capacity, remote control, and programmable touch-button tuning.

The digital multimeter you receive is a truly professional instrument you use in experiments throughout your course and as a key servicing tool on the job. Using it along with the NRI Discovery Lab, you'll learn how to measure voltage, current, and resistance and how to use it to diagnose all types of servicing problems.

## Advanced Systems Demand Advanced Technicians for Service and Maintenance

The art of TV/Audio/Video servicing has taken quantum leaps into the future. Now, successful technicians must understand advanced concepts like digital control, electronic tuning, laser video discs, microprocessors and more. NRI gives you the training you need for success... state-of-the-art concepts and practical, hands-on experience working with the kind of equipment you'll encounter on the job.

## 7 Decades of Teaching Electronics Skills At Home

NRI is the oldest, largest, and most successful school of its kind in the world. It has pioneered and refined the teaching techniques that make learning at home the NRI way one of the most economical and effective methods ever conceived. You learn at your convenience as a class of one, backed by skilled NRI instructors and carefully designed lessons that take you a step at a time toward your goal. No time away from your job, no night school grind, no classroom pressures. Yet your training is thorough and complete, with a foundation of hands-on experience unequalled by any other training organization.

## Send For Free Catalog Covering 12 Electronics Courses

Our 104-page catalog gives you all the details. In it, you'll find a summary description of every lesson and photos and specifications for every item of equipment included in your course. You'll also learn about other fascinating career opportunities in the world of electronics... Microcomputers, Industrial Electronics including robotics, Communications, and more.

Mail the postage-paid card today for your free copy. See how completely and how thoroughly NRI gets you started on your tomorrow today.



**NRI Schools**  
McGraw-Hill Continuing  
Education Center  
330 Progress Avenue  
Scarborough, Ontario M1P 2Z5  
or telephone 416-293-8787



# CIRCUIT MAKER KIT

## \$189<sup>00</sup>



- Provides **everything necessary** to create professional Circuit Boards
- **Excellent Teaching Tool**
- **Full Instructions** included
- **Open Stock** available on contents



- VISA, Cheque, Money Orders accepted. Ontario residents add 7% P.S.T. Postage and handling \$2.00
- Unit 37, 2220 Midland Ave., Scarborough, Ont. M1P 3E6 (416) 299-9633

Circle No. 9 on Reader Service Card

## PC/XT Compatible ECS1-PC/XT Special \$975.00

- 8088 processor
- optional Intel 8087
- numeric coprocessor
- 256K memory
- double sided double density disk drive
- detachable keyboard
- colour-graphic board
- 130 watt power supply
- support PC software
- 90 day warranty
- 8 slot Mother board

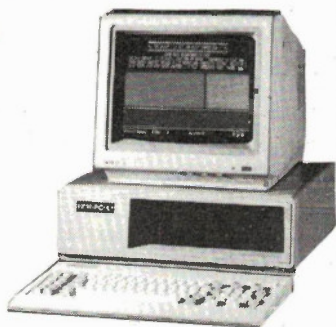

### XT/PC MAIN PERIPHERAL

Mother Board 8 Slot .....	\$249.00
Color Graphic Card .....	\$149.00
Multifunction .....	\$149.00
Monochrome Card .....	\$139.00
Monochrome Graphic .....	\$199.00
Game Port .....	\$ 49.00
RS232 Card .....	\$ 59.00
Parallel Interface .....	\$ 59.00
Disc Controller Card .....	\$ 89.00
Case .....	\$ 69.00
Keyboard (Cherry) .....	\$ 99.00
Power Supply 130 Watts .....	\$139.00
Printer Cable .....	\$ 25.00
RS232 Cable .....	\$ 25.00
Disk Drive Cable .....	\$ 15.00
Moving Message Board .....	\$495.00
TTL and CMOS test Card .....	\$ 99.00
150 Watt Power Supply .....	\$159.00
Modem 1200 B .....	\$395.00

## AT Compatible \$2995.00

- 512K memory
- 1 1.2M drive
- Colour card
- Keyboard
- 200 watt power supply



**ELECTRONIC CONTROL SYSTEMS**  
1590 Matheson Boulevard, Suite 1 & 2 Mississauga, Ontario L4W 1J1  
(416) 625-8036 Hours — Mon. to Fri. 10-6. Sat. 10-2

Circle No. 11 on Reader Service Card

# CANADA REMOTE SYSTEMS

OFFERS YOU!

## PUBLIC DOMAIN SOFTWARE

Canada's Largest Selection For CP/M, IBM, Macintosh Microcomputers

By Telephone — 12 remote Telecommunications Systems available 24 hours per day. Annual Access charge only \$55.00. No charge for downloading. For CP/M and IBM type microcomputers. Data Pac available.

By Mail — for over 200 different Computers. Over 1000 disks representing all major user groups including SIG/M and PCSIG. From \$10.00 per user group disk. Our special collection disks contain the most popular software and are priced from \$15 per disk.

## COMMERCIAL SOFTWARE

Specializing in CP/M and IBM commercial software, Low overhead, low prices, good service. We work with what we sell, and provide full assistance.

## COMMERCIAL HARDWARE

Including coprocessor boards for CP/M computers and a full line of modems. The new 2400 Baud U.S. Robotics Courier Modem is now available for only \$825.00

Call us at (416) 239-2835 or Circle Reader Service Number 15 for a free mini-catalog.



Circle No. 15 on Reader Service Card

## K.E.M.

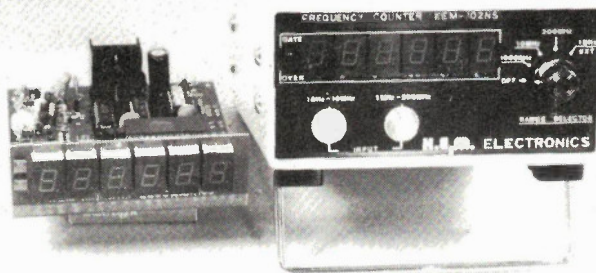

--- Assembled & tested metal case mounted Frequency Counter ---  
( 1 Year Guarantee )

(1) VHF Freq.-counter Model KEM-102NS \$159.98  
10Hz to 200MHz 3-range, 6-digit LED, zero blanking  
Sensitivity 30mVr.m.s., Input impedance 1Mohm or 50ohm  
Accuracy 1ppm (0.0001%)

(2) UHF Freq.-counter Model KEM-102NS-1G \$249.98  
10Hz to 1000MHz(1GHz) 4-range, 6-digit LED, zero blanking  
Sensitivity 30mVr.m.s., Input impedance 1Mohm or 50ohm  
Accuracy 1ppm (0.0001%)

----- Frequency counter Kit series without case -----

(1) 10Hz to 10MHz counter Kit: Model KEM-102N KIT \$69.98  
10Hz to 10MHz 2-range, 6-digit LED  
Sensitivity 30mVr.m.s., Input impedance 1Mohm  
Accuracy 3ppm (0.0003%) --- Last 10 sets only ---

(2) 10Hz to 200MHz counter Kit: Model KEM-102NS KIT \$94.98  
10Hz to 200MHz 3 range, 6-digit LED zero blanking  
Sensitivity 30mVr.m.s., Input impedance 1Mohm or 50ohm  
Accuracy 3ppm (0.0003%) --- New Model ---

(3) 200MHz Pre-scaler (Ratio 1/100) Kit \$19.98  
Maximum input 200MHz, Sensitivity 30mVr.m.s.

(4) High-Quality Metal Case Kit \$40.00

\$5.00 for shipping. Plus Prov. Tax for BC residents.  
Plus C.D.D. fee if required. Prices & specifications are  
subject to change without notice.

**K. E. M. Electronics Ltd**  
Mail to Box 69126 Station (K), Vancouver, B. C. V5K 4W4  
Office 879 E. Hastings St. Van. Tel (604) 251-1514

Circle No. 12 on Reader Service Card





# ELECTRONICS BOOK CLUB

## Keep In Step With the Future . . . Become a Part of the Fascinating World of Technology!

- High-Tech How-To
- Space Age Projects
- Digital Electronics
- Artificial Intelligence
- Robotics
- Computers
- Telecommunications
- *And much more!*

### Select 5 Books for Only \$2<sup>95</sup>

(Values to \$112.75)



1992 List \$14.95



800P List \$19.95 (paper)

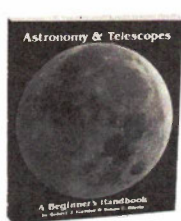

1419P List \$14.95 (paper)



1719 List \$18.95



1531 List \$17.95

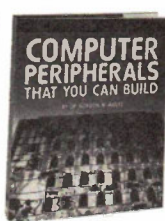

1449 List \$19.95



1604P List \$15.95 (paper)

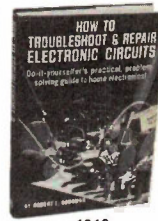

1218 List \$18.95



1835 List \$15.95

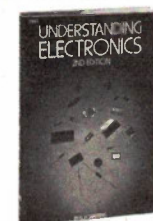

1553 List \$15.95

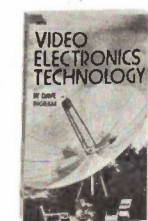

1474P List \$12.95 (paper)



1561P List \$18.95 (paper)

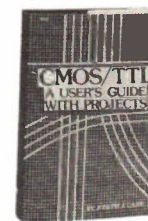

1650 List \$19.95



1858 List \$16.95

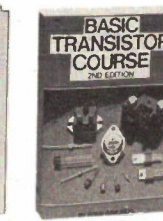

1605P List \$13.50 (paper)

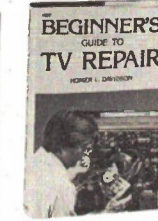

1897 List \$18.95

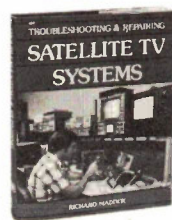

1977 List \$26.95

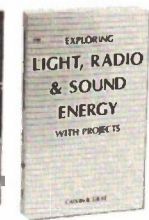

1758P List \$10.95 (paper)

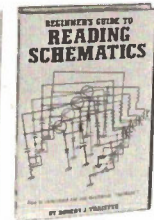

1536 List \$14.95



1539P List \$15.95 (paper)



1690 List \$19.95



1927 List \$23.95



1777 List \$21.95

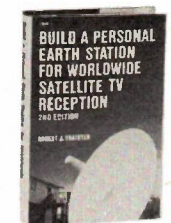

1909 List \$21.95



1625 List \$21.95



1599P List \$15.95 (paper)

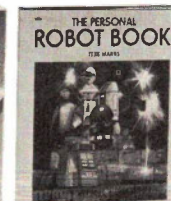

1896 List \$21.95



1108 List \$16.95

### FREE guide to mail order sources for electronic parts and components

A \$6.95 Value!

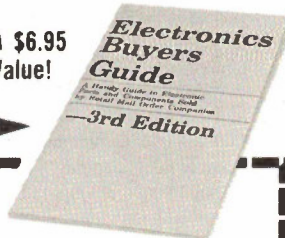

## FREE When You Join Now

### 7 very good reasons to join the Electronics Book Club

- **Big Savings.** Save 20% to 75% on books sure to increase your electronics know-how
  - **No-Risk Guarantee.** All books returnable within 10 days without obligation
  - **Club News Bulletins.** All about current selections—mains, alternates, extras—plus bonus offers. Comes 13 times a year with hundreds of up-to-the-minute titles to pick from
  - **Automatic Order.** Do nothing, and the Main selection will be shipped automatically! But . . . if you want an Alternate selection—or no books at all—we'll follow the instructions you give on the reply form provided with every News Bulletin
  - **Bonus Books.** Immediately get Dividend Certificates with every book purchased and qualify for big discounts of 60% to 80%.
  - **Extra Bonuses.** Take advantage of added-value promotions, plus special discounts
  - **Exceptional Quality.** All books are first-rate publisher's editions selected by our Editorial Board and filled with useful up-to-the-minute information
- Circle No. 10 on Reader Service Card

## ELECTRONICS BOOK CLUB

P.O. Box 10,  
Blue Ridge Summit, PA 17214

Please accept my membership in the Electronics Book Club and send the 5 volumes circled below, plus my FREE copy of *The Electronics Buyer's Guide* billing me only \$2.95 plus shipping and handling charges. (Payable in U.S. dollars.) If not satisfied, I may return the books within ten days without obligation and have my membership canceled. I agree to purchase 4 or more books at regular Club prices (plus shipping/handling) during the next 12 months, and may resign any time thereafter.

800P-1108 1218 1419P 1449 1474P 1531 1536 1539P  
1553 1561P 1599P 1604P 1605P 1625 1650 1690 1719 1758P  
1777 1835 1858 1896 1897 1909 1927 1977 1992

Name \_\_\_\_\_  
 Address \_\_\_\_\_  
 City \_\_\_\_\_  
 State \_\_\_\_\_ Zip \_\_\_\_\_ Phone \_\_\_\_\_

Valid for new members only. Foreign applicants will receive ordering instructions. Canada must remit in U.S. currency. This order subject to acceptance by the Electronics Book Club.



**COMPUTER PARTS GALORE INC.**  
316 College St.  
Toronto, Ontario M5T 1S3

**Toll Free Orders Only**  
**1-800-387-1385**  
**(416) 928-2161**

MAIL ORDERS: We accept VISA, MC, AMEX, credit cards. Money orders, cheques (2 week wait) are also OK. Minimum packing and handling fee \$5.00 or 5%, whichever is larger. The only COD we use is via CANPAR (Add \$4.00 COD fee) or motor freight. We do not use postal COD at all. All Ont. res. add 7%. All prices are subject to change without notice. Returns are subject to a 20% restocking charge.

## IBM CASE

We have the nicest case of all the various competing cases, ask any friend who has bought someone else's case and then has seen ours. The lid is hinged with pushbutton access. The back is cut for 8 XT slots and it comes with all the case back inserts for cards, card guides, blind disc filer plates, standoffs, feet, screws, all for **\$69.95**. SIDE SWITCH Please specify back or side cutout for power supply.

CLEARANCE, BACK SWITCH CASE ..... **\$59.95**  
We also have an IBM 8 Slot/6502 Board dual duty case for making IBM look-a-like 6502 systems ..... **\$79.95**

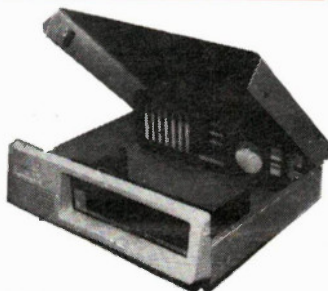

MEGABOARD CASE, similar to the above. Fits the MEGABOARD exactly for back power supply ..... **\$99.00**

## NICADS 8.4V 7 "D" 4A.H CELLS



A great buy, a pack of 7 brand new GE NICADS giving 8.4v at 4 Amp hours. Each cell is 12v and separates easy. Used as 5V backup through a 7805. Gives 5v 1 Amp for 4 hours. .... **\$14.95**

## WIRED CARDS FOR IBM

- (A) 384K RAM CARD. A ¼ sized card that has 384K of 64K DRAM on board. With OK ..... **\$ 89.95**
- (B) 512K RAM CARD. A full sized card with 512K of 64K DRAM on board. With 64K ..... **\$119.00**
- (C) 576K RAM CARD. A very popular card with 576K of 64K and 256K DRAM on board. This is a ¼ sized card for portable use. With OK ..... **\$ 79.95**
- (D) KRAM RAM CARD. A clone of the JRAM with up to 2 MBYTE on board using 256K DRAM. 100% compatible, complete with software for using as RAMDISC and RAMSPOLL. With OK ..... **\$139.00**
- (E) COLOR GRAPHICS. A clone of the popular PERSYST color card. Has three outputs and one input. A. RGB for IBM color monitor. B Video 1v P to P composite color video. C. Video gray scale 1v P to P for seeing color on green or amber monitor ..... **\$129.95**
- (F) MONOCHROME GRAPHICS/PRINTER. A workalike clone 100% IBM compatible for the HERCULES card. Has par printer port and hi-res text and graphics mono output ..... **\$159.95**
- (G) 384K HEXPACK. A copy of the AST 6-PACK, 100% compatible with software. Has Clock/calendar/alarm and 384K DRAM and serial and parallel ports and game I/O. With OK ..... **\$189.00**
- (H) 640K HEXPACK. Similar to above but with 640K on board using 256K and 64K DRAM. All other features the same. With OK ..... **\$279.00**
- (I) DISC CONTROLLER. For 1-4 DS-DD drives. Full IBM standard with cable and instructions. .... **\$ 79.95**
- (J) DISK CONTROLLER + I/O CARD. A very good card that has a clock/calendar/alarm and game I/O and serial and parallel ports and a standard 1-4 drive controller card on a full sized card. Very efficient card ..... **\$189.95**
- (K) I/O + 2. A clone of the very popular USA card of the same name. Has clock/calendar/alarm, with game I/O, serial and parallel, ports ..... **\$129.95**
- (L) PRINTER CARD. A standard centronics printer port for all parallel printers ..... **\$ 59.95**
- (M) SERIAL CARD. A standard ASYNC serial card for modem use etc. .... **\$ 49.95**
- (N) MODEM CARD. A 300/1200 Baud modem using the 8910 WORLD chip. Compatible with many popular software packages. .... **\$189.00**
- (O) 8255 I/O CARD. Uses 2 8255's to give 16 lines of I/O for various uses. Fully locatable ..... **\$129.95**
- (P) CLOCK CALENDAR CARD. A small card to add the clock/calendar/alarm battery to system ..... **\$ 49.94**
- (Q) GAME PORT CARD. Adds two std game I/O ports to the system ..... **\$ 39.95**

## SYSTEMS

All SME-XT systems share these attributes.

- High order compatibility due to the DTC bios which is recognized superior to others.
- 8 Slots for plug in cards, just like IBM
- Made right here in Canada
- Socketed for the 8087 Co-processor
- IBM compatible serial keyboard
- Disc controller using 9216 IC, the most advanced, for error free operation.
- Properly made 135W power supply with accessory plugs.

(A) Basic system 256K, 1 DSDD drive, & controller monochrome card, 135W PS and keyboard \$899.00  
OPTIONS, Add the amount indicated for the option.

- (1) 640K Motherboard with 640K ..... **\$ 80.00**
- (2) Color graphics card with gray scale ..... **\$ 60.00**
- (3) Parallel printer port card ..... **59.00**
- (4) Clock, calendar, alarm, serial, parallel, and game card ..... **\$110.00**
- (5) Extra drive, installed and tested ..... **\$150.00**
- (6) 10 Meg hard drive, w/controller ..... **\$699.00**  
20 Meg hard drive, w/controller ..... **\$849.00**
- (7) IRWIN 10 meg tape B/U ..... **\$599.00**  
IRWIN 20 meg tape B/U ..... **\$749.00**  
Tape cartridges for above ..... **\$ 34.95**
- (8) External hard drive box w/power supply for hard drive or tape B/U option, w/cables and ready to go ..... **\$249.00**

## NEW SME-XT 640K TO 1M BYTE

**BARE PCB \$39.95**  
**WIRED WITH 256K \$299.00**

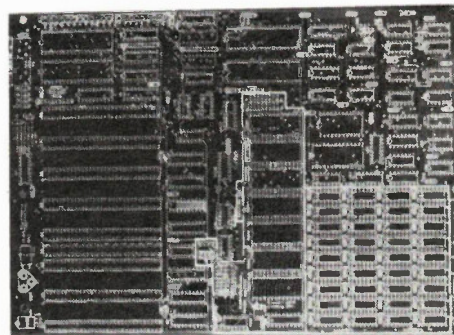

In response to popular demand we have developed an upgrade of the famous MBE-XT board. The new board is called the SME-XT and has space for up to 1 Mbyte on board. The most popular configuration is 640K which is the IBM max addressable memory. The extra RAM above 640K is normally used for system purposes such as video lookup, ROM sitting, and other uses. However, we can supply proms to allow full use of this overhead space on demand. The 256K RAMS are more highly evolved than 64K RAMS and board using them have far fewer problems with parity errors. We have decided to maintain the low price we pioneered with the MBE-XT and sell the new PCB at \$39.95 as well. All other attributes stay the same as the original IBM and the MBE-XT.

SME-XT ..... **\$39.95**  
Manual and Schematic ..... **\$ 4.95**

## HARD DRIVE BOX

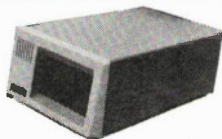

This nicely made box is ideal for externally mounted hard or floppy drives. It has space for one full height or two half height drives and power supply space at rear. This is a well made and rugged units for only **\$59.95**

## QUME

Yes we have the same QUME drives that IBM uses in their IBM-XT® system, 40 track, 1/2 height, double sided, double density. The exact ones you need to upgrade your old system or build your clone system up to the max. These are brand new drives that are from QUME's own inventory. They are absolutely perfect, at a perfect price of only ..... **\$145.00**

## MEMORY FLASH

64K-200Ns DRAM ..... **\$2.00**  
64K-150Ns DRAM ..... **\$2.00**  
256K-150Ns DRAM ..... **\$5.75**  
Set of 941256 ..... **\$44.00**

## SWITCHING POWER SUPPLY

**110V, 60Hz with Fan and two rear switched outlets**

These power supplies fit our cases.

130 WATT +5V - 14A; +12v - 4.2A; ±12V - 1/2A.  
Back Switch ..... **\$135.00**  
Side Switch ..... **\$139.00**  
CSA Approved 150W Side Switch P/S ..... **\$159.95**



## CABLES

Disc Drive cable (3 Con & twist) ..... **\$12.95**  
IBM Parallel printer cable ..... **\$14.95**  
IBM serial printer cable ..... **\$14.95**  
IBM 6" Keyboard extension (curly) ..... **\$ 9.95**

## KEYTRONICS 5150

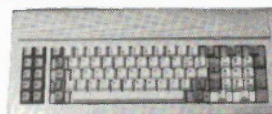

Yes the famous KEYTRONICS 5150 IBM® compatible keyboard. MADE IN USA. We bought a bunch and can sell them for only ..... **\$119.00**

We also have some Taiwan copies that are quite good and all are checked for only ..... **\$99.00**

And lastly we have some Taiwan copies of the famous KEYTRONICS 5151 keyboard with all the same enhanced features for only ..... **\$139.00**



Toll Free Orders Only  
**1-800-387-1385**  
(416) 928-2161

## SOLDERLESS BREADBOARD

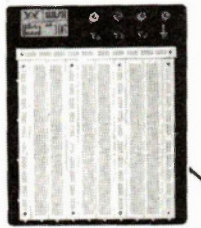

Solderless prototyping boards are the best way to quickly breadboard up a circuit. The holes are made especially for IC's, resistors, and other small parts with 22-28 gage wire leads, takes WW pins too.

- WB-106 ..... \$39.95  
3 IC strips, 5 power strips  
4 Blinding posts, Aluminum plate
- WB-104-3 ..... \$24.95  
2 IC strips, 1 power strip  
2 Blinding posts, aluminum plate
- WB-108 ..... \$49.95  
4 IC strips, 7 power strips  
4 Blinding posts, aluminum plate
- WB-104 ..... \$29.95  
2 IC strips, 4 power strips  
2 Blinding posts, aluminum plate.

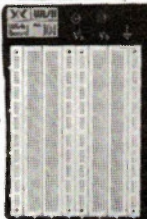
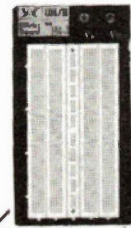

## MOTHER BOARD

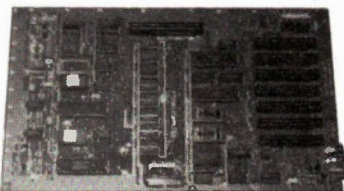

100% IIe® Compatible, for those of you who wish to build a clone of the very popular APPLE IIe®. This board is a reverse engineered copy of the IIe® and is 100% compatible. We have the motherboard and the custom ICs only. All other parts are widely sold. The custom ICs are workalike chips that do not infringe any copyrights. The software for operating the board must be obtained elsewhere as we do not have it for sale. When we say 100% we mean it.

- A very good buy at ..... \$49.95
- Custom IC set(2) ..... \$49.95
- Keyboard encoder (AY3-3800) ..... \$14.95
- Character generator, U/LC ..... \$14.95
- 48K 6502 Motherboard, same old 100% compatible 2+ clone ..... \$29.95

## IIe® ABS PLASTIC CASE \$59.95



This case is made to fit the Mother Board listed here for making IIe® clones and it makes a very nice looking copy. There is just enough difference to avoid design infringement. The case also has no brand names or other marks on it.

- A good buy at ..... \$59.95
- ABS numeric case for 48K motherboard. Exact fit. .... \$49.95

## APPLE IIe® DETACHED NUMERIC KEYBOARD \$99.00

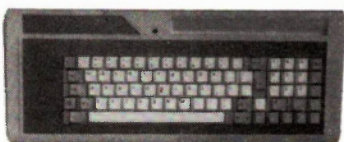

For those of you who would like to put your IIe in another case we have a high quality 100% plug in compatible Matrix keyboard with all IIe keys plus the highly desirable numeric keypad for quick entry of numeric data ..... \$99.00

## IIe® MATRIX KEYBOARD \$79.95



This keyboard fits the above case and has 100% clone compatibility, it will allow operation of all IIe® commands. Another bargain at ..... \$79.95

- 2+ numeric keyboard for 48K mother boards, 100% comp, 88 basic functions for only ..... \$69.95
- Standard same as above ..... \$69.95

## SWITCHING POWER SUPPLY



Another great bargain from PARTS GALORE. A small power supply switching style that give +5v-4A; ±12v 1A and -5v (adjustable) on a compact 4x8" open frame PCB. Cost Northern Telecom \$50.00 when they bought 5000 pieces. We got em when a subcontractor went belly up for 10% of that price and we are selling em for

**\$18.95 NEW IN BOX TESTED**

AC power cable (3 Wire) for above ..... \$2.50



This is a high quality Hall Effect keyboard made by Microswitch of Canada for AES data and now bought by us for 10% of the \$169.00 that AES paid for them in 10,000 lots. They are a very good word processing keyboard with both serial and parallel data outputs for use with APPLE and IBM type systems and come complete with a ribbon cable connector and complete pinout. .... \$24.95

## IBM POWER SUPPLY

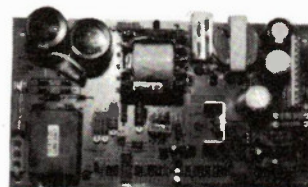

One of the nicest open frame IBM type switching power supplies we have ever seen. Came from the defunct NCR IBM compatible, runs the whole thing, has +5V-7A, +12V 3A, -5, -12 1/4 A. A very good unit for starter system. Will not run hard disc system. A real steal at ..... \$49.95

## 8" DRIVE SWITCHING POWER SUPPLY

**\$39.95**

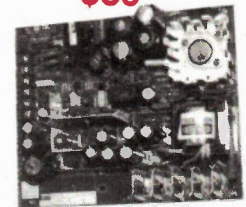

The greatest 8" Drive supply we have ever found. Has 24V-2.2A 5V-3A and -12V-17A. All you need for a dual 8" Drive system. A switching power supply by ASTEC

- 8088 CPU ..... \$12.95
- 8087 Math Processor ..... \$219.00
- 8237A-5 Prog. DMA Cntrl. .... \$8.95
- 8250 Serial Port ..... \$9.95
- 8253A-5 Prog. Interval timer ..... \$5.95
- 8255A-5 P.I.A. .... \$4.95
- 8259A Prog. Interrupt Cntrl. .... \$4.95
- 8284A ADC clock gen & driver ..... \$5.95
- 8288 Bus Controller ..... \$9.95
- 8272 Floppy Disk Controller ..... \$9.95
- NEC 765 Floppy Disk Controller (equivalent to 8272) ..... \$9.95
- Set of 8088, 8255A-5, 8237A-5, 8288, 8284, 8253A-5 and 8259A ..... \$44.00
- 6502 CPU ..... \$ 5.50
- 6845 CRT controller ..... \$ 9.50
- 6845 CRT controller ..... \$ 9.95
- Z80A CPU (4 MHz) ..... \$ 4.99
- MC3242 ..... \$11.95
- 74LS367 ..... \$ .82
- 74LS259 ..... \$ 1.39
- 74LS161 ..... \$ .99
- 74LS174 ..... \$ .82
- 74LS174 ..... \$ 1.70
- 74LS323 ..... \$ 4.55
- Card edge connector (50 pin) ..... \$ 2.49
- RCA jack PC mount ..... \$ .99
- 6 pin power square connector ..... \$ .99
- Phono jack (small) ..... \$ .99
- MPSA 13 trans ..... \$ .55
- 2N3904 trans ..... \$ .19
- 2N3906 trans ..... \$ .27
- MPSU11 trans ..... \$ .70
- 2N4258 transistor or equiv ..... \$ .69
- 1K SIP 10 pin ..... \$ .60
- 1K SIP 8 pin ..... \$ .69
- 10K SIP 10 pin ..... \$ .75
- 4 pos dip sw ..... \$ .95
- 20 pin female header for disk drive ..... \$ 1.78
- 20 pin male ..... \$ 1.60
- 50 pf trim cap ..... \$ .89
- 220 ohm trimpot ..... \$ .89
- 20 conductor ribbon cable ..... \$ .89/ft.

## PARTS, PARTS,

- 100ns delay line ..... \$5.00
- 7ns delay line ..... \$13.95
- 62 pin edge con (high quality) ..... \$1.89
- 5 pin Din conn ..... \$1.25
- Power conn ..... \$1.25
- Dip switch 8 pos ..... \$2.49
- 4.7k x 6 slip ..... \$ .99
- 4.7k x 8 pin slip ..... \$ .99
- 8.2k or 10k 16 pin Resistor or net ..... \$ .99
- 33ohm x 8 network ..... \$1.10
- Small speaker ..... \$1.99
- .1uf 50V high quality bypass capacitors ..... \$ .10
- Trimcap ..... \$ .99
- 34 pin card edge con. .... \$5.95
- 2718 ..... \$3.49
- 2732 ..... \$3.95
- 2764 ..... \$4.95

## MBE-XT

**AN IBM® XT Compatible 8 Slot Motherboard**  
MBE-XT BARE PCB WITH MANUAL AND SCHEMATICS.  
**\$34.95**

### LAZY BOARD

What Is your time worth?? We have had a bunch of MBE-XT boards stuffed and wave soldered so you can save all that time soldering them up. All you need are the IC's memory and BIOS and you are set to go ..... 149.00

FULLY WIRED AND TESTED WITH 64K ON BOARD WITH MEGABIOS AND MANUAL  
**\$275.00**



- 8088 16 Bit Microprocessor
- 8087 Math Processor. Optional
- Up to 256K Dram on Board
- Has Digital Delay Line for Error Free Memory Refresh
- 8 IBM Compatible Expansion Slots
- 4 DMA and Timer Channels
- 64K/128K Eproms Jumper Selectable
- Will run any Compatible BASIC
- IBM Power Plug Compatible
- Same PCB size as IBM XT
- Runs PC-DOS and CPM-86
- Compatible BIOS in stock

## MEGA BIOS

The amazing MEGABIOS® from DTC of Dallas. A fully rewritten BIOS that allows you to make a fully compatible legal system. Note they do not ask MEGABUCKS® for it, only ..... \$49.95

TAIWAN BIOS, not as good or 100% compatible but it will get you running and save you bucks ..... \$24.95

## IBM BARE PCB

- (A) Color Graphics (Persyst) ..... \$27.95
- (B) Monochrome graphics ..... \$24.95
- (C) Disc controller + Printer ..... \$17.95
- (D) Disc controller + Printer ..... \$24.95
- (E) Disc controller + Game ..... \$24.95
- (F) IO + 2 I/O clock etc. .... \$24.95
- (G) Multifunction card 11 function ..... \$24.95
- (H) AST SIXPACK COPY ..... \$34.95
- (I) Parallel printer ..... \$17.95
- (J) RS-232 card ..... \$17.95
- (K) Simple modem card ..... \$17.95
- (L) Disc for above ..... \$ 4.00
- (M) 512K card ..... \$24.95
- (N) 256K short card ..... \$19.95
- (O) IBM 6" extender for service ..... \$19.95
- (P) WW Proto, full sized with DB-9 & DB25 footprint. .... \$24.95
- (Q) WW Memory proto, full sized with 256K (1Meg) memory laid out on one end with DB-9, DB25 footprint ..... \$29.95
- (R) 512K Mapping PROM ..... \$12.95
- (S) Multifunction PROMS(2) ..... \$24.95
- (T) 2732 for color graphic ..... \$10.00

All cards come with a detailed parts list and placement drawing, we also have all parts needed for them.



# Heatsinks

***A guide to the functioning and selection of semiconductors heat-sinks.***

***By Bill Markwick***



TRANSISTORS and other semiconductors make great fast-acting fuses, especially when you don't want them to; overheat the junction and they expire rapidly and quietly. Well, they aren't particularly quiet if they're in the output stage of a power amplifier and their failing dumps the power supply into your speakers.

What usually happens in the case of overheating is not simply a massive melting of the chip, but localized heating of a tiny area. This tiny area suddenly shorts and the rush of current finishes the semiconductor for good. The moral here is to keep the *chip* well below the manufacturer's absolute maximum rating, usually listed at 150 or 200 degrees C for silicon devices. I stress the chip for the simple reason that it can be screaming hot when the sink itself isn't. How to predict the temperature rises and keep them under control is surprisingly straightforward, as we'll see.

The name *heatsink* isn't quite right; a sink implies a mass large enough to absorb your heat without an unacceptable temperature increase. The familiar metal heatsink is in fact a heat exchanger: the ambient air becomes the true sink (until it can radiate its accumulated heat into space-but let's not get carried away).

## **A Primer**

Without getting into the laws of thermodynamics, we can say that heat energy moving out of a source to some other place is like an electrical current. Since the path it takes will be an imperfect conductor, we can relate the thermal resistance to electrical resistance, and represent it on paper as a resistor symbol. The temperature will increase as we move along the thermal path from the ambient to the chip, and we can then equate the changing temperatures to the voltage drops along a series resistor chain.

Clear like zee mud, no? Here's an over-simplified example. Imagine that we have a transistor mounted on a sink. The heat from the transistor transfers into the heatsink and then into the air. The temperature is highest in the transistor and drops in the metal heatsink. The temperature of the ambient air can be taken as a constant; for now we'll assume that the room air will absorb all the heat without a noticeable temperature rise.

The schematic representation of the above would be a voltage generator (the chip) with two resistors in series (the transistor case and the heatsink-to-ambient). Now we come to some simple numbers. The thermal resistance is called  $\theta$ , or *theta*, and is specified in *degrees C per watt*. The first resistor represents the thermal resistance of the transistor case and the second one is the thermal resistance of the heatsink-to-ambient air.

Assume that the transistor chip is dissipating 5 watts of heat. To find the

**Electronics Today January 1986**



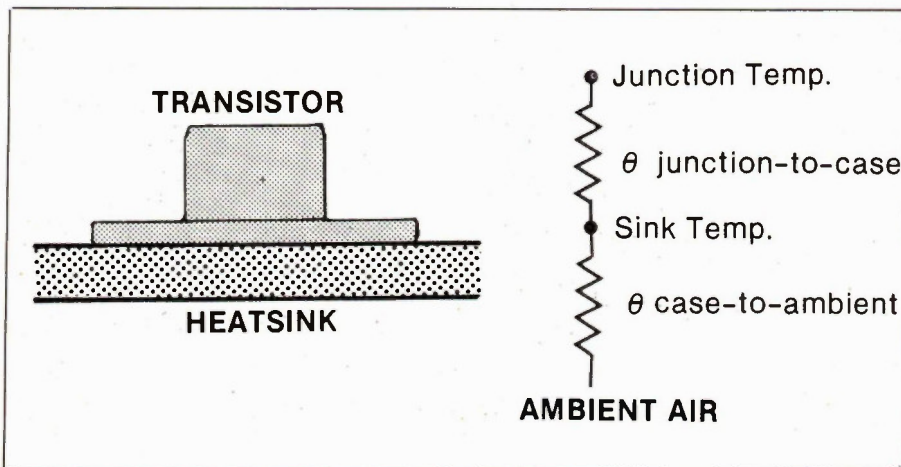

Fig. 1. A simplified resistive model of a transistor on a heatsink; it assumes perfect heat transfer between the case and the sink.

various temperatures, we start with the ambient air, which we'll assume is 25 degrees C.

Five watts of thermal energy will be passing through the sink, which we'll assume has a thermal resistance of 3 degrees C per watt. This raises the sink temperature to  $3 \times 5 = 15$  degrees above ambient, or 40 degrees.

Next the transistor case's thermal resistance, which we'll assume is 5 degrees C per watt, raises the chip temperature by  $5 \times 5 = 25$  degrees above the sink temperature, or 65 degrees C.

And there you are. Mind you, we've cut a few corners to make the explanation simple. A more detailed explanation follows.

### Basics

Even a complicated setup is calculated the same way as the above, except that the overall thermal resistance is made up of more series elements. Here are the elements making up the thermal path for a TO-3 power transistor mounted on an extruded finned heatsink external to the equipment case, a fairly common setup.

**1. The chip.** This is the silicon bit that will be making the heat. It's at the top of the resistive model, and its thermal resistance is designated as  $\theta_j-c$  (junction to case).

**2. The case.** The chip will be bonded tightly to the case, but there's still a thermal resistance which causes the chip to be slightly hotter than the bottom of the case.

**3a. Thermal compound.** Improves thermal transfer between the case and the insulator, the next item on the list.

**3b. Insulator.** This isolates the electrically live case from the grounded heatsink and is usually made of thin, prepunched mica, although there are proprietary insulating wafers and adhesives.

**3c. More compound.** This, plus the two items above, are lumped under  $\theta_c-s$  (case to sink).

**4. The heatsink itself.** The manufacturers will specify it as so many degrees C temperature rise above the ambient air for each watt dissipated. This is  $\theta_s-a$  (sink to ambient).

**5. The ambient air.** For now, assumed to be a constant at 25 degrees C, a typical value for warm room temperature air. More on this follows below, and then we'll try a working example of heatsink calculations.

### Ambient Air

If the heatsink is mounted outside a cabinet with unrestricted access to room air, the ambient temperature can be taken as the highest room temperature likely to occur, perhaps 25 or 30 degrees C. On the other hand, if the cabinet is mounted in a wooden box with restricted air circulation, or in an equipment rack with lots of other hot cabinets, or under the hood of a car, the air reaching the heatsink may be preheated to a considerable degree (sorry). You'll have to find out what the highest expected temperature will be, or if there's no way to find out, the heatsink system should be oversized by quite a bit. It all depends on how much safety margin you want and whether the semiconductors will be dissipating continuously, as in a power supply, or only occasionally, as in an intercom amplifier.

If you've allowed a huge safety margin and discovered that the required heatsinks are as large as the cabinet itself, the next step is to look into forced air cooling. Although it raises the cost and complexity, and adds the problem of fan failure, there's a huge increase in the performance of any heat sink. Aside from the fact that an increased mass of air is moving over the sink surface, it also blows

*continued on page 38*

# 40 MHz

## 3 MODELS FROM \$950

**5% discount** when you call Tom and order direct.

<ul style="list-style-type: none"> <li>■ 3 CH, Alternate Time Base Simultaneous Trigger View ..... \$1,215</li> <li>■ 2 CH, Delayed Sweep ..... \$1,075</li> </ul>	<ul style="list-style-type: none"> <li>■ 2 CH, Single Time Base ..... \$950</li> <li>■ P-P Auto Trigger</li> <li>■ Nationwide Sales and Service</li> </ul>
--	--

**interfax**

514-336-0392  
416-671-3920

**KIK**

613-726-8888  
604-430-1410



# Millifaradometer Project

*An ingenious, unusual and reliable way of measuring large-value capacitors.*

By Ray Bold

THIS instrument is capable of measuring capacitors in the range 1 $\mu$ F to 100,000 $\mu$ F, and was inspired by the purchase by the author of a goody bag containing a huge number of unmarked electrolytics, and the prospect of a long tedious exercise using a bridge to measure them. A handy electromechanical counter and some development work led to the construction of a prototype instrument from which this design derives.

Construction is straightforward. The meter uses a bench supply rated at 12V DC and the full load current is in the region of 200mA.

## Theory

If a capacitor, which is initially discharged, is charged from a constant current source, the voltage across it will change linearly with time. The time taken to charge to a given voltage will be dependent on the size of the capacitor and the magnitude of the charging current. Expressed mathematically,

$$CV = It$$

OR

$$t = CV/I$$

If we fix V and then I, then t will be a function of C, and if we then arrange to measure t, we will also be measuring C.

In this design, a constant current of either 9 $\mu$ A, 90 $\mu$ A, 900 $\mu$ A or 9mA is supplied to the capacitor under test (CUT). The voltage across the capacitor is monitored by a window comparator, and while the voltage is within the limits of the window comparator, a counter operates at approximately 10Hz to give an indication of the capacitor's size. Figures 1 and 2 help to illustrate the theory.

## Circuit Description

The circuitry around Q1 (Fig. 3) forms a

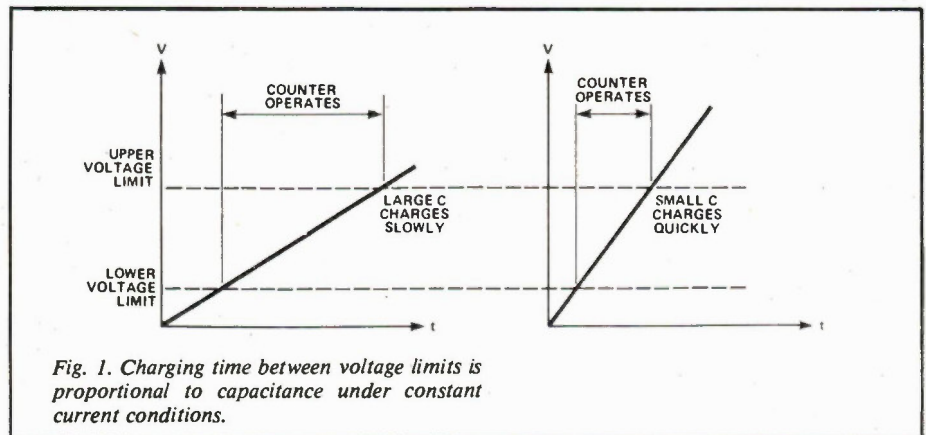

Fig. 1. Charging time between voltage limits is proportional to capacitance under constant current conditions.

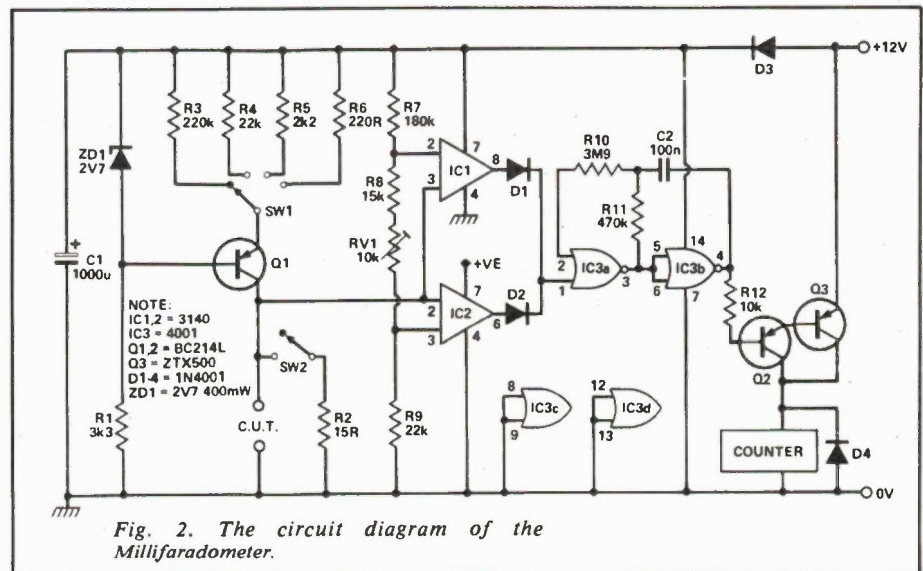

Fig. 2. The circuit diagram of the Millifaradometer.

constant current source with the current being selected by SW1. The capacitor under test is connected to the terminals marked CUT. SW2 and R2 remove any initial charge on the capacitor. When SW2

is opened the capacitor charges at a constant current and its voltage increases linearly with time. Since the relationship is  $CV = It$ , for a given current, the voltage will rise between two limits over a time



determined by the value of the capacitor.

IC1, IC2 and associated components form a window comparator whose output goes low when the voltage across CUT lies within certain limits. The limits can be adjusted by RV1, providing a means of calibration. The window comparator gates the astable built around IC3 which counts at the rate of approximately 10Hz, driving the counter via Q2 and Q3 as long as it is gated on.

D3 and C1 decouple the supply to the sensitive parts of the circuit and protect them from the interference generated by the counter. D4 suppresses the spikes generated by the counter. Figure 3 shows the voltages at various parts of the circuit during a measurement cycle.

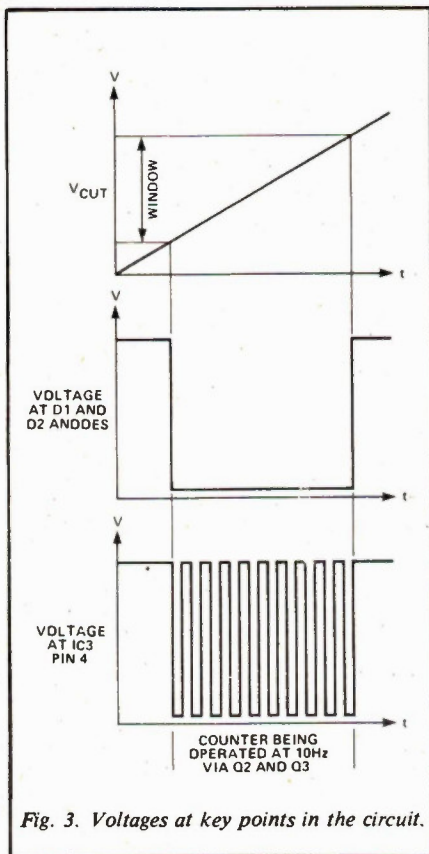

Fig. 3. Voltages at key points in the circuit.

**Construction**

The printed circuit overlay is shown in Fig. 4 and is mounted using two of the mounting posts in the case, drilled 3mm. The board is drilled 3.5mm and 3mm set screws are used. Another 3mm set screw, with nut and spacer is inserted just above IC1.

Take care to mount polarized components and semiconductors correctly, and solder in the semiconductors last. Component values are not critical but if R3 to R6 are close tolerance so much the better. Electrolytics have large tolerances which vary with age and temperature, so extreme accuracy is unnecessary.

Electronics Today January 1986

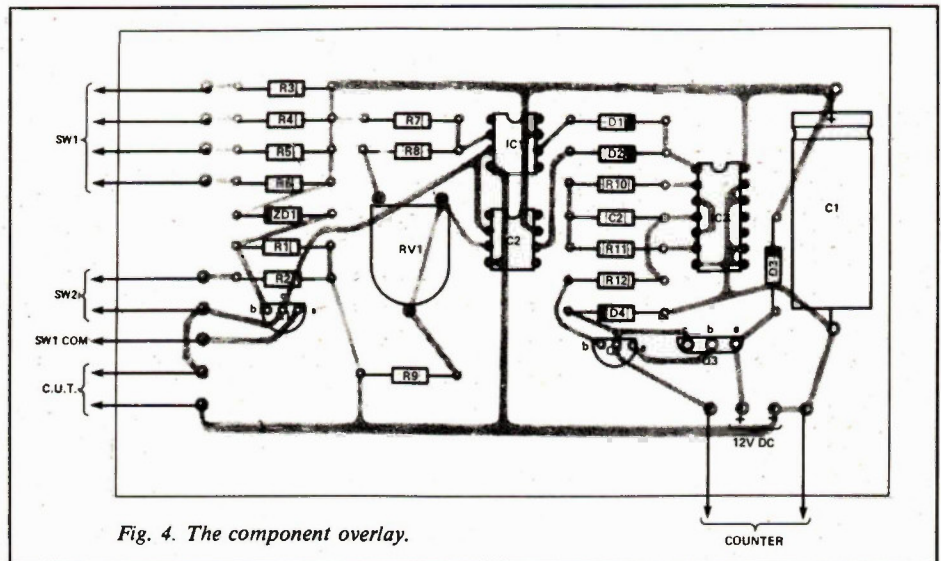

Fig. 4. The component overlay.

-Flying leads are used to connect the instrument to the bench power supply or 12V battery.

**Setting Up**

Find a capacitor between 10 and 20 uF. If possible, measure it accurately on a piece of commercial equipment. Reset the

counter to zero and connect the capacitor. With SW1 on the X1 range switch SW2 to test. The counter should operate. Note the reading and repeat the procedure adjusting RV1 to give consistently accurate results. With large value capacitors there is a delay before counting begins while the bottom of the window is reached.

# 100 MHz

## 3 CHANNELS...\$1,995

- Alternate Time Base
- Simultaneous Trigger View
- 2 ns/div, Max Sweep

- Multimode Display
- P-P Auto Trigger
- 60 MHz . . . \$1,550

**interfax**

514-336-0392  
416-671-3920

**KIK** #3 in scope sales

613-726-8888  
604-430-1410



## Parts List

### Resistors (All 1/4w 5% carbon film)

R1	.....	3k3
R2	.....	15R
R3	.....	220k
R4, 9	.....	22k
R5	.....	2k2
R6	.....	220R
R7	.....	180k
R8	.....	15k
R10	.....	3M9
R11	.....	470k
R12	.....	10k
RV1	.....	10k horizontal skeleton preset

### Capacitors

C1	.....	0u 16V electrolytic
C2	.....	100n polyester

### Semiconductors

IC1, 2	.....	3140
--------	-------	------

IC3	.....	4001
Q1, Q2	.....	2N5087
Q3	.....	2N4401
D1 to 4	.....	1N4001
ZD1	.....	2V7 400mW zener diode

### Miscellaneous

SW1	.....	Single-pole 4 way rotary switch
SW2	.....	SPST toggle switch

Counter, 12V, 10 impulses per second with reset; case (console type); PCB; terminals; pointer knob; red and black 4mm plugs; connecting wire; set screw; nuts, washers, transfer. For the counter, try getting one surplus. If this is a no-go, Electro Sonic Cat. #G0-875-106-3 should be ok. Electro Sonic, 1100 Gordon Baker Rd., Willowdale, Ont., M2H 3B3 (416) 494-1555.

## In Use

If in doubt about the value of a capacitor, set the range switch to a high range. The counter may count a couple of times or fail to count at all, which will indicate that a lower range is required. Starting on a low range may mean watching the counter for an excessive time until it stops. When counting finishes, simply add the number

of zeros indicated by the range switch and that is the value of the capacitor.

To test another capacitor, switch the test switch up, replace the tested capacitor with the one to be tested, zero the counter and select a likely range. Then switch the test switch to test and watch.

After finding the value of a capacitor (bearing the +50%/-20% tolerance in

mind) it is frequently possible to find the voltage rating by referring to catalogues, as these often give data including the physical size of capacitors.

The Millifaradometer can also be used to check electrolytics in faulty equipment. It should be remembered that a capacitor which is very leaky will charge slowly and seem to have a large value because of the current shunted through its own internal resistance. Capacitors which behave in this way should have their leakage checked with a multimeter set on resistance.

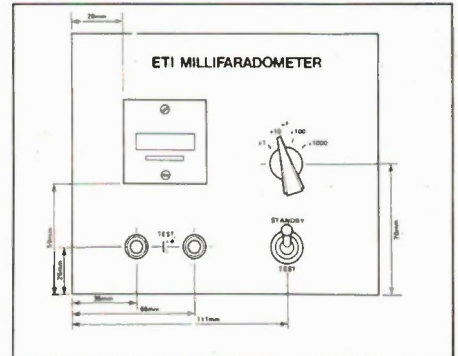
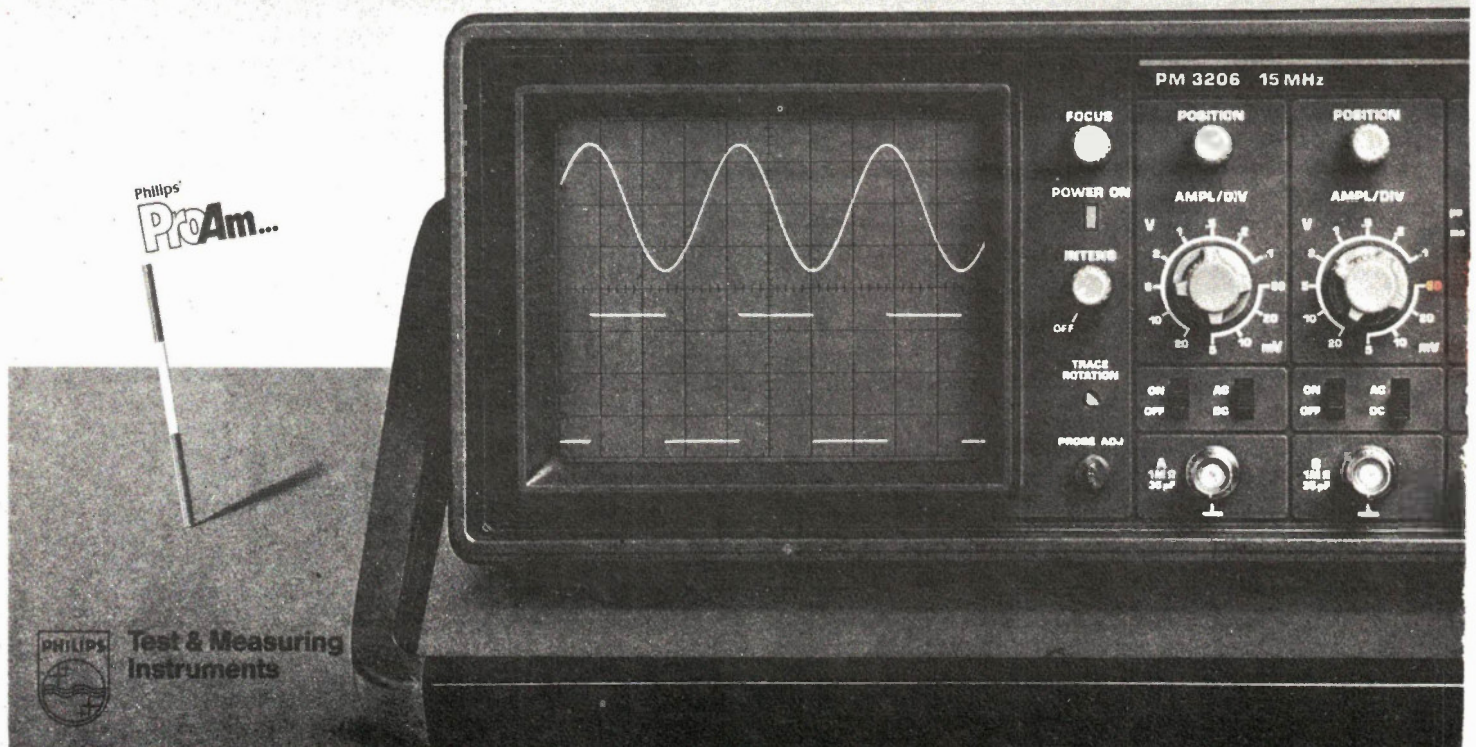
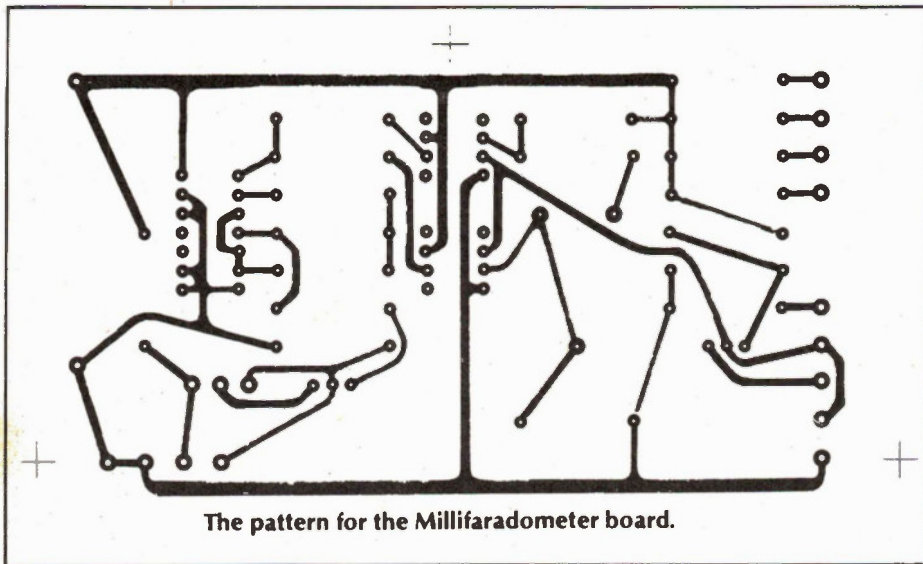

Fig. 5. Front panel layout of the ETI Millifaradometer.

# ...the Professional







The pattern for the Millifaradometer board.

### How It Works

The Millifaradometer consists of four basic sections.

- a) A constant current generator based on Q1 and associated components.
- b) A window comparator built around IC1 and IC2.

- c) A gated astable multivibrator around IC3a and IC3b.
- d) A counter and driver transistors Q2 and Q3.

With SW2 closed, the capacitor to be measured is connected across the terminals marked CUT. The switch

and 15R resistor ensure that the capacitor is discharged at the outset. When SW2 is opened the capacitor charges up via Q1, and the voltage increases linearly at a rate dependent on the current and size of the capacitor.

When the bottom of the window (set by the divider chain R7, R8, R9, RV1) is reached, the output of the window comparator goes low, gating on the astable multivibrator IC3a and b. This runs at approximately 10Hz and drives the counter via Q2 and Q3. After a time, determined by the value of the charging current, the size of capacitor and the width of the window (set by RV1), the output from the comparator goes high and the counter stops.

The charging currents and window width are so arranged that on range 1 the voltage across a capacitor of 10uF will change by 1V/s and during this time the counter will count to 10. A capacitor of 20uF will take twice as long and count to 20 in 2 seconds on range 1. On the X 1000 range a capacitor of 47,000uF will take 4.7 seconds to change its charge by 1V and the counter will register 47. ■

# scope at an "Amateur" price Philips PM 3206.

Philips'  
**ProAm...**

## You'll never get more scope for your money!

Among scope users, the difference between "pro" and "amateur" has always been clear. But now you needn't choose between big performance and little money. With Philips' PRO-AM you can have both! In a professional-quality scope that's been over the "torture trail".

Its 5 mV sensitivity over 15 MHz already puts it in the "pro" class. Its 80-square-centimetre rectangular tube with 2 kV acceleration gives a clear trace with no fudging at the corners. There's automatic triggering to hold a trace. TV triggering. External Z modulation. Choice of trigger channel.

For the whole story, contact

PHILIPS ELECTRONICS LTD. or  
Test & Measure Group R.A.E. INDUSTRIAL  
Telephone: (416) 292-5161 Telephone: (604) 291-8866

# PHILIPS



# SURPLUSTRONICS

**we will not be undersold**



## 8088 Computer Systems

**\$995**

Includes:  
 • 8088 motherboard  
 • High quality legal Bios  
 • One DS,DS 360K Drive  
 • Power Supply with Fan  
 • Keyboard  
 • Flip-Top case  
 • Disk Controller  
 • With plenty of spare slots  
 All you need for complete System is Video Board  
 Colours: ..... **\$159.00**  
 Mono ..... **\$159.00**

**\$339**

8088 motherboard with 256K (expandable on board to 640K) Fully assembled and tested with legal Bios, Flow soldered provision for 8087.

### 256K Memory

41256 (150nS) ..... **\$ 4.95**  
 Set of 9 ..... **\$43.95**

### 64K Memory

4164 (150nS) ..... **99¢!**

## IBM Compatible Keyboards

(Keytronics Serial Output), no housing ..... **\$39.95**

## IBM Style Case

Flip-Top 8 slot ..... **\$75.00**

IBM Compatible Switching Power Supply, 130W, with Fan ..... **\$134.00**

Set of 8088, 8255A-5, 8237A-5, 8288, 8284, 8253A-5, 8259A ..... **\$45.00**

## IBM Peripheral Cards

**Colour Video Board** ..... **\$159.00**

**Floppy Controller** ..... **\$ 99.00**

**Floppy Controller with RS232** ..... **\$139.00**

**Floppy Controller with clock/RS232** ..... **\$149.00**

**Parallel and Game Port Card** ..... **\$ 59.00**  
 Cable and connector extra.

**Peripheral Interface Card** ..... **\$139.00**  
 Includes two serial ports, parallel port, game port and provision for (but not including) real time clock.

**Clock/Calendar Option** ..... **\$ 29.00**  
 With battery backup.

### 256K & Multifunction Board.

Includes: Serial port, parallel port, game port, provision for optional real time clock/calendar and socketed for up to 256K RAM.

With 64K RAM ..... **\$149.00**

**512K Board.** Socketed for 512K including:

**64K RAM** ..... **\$119.00**

**IBM Compatible Disk Drives** **\$159.95**

Brand New, fresh from factory. Shugart SA455 40 track, double sided, double density Slimline. We have ordered 10,000 from Shugart - that is why we can pass the savings on to you.

### IBM Compatible Keyboards

Maxiswitch ..... **\$135.00**

Cherry ..... **\$ 99.00**

## IBM Style Case



Flip-Top, 8 Slot ..... **\$75.00**  
 With 150W Power Supply ..... **\$219.00**

## Disk Drives for IBM Computers

Shugart/Panasonic, 5 1/4" slimline, DD, DS 360K, 40 track ..... **\$159.95**

## Printers

Gemini 10X ..... **\$299.00**

Gemini SG10 ..... **\$379.00**

Gemini Daisy Wheel Powertype ..... **\$599.00**  
 18 cps, Bi-Directional.

## Monitors

Zenith ZVM123 Green and ZVM122 Amber .. **\$129.00**

## Complete 6502 System

- Assembled and fully tested (flow soldered)
- 64K, 80 x 24 video with soft-switch, floppy controller.
- System comes with blank EPROM's on board, does come with any proprietary software or Basic ..... **\$199.00**

### Complete System

- 6502 board (as illustrated above) with case, keyboard and power supply ..... **\$399.00**

### Complete System

- Using 6502 board above in IBM style flip-top case, using powerful 75 watt power supply with fan, programmable serial keyboard adaptor, IBM style keyboard ..... **\$459.00**  
 As above with one built in disk drive ..... **\$599.00**  
 As above with two drives ..... **\$749.00**

## 6502 Power Supply

For 6502 Case, CSA Approved 5V, 5A, + 12V 2.5A, -5V 0.5A, -12V 0.5A. .... **\$69.00**

## Kepeco Power Supply

5V 5A, + 12V 2.8A, + 12V 2A, -12V 0.5A, Open Frame

**\$38.95**

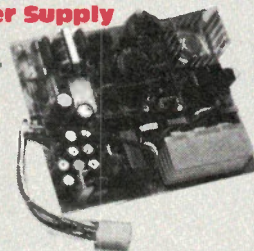

## 6502 Style Case



With Numeric Keyboard ..... **\$129.00**

## Panasonic Printers

Open Frame ..... **\$29.95**

Ideal for experimenters

Mail Orders add \$5.00 minimum for shipping & handling. Ontario residents add 7% P.S.T. Visa, Mastercard and American Express cards accepted: send card number, expiry date, name of bank and signature. Send certified cheque or money order, do not send cash. All prices on this page are final sale. No warranty, No returns, No refunds but HUGE savings. Warranties available at extra cost.

## IBM Style Power Supply

130W, +5V 13A, -5V 0.5V, +12V 4.5A, -12V 0.5A ..... **\$145.00**

## Power Bars with Surge Protectors

..... **\$49.95**

## Plug In Surge Suppressor

..... **\$11.95**

## Apple Cards

Assembled, flow-soldered/cleaned and 100% tested

16K RAM Card ..... **\$ 39.00**

80 x 24 video card ..... **\$ 39.95**

Z80A Card ..... **\$ 39.00**

Parallel Printer Card (cables extra) ..... **\$ 29.00**

128K RAM Card with 128K ..... **\$ 85.00**

EPROM Programmer with Software (programs 2716, 2732, 2732A, 2764) ..... **\$ 63.00**

8" Floppy Controller. Final Sale

- As is ..... **\$ 39.00**

## Modem Bargain!

Apple Compatible plug-in Autoanswer, Autodial, Touch Tone or Pulse Dial. Excellent for use with most Bulletin Boards. 300 Baud. Final Sale as is .. **\$39.95**

## Apple Compatible

**Disk Drives** 5-1/4" ..... **\$175.00**

## Apple Compatible Modem

**EXCELLENT HAYES MICROMODEM COMPATIBILITY**

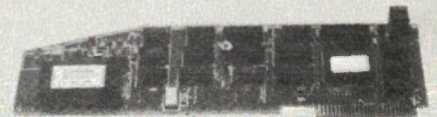

Plugs into your Apple or compatible computer, Direct connect, 300 Baud, Autodial, Autoanswer, Touch Tone/Pulse Dial, complete with documentation.

**\$139.95**

Hayes is a registered trade name.

Surplustronics, 310 College Street, Toronto, Ontario, M5T 1S3

More lines to serve you better  
**(416) 960-1350**



## Optical Encoder

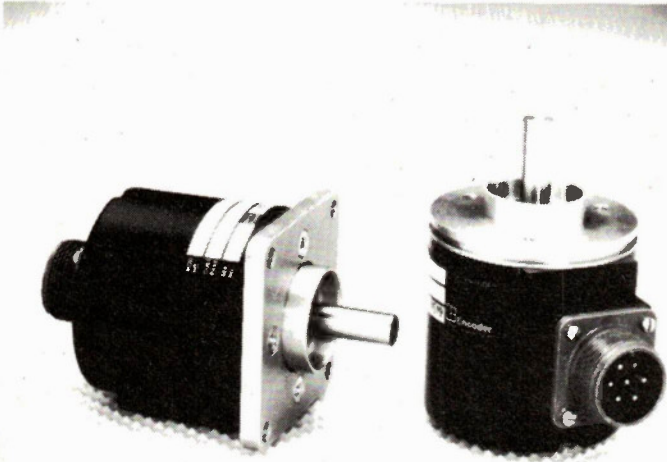

Litton Encoder Division introduces the Model 80 Incremental Optical Encoder, ideal for digital servos, numerically-controlled machines, X-Y plotters, etc. Outputs are DTL-TTL-CMOS compatible, with operating voltages available to 30 volts. Hybrid cir-

cuitry and a single LED provide higher reliability and improved performance. From EP Electronics International, 21 Amber Street, Unit 2, Markham, Ontario L3R 4Z3, (416) 475-8316.

Circle No. 18 on Reader Service Card

## Portable Oscillograph



Hioki's Model 8601 is a 4-speed oscillograph that will fit in the palm of your hand. Pressure-sensitive paper eliminates ink; frequency response is up to 80Hz. Input sensitivity is 0.1 to 10VDC. A

DC/RMS preamp module is available. From RCC Electronics, 310 Judson St., Unit 6, Toronto, Ontario M8Z 5T6, (416) 252-5094.

Circle No. 20 on Reader Service Card

The Miller wirestripper is the most popular one around; it's the flat one with the plastic covering on the handles. The one-millionth Miller was sold in Canada this summer by Len Flinkler and Company of Alexdon Road, Downsview, Ontario, who have represented Miller equipment for 30 years.

Circle No. 28 on Reader Service Card

Buzzwords of the Month Award: to the ADEE West Conference, San Francisco. The topic of the conference will be "Emerging Aspects of Electronic Circuitry Design Caused By Linkage of Design and Test and by Silicon Compilation and IC Design Integration". Whew.

## New Plotter



Roland DG Canada has announced their DPX-2000 8-pen plotter. Its 432 by 559mm size (17 by 22 inches) and optional stand makes it ideal for demonstrations or lectures as well as large-scale general plotting. It works with IBM PCs or compatibles, has serial and parallel inputs, and writes at 400mm/sec. The plotter lists at \$5595 suggested retail and the DPS-2 mobile stand at \$495. Roland DG Canada, 6691A Elmbridge Way, Richmond, BC V7C 4N1, (604) 273-4453, or offices in Toronto and Montreal.

Circle No. 19 on Reader Service Card

# PROBES FOR SALE

FROM THE BEST SOURCE FOR OSCILLOSCOPE PROBES AND DMM/VOM TEST LEAD SETS.



- Low cost
- High Quality
- Excellent Performance
- Slender, Flexible Cable

- Wide Range of Choice
- Switchable X1 and X10 Attenuation Factor
- 100 MHz Bandwidth

MODEL SP100  
**\$25.00**

Please add \$2.00 for shipping

Your Probe Specialists

Coline Canadian Sales & Stocking Source

Store Hours: Monday to Friday 8:00 am to 5:00 pm.

Saturday: 10:00 am to 1:00 pm.

**BCS**  
ELECTRONICS  
LIMITED

980 Alness St. Unit 7,  
Downsview, Ontario,  
M3J 2S2  
(416) 661-5505  
TELEX 065-28169



**INTRODUCING:  
THE NEW STANDARD  
FOR IBM PC/XT  
COMPATIBILITY**  
The ACS-1000 Super Computer

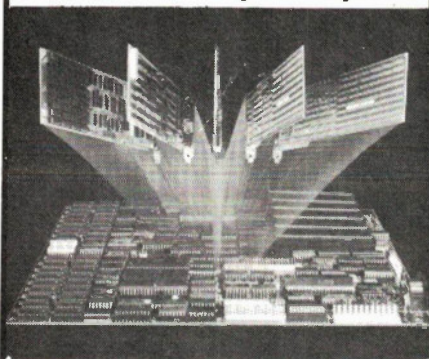

- 1 Megabyte On-Board Memory
- Built-in Disk Controller
  - up to 4 Floppies
  - SASI Hard Disk Interface
- 54 KB User Definable ROM
- Switchable: 4.77 or 8 MHZ
- Built-in Multifunction Board
  - Parallel Printer Port
  - 2 Serial Ports
  - Time-of-day Clock

**Seize Control of Your  
Hardware Destiny**

If you are using board level microcomputers you can have greater power, versatility and reliability by using the ACS-1000 single board SuperComputer.

The ACS-1000 is compatible with both software and hardware designed for the IBM PC/XT. It even has the same mounting holes and the same power supply connections. The difference is that the ACS-1000 offers a much higher level of integration and costs less than \$600 when ordered in quantity.

Save your Expansion Slots for true expansion. Disk Controllers, I/O ports and extensive memory are already built-in, simplifying production and freeing the 6 expansion slots to take on specialized work of your process control, CAD/ CAM or office automation applications. There's even a special port for a low cost piggyback modem.

See for yourself. We are offering a system evaluation kit for \$995.00. The 256K system includes bios, documentation, and an XT compatible power supply.

**Special introductory offer on peripherals and chips.**

Shugart SA 455 Floppy Drives **\$165.00**.  
IBM Compatible cases **\$80.00**, 150 Watt  
CSA approved Power Supplies **\$250.00**,  
Keyboard **\$155.90**, Chips 64K **\$2.50**,  
256K **\$10.00**.

To order call 604-888-2606 or write:  
**Soltech Industries Inc.**  
9274 - 194th Street  
Surrey, B.C. V3T 4W2

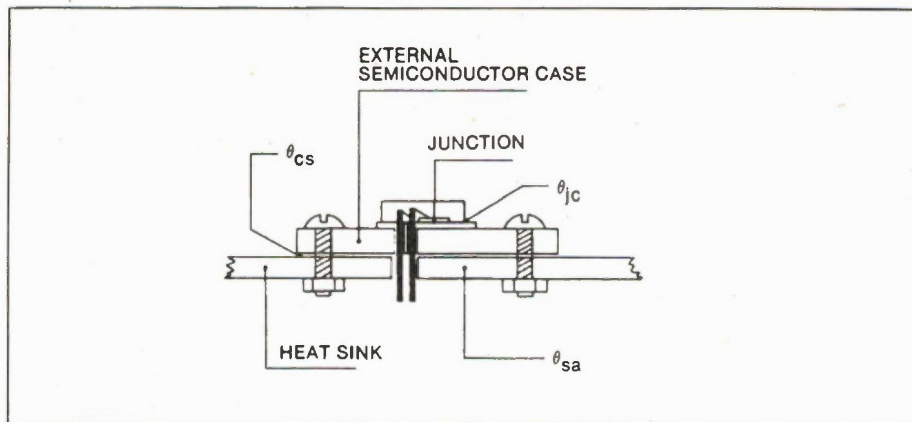

Fig. 2 A typical mounting situation for any semiconductor. It includes the thermal resistance between the case and the sink; illustration courtesy of Wakefield Engineering.

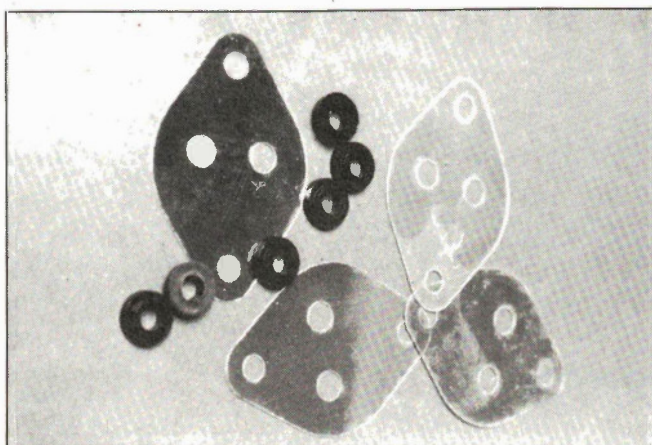

Fig. 3 Typical mounting hardware for the TO-3 transistor. The mica washers can be replaced by proprietary wafers or adhesives with better thermal properties.

away the skin of heated air that forms on any heated surface; this skin, which becomes visible if you let a bit of smoke drift onto the surface of a convection-cooled sink, is something that really reduces the efficiency of convection cooling. It's also the reason why a windowpane has a much higher R value than the glass alone would indicate, and the reason why it makes surprisingly little difference whether you mount the cooling fins vertically or horizontally. Getting rid of this clinging skin of heated air and providing a stream of air by using moderate airflows can double or triple the power that you can dissipate for a given temperature rise.

As an example, the popular Wakefield 423 heatsink has a temperature rise of 0.8 degrees C per watt with convection cooling; this falls to 0.2 with fan-forced air.

One of the big problems in implementing a fan is the proper mounting of the heatsinks to allow them to take full advantage of the airflow; some advice follows later on.

**A Practical Example**

Let's assume that you've concocted a regulated power supply using the good old

2N3055; not the latest in hi-tech transistors, but one that you can get almost anywhere for very little. The input voltage at the transistor's collector is 30V and the output voltage at the emitter is 24VDC at 1A continuous current.

This gives a power dissipation of  $(30 - 24) \times 1.5 = 9W$ . However, before you continue, it's best to think about all the worst-case parameters affecting the dissipation; otherwise, you may get a contraction that works nicely most of the time and dies quietly when the going gets rough. One thing to allow for is high power line voltage; it could rise to 10% above its normal value.

However, the worst thing that can happen to a regulator is usually a short circuit from the output to ground. The short circuit current will be higher than the normal current (unless you have foldback current limiting) and the voltage across the transistor rises to the full 30V of the power supply. If you assume that the current limiting circuit will hold the output current to 1.5A, then our dissipation is now  $30 \times 1.5 = 45W$ . This is an enormous jump from the normal figure; it's even higher if you allow for the 10% overvoltage.



Before we even get to the heatsinking part of things, it's worthwhile to continue the dissipation probe by looking at the Safe Operating Area (SOA) and power derating. The 2N3055 is rated at maximum 115W, 60V and 15A. However, the dissipation figure of 115W is valid only when the case temperature is 25 degrees C, and the Ic and Vce affect each other as shown by the SOA curve (supplied on data sheets); for instance, at a high Vce, current crowding may occur in the emitter region due to the chip geometry, leading to localized hotspots. According to the 2N3055 data sheet, 30V and 1.5A falls within the SOA, so we're okay there. The power dissipation, however, must be derated by 0.65W for every degree C rise in the case temperature above 25. If we can hold the case temperature at 100 degrees, the maximum dissipation becomes 115 - (75 x 0.65) = 66.25W.

Obviously, we've got a bit of margin here with only 45W of dissipation, and it also gives us a figure to go on: we'll aim for a maximum case temperature of 100 degrees C. Off we go.

First, we should find out if we can stay within the 100 degree case temperature figure. If not, we don't need to bother with calculating any further; the design would need some rethinking. The 2N3055 is specified at 1.5 degrees C per watt, junction to case. This gives a temperature of 1.5 x 45 = 67.5 degrees above the case temperature, an actual temperature of 67.5 + 100 = 167.5 degrees, just below the manufacturer's maximum junction temperature of 200 degrees.

Next we check the temperature difference across the insulator. Let's say that you've used a wafer and silicone compound that works really well; its  $\theta$  can be safely estimated at 0.3. This gives  $0.3 \times 45 = 13.5$  degrees. Add this to the 100 degree case temperature, and we find the heatsink temperature at the transistor area will be 113.5 degrees.

Thus the heatsink will rise  $113.5 - 25 = 88.5$  degrees above ambient. Since it's getting rid of 45 watts, we need a heatsink capable of  $88.5/45 = \text{approx. } 2$  degrees C per watt.

This is well within the capabilities of convection coolers. Thumb through the catalogue until you find one that fills the bill with regard to thermal specs and physical size. You'll probably find that it will be about 50mm (2 inches) deep by 75mm (3 inches) wide by 100mm (4 inches) long. The Wakefield 413 has approximately these dimensions, with a  $\theta$  of 1.4: it will rise about 63 degrees above ambient with a dissipation of 45W.

Without getting into the intricacies of circuit design philosophy, it's worth pointing out that what started as a 9W regulator suddenly jumped to 45W with all sorts of restrictions on the specs. In addition, all the items mentioned with regard to the 2N3055's safety apply just as well to diodes, thyristors, etc. If you've built semiconductor power devices that don't hold up too well under strain, it's well worth looking into the Safe Operating Area and power derating specs. (And that 9W regulator could be vastly improved by adding better short-circuit protection instead of more heatsinking.)

*continued on page 59*

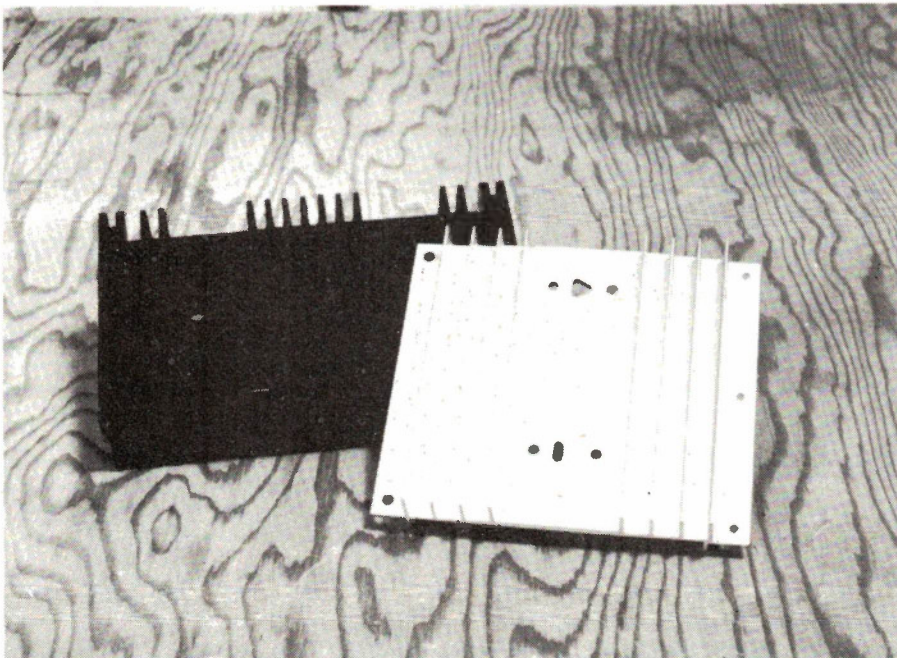

Fig. 4. Popular extruded heatsinks for large semiconductors are also available in uncut lengths for cutting to special sizes.

## XT COMPATIBLE Only \$980

### System includes

- 256K XT (JAPAN) Board + 1 DSDD Drive
- Colour Graphics/or Monochrome Display
- Case, Keyboard, 150 W Power Supply
- 90 Day Warranty

### PC/XT EXPANSION PRODUCTS

	Retail Price
Main Board 8 slot (256K)	\$290.00
Colour Graphics Card	\$115.00
Multifunction Card (384K) & Cable	\$230.00
512 RAM Card (OK)	\$ 90.00
Disk Controller Card & Cable	75.00
135 W Power Supply (Japan)	\$165.00
150 W Power Supply (Hydro Approved)	\$145.00
Monochrome Display/Printer Card	\$111.00
Monochrome Graphics/Printer Card (Hercules Comp.)	\$161.00
Panasonic Drive (JA 551-5)	\$160.00
Asuka Drive (for Apple)	\$145.00
Keyboard for IBM	\$ 99.00
Shugart (10MB) Hard Disk & Controller	\$850.00
Segate (20MB) Hard Disk & Controller	\$1,100.00
Flip-top XT Computer Case	\$ 65.00
High Resolution TTL Monitor	175.00
High Resolution Display Monitor	\$150.00

### RAMS

4116 150 or 200ns	\$ 0.80
4164 150ns (9pcs.)	\$11.00
41256 150ns (9pcs.)	\$70.00

### EPROMS

2716	\$3.00
2732	\$4.00
2764	\$4.50

Computer Parts, I.C. & Memories Specialist  
Dealers inquires welcome — price lowest in town

### PATRON COMPONENTS INC.

4002 Sheppard Ave. E. Suite 506,  
Toronto, Ontario M1S 1S6  
Tel. (416) 299-7731  
Telex: 065-25256 PATRON TOR  
FAX NO. (416) 298 4569

Circle No. 26 on Reader Service Card

## AMAZING SCIENTIFIC and ELECTRONICS DEVICES

PLANS — All Parts Available in Stock.

- LC5 BURNING CUTTING CO2 LASER . . . . . \$20.00
- RUB3 RUBY LASER RAY PISTOL . . . . . 20.00
- BTC5 1.5 MILLION VOLT TESLA COIL . . . . . 15.00
- GRA1 - GRAVITY GENERATOR . . . . . 10.00
- MAGNETIC CANNON/PROJECTOR . . . . . 10.00
- LRG3 SOLID STATE LASER RIFLE . . . . . 10.00

KITS — Includes Plans and Parts

- LHC2K SIMULATED RED/GRN/YEL LIGHT LASER . . . . . 34.50
- BTC3K 250,000 VOLT TESLA COIL . . . . . 159.50
- IOG1K ION RAY GUN . . . . . 109.50
- PSP3K PHASOR SHOCK WAVE PISTOL . . . . . 49.50
- STG1K - STUN/PARALYZING GUN . . . . . 39.50
- INF1K INFINITY TRANSMITTER . . . . . 134.50
- MFT1K 2-3 MILE RANGE FM VOICE XMTR . . . . . 49.50

ASSEMBLED AND TESTED PRODUCTS

- LGU30 RED 1MW PORTABLE HENE LASER 315.00
- TCL30 SOLID STATE TESLA COIL 35KV . . . . . 74.50
- IPG50 POCKET PAIN FIELD GENERATOR . . . . . 64.50
- BLS10 BLASTER DEFENSE WEAPON . . . . . 89.50
- ITM10 - 100KV SHOCK AND STUN GUN . . . . . 99.50
- PPF10 PHASOR PAIN FIELD PORTABLE . . . . . 249.50
- SNP20 SECURITY PHONE LISTNER . . . . . 99.50

• CATALOG CONTAINING DESCRIPTIONS OF ABOVE PLUS HUNDREDS MORE AVAILABLE FOR \$1.00 OR INCLUDED FREE WITH ALL ABOVE ORDERS.

PLEASE INCLUDE \$3.00 PH ON ALL KITS AND PRODUCTS PLANS ARE POSTAGE PAID. SEND CHECK, MO, VISA, MC IN US FUNDS.

### INFORMATION UNLIMITED

P.O. Box 715, DEPT. ET, AMHERST, NH 03031



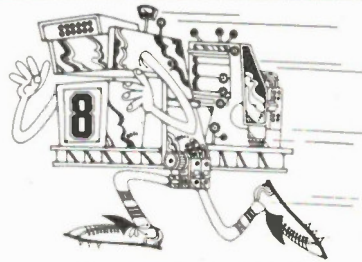

**FAST  
SERVICE  
BEST  
PRICES**

**\$5.99**

**TUBES**

Over 10,000 Tubes in stock

**\$5.99**

1BC2A \$7.85	3GK5 \$6.15	6AJ8 \$4.25	6CG7/ \$6.40	PQ3601 \$6.55	6JH5 \$13.60	6MJ6/ \$13.30	11AF9 \$22.10	15MF8 \$11.65	26HU5 \$14.35
1G3GT/A 6.85	3HA5/ 6.85	6AL3 6.15	6PQ7 6.40	6GJ7 7.50	6JS6C 11.10	6LQ6 13.30	11HM7 8.20	15A8 10.00	26LX6 13.00
1B3GT 6.85	3HM5 6.85	6AQ5A/ 6.40	6CG8A 7.70	6GK6 7.70	6JW8/ 6.70	6JE6C 13.30	12AT7 6.70	PC182 10.00	30KD6 13.00
2AY2 5.70	4E7 8.90	6HG5 6.40	6CJ3/ 7.10	6GWB 15.90	6JZ8 9.85	6ML8 9.65	12AU7A 5.90	16L8A 10.75	31JS6C 11.30
2CX5/ 6.15	4EJ7 8.40	6AQ8 7.50	6DW4B 7.10	6HA5 6.30	6KD6 13.20	6U10 8.75	12AX7A/ 6.15	17BF11A 12.20	33GY7A 12.60
2F05 6.15	4GJ7 7.70	6AUGA 6.75	6CM3 8.30	6HE5 9.40	6KD8 9.00	6V6GTA 5.15	7025A 6.15	17JN4A 7.70	34CG3 7.50
2HA5 6.50	4HA5 4.85	6AUBA 3.30	6CW5 8.20	6HQ5 6.15	6KG6 15.25	6X9 17.85	12BE6 7.40	17JN6A 9.60	34CD3 7.50
3A3C 7.10	4LJ8 9.20	6BA11 10.30	6DK3 8.05	6HS8 7.80	6KT8 8.20	8AC10 8.80	12BH7A 6.30	17JZ8 8.95	34DK3 8.20
3AT2B 9.90	5AQ5 6.55	6BK4C/ 12.80	6DH3 6.95	6HV5A 11.15	6L6GC 10.55	8CG7/ 7.30	12BY7A 7.20	17KV6A 10.60	35C5 7.10
3AW2A 7.20	5AR4/ 8.85	6EL4A 12.80	6DQ3 7.10	6HZ6 6.30	6LB6 13.30	8FQ7 7.30	12BV7/ 7.20	19C3/ 7.15	35LR6 12.70
3BW2/ 7.30	5GH8A/ 6.60	6BL8 6.80	6BL8 6.80	6J10/ 12.20	6LF6 12.70	8GJ7 7.95	12DQ7 7.20	20LF6 14.15	35W4 5.50
3BS2B/ 7.30	5G3501 6.60	6BQ5 7.20	6E8A 6.55	6Z10 12.20	6LJ8 8.75	8JV8 7.40	12CL3 6.80	21LR8 10.60	36KD6 13.00
3BT2A 7.30	5GJ7 7.50	6BW11 10.85	6EC4 8.60	6JCS/ 4.40	6LH8 6.55	8JL8 6.85	12DW4 6.80	21L8 10.95	40K06 13.00
3CB6 9.75	5GS7 9.65	6CA4 13.80	6EH7 8.05	6JBS/ 9.40	6LR6 12.70	9GH8A 6.85	12GH7A 8.60	22J86 11.45	36LW6 15.00
3CH3B 8.15	5LJ8 9.10	6CA7 13.60	6EJ7 8.30	6HE5 9.40	6LT8 8.75	9JW8 9.70	12H7 8.60	23Z9 11.55	36MC6 13.25
3CU3A 7.70	5UAGB 8.35	6CB6A/ 1.50	6EW6 5.95	6HE5 9.40	6LV8 10.75	9ML8 9.55	12HL7 8.20	24J66C 11.35	38HE7 13.10
3DB3/ 7.20	5A54A 8.35	6CT6 1.50	6FM7 9.30	6JCSA 7.05	6LW6 30.70	10GF7 9.55	12MD8 8.95	24LQ6 11.35	38HK7 12.80
3CX3 7.20	5Y3GT 7.85	6CG3/ 7.65	6GF7 9.30	6JD6 7.00	6LX6 13.10	10GK6 7.50	13GF7 9.60	25CG3 7.10	40KG6A 16.70
3DC3 7.70	6AD10 22.75	6BW3 7.65	6GH8A 3.95	6JEC/ 11.30	6LX8 6.65	10JA5 9.30	13Z10 12.60	25AX5 14.25	42EC4 8.95
3DF3 7.20	6AF9 20.30	6CE3/ 7.10	6GH8A/ 6.55	6LQ6 11.30	LCF302 6.60	10KR8 8.20	13J10 12.60	25JZ8 9.65	50C5 7.20
3DJ3 7.10	6AG9 22.75	6CD3 7.10							

**ALL OTHER TUBES PRICED AT \$5.99 EACH.**

**ELECTRONIC  
SUPPLIES  
INCORPORATED**

306 REXDALE BOULEVARD  
REXDALE, ONT. M9W 1R6  
TELEPHONE: (416) 741-4000  
WATS 800-268-0558

**THE WHOLESALE SOURCE**

**YOU'VE BEEN SEARCHING FOR!...**

- TRY US FOR
- NEEDLES AND CARTRIDGES
- AUDIO AND VIDEO ACCESSORIES
- SEMICONDUCTORS
- WIRE AND CONVERTERS AND MUCH MORE

\*We reserve the right to substitute.

Prices to extent of inventory.

• Mail Order:

Certified Cheque, Money Order, COD'S FOB Rexdale.  
Ontario Residents add 7% P.S.T.

Circle No. 24 on Reader Service Card

**We Import Direct and We Service What We Sell  
BEST QUALITY INSTRUMENTS AT LOWEST COST!  
Why Pay More?... Just a Few Examples:**



**DMM 601**

3 1/2 dig. 0.25% acc.  
0.1 mV - 1000 VDC  
0.1 uA - 2 A AC/DC  
0.1 mV - 750 VAC  
0.1 ohm - 20 M ohms  
Safety test leads incl.

**\$63.90**

**Dmm 6010 (same as 601) except: max.  
10 A AC/DC \$69.50**

**Synthesized R.F. Generator SD 1003**



8-512 (Model SD1004 MAX 1060 MHz) AM, O-90% FM In  
10-30-100KHz steps. Output attenuation in 10dB steps  
with Vernier Fine Control. Price 30-40% below "Industry  
Standard" prices at **\$3,600.00**

**JUST OFF THE  
PRODUCTION LINE IN  
KOREA UNBEATABLE IN  
EVERY WAY:**

Model DM 105, 3-1/2 digit, LCD  
Multimeter, 10 Meg Ohm DC in-  
put res. battery status indicator.  
Max 1000VDC at +/- 0.5% acc.  
— Max 750 VAC and max. DC cur-  
rent 2000mA. Res. 1 Ohm to 2  
Meg Ohm. All ranges overload  
protected. Shock Mounted  
display.

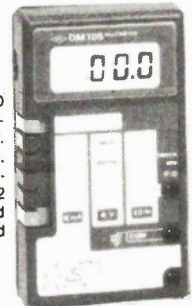

**ALL THIS FOR AN  
UNBELIEVABLE  
\$49.50**

**OSCILLOSCOPE 33330**

- 2 Chan.  
20MHz bandwidth  
Built-in components  
tester  
5 mV vert. sensitivity

Probes extra.  
Special Price **\$495.00**

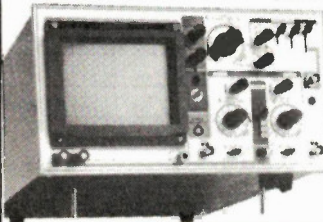

**Precision Analog Multimeter Model 5050E**

- Input resistance, 10M  $\Omega$ /DC
- 43 measuring ranges
- AC/DC current max. 12A

Introductory  
Price **\$67.50**



Model 605  
RF Generator  
100KHz - 70 mHz  
On fundamentals

Introductory  
price **\$183.00**

**NOW ALSO AVAILABLE:  
MODEL HC 775  
AUTORANGING**

3 1/2 Digit LCD, "memory" and low  
resistance "buzz" Features: DC  
Volts: Resolution 100 micro V,  
max. 1000V. AC Volts: Resolution  
1 mV, Max. 750V. AC/DC current:  
Max. 10A. Resistance: 0.1 Ohm  
— 2 Meg Ohm. Overload protec-  
tion on all ranges.



**AN AUTORANGING  
DMM AT  
\$79.50 ONLY**

Mail Orders: Visa, Certified Cheque, Money Order or C.O.D.'s F.O.B. Oakville, Ontario residents add 7% P.S.T.

**KB ELECTRONICS**

355 Iroquois Shore Rd., Oakville, Ont. L6H 1M3  
(416) 842-6888 Telex 06-982396 (KBEL OKVL)

Circle No. 25 on Reader Service Card



# Electronics From The Start, Part 7

*This month, integrated circuits, beginning with the versatile 555 timer.*

*By Keith Brindley*

LAST month we took a close look at capacitors, how they charge and discharge, storing and releasing electrical energy. The first thing we shall do this month is use this principle to build a useful circuit called an oscillator. Then, in turn, we shall use the oscillator to show some more principles of capacitors. So, we've got a twofold job to do.

Figure 1 shows the circuit of the oscillator we're going to build. It's a common type of oscillator known as an astable multivibrator. The name arises because the output signal appears to oscillate (or vibrate) between two voltages, never resting at one voltage for more than just a period of time (it is therefore unstable, i.e., astable). An astable multivibrator built from discrete, i.e., individual components, can be tricky to construct so we've opted to use an integrated circuit (the 555) as the oscillator's heart.

Inside the 555 is an electronic switch which turns on when the voltage across it is approximately two-thirds the power supply voltage (about 6V in the circuit of Figure 1), and off when the voltage is less than one-third the power supply voltage (about 3V). Figure 2a shows an equivalent circuit to that of Figure 1 for the times during which the electronic switch of the 555 is off.

You should be able to work out that the capacitor C1 of the circuit is connected through resistors R1 and R2 to the positive power supply rail. The time constant of this part of the circuit is therefore given by:

$$t_1 = RC = (R1 + R2)C$$

When the voltage across the switch rises to about 6V, however, the switch turns on (as shown in Figure 2b), forming a short circuit across the capacitor and resistor, R2. The capacitor now discharges with a time constant given by:

$$t_2 = R2 \times C$$

Electronics Today January 1986

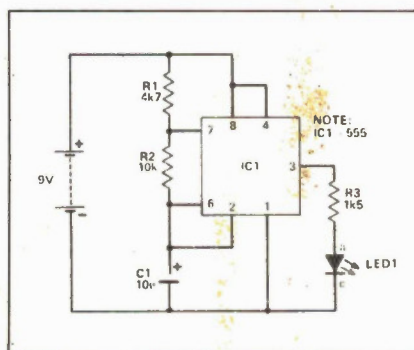

1 The multivibrator circuit showing the 555 IC.

Of course, when the discharging voltage across the switch falls to about 3V, the switch turns off again, and the capacitor charges up once more. The process repeats indefinitely, with the switch turning on and off at a rate determined by the two time constants. Because of this up and down effect such oscillators are often known as relaxation oscillators.

As you might expect the circuit integrated within the 555 is not just that

simple and there are many other parts to it (one part, for example, converts the charging and discharging exponential voltages into only two definite voltages, 9V and 0V, so that the 555's output signal is a square wave, as shown in Figure 2c). But the basic idea of the astable multivibrator formed by a 555 is just as we've described here.

Table 2 and Figure 4 show our results which should be similar to yours. The graph shows that the size of the output signal of the AC voltage divider is dependent on the frequency of the applied input signal. In particular, there are three clearly distinguishable sections to this graph, each relating to frequency.

First, above a certain frequency, known as the corner frequency, the output signal is constant and at its maximum.

Second, at low frequencies (close to 0 Hz) the output is zero.

Third, between these two sections the output signal varies in size depending on the applied input signal frequency.

Is this the same for all AC voltage dividers of the type shown in Figure 5? Well, let's repeat the experiment using a

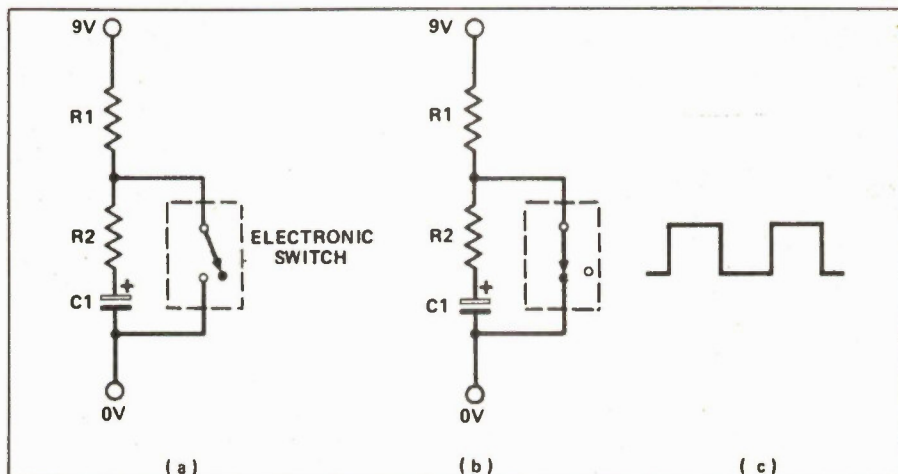

Fig. 2 (a) A circuit equivalent to Fig. 1 when the 555's switch is off; (b) shows the circuit when the switch is on; (c) shows the square wave output signal.



different capacitor for C2, to find out. Try a 10n capacitor and repeat the whole procedure, putting your results in Table 3 and Figure 6. Table 4 and Figure 7 show our results.

And yes, the graph is the same shape but is moved along the horizontal axis by an amount equivalent to a tenfold increase in frequency (the capacitor was decreased in value by tenfold, remember). A similar inverse relationship is caused by changing the resistor value, too.

Frequency, capacitance and resistance are related in the AC voltage divider by the expression:

$$f = 1/RC$$

where  $f$  is the corner frequency. For the first voltage divider, with a capacitance of 10n and a resistance of 1.5k, the corner frequency is:

$$f = 1/1500 \times 100 \times 10^{-9} = 6666 \text{ Hz}$$

which is more or less what we found in the experiment. In the second voltage divider, with a 10n capacitor, the corner frequency increases by ten to 66,666 Hz.

Remembering what we learned last month about resistors and capacitors in charging/discharging circuits, we can simplify the expression for corner frequency to:

$$f = 1/t$$

because the product  $RC$  is the time constant,  $t$ . This may be easier for you to remember.

An AC voltage divider can be constructed in a different way, as shown in Figure 10. Here the resistor and capacitor are transposed. What do you think the result will be? Well, the output signal size now decreases with increasing frequency, exactly the opposite effect of the AC voltage divider of Figure 5. All other aspects are the same, however: there is a constant section below a corner frequency, and a section where the output signal is zero, as shown in Figure 5. Once again the corner frequency is given by the expression:

$$f = 1/RC = 1/t$$

### Filter Tips

The AC voltage dividers of Figures 5 and 10 are normally shown in a slightly dif-

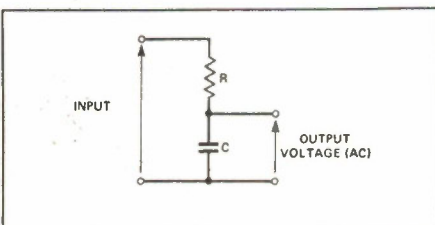

Fig. 5 A voltage divider with a capacitor.

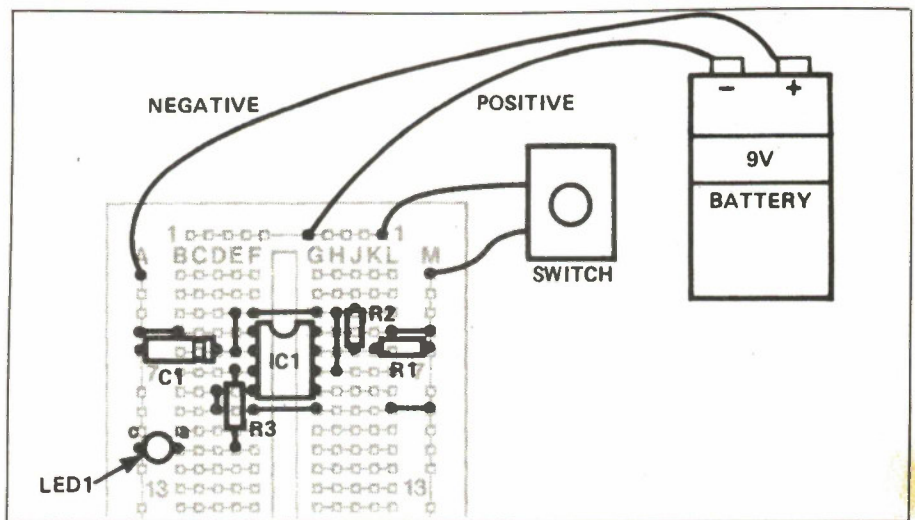

Fig. 3 The breadboard layout for the multivibrator circuit is shown in Figure 1.

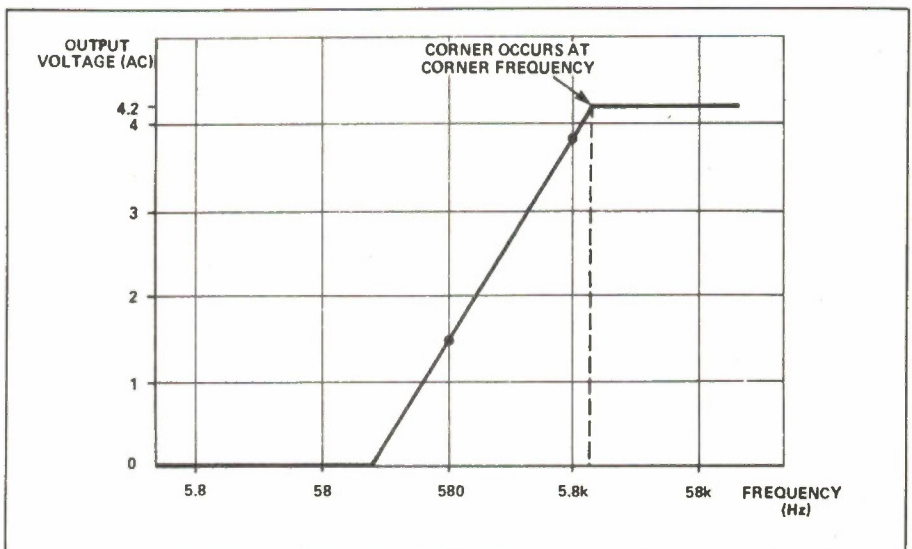

Fig. 4 A graph showing the results when a 100n capacitor is used.

ferent way, as in Figures 9a and b. Due to the fact that they allow signals of some frequencies to pass through, while filtering out other signal frequencies, they are more commonly called filters.

The filter of Figure 9a is known as a highpass filter because it allows signal frequencies higher than its corner frequency to pass while filtering out signal frequencies lower than its corner frequency.

The filter of Figure 9b is a lowpass filter; yes, you've guessed it, because it passes signals with frequencies below its corner frequency, while filtering out higher frequency signals.

Filters are quite useful in a number of areas of electronics. The most obvious example of a low-pass filter is probably the scratch filter sometimes seen on stereo systems. Scratches and surface noise when a record is played, or tape hiss when a cassette tape is played, consist of quite

high frequencies: the scratch filter merely filters out these frequencies, leaving the music relatively noise free.

Bass and treble controls of an amplifier are also examples of high- and lowpass filters: a bit more complex than the simple ones we've looked at here but following the same general principles. We'll also see many more examples of filters along the way.

You can try a few experiments of your own with filters if you want. Just remember that whenever you use your meter to measure voltage across a resistor in a filter, the meter resistance affects the actual value of resistance and can thus drastically affect the reading.

### Quiz

1) A signal of frequency 1 kHz is applied to a low-pass filter with a corner frequency of 10 kHz. What happens?



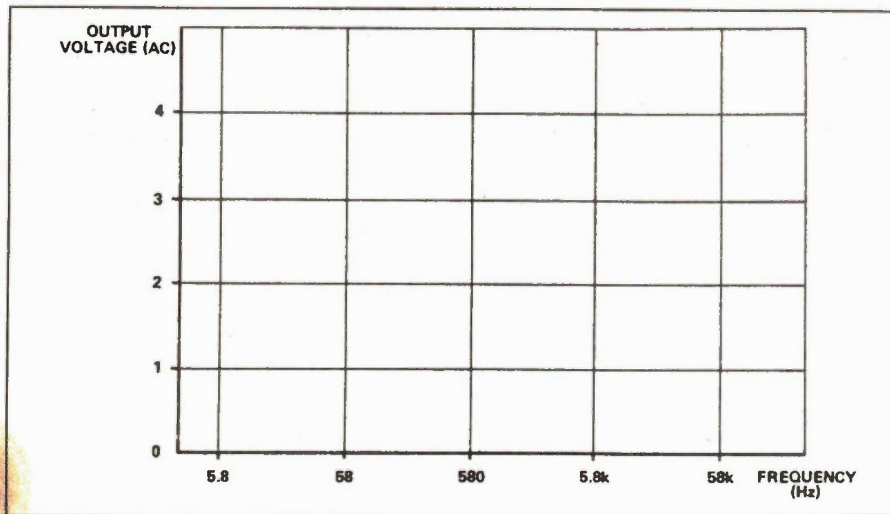

Fig. 6 A graph for you to use with the results from the experiment with the 10n capacitor. Use in conjunction with Table 3.

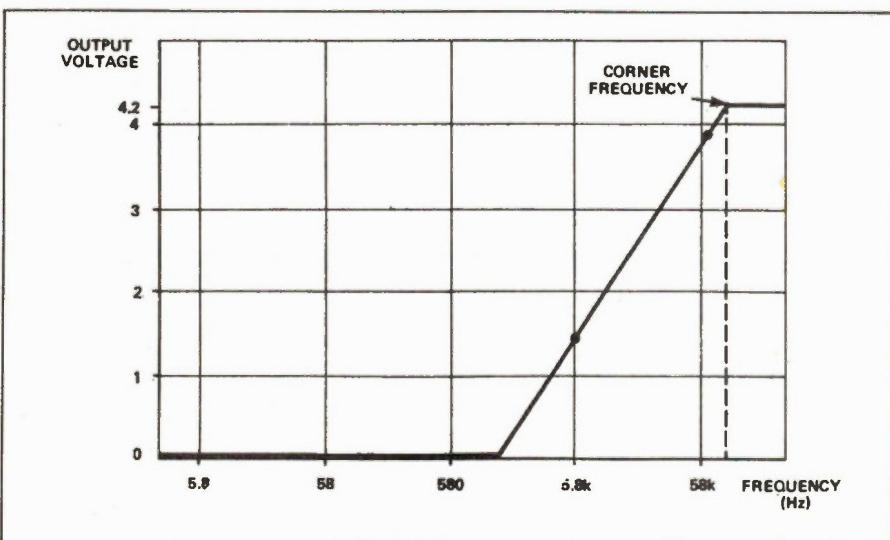

Fig. 7 Our results obtained with a 10n capacitor. Table 4 lists the results.

- The output signal is one-tenth the input signal
- The output signal is larger than the input signal
- There is no output signal
- The output signal is identical to the input signal
- All of these

2) A high-pass filter consisting of a 10k resistor and an unknown capacitor has a corner frequency of 100 Hz. What is the value of the capacitor?

- 1n
- 10n
- 100n
- 1000n
- 1u

### Throwing Light on It

The 555 IC is one of only two new types of electronic component this circuit intro-

duces you to. The other is a light emitting diode (LED) which is a type of indicator. One is shown in Figure 10. LEDs are polarised and so must be inserted into circuit the right way round. All LEDs have an anode (which goes to the more positive side of the circuit) and cathode (which goes to the more negative side). Generally, but not always, the anode and cathode of an LED are identified by the lengths of the component leads — the cathode is the longer of the two.

The complete circuit's Verobloc layout is shown in Figure 11, and a photograph of the circuit is in Figure 12. Build it and see what happens.

When you turn on, you should find that the LED flashes on and off, quite rapidly (about five or six times a second, actually). This means your circuit is working correctly. If it doesn't work check polarity of all polarised components: the battery, IC, LED and capacitor.

### Ouch, That Hertz

We can calculate the rate at which the LED flashes, more accurately, from formulae relating to the 555. A quick study of the squarewave output shows that it consists of a higher voltage for a time (which we can call T1) and a lower voltage for a time (which we will call T2).

Now, T1 is given by:

$$T1 = 0.7 t2$$

So, the time for the whole period of the squarewave is:

$$T1 + T2 = 0.7 (t1 + t2)$$

and as the frequency of a waveform is the inverse of its period we may calculate the waveform's frequency as:

$$f = 1/0.7(t1 + t2)$$

Earlier, we defined the two time constants, t1 and t2, as functions of the capacitor and the two resistors, and so by substituting them into the above formula, we can calculate the frequency as:

$$f = 1/0.7C(R1 + 2R2)$$

So, the frequency of the output signal of the circuit of Figure 8 is:

$$f = 1/0.7 \times 10 \times 10^{-6} \times (4700 + 20,000) = 5.8 \text{ cycles per second}$$

or, more correctly speaking:

$$= 5.8 \text{ Hertz (shortened to 5.8Hz)}$$

Equation 1 is quite important really, because it shows that the frequency of the signal is inversely proportional to the capacitance. If we decrease the value of the capacitor we will increase the frequency. We can test this by taking out the 10u capacitor and putting in a 1u capacitor. Now, the LED flashes so quickly (about 58 times a second) that your eye can't even detect it is flashing and it appears to be always on. If you replace the capacitor with one of a value of say 100u the LED will flash only very slowly.

Now, let's stop and think about what we have just done. Basically we've used a capacitor in precisely the ways we looked at last month: to charge and discharge with electrical energy so that the voltage across the capacitor goes up and down at the same time. True, in the experiments last month you were the switch, whereas this month an IC has taken your place. But the principle, charging and discharging a capacitor, is the same.

The current which enters the capacitor to charge it, then leaves the capacitor to discharge it, is direct current because it comes from a 9VDC battery. However, if we look at the output signal we can see that the signal alternates bet-



# Almost Free Business Software

The image displays several screenshots of business software. At the top left is a 'NOTE PAD' window showing an ASCII table with columns for ASCII, HEX, CHAR, and CMTL. Below it is a window with a 'RESET' button and various printer-related options. To the right is a 'MAXIT' window showing a 10x10 grid of numbers for a game. Below that is a 'PC TOUCH' window with a typing exercise and a statistics table. At the bottom left is a calendar for Friday, August 9, 1985, with a list of events and a keyboard shortcut legend.

Software Now! is pleased to make this amazing disk offer. Over the last year, Brian Greiner, our "By the Boards" columnist has been scanning Canada's computer bulletin boards for the best and most interesting public domain software available. We are pleased to make available a collection of the best business-oriented public domain software for PC-DOS and MS-DOS users. Naturally we've also included several fun programs as well, but we think you'll find this to be the most powerful set of public domain programs ever collected on a single disk . . . all for only \$19.95.

Here is what you get:

#### MA.BAS

The Micro Accountant is a complete, working accounting and check register program, with a 25K documentation file.

#### PCWINDW22

A "Sidekick" —like co-resident window utility. Pop-up window functions include ASCII table, stopwatch, alarm, printer set-up utility and notepad. The entire program takes up less than 30K of space on your disk.

#### PSHIFT

A time saving and convenient 'memory partition' utility. Lets you define up to nine memory areas. Load programs such as dBase II and WordStar into separate partitions and 'flip' between them instantly with simple keystrokes.

#### PC-TOUCH.BAS

Increase typing speed and accuracy with this easy-to-use typing tutor. Also provides accuracy and speed statistics.

#### PCYEARBK.EXE

Appointments and reminder program to help you keep track of your time.

#### TASKPLAN.BAS

Project management software which lets you track up to 50 tasks during 50 time periods (days, weeks or months).

#### NO COLOR

A handy little utility for users with monochrome monitors and colour software.

#### MAXIT

A simple but subtle game for two human opponents, or one player and the computer. Hours of fun!

#### PERTCHT

A sophisticated project management tool using the Program Evaluation Review Technique.

#### PLUS

More utilities to help organize maintain and copy your files, including a "monitor saving" program which blanks out your screen when it is not in use.

## \$19.95

plus 7% sales tax for Ontario residents

**Almost Free Business Software**

**Moorshead Publications**

**1300 Don Mills Road,**

**Don Mills, Toronto, Ontario**

**M3B 3M8**

**1-416-445-5600**

Have your Visa MasterCard or American Express card ready.

Please note: Software Now! distributes this software 'as is' and makes no guarantee that the software will perform on all systems. Programs with a .BAS file name extension require BASIC in order to run. Though all programs on the disk are freely distributed on public bulletin boards, some request users to send a token 'user fee' to the program's author. Please note that payment of such user-fees is entirely optional, but users who do send it in may be eligible for program enhancements and support.





**This ad is for all those  
who ever wonder  
where the money goes.**

It goes to children like this one. And to millions of other children and adults who require the services funded by a local United Way.

If you gave in your community last year, your gift to your local United Way went to make this kind of help possible. And, it was also used to help many others in your community who need help.

That's the way the United Way works. One gift, one time each year, helps hundreds of thousands of people all year round. Thousands of different, good causes in communities all across the country. Including yours.

Thanks to you, it works,  
for ALL OF US



**United Way  
Centraide**

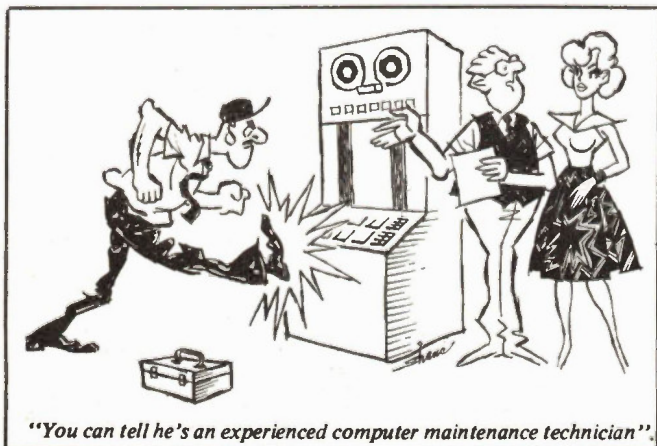

*"You can tell he's an experienced computer maintenance technician."*

# Moorshead Publications Order Form

**Subscriptions:**

Please complete reverse side of order form to start or renew a subscription.

**Back Issues:** \$4.00 each; Ontario residents add 7% sales tax. Please circle issues desired.

1977	February					July
1978	April	May	September	November	December	
1979	February	March	April	May	July	
	August	September	October	November		
1980	January	February	May	June	November	December
1981	January	February	March	April	June	July
	August	September	October	November	December	
1982	January	March	April	May	June	
	July	August	September	October	November	December
1983	January	February	March	April	May	June
	August	September	October	November	December	
1984	January	February	March	April	May	June
	October	November	December			
1985	January	February	March	April	May	June
	July	August	September	October	November	December

On the following items please add \$1.00 for postage and handling plus 7% Ontario provincial sales tax.

**Special Publications:**

ITEM	QTY	AMOUNT
Electronic Circuit Design \$3.95	.....	\$ .....
Projects Book No. 2 \$3.95	.....	\$ .....
Personal Computer Guide \$3.95	.....	\$ .....
50 Top Projects \$4.95	.....	\$ .....
Your First Computer \$3.95	.....	\$ .....
Computers in Small Business \$3.95	.....	\$ .....

**Binders:**  Electronics Today;  Computing Now!  
 Moorshead Publications  
 \$9.75 each plus 7% P.S.T.

## BOOKSHELF ORDER FORM

Code (e.g. BP12)	Title (Short-form is O.K.)	Price
.....	.....	\$ .....
.....	.....	\$ .....
.....	.....	\$ .....
.....	.....	\$ .....
.....	.....	\$ .....

## SOFTWARE ORDER FORM

.....	\$ .....
.....	\$ .....
.....	\$ .....
<b>Sub Total</b>	<b>\$ .....</b>
<b>Tax (Ontario Residents)</b>	<b>\$ .....</b>
<b>Postage</b>	<b>\$ .....</b>
<b>Total Enclosed</b>	<b>\$ .....</b>

Orders from the Bookshelf are tax exempt. Please add \$1.00 for postage. Remember to put your name and address on reverse side. See over for mailing details.

Do you currently subscribe to Electronics Today Yes  No  Computing Now!  
 Yes  No  Computers in Education Yes  No



BE SURE OF YOUR ISSUE EACH MONTH. SUBSCRIBE TODAY.



BOOKS, BACK ISSUES, SPECIAL PUBLICATIONS, BINDERS — SEE OVER

### Moorshead Publications

1300 Don Mills Rd., Don Mills, Toronto, Ont. M3B 3M8

**MERCHANDISE ORDER**  Please fill out form overleaf  
**SUBSCRIPTIONS:**  NEW SUBSCRIPTION  RENEWAL

**Electronics Today**

One year (12 issues) \$22.95  Two years (24 issues) \$37.95.

**Computing Now!**

One year (12 issues) \$22.95  Two years (24 issues) \$37.95

**Computers in Education**

One year (10 issues) \$25.00  Two years (20 issues) \$45.00

**Outside Canada (US Dollars)**

For U.S. please add \$3.00 per year  other countries add \$5 per year

NAME \_\_\_\_\_

ADDRESS \_\_\_\_\_

TOWN/CITY \_\_\_\_\_ PROVINCE/STATE \_\_\_\_\_

CODE \_\_\_\_\_ DATE \_\_\_\_\_

POSTAL CODE \_\_\_\_\_

Cheque enclosed DO NOT send cash

Mastercard Account No. \_\_\_\_\_

Visa Account No. \_\_\_\_\_

American Express Account No. \_\_\_\_\_

Expiry Date \_\_\_\_\_

Signature \_\_\_\_\_

INDEPENDENT LAB TEST SHOW  
 NEW ELECTRONICS TODAY  
 BINDERS TO BE NEW AND IMPROVED!



WE thought that the Electronics Today magazine binders had reached a state of perfection unmatched by any other product short of Brian Mulroney's suits.

Then the boys in the back room got at them and stayed up late at night redesigning the system that holds the rods that hold 12 issues of Electronics Today without cutting or punching.

They moved the rod holders further apart so that the spines of the magazines aren't ever crumpled, and they grouped the rods in pairs to hold the magazines neatly a nice distance apart.

We were overwhelmed. We called NASA to say that these binders should be taken on the next shuttle flight and shown to a grateful world on the evening news, but we haven't heard back yet.

The binders are available for \$9.75 each; the scientists in the lab haven't got around the fact that Ontario residents must add 7% Provincial Sales Tax. Send to:

**Binders**  
**Moorshead Publications**  
 1300 Don Mills Road,  
 Don Mills, Toronto, Ont. M3B 3M8



# Vibration Amplifier

**Check for engine noises easily with this handy gadget.**

**By I. Rees**

THE VIBRATION amplifier described in this article provides a convenient means of listening to sounds within a running mechanism. It involves the use of a pair of headphones to convert the amplifier into a stethoscope-like instrument. With the help of this device, out-of-place noises in an engine can be pinned down before extensive dismantling takes place.

## The Circuit

Figure 1 shows the circuit diagram. This is comprised, mainly, of a transducer and an amplifier feeding a pair of headphones. The transducer is an electret microphone similar to those found in cassette recorders. Normally, airborne noise would swamp conducted sounds, but a piece of PVC tape placed across the microphone's small inlet hole would rectify this.

The electret is not affected by magnetic fields, and can be used in AC driven units where 60Hz induction would otherwise be a problem.

Vibrations are transmitted up the probe (Fig. 2) to the plate which has the microphone attached to it. The mic picks up sound through its body. Bias for the microphone is supplied through R1. The output is coupled through C2 to the preset gain control, RV1. IC1 amplifies the signal two hundred times before supplying its output to the standard 1/4 inch stereo jack socket, SK1.

Although rather large, it allows the use of ordinary stereo headphones, which give an extended bass response; those with earmuff-type enclosures will provide even more rejection of airborne noise.

Electronics Today January 1988

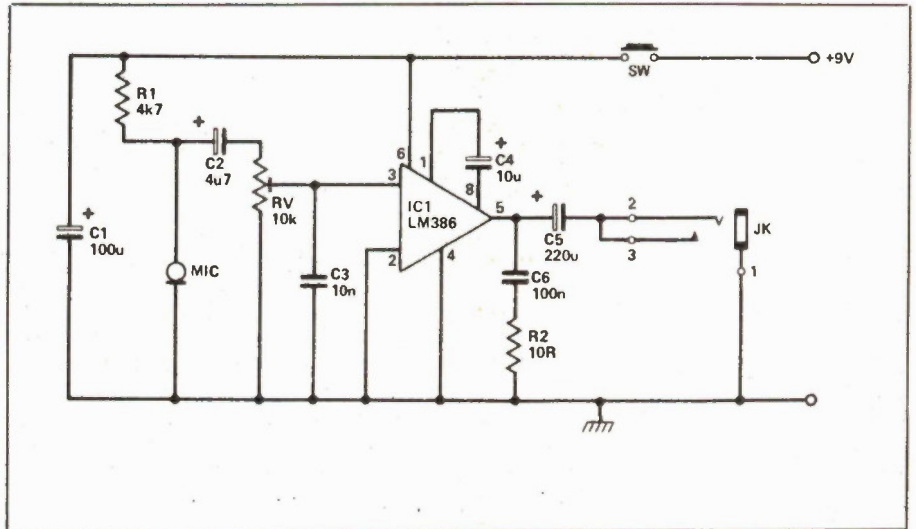

Fig. 1 The circuit diagram is comprised of a transducer to convert the vibration to a signal, and an amplifier.

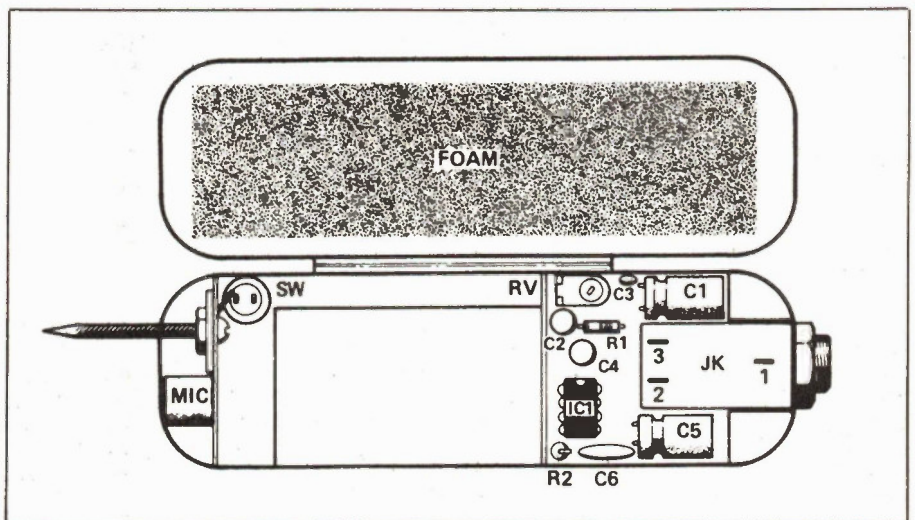

Fig. 2 The general internal layout of the Vibration Amplifier. The foam holds the works firmly in place.

The amplifier IC1 is an LM386. This was chosen for its small size, high gain, and requires few external supporting components. A push button switch allows the switching of the 9V battery supply.

## Construction

The prototype amplifier, including its battery, is contained in a bicycle tire repair kit box. The bottom of the box is plastic with a hinged metal lid. A 16SWG aluminum chassis (Fig. 3) strengthens the bottom of the box for mounting the probe and jack socket. The on/off switch protrudes through the lower part of the case, with its fixing nut on the outside.

The microphone is positioned between the case and the chassis. The terminals of the mic are against the wall of the case, with the PVC covered vent facing upright to pick up the vibrations.



the power amplifier's input impedance, it should have a value of 4K7.

The next practical assumption to make is that the potential at the transistor's emitter should be about 10% of the supply voltage, in this case, about 1.2V. This is to ensure DC stability over a wide range of operating conditions.

For the amplifier to provide maximum output voltage swing, the collector potential should lie halfway between the supply rail and the emitter potential. For a 12V supply it must be:

$$V_{CE} = (V_{R4} + V_{CC})/2 = 6.6V$$

From this we can calculate the nominal collector current (which, together with VCC, helps us determine a suitable transistor):

$$I_c + (V_{cc} - V_{ce})R_e = 1.14mA$$

The emitter potential has already been set at 1.2V, so R4 can be found from

$$R_4 = 1.2 / (1.14 \times 10^{-3}) = 1k \text{ (approx.)}$$

R1 and R2 are there to ensure that the transistor base is always supplied with enough current to maintain the required collector potential, and the third rule of thumb is that there should always be more than 10 times the required base current, IB, flowing down the bias chain R1-R2.

To determine the base current we have to look in the manufacturer's data sheet for probably the most important of the h-parameters, HFE, or the transistor's common emitter DC current gain. For a BC237B, HFE is between 250 to 500. The variation is due to manufacturing tolerances and we should take the worst case figure of 250 to ensure that our circuit will function correctly with any BC273B transistor. The rules of thumb used earlier make sure that a higher-than-minimum gain transistor will not significantly alter the bias condition we are about to set up.

Since base current equals collector current divided by current gain,

$$I_B = I_c / HFE = (1.14 \times 10^3) / 250 = 4.5\mu A \text{ (approx.)}$$

The current flowing down the bias chain, R1-R2, should be around 10 times IB, say, 50uA.

Since the transistor is passing collector current, the base potential must be about 0.6V above the emitter potential, 1.2 + 0.6 = 1.8V. It is clear that the potential across R1 equals Vcc - 1.8V, or 10.2V. Resistor R1 should pass around 50 uA and should therefore be about 10.2/(50 x 10<sup>-6</sup>) ohms. This comes to be about 204k and, bearing in mind that it is better to round down than up, since more

current is better than not enough, we set R1 at the preferred value, 180k.

To avoid a buildup of errors due to rounding, it is best to recalculate IR1, the current through R1. IR1 equals (10.2/(180 x 10<sup>3</sup>)), or about 56.67uA.

Since the current through R2 equals the current through R1 minus the transistor's base current, we can calculate R2 simply:

$$R_2 = 1.8 / ((56.6 - 4.5) \times 10^{-6}) = 34.5 \times 10^{-3} \text{ ohms.}$$

The nearest preferred value is 33 K.

The DC conditions are set up so that the transistor is operating in its linear region and can provide amplification. The amount of amplification, or voltage gain, is determined by the total collector impedance divided by the total emitter impedance.

Collector impedance equals R3 plus the load plus the transistor's own output impedance all in parallel. In most cases, the transistor's output impedance can be ignored as it is high compared with the collector load resistor. This makes collector impedance equal to 4K7 in parallel with 50k, or around 4k3. The transistor's emitter impedance is derived using complex mathematics from the diode equation and can be approximated to 25R/IE(mA).

Note that we've assumed that collector current and emitter current are equal. This is acceptable for modern day transistors with hFE figures of 200 or more. Some transistors have an hFE of well over 1000, these days, and in these cases the transistor's base-emitter current is so

small, compared with collector-emitter current, that it can be safely ignored.

The emitter resistance can now be calculated by dividing 25 by the emitter current in mA, bearing in mind that emitter current equals collector current:

$$R_e = 25 / 1.14 = 22R \text{ (approx.)}$$

This internal resistance is in series with the emitter load resistor R, so the total emitter Impedance is 1022R. The voltage gain is simply

$$A = 4300 / 1022 = 4.2 \text{ (approx.)}$$

This is not the value of 10 we were aiming for. To get that, the total emitter resistance should equal the collector resistance divided by the required gain, or around 430R.

### Current Complications

To alter R4 now would upset our carefully calculated bias conditions. So we introduce R5 and C2 to lower the effective emitter resistance to AC signals and therefore to increase AC gain. The DC bias conditions are left unaffected, thanks to C2, but to AC signals, R4 and R5 are in parallel.

R5 should be chosen so that R3 + (R4 in parallel with R5) equals 430R. Thus:

$$(1/1000) = (1/R_5) = 1 / (430 - 22)$$

in parallel with

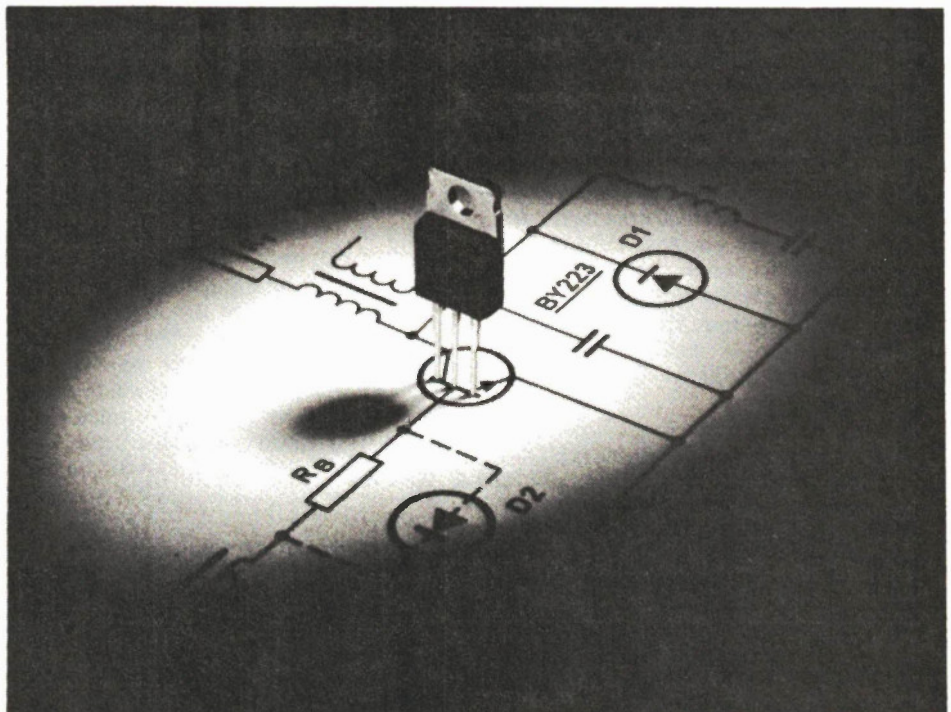



# Designing Transistor Stages

$$R5 = (408 \times 10^3) = 680 \text{ (approx).}$$

R5 determines the overall AC gain and can, of course, be altered for different requirements or even replaced with a small preset potentiometer. C2 should be large enough to pass the lowest audio frequency expected without too much attenuation. Very roughly, the AC gain will drop by 3dB when the reactance of C2 plus R5 equals R4, assuming Re is low. If the rolloff frequency is to be 20Hz, then:  $C2 = 1/(2\pi \times 320 \times 20) = 24.8\mu\text{F}$  (22uF is the nearest preferred value).

A quick look at the input impedance will complete the calculations around this single stage amplifier. Then we will be able to look at its limitations and some ways to overcome them.

The transistor's input impedance can be calculated from hFE and the total emitter resistance:

$$R_{in} = 250 \times 430 = 107k5,$$

But the input signal also has to flow through the DC bias resistor, R2, which can be considered to be in parallel with the input, reducing input impedance.

Total input impedance is approximately 107k in parallel with 33k, or about 22k. Happily, this still falls within the

original specification that input impedance should be greater than 10k.

## Maximum Gain

An interesting problem faced by many enthusiasts is to estimate the stage gain when the emitter resistor, R4, is totally decoupled; that is, when R5 is a short circuit. Some people guess quite high figures. Others like to impress and bring out a string of complex formulas straight from a text book. The formulas are enough to put most people out of electronics for life, while the guesses are usually wrong.

There is a very simple rule of thumb which works very well. The gain of a common emitter stage without emitter degeneration is simply 20 times the supply voltage.

Since this often surprises people, here are the sums:

Assuming high frequency operation, so that C2 is very low, and making all the other simplifying assumptions we've used so far,

$$\text{gain, } A = R3 / ((R5 \text{ in parallel with } R4) + R_e).$$

Since R5 = 0, this reduces to  $A = R3/R_e$

$$\text{Now, } R_e = 25 \times 10^{-3} / I_E \text{ and } I_E = I_c.$$

In turn,  $I_c = (V_{cc} - V_{ce}) / R3$ , so:

$$R3 = (25 \times 10^{-3} \times R3) / (V_{cc} - V_{ce}) \times 40.$$

$$A = (V_{cc} - V_{ce}) / (25 \times 10^{-3}) \text{ so}$$

$$A = (V_{cc} - V_{ce}) \times 1000 / 25 \text{ or } (V_{ce} - V_{cece}) \times 40.$$

If we now assume that component values are chosen so that Vce lies more or less midway between Vcc and 0V, then Vcc - Vce will be 0.5Vcc. Thus the gain equation reduces to  $A = 20V_{cc}$ .

The last assumption we made follows from setting the transistor's operating point. The '20Vcc' rule of thumb then gives the maximum gain under ideal conditions and without taking input and output loading into account. In practice, maximum gain is usually between 1/2 and 3/4 of this figure.

Next month, we'll discuss refinements to the common emitter circuit and other configurations. There will be considerably less mathematics, since the principles we've dealt with above should be enough to stand you in good stead should you want to make your own practical calculations.

## Electronics from the Start continued from page 43

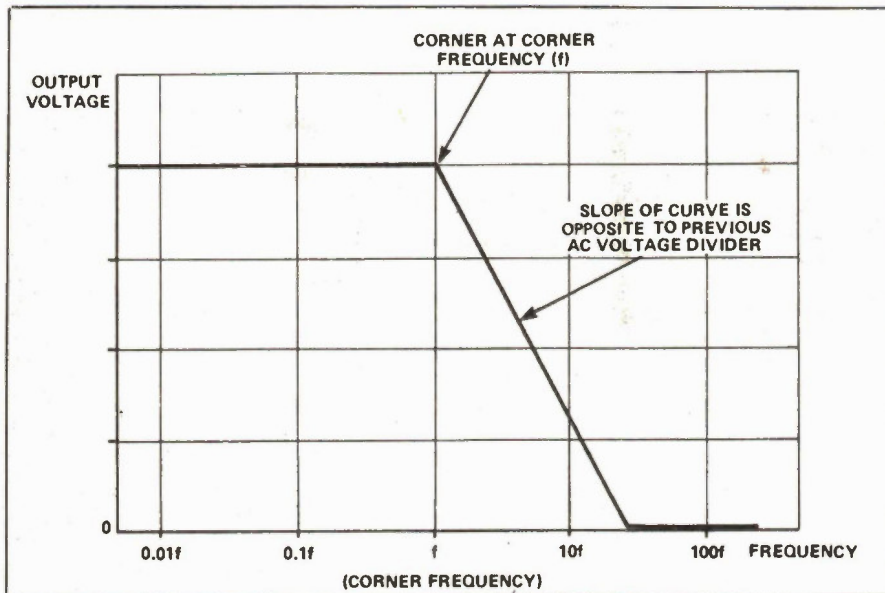

Fig. 8 This graph shows the similarities and differences between the circuit in Figure 10 and the circuit of Figure 5.

ween two levels. Looked at in this way, the astable multivibrator is a DC-to-AC converter. And that is going to be useful in our next experiment, where we look at the way capacitors are affected by AC. The circuit we shall look at is shown in Figure 5 and is very simple, but it'll do nicely. It should remind you of a similar

circuit we have already looked at; the circuit we have already looked at; the voltage divider, only one of the two resistors of the voltage divider has been replaced by a capacitor. Like an ordinary voltage divider the circuit has an input and an output. What we're going to attempt to do in the experiment is to measure the output signal when the input

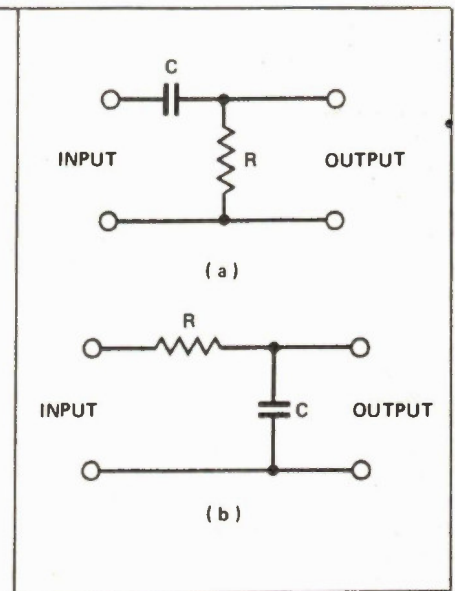

Fig. 9 The AC divider sections of the circuits in Figure 10 and 5.

signal is supplied from our astable multivibrator.

Figure 10 shows the whole circuit of the experiment and Figure 11 shows the Verobloc layout. The procedure for the experiment is pretty straightforward: measure the output voltage of the AC voltage divider when a number of dif-



# Designer's Notebook:

## Automated Test Equipment

### A look at signature analysis, and efficient method of testing complex circuits.

By W.P. Bond

THE increasing predominance of VLSI, microprocessors and large memories has made the use of advanced techniques of automatic testing essential. Signature Analysis (SA) is such a technique and, although first developed over a decade ago, it plays an important part in modern ATE.

SA is a data compression technique, introduced by Hewlett-Packard in 1970 as a field service aid for fault finding in microprocessor based equipment, but with unexpected applications in functional testing. The theory is fairly complex, at least if the math is not taken on trust. If we accept the mathematical foundations as sturdy, the process is reasonably easy to understand.

Fig. 1 shows a typical SA set up. It is, in effect, a pseudo-random sequence generator with an external input connected to the circuit node at which system data is being monitored. The heart of the device is a 16-bit shift register whose contents can be read out on a hex display. On successive clock pulses, the register will shift, producing a binary sequence at the output, X, and an associated sequence of hex numbers on the display. Assuming for the moment that the data input, W, is held low (that is, no data is entering the shift register), the device acts just like a pseudo-random sequence generator. The feedback loop through the exclusive-OR gate, XOR2, ensures that the shift register will cycle through all its possible states (with the exception of all bits zero) whatever the initial state (as long as it was not all bits zero). The proof of this derives from the theory of binary sequences and is

connected with the fact that the feedback loop is effectively generating a polynomial function whose value is determined by the state of the shift register at any given time. The state of the shift register at a particular time can, in turn, be specified by reference to preceding stages. In the simplified diagram of Fig. 2  $X_r$  is given by the expression:

$$X_{r-16} \text{ XOR } X_{r-12} \text{ XOR } X_{r-9} \text{ XOR } X_{r-7}.$$

This expression can also be written using what's called D-notation. This uses a particular operator, D (something like the differential operator of analytical calculus), to represent the effect of a delay of one clock cycle. The above expression becomes:

$$D^{16}(X) \text{ XOR } D^{12}(X) \text{ XOR } D^9(X) \text{ XOR } D^7(X),$$

where  $D_n(X)$  represents n successive operations on X.

If we wanted to generate the sequence of inputs into the Fig. 2 circuit, we could simply take any initial state of the shift register (except for all bits zero, which will never change) and work out successive values of the polynomial. We would get a sequence of ones and zeroes which would, eventually, start repeating. Starting from any single digit in the sequence and taking the next 15 digits (cycling around the sequence, if necessary) will produce states of the shift register.

It can be shown that the above polynomial will generate a sequence of 65535 digits before it starts repeating. Any device with n-stages which generates a sequence of 2-1 ones and zeroes before repetition is called, for obvious reasons, a maximum length sequence generator. In the case of the circuit shown in Fig. 2 we talk of a maximum length sequence (or m-sequence) of period  $2E16-1$ . Using the technique of starting from one digit within the sequence and taking a string of 16 consecutive digits, we arrive at  $2E16-1$  smaller sequences of 16 bits each. Since there can only be  $2E16$  possible sequences of 16 bits (this time including the all bits

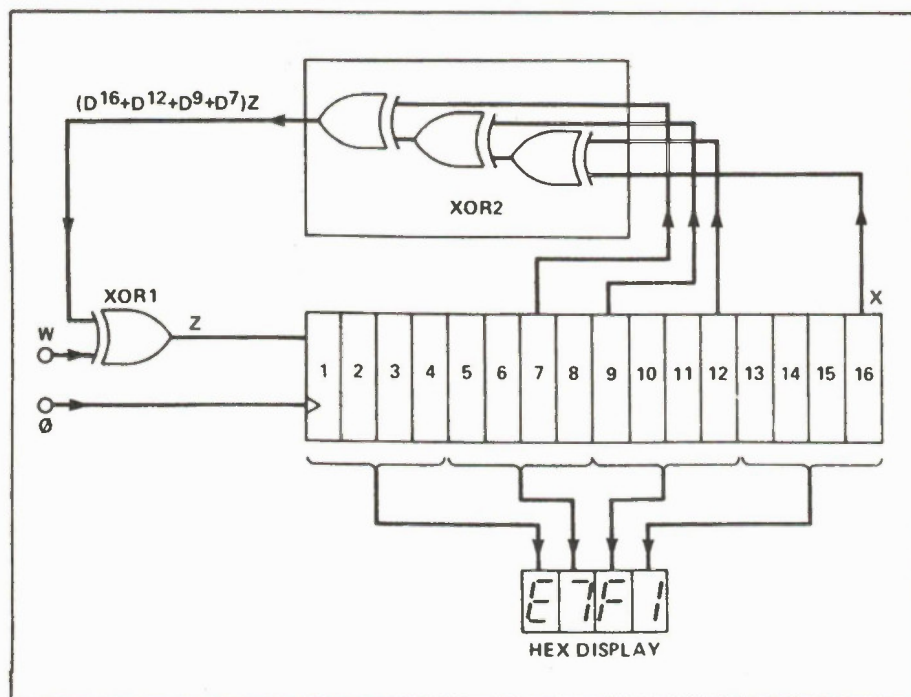

Fig. 1 Signature analysis set up.



zero option), and since the m-sequence doesn't start repeating until the 65536th bit, the m-sequence clearly gives rise to every possible state of the 16-stage shift register (with the familiar exception).

between 1 and 65535 already, all that will happen will be that the shift register lands somewhere else in its sequence and will carry on from there. Every data high will cause the shift register to jump to a dif-

ferent part of the sequence, so that a given sequence of data bits will generate a new sequence of numbers in the shift register. After a precise number of clock signals, enough to cover all states of the unit under test, the shift register is stopped and a final number can be read out. This is the signature of the input sequence (also known as the cyclic redundancy code, or CRC). Assuming all the circuits concerned are properly initialized and the time window does not deviate, the signature will be the same each time the SA device sees the same data input. Clearly, any single bit error is certain to be detected, since such an error will cause one and only one different jump in the sequence. Multiple bit errors will cause the sequence to jump several times, and it may end up where it would have been if no error had occurred. The chances of this happening are very small; with a 16-bit shift register, they amount to one in  $2^{E16-2}$ . There is an approximate 99.998% chance that a multiple bit error will result in a wrong signature and so be detected. This near certainty is possible because the original sequence is, in effect, random.

The main advantage of the signature analysis technique is that it is capable of detecting time related errors and can be used to test microprocessor-based systems, for example, or large memory configurations at full system speed. SA procedures require access to a test point for data input, access to a clock signal and the provision of start and stop signals to determine the time window (Fig. 4). The UUT's own clock is often used although it may be more convenient to use other bus signals (RD and WR), for example. Start and stop signals are often provided by a stimulus program built-in to UUT hardware.

Fig. 5 shows how SA can be applied to test an n-bit ROM. A counter is used to cycle through the ROM's address range and the outputs are monitored using the system clock as the SA clock. Start and stop signals are both taken from the MSB of the counter and therefore need to trigger on opposite edges. Using this method, there is no real limit to the size of memory that can be tested, which is particularly important with regard to newer devices and technologies like bubble memory with sizes upwards of one megabit.

The same principle can be used to test RAM, although a method of loading the memory with known data is required. In this case, the stimulus program which initializes the system, provides start and stop pulses and exercises all the test nodes may utilise RD and WR signals as clock inputs. Signatures arrived at when writing data to RAM using WR as a clock signal could simply be compared with signatures arrived at when reading data back using RD as a clock input. This is a less complicated procedure than one using the system clock of the UUT.

One difficulty in testing microprocessor-based bus systems is the presence of feedback loops. A bad signature may be propagated around the loop, for example on a data bus. In such a case, the presence of a fault could be detected but not isolated to component level. In the MPU system of Fig. 6, interrupts must first be disabled or masked if any meaningful and repeatable signatures are to be derived. The data bus must be broken by means of jumpers, switches or buffers and the processor should be allowed to free-run, cycling through its address range. This last can be achieved by putting an instruction on the MPU's now disconnected data inputs causing the program counter to increment and repeat as long as the instruction is present. Normally a no-operation (NOP) instruction will do the trick.

Signatures can be taken from the address bus. If these are wrong, either the micro is not free-running, or there is an address fault. Then the ROMs, RAM and I/O can be enabled in turn and their outputs verified on the data bus. Once again, the RAM must be loaded with known data. If the data bus cannot be isolated,

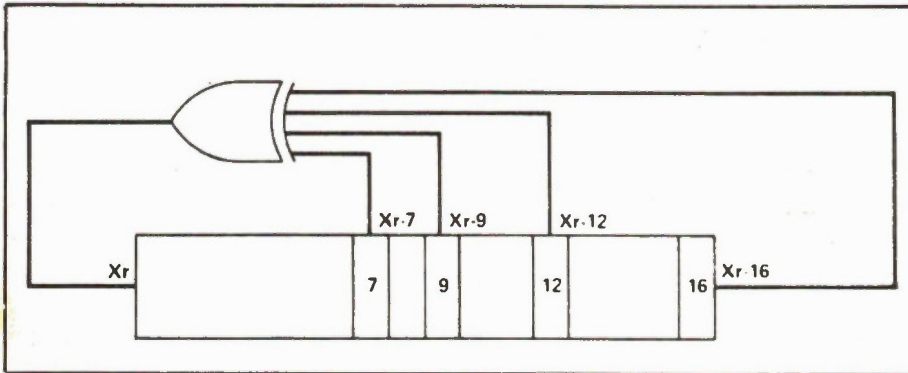

Fig. 2 A pseudo-random sequence generator.

CLOCK	I/P	A	B	C	HEX/DEC	O/P
1	1	0	0	1	1	1
2	1	1	0	0	4	0
3	1	1	1	0	6	0
4	0	1	1	1	7	1
5	1	0	1	1	3	1
6	0	1	0	1	5	1
7	0	0	1	0	2	0

**Table 1.**

*Three stage shift register pseudo-random sequences.*

The useful thing about the m-sequence is that there is no evident structure to it. It appears to be random, although it is in fact rigidly determined by the initial state of the shift register and the feedback (or transition) polynomial. By converting each of the states of the shift register into a decimal or hex number we can give another useful expression to this pseudo-random sequence. Table 1 shows the different ways of expressing the sequence for a 3-stage generator (Fig. 3): Check for yourself that the sequence now repeats.

In the above example, the decimal/hex sequence 1,4,6,7,3,5,2 can be simply read out of the shift register as with the Fig. 1 circuit. Whatever the number that comes up, we know exactly which number will follow it.

If we now go back to Fig. 1 and start feeding data in on W input, what will happen? Left to its own devices, the shift register will cycle through its sequence of 65535 numbers, one for every clock pulse. But as soon as the W input goes high (in other words, as soon as a data bit 1 arrives on the input), XOR1 will invert the bit on the feedback line. The shift register jumps out of its preordained sequence. Since this sequence includes every possible number

ferent part of the sequence, so that a given sequence of data bits will generate a new sequence of numbers in the shift register. After a precise number of clock signals, enough to cover all states of the unit under test, the shift register is stopped and a final number can be read out. This is the signature of the input sequence (also known as the cyclic redundancy code, or CRC). Assuming all the circuits concerned are properly initialized and the time window does not deviate, the signature will be the same each time the SA device sees the same data input. Clearly, any single bit error is certain to be detected, since such an error will cause one and only one different jump in the sequence. Multiple bit errors will cause the sequence to jump several times, and it may end up where it would have been if no error had occurred. The chances of this happening are very small; with a 16-bit shift register, they amount to one in  $2^{E16-2}$ . There is an approximate 99.998% chance that a multiple bit error will result in a wrong signature and so be detected. This near certainty is possible because the original sequence is, in effect, random.

The main advantage of the signature analysis technique is that it is capable of detecting time related errors and can be



one can often utilise tri-state buffers to isolate the MPU and then force an instruction on to it, vectoring it to a particular address in ROM containing an analysis routine. But such complications are enough to ensure that ATE only uses

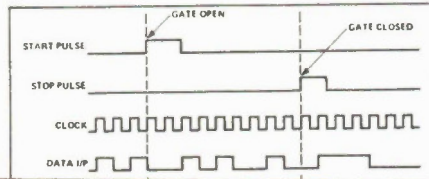

trolled by the ATE.

The ATE can selectively overdrive test signals and force a processor to redirect its activity from memory resident on the UUT to ATE-supplied memory, thus creating a memory overlay. On reset,

# Aptron Bugbuster Review

*Debugging 6502 machine code programs can be about as much fun as going to the dentist. The Bugbuster solves Apple code problems.*

By Reinhold Busch

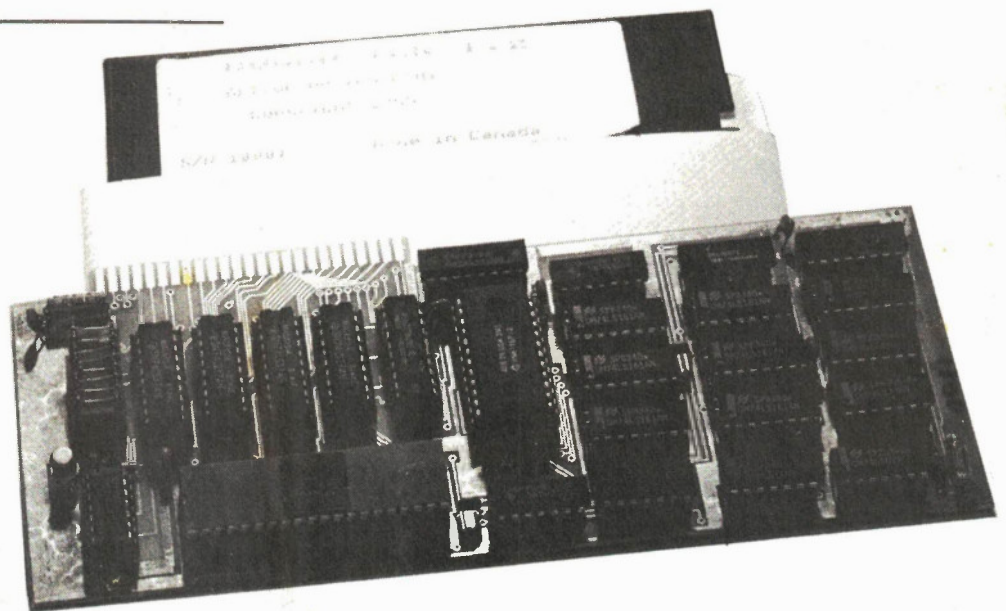

IT'S THREE in the morning and you're barricaded behind your Apple II with a pot of coffee and an ashtray full of smouldering butts. Those members of the family who are trying to get a pinch of shuteye are constantly awakened by the slamming of your fist on the desk. What's all the commotion about? Machine code bugs have infested your programming masterpiece and you've become delirious trying to get rid of them. What can you do?

Forget about industrial strength pesticides and heavy duty roach traps; they're useless. What you need is the Bugbuster AP512 logic analyzer, a hardware add-on with accompanying software that enables you to monitor the execution of machine code routines, with the added feature of being able to trace and save portions in memory for later perusal.

In addition to the card is the supporting software which is fully menu-driven and requires a minimum system size of 48K and one disk drive. The program itself utilizes 16K of either low (below \$5000) or high (above \$5000) memory; this can be selected by the user.

## Getting Started

Your first task after booting is to configure the system for slot location, high or

low memory allocation, and printer availability. For most applications, you will probably keep the Bugbuster in high memory as most user programs are loaded down around the \$800 area. Once complete, the main menu appears and you're ready for action.

From the main menu, exit to DOS and BLOAD your machine code program. Care must be taken here so as not to overwrite DOS; the Bugbuster must have DOS

THE BUGBUSTER LOGIC ANALYZER  
VERSION 1.2

APTRON DESIGN LTD  
COPYRIGHT (C) 1985



**Table 1**

Results when capacitor C2 is 100n

Value of C1	Calculated frequency	Measured voltage
10u	5.8	
1u	58	
100n	580	
10n	5.8k	
1n	58k	

**Table 2**

Our results (C2 ± 100n)<sub>2</sub>

Value of C1	Calculated frequency	Measured voltage
10u	5.8	0
1u	58	0
100n	580	1.5
10n	5.8k	4
1n	58k	4.2

**Table 3**

Results when capacitor C2 is 10n

Value of C1	Calculated frequency	Measured voltage
10u	5.8	
1u	58	
100n	580	
10n	5.8k	
1n	58k	

**Table 4**

Our results (C2 = 10n)

Value of C1	Calculated frequency	Measured voltage
10u	5.8	0
1u	58	0
100n	580	0
10n	5.8k	1.5
1n	58k	4

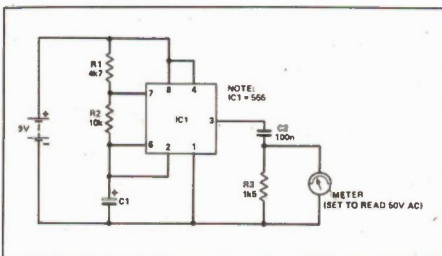

Fig. 10 The complete circuit combining the astable multivibrator and the circuit in Figure 5.

ferent frequencies are generated by the astable multivibrator, then tabulate and plot these results on a graph. Things really couldn't be easier. Table 1 is the table to fill in as you obtain your results and Figure 12 is marked out in a suitable grid to plot your graph. To change the astable multivibrator's frequency, it is only necessary to change capacitor C1. Increasing it ten fold decreases the frequency ten fold. Five different values of capacitor therefore give an adequate range of frequencies.

As you do the experiment you'll find that only quite low voltages are measured (up to about 4VAC) and as the meter's lowest AC range is 50V, you may not achieve the level of accuracy you would normally desire, but the results will be OK, nevertheless.

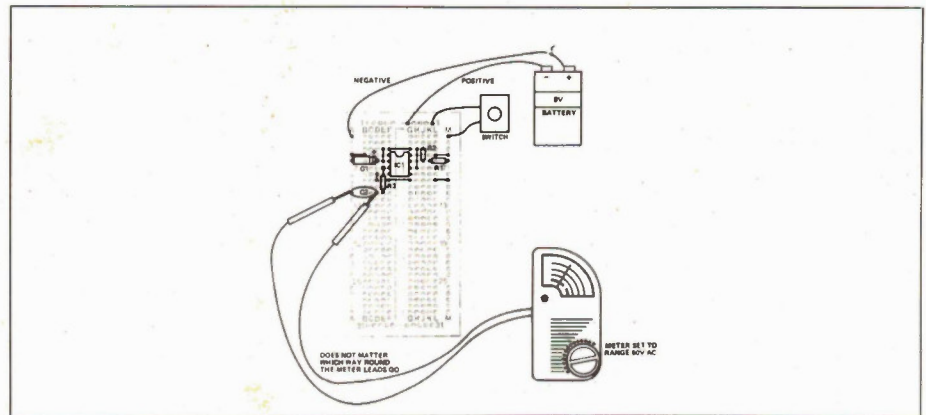

Fig. 11 The breadboard layout of the circuit in Figure 10.

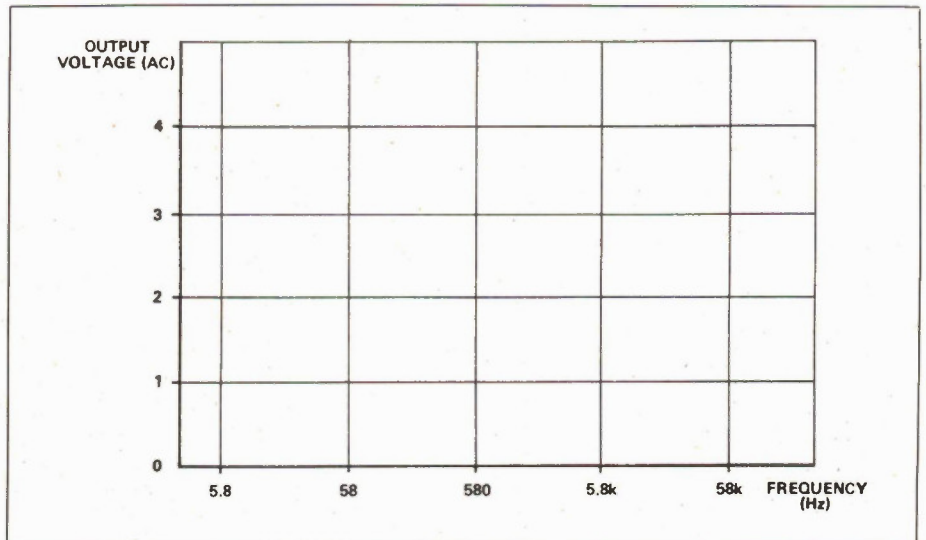

Fig. 12 A blank graph to record the results obtained in Table 1.



# ESCORT TEST INSTRUMENTATION

## QUALITY AT THE RIGHT PRICE!

WE DARE YOU TO COMPARE

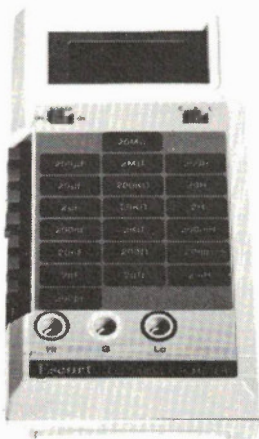

- MODEL ELC 120**  
3 1/2 DIGIT LCR METER  
Feature Packed Priced Right
- 3 1/2 Digit LCD Display
  - Capacitance, Resistance, and Inductance Measurements
  - Basic Accuracy 1.0%
  - 200 HR Operation
  - Test Frequency of 1KHZ

\$266.43 List Price  
**\$219.00** Introductory Offer



- MODEL ECT 620**  
3 1/2 DIGIT CLAMP-ON  
Extra Convenience
- 3 1/2 Digit LCD Display
  - DCV, ACV, ACA, RES.
  - Data Hold, Audible Continuity Test
  - Diode Test, Peak Hold
  - 0.5% Basic DC Accuracy

\$159.43 List Price  
**\$124.00** Introductory Offer

Offer expires January 31st 1986

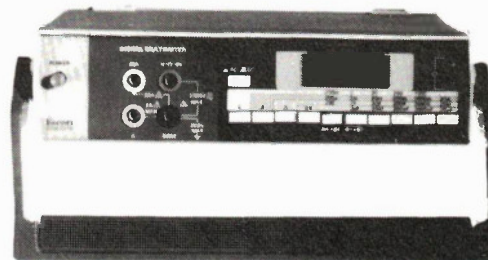

- MODEL EDM 2347**  
4 1/2 DIGIT MULTIMETER  
Feature Packed Bench Model
- 4 1/2 Digit LCD Display
  - 0.03% Basic DC Accuracy
  - True RMS ACA/ACV Measurement
  - Frequency Measurement to 200KHZ
  - Audible/Visual Continuity
  - Conductance Measurement
  - dB Measurement
  - Battery or AC Operation
  - Diode Test Function
  - Data Hold Function
  - 20A AC/DC Current Measurement

\$422.65 List Price  
**\$359.00** Introductory Offer

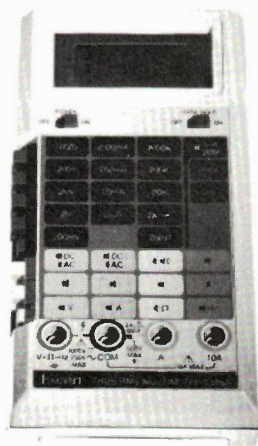

- MODEL EDM 1346A**  
4 1/2 DIGIT MULTIMETER  
Feature Packed Handheld
- 4 1/2 Digit LCD Display
  - 0.5% Basic DC Accuracy
  - True RMS Measurement (ACA/ACV)
  - Frequency Measurement to 200KHZ
  - Audible/Visual Continuity Test
  - Data Hold Function
  - Diode Test Function
  - 10A AC/DC Current Measurement
  - Up to 1000 Volt DC Measurement

\$299.60 List Price  
**\$249.00** Introductory Offer

**ESCORT:** A line of quality Electronic Test Instruments is the latest addition to Metermaster, backed by a full one year warranty... at an unbeatable price!

**Metermaster**

A Div. of R.H. NICHOLS CO. LTD.

Head Office: 80 Vinyl Court  
Woodbridge, Ontario L4L 4A3



5% Discount for Cash  
plus Student Discount 5% on all products  
Certified Cheque, or Money Order

All prices F.O.B.  
Woodbridge Ontario  
subject to change without  
notice P.S.T. extra  
where applicable

TORONTO (416) 741-9381 • MONTREAL (514) 337-0425 • EDMONTON (403) 432-7746 • OTTAWA (613) 727-3974  
• VANCOUVER (604) 937-3622

Circle No. 27 on Reader Service Card

Electronics Today January 1986



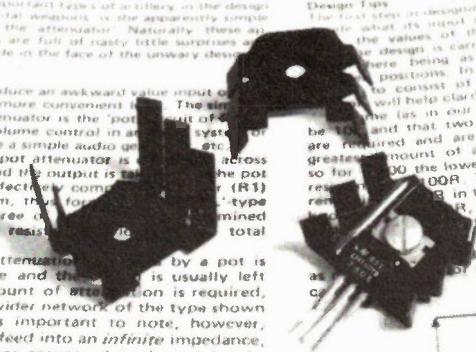

**Design Tips**  
The first step in designing an attenuator of the Fig. 2 type is to select the total resistance of total resistors. The values of the individual resistors are then determined by carrying out in a simple manner the design in many steps as there are three being in each of these steps, the design consists of an upper and a lower arm. The design will help clarify matters. In our example, we will assume that the total resistance is 100. The values of the two attenuation positions (10 and 100) are required and are 10 and 100. The greatest amount of attenuation is always the lowest so for 100 the lowest arm must contain 1/100 of the total resistance. This gives the value of R2 as 100. R2 must be 1kΩ - 100. The upper arm obviously contains the remainder of the total resistance.

**Attenuators**  
Attenuators are used to reduce an awkward value input signal to a lower and more convenient level. The simplest example of a practical attenuator is the 'pot' or potentiometer which may be used as a volume control in an audio system or as an output level control in a simple audio amplifier. The input signal to the pot attenuator is applied across the total resistance chain and the output is taken from the pot slider. Note that the pot effectively comprises two resistors (R1 and R2) resistive arm, the former being the upper arm and the degree of attenuation is determined by the ratio of lower arm resistance to the total resistance.

The precise amount of attenuation obtained by a pot is usually of little importance and the pot is usually left calibrated. If a precise amount of attenuation is required, a triple switched potential divider network of the type shown in Fig. 2 may be used. It is important to note, however, that this circuit is designed to lead into an infinite impedance, at least one that is very large compared to the total resistance of the divider chain.

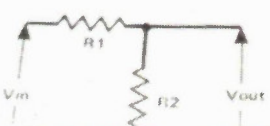
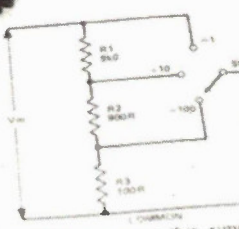
When it comes to stud-mount thyristors and rectifiers, use the manufacturer's mounting kit. In some cases (*another pun*), especially with larger units, the body can't be isolated conveniently, and you'll have to use nylon pillars for mounting the heatsink to the cabinet. These are usually available from the heat-sink manufacturer.

The clip-on method is convenient for small transistors dissipating a few watts, such as TO-5 driver transistors. There are various little metal spiders that slip over the TO-5 header; for instance, the Wakefield 209 gives a case temperature rise of 30 degrees at 1W. However, I've found that these little guys tend to work their way off the transistor if the unit is transported at all. If your handiwork is going to suffer any thumps, there are TO-5 transistors available with a heatsink fastened right on to the case, such as the RCA 40409 NPN. They get a bit expensive if you blow them out, though. You can't have everything.

### Mounting

There are three basic ways to mount a semiconductor to a heatsink: insulated, direct, and clip-on.

With the insulated type, the sink is usually fastened to the exterior of the cabinet for the best air circulation, although it might be mounted inside and provided with air via slots or louvers. Since transistor cases or rectifier studs are almost always connected to some circuit potential other than ground, it's best to isolate the semiconductor from the sink to avoid having a large, energized heatsink where almost anything metallic can short it. There's almost nothing to be gained from leaving out the insulating wafer.

If you're mounting the popular TO-3 metal power transistor, there are two ways to do it: the insulating kit for permanently wired transistors, and the socket system that allows rapid replacement of blown units. If you're building a unit that isn't under any strain and is unlikely to give any trouble, the most economical mounting method is to solder the leads directly to the pins; nylon sleeves and screws are used to isolate the case electrically. If you're making power amps or supplies that will see hard service, the ability to replace transistors quickly is well worth the slight cost of sockets. It's especially important in power supplies that drive large amounts of equipment; the whole works will be dead while you fumble with desoldering and soldering transistor leads.

The popular TO-220 plastic package poses more of a problem; although they mount with only one nylon screw, sockets are not easily obtainable in small quantities, though they do exist, from companies such as Molex. Generally, you can solder leads directly; these transistors are easier to change than the TO-3 package.

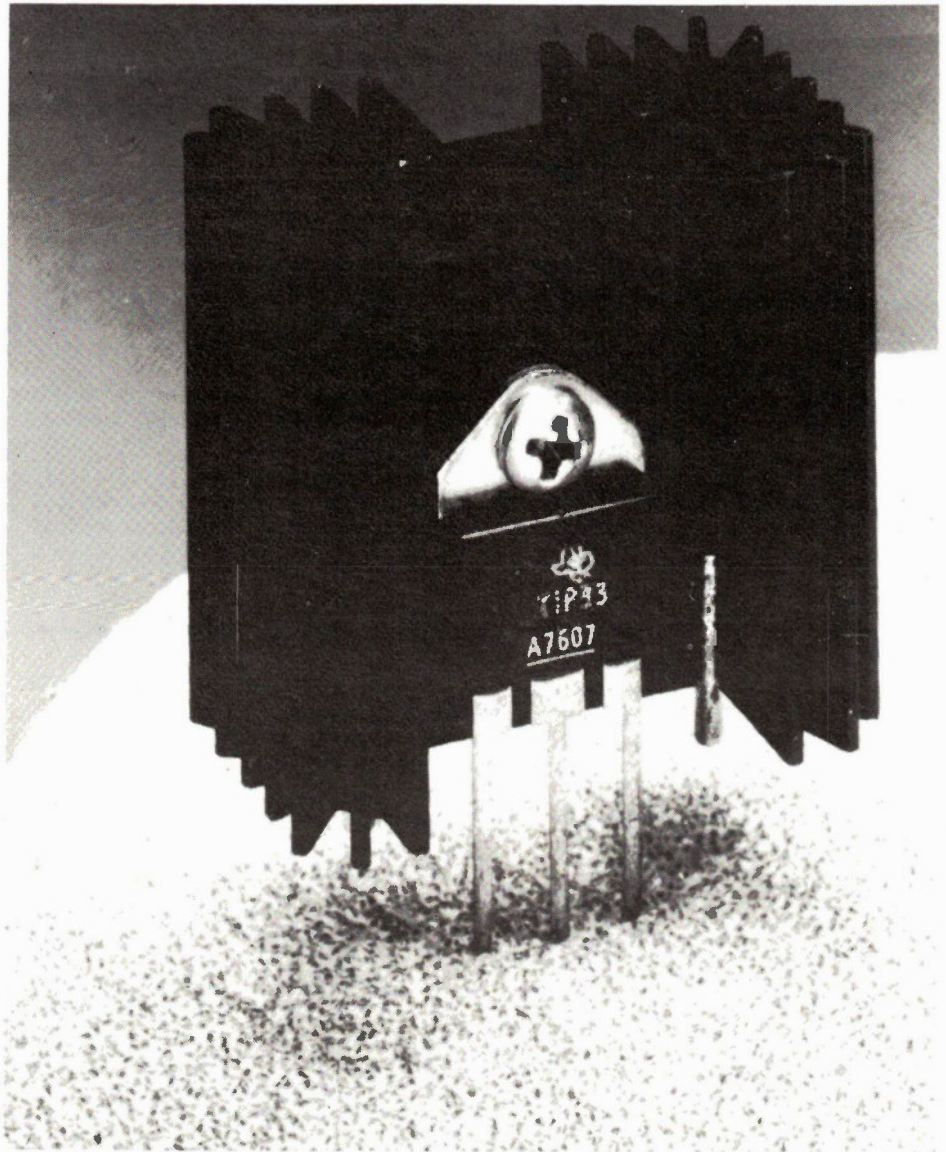



## Computers In Small Business

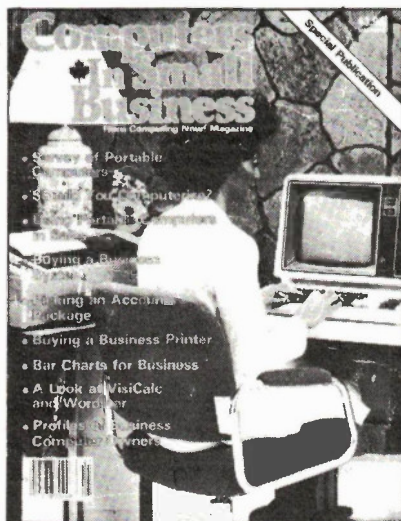

Small companies across Canada are hungry for knowledge about the microcomputer revolution. Many of them believe that they alone are ignorant about what is going on and what equipment is available.

This Special publication is addressed exclusively to this market. The articles comprise reprints of the very best material already published in *Computing Now!* magazine together with several specially commissioned features to form a well balanced publication. We believe this Special is of real use to the hundreds of thousands of small companies on the verge of buying a micro-computer.

**First Published  
March 1984**

\$3.95 plus \$1.00 postage and handling. Ontario Residents add 7% PST. For a copy call or write:

1300 Don Mills Road,  
Don Mills, Toronto, Ontario,  
M3B 3M8  
(416) 445-5600

There are even heatsinks made for little transistors, such as the TO-18 case. I've never felt comfortable with turning a tiny tranny into a power transistor; unless you have a really unusual circuit, it's probably best to go for a larger transistor.

Lastly, there are special-purpose devices designed for equalizing temperatures rather than getting rid of a whole lot of it. These usually consist of an S-clip that will hold two TO-5s together, or cups that mount them top-to-top. The whole idea is to make a differential amplifier or a bridge with both elements at the same temperature, more or less. Again, with the availability of integrated diff amps and op amps, this method isn't too popular.

### Q&A

**Is there an easier way to mount small transistors on PCB heatsinks than the insulator-wafer method?**

The Loctite company makes a special thermally conductive, insulating adhesive called *Output*. It eliminates all mounting hardware, but must be mixed with an activator. If you can't get it from an electronics supplier, you can contact them at 5115 Timberlea Blvd., Mississauga, Ontario L4W 2S3, (416) 625-6511.

**What about mounting the transistor straight onto the chassis?**

There are lots of unknowns here: the material, the thickness, the airflow, etc. Unless the chassis is very thick aluminum, it's probably best to limit this method to dissipations of a few watts at best.

**Is there anything to be gained from heatsinks with grooves extruded along the length of the fins?**

These serrations are meant to increase surface area with forced air cooling; the thermal air skin mentioned above prevents any gains with convection cooling.

**What about heat radiation as a factor in cooling?**

Radiation makes little difference at the temperatures encountered in semiconductor cooling. The black anodizing is more for appearance than anything. Incidentally, should you have to make an electrical connection to the sink for any reason, this anodizing is non-conductive and you'll have to scrape through it.

**Is there an easier way to mount heatsinks in the path of a fan?**

One way, if you're using standard rack mounting, is to buy a fan that's already mounted in a rackmount module. Examples are the Hammond RAVB series and the Rotron MB5100.

Heatsink companies generally make sinks extruded in quadrants, or other

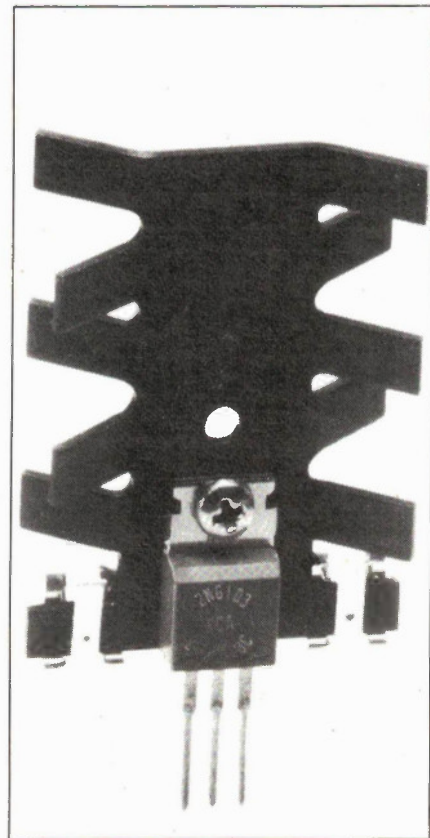

shapes like pieces of a pie. These sections are mounted together to form a circle through which the fan blows; the semiconductors are on the outside and the cooling fins project toward the centre into the airflow. An example is the Wakefield 1040P1 extrusion.

**Speaking of extrusion, is it worthwhile?**

Yes, indeed; most companies will supply short lengths of standard sink extrusions off-the-shelf. It's not only cheaper than individual sinks, but you can cut the sinks to larger sizes for more cooling, or even use a length as part of your chassis or cabinet. For custom profiles, you'll have to order a fair amount of extrusion, say 1000 pounds.

**What about no heatsink at all? How much power can the transistor handle?**

You'll have to find the manufacturer's spec for *theta*, case-to-ambient. If you want to keep the case temperature to a reasonable value, say 100 degrees C, then the temperature rise is  $100 - 25 = 75$  degrees (allowing 25 degrees for the ambient air). The power is then 75 divided by *theta*. The TO-220 case has a thermal resistance of 50 degrees per watt, giving a maximum power of 1.5 watts. If you derate the dissipation for 100 degrees C this drops to about one watt. ■



# TRANSPAC

FOR THE 4 IN 1 SUPERCOMPUTER  
THAT IS MADE IN CANADA AND COMES WITH A ONE-YEAR  
WARRANTY FROM XEROX® SERVICE CENTERS THROUGHOUT CANADA



Monitor not included

## THE SUPER FAST TRANSPAC II

CSA approved 150 watts power supply, genuine Keytronics Keyboard, 256K RAM, 2 serial and one parallel ports, real-time battery back-up clock plus speed selectable via external switch. 4.77 and 8MHz uses 8088-2 processor.

(Most software will run on the higher speed.)

# \$1825.00

## Other configurations

- TRANSPAC III  
10 Meg Hard Drive/1 Floppy/256K . . . . \$2586.35
- TRANSPAC IV  
10 Meg Hard Drive/2 Floppy/256K . . . . \$2749.00
- TRANSPAC V  
20 Meg Hard Drive/1 Floppy/256K . . . . \$2804.88
- TRANSPAC VI  
20 Meg Hard Drive/2 Floppy/256K . . . . \$2967.53

## SUPERB IBM PC & XT COMPATIBILITY AND MORE...

Not just Hardware but also Software compatibility. Supports PC-DOS and CPM/86. Will run all your favourite software such as Lotus 123, Autocad, Flight Simulator, Dbase III etc.

## MULTIFUNCTION FEATURES COMES AS STANDARD

- 2 Serial Ports (not just 1)
- 1 Parallel Port
- Real Time, Battery Back-up, Clock
- Memory expansion on-board to 1 megabyte
- 64K and 256K chips can be mixed
- Optional 8087-2co-processor
- Sasi Hard Disk Interface
- 54K User Definable Rom expandability
- Low Cost Modem Interface
- Ram Disk software included

## FLOPPY CONTROLLER CARD COMES AS STANDARD

Will Support Up To 4 Floppies

## HIGH-SPEED BOARD COMES AS STANDARD

Speed Selectable Between 4.77 MHz and 8 MHz via external switch.

**Note:** Up to now all these features were only available by purchasing expensive interface cards. Now with the ACS-1000 single board supercomputer (see reviews in March and May Issues of "Electronics Today") all these features come as standard on one board. What's more, since the ACS-1000 is a product of Top-Down integration all these functions will work together as never before. And, more importantly, since everything is already on the main board the remaining expansion slots will give you true expansion capability.

## PLUS MORE

- genuine Keytronics Keyboard
- reset switch
- speed selection via external switch
- 150 watt CSA approved power supply
- quiet slim-line DS DD 5 1/4 360K disk drives
- colour video adaptor included. RGB and composite board or Hi-Res monochrome board. (customer choice)
- ONE YEAR WARRANTY
- even after all the above standard features you still have 6 expansion slots
- made in Canada
- 256K RAM standard minimum

## WARRANTY

The TRANSPAC computer not only offers you high quality and high performance at low cost but also gives you one full year's service warranty — parts and labour — right across Canada from Xerox, one of the most reputable service organizations in Canada. This is possible because of the extra care we take in sourcing our components and our quality control. For example, every computer that leaves our site undergoes in total 72 hours of burning-in. This ensures a very high reliability rate in the field and of course, satisfied customers.

## TRANSPAC TRADING CORP.

for the computer that is not just another look-a-like

5485 — 128th St., Surrey, B.C. Canada V3W 4B5

Order line only 1-800-663-0073 Telex: 04-365628

Master Charge & Visa, Certified Cheque, COD, Money Order accepted.  
Shipping & Insurance extra.

IBM, PC, XT & PC DOS are registered trade marks of IBM Corp., CPM/86 is a registered trade mark of Digital Research, Inc. MS DOS, Flight Simulator are registered trade marks of Microsoft Corp. Lotus and 123 are registered trade marks of Lotus Development Corp., Dbase III is a registered trade mark of Ashton Tate. Autocad is a registered trade mark of Autodesk. Xerox is a registered trade mark of Xerox Canada.



to be operational, so check the boundaries of your program. If it's so large that it overruns the Bugbuster, don't panic. Immediately after the trace is complete, re-run the Bugbuster program, select the display mode and the trace will be displayed from the on-board memory of the card. The card will hold the trace in memory until a new trace is requested or until the power is shut off.

**Squeeze The Trigger**

The first item on the main menu allows for the setup of the trigger system. Once you've set up the Bugbuster card and it's enabled, it will monitor all goings-on within the Apple. At any given time the trace consists of the last 512 machine cycles; information in the trigger setup menu tells the card when to trigger and save the trace in memory for later

analysis.

For those of you who are into debugging peripherals and other external program sources, there is an external trigger feature on the Bugbuster card. A 16 pin header provides a connection for up to eight clip leads which are TTL compatible. If you're building your own Apple peripheral card, or just testing external equipment, this is ideal. You can monitor address decoding, and check on the function of clocks, and counters for correct operation.

**Seeing Is Believing**

What's all this about traces and triggers anyway? It's of no use unless you can see it, right? From the main menu, you simply select the Data Display mode and presto, the disassembled code appears beginning at the point at which the card was trig-

gered. Only 18 lines of code are shown at a time but it is possible to scroll up or down by using the commands shown at the bottom of the screen. Seeing the HEX output of the trace is possible by selecting the HEX mode, and alternately you can toggle back to the disassembled mode by typing, you guessed it, 'D'.

**Finally**

Loading and saving of any traces is simple enough; just follow the main menu choices and be careful to specify the correct disk drive and an appropriate filename. Data can be saved and retrieved for use at a later date.

*The Bugbuster AP512 is available from Apron Design, P.O. Box 13193, Kanata Ontario, K2K 1X4, (613) 831#0613; the basic hardware and software is \$199. ■*

**DOES YOUR DIGITAL CAPACITANCE METER DO THIS?**

FULL 4 DIGIT 0.5 INCH LCD DISPLAY COMPLETELY AUTORANGING WITH 10 RANGE MANUAL CAPABILITY

**AND THIS**

RANGE OF 0.0 pF to 1 FARAD (999.9 mF)  
0.5% BASIC ACCURACY UP TO 100 uF

**AND THIS**

READS DIELECTRIC ABSORPTION

**AND THIS**

EXTENDED PSEUDO 5 DIGIT  
RESOLUTION ON SOME RANGES ONLY

**AND THIS**

ABILITY TO ZERO LARGE CAPACITANCE  
VALUES UP TO 99.99 uF

**AND THIS**

CALCULATES TRUE CAPACITANCE  
IF CAPACITOR IS LEAKY

**AND THIS**

DIODE CLAMP AND FUSED  
PROTECTED INPUT.

DISCHARGE RESISTOR IN OFF  
POSITION AT TERMINAL INPUTS.

POWERED BY 9V BATTERY



**AND THIS**

IDENTIFIES TRANSISTORS (NPN, PNP)  
AND THEIR LEADS (E, B, C, ETC.)

**AND THIS**

TESTS ZENER DIODES AND RECTIFIERS.  
UP TO 20V ZENER WITH AC ADAPTOR,  
ZENER VOLTAGE WITH 9V BATTERY  
DEPENDS ON ITS CONDITION

**AND THIS**

AUTOMATICALLY CALCULATES LENGTHS  
OF CABLES IN FEET, METRES, MILES,  
KILOMETRES (THEORETICAL RANGE  
OF 9,999 MILES)

**AND THIS**

ABILITY TO SORT CAPACITORS IN  
MANY DIFFERENT MODES

**AND THIS**

ABILITY TO READ LEAKY CAPACITANCE  
(INSULATION RESISTANCE OR CURRENT)

**AND THIS**

CALCULATES TIME CONSTANTS WITH  
USER DEFINED RESISTANCE VALUES

**AND THIS**

HOLD FUNCTION FREEZES DISPLAY

**ONE YEAR PARTS & LABOUR WARRANTY**

**FOR ONLY THIS**



**MODEL MC300**

Approx. Size  
7" x 4" x 1 1/4"

**DAETRON**  
935 THE QUEENSWAY  
BOX 641  
TORONTO ONTARIO M8Z 5Y9  
(416) 255-9701

DEALER ENQUIRIES INVITED

MADE IN CANADA

PLEASE SEND ME \_\_\_\_\_

---(QUANTITY) MC300(s) @ \$149.95 \$ \_\_\_\_\_

CARRYING CASE \$19.95 \$ \_\_\_\_\_

AC ADAPTOR \$11.00 \$ \_\_\_\_\_

ONTARIO RESIDENTS ADD 7% PST \$ \_\_\_\_\_

SHIPPING AND HANDLING @ 4.45 per Instrument \$ \_\_\_\_\_

TOTAL \$ \_\_\_\_\_

I ENCLOSE CHEQUE  MONEY ORDER  BILL MY VISA

VISA CARD NO. \_\_\_\_\_

EXPIRY DATE \_\_\_\_\_ SIGNATURE \_\_\_\_\_

NAME \_\_\_\_\_

ADDRESS \_\_\_\_\_

CITY \_\_\_\_\_ PROV. \_\_\_\_\_ POSTAL CODE \_\_\_\_\_



The **BEST** is still "made in West Germany"

# HAMEG model HM203-5

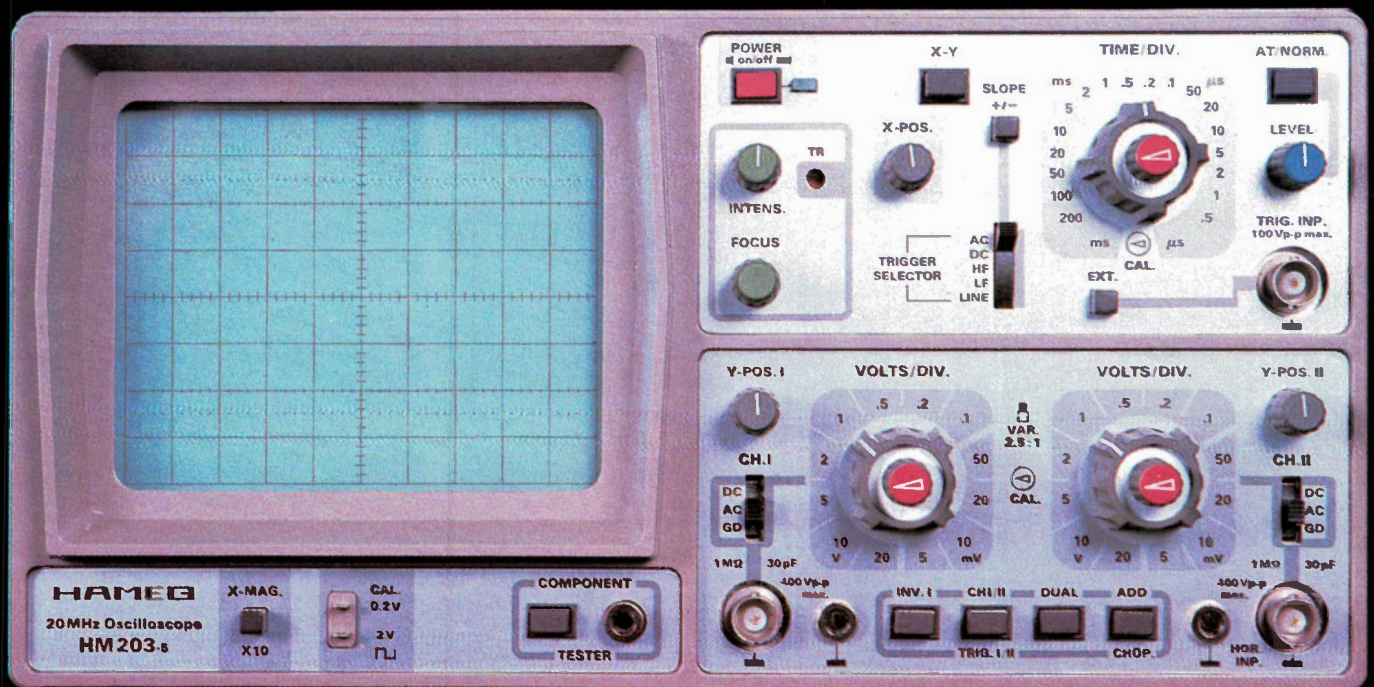

The 20MHz Oscilloscope that outsells all others in Western Europe. The model HM203-5 is available complete with two (X1-X10) probes. This CSA approved Oscilloscope is covered by a **two year** parts and labour warranty.

Immediate delivery from Stock  
All major credit cards accepted.

## \$770<sup>00</sup>\*

F.O.B. Downsview, Ont. FST Incl'd.

for the complete line of HAMEG instruments write or phone

**HAMEG** GmbH  
West Germany is represented  
and distributed in Canada by

**BCS**  
ELECTRONICS  
LIMITED

980 Ainess St. Unit 7,  
Downsview, Ontario  
M3J 2S2  
(416) 661-5585  
TELEX 065-28169  
Mon-Fri 8-5 pm, Sat 10-1 pm

\*Price subject to change





## The Most Powerful LAN Fits on a Disk.

Network Power. You knew that someday there would be a powerful LAN that didn't need old-technology network boards. It would be fast, easy to install, and run 99% of PC-DOS software. It would be expandable, provide remote access, password-protection, and enable you to use inexpensive terminals as workstations in a PC-DOS environment.

Dream no more, because the power is here.

Its name is LANLink™.

**A Software-Driven LAN Powerful Enough To Use RS-232 Ports for Network Communications.** In development for over three years, LANLink™ represents the next generation of local area networks. All of the logic which has traditionally resided on network boards is on LANLink's Satellite and Server Diskettes.

No additional hardware is required. Inexpensive serial ports replace "Kilobuck" Network Interface Boards making installation costs one-third that of a board-driven network.

**How To Configure a Smart Network...With Dumb Terminals, But Without Dedicated Servers.** Boasting a wide variety of configurations, LANLink™ is most often set up as a "Star" having up to eight satellites connected to a central, nondedicated server. Larger networks can have multiple servers, supporting a total of 73 or more network users.

R-LAN™ (Remote-LAN) gives users the ability to interact with a LANLink™ network in real time via modem. Plus, if MultiLink Advanced™ is run on a Satellite, inexpensive dumb terminals can be used to access network disks, files, and programs.

**99% of PC-DOS Applications Run in a Totally-Transparent Network Environment.** If you know DOS, you already know how to use LANLink™ COPY transfers files among users, and a 2-drive PC Satellite boots 1-2-3 from the Server's hard disk with the entry c:\lotus. Each satellite's access can be limited to specific disks, printers, and sub-directories. A wide variety of software including Lotus 1-2-3, dBASE III, and WordStar 2000 is fully compatible. LANLink™ has a collision-free data transfer rate which exceeds 115,000 BPS.

**Power Up Your PCs Today.** For complete details and the authorized dealer nearest you, call The Software Link TODAY. The LANLink™ Starter Kit is \$745 and includes modules for both a Server and a Satellite. For a limited time, 50 feet of shielded RS-232 cable will be included free of charge. Additional Satellite Modules are only \$320, each.

LANLink™ is immediately available and comes with a money-back guarantee. VISA, MC, AMEX accepted.

# LANLink™



**THE SOFTWARE LINK, INC.**

Developers of LANLink™ and MultiLink Advanced™

400 Esna Park Drive, Suite 18 Toronto (Markham), Ontario L3R 9V2

CALL: 416/477-5480

LANLink™ MultiLink Advanced™ & R-LAN™ are trademarks of The Software Link, Inc.

IBM, PC, & PC-DOS are trademarks of IBM Corp. WordStar 2000, dBASE III, and Lotus 1-2-3 are trademarks of MicroPro, Ashton-