

Electronics Today

\$3.25
MM70924

May 1986

Canada's Magazine for Electronics & Computing Enthusiasts

Troubleshooting

Techniques and Advice

Solid State Light Meter

A rugged project

Speech
Synth
Project



Microlab
Logic Trainer
Digital the easy way

Official Supplier of Computers to Opportunities Canada

BEST Compatibility

BEST computers are designed, manufactured and marketed in Canada by Exceltronix and our associated companies. We have become the largest Canadian manufacturer of microcomputers, a position achieved in a very competitive market.

All BEST computers come with standard features that other manufacturers regard as expensive options. The excellent reliability proved since the range was introduced enable us to offer warranties far, far better than the industry standard.

BEST MK III \$1895.00

- 256K RAM minimum using 41256K chips
- Phoenix BIOS
- Two DS, DD 360K floppy drives
- Colour Graphics Video Board
- Reset Switch
- 150W power supply
- IBM compatible, high quality keyboard
- Seven Expansion slots
- Parallel Printer Port
- Serial Communications Port (RS232-C)
- Real Time Clock/Calendar
- 4.77 and 8MHz

Other Configurations:

With 640K RAM	\$1995
With 10 Meg Hard Drive/1 Floppy/256K	\$2795
With 10 Meg Hard Drive/1 Floppy/640K	\$2895
With 20 Meg Hard Drive/1 Floppy/256K	\$2895
With 20 Meg Hard Drive/1 Floppy/640K	\$2995



Monitor and Printer not included.

BEST AVT-286 \$3495.00

Superb IBM AT Compatibility

- Runs faster than (12MHz) IBM AT but retains superb software compatibility
- 640K RAM standard
- Seven Expansion slots
- 2 Floppy drives, one 1.2 Meg, one 360K
- Colour Video Board with 4 modes of operation
- AT compatible keyboard
- Serial and Parallel Ports
- Heavy Duty Power Supply
- Keyboard lock and status panel

As standard configuration with fast-stepping Hard Drives:

20 Meg Hard Drives	\$4950
30 Meg Hard Drives	\$5475
40 Meg Hard Drives	\$5795



Monitor not included.

Warranty

We have such confidence in the time tested reliability of the BEST that we offer a 300 day warranty which is way above the industry standard. On-site service plan available at extra cost Nation-wide through 3M of Canada Ltd.

Call or Write for our Full Colour Catalogue

Our Spring 1986 catalogue gives full specifications on our IBM AT and XT compatibles, AVT-286, MK II, MK III and MK IV computers plus detailed specifications, with prices on our other products, made or distributed by us.

- PC Expansion Boards
- Modems
- Computer and other chips
- Scopes
- Controller Systems
- Software
- Apple compatible computers and expansion boards
- Printers and supplies
- Monitors, Disk Drives, Hard Disks
- Digital Display Signs

IBM is a registered trade mark of IBM Canada Ltd.



Exceltronix

319 College Street, Toronto, Ont. M5T 1S2
 (416) 921-8941. Order line only 1-800-268-3798
 Ottawa, 217 Bank Street (613) 230-9000
 Visa, Mastercard and American Express accepted.

BEST AVT-286: the IBM AT Compatible

Designed and made in Canada with pride.

Proving once again that Multiflex is an industry leader, by producing more than just affordable alternatives in personal computer design, we are pleased to announce the **BEST AVT-286 Microcomputer**, our new, fast IBM AT compatible. The AVT-286 is based on the 80286 microprocessor. The AVT-286 is supported by the Phoenix AT compatible Bios, the same software house that supplies the Bios for all other BEST computers as well as many of the well known IBM compatibles currently manufactured.

Check the long list of standard features that are included on the new **BEST AVT-286**:

- The AVT-286 runs faster than the (12MHz) IBM AT but retains superb software compatibility.
- The main board features a standard 640K RAM using state-of-the-art memory chips for fast, reliable data processing.
- Seven expansion slots of which five support IBM AT signals. The two remaining slots are compatible with IBM PC or XT peripheral boards.
- Presocketed for the optional 80287 math co-processor
- Two floppy diskette drives, one formatted for a capacity of 1.2 Megabytes, the other for 360K to read and write normal diskettes.
- The BEST Colour Video board which offers the user four modes of operation, composite and RGB output.
- An AT compatible keyboard.
- On board Real Time Clock/Calendar with battery backup.
- Parallel Port (for printers etc.) and Serial Port (for communications).



- Heavy duty Power Supply as standard allows for adding extra cards as well as a Hard Disk without requiring an upgrade.
- Attractive flip-top case.
- A keyboard lock with unique security key which prevents any unauthorised use of the system.

- A front control status panel provides information on the keyboard lock status, reset, power-on, disk activity and parity errors.
- A hardware reset button so the system can restart without having to power down.

The BEST AVT-286

Canadian designed and made, Super IBM AT compatibility, 640K RAM, Two 5.25in. Disk Drives (one high density 1.2Mb, one 360K), Serial and Parallel Ports, High quality keyboard, Keyboard lock and Status Panel. See detailed description above.

Simpler or more complex configurations available at most competitive prices.

\$3495⁰⁰

As standard configuration with a 20 Megabyte, fast stepping Hard Drive and Controller.

\$4950

Warranty

We have such confidence in the time tested reliability of the BEST that we offer a 300 day warranty which is way above the industry standard. On-site service plan available at extra cost.

The BEST IBM AT Compatible 4 Meg Memory Card

In order to take advantage of the memory addressing capabilities of the IBM AT or the BEST AVT-286 business computer, we developed a memory card to give the user up to 4 Megabytes of dynamic RAM. The memory card will run at speeds up to 16MHz, which is fast enough to meet the needs of any 80286 microprocessor on the market today. The design uses state-of-the-art (256K x 9) memory arrays, to allow for maximum memory in the smallest physical space. The ninth bit is used as a parity bit to insure the validity of the data. The card is available in memory sizes from

512K to 4 Megabytes in steps of 512K. Boundaries are switch selectable above 1 Meg in blocks of 512K.

With 512K	\$ 695
With 1 Meg	\$ 895
With 4 Meg	\$1995

Attention IBM Owners!

BEST AT Compatible Enhancement Card
This card includes the following features: Two Serial Communications Ports, One Parallel Printer Port and Memory starting from 128K to 512K in selectable boundaries. This card will allow IBM AT user with 256K or 512K of on-board memory to

expand that AT machine to full 640K capability as well as provide them with two serial ports and one parallel port.

..... \$299.00

Printers

Star Micronics SG10	\$379.00
Star Micronics SG15	\$599.00

Monitors

ZVM 1220A Amber Composite ..	\$135.00
ZVM 1230A Green Composite ..	\$135.00
ZVM 124 TTL Amber	\$229.00
ZVM 133 RGB Monitor	\$759.00

Call or write for our free 24-page catalogue.

Exceltronix

319 College Street, Toronto, Ont. M5T 1S2
(416) 921-8941. Order line only 1-800-268-3798
Ottawa, 217 Bank Street (613) 230-9000
Visa, Mastercard and American Express accepted

Circle No. 2 on Reader Service Card

Toronto Computing Centre Inc.

Formerly Surplustronics

**8088 Computer Systems
with 90 day Warranty**



From \$995

- Includes:
- 8088 motherboard
 - High quality legal Bios
 - One DS,DS 360K Drive
 - Power Supply with Fan
 - Keyboard
 - Flip-Top case
 - Disk Controller
 - With plenty of spare slots
 - All you need for complete System is Video Board
 - Colours: \$159.00
 - Mono \$159.00

8088 motherboard with 256K (expandable on board to 640K) Fully assembled and tested with legal Bios, Flow soldered provision for 8087.

\$339

AT Compatible Motherboard call for Best Price.

256K Memory

41256 (150nS)	\$ 5.55
Set of 9	\$49.49

64K Memory

4164 (150nS)	Please Call
--------------	-------------

Set of 8088, 8255A-5, 8237A-5, 8288, 8284, 8253A-5, 8259A \$45.00

IBM Compatible Keyboards

Maxiswitch	\$135.00
Keytronics 5151	\$195.00
IBM & Apple Compatible	\$149.00
AT Compatible	\$179.00

Printers

Copal SC550001	
180 cps, 132 column	\$699.00
Copal SC1500T	
180 cps, 80 column	\$499.00
Copal SC1200L	
120 cps 80 column	\$329.00

IBM Peripheral Cards

Colour Video Board	\$159.00
Monochrome Video Board	\$159.00
Floppy Controller with RS232	\$139.00
Floppy Controller	\$ 99.00
Modem 300 Baud	\$179.00
Multifunction Floppy Board	\$199.00
Multi I/O card with cables	\$175.00
Parallel and Game Port Card	\$ 59.00
Cable and connector extra.	
Peripheral Interface Card	\$159.00
Includes two serial ports, parallel port, game port and provision for (but not including) real time clock.	

Hard Drives
Half-height, with
Controller and Cables

10 Meg\$639.00
20 Meg\$975.00

Disk Drives for IBM Computers

Toshiba, 5 1/4" slimline, DD, DS 360K, 40 track	\$169.95
---	----------

Monitors

Zenith ZVM1230 Green and ZVM1220 Amber	\$135.00
Tatung, TTL, Hi-Res, 22MHz	\$199.00
Tatung Colour Switchable to green or amber	\$649.00
JIL 14in, composite RGB and NTSC	\$549.00

Complete 6502 Board

- Assembled and fully tested (flow soldered)
 - 64K, 80 x 24 video with soft-switch, floppy controller.
 - System comes with blank EPROM's on board, does not come with any proprietary software or Basic
-\$199.00

Complete System

- Using 6502 board above in IBM style flip-top case, using powerful 75 watt power supply with fan, programmable serial keyboard adaptor, IBM style keyboard

As above with one built in disk drive	\$699.00
As above with two drives	\$879.00

6502 Power Supply

For 6502 Case. CSA Approved 5V, 5A, + 12V 2.5A, -5V 0.5A, -12V 0.5A.	\$69.00
--	---------

Kepeco Power Supply

5V 5A,+12V 2.8A,+12V 2A, -12V 0.5A, Open Frame	\$38.95
--	---------



SALE ITEM

Panasonic Printers — Sale

Open Frame	\$29.95
ideal for experimenters. No warranty.	

**We carry a wide selection of
PC and AT Peripheral
Cards.**

Clock/Calendar Option	\$ 29.00
With battery backup.	
256K & Multifunction Board.	
Includes: Serial port, parallel port, game port, provision for optional real time clock/calendar and socketed for up to 256K RAM.	
With 64K RAM	\$149.00
With 256K RAM	\$299.00
512K Board. Socketed for 512K including:	
64K RAM	\$149.00

We have changed our name. We felt our previous name of Surplustronics did not properly describe our line of quality products. Service and prices are still the best available to which we now add warranties on most products.

IBM Style Power Supply

135W, + 5V 13A, -5V 0.5V, + 12V 4.5A, -12V 0.5A	\$145.00
150W	\$155.00
220W	\$259.00

Power Bars with

Surge Protectors\$49.95

Apple Cards

Assembled, flow-soldered/cleaned and 100% tested	
16K RAM Card	\$ 49.00
80 x 24 video card	\$ 69.95
Z80A Card	\$ 59.00
Parallel Printer Card (cables extra)	\$ 49.00
Parallel Printer Card with cable	\$ 69.00
128K RAM Card with 128K	\$ 99.00
EPROM Programmer with Software (programs 2716, 2732, 2732A, 2764)	\$ 79.00
Z80/64K Card	\$119.00
Serial Card (cable extra)	\$ 69.00
Floppy Controller	\$ 44.00
Prototyping Board	\$ 14.95

Modem Bargain!

Apple Compatible plug-in Autoanswer, Autodial, Touch Tone or Pulse Dial. Excellent for use with most Bulletin Boards. 300 Baud. Final Sale as is \$39.95

Apple Compatible Slimline

Disk Drives 5-1/4" \$179.00

Apple Compatible Modem \$159.00



Plugs into your Apple or compatible computer, Direct connect, 300 Baud, Autodial, Autoanswer, Touch Tone/Pulse Dial, complete with documentation.

IBM Style Case \$75.00

Suitable for

8088 or
Apple
Boards



AT Style Case\$169.00

Mail Orders add \$7.50 minimum for shipping & handling. Ontario residents add 7% P.S.T. Visa, Mastercard and American Express cards accepted: send card number, expiry date, name of bank and signature. Send certified cheque or money order, do not send cash. All prices on this page are final sale. No warranty, No returns, No refunds but HUGE savings. Warranties available at extra cost.

More lines
to serve you better **(416) 960-1350**

Toronto Computing Centre Inc. 310 College Street, Toronto, Ontario M5T 1S3



Our Cover

The Microlab 1 trainer serves to illustrate both our troubleshooting theme and its own review, which is on page 34; photo by Bill Markwick.

Electronics Today is Published by:
Moorshead Publications Ltd.
 (12 times a year)
 1300 Don Mills Road,
 Don Mills, Toronto, Ont. M3B 3M8
 (416) 445-5600

Editor: William Markwick
Assistant Editor: Edward Zapletal
Director of Production: Erik Blomkwist
Production Manager: Douglas Goddard
Production: Naznin Sunderji
 Dolph Loeb
Circulation Manager: Lisa Salvatori
Advertising Account Manager: Marlene Dempster

Publisher: H.W. Moorshead; **Executive Vice-President:** V.K. Marskell; **Vice-President - Sales:** A. Wheeler; **General Manager:** S. Harrison; **Controller:** B. Shankman; **Accounts:** P. Dunphy; **Reader Services:** M. Greenan, J. Fairbairn, R. Cree, L. Robson, N. Jones; **Advertising Services:** H. Brooks; **Advertising Telemarketing:** Rod Macdonald.

Newsstand Distribution:
 Master Media, Oakville, Ontario

Subscriptions:
 \$22.95 (one year), \$37.95 (two years).
 Please specify if subscription is new or a renewal.

Outside Canada (US Dollars) U.S.A. add \$3.00 per year. Other countries add \$5.00 per year.

Postal Information:
 Second Class Mail Registration No. 3955.
 Mailing address for subscription orders, undeliverable copies and change of address notice is:
 Electronics Today, 1300 Don Mills Rd., Toronto, Ontario, M3B 3M8

Printed by Heritage Press Ltd., Mississauga
 ISSN 07038984.

Moorshead Publications also publishes Computing Now!, Computers in Education, and Pets Magazine.

Circulation Independently Audited by MURPHY and MURPHY Chartered Accountants.

Advertiser's Index see page 57.

Electronics Today

May 1986
 Vol. 10 No. 5

Canada's Magazine for Electronics & Computing Enthusiasts

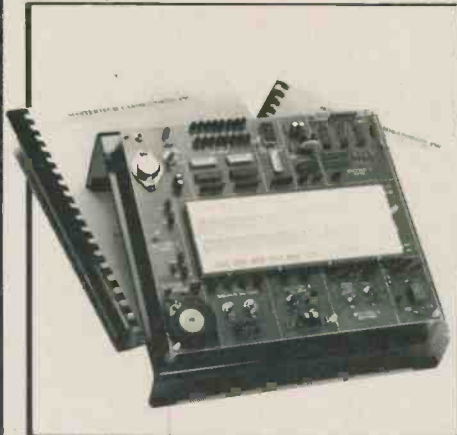

Product Review page 34

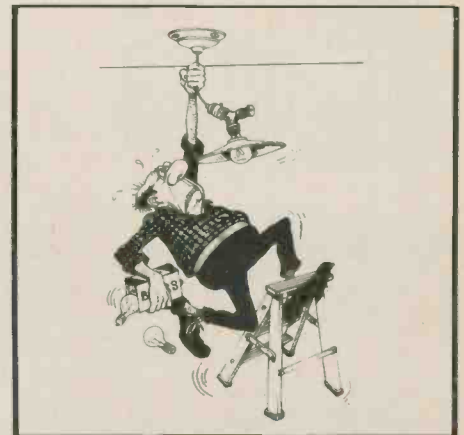

Troubleshooting page 30

Features

Display Technology	14
Troubleshooting	30

Projects

Peripheral Speech Synthesizer	9
Light Meter	21
Courtesy Light Extender	47

Product Review

Microlab 1 Trainer	34
--------------------	----

Series

For Your Information	6
The Beginner's Bench, Part 1	38
Designer's Notebook: Better by Design	54

Columns and Information

Software	18	Subscriptions	46
Product Mart	20	Books	51
Circuit Ideas	42	Next Month	62
Order Form	45	Computing Now! This Month	63

For Your Information

Omni-Directional Heatsinks



The radial design of the 2296C heatsink utilizes airflow from any direction to cool LSI devices and gate arrays. Designed for forced convection applications with dissipation of power up to 10W, the seven-fin design provides more surface area for heat dissipation than extruded or stamped heat sinks of similar size and volume.

Standing only .695 inches tall and 1.25 inches in diameter, the 2296C comes in gold chromate, clear, or black anodized finishes

for maximum performance in natural convection applications. To receive more information contact: Carol Cannon, Thermalloy Inc., P.O. Box 810839, 2021 West Valley View Lane, Dallas Texas 75381-0839, (214) 243-4321.

Circle No. 34 on Reader Service Card.

New Backup System for Hard Disks

Looking for an inexpensive, yet reliable form of backup, for your precious hard disk information? Well, stop looking. Alpha Micro of Santa Clara, California, has come up with a nifty system that utilizes a standard video cassette recorder (VCR). That's right!

The Videotrax (TM) videotape backup and restore subsystem consists of a special video controller board which links the VCR to any IBM PC/XT/AT or compatible hard disk, providing up to 80MB of highly reliable backup information.

The board is at home in any of the available expansion slots, and the MS-DOS menu driven software



resides on a 5.25" floppy disk. One of the more attractive features is the use of regular, inexpensive consumer quality video tapes for making the actual backup; a two hour video cassette gives 80MB of storage. This gives the system an advantage in cost-efficiency, convenience, and reliability over both floppy disk and streaming tape backup and restore methods.

Two modes of operation are possible with the software: disk

image and file-by-file. The disk image mode allows for high-speed backup and automatic detection of bad disk sectors for reassignment. The file-by-file mode permits backup of all files, specific files by name, file groups or selected files modified in prior sessions. Tape quality checks, full backup verification, a file directory, and audit trail are all available to the user through the software.

With the Videotrax's capability of transmitting pure video signal data, it's possible to send stored information over satellite, cable, and regular broadcast systems at a considerably reduced cost in comparison to present data communications methods.

Alpha is offering the Videotrax in two configurations: the videotape subsystem which includes the controller, software, and a computer controlled VCR (all tape functions such as play, fast-forward, etc. controlled by the software) for \$2290; and the second configuration, for those with their own VCRs, carries a current list price of \$995 (controller and software). The computer controlled VCR is available separately at a cost of \$1295. The Videotrax is available across Canada through Olivetti office equipment dealers.

For more information contact: Paul Manina, Vice President Micro Computing Products, Olivetti Canada, 3190 Steeles Ave. E., Markham, Ontario, L3R 1G9.

Circle No. 35 on Reader Service Card.

LOGIC PROBES FOR LOGICAL PEOPLE

CHOOSE THE PERFORMANCE YOU NEED FROM THE NUMBER ONE CANADIAN SOURCE FOR PROBES AND TEST LEADS

SPECIFICATION	PROBE LP10A	PROBE LP25	PROBE LP50	PULSER PR41	PULSER PG-1K
Frequency	17MHz	25MHz	50MHz	0.5/400Hz	1000Hz
Pulse Width	30nS	30nS	20nS	10uS	2uS
Input Limits	200V AC/DC	200V AC/DC	40V		
Fused Input	No	No	Yes		
TTL Levels 1/0	2.3/0.8	2.3/0.8	2.0/0.8		
CMOS Levels 1/0	70%/30%	70%/30%	70%/30%		
Input Impedance	1M	1M	1M/20pf		
Readout Display	3-led	3-led	7 segment		
Pulse Memory	Yes	Yes	No		
Tone Generator	No	Yes	No		
Illuminated Tip	No	No	Yes		
Replaceable tip	No	No	Yes	No	Yes
Output Cur.(max)				100mA	400mA
Variable pulse rate				No	1-50 pps
Single pulse				No	Yes
SYNC Input				Yes	No
Price*	\$33.00	\$71.50	\$95.00	\$82.50	\$85.00

PROBES AND PULSERS COMPATIBLE WITH TTL AND CMOS

*Includes F.S.T. Add \$2.00 for shipping. Ontario orders add 7%.

BCS Store Hours:
Mon-Fri 8 to 5, Sat. 10 to 1.

VISA & MASTERCARD accepted



980 Alness St. Unit 7,
Downsview Ontario
M3J 2S2 (416) 661-5585
TELEX 065-28169

Circle No. 4 on Reader Service Card

Contest Update: We said we'd draw for the contest winner and publish it in the May issue. Gulp... we messed up the timing on this one, because the May issue has to be at the printers at the end of March. The deadline is still April 15, but the results will have to wait until the next issue. The winner will still be notified as mentioned in the rules. Our apologies for making everybody wait, and we've bought a bigger calendar.

Electronics Today May 1986

Copyright

All material is subject to worldwide copyright protection. All PCB patterns are copyright and no company can sell boards to our design without our permission.

Liability

While every effort has been made to ensure that all constructional projects referred to in this magazine will operate as indicated efficiently and properly and that all necessary components are available, no responsibility whatsoever is accepted in respect of the failure for any reason at all of the project to operate efficiently or at all whether due to any fault in the design or otherwise and no responsibility is accepted for the failure to obtain component parts in respect of any such project. Further no responsibility is accepted in respect of any injury or damage caused by any fault in design of any such project as aforesaid.

Editorial Queries

Written queries can only be answered when accompanied by a self-addressed, stamped envelope. These must relate to recent articles and not involve the staff in any research. Mark such letter Electronics TodayQuery. We cannot answer telephone queries.

Binders

Binders made especially for Electronics Today (ETI) are available for \$9.75 including postage and handling. Ontario residents please add provincial sales tax.

Back Issues and Photocopies

Previous issues of Electronics Today Canada are available direct from our office for \$4.00 each; please specify by month, not by feature you require. See order card for issue available.

We can supply photocopies of any article published in Electronics Today Canada; the charge is \$2.00 per article, regardless of length. Please specify both issue and article.

Component Notation and Units

We normally specify components using an international standard. Many readers will be unfamiliar with this but it's simple, less likely to lead to error and will be widely used everywhere sooner or later. Electronics Today has opted for sooner!

Firstly decimal points are dropped and substituted with the multiplier: thus 4.7uF is written 4u7. Capacitors also use the multiplier nano (one nanofarad is 1000pF). Thus 0.1 uF is 100nF, 5600pF is 5n6. Other examples are 5.6pF = 5p6 and 0.5pF = 0p5.

Resistors are treated similarly: 1.8Mohms is 1M8, 56kohms is the same, 4.7kohms is 4k7, 100ohms is 100R and 5.6ohms is 5R6.

PCB Suppliers

ETI magazine does NOT supply PCBs or kits but we do issue manufacturing permits for companies to manufacture boards and kits to our designs. Contact the following companies when ordering boards.

Please note we do not keep track of what is available from who so please don't contact us for information PCBs and kits. Similarly do not ask PCB suppliers for help with projects.

K.S.K. Associates, P.O. Box 266, Milton, Ont. L9T 4N9.

B—C—D Electronics, P.O. Box 6326, Str. F., Hamilton, Ont. L9C 6L9.

Wentworth Electronics, R.R. No. 1 Waterdown, Ont. L0R 2H0.

Danocinths Inc., P.O. Box 261, Westland MI 48185 USA.

Arkon Electronics Ltd., 409 Queen Street W., Toronto, Ont., M5V 2A5.

Spectrum Electronics, 14 Knightswood Crescent, Brantford, Ontario N3R 7E6.

Drive A Winner!

Presenting the full line of kitted, add-in Winchester disk drives from Tandon and Varah's Direct. All at great sale prices!

Since Varah's Direct first introduced Tandon's terrific new Winchester drive kits, we've been fighting to keep up to the demand. No wonder they're so popular — never has so much capacity been made available so easily and inexpensively!

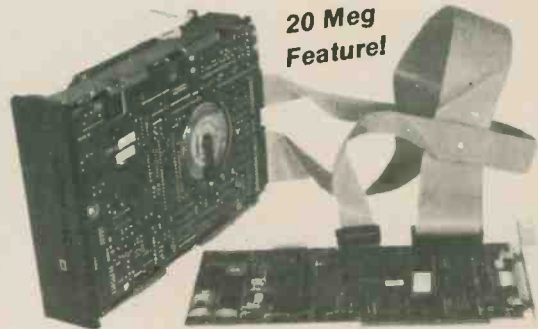

- Fully pretested and formatted.
- Easy to follow instructions.
- Complete 90-day warranty.
- Simply plug in, boot up and go!

Suggested List \$999

Limited Time Offer -

❖❖❖ \$879 complete ❖❖❖

A screwdriver and one of these complete drive kits from Tandon instantly gives you up to 40MB of extra storage capacity. Direct to you from the world's #1 disk-drive manufacturer ... with controller card, cables, and all accessories for guaranteed do-it-yourself installation!

To order your drive kit, write us or call (416) 842-8833 between 8:30 and 6:00 (EST), Monday to Friday. Quantities are limited, so act now!

IBM or Compatible	360KB Kit 1/2 Height Floppy	10MB Kit 1/2 Height Winchester	20MB Kit 1/2 Height Winchester	20MB Kit Full Ht. Winchester	DISKARD 21 21 MByte Card	40MB Kit 1/2 Height Winchester	40MB Kit 1/2 Height Winchester
PC							
XT							
AT							
Access Time	90 mS	85 mS	80 mS	40 mS	80mS	35 mS	35 mS
Varah's Direct Stock Number	62601 *	62611	62621	62625	62622	62640	62645 *
Introductory Price	\$169	\$729	\$879	\$999	\$1199	\$1899	\$1499
* Indicates compatibility						*No controller card needed	



For more information on the complete line of electronic components and supplies offered by Varah's Direct, write, circle, or call today for your free copy of the:

1986 Varah's Direct Reference Guide & Mail Order Catalogue

Not just a price listing, this is a fully referenced book supplying pin-outs, electrical specs, and dimensions on over 2500 items from our multi-million dollar industrial inventory. Contact us today for your free copy!

Varah's direct

LOCATIONS:
Vancouver
Edmonton
Calgary
Winnipeg
Oakville
Nepean

WRITE:
Varah's Direct
504 Iroquois Shore Rd.
Oakville, Ontario
L6H 3K4
(please include your
return postal code)

CIRCLE:
The reader service
number for this ad
OR CALL:
(416) 842-8833
Monday to Friday
8:00 - 6:00 E.S.T.

Tek's best-selling 60 MHz scopes: Now 25 ways better for not a penny more!

Now Tek has improved its 2213/2215 scopes with brighter displays. Greater accuracy. And more sensitive triggering. At no increase in price.

The 60 MHz 2213 and dual time base 2215 have been the most popular scopes in Tektronix history. Now, Tek introduces an "A" Series update with more than 25 specification and feature enhancements—things you have asked for such as single sweep—all included at no added cost.

A brighter display and new vertical amplifier design provides sharp, crisp traces.

That makes the 2213A/2215A a prime candidate for tasks like TV troubleshooting and testing, where fast sweeps are typical.

New features include 10 MHz bandwidth limit switch, separate A/B dual intensity controls (2215A only), and power-on light: additions customers have suggested for

giving these scopes the final measure of convenience.

Triggering, sweep accuracy, CMRR and many more major specifications are better than ever.

Check the performance chart: not bad for scopes already considered the leaders in their class!

The Price: Still \$2206* for the 2213A and \$2638* for the 2215A. Or, step up to the 100 MHz 2235 for just \$3114*. Prices include two 10X probes, 15-day return policy, world-wide service back-up and comprehensive 3 year

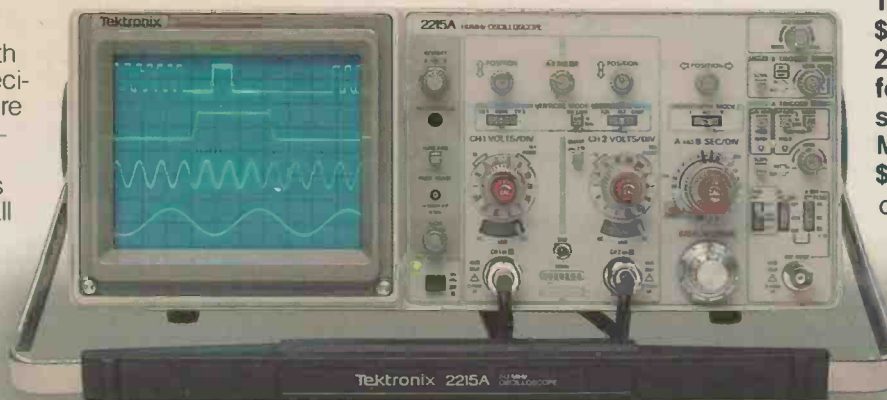

Specification enhancement	2213/2215 "A" Series	2213/2215
CRT brightness	14 kv accel. potential	10 kv accel. potential
Vertical accuracy	3%, 0° to 50°C	3%, +20° to 30°C
Chop rate	500 kHz	250 kHz
Input capacitance	20 pF	30 pF
CMRR	10 to 1 at 25 MHz	10 to 1 at 10 MHz
Channel isolation	100:1 at 25 MHz	Not specified
A Trigger sensitivity (int)	0.3 div at 5 MHz	0.4 div at 2 MHz
TV triggering	1.0 div compos. sync	2.0 div compos. sync
Sweep accuracy (in 10X)	4%, 15° to 35°C	5%, 20° to 30°C
Delay jitter	20,000 to 1 (2215A) 10,000 to 1 (2213A)	10,000 to 1 (2215) 5,000 to 1 (2213)
Holdoff Range	10:1	4:1

warranty. Ask about our extended warranty.

Talk to our technical experts.

Vancouver	604-291-1222
Calgary	403-250-7583
Edmonton	403-434-9466
Winnipeg	204-632-4447
Toronto	416-675-3865
Ottawa	613-225-2850
Montreal	514-697-5340
Dartmouth	902-469-9476

*Duty and F.S.T. Included.
Prices subject to change without notice.
All scopes are UL listed and CSA approved. 3-year warranty includes CRT and applies to 2000 family oscilloscopes purchased after 1/1/83

Tektronix Canada Inc.
P.O. Box 6500
Barrie, Ontario
L4M 4V3

Tektronix
COMMITTED TO EXCELLENCE

Parallel Speech Peripheral



An inexpensive vocal add-on for your micro.

By David R. Green

THE FOLLOWING is a description of how to construct your own speech processor peripheral for about \$20 to \$75 depending on how well stocked your junkbox is. The speech unit interfaces to a centronics print or user parallel port allowing almost any micro to obtain easy speech capability.

Since actual speech requires only 10 to 12 sounds per second, this unit can be driven from a BASIC program, by sending each successive address for each allophone sound. The only caution is: unless you have a fast processor/BASIC interpreter in your micro, don't use read and data statements as it will cause minute delays between some allophones as the processor runs through the program looping to and from the data statements. Also, to end a word, you must send a pause, varying in length from PA1 through PA5, to stop the speech processor from vocalizing the last allophone.

Circuit Description

This unit is so simple it defies description, but here we go anyway. Referring to the block diagram, the 74LS245 buffers the Electronics Today May 1986

data and control lines between the computer I/O port and the speech processor. The LS245 is enabled only when pin 11, the EN pin, is grounded. This usually occurs when the cable is plugged into the connector on the speech peripheral.

Referring also to the timing diagrams, the computer sets up the data on the I/O data bus, allowing for bus settling time, then pulses the handshake STROBE line low. This loads the data into the address latch buffer area of the SPO256-AL2 speech processor, which in turn utilizes this data to generate an internal address for the appropriate speech sound data location in the internal 16k ROM. The speech processor then shifts the speech sound data out of the digital out pin. At the same time as this, as soon as data is removed from the input address latch buffer area, the speech processor asserts the LRQ line and lowers the SBY line, signalling to the computer to send the next allophone address.

The low pass filter comprised of the 33k resistors and the u022 disc capacitors, eliminates clocking noise above 5kHz generated internally in the speech chip.

The LM386 and its associated components form an amplifier with a gain of 200 to supply sufficient level to drive the speaker and line output terminals.

Construction

As this is a reasonably simple unit, almost any technique may be used, perfboard or printed circuit.

The majority of the passive components are not critical in value, but try not to stray too far off. Referring to the schematic diagram, depending on what you have for power supplication, a complete +5 and +12 supply might have to be built. As little as +5 volts may be used to operate the LM386 audio IC supplied by the on-board 7805, but I chose to run it at +12 volts to obtain the maximum power output capability. Be sure you do not supply more than +12 volts to the audio IC as its absolute maximum specification is +15 volts.

Also, if you use a wall adaptor or build your own supply, be sure it is well filtered and regulated so as not to introduce hum in the audio.

The SPO256-AL2 speech chip is

Parallel Speech Peripheral

available from Radio Shack (cat # 276-1784) for about \$20. It comes complete with a full set of instructions including the allophone address chart.

your interpreter uses, send the decimal or hex value for the specific allophone required to the peripheral.

The 3.12 MHz crystal for the unit was not as easily available, so instead I used a 3.2768 MHz crystal which is only about 5 faster and simpler to get.

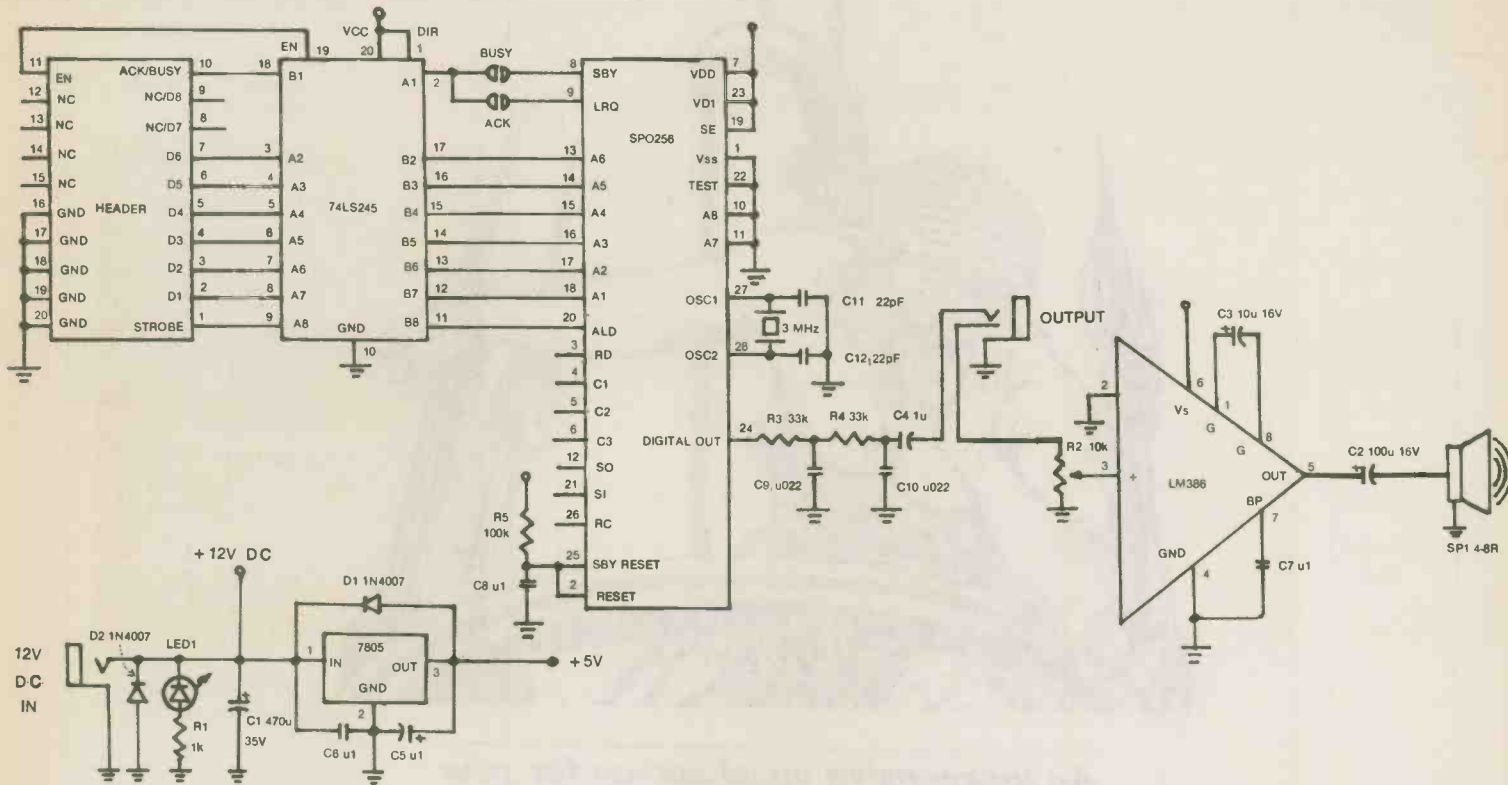
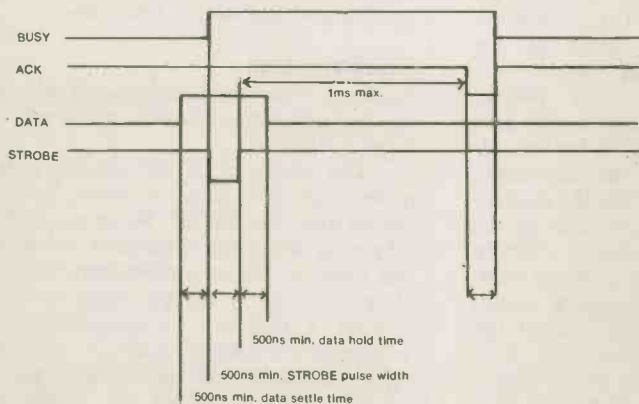

Fig. 1. Circuit for the speech peripheral.

Centronics Timing Diagram



NOTE: Rise and fall times of each signal must be less than 0.2μs.

SPO256-AL2 Timing Diagram

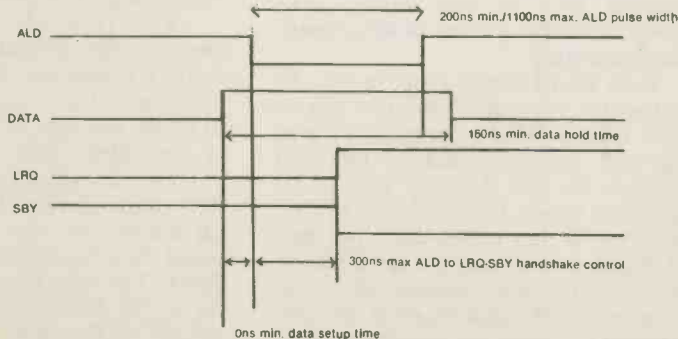

Fig. 2. Timing diagrams for the two types of connectors

Subscribe now to Computing Now!

Computing Now! is from the publishers of Computers in Education and Electronics Today and offers full coverage of what's happening in Canadian microcomputing. Get the most out of your micro with:



Listings!

From the ZX81 to CP/M to MS-DOS; programs for business use or just for fun.

Reviews!

The newest computers, the latest peripherals. Software, book reviews, and interesting gadgetry.

Programming!

Articles and discussions on how to solve those programming bottlenecks.

Systems!

If you're looking for a business system, you'll find information that lets you find the most efficient, most economical equipment for your needs.

Subscribe now:

\$22.95 for one year (12 issues) or \$37.95 for two years (24 issues).

Computing Now!

1300 Don Mills Road,
Don Mills,
Toronto, Ontario
M3B 3M8
Telephone (416) 445-5600

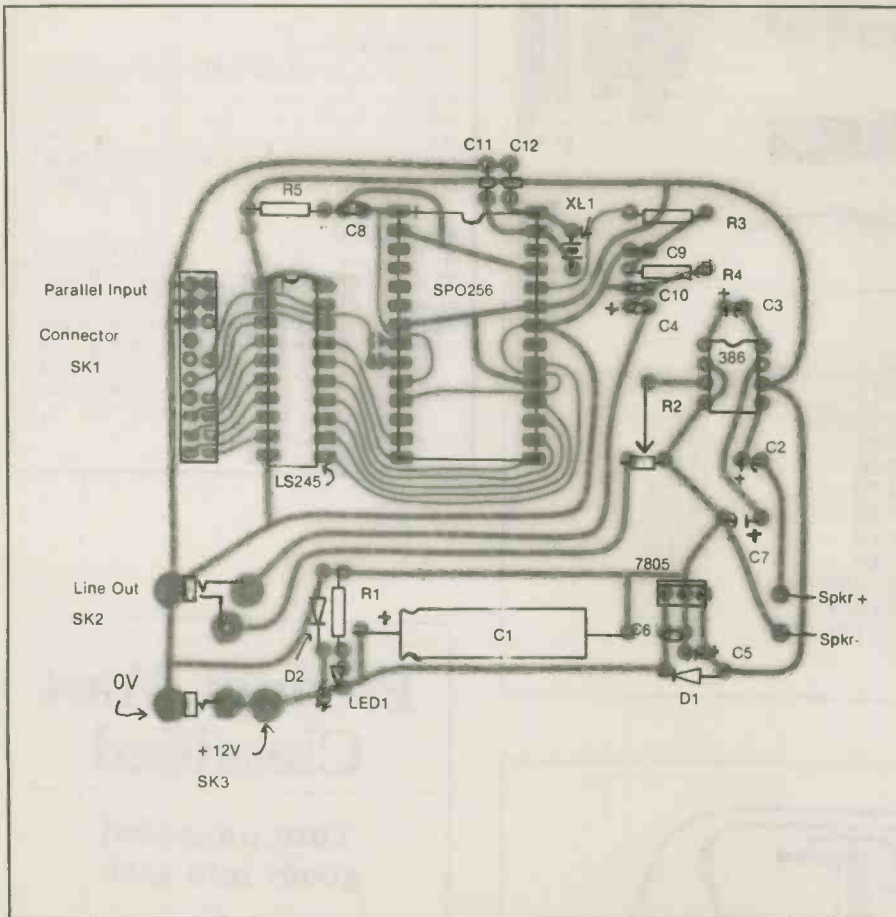
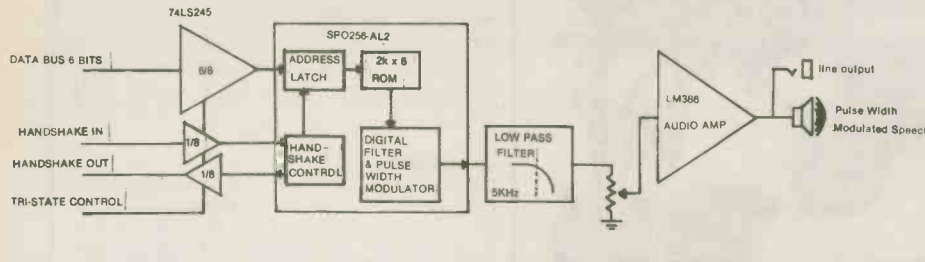

Fig. 4. Parts overlay.

Although many people complain about the use of the LM386 audio IC, I find it sufficiently loud when used in a high gain circuit and driving a reasonably decent speaker. If it is still not loud enough for you, the circuit includes a line out jack that can be hooked to your monitor, if it has audio in, or to an external high power audio system.

Programming

From BASIC, OPEN the parallel port or enable your print card. Using POKES, PRINT CHR\$(xx), or whatever method eg. TI-99/4A BASIC

10 OPEN#1:'PIO.LF.CR'
20 PRINT#1:CHR\$(27);CHR\$(7);

Electronics Today May 1986

CHR\$(45);
CHR\$(15);CHR\$(53);CHR\$(0)
30 CLOSE#1
40 END

If you are using a printer port, be sure to suppress any automatic line-feed or carriage-return codes, or the unit will talk forever.

**PRODUCT MART
CLASSIFIED
CALL (416) 445-5600**

Parallel Speech Peripheral

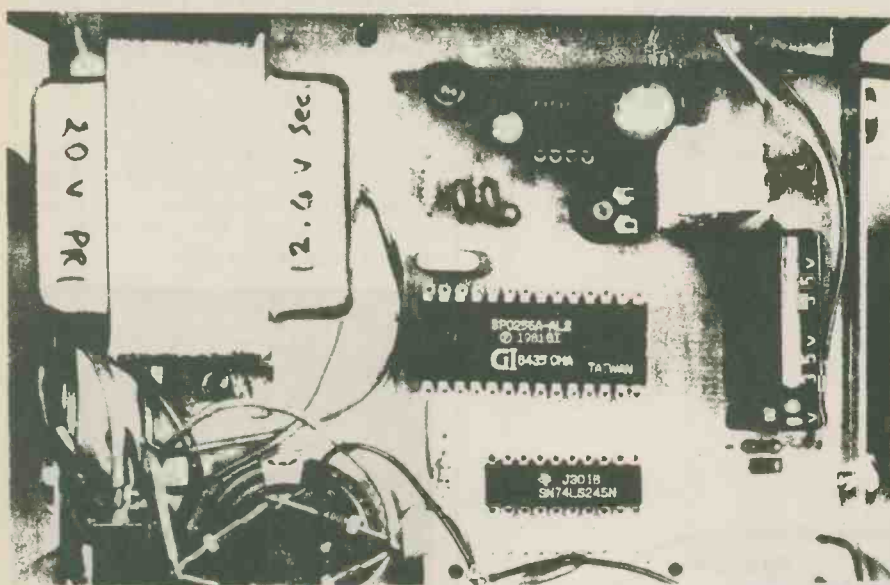

Table 1

Centronics pinout (pins 1-20)		Peripheral Connector pinout	
1 STROBE	11 BUSY	1 STROBE	11 EN
2 D1	12 Po	2 D1	12 NC
3 D2	13 STAT	3 D2	13 NC
4 D3	14 AFXT	4 D3	14 NC
5 D4	15 NC	5 D4	15 NC
6 D5	16 GND	6 D5	16 GND
7 D6	17 GND	7 D6	17 GND
8 D7	18 NC	8 D7/NC	18 GND
9 D8	19 GND	9 D8/NC	19 GND
10 ACK	20 GND	10 ACK/BUSY	20 GND

Parts List

Resistors 1/4W 5%

R1	1k
R2	min. p.c. pot10k
R3,433k
R5	100k

Capacitors

C1470uF 35V electro.
C2	100uF 16V electro.
C3	10uF 16V electro.
C4,5	1uF 35V tantalum
C6,7,8u1 disc
C9,10u022
C11,1222pF

Semiconductors

IC1	SPO256-AL2 speech processor
IC2	74LS245
IC3	LM386
IC47805
LED1	Radio Shack #276-041
D1,2	1N4007

Miscellaneous

XL1	3.12MHz crystal
SK1	20 pin, 0.1 in. header, 3M #3428
SK2	pc mount RCA-type jack
SK3	2 conductor closed circuit jack
PL1	20 pin, 0.1 in. insulation disp. plug, 3M #3421
SP12-4 in. 4 or 8 ohm speaker

case; +12V power source

Product Mart Classified

Turn unneeded goods into cash

Sound like a real challenge? It doesn't have to be. Not when you employ low-cost Product Mart advertising to sell the things you no longer need. Classified works for you by putting your selling information in the hands of people who are ready to buy. Call today for assistance in wording and placing your advertisement for maximum response.

Call (416) 445-5600

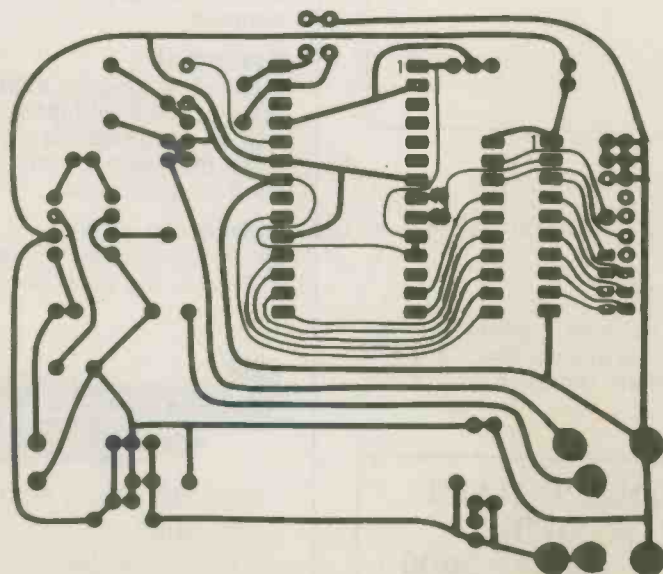

Fig. 5. Printed circuit artwork.

MARKET PLACE

MARKET PLACE

A New Inexpensive Way to Help You Do One Thing —

SELL MORE PRODUCTS

For more information or to place an AD
Call Marlene Dempster
(416) 445-5600

IBM COMPATIBLE COMPUTERS

BEST PRICES

ORION 640K TURBO
5XT MOTHER BOARD **\$849.00**
100% IBM Compatible

IBM Compatible Boards

	Price
* 1F02 384K Multifunction (S/P/G) OK	\$.175.00
* 1F03 384K RAM Ver 11 OK	\$. 89.00
* 1F03 512K RAM Ver 11 OK	\$. 99.95
* 1F05 Color Graphic	\$.119.00
* 1F06 Monochrome	\$.119.00
* 1F07 Mono-Graphic with printer port	\$.175.00
* 1F09 1M + II + (S/P/G)	\$.115.00
* 1F11 Parallel Printer (Cable extra)	\$. 35.95
* 1F12 Serial — RS232C	\$. 49.95
* 1F13 Game	\$. 29.95
* 1F14 Floppy Drive Controller + Cable	\$. 85.95
* 360K DS/DD Disk Drive	\$.125.00
* XT Compatible Mother Board OK	\$.225.95

IBM Hard Disk Drives

	Price
10M External w/power supply	\$.799.00
10M Internal	\$.799.00
20M Internal	\$.799.00
30M Internal	\$.1099.00

DISKETTES (Box of 10)
LIFETIME WARRANTY

Orion SS/DD	\$. 14.95
Orion DS/DD	\$. 17.50
Datatech SS/DD	\$. 15.95
Datatech DS/DD	\$. 19.95
Verbatim (Bonus) SS/DD (Box of 11)	\$. 15.95
No Name DS/DD	\$. 12.50

ORION ELECTRONIC SUPPLIES INC.
40 Lancaster St. W., Kitchener
(519) 576-9902

WAREHOUSE SALE

With this coupon

\$2.00 worth of Free Parts

AT OUR HUGE SURPLUS WAREHOUSE
Monday-Saturday 10:00 am — 5:00 pm at
20 Beverly Street, Toronto
416-977-0520

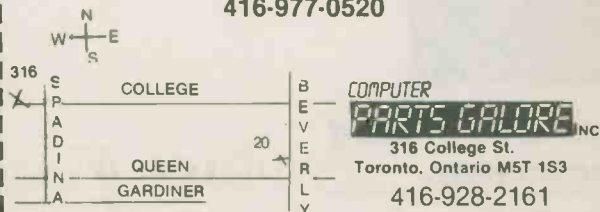

WE HAVE THOUSANDS OF ITEMS FOR SALE, ALL KINDS, OF POWER SUPPLIES AND CONNECTORS, ETC ETC, ALL THE SAMPLES WE HAVE LEFT OVER FROM THE APPLE CLONE ERA, ALL THE DEFECTIVE GOODS THAT WE DO NOT WANT TO REPAIR. ALL AT LOW LOW PRICES FOR THE HOBBYIST.

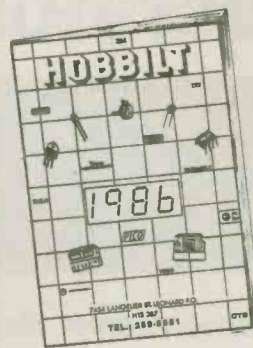

Yes. Yes!
its out! (FINALLY)

GET YOURS
NOW !

Return this
coupon and receive your
FREE copy.

Complete selection of
Electronic Supplies

HOBBYIST

7454 LANGELIER ST-LEONARD QUE. H1S 3B7

1st Annual

SPRING INTO ACTION



Join us as we bid farewell to our 1st wonderful winter and welcome in a new season of savings

Varah's direct

10% off

Simply send in this coupon with your order from our catalogue & receive 10% off our already low prices!

WHAT? You haven't sent in for your free copy of the 1986 Varah's Direct Catalogue.

Well hop to it! See page 7 of this or any other edition of *Electronics Today*. Or call (416) 842-8833.

*Offer expires June 30th, 1986



Display Technology

Some recent developments in solid state display technology.

By Keith Brindley

IT'S only right that we should give priority to age, and the CRT is certainly getting on a bit. It has been around for a hundred years or so in one form or other, although only as a display device in televisions since about 1930.

The resolution of a CRT display is dependent primarily on the distance between the phosphor spots produced by the electron beam as it forms the picture. In a colour CRT, the resolution depends on the distance between triads of primary colour spots, which in turn is dependent on the accuracy of the shadow mask used to direct the three beams to their respective colour phosphors. CRTs with spot distances (known as pitch sizes) as small as 0.2mm have been made, but typical television CRT displays have pitch sizes of about 0.6mm. In terms of resolution, the CRT has a way yet to develop, but we can expect television pictures of tremendous clarity from high resolution CRTs.

The problems associated with CRTs are not to do with picture clarity. They are large, ungainly and heavy; their depth is often as big as or greater than the screen size. They consume a lot of power, up to 200 watts or so. They are fairly easily damaged. None of this is any great disadvantage for AC-powered, fixed-site equipment, as long as you don't mind your television taking up all of the corner of the living room, or your computer taking up most of the room on your desk. If lightness, durability, and power consumption are important, then the conventional CRT will not do.

Sinclair's flat-screen CRT is one development of a traditional technology. As it stands, however, the device, though ingenious, is monochrome, difficult to view and constrained by its very ingenuity to remain small. Philips is one company developing a flat-screen colour CRT. While similar to the Sinclair device in that the electron beam is side-projected, it is totally different in other respects (Fig. 1). The Sinclair tube uses a familiar electron gun bent through 90 degrees. To engineer such a tube for the accuracy required of colour television would be very difficult. Philips use a single electron beam, like Sinclair, but it scans at three times the normal rate, so it can cover all three spots in a colour triad. It also has an unusual approach to deflection. After reversal of the beam, frame plates bend it to the required spot on the screen. Before hitting the screen the beam passes through an electron multiplier, increasing the number of electrons and so making a brighter spot. ITT and Siemens are the other two companies working on the developments of flat-screen colour CRTs.

The Liquid Crystal Ball

Apart from dabbling at new developments in CRTs (Sony's Trinitron CRT, a single electron beam device, and Toshiba's flatter, squarer tube) the Japanese appear to be leaving major CRT developments such as flat-screen devices well alone. Instead they are concentrating efforts towards flat-panel displays

which do not use electron beams at all.

The main force of their work so far has been in the development of LCD devices, but other technologies will probably form the display devices of the future.

There are a number types of LCDs, but the principle is the same in all of them (Fig. 2). A layer of liquid crystals is sandwiched between two transparent electrodes. The molecules of

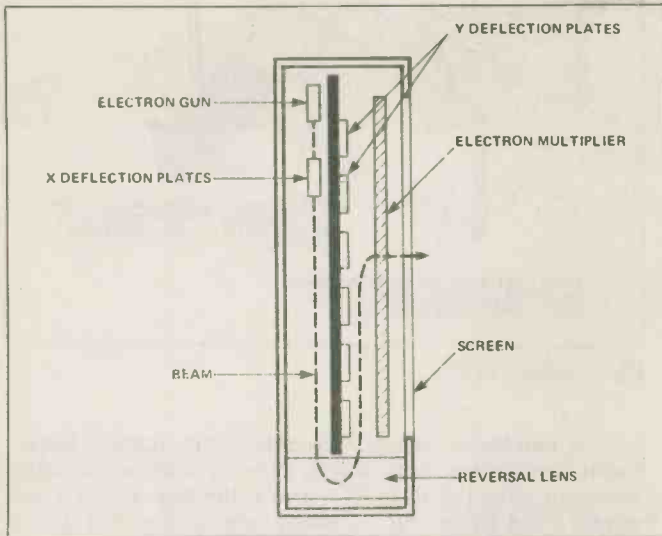

Fig. 1. Philips flat-screen CRT (simplified).

the liquid crystals are generally aligned in one direction and so light from behind the device can pass through. When a potential is applied across the electrodes, however, the molecules of the crystals all become polarized into another alignment, which prevents light from passing through the layer, making the layer appear dark.

Three main varieties of liquid crystal are used to make LCDs: nematic, cholestric and smectic (Fig. 3). The major difference is in how the molecules are aligned, and this produces greatly different LCDs.

Nematic liquid crystals are more commonly called 'twisted nematic' crystals, because the crystals sandwiched between the

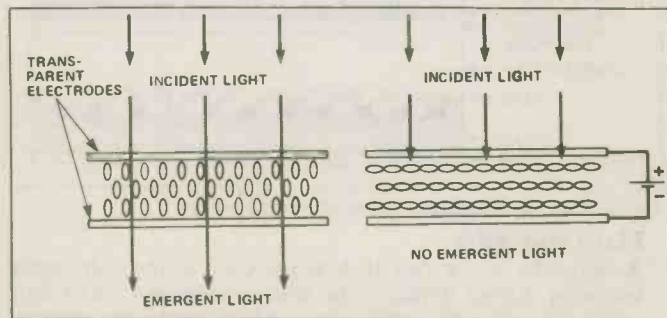

Fig. 2. LCD Operation.

transparent electrodes are twisted through 90 degrees between one electrode and the other when no potential is applied. Polarizing sheets (at 90 degrees to each other) are applied at the front and back of the device, so that light entering the LCD is polarized in one plane by the first polarizing sheet, passes through the liquid crystal where it is twisted through 90 degrees by the twisted nematic structure, then leaves the device through the second polarizing sheet (Fig. 4). Typically the LCD wouldn't normally be used like this, but a reflecting surface would direct the emergent light back through the setup, so that an observer on the same side as the incident light would see a transparent area.

Electronics Today May 1986

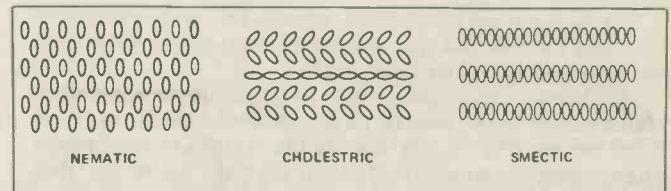

Fig. 3. Temperature dependent structures in liquid crystals.

When a potential is applied across the electrodes, the crystal becomes active, and the molecules are all aligned in one direction. The incident light, which is polarized by the first sheet, now passes through the liquid crystal without being twisted. It cannot pass through the rear polarizing sheet, cannot be reflected, and therefore cannot be seen by the observer. An opaque area is produced.

Cholestric crystals do not need polarizing sheets since a dye is added to the liquid crystal to absorb the incident light. LCDs using this principle are sometimes known as "guest-host"

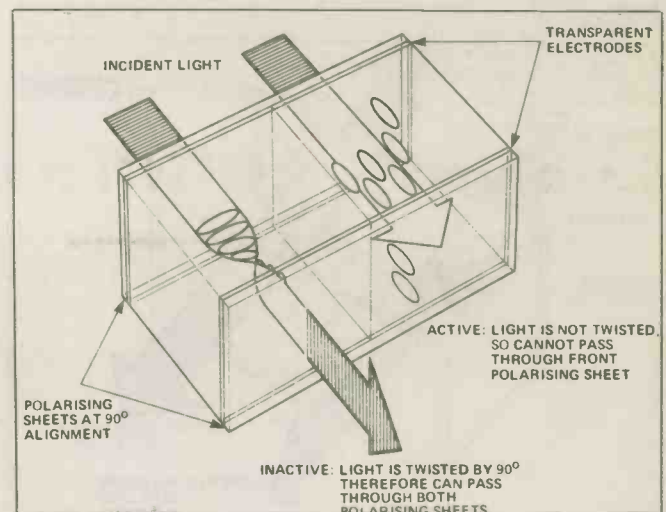

Fig. 4. Twisted nematic LCD.

devices. Dichroic dyes, which produce a different colour depending on which way their cells are aligned, are the "guests" in the liquid crystal "host".

In an inactive state, incident light passing through the liquid crystal is polarized by the natural twist in the structure, and because of the dye the emergent light appears coloured (Fig. 5). As with twisted nematic LCDs, when the activating potential is removed the structure reverts back to its inactive, though this time coloured, state.

Heat Waves

All liquid crystals have several temperature dependent phases, in which the ordering properties of the molecules change. Three phases: isotropic, nematic and smectic are used in smectic liquid crystal devices to create a different type of LCD. Smectic LCDs rely on three phenomena to do their job:

1. In the smectic phase, the molecular arrangement of the liquid crystals cannot be changed by an applied electric field.
2. When liquid crystals are heated to the isotropic phase then cooled to the smectic phase with no applied electric field, they become strongly disordered.
3. When heated to nematic phase, then cooled with an applied electric field to the smectic phase, the orientation of the molecules will be as in the nematic phase.

To exploit these phenomena, smectic LCDs use a matrix of electrical lines so that each display element in the display can be addressed and heated electrically.

By heating the liquid crystals to the isotropic phase, then cooling them to the smectic phase, incident light is prevented from passing (Fig. 6). By heating the crystals to the nematic phase, applying an electric field to align the molecules, then cooling to the smectic phase, incident light is allowed to pass.

The really clever bit is that by maintaining the temperature so that the liquid crystal is held in the smectic phase after it has cooled from an isotropic or nematic phase the crystal molecule arrangement remains fixed at what it was, prior to cooling. Smectic LCDs have a memory facility so that removing the "addressing" potential has no effect. To change the molecular arrangement requires a further addressing, heating and cooling procedure.

Most of the work currently being undertaken into computer-type LCDs is along the smectic lines. One of the latest LCD developments is STL's smectic-A 760 x 420 pixel prototype display which, it is hoped, will be on the market soon.

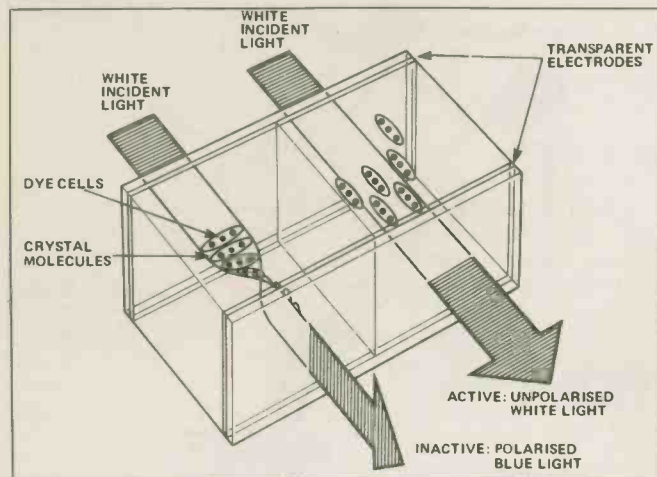

Fig. 5. Cholestric LCD.

Colour LCDs

The LCD techniques we've looked at so far have been for dot-matrix displays, ideal for computers but not so good for televisions. There are three reasons for this. First, the displays are monochromatic, and who wants a black-and-white television? Second, the display type is dot-matrix - each dot can only be on or off, unlike CRT screen spots which are graduated in brightness. Most important is the response time of these devices (the time it takes for the device to switch between active and inactive states). Common response times are around 300ms - great for computer or alphanumeric displays, but certainly not fast enough for television where each spot on the CRT screen is addressed by the electron beam every 40ms.

Two of these problems, colour and response time, are being tackled by a number of Japanese manufacturers with LCD devices which use thin-film transistors (TFTs) mounted directly on the glass which forms the casing to contain the liquid crystal. The transistors are thus in direct contact with the crystal itself (Fig. 7).

The use of TFTs dramatically reduces the LCD response time, down to a level approaching that required to display television pictures. By making an LCD element so small that it can be considered as a spot, and by grouping three spots into triads, coloured filters can be placed over the individual spots so that the triads can be addressed much like the triads of a conventional CRT. And, hey presto, we have an LCD colour television display device.

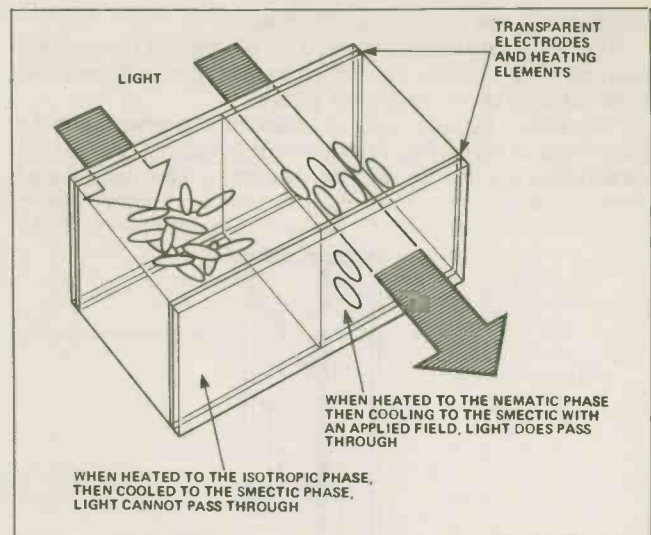

Fig. 6. Smectic LCD.

A number of Japanese manufacturers, notably Sanyo, Casio, and Citizen, have recently shown prototypes of colour television using this method. Sanyo's, the largest, is a 4 inch display. The Epson Elf, a colour television with a 2 inch display, was the first to be produced and has been on sale abroad for a year or so already.

The resolution of these displays is limited by the number of liquid crystal triads which can be produced in the device. At present the resolution doesn't even approach that of typical low-grade television CRTs, but it is only a matter of time - and research money.

Size is probably the colour LCD's greatest enemy. The quality of the colour display is limited by the constancy of the thickness of the layers in the device. The larger the device, the more difficult it becomes to maintain constant thickness. So, no wall-sized flat-panel television screens using LCDs yet, I'm afraid.

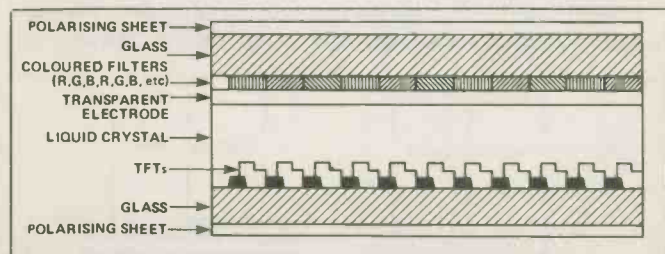

Fig. 7. Thin film transistors speed up response time.

Flat Contender

A contender in the race to beat the CRT as the only viable television display device is the electroluminescent (EL) flat-panel. Electroluminescence occurs when certain phosphorescent materials are influenced by an electric field.

Figure 8 shows a cross-section of an EL display, with criss-crossed electrodes allowing each point where two electrodes overlap to be addressed. The material sandwiched between the layers of electrodes is typically zinc sulphide, which emits a bright yellow-orange colour when an electric field is generated through it, but red, green and blue emitting materials have recently been isolated.

EL displays are of four main types: DC thick-film, AC thick-film, DC thin-film, AC thin-film. Thin-film varieties have proved to be the most successful so far, in terms of reliability and power requirements. In these, a layer of powder phosphor, typically around 30 um thick is deposited onto a

sheet of transparent oxide which forms the front electrode. This layer is then covered by a vacuum evaporated aluminium rear electrode. After etching horizontal and vertical rows and columns into the front and rear electrodes, the device is more or less usable. Such displays are of monochromatic dot-matrix form suitable for alphanumeric computer displays and graphics. By overlaying thin films of red, blue and green emitting phosphide layers, there is hope that EL displays suitable for reproduction of colour television pictures can be made. Their availability on a commercial basis is many years off yet.

EL displays generally need quite a high operating voltage (over 100V) and considerable current, so they are probably not the display to be used in portable equipment, but for flat-panel home or office use their potential is great.

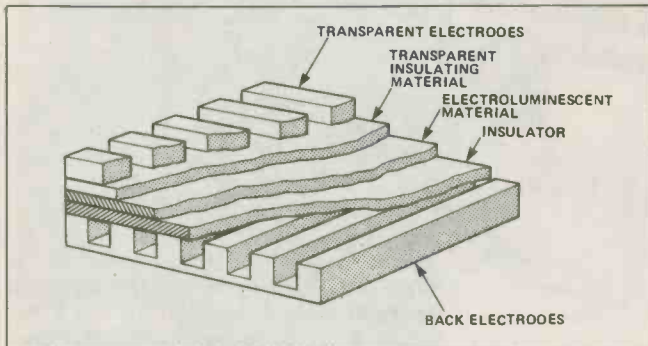

Fig. 8. Structure of electroluminescent display.

Plasma Gas Discharge

Plasma gas discharge of inert gases under a strong electric field is the basis of another type of flat-panel display - the plasma display panel (PDP). The gas breaks down into a plasma and gives off light. Neon indicators work in the same way.

The two main varieties of PDP differ in the applied voltages. In the DC plasma display the criss-crossed electrodes

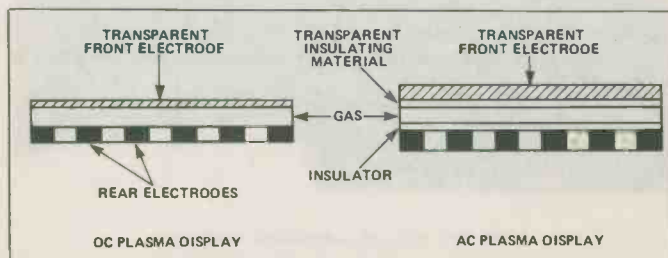

Fig. 9. DC and AC plasma displays.

are in direct contact with the gas. In the AC plasma display, the electrodes are close to the gas but electrically isolated from it (Fig.9).

Large sized PDPs have been developed, initially for military use, and now available on a commercial basis and used in many computers. Thomson-CSF, for example, has recently produced a 1024 x 1024 dot-matrix PDP display, whose resolution is not far short of a CRT.

PDP displays still have many disadvantages. Operating voltages are quite high (typically around 80V), they're not solid-state devices and can't be as rugged as LCD or EL displays. Colour displays suitable for television use are going to be difficult, if not impossible, to make.

ECDs

One new form of display device, just now reaching the market, looks as though it might topple the CRT in years to come. The electrochromic display (ECD) uses the fact that an electrochromic material changes its colour reversibly by redox reaction.

For example, amorphous tungsten trioxide (a-WO₃) turns reversibly from transparent to blue by reacting with lithium ions in an electrolyte, following the formula;

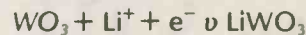

A simple display is illustrated in Fig. 10.

This display is much simpler in operation than an LCD, and

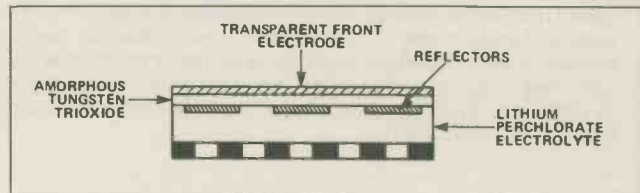

Fig. 10 A simplified electrochromic display.

would be much cheaper to make. It does, however, have significant disadvantages, not the least of which is its response times (over half a second to change from white to blue, and over two seconds to change from blue to white!). Significant development work is underway, and it's probably true to say that ECDs are only at the stage which LCDs were at 15 years ago (nowhere). Given a few years and some hard research and development...

Old and New

The problem for manufacturers is not just one of research and development because other factors, mainly financial, are also involved. CRTs are an old technology. They've been made for many, many years by experienced manufacturers. They are used mainly as a television display device, but they're also used in test equipment: oscilloscopes, spectrum analysers, logic analysers and frequency response analyzers, as well as in computers. Because of the numbers involved and because of tried and tested manufacturing techniques, they are very cheap.

Flat-panel displays, on the other hand, are new. They're relatively difficult to make and therefore expensive. So, manufacturers are going to be very careful to analyze the situation before they decide on any one other display technology which they think can fit the bill. No one display technology is yet capable of being better than the CRT in all applications. LCDs use much less power, but they have a very restricted viewing angle, low contrast, and can't be viewed in the dark (they are a non-emissive technology); EL displays are much thinner and are an emissive technology, but their power requirements are not much less than those of the CRT. ECDs are thin, have a wide viewing angle and high contrast, but they still have an unacceptably long response time.

At present, CRTs are unbeatable because technology rides on the back of its own success. New developments such as flat-screen, low-powered, high resolution colour CRTs will be along soon. But time is the CRT's own worst enemy. Given a few years, easier manufacturing techniques and lower manufacturing costs, flat-panel displays must surely beat the CRT. The questions are: which flat-panel device will do it, and when? ■

Almost Free PC Software

Volume VIII

This is another collection of fairly large applications. We've had to spread them over two disks. However, the extra three bucks is nothing compared to the power of some of this software. Whether you're interested in games, business applications or code hacking, you'll find something of interest in this larger than usual collection of programs. In addition to the programs themselves, the set includes all the support files needed to use them.

Load-Us allows users of the popular Lotus 1-2-3 and Symphony programs to run them on a hard drive. It isn't a cracking program, but, rather, a preboot to avoid the inconvenience of this copy protected software for legitimate users.

DDCal is a very clever perpetual calendar and desk diary. It keeps track of your appointments and performs several other functions that you probably thought could only be done on the backs of match books.

PC Key Draw is the remarkable public domain paintbox program which blows away so many commercial applications. It'll handle multiple screen images, business graphics and superb computer art...all in full colour. It's worth the cost of this package all by itself.

CPU is a tiny program to tell you the effective speed of your system.

Xray is a remarkable co-resident utility to monitor what a program is doing while it's busy doing it. It allows you to interrupt the execution of your code and have a look inside.

Game...well, there are no words for this program, or, at least, none that are printable. This game is a bit rude... depending on just how weird your mind is, it can get pretty bizarre. This program does use some suggestive language, and we recommend that young or sensitive users not boot it.

Tune is a very small music generator to make noises from within batch files. It's useful to see where things are in a complex process.

Chasm, or cheap assembler, is just the thing if you want to get into assembly language programming but don't want to spring for the Microsoft macro assembler package. It's reasonably fast, not too huge... it'll run in as little as sixty-four kilobytes... and, above all, cheap.

Getdir is a resident directory utility. It allows you to see what's happening on your disks even if you're in the middle of doing something else.

CopyPC, not to be confused with the commercial Copy II PC, is a quick disk backup utility for the IBM.

Lookit is a full screen browsing program to let you scroll forward and backwards through text files... a sort of a tiny word processor that can't edit anything.

Syslock is a security device for hard disk users. By implementing this package on your XT or compatible no one without a secret password will be able to have access to your computer.



This two disk set is available for just

\$22.95

plus seven percent Ontario Sales tax

Almost Free PC Software
Moorshead Publications

1300 Don Mills Road

Don Mills, Ontario

M3B 3M8

or you can order it by phone at

(416) 445-5600

during business hours. Have your VISA, Mastercard or American Express card handy.

Fine Print: This software has all been collected from public access bulletin boards and is believed to be in the public domain. The fee charged is to defer our cost in collecting, testing and debugging it and for the cost of the media and postage.

While we endeavour to make sure that all the software works, we are unable to assist you in applying it to your specific uses. This software is intended for use on PCs and true compatibles... it may misbehave on partially compatible systems.

Moorshead Publications warrants that the disk you receive will be readable. The post office, on the other hand, warrants nothing. If you are unable to read any of the files on your disk please return it to us for a prompt replacement.

Almost Free PC Software

Volume IX

The premise that good software ought to be cheap isn't one that the microcomputer industry as a whole seems to embrace, what with most programs costing several hundreds of dollars... and usually being copy protected, infested with bugs or poorly documented when you finally do get them. We think that cheap software is almost as fundamental as clean water and classic Coke.

This ninth volume of our popular almost free PC software represents another superb collection of programs for the IBM PC and compatible systems. Whether you're into games, business, hacking or just being in the same room as a microcomputer, this disk will enhance the usefulness of your PC at a cost that won't even dent your wallet, let alone blow it out of the sky as most applications packages can.

Small C If you've ever wanted to try writing programs in the C language, this compiler will fascinate you. It's a restricted implementation of C, producing code which is compatible with Microsoft's MASM and LINK programs... you'll need these to get it going.

Map is an interesting little utility which will check how DOS is situated in the memory of your computer and tell you a number of things about it. It's a useful programming tool, especially helpful if you're debugging software which interacts directly with DOS.

Note is the source file for the memory resident note pad that we ran in the March 1986 edition of Computing Now!. It requires MASM and LINK to use. It will create a resident memo page that you can call up from within any application.

Pango is one of the wildest games we've come across for the PC. While its premise is a bit improbable, it's fast and weird and more fun than a stoned house cat.

PC-Spell is a pretty decent spelling checker written in BASIC. Despite its pedestrian sounding origins, it's fast, accurate and easy to use. It can be listed if you want to see how it works, and comes with a large dictionary file and a utility to assist you in customizing it.

Peacock is a memory resident program which allows you to change the colours of your screen with alternate function keys. It's useful, for example, if you run software which insists on changing the screen to something loathsome.

Recover is a utility to assist you in getting data back from damaged files. It lets you look at your files one sector at a time and put the pieces back together.

SDB is a small relational database. It isn't dBASE III, but it also doesn't cost quite as much. It's still pretty powerful and is eminently suitable for many business applications. It features on line help.

Tally is a program which accurately counts the number of characters, words and lines in a file... all within your lifetime.

Xeno edits the tracks and sectors of your disks in a user friendly format... or, at least, one that doesn't lunge for your throat every time you boot it. You can use it to explore DOS, fix trashed disks, unerase files and do all the other low level magic that sector editors are renowned for.

All of this profound software... plus its attendant documentation and support files... is available for a mere

\$19.95

plus seven percent Ontario disk tax

from

Moorshead Publications

1300 Don Mills Road

Toronto, Ontario

M3B 3M8

or you can order by phone and frustrate Canada Post. Call

1 (416) 445-5600

Have your Master Card, Visa or American Express card ready.

Fine Print: This software has been collected from public access bulletin boards and is believed to be in the public domain. We have checked this software carefully to insure that it functions as it should. However, we cannot assist you in adapting it to your specific applications.

Moorshead Publications warrants that these programs will be readable when you get them. However, magnetic fields, cosmic rays, truck tires or the bends may adversely affect your disk in transit. If it doesn't function properly when you receive it please contact us for a prompt replacement.

```

0000 43 50 43 20 20 20 20 20 - 45 50 45 20 00 00 00 00  CPC  EXE
0010 00 00 00 00 00 00 00 E5 79 - 00 00 02 00 00 99 00 00  ey
0020 44 49 43 54 49 4F 4E 41 - 20 20 20 20 00 00 00 00  DICTIONA
0030 00 00 00 00 00 00 00 E5 79 - 00 00 29 00 00 03 00 00  ey )
0040 40 41 50 20 20 20 20 20 - 43 4F 40 20 00 00 00 00  MAP  COM
0050 00 00 00 00 00 00 00 E5 79 - 00 00 4A 00 00 27 00 00  ey J
0060 40 41 50 20 20 20 20 20 - 44 4F 43 20 00 00 00 00  MAP  DOC
0070 00 00 00 00 00 00 00 E5 79 - 00 00 54 00 00 05 00 00  ey T
0080 50 41 4E 47 4F 20 20 20 - 45 50 45 20 00 00 00 00  PANGO  EXE
0090 00 00 00 00 00 00 00 79 03 - 21 00 56 00 00 74 00 00  y ! V t
00A0 50 43 20 53 50 45 4C 4C - 42 41 53 20 00 00 00 00  PC-SPELLBAS
00B0 00 00 00 00 00 00 00 E5 79 - 00 00 74 00 00 05 00 00  ey t
00C0 50 43 20 53 50 45 4C 4C - 44 4F 43 20 00 00 00 00  PC-SPELLDOC
00D0 00 00 00 00 00 00 00 E5 79 - 00 00 76 00 00 00 00 00  ey v
00E0 50 43 20 53 50 45 4C 4C - 53 4F 52 20 00 00 00 00  PC-SPELLSOR
00F0 00 00 00 00 00 00 00 E5 79 - 00 00 7A 00 00 02 00 00  ey z
    
```

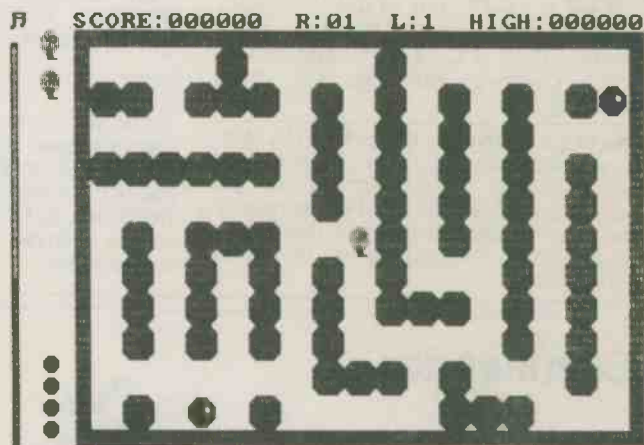

Product Mart *Where Buyers Find Sellers*

SPRING cleaning on all Apple computer music products. Complete system available in kit form: Bare keyboard manual for \$95.00; Keyboard kit parts for \$138.00; bare board synthesizer for \$29.00; Complete kit for \$249.00. Factory assembled for \$898.00 Call collect 1-416-475-1263 for free catalogue. Visa/Mastercharge. **CLASSIC ORGAN**, 300 Don Park Rd., Unit 12, Markham, Ontario L3R 3A1.

6502 MICROCONTROLLER

THE 6502 for your projects. 2 or 8k static ram, 2, 4, 8, 16, or 32K EPROM, 3 6522 VIA's, 1 or 2 Mhz clock, 85C02 hardware Compatible, small 8" x 4.5", **AGGA ELECTRONICS** a Division of RTP, P.O. Box 1848, Kelowna, BC, Canada, V1Y 8P2. Bare PCB with doc. \$44.95. BC Orders add 7% PST. U.S. orders add \$2.00 shipping.

"NEED A PCB?" We've got it. Single, Double and Feed Through, Best Prices. **PRO PC**, 279 Beauchemin, Sorel, Quebec, J3P 2N8 Tel: (514) 742-3562.

J&J ELECTRONICS LTD., Box 1437E, Winnipeg Manitoba R3C 2Z4. Surplus and Semiconductor Specialists. Do you get our bargain flyer? Send \$1.00 to receive the current literature and specials and to be placed on the mailing list for future publications.

HOBBILT ELECTRONIQUE

**WE DON'T SELL COMPUTERS.
WE JUST SELL THE PARTS!**

Send your name and address along with \$1.50 to: 7454 Langelier, St. Leonard Montreal, Que. H1S 3A7 Tel: (514) 259-5581.

STATIC RAM SALE. HM6264LP-15 11.95/7.95.95, HM6116LP-3 5.95/4.95/3.95, for 1/50/100pcs. Respectively these are low power, prime stock. Please send cheque or money order to: **SEQUATOR-DIGICON INC**, 5871 Victoria, Suite 217, Montreal, Quebec H3W 2R7. Tel: (514) 737-2592. Add \$2.00/\$5.00 P&H for 1/50-100pcs respectively.

SURPLUS Electronic Test Equipment: Oscilloscopes, Signal Generators, Frequency Counters, Meters and much more, Bargain prices, Guaranteed. **ALLIED INDUSTRIAL ELECTRONICS** Box 401 Pointe Claire Dorval Que. H9R 4P3 Tel: 514-631-6941.

LED...LED...LED.... Always in stock for immediate delivery by return mail. (5mm diffused) Red. 10, Green.12, Yellow.12, Amber.14, Orange.14, 2 Pcs holder. 04, Minimum order 100 each. Add \$2. for postage. Free sample and selection guide on your letterhead. To **SURPLUS ELECTRO QUEBEC**, 2264 Montee Gagnon, Blainville, P.Q. J7E 4H5.

COMPUTER and Electronics parts. Priced to sell. Send for free catalogue and get on mailing list for frequent. "Sale Flyers." **M.O. ENTERPRISES**, Box 2066, Bramalea, Ontario, L6T 3S3.

SARNIA now has surplus! Resistors, capacitors, I.C.'s, switches, LED's, and more! Thousands of electronic parts plus other interesting hobby gadgets (new deals arrive every week!) Almost every kind of manufacturers surplus you can imagine! Visit **SARNIA SURPLUS LIMITED**, 174 Christina St. N., Sarnia, Ontario, N7T 5T9 (519) 344-3044.

PRINTED CIRCUIT BOARDS for ETI and Ham Radio Projects. Our full list is free. Coleco Adam cassette drives new with schematic \$59.95, Joy sticks \$11.95, Keyboards \$76.50 new. **B-C-D ELECTRONICS**, P.O. Box 6326, Station F, Hamilton, Ontario. L9C 6L9.

THE BRUNELLE Commander SERIES

The Digital Capacitance Meter you've been waiting for... at the price you've been hoping for!

Dependability you can count on. Meets toughest demands!

Reading Rate
:0.5 second

Overrange Indication
Indication of "1"

Test Voltage
:3.2 volts peak maximum, "+" input terminal voltage is always higher than "-" input terminal

Input Protection
:The meter is protected against damage from charged capacitors by 0.25A, 250V, fast blow type fuse

Power Requirement
:9V battery

Battery Life
:Up to 200 hours typical with Alkaline
Up to 100 hours typical with Zinc-carbon

Accessories Supplied
:Test Lead (1), spare fuse (1), instruction manual (1) 9V Battery (Zinc-carbon)



\$99.00

Digital Capacitance Meter Model 2200



BRUNELLE INSTRUMENTS INC.
73-6th Range South
St. Elle d'Orford PQ
JOB 250
Tel: 1-819-569-1408 Telex: 05-836266

Available from:
• Active Components Stores across Canada
• Fathom Atlantic, Dartmouth, Nova Scotia
Mail orders accepted. Send certified cheque or money order.
Add \$3.00 for shipping. Quebec residents add 9% P.S.T.

Circle No. 7 on Reader Service Card

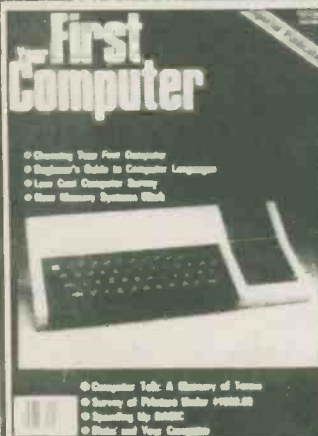

Your First Computer

Your First Computer is a special guide from Computing Now! maga-

zine for people who would like to get into computers but don't know where to begin. The publication includes articles on buying your first computer, buying a computer secondhand, a section on computer languages for beginners, surveys of computers and printers under \$1000.00, and a complete glossary of computer terms.

\$3.95 plus \$1.00 postage and handling. Ontario Residents add 7% PST. For a copy call or write:

**1300 Don Mills Road,
Don Mills, Toronto, Ontario,
M3B 3M8
(416) 445-5600**



Solid State Light Meter

A versatile solid state light measurement device.

By H. Wright

IN THE PAST, light meters used a delicate D'Arsonval analog meter movement for the readout display. These meters were easily damaged beyond repair if they were dropped on the floor or banged against a hard object. They also had no provision for calibration and groups of meters fresh from the factory frequently showed wide variations from meter to meter, and readout scales were coarse and nonlinear, requiring time consuming extrapolations between marked numbers. The result was often guesswork. Fig. 1 is a reproduction of the scale from a once popular foot-candle meter. Note the extreme cramping on the upper end of the scale.

Solid-state technology allows the elimination of the D'Arsonval readout. This gives us a meter without delicate mechanical parts; the only moving part is the on-off switch. Calibration adjustments can be provided so that groups of meters may be made to read the same, and, if drift occurs with time, a re-calibration is possible. Scales can be programmed to suit specific applications; an

advantage not usually possible in a light meter that depends on the D'Arsonval readout.

The meter described here is versatile. It can be used to establish light levels in ftC., for example, in a TV studio or on a motion picture set. It will measure industrial light levels in critical factory areas or will establish correct office lighting levels, and the scale can be adjusted to measure luminance values on a cathode ray tube face. Simple modifications combined with mechanical exposure calculators make it applicable to photographic exposure measurements.

The Sensor

The sensor chosen for the meter is a Vactec blue enhanced photodiode. This photodiode was considered to be the best choice because of its fast response and its availability with a spectral response close to that of the human eye. Fig. 2 shows the spectral response of the Vactec 9413B photodiode, and the linearity, which is also excellent over a wide range, is shown in Fig. 3.

The Circuit

Fig. 4 is the schematic diagram of the meter. It's built around the LM3914 which contains a string of ten comparators combined with an internal string of ten, 1,000 ohm resistors. The resistors provide the ascending set of references for the comparators, turning them on progressively with an increase in the input voltage. The light sensor provides these input voltages directly; the complications of an amplifier are avoided because the IC can be arranged to operate as a millivolt-meter.

The usual method of operating this IC is by tying the internal resistor string to the IC's internal reference voltage of 1.20 volts. When using millivolt input ranges, this method cannot be used because the reference output load resistor also determines and regulates the LED current in the range between 2.0 and 30 milliamps. Both ends of the internal resistor string are brought out to external pins on the IC. This permits use of a ground referenced external reference IC. This separates the functions of LED current control from

those determining input range. Pin 9 of IC1 is connected to pin 11 to program the IC into dot mode of operation. The bargraph mode is not suited to this meter because it places a heavy load on the battery.

If Fig. 4 is examined, the external reference system for a millivolt range is easy to follow. IC2 is a 2.5 volt reference

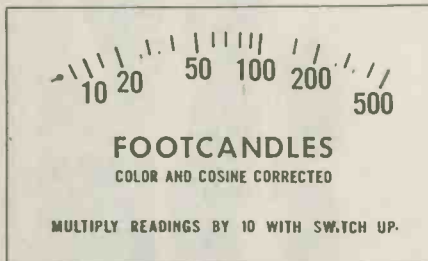

Fig. 1. A reproduction of the scale of an early type foot-candle meter.

IC driven by the 9 volt battery supply. The reference output is connected to a voltage divider consisting of a fixed resistor R3 and a trimpot R2. The ratio of resistors is such that R2, the scale range adjustment, provides a good range in millivolts for application to the internal resistor string. The value of R1 now determines only the LED current and therefore the maximum

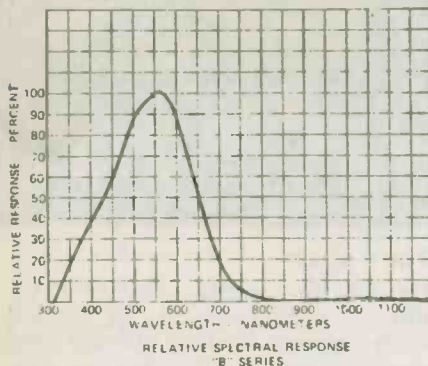

Fig. 2. Spectral response of the Vactec VTB 9413B photodiode.

value of total instrument current drain. In the prototype R1 was given the value of 470 ohms. Run-of-the-mill red LEDs were used. Some economy of battery drain could be gained if R1 was made larger and combined with narrower angle, more costly, high efficiency LEDs. Addition of a red filter or the even more effective 3M louvered neutral density filter, would also improve readability in the presence of strong ambient light.

The setting of R2 determines the instrument sensitivity. The actual input voltage in millivolts from the sensor, for a given light level, will be determined by the setting of R5, the calibrating load resistor. With R2 determining the full scale volt-

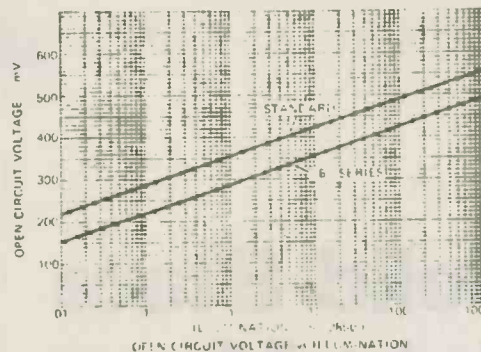

Fig. 3 Voltage vs. illumination for the photodiode (open circuit condition).

age, R5 then determines where a specific light level will indicate on the ten dot scale. For example, if the meter is to be used in a color TV studio, a peak level (LED-10) indication of 350-400 ftC would be desirable. This will accommodate the measurement of back light levels when the key light level is being roughed in at, say, 170 ftC. The combined adjustments of R2 and R5 could then place 170 ftC somewhere near the middle of the scale.

When part of the voltage reference voltage divider is made variable, the above type of scale-stretching is made possible. A near mid-scale LED could be made to read 100 ftC or any other value best suited to the service required. Thus the meter can be programmed for a variety of applications, TV studios, film operations, office and industrial lighting etc.

Flasher-Sounder Option

The basic meter of Fig. 4 is complete. Where the application requires frequent setting of light levels to the same value, a flasher or sounder can be added. The flasher is driven from a chosen LED output circuit on IC1, the one that indicates the particular level where flashing or beeping is required. Fig. 5 is the circuit for the flasher/sounder option.

The flasher or sounder is driven by a standard 555 IC which runs in the astable mode. With the R-C values shown the flash rate will be approximately 2-3 Hz. Electrolytic tolerances could affect the frequency slightly. The 555 will drive either a flasher LED or a small solid state sounder directly. Q1 is in series with the 555 pin 8 and V+ and forms an electronic On-off switch. The switch is controlled by the comparator IC3. Only one section of the 339 comparator is used. All other pins except the pin 3 positive supply pin, must be grounded.

The non-inverting input of the comparator is connected to the 2.5 volt reference through R8. The tripping voltage from the LED circuit is applied to the inverting input through trimpot R7, and the tripping voltage is obtained by placing a 100 ohm resistor between the chosen LED anode and V+. The comparator input is taken from the junction of the LED anode and R6. When the LED is off, the junction voltage approaches the supply voltage of 9 volts. When the LED is on, the LED current produces a small voltage drop and the junction voltage drops sharply without appreciably reduc-

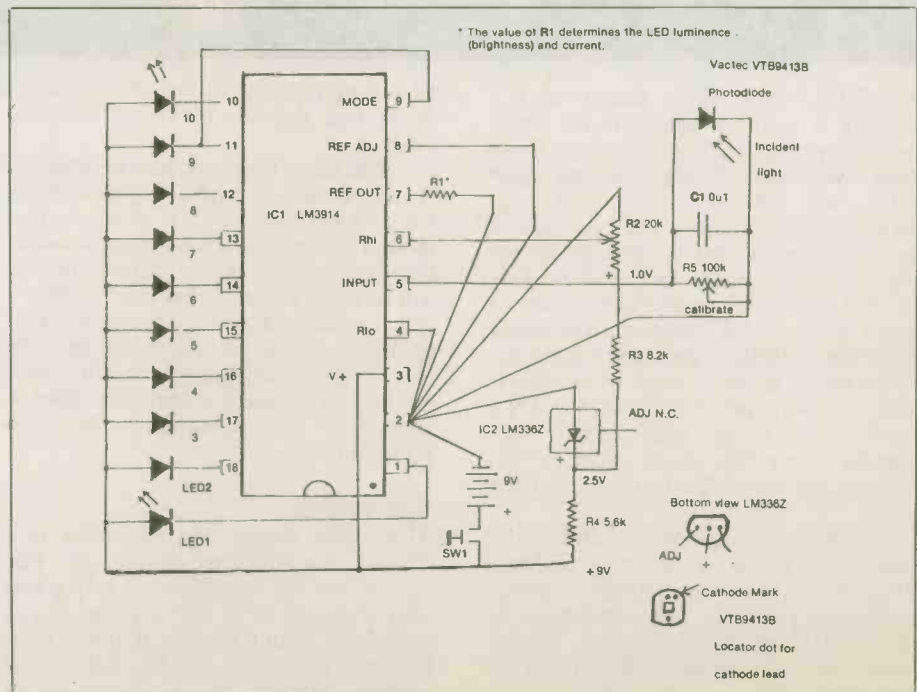

Fig. 4 Schematic of the lightmeter circuit.

ing the brightness of the LED. R7 is adjusted, with the LED off, to apply a voltage slightly greater than 2.5 volts. When that LED lights, the inverting input of IC3 drops below the reference input and the comparator trips, turning on Q1. This option increases the battery drain, but because the on-off switch is a spring loaded return push button, the extra current is only drawn when taking a reading.

The flasher circuit also doubles as a low battery indicator. If the battery voltage drops to somewhere between 7.5 and 8.0 volts, the voltage at the R6/LED junction drops low enough to trip the comparator, even though the LED may be off. It should be remembered that the flasher-low battery indicator circuits do not in any way affect the operation of the light meter. It will function normally without them. This is simply a useful option to be used or left out as the builder wishes.

cuit side of the board. If copper tape is used, it is desirable to run a second copper tape on the component side of the board under the ten LED anode leads, to anchor them firmly in place. Sockets for the ICs, with the exception of IC2, will simplify the soldering procedure and allow for easy replacement in case of failure or damage. Fig. 7 shows the position of components.

The aluminum bottom of the case becomes the front panel for the meter. A row of holes is drilled that will just allow the LEDs to be a very light push fit. These holes are spaced at 0.40" intervals to match the LED mounting positions. Retain the panel position that existed when the box was purchased.

In the prototype the photodiode was mounted in the end of the barrel of a miniature phone plug. A matching jack was positioned in the end of the case. Make sure the photodiode polarity is correct when mounting it. The anode should

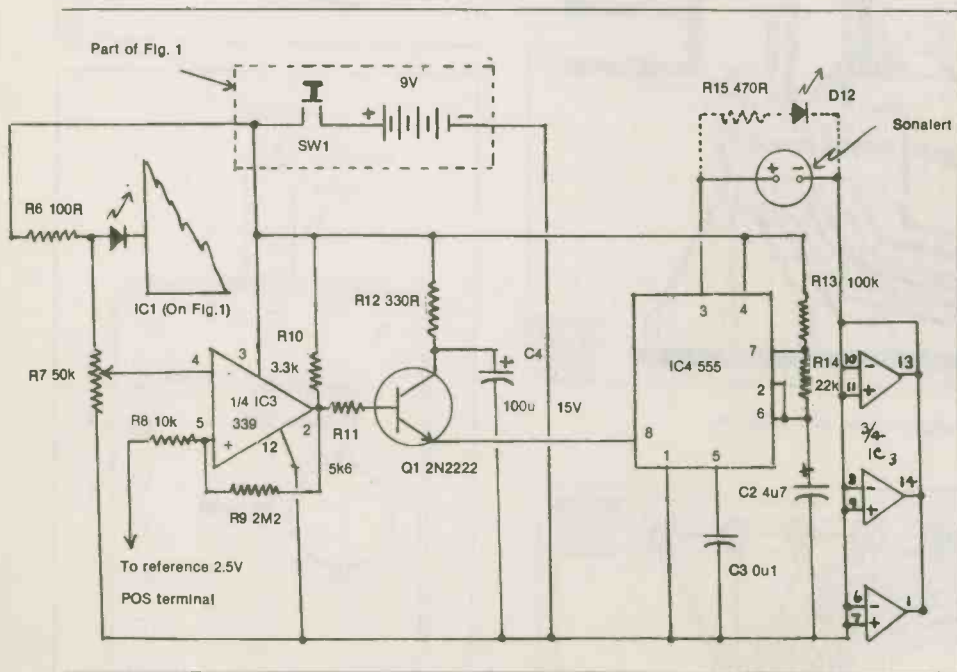

Fig. 5 Schematic for the flasher/sounder indicator.

Construction

The small number of components makes this light meter an easy construction project. It will fit into a small box such as Radio Shack # 270-233 (21/2' x 5' x 11/2'). The components can be mounted on a small 41/2' x 21/4' rectangle of perf board with 0.10 hole spacing. Fig. 6 is a pattern for either a printed circuit or one fabricated from stick-on copper patterns and tapes (Bishop Graphics E-Z system). The latter method was used for the prototype. It is simple, fast, does not require photography or chemicals and is easier to trace and check than point-to-point wiring. The LEDs are mounted on their leads, standing up in a row from the cir-

go to the tip and the cathode to the sleeve. A dab of silicone rubber will hold the photodiode firmly in place and provide some shock-proofing. If you prefer, the sensor can be mounted in a small hole in the end of the case, using a rubber grommet or silicone rubber. Fig. 8 shows the relationship of the panel, LEDs and sensor.

Before the panel is assembled with the perf board, clean it and spray it lightly with zinc chromate. This prevents the finish coat from peeling from the aluminum. A sprayed-on coat of gold will look good with the black case. Once the instrument has been calibrated, ftC numbers opposite each LED can be add-

Another Magazine From Moorshead Publications

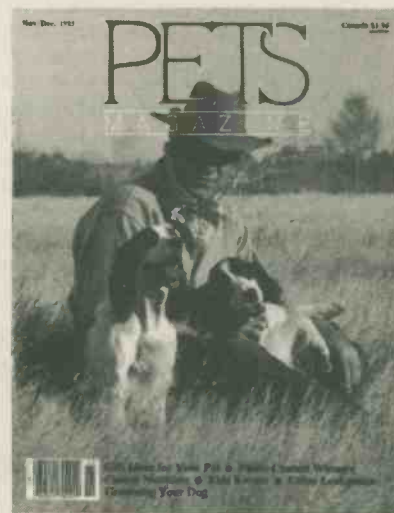

It too is about Pets but not the computers!

It is a bi-monthly magazine about small animal health, nutrition, obedience, and much more... from dogs, to cats, to birds, to fish. It also carries the stamp of approval of the Ontario Veterinarian Society.

In fact, it is the only magazine of its kind in Canada and we are proud to lend our publishing expertise to it.

**SUBSCRIBE NOW AT
ONLY \$9.95 FOR A FULL YEAR
OR \$15.00 FOR TWO YEARS**

Call (416) 445-5600 with credit card details or complete and mail.

SUBSCRIBE NOW!

Make sure you receive every issue of Pets Magazine. A two year subscription delivered to your home costs only \$15.00. One year is just \$9.95.

I wish to receive a subscription:

Name _____
Address _____
City _____ Province _____
Postal/Code _____

I wish to give a gift subscription to:

Name _____
Address _____
City _____ Province _____
Postal/Code _____

2 year subscription \$15.00 American Express Account
 1 year subscription \$9.95 Visa Card Account
 My cheque enclosed Master Card Account

MAIL TO:
Pets Magazine, Moorshead Publications
1300 Don Mills Road, Don Mills, Toronto,
Ontario, M3B 3M8 (416) 445-5600

Solid State Light Meter

ed. Rub-on numbers will give a professional look. The wear life will be improved if the panel is given a coat of clear lacquer. The prototype was calibrated for TV studio use and Fig. 9 shows the scale.

No guide is given for the location of the on-off push button switch. It should be placed so that it lies comfortably under the thumb when the meter is held to aim it at a light source. This will put it somewhere in the lower part of the panel to the left of the LED row.

Measure the locations of the three trimpots along the edge of the circuit board and the depth of the adjusting screws from the inner face of the front panel. Use these dimensions to locate and drill three holes in the appropriate side of the case. Make them large enough to admit a small jeweller's screwdriver.

Do not be surprised if the measured reference IC output is not right on 2.5 volts. Exactly 2.5 volts is not a requirement for this application; the important point is that the reference remain constant as the battery voltage drops. To get IC2 exactly at 2.5 volts would require more components. The adjust terminal of IC2 is left unconnected.

The only way the light meter can be calibrated with good accuracy is by reference to a high quality incident light meter that reads in ft-c or an exposure meter that has a foot-candle scale. If the reference light meter has interchangeable covers for the light cell, use only the flat faced cover during calibration. Many of these meters have a domed or humped translucent cover over the cell that integrates the light from an included angle

The most accurate calibration could be obtained if the meter is referred to a photometric laboratory foot-candle standard, but few have access to such a standard. Assuming a good meter of the D'Arsonval type is available, set up a table-top calibration procedure. The surface of the table should be covered by a dark, low reflectance material and there

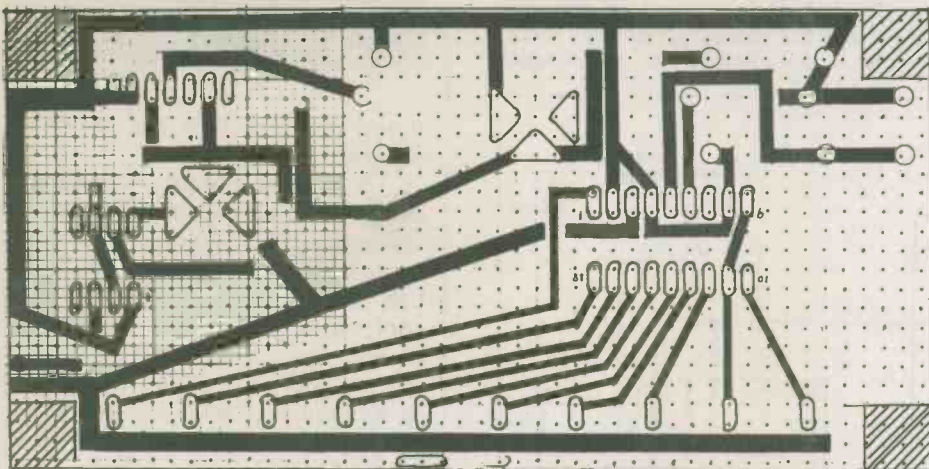

Fig. 6. Pattern for the printed circuit or E-Z system copper tapes and patterns.

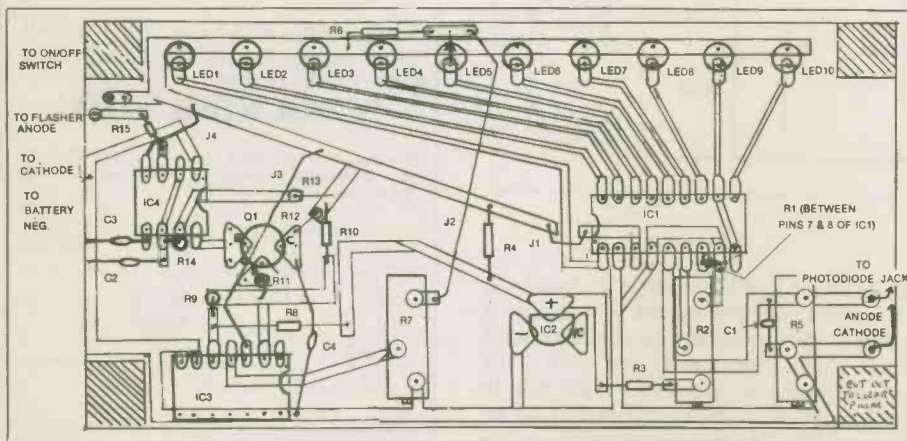

Fig. 7. Component positions for the meter and flasher/sounder option.

Calibration

If you have included the flasher or beeper in the meter, the first adjustment is to set the trip level of the comparator. With the electronics outside the case, connect a good voltmeter between R7 arm and ground. Adjust R7 for a reading of 2.6

greater than 180 degrees. Such a meter does not give anywhere near a true incident light reading. The meter described here has a very narrow angle of acceptance and will give an accurate indication of incident light when aimed carefully at the light source.

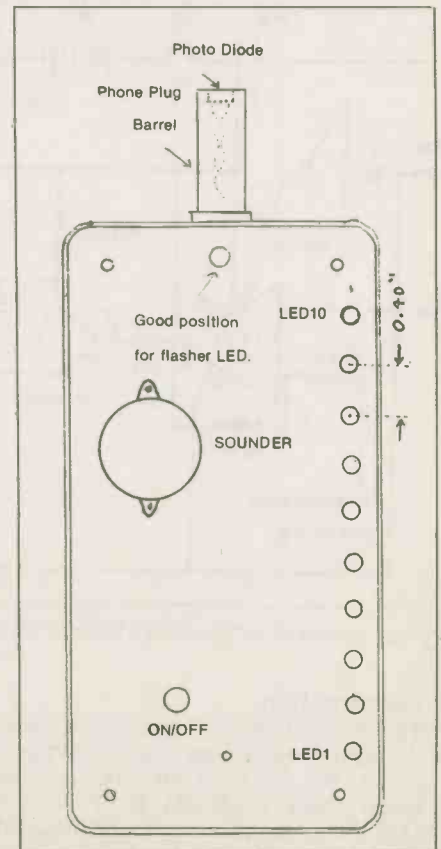
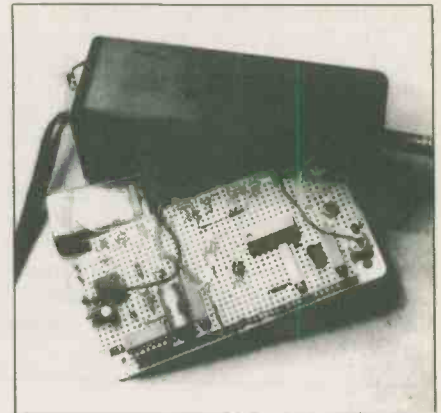

Fig. 8 Panel layout.

Continued on page 42

should be no other lights besides the test lamp and no uncovered windows. Use a desk or worktable lamp with a conical reflector and fit it with a diffuse 60 watt bulb. Lay this light source flat on the table as shown in Fig. 10. Further diffuse the light by taping a piece of good quality

SATELLITE ELECTRONICS



Catch the Excitement! Today, High-Tech Job Opportunities are Everywhere!

Now you can take control of your future with NRI's newest hands-on training and carve out your own place in today's electronics world. Select a new career field or start a business of your own. Now the choice is yours. And only NRI gets you where you're going with the *latest* professional instruments and test equipment you build and keep as you learn at home.

No other school of its kind has prepared so many people for successful careers in electronics. For over 70 years, NRI technical engineers and educators have demonstrated a unique ability to spot and anticipate the important technological trends, then develop state-of-the-art training that's prepared over 1.3 million ambitious people for successful careers in each new emerging field.

Now NRI presents *three* new state-of-the-art training opportunities in today's fastest growing electronics fields.

Build Your Own IBM-Compatible Computer as You Learn *Digital Electronics Servicing*.

A brand new course for an exciting new field... servicing computer peripherals (disk drives, printers, display terminals, modems, etc.) and the latest digital equipment found in industry today. Job opportunities for the trained digital technician have never been greater. It takes skilled personnel to keep today's digitally automated production lines and manufacturing equipment rolling. NRI trains you to be a high-demand digital technician or prepares you for your own independent service business.

As you learn, you'll get practical hands-on experience building your own 128K computer and disk drive. You'll also build, and learn to use and service, your own triggered-sweep oscilloscope, digital logic probe, and digital multimeter... instruments used by today's

ROBOTICS

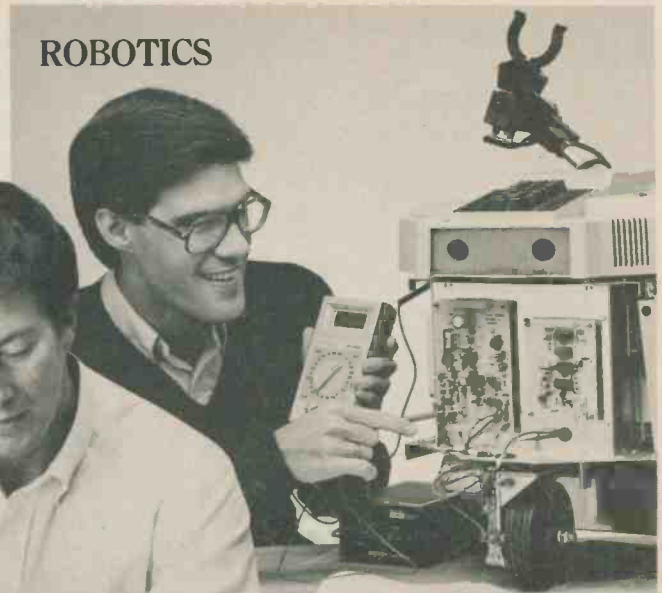

mobile robot. You get professional instruments and up-to-date training to prepare you to handle the technology that's changing the face of industry today.

Install and Troubleshoot Your Own Home Satellite TV Equipment as You Learn *Satellite Electronics*.

You've seen them in backyards, beside motels, atop office buildings, and in military installations—those sensitive dishes reaching out for TV programs, computer transmissions, data signals, and messages of all kinds from the growing number of satellites stationed 22,300 miles above the earth. Now NRI training can get you in on the ground floor of a new career or even a business of your own in this exciting new growth field.

NRI trains you to service consumer TVRO systems, as well as the larger commercial and military equipment used to transmit and receive worldwide communications: news, weather, national security & defense transmissions and all types of voice, data and video signals.

Learn to install satellite systems... adjust, troubleshoot and repair dishes, amplifiers, converters, antennas and receivers. And get "hands-on"

experience as you install your own satellite TVRO system that will bring TV signals from around the world into your home.

Send for Free Catalog of High-Tech Career Opportunities.

Now you, too, can catch the excitement. Just send for your free copy of the 100-page NRI High-Tech Electronics Careers catalog. See the future open up for you as you explore exciting new opportunities for higher pay, advancement—even your own business. Review the complete descriptions of the training you get, the equipment that makes each opportunity come to life. Send today and get your start on tomorrow. If the card is missing, write to us.



DIGITAL ELECTRONICS SERVICING

Only NRI trains you for so many careers on the leading edge of today's electronics revolution.

electronics professionals.

You'll receive and learn to use NRI's specially developed diagnostic software programs that show you how to troubleshoot and service today's peripheral and digital equipment... another NRI "hands-on" exclusive. When you select NRI's training in Digital Electronics Servicing, you'll be preparing yourself to move into one of today's hottest careers!

Build an Operating Robot as You Learn *Robotics and Industrial Control*.

Already, advanced robotics systems are producing everything from electronic circuits to automobiles. By 1990, over 100,000 "smart" robots will be in use, creating over 30,000 new technical jobs.

NRI trains you to operate, program, service and troubleshoot industrial robots as you build your own remote controlled, programmable

NRI SCHOOLS

McGraw-Hill Continuing Education Center
330 Progress Avenue
Scarborough, Ontario M1P 2Z5
or telephone 416-293-8787

We'll Give You Tomorrow.



Portable 10 MHz Mini-Scope

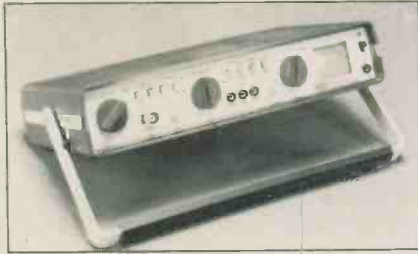

The Model 1010, full-featured, oscilloscope is a compact device offering DC to 10 MHz bandwidth, 12 sensitivity ranges and 21 time-base ranges in a 10" x 2.5" x 7" package weighing just two pounds. The mini-scope includes internal and external triggering with sensitivity of 1 div internal and 1V external. Coupling modes include: AC, DC, TV frame and TV line, and the slope is plus/minus selec-

table. The unit contains a 1' x 1.5' blue-white (5 horizontal and 4 vertical divisions) display and includes a built-in calibration circuit as well as a full complement of adjustments. For further information contact: Len Finkler & Co., 80 Alex-don Rd., Downsview, Ont., M3J 2B4. (416) 630-9103.

Circle No. 36 on Reader Service Card.

Automotive Electric Technogripes: Yer Humble Editor's car is into its fifth year, and by Detroit stand-ards, ready to be pressed into a cube of scrap iron. Some grouching about its electrics: why do they even bother with the red idiot lights for the alternator? The "idiot" must refer to the designers; they'll only detect a complete failure of the alternator output, not a lowering of the voltage. On three cars now, the alternator output has slipped below 12V, letting the battery die with nary a glimmer from the red light. Also, auto electric designers should buy pocket calculators so they can discover that a car's total electrical load often exceeds the alternator's output, particularly if you're stuck in traffic with the engine idling a lot. And why not have headlights that shut off with the ignition? No one does this, but there doesn't seem to be much reason to want headlights on with

the keys out. Four-way flashers fill the bill for emergency parking. And let's use relays that are strong enough to carry the rear-window defroster current without needing replacement the second the warranty runs out. And move the fuse cluster to where you don't have to lie upside down to get at it. We probably should forget micropro-cessors and fibre optic control channels until the engineers learn some basics. There.

Zentronics is offering a free Tran-zorb Selector Guide, designed to assist in designing transient over-voltage protection in electrical cir-cuits. Choose the reverse standoff voltage or maximum clamping voltage and the guide will select the protection device that suits. Con-tact Zentronics, 8 Tilbury Court, Brampton, Ontario L6T 3T4, (416) 451-9600.

Circle No. 37 on Reader Service Card.

DOES YOUR DIGITAL CAPACITANCE METER DO THIS?

FULL 4 DIGIT 0.5 INCH LCD DISPLAY COMPLETELY AUTORANGING WITH 10 RANGE MANUAL CAPABILITY

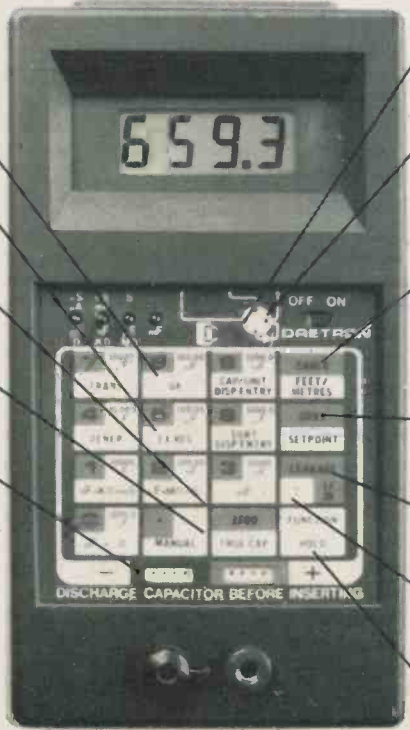

- AND THIS**
RANGE OF 0.0 pF to 1 FARAD (999.9 mF)
0.5% BASIC ACCURACY UP TO 100 uF
- AND THIS**
READS DIELECTRIC ABSORPTION
- AND THIS**
EXTENDED PSEUDO 5 DIGIT
RESOLUTION ON SOME RANGES ONLY
- AND THIS**
ABILITY TO ZERO LARGE CAPACITANCE
VALUES UP TO 99.99 uF
- AND THIS**
CALCULATES TRUE CAPACITANCE
IF CAPACITOR IS LEAKY
- AND THIS**
DIODE CLAMP AND FUSED
PROTECTED INPUT.
DISCHARGE RESISTOR 1N OFF
POSITION AT TERMINAL INPUTS.
POWERED BY 9V BATTERY

- AND THIS**
IDENTIFIES TRANSISTORS (NPN, PNP)
AND THEIR LEADS (E, B, C, ETC.)
- AND THIS**
TESTS ZENER DIODES AND RECTIFIERS.
UP TO 20V ZENER WITH AC ADAPTOR,
ZENER VOLTAGE WITH 9V BATTERY
DEPENDS ON ITS CONDITION
- AND THIS**
AUTOMATICALLY CALCULATES LENGTHS
OF CABLES IN FEET, METRES, MILES,
KILOMETRES (THEORETICAL RANGE
OF 9,999 MILES)
- AND THIS**
ABILITY TO SORT CAPACITORS IN
MANY DIFFERENT MODES
- AND THIS**
ABILITY TO READ LEAKY CAPACITANCE
(INSULATION RESISTANCE OR CURRENT)
- AND THIS**
CALCULATES TIME CONSTANTS WITH
USER DEFINED RESISTANCE VALUES
- AND THIS**
HOLD FUNCTION FREEZES DISPLAY

ONE YEAR PARTS & LABOUR WARRANTY

FOR ONLY THIS



MODEL MC300

Approx. Size
7" x 4" x 1 3/4"
DAETRON
A DIVISION OF BERGERON
TECHNOLOGIES INC.
935 THE QUEENSWAY
BOX 641
TORONTO ONTARIO M8Z 5Y9
(416) 255-9701
DEALER ENQUIRIES INVITED

MADE IN CANADA

PLEASE SEND ME (QUANTITY) MC300(s) @ \$149.95 \$ _____
 CARRYING CASE \$19.95 \$ _____
 AC ADAPTOR \$11.00 \$ _____
 ONTARIO RESIDENTS ADD 7% PST \$ _____
 SHIPPING AND HANDLING @ 4.45 per instrument \$ _____
 I ENCLOSE CHEQUE MONEY ORDER BILL MY VISA
 VISA CARD NO. _____
 EXPIRY DATE _____ SIGNATURE _____
 NAME _____
 ADDRESS _____
 CITY _____ PROV. _____ POSTAL CODE _____

Circle No. 9 on Reader Service Card

Take Up To \$117⁷⁵ In Books (Limit 5 Books) for \$3⁹⁵



ELECTRONICS BOOK CLUB

Keep in Step With the Future . . . Become
a Part of the Fascinating World of Technology!

- High-Tech How-To
- Space Age Projects
- Digital Electronics
- Artificial Intelligence
- Computers/Robotics
- Telecommunications
- Ironclad No-Risk Guarantee

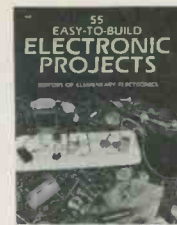

1999
List \$21.95



1013
List \$14.95



1663
List \$24.95

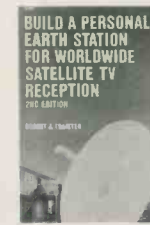

1909
List \$21.95



1671P
List \$16.95 (paper)

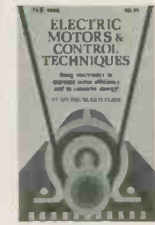

1465
List \$16.95



1984
List \$14.95



1211P
List \$12.95 (paper)



1793
List \$14.95



1693
List \$21.95



1199P
List \$14.95 (paper)



1553
List \$15.95



1927
List \$23.95



1625
List \$21.95



1825
List \$15.95



1896
List \$21.95



1925
List \$24.95



1719
List \$18.95



1632P
List \$12.95 (paper)



1758P
List \$10.95 (paper)



1650
List \$19.95



1593
List \$13.95

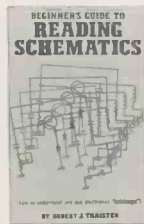

1536
List \$14.95



1875P
List \$14.95 (paper)



1474P
List \$12.95 (paper)



1996
List \$18.95



1183
List \$16.95



1870
List \$19.95

FREE
Handy, Pocket Sized
Resistor and Inductor
Color Code Calculator

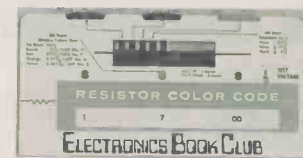

FREE When You Join Now →

7 very good reasons to join the Electronics Book Club

- **Big Savings.** Save 20% to 75% on books sure-to-increase your electronics know-how
- **No-Risk Guarantee.** All books returnable within 10 days without obligation
- **Club News Bulletins.** All about current selections—mains, alternates, extras—plus bonus offers. Comes 13 times a year with hundreds of up-to-the-minute titles to pick from
- **Automatic Order.** Do nothing and the Main selection will be shipped automatically! But . . . if you want an Alternate selection—or no books at all—we'll follow the instructions you give on the reply form provided with every News Bulletin
- **Bonus Books.** Immediately get Dividend Certificates with every book purchased and qualify for big discounts of 60% to 80%
- **Extra Bonuses.** Take advantage of added-value promotions, plus special discounts
- **Exceptional Quality.** All books are first-rate publisher's editions selected by our Editorial Board and filled with useful, up-to-the-minute information

© 1986 Electronics Book Club



ELECTRONICS BOOK CLUB

P.O. Box 10,
Blue Ridge Summit, PA 17214

Please accept my membership in the Electronics Book Club and send the 5 volumes circled below, plus my FREE Resistor and Inductor Color Code Calculator, billing me only \$3.95 plus shipping and handling charges. If not satisfied, I may return the books within ten days without obligation and have my membership canceled. I agree to purchase 4 or more books at regular Club Prices, (plus shipping/handling) during the next 12 months, and may resign any time thereafter. Canada must remit in U.S. dollars.

1013 1183 1199P 1211P 1465 1474P 1536 1553 1593
1625 1632P 1650 1663 1671P 1693 1719 1758P 1793 1825
1870 1875P 1896 1909 1925 1927 1984 1996 1999

Name _____
Address _____
City _____
State _____ Zip _____ Phone _____

Valid for new members only. Foreign applicants will receive ordering instructions. This order subject to acceptance by the Electronics Book Club

ETY-586

For Your Information

Panasonic from BUDGETRON

**NOW
IN STOCK**

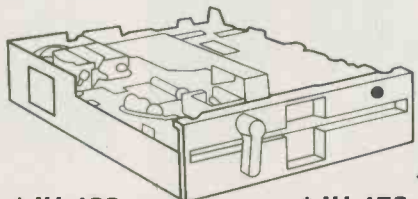

*JU-455

- For PC/XT, Compaq, Tandy and Compatibles
- Jumper changeable for AT

*JU-475

- 1.6 Mbytes capacity
- Variable compatibility—reads 96 or 48 tpi
- For PC/AT Compatibles

ONE YEAR WARRANTY

Dealer/OEM please call
Stocking Wholesaler

BUDGETRON
IMPORTER
DISTRIBUTOR **INC.**

1320 Shawson Dr.,
Unit 1, Mississauga,
Ontario L4W 1C3
Tel: 416-673-7800
Tlx: 06968080

Circle No. 11 on Reader Service Card

3M Canada Ltd. will transfer marketing, sales and service responsibilities for 3M photocopiers and facsimile equipment to the Canadian subsidiary of a new international company, Harris/3M Document Products Inc., starting May 1.

Telecommunications fans can now purchase a subscription to the iNet 2000 information service at 11 Eaton Business Centres across Canada. The iNet 2000 gives you access to information databases, electronic messaging, data conferencing, etc., and is available from Eaton's for a \$50 startup fee. PC owners get the communications software on a floppy disk.

Synercom of Houston, Texas, developers of computerized mapping services, has donated a \$144,000 software system to Ryerson Polytechnical of Toronto and a similar grant was made to the University of Quebec in late 1985. The software will be used by the 17 members of Ryerson's Geography department. Synercom plans to donate \$7 million of its software to Canadian universities over the next three years, and \$15 million to US universities. May their tribe increase, too.

The VCR was a hot item in 1985, according to the Consumer Electronics Marketers of Canada, with sales of 1.28 million units, up 11

percent from 1984. CEMC estimates that one Canadian household in three owns a VCR, and three out of four will own one by 1988.

Automated Production Equipment of Medford, NY, makers of PCB repair equipment, have sent us a press release for a Combat Circuit Repair Kit. Tools, fixtures and materials to repair any kind of PCB damage. In combat? Perhaps it's aimed at the service tech who makes house calls, fixing a TV while fending off three kids and a dog.

NCR Canada has produced a through-the-wall automated teller which they claim is faster than other bank machines and holds more currency. The Model 5084 is said to reduce lineups and minimize downtime due to cash depletion, particularly on weekends and holidays. May their tribe increase.

Keithley Instruments of Ohio has sold its handheld multimeter product line to TEGAM Inc. of Madison, Ohio. TEGAM also manufactures a wide range of thermometry products, voltage and battery testers, signal conditioners, etc. The Keithley company said that the sale completed their program to exit from the handheld test and measurement business.

Continued on page 33

When Accuracy Counts... You Can Count On Us... Since 1977

THE BRUNELLE Commander SERIES

Model 4070 - 4½ Digit Multimeter

\$189.00

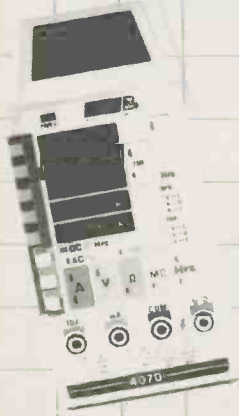

- 4½ digit LCD Display
- .05% basic DC Accuracy
- Overload Protection
- Audio and Visual Continuity Function
- Diode Test Function
- Transistor Test Function
- 10A AC/DC Current Measurement
- Up to 1000 Volts DC Measurement
- Safety Designed Input Jacks And Test Leads
- One (1) year warranty
- ClampOn Ammeter, Temperature Adaptor, HV Probes, Carrying Case, etc. (OPTIONAL)

Model 3020 - Function Generator

\$274.99

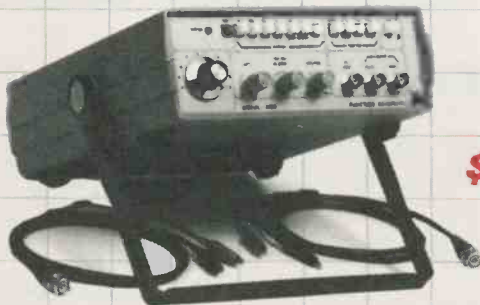

- .2HZ to 2MHZ (7 ranges)
- Wave Forms: Sine, Triangle, Square, Ramp and Pulse
- Output Level: ▶ 20VP.P Open Circuit
- VCF: 0 to 10V (1000:1)
- Attractive Styling
- Two (2) Year Warranty

• Quality + Price + Service = **BRUNELLE**



Brunelle Instruments Inc.
73-6th Range South
Saint Elie D'orford, Quebec, J0B 2S0
Tel: 1-819-569-1408 Telex: 05-836266

Mail Order: Certified Cheque, Money Order, COD's FOB
St-Elie, Quebec Residents add 9% P.S.T.

OR

CALL COLLECT: 1-819-569-1408



DataPerfect™

A Division of RAITRONICS LTD.

AT STARTER KIT

512K MEMORY (1MB)
8 SLOTS
1.2 Mb FLOPPY / HO CARD
COLOR GRAPHIC CARD
KEYBOARD
BATTERY BACKED CLOCK

\$2895.00

XT STARTER KIT

256K MEMORY (640 M/B)
8 SLOTS
1 DRIVE (360K)
COLOR GRAPHIC CARD
KEYBOARD

\$895.00

FULLY HAYES COMPATIBLE

300/1200 SMART MODEM
AUTO DIAL/AUTO ANSWER
AUTO SPEED SELECTION
SPEAKER/VOLUME CONTROL
RS232 CABLE

\$229.00



XT™ PORTABLE CASE

PRICE INCLUDES
CASE, FULL SIZE
KEYBOARD,
9" MONITOR,
135 WATT P.S.

\$695.00

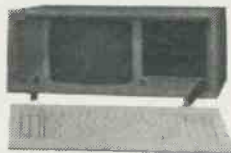

APPLE IIe COMPATIBLE

128K MEMORY

\$489.00

TERMS: M/C, VISA,
M.O., C.O.D.

Add 5% Shipping
\$2.00 Handling

207 WEST 6th AVE.,
Vancouver, B.C., CANADA V5Y 1K7

604-875-0207

Circle No. 27 on Reader Service Card

XT \$750

COMPATIBLE (Major Boards made in Japan)

- 256K Memory • One DSDD Disk Drive
- Controller Card
- Flip-Top Case and Keyboard
- Heavy Duty Power Supply • 180 Day Warranty

(All you need for complete system is Video Card and Monitor)



COMPLETE 640K SYSTEM \$1,285

- Two DSDD Disk Drive • Controller Card
- Colour Graphic Card or Monochrome Display Card
- Real Time Clock • Serial, Parallel and Game Ports
- Flip-Top Case and Keyboard • Heavy Duty Power Supply • 180 Day Warranty

(All you need to get the system ready to use is a Monitor)

MAIL ORDER: Cheque, Money Order, Certified Cheque plus \$20.00 for shipping and handling. Ontario residents add 7% P.S.T. (Prices subject to change without notice).

SUNIX INC.

578 MARLEE AVE. Telex: 06-217736 SUNIX TOR.
(At Glencoln Subway) Tel: (416) 781-3263
Toronto, Ontario
M6B 3J5 In Calgary, (403) 239-1813

Circle No. 28 on Reader Service Card

AMAZING

SCIENTIFIC and ELECTRONICS

DEVICES

PLANS — All Parts Available in Stock.

- LC5 BURNING CUTTING CO2 LASER \$20.00
- RUB3 RUBY LASER RAY PISTOL 20.00
- BTC5 1.5 MILLION VOLT TESLA COIL 15.00
- GRA1 - GRAVITY GENERATOR 10.00
- MAGNETIC CANNON/PROJECTOR 10.00
- LRG3 SOLID STATE LASER RIFLE 10.00

KITS — Includes Plans and Parts

- LHC2K SIMULATED RED/GRN/YEL LIGHT LASER 34.50
- BTC3K 250,000 VOLT TESLA COIL 159.50
- IOG1K ION RAY GUN 109.50
- PSP3K PHASOR SHOCK WAVE PISTOL 49.50
- STG1K - STUN/PARALYZING GUN 39.50
- INF1K INFINITY TRANSMITTER 134.50
- MFT1K 2-3 MILE RANGE FM VOICE XMTR 49.50

ASSEMBLED AND TESTED PRODUCTS

- LGU30 RED 1MW PORTABLE HENE LASER 315.00
- TCL30 SOLID STATE TESLA COIL 35KV 74.50
- IPG50 POCKET PAIN FIELD GENERATOR 64.50
- BLS10 BLASTER DEFENSE WEAPON 89.50
- ITM10 - 100KV SHOCK AND STUN GUN 99.50
- PPF10 PHASOR PAIN FIELD PORTABLE 249.50
- SNP20 SECURITY PHONE LISTNER 99.50

• CATALOG CONTAINING DESCRIPTIONS OF ABOVE PLUS HUNDREDS MORE AVAILABLE FOR \$1.00 OR INCLUDED FREE WITH ALL ABOVE ORDERS.

PLEASE INCLUDE \$3.00 PH ON ALL KITS AND PRODUCTS PLANS ARE POSTAGE PAID. SEND CHECK, MO, VISA, MC IN US FUNDS.

INFORMATION UNLIMITED

P.O. Box 715, DEPT. ET, AMHERST, NH 03031

Circle No. 29 on Reader Service Card

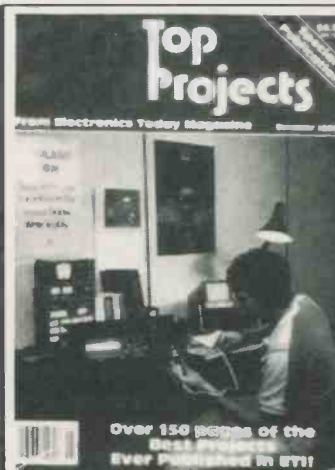

50 Top Projects

Fifty all-time best projects from Electronics Today magazine packed into one giant 156 page special. There are projects for beginner to the more advanced builder, including: Semiconductor Tester, Universal Counter, LED Level Meter, AM radio, and much, much more.

\$3.95 plus \$1.00 postage and handling
Ontario Residents add 7% PST.

For a copy call or write:

Moorshead Publications
1300 Don Mills Road,
Don Mills, Toronto, Ontario,
M3B 3M8
(416) 445-5600



Troubleshooting

Building a project is often the easy part; getting it going is where the fun begins.

By Peter Phillips

BEFORE describing fault finding techniques, a short but true story is appropriate to illustrate an aspect of servicing that often goes unmentioned. The author, who claims a good grasp of electronics, recently agonized over a fault in a popular model TV set. After a week of fruitless searching using sophisticated test equip-

ment, circuit manuals, textbooks and copious headscratching, a painful decision was made. On the pretext of inquiring about his health, a phone call was made to a friend in TV servicing.

Following his advice and a bit of soldering in an area remote from where the trouble *should have been*, the set was

soon working perfectly. Embarrassed and humbled, the next question was how the fault had been found in the first place. "By going around the set tapping things with the back end of a screwdriver." He then continued to rub it in, suggesting that technical knowledge could be something of a hindrance, and that many faults could be found with a non-textbook approach.

Before the many technically-minded readers wince in horror, this is not intended to promote the hit-it-with-a-hammer technique, but rather to impart some of the more commonly used ploys in tracing the problem.

Fault Categories

A fault in a piece of equipment can be categorized in three ways. The first is the problem occurring in a unit that worked normally prior to the fault. Classified as a breakdown, this fault is most typical and generally the result of a component failure. Another fault category is the construction error in a circuit, likely to be experienced by hobbyists both experienced and otherwise. The final type, the design error, is the nastiest and is often assumed by frustrated project builders. It should be considered only when all else fails.

Another fault variety is the intermittent type. Intermittents are very difficult to find; Murphy's Law will ensure that the problem occurs only when your back is turned. Even so, the beginner can often solve these faults, given the right approach. Yet another possibility is two or more faults occurring simultaneously.

If a project fails to work after its construction, try to determine which of the three categories the fault fits. If this is done prior to troubleshooting, a lot of time can be saved. For example, rule out design error by asking around to see if anyone else has had problems with the same thing. Where a category cannot be determined, assume a constructional fault.

The Breakdown

A fault in previously proven equipment will be in a component, a faulty connection, a printed circuit board, or will be the result of an accident. The servicing approach should begin by examining the events surrounding the fault. If the appliance belongs to someone else, don't always take their story for gospel. Few people are objective in describing a fault, particularly if they're embarrassed about the circumstances. Dropping the thing down two flights of stairs may be described as a minor bump. Details to establish include any previous history of the fault and other related problems. Like solving a crime, any information that can give a lead should be sought.

Before removing any covers, identify for yourself what symptoms the device is exhibiting. Identify unusual smells, sounds, visuals, vibrations, or any behaviour of any kind. Try all controls, seeing what is working and what is not, and how the controls affect each other.

Also, before prying into equipment operated from the AC power line, be sure that the equipment is isolated by a power transformer or isolation transformer. Some inexpensive tube-type radios aren't. If you don't understand the difference yet, *don't mess with the AC line.*

Now remove the covers and repeat the process, looking for anything that might give an indication. Ensure that all plug-in cards are tight and in the right places, and wobble any plug and socket combinations. Also apply pressure to any socketed components to see if loose connections are at fault.

Spraying contact cleaner on all switches, plugs and sockets with the power off is a good idea; even if it doesn't cure the problem, it's good maintenance.

The PCB

Having ensured that the problem is more than a loose connection, try a tap-test, using the plastic end of a small screwdriver. This may bring bad solder joints to light. As solder has little mechanical strength, likely problem areas are those where some physical strain is involved. Soldering in areas with heavy components or where subject to heating, or with PC mounted pins should be examined carefully. Gently wobbling large components or terminal posts while observing solder joints can often identify a dry-soldered or broken connection. Badly soldered joints may not

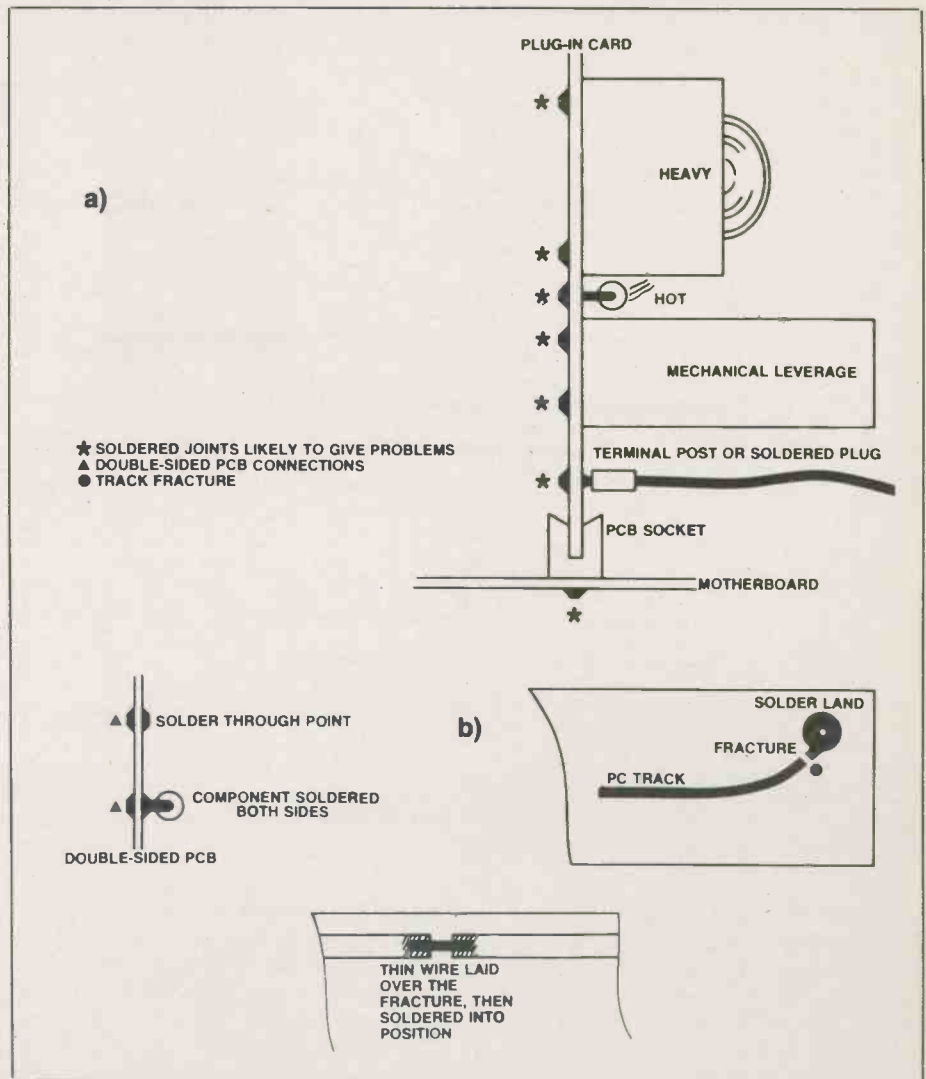

Figure 1. Some pc board problems.

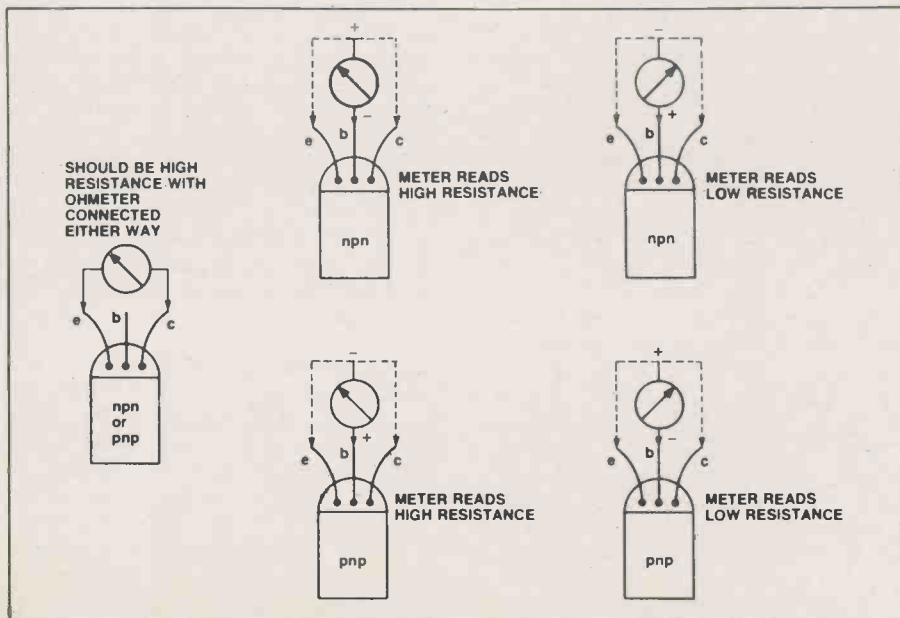

Figure 2. How to test a transistor using a multimeter. An analog meter should be on its low ohms range. Note that the polarity of the meter will reverse; the black lead (—) becomes the positive potential. Digital meters should be on 'diode' test without reversed lead polarity.

manifest themselves for years, and are the cause of a lot of trouble. Figure 1 shows some of the problem areas where solder joints are likely to fail.

Flexing the board gently can identify possible problems with PC tracks or connection points. If the fault is affected by bending the PCB, go to work with a soldering iron and magnifying glass. Double-sided PCBs are more prone to soldering failures where no strain is involved compared to single-sided boards. Careful resoldering of all connections in the affected area can do wonders.

Breaks in PC tracks are not uncommon, particularly at the point where the track joins the solder land. Some servicemen, after having tried everything else, run solder over every PC track in hopes of repairing invisible fractures. Repairing a track should be done by cleaning the track where the soldering is to occur and then overlaying a piece of wire across the break and soldering it into position.

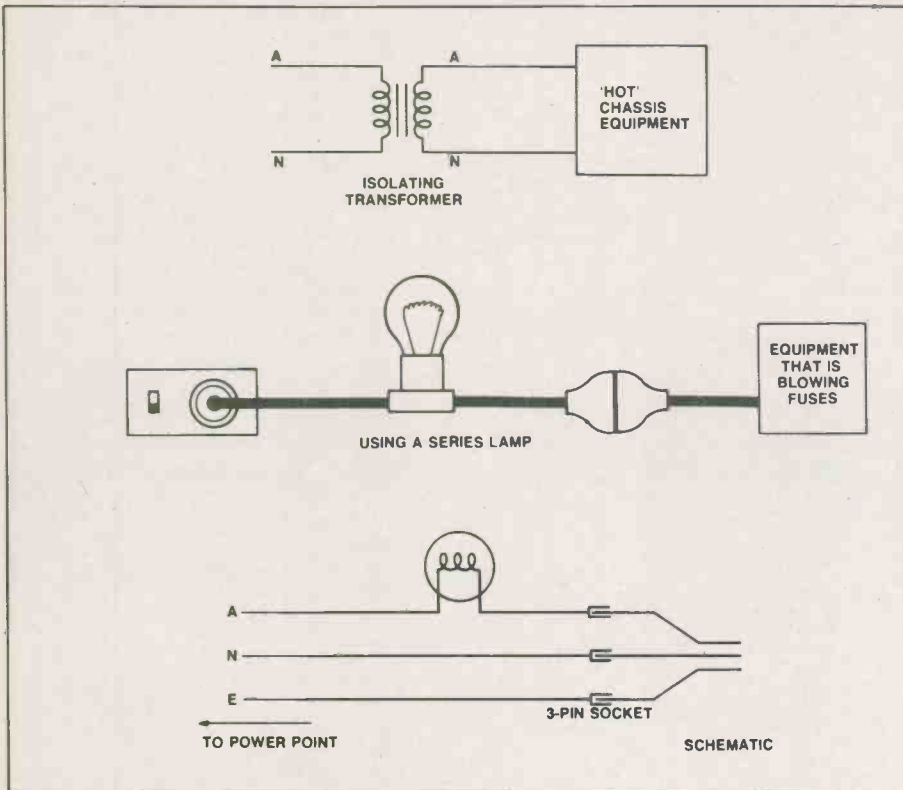

Figure 3. Power line consideration. Lamp wattage should be equal to or greater than, up to two or three times, that of the equipment being serviced.

Locating Faulty Components

If the appliance has not responded to the probe-and-prod test, then a component is probably the problem source. The simplest way to find out which one is to replace each component, one by one, until the fault is encountered. This is practical only on devices with very small component counts.

As a basic rule, try all the active components first. If a replacement is not available, test each component as well as possible using the techniques described further on in this article. Overheating of a component will at least pinpoint the area of a fault.

Sometimes the faulty section can be isolated using basic tests. If the equipment contains an audio amplifier, applying a signal to the volume control will determine if the amplifier section is working. This is done by touching the centre pin of the volume control with the blade of a screwdriver held in contact with the fingers. If an output buzz results, the problem is ahead of the volume control. No output suggests a fault in the power supply, amplifier or speaker. Power supplies can be tested with a voltmeter, or even a trouble lamp; if you have a voltmeter, test the power supply circuitry to see that it's producing the required voltages.

Active Component Faults

Active components generally break down

more often than passive ones. As ICs are often in sockets, searching for a faulty chip is usually the best place to start. The quickest way to establish if an IC is faulty is to replace it, but it should be remembered that there might be more than one fault. So leave the new IC in its socket even if the trouble is not found and go on to the next.

Some faults, particularly power supply faults, may have destroyed every on-board IC, and the fault is destroying ICs as fast as you replace them. To avoid burning out a storeful, try to test each IC as it's removed. This is often difficult, but preferable to burning out all your ICs. Placing the old one in another piece equipment can tell you if it's working or not, but this method obviously has its limits.

Transistor replacement should follow the IC check, unless all the ICs happen to be soldered in. The idea is to test the easiest things first, and transistors are more easily replaced than ICs. Often replacements are unavailable, requiring the testing of each transistor. Generally, transistors should be removed for testing, as parallel components can give misleading readings. Figure 2 shows how to test a transistor using a multimeter. When using an analog meter, set it to the low ohms range, and remember that the polarity of the leads is reversed for ohms measuring; that is, the black lead becomes

the positive. A digital multimeter should be on the diode setting, and its polarity not reversed.

If all the ICs and transistors appear to be working, and checks have shown no bad connections, PC track break or PSU problem, then the remaining components should be examined. Be wary of introducing more faults as you go, by bridging PC tracks or inserting wrong components.

Faults in Capacitors

A valuable hint in servicing is to test the capacitors associated with the power supply. If hum is present in the speaker, the PSU capacitors are suspect. Many a peculiar fault has been found by merely going around the circuit placing a known good capacitor across all those in the circuit, one at a time.

Ensure the polarities match when substituting, and always discharge the test capacitor before paralleling it with the next section. This is necessary in case the stored voltage from one section does damage to the next.

Capacitors rated over 100V can become leaky; this problem is prevalent in tube equipment. Always replace capacitors with one having a working voltage equal to or greater than the original, and use the same type as far as possible, though paper capacitors can be replaced with film types.

Faults in Resistors

Resistors, diodes, transformers, wiring and so on can all become faulty. But the possibility of this is less than for those items already discussed, meaning that the above should be checked last. Resistors, particularly old style types, can change their value; higher-valued types have a greater chance of doing this than the low-valued types. Normally a resistor will increase its resistance with time and use, the effect of which is easily tested with an ohmmeter. If an in-circuit resistor shows a higher value than it should, replace it; if it shows lower, lift one end and retest. In general, resistors are reliable unless their power dissipation rating has been exceeded. Wirewound resistors are prone to becoming open circuit, even under normal operation.

Transformers and PSUs

Transformers and inductors usually go open circuit. Alternatively, transformers can burn out, made obvious by the smell. In this case, find out why the transformer burned out before replacing it. Power supply transformers are usually protected by a fuse, and any inclination to increase the fuse rating should be avoided. A blown fuse is usually indicative of problems associated with circuitry that handles power, and not necessarily the power supply. A good servicing technique

**SPEND LESS
TO GET MORE
QUALITY SALES LEADS!**

**PRODUCT CARDS
SPRING 1986**

WHEN THIS CARD IS GONE PLEASE
CIRCLE NO. 66 ON READER INQUIRY CARD.

**ACTION MAILERS
HOT SIGNED SALE LEADS**

From Direct Response Cards.

- Direct Buyer Contact
- Cost Effective
- Easy To Prepare

**Reserve Your
Product Card
NOW**

Call MARLENE DEMPSTER
(416) 445-5600

Send Card back for more information

Name _____
 Title _____
 Company _____
 Address _____
 City _____
 Province _____ Tel. No. _____



**FINAL
OPPORTUNITY**

Save 61-64% and receive
these publications FREE..

One Month Only.

WHEN THIS CARD IS GONE PLEASE
CIRCLE NO. 67 ON READER INQUIRY CARD.



**Save 61-64% AND receive
one of these publications FREE**



\$14.95

12 issues of Computing Now! A saving of 61% from the newsstand price and \$0 off the regular subscription price AND receive one of these Special Publications (worth \$3.95) FREE!

\$27.95

24 issues of Computing Now! A saving of 64% from the newsstand price and \$1 off the regular subscription price AND receive one of these two Special Publications (worth \$3.95) FREE!

For US add \$3.00 per year; Other countries add \$5.00 per year.

Your Choice of Publication **Computers in Small Business** **Your First Computer**

- Cheque enclosed** * (Send with card in envelope)
- Bill Me** (Subscription will start on receipt of payment)

Please Charge

- Visa** **Mastercard** **Amex**

Card No.

Expiry Date

Name

Company (if applicable)

Address

City **Province**

Postal Code **Date**

See Us First!

**For unbiased, professional help applying
electronics design and manufacturing technology**

ONTARIO CAD/CAM CENTRE — Cambridge

• expert applications assistance in designing, manufacturing, testing and packaging of electronic components, boards, sub-assemblies
 • systems installed include PC-based systems to super-mini, full functionality systems. • applications engineering assistance for system needs analysis, specification, benchmarking, operator and management training, frequent seminars • technical consulting in the areas of system networking, data transfer and interfacing to service bureaus.

519-622-3100

ONTARIO ROBOTICS CENTRE — Peterborough

• wide range of manufacturing consulting services to the electronics industry. • factory check-ups, seminars • experienced engineers can help you improve product quality and lower costs by automating assembly operations, board in section, etc. • automatic testing to guarantee 100% quality • consulting is on fee — for service basis • complete range of robot systems, machine vision and interactive graphic systems.

705-876-1611



**Electronics
Automation Expertise**
 Ontario CAD/CAM Centre
 Ontario ROBOTICS Centre

WHEN THIS CARD IS GONE PLEASE
CIRCLE NO. 68 ON READER INQUIRY CARD.

Yes, I'd like more information on the CAD/CAM Centre Robotics Centre

Name _____ Title _____
 Company _____
 Address _____
 City _____ Prov. _____ Code _____ Tel: _____



Business Reply Mail
No Postage Stamp Necessary If Mailed
In Canada

Postage will be paid by

Moorshead Publications

1300 DON MILLS ROAD
DON MILLS,
TORONTO, ONTARIO
M3B 9Z9



**SPEND LESS
TO GET MORE
QUALITY SALES LEADS!**

PRODUCT CARDS SPRING 1986

WHEN THIS CARD IS GONE PLEASE
CIRCLE NO. 66 ON READER INQUIRY CARD.

Business Reply Mail
No Postage Stamp Necessary If Mailed
In Canada

Postage will be paid by



Moorshead Publications

1300 DON MILLS ROAD
DON MILLS,
TORONTO, ONTARIO
M3B 9Z9



FINAL OPPORTUNITY

**Save 61-64% and receive
these publications FREE..**

One Month Only.

WHEN THIS CARD IS GONE PLEASE
CIRCLE NO. 67 ON READER INQUIRY CARD.

BUSINESS REPLY MAIL
No Postage Stamp Necessary if Mailed in Canada
Postage will be paid by:
CORRESPONDANCE-REPONSE D'AFFAIRES
Se poste sans timbre au Canada
Le port sera paye par

**Ontario Centre for
Advanced Manufacturing**
c/o Moorshead Publications
1300 Don Mills Road,
Don Mills, Toronto, Ontario
M3B 9Z9



Helping You Apply
CAE/CAD/CAM
For Profit

WHEN THIS CARD IS GONE PLEASE
CIRCLE NO. 68 ON READER INQUIRY CARD.



YOUR PROBE SPECIALISTS
OSCILLOSCOPE PROBES AND DMM/VOM TEST LEAD SETS

WHEN THIS CARD IS GONE PLEASE CIRCLE NO. 69 ON READER INQUIRY CARD.

PROBES FOR SALE

FROM THE BEST SOURCE FOR OSCILLOSCOPE PROBES AND DMM/VOM TEST LEAD SETS.

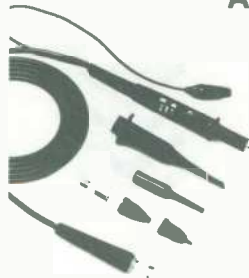

- Low cost
- High Quality
- Excellent Performance
- Slender, Flexible Cable
- Wide Range of Choice
- Switchable X1 and X10 Attenuation Factor
- 100 MHz Bandwidth

MODEL SP100
\$25⁰⁰

Please add \$2.00 for shipping. Ontario residents please add 7% PST.

Coline Canadian Sales & Stocking Source

Store Hours:
 Monday to Friday 8:00 am to 5:00 pm.
 Saturday: 10:00 am to 1:00 pm.

Please add \$2.00 for shipping

Name/Title _____
 Company _____
 Address _____
 City _____ Prov. _____
 Postal Code _____ Phone No. _____

Your Probe Specialists



980 Alness St. Unit 7,
 Downsview, Ontario,
 M3J 2S2
 (416) 661-8586
 TELEX 066-28169

NEW 20 AND 40 MHz high sensitivity 'scopes!

Meguro Electronics is proud to present its latest line of oscilloscopes, Models MO-1251A 20MHz and MO-1253 40MHz. Both are dual trace and feature a high 1mv/div. sensitivity. The MO-1253 has a delay time sweep function used to enhance the accuracy of fine measurements. The six inch high luminance cathode ray tube with beam intensity and scale illumination controls provide for more accurate and readable measurements needed in the fields of research and development, production lines and maintenance/servicing sections.

For further data contact: Mr. Henry Taub, RCC Electronics, Phone (416) 252-5094; Telex 06-984874

WHEN THIS CARD IS GONE PLEASE CIRCLE NO. 70 ON READER INQUIRY CARD.

NEW 20 AND 40 MHz high sensitivity 'scopes!



Meguro Electronics is proud to present its latest line of oscilloscopes, Models MO-1251A 20MHz and MO-1253 40MHz. Both are dual trace and feature a high 1mv/div. sensitivity. The MO-1253 has a delay time sweep function used to enhance the accuracy of fine measurements. The six inch high luminance cathode ray tube with beam intensity and scale illumination controls provide for more accurate and readable measurements needed in the fields of research and development, production lines and maintenance/servicing sections.

For further data contact: Mr. Henry Taub, RCC Electronics, Phone (416) 252-5094; Telex 06-984874

Name/Title _____
 Company _____
 Address _____
 City _____ Prov. _____
 P/C _____ Phone _____

NEW STABILANT 22 ELIMINATES ELECTRONIC CONTACT PROBLEMS

AT LAST - ELIMINATE ELECTRONIC CONTACT PROBLEMS

STABILANT 22 - Under development for over eight years by the Dayton Wright Group, this non ionic block polymer has the ability to reduce and stabilize contact resistance and noise. Excellent results on all types of contact material.

STABILANT 22 - really works. Absolutely amazing results are achieved on PCB edge connectors, sockets, switches, plugs, etc. Especially effective on micropower analogue and digital signals which are most vulnerable to distortion.

STABILANT 22 - is not a contact cleaner. A small amount applied to new or cleaned contacts, works at the molecular level to effectively increase contact area. Results are long lasting because it will not break down, evaporate or rub off.

ORDER SOME TODAY AND BENEFIT FROM THIS REVOLUTIONARY NEW DEVELOPMENT.

Application notes and technical data are included with the product.

Quantity	Size	Unit Price	Total
()	0.5cc syrette	\$ 33.00	\$ _____
()	5cc brush bottle	\$110.00	\$ _____

B.C. residents add 7% provincial sales tax. SORRY NO COD's.

Company purchase order number _____ is enclosed.

My cheque (or money order) for the full amount \$ _____ is enclosed.

Please charge my credit card () VISA or () MASTERCARD

Signature: _____

Card expiry date: _____ mm dd yy Card Number: _____

PLEASE PRINT

Name: _____ Company Name: _____

Address: _____ City: _____

Province: _____ Postal Code: _____ Telephone: () _____

Exclusively by: CYPRUS PRODUCTS INC. VANCOUVER, B.C. CANADA (604) 327-8814

WHEN THIS CARD IS GONE PLEASE CIRCLE NO. 71 ON READER INQUIRY CARD.

Business Reply Mail/Correspondance-reponse d'affaires
No postage stamps necessary if mailed in Canada
Se poste sans timbre au Canada

Postage will be paid by
Le ports sera paye par



BCS Electronics Ltd.
c/o Moorshead Publications
1300 Don Mills Road,
Don Mills, Toronto, Ontario
M3B 9Z9

BCS YOUR PROBE
ELECTRONICS SPECIALISTS
LIMITED

**OSCILLOSCOPE PROBES
AND
DMM/VOM TEST LEAD
SETS**

WHEN THIS CARD IS GONE PLEASE
CIRCLE NO. 69 ON READER INQUIRY CARD.

Business Reply Mail/Correspondance-reponse d'affaires
No postage stamps necessary if mailed in Canada
Se poste sans timbre au Canada

Postage will be paid by
Le ports sera paye par



RCC Electronics
c/o Moorshead Publications
1300 Don Mills Road,
Don Mills, Toronto, Ontario
M3B 9Z9

**NEW 20 AND 40 MHz
high sensitivity 'scopes!**

Meguro Electronics is proud to present its latest line of oscilloscopes, Models MO-1251A 20MHz and MO-1253 40MHz. Both are dual trace and feature a high 1mv/div. sensitivity. The MO-1253 has a delay time sweep function used to enhance the accuracy of fine measurements. The six inch high luminance cathode ray tube with beam intensity and scale illumination controls provide for more accurate and readable measurements needed in the fields of research and development, production lines and maintenance/servicing sections.

For further data contact: Mr. Henry Taub,
RCC Electronics, Phone (416) 252-5094;
Telex 06-984874

WHEN THIS CARD IS GONE PLEASE
CIRCLE NO. 70 ON READER INQUIRY CARD.

**Business
Reply Mail**

No Postage Stamp
Necessary if Mailed
in Canada

Postage will be paid by



CYPRUS PRODUCTS INC.
7648 Heather Street
Vancouver, B.C.
V6P 9Z9

**NEW STABILANT 22
ELIMINATES ELECTRONIC
CONTACT PROBLEMS**

WHEN THIS CARD IS GONE PLEASE
CIRCLE NO. 71 ON READER INQUIRY CARD.

100 pS Delay Line

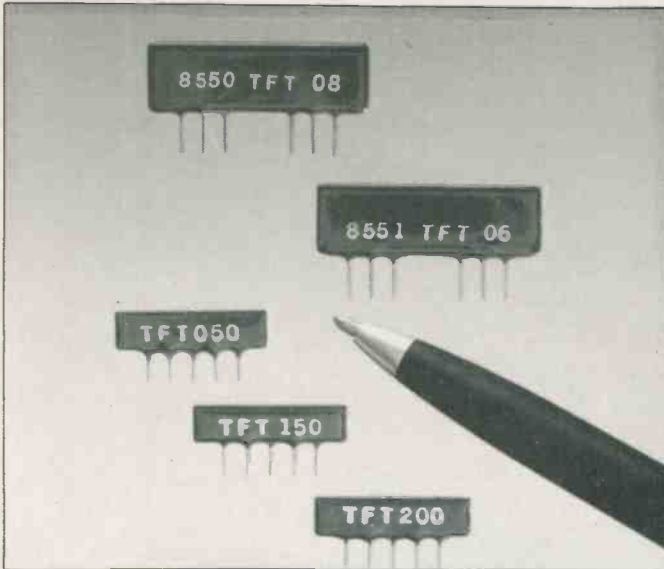

Designed for high-speed applications, these devices feature SIP construction for space savings and distributed capacitance for a remarkably consistent waveform throughout the signal path.

Other features include: time delay range of 100 pS -2.5 nS in 100 pS increments; broad frequen-

cy range up to the GHz band; high quality reproduction of original waveform; and low impedance to match high-speed gate arrays.

For more information contact: Ken Snyder, Thin Film Technology Corp., 6955 Washington Ave. So., Suite B, Edina MN 55435. (612) 829-0930.

Circle No. 38 on Reader Service Card.

Intelligent Dot Matrix Display

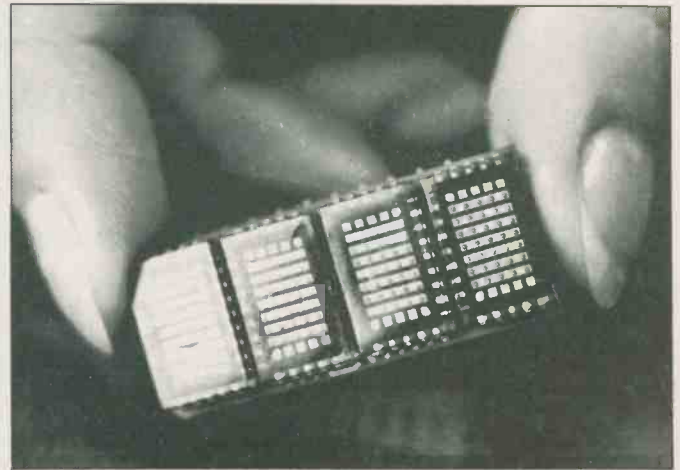

Siemens Electric Ltd. has added a new intelligent dot matrix display to its current line. The PD3435 features programmable brightness, blinking, display testing and darkening in a 5 x 7 matrix organization with 7mm symbols.

The PD3435 also contains 96 figures and characters in ASCII code, saving the user from having to supply character memory and generator, multiplex oscillator and

driver circuit himself.

The device is of the 4-digit variety, of which up to seven can be connected in a strip without extra assembly costs. Colours available include: orange and green.

For further information contact: Mr. G. Springer, Siemens Electric Ltd., 1180 Courtney Park Drive, Mississauga, Ontario, L5T 1P2. (416) 673-1995.

Circle No. 39 on Reader Service Card.

CANADA REMOTE SYSTEMS

OFFERS YOU!

PUBLIC DOMAIN SOFTWARE

Canada's Largest Selection For CP/M, IBM, Macintosh Microcomputers

By Telephone — 12 remote Telecommunications Systems available 24 hours per day. Annual Access charge only \$55.00. No charge for downloading. For CP/M and IBM type microcomputers. Data Pac available.

By Mail — for over 200 different Computers. Over 1000 disks representing all major user groups including SIG/M and PCSIG. From \$10.00 per user group disk. Our special collection disks contain the most popular software and are priced from \$15 per disk.

COMMERCIAL SOFTWARE

Specializing in CP/M and IBM commercial software, Low overhead, low prices, good service. We work with what we sell, and provide full assistance.

COMMERCIAL HARDWARE

Including coprocessor boards for CP/M computers and a full line of modems. The new 2400 Baud U.S. Robotics Courier Modem is now available for only \$825.00

Call us at (416) 239-2835 or Circle Reader Service Number 15 for a free mini-catalog.



Circle No. 14 on Reader Service Card

LASER 128

PERSONAL COMPUTER
128K RAM ON BOARD



APPLE COMPATIBLE
INTRODUCTORY PRICE

ONLY \$789.95

ONE FULL YEAR WARRANTY

RUNS LIKE //e, LOOKS LIKE A //c

HOT NEW item for '86

Built in Features

- 5 1/4" Disk Drive & Controller
- Z-80 Co-Processor RUNS CP/M
- Mouse & Joystick Port Interface
- Serial Printer Port Interface
- Parallel Printer RS-232 Interface
- Modem Port Interface
- 128K on board RAM — 32K ROM
- Expansion Slot (Apple @ Cards)
- Volume Control & Ear Jack
- Numeric Key Pad & 10 Funct. Keys
- Switchable to Divorak Keyboard
- LCD Display & Battery (Optional)
- RGB Runs Double Hi-Res, 16 Color Background, Backdrop & Text
- Graphics Resolution 560H x 384V

Optional Accessories

- External Drive \$207.00
- 256K Expand Ram Call
- Mouse \$113.95
- Serial Cable \$ 29.95
- Parallel Cable \$ 32.95
- Modem \$152.00
- RGB Cable \$ 29.95
- Joystick \$ 21.95
- LCD Display Call
- Battery Pack Call

Apple Peripherals

- Technico Drive \$174.95
- Z-80 Card \$ 39.95
- //e Numeric Key Pad \$ 49.95

Call for other peripherals

AB&C ELECTRONIC ENTERPRISES

P.O. BOX 662, THUNDER BAY, ONTARIO P7C 4W6
TELEPHONE (807) 623-6111

Ont. Res. add 7% P.S.T. Cert. Cheque or Money Order, Visa & Mastercard accepted. Allow three weeks for delivery. Full refund if returned within 15 days. Add \$5.00 for shipping & handling. Prices subject to change without notice. Apple //e, //c are registered trademarks of Apple Computer Inc.

Circle No. 15 on Reader Service Card

Product Review

Microlab 1 Digital Trainer

A thoroughly-designed protoboard plus a complete course in basic logic circuits.

By Bill Markwick

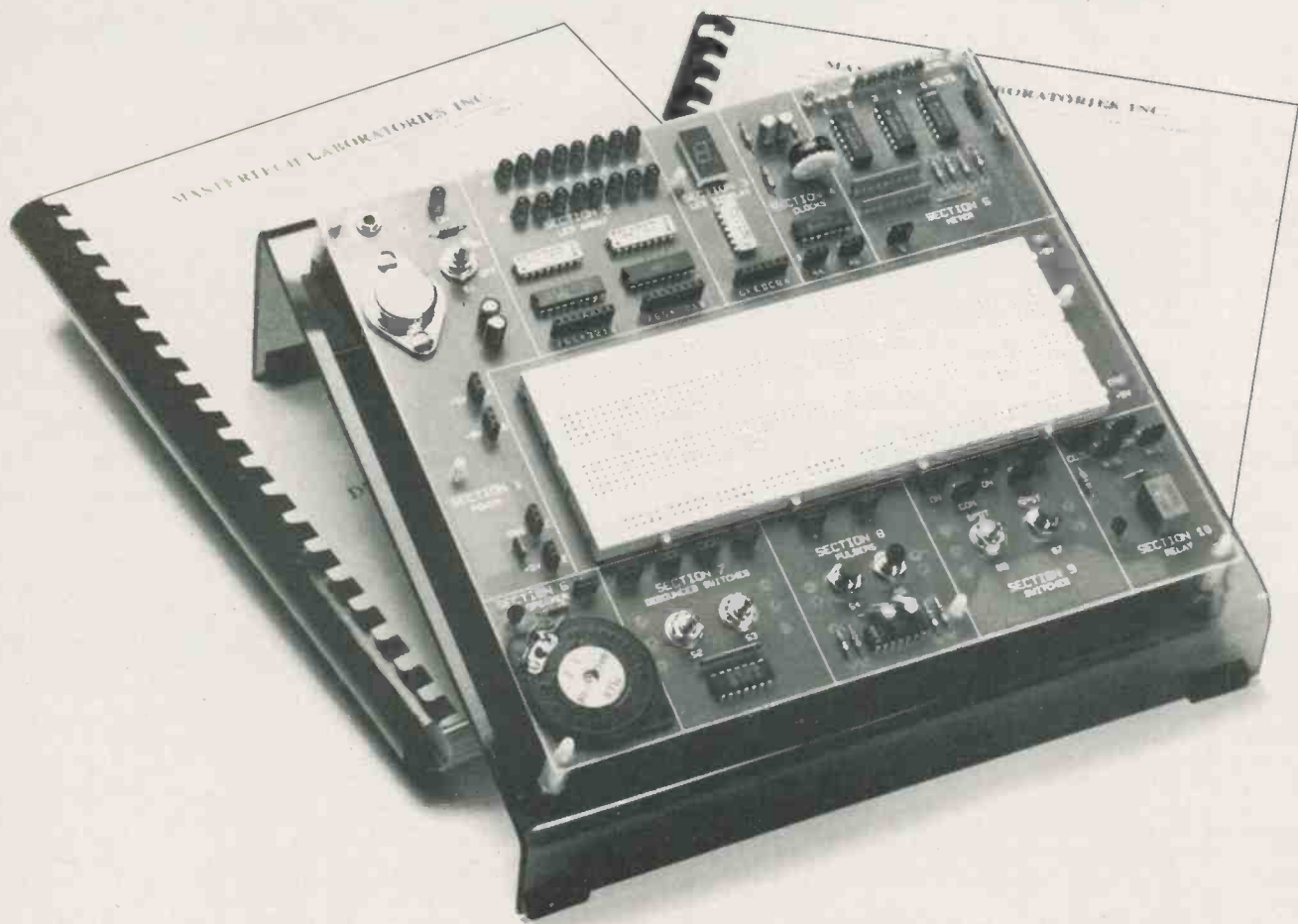

TO begin with a summary: there are lots of ways to learn logic circuits and basic digital techniques, but few as well designed and as complete as the Microlab 1 training course.

The package consists of a printed circuit eight inches square and mounted on an acrylic stand, two thick manuals, and all the wires and components needed for the course. On the printed circuit is a solderless breadboard and all the basic switches, clocks, and displays to perform the various experiments. It's powered by

an included 9V plugpack and onboard 5V regulators.

The course is designed for someone with no knowledge of electronic components, although the user should at least be aware of Ohm's Law and know how to read simple schematics. The engineering department of the University of Victoria evaluated the Microlab 1 and decided it would be suitable for a digital electronics course in Grades 11 or 12, and the trainer is now being used in a computer technology course at Victoria High School,

British Columbia. Of course, this doesn't mean that the unit won't be ideal for any of our readers who'd like a way to get a grasp on digital techniques conveniently (you don't even need tools or solder).

The Board

At the upper left of the board is a TO-3 version of the 7805 5V regulator, which supplies operating power to the power strips on the protoboard as well as driving the onboard circuits via printed circuit traces. The voltages and currents available

mean that the unit is self-protecting from shorts and overloads, as well as being completely safe for the operator.

There are three types of displays to indicate circuit status: 16 LEDs with driver ICs (each LED with its own input), a seven-segment LED numeral, and a ten-segment 0-5V voltmeter. Audible indication is provided by a piezo sounder at the bottom left. A relay at the bottom right can be used either as an audible sounder or as an output driver.

Circuits are provided with input signals in a number of ways. There's a clock with both 1kHz and a very slow variable output, two debounced toggle switches, two pulse generators with pushbutton triggers, and two unbuffered general purpose switches.

The Course

In general, each section of the course consists of a detailed (and clear) explanation of the particular technique involved, then a demonstrative circuit easily made up from the included components and jumper wires, and finally a series of self-test questions.

Not surprisingly, the course begins with an explanation of logic gates and inverters, basic switching and logic input-output levels. It's very easy to slip the jumpers into the clearly-labelled pins and

get the circuit going; the layout of the board concisely demonstrates the input-output signal flow.

Once the user is familiar with gating, the course demonstrates how flipflops work; the various switches and pushbuttons show clearly how the input and clock pin work together to produce the desired output.

Counters are next, with a 4-bit ripple counter put together from 74LS74s driving the LED arrays for a binary output. Counting and resetting are covered before up-down counting and data loading are shown with the 74LS193.

Shift registers are thoroughly covered; the user can construct his own from flipflops before going on to the IC version to learn loading, cascading, etc.

Lastly comes the data-handling section, demonstrating data-handling with the BCD to 7-segment decoder, various types of multiplexing, and the magnitude comparator.

One of the most tedious tasks in working with logic ICs is looking through stacks of manufacturer's specification sheets for basic facts. The Microlab includes a large appendix to the manual, and it's stuffed full with data sheets, further explanations, a glossary, and the test question answers.

And finally...

How long it takes to complete the course depends on the user (or the school). There are 40 labs in the manual, each one an in-depth coverage of a particular circuit; how fast you can build circuits is less important than how well you retain the derived information, so completion time will vary from person to person. In any case, you can learn at the rate best for you.

Once you do get it finished, the manual says that you can purchase add-on options such as analog-digital converters, arithmetic circuits, and microprocessor circuits.

It's obvious from only a few moments of experimenting that a great deal of careful thought has gone into the trainer design. It condenses an enormous amount of explaining into an eight-inch PCB and a clearly-written manual (besides that wonderful Appendix).

The trainer was originally introduced into the American market at \$249 (US), and by the time you read this, it will be introduced for sale in Canada. For more information on the Microlab 1, contact Mastertech Laboratories, 302 Royal Trust Building, 612 View Street, Victoria, BC V8W 1T5, (604) 388-6631. ■

"NO REASONABLE OFFER REFUSED"

OVER STOCK — CASH & CARRY SALE

Sold as is — where is

- Used Terminals from **\$75.00** ea. Many to choose from
- Used Printers from **\$100.00** ea.
- Used 1200 & 300 Baud Modems from **\$50.00** ea.
- Used 8 Meg Winchesters **\$450.00**

AND AS USUAL...

- New 5¼" Drives from **\$120.00** ea.
- Diskettes 5¼" SSDD **\$12.95**/package of 10
- Ribbons for all makes of printers
- New 300 Baud Modems @ **\$69.95**ea.
- New 1200 Baud Modems @ **\$349.00** ea.

CASH, VISA, CHEQUES
Call Jack Veffler

ESP Electronics Supply Parts

2220 Midland Ave.,
Unit 37
Scarborough, Ontario
M1P 3E6
Tel: (416) 299-9633

Circle No. 16 on Reader Service Card

K.E.M.

NOW JUST ARRIVED!

More Powerful More friendly

High Speed EPROM Toaster For Apple and IBM

From 2716 to 27256 all-round player. Function programming voltage (12.5V, 21V, 25V), and ROM selection totally software control. Just change I/F card, Can switch to IBM or Apple.

For Apple **\$185.00**

For IBM **\$195.00**

Extra I/F card Apple or IBM . . . \$ 79.00

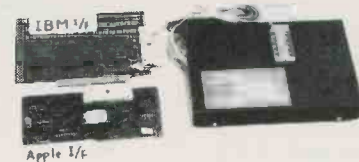

Also KEM High Speed Rom UV Eraser.
Erasing time only within 5 to 10 minutes.

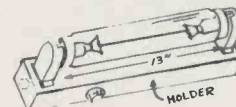

1 set **\$29.98**

Timer **\$ 4.98**

\$5.00 for shipping. Plus Provincial Tax for B.C. residents. Plus C.O.D. fee if required. Price and specification are subject to change without notice.

K.E.M. Electronics Ltd

Mail to Box 69126 Station (K), Vancouver, B.C. V5K 4W4
Office 879 E. Hastings St. Vancouver Tel (604) 251-1514

Circle No. 17 on Reader Service Card

COMPUTER PARTS GALORE INC.
316 College St.
Toronto, Ontario M5T 1S3

KEYBOARDS

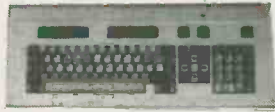

- (A) 5150 Style, 83 Keys, Std Layout, uses the long lasting Cherry Sw, IBM® Comp. \$ 99.95
- (B) 5151 Style, 105 Keys, Keytronic 5151 layout, Cherry Sw. IBM® Compatible \$139.95
- (C) 5180 Style, AT® compatible, with 83 keys by Cherry, 5150 layout \$159.95
- (D) 5181 Style, AT com, but 5151 layout \$189.95
- (E) AES DATA Keyboard, Par ASCII and Serial but not IBM. Runs Apples® very good general use ASCII keyboard \$ 24.95
- (F) APPLE NUMERIC BASIC FUNCTION, II+ \$ 69.95
- (G) APPLE STANDAR BASIC FUNCTION, II+ \$ 69.95
- (H) APPLE DETACHED II+, NUMERIC FUNC. \$149.95
- (I) FOX 2001 Internal keyboard, Iie \$ 69.95
- (J) FOX 2001 External keyboard, Iie \$139.95

POWER SUPPLIES



- (A) 150 Watt, Back/Slide Switch, with +5v-15Amp, +12v-5.5Amp, -5,12v-½Amp, A good quality, hydro approved unit \$139.95
- (B) 150 Watt, CSA approved unit, for the very highest system reliability, +5v-15Amp +12v-5.5Amp, -5,12v-½Amp, Slide Sw .. \$159.95
- (C) APPLE II+, or FOX 2001 Iie, power supply, +5v-5Amp, +12v-2.5Amp, -5, 12v-½Amp Very high quality \$ 79.95
- (D) OPEN FRAME Northern Telecom switcher as widely sold, +5v-4A, ± 12V-1Amp and -5 at 1 Amp, very good deal \$ 18.95
Power cord for (D) above .. \$ 3.50
- (E) IBM OPEN FRAME, came from the defunct NCR compatible, +5v-7Amp, +12v-3Amp, -5, 12v-½Amp, runs the whole thing \$ 59.95

Z-NIX MOUSE

The "Z-NIX" mouse is great, an absolute copy of the **MOUSE SYSTEMS MOUSE**, it eats it alive and runs it's software to boot. Runs with **PC PAINT, PC PAINT BRUSH, AUTOCAD and MICROSOFT SOFTWARE** (not all) Complete with manual and software \$119.00

**Toll Free Orders Only
1-800-387-1385
(416) 928-2161**

CASES



XT® CASE WITH AT® LOOK

- (A) Standard 8 slot hinged case XT® case. Fits slide or back power supply (Specify) Has much heavier metal than competitors for stability, takes 1-4 ½ sized drives and fits very well \$79.95
 - (B) Same as above, but the front looks like an AT case, with switch for KB and LEDS on front (picture) \$89.95
 - (C) ABS numeric case for II+ \$49.95
 - (D) ABS case for FOX 2001 \$49.95
 - (E) Hard drive box, holds 1 full sized or two ½ sized hard drives, good for portable tape backups as well \$59.95
- 40 Watt power supply for the above \$59.95
60 Watt power supply for the above \$79.95

DRIVES



QUME

- (A) Yes we have the drives that IBM bought for their own use, complete with the IBM® logo right on them. Brand new DS/DD ½ Height drives \$149.95
- (B) Panasonic drives, very quiet, as above but no logo, DS/DD ½ Height \$179.95
- (C) Toshiba drives, noiser than above, but cheaper, no logo, DS/DD ½ Height \$189.95
- (D) Seagate 20 Meg hard drive with Controller, ½ height \$889.00
- (E) Seagate 20 meg drum only \$750.00
- (F) Controller only \$199.00

GRAY SCALE ADAPTER

As you know the IBM colour graphics card does not look very good on a monochrome monitor. This is because often two colors look the same on monochrome so you cannot read red print on a blue background or some such. This little gray scale proportionately scales each color into a different intensity allowing easy viewing on amber, green or white monitors. We sell it as a kit for only (with cable) \$19.95
or wired and tested (with cable) \$24.95

* Note: The terms, IBM, XT, AT, PC are registered trademarks of International Business Inc.

WIRED CARDS FOR IBM®

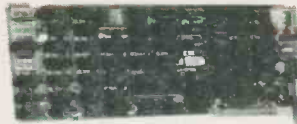

- (A) 384K RAM card, ¾ size for 384K of 84K DRAM. Wired and tested with OK \$ 79.95
Bare PCB and assembly data \$ 19.95
- (B) 576K RAM card, ¼ size for 576K of 256K DRAM. Wired and tested with OK \$ 59.95
Bare PCB and assembly data \$ 14.95
- (C) KRAM card, a clone of the JRAM card for 2 MBYTE of 256K DRAM. Runs all software 100% compatible, W & T with OK \$139.95
Bare PCB and assembly data \$ 29.95
- (D) COLOR GRAPHICS, A PERSYST clone, runs all software and our one has grey scale O/P & color comp and TTL RGB, W & T \$125.00
- (E) MONO GRAPHICS, A hercules clone, runs all software and has parallel centronics printer as well, W & T \$139.95
Bare PCB and assembly data \$ 24.95
- (F) 384K/MULTIFUNCTION card, exact copy of AST SIXPACK, Ser, Par, Clock, Cal, Game I/O with software and ports, W & T, OK. \$189.95
Bare PCB and assembly data \$ 24.95
- (G) DISC CONTROLLER, runs 1-4 drives has newest 9216 data separator with cables wired and tested \$ 59.95
Bare PCB and assembly data \$ 12.95
- (H) DISC + I/O Card. A very nice new card with disc controller plus AST sixpack on board without any RAM. Ideal for the new 640K motherboards, Ser, Par, Clock, Cal, Game, software and ports, W & T \$189.95
- (I) 10+2, An AST SIXPACK with no RAM, has Ser, Par, Clock, Cal, Game and software and ports, W & T \$129.95
Bare PCB and assembly data \$ 19.95
- (J) PRINTER, Centronics, Std parallel printer, ¼ size, W & T \$ 49.95
Bare PCB and assembly data \$ 12.95
- (K) SERIAL, std serial card, two ports ½ sized, W & T \$ 44.95
Bare PCB and assembly data \$ 12.95
- (L) CLOCK/Calendar, A ¼ sized card for these two functions, with battery \$ 49.95
Bare PCB and assembly data \$ 12.95
- (M) GAME, card, A ¼ sized card with 2 std game ports on it, W & T \$ 39.95
Bare PCB and assembly data \$ 12.95
- (N) EXTENDER, and 6" extender board for easy access for service \$ 14.95
- (O) PROTOTYPE, full sized with all WW area and a DB25, DB9 footprint \$ 24.95
- (P) RAM/PROTOTYPE, Full size with 256K/1 M RAM area for 64K/256K DRAM at end with DB25 and DB9 footprint \$ 29.95

MONITORS

Call for Details

We have all printers and ribbons in stock call for quote.

- Type A, AMBER composite \$149.00
- Type B, AMBER TTL (High res Mono) \$189.00
- Type C, COLOR composite \$349.00
- Type D, COLOR TTL RGB \$599.00

IBM COMPATIBLE SYSTEMS



XT ...\$829.00

What a deal, the nicest systems of all at the lowest price for good merchandise. The basic system has the following. For \$829.00

- 640K Motherboard
- 1 DS/DD 360K ½ Ht.DD
- 1-4 DD Controller
- Keyboard
- Colour Graphics Card
- Free software
- 256K RAM on board
- 8 XT slots
- Flip top case
- 150 Watt power supply
- All cabling & 24 hr. Test and burn-in

To upgrade the system to your choice please select from these options.

- Monochrome graphics card . Add \$ 49.00
- Ser/Par/game/clock/calendar Add \$ 110.00
- Printer card Add \$ 45.00
- Serial card Add \$ 49.00
- Second drive Add \$150.00
- KRAM CARD, OK Add \$139.00

640K XT MOTHERBOARDS



We now have several types of 640K motherboards with all the standard attributes of the "REAL" thing as well as some new ones. All have 8 XT slots, XT size, and 8087 socket and have 100% compatibility. The extra features are the use of 256K RAM to get 640K on the mother board plus the new desirable "TURBO" feature. The "TURBO" has two speeds, the basic 4.77 and either 6.67 or 8.00 Mhz. The 6.77 uses the -3 or standard 8000 chip set and RAM, the 8.00 needs the -2 high speed version and 120NS RAM. The speed advantage is the ratio of 6.67/4.77 = 1.39 or 39% faster and 8.00/4.77 = 1.67 or 67% faster, all other things being equal. Of course timing loops will be changed so that any real time output will be faster by the ratio unless the loop is fixed. The largest saving is in CAD programs with a lot of number crunching, smallest savings are disc intensive programs.

- SME-XT, wired with OK 3 hr burn-in \$199.00
- SME-XT, wired with no IC's at all \$ 99.00
- SME-XT, bare pcb, book parts list. \$ 34.95

TURBO 6.67 MHZ VERSION

- SME-XT A Wired, 3 Hr burn in, OK. \$229.00
- SME-XT A Wired, no IC's at all \$129.00
- SME-XT A Bare PCB, book, parts list \$ 39.00

TURBO 8.00 MHZ VERSION

- SME-XT B, wired, 3 hr burn in, OK. \$249.00
- SME-XT B, wired, no IC's at all \$139.00

All boards come with book and parts list, the wired with OK have BIOS included.

The Beginner's Bench, Part 1: Troubleshooting

By Bill Markwick

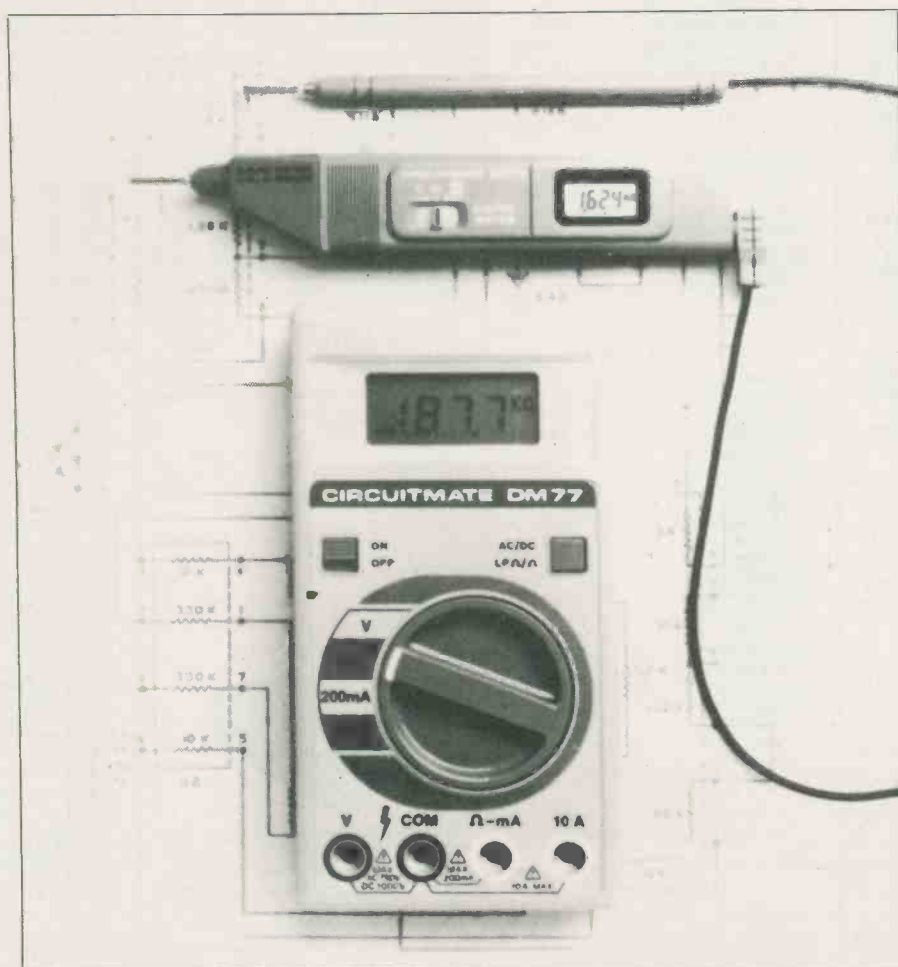

HELLO again. Welcome to a new series which will feature articles by various authors on building, troubleshooting and modifying your projects. We assume that you've had some grounding in basic electronics, such as our past series *Electronics From The Start*, that you have at least a grasp of Ohm's Law, and that you can solder. By soldering we mean clean, small, reliable joints that hang together forever,

and also the ability to rapidly go over a project, find poor solder work and correct it. If you're still struggling with that, the *Troubleshooting* article in this issue is a good grounding.

I'll start off this first part by taking up where the above article left off; that is, the assumption is that you've poked and prodded and thumped a defective device and have finally decided that it isn't going

to work unless you start measuring.

Someone once said "Once we can describe something in numbers, we begin to know something about it." I'm not sure who said that, but high school teachers used to put things like that up on the wall all the time. It's a true saying, as opposed to the harmless untruths they usually tell you.

To start getting those numbers, the best

and most common device is the multi-meter. If you don't already have one, they range from \$15 pocket analog types to digital bench types costing \$300 and up. I'd stay away from the bottom-of-the-line multimeters; for economy purposes, they have poor sensitivity and draw too much current from the circuit. They also have a limited number of ranges, and sometimes have jack sockets instead of a switch. I'd go for one with a sensitivity of 10,000 ohms per volt or higher. Incidentally, this sensitivity business was poorly explained in the *Electronics From The Start* series. All it means is the number of ohms that will be placed across the circuit under test; the value is multiplied by the selected number of full-scale volts. For instance, a 10k per volt meter set to the 5 volt range has a resistance of 50,000 ohms.

This has important consequences, as we've pointed out before in *ET*. We all have a tendency to believe religiously in what our meters are telling us, but if you place that 50,000 ohm meter across a voltage source which is fed through a 47k resistor, the error is nearly 50 percent. Yow.

As far as range features go, you'll need DC volts down to about 1V full scale, DC current up to 500mA or more, and AC volts from about 5 to about 500. AC current is rarely included on the lower-cost models and rarely comes in handy anyway.

Don't fret if you've taken possession of a meter that doesn't match my specs. It's more a matter of convenience than anything. I used one of those little tiny guys with 1000 ohms per volt for years, until recently when I left it on the current range and put it across my car battery, turning it into a ball of smoking plastic. I thought it had a protection circuit. Guess not.

Dead Circuits

Let's assume that you have an amplifier or simple logic circuit that isn't working. It not only lacks an output, it's totally dead, and there's no sign of obvious overheating. After checking out physical layout problems, set your meter to a DC volts range higher than the supply voltage.

Take a hard look at the range switch on your meter. It features volts, amps and ohms. In other words, you have an Automatic Ohm's Law Detector. No other single rule in electronics is as important. When you can relate the volts, amps and ohms of a circuit while you're asleep and dreaming about something else, you're starting to get the hang of it.

Next, you should have a schematic of the circuit under test. Once you get familiar with basic layouts and the techniques of troubleshooting, you can get by without one, but for now there'll be enough unknowns without a missing schematic.

Testing PSUs

Connect the negative lead to a ground point, using short lengths of flexible wire with insulated alligator clips on the ends. These leads are indispensable, by the way, and you can save time by buying a package of them at Radio Shack or other stores. The first thing to find out is whether the main power supply (PSU, Power Supply Unit) is working. If the unit has its own internal supply, make the first test by touching the positive lead to the positive terminal on the main filter capacitor. If the unit is battery powered, test the point where the battery holder or battery lead is soldered into the circuit. You should get a reading approximately equal to the required operating voltage, depending on the power line voltage at the moment or battery condition. We'll get back to what happens if you don't.

Another possibility is that the circuit is powered by a bipolar supply, i.e., plus-and-minus voltages. This is a bit of an inconvenience with analog meters that don't have a polarity switch; it means lead-switching to test the negative voltages. Digital meters have automatic polarity indication. By the way, the plus-and-minus approach doesn't mean that we have two different kinds of electricity. With a plus-and-minus 15V power supply, for instance, it simply means that we've taken a 30V supply and called it its midpoint ground, or zero volts. This is best seen when the bipolar supply is implemented with two 9V batteries in series with the ground (or zero volts, or common) connected to the midpoint. We have 18 volts split in the middle. Nothing to it, except for that annoying lead-switching.

Yet another possibility is that there's a series regulator after the main filter. These have been used more and more in recent years as they get cheaper and smaller. We'll come to regulators in a moment.

About the reading: if you didn't get one, or you got one far too low, don't assume that the supply is at fault. There could be a short or excessively low resistance in the following circuitry. Check for a blown fuse; if there is one, don't replace it with a higher-valued one or you may increase any damage already done. To prove out the PSU for sure, you'll have to open up the supply lead to the following circuit so that the PSU can run on its own. It may mean desoldering, or you may have to cut a PC track. It's worth the trouble. Did the PSU voltage come back up to normal? If so, you'll be looking for an over-current condition. If not, there are usually three possibilities: the filter cap, the diodes and the transformer. If you keep getting blown fuses, skip to the last paragraph of the *Narrowing Down* section.

The filter cap is usually an easy one: substitute another. If the PSU has been

always a head ahead

DYNAUDIO
AUTHENTIC FIDELITY

the innovators

DYNAUDIO LOUDSPEAKER COMPONENTS FEATURE

- PHA cones •
- Very High Power Hexacoils •
- Magnesium Diecast Baskets •
- Tuned Cavity Tweeter •
- and Mid-Range Units
- Vented Centre Magnets •

ALSO AVAILABLE

Computer Aided Design for Enclosures and Crossovers
Metalized Polypropylene Capacitors
Perfect Lay Winding Inductors
Speaker and Crossover Parts

WRITE OR PHONE FOR MORE INFORMATION
FREE CATALOGUE AVAILABLE



SOLE IN C
5940 Bergevin
Brossard, Québec J4Z 1Z2
(514) 656-2759

Circle No. 20 on Reader Service Card

FREE

CATALOG AND APPLICATIONS GUIDE

AFFORDABLE ENGINEERING SOFTWARE

PCDOS • MSDOS • CP/M • TRDOS

PDP — Plotter Driver Program For multi and single pen plotters	\$72.95
XFER — Transfer Function Synthesis Transfer functions → Electronic circuits	\$72.95
TEKCALC — Scientific Calculator Program Screen graphics/Statistics/Programmable	\$72.95
COMCALC — Communications Design Spreadsheet Communications budget calculator	\$72.95
RIGHTWRITER — Report Proofreader Program Version 2 — Applies 2,200 rules of English	\$97.95

ACNAP — AC Network Analysis	\$72.95
DCNAP — DC Network Analysis	\$72.95
SPP — Signal Processing Program	\$72.95
PLOTPRO — Scientific Graph Printing	\$72.95
PCPLOT — High Resolution Graphics	\$72.95
LOCIPRO — Root Locus Analysis	\$72.95
ACTFIL — Active Filter Design	\$72.95
STAP — Static Thermal Analysis	\$72.95
MATRIC MAGIC — Matrix Manipulation	\$72.95

BV Engineering
Professional Software

2200 Business Way, Suite 207, Riverside, CA 92501 U.S.A.
(714) 781-0252 All price U.S. \$ include S&H

Circle No. 21 on Reader Service Card

disconnected from the circuit, you can use almost any electrolytic with a suitable voltage rating just to see if it will come back to life. Individual diodes in the rectifier can be checked with an ohmmeter *with the power off*. They should read open in one direction and some low value in the other. Exactly what value is hard to say, because the voltage across a diode depends on the current through it and there's no telling what current your meter applies in the ohms position. This is why ohmmeters appear to give very inconsistent results when testing semiconductors, especially when you change ranges. The power transformer is easily checked; set the meter to AC volts (always start with the highest range if you're not sure which one) and put the leads across the secondary. The output should be about 70 percent of the DC operating voltage, though

would have put it, an R that's too low for the E and causes too much I.

The Hunt

The moral of the story so far: since the PSU runs everything, make sure it's okay first. Then you can continue with the hunt for the overcurrent condition (or whatever else is wrong).

Most electronics can be reduced to a power supply line feeding various functions, like a string of parallel resistors. The trick is to find out which one has gone wrong, with everything complicated by the fact that various functions can control each other via signal lines.

Suppose your project is a digital one, full of TTL or CMOS chips, and the PSU will only put out about a volt due to an overload somewhere. With only one volt, none of the ICs will work, and there's no

this usually eliminates tiny transistors in series with 10k resistors and so on. I use the word "usually" to hedge my bets, because in reality absolutely anything can go wrong. However, go for the obvious first and then track down the unlikely.

At some point you'll pull an IC or disconnect a wire and *voila!* The voltmeter returns to the proper power supply reading. The probable cause of the trouble on the homebuilt project will be one or more of: solder bridges on the PC, components in the wrong place, component orientation, or wrong connections.

All the above assumes that the PSU will keep working into a short. If it just keeps blowing fuses whenever you go to test, you'll have to reverse the above procedure: disconnect everything, prove that the PSU is okay, and then start reconnecting things one small section at a time. The one that blows the fuse is the culprit. If it's a bipolar supply, connect and disconnect both plus and minus leads with the power off, then power up for a test.

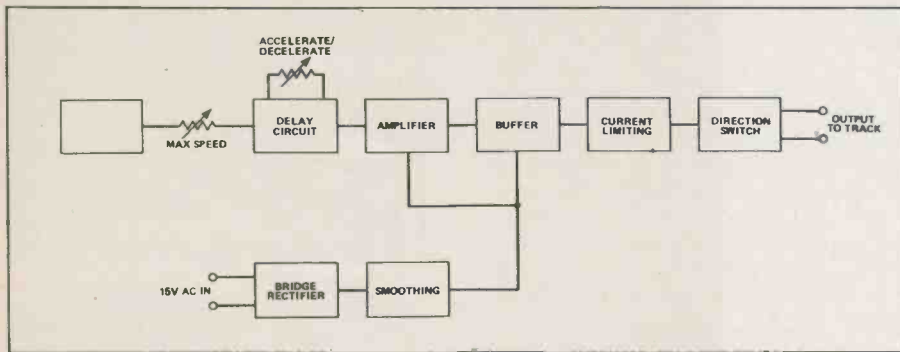

Fig. 1. All circuits no matter how complex break down into series-parallel function blocks like the above. The power and ground lines are in parallel and the signal path can be series or parallel or both.

it will rise if there's no load connected. If there's no output, check all the power wiring. If you have 115VAC going into the primary and nothing coming out of the secondary, you can assume a dead power transformer. This is a rare occurrence.

If the filtered DC is okay and there are voltage regulators, reconnect any open wires and test the output of the regulator(s). The main point here is that almost all regulators have some sort of current-limiting circuitry inside them to protect against shorts and overloads. This limiting action reduces the output voltage if the current goes too high, giving the appearance that the regulator has gone wrong. The only way to check it is to open up the output wiring from the reg and see if it runs okay open-circuit. Hint: is there a fuse in the DC line, either before or after the regulator? If so, it's an easy place to test PSU voltages and currents.

Let's assume that things are in this state: you've opened up the PSU output and connected the voltmeter. The voltage is OK. With the meter still connected, you reconnect the PSU and the voltage drops abnormally. Obviously, we're looking for an overcurrent condition, or as Mr. Ohm

hope of testing the project section by section. The only alternative is to start opening the power supply line section by section until the trouble is located. Sometimes this can be done just by pulling ICs out of sockets; sometimes it means desoldering or cutting PC tracks. In any case, leave the voltmeter connected to the positive supply rail and start disconnecting. The method to follow is to disconnect large function blocks at one time; for instance, in an audio amp, disconnect the preamp, then the tone control (or other function) and then the power amp. If it's all on one board, this may not be possible. Anyway, the whole idea is to narrow down the fault's location by testing in large blocks at first. This isolates much faster than testing a zillion small things.

Narrowing Down

Once you isolate things down to large subsections, you can save a lot of time by looking through the suspect section for obvious troublemakers while eliminating the innocent. In other words, our low supply voltage is going to be caused by something drawing lots of current, and

No Signal

This is just as likely as the supply line short, if not more so. The rescue method is a little more difficult to describe, because so many different things can account for troubles, including the supply line short described above. To really check it out, you should have a signal generator and an oscilloscope, but there are some quick tests you can make. For audio amplifiers, you can use a screwdriver shaft to inject a hum signal here and there; this is well-covered in our feature article.

Yet another test for audio amplifiers is to measure some voltages. Unlike digital circuits which will usually have an output of all-or-nothing, audio amplifier outputs are usually biased so that the output reads about half the supply voltage. This allows maximum signal swing in either the negative or positive direction.

If the amplifier stage you're testing is an emitter follower, look for about half the supply voltage on the emitter. By supply voltage I don't necessarily mean the output of the PSU, but the voltage supplied to that particular stage; it may have been decreased considerably by decoupling filters, which I'll come to in another issue. If the stage is an emitter follower, measure the voltage on its collector and take this as meaning the supply voltage.

If the stage is a common emitter, the collector should be at about half the voltage that you measure at the top of the collector resistor (transformer circuits are a whole other story). This voltage can stray from halfway by a whole lot, say 25 percent, but if it's within a volt of the supply voltage or ground, the transistor is either defective or it's being biased improperly by a circuit fault ahead of it.

If the stage is an op amp, it will probably be driven by plus-and-minus supplies, and halfway between any plus-and-minus supply is zero volts. This gets tricky. How do you tell zero volts from an open circuit, or an output that's shorted to ground?

At this point I'm going to have to cop out and ask you to wait for a future article on troubleshooting amplifiers like this, but for now your main concern is presence or absence of signal. A crystal earphone from a portable radio is a quick way of finding out. Their impedance is high enough that they won't draw excessive current from the stage under test. I hesitate to suggest using magnetic headphones, like a stereo headset; they conduct DC, which will kill the action of the circuit under test, and even if you add a blocking capacitor, their impedance is too low for test purposes.

Between hum-injection, voltage-measuring, and a crystal headset, you should at least be able to localize amplifier faults.

Digital

Digital circuits are a paradox; they're both easier and more difficult to troubleshoot. On the one hand, all the fussy biasing

components and so on are within the chip, leaving only pure functions to be tested. On the other, lots of things can go wrong that are very difficult for the beginner to trace without special equipment. What if one bit out of eight is missing? What if one bit out of eight is delayed?

If you've built a simple circuit that only has a few digital ICs in it, quick troubleshooting is limited to going over the PC traces for accuracy and lack of solder bridges, checking component locations, and finally substituting components.

But if you have some proper test equipment, even a simple logic probe, then you can start looking. Logic probes will at least tell you the hi-lo state of a logic line. Of course you can determine logic states of a static circuit with a voltmeter, but you can't detect a fast pulse or a burst of fast pulses. Sometimes one single pulse from a pushbutton conditioning circuit is necessary to start things off, or a strobe signal may be required for an IC to clock some data through. The logic probe will detect these for you.

But as you might expect, I can't give you an analog/digital testing course in two pages, so I'll have to wrap up with a summary until next month.

Summary

1. Learn Ohm's Law until it's as natural as breathing. You *do* breathe, don't you?
2. If you don't have any test equipment, the first investment should be a multi-meter.
3. If you make any wiring or component changes for testing, make them with the power off, then power up when they're completed. This is especially true for computer ICs.
4. When testing, do not, repeat do not, jump around measuring here and there and everywhere. What's the point? You'll only muddle yourself further. Be methodical. Test from the output back to the power supply, or the other way around, but remember that each measurement is a clue. And a bunch of clues jumbled around and mixed together is no clues at all.
5. And, of course, I don't want to nag, y'hear, but we want to keep you around for a while yet, so don't test things that aren't isolated from the power line with a transformer, and if you have to work on the power line side, keep one hand in your pocket. Seriously.

Next month we'll be back with more information that's not so general in nature. Till then, may your circuits behave.

Announcing a special Electronic Test Equipment review in the July issue of Electronics Today!

The Editor of Electronics Today has announced plans for a special addition to the July issue of the magazine.

The editorial environment is Test Gear oriented to let readers know what the well-stocked testbench is wearing in 1986. Plans include a lineup of **oscilloscopes, meters, power supplies, and other test gear** that makes troubleshooting and measuring easier and faster.

The supplement will be essential reading for everyone who wants to be abreast of changes and development in this important field of electronics.

Regular readership of Electronics Today is 43,000 and is expected to be expanded by an increased newsstand sale which makes the issue a unique advertising opportunity. Those marketing in this field can aid the preparation of this supplement by forwarding information to the Electronics Today editorial team.

Contact should be made with Marlene Dempster for space reservations and to discuss a total marketing plan at (416) 445-5600.

Cover Date: July 1986 — Copy Close: May 30th 1986

**Electronics
Today**



bond typing paper or letter paper over the front of the reflector. This is to get rid of bulb filament 'hot' spots. Provide a small box to support the meter at a level in line with the center of the light reflector and a weight to hold it in position. Set R5 to

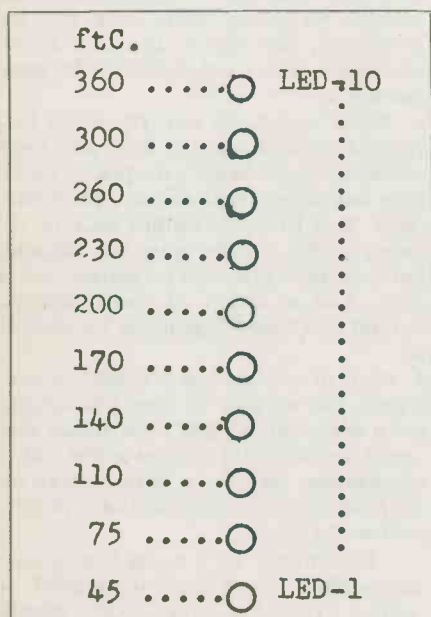

Fig. 9 The scale graduations used on the prototype.

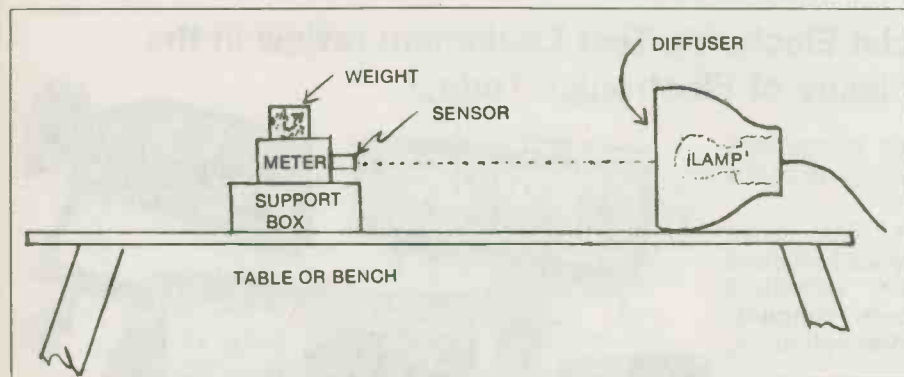

Fig. 10 Table top set-up for meter calibration.

mid-range and establish a light level reading on the reference meter that is to be your peak reading. This is done by moving the box closer to or further away from the source. Adjust R2 until LED 10 lights. Now check some mid-range LED that you wish to have indicate some special level. This can be done by sliding the box again. Adjust R5 and recheck the peak reading. The two adjustments interact, so it will be necessary to go back and forth between them a few times. For example, in the prototype, LED 5 was set at 170 ftC. and LED 10 at 360 ftC. Spacing of the other indicators was surprisingly linear at approximately 30 ftC intervals with some slight cramping at the top end. It should be remembered that the 3914 IC responds in a series of discrete steps. A halfway

point between LEDs is usable. This is where one LED is starting to extinguish and the next one is starting to light. This characteristic must be taken into account when going through the calibration procedure. It is particularly important when going through the calibration procedure to have the sensor faces on both instruments in exactly the same horizontal and vertical planes and at exactly the same distance from the light.

If a calibrating reference meter is not available a crude calibration can be performed with the same desk light. It should be diffused as before. With the meter on its support a level of approximately 100 ftC. will be present when the sensor face is about 11 inches away from the paper diffuser surface. 200 foot candles will be at 7 1/2 inches and 400 ftC. at 4 1/2 inches. This is a very rough calibration. If you do it this way, try to have it checked against a known meter before any critical measurements are made with it.

Operation

It is a good precaution to equip the meter with a neck cord. The ranges encountered in TV studios will center around 100 to 200 ftC. with the highest reading seldom above 400 ftC. If the meter is to be used outdoors, it is easy to double or quadruple

the range by mounting a piece of Kodak neutral density filter (N.D. filter) over the photodiode sensor. A filter of 0.30 N.D. will double the range because it has a transmission factor of 50. if the meter had been calibrated to a peak reading of 400 ftC., the 0.30 N.D. filter will raise it to 800 ftC. and all other LED indications will be doubled. A 0.60 filter will quadruple the range to 1600 ftC and both filters will raise it to 3200 ftC. If the phone plug mounting has been used for the sensor, the filter could be mounted in a small cap over the end of the plug.

Photographic Use

The meter could be adapted to photographic use. It can be used as it is if only ftC readings were required. A

mechanical converter of the sort found on most exposure meters would be required to translate the readings into shutter speeds, lens apertures and film speeds. it might be necessary to have an integrating dome over the sensor. This field has not yet been explored with the prototype and it could be an interesting experiment for the builder to pursue.

Parts List

Resistors (all 1/4W)

R1,R15	470R
R2	20k trimpot
R3	8.2k
R4,R11	5.6k
R5	100k trimpot
R6	100R
R7	50k trimpot
R8	10k
R9	2.2M
R10	3.3k
R12	330R
R13	100k
R14	22k

Capacitors

C1,C3	0.1uF 16V ceramic
C2	4.7uF 16V
C4	100uF 16V

Semiconductors

IC1	LM3914 dot/bargraph driver
IC2	LM336Z 2.5V reference
IC3	LM339 Quad comparator
IC4	555 timer
D1-D10,D12	Red LEDs (Preferably high efficiency)
D11	Vactec VTB 9413B blue enhanced photodiode
Q1	2N2222

Miscellaneous

Sounder	Electrosonic #A1-250
B1	9V battery
S1	SPST push-button, N.O. spring return, shallow profile.

case (Radio Shack #270-233); copper tape materials, or perfboard, or PCB; bolts; sleeves etc.

Electronics Today

Offers advertisers the opportunity to increase their sales and profits in the electronic field. Over \$200 million is spent annually for both electronics and micro-computer products by Electronics Today readers.

For advertising information

Call (416) 445-5600

for this type of trouble is to apply power through a 120V lamp in series with the power line and the device. Choose a wattage up to twice that required by the unit under test, and don't reapply power until the unit is fixed.

Diodes can become open or shorted. Power diodes in a bridge arrangement usually go faulty in pairs, but it's good practice to change them all anyway. Be careful to use components that match or exceed the original, especially with regards to the peak inverse voltage (PIV), sometimes called peak reverse voltage (PRV).

The Intermittent Fault

The intermittent fault is the bane of the serviceman. They're difficult to find, and you can never be sure that you've really fixed the fault. Bad solder joints are typical intermittent faults, and are best found by the prod-and-probe method. It often pays to resolder all the joints, taking

care that each connection is in fact a good one rather than a mere dressing-up of a dry joint.

An intermittent fault in a component can often be found by using a can of freeze spray. If the component can't be isolated, spray methodically over the whole board. If the component is temperature sensitive, this technique will often find the problem. Often the fault will only appear after normal operating temperatures have been reached, in which case normal operation will be restored after a freezing spray. Heating a component with a soldering iron and then freezing it is another method of localizing troubles.

Flow Chart

Figure 4 shows a summarizes all the troubleshooting technique described so far. No flow chart can cover all situations, but the suggested plan of attack is a good way to start. Critics may suggest that the

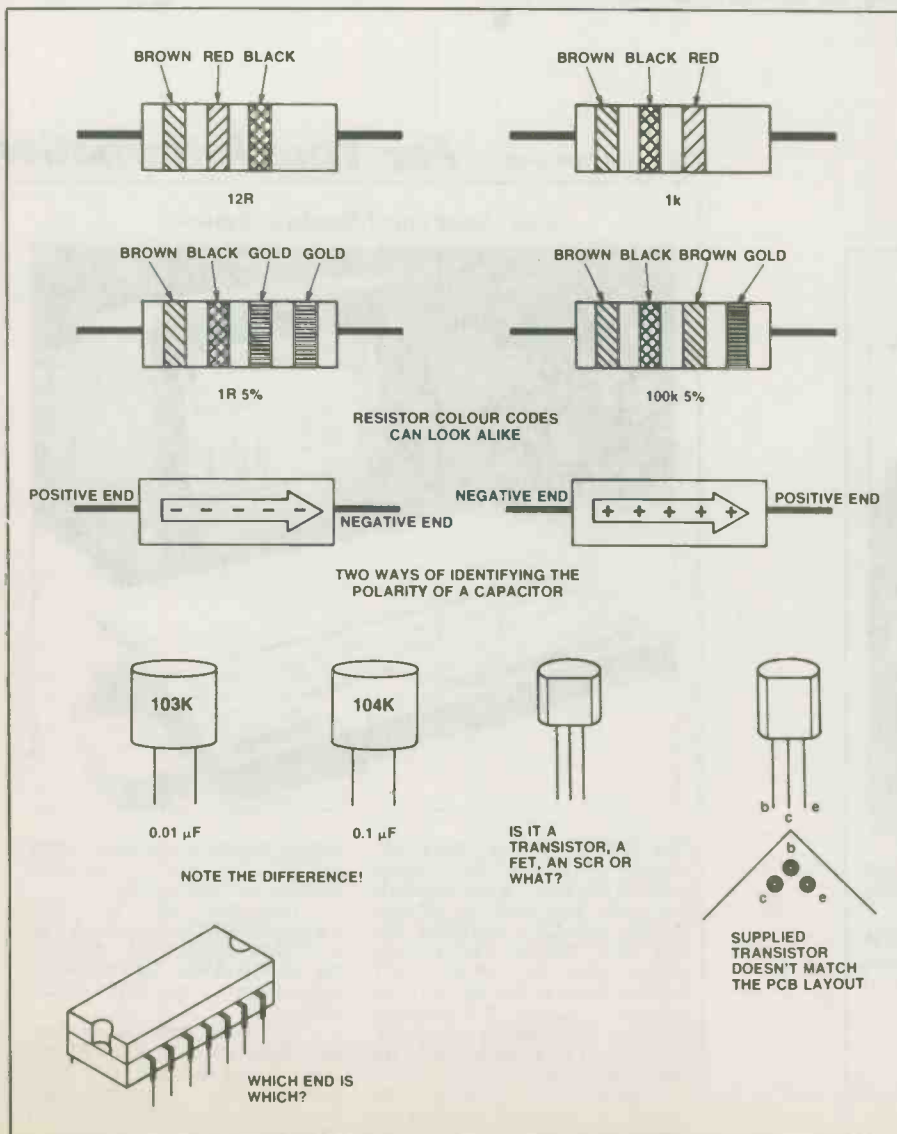

Figure 5. Common traps in component identification.

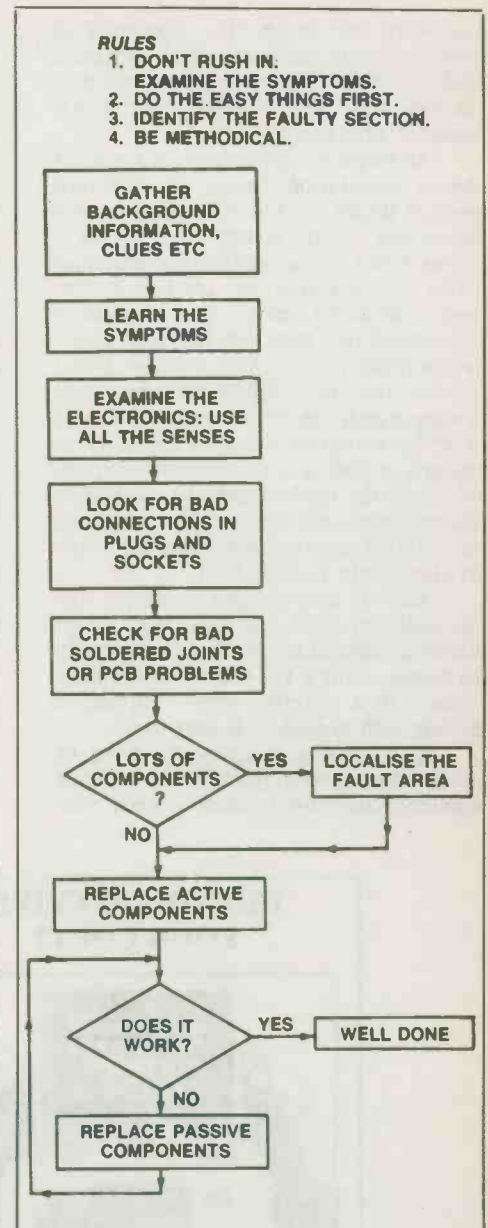

Figure 4. Fault finding flow chart.

chart is too simple or that the order is wrong. Experience will soon show you how to adapt the chart to specific circumstances.

With the chart are four basic rules. The rules are not in any particular order, but the intended message is to be scientific and methodical about the task. Luck has always played a part in servicing, but you can never rely on it. Remember that if the device used to work, it can be made to work again.

It is oft-quoted that "He who never made a mistake never made anything." The construction error is not necessarily the exclusive province of the amateur. Typical errors in circuit building are faulty soldering, bridged tracks, incorrect component orientation, incorrect components, mixed-up wiring in external

hardware and so on. The likelihood of poor soldering decreases with experience, and for this reason, complex projects should only be undertaken after experience with simpler ones.

An incorrect component, or incorrect device orientation sound like obvious enough problems, but some bizarre problems are worth mentioning. Figure 5 shows some of the possibilities that constructors should be aware of. If a kit has been purchased, parts may have been substituted that have different lead orientation from the one in the manual. Don't assume that any replacement part will always match the PCB layout. Similarly, different manufacturers may use different pinouts or coding or orientations. Typical of this is the method used to mark electrolytic capacitors. Some employ an arrow to mark the negative, others use the arrow to identify the positive lead.

And of course, there's always the possibility of mixing up the colours on resistors or capacitors. A 12 ohm can easily be mistaken for a 1K, which has the same colours in a different order. Slipping a decade with capacitors is easy to do.

IC polarizing is done with a dot or notch on one end to mark Pin One. Some manufacturers use a notch at each end,

one deeper than the other. The potential for reversing these is obvious.

Some toggle switches make contact when the toggle moves toward the contact in question, and some are the other way around. It pays to test switches with an ohmmeter or continuity tester before installing them.

Summary

This article has purposely stayed away from describing any technical fault finding methods. A knowledge of Ohm's Law and its implications is very useful, and in many cases indispensable. Given this background and a multimeter, servicing becomes easier, as faults can often be found very quickly. By noting the hints presented here, those starting out in electronics can give it a try.

Although they may not care to admit it, many service technicians repair equipment that they know nothing about by using the methods that have been out-



Continued from page 33 **For Your Information**

DID YOU RECEIVE YOUR COPY?



This catalogue is a comprehensive description of our Almost Free Software Volumes I through VII.

If you would like a copy of this catalogue, please circle the Reader Service Card Number or mail your request to:

**Moorshead Publications
Software Services**
1300 Don Mills Road
Toronto, Ontario
M3B 3M8

Circle No. 23 on Reader Service Card

New Atari One Megabyte System



The 1040ST, Atari Corporation's newest entry into the business systems market, is a one megabyte business oriented integrated design, with CPU, keyboard and disk drive built-in. The machine comes with ST BASIC, 1ST WORD (word processing as if you couldn't guess), NEOchrome (graphic art painting program), and a VT52 terminal emulator for telecommunications.

All software developed for the 520ST is compatible, and there are currently over 150 programs available for the ST series in-

cluding business, education, home productivity, word processing, graphics and accounting.

Included in the very reasonable \$1599.95 price is a high resolution monochrome monitor; for another \$300, the machine is offered with an RGB colour monitor.

For more information contact: Gail Park or Deborah Aimer, Panache Productions, 2220 Midland Ave., Unit 61, Scarborough, Ontario, M1P 3E6. (416) 291-3005.

Circle No. 41 on Reader Service Card.

Computers in Small Business

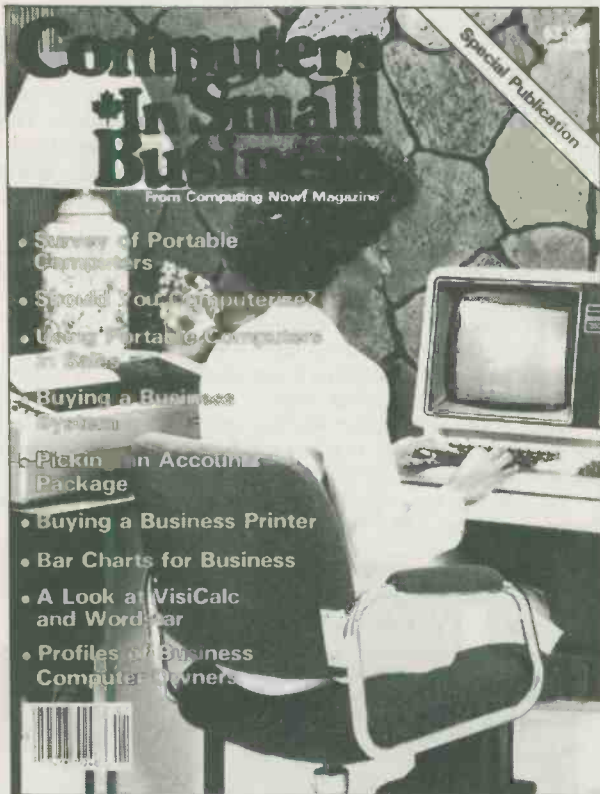

A Moorshead Special published especially for owners of small business who would like to learn how a microcomputer could improve the operation of their occupation. Included in this issue are such articles as: A Survey of Portable Computers, Should You Computerize? Using a Portable Computer in Sales, Profiles of business computer users and much, much more!

\$3.95 plus \$1.00 postage and handling. Ontario Residents add 7% PST. For a copy call or write:

**1300 Don Mills Road,
Don Mills, Toronto, Ontario,
M3B 3M8
(416) 445-5600**

Electronics Today May 1986

Moorshead Publications Order Form

Subscriptions:

Please complete reverse side of order form to start or renew a subscription.

Back Issues: \$4.00 each; Ontario residents add 7% sales tax. Please circle issues desired.

1977	February					July
1978	April	May	September	November		December
1979	February		March	April	May	July
	August		September	October		November
1980	January	February	May	June	November	December
1981	January	February	March	April	June	July
	August	September	October	November		December
1982	January		March	April	May	June
	July	August	September	October	November	December
1983	January	February	March	April	May	June
	August	September	October	November		December
1984	January	February	March	April	May	June
	July	August	October	November		December
1985	January	February	March	April	May	June
	July	August	September	October	November	December

On the following items please add \$1.00 for postage and handling plus 7% Ontario provincial sales tax.

Special Publications:

ITEM	QTY	AMOUNT
Electronic Circuit Design		\$3.95
Projects Book No. 2		\$3.95
Personal Computer Guide		\$3.95
50 Top Projects		\$4.95
Your First Computer		\$3.95
Computers in Small Business		\$3.95

Binders: Electronics Today; Computing Now!
 Moorshead Publications
\$9.75 each plus 7% P.S.T.

BOOKSHELF ORDER FORM

Code (e.g. BP12)	Title (Short-form is O.K.)	Price
.....	\$.....
.....	\$.....
.....	\$.....
.....	\$.....
.....	\$.....

SOFTWARE ORDER FORM

.....	\$.....
.....	\$.....
.....	\$.....
	Sub Total \$.....
	Tax (Ontario Residents) \$.....
	Postage \$.....
	Total Enclosed \$.....

Orders from the Bookshelf are tax exempt. Please add \$1.00 for postage. Remember to put your name and address on reverse side. See over for mailing details.

Do you currently subscribe to Electronics Today Yes No Computing Now! Yes No Computers In Education Yes No Software Now Yes No

BE SURE OF YOUR ISSUE EACH MONTH. SUBSCRIBE TODAY.



BOOKS, BACK ISSUES, SPECIAL PUBLICATIONS, BINDERS — SEE OVER

Moorshead Publications

1300 Don Mills Rd., Don Mills, Toronto, Ont. M3B 3M8

MERCHANDISE ORDER Please fill out form overleaf
SUBSCRIPTIONS: NEW SUBSCRIPTION RENEWAL

- Electronics Today**
 One year (12 issues) \$22.95 Two years (24 issues) \$37.95
- Computing Now!**
 One year (12 issues) \$22.95 Two years (24 issues) \$37.95
- Computers in Education**
 One year (10 issues) \$25.00 Two years (20 issues) \$45.00

Outside Canada (US Dollars)
 For U.S. please add \$3.00 per year other countries add \$5 per year

NAME _____

ADDRESS _____

TOWN/CITY _____ PROVINCE/STATE _____

CODE _____ DATE _____

POSTAL CODE _____

- Cheque enclosed DO NOT send cash
 Mastercard Account No. _____
 Visa Account No. _____
 American Express Account No. _____

Expiry Date _____

Signature _____

**Electronics Today Presents
 The World's First 3-D Binder Ad!**

The two photos below, which had to be printed sideways to fit the format, were photographed separately with the camera moved about two inches and can be blended into a three-dimensional image in a number of ways.

Try staring at one of them and move the page back and forth in front of your eyes until they blend. This method is extremely frustrating, though it works eventually.

Place a piece of cardboard about 3 inches square between your eyes and move the images up to the cardboard. This works, but they'll be out of focus, unless you have weird eyes.

Put a small slide magnifier or magnifying glass above each photo and look through them. This works really well except for the cost of the magnifiers.

Listen. If you've spent an evening trying unsuccessfully to get the two images to blend, we apologize for wasting your time with this foolery.

What won't waste your time, however, are the new Electronics Today binders, also available with Moorshead Publications on the spine for keeping Computing Now!, Computers In Education, or our special issues.

They hold twelve issues without cutting or punching, and they're spacious enough that the magazines are held fair and square without bunching or creasing.

To order yours, specify which imprint and send \$9.75 (Ontario residents add 7% sales tax) to:



Binders

Moorshead Publications
 1300 Don Mills Rd.,
 Don Mills, Ontario M3B 3M8



Courtesy Light Extender

This gadget extends car interior lights during locking and sounds a warning if the parking lights are left on.

by Paul Harding

IF you have ever left your car lights on, only to return to find the battery resolutely flat, or had to grope around in the dark to find the ignition switch after you have closed the car door, or even both, then this is the circuit for you. On the one hand, it holds the courtesy light on the twenty seconds after the car door has first been opened, and on the other hand it bleeps if the car door is opened while a light (any light you designate) is still on. Up to five lights can be monitored, and to cause minimum inconvenience, both functions are cancelled when the ignition (phase 1) is turned on.

The completed project is small enough to fit in almost any nook or cranny, and since it only used CMOS chips, it requires no power switch. A light reminder that has been switched off is no use to anybody.

The Circuit

Looking at the block diagram first, it can be seen that the circuit falls in to three main parts: a monostable, a gated oscillator and some mixed logic.

The monostable drives a relay, which in turn simulates the closing of a door switch, keeping the courtesy light switched on. It is triggered by opening any of the car doors.

The logic decides when the gated oscillator should be on; i.e., when any light is on, a door is open and the ignition is off.

The gated oscillator is merely a tone generator feeding a piezo element, switched on and off by a slow (2Hz) astable.

When the ignition is on, both the monostable and the oscillator are held off.

Now look at the circuit diagram (Figure 2). Since a negative going input is generated at CL when a door is opened, and a positive triggered monostable is used, an inverter (IC1a) is placed at the latter's input. The monostable consists of IC1b and c, and C1 and R3. A negatively triggered monostable is not used here because another NOR gate is required elsewhere in the circuit. R1 holds IC1a's input high; although the courtesy light will do this itself, a bulb failure would otherwise cause this input to float, leading to unpredictable circuit behaviour, and possible static discharge damage. Q1 buffers the monostable's output so that RLA1 can be driven.

The IGN line is tied to one of IC1's inputs, and this forces the monostable into a reset state when the former is high.

The lights reminder has five wired-or inputs, which will go high when a light is turned on. Opening a door will bring IC1a's output high, and these simultaneous high states will be inverted by IC1d, and the slow oscillator around IC2b is gated on. This, in turn, will gate

Courtesy Light Extender

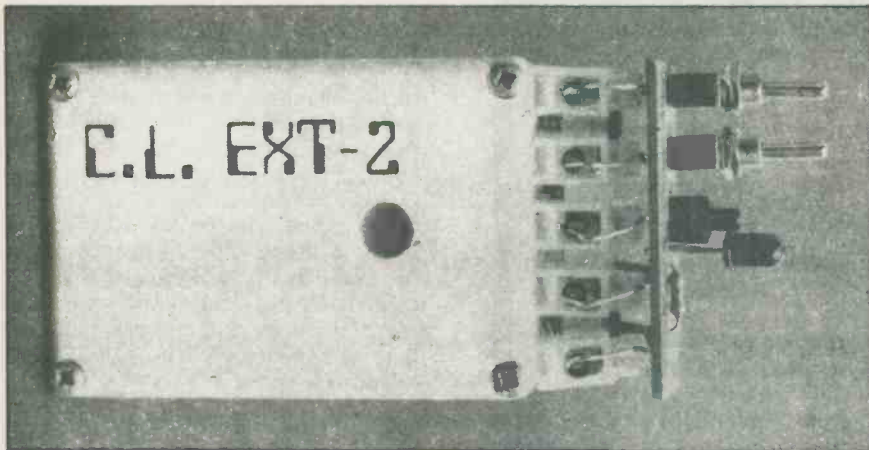

to use a grounded soldering iron, solder pins 7 and 14 first (to allow the internal protection devices to work) orientate them correctly, and install them last.

Short lengths of wire can be soldered into the holes for off-board connections, and flexible leads attached to these. Insulate the connections with rubber sleeving, and terminate the leads at a terminal block screwed to the outside of the case.

The connections to the various existing wires can be made using connectors, or by stripping the insulation off at a convenient point and soldering. Such connections must be insulated to avoid possible pyrotechnics.

The wiring diagram clarifies the connection details.

The circuit will work on any negative-

on the fast oscillator around IC2d, via IC2c, activating X1.

R1, 2,5,6,9, 10 and 11, and D7 protect the CMOS ICs from static damage. C4 is a supply decoupling capacitor, and D6 removes inductive spikes from the relay coil.

Construction and Installation

Construction is simplicity itself, since all the components, except for X1, fit onto one PCB. There are two wire links, one of which goes under the board (shown as a dotted line on the overlay diagram, Figure 3), and these should be fitted first. Next, insert and solder the resistors, diodes, transistor, relay and capacitors, in that order. Remember to observe the polarity of the diodes, and the electrolytic and tantalum capacitors. Some of the components are mounted too close to the ICs to allow sockets to be used for the latter, even though they are CMOS. Remember

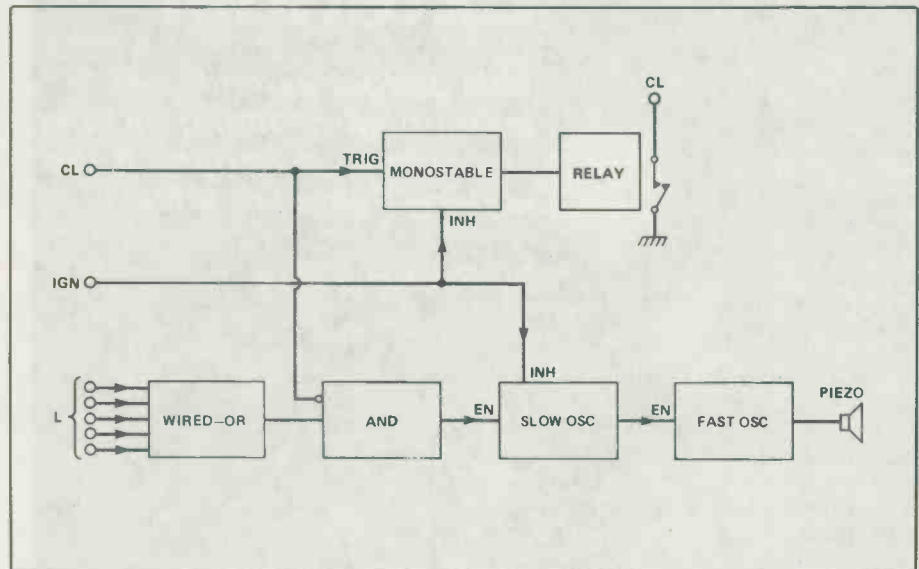

Fig. 1 The block diagram

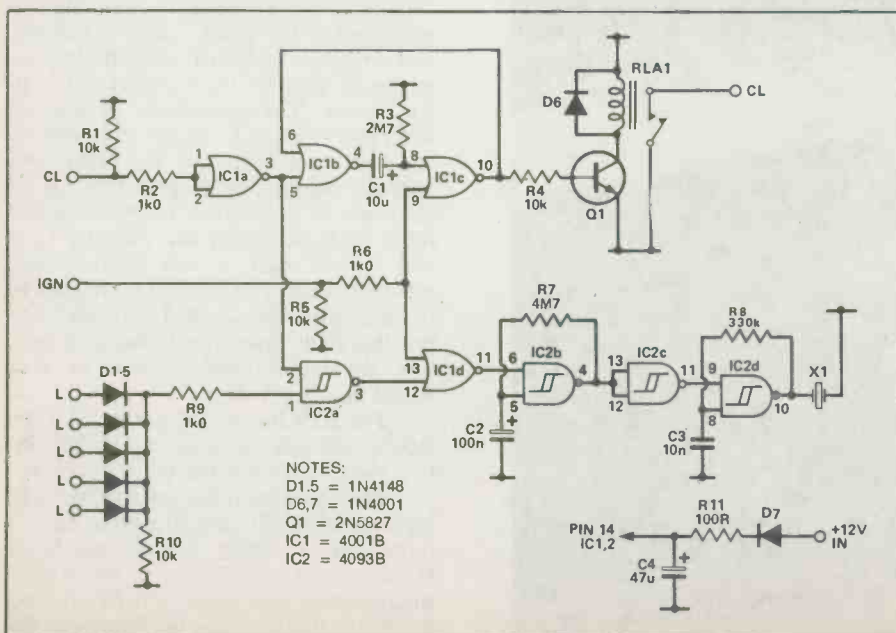
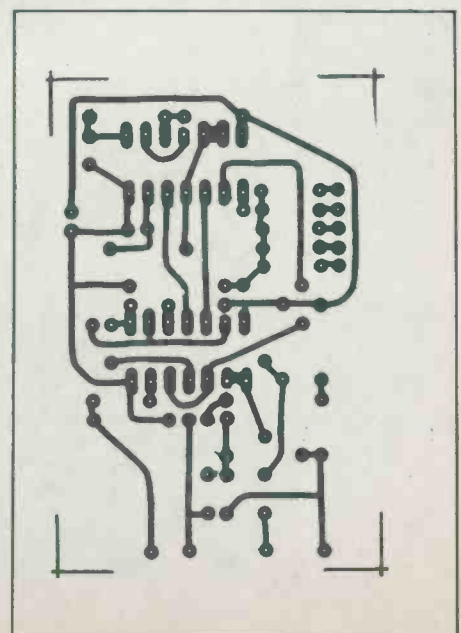

Fig. 2 The circuit diagram.



The PCB artwork.

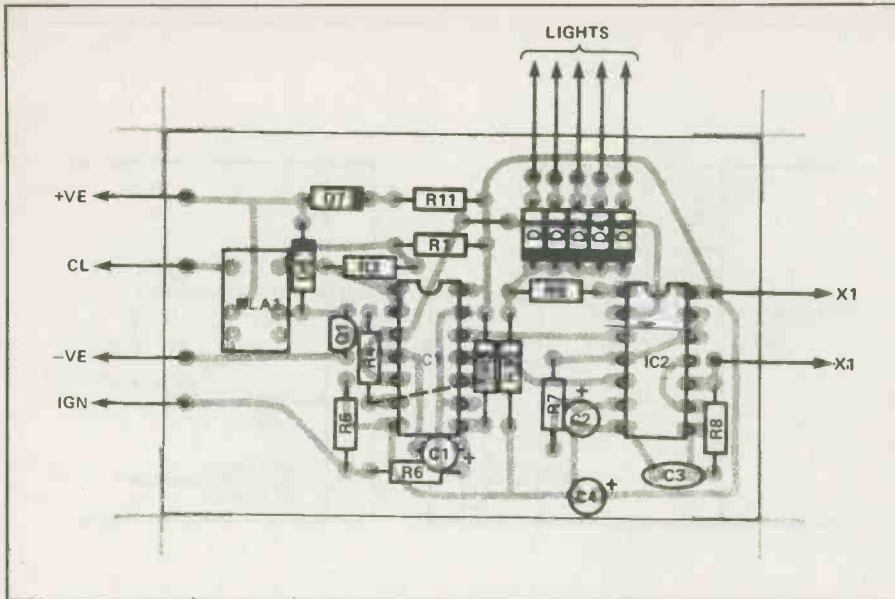

Fig. 3 The component layout. Note the wire links (one under and one above the board). Sockets cannot be used for the CMOS ICs, so note the handling precautions in the text.

Parts List

Resistors (All 1/4W, 5 percent)

R1,4,5,10	10k
R2,6,9	.1k
R3	.2M7
R7	.4M7
R8	.330k
R11	100R

Capacitors

C1	10u, 16V tantalum bead
C2	100n film type
C3	10n film type
C4	.47u 16V electrolytic

Semiconductors

D1-5	1N4148, 1N914
D6,7	1N4001 or equiv
Q1	2N5827
IC1	4001B
IC2	.4093B

Miscellaneous

RLA1	12V, 2A contacts
X1	piezoelectric sounder

Utility case, terminal block, wire, etc.

ground car whose lights are switched positive, and whose courtesy light is grounded when a door opens, i.e., most cars.

If the specified case is used, it will be necessary to trim off the corners of the PCB to ensure adequate clearance.

X1 can either be a cased or uncased piezo element. The former is screwed to the outside of the case, while the latter is stuck inside the lid of the case, over an 8mm hole to let out the sound. Remember to insulate the bare element to prevent short circuits.

Testing

Switch on any one of the lights being monitored, and open the car door. The piezo device should sound. Close the door, and the courtesy light should then remain lit for twenty seconds or so. Both functions should cease when the ignition key is turned to phase 1.

It will be found that the buzzer continues to sound even when the door has been closed. This is because the relay is holding the CL input low, and is unavoidable. ■

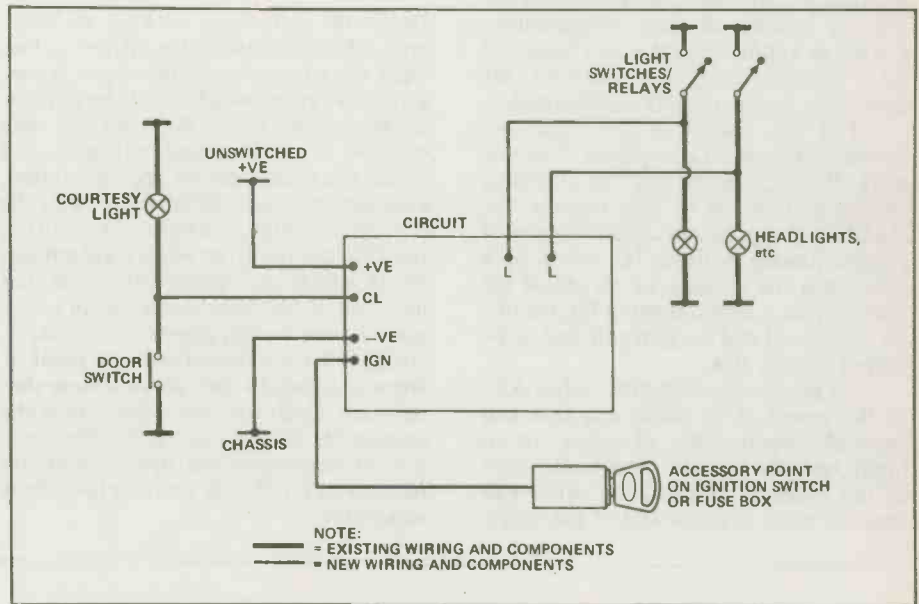
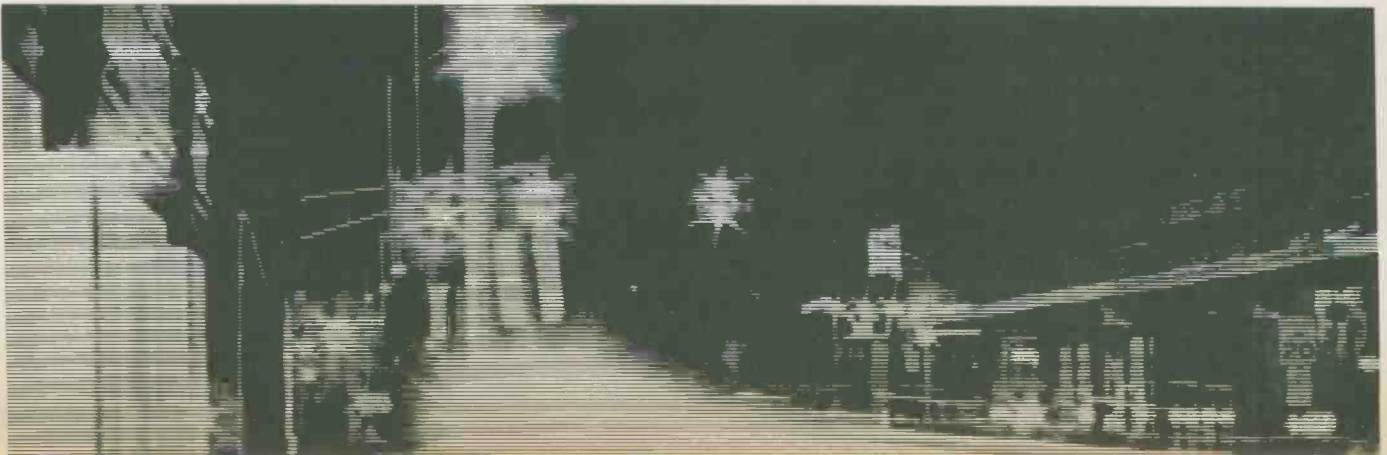

Fig. 4 The wiring diagram. The circuit will work for cars with negative ground, whose lights switch positive when a door opens. This includes most cars.



Analogue Opto-Isolator

By P. Cuthbertson

THIS CIRCUIT accepts an analogue input and transfers it to the output faithfully without any electrical connection, the link being optical. It is more usual to see V to f converters being used for this, but they demand more cumbersome circuitry and unless a train of pulses is required, the linear approach should be considered. Additionally, V to f converters integrate or smooth out the incoming waveforms, which may or may not be desirable. With slight modifications (changing a few resistor values) this circuit will feed A/D converters.

Linearity is maintained by using two opto-isolators; these are both non-linear, but equally so, and the effect can be made to cancel out. Although not done on the original, a dual type could be used to obtain the benefits of equal temperatures. It's not as important as it would be on a V to f circuit, and, the isolators are dissipating approximately equal power.

The two halves of the circuit are powered from separate supplies. The network R1,2,3,4 attenuates the incoming voltage and offsets it. This ensures that the LEDs always have a certain amount of current flowing in them. IC1 drives both LEDs and the voltages on its inputs are nearly equal. Current flows in R9, the offset is removed and the gain adjusted in the output circuit, IC4.

To get the best linearity, adjust RV1 to the centre of its travel and take two pairs of measurements of output versus input, one pair near the more positive end of the range of interest, the other pair near the more negative end of the range.

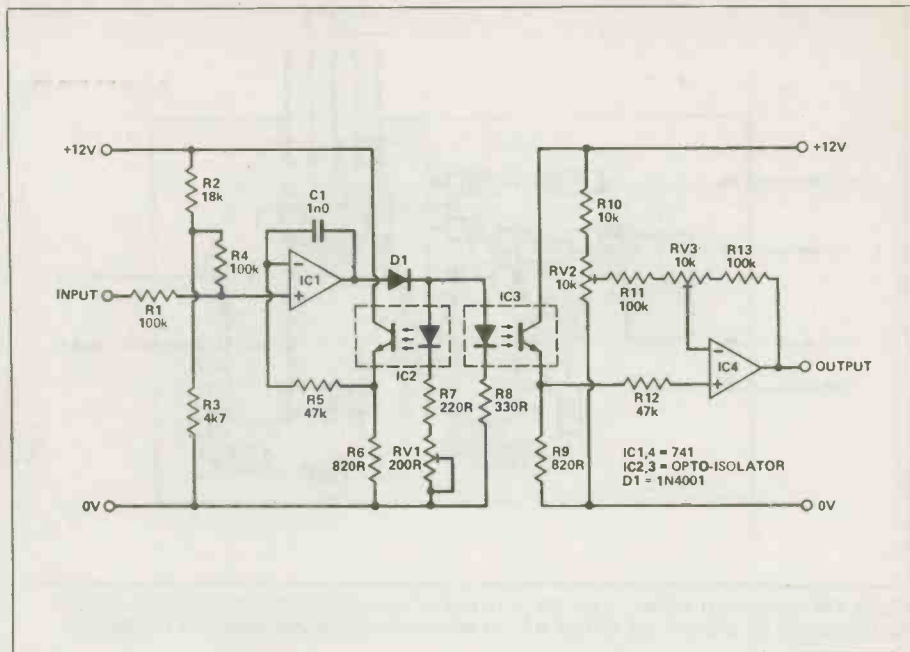

Divide the differences between the adjacent pairs of inputs by the difference between the adjacent pairs of output values, giving two ratios which should be approximately equal. Adjust RV1, making note of how far it has been adjusted, and repeat the measurements and calculation. Compare this new set of ratios with the previous ones. There are three possibilities: the error will have diminished, in which case adjust further in that direction; it will have increased, in which case reverse the adjustment direction; or you may have adjusted past the point of linearity in which case you will note that the ratio which was the larger is now the smaller. In this last case reverse the direction of adjustment but don't adjust too far back again. Repeat until the linearity is acceptable.

In fact, the linearity is only a few per cent out with a 330 ohm resistor in place of R7 and RV1. If you can stand a certain amount of non-linearity substitute the resistor. If you possess a ramp generator and scope capable of XY display then you will be able to adjust the linearity by eye.

Adjust the gain and offset once the linearity is satisfactory. Do not be afraid to alter resistor values to suit other input values. C1 is not usually necessary but I have included it as it stops any tendency to oscillation. The power supplies are simple 3 terminal regulators. The original circuit runs IC1 $\pm 15V$ but one may get away with just plus 15V, connecting pin 4 to ground. D1 would no longer be needed then since it only serves to protect the opto-isolator LEDs from polarity reversal.

Audio Amplifier Output Power Meter

By N. Walker

THE CIRCUIT uses the LM3914 Bargraph Display IC which is capable of driving ten LEDs and is therefore ideally suited to the readily available bargraph modules.

The circuit shows a single channel meter but an identical circuit can easily be made up to provide a stereo power meter. The unit operates in a range of 3V to 18V.

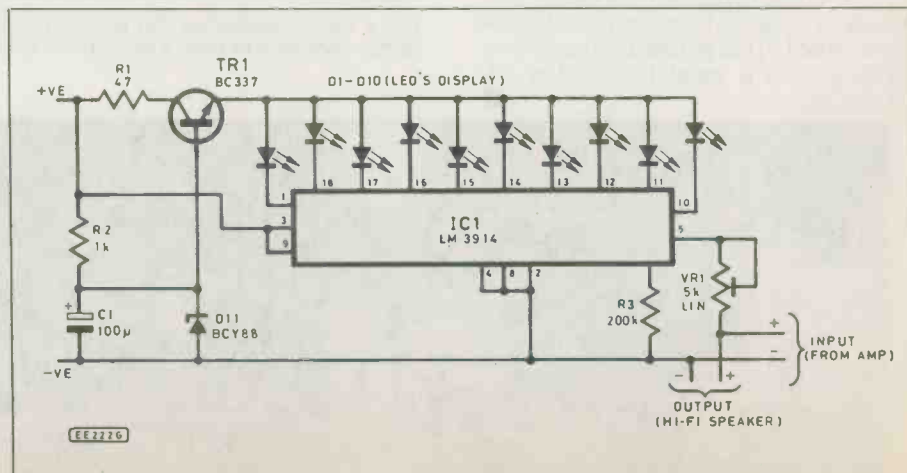

Designer's Notebook: Better By Design

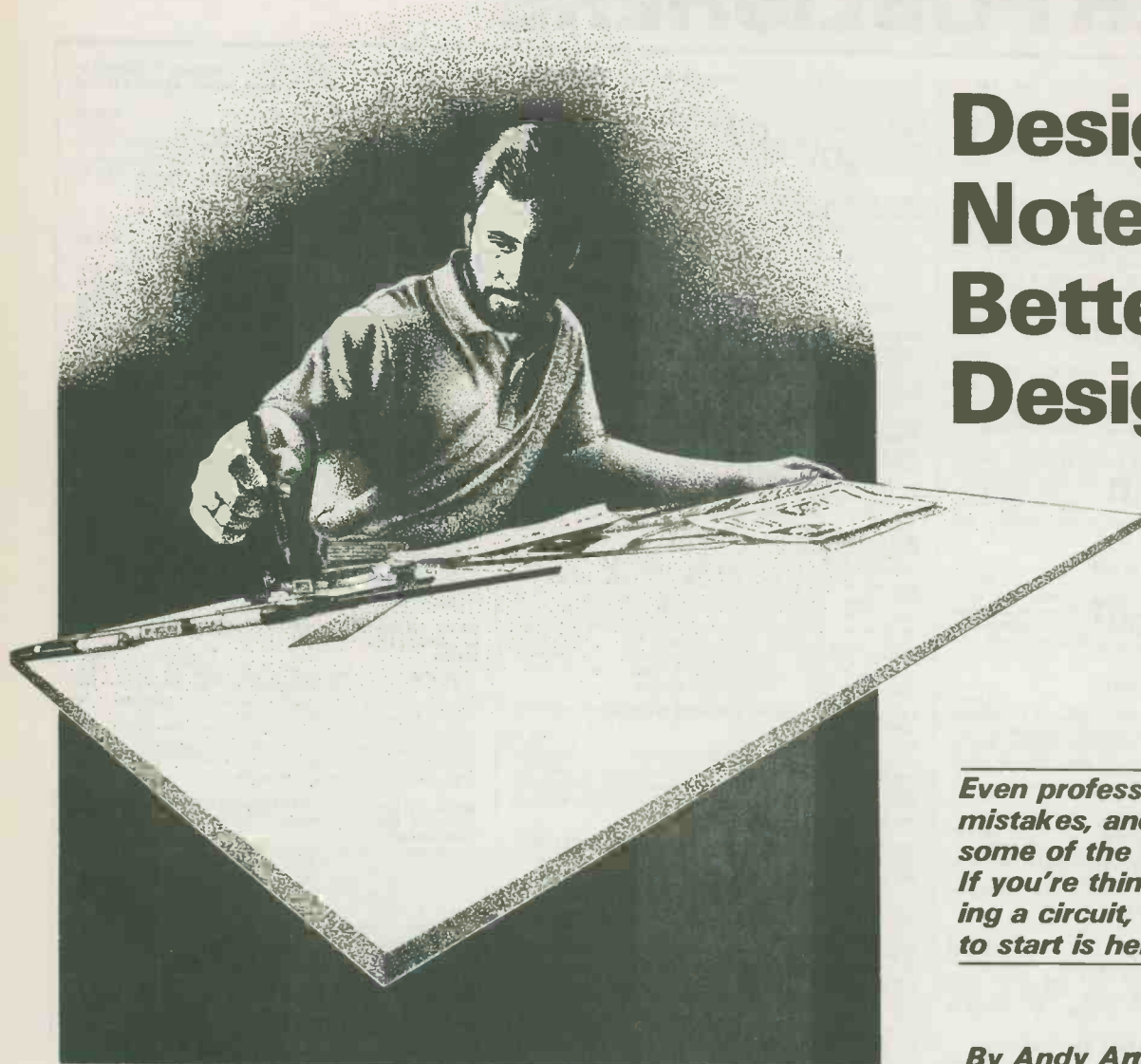

Even professionals make mistakes, and here are some of the common ones. If you're thinking of designing a circuit, the best place to start is here.

By Andy Armstrong

AFTER inspecting many designs at the draft stage, it is clear that there are some misunderstandings and design errors which crop up again and again. Some aspects of circuit design, for reasons unknown, seem to be ignored or glossed over by even the most seasoned practitioners.

Most of the problems fall into the category of "things which will work most of the time or work with certain samples of the components used".

A typical example was faced by a friend of mine in a vacation job after his second year at college, and involved unijunction transistors. Someone had designed (by dint of sheer building) a control unit, incorporating a unijunction, for an electric arc welder. The first production batch of welders worked very well, but none in the second batch worked at all.

It turned out that the circuit had been optimized by trial and error to work with a batch of unijunctions which were at the

edge of the specification. The next batch purchased had more typical characteristics, and the circuit could not cope. The configuration of the circuit was not designed to take account of the tolerances of unijunctions, but a change of component values centred the circuit on the typical operating parameters. Subsequently only one component value had to be changed if a batch of unijunctions was too far from typical.

Design Posts

Nobody expects magazine projects to be designed to industrial standards. This would be uneconomic because of the very large amount of time required to design even a simple circuit to production standard, and because of the need to make more than one prototype to double check a design. These limitations notwithstanding, a project design needs to be as close in standard to an industrial design as possible, and should, in particular, avoid

problems connected with variations in the electrical and mechanical characteristics of components.

Of course, there are differences in emphasis. For example, a circuit may rely on a particular component characteristic, perhaps requiring that two diodes have a similar voltage drop at a certain current. The home constructor could happily select the components, but in an industrial design, the cost of paying someone to grade components would mean that the real price of a 5 cent diode would be a lot more than 5 cents.

On the other hand, if too much decision-making on the part of the constructor is necessary to make a project work, then some of the people who build it will simply never succeed.

Family Characteristics

Many of the marginal designs encountered have used CMOS, so this is the place to start.

The 4000 series of CMOS is designed to work over a wide range of power supply voltages. Different manufacturers specify slightly different operating characteristics at different voltages, but here I shall refer to the Mullard/Sigmetics HEF4000B range. Some of the family specifications are reproduced here for reference.

A number of circuits use a CMOS gate output to switch a transistor, which is used to control a relay, lamp, etc. Normally, a small signal transistor is used to drive the load and in order to work well, the transistor must be switched on hard. This requires adequate base current; a rule of thumb is to use a base current of 0.1 times

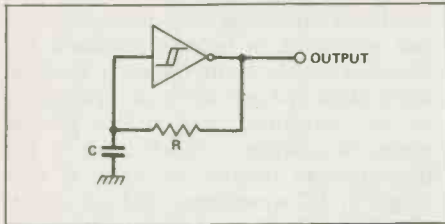

Fig. 1. Simple schmitt oscillator.

the required collector load current. This can exceed the current which the gate is guaranteed to supply, though in fact most gates manage well over the minimum specified current.

It is not a good idea to rely on your good fortune in selecting a gate. Back on the industrial front, I recently had to investigate a rash of mysterious board failures, and discovered that one of the CMOS gates was being asked to deliver

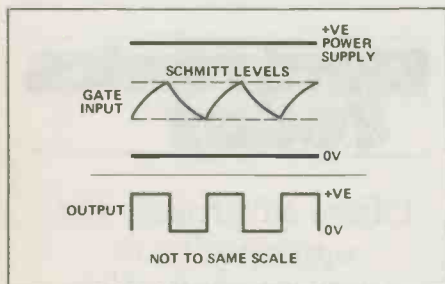

Fig. 2. Waveform diagram.

about twice its guaranteed output current. After a while, most gates from one batch failed, though the design had been produced without problems for several years beforehand. Presumably this batch of gates was unable to exceed its specification without damage.

To avoid this sort of problem in home projects, a CMOS gate sourcing current should have a load resistance of at least 1kohm per volt of power supply. If this means that the transistor it is feeding receives insufficient base drive to switch properly, then the answer is to use a Dar-

lington transistor, or two transistors connected as a Darlington pair.

Alternatively, you could use a power FET suitable for the desired load current. A power FET capable of switching several amps may be driven directly by a CMOS gate. The switching speed may be low, because of the limited rate at which the

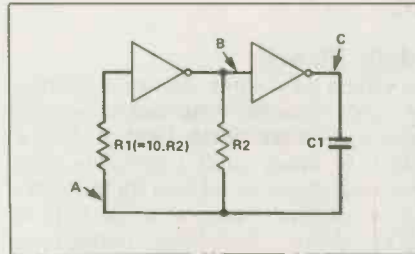

Fig. 3. Clock oscillator.

CMOS output can charge or discharge the FET gate capacitance. The heavy load presented to the CMOS gate output by this capacitance is of short enough duration not to risk damaging the CMOS chip unless a high frequency switching signal is used.

There is one exception to these stern warnings about overloading CMOS outputs. When powered from a 5V supply, most CMOS chips are designed to be short circuit proof. The practice of driving an LED from the output of a CMOS gate should not be harmful at this supply voltage, though the output will not provide a proper logic level when used in this manner. My recommendation is that this practice be confined to novelty circuits.

Clock Oscillators

Many projects incorporate some sort of oscillator, which may be needed to clock a counter, or to generate an audible tone. Figure 1 illustrates a simple oscillator circuit, using a Schmitt trigger IC. As shown in the waveform diagram, Fig. 2, the capacitor charges through the feedback resistor until the voltage on it reaches the positive threshold of the Schmitt trigger gate. The output of the gate then switches to logic 0 and the capacitor starts to discharge until it reaches the lower Schmitt threshold.

There are two drawbacks to this circuit. The Schmitt levels may vary widely from batch to batch of the chip, and the output frequency of the circuit is directly dependent on these levels. Also, the threshold levels are not symmetrical with respect to the power supply (the characteristic of Schmitts known as hysteresis), so the mark-to-space ratio of the output wave is not unity. If the mark-to-space ratio is not important, the circuit may be made more acceptable by the addition of a potentiometer to fine tune the frequency.

A more consistent circuit is shown in

Fig. 3, and its waveform diagram in Fig. 4. The junction point of R2 and C1 alternately takes up voltages outside the power supply rails, and then charges or discharges to approximately half the power supply voltage. Because the voltage range over which the capacitor works is large, small differences in switching level between different samples of chip do not have much effect on the frequency or the mark-to-space ratio. The frequency is approximately $1/(2.2 \times R2 \times C1)$.

Many project designers omit the resistor R1. If this component is omitted, then the junction of R2 and C1 is prevented from taking up a voltage outside the supply rails by the input protection diodes of the CMOS gate. The frequency is approximately three times the frequency given if R1 is included (and if R1 is, as specified, ten times R2). Variations in switching levels or gain between samples of chip now have a more significant effect, so the net effect is to decrease the predictability of the circuit's performance.

If very high value resistors are used in the circuit, then high frequency noise pickup on the input connected to R1 may be a problem. In this case, rather than lower R1 and make the operation less predictable, a capacitor of a few hundred picofarads may be added in parallel with R1. Practice has shown that this always solves the problem without any detectable effect on the correct operation of the circuit.

In some project designs, NOR or NAND gates are used instead of inverters.

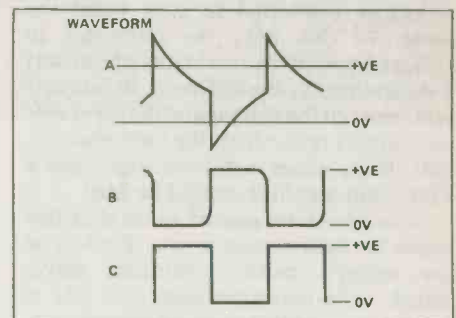

Fig. 4. Waveform for the clock oscillator.

The "spare" inputs may be used to gate the oscillator and turn it on or off in response to a logic signal. A logic 0 signal will stop a NAND gate oscillator, while logic 1 will stop a NOR gate oscillator. If it is necessary to start to clock a counter immediately the oscillator is started, then the rest of the oscillator should be considered. For example, if the signal is generated by pressing a switch, the response should be immediate or the user may begin to wonder if it is working.

The circuit shown in Fig. 5 will generate

a positive edge on its output immediately a logic 0 is applied to its control input. By its nature, the circuit in its inhibited state will always charge its capacitor in such a way that it is ready to switch as soon as it is allowed to do so.

Op Amps

The correct use of op amps is another area which seems to be difficult for some project designers. There are several aspects which cause problems.

First of all, some designers simply fail to take account of the input bias and offset current. If a bipolar op amp is used, the bias resistors should be of a low enough value that the voltage drop in

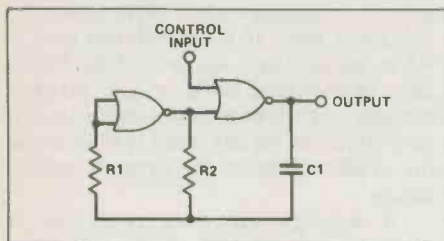

Fig. 5. An instant turn-on.

them is small. I recall seeing a reader's circuit in one electronics magazine, showing a 741 connected with all the bias current for the negative input flowing through a 4M7 resistor.

A good rule is to make the bias resistors as low as the rest of the circuit design allows, and to make the total DC resistance connected to each input the same. In this way, the difference in voltage between the two inputs (the offset) is determined by the difference in bias current between the two inputs (the input offset current) rather than the total bias current. If the offset is still too large, then a FET input amplifier should be used.

The open loop gain of an op amp also seems to confuse some people. The text of the reader's circuit mentioned above stated, "the maximum gain of a 741 is quoted as 20,000, but in this circuit it is wired to provide a gain of 47,000". This mistake arises from a misunderstanding about the way the op amp's gain is determined. The gain is determined by the ratio of the two feedback resistors in the circuit. You can use any ratio you please, but you cannot make the op amp give more than its maximum open loop gain.

A typical op amp frequency response is shown in Fig. 6. There are two relevant and related factors, the open loop gain and the gain-bandwidth product. The open loop gain defines the maximum low frequency gain the op amp can produce under any circumstances, and the gain-bandwidth product indicates the increase in gain with decreasing frequency.

An op amp having a gain-bandwidth product of 1MHz, for example, will have an open loop gain of unity at a frequency of 1 MHz. As the frequency is decreased, this gain will rise until the maximum open loop gain is reached, often at a frequency of about 10Hz, unless the internal stability capacitor is set to start rolling it off sooner.

Totally Slew

The effects of output slew rate limiting and of power supply variations on op amp characteristics are clearly illustrated by a mistake of mine, made when 741s were the normal choice of op amp for any task. In a car project, I used a 741 to clock a CMOS counter. According to the data books, the slew rate of the output of a 741 is inadequate to clock the CMOS counter reliably, but still the circuit seemed to work, at least some of the time. After a little experimenting, I found that the car battery voltage affected the circuit. It all worked well when the engine was running and the lights were turned off, but couldn't be relied on when the battery was being drained and its voltage dipped.

It seems that the op amp's slew rate was slightly higher when the voltage was higher. This was just enough to make the counter clock on.

The moral of this is that the slew rate of

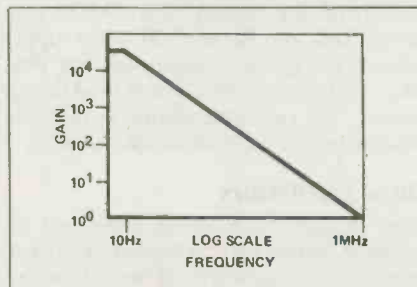

Fig. 6. Typical frequency response of an op-amp.

the op amp can be crucial, and that you should not assume that a characteristic which is specified to be just good enough with, say, +/-15V power supplies will still be all right at lower voltages. This is true even though the op amp may be specified to work at much lower voltages. Data books never claim that a circuit will work precisely as well under all circumstances.

Passive Components

There are two common areas of misunderstanding which I have noticed in the use of passive components. The problem with resistors is very simple: ordinary quarter-watt resistors have a low voltage rating that you have to watch when connecting to voltages above 300V, say. Resistors rated 1/2 watt and greater have a higher voltage rating and are

therefore generally okay to use in higher voltage circuits. Check the manufacturer's specs before assuming that resistance and dissipation are the only things to worry about. The voltage rating of a resistor can limit the maximum power that can be fed into it to less than its nominal wattage rating.

The other point of misunderstanding is in the use of non-polarized capacitors on AC, specifically when connected to the AC power line. Most people realize that a capacitor to be used on AC should have a DC rating equal to the peak of the AC waveform, but the problem does not stop there.

At any significant frequency, above a few Hertz, the voltage which the capacitor can withstand is reduced, because the chemical bonds in the dielectric material are stressed first one way then the other by an AC waveform, and in this process power is dissipated. Weak spots in the dielectric can become hot spots if subjected to AC waveforms, and can subsequently break down. Dielectric materials with higher levels of AC power dissipation suffer from this problem more severely. Generally, polypropylene capacitors are much better than polyester, while ceramics come in widely varying qualities.

One type of polyester capacitor, for example, is rated at 400VDC or 150VAC. A high quality polypropylene capacitor in the same catalogue is rated at 1000VDC, 350VAC at up to 5KHz. Some mica capacitors are rated to handle substantial RF signals. ■

Electronics Today

Offers advertisers the opportunity to increase their sales and profits in the electronic field. Over \$200 million is spent annually for both electronics and micro-computer products by Electronics Today readers.

For advertising information
Call (416) 445-5600

YOU'VE ALWAYS HAD A LOT OF COMPETITION. NOW YOU CAN HAVE AN UNFAIR ADVANTAGE.



Nobody ever said it was going to be easy. But it just got easier. Now there's Amiga.™ The first and only computer to give you a creative edge. Amiga makes you look better, sound better, work faster and more productively.

You can't buy a computer at any price that has all of Amiga's features. Nor can you find one that's easier to use. Amiga lets you point at symbols instead of learning complicated commands.

Amiga is friendly, but it's a powerhouse, too. It has twice the memory of Macintosh™ or IBM® PC. It costs less than either of them and can do everything they can do, better.

No other personal computer gives you over 4,000 colours, stereo sound and incredible dimension. Imagine the advantage of preparing business presentations with colour graphics and sophisticated animation right on your computer.

Need to make creative use of your time? Amiga can do as many as four or five things at once in separate windows on the screen. Not just display them. Work on them. No other personal computer can.

Amiga is IBM-compatible, too. A simple piece of software teaches Amiga to emulate the IBM operating system, so you can run most IBM programs. You'll have instant access to the largest library of business software in the world, including favourites like Lotus® 1,2,3, and dBase®.

And Amiga is endlessly expandable and adaptable. You can plug in printers (almost any kind), modems, musical keyboards, extra disk drives. You can even expand the memory to a whopping 8 megabytes with an optional expansion module.

See an Authorized Amiga Dealer near you. And don't wait. Your competition is gaining on you. Is that fair?

Amiga by Commodore.

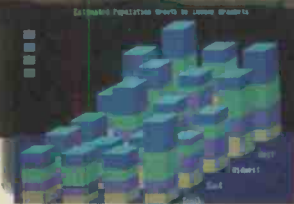

Amiga's 4,096 colours give your business graphics a visible advantage.



Amiga makes telecommunications fast, easy and colourful.



Amiga's 4 channels of stereo give you a sound advantage.



AMIGA GIVES YOU A CREATIVE EDGE.

™Amiga is a trademark of Commodore-Amiga, Inc. ™Macintosh is a trademark licensed to Apple Computer, Inc. ®IBM is a registered trademark of International Business Machines Corporation. ®Lotus is a registered trademark of Lotus Development Corporation. ®dBase is a registered trademark of Ashton-Tate, Inc. ©1985, Commodore Business Machines Limited.

Circle No. 6 on Reader Service Card

SCOPE SCOOP.

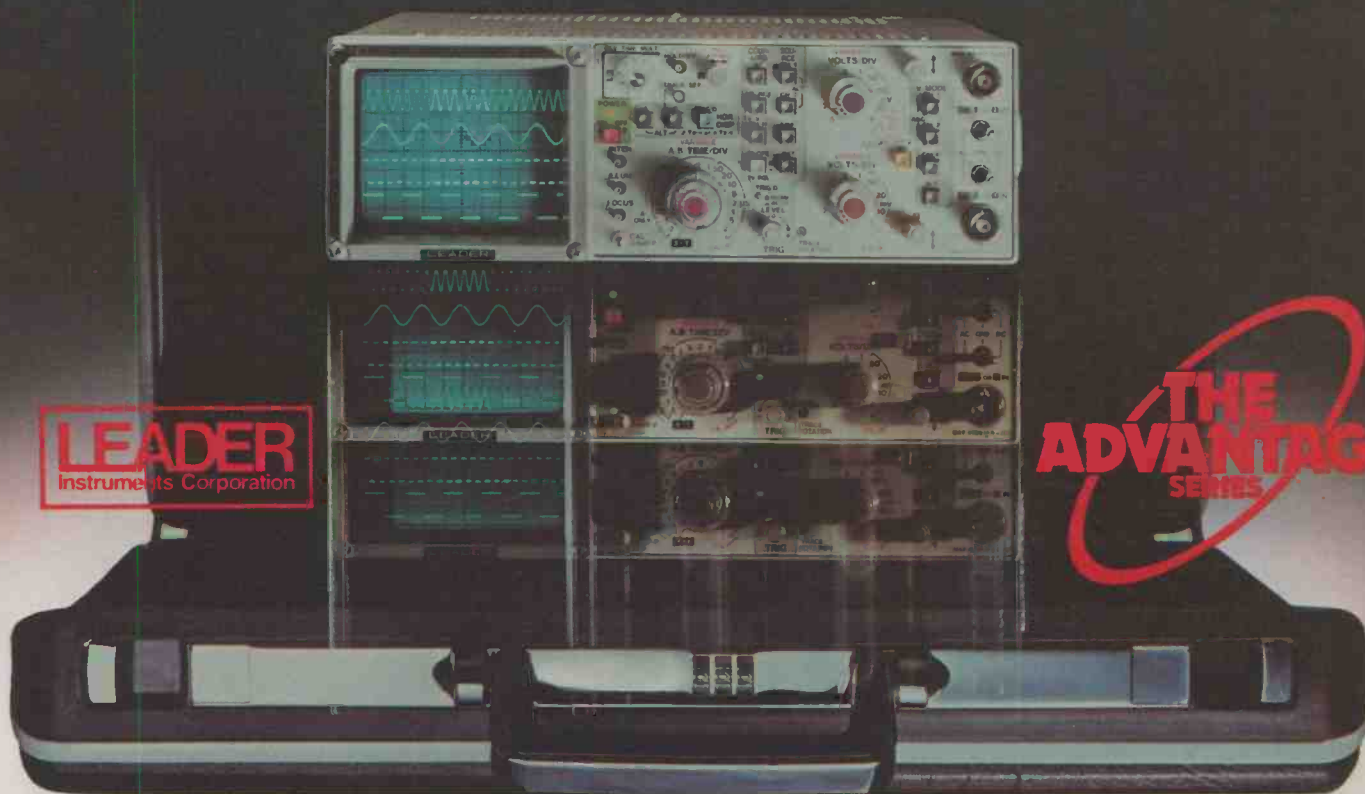

Omnitronix Announces An On-Site Diagnostics Breakthrough.

The new **Leader Advantage Series** gives you briefcase portability with lab-grade features. Finally there is a family of oscilloscopes that breaks the barrier between true portability and multi-feature functionality. Leader's new *Advantage Series* from Omnitronix. Their sturdy die-cast aluminum frames are just 230 x 290mm by 75mm high. And they weigh a mere 4kg!

But *Advantage* scopes include many features previously found only on lab-grade equipment — such as an internal graticule CRT display, 5mV sensitivity, channel I output, and alternate trigger.

Now you can take the lab to the problem instead of taking the problem to the lab.

That's the scoop. That's the *Advantage*.

The LBO-325 60MHZ/Delayed Sweep/Dual-Trace (Above) • Built-in delay line • Easy-reading scale illumination • 3.5 inch 2kV/1.2kV PDA CRT • TV-V, TV-H sync separation • Auto focus • ALT sweep • Variable trigger hold-off

The LBO-324 40MHZ/Delayed Sweep/Dual-Trace



- 3.5 inch 2kV/1.2kV PDA CRT • TV-V, TV-H sync separation • Auto focus
- ALT sweep • Variable trigger hold-off

LBO-323 20MHZ/Dual-Trace



- 3.5 inch 1.7kV CRT • TV-V, TV-H sync separation • Auto focus
- Variable trigger hold-off

Call or write for full information on the *Advantage*, and how to get it.

Circle No. 91 on Reader Service Card

Omnitronix Ltd.
Instruments that measure up.

2410 Dunwin Dr., Unit 4,
Mississauga, Ont. L5L 1J9
(416) 828-6221 Telex 06-22324

8100F, Trans-Canada Hwy.,
St. Laurent, Que. H4S 1M5
(514) 337-9500 Telex 05-824151

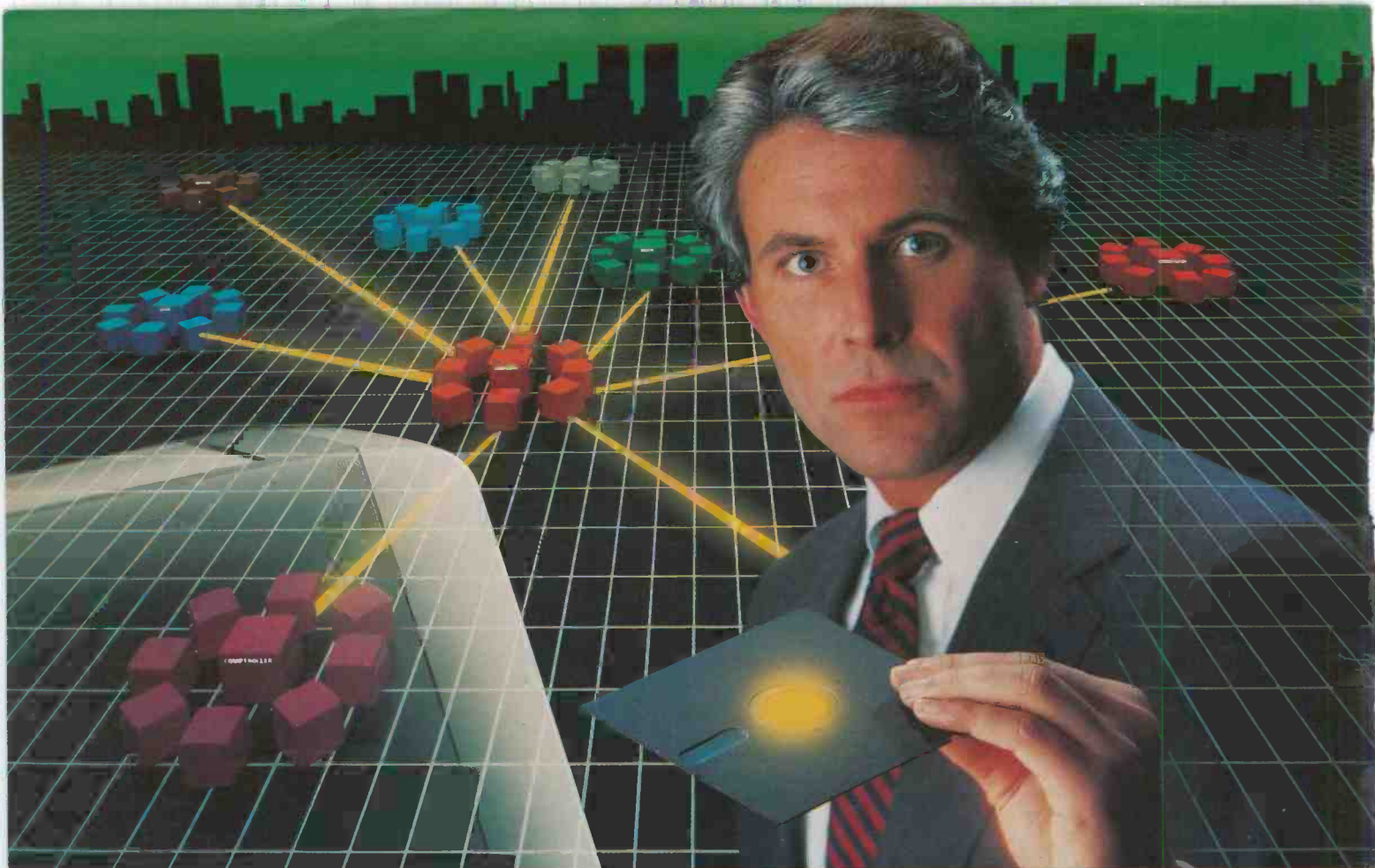

The Most Powerful LAN Fits on a Disk.

Network Power. You knew that someday there would be a powerful LAN that didn't need old-technology network boards. It would be fast, easy to install, and run 99% of PC-DOS software. It would be expandable, provide remote access, password-protection, and enable you to use inexpensive terminals as workstations in a PC-DOS environment.

Dream no more, because the power is here.

Its name is LANLink™

A Software-Driven LAN Powerful Enough To Use RS-232 Ports for Network Communications. In development for over three years, LANLink™ represents the next generation of local area networks. All of the logic which has traditionally resided on network boards is on LANLink's Satellite and Server Diskettes.

No additional hardware is required. Inexpensive serial ports replace "Kilobuck" Network Interface Boards making installation costs one-third that of a board-driven network.

How To Configure a Smart Network...With Dumb Terminals, But Without Dedicated Servers. Boasting a wide variety of configurations, LANLink™ is most often set up as a "Star" having up to eight satellites connected to a central, nondedicated server. Larger networks can have multiple servers, supporting a total of 73 or more network users.

R-LAN™ (Remote-LAN) gives users the ability to interact with a LANLink™ network in real time via modem. Plus, if MultiLink Advanced™ is run on a Satellite, inexpensive dumb terminals can be used to access network disks, files, and programs.

99% of PC-DOS Applications Run In a Totally-Transparent Network Environment. If you know DOS, you already know how to use LANLink™ COPY transfers files among users, and a 2-drive PC Satellite boots 1-2-3 from the Server's hard disk with the entry c:\lotus. Each satellite's access can be limited to specific disks, printers, and sub-directories. A wide variety of software including Lotus 1-2-3, dBASE III, and WordStar 2000 is fully compatible. LANLink™ has a collision-free data transfer rate which exceeds 115,000 BPS.

Power Up Your PCs Today. For complete details and the authorized dealer nearest you, call The Software Link TODAY. The LANLink™ Starter Kit is \$745 and includes modules for both a Server and a Satellite. For a limited time, 50 feet of shielded RS-232 cable will be included free of charge. Additional Satellite Modules are only \$320, each.

LANLink™ is immediately available and comes with a money-back guarantee. VISA, MC, AMEX accepted.

LANLink™



THE SOFTWARE LINK, INC.

Developers of LANLink™ and MultiLink Advanced™

400 Esna Park Drive, Suite 18 Toronto (Markham), Ontario L3R 3K2

CALL: 416/477-5480

Dealer Inquiries Invited

LANLink™ MultiLink Advanced™ & R-LAN™ are trademarks of The Software Link, Inc.
IBM, PC, & PC-DOS are trademarks of IBM Corp. WordStar 2000, dBASE III, and Lotus 1-2-3 are trademarks of MicroPro, Ashton-Tate, and Lotus Development Corp., respectively.

Circle No. 30 on Reader Service Card

AT LAST!

MODERN TECHNOLOGY MEETS OLD FASHIONED VALUE!

FINALLY - A PERSONAL COMPUTER SYSTEM YOU CAN AFFORD

Innovative technology and a remarkable low price have been combined to bring you good old fashioned value. Introducing the amazing new Atari 520ST™ personal computer system. For only \$1,199.95* Complete.

ATARI'S COMMITMENT: POWER WITHOUT THE PRICE

The powerful Atari 520ST™ delivers an incredible 524,288 bytes of RAM and comes complete with a 2 button mouse, 3.5" disk drive, high resolution monochrome monitor, TOS™ Operating System, including GEM™ Desktop, plus Logo™ and Atari BASIC programming languages! All for only \$1,199.95* \$300* more gives you 512 vivid colours with a RGB colour monitor.

COMPARE THE ST SYSTEM TO THOSE OTHER GUYS

	ATARI™ 520ST	IBM™ PCAT™	APPLE™ Macintosh™	COMMODORE™ PC10™
Price	\$1199.95*	\$7524*	\$4095*	\$2995*
CPU	68000	80286	68000	8080
Speed MHz	8.0	6.0	7.83	4.77
Standard RAM	512K	256K	512K	256K
Number of Keys	95	95	59	85
Mouse	Yes	No	Yes	No
Screen Resolution (Non-interlaced Mode)				
Colour	640x200	640x200	None	None
Monochrome	640x400	720x350**	512x342	640x352
Colour Output	Yes	Optional	None	Optional
Number of Colours	512	16	None	16
Disk Drive	3.5"	5.25"	3.5"	5.25"
Built-in Hard Disk (DMA) Port	Yes	Yes	No	Yes
MIDI Interface	Yes	No	No	No
No. of Sound Voices	3	1	4	1

WHY DO COMPUTER SYSTEMS, OFFERING LESS, COST MORE?

Is it that the other guys can't? Or that they won't? Compare - judge for yourself. You'll find the Atari 520ST™ gives you much more. For much less.

For the dealer nearest you write Atari (Canada) Corp., 90 Gough Road, Units 1 & 2, Markham, Ontario, L3R 5V5

IBM & PCAT are registered trademarks of International Business Machines Corp. Commodore & PC10 are trademarks of Commodore Business Machines Ltd. Apple & Macintosh are trademarks of Apple Computer Inc. GEM is a trademark of Digital Research Inc. Atari, TOS & Logo are trademarks of Atari Corp.

*All prices are manufacturer's suggested retail list. Plus applicable local taxes.
**With optional monochrome board (non hit-mapped)



ATARI
POWER WITHOUT THE PRICE

ATARI 520ST™ PERSONAL COMPUTER SYSTEM

Circle No. 31 on Reader Service Card.

HAMEG model HM203-5

Ideal for schools • industry • students • service

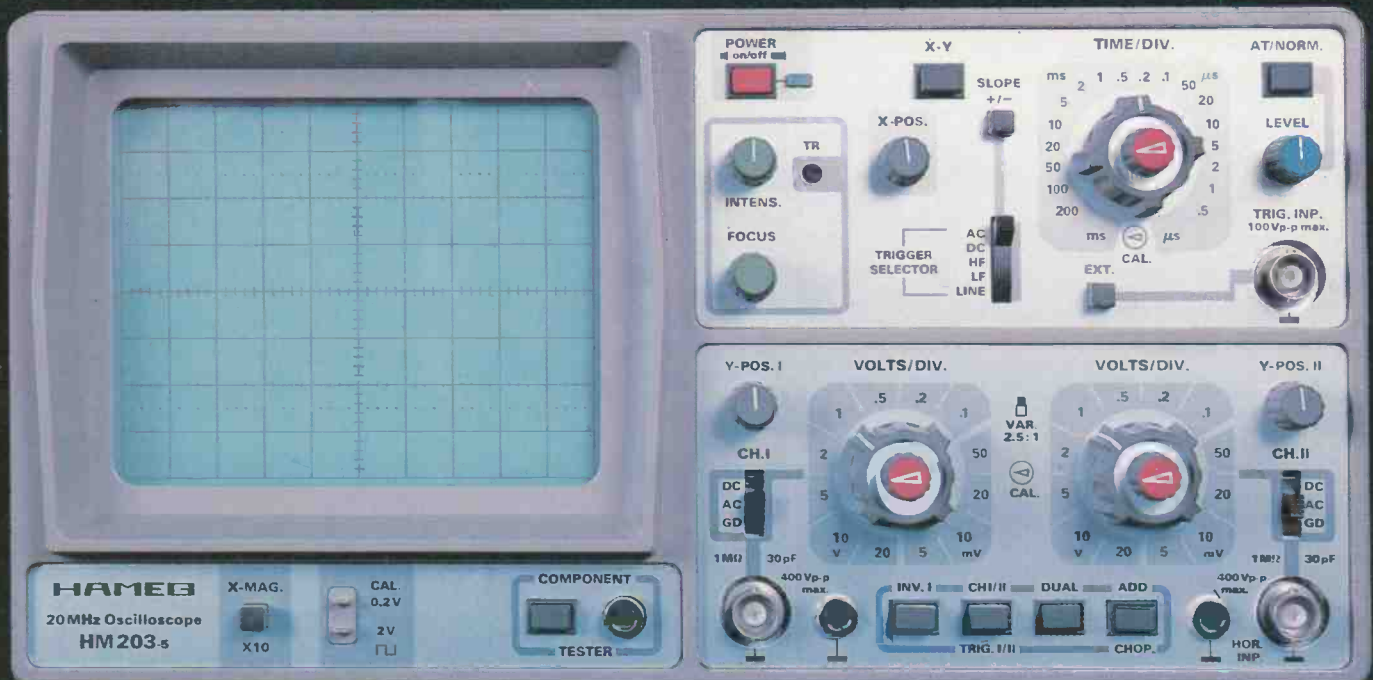

for the complete line of HAMEG instruments write or phone BCS

NEXT MONTH IN Electronics Today

Automotive Electronics

We look at the electronic and electrical systems in cars, from the micro-processor to the basics of alternators.

Multipurpose PCB

Make a number of projects with the same PCB: a capacitance meter, a photocell unit, an RIAA preamp, etc.

Atari Computer Review

Checking out the new 520ST: is it Atari's answer to the Mac?



COMPARE..... then make your selection

*Take home the European Champion at a special
HAMEG-BCS purchase price but only while
the supply lasts.*

The 20MHz Oscilloscope that outsells all others in Western Europe. The model **HM203-5** is available complete with two (X1-X10) probes. This CSA approved Oscilloscope is covered by a **two year parts and labour warranty.**

All major credit cards accepted.

Immediate delivery from Stock

\$695.⁰⁰

F.O.B. Downsview, Ont.
FST Incl'd
Shipping Extra

HAMEG GmbH

West Germany is represented
and distributed in Canada by

BCS
ELECTRONICS
LIMITED

980 Alness St. Unit 7,
Downsview, Ontario
M3J 2S2
(416) 661-5585
TELEX 065-28169

Mon-Fri 8-5 pm, Sat 10-1 pm

Circle No. 33 on Reader Service Card.



This Month in **Computing! Now!**

An Introduction to Unix

Looking at how this popular operating system works on microcomputers.

Gemini Printer Driver for the PC

Connect a Gemini printer to a PC and use this software driver for the best performance.

Akai SX60 Reveiw

We look at this Akai MIDI keyboard and put it through its paces.

The V20 for the PC

The V20 CPU for the PC has the best of both worlds: both 8080 and 8088 operating codes.

How to beat the high cost of cheap meters.



Contact your local authorized distributor now for immediate delivery.
Or for more information, call ACA toll-free 1-800-268-2856.

aca **Allan Crawford Associates Ltd.**
TEST & MEASUREMENT DIVISION

Toronto: (416) 890-2010 Montreal: (514) 731-8564 Ottawa: (613) 596-9300
Halifax: (902) 463-8640 Vancouver: (604) 294-1326 Calgary: (403) 291-3417

You get what you pay for.

So get the Fluke 70 Series.

You'll get more meter for your money, whether you choose the affordable 73, the feature-packed 75 or the deluxe 77.

All of them will give you years of performance, long after cheaper meters have pegged their fishhook needles for the last time.

That's because they're built to last, inside and out. So they're tough to break. They don't blow fuses all the time. You don't even have to replace batteries as often.

And they're backed by a 3-year warranty. Not the usual 1-year.

Of course, you may only care that the world-champion 70 Series combines digital and analog displays with more automatic features, greater accuracy and easier operation than any other meters in their class.

You may not care that they have a lower overall cost of ownership than all the other "bargain" meters out there.

But just in case, now you know.

FROM THE WORLD LEADER
IN DIGITAL MULTIMETERS.

FLUKE®



FLUKE 73

\$137*
Analog/digital display
Volts, ohms, 10A, diode test
Autorange
0.7% basic dc accuracy
2000+ hour battery life
3-year warranty

FLUKE 75

\$159*
Analog/digital display
Volts, ohms, 10A, mA, diode test
Audible continuity
Autorange/range hold
0.5% basic dc accuracy
2000+ hour battery life
3-year warranty

FLUKE 77

\$218*
Analog/digital display
Volts, ohms, 10A, mA, diode test
Audible continuity
"Touch Hold" function
Autorange/range hold
0.3% basic dc accuracy
2000+ hour battery life
3-year warranty
Multipurpose holster

* Canadian price. FST extra. Subject to change.

** Patent pending.