

CANADA'S OWN ELECTRONICS MAGAZINE

# **electronics today**

APRIL 1978

incorporating  
**electronic  
workshop**

**\$1**<sup>25</sup>

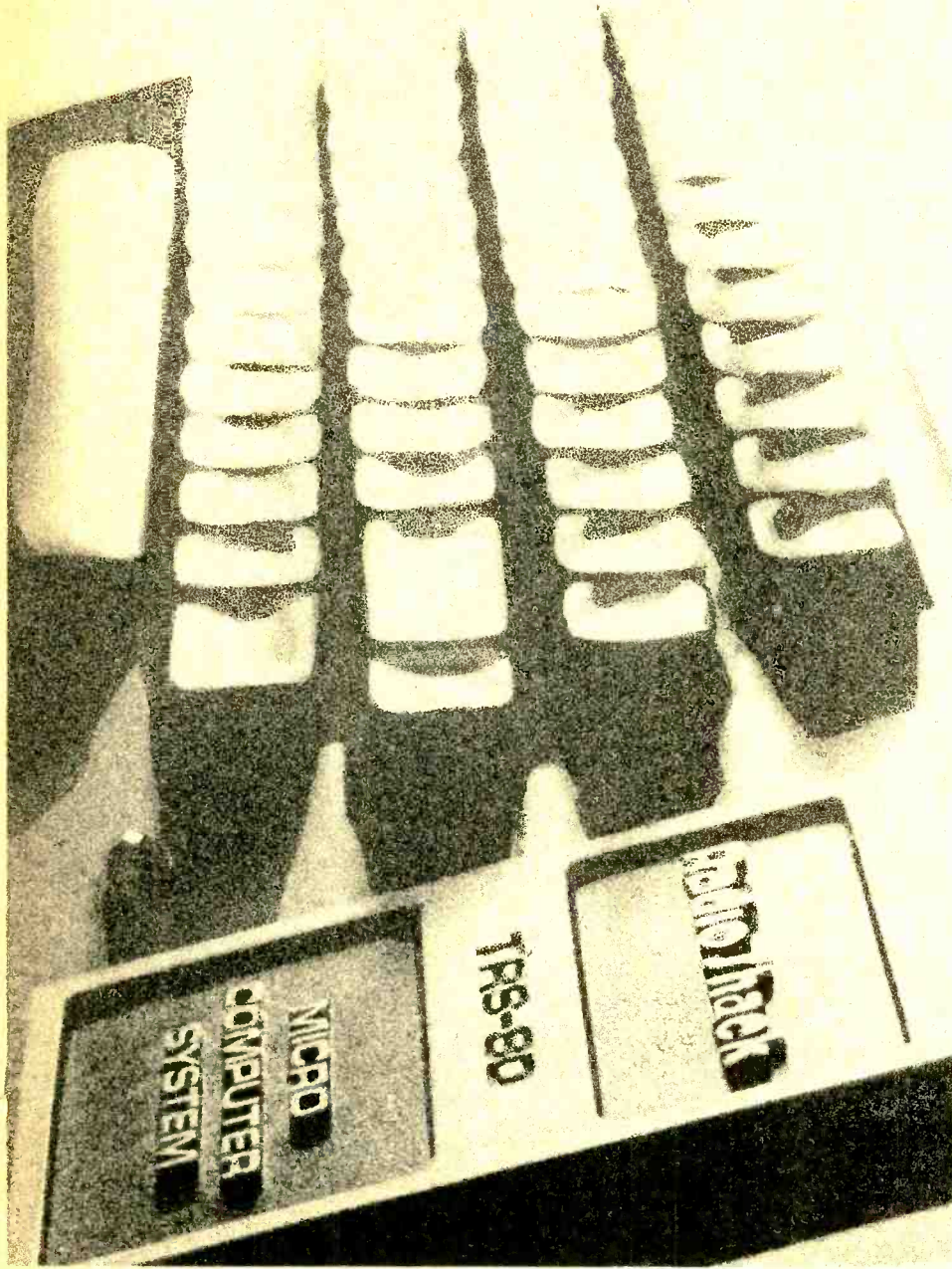

## **Projects**

Bucket-  
Brigade  
Delay Line

Dangerous  
Gas Alarm

Computer  
Power  
Supply

## **More PCB Negatives**

New Section  
for the  
Educated  
Audiophile

**ETI's X-Ray  
Examination of the  
Radio Shack Computer**



# ALPHA•TUNER•SERVICE

THE NAME OF QUALITY IN TUNER SERVICING

Service from coast to coast



## ATTENTION DEALERS:

Hundreds of satisfied customers across the country are utilizing our services because quality and service is our business.

**Quality** All tuner repairs are serviced by trained technicians

**Fast Service** 8 to 24 hour service is a must.

**One Year Warranty** Workmanship and parts are warranted for one year from the date of delivery

**Versatility** We rebuild all tuners of any model, or any make, including varactor-electronic, and all foreign makes.

**VHF-UHF-VARACTOR TUNERS 13.95 UHF-VHF-COMBO 21.95**

Major parts and shipping charges at cost. (dealer net).  
Bring tuners to our Montreal centre or send by mail.

**ats electronics**

8400 St. Lawrence Blvd. — Suite 201, Montreal, Que.  
Tel: 514/381-5838

Editor  
STEVE BRAIDWOOD BSc

Assistant Editor  
GRAHAM WIDEMAN BAsC

**Marketing Manager and Advertising**

PETER E. PRIEST

Advertising Services

SHARON WILSON

Advertising Representatives

JIM O'BRIEN

Eastern Canada JEAN SEGUIN &  
ASSOCIATES INC., 601 Cote Vertu,

St. Laurent, Quebec H4L 1X8.

Telephone (514) 748-6561.

Subscriptions Department

BEBE LALL

Accounts Department

SENGA HARRISON

Layout and Assembly

GAIL ARMBRUST

Contributing Audio Editor

WALLACE J. PARSONS

Editorial Director TOM GRAHAM.

Published by Electronics Today  
International (Canada) Ltd.

**EDITORIAL AND ADVERTISING  
OFFICES**

Unit 6, 25 Overlea Boulevard,  
Toronto, Ontario, M4H 1B1

Telephone (416) 423-3262

Printed by Livingstone Printing Ltd.

News Stand Distribution Gordon &  
Gotch, Toronto.

Subscription Rates \$12.00 per year,  
\$20.00 for two years. Send to Sub-  
scription Dept., ETI Magazine, Unit 6,  
25 Overlea Blvd., Toronto,  
Ontario, M4H 1B1.

**ALL ETI PCB PATTERNS ARE COPYRIGHT.**  
**NO COMPANY MAY SELL BOARDS TO OUR**  
**DESIGNS WITHOUT OUR PERMISSION.**

**INTERNATIONAL EDITIONS**

Electronics Today International  
25-27 Oxford St., London W1R 1RF, UK.

Editor Halvor Moorshead.

Electronics Today International,  
Ryrie House, 15 Boundary St.,  
Rushcutters Bay, Sydney, Australia.  
Editor Collyn Rivers.

Electronica Top Internationaal,  
Postbus 260, Emmen, Holland.

Editor Denis Loos.

Elrad,  
Kommanditgesellschaft, Bissendorfer  
Strasse 8, 3000 Hannover 61, Germany.  
Editor Udo Wittig.

# **electronics today**

international

## **CANADA'S OWN ELECTRONICS MAGAZINE**

### **PROJECTS**

**COMPUTER POWER SUPPLY** ..... 28

*Eight volts at 7.5 A, plus and minus 16V at 750 mA*

**BUCKET-BRIGADE AUDIO DELAY LINE** ..... 32

*The latest thing for audio experimenters*

**GAS ALARM** ..... 42

*Protect your home, your boat, your car, etc*

### **FEATURES**

**AUDIO TODAY** ..... 9

*ETI's new department for hifi nuts*

**AUDIO TODAY, LETTERS** ..... 12

*What the hifi nuts have to say*

**WE REVIEW THE TRS-80 COMPUTER** ..... 15

*Radio Shack's personal computer might be in your home soon*

**FFTs EXPLAINED** ..... 22

*Isn't it about time you found out what FFTs are?*

**ETI DATASHEET** ..... 39

*Panasonic MN3001, bucket brigade*

**BITS, BYTES, & BAUDS** ..... 47

*What's been covered in this six-part course*

**ETI SOFTSPOT** ..... 49

*Atomic decay game and pseudorandom number generator*

**TECH TIPS** ..... 57

*Ideas for experimenters*

**CLUB CALL** ..... 61

*If you're not in 3 electronics clubs already, this is for you*

**FEEDBACK** ..... 63

*Letters from our readers*

**THE FUN OF ELECTRONICS** ..... 65

*Just for a laugh*

### **NEWS & INFORMATION**

**News Digest** ..... 4

**Microfile** ..... 7

**ETI Binders** ..... 8

**PCB Negatives** ..... Centre Insert

**ETI Circuits** ..... 38

**Canadian Projects Book #1** ..... 41

**Next Month's ETI** ..... 45

**ETI Panel Transfers** ..... 46

**ETI Subscriptions** ..... 48

**ETI Marketplace** ..... 54

**ETI 741 Circuits** ..... 58

**ETI Publications** ..... 64

**Information** ..... 66

**Classified Advertising** ..... 66

**Cover: We didn't really use X-rays, of course, but we gave the machine a very thorough check-up. See page 15.**

Second Class Mail registration number 3955.  
Return postage guaranteed. Post Office returns  
to Unit 6, 25 Overlea Boulevard, Toronto,  
Ontario, M4H 1B1.

**Copyright:** All material is subject to world-wide  
Copyright protection. All reasonable care is  
taken to ensure the accuracy of the information.

# NEWS DIGEST

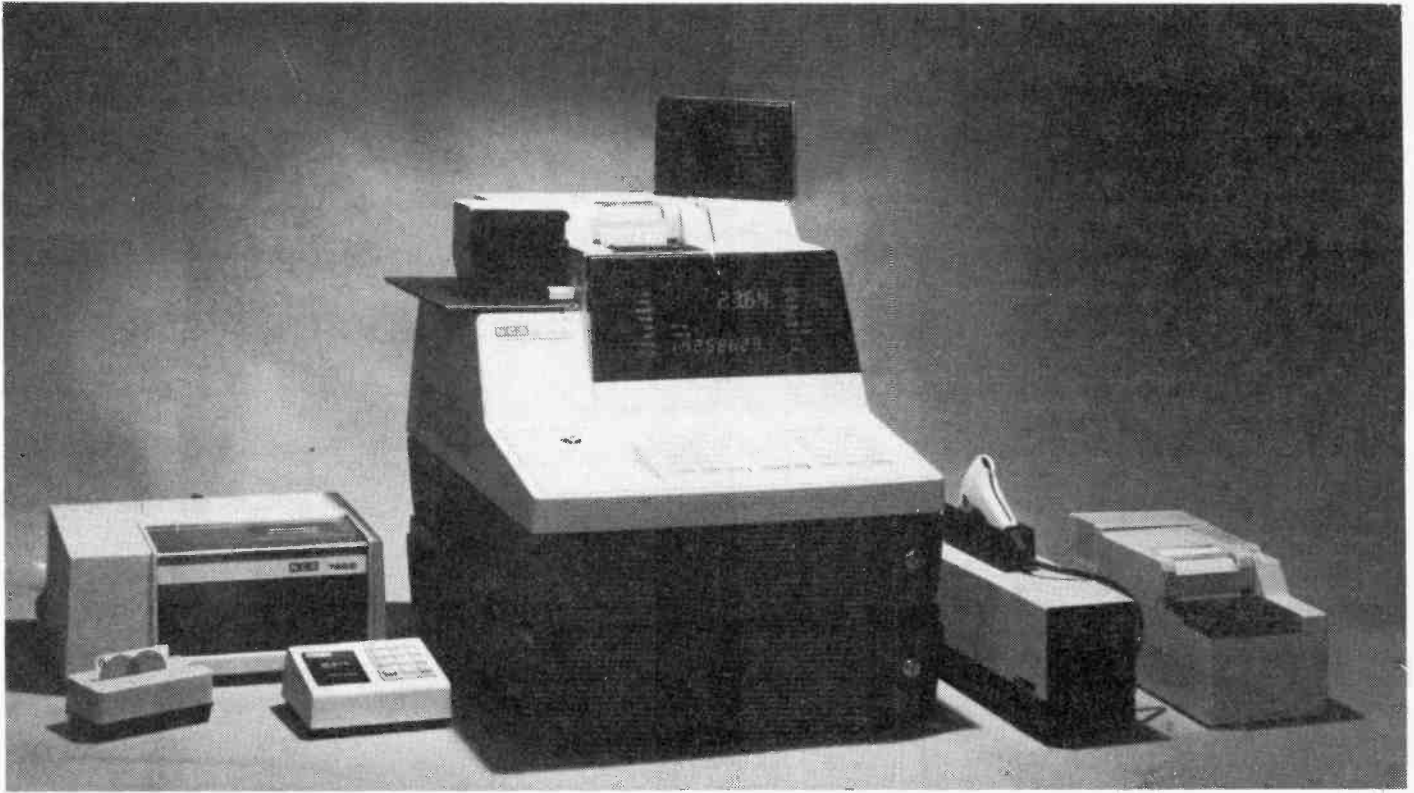

## New NCR Retail Terminals

What is claimed to be a new generation of electronic point-of-sale terminals, whose performance can be increased by adding plug-in modules, was announced recently by NCR Canada Ltd. Features include the use of proprietary NVRAM (Non-Volatile Random Access Memory), and the ability to use more than one processor. The 2140 can automatically read

merchandise tags with a scanning device or automatically read information encoded on the magnetic strip of a plastic card.

Additional modules include: Data communications to a computer system at another location; data consolidation, in which one "master" terminal automati-

cally summarizes totals for up to 15 other units memory capacity up to 128K bytes; Electronic Funds Transfer transactions, the ability to handle credit-authorization or debit transactions; and up to three printing stations.

Prices for the 2140-2000 begin at \$2,950.

## Digital AC Volts Amps Freq Meters

AC Volts, Amps and Frequency can be monitored with an AC digital panel meter from Electro Industries. The LM Series will simultaneously measure both AC volts with 1 volt resolution and frequency between 42 and 99.9 Hz with 0.1 Hz resolution. The indicator utilizes the double LED display, 0.3" high. The VA series is an AC volt/amps monitor with the same double LED display. Amps are displayed up to 999.9 amps AC and volts up to 600 volts. The LF series offers a choice of 3 models of frequency monitors with a full 4 digit display offering up to 0.01 Hz resolution, using 0.4" high LEDs.

For free detailed technical information contact Metermaster, 214 Dolomite Drive, Downsview, Ont. M3J 2P8.

## RF Data

Motorola has a new RF data manual, with complete data sheets, practical application notes, and cross-references. The two pound, 736 page volume describes RF power transistors with outputs up to 150 W, operable in commercial, military, aircraft, marine and ham bands from 1.5 MHz to 1 GHz.

Detailed application information includes impedance matching networks, mechanical RF construction techniques, biasing, reliability, noise figure and gain optimization procedures, mounting and heat sinking, as well as discussions of SSB linearity, broadbanding, and power combining.

Motorola's RF data manual is available for US \$3.50 each from US Motorola distributors.

## Rockwell's Bubble Business

Rockwell International has announced it has chartered a new organization to convert its bubble memory technology into a commercial business, and plans to announce new product specifications and prices very soon.

John L. Archer, formerly manager - Applied Magnetics, heads the new enterprise with the title of business director - Bubble Memory Products. Mr. Archer worked at Rockwell's Electronics Research Center where the first operating 1-megabit bubble memory devices were developed and produced in February last year.

## Cesco Appointed HEP-Motorola Rep

Cesco Electronics Ltd, have announced their appointment as the HEP-Motorola stocking representative for Canada.

HEP-Motorola is a line of packaged semiconductors intended for hobbyists and as service replacements. The line is accompanied by cross reference guides, technical information guides and Hep-notes which provide complete details of different projects.

HEP-Motorola will be sold to electronic parts distributors through a number of representatives in different areas of Canada. Cesco will carry good stocks of the line for fast service and delivery. Pricing policy is based on HEP-Motorola's own price list. Further information and the name of the rep in your area may be obtained by writing to Cesco Electronics Ltd, 4050 Jean Talon St West, Montreal, Que.

## HP Programmable Calc Books

Ten new books designed to provide owners of HP-19C and HP-29C programmable calculators with solutions to problems in such fields as finance, statistics and engineering are available from Hewlett-Packard. The books are \$10.95 each (plus tax and duty if applicable).

Each HP-19C/29C Solution book provides the user with 12 programs. For each there is a summary of the program, a listing of program steps, and an explanation of how the results are displayed on the calculator. The ten books in the "Solutions Library" are identified by subject:

1. Surveying. 2. Mathematics. 3. Statistics. 4. Finance. 5. Electrical Engineering. 6. Navigation. 7. Mechanical Engineering. 8. Civil Engineering. 9. Games. 10. Student Engineering. HP-19C/29C Solution books are available from Hewlett-Packard and selected retail outlets and college bookstores.

## Errata: Project Book

Please note that in Canadian Projects Book Number One, Fifty/One Hundred Watt Amplifier, Q6 is incorrectly shown as a 2N4250. It can be replaced by a 2N3904.



## Video Editor

The BVE-500A broadcast editing console from Sony permits fully automatic editing for a pair of Sony BVU-200A U-Matic videocassette recorders. A major advantage of the unit over existing editing consoles is "bidrex" — two self-return search dials that operate with picture in both forward and reverse modes.

Other features include a digital tape time counter (up to 79mm/59 sec/29 frames for both player and recorder), blinking lamp indicators (guide sequence of operation), automatic entry, butt edit, manual edit, automatic "on air" capability, edit preview and review, and entry time shift.

## Annual Recording Workshop

The third annual summer seminar on the fundamentals of recording will be held at The Banff Centre, School of Fine Arts, Mon May 29 to Fri, June 2, 1978. Stephen F. Temmer, President of Gotham Audio Corporation (New York and Hollywood) will be on hand. The intensive course features six hours daily of scheduled class and hands-on recording work. In addition, there will be evening discussion sessions probing the philosophy of recording and exploring ideas on future technology.

Lending the course greater weight is the fact that students and faculty of the Music Division of The Banff School of Fine Arts will be available for actual recording sessions.

The fee for the week-long course is \$225.00.

Address all queries to Communications, The Banff Centre, Box 1020, Banff, AB, T0L 0C0. Registration closes April 30, 1978.

## LCD Panel Meter PCB

In our February issue we inadvertently omitted the PCB pattern we were so proud of. Here it is.

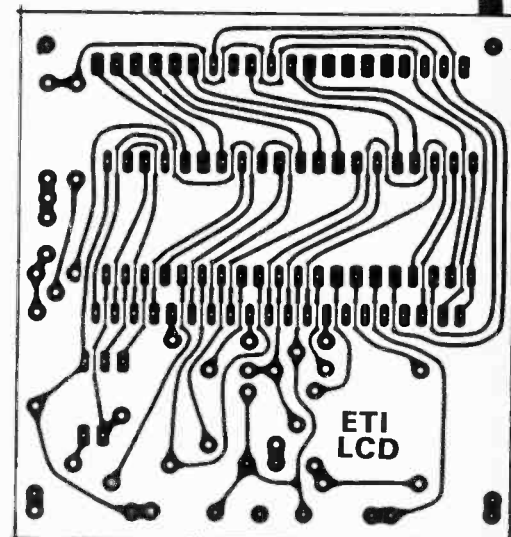



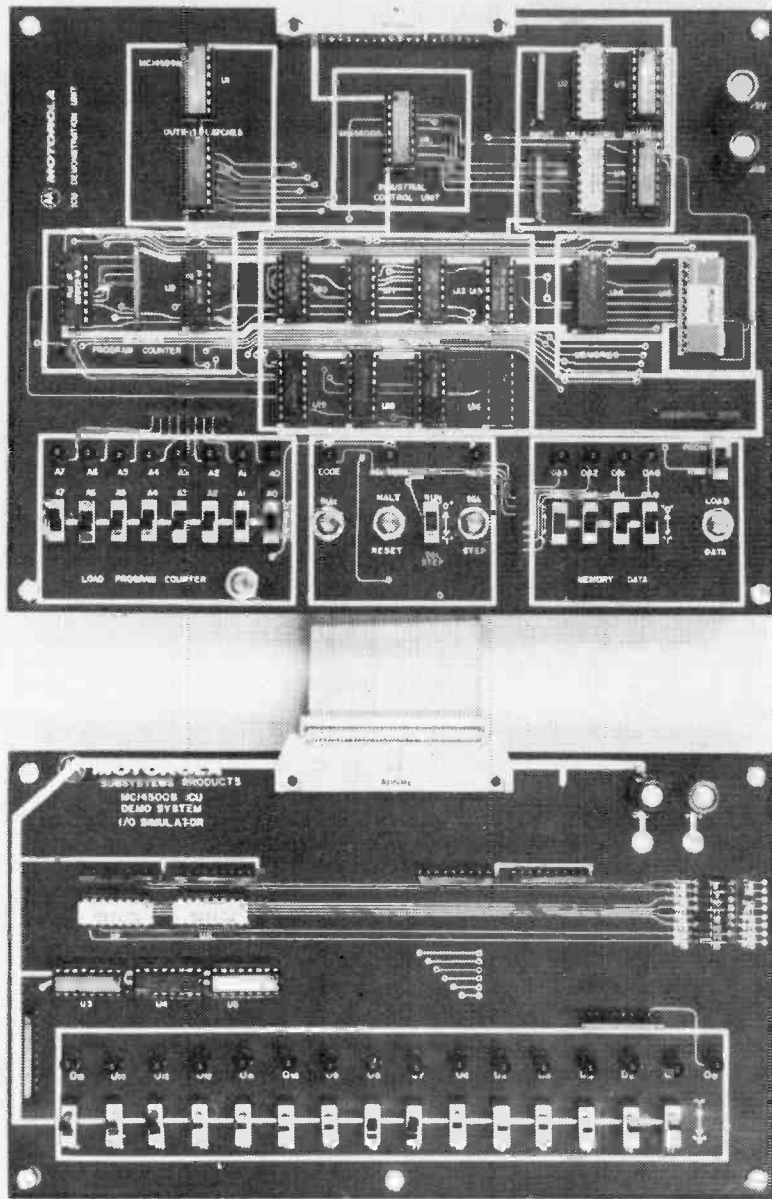

## Programmable Control Unit/Learning Aid

Motorola has announced a 2-board Industrial Control System that combines a prewired programmable logic controller (PLC) with an ancillary Input/Output Simulator that serves as a system development tool and demonstration unit. Based on the company's recently introduced single-bit microprocessor — the MC14500B Industrial Control Unit (ICU) — Motorola claim this system can serve as a learning tool to acquaint designers with the power and potential of a one-bit MPU and, thereafter, as a dedicated functional control system. As a functional system, the I/O Simulator is

replaced by the actual I/O devices associated with the working system.

The system has 15 inputs and 16 outputs, and incorporates a RAM capable of holding 128 ICU program instructions. The user is able to examine or change the contents of any memory location and has the option of single stepping or running his program. Alternatively, a programmed PROM may be installed in an available socket to run the program. Built-in LEDs display the state of the program within the system, thereby providing an easy means for monitoring or troubleshooting. The system accepts 16

## Micro Seminars

E&L Instruments will present four one-day "hands-on" microcomputer seminars to product designers attending the 25th ASME Design Engineering Show at McCormick Place, Chicago, Illinois, April 17-20, 1978. Design engineers and mechanical engineers will learn how to program and interface microcomputers in traditionally mechanical applications such as appliances, tools, process control, automotive instrumentation, and consumer goods.

For seminar registration information, contact Clapp & Poliak Inc, 245 Park Avenue, New York, New York 10016; telephone: (212) 661-8410.

## TDS-M68 Micro

The TDS-M68 microcomputer Training and Development System guides the user step-by-step through the learning process (from elementary introductory material to interrupt based sequential control examples), a lab package that includes real world devices (LEDs, relays, small motors, etc.) that are interfaced to and controlled by the computer, plus a practical, applications oriented, textbook covering programming, interfacing and application concepts (including worked out sample application examples). An instructor's guide and overhead transparencies are also available.

Six general purpose I/O ports (utilizing the SWTPC bus configuration) accept a line of interface boards that includes parallel and serial I/O ports, a cassette interface, an interrupt timer, a calculator module, an EPROM programmer, etc.

All items are available separately or as a total package. A descriptive brochure is available upon request from SDS Technical Devices, 1138 Main St., Winnipeg, Man., R2W 3F3.

instructions and can be uniquely tailored to a user's particular requirements. Designed with CMOS technology, it utilizes very little power and operates from a 5 volt power supply.

In the USA the DS14500A Industrial Control Unit Demonstrator System sells for \$295.00. This includes the Processor Board, the I/O Simulator Board and an appropriate 40-conductor ribbon cable. In addition, the Processor Board is available separately under part number DS14500B, at a cost of \$197.00 (unit quantity), for end-use application where an I/O simulator is not required.

## 6800 Programming

Bob Southern's "Programming the 6800 Microprocessor" was written to teach programming to community college students. He assumes no previous knowledge of programming and teaches the fundamentals of assembly language and machine-code programming of the 6800 processor and its peripheral devices. The ACIA and PIA are explored in detail in both non-interrupt and interrupt modes. The workbook asks the student questions after each new piece of information, and then gives the correct answer.

The book is available (\$6.75, prepaid) from The Algonquin College Bookstore, 1385 Woodroffe Avenue, Ottawa, Ontario, K2G 1V8.

## First I<sup>2</sup>L, Monolithic 10-Bit A/D Converter

A complete, 10-bit monolithic analog/digital converter, which for the first time in bipolar technology combines linear and digital circuitry on a single integrated circuit chip, has been developed by Analog Devices Semiconductor. The new AD571 is produced using the integrated-injection logic (I<sup>2</sup>L) technique which allows very high circuit densities to be fabricated on a single chip.

In addition to representing an advance in the application of I<sup>2</sup>L technology, the AD571 is also the first monolithic A/D converter to be laser wafer trimmed.

The AD571 is a successive approximation converter and includes a DAC, voltage reference, clock, comparator, successive approximation register and output buffer on a 120 x 150 mil chip. The device executes a complete conversion to 10-bit accuracy - 1/2 LSB with no missing codes in 25 microseconds.

Contact Tracan Electronics, Downsview, Ont.

## Programming Courses

The Computer Mart (Toronto) is organizing a series of Programming classes. Initially, the following courses will be held:

Introduction to Microprocessors (April 10), \$135.

Programming the 8080 (Mar. 21), \$179.

Programming the Z80 (April 11), \$179.

Introduction to the BASIC Language (no details available).

These courses will be held on week-day evenings. Each course runs for three weeks, two lessons each week on Tuesday and Thursdays (except Intro-



## Data Terminal Mart

The competitive data terminal market is now being served by a new style of retail operation. Data Terminal Mart reduces their overhead by limiting field sales staff, encouraging the small customer to come in to their sales outlets and save money. Hazeltine, Digital Equipment, Texas Instrument, Tektron, Teletype, Interdate, MI<sup>2</sup> and Misco Manufacturing are among the lines they handle, of particular interest to computer hobbyists would be DTM's

less expensive lines such as Soroc (a spin off from Lear Siegler) and competitively priced Dec-writers.

DTM finds that being located in hotels in Toronto, Montreal, and Calgary is very advantageous to business. In Toronto they are to be found in the Skyline Hotel, and in Montreal at l'Hotel Quatre Saison.

Franchises are also available in Vancouver and Ottawa, interested parties should phone Keith Tomlinson at (416) 677-0184.

## Monitor And Debug Interface Buses

The new Hewlett-Packard Model 10050A Adaptor and a companion 10051A Test Probe are designed to provide a fast and easy way to look at activity on the Hewlett-Packard Interface Bus (HP-IB/IEEE-488). Used in combination with the HP Model 1602A Logic State Analyzer, these accessories let the user monitor bus operation at full operating speeds without interfering with bus operation.

The Hewlett-Packard Model 10050A Adapter costs \$43.44 in Canada. The Hewlett-Packard Model 10051A HP-IB Test Probe which includes a 10050A is \$230. Duty and Taxes extra where applicable.

duction to Microprocessors). Indicated dates are the actual start dates for one course. The fees include the necessary text books, supplies and the cost of 'hands on' computer time where applicable.

The lecturer for these courses is Andy Johnson-Laird. Andy has fifteen years of programming, systems analysis and teaching experience.

The courses will be held at the Holiday Inn at the Don Valley Parkway and Eglinton Avenue. More details from Computer Mart Ltd, 1543 Bayview Ave, Toronto, Ont., M1K 4K4.

## Zentronics Data Products

Newly-formed Zentronics Data Products Division will incorporate the Data Products Group of Nedco Ltd. to coordinate the marketing and distribution of a full line of data products including those of Lear Siegler, Teletype and Extel and the microprocessor systems produced by several leading manufacturers.

The headquarters of Zentronics Data Products will be at 99 Norfinch Drive, Downsview, Ontario. Other locations include Montreal and Ottawa, and a fourth will open shortly in Vancouver. For more information call (416) 635-2822.

## Microcomputer Exposition

The International Microcomputer Exposition will be held in the Dallas Convention Center, Sept. 29 through Oct. 1. "Co-sponsored by several groups, including the American Association of Microprocessors, the exposition will be directed toward all levels of technology." (That's what the Press Release says: things have really advanced when microprocessors are so smart they can form their own association and hold an expo for all the other technologies. Ed.)

Further details from Beverly Tanner, 214-271-9311.

# PHILIPS

# TELEVISION CABLE CONVERTER



.....from PHILIPS

## GIVE YOUR TV MORE CHANNELS.....NOW!

With the new PHILIPS television Cable Converter, you can have the potential to receive your regular channels PLUS all additional stations available on your cable system.

Give your TV, and your whole family a wider choice of television entertainment.



**Install it yourself.  
All you need  
is a  
screwdriver.**

**ONLY  
\$49.95**

FOR FURTHER INFORMATION CONTACT YOUR NEAREST PHILIPS CONSUMER SERVICE CENTRE LISTED BELOW

Service Depots from coast to coast: Halifax: 902-429-0260 — Quebec City: 418-681-4639 — Montreal: 514-342-2043 — Ottawa: 613-829-9295 — Toronto, West: 416-781-5201 — Toronto, Central: 416-489-2022 — Toronto, East: 416-438-9822 — Hamilton: 416-547-4914 — London: 519-686-9671 — Sudbury: 705-560-4866 — Winnipeg: 204-774-1931 — Regina: 305-543-0466 — Saskatoon: 306-244-2299 — Calgary: 403-452-8491 — Vancouver: 604-434-6647.

# ServiceServiceService

# BINDERS

In response to many requests from our readers we have arranged for binders to be made so that you can keep ETI's first Canadian volume together and protected from damage. The binders are covered in attractive leather-look black plastic and are designed to hold twelve issues. The ETI design is printed in gold letters on the spine



The binders cost \$5.00 each, which includes postage and packaging. Do not send cash — you can pay by cheque, Mastercharge, or Chargex. Credit card orders must include your account number, the expiry date, and your signature. In all cases allow six weeks for delivery. Send your order to ETI Binders, Unit 6, 25 Overlea Blvd., Toronto, Ontario M4H 1B1. Don't forget to include your name and address. Ontario residents add 7% PST.





# Audio Today

Wally Parsons, ETI's Contributing Audio Editor, introduces this new column.

*ONE GREAT THING* about writing a column is that the first one is the easiest. At least, that's what everyone tells me. Seems that you don't have to write about anything in particular. It doesn't even have to be relevant to the subject with which it normally deals. Talk about what a great magazine you have, what a nice guy the editor is, and of course, the unusually perceptive readers.

Following along those lines, I might tell of the day early in January, when Steve asked me how I felt about doing a regular department on Audio. Being a man of humble mein, all I could say was, "Aw, shucks, fellas" And then I'd start off this column by telling you how this is your column, the readers', and what you say goes and all that.

But I'm not a humble kind of person, I'm arrogant, opinionated, stubborn, argumentive, impatient, and I like the sound of my own voice. And this column is not the readers', it's mine. It's mine to include what I deem suitable. But it is for the readers, a means of exchanging ideas, information viewpoints, so that I may teach you, you may teach me, and also teach each other. Anyone who doesn't like what appears in these pages is invited to move on, with no hard feelings.

This is not to say that I don't care. I do. But even more, I care about audio, and how to use its marvelous magical technology. Of special concern is the need to establish standards of excellence, and to encourage the application of rigorous critical standards in examining new techniques, and equipment, to distinguish real

technological achievement from hype and faddism. You won't find any "gee whiz" reporting in these pages, but you will find praise for worthwhile and interesting ideas and products. Or acid.

As for "unbiased", forget it; there's no such thing, and any reporter or commentator who claims to be is either a liar or a fool. Or both. But the biases will be obvious.

Readers' letters are more than welcome, indeed they are the life-blood of such a column. They tell me what concerns you, and form the basis for real dialogue. And you don't have to agree with me any time; audio is such a marvellous blend of hard technology, aesthetics, and fashion, with so many built-in contradictions, that you can't cast moulds. Readers should also be advised that politically I'm a left-wing nationalist with a certain Messiahist zeal to promote a real Canadian audio industry. Without it the amateurs and hobbyists are just play-acting. Therefore, I hope to be able to devote a great deal of attention to Canadian developments and products.

Yes, products, because product reviews will also be part of this department but not the sort of reviews you may be accustomed to. For one thing, these kind of test results are available elsewhere. Rather, more emphasis will be placed on the concepts embodied in new products and, in some cases, extended listening and in-use evaluation. This means that products will receive less than rave reviews, from time to time, but every attempt will be made to be fair. It's a different

approach, and one which we hope will be well received by our readers. It is my hope that Canadian advertisers will quickly realize the value of product reviews which are not only honest, but appear to be honest. Some reviewers seem enthusiastic about everything, so eventually the reader believes nothing he reads. I don't want that to happen here.

Record reviews are out. Obviously, if a recording illustrates some particular aspect of audio and is relevant, it will be discussed, but only on the technical level. An obvious example would be a direct-to-disc recording, while discussing such techniques. My feeling is that ETI's readers are reading these pages for technical material. If they want record reviews they will do as I do, subscribe to publications which specialize in that sort of thing. Too many audio magazines are really record magazines, and I don't think we need another one. ETI isn't supported by tax money, unlike some music publications, so we have to make it by writing for our readers.

Letters may or may not be published at the discretion of myself and other staff, unless the writer specifically requests that they not be, and are subject to editing. Again unless you request that it be withheld, publishing the writer's initials and home town will be a matter of discretion and common sense (we hope). By the way, if you want a personal reply, please enclose a stamped self-addressed envelope. Answers will be as prompt as our hectic schedule allows. Anyway, on with show.

## AUDIO HARDWARE

Back in the early '50s, a gentleman named Bachman, having pioneered work on the modern magnetic pickup, set about developing an appropriate arm. This was subsequently manufactured by Gray Research and Development Co as their Model 108 and was to be found in almost every broadcast installation up until the '60s. One of its most novel features was the use of a unipivot suspension with integral fluid damping. I was rather proud at the time of being able to fast-cue with it by throwing it above the record surface and have it gently lower itself right onto the starting groove. But even more important is the fact that that arm and its damping system was a major factor in the General Electric pickup's fine reputation among professionals, but not with audiophiles. Proper damping enabled it to deliver its full potential. The technique fell into disuse over the years, and I suspect that one of the reasons was the inability of many people who should have known better to distinguish between damping and friction drag.

## DAMPING

But damping has attracted some attention recently, largely as a result of records cut with excessive modulation levels and pickups with excessive compliances. In re-discovering the wheel, engineers have learned what we all knew way back: that pickup compliance and arm mass combine to produce resonance, that resonance produces a response peak at record warp frequencies and makes the system sensitive to external shock. Given the realization that a resonance condition is undesirable, and that any compliance/mass combination has a natural resonance, but that its effects can be virtually eliminated by proper damping, it naturally follows that any undamped arm/pickup combination is improperly designed. Further, since pickup and arm form a system, it is not possible to design one properly in isolation from the other. The fact that most pickup manufacturers do not manufacture arms, and most arm manufacturers do not equip their arms with pickups, therefore, speaks for itself. It is worth noting, then, that one of the very best pickups in the world, the Decca, really shows its stuff when

used in the (damped) Decca arm, yet is often disappointing when used in other ways.

## DISC TRAKER

A few manufacturers are catching on, though, and are scrambling to redesign their products along more rational lines, but there is still a vast area, particularly with regard to automatic, and semi-automatic single play turntables where some means of adding on appropriate damping would seem to be in order. One such device is manufactured by the Discwasher group under the name of "Disc Traker". It's a little gadget which is attached to the arm and has a part which rides on the record surface and another rigidly fixed to the arm. The fixed piece fits into the other as a piston and is said to provide pneumatic damping. In other words, it's what used to be called a dashpot. There's no way it will attach to my arm, but reports as to its effectiveness have been mixed. For example, it was tried on a Decca arm and pickup with results which could only be described as terrible, yet with a Formula 4 arm it turned an already excellent moving coil pickup into a spectacular performer.

I must confess to somewhat mixed feelings on this whole idea. It looks great, but . . . ! A 14-page booklet put out by the manufacturer goes into considerable detail on the subject of damping, but the absence of electrical equivalent models results in several statements having to be taken on faith, including some very questionable analogies with automotive shock absorbers. It deals with other systems of damping, but dismisses them in cavalier fashion without substantiating its objections. For example, the claim that oil pivot damping **increases** sensitivity to external shock runs quite contrary to experience, especially broadcasting studios where it's not unusual for inexpert and/or non-technical help to kick turntable consoles, stomp the floor and otherwise deliberately or inadvertently try to bounce the pickup around. As for accoustical feedback, I've run control room monitors, in the past, at levels which would make a disco habitue blanche. But you wouldn't hear the effect of any of these things at home.

Or the claim that dynamic damping is very delicate to adjust and unsuitable where the audiophile selects his own arm and pickup. Well, it just happens that for the past year I've

a) The DiscTraker tone arm damping device.

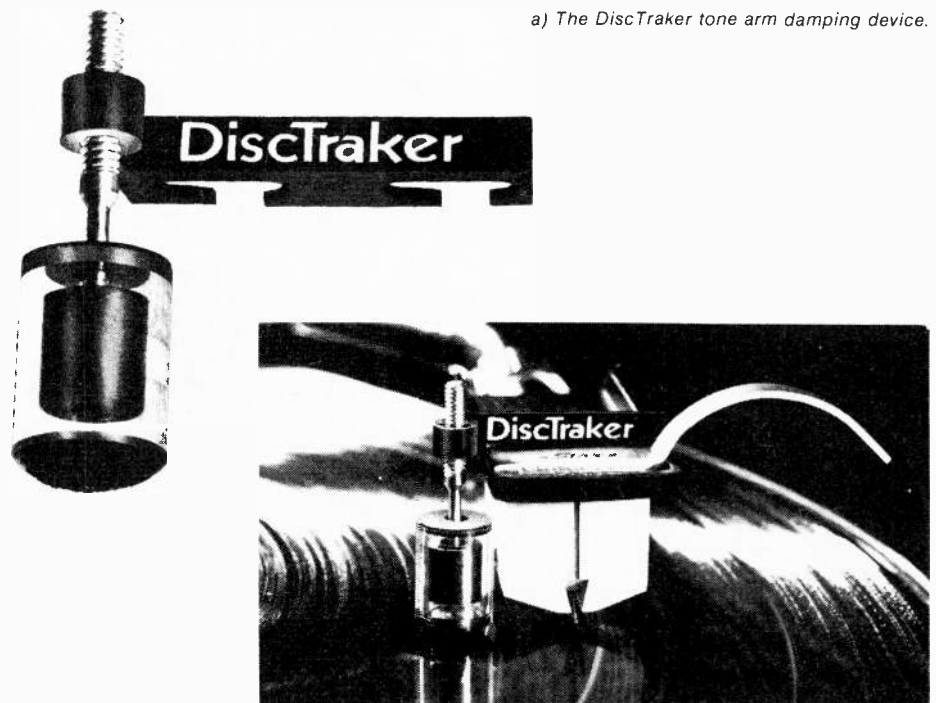

been using a dynamic damping system which adjusted so easily, and so effective that I'm considering looking for financing in order to market it.

However, this device does seem to offer a reasonable alternative to buying another, properly designed, arm, especially if you have an integrated arm/turntable. I have serious reservations as to its effectiveness in damping most resonances, and I very much doubt that it is effective on lateral resonances and the other kind of torsional, and secondary resonances, including the "collision effect" which Joseph Grado describes. However, it should be quite effective in controlling the wild overloads which result from record warp. These warps tax the elasticity of stylus suspensions, cause wild fluctuations in tracking force; drive armatures into non-linearity, overload amplifiers and send woofer cones into mad paroxysms of flutter.

I would suggest, however, that before you run out and buy one you read the Disc Traker brochure, then find a dealer able to demonstrate it on the same arm and pickup you now use, preferable with a speaker with extended low end response, but subject to woofer flutter, and a low damping amplifier such as a tube unit. Listen carefully both before and after, and watch the woofer. And bring your own record. At \$45.00 list I think you ought to be sure it will work on *your* set-up. If it does, it's a good buy. Also get a static neutralizer; you'll need it.

## THE SME APPROACH

A different approach is taken by SME, with the FD200 add-on unit for the Model 3009 Mk II, and which is an integral part of the Mark III. It consists of a little paddle mounted to the arm, and a trough attached to the base, and filled with a fluid. The paddle rides in the trough and the fluid damps arm movement caused by resonances, but does not interfere with normal movement of the arm as it tracks inward. The intriguing thing about this little gadget is that it seems to be a prettified version of a technique popular with amateurs for many years and written up on several occasions. Either they've been reading our mail or won't let pedigree stand in the way of a good idea. The technique is particularly useful on arms using needle or knife bearings, because, in one fell swoop it bypasses the problem of

limited surface area and fluid migration. An additional plus which no one seems to have considered, is that the device could probably be adapted to other arms including some automatic changers. Obviously, the experimenter is on his own, and it will cost \$43.00 to find out.

If you have an SME Mk II it will not upgrade it to a Mk III, which is a new design in several respects, but it will correct the one serious fault in what is otherwise an excellent arm.

Pickup arm damping is a sufficiently involved subject as to require an article by itself. As it is I've devoted enough time to it to crowd out Stanton's new stylus configuration which I've been using for the past few months, so it will have to wait.

DiscTraker is distributed by H. Roy Gray Ltd., 14 Laidlaw Blvd., Markham, Ontario L3P 1W7.

SME is distributed by A.C. Simmonds & Sons Ltd., 975 Dillingham Rd., Pickering, Ontario L1W 3B2.

## AUDIO CLUB NEWS

The Toronto Chapter of the AUDIO ENGINEERING SOCIETY held its January meeting at George Brown College, and was addressed by Lennox Blizzard, who teaches the acoustics course at George Brown College. Techniques of measuring various acoustical materials were demonstrated. This is an area in which many audiophiles are ill-informed, and find information hard to come by. The Society's membership is open to applicants on several levels, from Student, to Fellow, and with various degrees of expertise. Readers interested may contact me directly at ETI.

If you belong to an audio club or are interested in forming one, I'd like to hear about it and so would many others. Please write to me at ETI.

*b) A close-up of the SME FD200 fluid damper.*

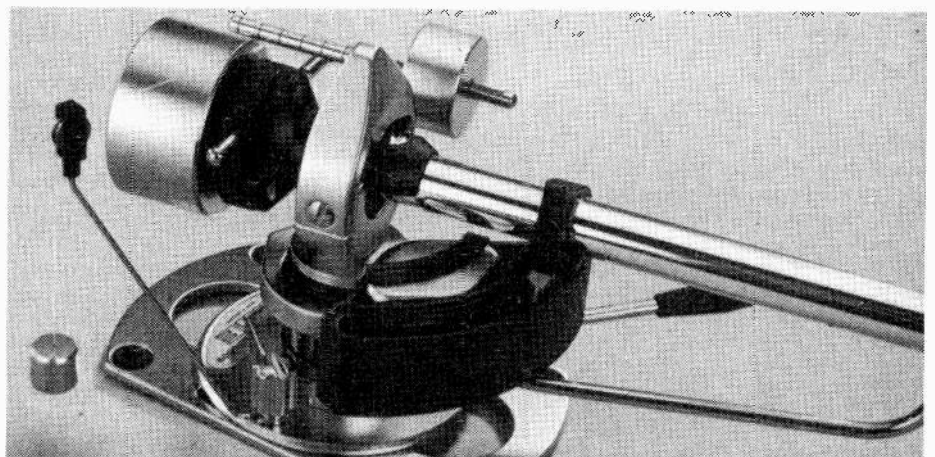
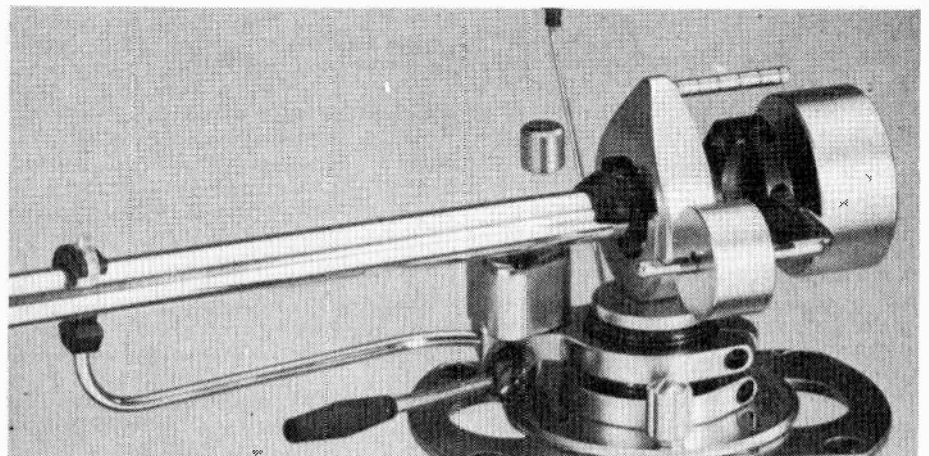



## 50/100 Output

Dear ETI:

In your Apr/77 issue, I have come across a problem in the 50/100 Amp. In the schematic on page 26, it shows only one output. I am not sure where the other output should be connected to, directly to the input (the lower lead) or to OV. Please help me.

Also, when are you going to publish plans for a suitable pre-amp for this amp. I presume that the pre-amp will have volume control, loudness control, high and low filters and bass and treble controls. I hope this is possible.

M.W. Winnipeg

*The amp is really a bridge circuit in which each power supply and each output device forms one of the legs, the output being taken between the two power supply junctions and the output devices junction. Strictly speaking, it doesn't matter which of the four junctions is grounded, or even if none is grounded. In this circuit, though, the "OV" point may be connected to ground, thus allowing the return side of the speaker to be grounded. In addition, since any preamp is likely to have a grounded return, the "Input Comm." terminal should also be grounded, preferably at the input terminal itself. A word of caution: since this project does not include chassis, etc., watch your grounding system carefully to avoid instability. Especially avoid stringing chassis grounds any old places which happen to be convenient. In general, keep inputs and outputs well apart, and be ready to experiment. And DO follow the setup alignment carefully.*

*A pre-amp project is a good idea, one which I'm considering tackling myself, sometime this year. Several good ideas appear in ETI Circuits No. 1 which you might find useful. In addition, our first Canadian Projects Book contains details of audio modules (plus the 50/100W Amp for those who missed it) which may be combined to suit your desires.*

## Tube Tale

Dear Sirs:

I have purchased lately some old tube amps. They are brand names, and I am about to rebuild and use them.

Even after using them for hours, they sound O.K., though the highs are not crisp and they are boomy at the low end.

The tubes passed the test. There is no audible hum or distortion. I tested out the power amp with a 1000Hz signal and observed the wave form at the speaker terminals (on both channels) on the scope. The lower part is a bit smaller and thinner than the upper one. What does it mean? I did

some research, and learned that the new tube amps are built of low noise tubes, metal film resistors and polyester and silvered mica capacitors.

The amps I own utilized 10-20% resistors and capacitors. If I change them to the above quality what results can I get?

Are there any low-noise 12AX7s and 6BQ5s on the market?

Since the output transformers are relatively small, by changing them with bigger and slightly more powerful quality transformers, would the overall performance be better?

I would appreciate all the advice I can get.

Mr. C.J., Toronto

*I mentioned in an article in ETI ("V-FETS For Everyone", Oct/77) that only a perfectionist, masochist, or a nut like me would get involved with tube amplifiers. Nice to know I have company. Welcome to the club.*

*To begin with, any comments I might make are limited by the fact that you supply no circuits, or make and model number, so I must speculate on the circuitry used. It's difficult to comment on the sound quality without knowing something about your speakers and other equipment. My own tube amps have a bright, clean, detailed high end, but not the rough edge often called crisp. As for the boom, this is really a fault of the speakers. Most speakers sold today exhibit poor impedance/frequency characteristics, the most noticeable fault being a pronounced impedance rise at the bass resonant frequency. Since efficiency rises at resonance, output also rises (See "Equalization", ETI March 78). Also since this corresponds to a condition of poor damping, there is a lot of hangover, resulting in a boomy sound. Most designers get away with this by counting on the high damping factor of transistor amplifiers to eliminate the peak and the hangover. This may be bad design but it is the way things are done. Generally tube amplifiers will exhibit damping factors of less than 20, as against upto 1000 for a big super-amp. Also, high effective damping factors are difficult to achieve with low power designs. Because of the phase compensating circuits used even the full damping may not be available at very low frequencies because the feedback rolls off from as high a point as 100 Hz. Your first instinct, then, would seem at first to be a good one: improve the low frequency response with a large transformer. While you're at it replace the coupling capacitors with larger value units. This will give better low frequency response and damping. It will probably also cause the amplifier to break into violent oscillation. At both audio extremes. Chances are this is a fairly simple circuit with two pentode output tubes driven by a paraphase phase splitter, and RC coupling. Such a circuit has a different number of phase shifts on each*

*half of the circuit, making stability a problem. There is obviously no room here to deal with this aspect properly, and in fact I'm in the process of preparing an article on feedback and I hope to cover tube circuits and their special problems. But as you can see, unless you have a lot of knowledge of feedback circuits you're asking for trouble if you play with it, especially if the manufacturer played some fancy tricks with phase margin.*

*I wouldn't pay much attention to the tube tests. The best test here is to substitute new tubes and see what happens. Use European or U.S. tubes wherever possible, not Japanese. The low noise version of the 12AX7 is a 12AX7A/7025, and its European counterpart (very quiet) is the ECC83. The 6BQ5 is a beam power tube and would not have a low noise equivalent. However if you don't mind paying a premium price you might try 7199A, an industrial tube available from such places as Electro-Sonic, Saynor, etc.*

*As for your proposed changes in resistors and capacitors, I don't know about you, but if I did it, along with the premium tubes, the most likely result would be a letter from my bank, specifically the guy who doesn't like overdrawn accounts. In a well-designed, sophisticated circuit they can make all the fancy circuitry meaningful, especially when dealing with direct-coupled circuits, cross-coupled phase splitters, differential amplifiers and push-pull drivers, and balanced primaries. Otherwise it isn't worth it.*

*The asymmetry of amplitude and shape in the scope trace you sent suggest high levels of odd and even harmonic distortion and I'm surprised you can't hear it. I hope this helps.*

## His Master's Voice

Sir:

In ETI Nov/77 issue, an article by Wally Parsons (The First Century) made mention of a poster of Nipper, and the machine he made famous.

I was wondering if you could suggest where I could get one of these posters (in colour if possible), for my music room.

Thank you.

R.G.H., Calgary, Alta.

*I didn't check at the time of the show, but a close look at my original colour slides suggest that this was not a new poster but an early copy of the original. In any case RCA informs me that they have not made posters generally available.*

*However, if you would write to the following address they might be able to help: Public Relations, RCA Ltd., 21001 N. Service Rd., Trans Canada Highway, Ste. Anne de Bellevue, P.Q.*

*Also, the inside liner of "The Worst of Jefferson Airplane" (RCA LSP 4459) has a large reproduction.*

*And, if all else fails, I have several photographs of a large stuffed "Snoopy" in front of one of my 6-foot high Transmission Lines. Looks pretty happy, too.*

## Organ Keyboards

Dear Sirs:

I enjoy your publication very much. I hope you can help me. I am interested in building an electronic piano or organ. Do you know if there are any companies in Canada who carry keyboards or plans, or kits for these projects? I have ordered plans from England (Maplin), however I would very much like to spend my money in Canada.

Thank you.

Ralph Sperry, 11112—134 Ave., Edmonton Alta. T5E 1K4  
P.S. Besides Heathkit

*Amateur organ building is almost a sub-culture in itself, and the only person I know who is involved in it could not come up with a single Canadian manufacturer. If there were any recently, they may have followed the Prime Minister's advice and left the country.*

*One U.S. source is: Devtronix Organ Products, 5872 Amapola Dr., San Jose, CA 95129.*

*There are organ building clubs in existence, and contacting one of them might help. Keep your eyes on our Club News section; as soon as we hear from such a group it will be included.*

*I am publishing your address so that any readers who wish to help may contact you.*

*This would also be a good time to remind potential advertisers that Mr. Sperry is undoubtedly not the only organ buff among ETI readers.*

## Spring Quest

Dear ETI:

I am interested in reverb and echo units. I was wondering if you will be putting any projects related to these areas in any of your future issues. What I am looking for is a method of producing reverb or echo effects. A circuit with component values could be greatly used.

A few companies have advertised springs which, when a signal is passed through them, produce a reverb effect. However, the springs seem to be in short supply as all my efforts to obtain one have been unsuccessful. The suppliers have either not had the springs in stock or they have been discontinued. If you might possibly be able to refer me to a supplier who might have these springs in stock I would greatly appreciate it.

D.A., Stettler, Alta

*Every supplier I know informs me that they are unavailable. Conjecture is that no*

*one is making them any more. This strikes me as a likely explanation. The spring reverb system has usually been a method of accomplishing on the cheap what would ordinarily cost thousands of dollars in studio equipment (At CBC in the early days of television we saved even more by using existing facilities — one of the ladies' washrooms. Sometimes got some interesting sound effects too!). The first one I ever built was plagued by the production of gong-like tones due to poor control of resonance damping, but even after solving these problems, it's not a satisfactory technique unless you spend thousands of dollars in refining it as AKG did with their unit.*

*The preferred approach today is to introduce delay digitally using a Bucket Brigade Device (BBD). A project using this technique is to be found in this issue.*

*Another approach is the Madsen tube, a long hollow tube, coiled up and carefully damped, with an input transducer at one end, and a pickup critically located along its length. If taping early Toscanini 78's is your forte, you might like this, but it's tricky.*

## AUDIO TODAY

Audio Today is ETI's new regular section dealing with news and views on topics ranging from loudspeaker design to audio circuits, from auditory perception to concert hall acoustics, from microphone techniques to designing domestic listening rooms.

If you want to express your views or report on news write to Audio Today, ETI Magazine, Unit Six, 25 Overlea Blvd, Toronto, Ont. M4H 1B1.

**This is easy-  
anyone can solder-  
WITH  
KESTER SOLDER**



**Handymen! Hobbyists!  
DO-IT-YOURSELFERS!**

Let Kester Solder aid you in your home repairs or hobbies. For that household item that needs repairing — a radio, TV, model train, jewelry, appliances, minor electrical repairs, plumbing, etc. — Save money — repair it yourself. Soldering with Kester is a simple, inexpensive way to permanently join two metals.

When you Solder go "First Class" — use Kester Solder.

For valuable soldering information send self-addressed stamped envelope to Kester for a FREE Copy of "Soldering Simplified".

**KESTER SOLDER COMPANY OF CANADA, LTD.**  
Litton P.O. BOX 474 / BRANTFORD, ONTARIO, CANADA N3T 5N9

# MAGNUM INTRODUCES DISCOUNT PRICING!

Effective immediately we are introducing our new Discount Pricing Policy, all merchandise including items listed in this advertisement are discounted by 5% - Quantity Discounts available upon request.

Here's how it works!  
You send in your order in the normal manner, with your cheque or money order, NOT CASH. We send you the merchandise plus MAGNUM DISCOUNT COUPONS equal to 5%



**50¢ MAGNUM electronics inc. 50¢**

72-74 STAFFORD STREET  
TORONTO, ONTARIO, CANADA M6J 2R8  
2 785 c

REDEEMABLE in MERCHANDISE  
REMOUSABLE in MARCHANDISE



value of the merchandise shipped. These new discount coupons can then be used as all or part payment on your next order. So Order NOW and start saving \$\$\$'s with MAGNUMS NEW DISCOUNT COUPONS.

## PRODUCTION LEFTOVERS AT DISCOUNT PRICES!

### RESISTORS FOR P.C. WORK 1/2 Watt 5% .500" spacing 10 of each 25¢

68R	1K2	7K5	47K
100R	1K5	8K2	56K
110R	1K8	10K	62K
120R	2K2	12K	100K
150R	2K7	15K	150K
180R	3K3	18K	180K
560R	3K6	22K	220K
680R	3K9	27K	240K
820R	4K3	33K	270K
1K	5K6	39K	470K

### 1MEG

### 1 Watt 5% .870 spacing 5 of each 20¢

2R2	6K1	1K5	2K2	2K7	3K3
-----	-----	-----	-----	-----	-----

### 5 Watt 10R 10% 2 of each 25¢ - 300R 10%

### 15 Watt 1K5 5% Each 20¢

### Trim pots Vertical P.C. #E097AC 2 pieces - only 50¢

1K / 2K2 / 22K / 47K

\$1.50 ea.	Electrolytic 1000 MFD 50 Volt
\$1.95 ea.	Electrolytic 2500 MFD 60 Volt
\$2.95 ea.	Electrolytic 4000 MFD 80 Volt
\$2.50 ea.	Electrolytic 8000 MFD 25 Volt + can
2 for 49¢	Led Red with 12" Leads
2 for 50¢	Zener Diodes 12 Volt 1 Watt
\$1.00 ea.	Reset - Breakers
	TRIP-AT = 1.6 amp.

### ETI PCBs for recent and current projects

#### including:

"3 Channel Tone Control"	\$4.20
"Digital Thermometer"	\$7.15
"Watchdog" (Both boards)	\$8.40
"Equalizer" (one ch.)	\$9.15
power supply	\$4.20
"Spirit Level"	\$4.90
"Compander"	\$9.95
PA50-4 50D50 Amp	\$6.95

### Precision Controls

4 Section Tandem 25K with Tap	\$3.95
4 Section Tandem Linear 250K	\$2.95
4 Section Tandem Linear 500K	\$2.95
2 Section Tandem 25K with Tap	\$2.50
2 Section Tandem Linear 50K	\$1.50
1 Section Detent Linear 50K	\$ .95

### Thermal Sensor

TO 5 Case Resistance at 25°C Min	
100K Resistance at 57°C Max 100 OAM	\$ .99

### Rotary Switch

Ceramic Plate 4 Pole 6 Position with Ball Detent	\$2.29
--	--------

### Knobs

1 3/4" Dia. 1/4 Flat Shaft Black with Spun Aluminum	.39
1 3/4" Dia. 1/4 Flat Shaft Brown with Spun Aluminum	.35
1 3/4" Dia. 1/4 Flat Shaft Brushed Aluminum	.49
7/8" Dia. 1/4 Flat Shaft Black with Spun Aluminum	.30
7/8" Dia. 1/4 Flat Shaft Brushed Aluminum	.39
5/8" Dia. 1/4 Flat Shaft Black with Spun Aluminum	.30
7/8" Dia. .187 Flat Shaft Black with Spun Aluminum	.30
5/8" Dia. 1/4 Flat Shaft Brown with Brushed Aluminum	.29
3/4" Dia. 1/4 Flat Shaft Black with Indicator and Aluminum Cap	.30
10MM Dia. 3.3 MM Square Shaft Brushed Aluminum	.19

### Reset - Breakers - \$1.00 each

TRIP-AT = 1.6 Amp	TRIP-AT = .2 Amp
TRIP-AT = .3 Amp	

### 50D50 STEREO POWER AMPLIFIER

PA50-1 Amplifier Module 100 Watts RMS (50/50)	\$49.50
PA50-3 Power Supply, Chassis, Mounting Hardware Heat sink	\$78.50
PA50-1 Combined with PA50-3 will make a complete stereo amplifier for	\$128.00
PA50-6 Combines both PA50-1 and PA50-3 completely assembled	\$195.00

### NEW FM TUNER KIT

FM Front End features Bi Polar Transistors IF MODULE

Utilizes the latest technology - ceramic Resonator, Phase Lock Loop-Detection, AGC, AFC, Meter, Hock Provisions  
TOTAL KIT PRICE \$21.95 for FM Front and IF Module

### Also Available

Multiplex Module	\$13.75
Power Supply Kit	\$13.75

### Terminal Strips

3 Terminal	.05
5 Terminal	.08
6 Terminal	.10
8 Terminal	.15

### Screw Terminals

4 Screw Terminal	.20
------------------	-----

### Barrier Terminal Blocks

4 Screw Terminals	.75
AC Chassis Receptacle	.19
Stereo Phone Jacks RCA Phono Jacks	.39
Dual Receptacle	.25
4 Receptacle	.40
5 Receptacle	.50

### Zener Diodes

Miniature Single Ended Electrolytic Capacitors	
1000 MFD 25 Volt	.65
1000 MFD 25 Volt	.50
1000 MFD 16 Volt	.40
100 MFD 35 Volt	.20
4.7 MFD 50 Volt	.10
10 MFD 35 Volt	.10

### MAGNUM electronics

72 Stafford St., Toronto M6J 2R8

Please send me the items listed below and include my MAGNUM Discount Coupons

Quantity	Item	Price	Total
.....	.....	\$. ....	\$. ....
.....	.....	\$. ....	\$. ....
.....	.....	\$. ....	\$. ....
.....	.....	\$. ....	\$. ....
.....	.....	\$. ....	\$. ....

### DO NOT SEND CASH

MINIMUM ORDER \$5.00 - NO C.O.D.'S



Send for your FREE Magnum Catalogue

# MAGNUM

ELECTRONICS INC.

72 Stafford Street, Toronto Ontario M6J 2R8 (416) 364-6754



# Radio Shack TRS-80

---

In the February 1978 issue of ETI we reviewed Commodore's PET system, and we were quite impressed. Radio Shack's TRS 80 aims at a similar market. Mark Czerwinski and Graham Wideman investigate.

---



WE ARE STILL not quite sure whose machine was "pre-hinted" first but the way we heard it, Radio Shack's preliminary announcement about the TRS 80 followed very closely the first words from Commodore on their PET. Is one machine a reaction to the other, or did both companies see the same market area opening up independently? We don't know. One thing is clear however, the two products are vastly different.

## THE MARKET

There must be a lot of people who could be made interested in home computing so long as **no** tinkering was involved. In addition, they are looking for convenience of operation, paying little attention to what is inside the box, but rather are concerned with what it can do.

What then are the characteristics of a machine that will fulfil their needs? It would need to be elementary to put together, include keyboard and video monitor, have built in easy-to-use programming language (such as BASIC) and the facility for long term storage of programs. It would also need to be inexpensive.

Both the PET and TRS 80 are designed on these lines, and it is particularly the built in BASIC that sets them apart from most other home computing systems.

## WHAT YOU GET WITH THE TRS 80

You can buy the package in the various separate units, or as a complete system. Let's suppose you buy the whole lot — what does it include? Out of the big box comes the main keyboard unit which contains the "brains" of the machine. Next there's a Radio Shack cassette recorder for storing data and programs over a long period. The biggest unit is the 12" video monitor included in the system. To complete the system there's a separate power supply to run the electronics.

In addition a comprehensive instruction manual, cassettes, and cables come with the set.

## THE FIRST RUN

Initial set-up is quite easy — simply put all four units on the same table, grab the cables and plug them all together. Three five-pin DIN plugs go

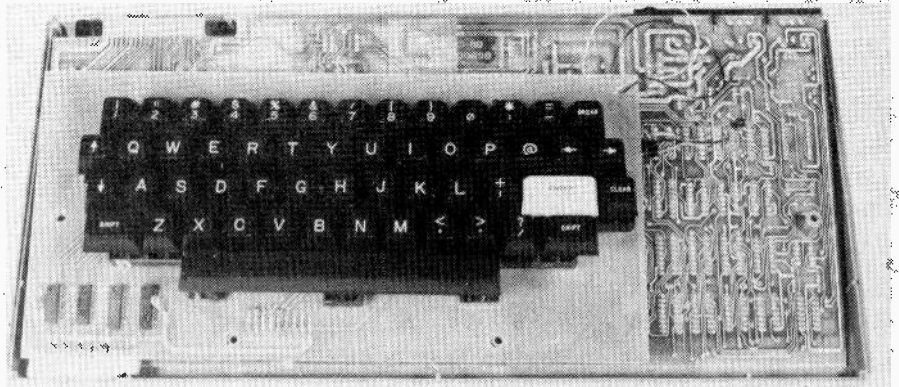
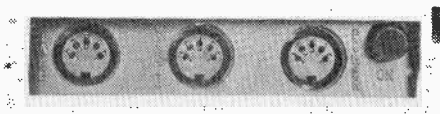

Removal of cover exposes sloping PCBs.

in the back of the keyboard, and they **can** be interchanged — but this does not appear to cause much damage. The sockets are labelled so this should avoid trouble. Plugging into the cassette recorder is less obvious since two of the plugs can be interchanged, with no labelling other than being different colours. Finally, you will have to run out and buy an "octopus" adapter, since there are three power cords to plug in.

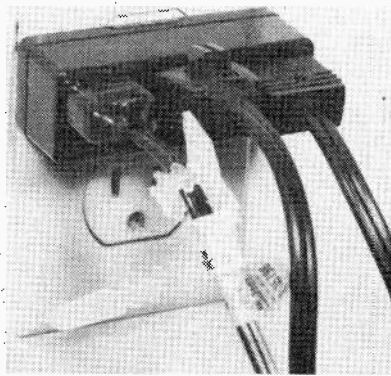

This sounds like a total of many cables running all about. It is.

Now you're ready to go, so on with the two power switches. Your friends are all standing around some eager to play with your new toy, some skeptical of computers, as the screen springs to life with a "READY". Now what? If you're a neophyte programmer you are going to have to reach for the programming manual.

We had very mixed feelings about this 233 page book. It is written in a very friendly, "let's get to know your computer" style as it takes the reader excruciatingly slowly through every nook and cranny of BASIC LEVEL 1.

The manual assumes you know nothing of computers or mathematics — which could get somewhat frustrating.

If you do have some experience you could probably skip straight to 232 — "Summary of Level 1 BASIC," and not miss too much. Refer to the contents to find any section you're not clear on, such as graphics etc.

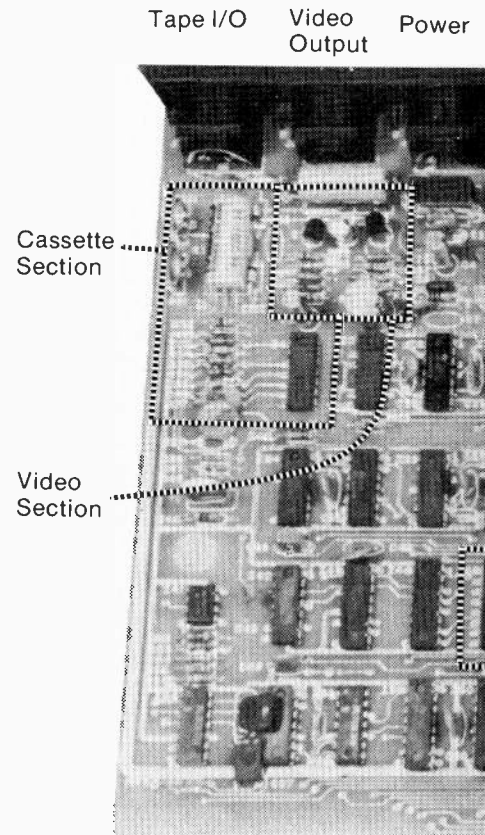

Overview of the main computer board.

In fact, what you'll most likely want to do is discover that CLOAD is the magic word for loading one of the cassette programs included with the set — such as Black Jack or Backgammon. Having thus won over your friends you can sit back and learn BASIC later.

Let's take a look at the hardware and software in more detail.

## HARDWARE

Looking at the total system, there are advantages and disadvantages to having four separate units. The main "pro" is the flexibility of being able to move the keyboard, video monitor and cassette recorder to suit your convenience. On the other hand, having such a multitude of cables and units lying about is a nuisance. A far nicer approach, in our opinion, would have been to combine the cassette deck and power supply in the keyboard box, reducing the packages to two. We suspect that the lack of integration was due to a rush effort in getting the TRS 80 on to the market, an impression supported by various other details.

## KEYBOARD UNIT

The keyboard itself is typical of that used with most hobby computers, fairly reasonable quality and operation. Also contained in this case is the main computer board. On this board are found a Z80 processor, 4K of ROM (BASIC Interpreter etc., see "SOFTWARE"), 4K of dynamic RAM (the Z80 does automatic refresh), and interfaces for keyboard, cassette and video monitor. On board regulation of the power supply is used.

We don't feel that this system would be much fun for hardware enthusiasts. It's difficult to manage when taken apart, the keyboard and main board are attached by an easy to break

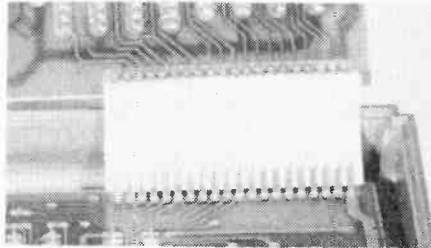

flexible cable with no plug. No I/O ports are on board, which rules out simple add-ons, such as switching

devices on and off, hooking up a speaker, and other popular experiments and applications. The back connector brings out the address, data and control buses. Thus a separate box with interface adapter could be added. Also on this connector are the keyboard lines, which would presumably facilitate adding more keyboards (possible numeric pad) in parallel with the existing one. The keyboard interface is done not with a Peripheral Interface chip as might be expected, but with ordinary buffers and latches, a cheap but less flexible system.

To summarize, this product does not appear to be aimed at the serious hardware person. Add-ons are difficult, although Radio Shack is coming out with an I/O unit. In addition, an S-100 interface is in the works, according to Radio Shack literature. The TRS-80 must then be best suited to software type, keyboard plus video (and later on a printer) applications. The suggested retail price of the keyboard and guts unit plus power supply is \$575.95 Canadian. The system including cassette and monitor is available for \$879.95.

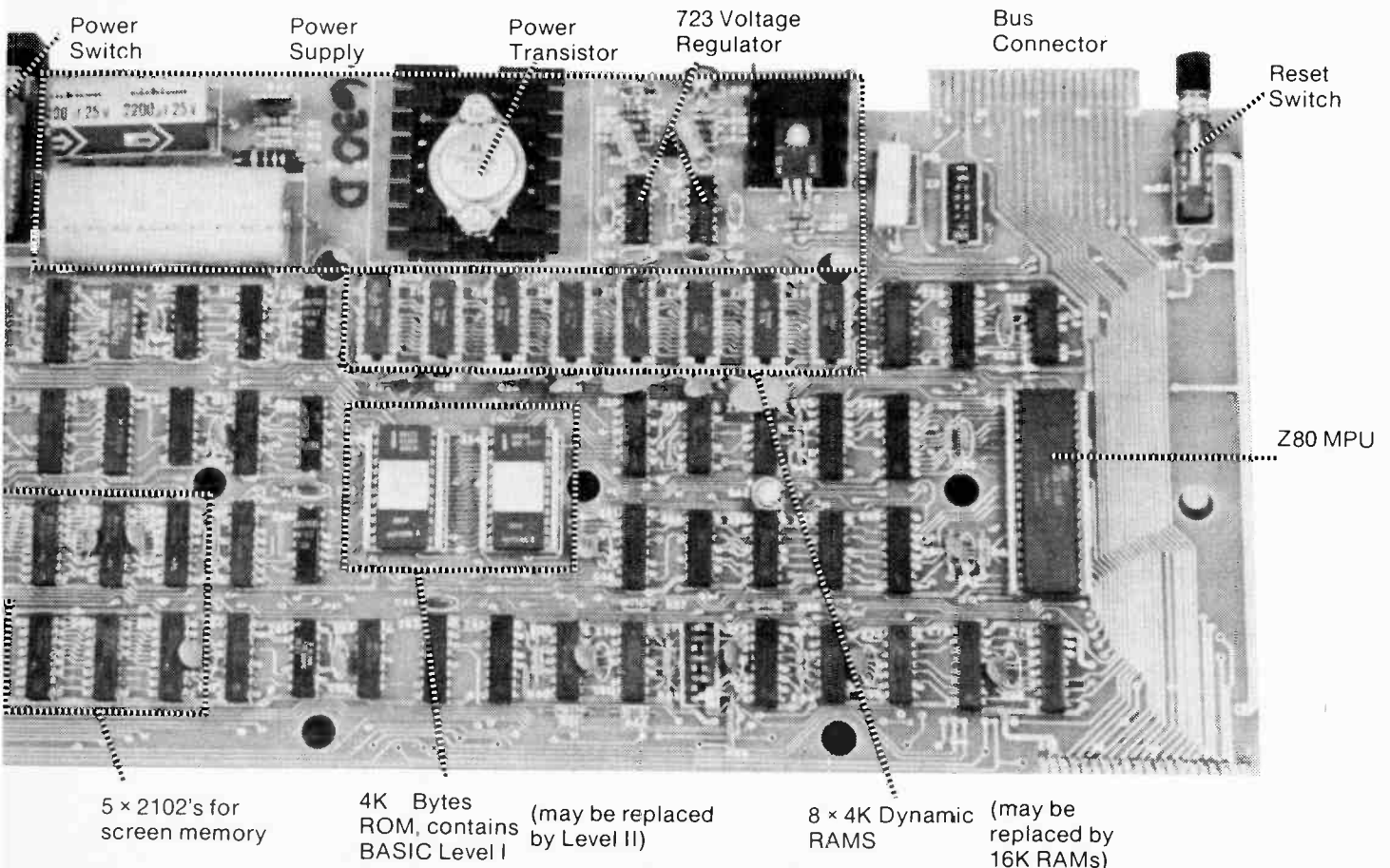



# Radio Shack TRS-80

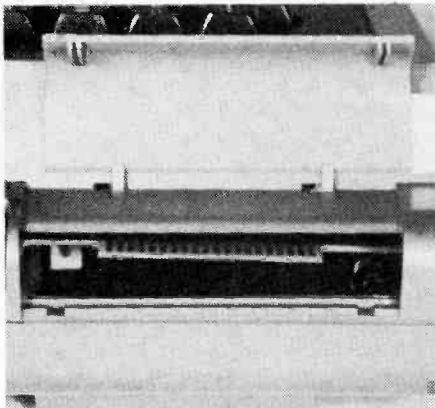

Opening the flap on the back of the keyboard provides access to the expansion connector and reset button.

## CASSETTE STORAGE

Data may be recorded on cassettes by means of the built in cassette interface which converts the data to a series of audio tones. Thus, any reasonable quality cassette recorder will do the trick. In fact, even our \$15 special managed the task, if a little unreliably. The cassette itself should also be fairly good since any tape "drop-outs" mean lost data. Radio Shack plans to introduce high quality five minute-per-side cassettes for this purpose.

The particular recorder recommended for this system, the CTR-41 is one of Radio Shacks better models at \$69.95. Cables from the keyboard connect to the "AUX" input, "EAR" output, and also the remote on/off jack. Thus, when recording or playing cassettes, the operator (you) pushes the desired keys on the recorder and the TRS-80 switches the recorder on and off at appropriate times. You also need to set the volume level when playing back tapes. When recording, a dummy plastic plug must be stuck in the MIC jack to deactivate the built-in condenser microphone. Altogether a bit messy, but it works.

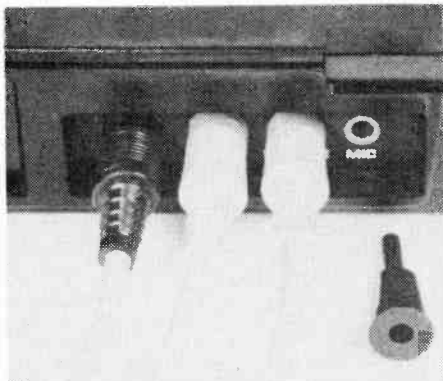

Here's the "Non-Maskable Hardware Microphone Interrupt Unit"

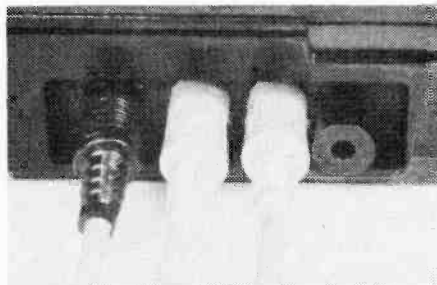

NMHIU shown in place.

## VIDEO DISPLAY

Described as "designed especially for the TRS-80" this monitor displays the 16 lines of 64 characters, or 128 by 48 dot graphics, with reasonable quality on a 12 inch CRT . . . at \$299.95!

Opening up the box to discover what you get at that price — inside there's the equivalent of a portable TV set, minus tuner, IF, sound section and speaker. The circuitry is AC-DC, which is very inexpensive to produce, but requires some kind of isolation between the monitor circuitry and the video output from the keyboard. To achieve this, an opto isolator circuit is included.

Should you happen to be part of the 99% of the population who like to save money — here's how. First, we measured the video output signal, it's a fairly popular arrangement with OV for sync level, 0.6V for black and 2V for white, into 75 ohms. Then you can refer to our January 78 issue to see how to modify your TV to accept video signal input.

Alternatively, you could get hold of an RF modulator (less than \$20) and use your TV without any modifications.

Finally, take a look at our pictures to see what you're getting inside that \$299.95 monitor.

## POWER SUPPLY

A Radio Shack brochure describes this unit as follows: "Important to any computer is a reliable source of pure DC power. This regulated supply converts standard 120VAC house current into the stable direct current required." This appears beside a picture of the TRS 80 system with each unit labelled, including the Power Supply.

In actual fact, the Power Supply unit output is 17V AC. (Regulation is done on the main board) This kind of

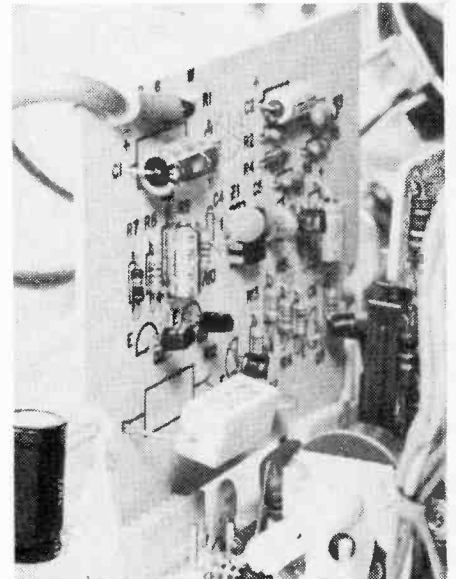

The upright board pictured here is the opto-isolator module, (Isolator in the mini-DIP)

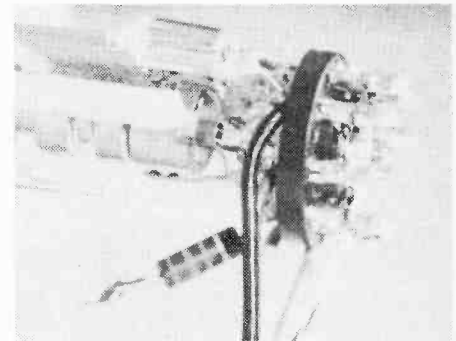

We thought point-to-point wiring was out of date, but point-to-mid-air? This hanging resistor connects to the CRT in the \$299.95 video monitor.

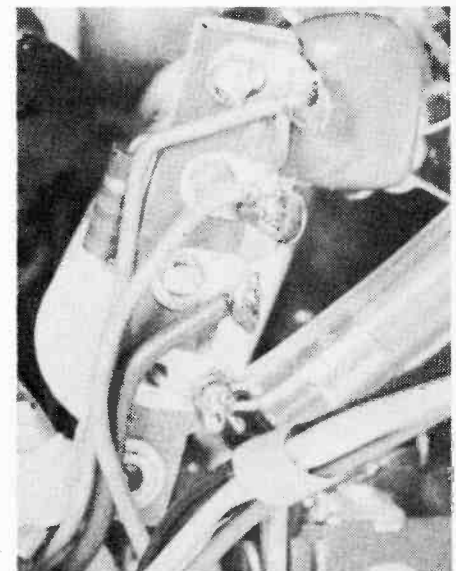

Another example of sloppy construction in the video monitor, tie strip off at an angle and only rivetted at one end. We hope the monitor internals will be cleaned up a bit.

# When I tell you that you can learn TV and audio servicing at home, you don't have to believe me. Believe 60,000 professionals!

**Almost half of North America's professional TV technicians have had home training. And among them, NRI is first choice by more than 3 to 1!**

I'm proud of a record like that. Because it means we're doing the job... helping thousands of ambitious people start rewarding new careers in a field that constantly needs new talent. And we're doing it in a way that works, with NRI's practical, power-on training!

## **Learn by Doing with Exclusive 25" Diagonal Color TV**

Only NRI training gives you the solid bench experience of constructing a 100% solid-state color TV from the ground up. In our Master Course, your theory lessons are reinforced with over 70 power-on experiments you perform as you build your own TV. And you get even more experience as you build and test circuits in our Discovery Lab™ and assemble your own professional working tools, including a 5" triggered sweep oscilloscope, TV pattern generator, transistorized volt-ohm meter, and more. It all adds up to extra experience and confidence.



In addition to NRI's exclusive TV, you also get a designed-for-learning 4-channel audio center, complete with enclosed speakers. Only NRI includes this modern equipment as part of its course. Other schools charge extra or even sell audio training as a separate course.

## **Learn at Home, At Your Own Pace**

In the past 63 years, NRI has taught over a million students in their own homes. Specially designed bite-size lessons concentrate on a single subject at a time to cover it completely and clearly. Our own engineer/instructors back you up with personal counseling and help when and if you need it. You decide how fast you want to progress, learn in your spare time without quitting your present job or going to night school.

The NRI way is the practical way, the professional way because it works. That's why two documented national surveys\* have shown NRI training to be the

overwhelming choice of the pros. And that's why NRI should be your choice, too.

## **Send for Free Catalog, No Salesman Will Call**

If you're interested in this kind of a future for you and your family, send the postage-paid card for a free catalog describing each course and showing the equipment you get. See the opportunities available in TV and audio servicing, CB servicing, aircraft or marine electronics, communications, and other fields. See for yourself why you can believe the pros when they pick NRI 3 to 1! If card has been removed, write to:



John F. Thompson, President  
**NRI Schools**  
McGraw-Hill Center for  
Continuing Education  
330 Progress Avenue  
Scarborough, Ontario M1P 2Z5

\*Summary of survey results on request

® Trademark McGraw-Hill

misleading advertising serves only to confuse the public and increase their distrust of electronics and probably doesn't do Radio Shack any good either.

## FUTURE HARDWARE

The first expansion of a TRS 80 that is possible is the replacement of the 4K RAM chips with 16K chips (\$399.95) (no kidding, it's that easy) and replacement of the 4K ROM, with the Level II BASIC kit contained in 12K ROM (\$159.95 — see "LEVEL II"). We have advanced details on a variety of other add-ons as well.

The key to further expansion is the "Expansion Interface" unit, which comes in its own TRS-80 style plastic box designed to sit under the keyboard. At \$399.95 this unit enables you to add more additional RAM (16 or 32K), dual cassettes, four mini floppy disks and a line printer. It includes a clock, and space for an extra PCB. And guess what, it has a separate power supply, but it has a slot in the back in which to place the power supply, and also the original TRS-80 power supply. The interface requires BASIC Level II.

The Mini Disk unit stores up to 96K bytes, comes with operating system, and for \$799.95 gives you an access time for any single byte of less than half a second.

Two printers are to be available. The "Line Printer" is a modified Centronics dot matrix impact printer capable of up to 110 characters per second and 80 or 132 characters per line, at \$1,899.95. Level II and the interface box are required. On the other hand a "Screen Printer" can be obtained for \$899.95, which according to Radio Shack literature will at the touch of a button reproduce your screen (including graphics) on 5½" electrostatic paper at a rate of 2,200 characters per second!

## SOFTWARE

As a home computer system, the TRS 80 is probably the least hardware oriented. There are two points which support his thinking: you can't get at the internal hardware without voiding the warranty and there is no hardware interface capability other than to the display and the cassette recorder.

So how would you go about evaluating a relatively complex product like this? Probably in the same way as you'd evaluate another type of product which enjoys a high profile at Radio Shack Stores: a home **stereo** system.

In choosing a computer system, the potential customer will be influenced by what he sees (ie: packaging) and by what he can be led to believe about it (by advertising, by friends, by using the system, and even by reading electronics magazines). That customer's attention will be focused on the keyboard and display not on the internals. It won't matter to him that a Z-80 incorporates efficient machine language instructions for data searching and moving or that it's a microprocessor that can run at a 2MHz clock rate. He will be more interested in what it can do as opposed to how it does it (he's buying capability, fun and perhaps even status, not speed).

## A LOOK AT WHAT YOU GET ON THE SOFT SIDE

The TRS 80 comes with "Radio Shack Level 1 BASIC" in 4K ROM. Level I claims to support "standard BASIC statements". But whose standard? It seems to be Radio Shack's since some important capabilities are missing (for example: exponentiation and array dimensioning). All calculations are performed in floating point with 5 or 6 decimal place accuracy. Twenty-six numeric variables are available (A to Z) along with one numeric array variable. Two 16-character string variables can also be used. Actually, these are more properly called "string things", since they cannot be compared, manipulated, indexed or used in any but the most mundane ways. You can input and output using them, but that's all folks.

Cassettes can be used to handle programs (CSAVE and CLOAD commands) or data (PRINT # and INPUT # statements). Since whatever

you have in memory will be wiped out if you cut off the power (intentionally or otherwise), having a cassette recorder to store your information permanently is invaluable. And it makes entering of other people's programs (such as the Backgammon and Blackjack games supplied by Radio Shack) especially convenient.

Speaking of which, the Backgammon game makes extensive use of the TRS 80's rather limited graphics capability: there are virtually no special graphics characters — you've got to construct whatever image you have in mind by turning on some points on the display (48 points vertically by 128 points horizontal). This can be tedious. Mind you, in the low cost home computer system field this is not unusual. To compensate you can write sub-programs which draw vertical and horizontal lines, draw patterns, fill them in etc.

## YOU AND YOUR PROGRAM

Immediately after powering up your display and keyboard, the following will appear:

READY

At this point you can:

- 1) do simple calculator type computations (immediate execution)
- 2) bring in a program from tape.
- 3) type NEW and enter a program

Program statements are preceded by line numbers to distinguish them from immediate execution statements, and keep them in order. A LIST command is available to display the program. Unfortunately the cursor control keys cannot be used to edit this display, so if you want to change a line in a program, you must retype the entire line.

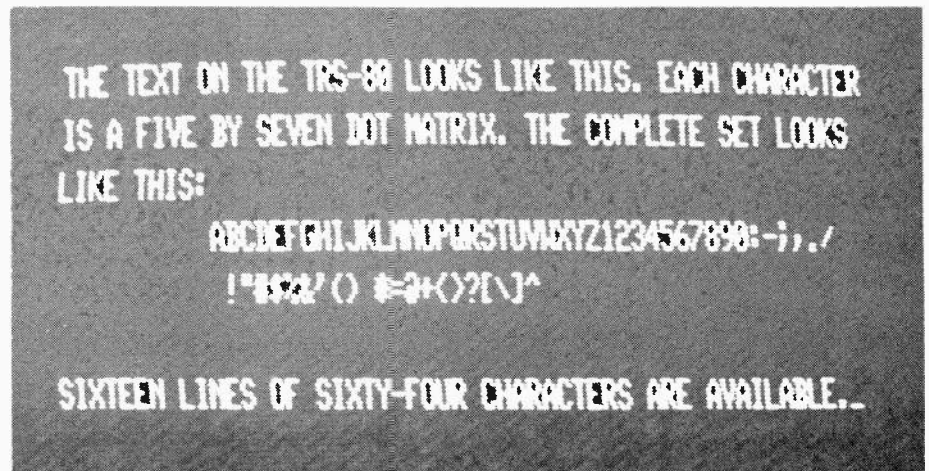

*This is the TRS-80 character set.*

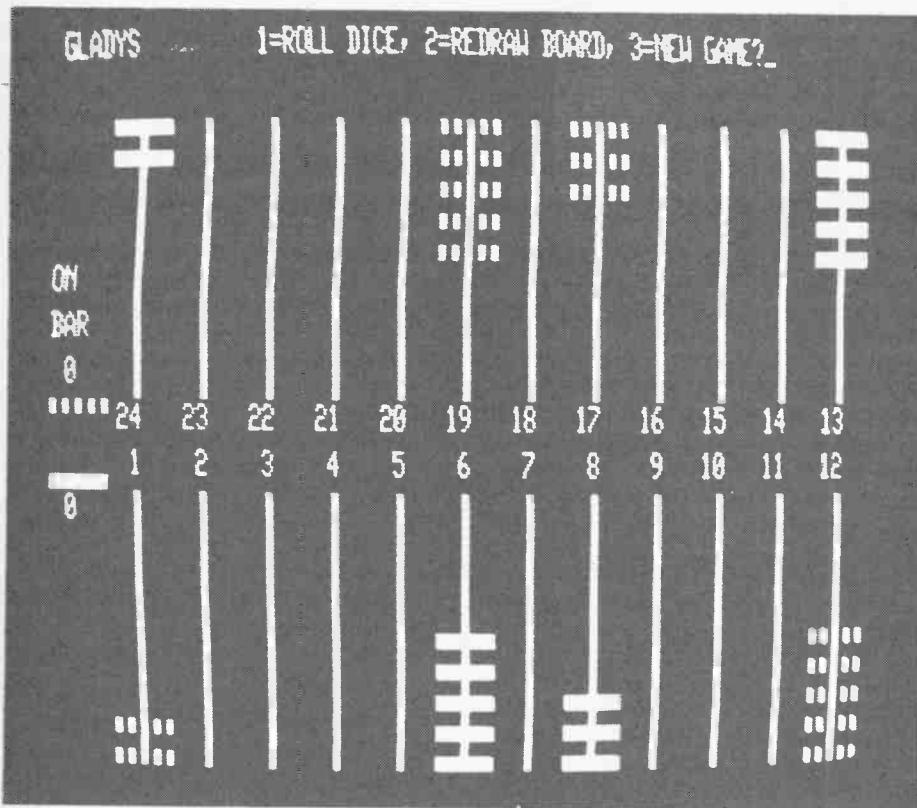

Here's the TRS-80 version of Backgammon.

WITH A BIT OF  
PLAYING ABOUT WE  
DISCOVERED THESE BIG  
LETTERS, ABOUT TWICE  
REGULAR SIZE.

We did it again . . . wonder where those big letters came from?

Output which would otherwise stream by while your program is executing can be frozen by depressing any key. Unfortunately, if you interrupt the program itself, you cannot modify the variables it is using and then return to the point of interruption. So your only alternative is to rerun the program and in many cases, that's a nuisance.

As for error messages, they are confined to: WHAT? HOW? or SORRY (along with an indication of where the problem is). These terse messages are not unexpected when you consider that the interpreter was written to fit into 4K of ROM. In a tradeoff of readability against the amount of program code you can fit into the standard 4K of RAM, Level I has a

"shorthand dialect". For example: G.=GO TO, N.=NEXT, and P.=PRINT. However, REA. seems to be a shortform of dubious value for READ (probably done for consistency).

## MAKE IT FIT

The overriding philosophy controlling the design of this interpreter seems to have been "make it fit". It's hard to believe that a 4K interpreter is anything but "stripped down" after you've used this one. Radio Shack has dropped a few hints about releasing a Level II BASIC. Until then it is unfair to compare this software package with, say, the 14K monitor/interpreter that comes in Commodore's PET. They're just not in the same leagues.

At the same time, it is somewhat unrealistic (no pun intended) for Radio Shack to claim, as they have in their sales literature, that "applications of the TRS 80 are limited only by the imagination and ability to write programs". Try something quite unimaginative like sorting a list of names. Good luck! You'll need it.

## LEVEL II

Sketchy details are available on Level II BASIC, an interpreter written by Microsoft. From the list of statements and functions to be available, it appears that this version of BASIC is at least as powerful as PET's including many editing features. In fact we would go so far as to say that Level II is the most significant upgrade for the TRS-80. We wonder how logical it is to sell a home computer with such a limited BASIC and then offer the upgrade as an option. Will this turn people off computing, or will most of them jump for BASIC II anyway? At the time of writing it was expected that Level II would be available after March '78.

## OVERALL IMPRESSION

Firstly, we were not nearly so impressed with this machine as with the PET, and for the same price range we should have been. Lack of hardware access, and software which is primitive, combined to make it a less attractive product to anybody with even a little experience in home (or for that matter any) computers.

In our opinion, to have a satisfactory computing machine, one needs the "optional" Level II BASIC. The cost of this system would then be \$1,039.90 (\$879.95 for TRS-80 plus monitor and cassette recorder plus \$159.95 for Level II). This machine would compare very favourably on a software application basis with the 4K PET. But you still don't have any hardware interface capability, something which ups the system cost to \$1,439.85.

The end result is that if you're in the market for a machine like this you should look very carefully at what you need and what you can get for the money.

Any guesses on where we'll be with systems like these 20 years from now? Buy yours now — in 20 years they'll be collectors' items.



# Fast Fourier Transforms

You may have heard of Fourier Analysis, but more often than not explanations of what this is all about are drowned in mathematics. E.J. Hughson describes how it's done electronically.

MUCH OF ELECTRONICS is concerned with the processing of signals of some sort or another. It is only natural then, that a lot of effort has gone into analysing these signals. On one hand one must know certain basic things about the signals in order to be able to build useful circuits. On the other hand, investigating signal properties with no particular applications in mind, has led to various useful results that later helped to simplify, improve or introduce new circuit designs. The field of study concerning signals is known, naturally enough, as "Signal Analysis".

In order to go deeply into some of the theory in this field, some pretty heavy math must be employed. However, it is quite easy to understand the majority of the material intuitively, and besides, that's a much more entertaining approach.

## THINK OF A SIGNAL . . .

How do most of us think of signals? Probably "signals" conjures up images of a scope with a waveform on it. Let's use this waveform as an example — suppose it's a 1KHz triangle wave. What characteristics does this waveform have? It is a voltage (say) varying up and down periodically, thus it has an "instantaneous amplitude" at each instant in time. This is what we see on the scope, an amplitude versus time graph. We can also say that the waveform has a characteristic we call frequency. Most of us use the term frequency to mean the basic frequency of repetition of the entire waveform. Why this distinction? Here's where a theoretical concept must be just accepted if we're not to get submerged in abstraction.

## FOURIER ANALYSIS

It is convenient to think of a **sine** wave as the "purest" waveform, and use this kind of wave as a basis for study of other waveforms. It has been found possible to make any other kind of waveform from a combination (sum) of sinusoidal waves of various frequencies and amplitudes. This is analogous to being able to combine the three basic colours of light, green, red, blue to form other colours.

In fact we have cheated a little bit, we should correct the above to say that any kind of waveform can be made from combinations of **sine and cosine** waves of various frequencies and amplitudes, a cosine wave being simply a sine wave but one quarter wave ahead.

Ok, so what? The next step is to introduce a graph of amplitude versus frequency. Figure 2 is an example in which we plot the "frequency content" of a sine wave of amplitude 1 and frequency 1KHz. There is only one point on the graph, because as we said before, a sine wave is considered to be "pure" or only one frequency.

So how about our triangle wave? What does its frequency content look like? Figure 3 shows that the frequency content is quite complex.

The graph shows that there is a large content of the fundamental frequency, with decreasing content of odd order harmonics.

The process of converting the "time" waveform to the "frequency" graph is called the Fourier Transform. The reverse process is called the Inverse Fourier Transform.

In the case of a repetitive waveform (such as the triangle wave) the Fourier Transform yields a frequency content graph which has non-zero points only

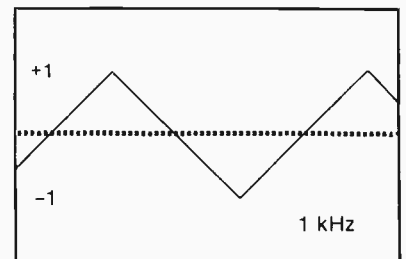

Fig. 1. Scope trace showing triangle wave

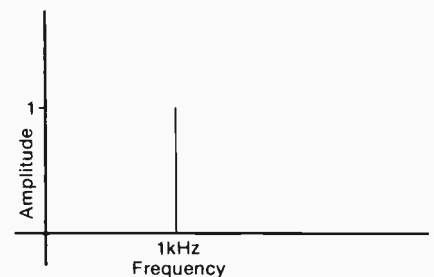

Fig. 2. Amplitude vs. frequency plot of 1KHz sine wave

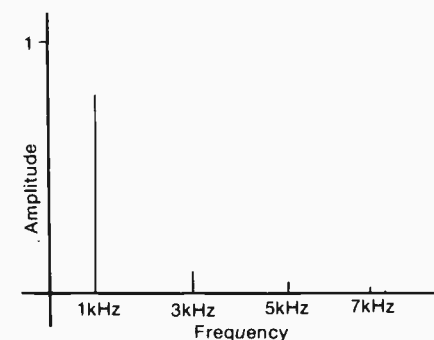

Fig. 3. Amplitude vs. frequency plot for triangle wave.

at multiples of the fundamental frequency. Thus, a series of numbers may be used rather than a graph to represent this information. For the triangle wave, the series is:

$$.81 \times (1\text{kHz sine}) - .09 \times (3\text{kHz sine}) + .032 \times (5\text{kHz sine}) - .017 \times (7\text{kHz sine}) + \dots$$

For a 1KHz,  $\pm 1\text{V}$  square wave the series is:

$$1.27 \times (1\text{kHz sine}) + .424 \times (3\text{kHz sine}) + .255 \times (5\text{ kHz sine}) + \dots$$

On the other hand, you are no doubt already familiar with frequency plots of noise, and particularly audio equipment response curves, which are nothing more than the frequency content graphs of the output with "all frequencies" fed in. (Fig. 4.) Note that the frequency plots in this example are continuous rather than just the odd point here and there.

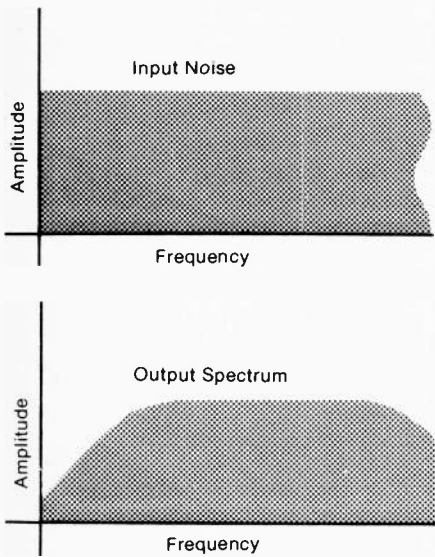

Fig. 4. Noisy amplitude vs. frequency spectra

because it is a series of separate points and time series because we have something changing with time. Figure 6 shows a sampled sine wave displayed on an oscilloscope.

If we were to measure the level of each of the points we would get a series of numbers. If we do this electronically using analog-to-digital conversion we get a series of digital numbers representing the discrete time series. OK so far? It is this set of digital samples which a Fourier Transform (or "Discrete" FT in this case) takes and turns into information directly showing the frequency or harmonic content of all signals which make up the original time series. The technique shows any components from DC to half the sampling frequency. (It is not possible to obtain any frequencies higher than this since it would contradict a fundamental rule concerning sampled waveforms, established by Nyquist.)

## ADDING NEW FREQUENCIES AND FILTERING

If the output numbers undergo an inverse DFT we get a series of numbers outputted which represent the original waveform.

By taking a waveform and analysing it using a DFT, then performing an inverse DFT on the output we can arrive back at the original waveform. A filter can be made by performing an inverse DFT only on those numbers representing the frequencies which are required.

Similarly, by adding numbers to represent new frequencies before performing an inverse transform extra frequencies will be present in the output time series (and after digital-analog conversion, in the output waveform).

The DFT does not work on analog or continuous information: only on a set of numbers representing the instantaneous values of a portion of a waveform. The result is a set of numbers corresponding to the frequency content of the waveform. Not only does DFT give us each frequency present in the original waveform, it also gives the relative phase and amplitude of each frequency component.

By performing a power calculation on the output frequencies a power spectrum may be obtained. Of course the more numbers or samples which are input to the DFT, the more information is available at the output. However, for a fixed set of numbers inputted, a fixed set of numbers is outputted.

## INTERPRETING THE NUMBERS ON THE OUTPUT

To illustrate how outputted numbers are interpreted consider a DFT performed on a portion of a time series containing 1000 samples. The 1000 numbers inputted will have various arithmetic operations performed on them and 1000 numbers (known as frequency cells) will be outputted. Of these 1000 cells only the first 500,

## DOING IT

A picture of actually doing the transform is shown in Fig. 5. The "transformer" could be a person with a piece of paper working out the graph or more usefully a machine doing the work. Suppose a computer was used to do the task on an input waveform, how would it do it?

## AUTOMATIC TRANSFORM

If an analog waveform is sampled at regular intervals, we get what is called a discrete time series — discrete

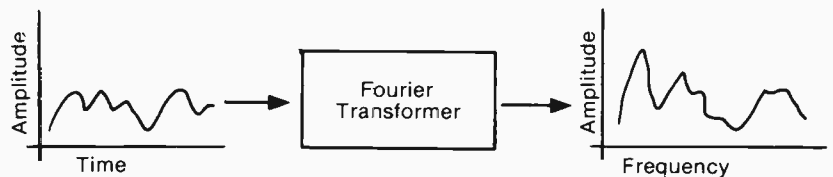

Fig. 5. The transform process

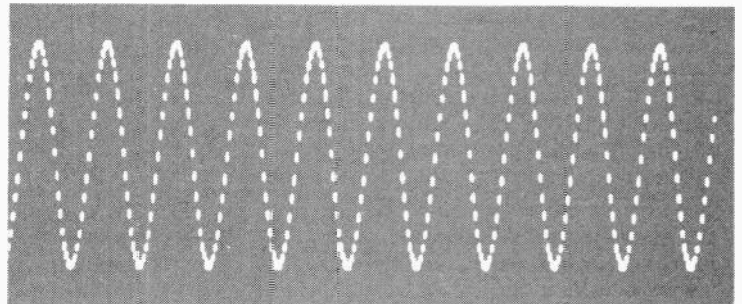

Fig. 6. Analog sine wave sampled at intervals

representing the frequency range, will have any real meaning.

For example, suppose all input numbers representing samples from an analog-to-digital converter are the same. (This would mean that a DC voltage would have had to have been applied to the converter.) Of the 1000 numbers obtained by the forward transform, only the first would have a value other than zero, since this first number is reserved for the DC content of the input series and all the energy of the input is in form of DC. (See Fig 7a)

Suppose now the output of an analog-to-digital converter is being sampled at 1000 samples/sec, also suppose a sine wave of 1 Hz is applied to the input of the converter. One thousand numerical samples or one second's worth of data is collected. If these 1000 numbers are used as the input of a Fourier Transform, then of the 500 numbers output, the first will have zero value (DC) but the second, reserved for frequency of 1 Hz, will have maximum value (Fig 7b). All others will have zero value also.

If the frequency of the sine wave inputted to the converter is now increased to 2 Hz, and the 1000 samples at 1000/sec are collected, the Fourier Transform processor output will consist of zeroes in all 500 numbers except the third corresponding to 2 Hz (Fig 7c). The output numbers, are the cells, cell 0 to cell 499 in this case being reserved for frequencies of 0 (DC) to 499 Hz. Figure 7 gives a graphic representation of these inputs and outputs. (NB, since the output cells are numbered starting from zero so also are the input samples, for clarity.)

## CELL NUMBER AND FREQUENCY

The example given above assumes a sampling frequency of one thousand per second so that with a 1000 point transformer the cell numbers automatically correspond to the frequencies they represent in the input time series. It is of course, not always practical to have the sampling frequency tied to the number of samples in the DFT as rigorously as this. But it is a very simple matter obtain the actual frequency to which a cell output corresponds. This is obtained by the following relationship:

Frequency corresponding to Cell Number (1st cell = 0)

$$= \frac{\text{Cell No.} \times \text{Sampling Frequency}}{\text{No. of points in FFT}}$$

The outputs depicted by Figure 7 are of course idealized. In practice slight errors will occur due to the finite number of bits used in the arithmetic of the calculation.

As so far discussed, the Discrete Fourier Transform both forward and reverse has been put in terms of numbers which are inputted, the calculation process and numbers outputted. The calculation process is very involved and tedious but could be carried out by a computer or even a hand calculator (if you had the time and patience). To perform a 1000 point transform, it would require over 2 million discrete calculations, tedious indeed!

## FAST TRANSFORM

The Fast Fourier Transform technique is able to reduce the calculations of a similar size transform to about 22,000 which is a significant reduction in the number of calculations and hence the amount of computer time. (Still a little much for the average pocket calculator, however!) So although digital computers can be used to obtain the results of FFTs under the control of a program, the amount of time needed to load the samples into the machine, to access and compute the data and to output the results makes even a general purpose digital computer an impractical signal analyser.

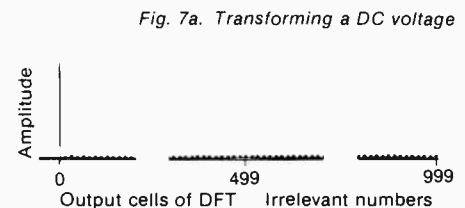
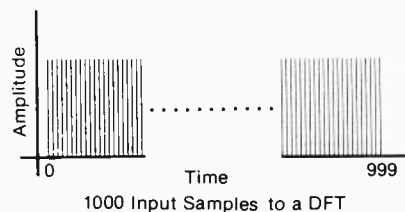

Fig. 7a. Transforming a DC voltage

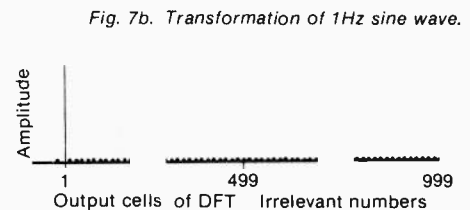
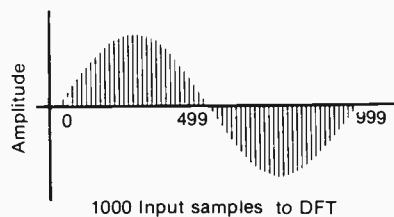

Fig. 7b. Transformation of 1Hz sine wave.

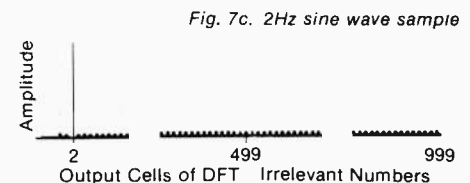
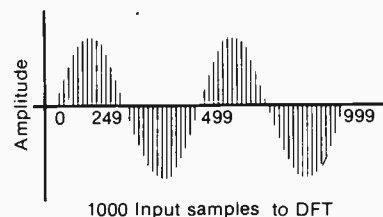

Fig. 7c. 2Hz sine wave sample

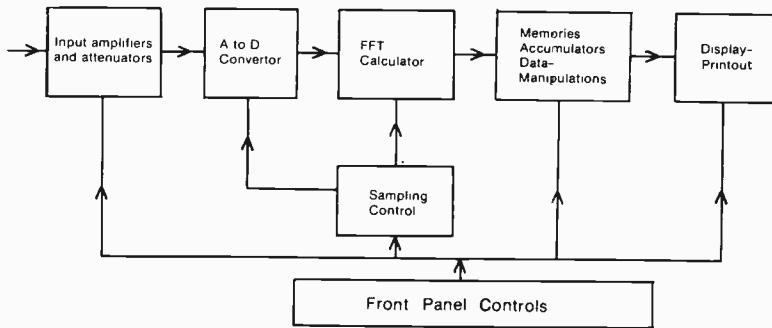

Fig. 8. Typical FFT Analyser basic functions

amplitude graduations and the two lines represent the energy in the cells corresponding to the frequencies of the 2 sine waves. (Note no other lines appear as all other cell values are zero). The display is produced by continuously outputting the cell numbers from the FFT result to a digital-to-analog converter and including the amplitude graduations.

## THE MATHEMATICS

This article is not the place to consider the in depth mathematical theory necessary to fully understand the processes which form part of the Fourier transform. Numerous books

and technical articles now exist on the subject. However the basic operation and its adaptability to digital hardware is quite easily understood.

One major constraint on an FFT processor is that the number of samples inputted to it cannot be varied completely. With most processors, the number of samples in fact have to be a power of 2, e.g., 32 or 64 or 256 or 1024. The more samples taken then the larger the range of frequencies which can be determined or alternatively the narrower the band width between cells. However, the calculation process takes longer. In practice sample blocks of 512, 1024, 2048 are amongst the most commonly chosen as these offer a compromise between frequency range and computation time.

Essentially in the case of a Forward Transform the samples from the time

series are loaded into a buffer and combinations of samples are added and subtracted from each other, multiplied by trigonometrical values usually looked up from a Read Only Memory. This process is repeated using different combinations of samples and trigonometrical values. The number of processing stages is related to the number of samples, eg, if 2048 samples were inputted, then 11 processing stages are needed. ( $2^{11}=2048$ ). If 512 samples were inputted, then 9 stages are required, etc. This is illustrated in outline by Fig. 10.

The advantage over the old 'conventional' method of computation is that with the conventional method the number of stages of calculation equals the number of samples. In a 512 point transform the process would be 512/9 or approximately fifty-five times shorter by using an FFT. In a continuous process where FFTs are being continuously computed, obviously a very real saving is made in terms of result presentation.

As mentioned earlier the FFT processing idea lends itself very easily to a dedicated machine and the idea of pipeline processing is used in most of these. Pipeline processing is used where a number of calculations in series are performed and where an unacceptably long delay results for the

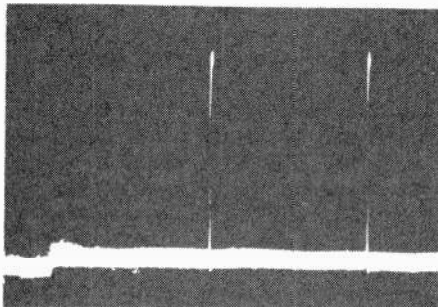

Displayed FFT output with two cells only present, corresponding to the series input. Note lines are same height and the second twice as far from zero frequency as the first.

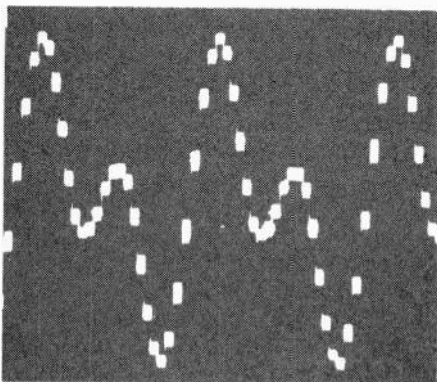

Original sampled time series — two sine waves with one twice the frequency of the other, both same amplitude.

Fig. 9. Actual inputs and output of a FFT processor

Fig. 10. FFT Processing stages for 512 point transform

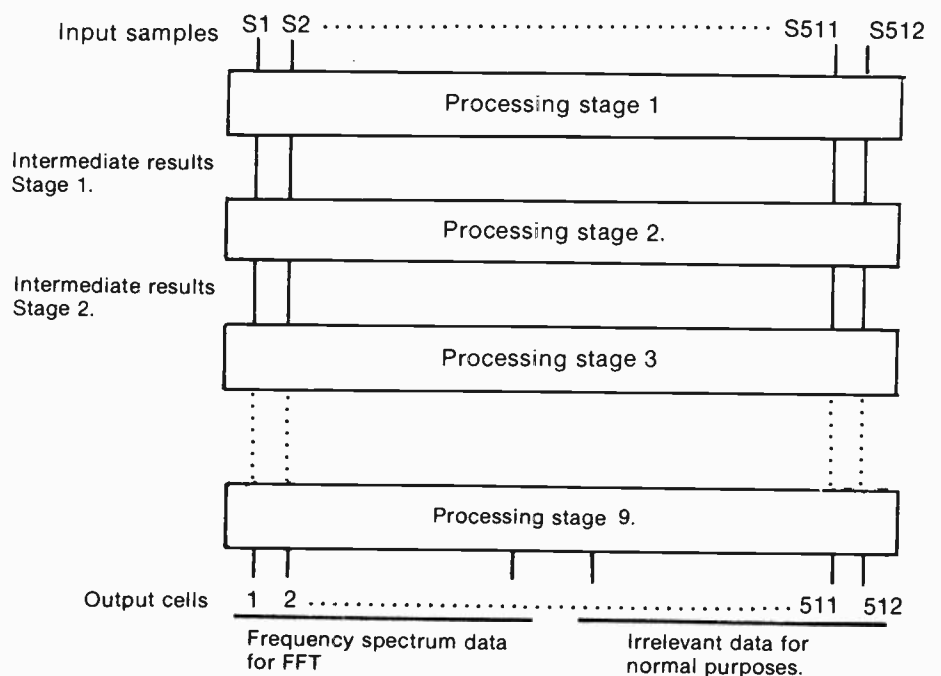



# Fast Fourier Transforms

computing of an answer before the next inputs are applied. Figure 11 shows an arrangement where this is likely to happen.

In this example an adder precedes a multiplier followed by another adder. With no pipelining, no further inputs can be supplied until enough time is allowed for the results of previous input numbers to be stored away. However with a pipeline processor, (Fig. 12) latches are included in strategic places allowing sets of numbers to follow each other as though they were coming down a pipe. Thus after the first set of results have trickled through the latches, a much

faster throughput of numbers will result.

This type of arrangement is very suitable in FFT processors since a large throughput of samples with much number crunching takes place.

## PRESENT & FUTURE FFT ANALYSERS

Essentially an FFT processor (which is the heart of modern spectrum analysers, voice print identifiers, etc) usually consist of a memory which stores the samples and intermediate results and a processor which computes intermediate results. The total samples are stored internally in

the memory and when the FFT process begins, the samples are taken in pairs, arithmetically operated on to form intermediate results and stored ready for the next level of processing. Two memories are sometimes used where samples and results are alternately read from one memory through the pipeline processor into the other memory, where they are ready for the next level of processing. This technique saves still more time in computing FFTs. See Figure 13.

This article has only touched onto the now very broad field of FFT processing technology. The approach lends itself easily to band shifting, frequency zoom effects and other features made relatively easy with a digital system.

Until the 1970s few people knew of Fourier Transforms. At best the term would evoke a feeling of something obscure, very mathematical and having few, if any practical applications. But in recent years a whole new world of applications has been unleashed.

FFT techniques are today used for a variety of applications including

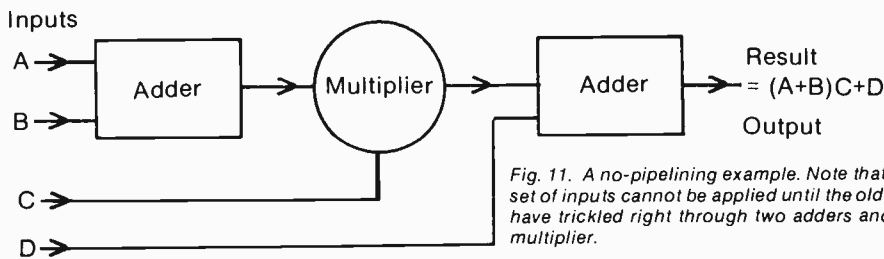

Fig. 12. Pipelining arrangement, here new inputs can be applied after only one adder's delay. After initial trickle-through processing speed is much better.

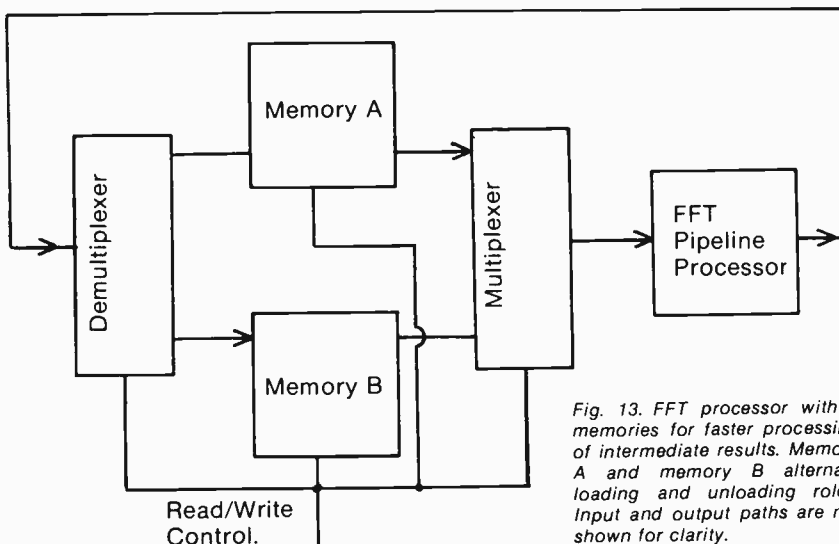
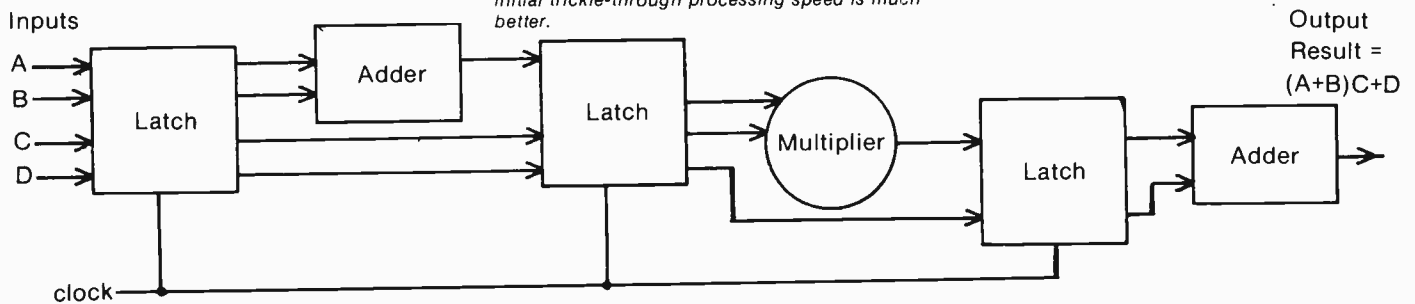

Fig. 13. FFT processor with 2 memories for faster processing of intermediate results. Memory A and memory B alternate loading and unloading roles. Input and output paths are not shown for clarity.

extraction of signals buried deep in noise, sonar processing, spectrum analysis of complex waveforms, voice print analysis and the digital synthesis of music. Research is finding still more uses, such as in the oral synthesizing interface of talking computers. Some day you may be able to phone a computer and hold an intelligent conversation with it, obtaining such things as account balances, travel reservations, etc, with tonal expressions no different from those of a helpful person!

With the advent of bubble memories and the ever decreasing size but increasing complexity of micro circuits, it appears that the FFT processing field will expand to a point where it will soon be a part of every day life, a truly big step forward from just 10 years ago when the technique was not even heard of.

# Announcing

A new concept  
in electronic  
equipment sales

Come and:

- Compare features
- Compare prices
- Choose the unit that's right for you

ACA  
ELECTRONIC  
CENTRES

The new ACA Electronic Centres will carry inventory of popular models of digital multimeters, oscilloscopes, power supplies, and other electronic test equipment.



Visit the Showroom  
nearest you

**Toronto:**  
6503 Northam Drive, Mississauga 416/678-1500

**Calgary:**  
2280-39th Ave., N.E., Calgary 403/276-9658

**Vancouver:**  
116 East 3rd Street, Suite 203, North Vancouver 604/980-4831

**Montreal:**  
1330 Marie Victorin Blvd., Longueuil 514/670-1212  
(Limited stock)

#### Service

All warranty and after  
warranty service performed in  
Canada.

**Allan Crawford Associates Ltd.**



TORONTO MONTREAL VANCOUVER OTTAWA CALGARY HALIFAX  
416/678-1500 514/670-1212 604/980-4831 613/829-9651 403/276-9658 902/469-7865

INSTRUMENT DIVISION, SCIENTIFIC/ MEDICAL DIVISION,  
SPECIAL PRODUCTS DIVISION

We accept: *Chargex-Visa and Master Charge*

#### Mail Orders

Clip and mail this coupon today for your free  
mail order catalog. Mail to: ACA Electronic  
Centres, 6503 Northam Drive, Mississauga,  
Ontario L4V 1J2

NAME \_\_\_\_\_

ADDRESS \_\_\_\_\_

CITY \_\_\_\_\_

PROV \_\_\_\_\_ POSTAL CODE \_\_\_\_\_

ETI 478

# Microcomputer Power Supply

This supply has been specifically designed to power S100 (Altair and IMSAI type) computer systems. You can modify it to suit your applications.

ALTAIR/IMSAI TYPE microcomputers which use the Altair, or S100, bus use separate cards for the CPU, memory, I/O and special functions. These 250 x 130 mm (approx.) cards each have on-board regulators to reduce cost by not requiring expensive high current regulation and b) avoid the damage which would be caused by catastrophic failure of such a regulator. With the on-board regulator scheme, if a regulator fails, damage is limited to one board.

S100 cards require three supply voltages; 8 V which provides the 5 V supply, +16 V which is regulated to 12 V to supply some MOS and linear IC's and -16 V for a -12 V supply to accommodate MOS substrate bias and op-amps. Although early Altairs had problems with an 8 V 8 A supply, the power consumption of memory has dropped considerably since then, and the 28 A supply of the IMSAI may be viewed as a slight over-reaction.

If the 16 V secondaries are not loaded, this supply can give up to 10 A at 7 V, though the transformer must be adequately ventilated — this is sailing rather close to the wind. We have used a pre-regulator to avoid problems with the output voltage rising too high on light loads. A side benefit of the SCR regulator is the provision of a 120 Hz sync pulse which can be used as a Real Time Clock.

## SPECIFICATIONS

<b>Nominal outputs</b>	+8 V @ 7.5 A +16 V @ 750 mA -16 V @ 750 mA
<b>Actual output voltages</b> @ full load, 120 V input	+7.5 V +15.3 V -16.2 V
<b>Regulation</b>	
+8 V output, 0 - 7.5 A	100 mV
+16 V output, 0 - 750 mA	1.5 V
-16 V output, 0 - 750 mA	1.5 V
<b>Ripple voltage</b>	
@ full load +8 V	0.7 V p - p
+16 V	1.0 V p - p
-16 V	1.0 V p - p

## DESIGN FEATURES

We initially had the transformer designed to give the required output voltage at full load but the moment we removed the load we knew that either a pre-regulator was needed or a much larger transformer to keep the voltage between the limits. Cost ruled out the larger transformer so that left the regulator.

We first designed a series regulator but due to the additional losses involved (a total of about 20 watts at 10A output) this was ruled out. The SCR (silicon controlled rectifier) regulator was chosen as it has very little extra power loss compared to a straight rectified supply. As high regulation is not

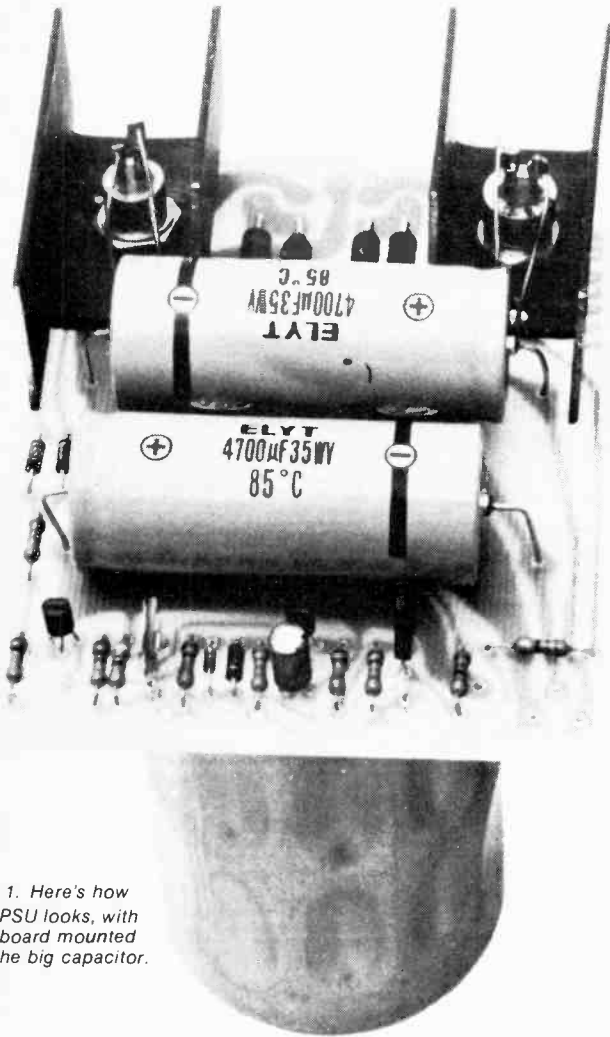

Fig. 1. Here's how the PSU looks, with the board mounted on the big capacitor.

needed we used a simple circuit without the usual choke associated with this type of regulator. Even so the output is maintained to approximately 1/2 volt over the load range.

## CONSTRUCTION

Mount all the components except the transformer onto the printed circuit board. Due to the size of the main filter capacitor, the PC board is mounted directly to it. The capacitor is then bolted to the chassis by its clamp. When mounting the capacitor ensure that the tracks on the PC board are clean or tinned, preferably use the star type lock washers between the board and the capacitor.

The SCRs must have heatsinks fitted, the ones shown are the minimum recommended. Alternatively a separate heatsink could be used. Remember that the currents are fairly high (peak currents around 40A in SCRs) and the cables used should be an appropriate size.

If the unit is to be used continuously at full load in an enclosure adequate ventilation must be provided.

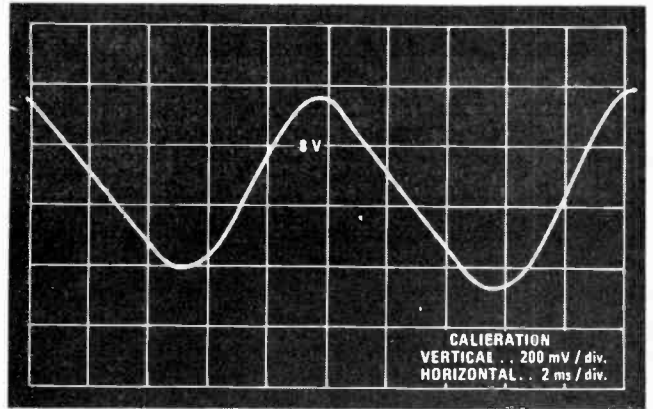

Fig. 2a. Ripple voltage on 8 volt output at 7.5 amps.

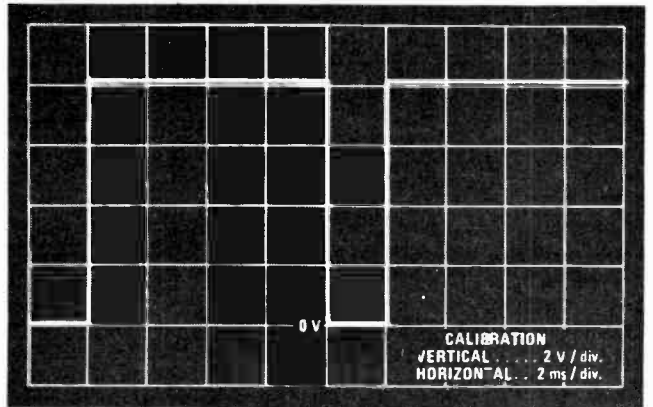

Fig. 2b. Sync pulse output.

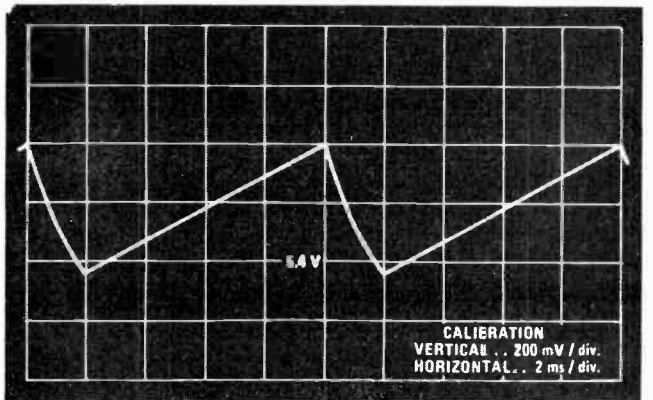

Fig. 2c. Waveform on the base of Q2.

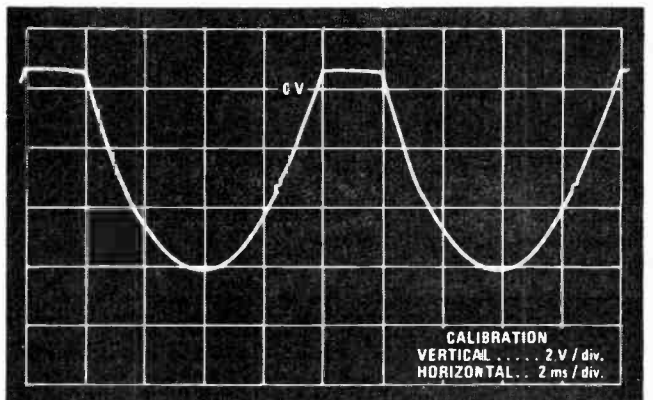
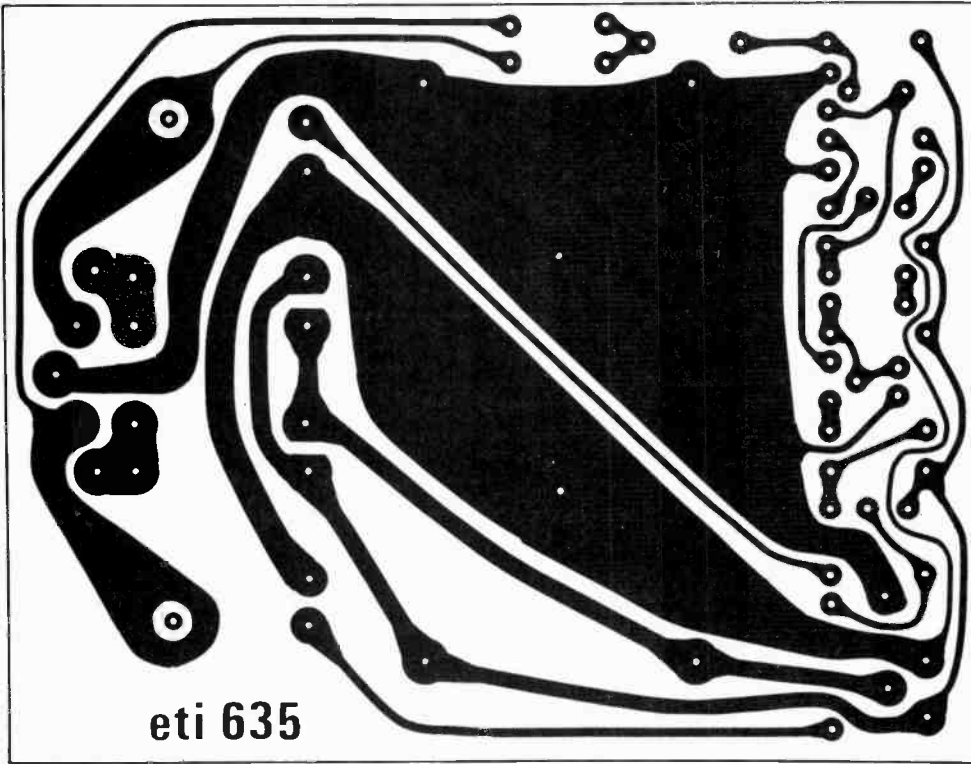

Fig. 2d. Waveform on the base of Q3.



Fig. 3. Printed circuit layout. Full size 130 x 100 mm.



## PARTS LIST

RESISTORS all 1/4W 5% unless otherwise marked

R1, 2	220
R3	100
R4	470
R5, 6	10k
R7	2k2
R8	22k
R9,10	10k

POTENTIOMETER  
RV1 500 trim

CAPACITORS

C1, 2	4700 $\mu$ 35V electro
C3	68000u (or more) 16V Philips or Mallory etc
C4	10u 25V electro.

SEMICONDUCTORS

Q1	T1P30C
Q2, 3	2N3904
ZD1	5.1V Zener 300mW
DI-D4	1N5404
D5, 6	1N4004
D7	1N914
SCR1,2	20A SCR

MISCELLANEOUS  
PC board ETI 635

TRANSFORMER  
For 8V supply — 18Vct @ 5A  
For 16V supply — 30Vct @ 1A  
Hammond Mfg supplies suitable types.

Fig. 4. Component overlay of the power supply. Note that capacitor C3 is bolted onto the copper side of the board.

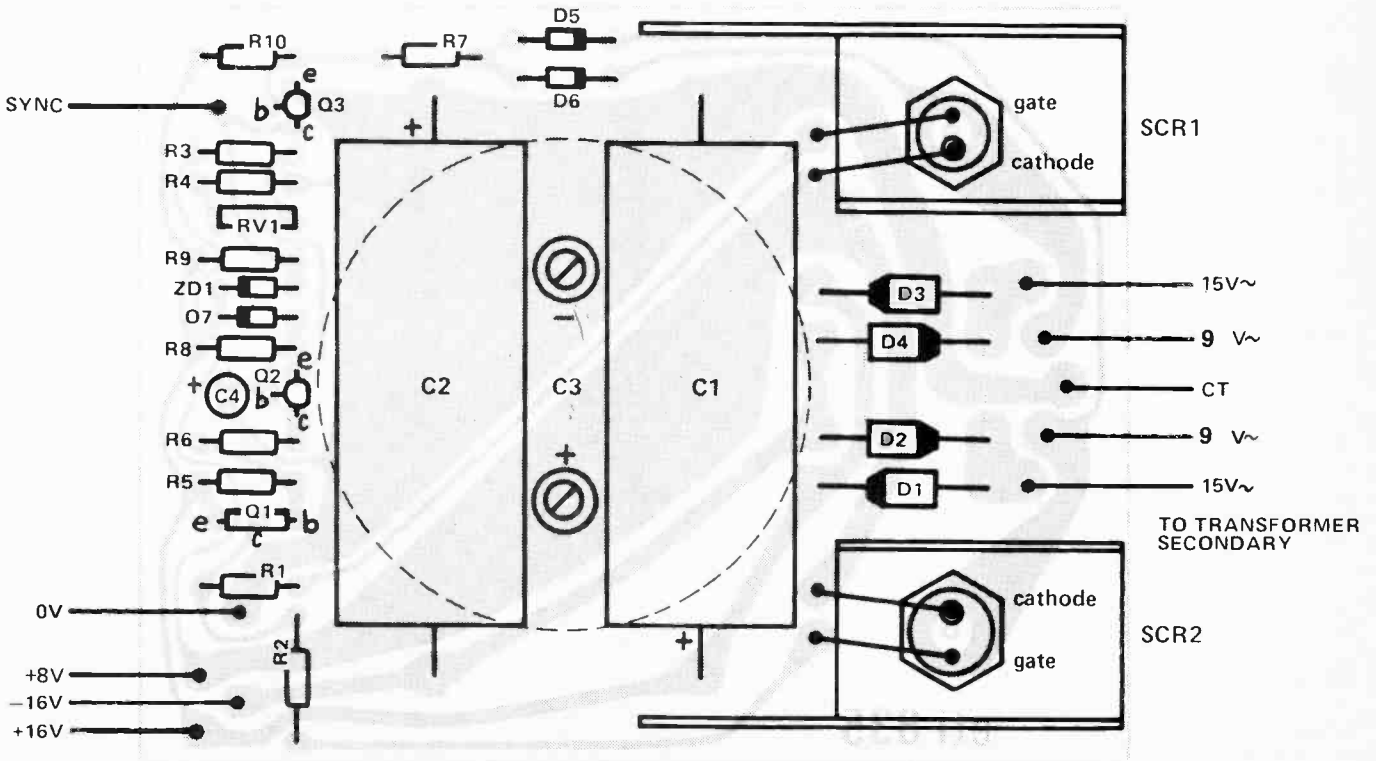

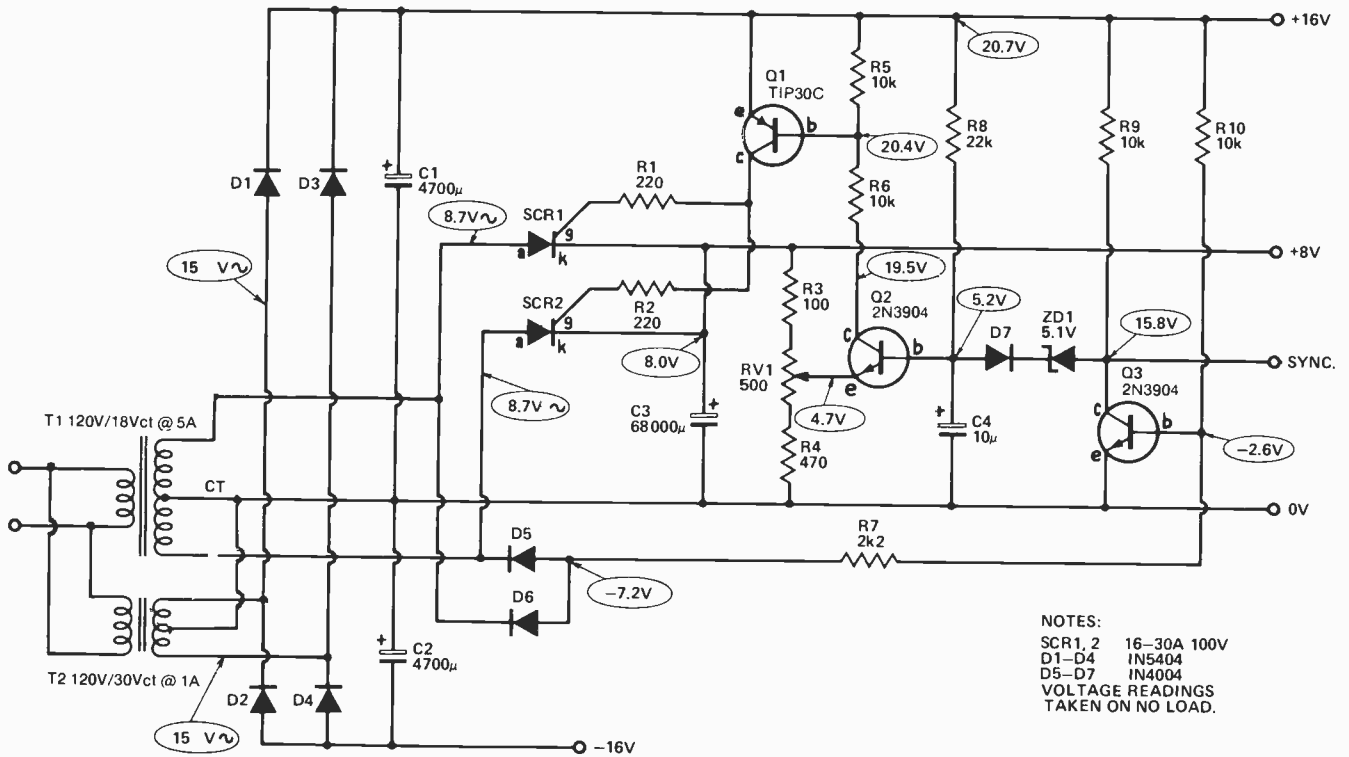

Fig. 5. The circuit diagram of the power supply.

## HOW IT WORKS

The  $\pm 16$  volt supplies are simply fullwave rectified and filtered, this giving adequate regulation and ripple rejection. The 8V supply however needs regulation. With this the normal rectifier diodes are replaced by SCRs (silicon controlled rectifiers) where the turn on point can be varied. The control of the SCRs is as follows.

Transistor Q3 is used to synchronise the triggering of the SCRs to the line frequency. It is normally biased "off" by the negative voltage generated by D5 and D6. However when the voltage approaches zero this transistor turns on for about 3ms. During this period capacitor C4 is discharged to about 5.6 volts and then it is allowed to charge up again via R7. The voltage rises only about 1V before it is again discharged by Q1.

This generates a sawtooth waveform at 120 Hz rate, transistor Q2 compares the voltage to that on RV1 which is proportional to the output voltage. The comparator transistor, Q2, controls the SCRs via Q1. Because the reference waveform is a sawtooth, as the output voltage falls the firing angle of the SCR moves forward in the cycle until the SCRs are on permanently and control is then lost. This point occurs at about 10A in this unit.

Due to the lack of a choke which is normally employed in this type of regulator, the relative fast charging of C3 causes the unit to move into a type of halfwave rectified output under light loads. The ripple still remains well within the 1Vp.p. limit specified.

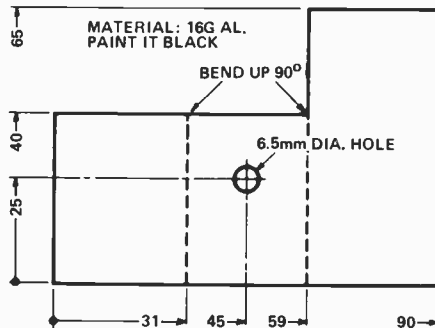
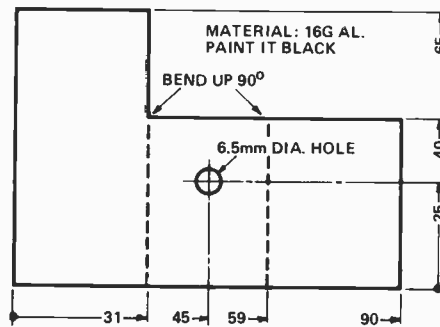

Fig. 6. Details of the heatsinks used on SCR 1 and SCR 2. Heatsinks of similar or larger area may be used if required.

## SPECIAL!

4K DYNAMIC RAMS

TMS 4030

Access time 300ns

\$2.00

each

CMOS — .20¢ each

CD4001	CD4007	CD4007
CD4015	CD4044	CD4021

LINEAR IC

MC14589	Dual op amp .50¢	
TLO80JFET	input op amp .75¢	
MOC1001	OPTO coupler .50¢	
PA301	Audio amp 13W RMS	
\$15.00	2 modules and board	

ACTIVE SURPLUS ANNEX

345 QUEEN ST. WEST

Telephone (416)368-7936

WE BUY AND SELL ANYTHING

# Bucket Brigade Audio Delay Line

---

This audio delay line uses the latest in IC technology, the 'Bucket Brigade' to give a simple unit suitable for various effects. However this is a project for the experimenter as full details for any particular use are not given.

---

ANYONE WHO has been in an anechoic chamber will appreciate the need for some reverberation. In music the use of artificial reverberation or echo can compensate for a 'dead' room or create a new effect. Up until recently reverberation was normally obtained by mechanical means such as a spring or plate which is vibrated or excited by an electrical signal; a pickup elsewhere on the plate or spring receives the delayed signal. Due to the nature of resonances in springs, multiple echos occur giving the effect of reverberation.

A single echo is obtainable by using a tape loop, recording the signal on one head and playing back through a second.

The distance between the heads and the tape speed determines the delay. Echo can also be obtained acoustically by a long tunnel with a microphone and speaker.

When the price of digital ICs started to come down a number of digital delay lines were developed. These used an A-D (analogue to digital) converter, a long shift register and finally a D-A converter. To accommodate the wide dynamic range required very good, fast, A-D, D-A converters along with a large shift register. Even with the low price of ICs these units still cost around \$500.00 or so (this is the main reason we have not published one as a project).

A number of years ago several IC manufacturers started playing with a 'digital' delay line which works by storing an analogue voltage on a capacitor and then transferring this voltage to another and then successive capacitor. This is accomplished by switching FETs on and off under digital control. The circuit became known as a bucket brigade and this name has stuck.

The IC we have chosen is the MN3001 which is a dual 512 step device. Brief specifications of other devices we know about are given below.



# Bucket Brigade Audio Delay Line

## USES OF BBD

Variable or fixed delay of analog signals  
 Reverberation  
 Echo  
 Tremolo, vibrato, flanging or chorus effects  
 Voice control of tape recorders  
 Time compression of telephone conversations  
 Voice scrambling

## CONSTRUCTION

As we are describing no mechanical arrangement our description of construction is limited to the assembly of the PC board. It is recommended that a socket be used for the BBD IC as it is an expensive MOS device. The inputs are protected but it should be handled with care. The same care should be taken with the CMOS IC but as a socket costs more than the IC it is hard to recommend it!

The interconnection between the pc boards depends on the effect needed.

## SPECIFICATIONS

Maximum input < 3% distortion	2.0V RMS
Delay time internal oscillator	6 – 30ms
Frequency response	see graph
Distortion 1V in 1kHz	0.3%
Signal to noise re 2V input	67dB
Supply current (A)	
+ 5V	6mA
- 15V	9mA
(B) + 5V	6mA
- 15V	6mA

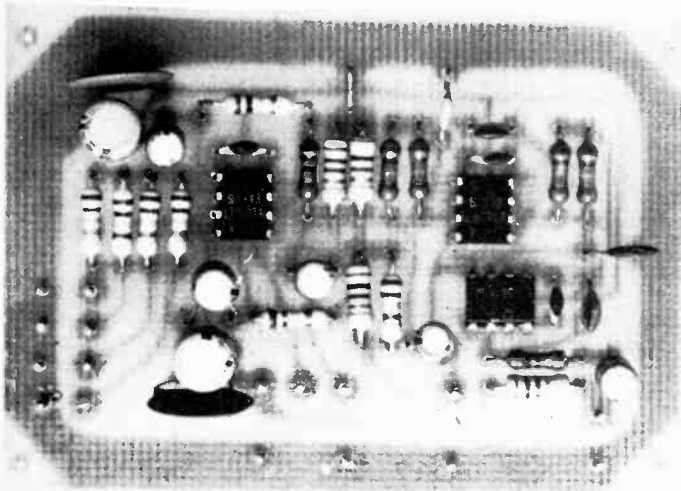

The mixer, filter board ETI 450B.

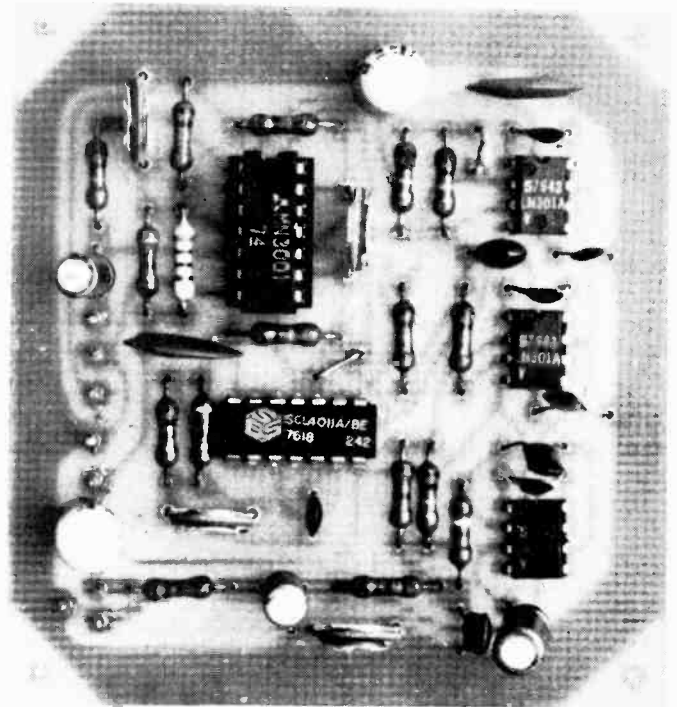

The bucket brigade board ETI 450A.

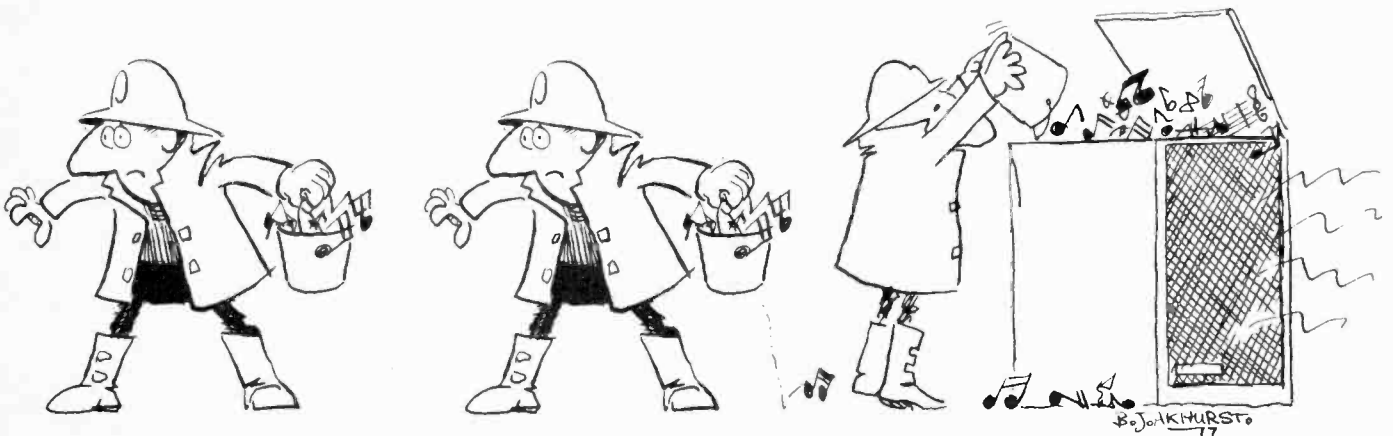

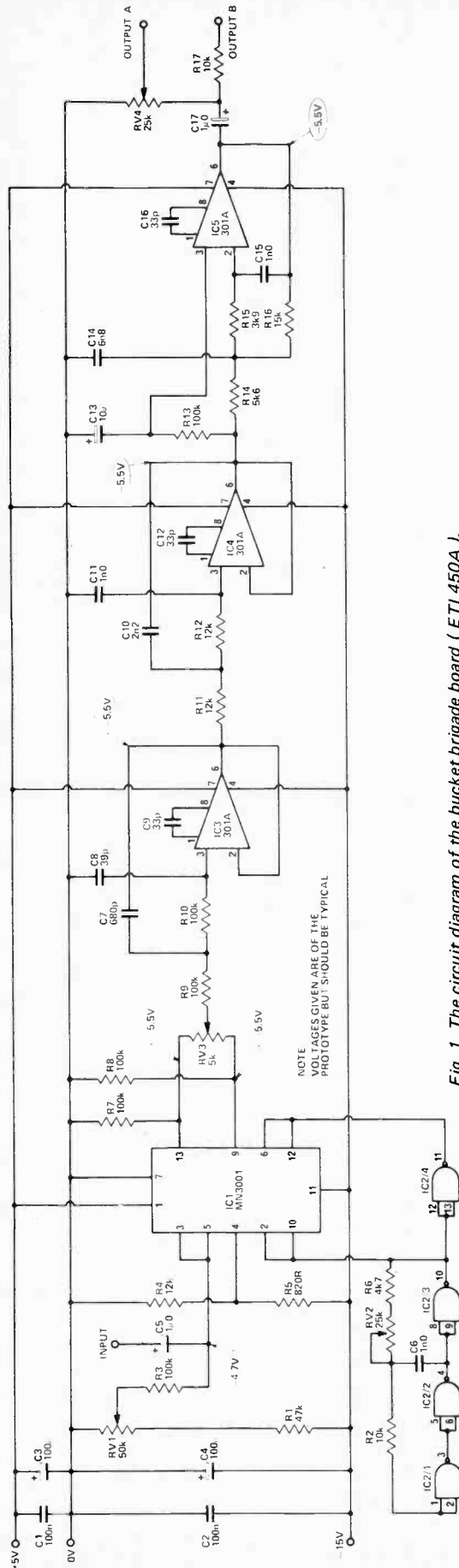

Fig. 1. The circuit diagram of the bucket brigade board (ETI 450A 1).

The bucket brigade device is an analogue delay line which samples the input waveform at an instant in time and stores this voltage on a capacitor. As we need more than just one point on the waveform we sample the input at least 2 times faster than the highest frequency required. A single capacitor cannot store more than one voltage at one time and so a series of capacitors is used. Before the second sample is taken the energy in the first capacitor is transferred to the second capacitor thus freeing the first to sample the input again. Then before the third sample the energy in the second capacitor is transferred to the third. The first into the second and the first again samples the input. This process continues on each sample with the energy in each capacitor being transferred to the next. Eventually we run out of capacitors and this then becomes the output. The number of capacitors, or stages, and the sample (clock) frequency determine the time it takes an input sample to appear at the output.

In the device we have used there are 512 stages in each of two identical and independent sections. The internal circuit diagram of the initial part and of the output stage is shown below (there are over 1000 capacitors and 2000 FETs in the IC!)

The transfer of energy is done using FETs which are controlled by the two clock lines CP1 and CP2. These are complementary square wave signals. Using a 40 kHz clock the input is sampled every 25µs then 'remembered' and transferred every 25µs. On the output, from stage 509 on, the signal is divided into two paths, one having an extra stage. This is needed as the signal on the output is only there for half the 25µs period. By adding these two out-of-phase outputs a continuous output results.

All of this transferring of energy does however waste energy and the output is of a lower amplitude than the input. In the MN3001 it is about 8.5dB lower. To increase the delay it is normal to connect two sections (or more if needed) in series. However the output has then

twice the loss and even with an intermediate amplifier this results in a lower signal to noise ratio.

A second method of obtaining a large delay is to run the two sections in parallel with each sampling on alternate half cycles of the clock waveform giving effectively two sampling periods per clock pulse. This allows the clock frequency to be halved for the same frequency response giving twice the delay with only one attenuation loss. However as you never get anything for nothing the lowering of the clock frequency increases the low frequency energy content of the noise, making the filter do more work.

Getting back to the circuit diagram we see that the input signal is coupled to the input of both halves of the BBD with dc biasing being provided by RV1. IC2 is used as an oscillator with frequency adjustable from about 20 kHz to 90 kHz giving delays of 5-25 ms per section. The output of IC2/3 is inverted by IC2/4 giving the two complementary clocks required by the BBD. The outputs of the BBD are mixed with RV3 being used to remove the

clock frequency before the 6 pole filter IC2 - IC4 removes all the other hash generated by the clocking. The first two sections of this filter have unity gain while the third stage has a gain of 8.5 dB to compensate for the loss in the BBD. These gains are of course below the cut off point!

The second board used is simply a mixer and 4 pole filter which can be used together or in separate parts of the unit. Due to the sampling done by the BBD, the frequency of an input signal must not exceed half the clock frequency otherwise it will appear at the output at some other frequency lower than the clock frequency. This effect is similar to modulation where two signals are multiplied together and produce components at the sum and difference frequencies. In this case, (if the input signal exceeds half the clock frequency) the square wave clock tends to multiply with the input signal. The sum and difference frequencies would then fall at quite objectional frequencies in the audio range. For this reason the 4 pole filter is used before the BBD.

## HOW IT WORKS



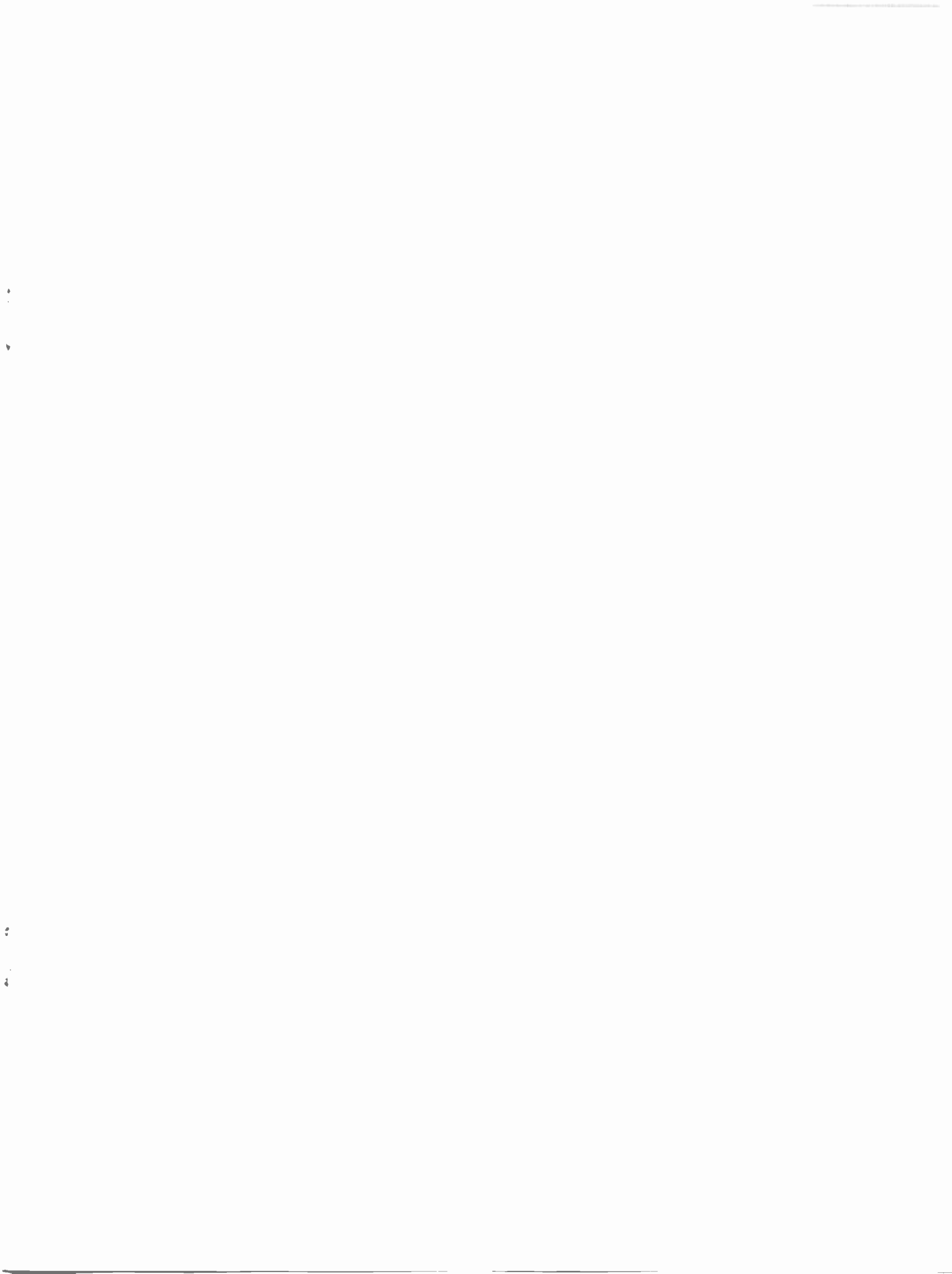

# ETI PCB Negatives

HERE WE present negatives for Feb, March and April issues. (We will try to squeeze in the Hammerthrow pcbs next time). These negs can be used with presensitized boards (eg. Injector). Typical exposure times under a No. 2 photoflood bulb with reflector at ten inches we expect to be around 20 minutes. Use test strip to make test exposures to find optimum exposure for your setup. Full details were given in Jan 78 ETI.

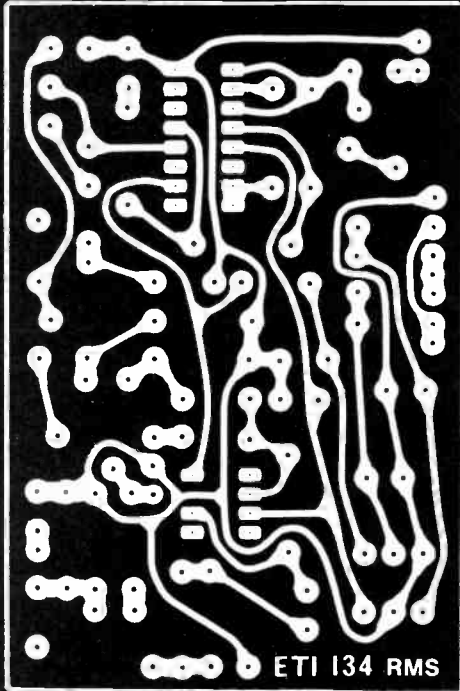

ETI 134 RMS

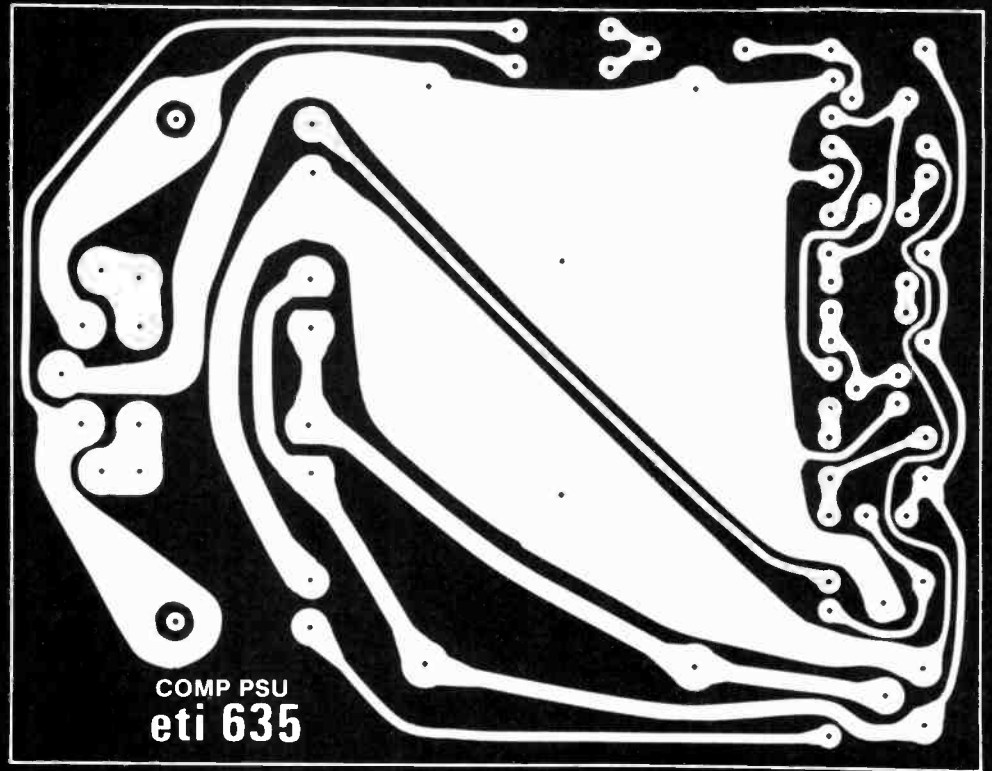
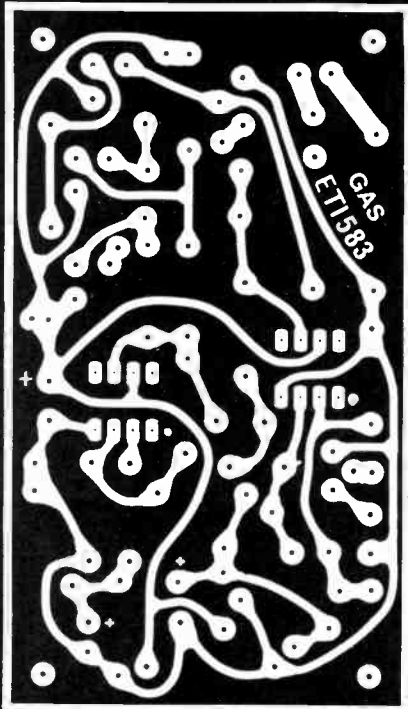

COMP PSU  
eti 635

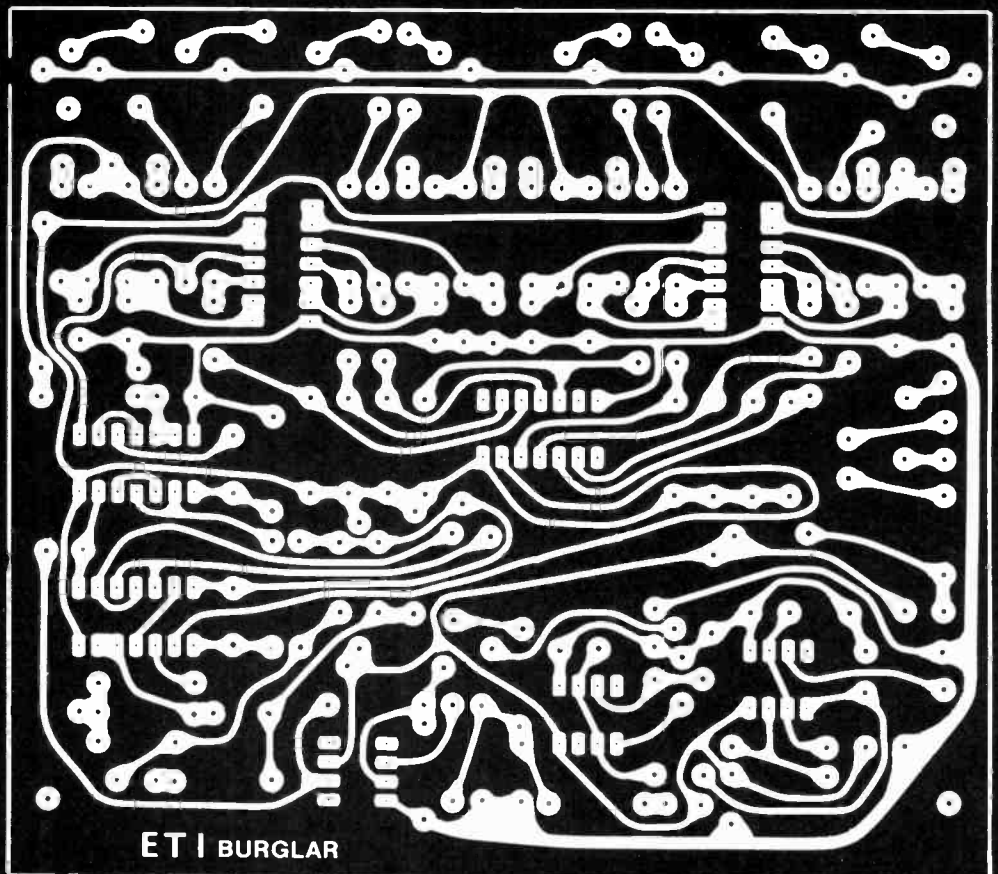

ETI BURGLAR

TEST NEGATIVE

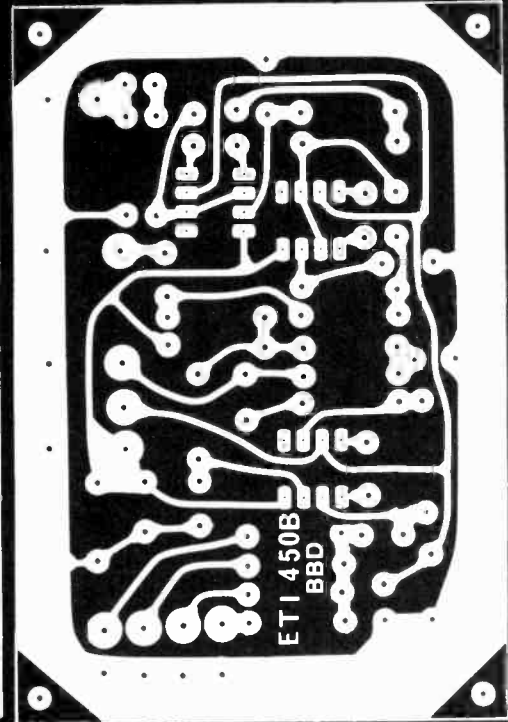
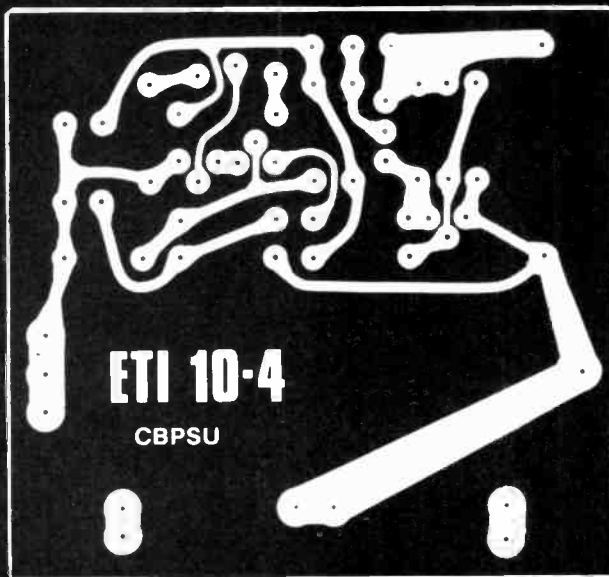
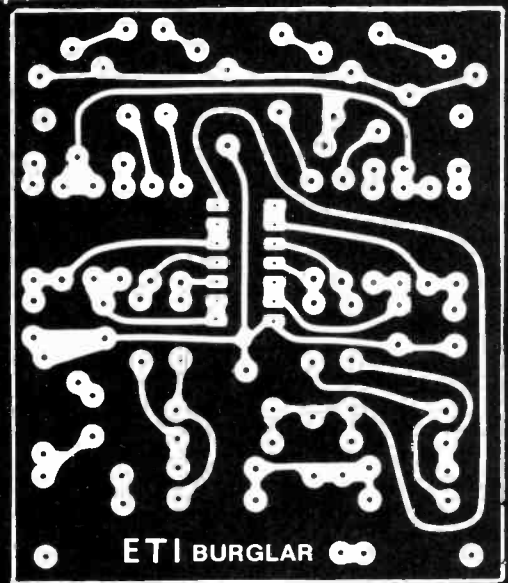
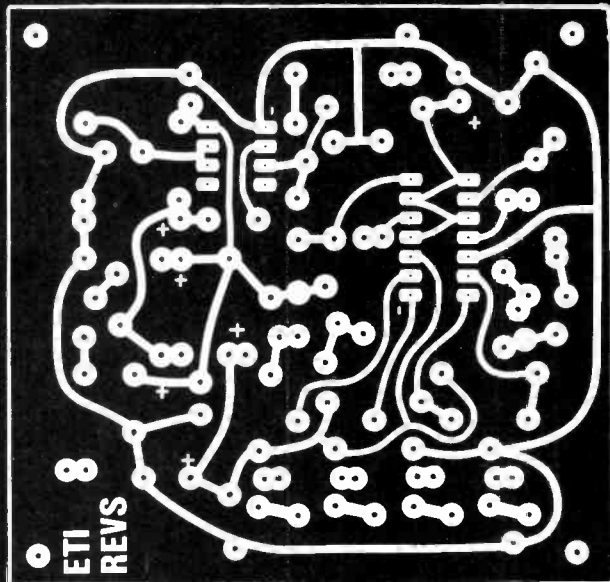
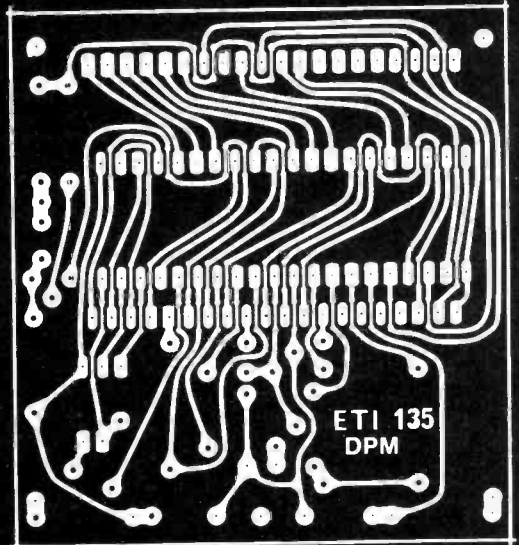
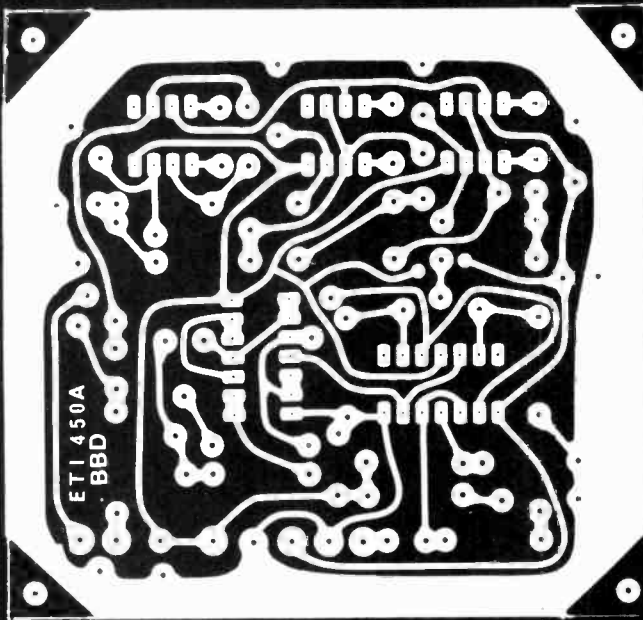
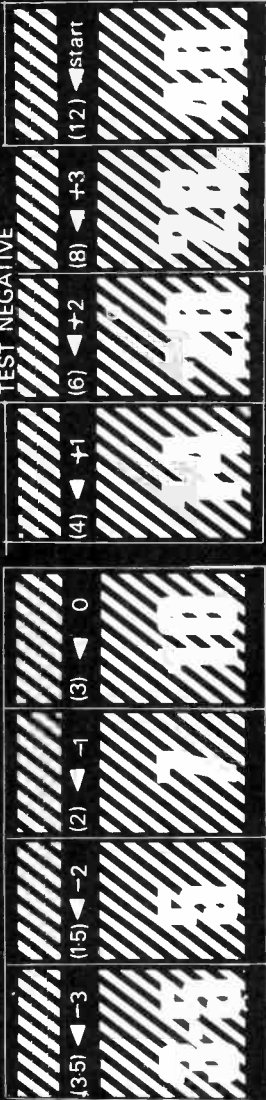



# Bucket Brigade Audio Delay Line

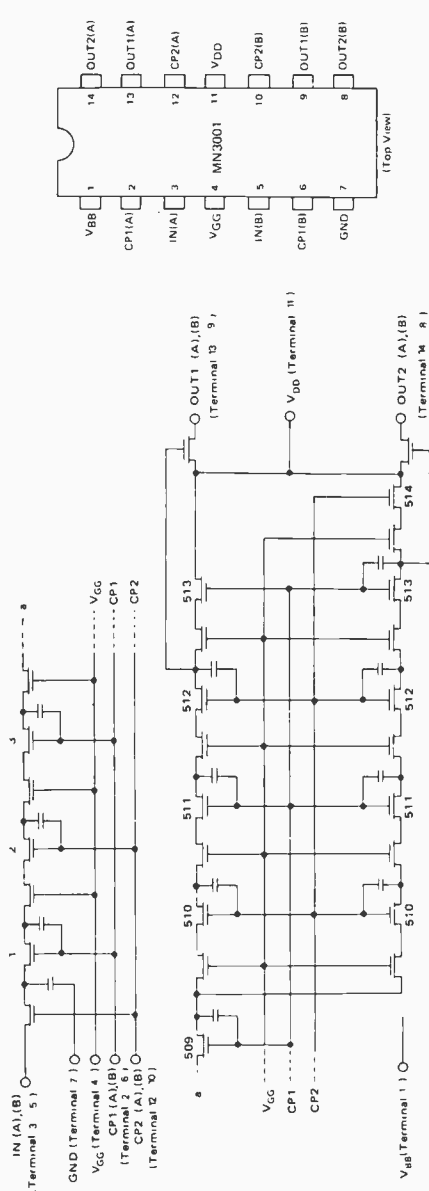

Fig. 2. The internal circuit of the MN3001 showing the first three and last four stages.

TYPE	MN 3001	MN 3002	MN 3003	MN 3004	TDA 1022	SAD 1024
NO OF STAGES	2 X 512	512	2 X 64	512	512	2 X 512
DELAY (ms)	1-25	1-25	0.16-3.2	2.5-3.2	0.5-50	0.2-170
INSERTION LOSS (dB)	8.5	8.5	3.5	1.5	4.0	
DISTORTION (%)	0.4	0.4	0.5	0.4	0.4	1.0
SIGNAL TO NOISE (dB)	70	70	>68	85	74	>70
SUPPLY VOLTAGE (V)	+5, -14, -15	+5, -14, -15	-8, -9	-15	-15	-15

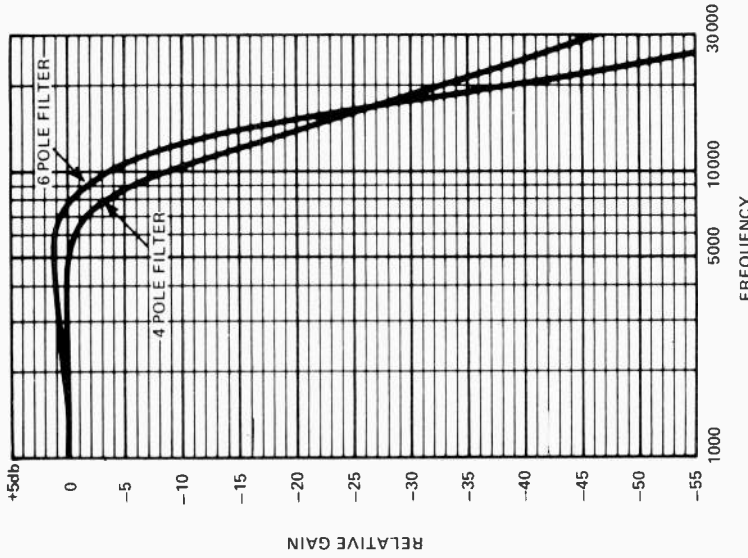
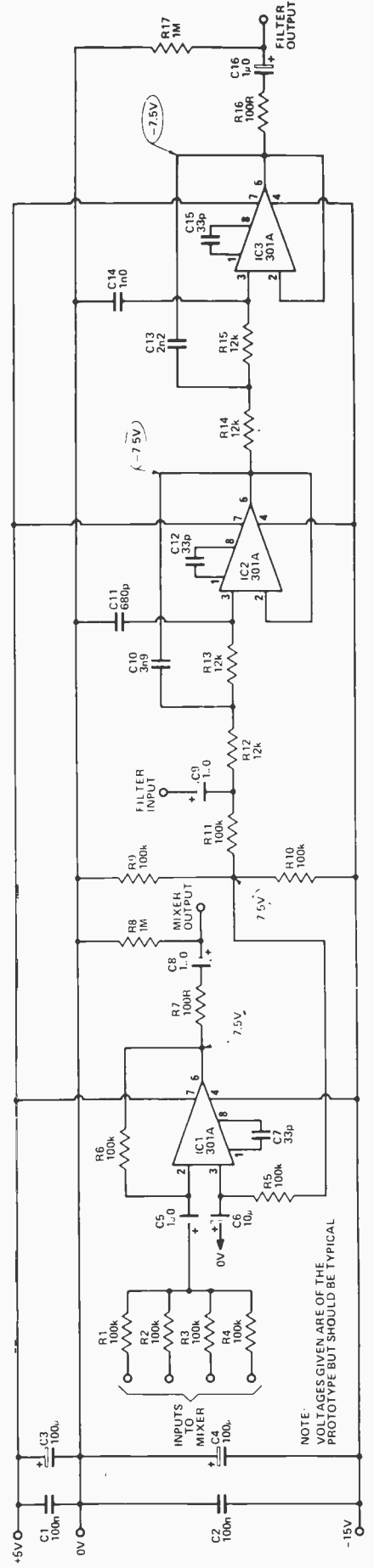

Fig. 3. The frequency response of the two filters. The overall response is approximately the sum of these two filters provided the clock frequency is at least 20 kHz.

Fig. 4. Summary of bucket brigade ICs

Fig. 5. The circuit diagram of the mixer, 4 pole filter board (ETI 450B).





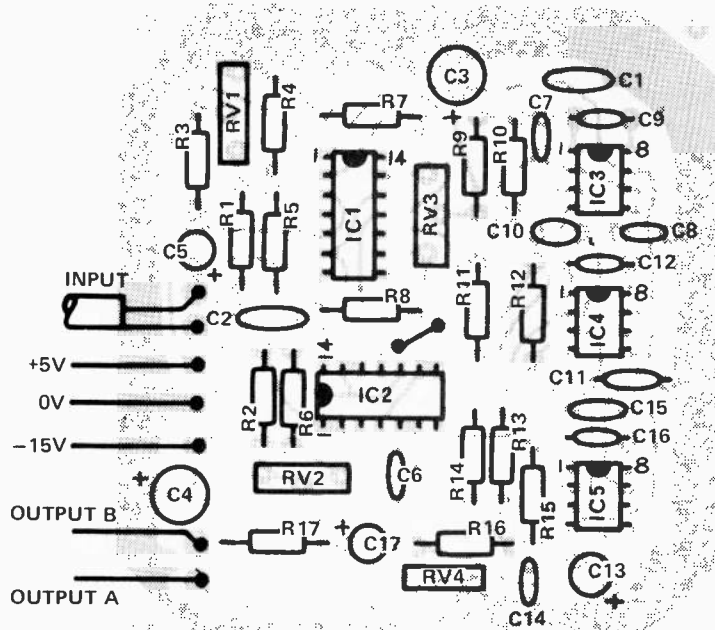

Fig. 6. The component overlay of the bucket brigade board.

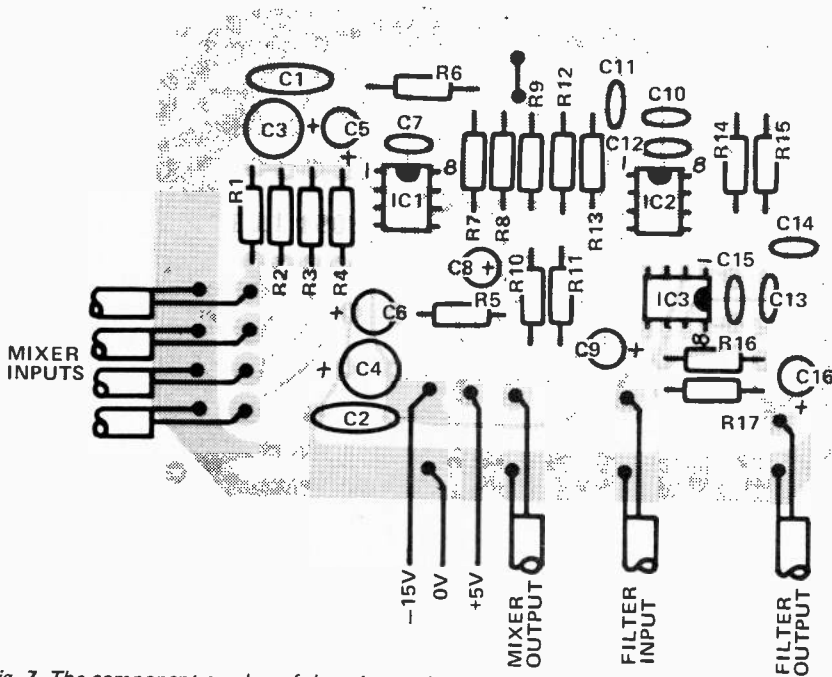

Fig. 7. The component overlay of the mixer - filter board.

**ADJUSTMENT**

RV1 is used to set the bias voltage. If an oscilloscope is available look at the output of the board while feeding in a sine wave signal. Adjust RV1 to allow the maximum input signal without clipping. RV2 adjusts the delay while RV4 sets the output level to compensate for differences in the loss of

the BBD sections. RV3 is used to remove the clock frequency from the output. If an oscilloscope is available look at the wiper of RV3 and adjust to give the smoothest output. The switching transients at this point are very high but these are removed by the filter.

**PARTS LIST**

RESISTORS all 1/4W 5% unless otherwise marked

- R1 ..... 47k
- R2 ..... 10k
- R3 ..... 100k
- R4 ..... 12k
- R5 ..... 820R
- R6 ..... 4k7
- R7-R10 . . . 100k
- R11,12 . . . 12k
- R13 . . . . . 100k
- R14 . . . . . 5k6
- R15 . . . . . 3k9
- R16 . . . . . 15k
- R17 . . . . . 10k

POTENTIOMETERS

- RV1 ..... 50k trim
- RV2 ..... 25k trim
- RV3 ..... 5k trim
- RV4 ..... 25k trim

CAPACITORS

- C1,2 ..... 100n polyester
- C3,4 ..... 100µ 25V electro
- C5 . . . . . 1µ0 25V electro
- C6 . . . . . 1n0 polyester
- C7 . . . . . 680p ceramic
- C8 . . . . . 39p ceramic
- C9 . . . . . 33p ceramic
- C10 . . . . . 2n2 polyester
- C11 . . . . . 1n0 polyester
- C12 . . . . . 33p ceramic
- C13 . . . . . 10µ 25V electro
- C14 . . . . . 6n8 polyester
- C15 . . . . . 1n0 polyester
- C16 . . . . . 33p ceramic
- C17 . . . . . 1µ0 25V electro

SEMICONDUCTORS

- IC1 ..... MN3001
- IC2 ..... 4011 (CMOS)
- IC3-IC5 . . . 301A

MISCELLANEOUS

- PC board ETI 450A

Kits are available for these from Livingstone Electronics and Dominion Radio. See their ads elsewhere in this issue.

**PARTS LIST**

RESISTORS all 1/4W 5% unless otherwise marked

- R1-R6 . . . . 100k
- R7 ..... 100R
- R8 ..... 1M
- R9-R11 . . . 100k
- R12-R15 . . 12k
- R16 . . . . . 100R
- R17 . . . . . 1M

CAPACITORS

- C1,2 ..... 100n polyester
- C3,4 ..... 100µ 25V electro
- C5 . . . . . 1µ0 25V electro
- C6 . . . . . 10µ 25V electro
- C7 . . . . . 33p ceramic
- C8,9 . . . . . 1µ0 25V electro
- C10 . . . . . 3n9 polyester
- C11 . . . . . 680p ceramic
- C12 . . . . . 33p ceramic
- C13 . . . . . 2n2 polyester
- C14 . . . . . 1n0 polyester
- C15 . . . . . 33p ceramic
- C16 . . . . . 1µ0 25V electro

SEMICONDUCTORS

- IC1-IC3 . . . 301A

MISCELLANEOUS

- PC board ETI 450B

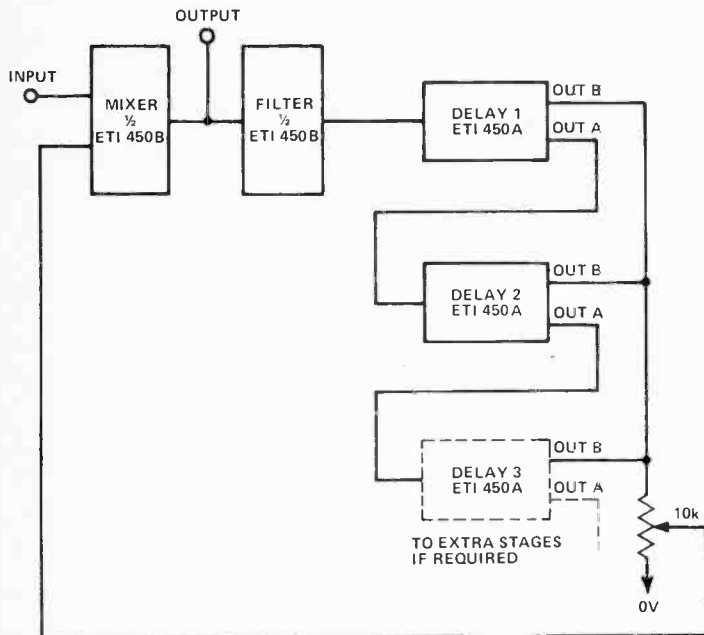

Fig. 8. The interconnection for reverberation.

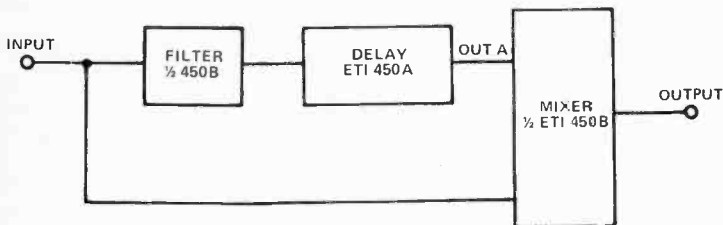
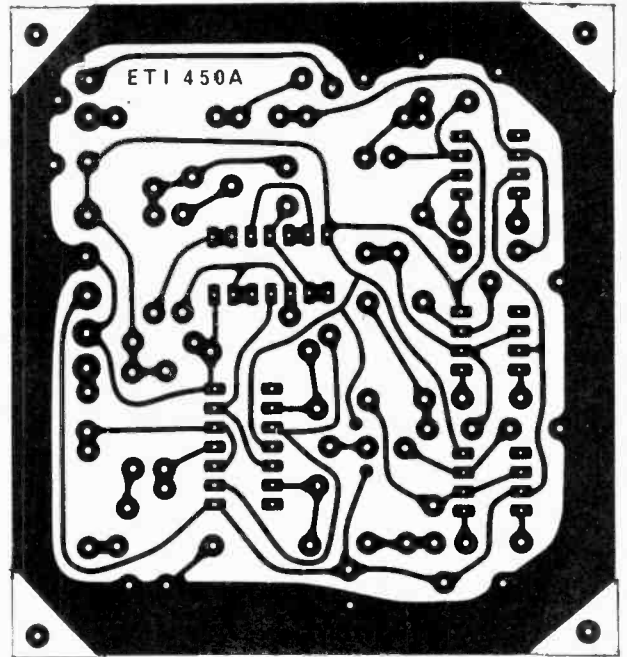
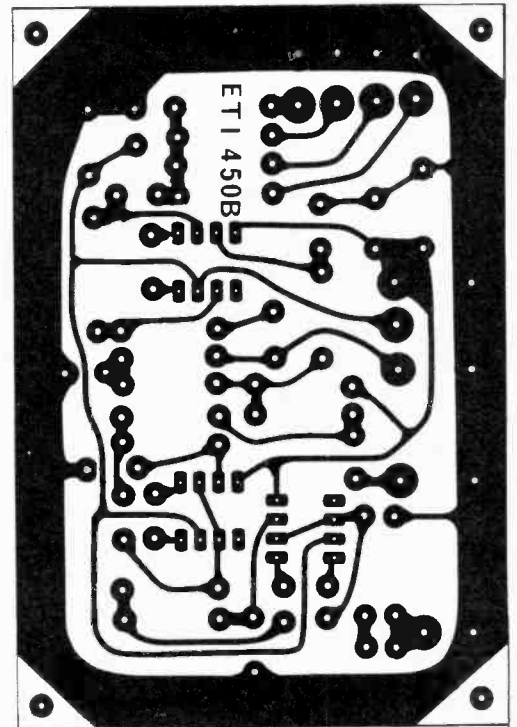

Fig. 9. Connections for a single echo. With a short delay this becomes a phaser.



## REVERBERATION

If the audio signal is fed via a mixer into the delay line and its output fed back into the mixer we have a feedback system which will repeat a single sound many times. This is reverberation. If several different delays are used the effect will seem more natural. With all feedback systems if the sum of all the delayed outputs exceeds the original sound uncontrolled oscillations will result. This is similar to howl-round in PA work and careful adjustment is

needed if long reverberation times are required.

## ECHO

This is similar to reverberation except the delayed signal is not fed back to its own input. A single echo only results (from a single delay) and it can be of any amplitude in relation to the original signal.

## PHASING (FLANGING)

By varying the delay times and by mixing in the right proportions total cancellation of some frequencies can occur. Now if the clock frequency is made variable a phasing or flanging effect occurs. A variable clock can be made by replacing potentiometer RV2 by an LDR and illuminating it with a bulb the brilliance of which is controlled (try a 555 timer). We must leave details of this to the individual constructor.

# AKTRON'S

New CB  
Sound Saddle  
let's you hear  
What you've  
been missing

Oaktron Industries puts your CB radio in the SB Sound Saddle to give you reception you never before thought possible. The specially made, built-in 3" x 5" voice communication speaker virtually eliminates unwanted high and low frequency interference — then directs the sound to you, not to the floor.

Oaktron's CB Sound Saddle is fully adjustable to almost any transmission hump. Even

if it is not permanently attached, it's designed to ride out any kind of trip with ease, yet is fully portable if you want to remove entire unit.

CB Sound Saddle includes all hardware needed, takes 4-6 minutes for custom assembly. No tools needed. Your choice of grilles; Black Enamel, Walnut Woodgrain or Chrome Plated. All American made for dependability's sake.

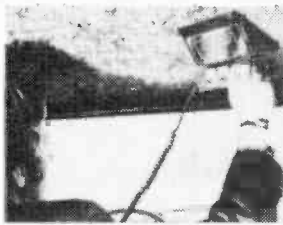

Meet a whole new concept in CB sound and convenience.

1. Powerful 3" x 5" voice communication speaker aims clear, crisp sound directly at you.
2. Puts your CB radio controls within easy reach.
3. Custom-fits completely secure on most any transmission hump.
4. Permanent or portable installation.

## omnitronix ltd.

2056 SOUTH SERVICE RD. TRANS CANADA HWY. - DORVAL, QUE. H9P 2N4 - PHONE: (514) 683-6993

ETI CIRCUITS No. 1

### ALARMS

Basic Alarm  
Photo Intruder Alarm  
Intruder Alarm  
Photo Electric Relay  
Low Temperature/Lights out  
Temperature Sensor  
Coolant level  
Water Level  
Electronic Lock  
Car Battery Watchdog  
Simple Car Alarm  
Simple Lock

### AMPLIFIERS & PREAMPLIFIERS

High Input Impedance  
High Impedance Buffer  
Low Output Impedance  
High Input Impedance  
Low Frequency Extender  
Virtual Earth Preamp  
IC Tape Head Preamp  
Simple Stereo Tape Player  
2.5 Watt  
20 Watt Slave  
10 Watt  
Loudspeaker Microphone  
Voltage Controlled Amp  
Wide Band Amplifier  
Video Power Amp  
Broadband Amp

### SIGNAL PROCESSORS

Fuzz Box  
Guitar Fuzz  
Fuzz Box  
Waa Waa  
Disco Autotune  
Simple Autotune  
Information Transfer  
Optical Pulse Conditioner  
TV Sound Pickoff  
Cracklefree Potentiometer  
Voltage to Frequency  
Sine to Square Wave  
Precision AC to DC  
Voltage Processor  
Universal Meter  
Double Precision  
Fast Half Wave  
Simple Chopper  
Noise Rejecting SCR Trigger  
Phase Shifter

### SIGNAL GENERATORS

Simple  
Variable Duty cycle  
Fast Edge  
FET  
Improved Multivibrator  
Variable Duty cycle  
Stable RC  
Cheap (CMOS)  
Simple TTL XTAL  
Uncritical XTAL  
Pulse  
Zero Crossing  
Simple Pulse

Needle Pulse  
Stable Linear Sawtooth  
Zener  
Noise  
Pink  
Simple Relaxation  
Triangle with independent slope  
Exponential  
Widerange Multivibrator  
Multiple Waveform  
Linear Sweep  
Step Frequency  
Beeper  
7400 Siren  
Simple Siren  
Ship Siren  
Two Tone  
Toy Siren  
Kojak, Startrek  
Sound Effects  
Sound Effects

### FILTERS

Bandpass  
Low & High Pass  
Rejection Notch  
Bandpass  
Cartridge EQ & Rumble  
Hum Stopper  
Tape Hiss Reduction  
Simple Crossover

### DIGITAL

Thermometer  
Heads or Tails  
Binary Calculator  
Voltmeter  
Seven Segment to Decimal  
Die  
Random Binary  
CMOS Die  
Multiplexer Hints  
Learning Memory  
CMOS Clock

### POWER SUPPLIES

Constant  
Temperature Stable  
Constant  
Voltage Controlled  
Precision Voltage Divider  
Dual Polarity  
Simple Balanced  
Voltage Divider  
Low Regulated  
Short Circuit Protected  
Simple TTL Supply  
ZN414 Supply  
Stable Reference  
Transformerless inverter  
DC to DC AC  
Voltage Multiplier  
Automobile Converter  
Shaver Adaptor  
DC-DC  
High Voltage From Battery  
Variable +ve or -ve output  
Simple  
12V from Battery Charger  
Bucket Regulator  
Adjusting Zener Voltage

Variable Zener  
Zener Boosting of Regulators  
High Power  
Electronic Fuse  
Better Fuse  
Regulator & Fuse  
Fas' Acting  
SCR Crowbar  
Voltage Polarity  
NI CAD Discharge  
Current Limiting

### TEST

Diode Checker  
GO-NO GO Diode Tester  
Zener Check  
GO-NO GO Transistor Tester  
Quick JFET Test  
Current Gain Tester  
Basic Transistor Tester  
Simple Transistor/SCR  
SCR Tester  
Crystal Check  
Crystal Checker  
Good/Bad Battery Tester  
Battery Tester  
Op-Amp Tester  
Op-Amp Checker  
Cheap Logic Probe  
Audible TTL Probe  
Audible Slow Pulses  
Logic Probe  
Logic Analyser  
I and O Display Probe  
Simple High Impedance  
Voltmeter  
Audio/RF Tracer  
Thermocouple Thermometer  
Metering Stabilised supplies  
Simple Frequency Meter

### TIMERS & DELAYS

Low Standby Drain  
741 Timer  
Self Triggering Timer  
Pulse Timer  
Pulse Delay  
Voltage Controlled Monostable  
Sequential Relays  
Door Chime Delay

### SWITCHING

Touch Triggered Bistable  
Touch Sensitive Switch  
Electronic Switch  
Sound Operated 2 Way  
SPST Switch Flip Flop  
Two Signals on one Wire

### INDICATORS

Line-o-Light  
3 Step Level  
Light Level  
Bargraph Display  
Fuse Failure  
Blown Fuse  
Back Up Lamp  
DC Lamp Failure

FM Tuner Station  
Current Flow  
Disco Cue

### FLASHERS

Dancing Lights  
Low Frequency Strobe  
Flasher  
Ultra Simple

### POWER CONTROL

LDR Mains Control  
Floodlamp Control  
Zero Crossing Sync  
Train Controller  
Low Differential Thermostat  
Simple Temperature Control  
Full Wave SCR Control

### AUTOMOBILE

Brake Lamp Failure  
Courtesy Light Delay  
Simple Hazard Light  
Light Extender & Reminder  
Four Way Flasher  
Headlamp Dipper  
Wiper Delay  
Suppressed Zero Voltmeter  
Rev Counter/Tachometer  
Auxiliary Battery

### DETECTORS & COMPARATORS

Peak Detect & Hold  
Window Detector  
Peak Program  
Positive Peak  
Reaction Comparator

### RADIO FREQUENCY

Crystal Marker  
100 kHz Marker  
RF Voltmeter  
RF Detector  
LED RF Indicator  
RF Amplifier Protection  
FET-Radio  
Op-Amp Radio

### MISCELLANEA

Phase Locked Loop  
Touch Doorbell  
Phase Lock Control  
Audio Mixer  
Virtual Earth Mixer  
Pop Eliminator  
Loudspeaker Protection  
Digital Capacitance Probe  
Digital Tape Recorder Adaptor  
Breakdown Diode Substitution  
Dual Function Charger  
Dual Mode Amp

Capacitor Substitution  
Electronic Capacitor  
Speeding Up Darlington's  
Shutter Saver  
Thyristor Sensitivity  
Sound Operated Flash  
Strength Tester  
Logic Noise Immunity

### TIPS

Identifying 74 Series  
Supply Pins  
Soldering IC's  
Tinning With Solder Wick  
PCB Stencils  
Front Panel Finish  
DIL Drilling  
Fluorescent Starting  
Avoiding Insulated Heat Sinks  
TTL Mains Interface  
Boost Your Mains  
High Resistance on Low Meters  
High Voltage Electrolytics  
Transistor Identification  
Template & Heat Sink for  
Power Transistors  
Transistor Socket  
Solder Flow Problems  
Odd Resistor Values  
Resistors in parallel  
CMOS DIL handling  
Identifying Surplus ICs  
Extending Battery Life  
Battery Snaps  
Power Supply or Battery  
Battery Checking  
Muck Remover  
Transformers in reverse  
Loudspeaker Checking  
Improving UJT Linearity  
Signal Tracer  
Crystal Earpieces  
Cheap Varicaps  
Zener Lifts Capacitor Rating

### DATA

741 Op-Amp Data  
BC 107-109 Data  
BC 177-179 Data  
CMOS & TTL Data  
2N3055 Data  
MJ2955 Data  
Bipolar Data Tables  
Bipolar FETs Rectifiers  
Diodes Pinouts Zener Misc

AN IDEAS BOOK  
FOR  
EXPERIMENTS

SEND \$5.00

To ETI Circuits,  
ETI Magazine,  
Unit Six, 25 Overlea  
Blvd., Toronto,  
Ontario. M4H 1B1

# Panasonic MN3001

THE MN3001 is the heart of our BBD experimenter's boards featured in this issue.

Each device contains two 512-stage BBDs with independent input, output and clock terminals. A pair of output terminals is provided in each BBD for cancellation of the clock component superimposed on the output signals.

P-channel silicon gate technology is used to fabricate the BBDs from chains of tetrode type MOS transistors and storage capacitors. The MN3001 is packaged in the standard 14-lead DIL plastic package.

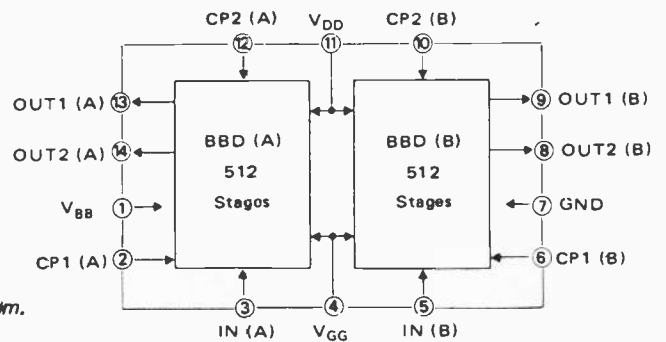

Fig. 1. Block diagram.

### OPERATING CONDITIONS (Ta = 25°C)

Item	Symbol	Conditions	Typ.	Unit
Drain Supply Voltage	V <sub>DD</sub>		- 15	V
Gate Supply Voltage	V <sub>GG</sub>		- 14	V
Back-gate Bias Voltage	V <sub>BB</sub>	V <sub>CPH</sub> = 0 ~ -1V	+ 5 *1	V
Clock Voltage "H"	V <sub>CPH</sub>	V <sub>BB</sub> = +4 ~ 6V	0 *1	V
Clock Voltage "L"	V <sub>CPL</sub>		- 15	V

\*1 The MN3001 can be used at V<sub>BB</sub> = 0V, if V<sub>CPH</sub> is fixed at -3V.

### ELECTRICAL CHARACTERISTICS (Ta = 25°C, V<sub>DD</sub> = V<sub>CPL</sub> = -15V, V<sub>GG</sub> = -14V, V<sub>BB</sub> = +5V, R<sub>L</sub> = 100 kΩ)

Item	Symbol	Conditions	Min.	Typ.	Max.	Unit
Clock Input Capacitance	C <sub>CP</sub>				350	μF
Clock Frequency	f <sub>CP</sub>		10		800	kHz
Signal Delay Time	t <sub>D</sub>		0.32		25.6	msec
Clock Pulse Width *2	t <sub>CPW</sub>				0.5T *3	
Clock Rise Time *2	t <sub>CPr</sub>			0.05T		
Clock Fall Time *2	t <sub>CPf</sub>			0.05T		
Input Signal Frequency	f <sub>in</sub>	f <sub>CP</sub> = 40 kHz, 3dB down	0		0.3f <sub>CP</sub>	kHz
Input Signal Swing	V <sub>in</sub>	2.5% Distortion			2	V <sub>rms</sub>
Output Signal Attenuation		f <sub>CP</sub> = 40 kHz, f <sub>in</sub> = 1 kHz		8.5	11	dB
Output Distortion	D <sub>tot</sub>	f <sub>CP</sub> = 40 kHz, f <sub>in</sub> = 1 kHz V <sub>in</sub> = 2 V <sub>rms</sub>			2.5	%
Noise Level	V <sub>N</sub>	f <sub>CP</sub> = 100 kHz Weighted by 'A' curve		0.25		mV <sub>rms</sub>
Signal to Noise Ratio	S/N	Max. Output Voltage vs. Noise Voltage		70		dB

### TYPICAL CHARACTERISTICS (Ta = 25°C)

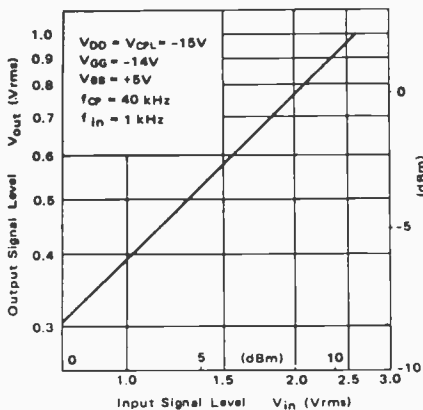

Fig. 2. Voltage transfer characteristics.

# Panasonic MN3001 Bucket Brigade

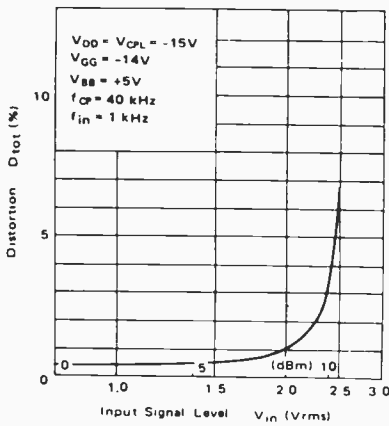

Fig. 3. Distortion characteristics.

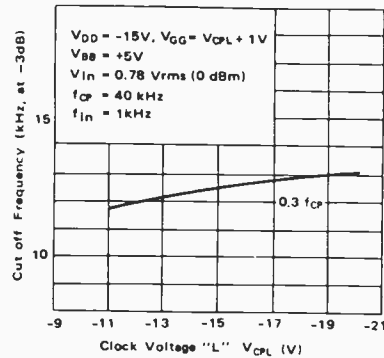

Fig. 4. Cut-off frequency.

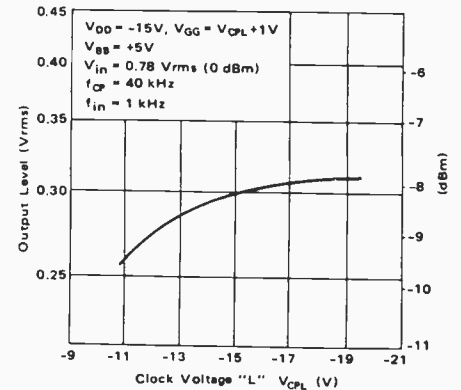

Fig. 5. Output voltage swing.

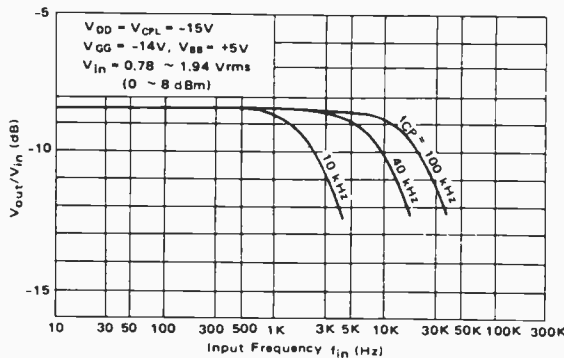

Fig. 6. Frequency response.

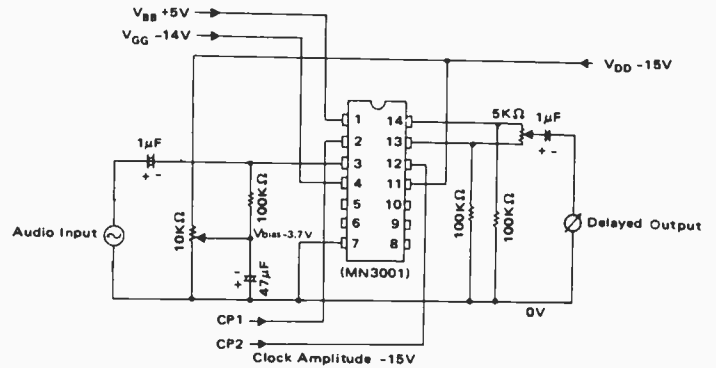

Fig. 7. Basic circuit with clock component cancellation (single channel).

Fig. 8. Compensation of DC level shift due to clock frequency change using two BBDs.

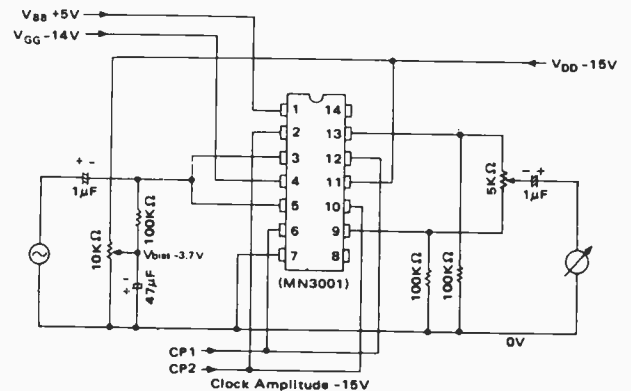
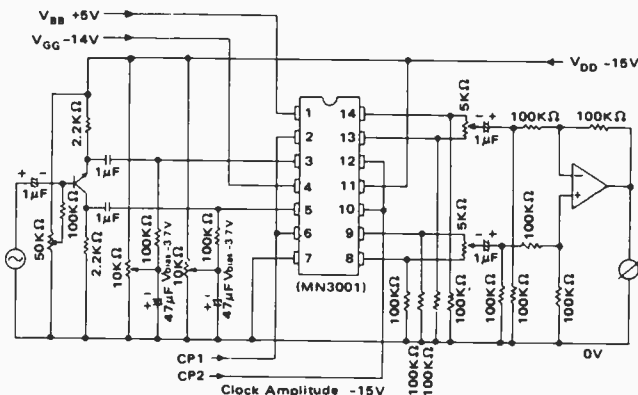
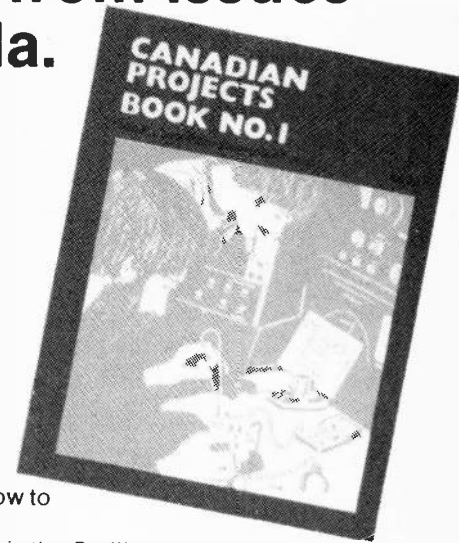

Fig. 9. Extension of bandwidth nearly twice using two BBDs. Effective sampling rate becomes twice clock frequency.



**Canadian Projects Book Number One gives you twenty-five projects from issues of ETI sold in Canada.**



## **The Best Of ETI For Only \$3.00!**

This book is a must for all Canadian electronics enthusiasts. We show you how to make your own digital voltmeter, and an injector-tracer for your test-bench.

Then you can set about building our induction balance metal locator — this is the Cadillac of metal locators, a big improvement on the usual BFO types. And when you are out searching for treasure you can relax in the assurance that our burglar alarm project is watching over your home (to make sure no-one steals your valuable Canadian Projects Book).

While you are building our electronic version of the Mastermind game you can keep your kids/parents/roommates occupied with your homebuilt reaction tester and double dice games. If the excitement gets too much you can relax with our biofeedback GSR (Galvanic Skin Response) meter (and if you want to do more experiments with biofeedback you can build our heart-rate monitor).

Another project for the experimenter is our sound-activated photographic flash trigger. With this device you can photograph a bullet leaving the barrel of a gun, or a balloon bursting, etc.

In addition to the projects mentioned above we have designs for fifteen audio projects. Eight of these can be connected together to make the mixer and power-amp sections of a discotheque sound system. For the musician we have plans for a fuzz box and for a phaser; for the beginner in electronic music we have our clever twenty-five note electronic organ which uses a touch-sensitive keyboard etched into half of the single PCB (and we include variable-depth tremolo, volume control, and two voices).

For the hi-fi enthusiast we have do-it-yourself instructions on how to build a simple LED indicator to tell you when you are overloading your amplifier. If you aren't getting the bass response you would like from your speakers you can build up a little gadget to put that right. If you are more adventurous with your sound system you will be interested in our audio limiter. This project can be used to protect your group's amplifiers from distorting when high-level signals are produced, it can be used to compress the dynamic range of a signal for recording or addressing public meetings, or it can be used as a voltage-controlled volume control for remote or automatic adjustment.

**There's got to be something in this book for all ETI readers. All the projects have been reworked since they were first published to update them with any information we might have received about availability of components, improvements, etc.**

## **All for the amazingly low price of three dollars.**

**To order Canadian Projects Book Number One send \$3.00 per copy (no extra to cover postage) to Canadian Projects Book, ETI Magazine, Unit Six, 25 Overlea Blvd, Toronto, Ontario, M4H 1B1.**

# Gas Alarm

This versatile alarm prevents the engine being started or electrical equipment used if there is a build up of gasoline vapour or gas thus protecting your boat against fire.

GASOLINE VAPOUR, closed space and electrical sparks are not ideal companions. Many a boat has been destroyed when the owner has switched on the ignition without realising there had been a fuel leak and that the vapour content in the engine compartment is at a dangerous level. Unfortunately the circumstances also lead to injury and loss of life. Therefore any system which can prevent this is of great value.

This unit is designed to meet this requirement and uses a semiconductor gas detector (TGS cell) to monitor the atmosphere in the engine compartment and either prevent the engine being started or shut it down if a high vapour concentration occurs during operation.

## CONSTRUCTION

This is relatively easy if the printed circuit board is used and the wiring diagrams are followed. Some precautions should be taken if the unit is to be used in a boat to prevent corrosion. The rear side of the board should be coated with a cellulose spray (dope, nail polish, etc.) and the box, while having to be near the control panel, should be shielded from direct spray. Although we have used a separate box the unit can be mounted behind the control panel if desired.

A small heatsink (about 25 mm square aluminium) should be bolted on to IC1 to keep it cool.

The relay we used can handle up to 6 A current but if higher currents are required it can be replaced with any 12 V relay providing its coil resistance is over 100 ohms.

Obviously the sensor must be mounted in the engine compartment and while it must be in free air it must also be protected against mechanical damage.



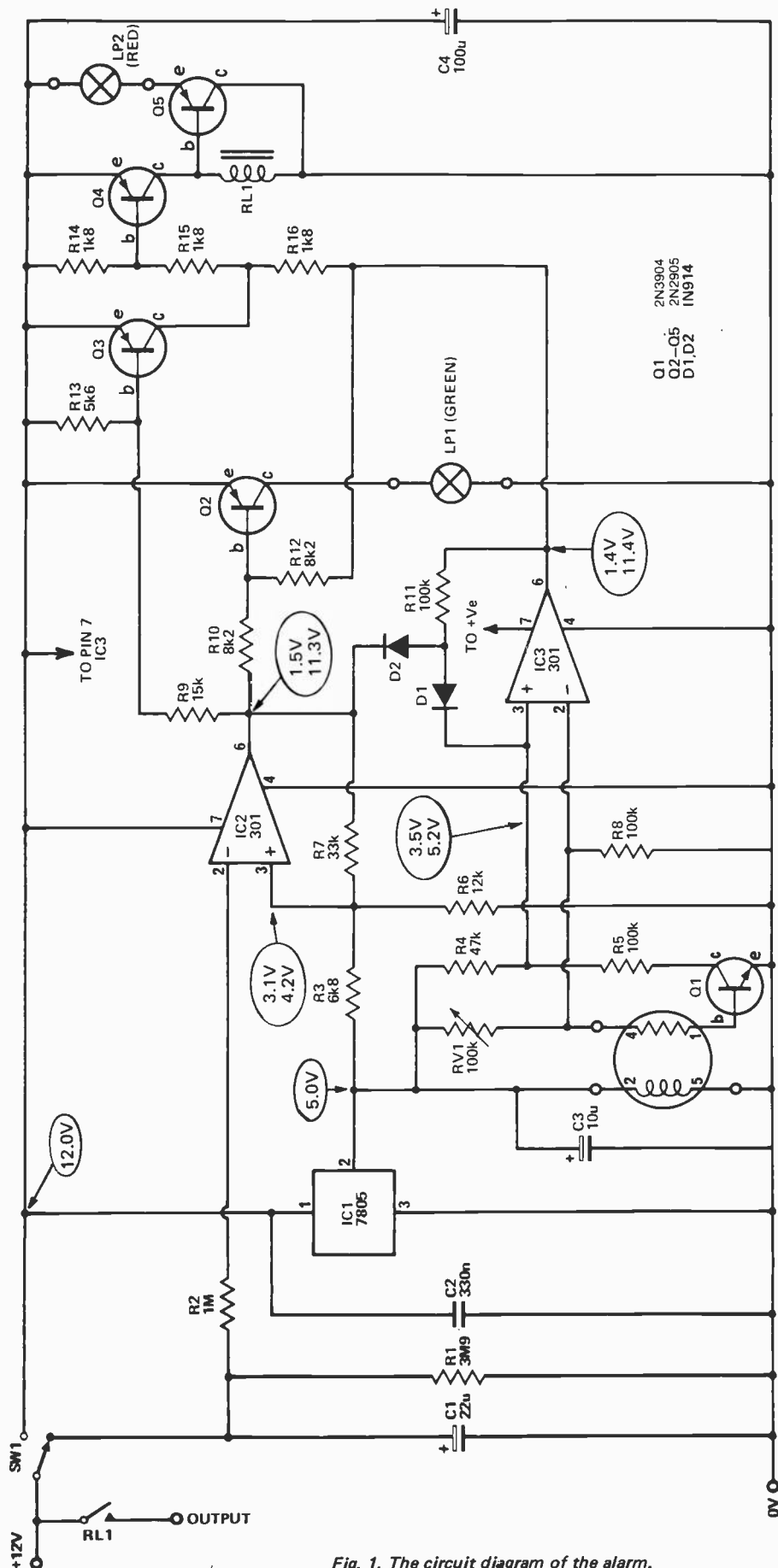

Fig. 1. The circuit diagram of the alarm.

## HOW IT WORKS

This project is designed primarily to monitor the concentration of volatile gases inside the bilge of gas-engined boats. The circuit provides an electrical cutout which prevents the engine from being started if fumes are present and also will remove all electrical power if fumes become present at any time.

The unit acts as a master switch and due to its warm up requirements, a two minute delay occurs on switch on. Two indicator lights indicate either "safe" or "fail" condition and in the initial warm up period both lights are on. The initial timing is performed by C1 and IC2. With the main switch off there is +12 V across C1. When it is switched on the capacitor is allowed to discharge through R1. IC2 compares the voltage on C1 with that on pin 3 (about 3 V). During this period the output of IC2 will be about +2 V.

IC1 is a 5 V regulator and supplies the power for the heater of the sensor. The sensor's resistance element is in series with RV1 and this voltage is compared to the voltage set by R4/R5.

The transistor Q1 gives a fail safe operation and if the sensor is not connected this transistor will be off giving +5 V on pin 2 of IC3. Resistor R8 ensures that the voltage on pin 2 will always be slightly less than +5 V.

If vapour is present the sensor resistance will be low and the output of IC3 will be high. During the first two minutes the diodes D1 and D2 prevent the feedback loop (R11) operating. After two minutes if the output goes high the reference voltage on pin 3 of IC3 will go above 5 V and therefore the IC will latch in that position.

The relay is operated by Q4 and for it to close the output of IC3 must be low (no vapour) and also the output of IC2 must be high (more than two minutes after switch on). If the unit does switch off, or prevents initial switch on, it must be switched off and then on again (after clearing the fumes) and the two minute delay operates again.

## INSTALLATION AND ADJUSTMENT

The sensor should be mounted in a position where vapour may be expected and should be mechanically protected against damage. The connection to the sensor should be via a 4 core cable (on long runs use a shielded cable) and the connection of the sensor is shown in Fig. 3. Note that it is symmetrical in layout and also the fact that it will fit into a standard 7 pin miniature tube socket.

The only adjustment is the sensitivity control and this is set by bringing a small container of gasoline near the sensor and ensuring it operates. The adjustment should be as sensitive as possible without giving false operation.

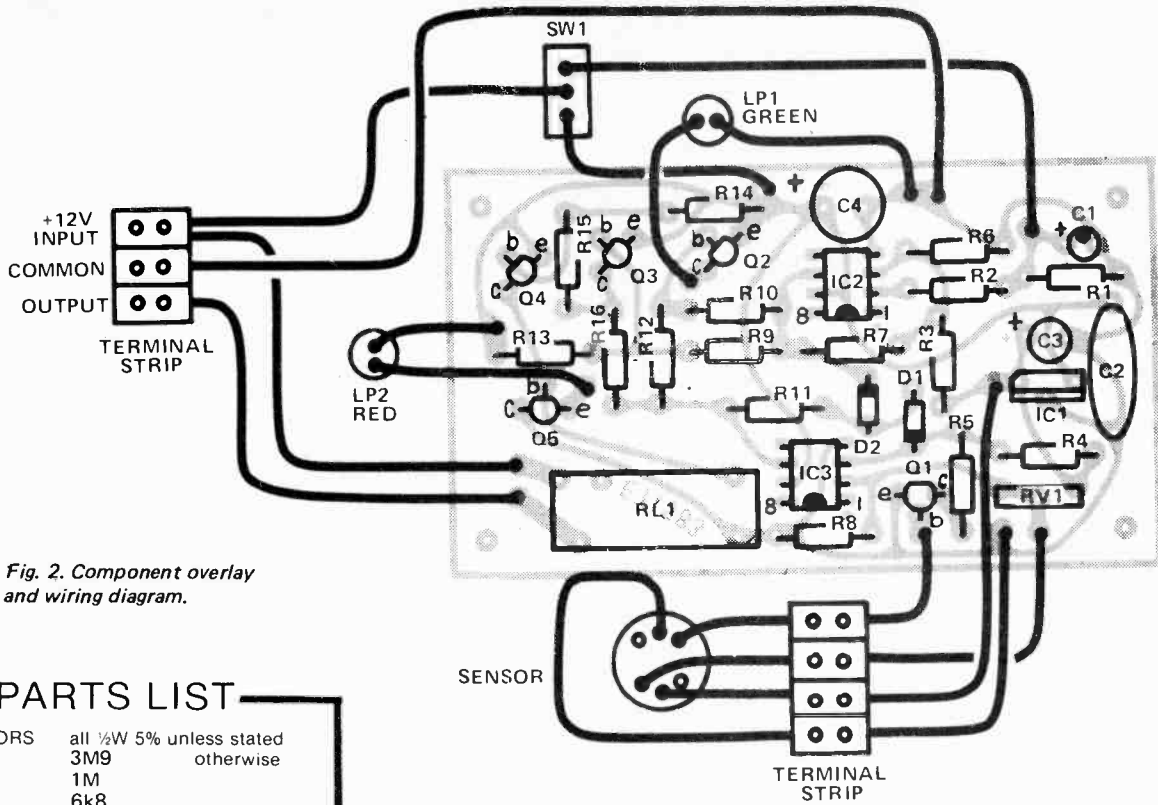

Fig. 2. Component overlay and wiring diagram.

## PARTS LIST

RESISTORS all 1/4W 5% unless stated otherwise

R1 3M9  
 R2 1M  
 R3 6k8  
 R4 47k  
 R5 100k  
 R6 12k  
 R7 33k  
 R8 100k  
 R9 15k  
 R10 8k2

R11 100k  
 R12 8k2  
 R13 5k6  
 R14-R16 1k8

POTENTIOMETERS  
 RV1 100k trim

CAPACITORS  
 C1 22μ 16V tantalum  
 C2 330n polyester  
 C3 10μ 16V electro  
 C4 100μ 25V electro

SEMICONDUCTORS  
 IC1 7805 regulator  
 IC2,3 301 or 741

Q1 2N3904  
 Q2-Q5 2N3638A, 2N2905

D1,D2 1N914

### MISCELLANEOUS

Gas Sensor: Figaro 812 or 813  
 PC Board ETI 583  
 LP1,2 Indicator lamps 12V  
 100 mA max.  
 SW1 single pole toggle  
 RL1 12V relay 280Ω coil single pole  
 Metal box to suit

The individual gas sensors and complete kits of parts are available from Livingstone Electronics, see their ad in this issue.

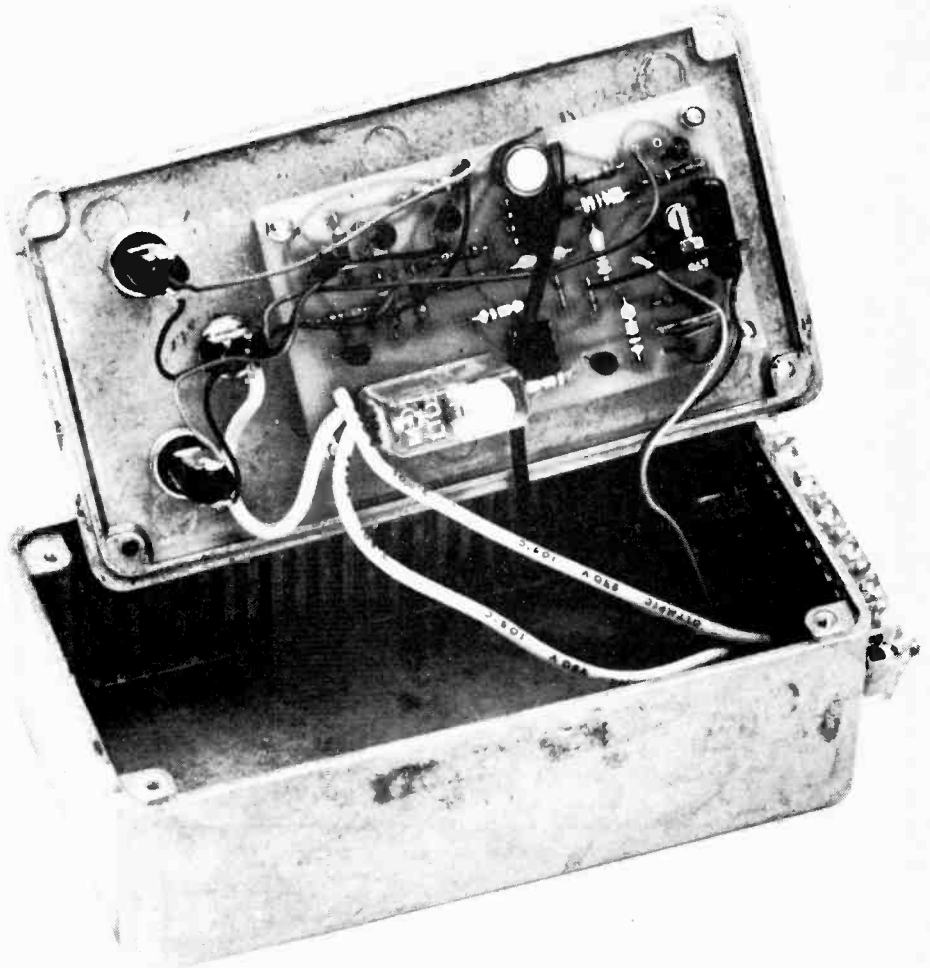

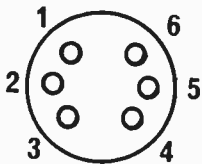
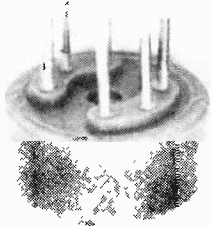

Underneath view.  
Note that pins 1 and 3 are internally connected as are pins 4 and 6.

Fig. 3. Connections of the sensor.

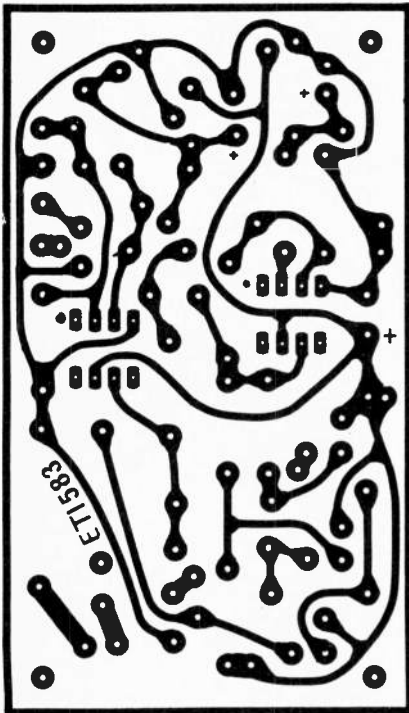

Fig. 4. Printed circuit layout.  
Full size 52 x 92 mm.

# WHAT TO LOOK FOR IN MAY'S ETI

## Audio Feedback Eliminator

By raising the signal from a microphone by 5Hz before it is fed to the PA system you can eliminate audio feedback in many cases. This project can also be modified for special effects (with variable frequency offset).

## Add-On FM Tuner

This PCB tuner can be added to a stereo amplifier or can be mounted in its own box. Then you can add up to three meters, a couple of switches, a rotary or slider tuning pot, etc., to your own custom-design.

## White-Line Follower

Mount this project in a suitable model car and it will follow a white line drawn on the ground.

## Tools in Canada

Tools aren't boring. Read about the new developments in this field and see how you can save yourself a lot of time in future. We look at what's on the market and who's selling it.

# MAKE SURE YOU DON'T MISS IT!

These articles are in an advanced state of preparation, but in order to keep you up-to-date with the fast-changing world of electronics we may have to change our plans at the last minute.



# NEW ETI KITS

FINALLY - We now have available COMPLETE COMPONENT KITS for current projects every month! Our kits include all components and misc. hardware as well as etched, drilled and plated p.c. boards with component layouts.

## ETI 450 BUCKET BRIGADE KIT

Complete kit both boards	55.00
Bucket Brigade board kit 450A	40.00
Mixer- Filter board kit 450B	15.00
MN3001 IC & Socket	25.00

## ETI 583 GAS SENSOR ALARM KIT

Complete kit (Specify Sensor type)	40.00
Plain metal box for above	3.00
Sensor & Socket (Specify type)	10.00
TGS812 suitable for Carbon Monoxide & TGS813 for gas vapours	

Prices are postpaid - Ont. Res. add 7% pst - no C.O.D.'s

Send \$1 for catalog - refundable with first order

*Livingstone* →  
*Electronics*

SUITE 201- 801 YORK MILLS RD.  
DON MILLS, ONTARIO M3B 1X7

Rapitape #

New from ETI

# eti PANEL TRANSFERS

no 1

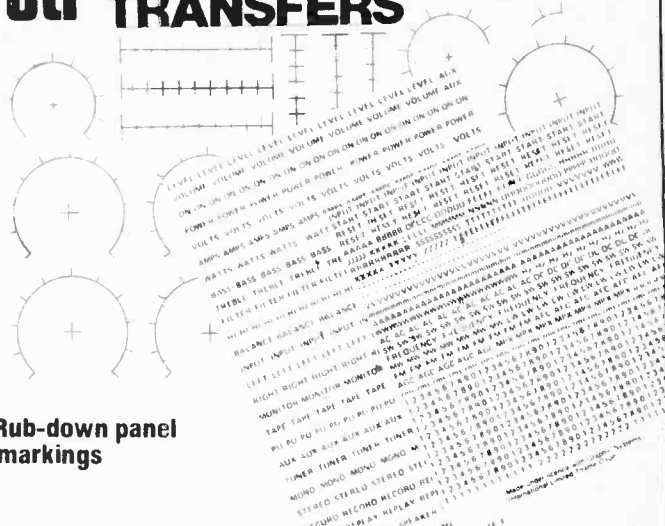

Rub-down panel markings

A really high quality system for finishing off your projects. The sheets include a mass of lettering and control scales for both rotary and linear pots.

The lettering is transferred simply by laying on to the panel and rubbing down - it's strong and permanent. The markings are on two

sheets (a full-sized one cut in half for easy postage) and contain sufficient lettering for dozens of projects.

Send \$3.50 (including postage) to ETI PANEL TRANSFERS, Unit Six, 25 Overlea Blvd., Toronto, Ontario, M4H 1B1. Ontario Residents add 7% PST.

## SPEC FOR SPEC

# LEADER DELIVERS THE BEST PRICES AVAILABLE

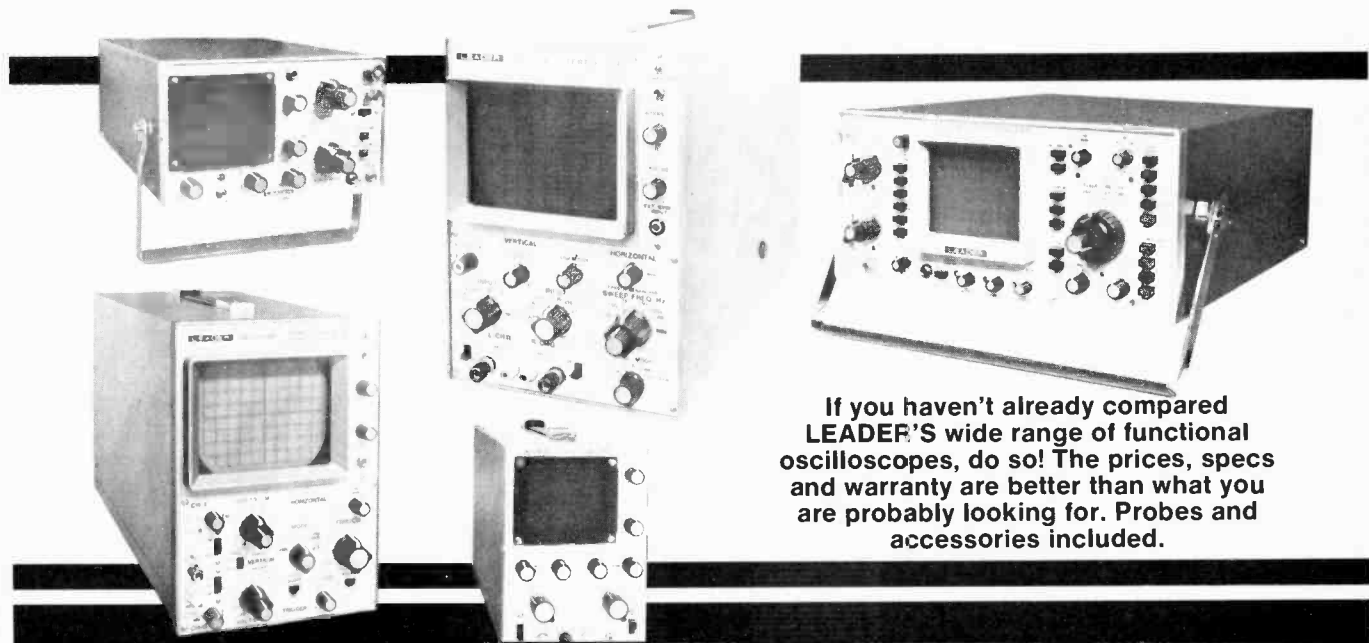

If you haven't already compared LEADER'S wide range of functional oscilloscopes, do so! The prices, specs and warranty are better than what you are probably looking for. Probes and accessories included.

LEADER TEST INSTRUMENTS

"PUT US TO THE TEST."

omnitronix Ltd.

WRITE FOR OUR DETAILED CATALOG.

2056 SOUTH SERVICE RD.  
TRANS CANADA HWY  
DORVAL, QUE. H9P 2N4  
PHONE: (514) 683-6993

# BITS, BYTES and BAUDS

A review of Bill Johnson's six-part introduction to personal computing concepts.

IN THE SEPTEMBER 1977 issue Bill Johnson started a six-part series to introduce the computer hobby to readers who previously knew nothing about computers. The series puts together all the main concepts of personal computing and enables the reader to construct a mental picture of how a computer works (and what all the common buzz-words mean) without needing to have any contact with the computers themselves. With this simple model stored in his cerebral memory the reader can tackle articles and sales literature written for the experienced computerist. The basic model will help the newcomer identify and file new information without any mental block.

To refresh the memories of readers who have followed the series (and to prompt you into going back over areas that were perhaps a bit hazy on first reading) and to guide any new ETI readers we will now briefly go over the main headings in the various sections.

Bits, Bytes and Bauds No 1 (Sept 77) looked at the state of data transmission before microcomputers were developed. This area is the nearest that hobbyists got to computers in the days before IC logic. From the start of the series Bill assumes the reader has no knowledge of digital electronics. This first part mentions the Baudot and ASCII codes, the asynchronous transmission of serial data and the use of the parity bit.

The microcomputer is introduced in the second part of the series (Nov 77),

with a look at how a piece of data can be stored in a memory. Briefly the arithmetic of binary numbers is examined. (But what's single precision arithmetic, as opposed to double precision? Maybe you'd better dig out your Nov ETI and make sure you've got it straight.)

In the December issue Bill pulls back from the memory and looks at the roads of access — the address bus and the data bus. So you should know what is a synchronous bus, and what is an asynchronous type. Also in this section the problem of communication with peripherals is introduced — what happens when the peripheral communicates much slower than the computer?

A further look at I/O techniques follows in part 4 (Jan 78). Here you can learn about interrupts and the clever way the computer uses the stack and the stack pointer during an interrupt. Pushing and popping the stack, the index register, maskable and non-maskable interrupts, priority setting, vector addresses, polling by the interrupt service routine, direct memory access. . . all these fearsome-sounding concepts are really very simple, aren't they?

Previously memory was an abstract place where data could be stored. In part 5 (Feb 78) Bill looks at what memory is like in practice. His words on ROM, paper tape, cassettes and floppy disks, are as easy to assimilate as the stuff on the back of a cornflakes packet. The need for leader, preamble

and checksum is clear to everyone.

Bill's final part (March 78) puts together a complete system and talks about the software ingredients — text editor, assembler, etc. The reader learns about the levels of language at which the programmer can communicate with the machine. Do you know whether you'd prefer a compiler-type or an interpreter-type high level language?

The course finishes without looking at specific components in the computer. You have a program, you have various forms of memory and you have peripherals. To know more about how the computer executes the program, how it actually drives peripherals, or how the program is written the reader can now look elsewhere. Much can be learned about specific microcomputer ICs by reading Microbiology in ETI (8008 and 8080 in Oct 77, 8085 and Z80 in Nov 77, 6800 and 6500 in Dec 77, 1802 in Jan 78, 2650 in Mar 78, and more to come). Reading the reviews of the PET (Feb 78) and the TRS 80 (this issue) personal computers will help the newcomer to appreciate the relative importance of hardware and software facilities.

Bits, Bytes and Bauds is completed but this doesn't mean ETI will move away from computer articles. On the contrary we intend to lead our readers from the beginner's stage further into personal computing as the hobby develops in Canada.

## IS YOUR POWER AMP. CLIPPING ?

*Livingstone* →  
*Electronics*

SUITE 201- 801 YORK MILLS RD.  
DON MILLS, ONTARIO M3B 1X7

FIND OUT WITH ETI 417 THE OVERLED This complete stereo kit is for 4, 8 or 16 ohm speakers from 5 to 100 watts RMS and could easily be mounted inside your power amplifier or other component. Kit includes an etched, drilled and plated p.c board as well as all the components, for only \$14.95

Price is postpaid - Ont. Res. add 7% p.st - no COD's  
Send \$1. for catalog - refundable with first order.

**AN IMPORTANT MESSAGE FOR READERS  
WHO DON'T HAVE A SUBSCRIPTION**

MARCH JUNE AUGUST SEPTEMBER DECEMBER NOVEMBER OCTOBER  
JULY JANUARY NOVEMBER FEBRUARY MARCH  
JUNE JULY JANUARY MAY AUGUST DECEMBER FEBRUARY APRIL MAY  
MARCH FEBRUARY NOVEMBER JANUARY JULY

**Twelve Issues  
of ETI at  
Half Price!**

You do something for us and we'll do something for you.

\*\*\*\*\*

**Here's what you do:-**

You sell one introductory subscription to ETI

**Here's what you get:-**

You get your own subscription half price.

**Here's how we help:-**

To make it easier for you we will not ask you to sell the subscription at full price — you can give your customer 50% discount on his "introductory" subscription.

**Two One-year Subscriptions for \$12!**

(Applicable only to new one-year subscriptions)

Valid only with the card in this issue and only until May 15, 1978

Not valid in addition to any other offer.

# Pseudorandom Number Generator

This month we have two more programs submitted by P. Cornes for the Sinclair Programmable calculator.

**Object** — To generate a random number of any required length up to eight digits in such a way that each digit can take any value from K to L.  
 OR generate single random numbers with values from K to L.  
 OR play an ESP game such that the player has the opportunity of entering a single digit number before the calculator generates a random number, both digits being displayed at the end of the run for comparison and statistical purposes.

## SLOT MACHINE

Use execution 1 with K = 1 and L = 4 and score wins according to the following table.

Display	Win
111.....	10
222.....	10
333.....	10
444.....	10
221.....	5
331.....	5
441.....	5
11.....	4
1---.....	2

With the values of win shown, the program gives a 95% pay-out.

## RACE

Use execution 2 with K = 1 and L = number of players (say four). Run the program and each time a number comes up enter a one in the table shown, in the next empty square down, underneath the number displayed. The first player to fill the column below his number is the winner.

## BATTLE

Use execution 3 with K = 0 and L = 5. Each player takes it in turn to enter his own number (one to five) and run the program. When the display appears subtract the smaller digit from the larger and then add the larger digit to this answer. The player with the highest number at the end of the round wins the round. The first player to win five rounds wins the game.

## EXECUTION

**Execution 1** —

Any number between 0 and  
 1/▲▼/Sto/▲▼/▲▼/goto/0/0/°/ce/  
 RUN/random digit/ if you require a two digit random number then press RUN again and a second random digit will be displayed alongside the first, a three digit random number, press RUN a third time etc . . . .  
 When you have a random number of the required length and wish to generate another number press the clear button followed by RUN/random-digit/ etc. . . .

**Execution 2** —

Any number between 0 and  
 1/▲▼/Sto/▲▼/▲▼/goto/0/6/°/ce/  
 RUN/random number/  
 RUN/random number/  
 RUN/random number/ etc . . . .

**Execution 3** —

Any number between 0 and  
 1/▲▼/Sto/▲▼/▲▼/goto/0/0/°/ce/  
 Your guess/RUN/random number and your guess  
 Your guess/RUN/random number and your guess  
 Your guess/RUN/random number and your guess

With the program as it stands the variables take the following values:—

K = 1  
 L = 6

Obviously with these values the program can be used to simulate the throwing of dice with executions 1 or 2.

When you come to change the variables you should do it in the following way:—

**Executions 1 and 3**

Choose a value for K from 0 to 8 (integer).  
 Choose a value for L from K to 9.  
 Replace line 9 and 10 with the value of L-K.  
 Replace lines 29 to 31 with the value of K — 1 (including sign).

Run as per execution instructions.

**Execution 2**

Choose a value K from 0 to 9 (integer).  
 Choose a value L between K and 99 (integer).  
 Replace lines 9 and 10 with L — K.  
 Replace lines 29 to 31 with K — 1 (including sign).

Run as per execution instructions.

With a moments thought you will see that there are one hundred and one uses for this program, a few of these are given above.

# Be the “New Professional” in electronics

**CREI trains you at home  
for the most important  
career levels in electronics —  
plus offers you special  
arrangements for engineering  
degrees**

Engineering Technicians and Engineering Technologists are meeting the unique and growing demands of the Canadian Electronics Industry for college-trained professionals. Engineering Technicians and Technologists are not journeymen and neither are they professional Engineers (P. Eng.); they are known as Application Engineers. They combine many of the journeyman's practical skills with those obtained through extensive training in the scientific principles of electronics enabling them to design and develop sophisticated circuits. In effect, they are the support force of the university-trained professional engineer.

Granted, there are many situations where the Engineering Technologist and Technician share the responsibilities of the graduate engineer.

Usually the training program for an Engineering Technician requires two years, full-time at a Community College and for an Engineering Technologist, three years full-time.

Through CREI home study programs you can attain equivalent depth of training plus the opportunity of specializing in your choice of the major fields in electronics.

The McGraw-Hill Center for Continuing Education, Toronto Ontario, of which CREI is a division has the facilities and the expertise to provide electronics training for entry into all professional levels in Canada, from journeyman to Engineering Technician, Engineering Technologist and, through certain accredited United States Colleges and Universities, to the Baccalaureate degree.

## **Unique Design Lab**

CREI gives you both theory and practical experience in circuit design with its Electronic Design Laboratory Program. The professional equipment included in this program allows you to construct, test out and correct the circuits you design until you have an effective circuit.

This Lab Program helps you understand advanced electronics. It also gives you practical experience in many other important areas of electronics, as in prototype construction, breadboarding, test and measurement procedures,

## Career Training at Home

circuit operation and behavior, characteristics of electronic components and how to apply integrated circuits.

Only CREI offers the unique Lab Program. It is a complete college Lab and, we believe better than you will find in most colleges. The "Lab" is one of the factors that makes CREI training interesting and effective. And the professional equipment in this program becomes yours to keep and use throughout your professional career after you complete the training.

### Engineering Degree

CREI offers you special arrangements for earning credit for engineering degrees at certain accredited United States colleges and universities as part of your home study training program. An important advantage in these arrangements is that you can continue your full time job while "going to college" with CREI. This also means you can apply your CREI training in your work and get practical experience to qualify for career advancement.

### Wide Program Choice

CREI gives you a choice of specialization in 14 areas of electronics. You can select exactly the area of electronics best for your career field. You can specialize in such areas as computer electronics, communications engineering, microwave, CATV, television (broadcast) engineering and many other areas of modern electronics.

### Free Book

In the brief space here, there isn't room to give you all of the facts about CREI college-level, home study programs in electronics. So we invite you to send for our free catalog (if you are qualified to take a CREI program). The catalog has over 80, fully illustrated pages describing your opportunities in advanced electronics and details of CREI home study programs.

### Qualifications

You may be eligible to take a CREI college level program in electronics if you are a high school graduate (or equivalent) and have previous training or experience in electronics. Program arrangements are available depending upon whether you have extensive or minimum experience in electronics.

# Send for this FREE Book describing your opportunities and CREI college-level programs in electronics

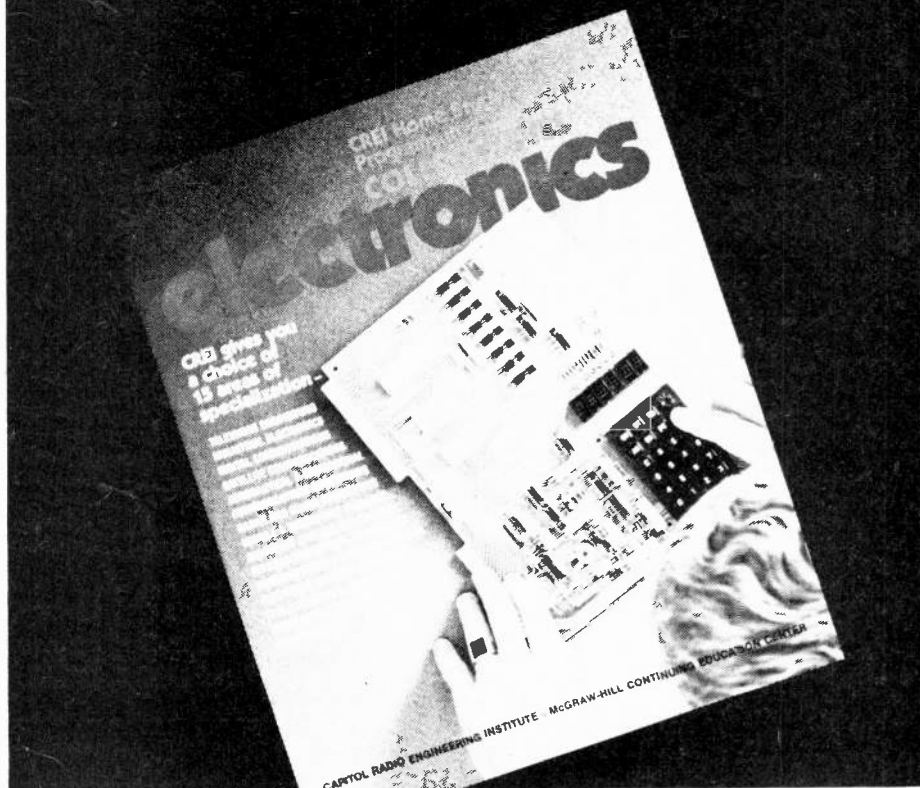

Mail card or write describing qualifications to



# CREI

**CAPITOL  
RADIO  
ENGINEERING  
INSTITUTE**

**McGraw-Hill Continuing Education Center**  
330 Progress Avenue,  
Scarborough, Ontario  
M1P 2Z5 (416) 293-1911

**Accredited Member National Home Study Council**





# Pseudorandom Number Generator

## FLOW CHART

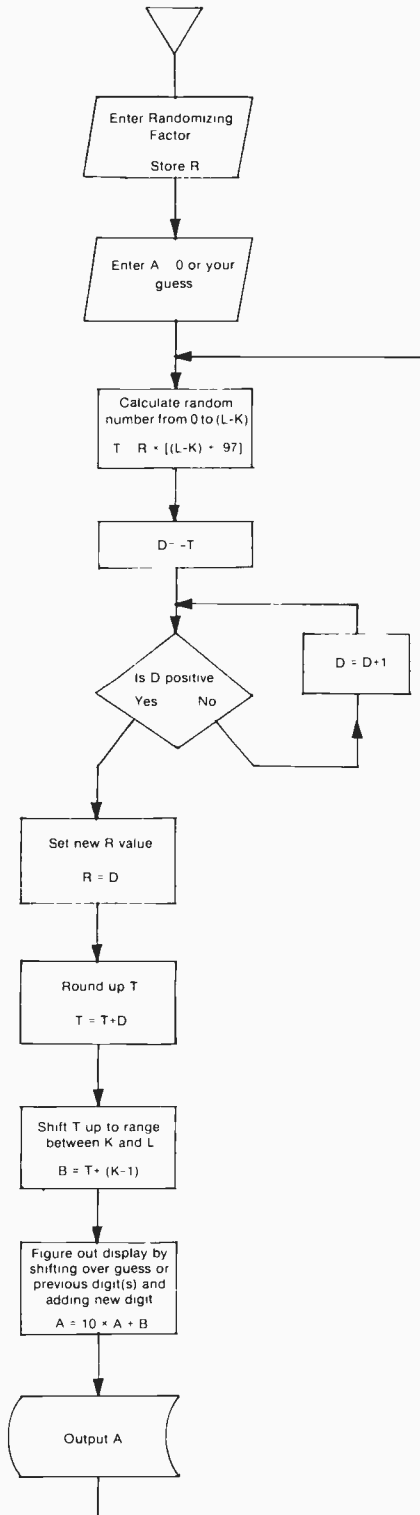

## PROGRAM

```

( x . 00
( # 3 01
( 1 1 02
( 0 0 03
( + E 04
( ( 6 05
( Rcl 5 06
( x - 07
( # 3 08
( 0 0 09
( 5 5 10
( . A 11
( 9 9 12
( 7 7 13
( = - 14
( Sto 2 15
( - F 16
( + E 17
( # 3 18
( 1 1 19
( = - 20
( v A 21
( GIN 1 22
( 1 1 23
( 7 7 24
( v A 25
( MEx 5 26
( + E 27
( Rcl 5 28
( - F 29
( # 3 30
( 0 0 31
( = - 32
( ) 6 33
( = - 34
( Stop 0 35
  
```

FINDS NEXT  
RANDOM NUMBER

DISPLAYS  
RANDOM NUMBER

1	2	3	4

START

FINISH

Above: the score sheet for the battle game and left are the listing and flow chart for the overall game.

The program above runs on the Sinclair Cambridge Programmable.

- A: Last guess or number
- B: Random digit from K to L
- D: Temporary storage
- K: Bottom limit
- L: Top limit
- R: Randomizing factor
- T: Temporary storage for random number from 0 to (L-K).

SOFTSPOT is ETI's programmable calculator software department. We know there are many of you who have gone to a lot of effort to write routines for your machines — how about sharing the fun. Send us a copy of your pet program, preferably with flow chart. To make things interesting we will restrict our choices to only those programs making use of loops or conditionals.

All programs we publish will be paid for.

Mail to: ETI Softspot  
Unit 6, 25 Overlea Blvd.,  
TORONTO, Ontario  
M4H 1B1

Don't forget to mention what kind of calculator you use — and we'd also be interested to know where you bought it.

## FLOW CHART SYMBOLS

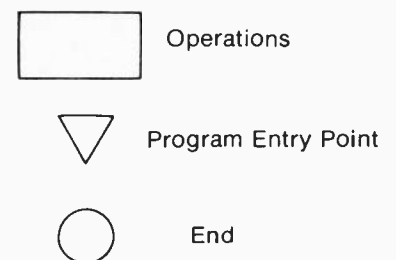
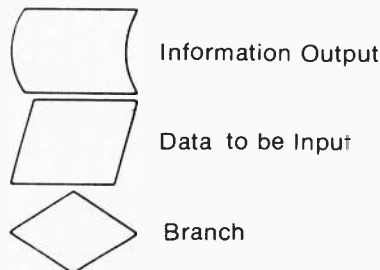

# Atomic Decay Game

Object — To simulate the decay of M grams of a radioactive material with a half-life of H seconds in such a way that:—

1. The player has the opportunity of guessing how much of the material (plus or minus T grams) is left after each second.
2. The player is given indications of right and wrong (hit and miss) guesses.
3. A running total of the player's score is displayed after each guess.

## EXECUTION

1/0/0/▲▼/sto/▲▼/▲▼/goto/0/0/0/RUN/ score (0) /  
 Your guess/RUN/Hit-Miss/RUN/ score/  
 Your guess/RUN/Hit-Miss/RUN/score/ etc . . .

With the program listing and execution sequences given the variables take the following value:—

M = 100 grams. H = 10 seconds. T = 1 gram.

Should you wish to change the variables (When you get used to playing the game) then:

To change M — Put the new value in place of the 100 at the beginning of the execution sequence.

To change T — Change lines 21 and 22 in the program to your new value (any 2 key-stroke number between .1 and 99)

To change H — This variable is the most difficult of the three to change as it requires calculation of a new F.

$$F = \exp(-.693/H)$$

If the answer is less than one, then replace lines 08 to 10 with the three most significant digits after the decimal point. If the answer is greater than one then replace lines 07 to 10 with the four most significant key-strokes.

e.g. If answer is 0.9330114 then put 933 into lines 08 to 10.

N.B. The only way the answer to this sequence can be greater than one is if your value for D is -ve in which case you are no longer working with a radioactive decay curve but with an exponential growth curve.

D= Difference between new mass and guess

F= Decay Factor

G= Guess

H= Half Life

M= Initial Mass

S= Score Total of Hits

T= Tolerance on guess

See next page for program.

## FLOW CHART

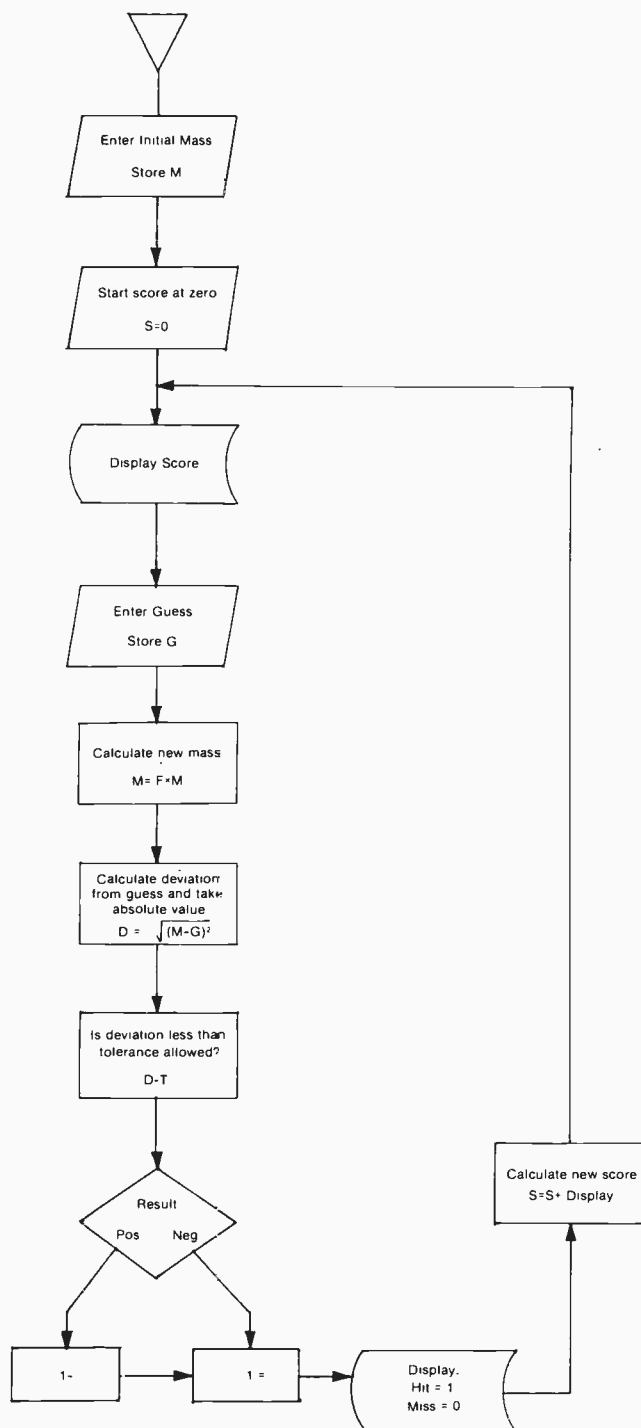

# ETI MARKET PLACE

We will allow you up to twenty-five words to advertise items you want to buy or sell, or to publicise meetings of clubs, etc. Advertising will be accepted at our discretion — we will not accept commercial or any form of company advertising. For more insertions mail in again.

Please send in your advertisement on the back of a postcard or empty sealed envelope.

**WANTED** APRIL/77 ISSUE OF E.T.I. OR REPRINT OF COMPLETE ARTICLE CONCERNING 50/100W AMP IN SAME ISSUE. W. MARKIN., P.O.B. 153, ERRINGTON, B.C. V0R 1V0.

**FOR SALE** COLLECTORS SPECIAL! AMERICAN BOSCH MODEL 61CB VINTAGE FLOOR CONSOLE RADIO. WORKING CONDITION. \$100.00 OR OFFERS. G.R. YAWORSKI, 14 CLIFTON CRESCENT, LONDON OR (519) 681-0154 EVENINGS.

**WANTED** I WANT TO BUY THE E.T.I. APRIL 1977 ISSUE. WRITE ME IF YOU HAVE THIS RARE ISSUE. BRUNO DORAIS, 524 ST. CLEMENT, BEAUMARNOIS, QUE. J6N 2A7.

**FOR SALE** 2 NEW MARANTZ 250 WATT OUTPUT METERS WITH BOARDS — \$80. 2 250W AMPLIFIER BOARDS R.S. PARTS, RCA INSTRUCTIONS, HEAT SINKS — BEST OFFER. CALL ONTARIO WK-DAYS MORN. (514) 325-1836, BORIS.

**FOR SALE** SILICON RECTIFIERS 500 M.A. 500 P.I.V. 13¢ EACH, ELECTROLYTIC CAPACITORS 12 UF 60V 14¢ EACH, 325 UF 5 VOLT 12¢ EACH. DOUG BRYAN, 29 DORCHESTER DR., BRAMALEA, ONT. L6T 3C8.

**PERSONAL AD** CLEANING OUT ELECTRONIC WORKSHOP! MANY PARTS NEW AND USED FOR SALE. SEND FOR LIST. D.W. BRYAN, 29 DORCHESTER DR., BRAMALEA, ONT L6T 3C8.

**LOOKING FOR** ANY INFO OR MOD ON XTORS RECEIVER VHF NO. R962/ARR-5Z ALSO DIAGS ON MULTI PLEXING LED OR GAS DIS & H ON BURROUGHS, 12 DIGITREADOUT NO. BR13451 OR 16 DIGIT PANAFLEX BURROUGH NO. 16401 (KR 85). IF BURROUGHS CAN DO IT E.T.I. READERS CAN. J.J. BOURE, 454 NOTRE DAME AVE., ST. LAMBERT, PQ. J4P 2K4.

**FOR SALE** 1 ONLY 604-B 16 OHM 15 IN. DUPLEX SPEAKER WITH ORIGINAL CROSSOVER — COLLECTOR'S ITEM. BEST OFFER. DONATO C., 10451 ROME AV., MONTREAL-N, QUEBEC H1H 4N8. PROMPT RESPONSE.

**FOR SALE** ELECTRO-VOICE "REGENCY". CORNER FOLDED HORN LOUDSPEAKERS DESIGNED BY KLIPSCH. 15W WOOFER, T25A/8HD MID-DIFFRACTION HORN. T35A EXPONENTIAL TWEETER. \$600./PAIR. MONTREAL (514) 620-1681.

**FOR SALE** 3500 T.V. & RADIO TUBES 0.10 EACH. NEW & USED ALL GOOD. BOXED 1000 SPEAKERS. 2 TO 4 INCH 0.15 COULD SHIP. YOUR COST. E.F. LAPORTE, ST. BARTHELEMY, CTE. BERTHIER, QUE. J0K 1X0.

**FOR SALE** PHASE LINEAR 2000 PRE-AMP WITH CABINET \$360.00. TOSHIBA 4-CHAN AMPLIFIER \$240.00. BOTH EXCELLENT CONDITION. JOE FARYNA, P.O. BOX 1082, THOMPSON, MANITOBA R8N 1M9. WILL PAY FREIGHT.

**FOR SALE** PAIA SYNTHESIZER — 3 VCO's, 2 VCA's, SEQUENCER, MULTI-MODAL FILTER, 2 ENVELOPE GENERATORS, REVERB, MIXER, KEYBOARD ETC. WALT JOHNSON, 1670 PELISSIER, WINDSOR, ONT. N8X 1N2. (519) 256-6939.

**FOR SALE** ASSEMBLED HEATHKIT. AMPLIFIER 60 WATTS PER CHANNEL AA-1506, STEREO PREAMP AP-1615, AUDIO EQUALIZER AD-1305, \$600. TERRY MILLER, R.R. 1, B252, GASPE, QUE (418) 368-3857.

**WANTED** ANYONE INTERESTED IN JOINING A CASSETTE TAPE RECORDING CLUB. TAPES FOR TRADE ONLY. ALSO THOSE INTERESTED IN A SCHEMATIC & CIRCUIT DIAGRAM TRADE CLUB. CONTACT JAMES PAYETTE, BOX 250, ECHO BAY, ONT. P0S 1C0.

**WANTED** DEMANDE LIVRES ET PERIODIQUES MECANIQUE ELECTRONIQUE PHOTO ENVOYEZ LISTE & PRIX. WANTED BOOKS AND MAGAZINES MECHANIC ELECTRONIC PHOTO. SEND LIST & PRICES. LACHAPPELLE, 3924 MENTANA, MONTREAL, QUE. H2L 3R8.

**FOR SALE** TELETYPE MODEL 35 R.O. PRINTERS. PIN FEED PAPER, 12 CHARACTER PER INCH. EXCELLENT CONDITION \$500. D. SHERK, 53 LARONE AVE., SAULT STE MARIE, ONT.

**FOR SALE** 11 1/2 FEET LONG 34 CONDUCTOR RIBBON CABLE, NEW UNUSED. WITH 2 SIDED PC BOARD EDGE CONNECTOR: .1 INCH CENTRES MOLDED ON EACH END. MADE BY AP PRODUCTS. \$10.00 O.B.O. MING HUI, 3085 COLWOOD DR., N. VANCOUVER, B.C. V7R 2R5.

## Atomic Decay Game PROGRAM

		+	E	00
		I	6	01
	SCORE DISPLAYED	Stop	0	02
		V	A	03
		ME*	5	04
		x	.	05
		#	3	06
		A	0	07
		9	9	08
		3	3	09
		3	3	10
		*	-	11
		V	A	12
		ME*	5	13
		-	F	14
		Rcl	5	15
		x	-	16
		=	-	17
		√x	1	18
		-	F	19
		#	3	20
		0	0	21
		1	1	22
		=	-	23
		V	A	24
		JIN	1	25
		3	3	26
		1	1	27
		#	3	28
		1	1	29
		-	F	30
		#	3	31
		1	1	32
		=	-	33
		Stop	0	34
		I	6	35

FINAL VALUE OF BRACKETS ADDED TO TOTAL RUNNING SCORE

CALCULATES NEXT VALUE OF DECAY CURVE

COMPARES GUESS WITH VALUE CALCULATED PLUS OR MINUS C GRAMS



CALCULATES HIT/MISS FIGURE 1 = HIT 0 = MISS

HIT/MISS DISPLAY

The program above runs on the Sinclair Cambridge Programmable.

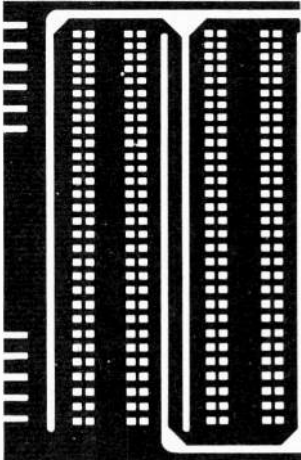

Printed Circuit Board materials for the Hobbyist and Technician.

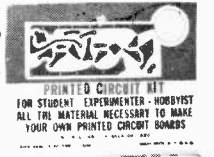
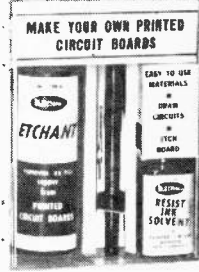
INJECTORALL — from Fingers to Doughnuts a very complete line of quality circuit board materials.

**omnitronix Ltd.**

2056 SOUTH SERVICE RD. TRANS CANADA HWY. DORVAL, QUE. H9P 2N4 · PHONE (514) 683-6993

# wire wrapping

**ok center ok**

**NEW HOBBY WRAP  
MODEL BW 630**



Battery  
wire  
wrapping  
tool

Batteries  
not included  
COMPLETE WITH BIT  
AND SLEEVE

**STRIP / WRAP / UNWRAP  
MODEL WSU-30**



**DIP IC INSERTION  
TOOL WITH PIN  
STRAIGHTENER**

MODEL  
INS-1416



**WIRE DISPENSER  
MODEL  
WD-30-B**



REFILLABLE

Write for complete OK Machine & Tool Catalogue

**len finkler ltd**

25 Toro Road, Downsview, Ontario M3J 2A6  
telephone 630-9103 telex 065-24010



# Intersil 3 1/2 DIGIT PANEL METER

## LCD or LED KITS



**BUILD A WORKING DPM IN 1/2 HOUR WITH  
THESE COMPLETE EVALUATION KITS**

Test these new parts for yourself with Intersil's low cost prototyping kits, complete with A/D converter and LCD display (for the 7106) or LED display (for the 7107). Kits provide all materials, including PC board, for a functioning panel meter.

ICL7106EV (LCD) \$42.56

ICL7107EV (LCD) \$36.40

# REPEAT OFFER

We have just received another shipment of the:

## KIM Microcomputer

For those who missed it last time one of the most powerful microcomputers at this price.

**ONLY \$275.00**

1024 byte RAM  
2048 ROM bytes  
30 I/O pins 2 timers

Power supply for KIM

complete with LED display and keyboard.  
Interface to teletype and audio taperecorder.

**ONLY \$45.00**

# BONUS OFFER

## Police Radar Detector

One of the most effective radar detectors available.  
Micro eye mark 1

with purchase of KIM **\$69.95**

without purchase of KIM, price is **\$99.95**

## We are now taking orders for the Commodore 2001 PET

Mail orders: Include \$3.50 (plus 7% Ont. Sales Tax, if Ont. Res.)  
Send Cheque, Money Order or Chargex, Master Charge;  
card information (number and signature).

To: **Marketron Corp. Ltd.,** Phone: (416) 923-1917  
1240 Bay Street Mall  
TORONTO, Ontario M5R 2A7

Store Hours: 10:00 a.m. to 6:00 p.m. Mon.-Wed.; Thurs & Fri. till 8:00 p.m.



**HYBRID AUDIO  
POWER AMPLIFIERS**

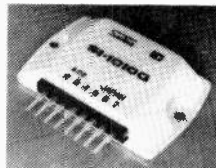

- Multi-purpose linear amplifiers for commercial and industrial applications.
- Less than 0.5% harmonic distortion at full power.
- 1/2 dB response from 20 to 100,000 Hz.
- Single or split (dual) power supply.
- Rugged, compact and lightweight packages.
- Built-in current limiting for SI-1030G, SI-1050G and efficient heat radiating construction.

**TYPICAL CONNECTIONS  
SI-1050G WITH SPLIT SUPPLY**

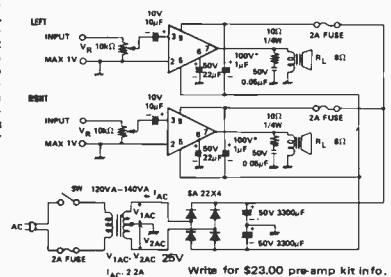

SANKEN Series SI-1000G amplifiers are self-contained power hybrid amplifiers designed for Hi-Fi, stereo, musical instruments, public address systems and other audio applications. The amplifiers have quasi-complementary class B output. The circuit employs flip chip transistors with high reliability and passivated chip power transistors with excellent secondary breakdown strength. Built-in current limiting is provided for SI-1030G, SI-1050G and all devices can be operated from a single or split supply.

- SI-1010G (10W output) \$ 8.40
- SI-1020G (20W output) \$15.70
- Socket for above 1.35
- SI-1030G (30W output) \$25.40
- SI-1050G (50W output) \$31.40
- Socket for above 1.35

Data with Application Notes.....\$ .50

Write for \$23.00 pre-amp kit info.

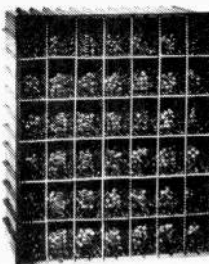

## 1/4 WATT 5% CARBON FILM RESISTOR KIT

COMPLETE WITH STORAGE BIN.  
Each KIT contains 20 each of 42  
different values of 1/4W Carbon Film  
Resistors from 68 ohm to 4.7 megohm

Order P/N RS-14-25 **\$24.90**

**CONTI  
ELECTRONICS  
LIMITED**

5656 FRASER STREET  
VANCOUVER, B. C.  
V5W 2Z4  
PHONE: (604) 324-0505  
TWX: 610-922-6037

EXCLUSIVE CANADIAN DISTRIBUTOR FOR E-Z HOOK

# COLOR ORGAN KIT



3 CHANNEL  
\$19.95



5 CHANNEL  
.....29.95

6 CHANNEL  
STEREO  
2 X 3 CH.  
37.95



Creates beautiful psychodelic lighting effects from any sound source. Easily connects to your stereo system, musical instruments amplifier, PA system, etc. divides the sound into three separate channels, low, med. and high frequency. You plug three lights or three sets of lights into the back of the controller (not to exceed 500 watts per channel). Each set of lights can be individually controlled.

LIMITED QUANTITY  
Stock Up Now..

## Receiving Tubes

.99		1.29		1.49		2.49	
4BZ6	9AU7	3DK6	10DE7	3HQ5	6HD7	2E26	10LZ8
6BJ6	12AU6	3CB6	12AT7	4HT6	6HQ5	3BH2	17BE3
6BH6	12BE6	6AU6	12BY7	5AT8	6JU8	6HJ7	17BF11
6BZ6	12AD6	6GK6	12BR7	6CL8	10JA8	6JT8	17KW6
6CB6	12AL5	6J6	12DB5	6EM5	10JY8	9ED4	27GB5
6J4	12SN7	6SQ7	19EA8	6GH8	12FX5	9V9	40KG6
6W4	12X4	8CG7	25AX4	6HB7	14GW8	10GN8	42EC4

## Relays \$3.95

No; KR-7 DPDT 3 FOR \$10.00  
24 V.AC 20 Amp

A small, low cost, highly efficient general purpose relay for handling light power loads such as small motors, solenoids and other relays, and general automation work. All AC models carry U/L labels;

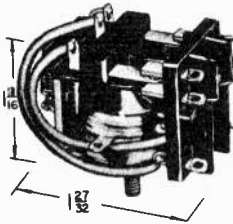

**KRP SERIES** Versatile, multi-contact arrangement. Enclosed in a clear cellulose acetate dust cover. Standard 8-pin octal-type plug for KRP5 and KRP11, 11-pin for KRP14. Weight: Approx. 3 ozs. Contacts: 5 amp, 3/16" dia. gold-flashed silver.

\$3.95

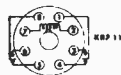

No; KRP- 70 3V. DPDT 5amp.  
11 pin 3 for \$10.00

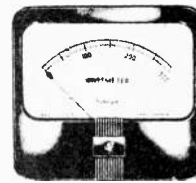
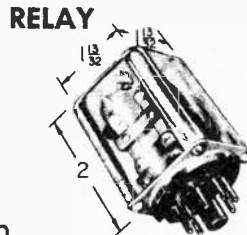

## Panel Meters

4 1/2" scale

A.C. VOLTMETER 0 - 234 v.A.C.

A.C. MILLIAMMETER TWO SCALES

LOW 0 - 27.5 ma.  
HIGH 0 - 242 ma.

\$6.95

5 for \$30.00

Special Computer Grade Capacitors YOUR CHOICE



SPRAGUE, MALLORY SANGAMO and G.E. GUARANTEED FOR ONE FULL YEAR

2" dia. x 4 1/2"	2" dia. x 4 1/2"	3" dia. x 4 1/2"
250 mfd. 350 v.	500 200 v.	1,500 100 v.
1,500 150 v.	2,000 50 v.	2,000 100 v.
3,500 75 v.	2,500mfd. 45 v.	3,750 75 v.
5,500 19 v.	5,000 55 v.	7,000 13 v.
7,000 13 v.	11,000 mfd 19 v.	7,750 10 v.
8,000 15 v.	14,000 13 v.	10,000 10 v.
11,000 10 v.	15,000 10 v.	10,000 10 v.
11,000 10 v.	19,000 8 v.	3" dia. x 4 1/2" 25,000 6 v.
74,000mfd. 10 v.	36,000 4 v.	

1.95 YOUR CHOICE

Plastic Cased

## "MOOVIT"

THE SUPER LUBRICANT

for tuners — switches — changers removes rust — inhibits corrosion permanent lubrication for every mechanical or electrical situation



CJM CAPSULE LENLINE JELLED MOOVIT 20 INDIVIDUAL APPLICATIONS OF MOOVIT IN FIRE ENGINE RED CAPSULES, IN A RE-USABLE ROUND PLASTIC BOTTLE NET PRICE PER PLASTIC JAR ~~\$2.99~~

SPECIAL 1.75

THIS IS PROBABLY THE BEST CLEANER LUBRICANT PRESERVATIVE AVAILABLE. FOR THE ELECTRONIC TECHNICIAN, THE MECHANIC OR THE TINKERER

## Miniature Lamps

FLASHLIGHT BULBS

PR-2 2.4v. 10 for 65¢  
PR-3 3.6v. 100 for \$4.50  
PR-13 4.75v.

PRE-FOCUSED BULBS

# 112 1.2v. 10 for 65¢  
# 222 2.2v. 100 for \$4.50

BAYONET BASE BULBS

# G590 14 v. 12 for \$1.00  
.06 A. 100 for \$7.00

SCREW BASE BULBS

# 248 12 for \$1.00  
2.5 v. 100 for \$7.00

## FUSETRON FUSES,

LIMITED QUANTITY  
Stock Up Now..



DUAL-ELEMENT SLOW BLOWING TYPE

1/4" x 1 1/4" 12c  
\* 1 1/2 amp. 100 for \$10.00  
\* 10 amp

## Rotary Relay



2.95 EACH

12 VOLTS D.C.

CONTACTS DPDT 10 A.

## READOUT TUBES

16 SEGMENT

Cold Cathode neon glow discharge tubes manufactured for in-line display of numbers, letters or symbols offer the following:

BEST READABILITY • LONGEST LIFE • SIMPLICITY • RUGGEDNESS  
ECONOMY • UNIFORMITY • ALL ELECTRONIC • NON FADING



150 v. DC COMMON POSITIVE  
approx. 3 ma. per segment  
16 SEGMENT

DISPLAY SIZE 4" x 2"  
5 for \$20.00

\$4.95



**GLOBE ELECTRONICS**  
CORP. LTD.

DISTRIBUTORS OF ELECTRONIC EQUIPMENT AND PARTS

1925 AVENUE ROAD - TORONTO, ONT. M5M 4A1

783-1801

783-1832

# tech-tips

Tech-Tips is an ideas forum and is not aimed at the beginner. ETI is prepared to consider circuits or ideas submitted by readers for this page. All items used will be paid for. Drawings should be as clear as possible and the text should preferably be typed. Circuits must not be subject to copyright. Items for consideration should be sent to ETI TECH-TIPS, Electronics Today International, Unit 6, 25 Overlea Blvd., Toronto, Ontario, M4H 1B1.

## BATTERY OPERATED VCO

R. Zaman.

BY USING the LM3900N quad-op-amp, a simple portable battery operated VCO can be made very cheaply. A1 forms an integrator, the ramp rate depending on the voltage  $V_i$  and capacitor C. This ramp is fed to a Schmidt trigger which switches at about 5.8V, making A1 ramp down, generating a triangular wave of about 0.85 V.

The Schmidt trigger feeds a transistor switch and an emitter follower.

The triangular wave is then fed to A3 which acts as an inverting amplifier, and the output is fed to A4 which is an exponential integrator set at a pseudo-ground of 4.5 V. The bias and gain pots must be adjusted to give the best sine waveform.

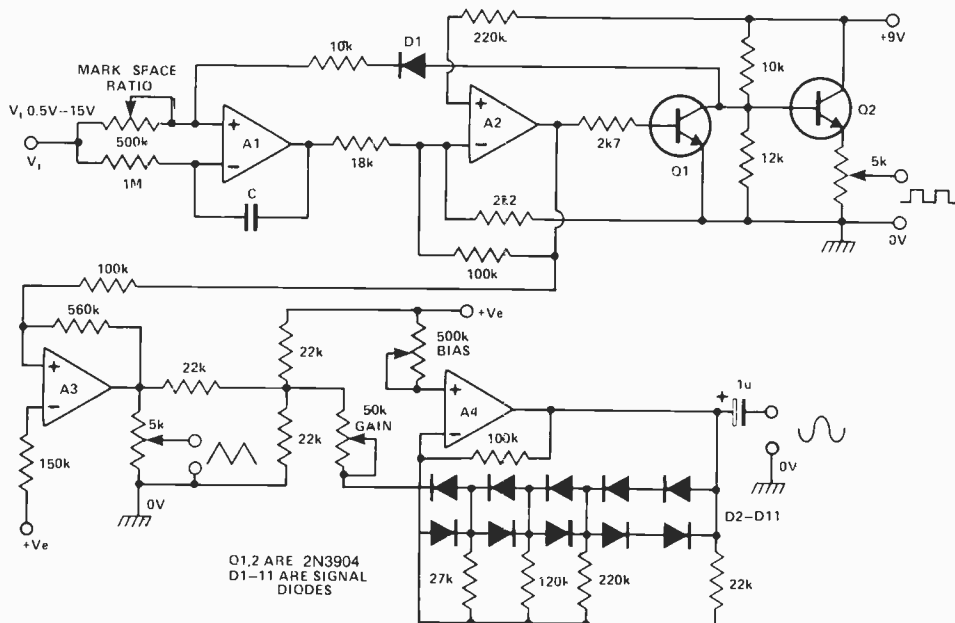

$V_i$  can be any positive voltage from +0.5  $\leftrightarrow$  +15.0 V, giving a frequency

range of about 1:100. Capacitor C can be any value from 10n $\leftrightarrow$ 47n and

the outputs have a low distortion up to about 20 kHz.

## NOVEL LOUDSPEAKER COUPLING CIRCUIT

P. Mills.

In most amplifier designs the speaker is fed by a high value capacitor to provide DC blocking, but this may result in a heavy switch-on surge, as the capacitor charges up.

An alternative approach, which is worthy of experiment, is shown in the diagram below. Here the ground side of the speaker is connected to the junction of two equal high value capacitors (1000 uF is typical), across the supply.

The amplifier output voltage will be at  $V_s/2$ , and so will the voltage across  $C_1$  (if  $C_1$  and  $C_2$  are equal); so as the supply voltage builds up, the DC voltage across the speaker will remain zero, eliminating the switch-on surge. The circuit is shown with the LM380, but could be applied to any amplifier circuit, providing that the DC voltage at the output is half the supply voltage.

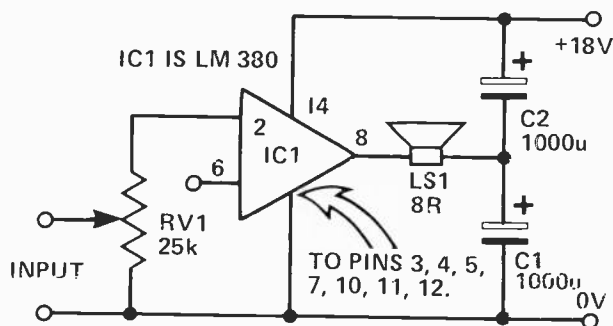

## HITS FOR ETI PROJECTS

Now Available

ETI Project No. 134  
True RMS Voltmeter  
Price only  
\$89.95

Project No. 450  
Bucket Brigade  
Audio Delay Line  
\$48.50

Cheque, Money Order  
or Master Charge  
include card expiry date  
and number  
DO NOT SEND CASH

**DOMINION RADIO &  
ELECTRONICS**  
535 Yonge St. Toronto  
Ontario M4Y 1Y5



# Where's the screwdriver?

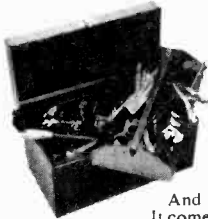

In a tool box, tools and parts are everywhere. They're hard to find. They get lost. (And they get dirty.)

With a Platt tool case, that wouldn't happen. It's designed so you'll know where everything is. Smaller tools are in individual pockets in our patented one-piece pallet. Larger tools and parts are in compartments. And papers and order book are in lid pockets. (Everything is neat and clean.)

And Platt's tool case helps you look more professional.

It comes in handsome, lightweight, durable ABS Thermo-plastic. Or rich looking vinyl reinforced by ABS Thermoplastic. What's more, it also has a 5 year guarantee.

Contact us for complete information on Platt's full line of tool cases and your nearest distributor.

**platt**

Cases for business and industry.

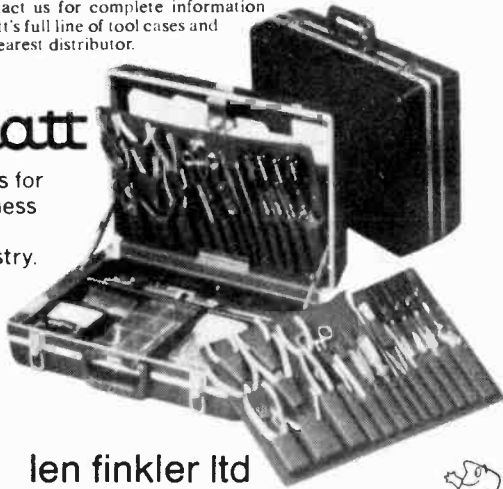

**len finkler ltd**

25 Toro Road, Downsview, Ontario M3J 2A6  
telephone 630-9103      telex 065-24010



## All in ETI's 741 Cookbook:

- Differential voltage comparator
- Open-loop inverting DC amplifier
- Closed-loop inverting DC amplifier
- Non-inverting DC amplifier
- Unity-gain DC voltage follower
- X100 inverting DC amplifier
- Variable gain inverting DC amplifier
- High impedance x100 inverting DC amplifier
- X100 inverting AC amplifier
- Non-inverting x100 DC amplifier
- Non-inverting variable-gain DC amplifier
- High input impedance, non-inv, x100 AC amplifier
- Non-inverting x100 AC amplifier
- DC voltage follower
- AC voltage follower
- Very high input impedance voltage follower
- Unidirectional DC v-follower, boosted output
- Bidirectional DC v-follower,
- boosted output
- Unity-gain inverting DC adder (audio mixer)
- Unity-gain balanced DC phase splitter
- Unity-gain differential DC amplifier (subtractor)
- Semi-log AC voltage amplifier
- Constant-volume amplifier
- 1kHz tuned amplifier (twin-T, acceptor)
- 1kHz notch filter
- Variable low-pass filter
- Variable high-pass filter
- Variable-voltage supply
- Stabilised power supply
- Stabilised power supply with overload protection
- Precision half-wave rectifier
- Precision half-wave AC/DC convertor
- DC voltmeter converter
- DC voltage or current meter
- Precision DC millivoltmeter
- Precision AC millivoltmeter
- Linear-scale ohmmeter
- Audio Wien-bridge oscillator
- Square-wave generator
- Precision temperature switch

Available from ETI for \$2 (includes postage). Just order our May 1977 issue from ETI Back Issues Dept, Unit Six, 25 Overlea Blvd, Toronto, M4H 1B1.

### JUMBO LED READOUT ARRAY



**\$1.95 LIMITED STOCK**

By Bowmar. .5 in. character common cathode. Designed for use with multiplexed clock chips 4 digits in 1 pack!

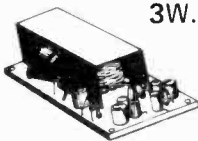

### 3W. AUDIO AMP

**\$3.95**  
2 1/2" x 3"

Assembled & tested. Not a kit. Has tapped output for either 4, 8 or 16 OHMS. With schematic.

### CMOS SPECIAL!

CD4001-5/\$1.    CD4011-5/\$1.  
CD4013-3/\$1.    CD4040-\$1. each  
CD4042-2/\$1.    CD4049-3/\$1.

### FILTER CAP

Mini Size. Axial. 1,000 MFD. 16 WVDC.    **4/\$1.00**

### RED LED READOUT FILTER

Very handy. Can be used with our calculator displays. 2 1/4 x 1/2"    **6/\$1.**

2708 1KX8 EPROMS 2708

Prime new units from a major mfg. 450 N.S. access time. Equivalent to 4-1702 A's in 1 package!    **450 ns \$15.75 each**

### MOTOROLA 7805R Voltage Regulator

Same as standard 7805 except 750 MA output. **TO-220. 5VDC output. 44c each    10/\$3.95**

### 4K STATIC RAM'S

2114. The new, industry standard. Arranged as 1K x 4. Equivalent to 4-21 L02's in 1 package! 18 pin DIP. 2 chips give 1Kx8. **2 for \$24.    8 for \$85.**

### OPCOA LED READOUT

SLA-1 Common Anode. .33 inch character size. The original high efficiency LED display.    **75c ea.    4/\$2.50**

### TRANSFORMER

12 Vac. 600 MA. PRI-115 VAC 60 HZ. Perfect for clocks or power supplies! **Small Size. \$1.95**

### LED IC Counter Kit

You Get: 1-7490; 1-7475; 1-7447; 1- Led Readout. All this for **\$1.99** (Led Readout is famous SLA-1. .33 in. By Opcoa.) **SALE! \$1.99!**

### 741C OP AMPS

Mini Dip. Prime new units. Has computer Mfg's house number. 12/\$2.    100 for \$15.

### DISC CAPACITORS

.1 MFD 16V. P.C. leads. Most popular value! By Sprague. 20 for \$1.00

**Full Wave Bridge 4 Amp 200 PIV 69c ea. 10/5.75**

**5V. NI-CAD Battery 4 cell Pack. Rated 500 MAH. NEW! \$3.95 pack**

**2N3904-House No. TO-92. NPN. VCEO-45. HFE 100 to 300 10 for \$1.00**

**Jumbo Red Leds** New by G.E. Like MV5024. Number SSL-22. **6/\$1.    25/\$3.75**

**Motorola PNP Power!** 2N4905. TO-3 case. 90W. VCEO-60; HFE-100 max. at 2.5A. Good mate for the 2N3055. 75c each. **4/\$2.50    PRIME!**

**TI POWER TRANSISTORS TO-220. VCEO-60V. 30W. TIP29A-NPN 44c TIP30A-PNP 44c**

**CMOS QUAD Bilateral Switch CM4116. By Solitron. An improved CD4016. 3/\$1.**

**Motorola Quad Op-Amp MC3401. Pin for Pin Sub for popular LM3900. 3/\$1.00**

## Digital Research Corporation

(OF TEXAS)  
P.O. BOX 401247C • GARLAND, TEXAS 75040 • (214) 271-2461

**TERMS:** Orders under \$15, add 75c. No COD's. We accept VISA, MasterCard, and American Express Cards. Money Back Guarantee on all items! Texas Res. add 5% Sales Tax. U.S. Funds Only! We pay postage.

## CHANNEL SPLITTER FOR RADIO CONTROL

G. Bathe.

This circuit is designed to replace the electromechanical reed units used as channel-splitters in radio controlled models.

The circuit is based on the MC 1310P integrated circuit, a chip that is primarily a stereo decoder for use in stereo radio tuners. When used as a stereo decoder, the MC 1310P automatically switches itself from the mono mode to the stereo mode whenever its input contains the 19 kHz subcarrier of a stereo multiplex signal at a sufficiently high level (16 mV), and switches back to the mono mode when the 19 kHz subcarrier ceases to be present. Pin 6 of the integrated circuit drives a stereo indicator lamp to give a visual indication of whether the circuit is operating in the stereo or mono mode.

It is this lamp driver facility of the MC 1310P that makes it an ideal chip to use as a channel-splitter. When used as a channel-splitter the circuit is not tuned to the 19 kHz of the stereo decoder but to the audio frequency that the circuit is required to detect, and the lamp driver output from pin 6 is used to drive a power transistor controlling a motor or other device.

The output from the detector of a radio receiver is amplified by the 2N3904 and then fed into a series of MC 1030P channel-splitters (connected in parallel) each tuned to a different audio frequency.

The audio frequency to which the channel-splitter responds is determined by the tuning circuit R1, VR1 and C1, and is given by the formula:-

$$f = \frac{1}{2\pi C1 (R1 + RV1)} \text{ Hz}$$

The value of C1 is chosen to give the required tuning range for the preset RV1. For example, if C1 is 10,000 pF, then the tuning range is approximately 750 Hz to 1,000 Hz.

The output is a switched current output between Pin 6 of the chip and the positive supply rail. This current should not exceed 35 mA and so a 470 ohm resistor is inserted in the output connection from Pin 6 as short circuit protection. If a voltage output is required then a resistor can be connected from Pin 6 to the positive supply and the voltage output taken from Pin 6.

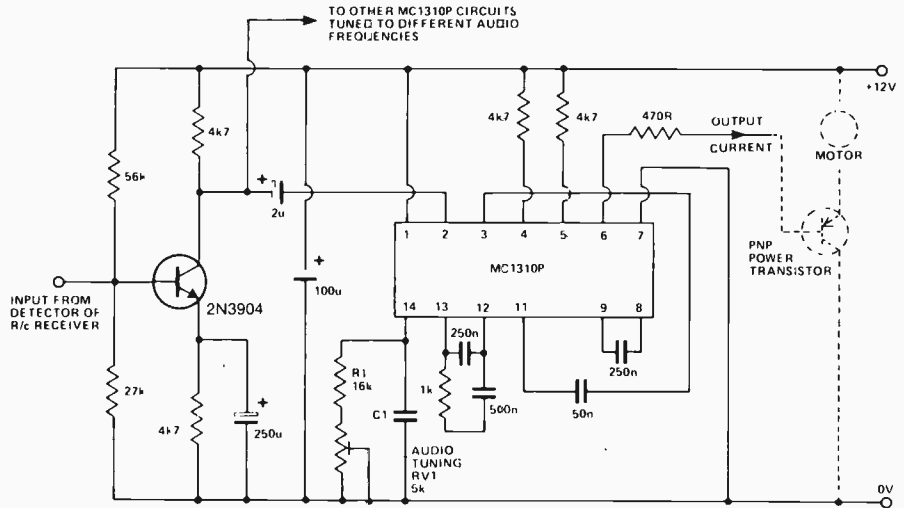

The MC 1310P is triggered when the input to Pin 2 contains its tuned frequency at a level greater than 16 mV. It can be triggered by noise if the noise level is greater than 16 mV. Some radio control transmitters tend to transmit noise when they are not transmitting a

tone, and if this is the case the transmitter should be modified to prevent noise being transmitted. This could be done by making the transmitter transmit an extra unused tone whenever it is not transmitting one of the used audio tones.

## CMOS RADIO

J. P. Macaulay

The circuit shown is of a simple AM receiver based on the 4011 CMOS IC.

The four gates in this package are used as linear amplifiers by connecting their inputs together and applying negative feedback.

L1, 80 turns of 22 SWG enamelled wire close wound on a 3/8" diameter ferrite rod, is the pickup coil. This is tuned by the 500pF trimmer and the resulting tank circuit referred to ground at RF by C1.

The high input impedance, that of IC1/1, 'seen' by the tank circuit ensures that little damping occurs, and thus the

receiver is highly selective. The output of IC1/1 is an amplified RF signal and is passed to IC1/2 for detection.

The unwanted RF appearing at the output of the detector is removed by the lowpass filter formed by R4 and C2.

The audio signal is then fed to an amplifier formed by IC1/3 and IC1/4.

The circuit's current consumption is about 10 mA when operated from a 9 V supply.

Note that the IC used must be a 4011AE and not the 4011B whose input protection network will prevent it from operating in the linear mode.

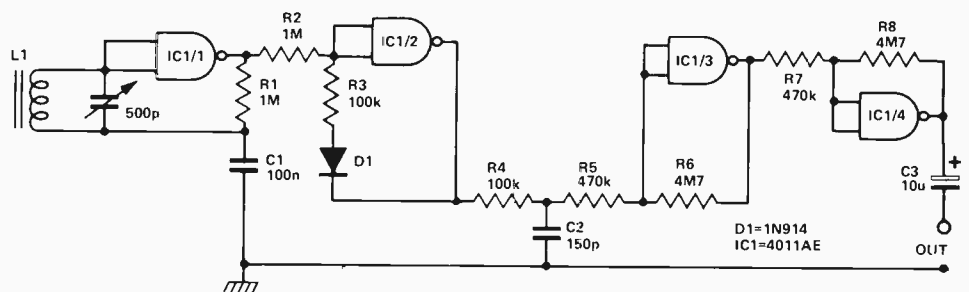

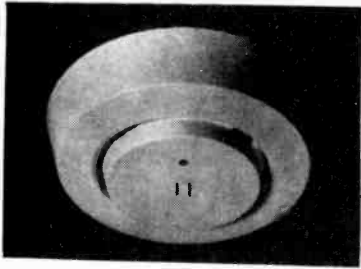

# A BURNING NEED!

Protect Your Family by Installing an  
Early Warning

## DICON SMOKE DETECTOR

Over 80% of fire victims are not burned to death. They are ASPHYXIATED. The major killer is smoke, especially when you are asleep.

### LOUD 85 DECIBEL ALARM

Our DUAL IONIZATION CHAMBER senses invisible combustion particles, even before there is visible smoke at the beginning of a fire. This provides valuable, often crucial TIME TO ESCAPE.

only  
**\$33.95**  
each

Uses inexpensive,  
easy to obtain,  
DURACELL Battery

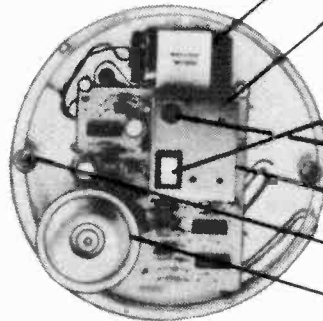

- BATTERY OPERATED:**  
Keeps working even if house power fails.  
Uses INEXPENSIVE, easy to obtain, Mallory 9 volt MN-1604 Duracell battery.
- DUAL IONIZATION CHAMBER:**  
Responds to fires in their earliest stages of development. Compensates for changes in humidity and temperature to VIRTUALLY ELIMINATE "NUISANCE ALARMS" caused by normal atmospheric changes in the home.
- LOW BATTERY WARNING:**  
Unit gives audible "click" every sixty seconds for a minimum of seven days when battery needs replacing.
- TEST BUTTON:**  
Pressing the button virtually duplicates the effect of smoke in the sensing chamber. Alarm sounds when button is pressed to test unit.
- OPERATING LIGHT:**  
This Light Emitting Diode (LED) flashes once every minute to confirm that the unit is receiving power from the battery.
- SUPERVISED SENSING SEMICONDUCTOR:**  
Continually on -- should electrical continuity to this vital component break, the alarm will sound immediately.
- EASY INSTALLATION:**  
Two screws and anchors (supplied) provide mounting simplicity. Nothing else to connect.
- ALARM:**  
85 DECIBEL ALARM to alert sleeping occupants AUTO-MATICALLY RESETS when the hazardous condition has passed.

 Underwriters Laboratories of Canada  
listed and labelled

Suggested retail price \$49.95

RKG Hospitality Services direct mail price only \$33.95

plus \$1.95 shipping and handling.

Clip and mail to:  
RKG Hospitality Services, Dept. 27A, P.O. Box 144  
Postal Station "R", 2 Laird Dr., Toronto, Ontario M4G 3T0  
Please send me my Dicon Smoke/Fire Detector for only \$33.95 plus \$1.95 shipping and handling. Ontario residents please add 7% P.S.T.

Total cheque/money order enclosed \_\_\_\_\_

Name \_\_\_\_\_

Address \_\_\_\_\_

City \_\_\_\_\_ Prov. \_\_\_\_\_ P.C. \_\_\_\_\_

Please print clearly

Chargex.     Master Charge.    Expiry date \_\_\_\_\_

Credit card no. \_\_\_\_\_

Signature \_\_\_\_\_

COD orders. Please include \$1.50 (Non refundable)

**15 DAY  
MONEY BACK  
GUARANTEE**

**TWO YEAR  
Warranty  
against defects  
in workmanship  
and materials**

# Club Call

## The Ontario DX Association

ODXA Headquarters, 1202 York Mills, No. 1910, Don Mills, M3A 1Y2.

**Aims and Objectives:** The Ontario DX Association, ODXA, is a body of Ontario radio listeners which seeks to unify listeners in this province and assist them to grow in and enjoy the hobby more. This is done by means of a monthly bulletin, entitled "DX Ontario", personal contact at local and province-wide meetings and other means of communication amongst the members. The ODXA is also committed to promote the hobby to the public and assistance and information is provided to those expressing an interest.

The idea to form the ODXA originated in the summer of 1974 and a three-man organizing committee then undertook to bring the club into reality. By February of 1975 our first bulletin was off the press. The club has continued to grow at a steady rate since that time and "DX Ontario" has been published monthly ever since.

**Newsletter:** "DX Ontario" presently averages 40 to 45 pages per month and deals primarily with listening to the medium and short wave bands. There are columns of loggings and verifications as well as news and schedules. We also have a monthly column discussing the programming heard on shortwave. Other columns include articles on stations, equipment, DX programs, and English broadcasts audible in Ontario.

**Meetings:** In the Toronto area members of the ODXA may attend a meeting held on the first Monday of each month, at 7:30 pm at the Downsview Public Library (Keele and Wilson). Often there are meetings held on Saturdays at the homes of members. And there are one or two weekend-long get-togethers held each year. All of these meetings are publicized in advance in "DX Ontario". Any listener is welcome to attend, and information on upcoming meetings may be obtained from ODXA Headquarters.

**Directors:** The ODXA is operated by the membership. An elected three-man Board of Directors directs club operations, supervising other such staff as

Publisher, Managing Editor, Treasurer, Membership Secretary and Publicity and Awards Committees. Approximately ten editors are on staff to edit the columns for the bulletin.

**Membership:** Membership in the ODXA is restricted to residents of Ontario. Annual dues are \$11.00 (special rate of \$8.00 for full-time students). Members receive a certificate, personal identifier (number), 12 issues of "DX Ontario" and are entitled to participate in all club elections and activities. Members are encouraged to make contributions to the bulletin, such as their loggings, reports of verifications received, etc.

If you would like to inquire about joining the ODXA, write to: ODXA Membership Secretary 18 Riverview Road Lindsay, Ontario K9V 1B1.

## The Canadian Computer Correspondence Club for Hobbyist Computer Users

5768 Davies Ave. Cote St. Luc, Montreal, Quebec, H4W 2R4.

**Aims and Objectives:** We at CCCC are a computer mail correspondence club formed to aid the hobbyist in programming in the most common hobbyist language, BASIC. We are non-profit and request that all new members enclose stamped, self-addressed envelopes or at least enclose an extra postage stamp when writing to us, so that we may keep expenses down.

**Membership:** Any person wanting to join, whether this person has access to or owns a BASIC computer, or not, will be accepted. Bimonthly (and maybe even monthly, depending on the number of members) newsletters will be sent out. In these letters, we will include information about the club, answers to members' problems, and interesting programs that members have sent in.

Contributions in the way of programs will be greatly appreciated. If a member has a program that has a bug in it, we would be glad to offer any assistance.

**Executive Members:** We, the executive members of CCCC, are experienced

programmers in BASIC and we would like to hear and correspond with other computer enthusiasts. We feel that we have enough experience to solve or help solve almost any problem.

I am presently the Chairman and the Chief Public Relations Officer of CCCC, and I hope to be able to have many ETI readers as members. There is no present charge for membership. Interested parties should send a SASE (self-addressed, stamped envelope) to the club address.

M. Salonin

## Club Help

I am working with students at our small school in Elphinstone (pop. 215), grades 7-12. There are a few students interested in electronics and lately we decided to get together weekly at noon. That's how ECEC (Elphinstone Collegiate Electronics Club) got together.

We started by dismantling TVs and other old equipment for parts, and by fixing minor ailments in electronic equipment.

Is there anyone who can suggest how we might obtain electronic components and appropriate projects for beginners in electronics with a very limited budget? The club would also be interested in hearing, from anyone who started out using salvaged components, what can be done with them in terms of building projects.

E.M. Shemeliuk, ECEC, Box 157, Elphinstone, Man. R0J 0N0.

## Previously Listed Clubs

TRACE: Computer Club, Toronto. See p7 Jan 78 ETI.

CSWLI: SWL Club, Thunder Bay. See p7 Mar 78 ETI.

TRAC: Amateur Radio Club, Thornhill. See p7 Mar 78 ETI.

## Club Call

Send information about any clubs not mentioned on this page to ETI Club Call, ETI Magazine, Unit 6, 25 Overlea Blvd., Toronto, Ontario, M4H 1B1.

DIODES/ZENERS				SOCKETS/BRIDGES				TRANSISTORS, LEDS, etc.					
1N914	100v	10mA	.05	8-pin	pcb	.25	ww	.45	2N2222A	NPN (2N2222 Plastic .10)	.15		
1N4005	600v	1A	.08	14-pin	pcb	.25	ww	.40	2N2907A	PNP	.15		
1N4007	1000v	1A	.15	16-pin	pcb	.25	ww	.40	2N3906	PNP (Plastic)	.10		
1N4148	75v	10mA	.05	18-pin	pcb	.25	ww	.75	2N3904	NPN (Plastic)	.10		
1N753A	6.2v	z	.25	22-pin	pcb	.45	ww	1.25	2N3054	NPN	.35		
1N758A	10v	z	.25	24-pin	pcb	.35	ww	1.10	2N3055	NPN 15A 60v	.50		
1N759A	12v	z	.25	28-pin	pcb	.35	ww	1.45	T1P125	PNP Darlington	.35		
1N4733	5.1v	z	.25	40-pin	pcb	.50	ww	1.25	LED Green, Red, Clear, Yellow		.15		
1N5243	13v	z	.25	Molex pins .01	To-3 Sockets	.45			D.L.747	7 seg 5/8" High com-anode	1.95		
1N5244B	14v	z	.25	2 Amp Bridge	100-prv	1.20			XAN72	7 seg com-anode (Red)	1.25		
1N5245B	15v	z	.25	25 Amp Bridge	200-prv	1.95			MAN71	7 seg com-anode (Red)	1.25		
									MAN3610	7 seg com-anode (Orange)	1.25		
									MAN82A	7 seg com-anode (Yellow)	1.25		
									MAN74A	7 seg com-cathode (Red)	1.50		
									FND359	7 seg com-cathode (Red)	1.25		

C MOS		- T T L -									
4000	.15	7400	.15	7473	.25	74176	1.25	74H72	.45	74S133	.40
4001	.15	7401	.15	7474	.30	74180	.75	74H101	.75	74S140	.55
4002	.20	7402	.20	7475	.35	74181	2.25	74H103	.75	74S151	.30
4004	3.95	7403	.20	7476	.40	74182	.95	74H106	.95	74S153	.35
4006	.95	7404	.15	7480	.55	74190	1.75			74S157	.75
4007	.35	7405	.25	7481	.75	74191	1.05	74L00	.25	74S158	.30
4008	.95	7406	.35	7483	.95	74192	.75	74L02	.25	74S194	1.05
4009	.45	7407	.55	7485	.75	74193	.85	74L03	.30	74S257 (8123)	1.05
4010	.45	7408	.25	7486	.25	74194	1.25	74L04	.30		
4011	.20	7409	.15	7489	1.35	74195	.95	74L10	.30	74LS00	.25
4012	.20	7410	.10	7490	.55	74196	1.25	74L20	.35	74LS01	.35
4013	.40	7411	.25	7491	.95	74197	1.25	74L30	.45	74LS02	.35
4014	.95	7412	.30	7492	.95	74198	2.35	74L47	1.95	74LS04	.30
4015	.90	7413	.35	7493	.35	74221	1.00	74L51	.45	74LS05	.45
4016	.35	7414	1.10	7494	.75	74367	.85	74L55	.65	74LS08	.25
4017	1.10	7416	.25	7495	.60			74L72	.45	74LS09	.35
4018	1.10	7417	.40	7496	.80	75108A	.35	74L73	.40	74LS10	.35
4019	.50	7420	.15	74100	1.15	75110	.35	74L74	.45	74LS11	.35
4020	.85	7426	.30	74107	.35	75491	.50	74L75	.55	74LS20	.25
4021	1.00	7427	.45	74121	.35	75492	.50	74L93	.55	74LS21	.25
4022	.85	7430	.15	74122	.55			74L123	.85	74LS22	.25
4023	.25	7432	.30	74123	.55	74H00	.15			74LS32	.40
4024	.75	7437	.30	74125	.45	74H01	.25	74S00	.35	74LS37	.35
4025	.30	7438	.35	74126	.35	74H04	.20	74S02	.35	74LS40	.45
4026	1.95	7440	.25	74132	1.35	74H05	.20	74S03	.30	74LS42	1.10
4027	.50	7441	1.15	74141	.90	74H08	.35	74S04	.30	74LS51	.50
4028	.95	7442	.45	74150	.85	74H10	.35	74S05	.35	74LS74	.65
4030	.35	7443	.65	74151	.65	74H11	.35	74S08	.35	74LS86	.65
4033	1.50	7444	.45	74153	.75	74H15	.45	74S10	.35	74LS90	.95
4034	2.45	7445	.65	74154	.95	74H20	.30	74S11	.35	74LS93	.95
4035	1.25	7446	.95	74156	.95	74H21	.25	74S20	.35	74LS107	.85
4040	1.35	7447	.95	74157	.65	74H22	.40	74S40	.20	74LS123	1.00
4041	.69	7448	.65	74161	.85	74H30	.20	74S50	.20	74LS151	.95
4042	.95	7450	.25	74163	.85	74H40	.25	74S51	.25	74LS153	1.20
4043	.95	7451	.25	74164	.60	74H50	.25	74S64	.20	74LS157	.85
4044	.95	7453	.20	74165	1.50	74H51	.25	74S74	.35	74LS164	1.90
4046	1.75	7454	.25	74166	1.35	74H52	.15	74S112	.60	74LS367	.75
4049	.45	7460	.40	74175	.80	74H53J	.25	74S114	.65	74LS368	.75
4050	.45	7470	.45			74H55	.20			74C04	.25
4066	.95	7472	.40							74C151	2.25
4069	.40										
4071	.35										
4081	.70										
4082	.45										
MC 14409	14.50										
MC 14419	4.85										

9000 SERIES	
9301	.85
9309	.35
9322	.75
95H03	1.10
9601	.45
9602	.45

MICRO'S, RAMS, CPU'S, ETC.	
74S188	3.00
1702A	4.50
MM5314	3.00
MM5316	3.50
2102-1	1.45
2102L-1	1.75
TR1602B	4.50
TMS 4044-45NL	14.50
8080AD	12.00
8T13	1.50
8T23	1.50
8T24	2.00
8T97	1.00
2107B-4, A	4.00
2708	11.50

LINEARS, REGULATORS, etc.			
MCT2	.95	LM320T5	1.65
8038	3.95	LM320T12	1.65
LM201	.75	LM320T15	1.65
LM301	.45	LM324N	.95
LM308 (Mini)	.95	LM339	.95
LM309H	.65	7805 (340T5)	.95
LM309K (340K-5)	.85	LM340T12	1.00
LM310	1.15	LM340T15	1.00
LM311D (Mini)	.75	LM340T18	1.00
LM318 (Mini)	.95	LM340T24	.95
LM320K5(7905)	1.65	LM340K12	1.65
LM320K12	1.65	LM340K15	1.25
		LM340K18	1.25
		LM340K24	.95
		78L05	.75
		78L12	.75
		78L15	.75
		78M05	.75
		LM373	2.95
		LM380 (8-14 PIN)	.95
		LM709 (8, 14 PIN)	.25
		LM711	.45
		LM723	.50
		LM725N	2.50
		LM739	1.50
		LM741 (8-14)	.25
		LM747	1.10
		LM1307	1.25
		LM1458	.95
		LM3900	.50
		LM75451	.65
		NE555	.50
		NE556	.95
		NE565	.95
		NE566	1.75
		NE567	1.35

## INTEGRATED CIRCUITS UNLIMITED

7889 Clairemont Mesa Blvd., San Diego, CA 92111 U.S.A.

No Minimum

All prices in U.S. dollars. Please add postage to cover method of shipping. Orders over \$100 (U.S.) will be shipped air no charge.

Payment should be submitted with order in U.S. dollars.

All IC's Prime/Guaranteed. All orders shipped same day received.

### SPECIAL DISCOUNTS

Total Order	Deduct
\$35 - \$99	5%
\$100 - \$300	10%
\$301 - \$1000	15%
\$1000 - Up	20%

Phone (714) 278-4394

BarclayCard / Access / American Express / BankAmericard / Visa / MasterCard

# FEEDBACK

## PCBs AND VEROBXES

I want to make the ETI Option Clock: where can I obtain the PCB and at what price?

Also, who is the distributor for the Verobox, and is it possible to obtain one catalogue?

N.M., Thetford Mines

ETI PCBs are advertised in the magazine (there is at least one company who supplies them for all projects). The distributors for Verobox are Electronic Packaging Systems PO Box 481, McAdoo Park, Hwy 38, Kingston, Ont K7L 4W5. Catalogues are available from this company.

## COVERS & CODES

In your "Feedback" column of Aug 77 a couple of readers were bitching about your June 77 cover — can one judge a book by its cover? If an individual is familiar with your publication one might expect that individual to concern himself not only with the cover, but also the contents. I'm wondering if the same individuals wrote back the following month regarding your July 77 cover, claiming subliminal significance of the young lady and/or the beverage. Some people can find fault with anything! I'm sure you'd be criticized by someone if your next issue appeared with no picture whatsoever on the cover (lack of

imagination).

Allow me to commend you on your adoption of the International Standard of component notation and units in an attempt to eliminate errors. It obviously works well for resistance and capacitance values (4k7, 5p6, etc.) so why not other measurements as well? eg, 6V3 for 6.3V, 1A5 for 1.5A, etc.

Back to covers again — your May 77 cover was absolutely stunning! With a bit of cropping, I think it would make an excellent conversation-piece to frame and proudly display on the wall of my shop.

T.McD., Hyde Pk., Ont.



**This Is A Mini-Ad!**  
 You Can Write, Draw or Advertise Anything You Like in This Space, for Only

**\$125**

...FOR MORE DETAILS CALL  
**Peter Priest**  
 on **416 423 3262**

## CM Electronics

P.O. BOX 546  
 STATION T, CALGARY  
 ALBERTA T2H 2H1

### WESTERN CANADA'S ELECTRONIC CENTRE

TTL		RESISTORS		LINEAR	
7400 \$ .24	7474 \$ .42	1/4 & 1/2 watt .04 ea. or \$3.00 per 100		LM301AN \$ 53	
7402 \$ .24	7475 \$ .64	YOUR CHOICE FOR MIXED VALUES		LM308N \$1.33	
7404 \$ .24	7476 \$ .48			LM311H \$1.32	
7406 \$ .32	7485 \$1.35			LM324N \$1.33	
7408 \$ .28	7486 \$ .42			LM376N \$1.60	
7410 \$ .24	7490 \$ .63			LM555N \$ .64	
7411 \$ .26	7491 \$ .90			LM556N \$1.18	
7413 \$ .54	7492 \$ .60			LM709CN \$ .49	
7414 \$ .98	7493 \$ .60			LM723CH \$ .75	
7416 \$ .33	74121 \$ .45			LM733CN \$1.46	
7417 \$ .33	74123 \$ .69			LM739CN \$1.66	
7420 \$ .25	74125 \$ .53			LM741CN \$ .47	
7427 \$ .40	74145 \$1.19			LM1458N \$ .78	
7430 \$ .24	74150 \$1.95			LM3900N \$ .92	
7432 \$ .33	74154 \$1.50				
7440 \$ .24	74161 \$1.14				
7441 \$1.19	74163 \$1.30				
7442 \$ .69	74177 \$1.09				
7447 \$ .98	74191 \$1.60				
7448 \$1.15	74192 \$1.14				
7450 \$ .25	74193 \$1.14				
7451 \$ .25	74194 \$1.14				
7473 \$ .42	74196 \$1.60				
		CMOS		I.C. SOCKETS	
		4000 \$ .28	4020 \$1.47	4052 \$1.40	low profile
		4001 \$ .28	4023 \$ .28	4066 \$ .98	8 pin \$ .25
		4002 \$ .28	4024 \$1.16	4071 \$ .38	14 pin \$ .29
		4007 \$ .28	4025 \$ .28	4072 \$ .38	16 pin \$ .29
		4011 \$ .28	4027 \$ .57	4081 \$ .38	18 pin \$ .39
		4012 \$ .28	4046 \$2.30	4082 \$ .38	22 pin \$ .48
		4013 \$ .61	4049 \$ .61	4511 \$1.89	24 pin \$ .55
		4017 \$1.30	4050 \$ .61	4518 \$1.40	28 pin \$ .64
		4018 \$1.30	4051 \$1.40	4528 \$1.53	40 pin \$ .92
		DIODES		ZENER DIODES	
		1N914(4148) \$ .09	1N746	to 1N759 \$ .17	
		1N4001 \$ .09	1N4728	to 1N4752 \$ .23	
		1N4002 \$ .09	1N4753	to 1N4764 \$ .33	
		1N4003 \$ .10	1N5221	to 1N5257 \$ .21	
		1N4004 \$ .10	1N5221		
		1N4005 \$ .11	1N5257		
		1N4006 \$ .11			
		<b>Send cheque or Money Order DO NOT SEND CASH</b>			

Further Prices Available Upon Request  
 Orders under \$25 add \$1 Post. & Handling  
 Minimum Order \$5.00 Please — Prices Subject To Change Without Notice



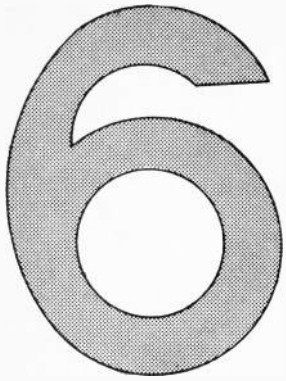

# ETI Publications

## Canadian Projects Book No. 1

**\$3.00**

Top projects from the early issues of ETI's Canadian edition, plus some of the projects from the UK edition's issues which were distributed in Canada in 1976. All projects use parts available in Canada. Those projects from UK edition have been completely re-worked in Canada for Canadian constructors. Includes a series of modular disco projects, plus games, biofeedback, metal locator, etc.

## Circuits No. 1

**\$5.00**

A brand new concept from the house of ETI. More than 100 pages packed with a wide range of experimenters circuits. Based on the 'Tech Tips' section carried in the overseas editions of ETI, Circuits 1 is the first of a series of specials — produced for the enthusiasts who know what they want, but not where to get it! Circuits 1 will also act as a catalyst for further development of ideas, ideal for the experimenter. The collection of more than 200 circuits is complemented by a comprehensive index, making searches for a particular circuit quick and simple. Also, similar circuits can be compared easily, due to the logical layout and grouping used throughout. Last and by no means least, Circuits 1 has no distracting advertisements in the main section!

## Top Projects No. 3

**\$2.50**

Twenty-eight projects from the UK edition of ETI. Includes Twenty-Five Watt Hifi Amp, FM Tuner, Line Amp, Dual Beam Scope Adapter, Impedance Meter, DVM, Ignition Timing Light, Colour Organ, Radar Intruder Alarm, Electronic Ignition, Fluorescent Light Dimmer, Drill Speed Controller, etc.

## Top Projects No. 4

**\$2.50**

Now available in Canada, this book contains 27 projects reprinted from the UK edition of ETI. Includes WaaWaa, Hifi Amp, Car Alarm, Audio Millivoltmeter, Pushbutton Dimmer, Expander-Compressor, Dual Tracking Power Supply, Photo Timer, Car Amp, Touch Switch, Exposure Meter, etc.

## Electronics — it's easy Volume 1

**\$3.50\***

The best introductory series to electronics ever published in a magazine. Volume three completing the series, will be available in a few months. Volume One introduces electronics to the beginner by going through the systems approach, basic concepts, meters and measurements, frequency and wavelengths, electronics and communication, capacitance and inductance, capacitive and inductive reactance, resistance, capacitance and inductance in combination, detection and amplification, elements of transistor amplifiers, emitter followers and DC amplifiers, and basic operational amplifiers.

## Electronics — it's easy Volume 2

**\$3.50\***

Volume Two introduces the sources of power, simple power supplies, how regulated power supplies work, general purpose supplies, generating signal waveforms, generating non-sinusoidal waveforms, all about electronic filters, more about filters, introducing digital systems, the algebra of logic, integrated circuit forms of logic functions, digital sub-systems, counters and shift registers.

**\$6.00 For Both\***

---

Send your order, with payment (not cash), to **ETI PUBLICATIONS**, Electronics Today International  
Unit Six

Please specify which publications you require,  
and print your name and address clearly.

25 Overlea Boulevard  
Toronto, Ontario  
M4H 1B1

# The Fun of Electronics

THAT NEW ANTENNA I DESIGNED IS SOMETHING ELSE! I JUST GOT A RECEPTION REPORT FROM ALPHA-CENTAURI!



YES SIR, FRED, THIS IS A QUALITY PRODUCT YOU'VE GOT HERE: THE BREAKDOWN VOLTAGE LISTED IN THE MANUAL IS DEAD-ON.

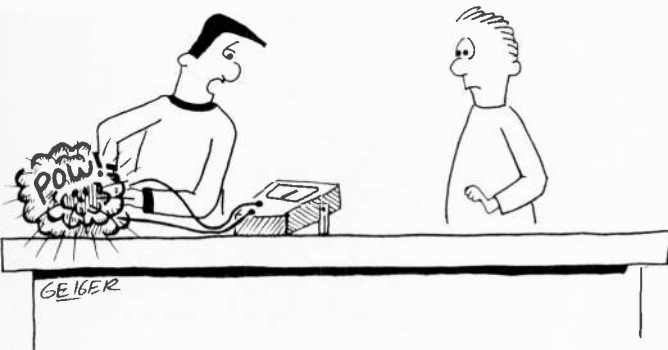

I BELIEVE WE'RE IN TROUBLE, SIR: THE LATEST RESEARCH FIGURES SHOW THAT IT TAKES 10 MONTHS TO DEVELOP A NEW PRODUCT, AND ONLY 6 MONTHS FOR THAT PRODUCT TO BECOME OBSOLETE.

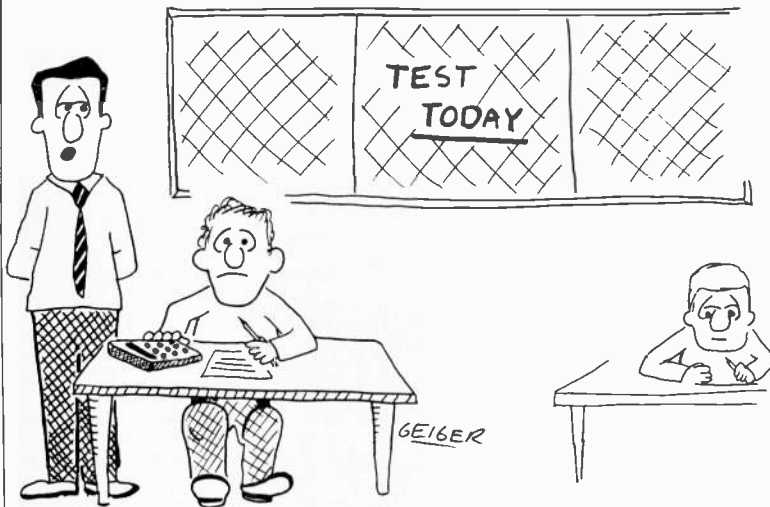
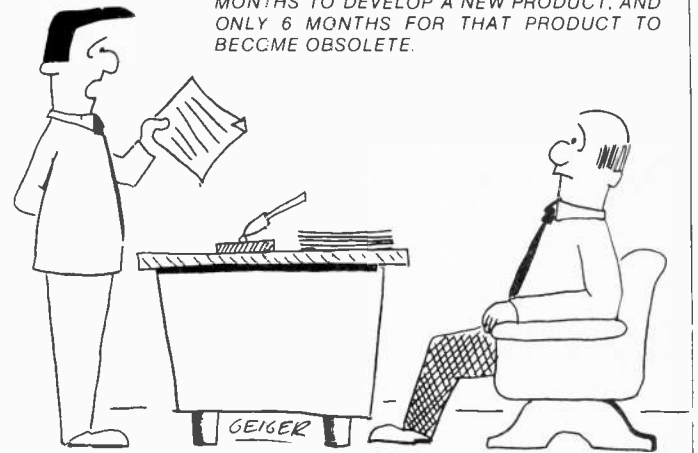

I SHALL BE CERTAIN TO GIVE YOUR CALCULATOR AN A+. JONES, YOU, HOWEVER, WILL BE RECEIVING AN F.



WHAT'S THE MATTER, HAVEN'T YOU EVER SEEN A VACUUM TUBE BEFORE?

# INFORMATION

## COMPONENT NOTATIONS AND UNITS

We normally specify components using the recently agreed International Standard. Many readers will be unfamiliar with this but it's simple, less likely to lead to error and will be used by everyone sooner or later. ETI has opted for sooner!

Firstly decimal points are dropped and substituted with the multiplier, thus 4.7uF is written 4u7. Capacitors also use the multiplier nano (one nanofarad is 1000pF). Thus 0.1uF is 100n, 5600pF is 5n6. Other examples are 5.6pF = 5p6, 0.5pF = 0p5.

Resistors are treated similarly: 1.8Mohms is 1M8, 56kohms is 56k, 4.7kohms is 4k7, 100ohms is 100R, 5.6ohms is 5R6.

## BACK ISSUES

Previous issues of ETI-Canada are available direct from our office for \$2.00 each. Please specify issue by the month, not by the features you require.

## EDITORIAL QUERIES

Written queries can only be answered when accompanied by a self-addressed, stamped envelope, and the reply can take up to three weeks. These must relate to recent articles and not involve ETI staff in any research. Mark your letter ETI Query.

## NON-FUNCTIONING PROJECTS

We cannot solve the problems faced by individual readers building our projects unless they are concerning interpretation of our articles. When we know of any error we shall print a correction as soon as possible at the end of News Digest. Any useful addenda to a project will be similarly dealt with. We cannot advise readers on modifications to our projects.

## COMPONENT STORES

ETI is available for resale by component stores. We can offer a good discount and quite a big bonus, the chances are customers buying the magazine will come back to you to buy their components.

## PRICES

All prices quoted in the editorial of ETI are in Canadian dollars, except where stated. Advertisers in U.S. may give U.S. dollar prices. Where we only know an overseas price, e.g. in U.K. pounds, we convert approximately to Canadian dollars, erring on the conservative side, where possible.

## COMPONENT SUPPLY

We do not supply components for our projects and are unable to supply advanced information on components used in any projects. However to enable readers to obtain printed circuit boards without undue delay we will be supplying retailers and manufacturers with certain p.c. board designs. Any company interested in receiving such designs should write to us on their headed note paper requesting details.

MA 1002 AC Clock Mod **\$14.95**, +TR & SWS. . . . . **\$19.95**  
 MA 1003 12 VDC Car Clock mod +3 SWS. . . . . **\$24.95**  
 Strong Stn Wagon Tailgate Mtr. 12VDC . . . . . **\$ 4.95**  
 IC SOCKETS 8-25d, 14-25d, 16-30d, 24-25d . . . . . **40¢ \$ 1.00**  
 FM-1 FM wireless Mike Kit 100 FT Range . . . . . **\$ 2.95**  
 FM-2 Ditto with 1 Trans Mike Preamp . . . . . **\$ 4.95**  
 MG-1 Mag Stereo Preamp Kit High Sens . . . . . **\$ 5.95**  
 MG-2 Mag Stereo Preamp & Control Kit . . . . . **\$14.95**  
 CPO-1 Code OSC Kit . . . . . **\$2.95**, Brass Key . . . . . **\$ 3.95**  
 LO-1 Light Organ Kit 200 W per chan (3) . . . . . **\$12.95**  
 14V-5.5A Trans . . . . . **\$5.95**, 100V-25A Bridge . . . . . **\$ 3.50**  
 12VCT-500MA . . . . . **\$1.50**, 25V-200MA . . . . . **\$ 1.50**  
 16VCT-300MA + 21V200MA . . . . . **\$1.50**, 50VCT-200MA . . . . . **\$ 1.50**  
 53VCT-2A . . . . . **\$4.95**, 2200 UFD-35C . . . . . **\$ 4.00**  
 50d . . 10/ . . . . . **\$ 4.00**  
 Heavy Duty Line Cords 2 Wire. 50d, 3 Wire . . . . . **85¢**  
 C.O.D., Chargex, Mastercharge, Collect all OK

Send for our FREE 1978 Catalogue  
**ARKON ELECTRONICS LTD.,**  
 91 QUEEN ST.E., TORONTO, ONT.  
 M5C 1S1  
 (416) 868-1315

## CLASSIFIED

**J & J ELECTRONICS LTD.,**  
 P.O. Box 1437 E,  
**Winnipeg, Manitoba R3C 2Z4**  
 Semiconductor Specialists  
 Do you get our bargain flyers? Send \$1.00 to receive the current literature and specials and to be placed on the mailing list for the future publications.

 **SUPERSTRIP**  
 The Quality Full-Size Breadboard

ONLY **\$19.95**



**840 NICKEL-SILVER TIE POINTS**  
 6½ in. x 2¼ in. (165mm x 57mm)

B.C. add 7% tax. Handling 65c/order  
 For rush delivery, send M.O. to:  
 Wolverton Enterprises, 5, S. Hythe Avenue, Burnaby, B.C. V5B 3H6.

**AUDIO KITS BUILD YOUR OWN AND SAVE**  
 20+20W Stereo Amp. with Tone and Power Supply **\$38.00**  
 30+30W Stereo Power Amplifier **\$34.00**  
 40+40W Semi-Assembled Stereo Power Amp. **\$38.00**  
 50+50W Stereo I.C. Drive POW. Amp. **\$47.00**  
**AUDIOVISION SERVICE**  
 P.O. BOX 955, STN. B. WILLOWDALE, ONT. M2K 2T6

**AMPLIFIER KITS, ELECTRONIC PARTS**  
 New, expanded FREE '78 catalog, new lower competitive prices.

50W/50W complete stereo kits **\$155.00**  
 60W low TID pow module **\$38.00**  
 100W low TID pow module **\$70.00**  
 Class-A 60W pow module **\$130.00**  
 Stereo low TID pre-amp **\$95.00**  
 Stereo Active tone-control **\$40.00**  
 MJ802/MJ4502 5MHz 200W **\$8.50/Pr.**  
 2N3055/MJ2955 2MHz 100W **\$3.00/Pr.**  
 1N4148 .05, 1N4003 .10, 2N5088 .25  
 LM-741 .30, LM-1310 1.50, LM-555 .55  
 7400N .22, 7404N .22, 7490 .60  
 Resistor .05, capacitor .10, etc.

Post. & pack. add 10%, Que.Res. add 8% S.T.

**COMPUTRONICS**  
 P.O. BOX 531, STAT. "H"  
 MONTREAL, QUEBEC H3G 1R0

# FREE!

THE NEW 104 PAGE WINTER, 1978 EDITION!

Choose from more than 60 new items for winter kitbuilding fun. Nearly 400 kits in all to help you get the most for your electronics dollar!



The world's largest selection of quality electronic kits. Plus dozens of Heath-recommended name-brand products too!



Budget-Priced Digital Alarm Clock



Programmable Home Heating Control



Medium-Power AM/FM Stereo Receiver



Unique Electronic Digital Scale

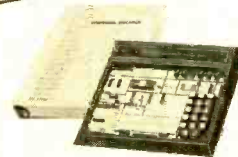

Microprocessor Course and Trainer



Bally Pinball Machine in kit form



Personal Computing Systems

Learn about the fascinating and rewarding hobby of electronic kitbuilding. Experience owning a top-performing, high-quality electronic product that you built with your own hands.

Our easy-to-read assembly manuals are your kitbuilding "partner" from start to finish. Large, clear illustrations and step-by-step instructions lead you to successful completion and the thrill of "turn-on". It's easy, it's fun, and it's personally satisfying.

Send for your FREE catalog today! 

**FREE CATALOG** SEND TODAY

HEATH <b>Schlumberger</b>	Heath Company, Dept. EU 178 Mississauga, Ont. L4X 2R7
Please send me my FREE Heathkit Catalog. I am not on your mailing list.	
Name _____	
Address _____	
City _____	Prov _____
CL-644	Code _____



# SYLVANIA

## electronics

COLOR PICTURE TUBES / LAMPES-IMAGE EN COULEURS

**SYLVANIA**  
**SYLVANIA**  
**SYLVANIA**

**colorbright**  
**85XR**

ALL NEW PICTURE TUBE  
WITH X RAY INHIBITING GLASS

**XR**

NOUVELLE LAMPE ÉCRAN  
EN VERRE INHIBITEUR DE RAYONS-X

**SYLVANIA**  
**SYLVANIA**

**SYLVANIA**  
**SYLVANIA**  
**SYLVANIA**

**colorbright**  
**85**

PICTURE TUBE WITH NEW SCREEN  
RARE EARTH PHOSPHORS

**CB**

LAMPE AVEC NOUVELLE ÉCRAN  
PHOSPHORES DE TERRES RARE

**SYLVANIA**  
**SYLVANIA**

**SYLVANIA**  
**SYLVANIA**  
**SYLVANIA**

**colorscreen**  
**85**

PICTURE TUBE WITH NEW ELECTRON GUN  
RARE EARTH PHOSPHORS

**CS**

LAMPE ÉCRAN AVEC NOUVEAU CATHODE  
PHOSPHORES DE TERRES RARE

**SYLVANIA**  
**SYLVANIA**



LA CORPORATION

**GTE**

**SYLVANIA**

CANADA