

# MERCURY ARC RECTIFIER PRACTICE

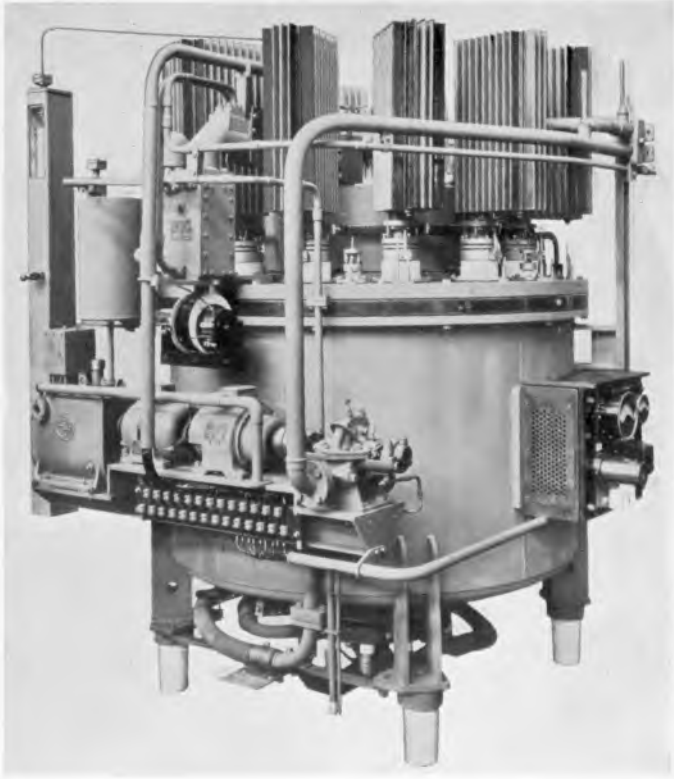

A typical steel tank rectifier.

*[Frontispiece.]*

# MERCURY ARC RECTIFIER PRACTICE

By  
FREDERICK CHARLES ORCHARD  
A.M.I.E.E.

PITTSBURGH  
INSTRUMENTS PUBLISHING COMPANY  
1936

MADE AND PRINTED  
IN ENGLAND

PRINTED IN GREAT BRITAIN BY THE LONDON AND NORWICH PRESS, LIMITED,  
ST. GILES WORKS, NORWICH

## P R E F A C E

THERE has been of recent years such a rapid development in the design and the application of the mercury arc rectifier equipment of both the glass bulb and the steel tank types that there is now an ever increasing number of these equipments being installed in this country and abroad, for service on public supply systems, railways and for industrial purposes.

Every new development is naturally followed by a mass of written matter which, generally, falls into two classes (*a*) that devoted to descriptions and the statement of elementary principles, and (*b*) that giving the scientific or mathematical theories involved. The former class is of no practical use, while the latter, though excellent in every way for designers and men of advanced knowledge, is also of very little actual assistance to the men who have to install and operate the equipment.

The plant engineer and the operator are not usually assisted by the early literature, and so only too often these engineers make acquaintance with the subject in the hard school of experience, and sometimes have to pay dearly for the mistakes made due to a lack of understanding of the apparatus concerned. *The subject matter contained herein has been arranged to bridge the gap between the two classes of literature referred to above and therefore should be of some assistance to those engineers just mentioned.*

Though "an ounce of practice is worth a ton of theory," it is equally true that to set out practical issues only in a book without at least some simple theoretical treatment of the subject would leave the work but partly complete. Therefore, sufficient theory has been included to enable a reader to apply the practice with a logical understanding, thereby to

cultivate that confidence necessary for intelligent building and operation of the equipment.

The sub-station, its choice, lay-out and allied problems have also been treated from a practical point of view.

The general interest chapter at the end of the book has been similarly treated, and the practical future application of mercury arc rectifier units have been described and illustrated.

In writing this book I have become indebted to several engineers, to whom I now offer my very sincere thanks. I would particularly mention W. A. Bennett, Esq., B.Sc., for reading through the MSS., and for providing much useful constructive criticism.

Acknowledgments are due to the City Electrical Engineer of Birmingham, F. Forrest, Esq., M.I.C.E., M.I.Mech.E., M.I.E.E., for permission to use certain photographs, the British Thomson-Houston Co. Ltd., of Rugby, the British General Electric Co. Ltd., Witton, the Hewittic Electric Co. Ltd., Hershaw, the English Electric Co., Stafford, and the Electric Construction Co. Ltd., of Wolverhampton, for illustrations, drawings and photographs. Photographs have also been included by courtesy of the British Broadcasting Corporation, the London Passenger Transport Board, the North-Eastern Electric Supply Co., and the L.N.E. and L.M. & S. Railway Companies.

Finally, I would thank my publisher for presenting the opportunity of writing this book for the benefit of men actively interested in this new type of converting plant and those students and juniors who hope at a later date to join that fraternity.

F. C. ORCHARD.

BIRMINGHAM, 1935.

# CONTENTS

## CHAPTER I

PAGE  
I

### GENERAL PRINCIPLES . . . . .

Brief history of the rectifier—Steps in discovery. Overcoming early difficulties. Commercial production. The valve action of the rectifier. Addition of mercury to the valve. First principles of rectification. Mechanical analogies. Commutation of the arc. Arc voltage drop. Reactance. Effects of overlap. Reactance in the external circuit. Transformers—Secondary connections. The interphase reactor. Wave form of induced pressure. Transformer ratings. No load pressure rise and its control. Heavy duty considerations. Cable calculations.

## CHAPTER II

### THE CONSTRUCTION OF RECTIFIER PLANT . . . . . 34

The glass bulb rectifier—anode inductance coil—glass bulb—cathode choke—ignition and excitation circuits—sequence of operation of excitation circuit—cooling fan—methods of voltage control. Steel tank rectifiers—vacuum chamber—cathode—anode shields—seals—mercury vapour pump—McLeod gauge—Pirani gauge—intermediate vacuum chamber—water cooling systems—smoothing circuits—surge protection.

## CHAPTER III

### RECTIFIER SUB-STATIONS . . . . . 64

General considerations. Low and medium power plants. High power plants. Architecture of sub-stations. Rectifier plant capacity. Layout of sub-stations. Steel tank rectifier sub-stations. Indoor versus outdoor transformers. Automatic sub-stations—two examples. Automatic features on steel tank rectifiers—control circuits—relays and protective features—remote control. Traction schemes. 3-wire operation. E.H.T. switchgear considerations.

## CHAPTER IV

### RECTIFIER PLANT INSTALLATION . . . . . 96

Glass bulb rectifier sub-stations. Steel tank rectifier sub-stations—pumping apparatus—cooling systems—vacuum connections and apparatus. Transformers. Resonant shunts. Small wiring. Anode cables. General information on running electrical connections. Miscellaneous items. High speed circuit breakers. Earthing.

CONTENTS

CHAPTER V

PAGE

SUB-STATION TESTING . . . . . 115

Oil circuit breakers. Pressure testing switchgear—types of high potential test—methods of applying—test voltage regulation—precautions to be taken—measurement of test pressure—use of sphere gaps—calibration of gap—correction for wave form factor. Relay testing. Transformer pressure testing. High speed circuit breakers. D.C. switchgear. Glass bulb rectifier tests. Steel tank rectifier tests. Vacuum pumping. Seepage tests. Insulation tests. Water supplies. Pirani gauge. Vacuum relay. Surge arresters. A.C. protective relays. Instructions prior to a bake-out. Phasing out. Striking the arc. Bake-out—half wave—full wave—overload—divided and emergency forms. Adjustments during bake-out. Final instructions—General tests. Transformer losses. Overall efficiency tests.

CHAPTER VI

SUB-STATION MAINTENANCE AND OPERATION . . . . . 155

Operation of glass bulb rectifiers. Operation of steel tank rectifiers. Maintenance of glass bulb rectifiers. Maintenance of steel tank equipments. High speed circuit breakers—maintenance and operation—contact tips—calibration. Transformers. Calcium chloride and silica gel breathers. Maintenance of automatic features. Staff organization. System of inspection and overhaul. Records. Regulations.

CHAPTER VII

GRID CONTROL . . . . . 175

General principles of grid control. Arrangements of grid. Arc control by grids. Grids used as a form of protection. Grid control of voltage. Methods of exciting the grids. Power factor. D.C. voltage wave distortion. Some applications of the grid controlled rectifier. Possible future applications.

CHAPTER VIII

CONCLUSION . . . . . 201

Rectifiers and rotating types of converting apparatus compared—efficiency—power factor—wave forms—noise—voltage regulation—3-wire operation—sub-station building—maintenance—control—capital cost. Comparative costs, choice of type of plant—automatic rotaries, manual rotaries and rectifiers compared—example—capital and building costs—labour costs—overheads—losses—rates—spares. Recent examples of the application of the mercury arc rectifier.



# CONTENTS

xi

	PAGE
APPENDIX . . . . .	213
(a) Maximum safe loads on chains—wire and hemp ropes.	
(b) Standard copper conductors table.	
(c) Fuse wire table.	
BIBLIOGRAPHY . . . . .	217
INDEX . . . . .	219

# Mercury Arc Rectifier Practice

## CHAPTER I

### GENERAL PRINCIPLES

#### **Brief History of the Rectifier**

THE first investigation of the physical properties of current conduction underlying the operation of the mercury arc rectifier was carried out by Sir Ambrose Fleming in 1889, when studying the "Edison Effect" in the carbon filament lamp. While experimenting with the arc produced between two carbon pencil electrodes, he found that by placing a third electrode of carbon in close proximity to the arc and then holding an ordinary bar magnet opposite to the third electrode, but on the other side of the arc, that the arc was deflected into contact with the added electrode. Furthermore, when a galvanometer was connected across the third electrode and the positive carbon, the needle of the instrument was deflected, but no deflection could be observed when the connection was transferred to the negative carbon. This experiment led Fleming to state that :

"Negative electricity can pass along the flame-like projection of the arc from the hot negative carbon to the cooler third carbon but not in the opposite direction."

In 1900 Peter Cooper Hewitt discovered that if an arc is struck in mercury vapour at a low pressure, it will pass current in one direction only, and, furthermore, the voltage drop in the arc is only of the order of a few volts. The first British Patent specification taken out by Cooper Hewitt was given

the number 4,168 in 1903, although under the Patents Act of 1901 the date claimed is the 30th of October, 1902.

### Steps in Discovery

During the course of experimental work it was found that when a positive and negative electrode, or as they are now termed, cathode and anode respectively, were placed in a sealed vessel from which all the air had been removed, a much higher potential was required to strike the arc. When the arc was struck, it then appeared as if some form of resistance had been removed because the current flow greatly increased.

The next step was the inclusion of a rarefied gas in the sealed chamber, when it was observed that the potential necessary to strike the arc was very much reduced while the current flow still remained high. With mercury vapour in the chamber, the potential required for the production of the arc was only of the order of 20 to 30 volts. This phenomenon will be explained later.

The early rectifier was of the glass enclosed type, and because of the difficulties in sealing the leads to the electrodes only a limited output of about 10 amperes was obtainable. In the course of time further developments took place, and a type of glass was eventually produced which possessed the ability to withstand large temperature variations and the seals for the electrodes were made with greater ease and certainty.

### Overcoming the Early Difficulties

Progress was almost negligible during the war years of 1914 to 1918, but in the succeeding years rapid strides were made in the development of this type of plant.

One of the early troubles was the tendency under certain conditions for the one-way control or valve action to cease and a reversal of flow of power to result. This condition became known as a back-fire. The first marked advance came from a serious study of back-firing phenomena, and it was found that there were three prime causes. One was due to the rays emitted from the cathode striking direct on to the

anode, another the presence of impurities in the anode material, while the third was due to the presence of foreign gases in the rectifier chamber. These difficulties were overcome by housing the anodes in bent arms so that the rays did not make direct contact with the anodes, more care being taken in the selection of material for the anodes, and a method of driving the foreign gases out of the chamber devised. This last development was termed "baking out" of the rectifier.

If a bulb is sealed without a bake-out process being made, immediately the bulb is struck up the anodes will give off foreign gases in large quantities and the bulb will in con-

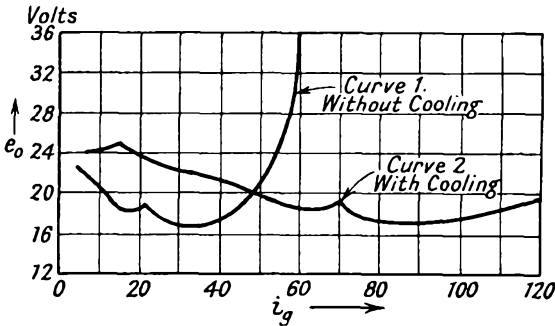

FIG. 1.—Effect of air cooling on current voltage curve of a glass bulb rectifier.

sequence be ruined. During the course of manufacture the air is extracted from the chamber by means of vacuum pumps, and in order to drive off any traces of occluded gases in the material of the anodes an artificial load is applied to the rectifier while operating at a low voltage. The loading is gradually increased until the anodes are working at a light red heat. During the loading process large quantities of occluded gas are driven off which is instantly removed by the vacuum pumps. When the bake-out, as this operation is termed, has been completed the bulb is sealed.

The second marked advance was the artificial cooling of the bulb by a blast of air from a fan mounted beneath the bulb. In Fig. 1, due to Guntherschulze, are seen two curves,

one indicating that the voltage falls with an increase in the current flow and then rises very rapidly. This sudden rise in pressure is produced as a result of the load current increasing the temperature of the bulb, which in turn raises the vapour pressure and consequently the resistance of the vapour path. As in all electrical circuits, an increase in resistance generates additional heat and so the effect is cumulative. Curve 2 in Fig. 1 is a very similar one to the first, but it has abscissa points three times the value of the other curve. An inspection of these curves reveals the fact that artificial cooling is only essential when the loading exceeds the value given at the point of cross over of the two curves.

The third advance concerned the leading-in connections to the electrodes for carrying heavy currents. Though artificial cooling added to the ability of a bulb to carry additional current it had no measurable effect on the leading-in connections. Originally several platinum wires were arranged in parallel and fused together into the glass to form a seal, but it was extremely difficult to make the resistance of all the platinum wires equal. Any inequality in the values of the resistance resulted in a fusing of the wires. The discovery of molybdenum fused borosilicate glass as a seal and lead-in enabled the current carrying capacity to be increased very considerably.

### **Commercial Production**

The intricate shape of the anode arms and the position of the auxiliary electrodes made commercial production of the bulbs impossible unless the arms were welded on to the main chamber. Welding those parts on to the chamber is a process which necessitates great care if strains are to be avoided in the glass when the bulb is subjected to the varying temperatures common to load conditions. It is an important and very necessary part of bulb production to test each weld for soundness of construction during the building of the bulb. The test consists in subjecting the weld to a polarised light and it is then observed through a Nicol prism. If the weld is a good

one the colour seen in the prism is an even violet colour, but the slightest strain in the glass is shown up by a spectroscopic effect. A faulty joint is given a re-heating treatment and again tested in the above manner.

The limitation of the glass bulb was found to be the current carrying capacity of the electrodes and the seals, so that above 200 to 250 amperes per cathode seal it became apparent that the load could only be supplied by operating two or more bulbs in parallel. At this stage greater attention was directed towards the development of the steel tank or metal clad rectifier which did not suffer from the same limitation in current output.

If the current limitation of the glass bulb was about 650 amperes it did not prevent very large numbers of them being installed for power supply purposes. The Hewittic Electric Company Ltd. were the British pioneers of this type of plant, and as far back as 1924 they supplied units in Birmingham for the operation at 550 volts of seven miles of double tramway track. This system has given every satisfaction. A considerable number of units were also supplied to give a three wire service at 220-0-220 volts to suburban areas and to boost across the outers of heavily loaded D.C. feeders from rotary converter substations in the city network.

With the steel tank rectifier the problems met with in producing airtight seals in a metal container were many and difficult, but after considerable research Bela Schafer, of the Brown Boveri Company, successfully overcame most of them. At about the same time the General Electric Company of America also met with success in their investigations of the problem. It was the former company, however, who developed the steel tank rectifier commercially first, with any degree of satisfaction to the user. In 1923 the first fully automatic steel tank rectifier to supply a public distribution in this country was commissioned by the Brown Boveri Company in Birmingham.

During the past few years several British firms have taken up the manufacture of the rectifier, and in December, 1930,

the British Thomson-Houston Company, of Rugby, commissioned the first steel tank rectifier equipment for heavy traction railway service in Great Britain at the Hendon Substation of the London Electric Railway Company. This equipment has a capacity of 1500 k.w. at 615 volts. On May 11, 1931, this same firm put into service the first equipment on a system carried out in conformity with the recommendations of the Railway Electricity Committee's Report, 1927, to the Minister of Transport. This set has a capacity of 1,500 k.w. at 1,500 volts.

The next revolutionary step came with the application of grid control, but this will be dealt with in a later chapter.

### **The Valve Action of the Rectifier**

Wireless broadcast reception has become so popular that very few engineers interested in this book will not have a good working knowledge of the theory of the ordinary diode or two electrode valve. It is, therefore, considered that the easiest method of explaining the principles of the rectifier will be with reference to that valve.

Consider first the ordinary type of valve with its two electrodes, the filament or cathode, and the plate or anode. By supplying current to the filament it is heated up until it emits negative electrons, but if the anode is negatively charged then since poles of like polarity repel each other then most of the free electrons will be forced away from the anode and no current will flow through the anode circuit. If the anode is then given a positive charge with reference to the filament potential the negatively charged electrons emitted by the filament will be attracted to the anode and a current will flow round the circuit.

A complication then arises, for an electron being negatively charged will tend to repel other free electrons within the confined space of the valve, so that when there is a stream of them flowing from the cathode to the anode they set up in the space what is called a negative space charge which tends to impede the passage of free electrons in the stream. This

effect is equivalent to an increase in the resistance of the internal circuit, so that by applying a D.C. voltage between the cathode and the anode the increase in the current flow will become less as the potential difference is raised, until the current attains a steady value, even though the applied voltage is allowed to still further build up. The space charge is by that time strong enough to resist any further electronic flow and the limit of emission is reached.

### **Addition of Mercury to the Valve**

Suppose now a globule of mercury is inserted in the glass container prior to the evacuating process. When the valve is gradually heated up by the impression of a suitable voltage on the filament and anode as before, the valve will behave just as it would under ordinary conditions, but very soon it will be observed that the valve lights up with the characteristically bluish green tinge so familiar with the rectifier bulb of to-day. Immediately this condition is reached, any increase in the applied voltage difference will cause an extremely rapid rise in the amount of current flow round the circuit which, unless precautions are taken, will destroy the filament.

This remarkable effect is the result of the negatively charged electrons given off under the extra voltage applied at the time the mercury vapour is produced having such a high velocity, that immediately they collide with the mercury atoms the impact is sufficient to knock off an electron and leave the remainder of the atom as a positively charged ion. These additions to the electron stream flowing from the cathode to the anode now have to pass through an electrostatic field made up by the charges due to themselves and to the positive charges of the free ions. The positively charged ions are attracted to the cathode, but, because of their larger mass, at a speed very much below that attained by the electrons. During the passage of the ions to the cathode their positive electrostatic field tends to neutralise the negative space charge due to the electrons and thus the internal resistance of the



valve is reduced. Hence the remarkable increase in the amount of current flowing round the valve circuit.

This results in a considerable increase in the limit of saturation of the valve, and also it enables a very much lower voltage to be applied for a given amount of current.

The substitution of a pool of mercury for the metal filament is all that is necessary to convert the valve into a simple form of mercury arc rectifier. A metal filament could not be used in large power rectifiers because of the high temperatures involved, which would quickly destroy the metal. A pool of mercury on the other hand may gradually evaporate, but it is automatically condensed on the walls of the bulb or chamber from whence it drains back again into the main pool at the base of the container.

### **First Principles of Rectification**

There are two very important principles involved in rectification which should be clearly understood.

PRINCIPLE NO. 1.—It is only possible for an anode to function, i.e., to supply a uni-directional current, during the interval of time when its potential is greater in a positive direction than that of any other anode and of the cathode.

PRINCIPLE NO. 2.—If any two or more anodes are required to give a uni-directional current in parallel over any given interval of time those anodes must have equal potential and otherwise comply with principle No. 1.

Having stated those two very important fundamental principles of rectification a mechanical analogy may assist in fully understanding that which is to follow.

### **Mechanical Analogies**

Fig. 2 represents a single phase high tension supply feeding a rectifier through a transformer stepping down to a suitable

voltage. There is a mid-point tapping on the secondary winding. The rectifier is shown as a disc, having two segments forming a commutator each of which is connected to the free ends of the transformer secondary winding. These segments correspond to the anodes. The centre of the disc represents the positive pole of the rectifier and is joined to the positive

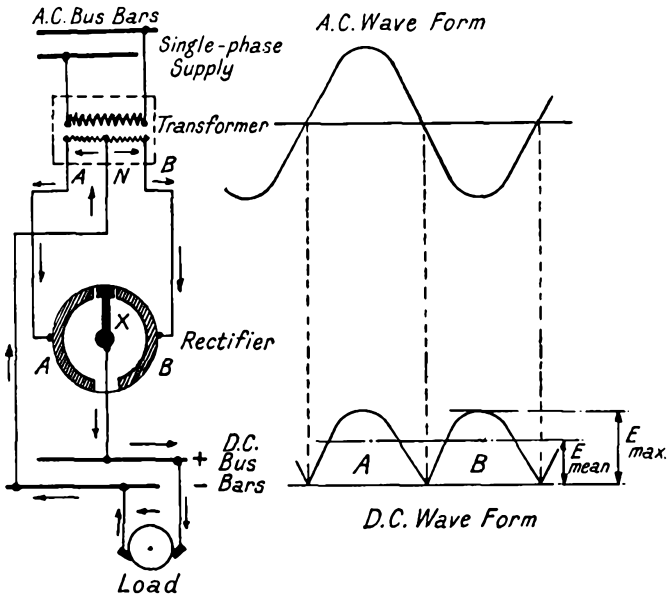

FIG. 2.—Diagram of mechanical analogy of a single-phase rectifier.

bus bar. The mid-point tapping on the transformer is joined to the other D.C. bus bar to form the negative return to the system. The commutating bar X takes the place of the arc, and is driven by some means at double the supply frequency and makes a wiping contact with the segments. When anode A is at a positive potential to the neutral N, the arm X is travelling over the segment A and current will flow in the direction shown by the arrows. During this interval the half winding B-N has a negative potential with respect to the half winding A-N. At the instant when the

voltage wave of the supply reverses its direction in the whole winding A-N-B the arm moves on to segment B. Thus the current supplied to the load is uni-directional but highly pulsating, varying in value between zero and a maximum.

Fig. 3 illustrates the three-phase case where a 3/3 phase transformer is used and the moving arm now travels over

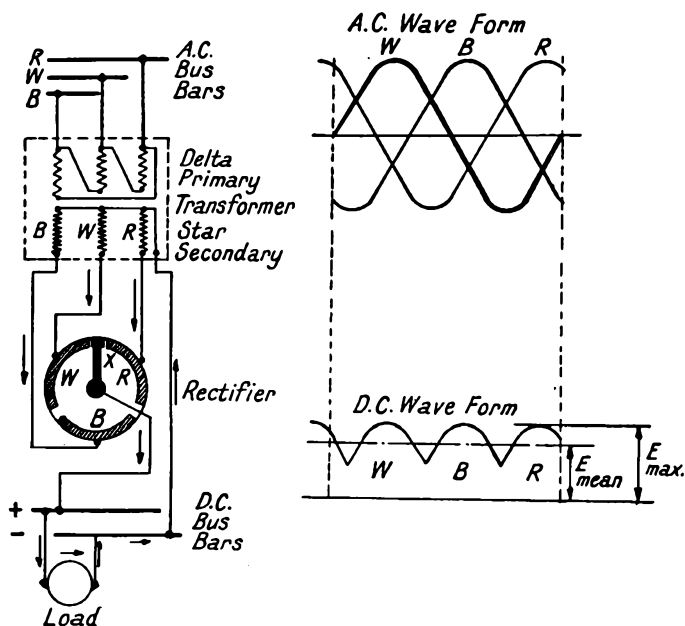

FIG. 3.—Diagram of mechanical analogy of a three-phase rectifier.

three segments. The result of using a three-phase supply is to greatly reduce the amplitude of the ripple or D.C. pulsations and to increase their frequency to that of the supply. This, it will be observed, gives a very much smoother wave form.

If a three-phase primary is used but the secondary side of the transformer is so wound that a six-phase supply can be obtained for the rectifier, then the diagram would be as shown in Fig. 4. The frequency of the pulsations in the D.C. wave

form would be the same as the frequency of the supply to the rectifier, but the amplitude would be very much reduced.

### Commutation of the Arc

Leaving the mechanical analogies now and returning to fundamental principle No. 1, it will be noted that the datum

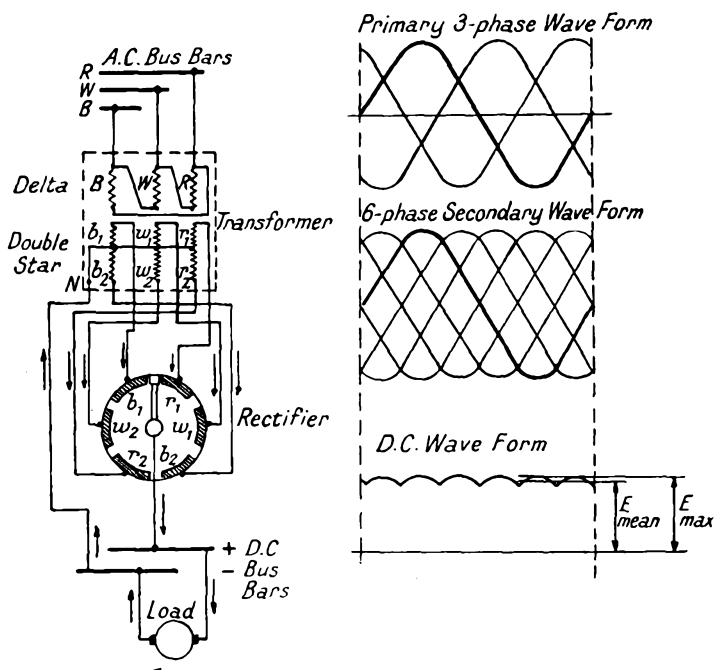

FIG. 4.—Diagram of mechanical analogy of a 3/6-phase rectifier.

of potential reference for the rectifier equipment is the cathode voltage. A wave of potential in an A.C. supply alternates from zero value to maximum through zero to a maximum in the opposite direction and back to zero again for each complete cycle or period. It follows then that an arc can only exist when the potential wave applied to an anode is at a higher value than that of the cathode and of positive polarity. As each anode potential wave rises and falls in phase sequence

above the cathode value so the arc passes from one anode to the next in the sequential order. The difference in an anode potential and that of the cathode during active arc action represents the internal voltage drop in the rectifier, which varies between 15 volts for a small glass bulb equipment to over 30 volts in very large metal clad types.

During arc operation the cathode emits huge quantities of electrons which, together with those produced by collision with the mercury atoms, pass in a stream to that anode which is at positive potential to the cathode, and are absorbed by it. The anode then becomes charged, which charge will pass away to the external circuit for as long as the electrons continue to flow to that anode. As soon as the potential wave on that anode falls to that of the cathode the arc will either cease or will pass on to the next anode in the order of firing. When the potential wave falls below that of the cathode value it is negative to the latter, and, since like poles repel each other, the electrons streaming formerly to that anode are now repelled from it.

The anode potential may have any value from 15 volts to 40 volts positive in relation to the cathode voltage and this small pressure enables a sufficiently strong electrostatic field to be set up to maintain an arc within the rectifier.

### Arc Voltage Drop

The drop in the arc is not constant throughout the whole length of the arc. At the anode the drop is only 3 to 5 volts, while at the cathode the drop is about 7 to 10 volts, the remaining drop, i.e., 5 to 15 volts are expended in the arc. This last drop is dependent upon the cross section of the arc and also the vapour pressure, but 0.05 to 0.22 volts per centimetre length of arc path is a usual value obtained in practice. Diagrammatically this condition can be shown as in Fig. 5, and a further point of interest is that as phase 1 becomes positive to the cathode at (a), then rises to a maximum and drops to (b), i.e., the period of active arc function, phase 2 becomes positive to the cathode at (b) rises to its maximum

value and then drops to (c). The arc is, therefore, transferred from one anode to another at points (a), (b) and (c). In this figure the effect of reactance has been ignored.

**Reactance**

Reactance in any electrical circuit tends to oppose instantaneous alteration in the current flowing and at points (a), (b) and (c) in Fig. 5 this characteristic could be expected to take effect since the rectifier equipment must have some inherent reactance. Reactance then can be expected to

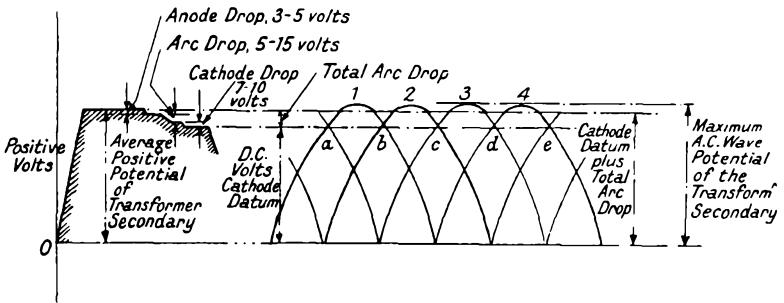

FIG. 5.—Diagram of relative voltages. Diagram is not to scale for the purpose of clarity.

oppose arc transference from one anode to another. The pressure tending to cause the transfer of the current is obviously the potential difference between those anodes marked 1 and 2. During the time the reactance is asserting itself this pressure difference must be absorbed so that the net voltage is the mean value of the two-phase pressures. At the end of the reactance effect the anode pressure wave asserts itself in anode 2 and the wave rises to its normal value at that point on the pressure wave and carries on the periodic sine form until it comes to the point where anode 3 is due to take over operation. Then again the reactance takes effect as before. This condition produces a period of "overlap," i.e., two anodes function in parallel during arc commutation or transfer from one anode to the other.

### The Effects of Overlap

The overlap gives rise to two conditions as follows :

1. During that period both anodes must have equal potential with respect to the cathode voltage, the one wave having a falling characteristic while the other wave has a rising characteristic.

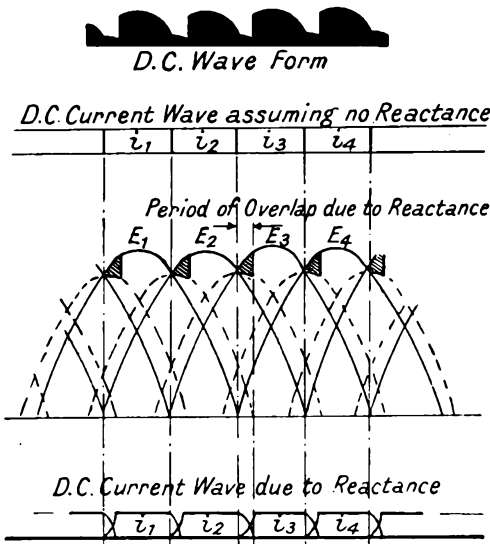

FIG. 6.—Diagram showing the effect on the D.C. pressure and current wave forms due to the reactance overlap.

2. In effect a short circuit exists between the two anodes. This produces an alternating component into the circuits of the anodes 1 and 2 which will be superimposed on the D.C. current to oppose that from anode 1 and to assist that in anode 2.

The net result of these two conditions will give a pulsating ripple in the D.C. circuit, but instead of the wave shape being sinusoidal it will become crested and the average value of the D.C. will drop by the amount shown hatched in Fig. 6. A

similar distortion will naturally appear in the A.C. wave form, so that the greater the overlap the more will be the drop in the D.C. pressure and in the R.M.S. value of the anode current.

Quite generally the leakage flux of the main transformer is the most important part of the total circuit reactance, and with a well designed transformer the D.C. pressure drop on that account will be about  $2\frac{1}{2}$  % with a working voltage of 600. Where anode inductances are used to increase the total circuit reactance without increasing the transformer reactance the pressure drop will be slightly more. Normally for the working pressure specified above, the regulation will be about 6 % after taking into account the copper losses, the increase in arc drop from no-load to full load, the drop in the smoothing coils and in the interphase reactor.

It is not good practice to specify a closer regulation than about 6 %, since the possible short circuit current which would flow under conditions of back-fire or other D.C. short circuit fault may be extremely large. Closer regulation would, therefore, mean an unnecessary expenditure in switchgear of higher rupturing capacity on both the D.C. and the A.C. sides of the equipment.

### **Reactance in the External Circuit**

The external circuit reactance also has an effect on the regulation to be expected, for if the rectifier equipment is large compared with the capacity of the alternator which supplies it with current, and further, the interconnecting feeders are long ones, the total circuit reactance will cause increased overlap in the commutating period so that the overlap short circuiting currents must flow through the whole system. Regulation in a very bad case may be 50 % greater than would be considered normal.

### **Transformers**

Rectifier transformers are designed in conformity with standard power transformer practice, but usually differ in construction in the arrangement of the secondary windings.



The most common types of connections will now be considered.

### Three-Phase Secondary

This type is the simplest possible form of connection for operation from a three-phase supply. The high tension wind-

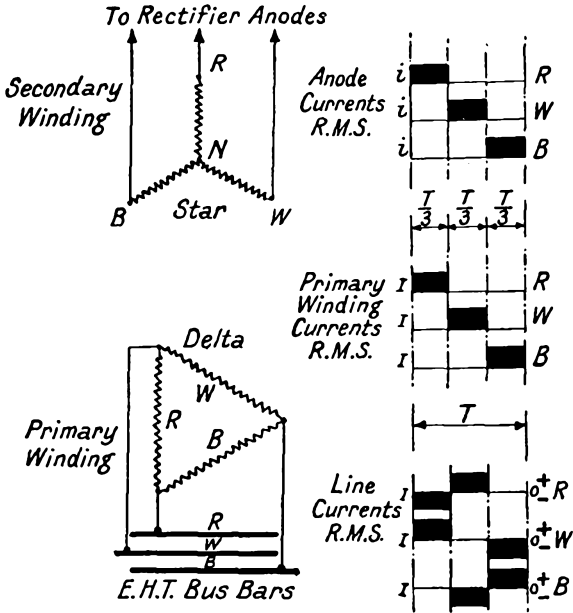

FIG. 7.—Delta/star three-phase transformer connections and current values.

ing is delta connected, the secondary being in star. The three free ends of the secondary are connected to the anodes of a three arm bulb and the star point is joined to the D.C. negative bus bar. This is a system that is useful for small rectifiers of about 100 amperes or less. The primary cannot be connected in star because each anode fires separately, and since current only flows in one secondary limb at a time the primary current must enter the corresponding limb and return through the two remaining limbs. Thus, with a star/star

connection two primary limbs are carrying current without a corresponding secondary current flowing, which results in a large uni-directional leakage flux and, consequently, bad regulation. With the delta connected primary such an unbalancing of the magnetic flux cannot occur, but on the other

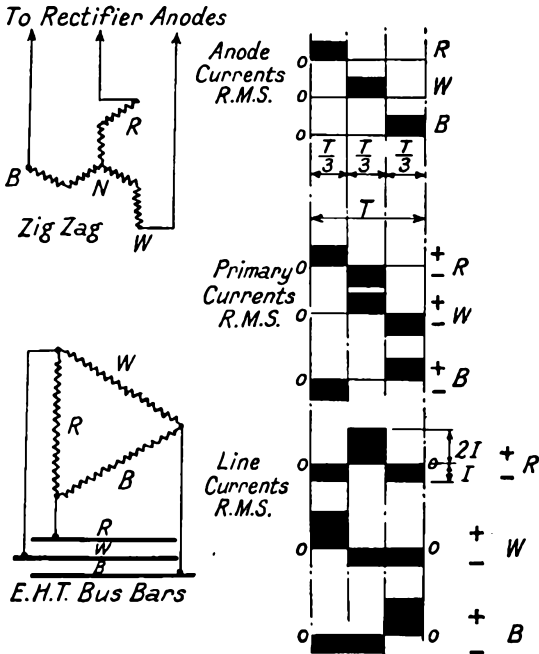

FIG. 8.—Delta/zigzag three-phase transformer connections and current values.

hand the magnetic flux is still not asymmetrical. This may be appreciated by inspection of Fig. 7.

To overcome this difficulty a zigzag secondary can be used as in Fig. 8, and furthermore, since the sum of the individual phase currents in the primary is zero at all instants a star connection can be utilised. From table I at the end of this chapter the advantages of this form of connection will be readily appreciated when compared with the straight delta/star

system and, therefore, should always be preferred for rectifiers of small capacity.

**Six-Phase Connections**

The most simple form of six-phase connection is that shown in Fig. 9, but unfortunately it has one serious fault. The

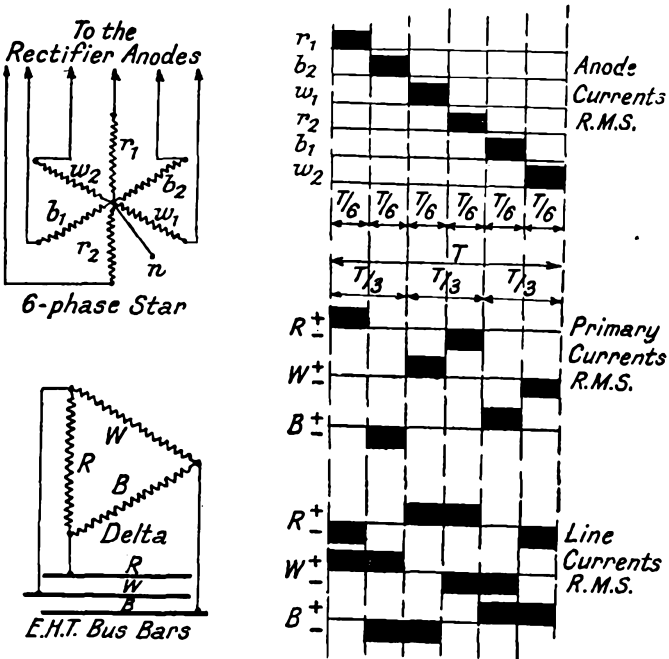

FIG. 9.—Delta/double star six-phase transformer connections and current values.

primary phase currents with this form of connection are uneven, so that there is left in the core during active operation a triple frequency m.m.f. which generates within the windings a triple frequency current. This current circulates round the winding and adds to the total circuit reactance, resulting in an adverse effect on the regulation. On account of this very undesirable feature this type of winding is rarely used except

where poor regulation may under certain circumstances be an advantage.

**Six-Phase Double Star**

This type of winding represents the simplest practical form for general purposes though not necessarily the best for every

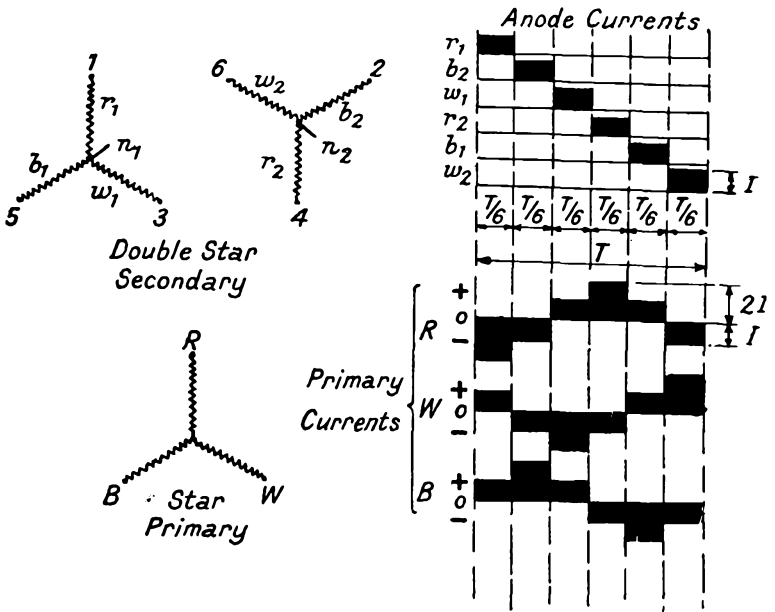

FIG. 10.—Star/double star transformer connections and current values.

circumstance. The primary may be star or delta connected, but the latter is to be preferred because it forms a closed path for the third harmonic to circulate freely without becoming objectionable. With the star connection the strong third appears because of the variable permeability of the transformer core and there is a phase pressure distortion due to the characteristically unbalanced loading of the transformer during the firing periods of the rectifier.

### Primary Currents in Six-Phase Star/Double Star

Fig. 10 is drawn to illustrate the currents flowing in the primary windings of the star/double star connection while the D.C. currents and pressures in the secondary windings of the transformer over a period of one complete cycle are split up into the operating times for each of the six anodes. Each secondary phase,  $r_1, w_1, b_1, r_2, w_2, b_2$ , carries the full amount of direct current passing to the external circuit for a period of one-sixth of a cycle or, in general, for a time  $2\pi/p$  where  $p$  equals the number of phases in the secondary. By inspection of the diagram it will be seen that the corresponding primary current flow in any one phase at any interval of time does not exceed two-thirds of the direct current and this only occurs twice in each complete cycle. In the remaining four parts of the cycle the current is only a third of the direct current. We, therefore, get the apparent anomaly of having a transformer with two K.V.A. ratings, one for the primary side and another for the secondary side. For the case in question the rating of the secondary winding is 73% greater than that of the primary.

### Primary Currents in Six-Phase Delta/Double Star

These are the same as for the six-phase star, so looking at Fig. 9 the secondary side still carries the full load current per phase in order of firing, i.e.,  $r_1 b_2 w_1 r_2 b_1 w_2$ , for the same interval of time, but the maximum peak value of the current in the primary phase is the same as in the secondary phase. This current is, however, only carried twice per cycle and has alternating polarity, so that here again there are two transformer ratings. In this case the secondary rating is only 41% in excess of the primary rating.

Although these diagrams do not represent the actual and true wave shapes they do serve the useful purpose of graphically illustrating the difference in the ratings of the two sides of the transformer and the poor utility made of the windings. It is all to the good then if the utility factor and the efficiency

can be improved and towards that end the interphase reactor was developed.

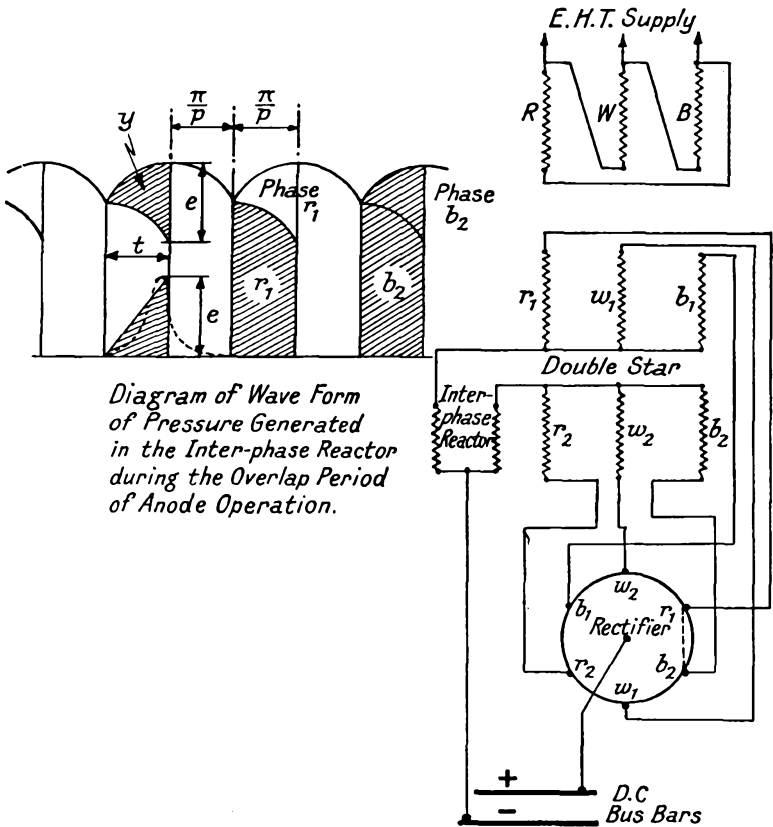

FIG. 11.—Delta/double star transformer connections with neutrals coupled through an interphase reactor.

### The Interphase Reactor

Under the sub-heading Reactance it was stated that the addition of reactance to the rectifier circuit produces overlap, i.e., two anodes function in parallel for a certain interval of time. If an absorption coil or, as it is now called, an interphase transformer is inserted in the neutral leads to the transformer secondary windings as shown in Fig. 11, the middle

point being carried to the negative bus bar, then during the operation of the phases  $r_1$  and  $b_2$  a closed circuit will be made via the arc during the period of the overlap. Let  $i_{r_1}$  and  $i_{b_2}$  represent the load currents in the phases  $r_1$  and  $b_2$  respectively, while  $e_{r_1}$  and  $e_{b_2}$  are the no-load terminal pressures, then, according to the second law of Kirchoff

$$e_{r_1} - L \cdot \frac{d \cdot i_{r_1}}{d \cdot t} = e_{b_2} - L \cdot \frac{d \cdot i_{b_2}}{d \cdot t}$$

Where  $L$  = the transformer inductance in henries per phase plus one half of the reactor coil inductance.

But  $i_{r_1}$  has a falling characteristic while  $i_{b_2}$  is rising, so that while  $L \frac{d i_{r_1}}{d t}$  is positive,  $L \frac{d i_{b_2}}{d t}$  must be negative with respect to it and the inductive pressure generated in the one phase reduces the resultant anode potential, while in the other there is an increase. Therefore the anode potentials are maintained equal.

The pressure generated in the coil at any instant is given as

$$v = 2 \cdot \times \frac{I \cdot X \cdot \sin \omega t}{1 - \cos \mu}$$

Where  $\omega t = 2\pi \sim t$ .

$$X = 2\pi \sim L$$

= The transformer reactance per phase plus half that of the reactor coil, i.e., phase to neutral reactance of the circuit.

$\sim$  = The frequency of supply in cycles per second.

$\cos \mu$  = An expression connecting the value of the circuit reactance with the period of overlap, and is equal to

$$1 - \frac{I \cdot X}{E \cdot \sqrt{2} \sin \pi / \phi}$$

Where  $I$  = The value of the constant D.C. current.

$E$  = The effective secondary phase pressure.

$\phi$  = The number of anodes or secondary phases.

$t$  = Zero in the above expression when the phase pressure waves intersect.

### Wave Form of Induced Pressure

The wave form of the induced pressure due to the reactor is shown in Fig. 11. The resultant anode pressure with a reactor in operation has been said to be reduced in the one case and increased in the other by the inductive pressure generated during the period of the overlap, which is shown in the areas marked  $r_1$  and  $b_2$  respectively. The difference between these two shaded areas ( $y$ ) represents the potential

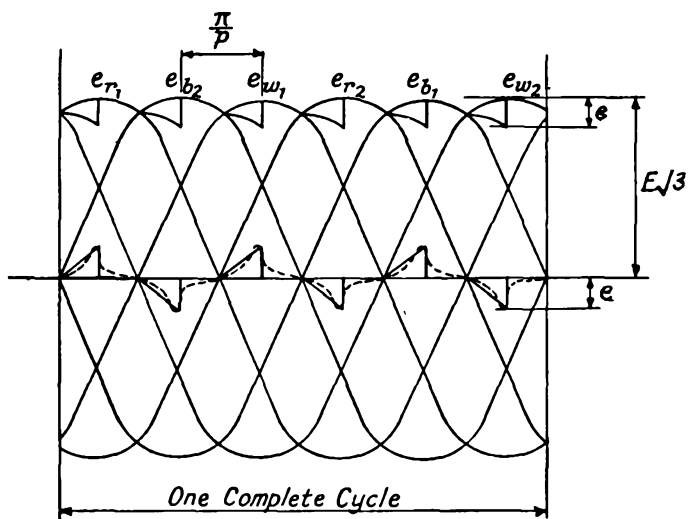

FIG. 12.—Diagram illustrating the generated pressures due to the interphase reactor.

difference across the reactor during the interval of time ( $t$ ) so that at any given instant the height of the ordinate in ( $y$ ) gives the P.D. at that instant.

If these ordinates are redrawn on the base line it will be noted that the wave shape is triangular, hence the shape shown in Figs. 11 and 12. In practice, however, the shape would be modified as indicated by the dotted lines.

Having illustrated briefly how the anode potentials can be made to equalise by the addition of reactance to the circuit it is only then necessary to design a suitable coil to prolong



the period of overlap as much as is practicable. Fig. 13 shows the effect on the A.C. wave form by adding the auxiliary voltage generated by the reactor to the secondary pressure wave, and it is to be noted that the effective time of anode operation is increased 100%. It is thus that the three-phase loading of the rectifier transformer is obtained while retaining the six-phase rectification characteristics which are so desirable. Not only does this overlap increase the efficiency of the transformer and the utility factor, but it also enables the rating of the anodes to be reduced almost by one half, a condition shown in Fig. 13.

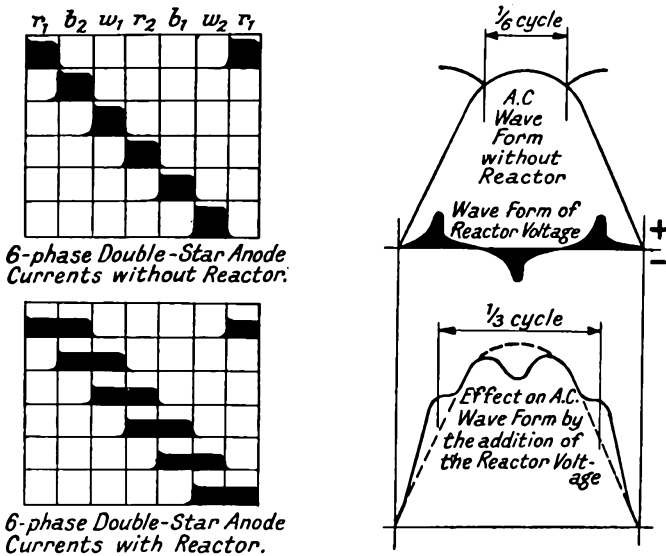

FIG. 13.

The effect of a reactor on the anode pressure and current wave forms.

### Transformer Ratings

With star/double star connections in the transformer and an interphase reactor the secondary windings of the transformer will only have a rating of 41% instead of 73% in excess of the primary rating where a reactor is not used. The net

overall rating of the transformer is, therefore, reduced by about 12%. The primary rating is the same with or without the reactor in circuit and the secondary rating is reduced by some 18% with the reactor. In the delta/double star connection the primary rating is reduced by 18% with the reactor in service and so is the secondary, giving a net overall reduction in the average rating of 18% for the whole transformer.

### Regulation

Furthermore, the drop in the voltage from no-load to full load, i.e., the regulation, need be no more than about 6%, whereas without the reactor the regulation would be about 10% to 12%. This is accounted for by the fact that reactance is added to the circuit without adding it to the transformer. Without the reactor the transformer reactance would be designed to give the latter regulation in order to limit the possible short circuit current under fault conditions.

The interphase reactor coil in practice under no-load conditions has but a small current flowing through it due to the triple frequency pressure existing between the neutrals of the transformer secondaries and cannot exert any influence upon the rectifier circuit. As soon as the load current flows the core of the interphase reactor becomes magnetised and the full reactance is induced. In consequence, the no-load voltage of the rectifier may be 20% higher than the normal full load pressure and 15% higher than the light load voltage. This arises through the fact that at no-load the rectifier is operating as a pure six-phase unit, whereas, with the load connected, the reactor changes the operation over to double three-phase. The complete change over from one form of operation to the other takes place at approximately 1% of full load current. In large rectifiers this characteristic rise in the pressure at no-load may be objectionable when paralleling the set on to a system that has no power to absorb the excess voltage for the time that is necessary to cause the change over from six to three-phase operation. Methods of overcoming this difficulty will now be described.

### **No-Load Pressure Rise and its Control**

The three common connections which give a no-load pressure rise are the double-three-phase (15%), the quadruple zig-zag (20%) and the triple-four-phase (10%).

It should be obvious that since the pressure rise is due to lack of exciting current flowing through the negative return of the rectifier, then if the reactor can be separately excited the pressure rise can be prevented. A separate exciting transformer supplied from the main transformer and arranged to work at a high value of saturation is a suitable method of giving a triple frequency current to the reactor. This method, however, produces a different wave form from the normal, but the effect on the anode voltage and on the D.C. wave form is slight and of no consequence since load is not being transmitted. When load is switched on to the rectifier, normal operation of the reactor is obtained which gives rise to a small circulating current round the exciting circuit due to the difference in the two waves generated. The exciting transformer has a capacity at normal frequency of about 0.1 to 0.15 of the K.V.A. of the main transformer. The losses, however, are high on account of the high degree of saturation at which the exciting transformer works and may amount to as much as 0.2 of the D.C. rating of the unit.

Another method is to use a loading resistance across the D.C. terminals having a capacity of about 1% of the D.C. rating of the rectifier. This method combined with a suitable current relay to cut in or out the loading resistance as required to keep down the light load pressure rise obviously shows a large saving in the running costs over the previous method.

There are other methods of overcoming the difficulty which are of a more or less complicated nature, but because no-load voltage control is not generally of any importance the matter will not be pursued further.

### **Six-Phase Triple Star Connections**

The six-phase double star connection has been illustrated in Fig. 11, but when used without a reactor the rating is large

for the primary side because the anode current has a rather large triple harmonic. This harmonic must be able to flow without undue reactance so that a corresponding current is required to circulate round the delta winding.

Furthermore, there is an unnecessarily steep voltage drop with this type of connection. By inclusion in the circuit of a reactor the reactive drop is reduced to one-third and the secondary K.V.A. rating of the main transformer to 1.48 times the D.C. rating in k.w. instead of 1.81 times the D.C. rating without the reactor.

If the six-phase double star connection is replaced by a six-phase triple star winding the zig-zag form of the connection cancels out the triple harmonic m.m.f.'s, which renders it possible to reduce the K.V.A. rating of the secondary from that required in the plain double star without reactance, i.e., 1.81 times the D.C. rating to 1.79 times the rating. Though this difference is but slight it must be remembered that the interphase reactor is not now necessary, so that the extra cost of the higher secondary rating with this connection is about the same as for the double star with the reactor. Delta or star primaries can be used with the triple star secondary.

There is little to choose otherwise between the double or the triple star forms, for given the same percentage reactance the short circuit currents, power factor, regulation and wave forms are the same, while there is very little difference in the initial cost. If anything the triple star is preferable for the higher voltage rectifiers and the double star for the medium pressure sets.

### **Heavy Duty Considerations**

With heavy duty rectifiers it may be necessary, because of the limitation of the current carrying capacity of the anodes, to use two, three or more anodes in parallel per phase. Having one phase per leg on the transformer with a separate lead to each of the anodes is not practicable, because the arc drop would prevent equal load sharing between them. In small rectifiers it is common to use a compensating reactor, which is

a small transformer having three limbs on each of which is a winding. The free ends of each winding are connected to an anode, while the mid-point tapping is connected to the transformer secondary terminal as shown in Fig. 14A. In larger rectifiers it is more satisfactory and also cheaper to wind each secondary phase with two or more identical windings connected in parallel as indicated in Fig. 14B.

Sometimes, instead of the parallel operation of several anodes

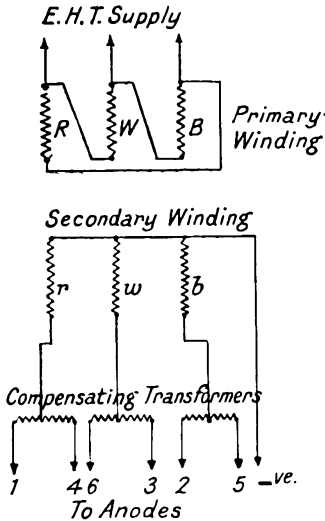

FIG. 14A.—Delta star transformer connections with the anodes supplied through compensating transformers.

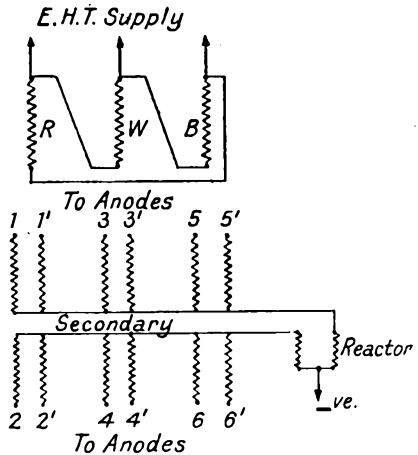

FIG. 14B.—Delta double six-phase double star connections. Two anodes are supplied in parallel through identical windings on each limb of the transformer.

on the six-phase system, a twelve-phase scheme is used. There are several twelve-phase connections in common use to-day, but with all of them there is a very objectionable feature, namely, a sensitiveness to A.C. wave distortion. If there is a prominent 5th and 7th harmonic in the supply the rectifier has a marked tendency to revert to six-phase working over a fairly wide range of load. The wave form on the D.C. side is generally believed to be the better the more phases there are on the secondary side supplying the rectifier, but that is not

true for the twelve-phase case. Though the 6th and the 18th harmonic may be eliminated, the 12th and the 24th remain with the same amplitude as before, and since these are the usual harmonics to cause telephonic interference there is nothing to be gained on that score by using a twelve-phase connection in preference to a six-phase.

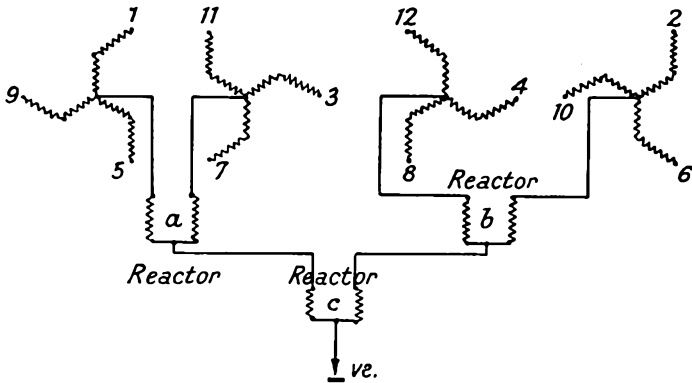

FIG. 15.—Quadruple zigzag twelve-phase connections. The secondary windings only shown.

### Quadruple Zigzag Connections

This form is quite common even though it needs three-inter-phase reactors. There are four separate three-phase windings displaced in phase relation by 90 degrees. The neutral points are connected together through one reactor for two of the systems and those of the other two systems are connected through another reactor, the two reactors then being connected through a third to the negative bus bar. The two similar reactors operate at triple frequency, while the third reactor operates at six times the fundamental. With this form of connection one anode in each group operates simultaneously and, therefore, each of them carry one-fourth of the D.C. load current for a third of a cycle (see Fig. 15).

### Triple Four-Phase Windings

This system is made up of three separate four-phase windings

connected 120 electrical degrees apart with the three neutrals connected together through a three limb reactor. The winding thus arranged serves one anode in each of the four systems so that each of the anodes carries a third of the D.C. load for an interval of 90 electrical degrees. The primary must, however, be connected in delta because the currents flowing within the winding are not asymmetrical. The big advantage of this type of connection as a whole compared with the

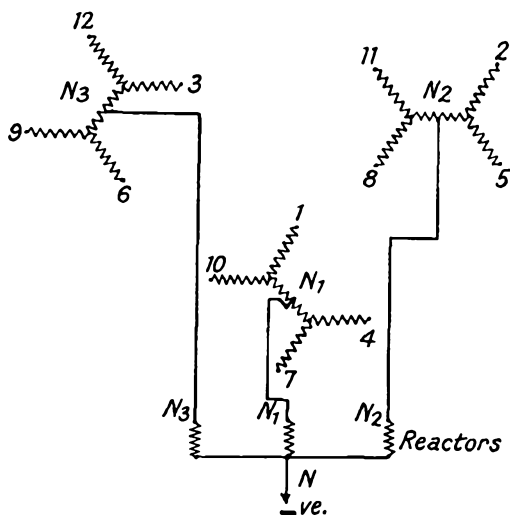

FIG. 16.—Triple four-phase transformer secondary connections.

quadruple zigzag is in the fact that the no-load pressure rise is only about 10 %, i.e., half that of the latter connection (see Fig. 16).

### Double Triple Star Windings

This system, though it appears very complicated, has a good utility factor and does not require interphase reactors. The primary is interesting because it is split up into two windings in series, the one winding being a star connected in series with the other winding which is in delta. With this type the anodes

again function over a period of a quarter of a cycle, and there are three anodes always operating at any instant (see Fig. 17).

Table 1 summarises the information given in this chapter regarding the various forms of transformer connections, and it will be found of assistance also in calculating the sizes of cables necessary for connecting up a rectifier set if the transformer connections are known.

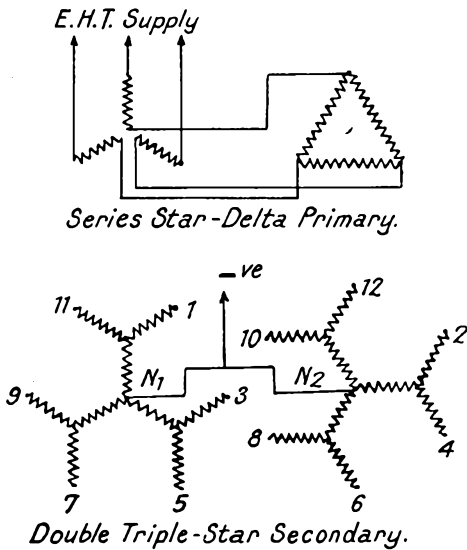

FIG. 17.  
Double triple star secondary connections with the primary connected in series star-delta.

### Cable Calculations

From Table 1 it will be appreciated that the copper section of the cables on the secondary sides of the transformer are not in strict ratio as is the case for simple power transformers. It will be assumed that a small rectifier of 23 k.w. output is to give a two-wire supply at 230 volts. From Table 1 the best form of transformer connection would be the delta three-phase zigzag which from column 4 has an anode load factor of



0.577. The section of copper from the three anodes to the transformer secondary terminals should be capable of carrying  $\frac{23 \text{ k.w.}}{230 \text{ Volts.}} \times 0.577$  amperes, i.e., 57.7 amperes per phase.

Assuming the I.E.E. standard of rating the nearest size of copper would be made up of 19 strands of wire 0.052. Though the R.M.S. value of the anode voltage to neutral is only  $\frac{\text{D.C. Volts}}{1.17}$  i.e., 196 volts, it would not be advisable to use a

low specification cable. Lead covered rubber cable with an insulation for 2,000 volts might be preferred for reasons to be given later. On the high tension side the primary K.V.A. is given in column 5 as 1.225 times the k.w., rating of the rectifier, therefore the actual K.V.A. in this case is 28.2, so that the high tension current to be carried will be

$$A = \text{amperes per phase} = \frac{\text{K.V.A.}}{V \cdot \sqrt{3}} = 16,300/V.$$

Where V = The primary pressure between phases. The copper section can then be calculated and a suitable cable size chosen.

The same principles apply to calculations of cable sizes for the other systems of connection given in the table.

TABLE I.

D	1. Diagram No.	3. Transformer Type.		4. Anode Current Factor.	5. Primary KVA KW.	6. Secondary KVA KW.	7. Inter- phase Reactor KVA KW.	8. Trans- former Winding Utility Factor.	9. D.C. on Load Voltage Factor.	10. D.C. off Load Voltage Factor.	11. D.C. off Load Pressure Rise.
		Primary.	Secondary.								
	7	Delta	3-phase Star	0.577	1.505	1.505	—	0.664	1.17E	—	—
	8	Star or Delta	3-phase Zig-Zag	0.577	1.225	1.735	—	0.678	1.17E	—	—
	9	Delta	6-phase Star	0.408	1.28	1.81	—	0.645	1.35E	—	—
10 and 11		Star or Delta	Double 3-phase	0.289	1.05	1.48	0.085	0.741	1.17E	1.35E	15 %
		Star or Delta	Triple 3-phase	0.408	1.05	1.79	—	0.704	1.35E	—	—
15		Star or Delta	Quadruple Zig-Zag	0.144	1.01	1.65	0.09	0.704	1.17E	1.40E	20 %
16		Delta	Triple 4-phase	0.167	1.02	1.61	0.035	0.741	1.27E	1.40E	10 %
17		Series Star/ Delta	Double Triple-phase	0.173	1.03	1.67	—	0.741	1.40E	—	—

E = R.M.S. Anode Pressure.

## CHAPTER II

### THE CONSTRUCTION OF RECTIFIER PLANT

#### **The Glass Bulb Rectifier**

IN the glass bulb equipment there are (a) the main step down transformer and (b) the rectifier cubicle which houses the bulb and all the auxiliary apparatus.

The main step down transformer may have any type of connection of the secondary windings given in Chapter I, and may be arranged to supply one, two or more bulbs in parallel as desired.

Mounted on the front of the cubicle of the early rectifier was a three-phase A.C. air break knife switch connected in the circuit between the transformer secondary windings and the anode fuses protecting the bulb. Later, this switch was replaced by an oil circuit breaker, in the tank of which was fitted the fuses for the protection of the anode circuits against fault currents. This switch being arranged for hand operation and not for automatic tripping under fault conditions. Since the A.C. switch was merely an isolating device to enable a cubicle to be made "dead" while retaining the associated bulb working off the same transformer, in service, the switch was later replaced by pole operated isolating links. Anode fuses were still retained for circuit protection.

In the event of a serious fault the main oil circuit breaker on the high tension side of the main step down transformer is arranged to open by the operation of a three-phase inverse time limit overload relay.

#### **The Anode Inductance Coil**

An important part of the auxiliary equipment in the rectifier

cubicle is the three-phase anode inductance. The magnetic circuit is divided into two parts and between these two sections non-magnetic packing can be inserted in order to readily vary the value of the inductance of the coil. The object of thus arranging for adjustment of the amount of inductance in the anode circuits is to facilitate balancing the bulbs for parallel operation. Slight differences in the length of the anode arms between two bulbs which are to operate in parallel, or a difference in the size of the condensing chamber, or even in the degree of vacuum may render one bulb more liable to take an unequal share of the load.

Where two cubicles work in hexaphase parallel it is usual to have only one inductance core wound with two separate sets of windings, one for each bulb. This enables a much finer adjustment to be made, and gives a better performance while simplifying the cubicle layout.

### **The Glass Bulb**

The glass bulb may be either of the three arm type for three-phase operation or of the six arm type for six-phase working. The arms carry the anodes from which cables are taken to the anode inductance windings. Each bulb also has an ignition electrode and two excitation electrodes. The circuits for these latter will be given on the next page. The cathode is formed by a pool of mercury at the base of the chamber from which part one or more connections are taken to the cathode inductance coil or the positive side of the D.C. system. The number of cathode connections, of course, depends upon the ampere rating of the bulb.

### **Cathode Inductance Coil**

From the cathode of the bulb the rectified current is taken to the cathode inductance coil. This piece of apparatus helps to partially smooth out the ripple from the D.C. circuit, but is mainly used to assist in the sharing of the load between bulbs by adjustment of the magnetic circuit as in the case of the anode inductance coil. From the cathode inductance coil a

connection is then made to the D.C. circuit breaker mounted on the top of the front panel of the cubicle.

### Ignition and Excitation Circuits

The ignition and the excitation electrodes receive their supply from a small winding on an auto-transformer. A

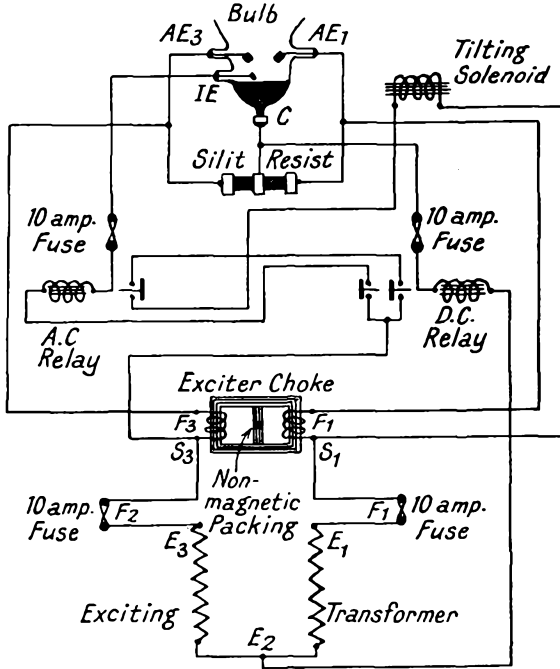

FIG. 18.—Typical ignition and excitation circuit.  
Glass bulb rectifier. (H. E. Co.)

typical circuit diagram is given in Fig. 18. To start up the bulb it is necessary to bring the ignition electrode into contact with the cathode mercury pool. This is arranged either by mounting the bulb in a cradle free to rock about a fulcrum so that the mercury is sloped into contact with the fixed ignition electrode, or the electrode may be movable and by the action of a small electro-magnet bent down into contact with the

mercury. In the former case the ignition electrode I.E. is energised before and during the tilting operation, but is cut out of circuit immediately the bulb strikes up.

With hand titling I.E. is energised during the tilting action by closing a push button switch, or it may be connected in circuit through a carbon shunter contactor made to open circuit when the bulb strikes up. The electrode I.E. is connected through a resistance in the hand tilting types or a relay in the automatic types to terminal E<sub>3</sub> of the excitation winding and after contact is made between I.E. and the cathode pool C, the bulb on returning to the vertical position under the action of gravity will cause an arc to be drawn out between them. This small arc is sufficient to ionize the mercury vapour in the bulb to allow the excitation electrodes to function.

If the bulb is cold, the titling operation may have to be repeated several times before sufficient vapour pressure is produced for the excitation electrodes to remain in constant operation. If, however, the vacuum is normal and the amount of excitation current has been correctly adjusted, the bulb should strike up as soon as the ignition arc has been drawn out.

### Sequence of Operation of Ignition Circuit

The sequence of operation of the typical circuits shown in Fig. 18 will now be described. The excitation transformer winding becomes energised immediately the main rectifier transformer switch is closed. The circuit is then complete from the terminal E<sub>3</sub> through Fuse F<sub>2</sub> to two contacts on the D.C. relay. From one of these contacts a lead is taken to the A.C. relay coil through a 10 ampere fuse and another lead taken from the fuse to the ignition electrode I.E. The remaining contact of the D.C. relay is connected to the A.C. relay and continued on to the tilting coil solenoid, a second 10 ampere fuse and back to the excitation transformer windings at E<sub>1</sub>. These circuits enable the tilting solenoid to be energised, causing the cradle of the bulb to be rocked over to one side whilst at the same time the A.C. relay coil and the

ignition electrode are energised. The A.C. relay then opens the tilting coil circuit, the bulb returns to the vertical position under the action of gravity, an ignition arc is drawn out and the bulb is struck up. If the bulb fails to strike up at once the whole process is repeated until it does. When the bulb is

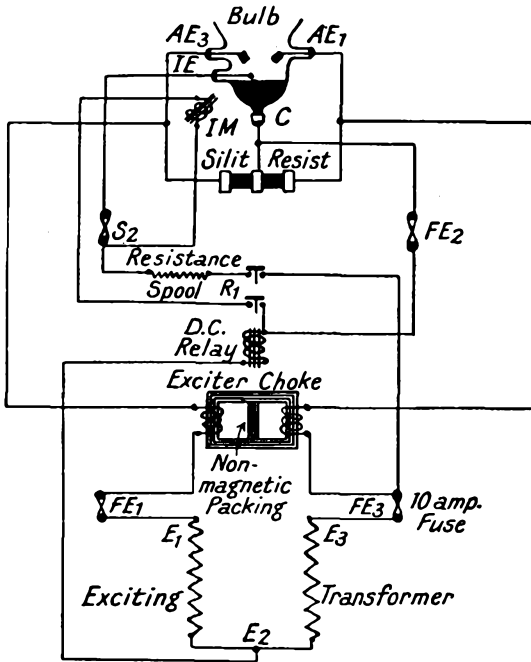

FIG. 19.—Typical ignition and excitation circuit.  
Glass bulb rectifier. (H. E. Co.)

operating on the exciter circuit a path is formed from E<sub>3</sub>, via the mercury vapour through the exciter chokes to the cathode pool C, then via the D.C. relay coil to the mid-point of the exciter winding at E<sub>2</sub>. Thus the D.C. relay is energised and opens its contacts to cut off the supply to the A.C. relay and to the tilting coil.

To-day the tilting operation is not often used for ignition purposes, the electro-magnetic attraction of the ignition

electrode is preferred because of its simplicity. The diagram shown in Fig. 19 illustrates the circuit for this method of starting up, and it will be noticed that as before  $E_3$  supplies the coil of the electro-magnet via the contacts of a D.C. relay and also a resistance spool  $R_1$ . When the coil is energised the ignition electrode is attracted into contact with the mercury pool and as soon as the arc is struck up the current flowing from the cathode through the relay to the mid-point of the exciter winding is sufficient to cause the relay to open the contacts and so cut off the supply to the electro-magnet and the ignition electrode.

### Cooling Fan Circuit

In Chapter I, Fig. 1, the effect of a cooling apparatus on the loading capacity of a bulb was illustrated. It is, therefore, almost universal practice to include in the equipment a motor driven fan unit for each bulb. In many cases in the main anode lead to the cathode inductance coil is inserted a heavy current type relay which passes through its thick copper winding the current output to the D.C. bus bars. A soft iron plunger operates a set of contacts which are arranged to make a circuit when the load reaches a predetermined value and breaks the circuit again when the load has been reduced to a value somewhat lower than the initial operating setting. Thus if the load is a slightly fluctuating one, round about the critical operating value of the relay, the difference in the settings for closing and opening the fan motor circuit prevents a continuous closing in and tripping of the motor.

The fan is operated by a three-phase squirrel cage motor at a low voltage. In some cases the speed of the motor of the fan is varied according to the amount of load on the equipment. This variable speed control is accomplished by the use of a three-phase choke in the supply circuit to the fan motor. The choke is of special design, having additional windings which are connected in series with the negative connection to the main transformer neutral. Thus at heavy loads the choke coil magnetic circuit becomes saturated and the choking



effect on the A.C. coils is considerably reduced. A reduction in the choking effect is followed by an increase in the voltage applied to the motor and hence an increase in speed is obtained. Conversely, at low loadings the flux is small and the choking effect correspondingly great so that the applied voltage to the motor is reduced and so, therefore, is the speed. Thus the fan motor speed is dependant upon the amount of induced flux in the magnetic circuit due to the load current.

The early types of fan generally had two blades made of sheet metal, but where the substation was situated in a residential district this type of blade was objectionable on account of the windage noise it produced. This type of fan was followed by the wooden propeller type with more satisfactory results. The amount of air displaced by the fan is considerable and, therefore, special attention must be paid to the ventilation of the substation. Dust and dirt is easily drawn into the cubicle, and in cases where the fan is arranged to draw air from outside the building special air filters are essential if maintenance work is to be reduced to an absolute minimum.

The fan is a very important piece of auxiliary apparatus, as will be appreciated from the study of Fig. 1, for a failure to operate when the bulb is under heavy load may cause it to back-fire. A back-fire does not always damage the bulb and it can often be struck up again immediately on the excitation circuit. If, however, the colour of the gas within the bulb is tinged with pink, then the bulb should be allowed to remain operating on excitation only until the colour is normal. The bulb may then be put into service.

### **Voltage Control Methods**

There are several methods in commercial use for enabling a variation of the output voltage to be obtained.

I. TAPPED AUTO-TRANSFORMER SYSTEM.—From the main L.T.A.C. switch or isolator cables are taken to a three limb auto-transformer which has a number of tappings which are connected to segments on a three-phase regulator. A spider

is arranged so that it may be hand or motor operated to travel along the regulator so that the voltage to the anodes may be varied over the full range of the tappings. When the spider contacts move from one segment to the next the small auxiliary fingers first comes into contact with the next higher segment, and for the pass over time the two segments are in parallel through a resistance which bridges the main and the auxiliary fingers of the spider. Thus the circuit to the anodes is never broken while changing from one tapping to another.

2. INDUCTION REGULATOR METHOD.—An induction regulator can be connected into the E.H.T. side of the main transformer or into the secondary circuit to the anodes, but the former is to be preferred since the current to be handled is so much smaller. The regulator can be arranged to boost or buck the applied voltage to the anodes, which in turn varies the voltage to the D.C. bus bars. The induction regulator lends itself to remote control or local control by means of a simple type of pressure relay. The main advantage of this system is that it gives a continuous variation throughout its whole range, but on the other hand it is somewhat inferior to the on-load tap changing method on account of the higher losses and also the initial cost. There is also a greater inherent regulation drop together with a lower power factor. It is not, however, suitable for very high voltage operation.

3. TRANSFORMER ON-LOAD TAP CHANGING.—In this method referred to above the main step down transformer is fitted with a system of switches on the primary side to insert or cut out portions of the primary winding for the purpose of varying the induced secondary voltage applied to the anode of the rectifier. This method of voltage control is ideal where the range of D.C. pressure is not too great and where the variation is not required to take place too often. For traction work it is usual to fit tap changing gear of a less complicated nature, but which can only be operated when the rectifier is off load. It is not generally essential to fit on-load tap changing gear to rectifiers used for this work.

4. GRID CONTROL OF VOLTAGE.—The D.C. pressure can be

varied over very wide ranges with this form of control, but it has the great disadvantage of wave form distortion and power factor limitation. This subject will be treated more fully in a later Chapter.

5. INTERPHASE REACTOR CONTROL.—This system is not of much practical use. The method of control is obtained by

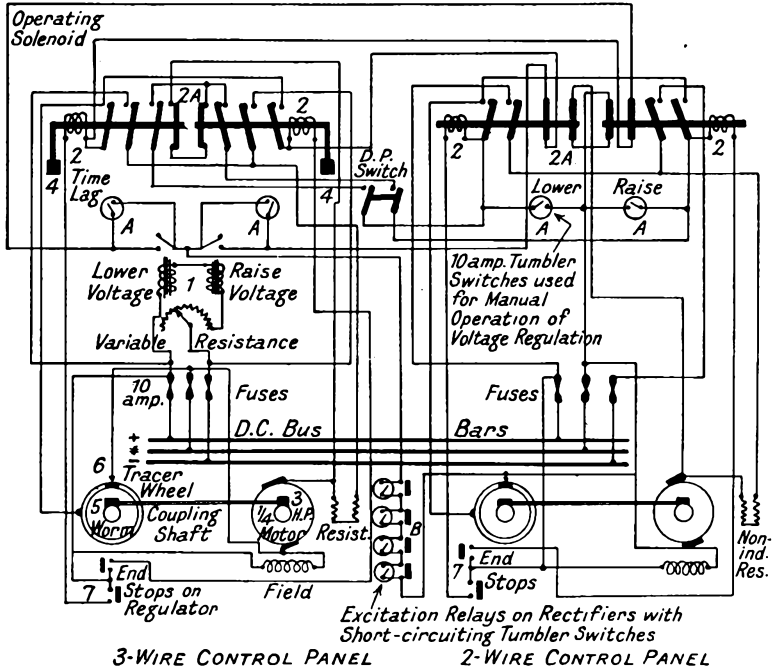

FIG. 20.—Complete diagram of connections for an automatic voltage control scheme.

winding on to the interphase reactor or transformer a shunt coil to enable the degree of saturation to be varied which will produce a limited variation in the D.C. pressure.

### Example of Simple Pressure Control—Auto-Transformer Type

In Fig. 20 a simple form of voltage control panel is illustrated and is designed to work in conjunction with the auto-trans-

former tapping system described above. A pressure type relay is connected across the D.C. terminals of the rectifier equipment and is arranged to close either of a pair of contacts at a pre-determined maximum or minimum value of voltage and can be set to a fine degree of closeness. The closing of either set of contacts will energise one of the two solenoids 2, which mechanically controls a set of contacts mounted on a movable

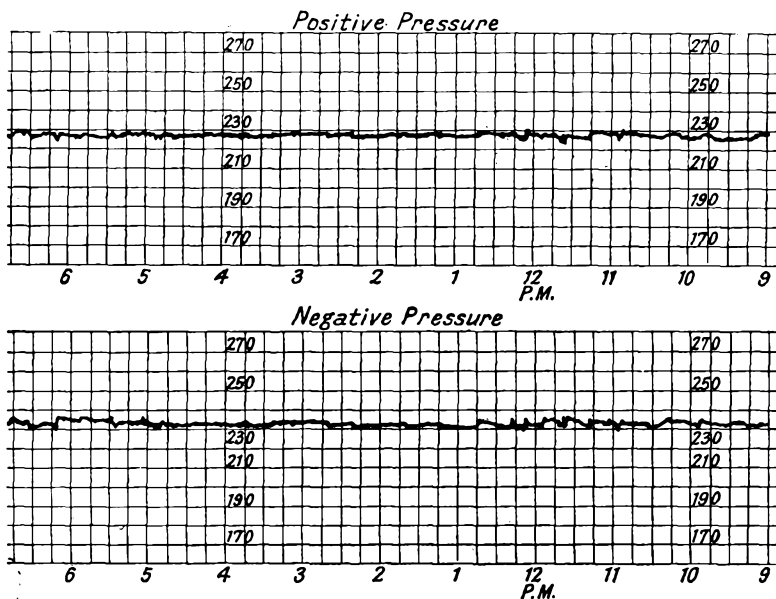

FIG. 21.—Pressure regulation curves obtained by the use of the scheme illustrated in Fig. 20.

bar. Each contactor bar has four sets of contacts 2A, two of which control the supply to the regulator operating motor 3 and are closed as the solenoid is energised. Another set of contacts short circuit the motor armature when the solenoid is de-energised and the last set is connected up to a double pole switch D.P. on the booster control panel if such an equipment is installed in the substation.

Solenoids 2 are interlocked mechanically so that one only can operate at a time. The contactor bar arms are fitted with an

oil dash-pot which has an adjustable feature for controlling the time lag of operation. This dash-pot 4 is used for the purpose of preventing the motor operating the regulator on momentary fluctuations of the D.C. pressure. The operation of one solenoid causes the regulator motor to run in one direction, while the other solenoid reverses the direction of rotation.

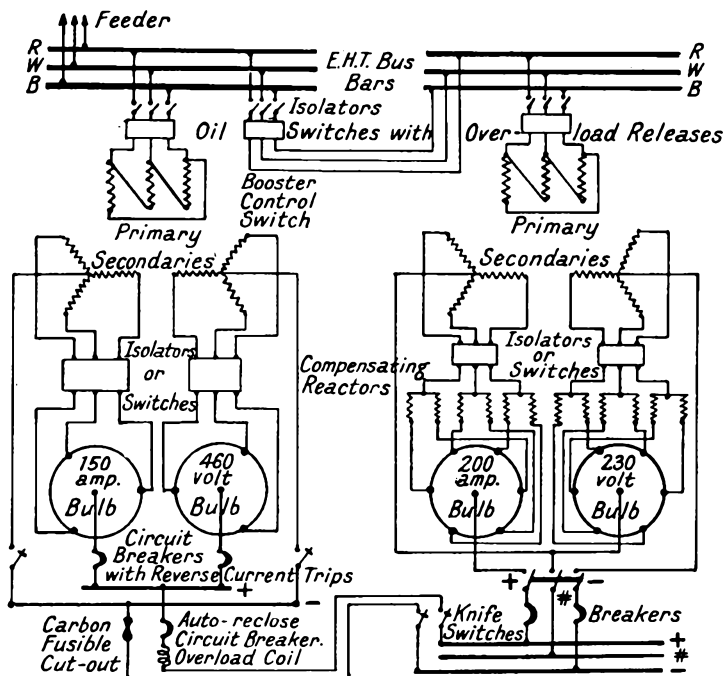

FIG. 22.—Diagram of connections of an automatic glass bulb rectifier equipment for supplying a three-wire D.C. distribution system.

Where two or more bulbs operate in parallel the regulator shaft of each cubicle is coupled through worm reduction gearing and the chain wheels to the main operating motor shaft, so that the voltage is varied in each set together.

When a solenoid is energised the motor revolves until one complete revolution of the regulator shaft has been traversed, irrespective of whether the responsible contacts on the voltage

## THE CONSTRUCTION OF RECTIFIER PLANT 45

relay have opened or not in the meantime. When a complete revolution of the regulator shaft has been traversed the motor

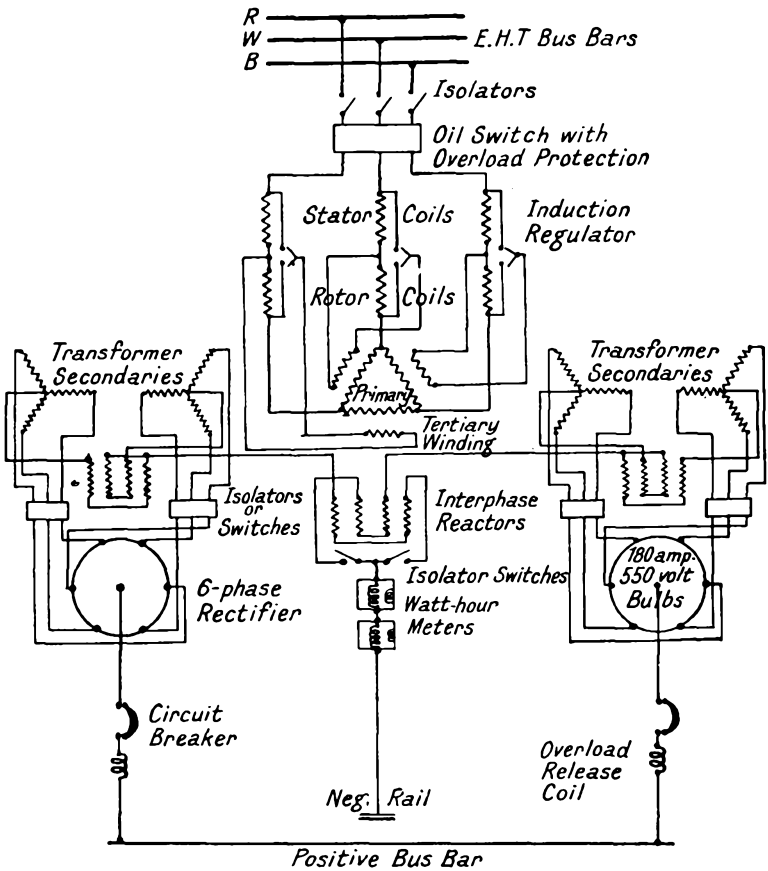

FIG. 23.—Diagram of connections of an automatic glass bulb rectifier equipment for supplying a two-wire traction system. The pressure is controlled with an induction regulator on the E.H.T. side of the equipment.

armature circuit is broken by the contact 6 on the shaft 5. If the contacts on the relay 1 still remain closed a further complete revolution will be made and so on until the pressure is at the constant predetermined value of the relay setting. If the

pressure relay fails to open circuit before the regulator spider has reached the end of its permissible travel a limit switch 7 is arranged to open the motor circuit by de-energising the operating solenoid 2. The motor feed is also interlocked with the excitation circuit of each bulb, which prevents the regulator

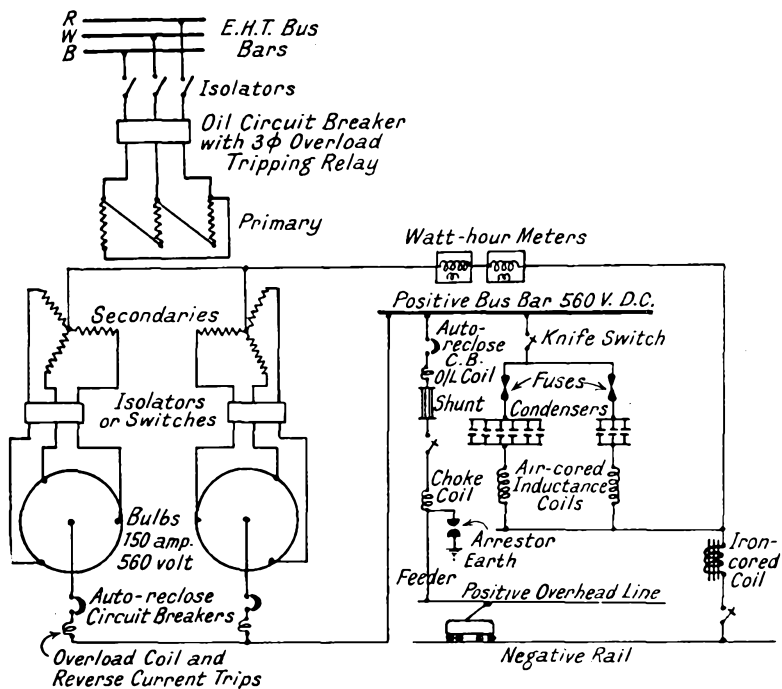

FIG. 24.

Diagram of connections of an automatic glass bulb rectifier equipment for traction service. Note the arrangement of the smoothing circuits.

operating when there is a total failure of the E.H.T. supplies, or when any one or more bulbs have failed to strike up. Manual operation can be carried out by means of the two push button switches. The regulator of any bulb or bulbs may be operated if any other bulb is out of service by closing the interlocking switches B. The regulating equipment of the 3-wire set is entirely independent mechanically of the booster set, though

with the double pole switch D.P. closed the regulators of the balancer and the booster will keep in step. An actual chart is traced in Fig. 21 showing the degree of regulation obtained from this system of voltage control. It is a simple and entirely automatic system.

Figs. 22, 23 and 24 are line diagrams of the connections of typical glass bulb rectifier equipments.

### **Metal Clad or Steel Tank Rectifiers**

The steel tank rectifier has of recent years settled down to fairly common forms of construction and the differences in manufacture are mainly those of detail only.

#### **The Vacuum Chamber**

The usual shape of the chamber is cylindrical with a dished bottom arranged to permit mercury condensate to run down quickly to the cathode pool. It is of welded steel plate construction, the material being specially chosen for its freedom from porosity and the ease with which the shell can be fabricated. It is also immune from attack by the mercury contained in it. The chamber is usually housed in a further shell which acts as a water jacket for cooling purposes.

The anodes are mounted on the top of the tank, while the anode shields are either wholly or partly arranged to fit within the main chamber. It is common for the anode plate to be made removable by simply breaking down a main vacuum joint, so that easy access is rendered possible to the interior of the chamber. Internal cooling is also common in all but the very small sizes of rectifier, a construction which assists in the rapid condensation of the mercury vapour and so controls the pressure within the normal working limits. The amount of internal cooling surface has to be designed for each given rating of the rectifier, for too great a surface has a detrimental effect upon the operation of the set.

There are also baffles of sheet construction surrounding each



anode to prevent spray from the cathode hitting the anode material and so producing a local hot spot. This form of anode protection is further assisted by a baffle made by the

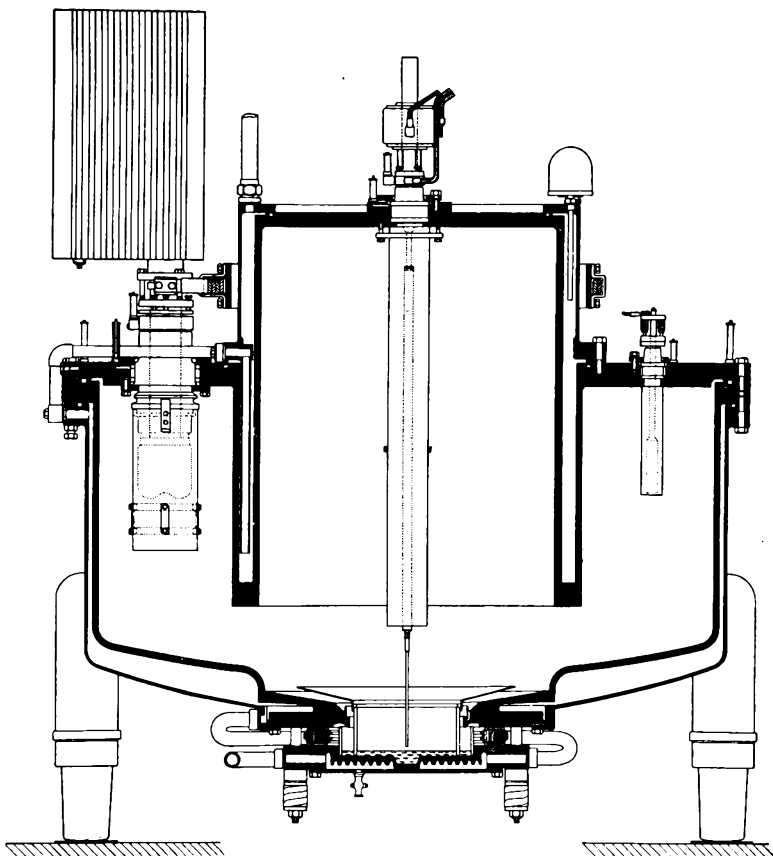

FIG. 25.—A sectional view of a typical steel tank rectifier. (B.T.H.)

flume of the main condensing chamber (see Fig. 25). It will be noticed in the diagram of this typical rectifier that the mercury condensate will drip down the walls of the flume into the cathode pool without any chance of the globules falling into the anode shields.

### **Cathode**

The cathode mercury pool is carried in a water jacketed steel plate, insulated from the vacuum chamber by an annular porcelain insulator. The cathode spot is centred by a refractory insulating cylinder of quartz or other suitable material. The cathode is water cooled to maintain the mercury at a comparatively low temperature, though the wandering spot may have a temperature of about  $2,000^{\circ}\text{C}$ . The condensate will drop on to the sides of the tank and run down into the cathode pool, but the refractory liner dips into the mercury and acts as a separator. In this way any impurity gathered by the mercury is trapped in the annular pool while the main pool is kept clean.

### **Anodes**

The dimensions of the anodes are governed by the amount of current to be passed, the limitations of current density for the material used in their construction, the density in the arc path at a maximum allowable overload and the internal temperature conditions. The heat generated at the surface of the anode may be of the order of about 5 watts per ampere, which is mostly dissipated by radiation within the rectifier. In the earliest types the anodes were made of iron and one British manufacturer uses this material to-day, but since the temperature of the anodes may be as high as  $600^{\circ}\text{C}$ . any impurity in the iron would assist in the production of a local hot spot sufficient to cause fusion and possible back-fire. Graphite of special grade is the material in most common use now for the anodes, and it has extremely long life even under the most severe of service conditions and may be considered practically indestructible.

### **Anode Shields**

Shields are used to protect the anodes from direct contact with the blast of mercury vapour and also the spray from the cathode. They also serve to reduce the stress in the anode due to electronic bombardment at the time when the potential

wave is in the negative half cycle. The addition of such shields reduces the tendency to back-fire to a remarkable extent and as a consequence a further refinement is often added in the form of division plates within the shield to further subdivide the arc path to the anode. This advance in design enabled heavier currents per anode to be carried and permitted operation of the rectifier at higher tank temperatures.

Sub-division of the arc path cannot be carried out indiscriminately, for such protection of the anode can only be increased up to the limit of stability of the arc, i.e., up to the point where any further division would render it impossible for the anode to pick up current in the normal direction.

The temperature attained by these shields is governed by the amount of heat absorbed from the presence of the arc within it and the heat dissipated by radiation and conduction.

The shields may be insulated or earthed to the side of the tank, but in the former case the potential attained will float with respect to its anode voltage.

## Seals

The design of the seals has been a difficult problem, but to-day there are four main types, (*a*) the rubber seal, (*b*) the mercury seal, (*c*) the micalex seal and (*d*) the Weintraub seal.

**THE RUBBER SEAL.**—This is the most simple form of seal in use. It consists of a flat rubber ring of high quality material reinforced in a gas-tight manner on the vacuum side by a flexible iron V-ring, which is pinched down when the holding down bolts are tightened.

**THE MERCURY SEAL.**—As in the first seal a porcelain insulator is used, but the joints are packed with a resilient material and this packing covered with mercury. In some cases a sighting glass is fitted to give continuous indication of the tightness of the seal by the level of the mercury in the gauge glass. In other cases a tell-tale dipper rod floats in a pocket so that if a seal fails the rod drops to the bottom of the pocket and the faulty seal quickly detected.

**THE MICALEX SEAL.**—Micalex is the name given to a mixture

of mica and lead borate which is moulded under a great pressure and at a high temperature so that it can be used as the insulator as well as the seal.

**THE WEINTRAUB SEAL.**—This form of seal consists of a number of thin mild steel cones which are separately enamelled with a special glass which, after assembly in the form of a seal, is electrically heated in an oven until the whole is fused solid. The seal is then bolted down to the specially machined face of the tank. The one very great disadvantage of types *a*, *c*, and *d* is the extreme difficulty of quickly locating a faulty seal.

### Excitation and Ignition

In the steel tank rectifier the ignition electrode is nearly always of the "dipping rod" type. This is a plunger inside

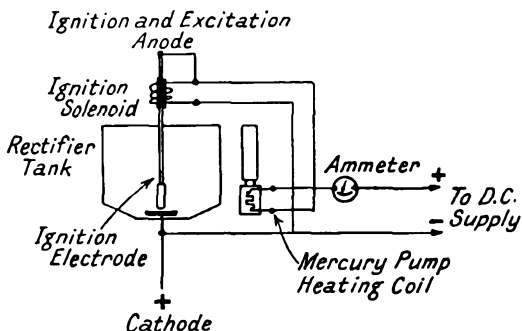

FIG. 26.  
Ignition and excitation circuit diagram. (E. E. Co.)

the vacuum chamber and is made to dip into the cathode mercury pool by a solenoid on the top of the tank. The ignition electrode is usually supplied with current of the same kind as the excitation electrodes, i.e., either D.C. or A.C. The excitation electrodes may be supplied with current at a low voltage by a metal rectifier of the copper oxide type or by a small glass bulb rectifier. Another method is to use a small motor generator set coupled to the water cooling circulating pump. The heating coil of the mercury vapour pump is connected in series with the excitation arc, which tends to

stabilize the latter and the no-load losses of the equipment are reduced by about 0.75 k.w. (See Fig. 26.)

If A.C. excitation is used there may be two excitation electrodes operating single phase or there may be an excitation electrode adjacent to each main anode operating on a complete polyphase system, but lagging in phase behind its main anode by 30 electrical degrees. The advantages claimed for the polyphase system are that greater stability of the main arc is obtained since the whole excitation ionization is given to each main anode in turn and the anodes can therefore be designed with better protection against the possibility of back-fire, and, furthermore, this scheme facilitates the starting up of the main anodes. The disadvantage of A.C. excitation is in the fact that at least one extra vacuum seal is required on the rectifier and that an additional contactor, choking coil and resistor is necessary.

The excitation circuit loss is about 0.5 to 1.0 k.w., and for a given circuit loss A.C. excitation can provide a larger exciting current than can be obtained with the use of D.C., since the arc can be stabilised by a series reactance instead of a series resistance.

### **Mercury Vacuum Pump**

The first of the two pumps operating in series for the efficient maintenance of a good vacuum within the chamber works on a similar principle to that of the steam ejector. A typical arrangement is given in Fig. 27. Mercury is boiled by means of a small electric induction type heater and the vapour produced is caused to issue through one or more jets as at (A) and (B) to extract and trap the air. Passing from one stage to the next the mixture of mercury vapour and air enters the bottom chamber where the mercury is condensed out. The condensate is then allowed to return to the boiler for re-circulation, while the air is passed on to the next stage through the pipe (C). The first pump was produced in practical form by Dr. Langmuir in 1916.

If a simple resistance type of heater was used to boil up the

mercury the resulting temperature of the heater element would be very close to its safe limit after making due allowance for heat drop in the air space and the insulation. It is, therefore, preferable to use the induction type of heater as shown in the

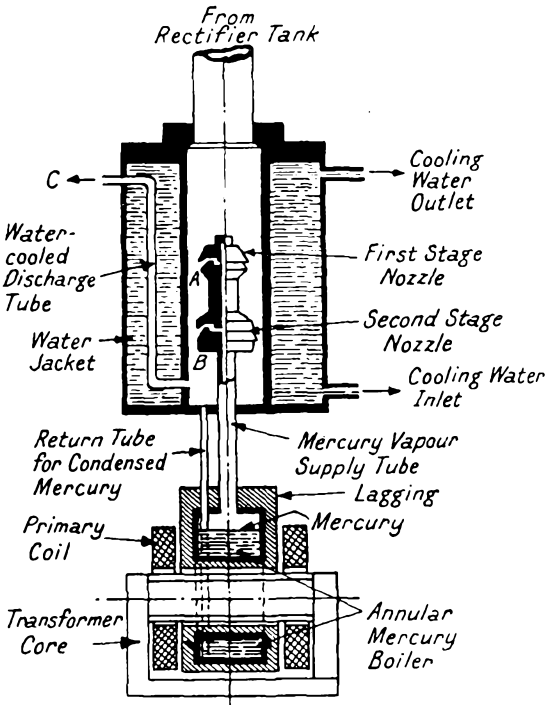

FIG. 27.—Diagram of a two-stage mercury condensation Vacuum Pump, with induction type heating unit.

drawing given, i.e., the boiler is made to form a hollow ring threaded over a transformer core so that the heat is generated directly in the boiler. This method reduces the maximum temperature present and also enables the windings of the heater to remain cool.

Although the "Diffuser Pump" just described has a large volume pumping capacity, it cannot operate with its outlet at atmospheric pressure. There must be some form of ex-

hauster and this consists of a motor driven oil-pump. There are several types of pump in use, but two only of the most common types will be illustrated. Fig. 28A and Fig. 28B show that in both types the rotor and the stator have a clearance between them which is filled with oil. As the air is passed on from the condenser chamber of the first pump it is drawn by the speed of the rotor of the rotary pump into the space between the rotor and stator and forced through an

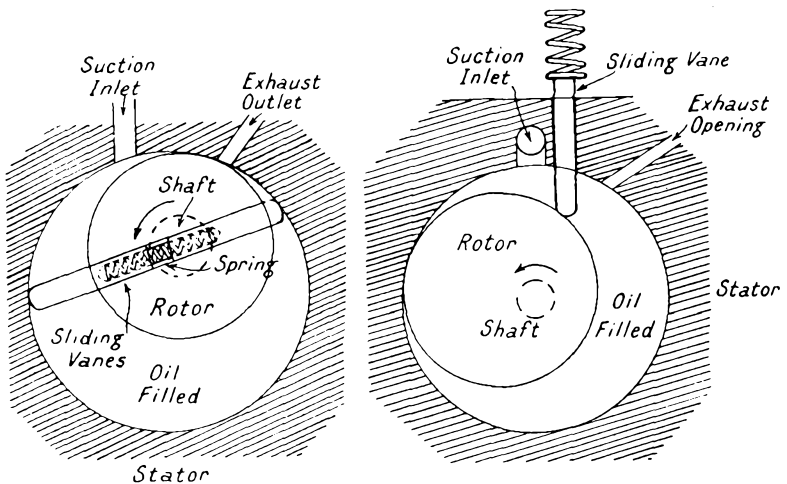

FIG. 28A.—Rotary vacuum pump with the vane in the rotor.

FIG. 28B.—Rotary vacuum pump having the vane in the stator.

exhaust exit in the latter to atmosphere. Fig. 28B is of the type which allows a more perfect lubrication and lower stresses in the springs than that shown in Fig. 28A.

For any given pumping speed the rubbing velocities can be made a minimum if the rotational speed is reduced to a minimum so that it is common to use this pump in conjunction with a set of reducing gears. This increases the efficiency and the power factor of the driving motor.

The pump is fitted with an automatic cut-off valve on the suction side, so that when the pump shuts down it closes to prevent the oil which leaks slowly through the clearance spaces

from being sucked back into the vacuum system. The rotary vacuum pump usually consumes about 0.2 to 0.4 k.w.

### The McLeod Vacuum Gauge

The McLeod vacuum gauge is nearly always a standard fitment on all rectifiers and its principle of operation may be understood from the diagram in Fig. 29. It is arranged to be able to raise the mercury M in the tube T, which will then cause the gas trapped in the bulb B to be compressed, so that if its volume is reduced to V it will be necessary to have a head of mercury H to hold it there. With a perfect gas in the bulb the original pressure in microns is then equal to the head H in mm. divided by the ratio of compression and multiplied by 1,000.

This gauge is simple to operate and is very reliable since the calibration is fixed by the constant dimensions of the instrument. It has one disadvantage in that it must be manually operated and, therefore, cannot be applied to automatic indication of the state of the vacuum.

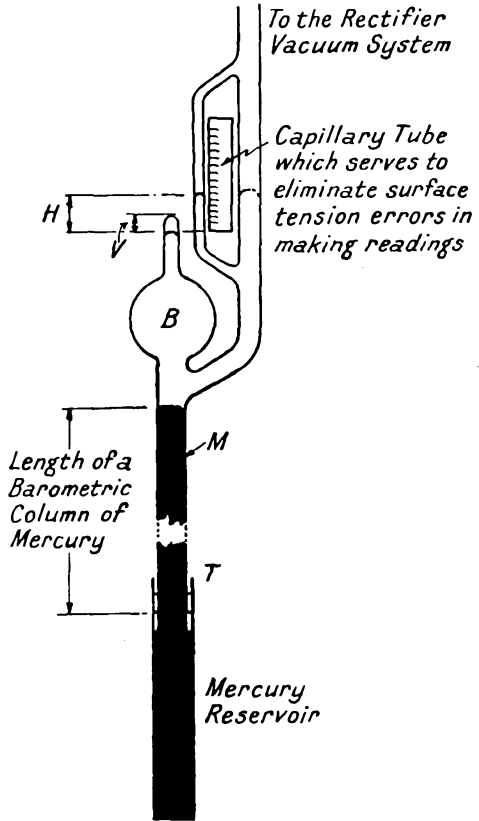

FIG. 29.—Diagram to illustrate the principle of the McLeod vacuum gauge.



### The Pirani Vacuum Gauge

The principle of operation of this gauge may be followed from the illustration given in Fig. 30 and also Fig. 31, where it will be seen that two valves are used, one of which is connected to the vacuum chamber. If a foreign gas is present in the chamber it will lower the temperature of the filament in the valve which will in turn create an out of balance on the bridge.

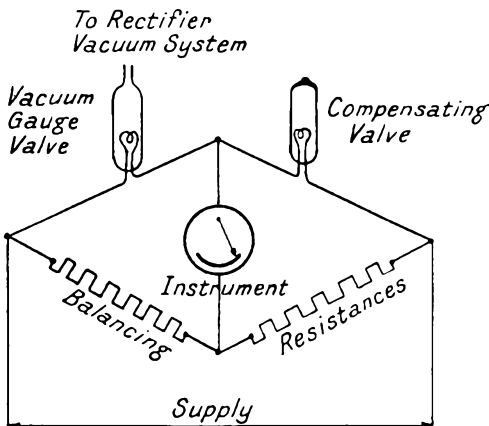

FIG. 30.—Diagram to illustrate the principles of operation of the Pirani vacuum gauge.

temperature co-efficient to render it as sensitive as possible to variations in the vapour pressure. A compensating valve is necessary to correct for differences in the ambient temperature and to make the gauge insensitive to current supply variations. These valves are run very much below a dull red heat so that deterioration

is reduced to a minimum. This gauge is used generally to operate a vacuum relay when the pressure has increased, say, from 6 up to 20 microns, depending upon the type of rectifier, to shut the equipment down. When, however, the pumps have reduced the pressure again to, say, 2 to 5 microns, the rectifier is released for a re-start. There are two common methods in use for performing this operation, one utilises a contact making relay which intermittently clamps down on the micron-meter needle and afterwards releases it. This process is repeated continually during the abnormal condition of the vacuum chamber. The other method is to use a direct acting relay with its operating coil connected in series with the micron-meter. It is then usual to use D.C.,

because the instrument can be more robust and will have a further advantage in so far as it will be more sensitive. A micron is equal to 0.001 mm. of mercury.

**Intermediate Vacuum Chamber**

Between the mercury pump and the rotary vacuum or "backing pump" it is usual to insert an intermediate vacuum chamber in order that the rotary pump may be shut down for certain periods while the mercury pump continues in service. Should it be necessary to store a large quantity of air in the

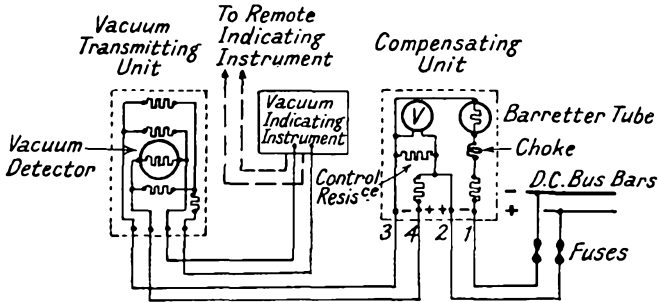

FIG. 31.  
Connection diagram of Pirani system of vacuum measurement.

intermediate chamber it will nearly always be necessary to add a non-return valve in the form of a barometric column of mercury, otherwise, should a failure of the A.C. supply occur to render the mercury pump inoperative for a protracted period, then the air would be returned to the main vacuum chamber and seriously reduce the vacuum. In the ordinary way it will usually be considered safe to use an intermediate chamber designed of such size to permit of the rotary pump being shut down while the rectifier is not in active service, the mercury pump, of course, operating all the time whether the rectifier is in service or not. Recent practice, however, is to run both the rotary pump and the mercury pump continuously even when the rectifier is shut down.

**Water Cooling Systems**

There are two cooling systems in a rectifier equipment, the

one serving the rectifier itself and the other serves the mercury pump. This division of the cooling is necessary because the temperature and the periods of operation of these two parts are different.

For cooling the main unit, the rectifier, the most simple scheme is that in which the water supply is taken from the ordinary town's supply of tap water, and after serving its purpose, it is run off to the usual drainage system. The rectifier tank is not at earth potential, while the cathode, which is also water cooled, is at the potential of the D.C. bus bar to which the rectifier is connected. It is evident then that certain precautions have to be taken in the design of the cooling system to maintain the tank at its normal potential above earth and to keep the cathode insulated. Pure water is a good insulator, so that in practice it is only necessary to insulate the supply pipe work from the rectifier by inserting a length of rubber tubing in the system at certain places. The length of the rubber hose depends on the purity of the tap water and also on the cross section of the water column needed to give the required flow. A length of about 10 feet will usually be sufficient for medium voltage rectifiers. The leakage current is but a few milliamperes, and that is limited so that the electrolytic corrosion taking place at the junction of the pipe system and the rubber hose is a minimum. Non-corroding metal bushes may be used to overcome this difficulty.

The temperature of the rectifier is controlled by a thermostat-operated water valve regulating the flow to maintain a constant outlet temperature. The most efficient operating temperature of the rectifier is thus easily obtained while at the same time the water consumption is reduced to the least possible amount.

Tap water is not always available, however, and the water to be used may not be all that could be desired from the point of view of purity, so that a closed system must be designed in which is incorporated a re-cooler. This latter addition is often of the fan cooled type where the water is circulated

through a network of tubes assembled in the form of a radiator and the tubes being subjected to the blast of air from a motor driven fan. It is usual to mount the re-cooler on insulators so that the potential with reference to earth is the same as the rectifier, and so electrolytic action is avoided. In such a scheme the blower and its motor are anchored at earth potential and the air is supplied to the re-cooler through trunking with an insulated section fitted beneath the re-cooler. The temperature of the rectifier is again controlled and the most simple method in common use is to cause the water to circulate the whole time the rectifier is in operation and to start and stop the blower motor by means of a thermostatic relay. This system has the advantage of simplicity and economy of energy consumption, while the temperature may be controlled within predetermined upper and lower limits to suit the conditions under which the rectifier is to operate.

There are certain other advantages of this system, even though the mains water supply is otherwise entirely satisfactory, namely, absolute independence of the mains supply, thus eliminating the risk of interruptions, which are more likely than accidental failures, and, furthermore, the water can be so maintained that the amount of solid matter in suspension can be made a minimum, while the amount of dissolved air in the water is kept fairly constant. These conditions help very considerably to maintain clean water jackets.

It is of prime importance to maintain the temperature of the mercury pump at as low a value as is possible, and in this case, too, either direct or re-cooler systems may be used for cooling the pump. Sometimes another method may be used, in which, instead of the air blast re-cooler, a water to water system in which a low grade water is made to dissipate the heat from the circulating water proper.

Although it is essential to have good clean water circulating round the main rectifier and pump systems, it is not necessary to go to the extent of using distilled water for this purpose.

### Smoothing Circuits

Smoothing circuits are necessary with either glass bulb or steel tank rectifiers when the harmonics in the D.C. output from the rectifier are likely to cause interference in adjacent communication lines. The R.M.S. values of the harmonics in the D.C. voltage waves are as given in Table 2. From the figures given it will be noticed that the frequency of the harmonics are multiples of both the periodicity of the A.C. supply and also of the number of phases used in the secondary side of the rectifier transformer. In general it is only the harmonics below 1,200 cycles which give trouble, i.e., the 24th in a 50 cycle system. The resultant ripple value is given at the foot of the table and the reason for the smoothing circuit in six-phase equipments is obvious and equally plain is the reason why it is not so important to include smoothing equipment in a twelve-phase rectifier unit. These figures are based on the assumption that the A.C. supply to the rectifier transformer has a wave form free from harmonics.

The most effective smoothing circuit takes the form of tuned resonant shunts which act as a by-pass for the harmonics. The D.C. reactor limits the harmonic current which may flow round the circuit and the tuned portion shunts it away from the load circuit. The harmonic applied in the load circuit is very approximately equal to the

$$\frac{\text{Impedance of the shunt circuit}}{\text{Impedance of the D.C. reactor}}$$

and is usually arranged to have a value less than one-sixth of the original value and sometimes of one-tenth.

Any slight variation of the supply frequency would normally effect the tuned circuits, but to avoid such a possibility it is usual to design the condensers so that the tuning is made broad enough to cope with any normal variations which may be expected.

The D.C. reactor (Fig. 32) may be of the air-cored type or it may have an iron core, but in the latter case it is essential to design the reactor so that the flux density is low, otherwise

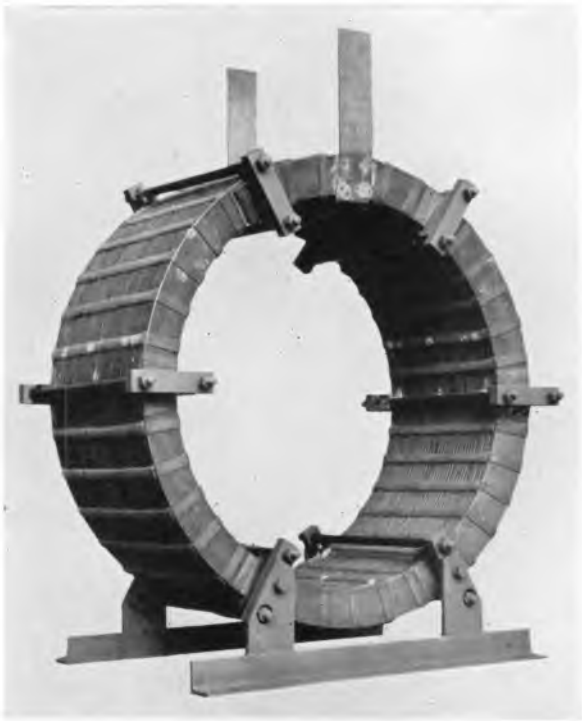

FIG. 32.—A self cooled air cored D.C. reactor. (B. T-H.)

[To face page 60.]

## THE CONSTRUCTION OF RECTIFIER PLANT 61

the effective inductance will be seriously reduced on account of saturation, when the load passing through it is at or above the full rated output of the rectifier equipment.

The provision of a D.C. reactor alone is not sufficient to reduce the value of the harmonics to the degree stated above, so several tuned circuits made up of air-cored coils in series with condensers are connected across the bus bars. Fig. 33 illustrates the method of connecting a resonant shunt smooth-

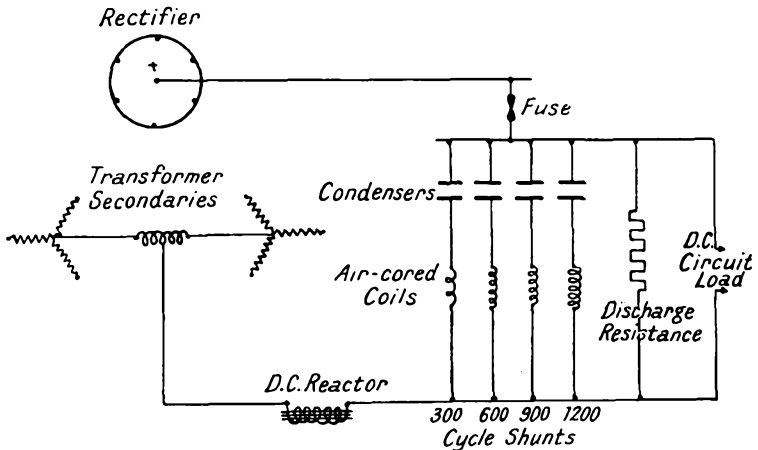

FIG. 33.—A typical tuning circuit for a 50-cycle rectifier equipment.

ing circuit. A similar scheme is shown in Fig. 24, where the whole connections of a complete glass bulb sub-station are given. In some cases, particularly where a multi-unit glass bulb sub-station is designed, it is common to find one set of tuning circuits for the complete sub-station. This arrangement is quite suitable for such cases, but where large metal-clad or steel tank rectifiers are used the economy is not so marked and it is usual, therefore, to supply smoothing circuits with each unit.

Interference with telephone transmission is more likely to arise where the rectifier supplies a traction load with the overhead lines or the third rail running adjacent and parallel to the telephone lines. The inductive loop of the power circuit

is very large, and since it is completed through earth any inequality in the insulation resistance to earth of the adjacent telephone lines renders them particularly susceptible to inductive effects from the power circuit.

Interference may also be caused by the D.C. waves from other sub-stations operating in parallel with the rectifier sub-station and which have no smoothing circuit, superimposing upon the slight ripple present to produce a marked peaky wave form. In such cases it is sometimes necessary to separate the sub-stations permanently on the D.C. side, the feeders supplying definite sections of the track.

Harmonics may also be a nuisance where the load is of an electrolytic nature because the harmonic currents will flow and produce heat in the circuit without doing any useful work. A smoothing circuit in such cases is a sound investment.

Owing to the characteristic loading of a rectifier transformer, the primary current drawn from the supply mains will also have prominent harmonics, although it is extremely rare to find interference arising due to their presence in the A.C. system. This is most fortunate since the cost would be extremely high for a suitable smoothing circuit on the A.C. side.

### **Surge Protection**

When a rectifier is started up from cold and the mercury pressure is in consequence somewhat low, the normal balance between the ions and the electrons in the arc stream may be upset if the load current exceeds a certain critical value. If the vapour pressure is very low and the load current demand is suddenly increased, there will at first be a slow increase in the arc drop until at the critical current value there will be set up within the tank violent high voltage surges across the arc. Such high voltage surges may cause a back-fire. In any case the surge will appear at the transformer secondary terminals and a breakdown at the end turns of the winding may occur.

The insulation of the windings of the transformer must,



THE CONSTRUCTION OF RECTIFIER PLANT 63

therefore, be designed to withstand these surges. It is wise, however, to limit the effect of the surge as much as is possible and practicable by fitting surge gap arresters with a resistance in series across the various secondary windings. For this reason, also, the cables from the anodes should have a good specification, as stated at the end of the first Chapter, and a high voltage pressure test should be applied to them before putting the plant into service.

TABLE 2

FREQUENCY OF THE HARMONICS IN RECTIFIED CURRENT.	NO. OF SECONDARY PHASES.			
	2.	3.	6.	12.
$2 \times f = 100$ cycles ..	42.2	—	—	—
$3 \times f = 150$ „ ..	—	17.7	—	—
$4 \times f = 200$ „ ..	9.44	—	—	—
$6 \times f = 300$ „ ..	4.05	4.05	4.05	—
$8 \times f = 400$ „ ..	2.25	—	—	—
$9 \times f = 450$ „ ..	—	1.77	—	—
$10 \times f = 500$ „ ..	1.43	—	—	—
$12 \times f = 600$ „ ..	0.99	0.99	0.99	0.99
$14 \times f = 700$ „ ..	0.73	—	—	—
$15 \times f = 750$ „ ..	—	0.63	—	—
$16 \times f = 800$ „ ..	0.56	—	—	—
$18 \times f = 900$ „ ..	0.44	0.44	0.44	—
$20 \times f = 1,000$ „ ..	0.36	—	—	—
$21 \times f = 1,050$ „ ..	—	0.32	—	—
$22 \times f = 1,100$ „ ..	0.29	—	—	—
$24 \times f = 1,200$ „ ..	0.25	0.25	0.25	0.25
Resultant Total Percentage Ripple	61.5	25.8	5.8	1.4

Where  $f$  = the fundamental frequency of the supply, i.e. 50 cycles per second.

## CHAPTER III

### RECTIFIER SUB-STATIONS

#### **General Considerations**

THOUGH there are two types of commercial rectifier equipment, the glass bulb and the steel tank, it is not often that one has the choice of either to suit any given D.C. circuit requirements. In general, where the voltage is that in common use for industrial purposes, i.e., between 200 and 600 volts, and the power output from the sub-station is not greater than about 500 k.w., the glass bulb rectifier has the field entirely to itself both from the financial and the engineering points view. With the same voltage range, but for power outputs of 500 to 1,000 k.w., either type might be chosen, the actual choice mainly depends upon the special circumstances of the case. For loads exceeding 1,000 k.w. the metal tank type of equipment has the greater advantages, especially where the voltage is of a high order, such as in railway traction service at 1,500 or 3,000 volts.

#### **Low and Medium Power Plants**

It has previously been stated that the capacity of a glass bulb rectifier is limited by the current which can be safely carried by the electrodes and may be up to 650 amperes as a maximum. If then a larger current output is desired from the sub-station, it is necessary to use a number of bulbs operating in parallel. This arrangement is extremely flexible in so far as :

- (a) The sub-station may be erected at first with a minimum capacity and units added as and when the growth of the load dictates.

- (b) The capital cost of the plant can at all times bear an economical ratio to the load demand while the load is developing.
- (c) Should a fault arise on any part of the apparatus it will more often than not only disable one unit. Such a failure is not serious since the policy of running up to full capacity without any spare plant is never adopted. At the worst the sub-station can be operated at a reduced capacity.
- (d) The plant can be arranged to operate at maximum efficiency by shutting down during the periods of light load service all plant which is in excess of the demand. If current type relays are fitted into the main feed from the rectifier to the bus bars the sets can be tripped in or out of service quite automatically.
- (e) During the light load periods the sets which are shut down can be isolated from the A.C. and the D.C. bus bars and maintenance work carried out at a time when day rates are payable, thus keeping the labour costs down to a minimum.
- (f) Building on the unit system enables all the components to be similar for each type of cubicle and they are, therefore, interchangeable. This is sometimes a very useful asset. Furthermore, since the components are small the cost of replacements is also light.

From the above it is evident that the glass bulb rectifier is an attractive investment where D.C. is required in moderate amounts at low or medium voltages.

For very heavy currents at rather low voltages as met with in electrolytic process work the rotating type of converter is the better proposition. The major reason for this statement is obvious from a glance at the efficiency curves in Fig. 34.

### **High Power Plant**

Where the D.C. load to be supplied is heavy, say above 1,000 k.w., the metal-clad rectifier is more suitable than the

glass bulb type for two main reasons, (a) the unit is more robust and will generally stand greater overloads without distress, and (b) the space taken up by the plant for large capacities can be very much less than would be required by the large number of single units necessary for the same size of sub-station. The metal-clad units are not made in sizes less than 500 k.w., although one British firm is developing a rectifier of 100 k.w. capacity. It is too early yet to say whether this small size

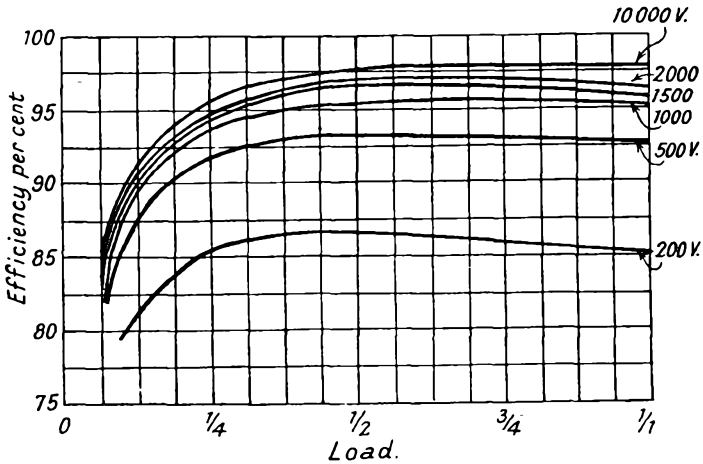

FIG. 34.—Rectifier equipment efficiencies at various D.C. voltages.

will be able to compete with the glass bulb type of the same capacity both in initial and in maintenance costs.

With rotating converting plant it is common practice to choose a number of units of perhaps two or even three different sizes all to operate in parallel. Furthermore, the rating is chosen as small as possible because of the appreciable savings to be made in (a) the first cost of the plant, and (b) the light load losses. The all-day efficiency of the plant can be made high by careful selective use of the size and number of machines in commission for a given load demand.

The rectifier, on the other hand, presents entirely different problems from those of the rotary converter and generally the

policy just mentioned seldom pays where the rectifier is concerned.

With the rotating converter the efficiency curve rises rapidly from no-load to about one-third load, but the rectifier has a high efficiency at light load and is fairly constant up to  $5/4$  of full loading. There is, therefore, no object in having the sub-station capacity made up of rectifiers of different sizes with a small unit to take care of the light load period. Furthermore, the rectifier has now got well beyond the purely experimental stage and it is not necessary to use a large number of the smaller units in place of a few large ones.

The Americans have developed what they call a "Sectional Rectifier," which is in principle two or sometimes three small rectifiers assembled vertically in a common frame but having common pumps, cooling apparatus, and transformers. The advantages claimed for this form of construction are :

- (a) Small rectifiers are more easily manufactured than large ones.
- (b) As the arc length is so much shorter the arc drop is proportionately less, which gives a slight increase in the efficiency, and
- (c) One small unit can be taken out of service without seriously effecting the sub-station capacity.

Whether this system will spread to this side of the Atlantic is doubtful, for the modern British unit is as reliable as its associated transformer and switchgear. Advantages (a) and (b) are more in the nature of selling points.

### Architecture of Sub-Stations

The modern tendency is to design the sub-station building so as to harmonise with the local architecture. This can often be done without any additional expense and is a wise policy. The photograph given in Fig. 35 is a typical example of a small sub-station situated in a modern housing estate. This building houses a transformer, four rectifier units of the glass bulb type, together with the associated E.H.T. and L.T. switchgear. Fig. 36 is of a larger glass bulb sub-station



FIG. 35.—A typical form of rectifier sub-station construction which is cheap and yet pleasing to the eye.



FIG. 36.—A really pleasing type of sub-station architecture.

*[To face page 67.]*

situated in a good class residential district. Both these sub-stations supply a three-wire network at 230-0-230 volts. A third example in Fig. 37 is of a sub-station supplying a tramway system at 550 volts. Here the transformers are located on a raft outside the main building.

This last example is very interesting from the engineering point of view, since the capacity is at the maximum figure given earlier for the range of sizes where either the glass bulb or the metal tank rectifier can be used. The glass bulb type was favoured since the site is some seven miles out from the centre of the city and in a sparsely populated district. The load was of a particularly difficult nature, a rush traffic peak occurring in the early morning and evening when employees were transported to and from a large works. Nearby was also a favourite beauty spot, so that during fine week-ends in the summer months and at holiday periods a very heavy traffic indeed was experienced.

Because of the situation and the peculiar circumstances of the loading, for economic reasons the sub-station had to be of an entirely automatic nature. It was not a financial proposition to resort to remote control since the nearest manually operated rotary converter sub-station was situated some five miles away. This sub-station has proved itself over a period of ten years a remarkable success from both engineering and financial viewpoints.

It is interesting to note that the floor level is 4 feet above the ground; a construction necessary because an adjacent river is subject to flooding in the winter months. The main building has internal dimensions of 30 feet by 20 feet, so that the capacity installed is at the rate of 1.33 k.w. per square foot of superficial area. The building and site cost was approximately £0.75 per k.w. of capacity. Fig. 37A is of a cubicle inside this sub-station.

With heavy duty rectifiers it is only to be expected that a more substantial building is essential, but here again the general architecture can be made pleasing to the eye without much, if any, addition to the cost of the building.



FIG. 37.—A glass bulb traction rectifier sub-station giving a 550 volt D.C. supply to a tramway system.



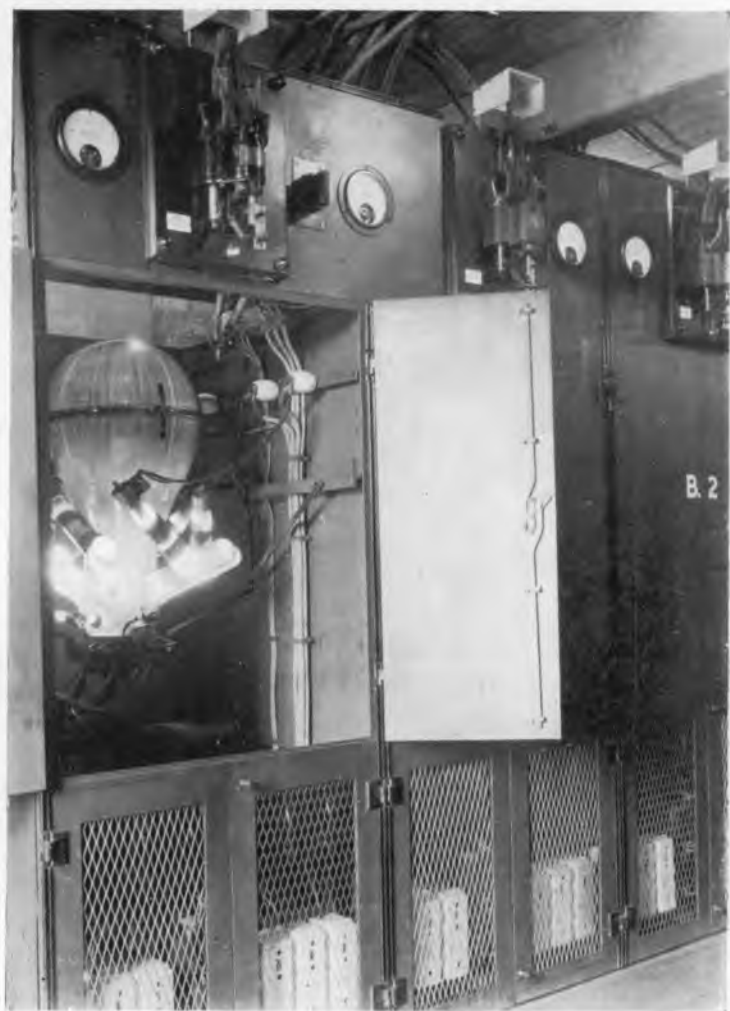

FIG. 37A.—One of the cubicles inside the traction sub-station shown in Fig. 37. Note the auto-reclose circuit breakers at the top of the photograph. These sets were made by the Hewittic Electric Co., Hershham.

### Rectifier Plant Capacity

Before a sub-station can be designed it is of course necessary to decide upon the number of units it is going to house. Given a certain anticipated load demand the first question is by how much ought the capacity installed to exceed that demand. This is often a personal matter, for no two engineers always agree even in a specific case upon what constitutes a safe margin or factor. Leaving this matter as it stands there is the associated question of what overload ratings the plant shall have.

It has been the custom for engineers in soliciting tenders for rotating converting plant to specify certain definite overload capacities, but the rectifier fundamentally has little or no overload capacity for the simple reason that it has little or no thermal capacity. The specification of certain overload ratings means, therefore, that a manufacturer will supply an equipment to the specification, but had the manufacturer been left to supply a suitable size of plant for the load expected it would have had a rating at that load. In other words, a unit made to an overload requirement is a machine made larger than is necessary. The most economical rating of a rectifier is then, that which is capable of supplying the characteristics of the given load without involving additional cost.

The capacity of a rectifier for taking heavy momentary overloads is considerably superior to any form of rotating converter machine.

An overload specification is not quite as easy as it at first appears because the equipment essentially comprises the rectifier and the associated main transformer. The rectifier is to some extent effected in its size by the continuous rating and the sustained overload rating, but the requirement of greatest importance is the specified maximum momentary overload rating. On the other hand, the transformer size is not effected by the momentary overload rating, but is by the continuous and sustained overload rating. Standard power transformers are rated to stand sustained overloads of 25 % for two hours or 50 % for one hour.

There are then two different characteristics to be considered in relation to the load to be supplied.

For industrial purposes heavy momentary overloads are not common, but there are usually sustained overloads to be supplied. In traction work the reverse is more often true, the momentary overloads sometimes being extremely severe. It is not surprising under the circumstances that there is a standard overload requirement more suitable to rectifiers for one purpose than for another.

The values commonly applied are as follows :

**INDUSTRIAL SERVICE.**

- 25 % overload for 2 hours, or
- 50 % overload for 15 minutes, and
- 100 % overload for 15 seconds.

**RAILWAY SERVICE.**

- 50 % overload for 1 hour, and
- 200 % overload momentarily.

This last figure is usually safely carried for a time interval of about 5 seconds.

### **Layout of Sub-Stations**

Whatever the type of sub-station it should be well ventilated, free from damp and during the winter months the temperature should be maintained at a value not lower than about 15° C. This last requirement is important where the steel tank rectifier is installed if trouble due to frozen water supplies is to be avoided. Even with the glass bulb sub-station it is not wise to allow the ambient temperature of the sub-station to fall much below the value given.

Unless it is quite definite that the initial load will not grow during the course of time, it is false economy to erect a building only just large enough for the necessary plant. For instance, Fig. 38 is a ground plan of a sub-station which will house four 100 ampere type bulbs and six 150 ampere bulbs together with the associated E.H.T. and L.T. switchgear. The transformers may also be accommodated inside the building. Incidentally, though there is the very slight fire

risk due to having oil cooled transformers, the heat which is dissipated serves a useful purpose in maintaining the temperature of the sub-station at a reasonable value in the winter. In a large sub-station which is under continual heavy load it may be necessary in the summer months when the temperature is high to have the emergency door left open, but an extruded metal door also fitted to prevent unauthorised entry.

If a three wire supply is to be given from this sub-station

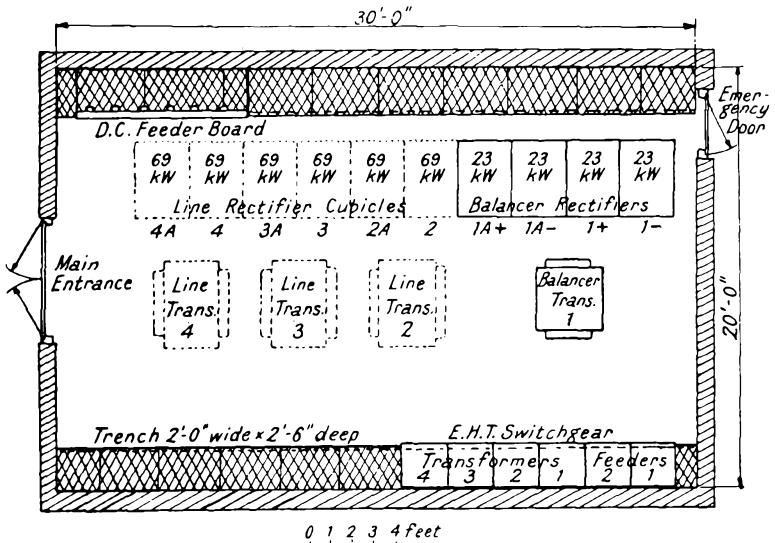

FIG. 38.—A layout of a glass bulb rectifier sub-station.

at a pressure of 230-0-230 volts, the four 100 ampere units can be used as balancers and the six 150 ampere units to boost directly across the line. The full load capacity of the sub-station being approximately 500 k.w. At the commencement it may be possible to meet the demand with the four units, the boosting sets being installed a pair at a time as the load grows. This size of sub-station has been found to form an ideal standard for small capacities.

The layout is particularly simple and clean and the amount of cable between the various components is very small.

Switching on the rectifiers is carried out from the passage between the sets and the wall, while the space between the cubicles and the transformers is wide enough to permit of the bulbs being removed.

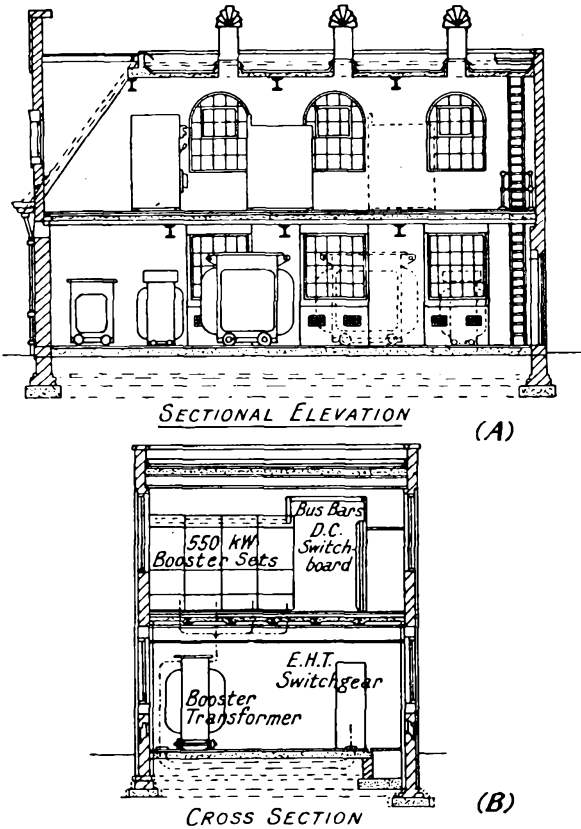

FIG. 40.—A. and B. These drawings refer to the sub-station shown in the photograph in Fig. 39.

The E.H.T. feeder cables enter the station along one trench and the L.T. feeders along the other. The open spaces of the trenches are covered by chequered cast iron plates resting on curbs grouted into the edges of the trenches. The cables from the E.H.T. switchgear to the transformers, the transformer



FIG. 39.—Another pleasing type of sub-station architecture.

[To face page 72.]

secondary side to the rectifier anodes and from the cathodes to the D.C. bus bars are all taken overhead and supported in racks fitted to the ceiling. An exterior view of this type of sub-station is given in Fig. 35.

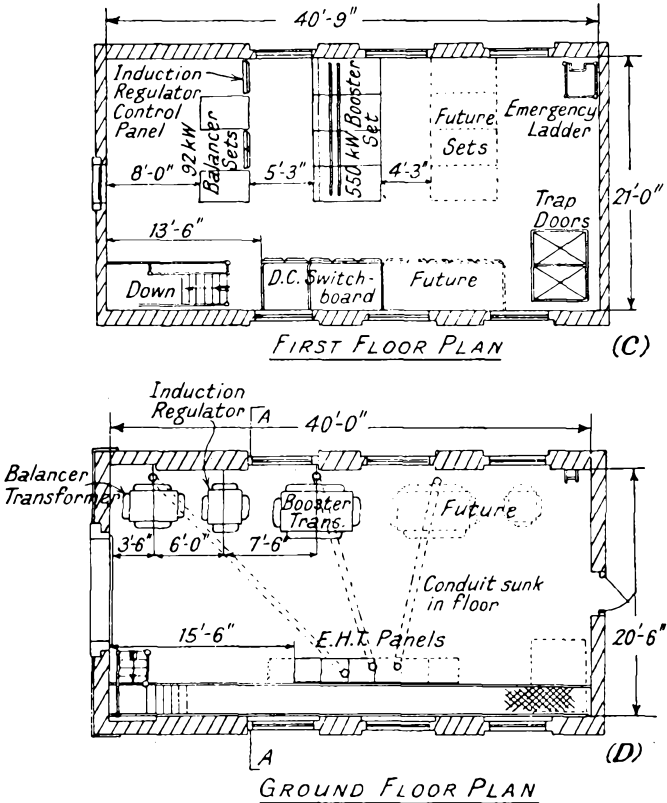

FIG. 40.—C. and D. These drawings refer to the sub-station shown in Fig. 39.

And entirely different type of sub-station is shown in Fig. 39, which has an internal layout, as shown in Fig. 40, a, b, c and d. This sub-station is an interesting example of the application of mercury arc rectifiers for supplying a small residential load. In the first place there was a long D.C. feeder from a

manually operated rotary converter sub-station to a small network of mains. After a few years the area suddenly began to develop rapidly and the load necessitated the laying of a larger feeder or an extra feeder. It was difficult to maintain the pressure to the network, for the neutral was as usual half the section of an outer and there was an out of balance which alternated from one side to the other at intervals during the day. The length of the proposed new feeder was such that the capital cost was out of all proportion to the load to be supplied, and consequently a rectifier equipment in the heart of the network was considered. By a study of the loads on the mains, nodal points were fixed and a suitable location for the sub-station arranged to permit the feeders being of equal length. The only available site was not wide enough for the single floor type of sub-station, so the two storey type shown was designed.

The balancer sets were continuously in service operating in parallel with the rotary converters at the remote sub-station. The pressure was maintained by the pressure type relay scheme given in Fig. 20. Current operated relays fitted in the main leads from the cathodes to the bus bars, served to trip into service the line boosting sets at a predetermined load and to drop them out again when the load had fallen to a value which the balancer sets could supply. A load sharing relay maintained the balance of load between the three-wire sets and the line sets in such a manner that the increasing increments in load were taken by the line sets and the three-wire sets left to do any balancing that was necessary. The line sets could also be switched in from the manual sub-station over a pilot line. This scheme has been very successful and economical.

### **Metal Tank Rectifier Sub-Stations**

The quest of simplicity in layout and construction is even more essential with this type of substation than with the glass bulb type, mainly because there are more extraneous auxiliaries. The layout can be simplified by arranging the main transformer, interphase reactor, the bake-out windings and the surge



arresters as one unit. The D.C. generator which supplies the Pirani Gauge and the grid bias, if grids are used, may be combined with the water circulating pump and the driving motor for the vacuum pump. These later items can be mounted on the rectifier unit. The ignition, excitation and insulating transformer can also be mounted as one unit.

The rectifier is commonly located within an enclosure and access prohibited to unauthorised persons. The live parts of the re-coolers and the water piping are carried overhead, on insulated supports.

Close to the rectifier is the main transformer so that the connections from the secondary side to the anodes are made as short as possible, and furthermore taped copper strip may be used instead of cable.

The design of the enclosure is controversial, some engineers prefer an open or plain handrail form of protection, which, in their belief, avoids the illusory appearance of safety which tends to cause carelessness. Others prefer a fine wire mesh screen with gates interlocked with the A.C. and the D.C. switches, so that entrance to the enclosure cannot be made while the rectifier is connected to either side. It is a question of personal opinion which type of enclosure is used.

Though two storey buildings are not very convenient for the metal tank rectifier equipment, where superficial area is limited, it is common practice to construct a basement. In a large sub-station this is often an advantage, for the rectifier can be partly sunk in a pit to render inspection and maintenance an easy matter.

Lifting facilities are essential, but whereas sometimes all that is considered necessary is a girder running over the centre line of the rectifier to which can be attached blocks and tackle, it is well worth the extra expense by providing a travelling crane. The fitting of wheels to the rectifier so that it may be rolled along the sub-station to a girder where it can be lifted on to a transport vehicle is a very mixed blessing. The weight of the rectifier, and this also applies to the transformer, is such that rolling the plant along the floor will damage the

surface. Again, moving the plant along the floor will involve a disturbance of the piping and connections, while an aisle must be left down the whole length of the sub-station of sufficient width to permit the passage of the widest piece of apparatus installed. Obviously this involves a greater floor

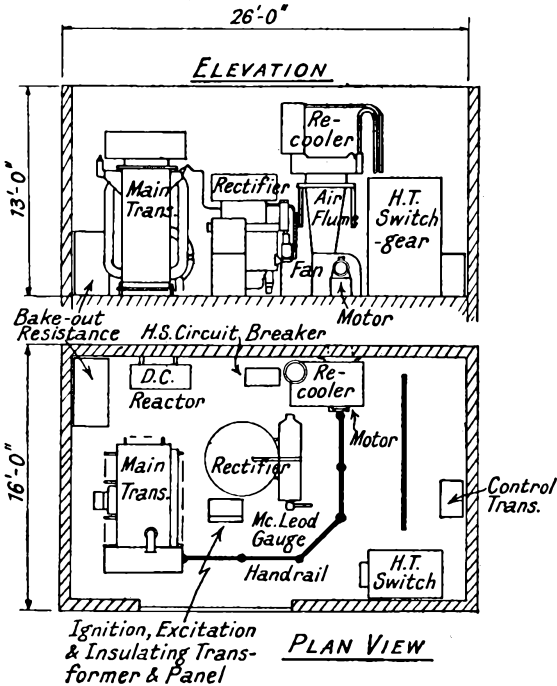
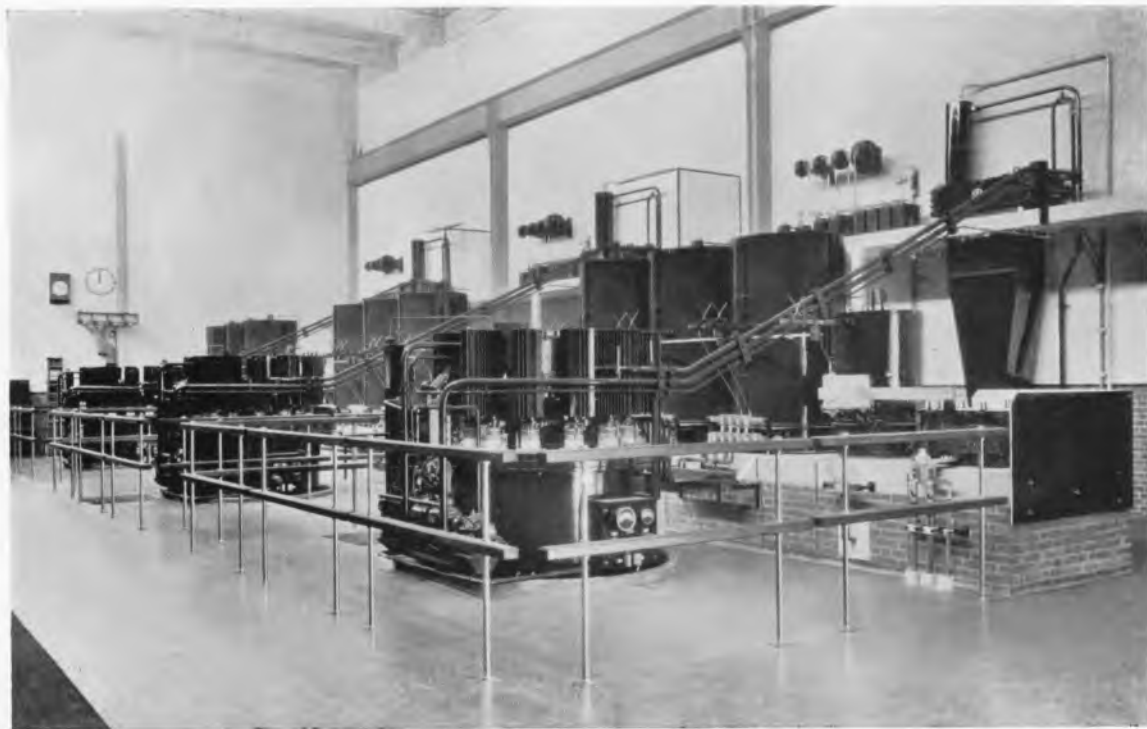

FIG. 42.—A typical modern industrial steel tank rectifier sub-station layout (B. T.H.)

area and larger building, which extra cost would certainly be more than the price of a travelling crane.

With a careful layout of the plant, the capacity of the sub-station per square foot need be no more than for a glass bulb installation such as given in Fig. 37, and may be as low as 0.5 square feet per k.w. If one square foot per k.w. is allowed a very good design can be obtained. Fig. 41 is of the Manor House Sub-station of the London Passenger Transport Board,



*[To face page 76.]*

FIG. 41.—The Manor House Sub-station of the London Passenger Transport Board. The equipment in this sub-station comprises 3—1,500 K.W. B.T.H. Steel tank rectifiers with air blast transformers and arranged for remote control.

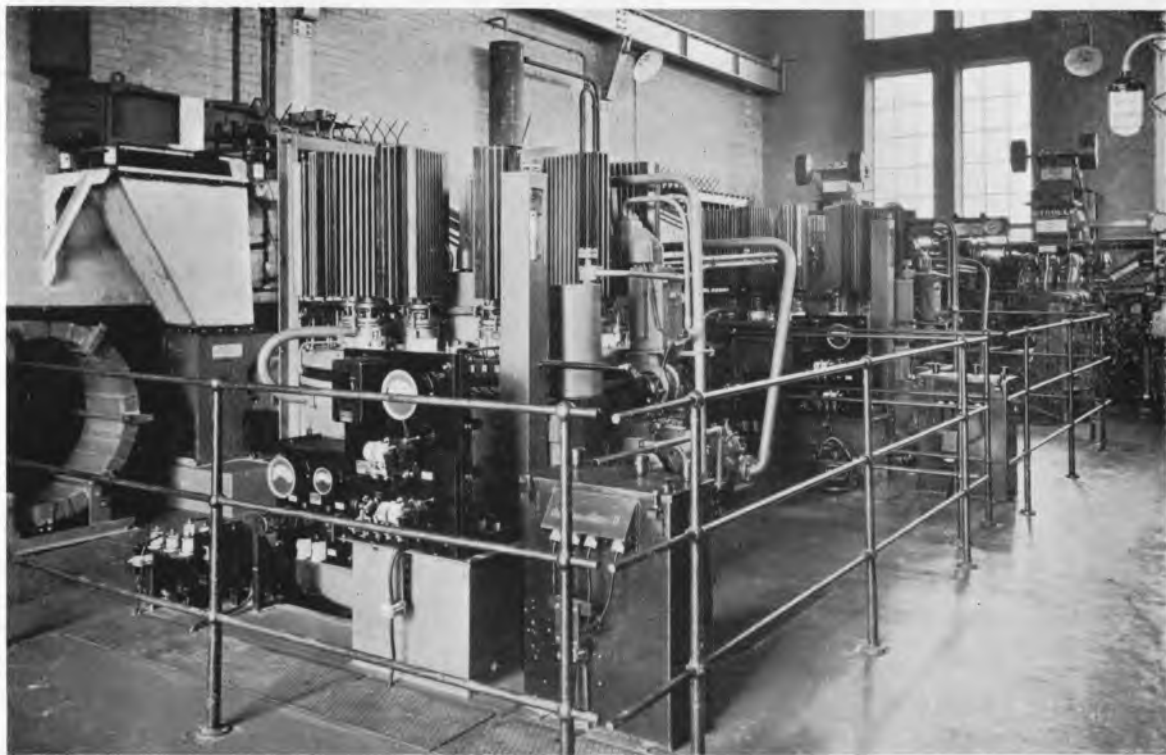

FIG. 43A.—A photograph of the Hornchurch Sub-station of the L.M. & S. Railway Co.—Barking, Upminster Line.

which is typical of good sub-station design. A small, single unit industrial sub-station is given in Fig. 42. Yet another design is shown in Fig. 43, and is of the L.M.S. Railways Co.'s Hornchurch Sub-station. The transformers in this case are located outside the building on a raft.

### Indoor Versus Outdoor Transformers

On account of fire risk some engineers prefer, where possible,

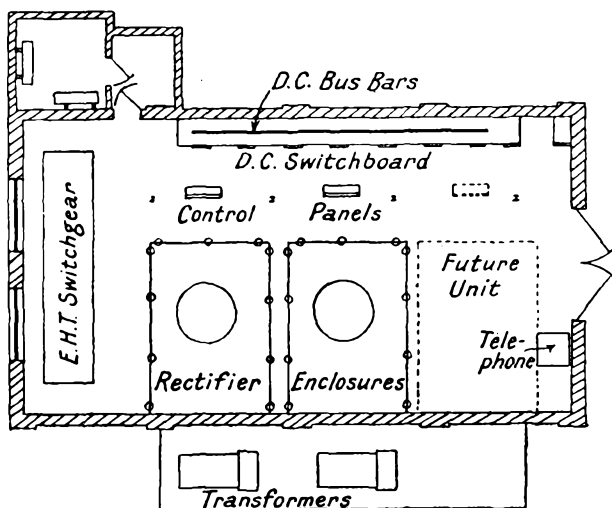

FIG. 43.

A plan view of the Hornchurch Sub-station of the L.M. & S. Railway Co. In this building there are 2—1,200 k.w., 630 volt B.T.H. steel tank rectifiers. This sub-station is 60' 0" by 32' 0".

to locate oil cooled transformers out of doors. Transformers to-day are so well designed and reliable that the risk of an explosion is very slight, but even so, where a sub-station is located in a city fire danger zone, then the risk is not to be undertaken lightly. It is true that with external location maintenance of the tank in good condition in polluted atmospheres is somewhat costly, this is offset in the saving of building costs by the reduction of size required for the plant and the lower fire insurance rates.

Where, for certain reasons, it is not policy to locate the transformers out of doors, yet the risk of a fire is undesirable, air cooled transformers may be placed inside the building. With such transformers it is necessary to have ducts beneath the casing and blowers to force cool air through the windings. Here again the choice of type of transformer is a personal matter.

### Automatic Sub-Stations

Rectifiers lend themselves admirably to automatic control and two simple examples of glass bulb sub-stations will be given in detail.

Fig. 44 is a control diagram for an equipment consisting of two 92 k.w. balancing sets and four line sets. The latter have a total capacity of 270 k.w., and are remotely controlled from a distant manual sub-station. The balancing units are in continuous service, the neutral of the network being earthed at the manual sub-station. The pilot is a three-core cable, of 7/20 section, rubber insulated and with lead covering. One of the cores is used to control the line units while the remaining two cores are used to obtain indications of the load on either the balancing units or the line units. When the load on the balancers reaches 80 % of their capacity, the attendant at the remote sub-station closes switch 1 and so causes a current to flow from the negative bus bar through the pilot core to the control knife switch at the rectifier sub-station. After passing through this switch the circuit is completed via resistance 2, pilot relay coil 3 and the switch fuse to the neutral bus bar. When relay 3 is energised its contacts 3a make a circuit from the positive bus bar via the switch fuse, contact 3a, contactor coil 4, auxiliary switch 5 on the booster oil switch back to neutral. This causes 4a to close and complete a circuit for coil 6, the closing coil of the oil circuit breaker. With the energising of this coil the oil circuit breaker closes and the booster E.H.T. bus bars and transformer are charged off the E.H.T. supply.

The transformer switches or oil circuit breakers are usually

left closed so that immediately the bus bars are charged pressure is applied to the anodes of the bulbs. When the oil circuit breaker closes, auxiliary switch 5 opens, coil 4 is de-energised, contacts 4a open and this circuit is then normal again. When the booster bulb arcs have struck up the excitation relays close, thereby causing device 7 to close its contacts

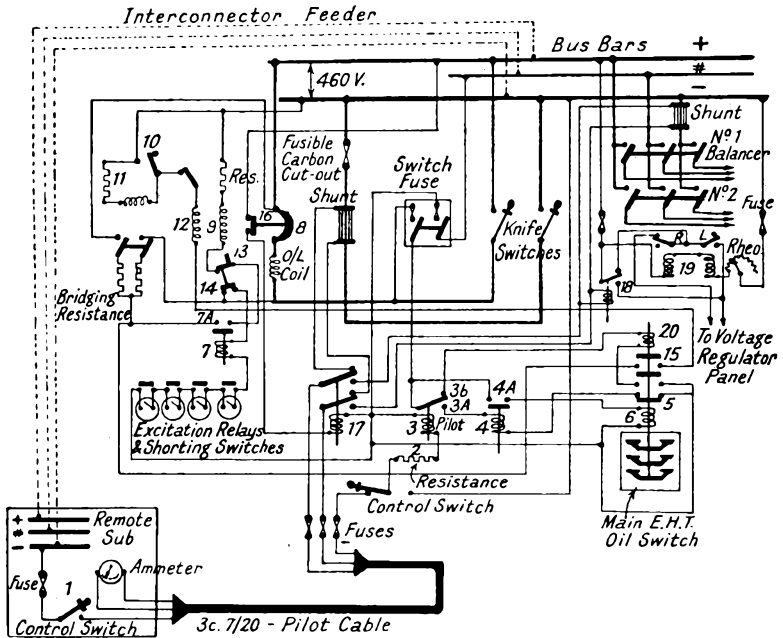

FIG. 44.—A wiring diagram of an automatic and remote controlled glass bulb rectifier sub-station.

7a and to pass current to the controlling coil 9 of the auto-reclose circuit breaker 8. The controlling coil contacts 10 short out resistance 11, the operating coil 12 is energised and causes the circuit breaker 8 to close. Since the negative feed is permanently closed through a fusible carbon cut-out the line sets are now in parallel on the D.C. bus bars. After 8 has closed, contacts 13 and 14 open, the controlling coil is de-energised and also the coil 7. The operating coil 12 is inter-

locked with contacts 15 on the oil circuit breaker. When 8 is closed a pair of contacts 16 cause contactor 17 to be energised to change over the remote ammeter from the balancer to the line shunt. The attendant can then see when the line or booster units have taken up the load and its amount.

The auto-reclose circuit breaker is set to open at a pre-determined overload and to reclose automatically after a certain time interval. The breaker will then remain closed provided that the fault or overload has been removed from the D.C. system. Relay 18 is of the current operated type which is calibrated within the safe current carrying capacity of the bulbs. When the safe value has been exceeded this device will disconnect the voltage controlling device 19 and cause a contact to be closed to lower the pressure from all the units. Should the overload persist until the voltage has been reduced to the minimum, the rectifier circuit breakers will then operate to disconnect the units from the bus bars.

To shut down the line units when the load has fallen to within the capacity of the balancer units it is only necessary to open the remote switch 1. This action de-energises 3, the throw-off spring thereby forcing contacts 3b to close the trip coil (20) circuit and so drop out the oil breaker controlling the supply to the line transformers. The opening of the oil breaker causes the D.C. circuit breaker 8 to open and the line sets are then isolated from the system.

Normally, the time taken to parallel the line units on to the D.C. system after closing the remote switch 1 is only a matter of about 3 seconds. Shutting down is almost simultaneous with the opening of the remote switch 1.

The D.C. pressure from the rectifiers is controlled in the manner described on pages 42 to 46.

### **The Second Example**

When a D.C. feeder is heavily overloaded, and it is not an economical proposition to lay more copper down, a rectifier equipment can be arranged to boost the pressure in the network at its low points. The sub-station in this example has installed



one set of four units totalling 276 k.w. capacity and is capable of automatically controlling the pressure to the network. Fig. 45 is a connection diagram of this type of sub-station. Device I is the master control relay energised from a potential transformer. With a normal E.H.T. supply, contacts 1a are

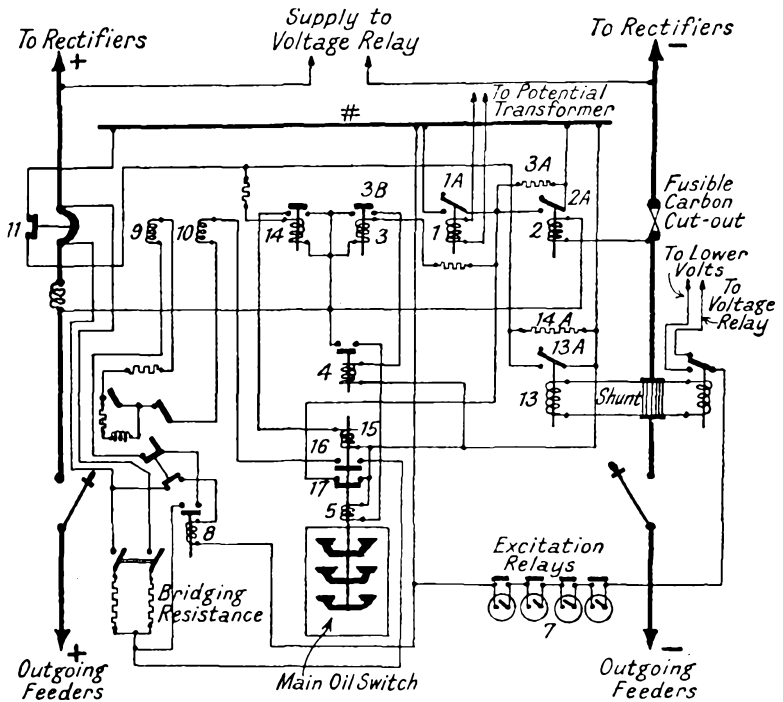

FIG. 45.—A wiring diagram of a self-controlled glass bulb rectifier sub-station

open, but if the circumstances are not normal then contacts 1a are closed and it is not possible for the contacts of the pressure relay 2 to close. When the D.C. network pressure falls to the value of the setting of the pressure relay 2, the contacts 2a open which de-energises, through the insertion of a high resistance, the time delay device 3. When the pre-determined time interval, which is adjustable up to five minutes, has elapsed, the contacts 3b close to cause 4 to be energised,

which is a contactor solenoid, causing its contacts to close and to pass current to the main oil switch closing coil 5. An auxiliary switch 17 closes with the oil breaker and short circuits 3a to cause 3 to be energised once more. The contacts 3b now open and also 4 is de-energised so that the closing solenoid circuit is now open circuited.

The main oil breaker having closed, the E.H.T. supply is impressed on the transformer bus bars, the transformers become charged because their oil breakers are normally left closed, and the rectifiers strike up on excitation current. Immediately the bulb arcs have struck, the auxiliary relays 7 which are connected in series with each other, now close to cause device 8 to be energised. The contacts of 8 being thereby closed, cause coil 9 to be energised, which is the controlling coil of the auto-reclose circuit breaker. This circuit breaker operates in exactly the same manner as the one in the previous example.

When the circuit breaker has closed, the voltage control relay operates to adjust the pressure of the rectifiers to the required voltage. A maximum current device is used again, as in the previous example, to reduce the pressure when the units are overloaded, but if the excess load persists after the voltage has been reduced to a minimum then the auto-reclose circuit breaker opens. When the overload has been removed the breaker will automatically reclose and the pressure will be regulated in the normal manner.

When the load has been reduced to a predetermined value a minimum current device 13 opens its contacts 13a, which causes to be de-energised, the time delay device 14 by inserting a high resistance in the circuit. When the time interval has elapsed, this device energises, by the closing off its contacts, the oil circuit breaker trip coil 15, thus causing the oil breaker to open. Then auxiliary switch 16 is also opened, which causes the auto-reclose circuit breaker to open and isolate the rectifiers from the D.C. bus bars. Another auxiliary switch 11 on the D.C. breaker having at the same time closed, shorts out 14a and so resets 14.

A typical load chart is shown in Fig. 46, and attention is drawn to the drops in pressure at 8.50 a.m. and at 2.5 p.m., which bring in the sub-station on low voltage. When the load has fallen to 150 amperes the sub-station is shut down. Note also the voltage on the sub-station D.C. bus bars with and without the rectifiers in operation.

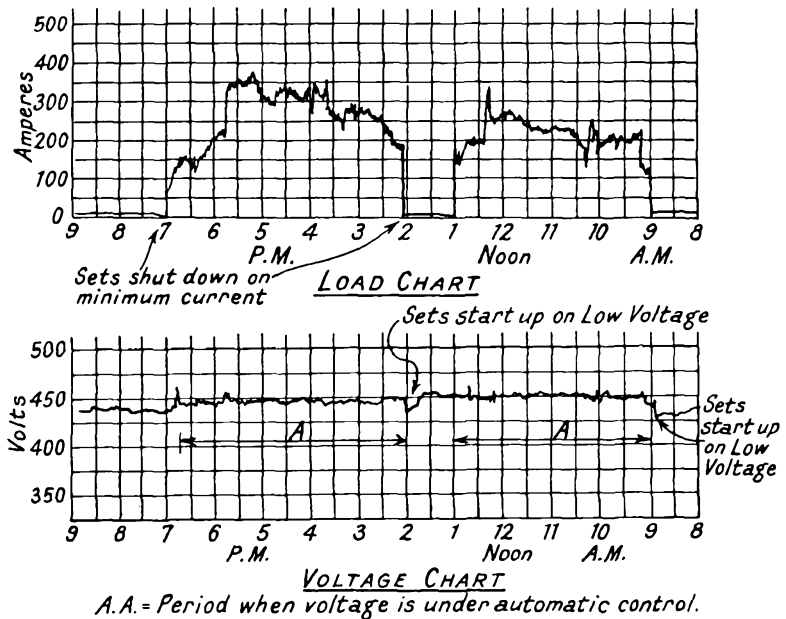

FIG. 46.—A load and voltage chart obtained from a glass bulb rectifier equipment controlled by the scheme shown in Fig. 45.

### Automatic Features on Steel Tank Rectifiers

The steel tank rectifier is just as adaptable to automatic operation as the glass bulb equipment. With heavy duty equipment, high speed feeder circuit breakers are essential on account of the very high currents which may flow under fault conditions. In traction work, or where the rectifier sub-station is to operate in parallel with other converting sub-stations, the rectifier is connected to the D.C. bus bars through

high speed circuit breakers arranged for reverse current tripping to disconnect the equipment from the system in the case of a back-fire.

The rectifier may be started up by remote control providing the protective devices on the equipment indicate that the conditions are normal. The remote operation closes the main oil breaker which energises the main transformer. A temperature thermostat controls the starting sequence until the rectifier is at a temperature which renders it fit for taking up the load. In the older equipments, if the rectifier temperature was too low, an internal heater was automatically switched on and when the temperature became normal the heater contactor opened, the ignition and excitation transformer became energised and the starting sequence carried through. If the temperature is normal when the remote control switch is closed, the rectifier will start up immediately. As soon as the rectifier arc has struck, and voltage appears across the terminals of the D.C. side of the unit, then the D.C. breakers close and the rectifier takes up the load.

In general, the mercury vapour and rotary pumps are in continuous operation whether the rectifier is in service or not, but in some cases the rotary pump is arranged to be in operation only while the main oil breaker is closed. To shut down the unit, the main A.C. and D.C. breakers are tripped.

The rectifier is protected so that it shuts down automatically in the event of any of the following disturbances arising and the control scheme may be arranged so that the plant will automatically restart upon resumption of normal conditions.

- A. Heavy drop in the A.C. pressure or a total failure.
- B. Failure of the rectifier vacuum.
- C. Excess temperature due to a failure of the cooling system.
- D. Excess temperature of the vacuum pump.
- E. D.C. overloads.

If a rectifier back-fires, the D.C. and E.H.T. circuit breakers will be tripped out, and in the case of a fully automatic unit the control scheme may be arranged to give automatic re-

starting features, incorporating a lock-out device which is operated after a predetermined number of unsuccessful attempts to re-start have been made. If the unit is arranged for remote control, the scheme is frequently arranged so that an indication is given back at the control point, when the plant is automatically shut down and the attendant may then take the necessary steps to initiate the control for the restarting of the plant.

Automatic features are rendered inoperative until reset by hand, if

- A. the A.C. earth leakage relay operates.
- B. the motor driving the rotary vacuum pump fails.
- C. the main transformer becomes overheated.
- D. the starting sequence is not completed in a certain time.
- E. any of the auxiliary circuits which are at the tank potential above earth, break down.

### Control Circuits

To operate the auxiliaries and protective circuits a low voltage supply is necessary. There are several sources of supply available as a rule, any one or more of which may be used. These supplies will now be briefly reviewed.

The most common source is from an auxiliary or control transformer energised from the main E.H.T. bus bars or from the live side of an incoming E.H.T. feeder. The control transformer may be protected either by an oil circuit breaker, or, in certain cases, it is satisfactory to use current limiting resistances and E.H.T. fuses, the latter also serving as isolating links. Fuses are used to protect the L.T. side. If the high voltage system is in the super tension class then the scheme suffers from the great disadvantage of high initial cost and is not satisfactory from the engineering point of view.

An A.C. supply can also be obtained by having an auxiliary winding on the main transformer, but this scheme has the great disadvantage that the supply is only available after the main transformer has been charged. Furthermore, if a fault

occurs on the transformer auxiliary winding itself, there is no adequate protection, since the main oil breaker controlling the E.H.T. supply to the transformer has its overload trip set up to suit the capacity of the rectifier unit and not for the capacity of the auxiliary winding.

D.C. control is sometimes used and this can be obtained from three sources, (a) the D.C. network, (b) the rectifier itself, and (c) from a secondary battery. Supplies from the D.C. network are rarely convenient, for the supply is not available until the rectifier is feeding the network, unless there is another sub-station operating in parallel with the rectifier. If a supply is to be taken from the rectifier, this again means that the rectifier has to be in service before supplies are available. This source of supply is, however, useful for closing the D.C. circuit breakers or for energising the hold-on coil of the high speed circuit breakers. If the D.C. voltage from the rectifier is high, such as is common with traction supplies, then the great disadvantage of using this scheme is that the control wiring is at the same high potential above earth. A secondary battery supply is commonly used for the trip circuits since it is entirely independent of any operating conditions of the A.C. or the D.C. systems to which the rectifier is connected. The disadvantage of using such a supply for all purposes is that of cost and also the fact that arrangements have to be made for the charging of the battery.

In general the supply is chosen by the manufacturer to suit the individual circumstances of the case.

### **Relays and Protective Features**

**A.C. PROTECTION.**—The type of relay used for this purpose is the well known inverse time limit relay. It is an induction type of instrument and affords protection against overload and earth leakage.

**WATER CIRCUIT PROTECTION.**—The arrangement generally adopted in this country is for a thermostat to be provided in the water circulating system so that a relay trips and shuts down the plant following an abnormal temperature in the

system consequent upon a failure or, partial stoppage, in the water circulating system. The relay is self re-setting so that the control scheme can be arranged for the plant to restart automatically if required, when the temperature falls to a normal value. The same arrangement is adopted by most manufacturers on the water circulating system for the mercury vapour vacuum pump.

**VACUUM PROTECTION.**—The rectifier is shut down upon a failure of the vacuum and this is carried out by the Pirani gauge and is dealt with in greater detail elsewhere. Though some manufacturers use an A.C. supply for the Pirani gauge circuit, it is more common for D.C. to be used. The source of supply in such cases is obtained from a special transformer which supplies a metal rectifier. The transformer is interesting in so far as it is designed to give a constant secondary voltage with a constant load, even though the primary voltage may vary considerably. In fact a 20% variation in the primary potential will only produce a 0.25% variation in the applied voltage to the gauge after rectification. Included in the metal oxide rectifier circuit is a smoothing choke. It is also possible to use a supply of D.C. current from a motor generator, in which case the generator is coupled to the motor driving the rotary vacuum pump.

**SEQUENCE TIMING RELAY.**—Immediately the initial operation is made to start up the rectifier, the timing sequence relay commences to time. If the starting time is longer than normal then the relay operates and the rectifier is shut down and locked out until this relay has been reset by hand. Under normal operation the relay resets when the starting sequence has been completed.

**LOCKOUT RELAY.**—When an abnormal circumstance arises, the operation of a specific relay is passed on to the lockout relay and the rectifier is shut down and cannot restart either automatically or by hand until the relay has been reset by hand.

**TEMPERATURE RELAYS.**—These relays are in the form of thermostats and are situated in places where an excess temperature is dangerous to the efficient working of the rectifier.

This type of relay usually comprise a bi-metal strip which is dependent for its operation upon the difference in the coefficient of expansion of the two metals used in its construction. The unequal expansion causes the strip to bend and to make contact with a mechanism so that a very quick snap action is obtained. When the abnormal circumstance has been removed, the bi-metal strip cools down and the circuit returns to normal.

### **Remote Control of Plant**

Remote control may be obtained by one of the well-known methods, either by direct pilot wire control, supervisory control or one of the numerous selector schemes which are available.

With a direct pilot system, the number of pilot wires between the sub-station and the control point is a function of the number of operations and indications which are required, and this scheme is so well known that a description is unnecessary.

A supervisory control scheme involves the use of apparatus similar to that employed in automatic telephone exchanges, and necessitates only two or three pilot wires. In this case the particular control for indication required is "selected" before the actual operation is performed or the indication obtained at the control point.

It is not possible to give here a complete description of a typical control scheme, but with each installation the manufacturer invariably furnishes full instructions regarding the operation and maintenance of the equipment for the guidance of operators and maintenance staff.

The other control schemes available all operate on the selector principle, so that the required controls and indications are obtained with fewer pilot wires than are necessary with direct pilot control. A few notes regarding a typical scheme of this type are given as these are likely to be of general interest.

The system known as the Midworth Repeater enables control and also remote indications to be obtained with relatively few pilot wires. The component parts comprise a transmitter



and one or more receivers ; the latter being a form of moving coil milliammeter scaled to suit the indication required. The principle of operation may be understood from a study of Fig. 47. The transmitter contains an originating movement which gives the indication required and which it is desired to transmit to the sub-station. The receiver translates the message into

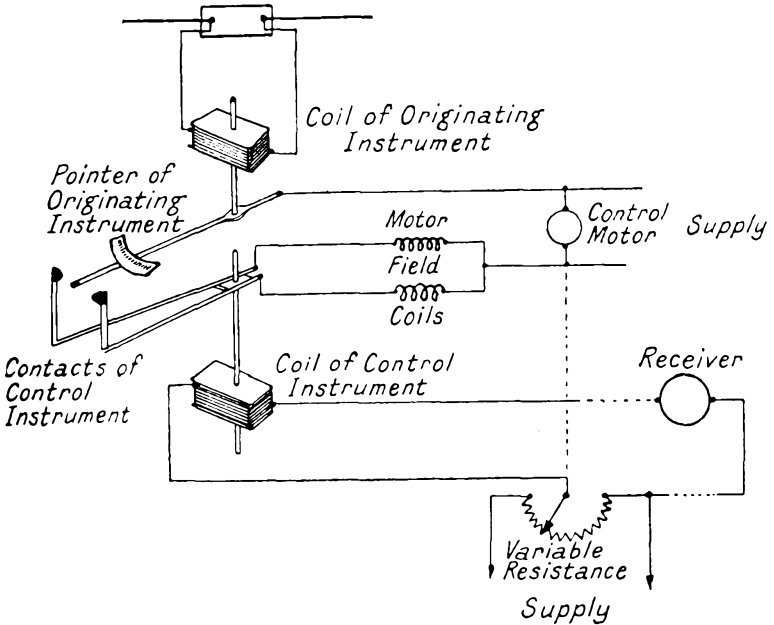

FIG. 47.—The principle of operation of the Midworth Repeater System of remote control.

variations of an electrical current in a series repeater circuit which includes the receivers.

If the pointer of the transmitter is deflected, a contact is made with one of the arms of the control movement, and this completes one of the field circuits of the control motor which rotates and drives the moving arm of the variable resistance unit. The current in the coil of the control movement is, therefore, altered until its contact arm is deflected so that the pointer of the originating instrument is floating freely between

them. Obviously then, since the coil of the receiver is in a common circuit with the coil of the control instrument, the deflection of the pointer of the receiver will be the same as that of the control instrument and also of the originating instrument.

By making the receiver similar to the transmitter, then the deflection of the pointer can be made to control the operation of a motor, which in turn can be arranged to move a contact over a series of selector studs. In this manner one pair of pilot wires can be made to do the duty of a number of circuits.

The installation of a remote controlled sub-station plant obviously necessitates a decision regarding the type of control to install, and such a decision is influenced by a number of factors, such as the distance between the sub-stations concerned, the number of controls and indications required, the cost of pilot cable and its installation, the cost of the control apparatus, etc.

Future requirements should always be given consideration, since it is possible to extend a supervisory control scheme to a further sub-station without the necessity for additional pilot wires being laid back to the control point. A control board is shown in Fig. 48.

### **Schematic Diagram of Steel Tank Rectifier**

A simplified schematic diagram of the connections for a steel tank rectifier is given in Fig. 49, and it will be noticed that with this arrangement a control transformer is connected on the bus bar side of the supply to the main transformer oil breaker. The control transformer may be protected by tetrachloride fuses and also current limiting resistances. Two of the three low tension phases are also protected by fuses. Fig. 50 is a schematic diagram of a typical traction sub-station and in this case the control transformer is connected to the E.H.T. side at the isolating links of the incoming feeder. It will be noticed that reverse current high speed circuit breakers are included with the rectifiers and forward tripping high speed circuit breakers are utilised on the outgoing feeders. The

[To face page 90.



FIG. 48.—A view of a remote control switch and instrument board for a steel tank rectifier sub-station.  
(G. E. C.).

high speed circuit breaker on the rectifier, since it only forms a protection when a reverse current flows, cannot protect the rectifier when a severe forward D.C. overload is experienced.

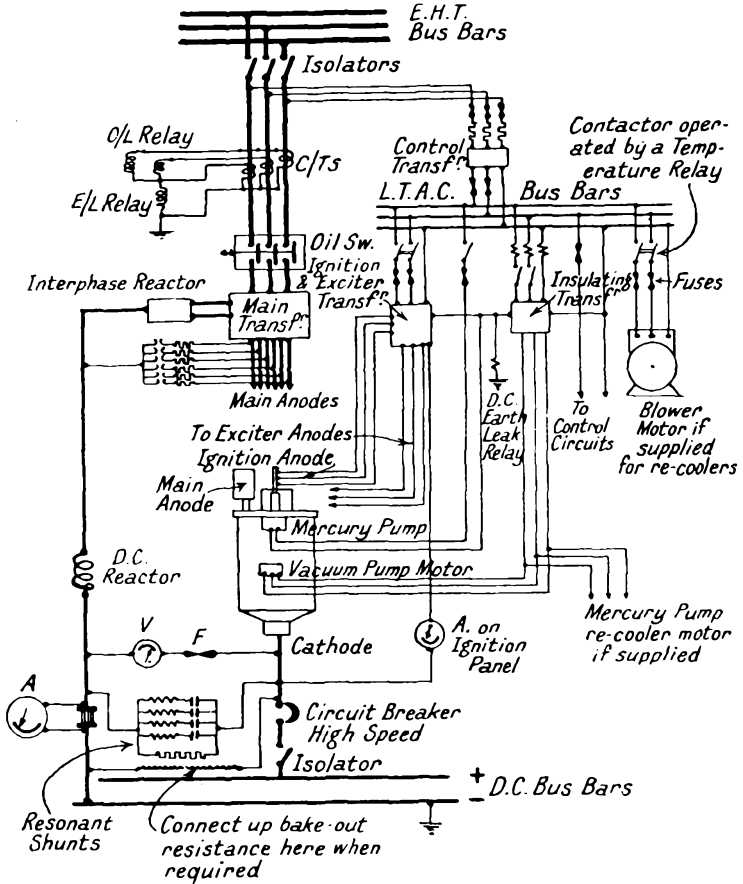

FIG. 49.—Schematic diagram of connections of a typical steel tank rectifier equipment. (B. T-H.)

This is of no consequence, however, since the A.C. overload tripping relay would operate the trip coil on the main transformer oil circuit breaker. On the track feeders, the high speed breakers trip on forward current only. If a fault occurs

at, say, X in Fig. 51, the breakers at A and at B would trip to isolate the faulty feeder from the system. The feeders entering the track-breaker cabin would tend to supply fault current to the faulty feeder, but since the direction of flow of current

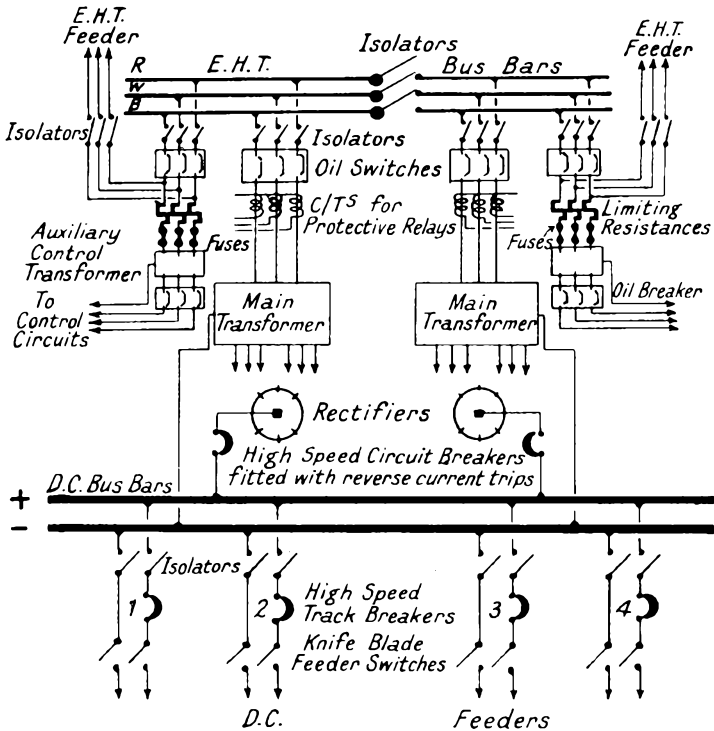

FIG. 50.—Typical diagram of a steel tank rectifier sub-station supplying a traction system. (G. E. C.)

would be the reverse from normal, the high speed track breakers would not operate. The feeder 3 in sub-station No. 1 and feeders 1 and 2 in sub-station 2 would pass fault current to the track feeder cabin, but since the total amount of fault current flowing would be divided between them in varying proportions their breakers would not clear. Discriminative protection is therefore obtained.

### Three-Wire Operation of Rectifiers

If the output required from the rectifier units is large and where the out of balance is or may become heavy, the rectifier is not entirely suitable when connected in series across the outers for balancing purposes. Furthermore, the greatest loss in any rectifier equipment is that due to the arc drop, so where two rectifiers are connected, as stated, in series across the outers of a three-wire distribution, i.e., one rectifier between positive and neutral, the other between negative and neutral, the

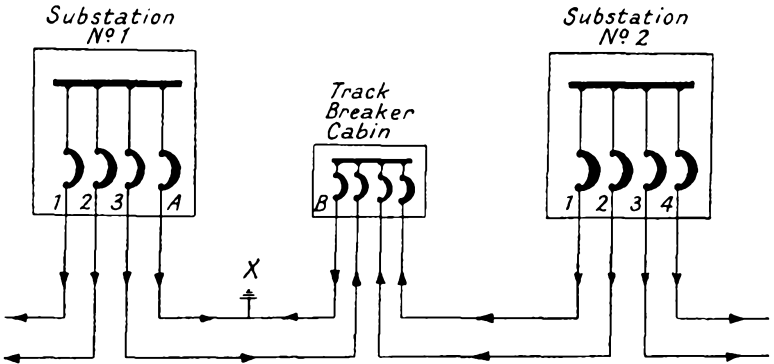

FIG. 51.—Track connections of a railway system with a feeder fault indicated to show the direction of flow of fault current.

then the arc drop is double that which would occur if only one rectifier were connected across positive and negative. The plant efficiency is thereby reduced.

The alternative to connection of rectifiers between the mid-wire and the outers is the use of a rotary balancer machine, and this is the usual method adopted with heavy equipments. The usual arrangement is for the balancer to be connected across the positive and negative sides of the rectifier unit so that it is run up to speed before the plant is connected to the D.C. bus bars. This arrangement is, of course, essential in the case of a rectifier unit supplying an isolated three-wire system, otherwise there would be the danger of trouble arising due to the outers being made alive before the mid-wire connection was made.

In cases where the rectifier equipment is provided with voltage control apparatus, it is usual to arrange the control scheme so that on shutting down the plant the voltage regulating equipment returns to the minimum voltage position. Unlike other plant the rectifier can be paralleled on to the D.C. bus bars at a voltage very much below the bus bar pressure, and after paralleling the voltage can be raised and the load taken up without any sudden variation in the pressure or flickers being produced out on the network.

### **E.H.T. Switchgear Considerations**

The switchgear in a sub-station does not always receive the consideration it deserves. It is not sufficient to install switches capable of carrying the current required under service conditions; the rupturing capacity is equally, if not more, important.

When the approximate locality of the sub-station has been decided upon, the next step is to find out which is the nearest source of E.H.T. supply. Having fixed the source from which an E.H.T. supply may be obtained the possible short circuit K.V.A. should be calculated for the position on the E.H.T. system which the sub-station is to occupy.

The stage is now reached where engineering and finance rarely agree, and all too often the latter decides what type and size of switchgear shall be purchased for the sub-station. If the calculated rupturing capacity of the switchgear required is high the equipment will be expensive, but since this apparatus is not directly revenue earning it is a great temptation to economise on less expensive switchgear having a smaller rupturing capacity rating. If this procedure is adopted, then there is always the possibility of damage to the sub-station plant, a total system failure, or even a heavy loss of revenue due to one bad shut-down. Furthermore, there is the added possibility of injury to a sub-station attendant.

There does not appear to be any definite safety factor accepted by all the switchgear manufacturers in their designs, but the best of them rate their products at a figure which will

allow the " extreme " condition to be handled without destroying the switchgear or the adjacent plant.

Because the manufacturers allow a generous factor of safety, and because it is admitted that a switch may never be called upon to perform an " extreme " duty, it is often considered that these facts justify the purchase of switchgear having a lower declared rupturing capacity than that desired according to calculation. If this policy is pursued too far it is only fair to the attendants to arrange for all the E.H.T. switches to be remotely controlled.

Where the sub-station is privately owned and the supply is taken from a Public Supply Authority or other external source, then it is desirable that the supplier should be asked to state in writing what the possible short circuit K.V.A. would be on the sub-station bus bars under normal feeding conditions.

Now that the National Grid is in operation, it is even more important to take this precaution, on account of the added capacity behind the supply, due to the interlinking of great generating stations.

With rectifier equipments the question of rupturing capacity is very important since a severe back-fire is essentially a dead short circuit across the secondary side of the main transformer, and, if the A.C. oil circuit breaker failed to clear the equipment off the bus bars and the switch welded in, a serious explosion might result.

It is also very important to have a good system of protection on the E.H.T. side and for systematic maintenance to be arranged.



## CHAPTER IV

### RECTIFIER PLANT INSTALLATION

IT is not proposed to deal at any great length with the installation of the glass bulb equipments since such equipments comprise one or more cubicles, each of which may be regarded almost as a self-contained unit. Furthermore, some of the remarks in regard to the installation of the metal tank rectifier apply equally well to the glass bulb plant, for instance, the anode connections, earthing, smoothing circuits, surge arrestors (in the glass bulb equipments of a size comparable to the usual steel tank units, surge arrestors are often mounted in the same manner, i.e., either on the wall in a convenient position, or very frequently fixed to brackets from the cover of the main transformer secondary terminals), small wiring, transformers, etc.

In dealing with the installation of plant it must first of all be pointed out that the supplier of a glass bulb or steel tank rectifier equipment is almost invariably called upon to furnish complete, or at least skilled erection of the plant, so the information which is given in this chapter is intended more to be of service if an equipment has to be overhauled completely or, for instance, removed to another site without the manufacturer being called in to deal with the matter.

#### **The Glass Bulb Sub-Station**

The drawing office staff usually prepare a sub-station layout drawing in accordance with which the individual items of plant should be located. The cable runs can often be left to be arranged on site, but if a number of similar sub-stations are to be erected it is usual to adopt a standard scheme or layout. After all the items, i.e., the rectifier cubicles, transformers, E.H.T. and L.T. switchgear, smoothing circuits, etc., have been

positioned, all iron work in connection therewith should be effectively earthed to the sub-station earth cable. All lead covered cable should also be bonded to earth.

The station earthing joints where each item is connected to the main earth connection should always be sweated to form a good joint.

All cables should be carefully checked over and all small wiring compared with the wiring diagram issued by the manufacturer with the equipment.

There are certain precautions to be taken with regard to the handling of the fragile glass bulbs. These are usually transported in wooden crates in which a webbing chassis is spring supported to carry the bulb in an inverted position. The bulb is in this manner flexibly supported and is protected against sudden mechanical shock. After taking the cover off the crate, the top securing springs must be carefully released, when it will then be possible to lift the bulb out of the crate. When turning the bulb into the vertical position very special care must be taken that the heavy mercury is not allowed to fall violently into an anode arm.

Great care is again essential in fixing the bulb into position in the cubicle, for the amount of space available in the cubicle is usually very small and it is quite easy to knock an anode arm against the side channels and so break the arm off. When fitting the clamping connections to the anode, cathode, ignition electrode and exciter electrode terminals, no greater force than finger pressure is permissible. The position of the bulb must be adjusted so that the level of the mercury pool at the cathode is such that the ignition electrode can make contact with the mercury during the ignition process. This position may have to be still further adjusted after about 100 hours operation.

The question of testing out the various items will be dealt with in the next chapter.

### **Steel Tank Rectifier Sub-Stations**

It is usual to despatch the steel tank rectifier under vacuum,

though with certain auxiliary parts, such as the McLeod gauge, removed. In lifting the rectifier, the eye bolts provided should always be used and the slings should make an angle with the floor of not less than about 60 degrees.

It is essential to keep the rectifier on a level with the floor when slinging if it has been despatched with the mercury in the seals. Otherwise, mercury is liable to be spilled. Great care must be taken to see that no heavy blow is given to the rectifier during the slinging operation, especially on such parts as the main anodes or the ignition electrode.

In some cases machined steel pads, one for each foot, are provided which should be grouted into the floor prior to the unloading of the rectifier. The correct method of fitting the pads is to support them on steel wedges which will allow adjustment of the level of the pads so that each may be lined up with the others to form a completely level bed for the rectifier. When the pads have been lined up a heavy weight should be placed on each pad and a mixture of one part of Portland cement to one part of good clean sharp sand floated under the pads.

When the grouting has set, the insulating feet may be fitted to the rectifier, and then the whole unit can be lowered on to the prepared bed. Test each foot with a feeler gauge and be sure that the weight of the rectifier is evenly divided between them. If, for any reason, the rectifier is not now absolutely level then shims should be placed under the feet which are at fault until the rectifier is level. Then lift the rectifier and place the insulating material on the pads and lower the rectifier into position.

Parts which are removed for despatch purposes are usually given a number or otherwise marked, so that each item can be placed into position without the importance of correct assembly being stressed.

Having placed the rectifier in position an examination should be made of all the mercury seals if this method of sealing is used. In some types the mercury is fed to each of the mercury sealed joints by a small stand-pipe having a

wooden float in it to indicate the level of the mercury, and in others a gauge glass is used for constant visible indication of the mercury level. For the main joints in the tank, i.e., between the anode plate and the tank, there may be more than one mercury level indicator. For transport some stand-pipes or gauges are often plugged, others are blanked off with rubber and the mercury removed. These rubber plugs or blanking sheets should be removed now, the correct rubber gaskets fitted, the gauge glasses or stand-pipes replaced and the mercury poured into the seal.

When joints have been so filled to the height stated by the manufacturer, the floats or the visible level of the mercury may drop somewhat, due to the escape of any trapped air within the gauge glass or stand-pipe. Should there be a continued fall in the level of the mercury, then a leakage is indicated. Where a leak is suspected, very carefully go over all the holding down bolts belonging to that particular seal and pull up. Special care must be taken in tightening up the bolts to avoid damaging the seal and its component parts. Should a leak persist, even after this attention, then it is very desirable to report the fact to the manufacturer of the plant.

The gauge glass or stand-pipe should not be filled too full with mercury in the first instance, otherwise when the rectifier heats up under the initial bake-out the mercury will expand and spill over. Spilled mercury may run anywhere and should any globules find their way to inaccessible places they may become a potential source of trouble. The author has known cases where a damaged glass bulb shed its mercury into various coils beneath the bulb and in a comparatively short space of time found that the coils broke down to earth. The mercury will attack the sulphur content in the insulation, thereby weakening the material, and in consequence of the very intimate contact which the mercury makes with its place of lodgement, a good conducting path was produced.

On no account should oil or grease be allowed to come into contact with the vacuum joints or on the anode stems, etc.

Benzine or alcohol may be used for cleaning purposes during and after assembly.

**The Pumping Apparatus**

After the erection of the rectifier it is desirable to start the

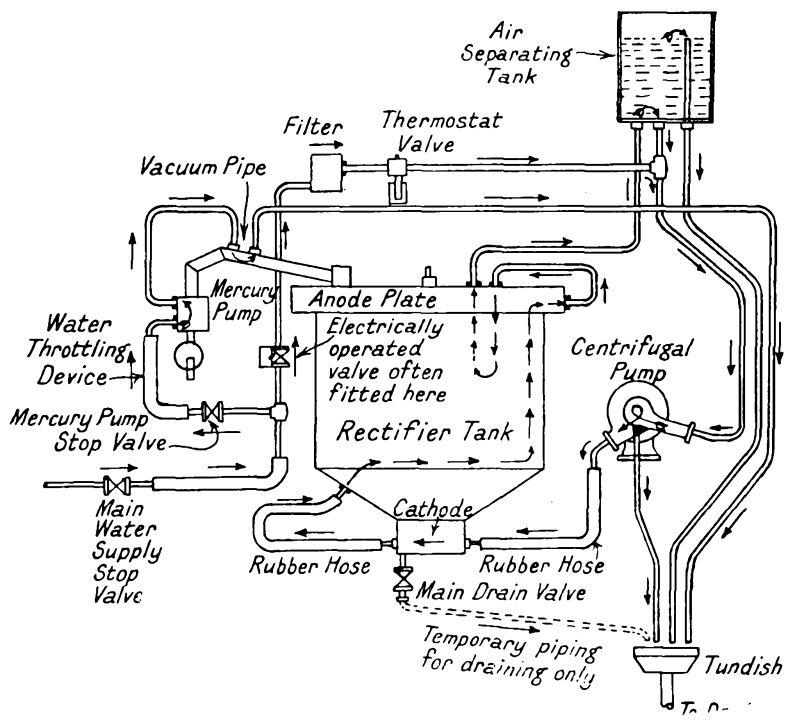

FIG. 52.—A typical tap water cooling system. (B. T.H.)

vacuum pumps working at the earliest possible moment. Towards this end, it is necessary to connect up the water circulating system before anything else. Whatever cooling system is used the pipes must be accurately fitted to the rectifier to avoid a mechanical strain on the pumps. There are three main schemes of water cooling in common use.

1. Tap water cooling for both the rectifier and the mercury pump, and a typical diagram is shown in Fig. 52.
2. Closed water cooling circulating system for the rectifier, but tap water cooling for the mercury pump, as shown in Fig. 53.

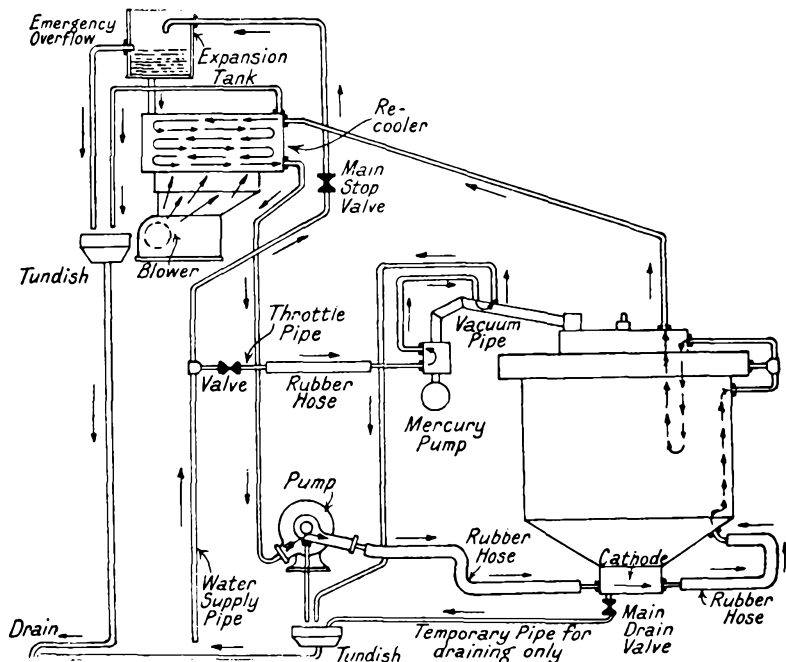

FIG. 53.—A typical closed cooling water system with tap water cooling of the mercury pump. (B. T-H.)

3. Entirely closed water cooling circulating system for both the rectifier and the mercury pump. (See Fig. 54.)

Though these diagrams are typical of a particular system most schemes are on similar lines.

### Cooling System—1

Though both the rectifier and the mercury pump are tap water cooled there are two separate circulating systems. One

cools the mercury pump and main vacuum pipe, the flow of water being controlled by a regulating device which allows a certain water consumption per hour according to the size of the rectifier. The water supply is arranged to give a practically constant outlet temperature. The other cooling system controls the temperature of the rectifier.

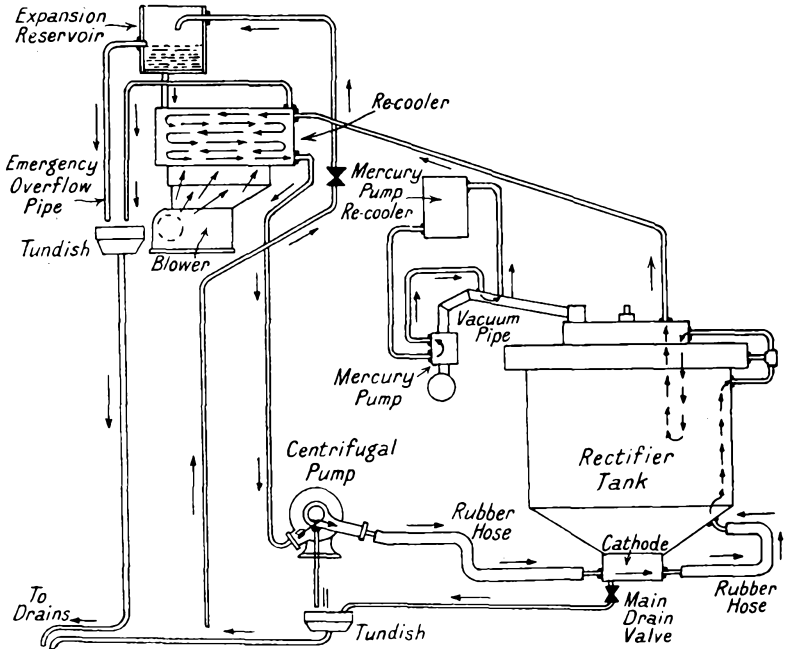

FIG. 54.—A typical completely closed cooling water system with re-cooler tank. (B. T-H.)

The rectifier tank assumes a potential near to its cathode and, therefore, it is highly important when connecting up the water system to remember this fact. When jointing up the pipe system to the town's water supply it is necessary to separate the rectifier pipes from the supply mains by a length of rubber hose. Though this is a good form of insulation it is not perfect and a slight leakage of current is to be expected. There will also be a small leakage due to the fact that the

relatively pure water of the town's supply is not a complete insulator. The leakage current will cause electrolysis to take place and the free oxygen will combine with the iron to form iron-oxide, or if a chloride is present in the water this will separate out to combine with the iron to make chloride of iron. Corrosion of any kind is to be avoided if possible.

The rubber hose therefore serves two purposes, (a) the length is dependent upon the voltage of the cathode, for the current to earth must be only a few milliamperes, and by virtue of that length, (b) it limits the amount of electrolytic action. For voltages up to about 600, the length of the rubber hose should be about 10 to 15 feet, but it depends upon the ohmic resistance of the water used and its chemical composition. For high voltages of 1,500 and more, the length of the rubber hose may be upwards of 75 feet, which would be coiled on an insulated frame and housed in a safe enclosure.

A drain cock is always fitted to drain the tank, the mercury pump jacket, and other points. Where the anodes are water cooled certain precautions have to be taken when removing the radiators. The water should be drained off at the plug and a dip stick inserted in the anode stem to force out as much water as possible. If a rag is now packed round the anode stem, when the radiator is lifted, the very little water which remains will be absorbed by it.

## 2. Closed and Tap Water Cooling System

The cooling of the mercury pump is exactly the same as in the previous method.

The water for the rectifier in this case passes from the mains supply to the expansion reservoir, flows via the re-cooler, through the rectifier jackets and back to the re-cooler. The re-cooler should be situated at a higher level than that of the rectifier to permit any air which may get trapped, to rise into the expansion reservoir and escape to atmosphere. Should such a position not be possible, then it is essential to fit air relief cocks. These cocks must be used during the initial filling process so that air locks are avoided.



Fig. 53 shows two overflow pipes, the one to prevent an overflow from the expansion reservoir, but under normal circumstances the second overflow pipe regulates the amount of make up water required. The pipes are so arranged that when additional make up water is required it has to flow through the rectifier before it can escape through the overflow pipe. Thus the amount of cooling carried out by the re-cooler can be supplemented by additional cold water if it is found necessary to operate at a reduced temperature.

When the pump is in service it will be found that the level of the water in the expansion reservoir drops considerably because of the friction head of water flowing through the re-cooler, but at no time should this level be allowed to fall below the figure given by the manufacturer.

During the erection of the re-cooler components care should be taken that no strain is placed on the tubes. The equipment should be lifted by the eye bolts or other means which may be provided for that purpose. All joints should be screwed and treated with red lead and gold size, or with Dixon's compound. The re-cooler should be mounted on insulators and the same care taken in avoiding contact with any earthed metal. If the pipe work is situated in a place where moisture is likely to condense on them then the pipes should be effectively taped up. Never, under any circumstances, construct pipe-work over the electrical apparatus. Where the runs are long, the pipes should be supported at regular intervals on insulators.

To fill the system with water for the first time, it will be necessary to blow off air from the pump and, as before, this can be done with the pump shut down. It will be essential to repeat this attention at frequent intervals during the first few days working. Use only clean non-corrosive water, but it is not necessary to go to the extent of using distilled water, which is sometimes suggested.

The circulating pump should run whenever the rectifier is in service, but the blower motor only operates intermittently, since it is under the control of a thermostat.

### 3. Total Closed Cooling Systems

From an inspection of the Figs. 53 and 54, it will be noticed that the only difference between them is the addition of a mercury pump re-cooler and the consequent alteration of the pipe-work. The mercury pump re-cooler comprises a motor driven circulating pump immersed in a water tank and combined with a fan cooled radiator. Both the main re-cooler

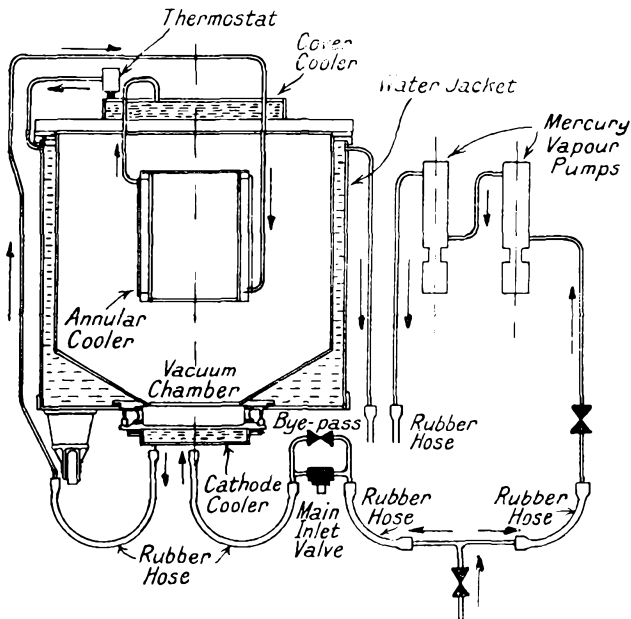

FIG. 55.—A section through a typical steel tank rectifier showing the internal cooling system. (English Electric.)

and the one for the mercury pump should be located in a position where there is an ample supply of air for cooling purposes. Furthermore, the re-coolers should be mounted on insulators, and whenever possible at a higher level than that of the rectifier itself.

The mercury pump re-cooler and the rectifier re-cooler with this system should run continuously.

Fig. 55 shows the internal cooling system of a typical steel tank rectifier unit.

Having now given a general outline of three typical schemes of cooling rectifiers the various tests to be carried out will be left over to the next chapter.

As soon as the water system has been tested the pumps should be set to work to enable the vacuum pumps to be started. If there is a delay in running the necessary pipe-work it is desirable to connect up a temporary supply to the cooler system. If the rotary vacuum pump motor is also used to drive the centrifugal water pump, it is not wise to run the latter for long periods without water and, therefore, it should be disconnected temporarily. The rotary vacuum pump can then be started and run until it is possible to connect up the permanent pipe-work.

There is a word of caution necessary. The rectifier tank and everything in electrical connection with it, including the apparatus on the secondary side of the ignition and the excitation transformer, have a potential near to that of the cathode, and therefore extreme care should be taken that any earthed metal shall not come into contact with either the apparatus or the pipe-work connected thereto.

### **Vacuum Connections and Apparatus**

It is usual to disconnect the McLeod vacuum gauge before despatching the rectifier to the sub-station. The main vacuum pipe is also disconnected and blanked off. To assemble the gauge it is first necessary to remove the top and the bottom end covers and then the front cover. If the glass tube is in a sound condition, i.e., has not been damaged in transit, and the mercury seal at the top of it contains mercury the assembly may be continued. If, however, it is necessary to replace the tube, the new tube should be thoroughly cleaned and made dry inside and then set up so that no strain of any kind is imposed upon the glass. The gasket seal should be firmly fitted, but without excess pressure, inside the glass tube. Where the mercury forms a seal the well must be perfectly

dry and clean. The metal parts should be polished free from any rust or scratches and then wiped over with benzine to make sure that there is no grease or oil on the surface.

In setting up the tube it is necessary to see that the inside surface of the top of the capillary tube is exactly level with the indicating line on the scale. Should adjustment be necessary then extreme care must be taken that no strain is thrown on the glass scale when tightening up the supporting brackets.

The correct amount of mercury is always sent out in the mercury flask and the cover plate and gasket at the top of it should now be removed. The lower bracket of the mercury flask is located between two rubber buffers to prevent it moving up and down. The top buffer should be removed and the flask raised a distance of about 6 inches, after which the buffer can be replaced in the new position some 4 inches above its original one. It will then be noticed that in this new position the buffer can act as a stop for the lower bracket of the mercury flask. The gauge glass tube will also be found to dip in the mercury which is in the mercury flask and the latter can be raised up to the limit imposed by the top rubber buffer, i.e., a position a little below the operating handle.

At the back of the operating handle will be found a spring which serves the purpose of applying a pressure to the friction device in the handle. This spring tension should now be adjusted so that it is possible for the mercury flask to run down the gauge steadily under its own weight when released and without shock.

Next turn to the connecting pipe and see that it is perfectly clean and is otherwise in good condition. Remove the blanking piece from the rectifier main vacuum pipe and as quickly as possible fit the connecting pipe. Care being taken during the fitting to see that the gaskets are in the correct position and sitting well, i.e., are not nipped in the spigots. Tighten up the bolts evenly.

If other vacuum connections have been removed for trans-

port these should now be connected up, similar care being taken with regard to cleanliness.

Always take off the vacuum blanking plates on the rectifier last and connect up the parts as quickly as is possible to reduce the time in which a leakage of air to the tank may occur. The longer it is before the vacuum connections are completed the longer it will take in pumping out.

### **Transformers**

When the transformer arrives on site it should be examined for possible damage received during transit, and if any damage is observed it should be reported to the manufacturer at once. It is usual to send transformers with but sufficient oil in the tank to cover the windings, the remaining oil being delivered in drums. If it is not possible to pour in the make up oil within a few days of delivery it should be stored in a warm dry place with the drum lying on its side and with the bung downwards. It is preferable not to open the bungs until the oil has had time to rise to the temperature of the store room.

After the transformer has been put into position, it should be cabled up and then the make up oil added to the level shown on the gauge glass. It is a wise precaution to take samples from each drum of oil and to have it tested for dielectric strength before pouring into the transformer tank.

The pressure test should follow in the manner indicated in the next chapter, and then, if possible, the transformer should be charged to allow as long a period as is possible preceding actual use, for the transformer to warm up. The heat generated by the iron losses minimises absorption of moisture and also allows the windings to settle down.

### **Resonant Shunts**

The main smoothing component, the D.C. reactor, must be bolted securely to the floor and so also must the main leads to it be firmly cleated down. All metal work in the neighbourhood which might be effected by the strong magnetic field from the reactor should be bolted in position to prevent move-

ment. The reader is now referred to Figs. 56 and 56A, which are typical for a smoothing circuit. It is important when wiring up the circuit that the resistance of the various leads does not exceed the values given by the manufacturer and it is even more important to see that those leads are run non-inductively. It is preferable to run the leads as close together

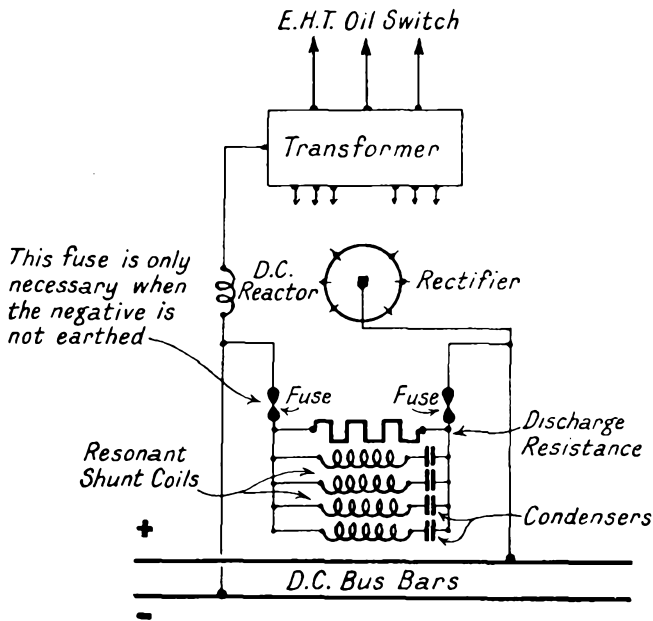

FIG. 56.—A resonant shunt or smoothing circuit.

as possible and to join the main leads to the bus bars at a point where the latter are also in close proximity. Never use a cable which is armoured or run the leads in steel conduit, or even use steel cleats unless the precaution is taken to make the magnetic circuit common to both, i.e., avoid a current flowing in the covering due to induction.

The various coils of the shunt must be mounted at least one foot apart and be clear by the same amount from any adjacent iron work, such as the building girders. The con-

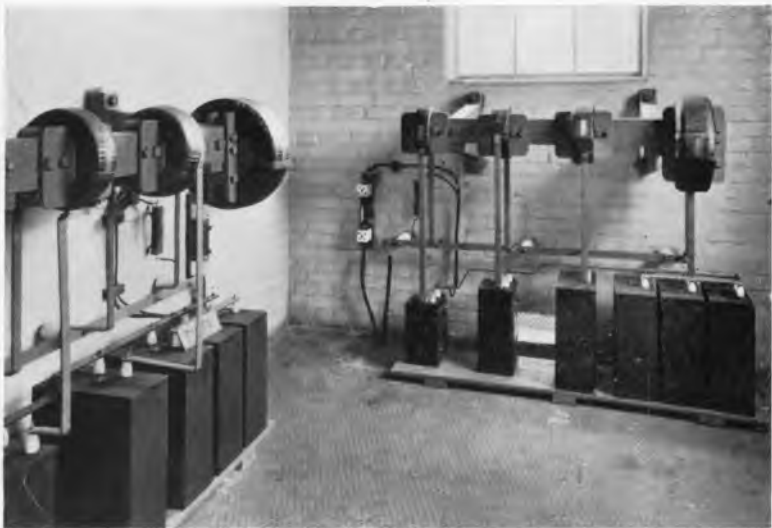

FIG. 56A.—This photograph shows a very good layout of a resonant shunt or smoothing circuit apparatus. (B. T-H.)

[To face page 109.]

ductors to the corresponding condensers should be made of copper strip dropping vertically downwards to the condensers in the equipment. These leads should be parallel to each other.

A fuse must be inserted in each main lead to the tuning system and a discharge resistance connected across the main leads. At no time should work be carried out on the tuning system unless the precaution has first been taken to prove that the condensers have been discharged.

When connecting up the various components of the tuning system it is absolutely essential to see that the coils are connected in with the condensers designed for that particular circuit. It is usual to assign a number or other designation to each coil and condenser to facilitate the erection of the equipment.

A blown fuse may indicate either a breakdown of a condenser or coil insulation or it may be caused by a drop in the frequency of the supply which, thereby, overloads the shunts. It is as well then to first enquire whether the supply frequency has dropped below normal before carrying out any investigation on the equipment for a possible fault.

### **Surge Arresters**

All connections to the surge arresters should be run non-inductively. If cable is used for this purpose, the specification should allow for insulation very much more than that required for the voltage applied to the anodes. In fact the anode cables should be insulated to withstand a pressure of 2,500 volts for medium pressure rectifiers and 5,000 volts for traction rectifiers of 1,500 volts.

### **Small Wiring**

The small wiring for the ignition and the excitation circuit, the anode and tank heaters if fitted, and any wiring which is connected to apparatus mounted on the rectifier itself should be insulated for a voltage equivalent to that ordered for the anode cables. The remaining small wiring can be insulated



for its rated working pressure or nearest standard. Where small wiring carries D.C. current these should be arranged to avoid mutual induction effects.

### **Anode Cables**

The cables for the main anodes should have a cross sectional area sufficient to carry the R.M.S. value of the current in the anode at its full rated output. The size may be calculated in accordance with the instructions given at the end of Chapter I. The insulation should be as specified above.

Though the terminals on the anodes and the cathode are designed to carry reasonable weight it is advisable to relieve these terminals of as much weight as possible. Side thrusts and strains particularly should be avoided. The cables or taped copper strip connections, if such are used, for connecting the transformer secondaries to the anodes should be very securely braced or cleated since under short-circuit conditions large forces are produced.

The creepage distance over the insulation at the terminals of the cables should be sufficient for the high voltage which may occur under short-circuit conditions.

### **General Notes on Running Electrical Connections**

If iron conduit or magnetic metal cleats or armoured cables are to be used, very careful consideration must be given to their use if inductive effects are to be avoided. Especially do these remarks apply to the wiring of such circuits as that of the earth leakage relay, the high speed circuit breaker holding coil, the ignition anodes or the excitation transformer neutral.

All small connections should be sweated into spade or other terminals and securely located with lock-nuts. Large connections such as bus bar joints should be carefully bedded in, by grinding if possible. After bolting up the joints, feeler gauges should be used to test the intimacy of the contacts. A voltage drop test across the joint is a safe precaution to take against connections becoming hot in service. A method of taking this test is given in the next chapter.

Keep all earthed metal apparatus and cables, also instruments and wiring well away from the main D.C. reactor, for this piece of apparatus produces a very strong magnetic field.

### **Miscellaneous Items**

If the rotary vacuum pump has a shut off valve which is solenoid operated, the latter must be disconnected until the pump has been tested for correct direction of rotation.

Disconnect the supply to the Pirani gauge until a good vacuum has been obtained in the rectifier.

### **High Speed Circuit Breakers**

The high speed circuit breaker may be mounted at any convenient spot and bolted directly to the floor, or supporting iron work frame. The only stipulation regarding its location is that no earthed metal shall be immediately above the archchute at a less distance than that specified by the maker for the voltage at which the breaker is to operate.

The breakers should not be erected in a damp position, and sufficient space must be allowed round the breaker to permit of easy inspection or operation by hand if the electrical operating coils should fail. It is a wise safeguard against personal accident to rail off the breakers since a part of their frame work is at the line potential.

When erecting high speed circuit breakers, it is first essential to see that all component parts are clean and undamaged. All grease or vaseline which may have been smeared over the apparatus for protective purposes while in transit must be removed.

The wiring must be carried out in accordance with the diagram supplied by the manufacturer. Particular attention being paid to the polarity of the holding-on coil connections and to the direction of current flow through the main circuit. Diagrams Figs. 57A and 57B are given as typical of "forward current tripping" and "reverse current tripping operation." Fig. 57C is a photograph of this breaker.

It is usual to fit connection studs with a locking washer or lock-nut, which must be pulled up tightly.

The rectifier higher speed circuit breaker is arranged for reverse current tripping and is fitted with an interlock to trip the main A.C. oil circuit breaker in the case of a back-fire occurring. Another interlock is advisable to trip the breaker when the oil circuit breaker is opened either under fault

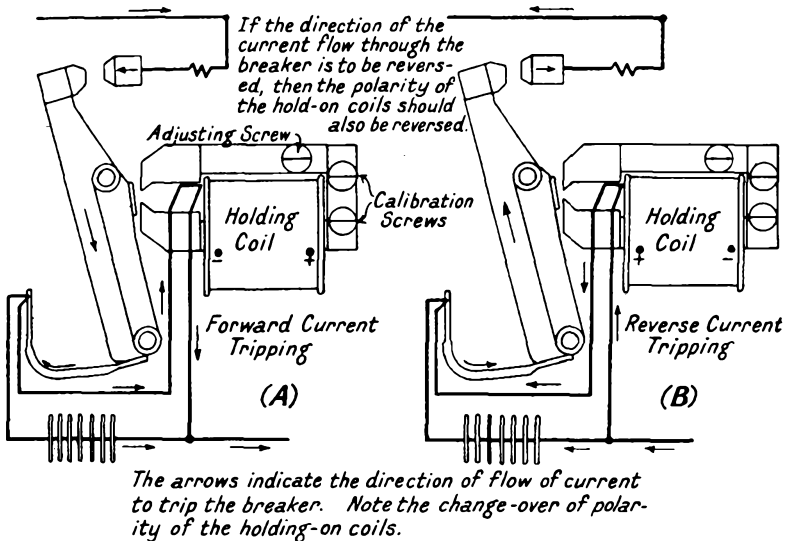

FIG. 57A and B. Connection diagrams for a typical high speed circuit breaker showing current directions for forward or reverse tripping operation.

(B. T-H.)

conditions or normal operation to render the rectifier "dead." This is a precaution against an operator receiving a shock by making contact with the rectifier components while the A.C. oil circuit breaker is open.

If the rectifier equipment includes a rotary balancer, the switches controlling the machine should be interlocked with the high speed circuit breaker to disconnect the balancer and the rectifier simultaneously from the system.

### Earthing

All metal parts normally at earth potential, such as switch-

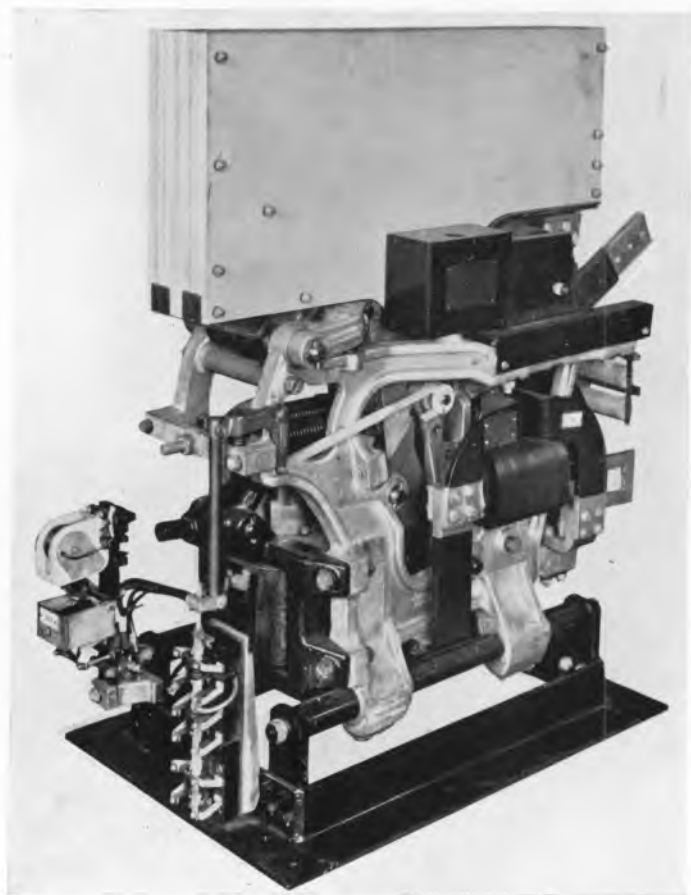

FIG. 57c.—A B. T-H. type R. J. R. high speed circuit breaker having a rating at 750 volts of 2,250 amperes as used for steel tank rectifier reverse current protection.

*[To face page 113.]*

gear casings, should be solidly earthed to the sub-station earth plate. Those parts of the equipment "where a high pressure or extra high pressure, or energy, is transformed down for use at a lower pressure, suitable provision shall be made" according to the Board of Trade Regulations, "to guard against danger by reason of the low pressure system becoming accidentally charged above its normal pressure by leakage or contact from the higher pressure system."

There are three main methods of complying with this regulation, (a) by solidly earthing some suitable point on the low pressure system, or (b) by using an earth shield between the secondary and the primary windings of the transformer or, (c) by the provision of a static earthing device which connects the low pressure side of the transformer to earth in the case of a breakdown between the high and low tension windings.

This last method is the most common one in use, and the earthing device is simple. It consists generally of two electrodes, one of which is connected to the system and the other is solidly earthed to a terminal on the tank. Between the two electrodes is a di-electric, which may be made of mica or paper, or other suitable material. If an excessive pressure arises between the electrodes, the di-electric is punctured and an earth connection thus formed. This device should be disconnected when the initial tests are being made on over-voltage.

To include anything in this earthing connection which would prevent the winding being solidly earthed in the case of a fault would clearly be against the regulations, but it is allowable to connect a series coil in the earth connection to operate a tripping device under fault conditions and thereby trip the A.C. and the D.C. circuit breakers, and to also lock the plant out of service until the trouble has been investigated.

All earth cables or tapes should have ample cross sectional area to carry the maximum possible fault current to earth continuously.

## CHAPTER V

### SUB-STATION TESTING

BEFORE segregating the testing of rectifier equipments into the two natural classes, i.e., the glass bulb and the steel tank types, there are a number of tests common to components in both types of plant. It is proposed to treat these common items first.

#### **Oil Circuit Breakers**

A careful inspection of the E.H.T. switchgear is essential before making any tests to avoid leaving, inadvertently, such things as spanners, nuts, bolts and other metal items inside. The insulating bushes or porcelains should be wiped free of all grease or dust and all operating toggles, interlocks and safety devices cleaned and, where necessary, oiled. Inspect the earthing bar and connections to the sub-station earth.

The oil circuit breaker tank can then be lowered and cleaned out preparatory to filling up with new switch oil. The switch contacts should next receive attention and the treatment depends upon the type of contact used. There are two main types, the laminated brush contact and the spring loaded finger type. Both types should have the contact making surfaces tested with a 0.0015 inch feeler gauge and if this is passed between the surfaces it is essential to bed them in until the feeler will not go in. If the tests are in order the contact surface should be smeared with a trace of Prussian blue mixed with oil, the switch closed and then opened. If the contact making surfaces are now examined they should present an even smear, but if any high spots are apparent then the contacts need attention.

In bedding in the contacts of the spring loaded finger type,

a mixture of fine pumice and oil makes a very good abrasive, but afterwards this mixture must be removed by washing well with switch oil. With the laminated brush type a grinding mixture should on no account be used because the abrasive may lodge between the leaves of the brush. Only a hard scraper should be used for bedding in this type of contact.

Fig. 58 is given to illustrate the possible conditions to obtain

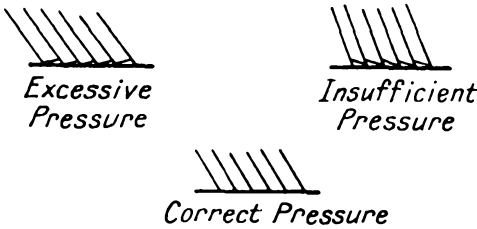

with the laminated brush type of contact, two of which are wrong and one right.

Arcing tips should be adjusted, if necessary, to make contact before and to break contact after the main switch contacts.

FIG. 58.  
Bedding in laminated type switch contacts.

After these tests and attentions, the breaker may be cleaned and any work's vaseline removed, the tank swilled out with switch oil and finally filled with oil to the level indicated by the maker. After filling up with oil, the tank should be raised into position to prevent the ingress of dust and moisture, etc.

Follow up with an insulation test on the circuit breaker with a 1,000 volt megger.

### Pressure Testing Switchgear

The B.E.S.A. specification for over-potential tests on site for new gear gives a test pressure of twice the normal rated working pressure plus 2,000 volts, applied for one minute. This test covers the one minute puncture voltage and also the flash-over point, being a check on the same test taken at the works. The duration test allowed by B.E.S.A. is 60 % of the one minute test voltage just given applied for 10 minutes. This duration test is to be preferred to a repeat of the over-potential test on site.

Prior to making a pressure test remove the voltage transformer fuses.

The testing equipment should comprise a high voltage testing transformer of ample size, with some form of regulator for controlling the pressure applied to it. Across the high voltage terminals of the testing transformer there should be connected a spark gap and series resistance, the latter having a value of at least one ohm per volt of the test pressure. Before applying a pressure test the spark gap should be calibrated. For fuller information on this matter the reader is referred to a Technical Report, No. 1/S2 Appendix V of the British Electrical and Allied Research Association, published in the Journal of the Institution of Electrical Engineers, Volume 64, Number 349. The calibration should be carried out to the recommendations made in that report.

Where the test voltage to be applied is between 10 K.V. and 50 K.V., a needle gap may be used (British standard needle, size No. 17, double large), though for test pressures of 30 to 50 K.V. a sphere gap is preferable.

The problems associated with high potential testing are not always fully appreciated, and since the breakdown and damage to plant resulting from the application of too high a test pressure may be very serious, the procedure is dealt with at some length in the following pages.

### **Types of High Potential Tests**

There are two principal types of high voltage test :

- (a) Applied high voltage tests—these are performed by the application of an externally produced high voltage between the windings or connections under test, and the remainder of the apparatus.
- (b) Induced voltage tests (for transformers) in these tests the transformer itself is operated at a voltage sufficiently in excess of its rated voltage to generate in the windings a voltage of the required magnitude.

The first type of test is invariably applied to apparatus after completion of erection on site.

### **Method of Applying High Voltage Tests**

The value of the applied testing voltage and the duration



of the test should be in accordance with the appropriate B.E.S.A. Specification for the particular apparatus.

No tests should be applied whilst any part of the plant is at a temperature higher than that corresponding to the rated load temperature.

The test should be commenced at a voltage of about one-third of the full test pressure, and should be increased to the full value as rapidly as is consistent with the voltage being indicated by the measuring instrument.

### **Voltage Regulation**

The methods or regulation of voltage on high potential tests are as follows :

(a) By a series resistance in circuit with the low tension winding of the test transformer.

This method is only satisfactory for small gear where the plant has little or no capacity and where leakage currents are limited to a small amount. The tendency with this method is for a very "peaky" wave form to be produced.

(b) By rheostat control in the field of the exciter of the supply alternator, or in the rotor circuit of the alternator.

This method is only satisfactory to a limited extent, particularly if leading current is drawn from the alternator. The rheostats must be large enough to cut down the alternator excitation to almost zero, and must be graded to give a steady rise of voltage as the excitation is increased.

(c) Induction regulator in the L.V. supply circuit.

This is undoubtedly the best method of voltage control for testing purposes.

### **Precautions to be Taken**

It is absolutely essential that the fullest possible precautions should be taken to guard against danger to human life during high voltage testing, and to avoid breaking down of the insulation on plant by incorrect application of test pressures. The following points should be carefully kept in mind when such tests are performed.

1. The supply for the testing set should be taken from a source having a wave form as near as possible to a sine wave, and if an alternator is used, then in order to avoid instability and a possible rise of voltage the test current taken from the machine should not exceed about one quarter of its normal ampere rating.
2. The insulation of windings, etc., must be thoroughly dry and the plant clean and free from dirt or foreign matter.
3. The insulation resistance of the plant should be taken with a megger before and after the high potential test.
4. In the case of inductive windings in high voltage apparatus, motors, generators, transformers, etc., all accessible points on the winding under test must be connected together. Other parts not under test should be soundly earthed to prevent accumulation of static charges.
5. Care should be taken that electric lamps and wiring in proximity to plant subjected to high potential tests are screened or earthed to prevent any breakdown due to accumulation of static charges.
6. It is essential that no portions of plant which have been tested should be handled until they have been discharged by using a pair of discharging tongs or a similar device.
7. Rubber shoes and gloves must always be worn by persons engaged in high potential testing, and at least two men should be present to conduct such tests.
8. It is very desirable that the switch used for the L.V. circuit of the testing transformer should be fitted with springs so that the switch opens when released. The switch should never be fixed in the closed position, but held in by hand.
9. The space occupied for testing purposes must be roped in or otherwise enclosed so that no persons can approach any live conductor and no unauthorised person should be allowed inside the enclosure.

10. Due to the effect of capacity, of the windings of plant under test, a resonant circuit may be produced, and when a test is in progress the sound caused by leakage on the windings will pulsate slowly, and an increasing swing will develop on the voltmeter needle. With these conditions it is necessary to re-connect the transformer windings or to insert a reactance in the L.V. supply circuit.

### Measurement of Voltage

The breakdown of any insulation is determined by the peak or crest value of the applied A.C. voltage wave, and for this reason it is essential that the ratio of the peak values to the R.M.S. values of the voltage wave should be determined. The measurement of voltage on the L.V. side of the test transformer does not give an accurate indication of the H.T. voltage applied to the apparatus under test, since the effect of capacity current is to alter the real transformation ratio of the transformer.

The most usual methods of measurement of voltage during high potential tests are as follows :

1. The use of an electrostatic voltmeter on the H.V. side.
2. The use of a specially wound transformer coil on the core of the test transformer, in conjunction with an L.T. voltmeter.
3. The use of a special tapping on the H.T. side of the test transformer, in conjunction with an electrostatic voltmeter.
4. The use of a peak reading voltmeter.

The first three of the above methods all indicate R.M.S. value of the voltage wave, and a spark gap which indicates peak value must be used for calibrating purposes. The spark gap should also be used as a safety device to prevent breakdown of the apparatus under test due to excessive pressure rises or surges.

When employing a sphere gap, reference should be made to B.S.S. 358/1929—"Measurement of Voltage with

Sphere Gaps," and the following precautions should be observed.

- (a) On all tests the bottom or fixed sphere must be soundly earthed, and all earthed bodies should be kept away from immediate proximity to the sphere gap.
- (b) The spheres should be wiped dry, preferably with a chamois leather to remove dirt and grease, and the spheres should not be handled again.
- (c) A preliminary discharge should be made before each series of readings to remove particles of dust, but care must be taken to avoid appreciable heating of the spheres by a number of discharges in rapid succession.
- (d) A carborundum, or similar type of resistance should be connected in series with the gap on its non-earthed side, in order to damp out high frequency oscillations in the event of a sparkover, and to limit the current which will flow. The value of the resistance should be at least 1 ohm per volt of test pressure.
- (e) Close the gap and check the marking on the calibrated spindle to see that it records zero with the gap just closed.

### Use of Sphere Gap

With a given size of spheres the setting of the gap for a particular voltage may be found by reference to B.S.S. 358/1929, and certain corrections may be necessary since the sparkover voltage for a certain gap decreases with decreasing barometric pressure and increasing temperature. These gap settings and correction factors are fully set out in B.S.S. 358, and it will be found to be an advantage to plot the figures in the form of curves, copies of which can be kept with the testing equipment.

When testing, the first step is to check for wave form distortion, and it is recommended that the following procedure be adopted :

1. Set the gap to a sparking distance equivalent to the full test pressure and connect across the transformer on open circuit. Increase the voltage until sparkover occurs, read and record the reading on the electrostatic voltmeter.
2. Alter the gap setting to a value equivalent to 120% of the normal testing pressure and with the transformer still on open circuit repeat the test as in (1).
3. Reduce the gap setting to a value equivalent to 60% of the normal testing pressure, connect the apparatus to be tested to the high voltage side of the transformer and repeat the test as in (1).

The first two tests are to check the supply wave form and the calibration of the electrostatic voltmeter, and the third test to determine the voltage wave distortion with the apparatus to be tested, connected in the circuit. From the third test a calculation is made of the reading on the voltmeter for the full pressure test on the apparatus.

The ratio of peak to R.M.S. value of a pure sine wave (i.e., the form factor) is 1.414 : 1, but owing to capacity effect, and in some cases the use of series resistance in the primary side of the test transformer, the wave distortion may give an actual form factor of possibly 2.5 : 1:

The normal electrostatic and dynamometer type instruments record R.M.S. values and spark gaps are calibrated for a pure sine wave with a form factor of 1.414 : 1. As explained previously, the peak value of the voltage is the determining factor in insulation breakdown, and this is the value which really has to be measured and used as the standard of the test.

In order to ascertain the actual voltmeter reading corresponding to the required peak value, the following example is given in which correction for barometric pressure and temperature is neglected.

Test pressure on apparatus	.	(R.M.S.) 20,000 volts.	
Equivalent peak value with sine wave			
$20,000 \times 1.414 =$	.	.	. 28,280 volts.

60 % of normal test pressure . . . (R.M.S.)	12,000 volts.
Equivalent peak value with sine wave	
$12,000 \times 1.414 =$ . . . . .	16,968 volts.
Gap setting for 12,000 volts. R.M.S. with	
20 mm. sphere (B.S.S.358) . . . . .	4.85 mm.

With this setting, connect up the apparatus as in test No. 3, referred to previously, but suppose now the gap arcs over when the electrostatic voltmeter reads 7,750 volts, then the following calculation becomes necessary :

7,750 volts R.M.S. on voltmeter has peak	
value . . . . .	16,968 volts.
Ratio of peak value to R.M.S. value of this	
wave form is— $16,968 \div 7,750 =$ . . . . .	2.19
Peak value of full test pressure is . . . . .	28,280 volts.
Hence, with 2.19 : 1 form factor on test wave	
form, the R.M.S. reading of electrostatic	
voltmeter must be— $28,280 \div 2.19 =$ . . . . .	12,900 volts.

The test at full pressure must, therefore, be carried out with the voltmeter reading at 12,900 volts, and before applying this test the sphere gap should be opened out to a value corresponding to 120 % of the normal R.M.S. volts, i.e., 24,000 volts (R.M.S.), and it then functions as a safety gap against excessive pressure rises.

**Relay Testing**

The overload and earth leakage relay is operated by a supply from current transformers on the main conductors of the E.H.T. switchgear. It is, therefore, essential to see that the polarity of the current transformers is correct. This may be checked by the "kick test" as illustrated in Fig. 59. With correct

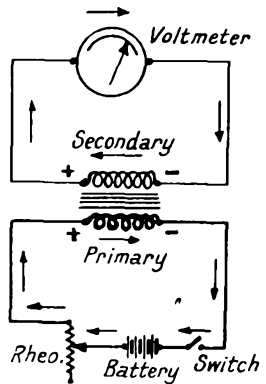

FIG. 59.—Connection diagram for taking a "kick" test for the purpose of checking the polarity of instrument or relay current transformers.

polarity and the connections made as shown, the voltmeter needle will be deflected towards the negative terminal of the voltmeter when the small switch is closed. This test simply proves that the instantaneous direction of output current flow from the secondary windings of the current trans-

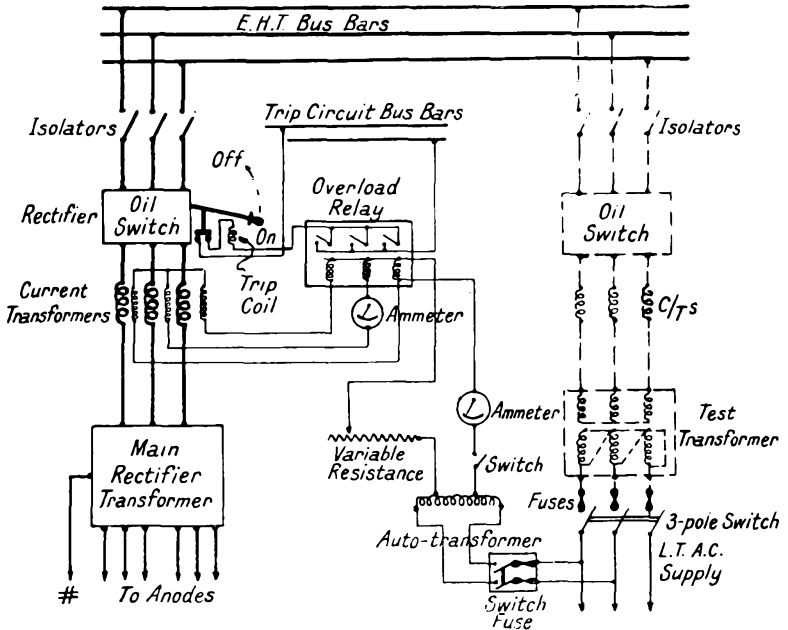

FIG. 60.

Connection diagram for a single phase test of an overload protection relay.

former corresponds to the direction of input current flow to the primary winding at any given instant in time.

The secondary wiring should now be checked up in accordance with the wiring diagram supplied and an occasional terminal tried for tightness.

A single phase L.T. A.C. supply may be used to test the overload relay and trip coil by connecting up the test apparatus as shown in Fig. 60, the relay being tried on all its settings. This method, though testing the relay and the trip coil, has the disadvantage in that it does not comprise a complete test of

the whole protective circuit. The method shown in Fig. 61 is to be preferred since it also proves the current transformers, relay, trip coil and the whole of the small wiring forming the trip circuit. Either a small test transformer or any convenient L.T. A.C. supply can be used and the pressure adjusted by

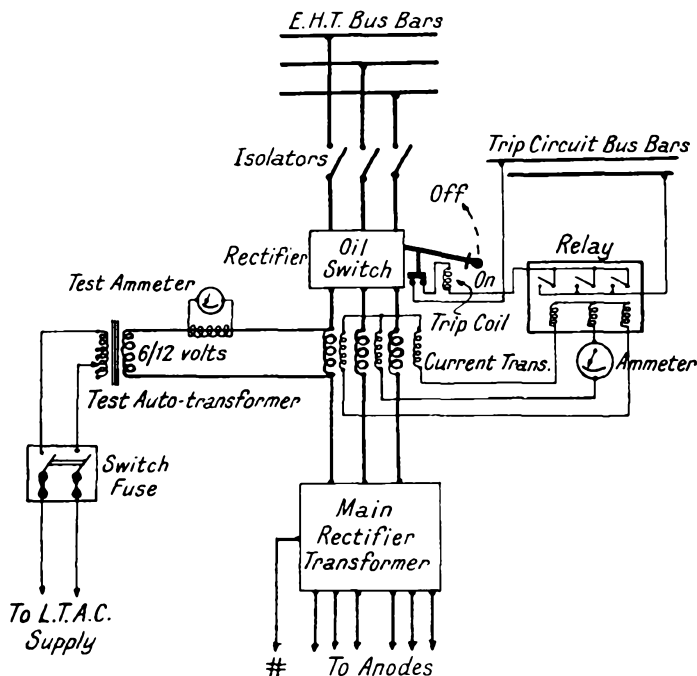

FIG. 61.—A connection diagram for a single phase test where the test current is passed through the primary of the current transformers.

the auto-transformer to a voltage of the order of about 6 to 12 volts. In using this type test, where possible the test leads should be clamped on to the current transformer terminals to obtain as near as possible a condition equivalent to that given by service conditions. It will be appreciated since it is unnecessary to make any disconnections for the purpose of the test that mistakes cannot occur, as in other methods, of re-connecting after the test. This is a most important feature.



It is also useful to keep a set of spare current transformers for test purposes to use in place of the special test transformer and to connect them up as shown in Fig. 62.

**Transformer Pressure Testing**

Before undertaking a pressure test on the windings an insulation test should be made with a megger. It is then wise

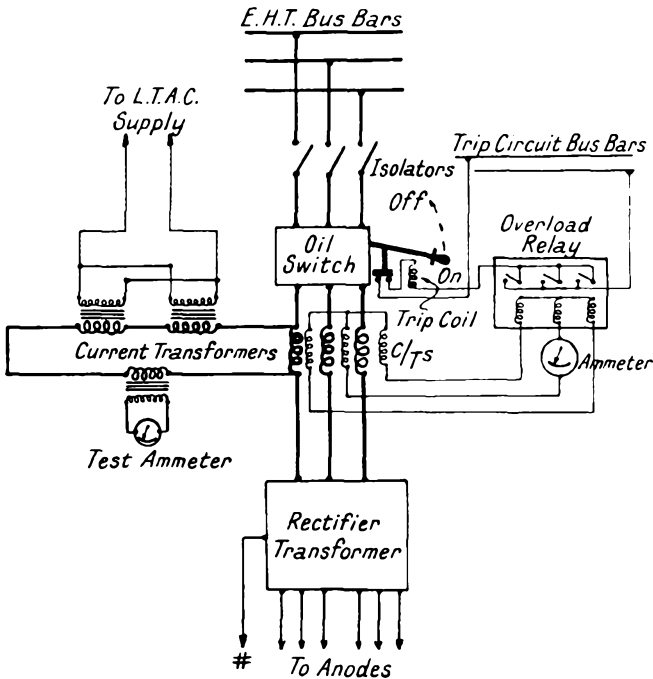

FIG. 62.—A connection diagram for a similar test to that shown in the previous figure but using separate current transformers.

to take a sample of the oil in the tank and to have it analysed. The container for the sample should be perfectly dry and clean, a suitable receptacle being a quart Winchester bottle. The sample should be drawn off from the bottom of the tank, and in doing so it is necessary to run off some of the oil from the cock to be sure that a representative sample is obtained, then

the bottle washed out with some of the oil before being filled and securely stoppered.

If the chemical and the di-electric tests are satisfactory the pressure test of the windings may be proceeded with. The testing apparatus which was used for the switchgear can be used for the transformer test and the test pressure to be applied is 75 % of twice the working voltage plus 1,000 volts, e.g., if the service voltage is 11,000 volts then the test pressure will be 17,250 volts applied for one minute. The L.T. windings must be earthed at the time of the test. The reader is referred back to the remarks concerning peak voltages obtained in pressure testing apparatus on pages 122 to 123.

### High Speed Circuit Breakers

It is essential to check up the wiring of the breaker against the diagram issued by the maker, special attention being given to the relative direction of current flow through the main contacts and the holding-on coil. Take great care that the low voltage wiring does not make contact with the high voltage parts of the breaker. Next, operate the breaker with the hand operating lever and so check for freedom of operation. All the interlocking features should be similarly treated for positive operation. With the breaker closed, see the main contact tips are in correct adjustment. A typical wiring diagram and schematic arrangement are given in Fig. 63, while Fig. 57c is a photograph of the actual breaker. In this case the hold-on coil with the series resistance form a separate circuit from that of the re-set contactor and resistance. The drum controller type of control should be tried to see that the spring loading brings the drum to the mid (off) position. A movement to one side closes the breaker and to the other side the breaker is caused to open. Follow out the connections and check that the " off " position of the switch makes the holding coil circuit and is maintained when the switch is thrown over to the " close " position. A part of the hold-on coil resistance is now short circuited which permits an over-excitation effect to prevent the holding armature from being mechanically dis-

lodged from its position. Furthermore, the operating coil circuit for the re-set contactor is made, the contactor accordingly closed to energise the breaker closing coil. With the closing of the breaker the re-set contactor coil is shorted out to de-energise the contactor, the supply to the closing coil is disconnected, and this allows the closing lever to return to the " off " position.

This last operation permits the main contacts of the breaker

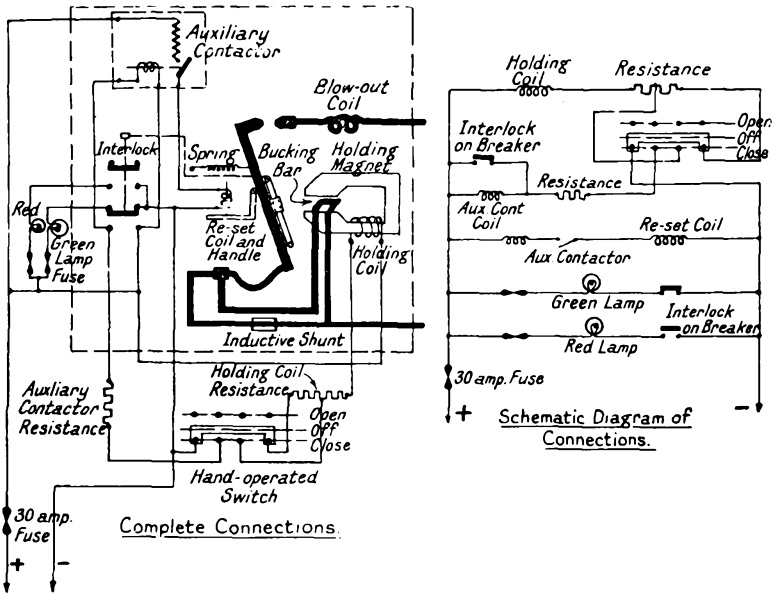

FIG. 63.—A complete diagram of connections for the B. T. H. high speed circuit breaker Type R. J. R., together with a schematic diagram of operation.

to close and the main circuit is thus completed. Release of the control switch interrupts the coil circuit of the re-set contactor, but the main holding-on coil circuit continues to be energised.

Moving the control switch to the " open " position interrupts the hold-on coil circuit, releases the magnet and the breaker opens.

After testing, inspect the hold-on coil core face and the laminated armature to be sure that no particles of matter have become lodged therein. These faces are bedded to make a good magnetic circuit and, therefore, foreign matter would not only tend to prevent the breaker from being securely held in, but it would also reduce the tripping current value.

If a milking booster is available or some other portable low voltage D.C. generator, then it should be connected to permit a current to be passed through the main contacts to test the tripping values and the release feature of the breaker. A failure of a breaker to open at a given setting may be due to a wrongly connected hold-on coil or the main connections may be reversed.

These remarks apply to the type R.J.R. breaker made by the B.T.H. Co., but similar tests should be made on those of different manufacture.

### D.C. Switchgear

Air break knife switches should comply with British Standard Specification No. 109 and, in general, current carrying capacities up to 2,000 amperes are designed with contact densities between 50 and 70 amperes per square inch, giving a temperature rise within the limits of the B.S.S. of 20° to 30° C.

Air circuit breakers should comply with B.S.S. No. 110 and again, in general, contact densities of 500 amperes per square inch for sizes varying between 100 and 10,000 amperes current carrying capacity will give a temperature rise within the specified limits.

In regard to the bus bars, these may be of copper or aluminium strip  $\frac{1}{4}$ " thick and spaced  $\frac{1}{4}$ " apart, and can be designed for a current density of a 1,000 amperes per square inch with capacities up to 4,000 amperes without exceeding the 30° to 35° C. rise specified in B.S.S. No. 1591. For very heavy loads or where the load is consistently heavy, it is advisable to run at a lower current density. The coefficient of expansion of copper is 0.0000166" per degree C., which will give a total expansion on a 30 feet length of bus bar for a 35° C. rise of 0.209 inches,

but, in addition, there may be a winter and summer variation of another  $35^{\circ}$ , so the total expansion now becomes 0.418, or nearly  $\frac{1}{2}$ ". If such a bus bar couples together feeder panels, etc., with rigid connections heavy stresses would be imposed on the panels and the supports. It is, therefore, essential to fit in expansion joints every 15 or 20 feet, depending upon the rated current density of the bus bar and the current distribution through it.

With all the above three items, unless the contact making surfaces are truly bedded, the permissible temperature rise may be exceeded and heating troubles be experienced. It is in consequence a wise precaution to take a drop test across all knife switches, circuit breakers and bus bar joints. For this purpose a milli-voltmeter should be used with flexible leads terminating in insulated exploring points. A measured current is steadily passed through the part under test and the drop across the apparatus or joint measured on the milli-voltmeter. In general, a milli-volt drop of less than 10 may be considered satisfactory for knife switches and air breakers. For bus bar joints the drop should not greatly exceed that to be obtained from a test on an equivalent length of bus bar. If such conditions do not exist, then careful bedding-in and cleaning of the contact making surfaces is essential and further tests made.

### **Glass Bulb Rectifier Tests**

The tests to be made on the rectifier cubicles are of an elementary nature and present no real difficulties. Firstly the cubicle must be inspected carefully with a view to retrieving any spanners, pliers and other tools used in the course of erection. All fuse holders should be wired to suit the circuit which they are to protect. Each circuit should be megger tested and the readings logged. If the preliminary inspections and megger tests have proved satisfactory the oil circuit breaker protective relay should be set light. All fuses should be removed from the rectifier unit, and if isolating links are used in the anode circuit these should be opened. Closing

the oil circuit breaker charges the main transformer only, and this should be left charged until the tester is ready to proceed with the tests.

To proceed, shut down the transformer and then close the anode isolating links and insert the fuses in their holders. When the main oil breaker is again closed, the rectifier bulb should strike up and operate on excitation current. If the bulb fails to strike up, examine the position of the bulb in its cradle and notice whether the level of the mercury in the cathode is such that the ignition electrode can make contact with it during the ignition process. If not, then the bulb should receive the necessary attention.

Referring back to Figs. 18 and 19, take voltage readings between E1 and E2, also E3 and E2, and again between E1 and E3. On open circuit the two former readings should be equal and half the value of the latter. When the bulb is operating on excitation current the drop across each excitation choke coil should be equal. Examine the control fuses to be sure that one has not blown or see that a good contact is being made. After exploring with the voltmeter the point of open circuit can be found and the fault remedied.

The excitation currents should next be checked by using a low reading D.C. ammeter inserted in the circuit to the D.C. relay coil. If the excitation current is not at a value suitable to the size of bulb in use, the choke packing should be varied. Generally, it is usual to allow about 4 amperes for the smaller 20 to 30 ampere capacity bulbs and about 7 amperes for the larger type of bulb, but the amount should be made and maintained at the value specified by the manufacturer.

The voltage across the anodes should be checked and from each anode to the appropriate neutral of the transformer secondary winding. With parallel operated anodes the voltage between the anodes in parallel per phase should be zero. The voltage between each anode and the transformer neutral should correspond to the voltage specified as phase to neutral voltage on the transformer diagram.

Next check the direction of rotation of the air blast cooling

fan motor and if the air is not being blown up against the bulb two of the supply leads to the fan motor should be interchanged.

At the completion of these tests, the D.C. voltage should be checked and adjusted to that of the D.C. bus bar potential, when the D.C. circuit breaker may be closed and the unit paralleled on to the D.C. bus bar. Load may then be taken after setting up the oil breaker tripping value, and the drop across the cathode choke coil checked.

Where several units are to operate in parallel the drop across each cathode choke should be equal, but if the bulbs will not share the load equally over the full rated output of the bulb, this may be corrected by adjustment of the magnetic gap in the anode and cathode chokes of the unit giving trouble. (See pages 34 and 35.) The correction having been made, the bulbs should be subjected to a "working in" period as indicated in the next chapter.

The simplicity of this type of converting apparatus forms an extremely attractive feature and the whole of the testing can be carried out within a very short time.

### **Steel Tank Rectifier Tests**

In preparing for the initial operation of the pumps it is desirable to check that the automatic shut-off valve, which in some makes is incorporated in the rotary pump on the suction side of the latter, is working quite freely, by moving it round slightly by hand. It is not wise to dismantle this valve, because it is usually set with its correct adjustment at the works when under test.

If the rotary pump is solenoid operated, two sets of leaf springs are arranged beneath the solenoid core to increase the speed of reclosing of the valve. The setting of the springs should not allow them to foul the bottom of the solenoid core when they are deflected upwards.

With a solenoid operated shut off valve it is essential before starting the pumps to disconnect the solenoid and test the direction of rotation of the pump motor. This should agree

with the indication stamped on the pump casing. Correct the direction of rotation if necessary.

In most cases where a valve is used between the mercury vapour pump and the rotary pump mechanical operation is arranged and the valve only opened when the pump is in operation. Some manufacturers use a barometric seal in place of a valve. This seal is in principle a valve and comprises a tube about 36 inches long, the upper end of which is connected to the top of the mercury vapour pump while the lower end is connected to an intermediate vacuum chamber, or inter-stage reservoir. This latter has in it a mercury pool into which the bottom of the tube slightly dips. The inter-stage reservoir is connected to the rotary vacuum pump and is exhausted by it, but when the pump stops working and the pressure increases, the mercury rises up the tube to approximately barometric height and thus makes an extremely effective leak proof seal or valve. An oil trap is often fitted to the barometric seal which serves the purpose of preventing oil or oil froth from entering the seal during the time the rotary pump is shut down.

In some cases two barometric seals are used, one connected between the inter-stage reservoir and the rotary vacuum pump, the other between the inter-stage reservoir and the mercury vapour pump. In this system, the latter seal is necessary, for in the case of a failure of the E.H.T. supply lasting more than about 15 minutes, the mercury vapour pump ceases to operate and the inter-stage reservoir will feed back into the rectifier, and lock it out until the mercury vapour pump has had time to heat up again to evacuate the rectifier. With the two seals, the inter-stage reservoir cannot feed back into the rectifier during a failure of the E.H.T. supply and as soon as the supply is restored the rectifier vacuum is usually good enough to permit the plant to be operated until the mercury vapour pump is again doing full duty.

A contact making pressure gauge can be fitted to the inter-stage reservoir to cause the rotary vacuum pump to operate as and when required, which may be for only short intervals.



Prior to running up the pump, release the air in the centrifugal pump by opening a small pet cock, which is provided for this purpose, on the top of the casing. Run up and shut down again several times to allow any air in the circulating system to become trapped in the centrifugal pump. Each time the pump is shut down the accumulation of air should be blown off through the pet cock.

Adjust the water pump glands to permit a slight drip of water from each gland when the pump is in operation. When these preliminary tests have been completed shut down the water pumps and prepare for the pumping down of the vacuum pipes and the main rectifier tank.

### **Vacuum Pumping**

Assuming the vacuum connections have been made as instructed in Chapter IV, the McLeod gauge should be ready for use. The covers of the gauge should, however, be fitted into position if this has not already been done.

Run up the roughing pump or rotary vacuum pump with the main rectifier vacuum valve closed. The pump will now pump down the vacuum pipe connections. Next turn on the cooling water supply to the mercury vapour pump and switch on the supply to the mercury vapour pump heater circuit.

A typical pump of this type is shown in Fig. 64. Do not switch on the supply to the heater, however, if the first initial rush of air obtained on starting the rotary pump has not ceased. Neither should it be switched on if the mercury cannot be raised up into the bulb of the McLeod gauge.

With the mercury vapour pump in service the vacuum should now fall rapidly towards zero, but, of course, the time taken to pump down will depend upon the length of time the mercury pump has been open to the atmosphere. While pumping down, examine the excess temperature relay on the mercury vapour pump jacket and see it is functioning properly, otherwise an accidental cut-off in the water supplies during the remainder of the testing may give rise to some difficulties. The



FIG. 64. — A typical mercury vapour vacuum pump with an induction heated mercury boiler. (B. T-H.)



FIG. 66. — A typical McLeod vacuum gauge with the cover removed.

[To face page 134

water outlet temperature should not exceed that specified by the maker.

By now it should be possible to raise the level of the mercury in the McLeod gauge well above the top red indication line on the gauge scale with the mercury flask in the top position. Lowering the flask to the bottom stop should cause the mercury

**Note:**

*The scale must be fixed so that the red line is exactly level with the top inside curve of the capillary tube.*

*Adjust the top of the mercury meniscus in this tube to the red line on the scale.*

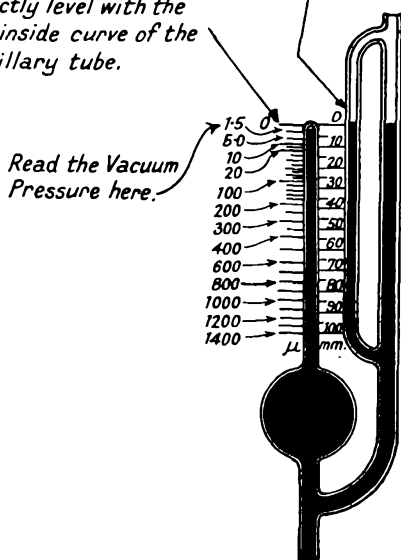

FIG. 65.—Method of reading the McLeod Vacuum Gauge. The diagram indicates a vacuum pressure of 1.5 microns. One micron is equivalent to 0.001 m.m. of mercury.

level to fall well below the bottom junction of the bulb on the main gauge stem.

Care must be taken in raising and lowering the flask to avoid the hammer action of the mercury which may be sufficient to break the glass. For consistent and accurate results in the readings, the mercury level should be allowed to fall below the bottom junction of the bulb on the main stem for a few seconds prior to making a test.

At the end of about two hours continuous operation of the pumps, a test should be made of the vacuum and if this is now about 1 micron, i.e., about 0.001 mm. of mercury, the main vacuum valve of the tank may be opened. When opening the valve, a continuous set of readings should be taken as rapidly as possible on the McLeod gauge. The highest reading obtained will give a good indication of the extent of the leakage which has taken place since the equipment was tested at the works and the main vacuum valve closed for the purpose of retaining the tank vacuum during transit to site. From an inspection of Fig. 65, there should be no trouble in taking readings on a McLeod vacuum gauge. Fig. 66 is a photograph of this type of vacuum gauge.

### Seepage Tests

With the pumps still in service and the vacuum valve open, the tank will be pumped down and this should be continued until a pressure of 1 micron or even better is obtained and then the pumps shut down. A series of readings of the vacuum pressure must be taken now over a period of about twelve hours. At first the readings should be made at intervals of about 10 minutes, after an hour the intervals between the tests may be increased until for the last two hours the readings need only be taken each half hour. The test should be logged, giving the time of each separate test, the vacuum reading and the tank temperature.

At the end of the second period, i.e., about twenty minutes after the pumps have been shut down, the mercury pump will fail to hold back the air in the intermediate or inter-stage chamber which is located between the roughing or rotary pump and the mercury vapour pump. This state will be indicated by a rise of pressure recorded by the vacuum gauge. During the next ten minutes conditions will settle down and the readings become fairly even. If now the readings over the last eight hours of the twelve-hour test show an average leak of not more than about 2 microns per hour for a 12 anode tank, or about 4 microns for a 6 anode tank, the rectifier can be

considered as satisfactory and the general testing out continued in accordance with the instructions to follow.

If the values for the allowable leakage are very much exceeded, then it is essential to trace the source of the leakage. Towards that end, a further seepage test can be made. For the second seepage test start up the pumps and bring the vacuum down to the figure previously given, namely 1 micron, and then close the main vacuum valve on the rectifier tank. Stop the pumps, take a seepage test as before, but this time the test will only be on the vacuum pipe connections. This test may indicate the source of the trouble, and, if so, the connections should be remade where necessary.

At the end of the twelve-hour test on the pipe connections run up the pumps once more if the trouble has not been indicated by the second seepage test, and again obtain a vacuum pressure of 1 micron. At this stage the vacuum valve on the rectifier should be opened as rapidly as possible and a vacuum test made. The highest reading obtained will then give the leakage in the main tank during the time of the seepage test on the vacuum pipe connections.

The pipe leakage should not exceed 10 to 20 microns per hour over the twelve-hour period of the second seepage test.

Though these tests are very essential to determine the vacuum condition is such that preparation may be made for the bake-out, some latitude for the leakage values given is permissible. If a seepage test is made after the final bake-out, then a more consistent set of readings agreeing with the values of leakage allowable must be obtained before putting the rectifier into commercial service. Furthermore, if the vacuum system has been opened to atmosphere it is advisable to run the pumps for twenty-four hours before taking a seepage test, and only then if the vacuum of 1 micron has been obtained.

A serious leakage in the tank should be reported to the manufacturer at once.

Assuming that these tests have proved satisfactory, start up the pumps again and run until a pressure of 1 micron has been once more obtained and then shut down. Run the

pumps occasionally to maintain the vacuum until the bake-out has been completed.

### **Insulation Tests**

The electrical circuits throughout should be tested with a megger and the readings logged for each individual circuit. Following on these tests, strike up the arc in the rectifier and with a 1,000 volt megger test each anode to the cathode. The megger terminals should be connected to the rectifier with the negative applied to the anodes and the positive to the cathode. The readings should all be about 10 megohms if the insulation is in good order.

### **Water Supplies**

These have already been treated as far as the actual water connections are concerned, the only remaining items being the testing out of the allied apparatus. The centrifugal pump motor should be switched in and the direction of rotation checked against the arrow cast on the motor case. Correct if necessary by interchanging two of the supply leads to the motor. If a forced draught fan is in use, the direction of rotation of the fan motor must be checked and, if necessary, corrected. Examine the temperature relay on the water jacket of the mercury vapour pump and check the temperature attained. The outlet water temperature from the mercury vapour pump in the re-cooler system should not be more than that specified by the manufacturer above the ambient air temperature of the sub-station. A photograph of a typical re-cooler system is given in Fig. 67.

### **Pirani Vacuum Gauge**

The Pirani vacuum gauge has been adopted as a standard instrument by nearly all British manufacturers. This gauge uses the principle of the Wheatstone bridge having four resistance legs, with the gauge and relay connected into the circuit usually occupied by the galvanometer. Of the four resistance units, two of them are identical valve filaments and

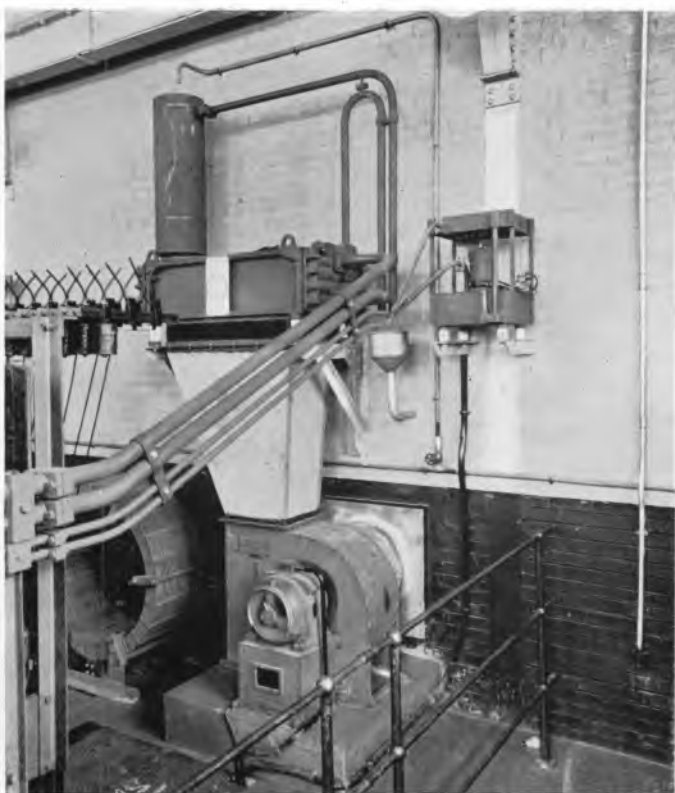

FIG. 67.—A typical installation of main re-cooler for a steel tank rectifier and an auxiliary re-cooler for the mercury vapour vacuum pump. (B. T-H.)

[To face page 138.

so arranged that one of them operates in a glass container sealed under a good vacuum, while the other valve is connected to the rectifier tank and its filament operates under the vacuum pressure of the main rectifier tank. The filament in the sealed valve acts as a balancing compensator to the other filament. The remaining two resistance elements have identical ohmic resistance, but provided with a slide wire type contact so that a zero balance of the valve filament resistances can be made.

The rate of heat loss in the compensator valve filament is constant since the vacuum in which it operates is also constant. The rate of heat loss in the gauge filament depends upon the degree of vacuum within the tank of the rectifier. The resistance of the filament is a function of the rate of heat loss and a measure of the degree or relative vacuum in which the two valve filaments operate. The difference in resistance between these two valve filaments due to the difference in the degree of vacuum in which they work can be balanced out to zero by the adjustment of the slide wire contact.

Where complete automatic operation is not used, the Pirani gauge does not operate continuously, and it is, therefore, essential to incorporate a time delay relay to ensure that the gauge and the compensator filaments are heated to the proper temperature before the vacuum relay is permitted to pass on control operations to the rectifier.

It will now be appreciated why instructions were given earlier not to connect up the Pirani gauge electrically until a good vacuum had been obtained.

If, for any reason, such as the gauge having been opened to atmosphere, or operating under a poor vacuum, a small zero error occurs an adjustment should be made. To carry out the correction the vacuum should be tested by the McLeod gauge and if the pressure is in the region of 1 micron, the fuses of the Pirani gauge control circuit can be placed into position and the gauge operated for several days, the vacuum always being maintained at about 1 micron or better. At the end of the preparatory period, pump down the rectifier until



the vacuum pressure in the rectifier tank, which should be cold, is at zero microns as indicated by the McLeod gauge. It will then be time to adjust the micron-meter to the zero reading by adjustment of the slide wire contact. Only a very slight movement will be necessary as the gauge is always set at the works.

The correct amount of current for operation of the Pirani gauge circuit is indicated by a red line upon the scale of the ammeter which is frequently provided with the equipment. A typical view of such a gauge is shown in Fig. 68 and 68A.

### **Vacuum Relay**

One form of vacuum relay is known as the Creed type. If any adjustment of this relay becomes necessary, it must be very carefully carried out, but normally it is preferable to call in the service of a maker's engineer.

### **Surge Arresters**

Examine these and determine that the links between the horn gap and the resistance are intact and in a good condition. It is usual for a drawing to be provided showing the gap which is suitable for the voltage of the particular rectifier.

### **A.C. Protection Relays**

The A.C. overload relay having been tested, the setting should now be adjusted to pass normal currents associated with the magnetising current rush on charging the main transformer. After the above adjustment the main oil circuit breaker can be closed to charge the main transformer.

### **Instructions Prior to Bake-Out**

1. Fill all the anode coolers to a depth specified by the manufacturer.
2. The A.C. overload relay having had its setting made according to instructions given in the previous paragraph, should not again be altered at this stage.



FIG. 68.— A typical Pirani vacuum gauge and main vacuum valve. (B. T-H.)

[To face page 140.]



FIG. 68A.  
Typical Pirani vacuum gauge instrument panel. (B. T-H.)

3. Make a careful inspection of all water joints, also the mechanical and the electrical connections, etc., to determine that nothing has been forgotten during the erection work.
4. Remove all loose steel material from the vicinity of the D.C. reactor.
5. Finally, check up the surge arrester gaps.
6. Turn on all water supplies.

### Phasing Out

To check the relation of the phases and the direction of rotation of the main and the auxiliary anode pressure waves, the voltage between different anodes and also between the anodes and the neutral point of the transformer should be measured. These pressures must be taken with the rectifier on open circuit but with the arc in operation within the tank. With parallel operated anodes the voltage between anodes in parallel per phase should be zero. The voltage between the anode and the neutral should correspond to the voltage specified on the transformer winding diagram.

The voltage between adjacent anodes or in the case where two or more anodes operate in parallel per phase, between adjacent sets of anodes, should be equal to the phase to neutral pressure for a six-phase rectifier or 0.518 times that value for a twelve-phase connection.

If the excitation system is a multi-phase A.C. one, check up the excitation anodes in a similar way. The voltage between adjacent excitation anodes should be equal to the phase to neutral pressure of the excitation transformer for a six-phase connection, or 1.732 times that value for a three-phase connection, or twice that value for a single phase full wave form of excitation.

It is also important to check that the phase relationship between the main anodes and the excitation anodes is also correct. To carry out this check connect solidly together the neutrals of the main and the excitation transformers. Take pressure readings between main anode No. 1 and excitation

anode No. 1. If now readings are made between excitation anode 1 and each main anode, the first result should be the lowest. This check should be repeated, using another excitation anode, preferably not one  $180^\circ$  from the first, and if the result is the same, then correct phase relationship is apparent.

A phase rotation test can be made with the usual phase rotation meter, or by connecting up a small three-phase motor of known phase rotation to three equidistant anodes. Do not forget the voltage of the anodes and step down if necessary to carry out this test.

The correct phase rotation, i.e., the successive order of operation of the anodes, is given by the maker on a drawing with the equipment. It is usual to arrange for anti-clockwise rotation when looking down on the top of the rectifier tank.

### Striking the Arc

Before attempting to strike the arc, first check that the bake-out resistor has been correctly connected up.

The ignition arc may then be struck by energising the ignition electrode solenoid for sufficient time to cause that electrode to dip momentarily into the mercury at the cathode pool. On no account leave the solenoid energised for even a few seconds, repeated quick attempts to strike the arc should be all that is necessary; even so, care must be taken that the ignition solenoid does not overheat. In particularly stubborn cases a D.C. supply should be connected up to the ignition electrode to give a constant potential for the instant of withdrawal of the electrode from the mercury. A suitable supply can be obtained from the Pirani gauge generator, or from the sub-station bus bars if this latter voltage is low. A resistance must be placed in series to limit the current flowing through the circuit to about 2 amperes or less, the supply being connected with the positive pole to the electrode and the negative pole to the cathode.

It is this difficulty in striking the arc which makes some manufacturers prefer the D.C. system to the A.C. system for ignition purposes, but this difficulty usually disappears after

the bake-out operation. Whether A.C. or D.C. ignition is used, it must be appreciated that the current flowing through the circuit via the ignition arc must be stabilised either by a reactance or a resistance in series with the arc.

### **Bake-Out**

Before a rectifier can be put into commercial service it is not only essential to obtain a good vacuum in the tank, but it also is necessary to subject the anodes to a forming process. It is usual to form-out or bake-out in two stages, the one at the works and the other on site. The purpose of the bake-out is to extract all occluded gases from the material forming the walls of the vacuum system and from the anodes themselves. The bake-out is the name given to the process of heating the tank and the vacuum exposed material to a higher temperature than that usually attained in commercial service. While this heating up goes on the vacuum pumps are drawing off the gases liberated. After the process is completed the normal temperature is below the bake-out temperature and the quantity of gas liberated is very small and can be dealt with by the pumps without the danger of a back-fire, etc.

Where a site bake-out is required, and in modern equipments this is not always necessary, it is undertaken by the manufacturer under the terms of his contract. In the very unlikely event of the tank having to be opened up to atmosphere, it is always preferable to obtain the manufacturer's service. Where, however, this is not possible, the following general instructions may prove useful.

### **Half-Wave Bake-Out**

In the half wave bake-out full pressure is applied to two anodes from one phase of the main transformer and a resistance is connected in series. Each pair of anodes in succession should receive a half wave bake-out in this way. The duration of the bake-out process for each pair of anodes should be such that a steady vacuum of at least 10 microns is held for about 30 minutes. If the pressure rises above 10

microns stop the bake-out and pump down to a satisfactory vacuum before restarting the bake-out. Continue the bake-out until all the anodes have been treated. A series of records should be made during the tests and the readings logged.

### **Full-Wave Bake-Out**

When the half wave bake-out is finished re-examine the bake-out diagram and reconnect the resistor for the full wave bake-out as instructed. The first connection to be selected must be that which gives a minimum current in the circuit.

Pump down the rectifier again to a reasonable value and switch on to strike the arc. During the bake-out, the pressure between the ignition electrode and the cathode should fall to a low value, and then increase as the current is increased to the maximum. The voltage from the tank to the cathode will also rise with an increasing current and will become steady.

During the bake-out, but more particularly in the early stages where comparatively low currents are in use, it is most important to check very frequently, that all the anodes are doing their work, by using a clip on ammeter, the pincers type being very suitable for this purpose.

A decrease in the voltage drop across the bake-out resistor, or an indication by the ammeter of an unsteady cathode current is a sign of failure on the part of one or more anodes to take a share of the bake-out load.

If, however, the anodes are particularly stubborn in picking up the load, it will probably be found that the phase relationship or phase rotation of the anodes has been incorrectly checked up.

The load can be increased by altering the connections to the resistor when the vacuum pressure is holding steady at not less than 5 microns with all the anodes in operation. The vacuum pressure should not be allowed to rise above 10 microns at any time during the bake-out, as indicated by the McLeod vacuum gauge. Should this pressure be exceeded, it is necessary to drop down to the next lower connection.

The water outlet temperature of the rectifier can be allowed

to increase somewhat during the bake-out, but if there is any tendency to go appreciably higher, the rate of flow of cooling water must be increased to bring the temperature of the outlet water down to normal value as specified by the manufacturer.

While the bake-out is in progress, keep a continuous watch on the mercury seals, if these are used, and any sign of leakage or of slackness of the seal bolts should immediately be followed by a very cautious screwing down of the nuts round the seal.

At the higher current values near the end of the bake-out, the pressure drop across the resistor should be perfectly steady. When a change over is made from one set of connections to another, the pressure drop should not alter more than a few volts. The current through the resistor, on the other hand, will at first be somewhat higher than its final steady value, because the resistance grids will not have attained normal working temperature. This slight increase in the current flow, which steadily falls to a constant value, does not, during that time, appreciably effect the voltage drop across the resistor. A heavy voltage drop while all the anodes are active would indicate an abnormal arc drop and that the current was being increased too quickly. In such a case, drop back to the next lower connection on the resistor, and also re-examine the logged readings to see that no detail has escaped attention which may further account for the extra drop in voltage.

While the higher current resistance grids are in use the depth of the water in the anode coolers should be increased to limit the anode stem temperature to the value recommended by the manufacturer.

The bake-out on the final resistor grid connections corresponding to the maximum continuous current flow must be maintained until a vacuum pressure of at least 1.5 microns has been steadily maintained for at least six hours.

If the main rectifier transformer is in use during the bake-out process, then care should be taken that the temperature rise does not reach an abnormally high value, and, if necessary, a period of cooling down should be allowed.



When the full wave bake-out connections cannot be applied to all the anodes, i.e., six only out of the twelve in a twelve anode rectifier, it is necessary to change over from one set of six anodes to the other at regular intervals. This change over should be made every six hours until the current flowing is half the maximum continuous bake-out current on the final connections. Afterwards a change over of anodes can be made every three hours until about eight hours from the completion of the bake-out, when a two hourly change over is advisable. In this manner all the anodes are maintained at a satisfactory temperature, none of them being allowed to get too cool before having the bake-out current passed through them.

### **Over-Load Bake-Out**

Again connect up in accordance with the diagram supplied with the equipment. The anodes need carry the current once only for the time specified by the maker, providing the vacuum pressure during this bake-out does not rise higher than about 1 micron. Should this pressure be exceeded, alter the connections back again, then the maximum current bake-out should be applied until readings taken suggest that a second attempt at the over-load bake-out can be made.

### **Final Bake-Out Instructions**

Having satisfactorily completed the over-load bake-out, return to a maximum continuous current bake-out connection and proceed with a further term of bake-out, but this time reducing the water outlet temperature. On no account reduce the temperature below that recommended by the maker. Continue the bake-out until at least 1.5 microns vapour pressure has been recorded over a period of six consecutive hours. This completes the bake-out instructions.

### **Divided Bake-Out Instructions**

Where the bake-out has been applied on the sandwich principle, i.e., six anodes at one time following on with the

remaining six anodes in a twelve anode rectifier, a further run still is essential, this time with all the anodes operating simultaneously. The ordinary six anode full wave bake-out connection can be used, but the connections should be made so that every pair of adjacent anodes are connected solidly together to each phase of the bake-out winding.

Under normal operation the anodes would not share the load equally if connected in this way, but operation at low tank temperature and with a heavy current will not cause any difficulty on that account. This form of bake-out must be applied for about twelve hours at a reasonable tank temperature. This completes this form of bake-out operation.

### **Emergency Bake-Out**

The above instructions are given where it is required to obtain a complete bake-out in a very thorough manner. It may not always be possible to spend so much time in preparing the rectifier for commercial service and a short bake-out method will now be indicated.

The various bake-outs just explained can be applied, but the individual times spent on each resistor connection can be reduced. Very great care indeed is essential in making this short time bake-out, a keen watch being made on the vacuum pressure, and at no time should the pressure be allowed to rise higher than about 10 microns. A rise above that value will indicate that the bake-out is proceeding too fast. Drop back to the next lower resistor connection for a time and try again. The length of time allowed for forming on each connection should be sufficient to obtain a maximum gas evolution. If six anodes are baked alternately, the change over from one set of anodes to the other can be made at shorter intervals than those specified above, but the final bake-out on all twelve anodes simultaneously should not be omitted.

### **Adjustments During Bake-Out**

Adjustments should not be necessary if a thorough bake-out has been applied at the works.

Set all the thermostats in accordance with the recommendations laid down by the manufacturer. In the case of the excess temperature thermostat, if this is of the tilting mercury type, where the contact is broken at the maximum rise in temperature permitted, adjust the top screw so that it is not possible for the thermostat to open the contacts in the opposite direction at the lowest service temperature.

Set, if necessary, the Pirani gauge zero as explained earlier.

### **Final Instructions**

When the bake-outs have been completed, the level of the water in the anode coolers should be reduced to the normal amount specified by the maker. Test all the anodes and cathode seals for slackness in the holding down nuts and tighten if necessary. Use extreme care in this operation. Particularly note whether the clamping ring nuts are tight if these are used between the main anode stems and the insulators.

If the rectifier has been opened up to atmosphere during the erection and prior to the bake-out operation, it is advisable to drain out the oil from the rotary vacuum pump after taking the precaution of first closing the main rectifier vacuum valve. Draining the pump will be made much easier and quicker if the pump is turned by hand. Having removed the oil, the casing and the external parts should be wiped dry and clean. Any rust must also be removed. Follow up this cleaning with a swill out with clean oil, and then the pump can be refilled to the normal level. Do not leave the pump without oil for a longer period than about 30 minutes, and do not open the pump valve.

Set up the A.C. overload relay to carry normal overloads. Check up the A.C. earth leakage relay.

### **General Tests**

Rectifiers cannot be tested so easily as rotating converting plant, and the only satisfactory method is by actual load at full rated pressure. This often presents a serious difficulty

where the load to be supplied cannot be maintained at the maximum rated output of the rectifier for the requisite length of time to take the necessary readings. It is usual to subject rectifiers to a high voltage test, and to operate them on rated loads and overloads, and to also check the guaranteed performance figures at the works. Heat runs as made on all rotating converter plants is of no importance, since the temperature rise is not a limiting feature in the design. If the rectifier is used in conjunction with a re-cooler type of cooling system, it should always be tested with its own re-cooler apparatus.

When a number of rectifiers have been ordered at one time, it is usually sufficient to test the first one and then only check the others with a high voltage test and tests at full rated current output at a reduced voltage.

It may be as well here to draw attention to some of the difficulties in making accurate measurements of rectifier characteristics. These difficulties are experienced because the shapes of the current and also the voltage waves are not regular. On the A.C. side the current wave invariably contains harmonics with a very appreciable magnitude, so that instruments which are effected by a varying frequency are of no use for accurate measurements. The type of instrument suitable for this part of the rectifier circuit is limited to the dynamometer, or the hot wire types.

For direct current measurement the instrument must be chosen to suit the purpose in hand, i.e., if the average values of the direct current components are to be determined, then permanent magnet instruments are suitable, but if the R.M.S. values are required then the dynamometer or hot wire types only can be used. The reason for this is, of course, that the D.C. side has a superimposed ripple on the constant D.C. characteristic.

Power factor meters and ordinary type watt-meters are also rendered useless for accurate determination of rectifier constants.

The power factor can be measured by the ratio of the total

watts to the volts multiplied by the amperes, and not by the two watt-meter method.

To arrive at the efficiency of a rectifier equipment it is usual to calculate the value from the summation of losses. Of the losses to be measured, the arc loss is perhaps the most difficult to determine. The arc drop cannot be accurately measured by D.C. for two reasons, (a) the actual arc moves from one

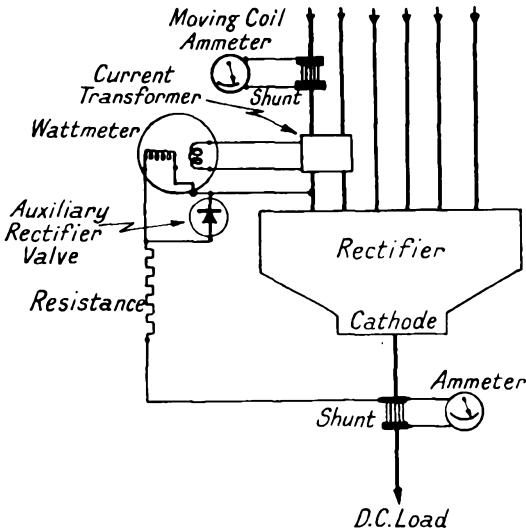

FIG. 69.—A diagram of connections for taking a test on a rectifier for arc loss by a watt-meter method.

anode to another and is in consequence dynamic, (b) the arc is only in operation from one particular anode for a part of a complete cycle. It therefore follows that the measurement of a stable D.C. arc drop would not take into account the rather variable conditions of ionization which appear with the use of the dynamic arc.

Even if a watt-meter is used special precautions have to be taken in measuring the arc loss. If the current coils are connected in series with the anode, and the potential coil connected between the anode and the cathode, then a very high pressure is applied to the pressure coil during the negative

half of the cycle. On the other hand, if the rectifier is set to work at a reduced voltage to overcome this difficulty the overlap is increased, which has the effect of changing the value of the arc drop, and consequently the arc loss.

The only satisfactory method in which watt-meters can be used is to shunt the inverse voltage from the potential coil by a valve, and so the loss can be ascertained at full working voltage. The scheme of connections for such a determination are as shown in Fig. 69. If the watt-meter readings are multiplied by the ratio of the cathode amperes to the anode amperes, then the total arc loss is obtained. The current must be measured by a moving coil instrument.

It is not permissible to use ordinary current transformers for supplying the current coil of the watt-meter when the current to be measured is high. Special current transformers are necessary wound with two primaries connected in the circuit of two phases of the rectifier transformer, but with opposite polarity, so that the direct current components of the anode current will not magnetize the core of the current transformer, i.e., the two D.C. components will cancel out.

In the connections shown for the potential coil it will be noticed that an external resistance is placed in series with the coil while the valve shunts the coil. With this arrangement, when the anode has a positive potential, the valve filament is also positive to the plate and the current is, therefore, only free to pass through the current coil of the watt-meter. When the anode is in the negative half cycle, the plate is positive to the filament and a shunt circuit thereby made through the valve.

The watt-meter must be carefully protected from all stray fields, even the earth's magnetic field. With these precautions the watt-meter will measure the true total loss, and the calibration is the same for the ordinary type of watt-meter.

The arc drop cannot be accurately determined even by the oscillograph without taking very great precautions for similar reasons to those given above.

### Transformer Losses

The  $I^2r$  loss of the windings may be calculated from their measured D.C. resistances, as in the case of ordinary power transformers. The stray loss is nearly the same as that obtained on an ordinary short circuit test with the same current flowing through the transformer. To the  $I^2r$  loss has

6-PHASE DOUBLE STAR.

Watts = A.C. watts on test  
 $W_1$  as shown.  
 (excludes interphase reactor.)

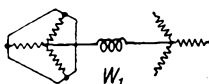

One Test only required.

6-PHASE TRIPLE STAR

Watts =  $\frac{1}{2}W_1 + \frac{1}{3}W_2 + \frac{1}{6}W_3$

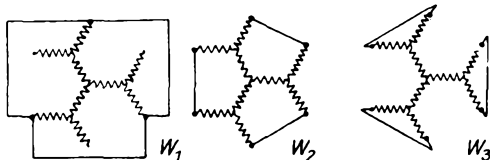

3 Tests required

12-PHASE QUADRUPLE ZIG ZAG

Watts =  $1.12W_1 - 0.12W_2$

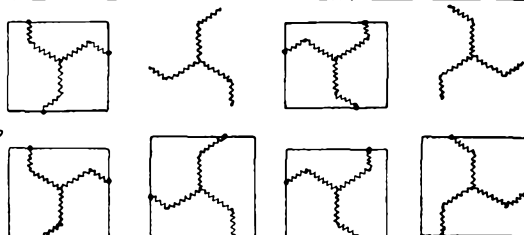

Test  $W_1$   
 2 Tests required

Test  $W_2$

FIG. 70.—Diagrams of connections for determining rectifier transformer copper losses. The primaries are supplied at normal rated current. The input watts are measured with the secondary windings shorted as shown for each type of winding.

to be added the stray loss, equal to the difference between the measured loss and the calculated loss on a complete secondary short circuit with exactly the same current input on the primary.

The copper loss and the stray loss can be determined by direct measurement if the secondary windings are short circuited as shown in Fig. 70, and the primary applied voltage measured with full rated current in the primary.

Load tests can only be made with the rectifier, and not by

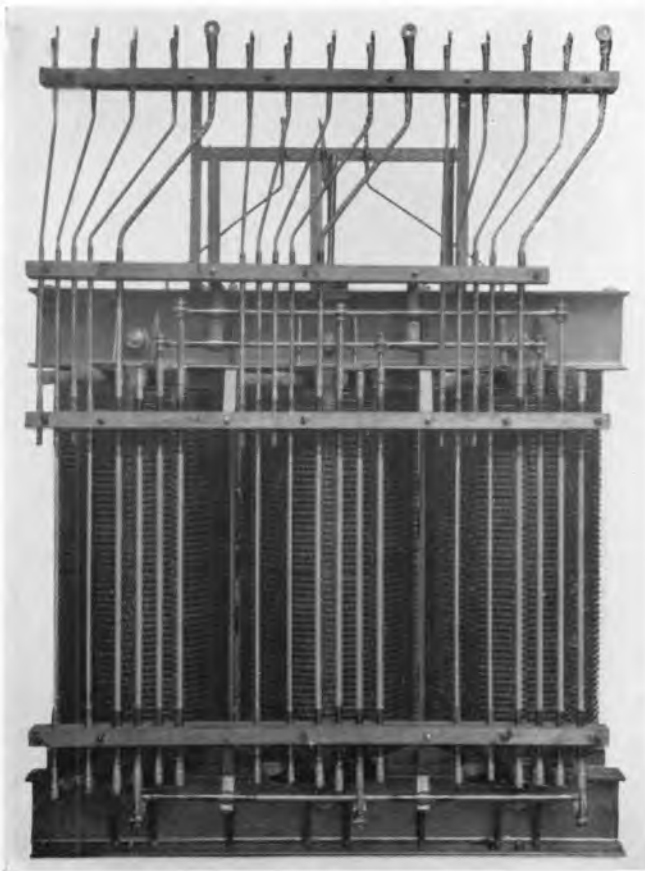

FIG. 71A.—A typical rectifier transformer core and coils. The view shows the secondary connections to the coils. (B. T-H.)

[To face page 152.]



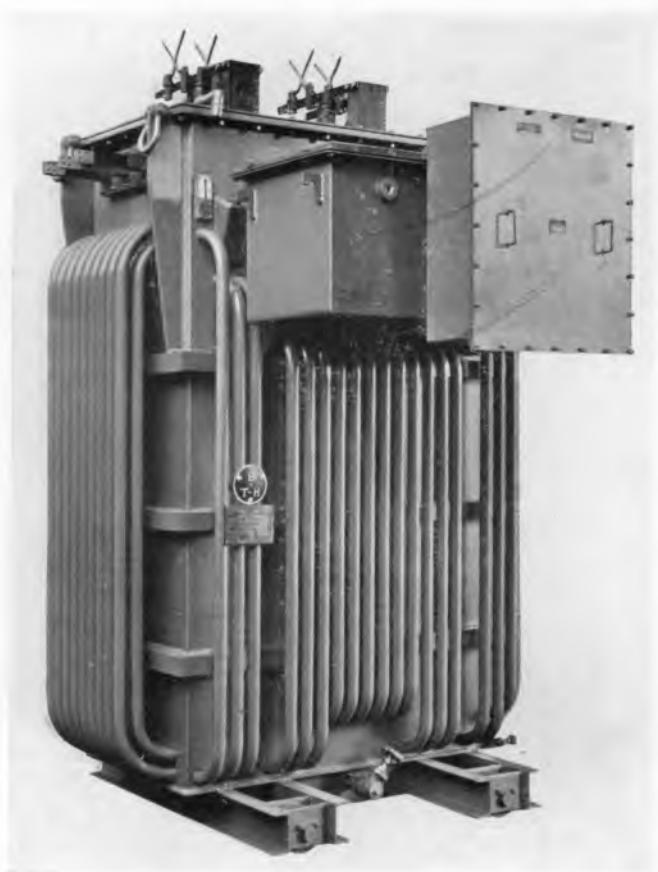

FIG. 71B.—An exterior view of a rectifier transformer for a 500 K.W. unit equipped with electrically operated "on-load" tap changing gear. (B. T-H.)

running two similar transformers back to back, because of the difference in the K.V.A. ratings between the primaries and the secondaries. Ratio tests can be applied by using a reduced voltage in the same manner as for ordinary power transformers. A core is shown in Fig. 71A and an exterior in Fig. 71B.

### Overall Efficiency of Rectifier Equipments

The losses within the rectifier at various loadings can be calculated from the arc loss test. The losses in the transformer core can be assumed without appreciable error to be constant at all loadings. The copper losses can also be assumed to be proportional to the square of the current flowing through the windings. As for the auxiliaries, their losses should be taken as a proportion of the time during which they operate. The summation of all these losses at the various loadings give the overall efficiency at each value.

Typical overall efficiency curves are given in Fig. 72, all the losses being included and based on actual plant test data. It will be noticed that the regulation is about 6% from light load to full load of the rectifier equipment.

The power factor is approximately constant from 25% of full load to 100% overload. This is determined by the reactance and the magnetising current of the transformer when supplying the rectifier. In connection with the resultant power factor of the current drawn from the A.C. supply, there are two values to be considered:

I. The total power factor, which is practically only of theoretical interest; and

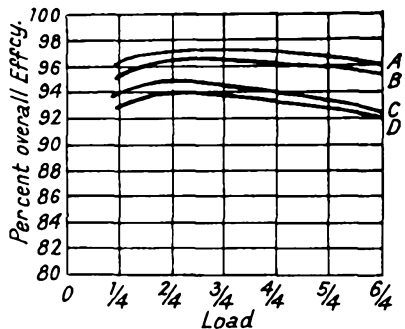

FIG. 72.—Rectifier efficiency curves.

Curve A. is for a 3,000 volt rectifier which includes the losses due to grid control apparatus. The no-load loss in this case is 0.65%.

Curve B. is for a 1,500 volt unit. The no-load loss is 0.76%.

Curve C. is for a 630 volt unit with a no-load loss of 0.70%.

Curve D. is for a 500 volt unit with a no-load loss of 0.80%.

2. The power factor of the fundamental current drawn from the supply, this being the value which determines what effect the addition of the rectifier will have on the power factor of the A.C. system as a whole, and this latter value is usually denoted by  $\cos \phi$ . In the six-phase rectifier the value of the power factor to be expected with a well designed plant is 93 % to 94 %, and for a twelve-phase rectifier the value rises to about 97 %, and even higher values are obtained with heavy duty equipment.

## CHAPTER VI

### SUB-STATION OPERATION AND MAINTENANCE

#### Operation of Glass Bulb Equipments

BEFORE commissioning a glass bulb unit, it is an advantage to firstly give the bulb a period of "working in" loading. This attention is carried out as follows :

1. The proper value of excitation current for normal operation conditions for the particular size of bulb in use should be adjusted, if necessary, by means of the non-magnetic packing in the gap of the excitation choke as explained in the previous chapter.
2. The bulb should be allowed to operate on the excitation current for about 24 hours without the cooling fan in service.
3. The loading shown in Fig. 73 should then be applied for the time intervals stated thereon.

The bulb will now be in condition for normal service. After about the first 100 hours operation it may be necessary to adjust the value of the excitation current again. It will not then be necessary to check the value for some considerable time, in fact, in most cases, until trouble is experienced with maintaining the bulb alive on excitation current.

The bulb will be found to blacken in service, but this need cause no concern. With continued discolouration it may be necessary if the bulb is difficult to start up on the excitation current to readjust the position of the bulb in the cradle, to ensure that ignition can be made. The filming of the mercury on the sides of the bulb, reduces the level of the mercury at the cathode pool, with the result that the ignition

electrode fails to dip into contact with it during the ignition process.

The operation of a glass bulb equipment is very simple, and consists only in closing the main oil circuit breaker to charge the main transformer, regulation of the D.C. voltage from the rectifier and the final paralleling of the unit on to the bus bars.

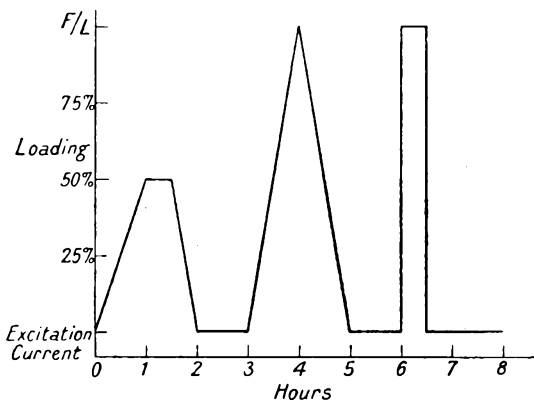

FIG. 73.

A "working-in" scheme for glass bulb rectifiers.

It has been indicated elsewhere that a rectifier can be paralleled on to the D.C. bus bars at a voltage below that of the D.C. bars, and when the voltage of the rectifier has been raised above that of the bars the load is taken up smoothly.

To shut down, the D.C. breaker is opened, the voltage of the rectifier is reduced to the minimum and then the main A.C. oil circuit breaker is tripped.

Operation in the normal service consists in maintaining a suitable voltage of the bus bars, but since it is so easy and cheap to install automatic voltage control, it is common practice to incorporate this feature in the equipment and the units can then be left to take care of themselves for as long as load current is required from them.

### Operation of the Steel Tank Equipment

To put a steel tank rectifier on load, set all the pumps into

operation, charge up the ignition and the excitation transformer, strike the ignition arc and when the excitation arc has picked up, the A.C. and the D.C. breakers may be closed in turn. To shut down the equipment, open all the switches in the reverse order to that just given.

Take temperature readings when the rectifier is put into commission and log again after a prolonged period of heavy loading; then again on the decrease of load at the time when the thermostatic valve has just closed. If a re-cooler system is in use the temperature readings taken should include that of the inlet water and the outlet water at the time the blower starts and stops.

There can be no harm done if the rectifier is paralleled on to the D.C. bus bars at a low pressure, as stated above, since no reverse current can flow through the unit.

The volt ampere characteristic of the rectifier, providing it is not controlled by such auxiliary apparatus as "on-load tap changing" gear on the main transformer, or by grid control, is of the shunt type, i.e., the characteristic curve will be a drooping one of about 6% from light to full loading. Any plant which is to operate in parallel with such a rectifier should have the same or a very similar characteristic, to enable all the plant in operation on common bus bars to share the load equally between them in proportion to their respective capacities.

It has been stated in an earlier chapter that where an inter-phase transformer is incorporated in the rectifier equipment, a pressure rise will occur between no-load and about half to one per cent. of full load. If the load is of such a nature that this excess voltage can be absorbed by it for the fractional period of time taken by the rectifier in picking up load, no ill effects will be noticed. In other cases it may be necessary to install some form of corrector as previously described.

If the reactance in the A.C. supply to the rectifier is high it will not appreciably effect the applied E.H.T. potential to the rectifier anodes, but it will affect the D.C. voltage regula-

tion. It is possible to meet such circumstances if the designer is given access to the E.H.T. system details.

It is not advisable to permit a rectifier to operate for long periods of time on no-load unless the specification directed attention to be given to the possibility of such service requirements.

Normally, the rotary vacuum pump should be in service for not less than about 15 minutes in every six hours. The mercury pump, on the other hand, should be in continuous operation. Should the E.H.T. power supply fail and the duration of shut down be sufficient to allow the mercury pump to cool right down, it should be allowed to warm up again before paralleling the rectifier on the D.C. bars.

If the equipment is shut down for lengthy periods both pumps must be run periodically, say for two hours each day. The oil level in the rotary vacuum pump should be examined once each week and topped up if found necessary.

Where the plant capacity of a sub-station is much in excess of the load requirements it is a wise policy to divide the intervals of off load or stand-by equally between the units concerned. Rectifiers, unlike most other plant, do improve with length of service, and, furthermore, over very extended periods of service it has been established that there is nothing to wear out or deteriorate in the rectifier itself, due to the fact that the components operate in a vacuum.

In service it will be found, if A.C. ignition is used, that the ignition arc is not always produced at the first attempt. This is not because anything is wrong with the set, as this depends upon the magnitude and direction of the ignition anode current at the instant of breaking circuit of that anode at the face of the mercury cathode. For this reason it is recommended that the ignition arc is struck before the main A.C. potential is applied to the main anodes. All rectifiers are designed to carry full load and peak loads within a certain range of temperature, but if the rectifier is operated at temperatures below that range then the capacity may be reduced. In most cases the range of temperature is between 35° and 55° C. Should

there be at any time evidence of sparking at the surge arresters, it is an indication that the permissible load is being exceeded and should be immediately reduced until the tank temperature has risen to within the range for which the rectifier has been designed.

### **Maintenance. Glass Bulb Rectifiers**

With a cooling fan drawing air into the cubicle at the base, it is very essential to maintain absolute cleanliness of the sub-station floor. It may not be possible, for financial reasons, to lay down a tiled floor, so that a concrete floor is usual. The surface should be a smooth finish, so that dust and dirt is not harboured in the floor. The cubicle should be dusted out with a soft hand brush, care being taken not to knock the arms or seals of the bulb.

All mechanically operated parts should be cleaned, oiled or greased at regular intervals.

The E.H.T. and L.T. switchgear, also the main transformer maintenance is referred to later.

### **Maintenance. Steel Tank Rectifiers**

The attention to be given to steel tank rectifiers should be dealt with in a systematic manner and the degree of attention required is, of course, to some extent determined by the conditions under which the plant has to operate. In general, the routine attention to be given to rectifiers may be sub-divided into three sections :

- (a) Points to receive daily attention, or in the case of an automatic equipment, at each visit of the inspector.
- (b) Points to be attended to at intervals of approximately one week.
- (c) Points to be attended to once every three months.

The manufacturer of the plant will almost invariably furnish full instructions regarding the adjustment and maintenance of the equipment, and such instructions should be carefully adhered to so that efficient and reliable service is always obtained.



The routine daily attention required will generally be as follows :

1. Record water inlet and outlet temperatures and compare with the figures given by the manufacturers.
2. The vacuum should be logged and it should always be better than 2 microns. Examine all seals.
3. Shut down the rotary vacuum pump to check the operation of the automatic shut off valve.
4. Examine the level of water in the expansion tank if a re-cooler is used.

The weekly attention required will be generally as follows :

1. If a mercury pump re-cooler is used, check the level of the water.
2. Check the oil level in the rotary vacuum pump.
3. Examine the surge arrester links.
4. See that the small drip from all the glands is maintained. Also see that the pipes from those glands are clear.
5. Check up the outlet temperature of the water from the mercury pump.

At intervals of three months the following points will generally require attention.

1. Inspect the water level in the anode coolers and top up if required.
2. Check and reset if necessary the gap at the surge arresters.
3. If a D.C. generator is used, examine the brushes and clean out the boxes and give the generator the usual attention.
4. Turn the pump set round by hand to check for free operation.
5. Check the oil level in the gear chamber of the pump and if it is found that the level has risen then the pump gland must be tightened up.
6. Check up the operation of all thermostats.

7. With a re-cooler system stop the pump, fill up with water, re-start the pump, and then measure the depth of water in the expansion tank with the pump in operation. See that the depth of water is as specified by the maker.
8. If a re-cooler is used the difference between the inlet and the outlet water temperature should not rise more than that allowed by the manufacturer. If the temperature does rise higher or the water in the expansion tank decreases to below the specified level, then the tubes should be cleaned by pushing a soft rag through them.

Once each year drain out and replace the oil in the pump chamber of the rotary vacuum pump.

### **High Speed Circuit Breaker Maintenance and Operation**

A thorough inspection of the high speed circuit breakers should be carried out at regular intervals according to the service conditions. Examine as follows :

1. The main contacts tips. If any sign of pitting exists due to normal operation of the breaker it is not essential to reface the contacts unless large globules of copper are evident. Never file the contact tips of any high speed breaker.
2. Clean the holding faces of the magnet and armature. Afterwards apply a thin film of light grease.
3. Remove all copper deposit that may have lodged in the arc shutes. This is very important and must not be neglected.
4. Check up the adjustment of the interlock mechanism and be sure that the interlock tie rod is not jammed with the breaker in the closed position. Replace burnt or worn contacts on the interlocking feature.
5. Operate manually to see that the breaker is perfectly free in its movements.

6. Try the connections to the breaker for absolute tightness.
7. Make a general observation of all moving parts and replace any that have become worn out.

### Contact Tips

It is usual to make both the stationary and the movable contact tips renewable. The tips should be removed for new ones if the wear exceeds about 0.25 inches. In the type of breaker referred to elsewhere, the moving contact tip is removed by unfastening the four bolts which extend through the arm, the contact surfaces being clamped against the

surface of an aluminium contact arm. The surface of this alloy arm oxidizes upon exposure to air and the oxide should be removed before assembling the tips again. Cleaning may be done with fine emery cloth and afterwards a trace of vaseline should be applied to prevent re-oxidation.

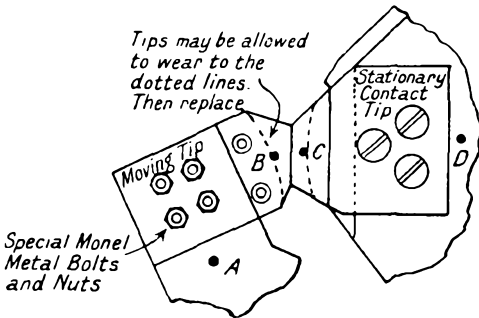

FIG. 74.—Contact resistance test on a high speed circuit breaker. Tapping points are indicated at A, B, C, and D.

tion. It is not necessary to remove the vaseline when fitting the new tips. In fact, it is preferable to let the vaseline remain on.

If possible, always carry out a contact drop test after fitting new contact tips. Fig. 74 is given to indicate how this test should be applied. At A, B, C and D the contact resistance should be as given in Table III, but if these values are much exceeded then a re-examination should be made of all connections in an effort to find a cause. The current to be passed through the breaker during the test should be at least equal to the minimum value stamped on the calibration plate.

TABLE III

		Contact Resistance in Ohms.
Moving contact head	. Points A.B.	0.000002
Main contacts	. Points B.C.	0.00001 to 0.000024
Fixed contact head	. Points C.D.	0.000002

### Calibration

The current required in the bucking bar to trip the circuit breaker is fixed by the magnetic flux holding the armature closed. Any change in the calibration is effected by keeping constant the ampere turns of the holding coil and varying the flux or holding power of the armature by changing the reluctance of the holding coil magnetic circuit. This can usually be carried out by adjusting screws.

If the screws near the end of the holding coil are eased out, then the reluctance of the holding coil magnet circuit is increased, which decreases the magnetic flux holding the armature closed for tripping the breaker. The breaker is calibrated by marking the trip current for a number of different positions of these calibrating screws on the adjacent brass plate.

A compensating screw is also provided to take care of the alterations due to wear of the contact tips. The current required to trip the breaker slightly increases with the wear of the tips. After fitting new contact tips the compensating screw should be returned to the original position.

When a holding coil is excited from a separate source which is subject to considerable voltage variation, the holding coil magnetic circuit is also effected, which in turn effects the calibration of the breaker. At the lower tripping values this is most noticable, because at such values the magnet is at minimum saturation. A change in voltage does not produce a constant change in magnetic flux over the whole working

range, and Fig. 75 is given to illustrate the effect of voltage changes on the tripping point of a high speed circuit breaker.

The calibration range in this case is 2 to 1.

## Transformers

There are so many good books dealing with transformers that it is not necessary to detail here the various methods of drying out on site, sampling and testing of oil, etc. The reader

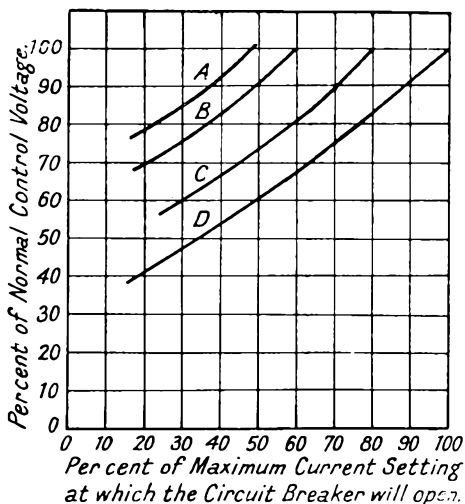

FIG. 75.

Curves showing how the tripping value of a high speed circuit breaker is effected by a variation in the control pressure. (B. T-H.)

will, no doubt, have several such books in his library to which he may refer. A few practical notes may not, however, be out of place.

Whatever precautions are taken to avoid moisture entering a transformer, it is often during the time when the sub-station is drying out that moisture may enter. A constant watch should be kept for signs of moisture condensation around the man-hole covers, terminal bushings, and other parts above the oil level. If the transformers are connected to a high

voltage circuit of 20,000 volts or more, a dielectric test of the oil ought to be made at least once a week during the first month of active operation.

When transformers are under continual heavy load, it may be found that there is evidence of condensate on the lid or other parts which are at a lower temperature than the oil, and more especially when the air temperature is low. Though this may not present immediate danger, it does show that there is more moisture about than is safe. It is essential to remove this moisture and steps taken to avoid any further accumulation. If, on the other hand, a transformer operates at a comparatively light loading, moisture may not be directly observable, but a large amount may be present in the oil. In such circumstances it is wise to test the dielectric strength every six months.

Should it not be possible to shut down the transformer while the sample is drawn off, it should at least be done at a time when the load is light, for at this time the moisture tends to settle at the bottom of the tank. Furthermore, the oil should be drained off until all trace of visible moisture in the oil has been removed. At the same time it is, of course, important to maintain the oil level by the addition of new oil.

If the last sample drawn off breaks down under the dielectric test, the whole of the oil should be dried out and the most effective method is by means of a centrifuge which has heater coils for raising the temperature of the oil sufficient to drive off the moisture.

If the amount of water present has been sufficient to impregnate the coil insulation, then several repeated heat treatments of the oil must be made, for the moisture will continue to exude for some time and so contaminate the oil again.

The oil level should always be maintained up to the level on the gauge. If conditions of bad transformer ventilation or extreme overload exist for any length of time, then the oil temperature may rise to a point where a deposit is thrown to the surface. This condition should be rectified by draining

out the tank and thoroughly cleansing it. New oil should then be added to the tank up to the gauge level.

Where calcium chloride breathers are fitted, it is essential to inspect the condition of the charge at frequent intervals and replace it if found to be heavy with moisture. When replacing the charge use pure fused granular, medium mesh, anhydrous calcium chloride.

A type of breather which is a new departure and is becoming fast very popular is known as the Silica Gel Breather. This type of breather consists of an outer container of mild steel tubing with top and bottom covers, while an inner container of zinc holds the gel charge. In the base is a plug carrying two turns of copper coil, the opening of which is protected by fine mesh copper gauze to prevent the ingress of foreign bodies. The inner container is supported above the copper coil, and is so arranged that as the transformer breathes the air must pass through the gel charge, which is standard granular silica gel, impregnated with cobalt chloride. In its dry state the charge is a deep blue colour, but changes to a whitish pink when saturated with moisture. An inspection tube at the top of the breather allows the charge to be kept under observation, and when the colour changes near the top the charge should be renewed. The interesting feature of this type of breather is that the  $\text{SiO}_2$  (Silica Gel) absorbs nearly all the moisture in the air passing through it by condensation in its pores. When air of somewhat lower humidity is passed through the breather the gel will give off moisture and so more or less re-activate itself. When the moist air flows through it, the latent heat of the vapour is converted into sensible heat, which, if it could be retained, would be sufficient to entirely re-activate the gel charge when the dry air was expelled. Since, however, loss of heat is inevitable, the heat generated by the transformer when on load tends to assist in re-activation by supplying the additional heat required. The charge is in this way maintained in good condition for a very lengthy period before it becomes necessary to replace the charge.

It is obvious from the above, that when a charge has become

saturated, it may be restored to good condition by proper heat treatment, and for that purpose a spare charge can be kept in stock ready for service while the original charge is being re-activated. The inner containers are removable, and when delivered they are fitted with lids which should be removed before the breather is fitted to the transformer. To dry the charge, place the complete inner container in an oven or some form of heater and raise the temperature to 300° or 400° F. until the blue colour has returned. Before it has had time to cool off, the lids should be replaced and sealed off with adhesive tape. The charge may then be kept in store indefinitely and used again when another charge needs re-activating.

With water cooled transformers the water should always be circulating when the transformer is energised. If the water supply fails, reduce the load as much as is possible, and pay very careful attention to the temperature of the oil at the top of the tank. Should the temperature rise higher than about 80° C. the transformer must be shut down. This maximum value should never be exceeded and only maintained for brief periods under emergency conditions.

The temperature of the inlet water for normal service should not, in general, be higher than about 25° C.

In water cooled transformers the water will in time cause a scale to form in the cooling coils. A high oil temperature with the water flowing indicates that the cooling tubes are becoming choked with sediment and need cleaning. To clean the tubes do not remove them from the tank, but disconnect the feed pipes from the glands on the tank and fit temporary piping, so that the tubes or coils may be filled and emptied as required. Remove all water from the coil, either by blowing out or syphoning, and then fill up with a solution of hydrochloric acid of a specific gravity of 1.10. This proportion may quite easily be judged since a solution of equal parts of commercially pure concentrated acid and water will have the specific gravity desired. After the solution has been standing in the coil for about an hour, drain off and flush out well with water. Do not block up the ends of the coil while the solution



is inside, because the action is often of a violent nature. When copper coils are fitted these do not clog up so much as iron coils, but the treatment can be the same for both materials.

There is practically no danger of moisture formation if the transformer oil is at all times kept at a temperature of about  $10^{\circ}$  C. higher than the air temperature.

### **Maintenance of Automatic Features**

It is not possible to lay down any hard and fast rules for the maintenance of the automatic features, for it clearly depends upon the type of feature and its service conditions. In general, it should be arranged to keep all parts clean, free from rust, and instrument oil used sparingly where essential for free movement of the operating mechanisms.

As contacts burn away, these should be replaced, and if oxidation takes place this should be removed very carefully. In some cases it may only be necessary to wipe over the contact. Contact pressures must be periodically checked and adjusted if necessary.

Never use cotton wool, waste or other fibrous material for cleaning purposes, fine particles may be the cause of the apparatus failing to operate when required.

Where there are magnet gaps these need checking, otherwise the device may fail to operate due to residual magnetism.

It is often the case after setting a relay, the actual setting is affected upon replacing the cover. A check should be made of the setting when the cover has been fitted and further adjustment made, if necessary.

Remember that relays are delicate instruments and treat them accordingly.

### **Staff Organization**

Reliability of supplies is very largely dependent upon good staff work and close co-operation. The employment of men who are keen to understand the apparatus under their charge and are quick to diagnose trouble is most essential where mercury arc rectifiers are concerned.

It is usual to make mercury arc rectifiers automatic, and in consequence special arrangements have to be made for organised maintenance. Where a large number of sub-stations exist, it may be essential to employ a number of attendants on shift work and to allocate to each certain sub-stations and plant. By giving each man definite units to maintain and keep in good working order encourages him to give of his best, while at the same time any neglect can be immediately taken up with the man concerned without excuses being offered implicating another attendant.

Some system must be arranged if maintenance costs are to be a minimum and the following example may be of some assistance in forming a maintenance staff.

Where there are a large number of sub-stations, these may be divided up, according to their geographical location, into "areas" and further sub-divided into "districts." In charge of the whole system a specialist engineer should be engaged and he will require an assistant. Each "area" may have a junior engineer in charge whose duty it should be to take control of the two attendants attached to each "district." The attendants work in shifts of 8 hours each, one working the morning shift, from 7.0 a.m. to 3.0 p.m., the other taking the evening shift, from 3.0 p.m. to 11.0 p.m. Thus, there is one attendant on each "district" during the normal working hours.

In addition to the men in charge of the plant each morning shift man has an assistant, who may only be a labourer, to assist the attendant in cleaning operations.

The attendant's duties may be arranged as follows: The morning men take over their plant for cleaning and render the plant "dead," so that the unskilled man can work in safety. The evening shift men simply visit each sub-station on the "district" and observe the running conditions and log the loading and temperature readings in the sub-station log book. Any abnormal condition either in the plant or the loading should be reported at once to the "area" engineer.

At the end of each week the attendants change over shift, the evening men taking morning duty and the morning men evening shift. In addition to the "district" attendants, one or perhaps two more attendants should be employed to act as reliefs in case of illness or holidays, or when the regular man is held up on a breakdown. These men may work from 11.0 a.m. to 7.0 p.m., so that if the peak loading is experienced between the usual hours of 5.30 p.m. and 6.30 p.m., there will be a stand-by man available in case of emergency to render assistance wherever it may be required.

The "area" engineer holds a watching brief over the attendants and sub-stations in his "area," and is responsible for seeing that the equipment is maintained in good condition and working order. He supervises the work of the morning shift men and sees that adequate spares are always in stock in each of the sub-stations. This man must be competent and capable of giving advice to attendants in time of trouble. It should be left to his discretion whether the abnormal circumstance is such that the chief assistant engineer should be called out on the job. When an abnormal circumstance has arisen, it is the "area" engineer's duty to gather the details of the case and make out a full report to the chief engineer without delay. He is also responsible for seeing that the testing is carried out according to the schedule drawn up for effective maintenance, and that the line leakage test, rail point drop test, gas main to track potential test and any other tests are made at the recognised times and the results reported to head office.

A large number of separate items of plant which require periodical inspection and overhaul need some system of recording, if an item is not to be overlooked. To that end it is a good scheme to arrange for a wall chart to be placed in the sub-station on which the attendant can record the date on which he carried out the inspection, cleaning or repair, etc. Though the details to be incorporated in the chart depend on the particular sub-station concerned, the following example may serve to show the method to be adopted.

SUB-STATION OPERATION AND MAINTENANCE 171

SWITCH No. 1. Met-Vic. 350,000 K.V.A. Break-capacity.  
 Normal current carrying capacity 400 amps. Protection.  
 P.B. overload. Setting. 200%. Time 4 secs.

Inspected ...	1/3/35	1/6/35		
Condition of oil	bad	good		
Oil sample ...	1/3/35	—		
Result of test ...	moisture	—		
Oil topped up or changed ...	changed	—		
Contact attention ...	arc tips replaced	—		
Special remarks	complete o'haul	O.K.		
Inspector's name ...	A. Jones	A. Jones		

A record chart or card index to be made out for each switch in the sub-station.

Similar charts or record cards can be made up to cover the following items of plant :

**Switchgear Relays**

- Date trip settings tested.
- „ settings altered.
- Reason for alteration.
- New settings.....
- Date contacts cleaned.
- „ contacts renewed, etc.

### Rectifier Plant

#### GLASS BULB UNITS.

- Date sets cleaned and overhauled.
- „ excitation tested. Value.....
- „ excitation current altered. Value.....
- „ bulb replaced. Number of.....
- Length of life of the bulb.....hours.

#### STEEL TANK EQUIPMENTS.

- Date insulators cleaned.
- „ mercury levels in seals made up.
- „ vacuum pump oil topped up.
- „ vacuum pump oil changed.
- „ hose pipe and connections inspected.
- „ water and blower motor bearings packed.
- „ water added to circulating system.
- „ automatic shut-off valve tested.
- „ Pirani gauge contacts inspected.
- „ surge arrester links inspected.
- „ „ „ gaps adjusted.
- „ anode cooler water made up.
- „ D.C. generator cleaned.
- „ pump gear chamber oil made up.
- „ pump set tested by hand rotation.
- „ water jacket examined for sludging.
- „ water jacket cleaned out.
- „ excitation current adjusted. Value.....
- „ of general overhaul.

### Transformers

- Date oil topped up.
- „ oil sample taken.
- Result of test.
- Date oil centrifuged.
- „ water cooler tubes cleaned out.
- Temperature of oil after a peak load run ..... °C.

### D.C. Switchgear

- Date main contacts on circuit breakers inspected.
- „ operating coils on H.S. breaker tested.
- „ H.S. breaker auxiliary contacts cleaned or replaced.
- „ lock-out signals tested.
- „ high speed breaker tips replaced.
- „ trip settings tested.
- Cyclometer readings.....

### Buildings

- Date drains inspected and cleaned.
- „ station floor mopped over and general cleaning.
- „ windows cleaned.
- Details of painting work.
- Details of repairs.

### Spares

- Date, type and quantity received in the sub-station.

### Office Records

- Capital cost of plant, buildings, land, etc.
- Cost per unit of output.
- Losses calculated daily, monthly and annually of the following :
  - Rectifiers, station lighting, heating, etc.
  - Records should be kept of men's time, water consumption, rates, fire insurance, other insurance, replacements, supervision charges, etc.
  - Maximum load readings daily on rectifiers, D.C. feeders, E.H.T. feeders, etc.
- Accident reports and compensation claims.

These lists can be added to according to the circumstances of the supply and the organisation existing prior to rectifiers being used for conversion purposes.

Regulations insist that in each sub-station there shall be the following :

1. A plate fixed in a prominent position giving instructions for dealing with cases of electric shock.
2. A copy of the Workman's Compensation Act.
3. The Electricity Regulations.
4. Factory Act extracts.
5. An accident report book.
6. Ambulance perquisites.

Fire appliances should be fixed in convenient positions and periodically tested and refilled if necessary. Paraffin hurricane lamps are also useful in cases of a total failure of E.H.T. supplies during hours of darkness. Framed wiring diagrams should be placed on the walls for reference, loose blue-prints become a nuisance and need too frequent replacement.

Though the attentions required present an apparently formidable list when made out in the manner described, rectifiers are very easy to maintain, and the costs are low when a comparison is made with other forms of converting plant.

In common with all forms of plant, the maintenance costs depend very largely on the efficiency of the maintenance staff, and it cannot be too strongly emphasised that attention to details is the prime factor in keeping down those costs to an absolute minimum.

In conclusion, the most important thing to remember in maintaining electrical plant is never to wait for trouble to develop, always try to anticipate it, and to do so make the routine inspection and attention as regular and thorough as possible. Immediate attention to minor matters will often prevent a development of a major character.

## CHAPTER VII

### GRID CONTROL

#### General Principles of Grid Control

THE principles of the radio valve were used in the first chapter to illustrate the *modus operandi* of the mercury arc rectifier, and, as in the radio valve, a grid can be used in a rectifier, but with the following essential difference in its control effect. In the radio valve the anode current at all times bears a definite relation to the grid potential applied, but in the rectifier the grid cannot control the anode current once it has commenced to flow. Grid control can only be exercised to delay the ignition point on the anode voltage wave.

To understand the reason for this difference in the control effect, assume a certain instant in time when the anode potential is negative in respect to the cathode voltage and that a negative potential is applied to the grid. The space between the anode and its grid is then almost entirely free from ionization, due to the shielding by the grid field. The anode potential wave may then pass through many cycles, but the arc cannot strike up through a de-ionized space so the rectifier is rendered inoperative. If the grid potential is now changed to a positive value at the instant when the anode potential is positive to the cathode, then both the anode and its grid are positive and will attract in ionization. Following on the ionization of the space between the grid and the anode, the arc is then free to strike from the anode to the cathode through the grid meshes. By adjustment of the instant of polarity change on the grid in respect to the anode voltage wave the arc can be delayed to any desired degree.

Having assumed that the arc has now been permitted to strike up, let the grid potential become negative. As soon as



the grid is charged up negatively it becomes clothed in a thin film of positive ions, which very effectively neutralises the grid field. This film at the current densities common in actual practice is only very thin and is not sufficient to close up the holes in the grid mesh. The arc is, in consequence, not appreciably effected at this stage. If, now the grid is maintained at a negative potential while the anode voltage continues its periodic wave form, immediately the anode voltage becomes negative to the cathode the space between the anode and the grid becomes de-ionized, by the action of the grid field. As long as the negative potential is maintained on the grid the anode will not take up the arc.

It has been stated in Chapter I that in service the anodes are never more than about 15 to 40 volts positive to the cathode, depending on the size of the rectifier, so that a comparatively weak di-electric field is required for arc control. Furthermore, since the applied voltage to the grid is small, the extra losses in the equipment are also small. In fact, the grid only takes a few milliamperes charging current. The usual voltage applied, though by no means critical, is only a few times that of the rectifier arc drop and in practice may have a value between 25 and 250 volts, depending upon the voltage rating and size of the rectifier.

### **Arrangement of the Grids**

Very little constructional alteration is required to a standard rectifier to accommodate grid control apparatus. The grid itself is a perforated screen surrounding the anode but insulated from it and an external lead brought out to a terminal mounted on the tank. The grid and its lead must be screened with de-ionising shields outside them, in order to limit the amount of ionization from the arc on other anodes which may reach them. At the same time the grid and the anode must be left free to pick up the arc when required. The dimensions of the grid and screens are not critical and some latitude is permissible in their design. The de-ionising shields are not always insulated, but may form a part of the arc guide or

main anode shield, and so have a floating potential. Careful design is, however, necessary, since during the operation of the grid its potential will be approximately equal to the cathode voltage, so that at the peak of the negative half cycle of the anode voltage wave the space between the grid and the anode must be capable of withstanding twice the D.C. rated voltage of the rectifier. The voltage stress per unit of length of this space may be as high as 5,000 volts per inch.

### Arc Control by Grids

It has been stated that as long as the grid potential is maintained negative in relation to the cathode pressure the

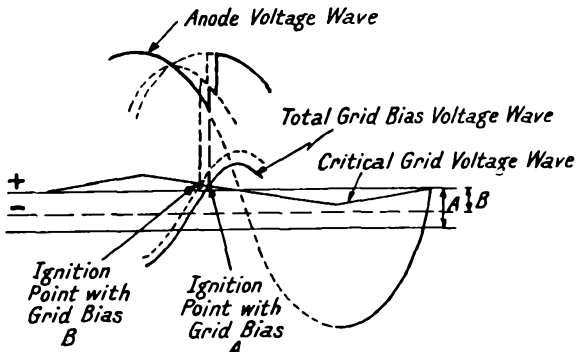

FIG. 76.—The gradual system of biasing the grids.

arc is suppressed, but immediately the polarity of the grid is reversed the arc is free to strike up at the anode. The change in the polarity of the applied potential can be made to take place gradually, or it can be in the manner of an impulse. Fig. 76 illustrates the former method of changing the polarity of the applied potential to the grid, and it will be noticed that when the potential wave of grid bias becomes positive the arc is struck up. In Fig. 77 the anode (2) is firing normally and under the control of a grid. If the grid of anode (3) is charged negatively just prior to the wave becoming positive to the cathode, the arc will be suppressed until at the point "X," a positive impulse is given to the grid and the arc is taken up

by anode (3). The effect on the anode voltage wave is clearly shown. Though both these methods have been applied, in practice it is preferable to use the impulse system, even though it is more difficult to apply, because of its advantages over the gradual method. The two main advantages of the impulse system over the gradual system are, (a) it is very much more

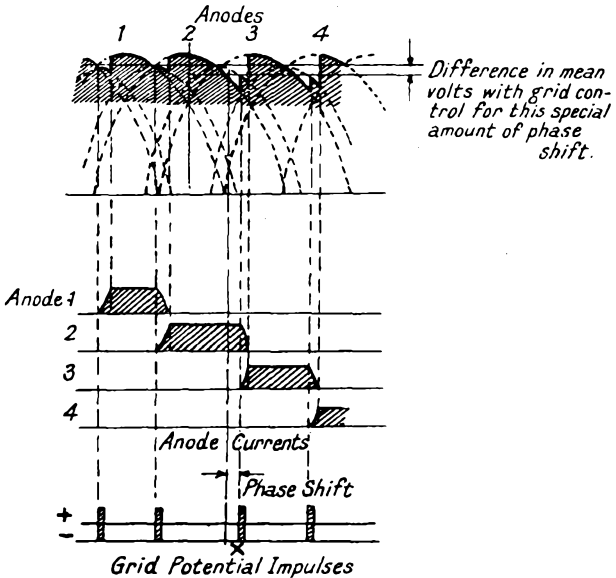

FIG. 77.—The impulse system of biasing the grids.

definite in action, and (b) it does not adversely effect the regulation of the rectifier.

These two advantages may be realised from an inspection of Fig. 78 and Fig. 79. In the former an arc drop curve is drawn alongside the anode voltage wave curve, and illustrates the phase shift of the point of ignition due to the variation in the arc drop from 25% of full rated output to 125% load. The difference in the phase points at which ignition takes place at 25% and at 125% of full loading is quite appreciable, and may amount to 15 degrees or even more. Fig. 79 shows

how a phase shift of the point of ignition is brought about due to variation in the temperature of the rectifier. The arc drop varies with the temperature of the rectifier and a typical curve is plotted alongside the anode wave curve as before.

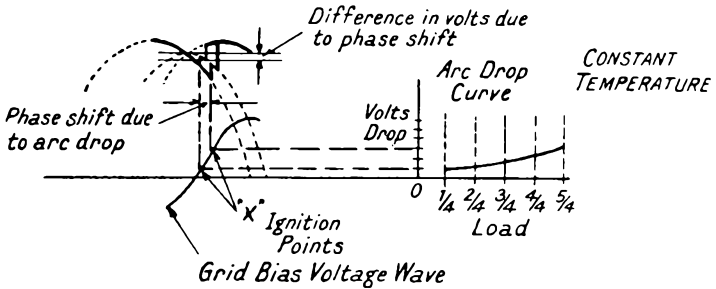

FIG. 78.—This diagram illustrates the variation of the ignition point in the gradual system of grid biasing when the load increases. A constant temperature is assumed. (The diagram is not to scale.)

Here again the phase shift of the point of ignition is considerable.

The phase shift of the point of ignition obviously reduces the maximum value of the anode potential to cathode voltage

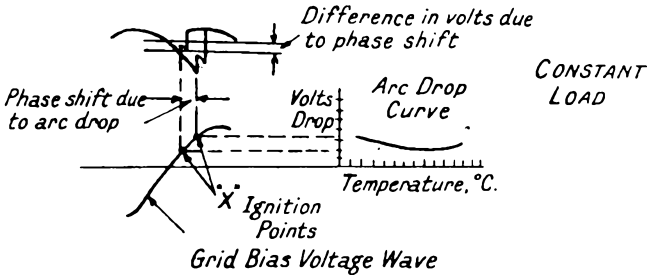

FIG. 79.—This diagram shows how the ignition point is varied in the gradual system of biasing the grids if the temperature increases. A constant load is assumed. (This diagram again is not to scale.)

and results in a lower D.C. output pressure. The reduction in the D.C. voltage increases with the load, and varies with the temperature, so that it is tantamount to regulation and the curve of pressure drop must be added to the normal regulation. It is also obvious that if the applied grid bias potential is not

absolutely constant, that in combination with the above effects, a bad regulation may be produced. For these reasons it is preferable to use the impulse method of biasing the grids.

The simplest application of grid control is for the rapid suppression of the whole load current or for protection in the case of a back-fire.

The grids can be excited in any suitable way during the normal operation of the equipment, and when it is desired to stop the flow of load current all the grids are given a sustained negative charge. Thus, as each anode potential wave passes into a negative state in relation to the cathode voltage, the space charge is de-ionised between the anodes and their grids, and the arc transference from one anode to another is prevented. Thus, the arc either ceases immediately the applied voltage wave drops below that of

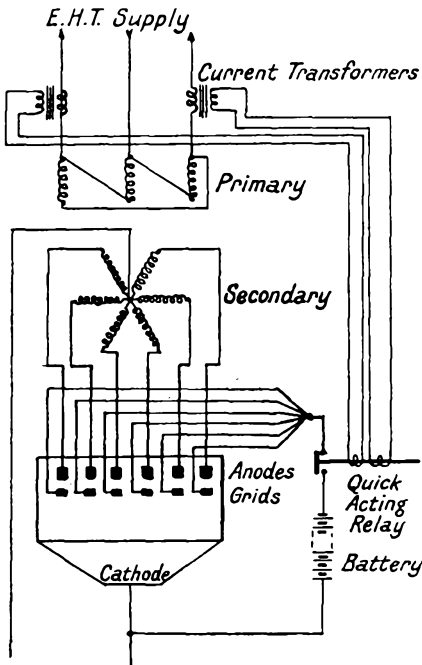

FIG. 80.—Biasing the grids via a quick acting relay for protective purposes.

the cathode pressure, or it will hang on due to the inductance in the external circuit until the losses in the circuit and the alternation of polarity of the anode potential wave destroy it. The interruption of the current flow is, therefore, very rapid and has the great advantage that it is impossible for a high voltage surge to be produced, as is always experienced when forcibly breaking a circuit with switches.

In applying this principle for purposes of protection, in the case of a back-fire, it has to be remembered that a back-fire

is the combined condition of current flow from the cathode to the anode concerned and from the remaining anodes as they successively attain a positive potential.

If a negative potential is applied to all the grids, the anodes supplying current to the back-firing anode will cease to function immediately their applied voltage becomes negative to the cathode or datum pressure. Thus, that component of the

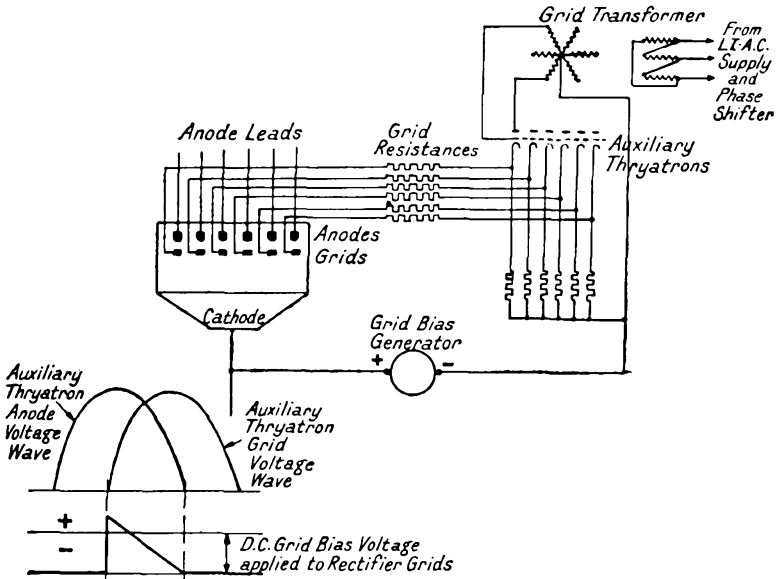

FIG. 81.—The auxiliary Thyratron method of biasing the grids.

total back-fire current supplied by the A.C. system is rapidly eliminated. The grid cannot suppress the arc at the back-firing anode, since the current contains the D.C. component fed back from the D.C. system and, therefore, does not attain a negative potential with respect to the cathode. The reverse current D.C. breaker will remove the D.C. component and the rectifier will then be cleared of back-fire current from both the A.C. and the D.C. systems.

If it is required to use the grids as a form of protection against back-fire conditions and D.C. short circuit, the grids

can be excited from either a D.C. generator or from a battery—but never from the rectifier itself—via a light quick acting relay as shown in Fig. 80. The relay is operated from current transformers in the main H.T. supply to the rectifier transformer.

If grid protection against back-fire only is desired Thyatron valves may be used to energise the grids as depicted in Fig. 81.

Two oscillograms are given in Fig. 82 and 82A, to show the advantage gained by the use of grid control under short circuit

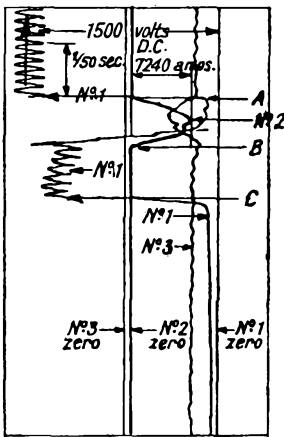

FIG. 82.

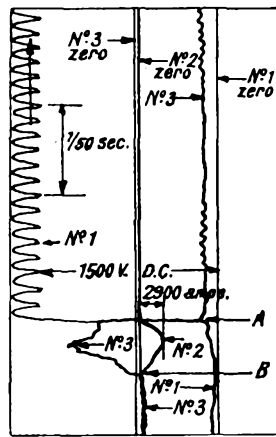

FIG. 82A.

FIG. 82.—This is an oscillogram of an applied short circuit on a 1,500 volt rectifier. In this case the short was interrupted by a high speed circuit breaker, the grids not being energised.

FIG. 82A.—This oscillogram shows an identical short circuit condition removed this time by energising the grids. Note.—The remarkable reduction in the peak value of the short circuit current and the rapidity of removal.

conditions. In each case the short circuit was applied at "A" and interrupted at "B." In the former figure the grids were not energised, reliance being placed on the A.C. overload tripping circuit and the D.C. high speed circuit breaker to clear the rectifier of the fault. The high speed breaker tripped and because of the interlocks the A.C. breaker also operated, and the rectifier was in consequence shut down. The maximum value of the fault current was 7,240 amperes, and this was

effectively cleared in approximately 0.018 secs. At "C" the oil switch tripped. In the second oscillogram the same short circuit was applied to the same rectifier, but this time the grids were energised. The rapidity of removal of the short in this instance can be appreciated from the fact that neither the high speed breaker nor the oil switch tripped. The maximum value of the short-circuit current was 2,900 amperes, or about 40 % of that produced in the previous case. The time taken to clear the fault was approximately 0.012 sec., or only about 66 % of the time previously taken.

The advantages to be gained by grid suppression of fault current are :

1. Extreme rapidity of the clearance of fault current.
2. Simplicity of the grid control apparatus.
3. Due to the reduction of the shock to the A.C. system, discriminative settings of the A.C. overload relays on the station H.T. feeders or ring mains can be arranged.

Though there are these undoubted advantages the use of energised grids for this purpose is not as common as one might expect it to be. Short circuits usually occur only outside on the track so that it would be a very great disadvantage to disconnect the rectifier, even if only for a very brief period, each time one single feeder developed a fault. A high speed circuit breaker on each track feeder would be a much better form of protection, the rectifier maintaining supplies to the remaining healthy feeders. There may, of course, be special circumstances where this application of grid control may be desirable.

### **Grid Control of Voltage**

Fundamentally, the control of the D.C. output voltage from the rectifier is based on the fact that the average value of the voltage depends upon the position of the ignition point on the main anode potential wave, during the positive half cycle. It will have been appreciated from the diagrams already given



in this chapter that the later the point of ignition on the anode pressure wave the lower the average D.C. voltage becomes. This is still further illustrated in Fig. 83, and it should be noted as the voltage is reduced the current lags behind and the output voltage becomes more and more distorted. When the rectifier is on load, the harmonics approach very closely the no-load values, so that transformers and smoothing circuits designed for rectifiers without grids are rarely

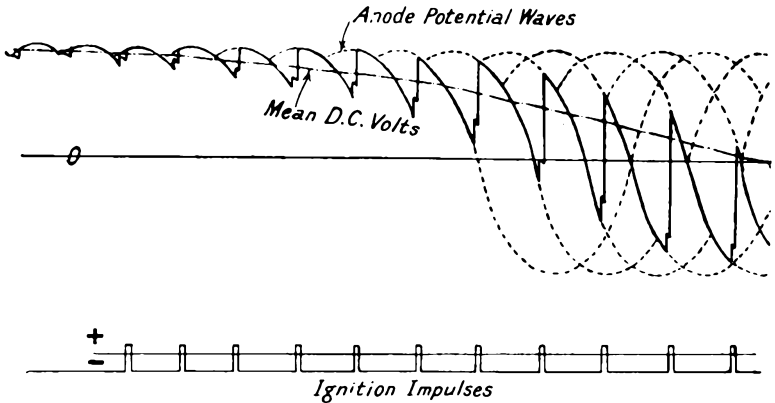

FIG. 83.—This drawing shows the drop in the mean D.C. voltage from a rectifier with a gradual variation in the point at which ignition is allowed to take place.

suitable for use with grid controlled rectifiers. Where the transformer secondary connections are in double star or in quadruple zigzag, the no-load pressure rise, and also the voltage across the terminals of the interphase transformers will be very much greater than for ordinary rectifiers.

The regulation drop in volts is the same as for the rectifier without grid control for equal loads and reactance. Furthermore, a reduction in voltage by grid control does not appreciably effect the regulation from no-load to full load, the regulation curves remaining approximately parallel over the whole range. These remarks apply to the modern rectifier using an impulse method of energising the grids as distinct from the gradual method. This was fully explained in the paragraph on Arc Control By Grids.

Because the reduction of voltage by grid control does not appreciably effect the secondary current in the transformer, it follows that the primary current likewise is not effected. On the other hand, the power output from the rectifier is proportionably decreased so that the primary power factor is reduced in almost direct proportion to the decrease in the output voltage.

The serious reduction in the primary power factor and the increase in the distortion of the D.C. wave form tends to restrict the application of energised grids to cases where a small voltage range only is necessary or where the drop in volts is required for very short periods, such as in running up D.C. motors against load conditions.

The range of output voltage control is greater than can be obtained from any other converter with the exception of the D.C. generator and is, therefore, suitable for certain purposes where an infinitely variable voltage is necessary. The grids may be used to give traction rectifiers, either a level or over compound characteristic, but unfortunately a scheme of automatic compounding is so complicated that it is less of an attraction than it at first appears to be. The ordinary rectifier with its shunt characteristic has proved to be so suitable to traction loads that over or even level compounding is but seldom justified in practice. On the ordinary power and lighting load, on-load tap changing transformers offer a better proposition than the use of grids for pressure control.

### **Methods of Exciting the Grids**

There are several methods of exciting the grids and these will now be briefly reviewed.

**Synchronous Contact Method.** This was one of the first methods designed for energising the grids, and makes use of a rotating contact driven by a synchronous motor, as shown in diagrammatic form in Fig. 84. The grids are given a negative bias, and the polarity is reversed to each grid in correct rotation by means of the rotating contact brushing over a set of contacts on a stationary disc. To vary the instant of change of the

polarity at the grids with reference to the ignition point on the main anode potential wave it is only necessary to move the disc round a little.

The same principle can be applied with a greater degree of accuracy and dependability by using a synchronous motor provided with a field comprising two windings placed at right angles to each other. By variation of the relative strength of these two fields the rotor can be advanced or retarded relative to the rotating field of the stator. Thus the effective flux is varied relative to the centre line of the poles in the rotor.

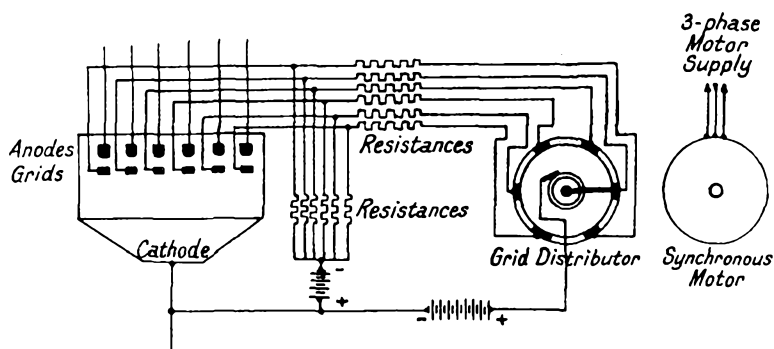

FIG. 84.—An illustration of the principle of grid excitation by the rotating contact method.

The principle of the synchronously driven commutator is given in Fig. 85, but the motor must be so energised that it accurately keeps step with any phase swinging of the applied voltage to the main anodes.

### Peaking Transformer Excitation

The simplest form this method can take involves the use of a separate transformer for each grid. The exciter transformer is provided with two windings, the one is connected in star, and the other in delta. The ampere turns on one limb are maintained constant, but the other coil has an adjustable resistance in series at the star point to vary the ampere turns, and furthermore this latter coil is displaced in phase by  $150^\circ$

from the other. By highly saturating the core, flat topped flux waves are induced so that the rate of change of flux and, consequently, the E.M.F. induced is not appreciable until the resultant ampere turns pass through zero. At that instant

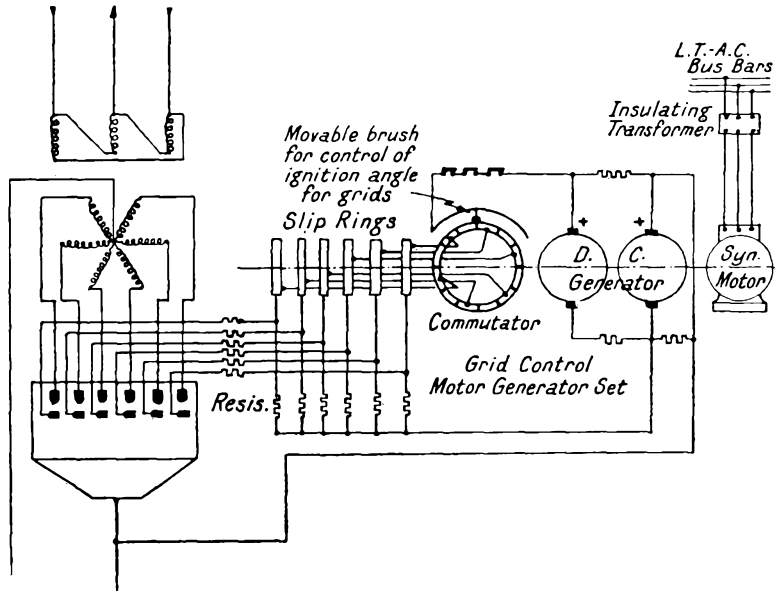

FIG. 85.

The synchronously driven commutator method of exciting the grids.

a peaky voltage is induced, covering a period usually of about  $10^\circ$ , which, when superimposed upon the constant negative potential applied to the grids, is sufficient to cause the arc to strike up. Variation of the resistance will vary the phase angle of the applied peaking potential. Fig. 86 illustrates this method of control.

### Thyatron Valve Control

This system has already been illustrated in Fig. 81 and needs no further explanation.

### Gradual or Sine Wave Control

In this method an induction regulator or a small trans-

former is used to deliver a sine wave which is superimposed upon the constant negative bias applied to the grids by a battery or separate rectifier, and the peak value is arranged to attain a higher potential than that of the constant supply. The peak of the positive half wave then reverses the polarity of the grids, which can be made to occur at any predetermined

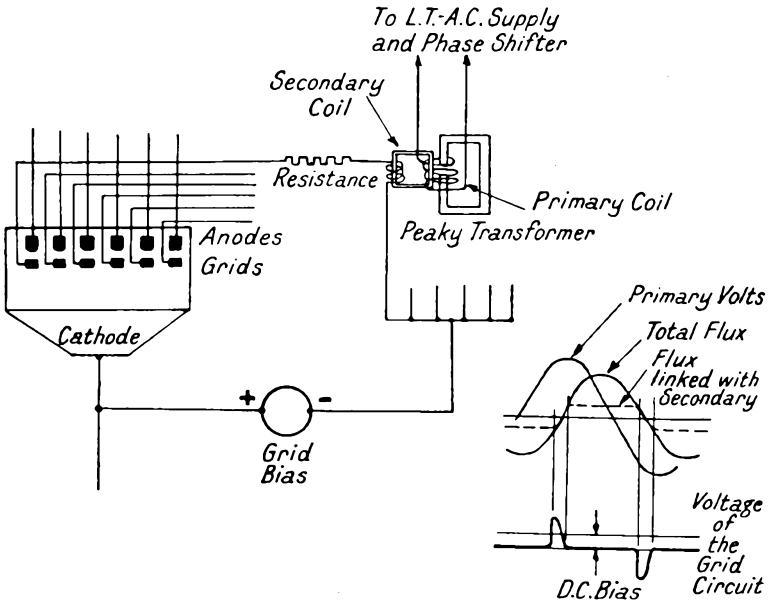

FIG. 86.—A method of exciting the grids by means of a peaking transformer.

instant. The ignition point can be controlled by variation of the value of the applied constant negative potential, as shown in Fig. 76.

**Inclined Potential Method**

This system is a variation of the gradual or sine wave method, and is shown diagrammatically in Fig. 87. This scheme is only suitable for small rectifiers. The biasing voltage applied to the grids is positive in this case and the inclined potential curve crosses the ignition potential line at a pre-

determined point arranged by adjustment of the regulating resistance. The more positive bias given to the grids the greater will the output voltage of the rectifier become. This scheme, like all other methods operating on the gradual

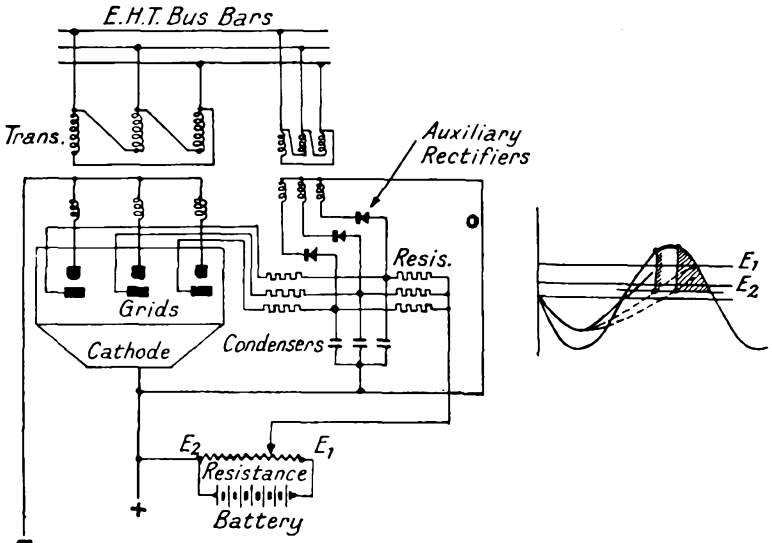

FIG. 87.—The inclined potential method of grid excitation.

potential principle, is not satisfactory in practice for the reasons given in the paragraph on Arc Control.

### Inverted Operation

If a rectifier is connected to a system which has constant running synchronous plant on the A.C. side to assist in the commutation of current from one anode to another in the rectifier, then, by delaying the ignition point beyond that which gives a zero D.C. voltage under ordinary conditions of voltage control the rectifier can be operated inverted. This presupposes that there is also a source of D.C. supply on the rectifier bus bars which can be used to drive current through the rectifier against the A.C. system.

Such a condition of operation is depicted in Fig. 88, where

at A anode 1 ignites, and since it is more positive than anode 6 it will take over the current from anode 6 and complete the commutation from 6 to 1 at B. It will be noted that when a rectifier is so controlled, and it changes over from normal operation to inverted operation that the D.C. voltage is reversed, but not the current. Commutation and de-ionization of the anode zone must be absolutely complete before point C is reached or the current will commute back

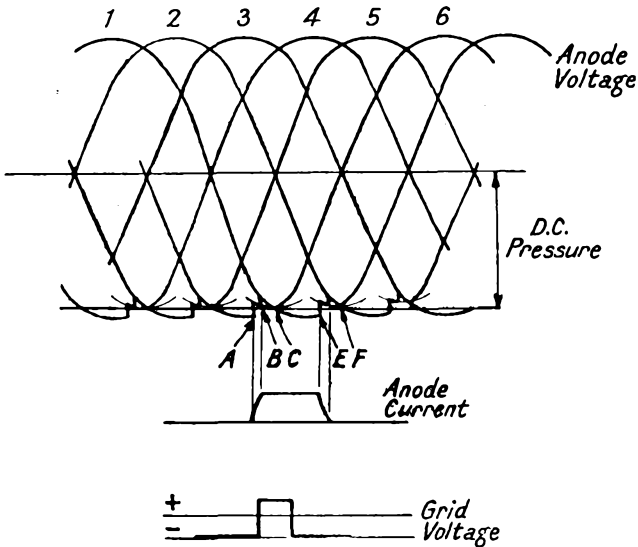

FIG. 88.

The operation of a six-phase line excited rectifier running inverted.

to the previous anode. If the current should revert back to the former anode a very heavy short circuit current will flow, because at the point C the A.C. and the D.C. voltages boost each other.

For perfect operation of a rectifier running inverted it is essential that the grid control apparatus is in perfect order and giving constant impulses in regard to their phase position on the anode potential wave to which each applies. The A.C. line voltage must also be reasonably constant and free from

momentary drops in pressure. Because these conditions are never exactly met in practice, it follows that a rectifier running inverted is somewhat less stable than if it operates in a normal manner.

It should also be noted that the current is out of phase with the voltage, and consequently it will draw a reactive K.V.A. from the A.C. supply. If the A.C. system is not able to supply this K.V.A. demand then instability will result.

### Power Factor

It should be appreciated from the foregoing that the voltage and the current waves on the A.C. side of a rectifier equipment

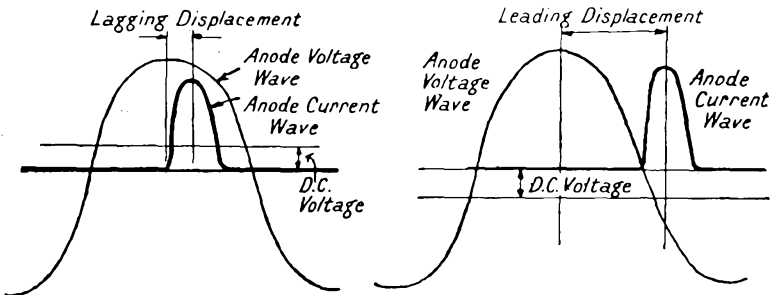

FIG. 89.—The diagram on the left of this figure illustrates rectification at a reduced voltage under control of the grids. On the right of the figure regeneration or inverted operation is shown, again under conditions of reduced voltage by grid control.

are by no means sinusoidal. Therefore, in solving the problem of power factor it must be borne in mind that it is numerically equal to two factors which evaluate the degree of displacement between the current and voltage waves and the degree of distortion. Wave distortion is dependent upon the amount of reactance in the transformer circuit and the point at which ignition is allowed to take place by the grid control apparatus. The distortion is fixed by the arrangement of the transformer secondary connections and the number of phases utilised.

Fig. 89 is drawn to illustrate the displacement of the current with reference to the voltage wave with the rectifier operating in a normal manner and also running inverted. This is in the



nature of an extreme drawing, for it only depicts conditions applying to one anode, but when all six anodes are in operation the resultant waves on the H.T. side of the transformer will more nearly approach a sine form.

As the ignition point is delayed the displacement factor is decreased proportionally until at zero volts there is a zero displacement factor. The distortion factor, on the other hand, is altered but very little, so that for practical purposes it can be assumed that the displacement factor is equal to the ratio between the D.C. volts delivered to the circuit under grid control of pressure to the rated D.C. voltage of the rectifier. In other words, given a rectifier with a normal rated voltage of 460 volts, which under control of its grids is made to deliver a pressure to the bus bars of 230 volts, will produce a power factor of approximately 0.5. It does not follow, however, that such a condition results in an additional magnetising or demagnetising current being drawn from the A.C. system at times of bad power factor operation since at no period is there a component at  $90^\circ$  to the voltage wave.

An average value of power factor to be expected on full load under normal operation is between 0.93 and 0.96, but when operating inverted the power factor will only be about 0.87, due to the fact that the arc is commutated prior to the peak value of the anode voltage wave being reached.

### **D.C. Voltage Wave Distortion**

This has been referred to before in an early chapter, and it will be remembered that in a 50 cycle rectifier operating without grid control that harmonics of the order of 300, 600, 900, and 1,200 cycles appear in the D.C. pressure wave. When grid control of voltage is used to decrease the D.C. pressure the amplitude of these harmonics increases greatly. As an example, if the D.C. volts are reduced 20% the 300 cycle harmonic may be increased 10%, and the higher harmonics will also increase a proportional amount, so that extra tuning or smoothing is essential with grid controlled rectifiers.

The cathode choke, if it is included in the equipment, will

not smooth out the harmonics in an equal degree over the whole range of load, since it obtains its magnetic properties from the D.C. load current passing through it. It therefore becomes necessary to modify the design of the tuned resonant circuits. Additional tuned circuits may be necessary if grid control of voltage is

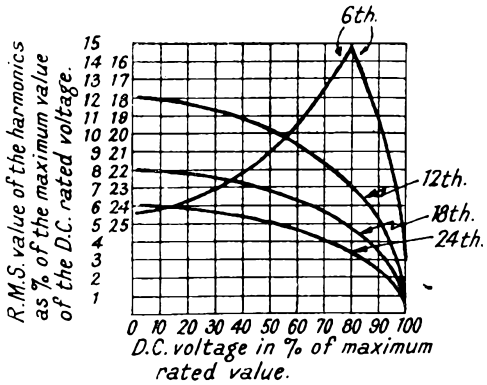

FIG. 90.—A graph showing the harmonics in the D.C. voltage from a six-phase rectifier or inverter with grid control, assuming infinite D.C. inductance and no overlap.

desired over a very wide range in pressure owing to the multiplying effect on the amplitude of the harmonics—which would normally not cause interference with telephone circuits—by reducing the voltage. Fig. 90 is a graph showing the harmonics in the D.C. voltage of a six-phase rectifier with grid control, whether under normal operation or running inverted.

**Some Applications of the Grid Controlled Rectifier**

Though the principles of grid control of rectifiers were well understood by Cooper Hewitt twenty years ago, it has only recently become a practical proposition. To-day the limitations of the grid system of control are more fully appreciated and generally it has not so many real servicable applications as one might have been led to suppose from reading the press statements even recently.

The most important application which is likely to be exploited to the full in the future is with the inverter. The development of the very high voltage rectifier is even yet in the experimental stage, but there is no doubt that it will not be long before a unit is produced to render high voltage D.C.

transmission a practical proposition. Up to the present the highest voltage obtained in one single unit is about 30,000 volts D.C., so that if two or three of these units were connected in series a transmission voltage of a practical value would be obtained. Rectifier development has been so rapid during recent years that one is left to wonder whether the national

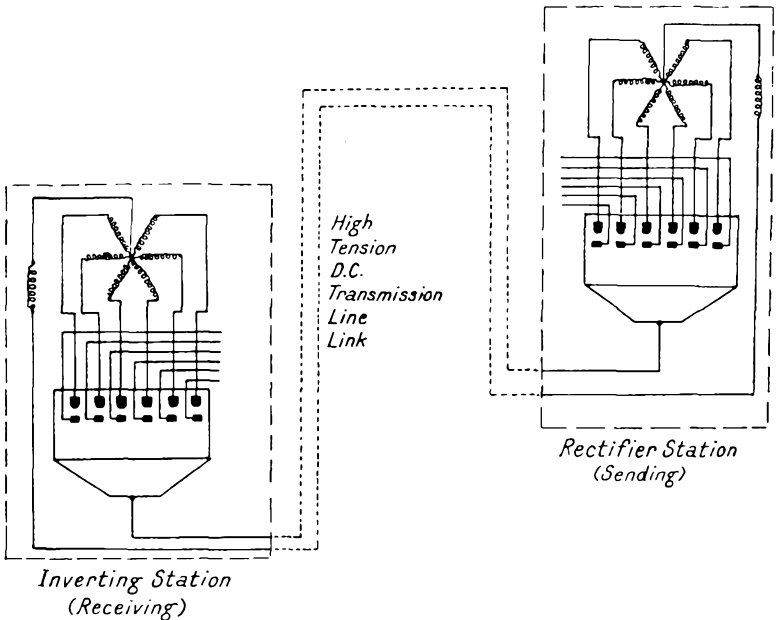

FIG. 91.—A schematic diagram for connecting up two rectifiers to act as a link between two A.C. systems. By means of such a high voltage D.C. link systems of differing voltage and frequency can be made to operate in parallel economically.

grid transmission system would still have been on A.C. if the scheme had been mooted ten or perhaps five years hence. As it is the capital sunk in the grid is so huge that a change over to D.C. high voltage transmission is likely to be long delayed. Though this country may not use high voltage D.C. for transmission of large blocks of power until the financial aspect of the problem has been satisfied, it does not necessarily

mean that British engineers may not build plant for service in other countries.

It has been stated earlier in this chapter that when a rectifier is running inverted it is necessary to have synchronous machinery in operation at the receiving end to supply the wattless K.V.A. of the A.C. load in addition to that required

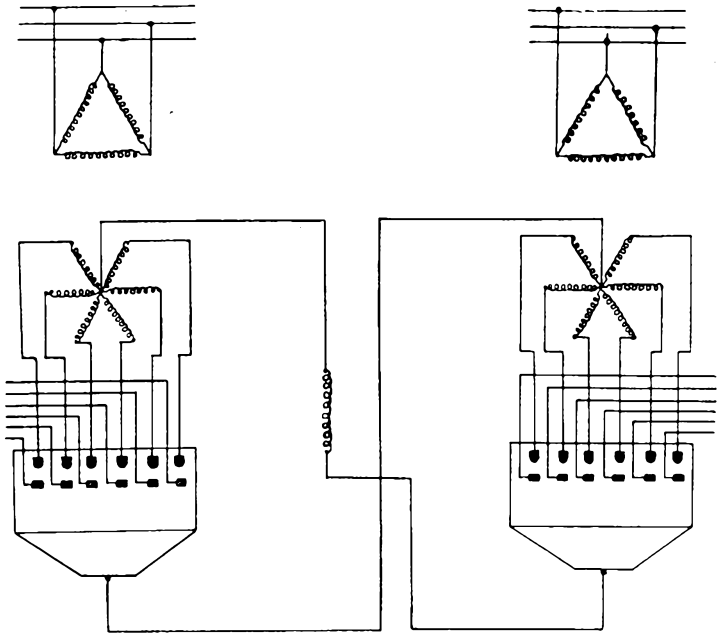

FIG. 92.

The interconnection of two rectifiers as shown can by the aid of grid control be made to act as a three to three phase frequency changer unit.

by the inverter at the maximum peak load. It therefore means that high voltage D.C. transmission by means of rectifiers at one end, and inverters at the other, can only be successful where large blocks of power have to be supplied.

The obvious application is as a link between two very distant power stations, especially when the frequency of the A.C. system is a common one used for industrial purposes and the length of transmission line too great for economical

transmission of power. Furthermore, it does not matter whether the frequencies of supply at the two power stations concerned are the same. (See Fig. 91.)

It follows from the last sentence that a rectifier and an inverter can be used for frequency conversion. If the load at the inverter end is made up of an amount of synchronous plant sufficient to supply the wattless K.V.A. necessary,

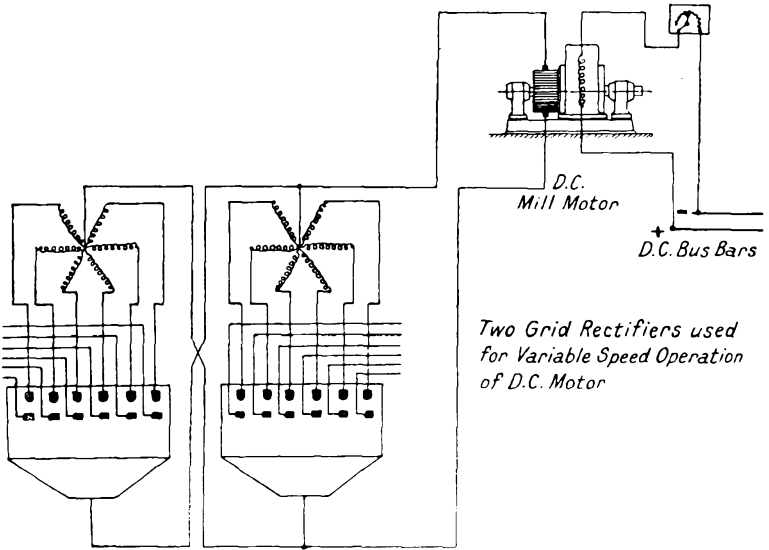

FIG. 93.—Two grid controlled rectifiers connected as shown can be used for variable speed operation of a D.C. motor and is particularly useful for mill purposes.

and is a high D.C. voltage of at least 1,500 volts, then as a frequency changer the system is more efficient than a corresponding rotating conversion unit. Connections for frequency conversion are shown in Fig. 92. High frequency current can also be obtained with suitable connections and at the present time it is possible to obtain current at a frequency of 3,000 cycles, although this is only in the experimental stage.

By connecting up a rectifier and an inverter oppositely but to operate in parallel it is possible to send current through a

circuit in either direction. If with this connection the grids are arranged to regulate the D.C. pressure of each unit together, the combination can be used as a Ward-Leonard set. This principle has been applied and given every satisfaction in a rolling mill using a 100 h.p. motor. A system of connections is given in Fig. 93.

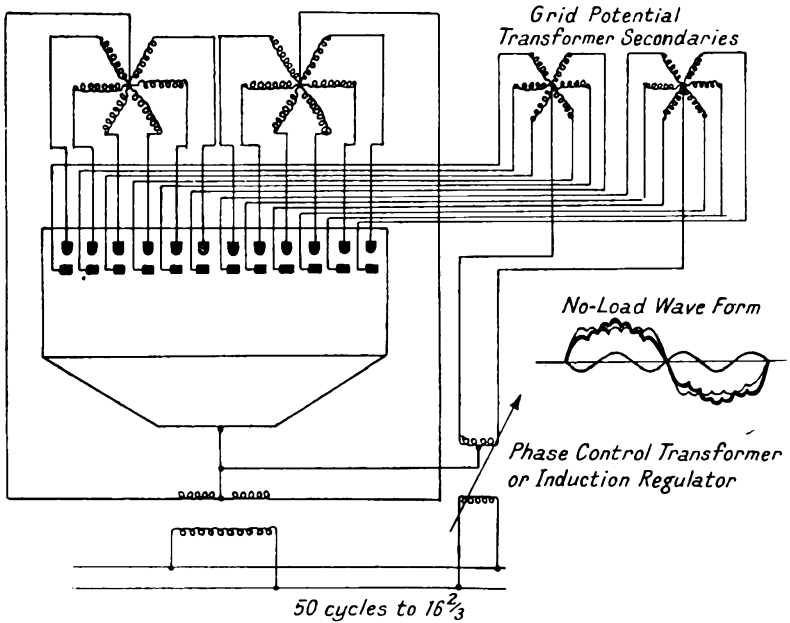

FIG. 94.—Frequency changing by using two six-phase systems with separate grid control in one steel tank can be arranged as shown above. The no-load wave form is also indicated for a case of three to single phase wave change.

Hitherto one obstacle to the use of rectifiers on a traction system which is operating with rolling stock capable of regeneration is the fact that a rectifier can only supply current to the system, but cannot receive it back. The use of an inverter unit for returning current to the A.C. system is a solution to the problem.

### Possible Future Applications

Where a low frequency railway supply on a single phase

system at 16.66 cycles is required this can be obtained by means of special connections from a rectifier supplied with current at 50 cycles three-phase. This is shown in Fig. 94.

Commutatorless variable speed A.C. motors may be used in traction locomotives if the connections are arranged as

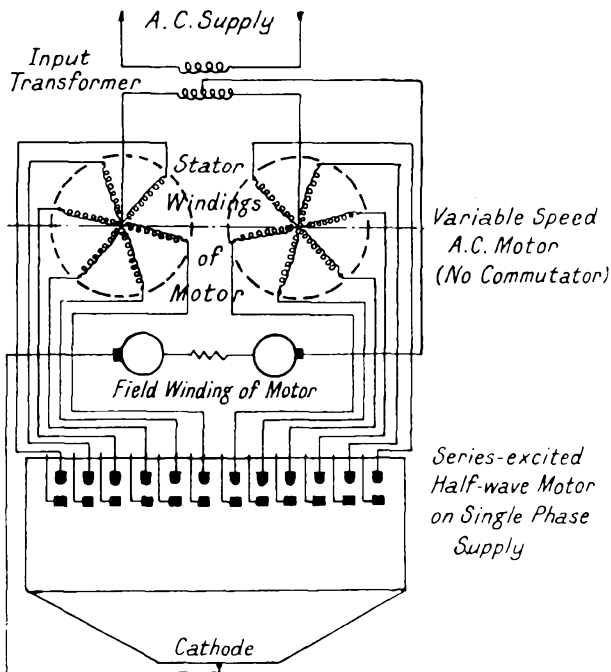

FIG. 95.—This connection diagram indicates an example of a variable speed A.C. motor employing grid controlled rectifiers instead of commutators. In this case a series-excited half wave motor is shown on a single phase supply.

shown in Figs. 95 and 96. The motors can have series or repulsion type windings.

A locomotive may also have a single phase rectifier and supply current to D.C. motors for driving purposes. By using the grids, the D.C. voltage can be varied to suit the conditions of operation and also to enable power to be returned to the A.C. system at times when the motors are being retarded.

In low frequency traction service the rectifier may yet become so developed that frequency changing will be done in

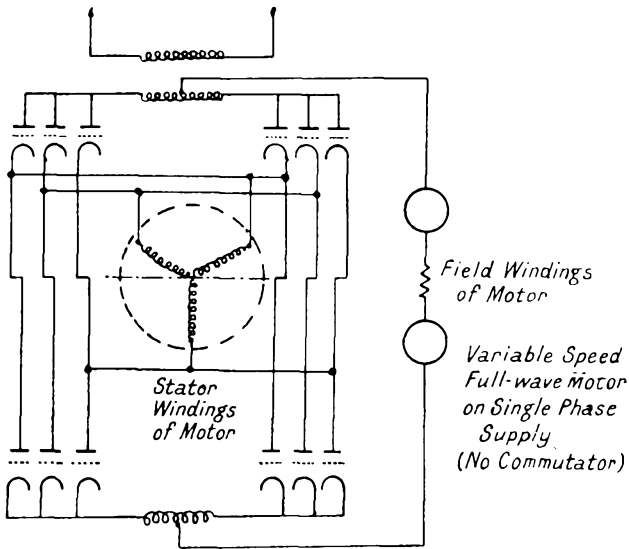

FIG. 96.—Another example of a variable speed commutatorless A.C. motor on a single phase supply, but arranged for full wave series excitation. Grid control is again used in this system.

one stage instead of two as described above. The principle of operation of the direct frequency changer unit is that a

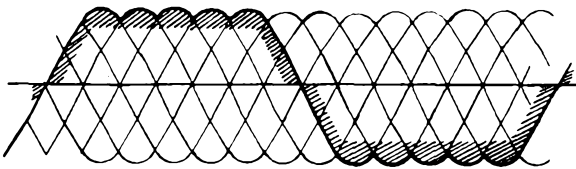

FIG. 97.—With connections as shown in Fig. 94, the no-load output voltage wave for frequency changing from three-phase 60 cycles to single phase 25.7 cycles is indicated.

suitable number of phases are allowed to function and combine to form one half of the low frequency wave, the other half being made up by similar means. As an example, in Fig. 97 a



three-phase 60 cycle system supplies current to a rectifier, and the anodes are so controlled that a single phase 25.7 cycle supply is produced. The problem of passing reactive K.V.A. from the high to the low frequency system has yet to be solved.

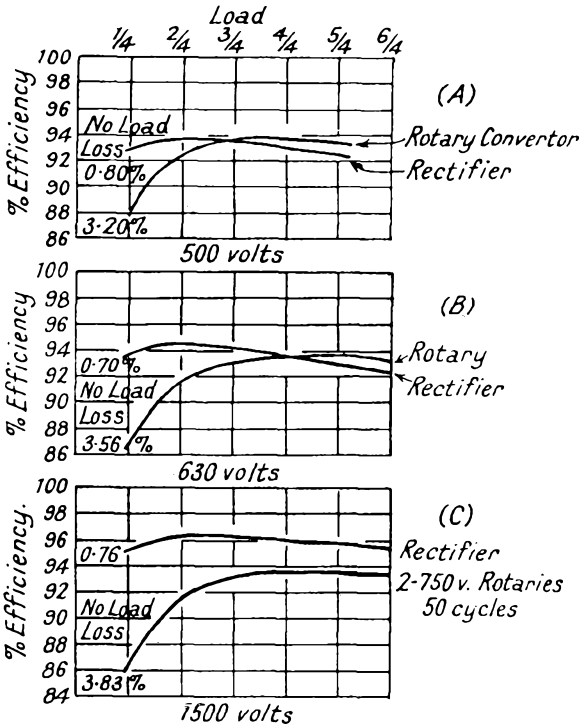

FIG. 98.—Three charts of comparative overall efficiencies. The rectifier losses include the following:—actual arc drop, main transformer, auxiliaries and the smoothing circuit. The rotary converter losses include the stray load loss in accordance with B.S.S. 269 and the transformer losses.

## CHAPTER VIII

### CONCLUSION

FOR many years past the majority of conversion schemes have been dealt with by the installation of rotary and motor converters, and, in some cases, motor generator sets. This class of apparatus has given ample proof of its reliability, and in general, the rotary converter has been the most popular type of unit due to its efficiency being somewhat higher than the other types.

In certain cases the motor converter is to be preferred to a rotary converter on account of its greater stability, the elimination of the step-down transformer, and the absence of heavy L.T. A.C. slipring connections when required for use on a D.C. system at low voltage and high current.

It is not proposed to deal with the relative merits of rotating converting plant, since the individual advantages and disadvantages of the various types are generally well known. It is, however, most desirable to consider what advantages may be obtained by the installation of rectifier plant for conversion schemes.

It is not sufficient to give consideration to a comparison of capital cost and efficiency, but also to bear in mind such points as noise, wave form, power factor, voltage regulation, three-wire operation, maintenance, building costs, and whether the plant is required for manual, remote control or automatic operation. These points must be considered for each individual installation, since it is impossible to define the limits of the field of application for either rectifiers or rotating converting plant.

As a matter of general interest, and, as a guide to the basis on which comparisons should be made, the following notes

are given, and in certain details some of the statements made in previous chapters are recapitulated.

### Efficiency

Consider the graph Fig. 98A, where the comparative efficiency of a rectifier and rotary converter is given for operation on 500 volts D.C. The no-load loss of the rectifier is 0.80 %, but the no-load loss of the rotary is 3.20 %, an advantage to the former of 2.40 %. At about 75 % of full rated output the efficiency curves cross over and above that loading the rotary is the more efficient. In (B) where the comparisons are made for equipments operating at 630 volts the curves are similar, but in this case the rectifier shows to better advantage by the comparison. Now in (C) the advantage of the rectifier over the rotary is most marked and nowhere is the efficiency of the latter higher than the former. As the voltage increases it is not practicable to run three or more rotaries in series so that a motor generator would be necessary, but this has a very much lower efficiency than one single rotary, the difference in efficiency between the motor generator and the rectifier is even more marked than in the previous examples.

As an example, a motor generator for a traction system of 3,000 volts would have an efficiency curve as follows: 25 % load 81 %, 50 % load 89 %, 75 % load 90.5 %, 100 % load 91.5 % and with a no-load loss of 4.58 % on the other hand the rectifier would have corresponding values of 96.3 %, 97 %, 97 %, 97 % and 0.65 %. The rectifier, therefore, has the high voltage field to itself and is not likely to be ever challenged, except possibly where regeneration is required on traction systems.

At voltages below 500, the rectifier efficiency by comparison with the rotary begins to drop rather heavily. The reason for this, of course, is that the principal loss in a rectifier equipment is that in the arc, and since this is almost constant, irrespective of the capacity of the rectifier, and may have a value of between 15 and 30 volts, it follows that at 100 volts the losses will be approximately equal to the ratio of the arc drop to the rated voltage, i.e., 15 % to 30 %, which is a serious

amount. To sum up these observations, for voltages of 400 to 600 the rectifier and the rotary have about equal points in regard to overall efficiency. From 600 to 1,500 volts the rectifier shows to advantage and may give a saving in losses up to about 10% over a given time. Above 1,500 volts the rectifier holds the field almost completely.

In considering the question of efficiency, load factor must also be taken into account. For example, if the load factor on a 240 volt D.C. system is very low, then, although the rectifier has a decidedly lower efficiency curve than the corresponding rotary converter, the losses at no-load and very light loads are comparatively small, so that the "all-day" efficiency may actually be higher than that of the rotary converter.

### **Power Factor**

Power factor may generally be controlled within certain limits on rotating converting plant, and, for instance, is usually adjusted to unity at full load and mean D.C. voltage for rotary converters and motor converters. In the case of motor generator sets the A.C. machine may be a synchronous motor or an induction motor with a phase advancer, whereby it is possible to obtain leading wattless current for power factor correction purposes.

In the case of a rectifier unit, the power factor is largely outside the control of the designer, and depends upon the reactance and magnetising current of the transformer when supplying the rectifier. For six-phase equipments the power factor will usually be between .93 and .94 from quarter load to full load, and for twelve-phase equipments it may be as high as .97.

### **Wave Form**

The D.C. wave form of rotating converting plant contains probably a small tooth ripple, but otherwise does not appreciably deviate from a straight line, and interference troubles are practically non-existent. On the other hand, the rectifier has very definite harmonics in the D.C. wave form, and it is

necessary to consider whether interference with radio or neighbouring communication circuits will arise. A fairly expensive equipment is, of course, necessary to smooth out the harmonics if interference is produced.

### **Noise**

Modern rotating plant can be made reasonably free from noise although, particularly at the higher speeds, the plant cannot be said to be quiet, and since ventilating openings are required in the building, annoyance may be caused in residential districts.

The steel tank rectifier is practically noiseless due to almost complete elimination of moving parts. Furthermore, the sub-station can in many cases be constructed without ventilating openings which also ensures the elimination of dust and dirt. The glass bulb unit requires an open fan, which can be made to give reasonably quiet operation and, although ventilating openings are necessary in the building, very little noise can be noticed even in the immediate vicinity of the sub-station.

### **Voltage Regulation**

One great advantage of rotating conversion plant is that D.C. voltage regulation is inherently obtainable within reasonably wide limits, and the effect of series windings to give a compounding effect is, of course, universally known.

The rectifier has an inherent shunt characteristic, and to obtain D.C. voltage control, additional plant is necessary. This, of course, necessitates further capital expenditure and the maintenance of the additional apparatus.

### **Three-Wire Operation**

The rotary and motor converter may be constructed to operate on a three-wire system and to deal with the mid-wire out-of-balance current ; the motor generator set requires a static balancer or a separate balancer set.

The rectifier is inherently a two-wire machine, so that for three-wire service it is necessary to install a rotary balancer

set or, alternatively, balancer bulbs may be employed between mid-wire and outers. Here again increased capital expenditure and maintenance is involved and additional losses are introduced by the balancer equipment.

Where balancer bulbs are employed it must be realised that these units are operating at half the full line voltage and, therefore, at a reduced efficiency, and, unless suitable precautions are taken, these bulbs may tend to operate as series units to supply the line current.

If a rotary balancer set is employed, then suitable starting and control gear is required, and in the case of any but manual sub-stations, this is necessarily of the contactor type for automatic starting and protection.

### **Sub-Station Building**

With rectifier plant an absence of any tendency to vibration, and the generally lighter construction of the plant allow savings to be made in the construction of the building and foundations, although it must be remembered that the transformer for the rectifier is generally larger than the one for the corresponding rotary converter, and in the case of the motor converter a transformer may not be required. The floor space required for a rectifier equipment is frequently less than that for a rotary converter, and is progressively less the higher the D.C. system voltage becomes.

In view of the foregoing remarks, it is often possible for negotiations to be conducted more easily for sub-station sites in congested areas.

### **Maintenance**

The maintenance and upkeep details associated with rotating conversion plants are well known, and the reader will have learnt from preceding chapters the extent of the attention and replacements required with the rectifiers.

If a steel tank rectifier has to be opened up, the cost and the time the equipment is out of service is greater than any ordinary time taken for maintenance of rotating plant. On

the other hand, there is no reason why a modern rectifier should ever require to be opened up, since there is nothing in the inside of the tank subject to wear, and, as the parts operate in a vacuum which improves with service, the "life" of a rectifier tank is extremely long. It follows that the maintenance costs are lower than where slip rings, commutator and brush gear require attention.

The replacement of brushes on high speed converting plant, over a number of years, is an expensive item and is comparable with the replacement of bulbs in a glass bulb equipment.

### **Control**

The control gear required for a rectifier equipment is comparatively simple, and very small additions are required to convert a manually controlled unit to render it suitable for remote or fully automatic control. The time for starting up is very short, since no synchronising and paralleling operations are required.

With rotating conversion plant the control gear for manual operation is also comparatively simple, but becomes quite extensive where remote control or automatic operation is required. In place of the hand operated starting and running switches, contactors are necessary, and numerous relays are required for synchronising, paralleling and protective purposes.

The rectifier almost invariably shows up to great advantage where plant is required for unattended sub-stations, since the cost and maintenance of the necessary control gear is decidedly lower than for other forms of converting units.

Rectifiers are not so much affected by brief heavy overloads or by A.C. system disturbances, since there is no synchronising and no stored energy due to the inertia of rotating parts. Parallel operation with other plant is also readily obtained, due to the irreversibility of the rectifier, and the voltage of operation has no marked effect on the power factor unless grid control is employed for such a purpose.

### Capital Cost

A comparison of actual costs of converting equipment is, in general, unsatisfactory in a book of this nature, since prices are subject to variation depending upon numerous conditions. Furthermore, each problem has its own peculiarities so that a strict comparison should only be made against tenders for a given specification. It can be assumed for a preliminary survey that for plant to operate at 500 to 600 volts that the rotary and the rectifier equipments will roughly cost about the same. At higher voltages the rectifier is progressively cheaper and at lower voltages dearer than the corresponding rotary equipments.

The present minimum economical size of a metal clad rectifier is about 500 k.w. The glass bulb rectifier can be made down to very small capacities, but though the initial costs may not be too attractive, by taking into account also maintenance and operation costs, the saving by the use of rectifiers in place of other forms of conversion unit may become a sound financial proposition.

### Comparative Costs

It has been stated that to give actual costs of comparison serves no useful purpose except where equipments are quoted against a definite requirement. Even then, with prices continually altering it is not safe to set down the costs in £ s. d. in a book. It is, therefore, preferred in giving the following example to compare costs on a percentage basis. In general, if certain prices rise all plant is effected and the same applies if the costs of production fall. The percentage variation in difference of costs is modified in consequence but little, and the example will remain comparatively true to facts.

Let it be assumed that a sub-station is to have a capacity of 1,500 k.w., and is to supply energy to a suburban tramway traction system at 500 volts. A load chart to be expected is as given in Fig. 99, which is in fact taken from actual charts. It will be noticed that the sub-station is to house three similar equipments and that one unit will operate for twenty-four



hours, the second one will be started up when the load on the first is 75 % of the rated output of No. 1 unit. When the load has increased to 75 % of the total rated output of the two units combined, the third unit will start up. As the load decreases the units will drop out of service in the reverse order and at loadings, which will leave a margin on the remaining running plant to prevent the unit which drops out from immediately starting up again.

Three schemes suggest themselves, namely (a) a three unit

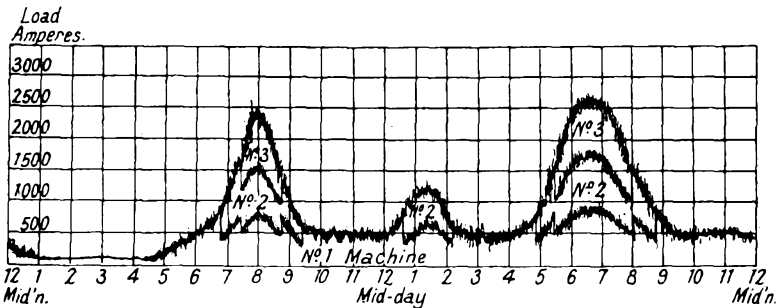

FIG. 99.—A summated load chart of three 500 K.W. 560 volt rotary converters used to supply a typical suburban tramway system.

The load factor of No. 1 machine is	71.5%
" " " No. 2 " "	29.4%
" " " No. 3 " "	16.5%

The total energy demand per day is about 14,000 K.W.H. making an annual demand of 5,110,000 K.W.Hs.

manually operated rotary converter sub-station, each machine of 500 k.w. capacity, (b) an automatic rotary converter sub-station, and (c) an automatic mercury arc rectifier sub-station.

Turning to the chart in Fig. 99, it is noted that the load factor of the units will be 71 % for No. 1, 29.4 % for No. 2 and 16.5 % for No. 3. The total daily energy demand will be 14,000 k.w. hours, or 5,110,000 k.w. hours per annum, approximately.

Consider now graph (a) in Fig. 100, and it will be observed that the automatic rotary converter sub-station is the most expensive from the point of view of initial capital cost. This cost is taken for purposes of comparison as 100 %, the plant

taking 81.6% and the building 18.4% of the total price. Since the buildings will be the same size for all three types of converting unit, the differences in the total price of each sub-station is made up in the variation of the purchase price of the respective units and distribution gear. The manual rotary converter sub-station is the cheapest, at 77.6% of the cost of an automatic rotary converter sub-station, while the cost of

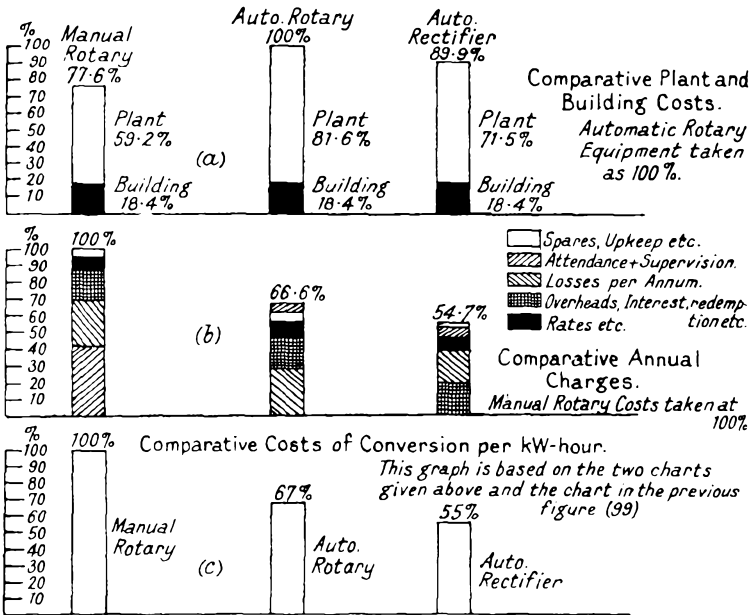

FIG. 100.—Three charts given to indicate the comparative costs for a suburban tramway system with a capacity of 1,500 K.W. at 560 volts D.C. operating under the condition illustrated in Fig. 99.

the rectifier sub-station comes between the two extremes, at 89.9% of the cost of the automatic rotary sub-station.

These costs are based on the price of the conversion units, two 11,000 volt feeder switch panels and a panel for each transformer to the converter unit, a D.C. switch board for the control of the D.C. side of each unit, and includes for 4 D.C. feeders. All the necessary automatic control gear in the case

of the two automatic types and also high speed circuit breakers on the D.C. feeders.

Now refer to graph (b). The costs here have been made up as follows:

**LABOUR COSTS.**—For the manual rotary sub-station a four cycle shift has been allowed for, comprising an attendant and an assistant. In both the automatic sub-stations allowance has been made for a daily visitation by an attendant, and each week for the attendant to work two days of eight hours each, with a mate and cleaner for overhaul and general cleaning purposes.

**OVERHEADS.**—In these costs 10% has been allowed for supervision on the labour charges just mentioned. The redemption of capital costs of the equipment has been allocated as equal increments spread over twenty years for the plant and fifty years for the building. Loss of interest on capital at  $3\frac{1}{2}$ % per annum has likewise been spread equally. Insurance of the plant has been taken at 1/- per £1,000. A common amount has been added for upkeep of the building, which includes light, heat, repairs and pointing.

**LOSSES.**—The losses have been calculated on a basis of 0.5 pence per unit, and in accordance with the graphs of efficiency given in Fig. 72 and the chart in Fig. 99.

**RATES.**—The rateable value has been assessed at £2 per square yard of superficial area covered by the building and the rates payable at 15/- in the £. The water rate has been fixed at  $7\frac{1}{2}$ % per annum of the rateable value or assessment. The water used for cooling purposes in the cases of the rectifier sub-station should not exceed the allowance if a re-cooler is used.

**SPARES.**—In this item new brushes have been allowed for on a basis of a complete replacement per machine per annum. Cleaning materials, oil, recorder charts, and sundry other items have also been included.

It will thus be seen that the ground has been covered fairly

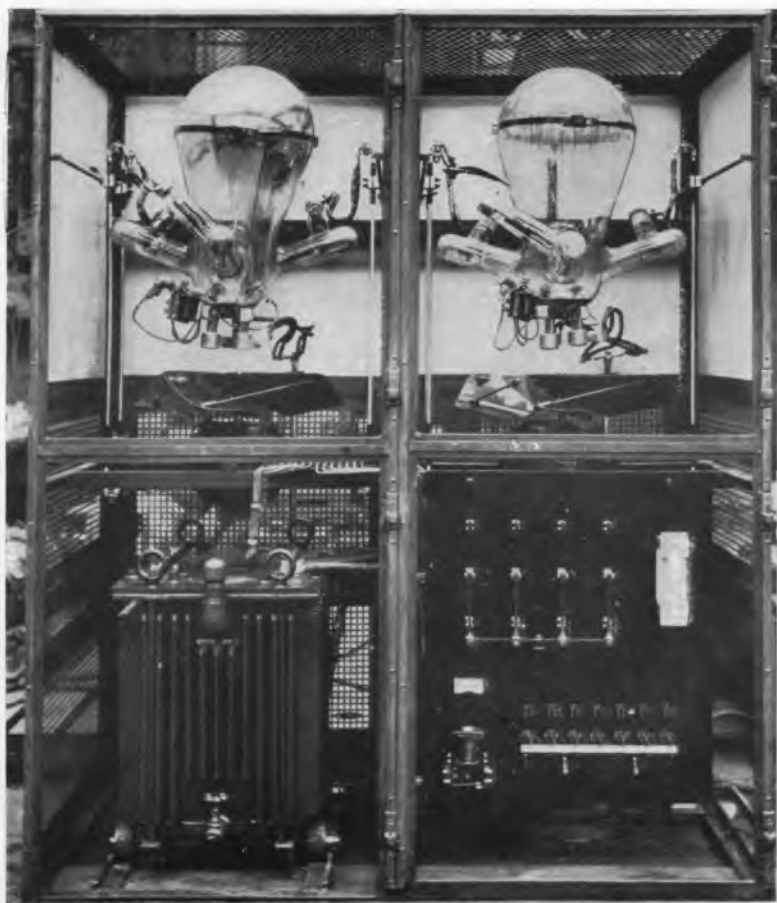

FIG. 101.—A typical cinema equipment which is particularly compact in so far as the transformer is housed in the rectifier cubicles, and the whole equipment self contained within a sheet iron enclosure.

[To face page 210.]



FIG. 102.—A small tramway traction equipment used to boost the pressure at the end of a track overhead line.

completely and that most of the charges are based on data which is common to all three types of sub-station.

The manual rotary converter sub-station now appears in an unfavourable light, and if again a datum of 100 % is used it will be noticed that the automatic rotary converter sub-station has a value 33.4 % cheaper, while the rectifier is 11.9 % cheaper still.

The third chart (c) has been plotted to show the relative cost per k.w. hour of output from each of the sub-stations under consideration. The manual rotary converter unit price has been used as a datum.

If it is assumed that the energy is sold at 0.85 pence per k.w. hour, which is a fair average price for sales in this country, the relative profits obtained from each type of sub-station will be as follows :

Automatic rectifier . . .	100 %
Automatic rotary . . .	97 %
Manual rotary . . .	88 %

Thus for the cases under consideration the nett profits over the twenty year life of the plant are

RECTIFIERS.—£38,600 more than obtained from the manual sub-station ; or  
 £10,260 more than obtained from the automatic rotary converter sub-station.

The foregoing example clearly indicates that for the particular conditions which have been taken into account the installation of rectifier equipments is certainly the most attractive proposition. It must be realised that the example is only for one particular case, and with a particular size of unit. In other cases it may be found that rotating plant is the most favourable type of unit to install, and each individual installation must be considered separately.

The object of the example is to indicate that the rectifier can be, and actually is, a serious rival to rotating plant, and it is destined to become more popular as engineers become less

conservative and more familiar with this type of unit for conversion purposes.

In conclusion a few examples of the application of the rectifier will be given.

The first photograph in Fig. 101 illustrates a small rectifier equipment for service in a cinema. The input is at 400 volts three-phase 50-cycles, and the output is at 100 volts and 15 amperes from each bulb. A change over switch is provided so that supplies may be given from either bulb at will. This is a neat unit, the transformer being housed in the base of one of the bulb cubicles. The electro-magnetic ignition apparatus is clearly seen on the left hand side of each bulb. The cooling fans should also be noted.

The second photograph, Fig. 102, is of a small traction rectifier arranged for six-phase operation with a capacity of 100 k.w. at 400 volts. The L.T. A.C. supply is controlled by a switch mounted on the side of the transformer. These two equipments have been made by the Electric Construction Co., Wolverhampton.

Fig. 103 is a B.T.H. 1,200 k.w. rectifier equipment for service on a 1,500 volt traction system. Installed at Erimus sub-station, Newport-Shildon Line, London & North Eastern Railway.

Fig. 104 shows a B.T.H. 500 k.w. 500/520 volt rectifier equipment arranged for automatic operation on a three-wire power and lighting service, installed at Gateshead Sub-station, North-Eastern Electric Supply Co.

Fig. 105 illustrates 2-2,000 k.w. B.T.H. rectifier equipments with air blast type transformers and arranged for remote control.

Clapham Common Sub-station, London Passenger Transport Board.

Fig. 106 is a photograph of a B.T.H. steel tank rectifier equipment for operation at 20,000 volts D.C., installed at Droitwich Station of the British Broadcasting Corporation.

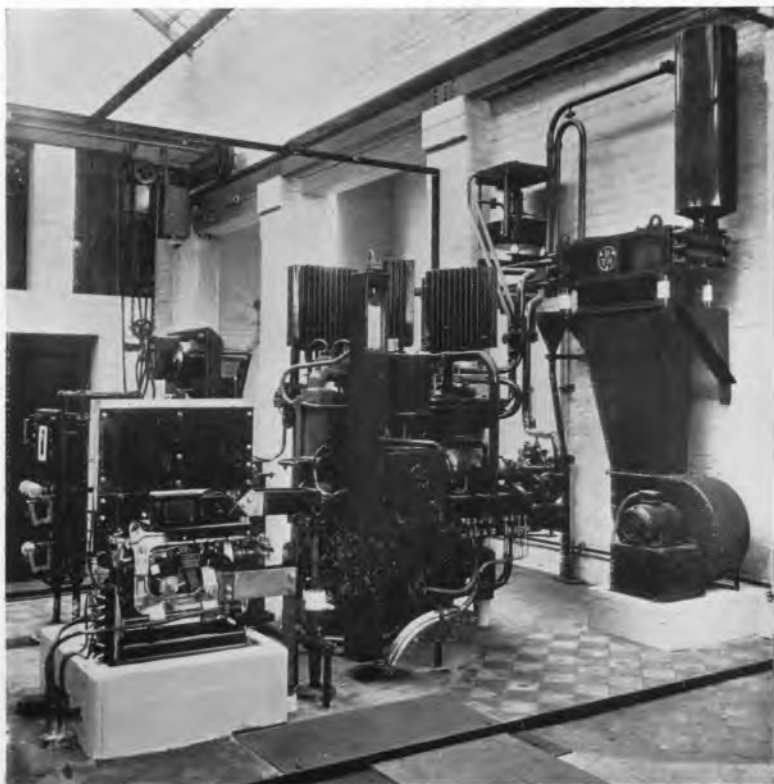

FIG. 103.—A B.T.H. 1,200 K.W. 1500 volt traction equipment at the Erimus sub-station on the Newport-Shildon Line of the London & North Eastern Railway Co. The arrangement of the re-cooler system and the mounting of the high speed circuit breaker are worth noting.

[To face page 212.



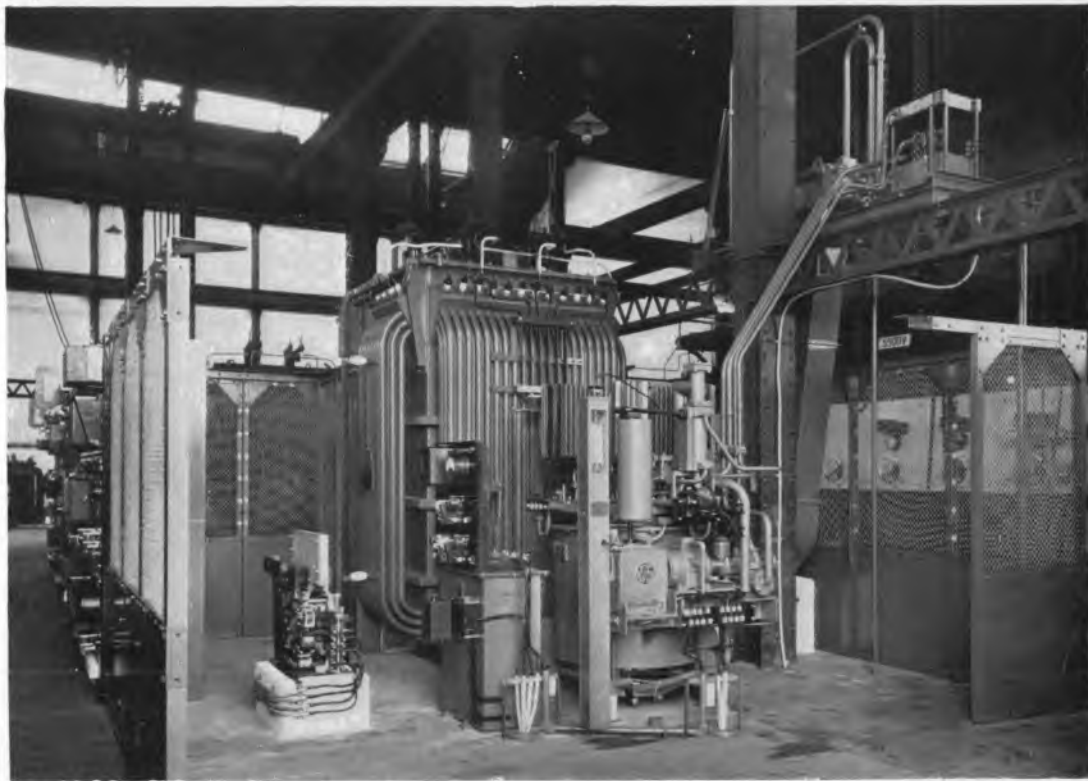

FIG. 104.—A 500 K.W. 500/520 volt fully automatic unit at Gateshead used by the North Eastern Electric Supply Co. to feed into a 3-wire lighting and power system.

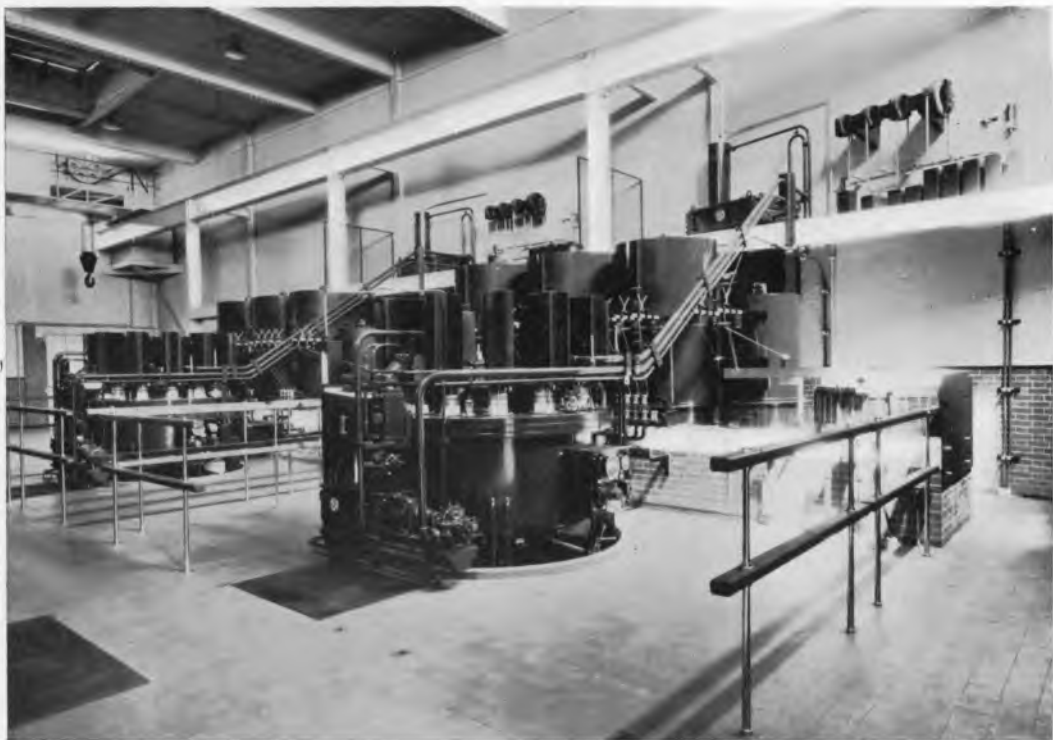

FIG. 105.—A particularly pleasing sub-station layout is that of the Clapham Common sub-station of the London Passenger Transport Board.

[To face page 213.]

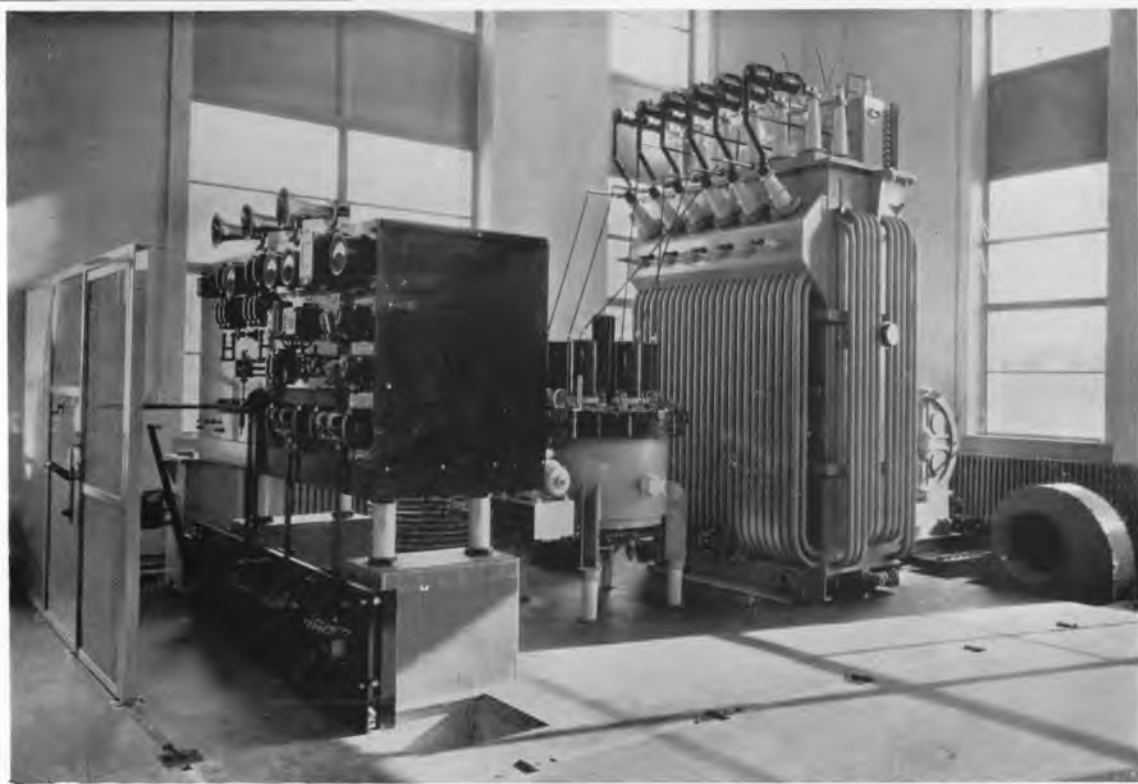

FIG. 106.—An interesting application of high voltage rectification. This is a view of one of two 20,000 volt equipments at the Droitwich Station of The British Broadcasting Corporation. The surge arrestors and series resistances on the top of the transformer are noteworthy.

# APPENDIX

## TABLE I

### STANDARD COPPER CONDUCTORS

Number & Diameter of Wires	Area in Square Inches	Amperes at I.E.E. Rating	Weight in lbs. per 1,000 yds.	Resist in Ohms per 1,000 yds.	Volts Drop per 1,000 yds.
1/.036	.001	4.1	11.7	23.59	96.7
1/.044	.0015	6.1	17.6	15.79	96.7
3/.029	.002	7.8	23.4	12.36	96.7
3/.036	.003	12.0	36.1	8.019	96.7
1/.064	.003	12.9	37.2	7.463	96.7
7/.029	.0045	18.2	54.4	5.281	96.7
7/.036	.007	24.0	83.8	3.427	88.3
7/.044	.010	31.0	125.2	2.295	77.0
7/.052	.0145	37.0	174.9	1.643	65.3
7/.064	.0225	46.0	264.9	1.084	53.6
19/.052	.040	64.0	475.5	.606	41.7
19/.064	.060	83.0	720.3	.400	35.7
19/.072	.075	97.0	911.6	.316	33.0
19/.083	.100	118.0	1211.0	.238	30.3
37/.064	.120	130.0	1403.0	.205	28.6
37/.072	.150	152.0	1776.0	.162	26.3
37/.083	.200	184.0	2360.0	.122	24.0
37/.093	.250	214.0	2963.0	.097	22.1
37/.103	.300	240.0	3635.0	.079	20.4
61/.093	.400	288.0	4886.0	.059	18.2
61/.103	.500	332.0	5994.0	.048	17.1
91/.093	.600	384.0	7290.0	.039	16.3
91/.103	.750	461.0	8942.0	.032	15.9
127/.103	1.000	595.0	12481.0	.023	14.7

TABLE II  
 MAXIMUM SAFE LOADS ON CHAINS, WIRE AND HEMP ROPES

CHAINS			STEEL WIRE ROPE		
Maximum Load on Single Chain.			Maximum Load Single Rope.		
Dia. of Chain in inches	Chain Vertical lbs.	Chain at 45° lbs.	Circumference of Rope in inches	Rope Vertical lbs.	Rope at 45° lbs.
·1875	550	350	1·0	750	500
·25	1,000	700	1·125	1,000	650
·3125	1,500	1,000	1·25	1,300	850
·375	2,200	1,500	1·375	1,750	1,200
·4375	3,000	2,250	1·5	2,250	1,500
·5	4,000	3,000	1·625	2,600	1,750
·5625	5,000	3,500	1·75	2,900	1,950
·625	6,000	4,500	1·875	3,200	2,200
·6875	7,500	5,500	2·000	3,500	2,350
·75	9,000	6,500	2·125	4,000	2,700
·8125	10,500	7,500	2·25	4,500	3,000
·875	12,000	8,500	2·375	5,000	3,300
·9375	14,000	10,000	2·500	5,500	3,700
1·00000	16,000	11,500	2·625	6,000	4,000
1·0625	18,000	13,000	2·75	6,500	4,300
1·125	20,000	14,500	2·875	7,000	4,700
1·1875	22,500	16,000	3·0000	7,750	5,250
1·25	25,000	17,500	3·25	8,750	5,750
1·3125	27,500	19,500	3·5	9,750	6,500
1·375	30,000	21,500	3·75	11,500	7,750
1·5	33,500	23,500	4·0000	15,500	10,000
1·625	38,000	26,500	4·25	17,000	11,500
1·75	42,500	30,000	4·5	18,500	12,500
1·875	48,000	33,500	4·75	20,500	13,500
2·0000	55,000	38,500	5·0000	21,500	14,500
			5·25	23,500	15,500
			5·5	25,500	17,000
			5·75	27,500	18,500
			6·00000	30,000	20,000

HEMP ROPES

Maximum Load Single Rope.

Circumference of Rope in inches	Rope Vertical lbs.	Rope at 45° lbs.
1·0000	80	50
1·5	160	110
2·0000	280	200
2·5	450	300
3·0000	650	450
3·5	875	625
4·0000	1,125	800
4·5	1,425	1,000
5·0000	1,750	1,250
5·5	2,125	1,500
6·0000	2,500	1,750
6·5	3,000	2,100
7·0000	3,500	2,500



Takes load of two single ropes or chains.



Takes load of four single ropes or chains.

FUSE WIRE TABLE III  
PART I

Fusing Current, Amps.	COPPER		ALUMINIUM		PLATINOID	
	Dia. in.	S.W.G. (app.)	Dia. in.	S.W.G. (app.)	Dia. in.	S.W.G. (app.)
1	·0021	47	·0026	46	·0035	43
2	·0034	43	·0041	42	·0056	39
3	·0044	41	·0054	39	·0074	36
4	·0053	39	·0065	37	·0089	35
5	·0062	38	·0076	36	·0104	33
10	·0098	33	·0120	30	·0164	27
15	·0129	30	·0158	28	·0215	24
20	·0156	28	·0191	25	·0261	23
25	·0181	26	·0222	24	·0303	21
30	·0205	25	·0250	23	·0342	20
35	·0227	24	·0277	22	·0379	20
40	·0248	23	·0303	21	·0414	19
45	·0268	22	·0328	21	·0448	19
50	·0288	22	·0352	20	·0480	18
60	·0325	21	·0397	19	·0542	17
70	·0360	20	·0440	19	·0601	16
80	·0394	19	·0481	18	·0657	16
90	·0426	19	·0520	18	·0711	15
100	·0457	18	·0558	17	·0762	14
120	·0516	17	·0630	16	·0861	13

## PART II

Fusing Current, Amps.	TIN		ALLO-TIN		LEAD	
	Dia. in.	S.W.G. (app.)	Dia. in.	S.W.G. (app.)	Dia. in.	S.W.G. (app.)
1	·0072	37	·0083	35	·0081	35
2	·0113	31	·0132	29	·0128	30
3	·0149	28	·0173	27	·0168	27
4	·0181	26	·0210	25	·0203	25
5	·0210	25	·0243	23	·0236	23
10	·0334	21	·0386	19	·0375	20
15	·0437	19	·0506	18	·0491	18
20	·0529	17	·0613	16	·0595	17
25	·0614	16	·0711	15	·0690	15
30	·0694	15	·0803	14	·0779	14
35	·0769	14	·0890	13	·0864	13
40	·0840	14	·0973	13	·0944	13
45	·0909	13	·1052	12	·1021	12
50	·0975	13	·1129	11	·1095	12
60	·1101	11	·1275	10	·1237	10
70	·1220	10	·1413	9	·1371	9
80	·1334	10	·1544	8	·1499	9
90	·1443	9	·1671	8	·1621	8
100	·1548	8	·1792	7	·1739	7
120	·1748	7	·2024	6	·1964	6

## BIBLIOGRAPHY

A.I.E.E. REPORT, 1926.

“Mercury Arc Rectifiers.” Vol. 45, pp. 951-952.

BUTCHER, C. A.

“Applications of Mercury Power Rectifiers.” *A.I.E.E. Jour.*, Vol. 46, pp. 446-450. 1927.

ELLIOT & PARSON.

“Experiments on a Mercury Arc Converter.” *Electrician*, Vol. 67. 1911.

FLEMING, SIR J. A.

“Mercury Arc Rectifiers and Mercury Vapour Lamps.” Pitman. 1925.

GUNTHESCHULZE.

“Electric Rectifiers and Valves.” Chapman & Hall.

JOLLEY, L. B. W.

“Alternating Current Rectification.” Chapman & Hall.

LEBLANC.

“Mercury Vapour Converters, their Capacity and Efficiency.” *Electrician*. 1913.

MARCHANT, E. W.

“Methods of Getting Rid of Telephone Interferences from Mercury Arc Rectifiers.” *I.E.E. Jour.*, Vol. 62. 1924.

“Mercury Arc Rectifiers and Telephone Interference.” *I.E.E. Jour.*, Vol. 69. E.R.A. Report.

MARTI, O. K.

“Rectification of Alternating Currents.” *A.I.E.E. Jour.*, Vol. 45, pp. 832-846.

MARTI, O. K., and WINOGRAD, H.

“Mercury Arc Power Rectifiers, their Applications and Characteristics.” McGraw-Hill. 1930.



- ORCHARD, F. C., PATTERSON, J. H., and THURMAN, A. T.  
 "Electric Transmission and Distribution." *Pitman*,  
 Vol. 6, pp. 1388-1433.
- PRINCE, D. C.  
 "Mercury Arc Rectifier Phenomena." *A.I.E.E. Jour.*,  
 Vol. 46, pp. 667-674.  
 "Rectifier Voltage Control." *A.I.E.E. Jour.*, Vol. 45,  
 pp. 630-636.  
 "Mercury Arc Rectifiers." *A.I.E.E. Jour.*, Vol. 45,  
 pp. 1087-1094.
- PRINCE, D. C., and VODGES, F. B.  
 "Principles of Mercury Arc Rectifiers and their Circuits."  
 McGraw-Hill. 1927.
- RISSIK, J. W. and H.  
 "Traction Rectifiers." *I.E.E. Jour.*, Vol. 69.  
 "Mercury Arc Rectifier Transformer Connections."  
*Electrical Times*. July, 1934.
- ROGERS, G.  
 "Automatic and Semi-automatic Mercury Vapour  
 Rectifier Sub-stations." *I.E.E. Jour.*, Vol. 63, pp. 157-  
 172.  
 "Mercury Arc Rectifier Sub-stations." *Electrical Review*.  
 1924.
- ROSLING, P.  
 "Rectification of Alternating Current." *I.E.E. Jour.*,  
 Vol. 63, pp. 624-632.
- SCHULZE, G.  
 "Experiments on Mercury Vapour Rectifiers." *Elektro-  
 tech. Z.*, Vol. 30, pp. 295 and 373. 1909.
- STIGANT, A., and LACEY, T.  
 The Johnson and Phillips' "Transformer Book." 1935.

## INDEX

- A**CCIDENT report book, 174  
 A.C. relays, 37, 38, 86, 140  
 Air break switches, 34  
 Air filter, 40  
 Alternator, 15, 118, 119  
 Ambulance perquisites, 174  
 Anode, arms, 3, 97  
 — baffles, 47  
 — coolers, 140, 145, 148, 160  
 — fuses, 34  
 — impurities, 3, 49  
 — inductance coil, 15, 34, 35, 132  
 — load factor, 31, 33  
 — protection, 47, 50, 52  
 — rating, 24, 49, 111  
 — shields, 47, 48, 49, 50, 176  
 — stem draining, 103  
 — stress, 49  
 — temperature, 49, 102  
 — voltage drop, 12  
 Arc commutation, 11, 13, 15, 180, 190  
 — control by grids, 176  
 — stability, 50, 51, 52, 62, 142  
 — striking of, 2, 36, 37, 38, 78, 84, 131, 138, 142, 144, 157, 158, 175, 177, 187  
 — voltage drop, 1, 4, 12, 15, 27, 62, 67, 93, 145, 150, 151, 153, 178  
 Architecture, 67  
 Arcing tips, 116  
 Artificial loading, 3, 26  
 Atmospheric pressure, 53  
 Automatic features, 65, 78, 79, 80, 81, 82, 83, 84, 85, 86, 87, 88, 156  
 — shut off valve, 54, 58, 112, 132, 134, 136, 137, 148, 157, 160  
 — sub-stations, 78  
 Auto-reclose circuit breakers, 79, 80  
 Auto-transformers, 40, 42
- B**ACK-FIRES, 2, 15, 40, 49, 50, 52, 62, 84, 95, 113, 143, 180, 181  
 Bake-out, adjustments, 147  
 Bake-out, divided, 146  
 — emergency, 147  
 — final, 136, 146, 147  
 — final instructions, 148  
 — full wave, 144  
 — half wave, 143  
 — instructions prior to, 99, 137, 140  
 — overload, 146  
 — resistor, 142, 144  
 — what it is and does, 3, 143  
 — windings, 74  
 Balancer-rotary, 93, 113, 205  
 Barometric seal, 57, 133  
 — pressure, 57, 122  
 Backing pump. *See* rotary vacuum pump.  
 Bedding in switch contacts, 115, 129  
 Bela Schafer, 5  
 Benzine, 100, 107  
 Birmingham, 5  
 Board of Trade Regulations, 114  
 Borosilicate glass, 4  
 Breathers, calcium chloride, 166  
 — silica gel, 166  
 Brief history of rectifiers, 1  
 British Broadcasting Corporation, 212  
 British Thomson-Houston Co., 6  
 British patents, 1, 2  
 British standard testing needles, 117  
 Brown Boveri Co., 5  
 B.S.S. 109 air break switches, 129  
 — 110 air circuit breakers, 129  
 — 1598 bus bars, 129  
 — 358 sphere gaps, 120, 121  
 Buildings, 70, 71, 75, 76, 205  
 — costs, 68, 77  
 Bulbs, adjustments to, 37, 97, 131, 155  
 — artificial cooling, 3, 4, 39  
 — blackening, 155  
 — handling, 97  
 — seals, 5

Bulbs, strains, 4, 5  
 — production, 4, 5  
 — transport, 97  
 — working in, 40, 132, 155  
 Bus bar expansion, 129, 130

**C**ABLES, 71, 73, 75, 96, 97, 108, 109, 111, 114  
 — calculation of sizes, 31, 32, 111  
 — specification, 32, 63, 110, 111  
 — creepage clearance, 111  
 Calcium chloride breathers, 166  
 Calibration of high speed breakers, 163  
 Capital costs, 27, 65, 66, 68, 90, 207  
 Cathode inductance coil, 35, 39, 132, 192  
 — voltage drop, 12  
 Choice of type of plant, 64, 69  
 Commercial production of bulbs, 4  
 Commutator-less motors, 198, 199  
 Comparative costs, 207  
 Compensating reactor, 27  
 — valve, 56, 139  
 Contact tips of H.S. breakers, 161, 162  
 Contact making relays, 56  
 Control circuits, 85, 86, 206  
 — of cooling fan speed, 39, 40  
 — of voltage by grids, 41, 176  
 — transformers, 85, 90  
 Cooling, artificial, 3, 4, 39  
 — water, 47  
 — water systems, 57, 58, 59, 100, 101, 102, 103, 104, 105, 106  
 Copper-oxide rectifiers, 51, 87  
 Creed vacuum relay, 140  
 Critical value of load current, 62  
 Current, conduction, 1  
 — limitation, 5, 27, 39, 49, 50  
 — relays, 26, 39, 65, 74, 80  
 — transformers, 123, 125, 126, 151  
 — limiting resistances, 85, 90

**D**.C., bus bars, 129  
 — reactor, 60, 61, 108, 112, 141  
 — relays, 37, 38, 39, 131  
 — switchgear, 129  
 Dielectric tests on oil, 165  
 Diffuser pump. *See* mercury pump.  
 Diode valve, 6, 176  
 Direct acting relays, 181, 182  
 Discriminative protection, 92, 183  
 Displacement factor, 192

Distortion factor, 192  
 Divided bake-out, 146  
 Dixon's compound, 104  
 Draining anode stems, 103  
 Drawing office staff, 96

**E**ARTHING, 96, 97, 104, 106, 112, 113, 115, 119, 121  
 Earth leakage relay, 85, 86, 111, 123, 148  
 Economic rating, 65, 66, 67, 69, 207  
 Edison Effect, 1  
 Efficiency, 65, 67, 93, 149, 150, 153, 202  
 — all day, 66, 203  
 — curves, 66, 200  
 — of rotary converters, 67, 202  
 Electric Construction Co., 212  
 Electro-magnetic ignition, 36, 37, 38, 39  
 Electrolysis, 58, 59, 62, 65, 103  
 Electrostatic field, 7, 12  
 Emergency bake-out, 147  
 — door, 71  
 Excitation chokes, 36, 38, 52, 131, 155  
 — general information, 35, 36, 51, 52, 141  
 — relays, 78  
 — transformer, 37, 75, 84, 106, 111, 157  
 Expansion reservoir, 103, 104, 161

**F**ACTORY Act, 174  
 Failure of E.H.T. supplies, 46, 84, 94, 133, 158  
 Fan motor circuits, 39  
 — speed control, 39, 40  
 Final bake-out, 136, 146, 147  
 Fire insurance, 77  
 — risk, 70, 71, 77, 78, 174  
 First principles, 8  
 Fleming, Sir Ambrose, 1  
 Foreign gases, 3, 52, 56  
 Frequency conversion, 196  
 — high, 196  
 — variation, 60, 110, 149  
 Full wave bake-out, 144  
 Fuses, E.H.T., 85, 90, 116  
 — L.T., 34, 37, 85, 90, 110, 130, 131

**G**E.C. of America, 5  
 G.E.C., British, 90

- Generator, D.C., 75, 129, 160, 185  
 Grid, arrangement of, 176  
 — methods of exciting, 171, 178, 184, 185, 186, 187, 188  
 — protection, 180  
 Grid control, of arc, 177  
 — — of voltage, 183  
 — — principles, 175  
 Guntheschultze, 3
- H**ARMONICS, 18, 19, 25, 26, 27, 28, 29, 61, 62, 63, 149, 184, 192, 203  
 Heavy duty rectifiers, 3, 8, 27, 65, 68  
 Hendon sub-station, 6  
 Hewitt, Peter Cooper, 1  
 Hewitt Electric Co., 5  
 High frequency current, 196  
 — — oscillation, 121  
 High speed breakers, 83, 86, 90, 91, 92, 111, 112, 113, 183  
 — — — calibration, 163  
 — — — operation and maintenance, 161  
 High voltage tests, 116, 149  
 — — — calculations, 122, 123  
 — — — form factor, 122  
 — — — induction regulator control, 118  
 — — — measurements, 120  
 — — — methods of applying, 117  
 — — — on transformers, 114, 126  
 — — — precautions, 116, 118  
 — — — rheostat control, 118  
 — — — series resistance control, 118  
 — — — types of, 117  
 — — — voltage regulation, 118  
 — — — sphere gaps, 117  
 High voltage operation, 41, 212  
 — — — transmission, 85
- I**GNITION, 35, 36, 51, 131  
 — — and excitation circuits, 36, 51  
 Inclined potential control, 188  
 Industrial service, 64, 70  
 Induction heaters, 53, 134  
 — regulators, 41
- Inductive loop, 61, 62  
 Insulation tests, 116, 119, 126, 138  
 Insulating pads, 98  
 Installation of plant, 96  
 Interconnecting cables, 15  
 Interference, 29, 60, 61, 62, 193, 203  
 Intermediate vacuum chamber, 67, 133, 136  
 Internal cooling system, 47  
 Interphase reactor, 15, 21, 23, 24, 25, 26, 27, 29, 30, 42, 74, 157, 184  
 Inverse time limit relay, 34, 86, 91, 123  
 Inverted operation, 189, 193
- J**OINTING pipe work, 104
- K**ICK test, 123  
 Kirtchoff, 22
- L**ABOUR costs, 65, 210  
 Langmuir, Dr., 52  
 Lay-out of sub-stations, 70, 71, 72, 73, 74, 75, 76, 96  
 Leakage current, 58, 102, 114, 118  
 Limit of emission, 7  
 Limit switches, 46  
 L.M.S. Railway Co., 212  
 L. & N.E. Railway Co., 212  
 Load factor, 208  
 — sharing, 27, 35, 74, 157  
 — — relay, 74  
 Loading resistance, 26  
 Lock-out relay, 85, 87  
 London Electric Railway Co., 6  
 London Passenger Transport Board, 212  
 Losses, 53, 93, 210  
 — of revenue, 94  
 — in excitation circuit, 52  
 — in induction regulator, 41  
 — in interphase reactor, 26  
 — in transformers, 108, 152  
 Low power plant, 64
- M**AINTENANCE of automatic features, 95, 168  
 — — buildings, 173  
 — — glass bulb rectifiers, 65, 159, 172, 205  
 — — high speed breakers, 161  
 — — relays, 171  
 — — steel tank rectifiers, 75, 159, 172, 205

- Maintenance, switchgear, 95, 171, 172  
 — — — transformers, 77, 164, 172  
 McLeod vacuum gauge, 55, 98, 106,  
 134, 135, 136, 139, 140, 144  
 Medium power plant, 64  
 Mercury, addition to a valve, 7  
 — pump, 51, 52, 57, 58, 59, 84,  
 87, 101, 103, 133, 134, 136, 138,  
 158, 160  
 — seals, 50, 98, 106, 145  
 Micallex seals, 50  
 Micron meter, 56  
 Micron, value of, 55, 57  
 Midworth repeater, 88, 89, 90  
 Minister of Transport, 6  
 Molybdenum, 4  
 Motor generators, 51, 87
- N**ATIONAL Grid, 95, 194  
 Negative space charge, 6, 7  
 Nicol prism, 4  
 Noise, 204  
 North Eastern Electric Supply Co.,  
 212
- O**FFICE records, 173  
 Oil circuit breakers, 34, 78-86,  
 90, 95, 113, 130  
 Oil dash pots, 44  
 Oil dielectric strength, 108, 126, 127,  
 165  
 Oil trap, 133  
 Oil storage, 108  
 Operation of glass bulb rectifiers, 155  
 — — — steel tank rectifiers, 156  
 Overflow pipes, 104  
 Overhead costs, 210  
 Overlap, 13, 15, 21, 22, 23  
 — effects of, 14  
 Overload bake-out, 146  
 — general information, 49, 66, 80,  
 84, 91  
 — ratings, 69, 70  
 — relays, 34, 86, 91, 123, 130, 148
- P**ARALLELING, 25, 80, 94, 132,  
 156, 157, 158, 206  
 Parallel operation, 35, 44, 64, 83, 86  
 Peaking transformer, 186  
 Phase rotation, 141, 144  
 Phase shift of ignition, 178, 179  
 Phasing out, 141  
 Pirani vacuum gauge, 56, 75, 87, 112,  
 138, 142, 148
- Plant capacity, 65, 69  
 Power factor, 27, 42, 149, 153, 185,  
 191, 192, 203  
 — — — meters, 149  
 Portland cement, 98  
 Pressure rise, control of, 26  
 — — — no-load, 25, 30, 33, 157,  
 184  
 — — — relays, 41, 43, 74, 80, 81, 133  
 — — — tests, 63, 108, 114, 116  
 Principles of rectification, 8  
 — — — grid control, 157  
 Protection, 84, 85, 86, 95, 125  
 Protective enclosures, 75, 103, 112,  
 119
- Q**UARTZ, 49
- R**AILWAY Electricity Committee's  
 Report, 6  
 Rates, 210  
 Reactance. *See also* overlap, 12, 18,  
 21, 23, 24, 25, 27, 153, 157, 184  
 — effect of, 14  
 — in external circuit, 15  
 Reactive K.V.A., 191, 192, 195, 196,  
 200  
 Reactor, compensating, 27  
 — interphase, 15, 21, 23-30, 42,  
 74, 157, 184  
 — D.C., 60, 61, 108, 112, 141  
 Recorders, 58, 59, 75, 103, 104, 105,  
 138, 149, 157, 160, 161  
 Records, 173  
 Rectification, principles of, 8  
 Regeneration, 197  
 Regulation, 15, 17, 18, 25, 27, 41,  
 47, 157, 179, 184, 204  
 Relays, 78-88  
 — testing, 123  
 Remote control, 41, 68, 74, 78, 84,  
 85, 88, 95  
 Replacement costs, 65  
 Resistance heaters, 52, 53  
 — temperature coefficient, 56  
 Resonance, 120  
 Resonant shunts. *See* smoothing  
 circuits.  
 Reverse current trips, 84  
 Rotating converters, 5, 66, 69, 148  
 Rotary vacuum pump, 54, 55, 57, 75,  
 84, 85, 87, 106, 112, 132, 134, 136,  
 148, 158, 160, 161

- Rubber hose, 58, 102, 103  
 — seals, 50  
 Rupturing capacity of switchgear, 15,  
 94, 95  
 Rubbing velocity in pumps, 54
- SEALS**, 2, 3, 4, 5, 50, 52, 98, 106,  
 148, 160  
 — leakage, 99  
 — current limitation of, 4, 5, 64  
 Secondary batteries, 86  
 Sectional rectifiers, 67  
 Seepage tests, 136  
 Sequence timing relay, 87  
 Short circuits, 15, 25, 27, 83, 92, 94,  
 95, 111, 182, 183  
 Silica gel breathers, 166  
 Sine wave control of grids, 187  
 Small wiring, 97, 110, 112, 123, 125,  
 127  
 Smoothing circuits, 15, 60, 87, 96,  
 108, 192  
 Spares, 210  
 Spare plant, 65  
 Specifications, 69, 158  
 Spectroscopic effect, 5  
 Sphere gaps, 117  
 — — use of, 121  
 Staff organisation, 168  
 Static earthing device, 114  
 Sub-station lay-out, 70, 71, 72, 73,  
 74, 75, 76, 96  
 Surge arresters, 63, 75, 96, 110, 140,  
 141, 159, 160  
 — protection, 62, 159  
 Switchgear, considerations, 15, 94,  
 114  
 — safety factor, 94, 95  
 — purchase of, 94
- TAP** water, 58, 59, 101, 102  
 Technical Report on Pressure  
 Tests, 117  
 Testing, anode currents, 132  
 — bus bar joints, 130  
 — cathode chokes, 132  
 — circulating pumps, 138  
 — cooling fan motors, 132, 138  
 — excitation currents, also voltage,  
 35, 37, 131, 141, 155  
 — glass bulb rectifiers, 130  
 — H.S. circuit breakers, 127, 162  
 — ignition circuits, 131, 158  
 — insulation, 116, 136  
 Testing, insulating feet, 98  
 — McLeod gauge, 55, 107, 135  
 — oil circuit breakers, 115  
 — phase rotation, 141, 144  
 — phasing and voltage, 131  
 — Pirani gauge, 138, 139  
 — pressure, 116  
 — relays, 123, 124, 125, 126  
 — rotary pumps, 132  
 — seepage, 136  
 — steel tank rectifiers, 132  
 — surge arresters, 140  
 — transformers, 126, 152  
 — vacuum, 136  
 — — pipes, 136  
 — water glands, 134  
 Thermostatic relay, 59, 84, 87, 134,  
 138, 148, 157, 160  
 Thermal capacity, 69  
 Three-wire operation, 47, 93, 204  
 Thyatron valve, 182  
 Tilting coil, 37, 38  
 Time delay relay, 44, 139  
 Timing sequence relay, 87  
 Town's water supply, 58  
 Traction service, 5, 6, 41, 61, 64, 68,  
 70, 71, 83, 86, 90, 91, 185, 198, 207  
 Transformers, air cooled, 78  
 — double-three-phase, 26, 27, 184  
 — double triple star, 30  
 — efficiency, 20, 24  
 — end turns, 62  
 — general information, 8, 15, 77,  
 108, 131, 145  
 — indoor *v.* outdoor, 77  
 — inductance, 22  
 — K.V.A. ratings, 20, 24, 27, 69  
 — leakage flux, 15, 17  
 — losses, 108, 152  
 — oil, 108  
 — on load tap changing, 41, 157  
 — overheating, 85  
 — peaking, 186  
 — permeability, 19  
 — pressure tests, 114, 126  
 — quadruple zigzag, 26, 29, 184  
 — six-phase delta double star, 18  
 — — star double star, 19  
 — — triple star, 26, 27  
 — three-phase, 16, 31  
 — — zigzag, 17, 31  
 — triple four-phase, 26, 29  
 — utility factor, 20, 24, 30, 33  
 — water-cooled, 167  
 — water tubes, cleaning, 167, 168

- Transmission, high voltage, 194  
 Triple frequency M.M.F., 18, 25, 27  
 — — — current, 18, 26
- UTILITY** factor, 20, 24, 30
- VALVE** action of rectifier, 6  
 Vacuum chamber, 47, 49, 51, 55, 56  
 — interstage reservoir. *See* interstage reservoir.  
 — piping, 75, 76, 102, 104, 106, 107, 134  
 — protection, 87  
 — pumping, 3, 106, 108, 134, 136, 143  
 — relays, 56, 140  
 Vapour pressure, 4, 7, 12, 35, 37, 52, 62, 139  
 Variable speed control of fan motors, 39, 40  
 Ventilation, 40, 70  
 Voltage drop tests, 111  
 — factors, 33
- Voltage control, 40, 41, 42, 80, 81, 82, 83, 94
- WANDERING** hot spot, 49  
 Ward-Leonard, 197  
 Water circulating pumps, 51, 75, 104, 105, 106, 134, 138, 160  
 Water as an insulator, 58, 103  
 — cooled transformers, 167  
 — cooling, 57, 59, 100, 134  
 — distilled, 59, 104  
 — jacket, 47, 49, 59, 103, 138  
 — supplies, 58, 59, 70, 138  
 Watt meters, 150  
 Wave form, 10, 14, 19, 26, 27, 35, 60, 62, 119, 121, 122, 123, 149, 203  
 — — distortion, 19, 28, 42, 62, 122, 184, 185, 191, 192  
 — — of induced pressure, 21, 23, 122  
 Weintraub seal, 51  
 Welding glass bulbs, 4  
 Wheatstone bridge, 56, 138  
 Wireless reception, 6  
 Working in bulbs, 40, 132, 155  
 Workman's Compensation Act, 174