

Stanford University Libraries

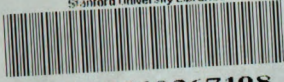

36105010267198

# COMPLETE DIO BOOK

---

AND FRANCIS YATES  
AND  
S GERARD PACENT



**THE  
COMPLETE RADIO BOOK**



**Tuning in a transatlantic message**

# THE COMPLETE RADIO BOOK

BY

**RAYMOND FRANCIS YATES**

Former Managing Editor "Popular Science Monthly" and Editor of "Everyday Engineering Magazine." Member Institute Radio Engineers, American Society of Mechanical Engineers, American Institute Electrical Engineers, American Physical Society. Radio Editor New York "Evening Mail"

AND

**LOUIS GERARD PACENT**

Member Institute Radio Engineers, Past Vice-President Radio Club of America, Chairman and Director of the Publication Committee, Radio Club of America. Member American Institute Electrical Engineers

ILLUSTRATED WITH DIAGRAMS,  
PHOTOGRAPHS AND MAPS

STANFORD LIBRARY



NEW YORK  
THE CENTURY CO.

1922

55

**This Book is Endorsed by the Radio Section  
of the  
Associated Manufacturers of Electrical Supplies**

**298732**

**COPYRIGHT, 1922, BY  
THE CENTURY CO.**

WYANDOTT GROUNDS

**PRINTED IN U. S. A.**

**Dedicated to the scientists, engineers,  
and inventors who through their labor  
and genius in perfecting the art of radio  
communication have placed at the dis-  
posal of mankind one of the most useful  
and powerful instrumentalities of the age**

## FOREWORD

The authors of this book have made what they believe is the first attempt to outline the practical, commercial, and romantic sides of radio telephone and telegraph communication. In preparing the manuscript they visualized a book that would instruct and entertain the layman. The practical information has been made as readable as possible and the subject matter has been carefully chosen so as to include the many problems that confront the beginner in either the construction or operation of a radiophone receiver or transmitter.

The story of radio, its development and application, forms one of the most interesting chapters in the history of science. Few people realize the importance of this new art in our every-day life or what the future holds for it. The Radio Age is here, with all of its wonders and all of its possibilities.

The authors wish to thank Mr. L. M. Clement and Mr. H. Houck for their kindness in reading the manuscript. They also wish to thank Miss Mary Texanna Loomis, principal of the Loomis Radio School, Washington, D. C., for her coöperation in supplying the records of the work of Dr. M. Loomis. They take this opportunity to thank Miss Virginia Waterson for her effort in collecting the biographical material and Mrs. R. F. Yates for her work in typing the complete manuscript.

RAYMOND FRANCIS YATES

LOUIS GERARD PACENT

vii

## CONTENTS

CHAPTER		PAGE
I	COMMUNICATION, ANCIENT AND MODERN . . . . .	3 ✓
II	THE "HOW" AND "WHY" OF RADIO . . . . .	53
III	RADIO TELEPHONY . . . . .	74
IV	RECEIVING FROM THE BROADCASTING STATIONS . . . . .	82
V	RADIO AS A HOBBY . . . . .	93 ✓
VI	RADIO FOR THE TRAVELER AND VACATIONIST . . . . .	131
VII	THE VACUUM TUBE . . . . .	137
VIII	THE VACUUM TUBE IN VARIOUS RÔLES . . . . .	158
IX	THE LONG ARM OF RADIO . . . . .	169
X	WORLD-WIDE RADIO . . . . .	187
XI	RADIO ON THE SEVEN SEAS . . . . .	213
XII	RADIO IN THE HOME . . . . .	225
XIII	RADIO ON THE FARM . . . . .	241
XIV	RADIO IN THE NATION'S BUSINESS . . . . .	251
XV	RADIO IN THE AIR . . . . .	266
XVI	RADIO AND THE NEWSPAPER . . . . .	278
XVII	WHO'S WHO IN RADIO . . . . .	286
XVIII	QUESTIONS AND ANSWERS . . . . .	316
	INDEX . . . . .	329



## LIST OF ILLUSTRATIONS.

	PAGE
Tuning in a transatlantic message . . . . .	<i>Frontispiece</i>
Communication of South American savages . . . . .	5
Semaphore system of signaling as used in France during the Revolution . . . . .	11
The first wireless or radio transmitter and receiver used by Professor Hertz . . . . .	32
One of the early ground "wireless" systems . . . . .	34
Dr. Loomis's oscillator . . . . .	39
Loomis's theory of radio transmission . . . . .	39
Another sketch from Loomis's note-book . . . . .	42
The instruments for a simple radio telegraph transmitter . . . . .	60
Damped and undamped waves . . . . .	60
The Alexanderson high-frequency alternator . . . . .	67
Simple radio receiving outfit . . . . .	72
The radio link between Avalon and Los Angeles . . . . .	80
Variable condenser connection . . . . .	83
Loading coil connection . . . . .	83
De luxe receiver . . . . .	84
Simple vacuum tube receiver . . . . .	84
Construction of one-wire aërial . . . . .	85
Details of buzzer test . . . . .	87
Two-stage amplifying receiver . . . . .	88
A simple crystal receiver . . . . .	88
How to connect telephone receivers . . . . .	90
Complete set for two-stage amplification . . . . .	93
Instruments used in radio receiving outfits and the diagram- matic symbols . . . . .	96
Instruments used in radio transmitters and the diagram- matic symbols . . . . .	97
Construction detail of four-wire aërial . . . . .	100
Connections of simple crystal receiving outfit . . . . .	103

	PAGE
A crystal receiver with a variable condenser . . . . .	104
An indoor or loop type of aërial . . . . .	104
How the loose coupler is used in a crystal receiver . . . . .	106
How two variable condensers are used in a crystal receiver circuit . . . . .	107
Simple vacuum tube receiver with grid leak and grid condenser	108
Connections for regenerative vacuum tube receiver . . . . .	109
Connections for two-stage vacuum tube amplifier, using the regenerative principle . . . . .	111
Connections for radio-frequency amplifier, using the loop or indoor antenna . . . . .	112
Typical amateur station . . . . .	113
Artist's room of a broadcasting station . . . . .	113
Construction of loop antenna . . . . .	113
Simple transmitter employing spark coil . . . . .	114
Powerful transmitter employing transformer and operating from electric light circuit . . . . .	116
Transmitter employing five-watt transmitting vacuum tube . . . . .	118
A ten-watt combination radiophone and telegraph transmitter . . . . .	119
A combination radio telegraph and telephone outfit . . . . .	120
Necessary apparatus for twenty-watt vacuum tube telephone transmitter . . . . .	120
A radio amateur playing a game of checkers through the air	120
International Morse Code and Conventional Signals . . . . .	123
The radio receiver takes the monotony out of fishing . . . . .	132
Type of variable condenser used in radio receiving circuit . . . . .	141
Various parts of a vacuum tube . . . . .	141
Principle of the two-element vacuum tube . . . . .	142
Two-element vacuum tube connection and receiving circuit . . . . .	145
Three-element vacuum tube of De Forest in receiving circuit . . . . .	149
Regenerative receiver with grid leak and grid condenser . . . . .	153
A two-stage regenerative receiver . . . . .	155
Connections of various instruments used in ultra-micrometer	160
Diagrammatic explanation of operation of vacuum tube amplifier for the deaf . . . . .	162
Diagram of the principle of radiodynamics . . . . .	173
Transmitting and receiving apparatus used in the Belin system . . . . .	179

## LIST OF ILLUSTRATIONS

xiii

PAGE

Photograph of President Harding flashed across the Atlantic Ocean . . . . .	180
The Belin photographic transmitter. . . . .	180
Perforated tape produced by the Creed automatic typewriter	184
Interior of transatlantic operating room of the Radio Corporation of New York City . . . . .	189
American plan for transoceanic radio communication . . . . .	192
The first English plan for world-wide communication . . . . .	194
The present English plan for world-wide radio system . . . . .	197
The French radio plan . . . . .	199
The pre-war German plan for world-wide radio system . . . . .	201
The aerial system used at Radio Central . . . . .	203
A comprehensive map showing the world submarine cable system . . . . .	208
A typical ship station . . . . .	216
How the radio compass functions . . . . .	220
Interior of a broadcasting station . . . . .	244
Farmer listening in for market reports . . . . .	244
Using radio in German brokerage office . . . . .	253
Radio station of the New York Police Department . . . . .	253
Aëroplane equipped with a radio telephone transmitter . . . . .	272
W. G. H. Finch reading the news from automatic tape recorder	289

**THE  
COMPLETE RADIO BOOK**

# THE COMPLETE RADIO BOOK

## CHAPTER I

### COMMUNICATION, ANCIENT AND MODERN

**L**IVING creatures existed on this planet for millions of years before they could express thought; before they could communicate with each other. As the ages rolled by, a few of the more progressive creatures became able to make barking sounds and gestures to make known the ideas they evolved in their sluggish minds. The desire to talk came with the first spark of intelligence, and, as time went on, this desire became so intense that nature satisfied it. With the evolution of man came the evolution of language. From the snarls and grunts of the early cave-man there developed the first human tongue.

As men multiplied, and roving tribes came into being, necessity grew for communication over distances. The original means of communication that nature had provided for man became inadequate, since they were effective only over comparatively short ranges. Although men were separated, they still wanted to express their thoughts to each other. Probably the early uncivilized tribesmen did find some method of "talking" over considerable distances. What these methods

may have been is a matter of conjecture. We do know, however, that many of the uncivilized tribes of to-day have developed ingenious methods of what might be called "wireless" communication. A traveler returning from the wilds of South America tells how the natives along the Amazon were apprised of his coming several hours before he reached the various villages. He discovered that an extremely novel method of relaying this information was used. The receiving and transmitting stations were simply large hollow logs. One end of a log was placed in the water and the other end beaten with a club. The vibrations that were set up in the log were imparted to the water, and, since water is a good conductor of sound, they were carried up and down the river for a distance of several miles. The receiving was done with a similar log used as a resonator. The "operator" held his ear to one end of a log with the other end in the water. In this way the delicate vibrations transmitted through the water became audible. By the use of a code, the natives were able to "talk" with each other when they became separated beyond the range of the voice.

We are all more or less familiar with the communication systems employed by American Indians. The more we study the lives of these primitive savage people, the more we must esteem them for their ingenuity and inventiveness. They communicated from hilltop to hilltop by the use of smoke. A blanket was placed over a smoldering fire, which allowed a red man to release volumes of smoke at suitable intervals.

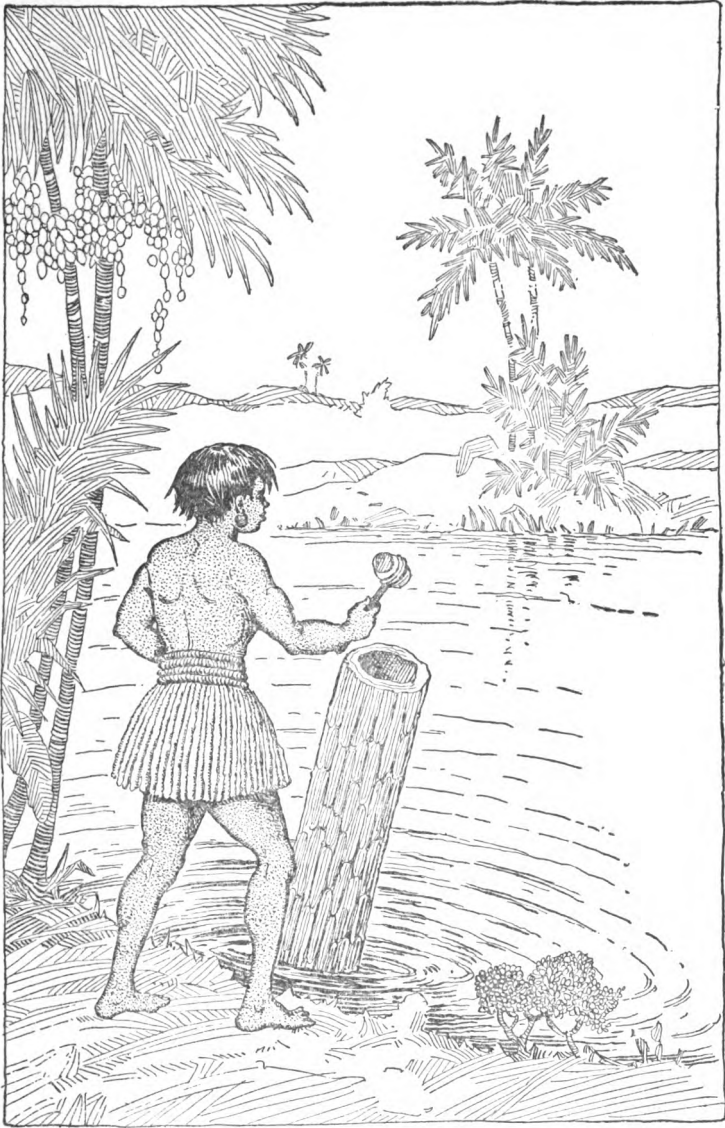

Some of the savages of South America communicate through water by the use of two hollow logs, one at the receiving station and one at the transmitting station. The sender beats upon his log with a mallet and the listener holds his ear to the receiving log.

The smoke-clouds produced formed characters of a crude code which carried intelligence to another red man on a hilltop several miles away.

The Indians used another system which was equally ingenious. By beating upon the ground in a certain fashion they were able to set up vibrations that could be detected by trained ears over considerable distances. In receiving such messages, the Indian lay perfectly quiet with one ear close to the ground. Each tribe had its own particular code, so that its secrets could not possibly be betrayed to the enemy during war.

We must come to look upon all these early forms of communication as telegraphy, since telegraphing is not necessarily carried on by electrical means. The word comes from the Greek, "tele" (afar) and "graphein" (to write). The early methods of telegraphy employed by civilized man were no more ingenious than those used by the savages. Lanterns, fires, flags, and guns were employed. Our own Paul Revere found a use for the lantern system of telegraphy, and our history books tell us how the opening of the Erie Canal was signaled from Albany to Buffalo by the use of cannons stationed at regular intervals.

The ancient Greeks and Romans devised a method of signaling with fires. Pots filled with straw and oil were used. By arranging these in certain order and lighting them according to a prearranged system, characters could be expressed over distances that were of necessity limited by sight. High elevations had to be used, and, after considerable preparation, the Greeks



and Romans were probably able to transmit messages at a speed that would have meant a period of from two to three weeks for sending the Dempsey-Carpentier fight returns. That this system was used only in urgent cases there can be no doubt.

A wise Grecian army commander named Æneas invented a telegraph system that at once marks him as an early Marconi. Æneas lived in the time of Aristotle and he therefore had very little to work with in the way of a knowledge of science. The apparatus he developed was intended for communication between armies. Two large earthen pots were used for receiving and transmitting stations. Each pot was provided with a valve or spigot and a wooden float. The float carried a stick arranged in an upright position, and this was marked off in divisions. Each division represented a certain sentence. When communications were started, the pots were filled brimful of water. Then the distant sender lighted a torch. At this moment the receiving operator was all attention. When he saw the distant torch go out, he immediately opened the spigot at the bottom of the pot, allowing the water to run out. The man at the sending station did the same thing. As the water ran out of the pots, the floats and "message sticks" were carried downward. When the division that represented the message that was to be transmitted reached a position in line with the top of the pot, the distant sender again exposed his torch and the receiver responded by closing the spigot. He then read the

message from the stick. History does not tell how many disasters befell the Greek armies through a leaky spigot.

Kepler, in his "Concealed Arts" (published about 1600), advised the use of characters cut in the bottoms of barrels. These he would have used for transmitting messages at night by illuminating the characters with oil lamps. Kepler did not realize how dangerously near he was coming to our modern electric signs. We do not know whether or not his apparatus was ever used, but he must at least be credited with having made a valuable suggestion.

Strada, the Italian historian, refers to a telegraphic contrivance in his work *Prohusiones Academicæ*, published in 1617. Here he mentions "chimerical correspondence between two friends by the help of a certain lodestone which had such virtue in it that if it was touched to several needles, when one of the needles so touched began to move, the other, though at ever so great a distance, moved at the same time and in the same manner." Strada must have been badly misinformed. He probably obtained his information regarding this telegraphic system from some ancient quack who slightly understood the magnetic properties of the lodestone and "invented" this mysterious contrivance in his own mind. He took advantage of Strada's gullibility, and history was burdened with a doubtful outline that sounds like a patent-medicine story. Strada's efforts were unavailing; they remind us of one of the early wireless telephone frauds in this coun-

try. The prospective stockholders of a fly-by-night "wireless corporation" were called together to witness a wonderful demonstration between the cities of New York and Philadelphia. Everything went well until it was found that a Western Union wire had been leased to help the "wireless messages" along. Communication such as that referred to by Strada could only be accomplished through the medium of wires and electric currents which were quite unknown in his day.

At the close of the seventeenth century Dr. Hooke originated a practical system of signaling from hill to hill. His attention was drawn to the subject at the siege of Vienna by the Turks in 1683. The Hooke system employed letters which were run out in proper order for spelling. At night the letters were illuminated with oil lamps. This system was very unsatisfactory with the unaided eye, since nature did not design our eyes for telegraphic service. Dr. Hooke hit upon the happy idea of using a telescope, and his "wireless" system at once became effective for distances of more than forty miles.

It is unfortunate that some of these early telegraphers did not have the opportunity of studying signaling on the New York Curb Market. Here they would have learned much about the art of communication. For rapidity and accuracy the "men on the Curb" are hard to beat. A Frenchman by the name of Amontons developed a secret cipher which came into some use. Had Amontons been schooled on the New

York Curb Market he could have developed a secret code that would have mystified the uninitiated who tried to read it.

In 1767 Richard Edgeworth, father of the famous author, Maria Edgeworth, signaled with the sails of a windmill. Edgeworth devised an ingenious code, the various characters of which were denoted by different positions of the arms of the mill. Although history does not record the fact, Edgeworth very probably invented what we recognize to-day as the semaphore system of signaling, which can be carried on by the use of the arms and two small flags. The Edgeworth semaphore method was used until the year 1870, at which time it became impractical, owing to the wide application of wire telegraphy. Our railroads to-day relay signals to their engineers by the use of semaphores. This is an application of "windmill wireless" that Edgeworth probably did not anticipate.

Claude Chappe of Paris caused a great commotion during the French Revolution when he put into operation a semaphore intelligence transmitter. A high pole was used, upon the top of which was mounted a semaphore. This was controlled by an operator who pulled a cord when he desired to change its position. That the French became unduly excited over Chappe's contrivance is indicated by Barère de Vieuzac's version of it. He said, "Remoteness and distance almost disappear."

Each Chappe station required the services of three operators. One was used to manipulate the sema-

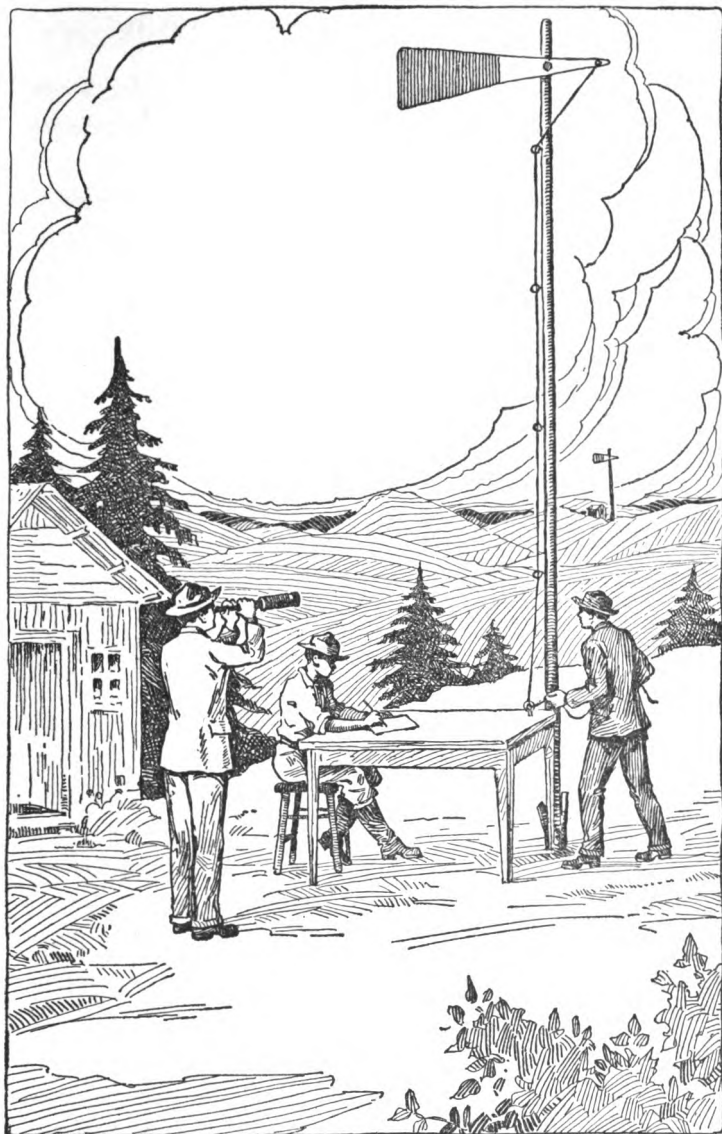

How the semaphore system of signaling was used in France during the revolution. The distance covered depended entirely upon the power of the telescopes used at the time.

phore, another to read the distant semaphore with a telescope, and the third to write down the messages as they came in. The first machine was set up on the roof of the Louvre to communicate with the army at Lille. At night lamps were placed on the arms so that they would be visible.

In 1796 communication history began to be made on the British Isles. Several huge wooden octagons were mounted in such a way that they could be turned to various positions by a crank. Certain combinations of the positions of the octagons represented certain characters. By means of this crude system, a message was sent from Dover to London in seven minutes. The distance covered was sixty-six miles. A relay system was used; it does not require much reasoning to decide that the message sent must have been very short.

Four years after the development of the octagon telegraph stations, John Boaz of Glasgow, Scotland, assembled an ingenious telegraphic device made up of lamps. Twenty-five lamps were used and they were arranged in a square, with five lamps in a row. By covering certain lamps with blinds, Boaz was able to transmit characters over a reasonable distance. This system was ideal for night use but utterly impractical for daylight service.

Further improvements in semaphore signaling were made in France in 1805. The distances covered could not be increased, however, since the system depended upon the efficiency of the telescopes of the day and upon

the natural limitation of human eyesight. Man's early triumphs over space and time did not border on the marvelous.

The history of the world's postal system is essentially a part of the history of communication. The early Hebrew and Persian kings used a postal service, and letters were sent "by post on horseback riding the swiftest steeds that were in the king's service." In the book of Job we come across the term "sealing clay," which was probably a substitute for our modern sealing-wax. Letter-carriers were known as early as the first century. Jewish patriarchs sent messages from Palestine to the remote seats of learning in Babylon. That this interchange of ideas influenced the learning of the early peoples there can be no doubt.

Assyrian and Persian monarchs had enough respect for each other's ideas to go to the trouble of establishing communication. They built stations a few days' journey apart, where fresh horses were kept ready for post carriers. Virtually the same idea was used in the Roman Empire. Stations were situated certain distances apart, where the riders were supplied with steeds. The resemblance between our postmen of to-day and the postmen of old is very remote, yet they are still "postmen," and they probably will remain postmen until the postal system passes into disuse, if that ever happens.

The Spanish conquerors found the Peruvian monarchs had established an efficient postal system. The stations were five miles apart, and the riders, by forc-

ing their horses to the utmost and changing them frequently, were able to cover 150 miles in a single day, which, considering the time and age, was a very respectable speed. Even to-day, with our efficient postal system, cases are heard of where it has taken a letter two days to go from one part of a city to another part, with automobile trucks to carry it.

Sending a letter by mail in the early days was by no means possible for a poor man. Only the word of kings and rich men could be sent, since the service was as costly as it was slow. We can rest assured that there was no necessity for the use of an electric canceling machine.

Macaulay tells us that William Dockwra was the first man to establish a postal route in the City of London. Titus Oates, who was flourishing at that time, published broadcast the assertion that this new method of delivering letters was a Jesuitical conspiracy in disguise. It was said that if the letters were to be searched they would be found full of incendiary doctrines.

Gay old Henry VIII must go down in history as the monarch who first appointed a postmaster, or "master of postes," as he preferred to call him. The term "postmaster" originated at that time. It is fair to say, however, that the duties of the early postmasters were rather light.

America's postal facilities began at New York during the year 1672 and managed to continue to exist



for more than one hundred years. The growth of the colonies emphasized the need of a new postal system, and Benjamin Franklin, who had charge of the colonial postal system from 1753 to 1774, was made postmaster-general by the Continental Congress, with offices at Philadelphia, serving in this position from 1775 until 1776. As demands on the service grew, deliveries were made between New York and Philadelphia twice a week in the summer and once a week in the winter. The total earnings of the New York post-office from 1775 to 1776 were \$550. That the postal service made little progress between that time and the middle of the nineteenth century is proved by the fact that in 1854 postage on a single letter for thirty miles was six and one fourth cents, for eighty miles ten cents, for one hundred and fifty miles twelve and one half cents, and for four hundred miles eighteen and three fourths cents. Nothing but correspondence was carried.

Our postal service to-day is wonderful, to say the least. Millions of letters are handled every hour by several thousand employees. Tons and tons of first class matter are handled daily, and our postal bill for a single year's time runs into the hundreds of millions. Emerson has said: "To think that a bit of paper containing our most secret thoughts and protected only by a seal, should travel safely from one end of the world to the other without any meddling with it." Most of us remember Longfellow's words:

Kind messages that fly from land to land,  
Kind letters that betray the heart's deep history,  
In which we feel the pressure of the hand;  
One touch of fire and all the rest is mystery.

Samuel F. B. Morse stands out as one of the makers of communication history. Although he was not the first to attempt the instantaneous transmission of intelligence over wires, he was the first to make a success of it. Sir Charles Wheatstone invented a magnetic system of telegraphy which failed to meet the commercial needs of his day. Other inventors and scientists attempted to devise electrical communication systems which were unsuccessful.

In 1829 Morse went to Europe to study art, with no thought of becoming an inventor. On the ship coming back he met Dr. Charles T. Jackson, who had seen some of Ampère's experiments in Paris. Ampère was one of the electrical wizards of the day and his work was widely discussed. So impressed was Dr. Jackson with Ampère's electromagnets that he brought one back with him to America, and he gave a demonstration to Morse on the way over. It filled Morse with awe—and with ideas. He at once thought that the principle of the electromagnet could be applied to the transmission of intelligence.

Morse was later appointed professor of arts and designs in the then infant College of the City of New York. While connected with this institution of learning, he became acquainted with Professor Gale, who headed the chemistry department. Through Gale,

## COMMUNICATION, ANCIENT, MODERN 17

Morse met Professor Henry, who was doing very important research work with electromagnets. Morse's contact with Henry resulted in inspiration. Henry showed him how the strength or pulling power of an electromagnet could be increased by using a larger amount of wire. Before that time Morse had not been able to make his crude telegraphic device respond quickly without the use of considerable current strength. Henry's research work pointed the way to a more successful instrument.

One day while Morse was hard at work in his little shop, an alert young man by the name of Alfred Vail wandered in. When Vail learned what Morse was working on he became all eyes and ears. Unlike most of the others who heard of Morse's work, he did not condemn him as on the verge of insanity. Vail at once entered into a partnership arrangement with Morse and went to his father, who was an ironmaster of Morristown, New Jersey, for financial assistance. The elder Vail was a practical-minded, hard-headed business man, and he at once realized the importance of Morse's work. As a result two thousand dollars was at once forthcoming.

Vail went to work in his father's shops to improve Morse's model. They worked together on it like beavers, and in the year 1838 Morse and young Vail gave a practical demonstration which was entirely successful.

In those days the world had little use for men with new ideas. Morse suffered the tortures that had been

suffered by many of the great inventors before his day. Fulton was a fool and Stephenson was the craziest man who ever lived, according to the wise men of their day, and Morse was destined to be the object of ridicule of the same kind. He tried to raise capital in New York and Philadelphia, but the financiers and moneyed men were barely courteous enough to listen to his story. His telegraphic apparatus, which is looked upon as a very simple thing by the average schoolboy of to-day, was condemned as a scientific toy.

Morse was possessed of indomitable courage. He went directly to Congress. As a result of his efforts a bill was introduced for an appropriation of \$30,000 to test the new system of rapid communication. Many of the sagacious congressmen from the wooded sections of the country fought bitterly against the bill. Why waste \$30,000 on an impossible invention?

While Congress was considering the problem Morse went to Europe to secure patent protection in foreign countries. Upon his return he found Congress still indifferent. In 1843, however, the opposition was overcome and the bill was passed. Morse had planned to lay wires underground, but this system failed and it became necessary to string them on poles, and the despised telegraph-pole had its birth: that is one thing for which Morse will never be forgiven. On May 23, 1844, Morse sent the first message over the experimental line that was constructed between the cities of Baltimore and Washington. Morse's historic message

still rings in the ears of the world. "What hath God wrought?" the little instrument spoke in the language of dots and dashes.

In 1919 the length of the world's telegraph wires was one and one half million miles. Millions of words buzz over them daily. The business of nations is carried on largely over copper threads. Who can say that telegraph wires are not nation builders?

The history of cable communication is interesting. Morse foresaw the possibilities of international communication by submarine cables as early as 1842, when he laid an experimental cable across New York Harbor. Morse was by no means a dreamer. His foresight was cold and calculating. In the year 1850 the first successful cable was laid across the English Channel.

Morse dreamed of an international submarine cable, and he succeeded in interesting Cyrus Field, a retired New York merchant, in the venture. Field was enthusiastic because he realized the necessity for world communication. The support of the British and United States governments was enlisted, and naval vessels from both countries sounded the ocean bottom and made a favorable report. Morse and Field succeeded in forming an American company, after which Field went to England and organized what became known as the Atlantic Telegraph & Cable Co. Field certainly chose an ambitious name, as subsequent experiences proved.

The company formed by Field made a wise step when it enlisted the services of Professor William

Thomson, later Lord Kelvin. Thomson had one of the greatest scientific minds of the day; he was a prince of experimenters. The work he did in submarine telegraphy will forever mark him as one of the greatest inventors that ever lived.

After the preliminary work was finished, the cable-laying between America and England was started, in 1857. The English war-ship *Agamemnon* and the United States ship *Niagara*, which carried 2500 miles of cable in her hold, left the Irish coast. The cable was made up of seven strands of copper wire encased in a gutta-percha covering. After a few miles of cable had been laid, the cable parted, and the first attempt to span the Atlantic Ocean was frustrated.

Field was what might be called a bull-headed man. He never entertained the thought of being beaten. The second attempt was made in June, 1858. At this time the *Agamemnon* and the *Niagara* met in mid-ocean, where the cable was spliced. The vessels then started in opposite directions. The cable parted several times, and the project had to be abandoned again. By this time several million dollars had been lost, to say nothing of the cooling effect that the failures had on the financial supporters of the Atlantic Telegraph & Cable Co.

Field went ahead as though nothing had happened. In July of the same year the ships went out again, and on August 6 the *Agamemnon* reached the Irish coast and the *Niagara* reached the Newfoundland coast, with 2500 miles of cable resting on the bottom of the

Atlantic Ocean. Communication between the two countries was at once established by the use of the ingenious apparatus that had been devised with the aid of Professor Thomson. President Buchanan exchanged messages with Queen Victoria. Everything went serenely for one month, and then another catastrophe occurred. The voltages used on the cable were too high, and as a result the insulation gave way, which rendered the cable useless.

Field went on with his work undaunted. If there was ever a man who fought for a thing that he believed in, it was Cyrus Field. Through his efforts the *Great Eastern*, the most wonderful vessel of her day, started from the Irish coast in July, 1865. When she got well on her way the machinery that paid out the cable broke, and the cable was lost. On July 13, 1866, the *Great Eastern* started out again. Two weeks later the end of the cable was on the shore of Newfoundland. From that day to this there has been no interruption in the transatlantic cable service. Cables radiate from our shores to all parts of the world.

The evolution of the telegraph was rapid. Scores of patents were taken out, some covering important improvements while others covered fancied forward steps. A real advance was made when a duplex method of transmission was developed, which enabled two messages to be sent over the same wire simultaneously. To-day many thousand words can be sent over a single wire in an hour by the use of automatic transmitters and receivers.

Fortunately man is a hard creature to satisfy. When he found that he could translate his thoughts into dots and dashes and send them over wires, he looked forward to the day when he would be able to transmit speech itself.

There is a dingy little work-shop at 109 Court Street, Boston, where one of the most useful instruments of the age was born. Here Bell discovered that the human voice could be transmitted from one place to another over a copper wire. To-day we rush into a telephone booth, never once thinking what this instrument means to the life of the world. How many weary steps it has saved, how many messages of life and death it has carried, and how many countless millions of dollars it has added to our prosperity!

During the year 1864, Alexander Graham Bell was working on an invention which he called the "harmonic telegraph." It was Bell's idea to develop an apparatus that would allow more than two messages to be sent over a telegraph wire simultaneously. At that time the patents covering the duplex system were controlled by the Atlantic & Pacific Telegraph Co. Possession of the patent rights gave this organization a tremendous advantage over its only competitor, the Western Union Telegraph Co. Bell must have been a shrewd man, for he realized that the Western Union company would be greatly interested, to say the least, in a device that would allow it to multiply the capacity of its lines by six. At that time the Western Union company



was probably more interested in such a device than even Bell realized.

Bell's harmonic telegraph was made up of vibrating reeds controlled by electromagnets. By having each reed tuned to a certain frequency, Bell thought it would be possible to get a selective action which would bring about the result he sought. As with many other inventions, the theoretical possibilities of Bell's device were alluring, but when the acid test of practical application was made the apparatus failed to function properly. In this instance, however, it was not a case of "genius gone wrong," for Bell's idea was fundamentally sound.

Had Bell been successful with his harmonic telegraph, it is doubtful whether the telephone would have been born at that time. The successful culmination of his experiments would have placed an enormous amount of wealth at his disposal, since the Western Union company would have been very kind to him indeed had he been able to place in its hands patent rights that would have enabled it to go its competitors "one better."

There now enters into telephone history a young man named Thomas A. Watson. Watson was a clever mechanic in the employ of Charles Williams, who ran a mechanical and electrical shop at the Court Street address. Watson was detailed to help Bell in his experimental work. Williams's place was a rendezvous for wild-eyed inventors who came there for help and inspiration. Bell was one of a few who had a really worth-while idea.

Watson helped Bell a great deal with his work and experimented with him for several months. One day Bell said to him: "Watson, I want to tell you of another idea I have, which I think will surprise you. If I can make a current of electricity vary in intensity, I should be able to transmit speech telegraphically." Watson was impressed with the idea, but financial difficulties interfered with its immediate construction. Gardner G. Hubbard and Thomas Sanders, who were backing Bell, insisted that the wisest thing to do was to perfect the harmonic telegraph. They thought he was building air-castles when he talked wildly about his telephone idea. It would seem that this refusal on the part of his supporters was an act of providence, as we shall see later.

June 2, 1875, must go down as the greatest day in the history of communication. Bell was working with his harmonic telegraphic apparatus in one room and young Watson was in another working feverishly in an attempt to adjust the instruments. The attic rooms were hot, and Watson's enthusiasm was wrestling with his temper. Work as he would over the transmitters, they refused to operate satisfactorily. One of the springs stopped vibrating and Watson plucked it to start it again. It did not start, and he kept plucking at it. Suddenly Bell rushed into the room wildly and said: "What did you do then? Don't change anything. Let me see." That fleeting moment gave birth to the telephone.

When young Watson plucked the spring he caused

it to vibrate over the pole of an electromagnet. This vibrating spring caused the current to fluctuate with it, and the instrument in Bell's room was able to transform that current into a faint echo of sound. Bell had his ear to the instrument at the time, and he heard the sounds. They thrilled him through and through. He knew perfectly well that a mechanism that could transmit and reproduce all the complex vibrations of one sound could do the same for any sound, even that of speech.

The experiment was repeated a number of times, and before Bell and Watson parted late that night, one of the greatest discoveries of the ages had been verified. Watson's enthusiasm slipped back into high gear. He went to the shop the next morning and set to work on the first telephone from directions that Bell had given him the night before. Within a short time Watson had assembled a very mysterious-looking piece of apparatus. To the uninitiated it could have been anything from a cream-separator to a divining-rod.

The first telephone line was set up in Williams's shop. One instrument was placed on the top floor and one on the third. The first experiment was barely successful. Watson shouted at the top of his voice, but he could not make Bell hear. Watson, however, caught various parts of Bell's words.

Further improvements were effected before the telephone apparatus behaved as its inventor wished. After these improvements had been made and some experimenting done, the first really intelligent message

was sent. It was by no means as poetic as Morse's "What hath God wrought?" It was, "Mr. Watson, please come here. I want you." Had Bell realized that these words would be recorded in history, he would, perhaps, have used a premeditated phrase that would have fitted the situation. More undignified phrases, however, have passed over telephone lines since that time, as any one can testify who has had trouble with "busy wires."

With the aid of Bell's able supervision and Watson's deft fingers, the speech-making of the telephone was constantly improved. At first it was necessary to repeat a sentence several times before the speaker was sure that it was received correctly. In the summer of 1876 the health of the telephone had improved to such an extent that it was able to talk in a husky manner.

When the Centennial Exposition was held at Philadelphia, Bell had enough courage to place his instruments on exhibition there. He probably thought that everybody would share his enthusiasm, but in this he was disappointed. Many people smiled as they passed his booth. Sir William Thomson, who was visiting the country at the time, tried Bell's telephone. In his report he said: "Needless to say, I was astonished and delighted. So were the others who witnessed the experiment and verified with their own ears the electric transmission of speech. This, perhaps the greatest marvel heretofore achieved by the electric telegraph, has been obtained by appliances of quite a

homespun and rudimentary character." The last words cut Watson to the quick. He says to this day he has never forgiven Sir William Thomson for that last line.

It was on October 9, 1876, that the telephone got its first real tryout. At that time speech was successfully transmitted between Boston and Cambridge over a line two miles long. After some trouble, Watson, out in Cambridge, heard Bell's "Ahoy!" After "ahoying" back and forth several times, regular conversation was carried on. Later tests on longer lines followed until the commercial feasibility of the telephone had been proved beyond the question of a doubt.

Bell was soon the wonder-man of the hour. Scientists flocked to see his telephone. His little garret laboratory became the shrine of the technicians of the day. Two young Japanese visitors made the discovery that the telephone was able to handle Japanese jargon—an accomplishment indeed!

Later, Bell's financial supporters approached the president of the Western Union Telegraph Co. and offered him the complete rights to the Bell patents for \$100,000. Luckily for Bell, that official did not have enough foresight to realize the importance of the patents and he contemptuously turned the offer down. Two years later the Western Union company would have been willing to buy the patents for the fancy figure of \$25,000,000.

The space is not available that would be necessary for a complete outline of the development of the tele-

phone since those early days. At least a volume would be required to give anything more than a treatment that would emphasize the most interesting features. The reader of this book does not need to be impressed with the size of the telephone industry to-day. Telephone statistics make the most interesting mass of figures that one could wish to read.

After man had exhausted the possibilities of wire communication by the transmission of speech, he sought new worlds to conquer. The transmission of intelligence without the use of metallic connecting mediums was regarded as a possibility. The first hazy ideas of wireless began to take form. At the present time, there is some question as to whether or not man was the first animal to make use of electromagnetic waves as thought-carrying vehicles. There is a possibility that nature "beat him to it," as the saying goes. Lawrence C. F. Horle, a New York radio engineer, believes that moths employed this method of communication long before man dreamed of it. Many technicians when reading this statement will throw up their hands and say "Impossible!" Mature consideration, however, will reveal the logic of the belief.

In the firefly we have a creature that is able to emit visible radiations that affect our eyesight: in ordinary, every-day language, they produce light. They are living lamps. As we shall see later, there is no difference between what we call light waves and wireless waves. If one insect like a firefly can emit visible

waves it is not impossible that a creature like a moth can propagate invisible or wireless waves.

The female moth is able to summon the male moth in the most mystifying manner. The female, housed in a scent- and sound-proof container, has been able to call the male from a distance of nearly one mile. The response of the male is unfailing, and he flies in a direct line to his mate. In the past the moth has always been credited with a peculiar instinct, but the word instinct is frequently used when an explanation is lacking. Mr. Horle believes that this "instinct" or "sense" is radio in nature.

Those of us who understand radio know that it is necessary to use an electric current to set up radio waves. "How can a living creature like a moth be a generator of electric current?" the skeptics ask. There is plenty of proof available to show that living organisms can produce currents of no mean potential. In the *Gymnotus electricus*, or electric eel, we have a living creature that is a veritable power plant. It has arranged within its body a number of electric cells connected in series, and it is able to use these in such a way that it can deliver a shock strong enough to make a large man develop a considerable respect for it, once he has made accidental contact. Humboldt gives an interesting account of combats between electric eels and wild horses that had been driven by the natives into the swamps inhabited by the *Gymnotus*. When the *Gymnotus* reaches a length of five to six feet it is able to deliver a "jolt" that would make a home

shocking-machine turn green with envy. Even the human heart generates a weak galvanic current at every pulsation. The Raia torpedo is another creature that is like a living dynamo. From all this we learn that it is not impossible for the dusty little moth to generate a current within its own body, and furthermore, it is not unreasonable to assume that it can transform this current into electromagnetic waves.

Those of us who are really bright will say, "Aha, I see the connection now, the moth has antennæ, and every telegraphic station has antennæ." Although this sounds "wild," it is at least within the bounds of reason. If the moth uses radio it probably uses its antennæ to propagate and receive the radio waves. When the female is calling the male moth, he handles his antennæ in a most uncanny fashion. He will twist them first in one direction and then in the other, as though he were trying to locate the position of the female. When he makes up his mind he takes to his wings and flies directly to his mate.

Mr. Horle devised a super-sensitive receiver to listen in for "mothgrams." Since the total energy represented by a moth is much smaller than that which would be necessary to cause an audible sound in a modern radio receiver, Mr. Horle decided that a method of extreme amplification would have to be used. He employed an electrical system that would take minute currents and magnify them. Although Mr. Horle listened for several weeks to learn the secrets of Mr. and Mrs. Moth, he had not, up to the time of



the printing of this book, been able to obtain anything but negative results. The problems that he faced in the operation of the sensitive apparatus he had assembled were of the most disheartening nature.

By a series of brilliant mathematical processes, James Clark Maxwell figured that such things as electromagnetic or radio waves should exist. In cold mathematics he was led to believe that the "unseeable," the "unsmellable," the "unfeeleable," and the "unhearable" existed. This all happened in 1865 when Maxwell was a professor of physics in the University of Edinburgh, Scotland. In a letter to C. H. Cay, under date of January 5, 1865, Maxwell said, "I also have a paper afloat with a magnetic theory of light, which, till I am convinced to the contrary, I hold to be great guns." In that paper Maxwell predicted that electric oscillations in a circuit would produce electric waves in the ether, or, we might say, in surrounding space, and that these waves would travel with the velocity of light. Maxwell's theory was a masterpiece. It was one of the most beautiful pieces of philosophy that were ever evolved in the mind of man.

A few years later, in 1888, Professor Heinrich Hertz of Karlsruhe performed experiments that proved definitely the existence of the radiations that were predicted by Maxwell's mathematics. Later, at Bonn, Hertz performed a number of classical experiments which at once gave him a place among the great minds of the world. He not only propagated radio waves,

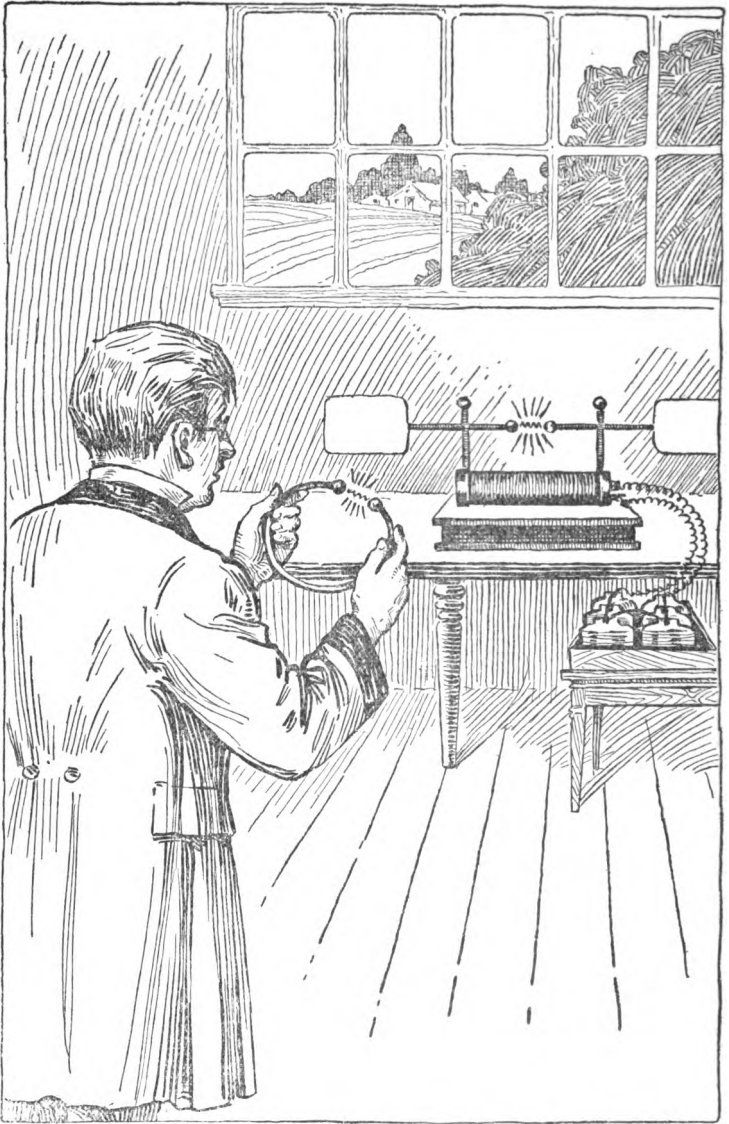

The first wireless or radio transmitter and receiver used by Professor Hertz. Hertz, working this simple apparatus, paved the way for the later triumphs over space and time in the transmission of human intelligence.

but he detected them. He played with them as a boy plays with a new toy. Yet little did he realize that he was laying the foundation of a new science of communication. Hertz shot the waves back and forth across the laboratory, measured them, polarized them, refracted them, and put them through all the experimental antics that could be imagined. He pulled them out of nature's secret archives and brushed the dust off of them. Incidentally, the antenna or "resonator" that Hertz used in detecting these waves was simply a piece of wire bent in a loop with two little brass balls arranged at the ends. Since the loop looked like the antenna of a moth, Hertz gave it this name.

Before the work of Hertz, Sir Oliver Lodge made some experiments with Leyden jars that came dangerously close to robbing Hertz of all his glory. But it is the old story of a miss being as good as a mile, and Hertz must be given full credit for the discovery of electromagnetic waves, after their existence had been foreseen by Maxwell.

In this outline of the history of radio it can only be hoped to hit the "high spots," so to speak. There have been many fingers in the radio pie. Hundreds of men have made contributions to the art, but it would be impossible to describe their work in the confines of a single volume.

Before Marconi's entrance into the radio arena, considerable work had been done by different investigators in an attempt to use the earth and water as conducting mediums for the transmission of intelli-

gence. Samuel Morse made an attempt in 1842. Receiving and transmitting stations were set up on opposite sides of a canal. After some preparation, Morse succeeded in making a galvanometer at the receiving station give a few faint wabbles that indicated the passage of a current. Of course, this system may be called radio, with apologies. Some time after Morse's experiments, Vail and Rogers carried the perfection of Morse's apparatus a step forward and succeeded in establishing communication across the Susquehanna River, a distance of nearly a mile.

J. B. Lindsay in 1860 developed a system similar to Morse's, but on a larger scale. Lindsay sent signals that barely broke the record made by Vail and Rogers.

Professor John Trowbridge of Harvard University suggested an improvement upon the original Morse

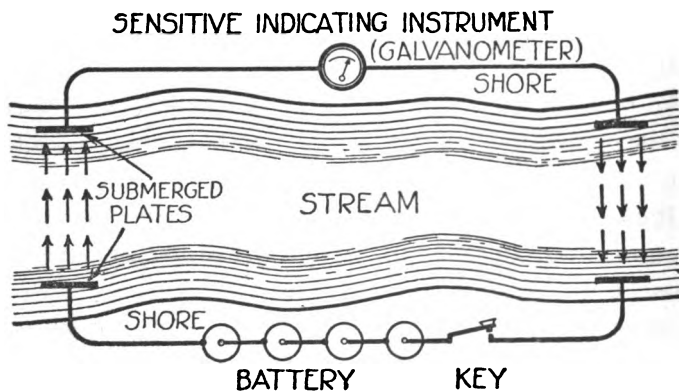

One of the early ground "wireless" systems used in this country for communication over short distances.

experiments. He advocated the use of a rapidly interrupted current in the sending circuit and a telephone receiver in the receiving circuit. His suggestion was highly practical, and at a single stroke he had wiped out many of the objections to the Morse system. Bell was fascinated by Trowbridge's proposal, and he made some experiments on the Potomac River with the system. He successfully carried on communication up to a distance of a mile and a quarter.

The work of a certain Dr. Mahlon Loomis, a dentist at Washington, forms one of the most interesting chapters in the history of radio telegraphy. Back in the sixties Loomis had a dental office at 907 Pennsylvania Avenue. The man had missed his calling. He was an inventive genius and a practical dreamer. Consequently, the gentle art of extracting aching molars and the manufacture of "store teeth" did not appeal strongly to him. He was a keen student of electricity, and he gradually became obsessed with the idea that it was possible to transmit intelligence between two points without the use of metallic wires. He set about the development of a system which gave some results long before Marconi was born.

In presenting the following records of Dr. Loomis's work, the authors do not wish to be misunderstood. They are by no means asserting that Loomis discovered radio telegraphy, as we understand it today. The interesting records are presented for what they are worth. In Loomis's day electrical science was in its infancy, and it is therefore very difficult

to give Loomis's notes the proper interpretation. Quite naturally he speaks vaguely in many instances, and even the most thoughtful consideration does not seem to reveal the facts that he had in mind. As is pointed out in another part of this chapter, successful radio telegraphy was finally brought about through the use of high-frequency currents. Such currents were not known at the time of Loomis's experiments. It cannot be said with certainty that he did not use such currents. If Loomis did use them, he is, without doubt, the discoverer of radio telegraphy. In his patent specifications it is interesting to note that he mentions the word "pulsations," but the specifications, in the light of our present-day knowledge, are so ambiguous that it is difficult to get their real meaning.

If Loomis did not use high-frequency currents, he must at least be credited with an idea that marked him as a genius. According to his records the system of radio telegraphy that he evolved was successful in transmitting signals over no small distance, and the world owes this wonderful man a great debt, which unfortunately it has never paid. In reviewing the personal records of Dr. Loomis's work, the authors have taken the greatest care to choose the notes that are most pregnant with facts, and they are presented in this chapter in an effort to give "honor where honor is due."

Loomis's struggle against adversity is a sad chapter in the romance of invention. He was characterized as a wild, impractical dreamer, and his claims and ideas

were ridiculed and belittled. As a matter of fact, he was a faithful, kind-hearted, mild-tempered man with a persistency that commanded the greatest respect. He walked steadfastly into the teeth of opposition, never once losing sight of his object.

In 1869 he succeeded in prevailing upon a number of Boston capitalists to advance enough money to put his discovery on a commercial basis. Everything was progressing beautifully when the greatest financial collapse (Black Friday) that has ever been known in this country caused his backers to lose everything they possessed.

Loomis, patient and cheerful, hurried back to his little dental office on Pennsylvania Avenue, where he remained long enough to earn the necessary cash to take him to Chicago. In 1871 he went to that city and presented his ideas to some moneyed men, who agreed to finance him. Providence had more bad luck in store for this unfortunate inventor. This time it was Mrs. O'Leary's perverse cow that interfered with Loomis's success. The great fire that swept through the city reduced his supporters to poverty, and he again found it necessary to return to his dental office.

Dr. Loomis called his system "aërial telegraphy." His first public demonstration was made in 1866 from two peaks of the Blue Ridge Mountains in Virginia. These peaks were eighteen miles apart. The following notes, which describe this demonstration, have been extracted from Dr. Loomis's personal diary:

From two mountain peaks of the Blue Ridge in Virginia, which are only about two thousand feet above tide-water, two kites were let up — one from each summit — eighteen or twenty miles apart. These kites had each a small piece of fine copper wire gauze about fifteen inches square attached to their under-side and connected also with the wire six hundred feet in length which held the kites when they were up. The day was clear and cool in the month of October, with breeze enough to hold the kites firmly at anchor when they were flown. Good connection was made with the ground by laying in a wet place a coil of wire one end of which was secured to the binding post of a galvanometer. The equipments and apparatus at both stations were exactly alike; it was arranged that at precisely such an hour and minute the galvanometer at one station should be attached, to be in circuit with the ground and kite wires. At the opposite station the ground wire, being already fast to the galvanometer, three separate and deliberate half-minute connections were made with the kite wire and the instrument. This deflected or moved the needle at the other station with the same vigor and precision as if it had been attached to an ordinary battery. After a lapse of five minutes, as previously arranged, the same performance was repeated with the same results until the third time. Then fifteen minutes precisely were allowed to elapse, during which time the instrument at the first station was put in circuit with both wires while the opposite one was detached from its upper wire, thus reversing the arrangements at each station. At the expiration of the fifteen minutes the message or signals came in to the initial station, a perfect duplicate of those sent from it, as by previous agreement. And although no "transmitting key" was made use of, nor any "sounder" to voice the messages, yet they were just as exact and distinct as any that ever traveled over a metallic conductor. A solemn feeling seemed to be impressed upon those who witnessed the little performance as if some grave mystery hovered there around the simple scene, notwithstanding the results were confidently expected, although the experiments had been continued for nearly two days before the line would "work," and even then it continued to transmit signals only about three hours, when the circuit became suddenly inoperative by the moving away of the



upper electric body. Hence it is that high regions must be sought where disturbing influences cannot invade, where statical energy is stored in a vast unbroken element, enabling a line to be worked without interruption or possible failure. No speculation need be indulged as to whether the theory is correct, for theory and speculation must stand aside whether they will or not, and square themselves with the demonstrated truth.

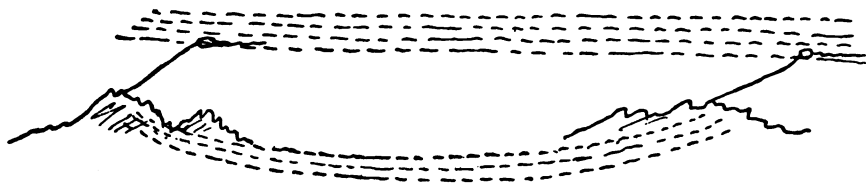
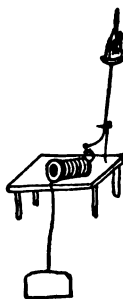
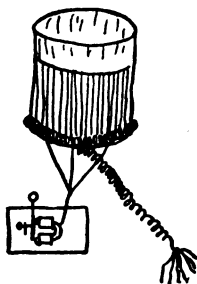

Cohoston Mountain, Va  
Spur of Blue Ridge

14 miles apart

Bearsden Mt Va  
Spur of Blue Ridge

*Sent signals by Aerial Telegraph between these two stations by elevating a kite on each mountain, the string of which was a small copper wire attached to galvanometer each, ground and lying in water. The signals perfect during the cloudy part of the day. Elevation about fifteen hundred feet.*

A particularly significant sketch copied from Dr. Loomis's notebook. The apparatus shown in the upper right-hand corner closely resembles the oscillator used in the early Marconi experiments. It has both the aerial and the ground connection. The lower sketch illustrates the Loomis theory of radio transmission. The upper left-hand corner illustrates the receiver. The handwriting is that of Dr. Loomis.

Many of the sketches made by Dr. Loomis are very interesting. One of them, given herewith, shows how

he used a kite to elevate his aerial. It is generally believed that Marconi was the first man to employ an aerial of that type, but here we have definite proof that this path-finder, Loomis, used such a device several years before Marconi was born. Dr. Rogers of Hyattsville, Delaware, who is the inventor of an underground telegraph system, recently said to a relative of Dr. Loomis:

“Dr. Loomis had the aerial, and he was the first one who had it. He sent up kites and hung copper wires on them. He also had the underground idea, and it was after talking with him that I started out to try to perfect the underground system of communication which I finally did and which assisted considerably in the late war.”

Loomis was granted a patent on July 30, 1872. His patent specifications follow:

UNITED STATES PATENT OFFICE

Mahlon Loomis, of Washington, District of Columbia

Improvement in Telegraphing

Specifications forming part of Letters Patent No. 129,971,

dated July 30, 1872

To All Whom It May Concern:

Be it known that I, Mahlon Loomis, dentist, of Washington, District of Columbia, have invented or discovered a new and improved Mode of Telegraphing and of Generating Light, Heat and Motive Power; and I do hereby declare that the following is a full description thereof.

The nature of my invention or discovery consists, in general terms, of utilizing natural electricity and establishing an electrical current or circuit for telegraphic and other purposes without the

aid of wires, artificial batteries, or cables to form such electrical circuit, and yet communicate from one continent of the globe to another.

To enable others skilled in electrical science to make use of my discovery, I will proceed to describe the arrangements and mode of operation.

As in dispensing with the double wire (which was first used in telegraphing) and making use of but one, substituting the earth instead of a wire to form one-half of the circuit, so I now dispense with both wires, using the earth as one-half the circuit and the continuous electrical element far above the earth's surface for the other part of the circuit. I also dispense with all artificial batteries, but use the free electricity of the atmosphere, coöperating with that of the earth, to supply the electrical dynamic force or current for telegraphing and other useful purposes, such as light, heat and motive power.

As atmospheric electricity is found more and more abundant when moisture, clouds, heated currents of air, and other dissipating influences are left below and a greater altitude attained, my plan is to seek as high an elevation as practicable on the tops of high mountains, and thus penetrate or establish electrical connection with the atmospheric stratum or ocean overlying local disturbances. Upon these mountain-tops I erect suitable towers and apparatus to attract the electricity, or, in other words, to disturb the electrical equilibrium, and thus obtain a current of electricity or shocks or pulsations, which traverse or disturb the positive electrical body of the atmosphere above and between two given points by communicating it to the negative electrical body in the earth below, to form the electrical circuit.

I deem it expedient to use an insulated wire or conductor as forming a part of the local apparatus and for conducting the electricity down to the foot of the mountain, or as far away as may be convenient for a telegraph office, or to utilize it for other purposes.

I do not claim any new keyboard nor any new alphabet or signals; I do not claim any new register, or recording instrument; but

What I claim as my invention or discovery, and desire to secure by Letters Patent, is—

The utilization of natural electricity from elevated points by connecting the opposite polarity of the celestial and terrestrial bodies of electricity at different points by suitable conductors, and, for telegraphic purposes, relying upon the disturbance produced in the two electro-opposite bodies (of the earth and atmosphere) by an interruption of the continuity of one of the conductors from the electrical body being indicated upon its opposite or corresponding terminus, and thus producing a circuit or communication between the two without an artificial battery or the further use of wires or cables to connect the cooperating stations.

MAHLON LOOMIS

Witnesses:

BOYD ELIOT

G. C. WILSON

Inspired by the success of Samuel Morse, Loomis carried his idea to Congress and made an appeal for financial assistance. He worked with that body from 1869 to 1873, when there was passed a bill incorporating the "Loomis Aërial Telegraph Co.," which was subsequently signed by President Grant. Congress, however, overlooked the matter of appropriating \$50,000 which had been asked for, and which was necessary to cover the experiments that had been planned to bring the Loomis apparatus to a state of commercial perfection.

Senator Sumner introduced the first bill for Loomis in January, 1869. He straddled the proposition and engaged in the favorite congressional sport of "passing the buck" to his colleagues. He said in part: "In presenting this petition I desire to say that I perform a duty and content myself with remarking that it is

either a great case of moonshine or it marks a great epoch in the progress of invention. I do not under-

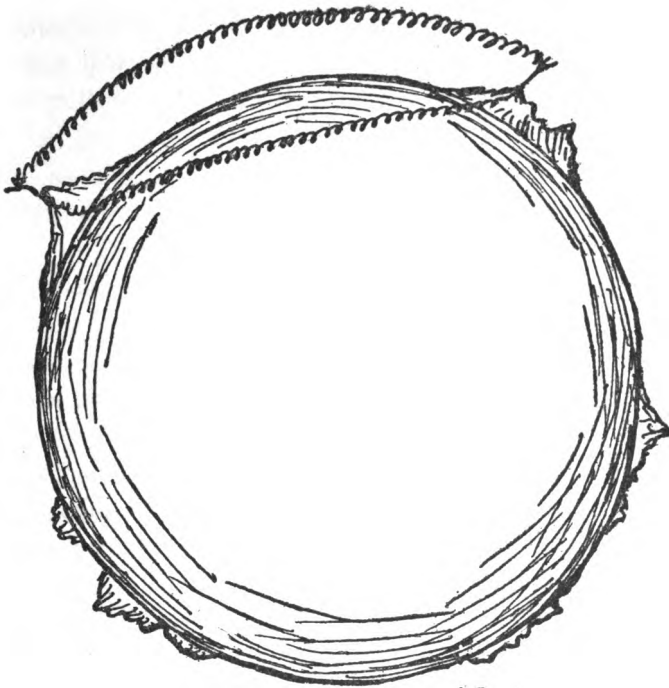

1865

Another sketch from the Loomis note-book. This corresponds in a rough way with the modern theory of radio telegraphy and telephony. Loomis understood that wireless currents passed through the ground for the return circuit.

take to express an opinion upon it. I ask the reference of the petition to the Committee on Patents."

Representative Bingham was the only member of Congress at the time who appeared to have the fore-

sight that was so sadly needed by the other members. In speaking of the bill he said: "I pray the House to consider it favorably and allow it to pass. If no good comes of it, there can be no harm, and favorable action by the House of Representatives on the bill will signify to the world that the House is disposed to consider and not treat with derision and scorn any honest endeavor to better in some way the condition of individual and collective man." Bingham's speech came like a breath of fresh air.

Congress blundered, and the newspapers, as usual, blundered with it. Some of the editorials printed regarding this discussion were sprinkled profusely with the very essence of asininity. One New York editor said:

"Who will not be edified to know that the time of the House of Representatives was taken up for an hour or more Monday night by an elaborate oration by Mr. Conger of Michigan, in support of a proposition for establishing an aërial telegraph? Yet all of this the House of Representatives listened to and 'The Congressional Globe' gravely prints. And yet there are those who affect to be surprised that men of sense and character withdraw themselves from our public life. When some one asked the philosopher Crates why he took no interest in state affairs, he calmly made answer, 'How can I trouble myself with state affairs when they are given over to the hands of block-heads?'"

"The Buffalo Express," not to be outdone by the

editor just quoted, printed this sarcastic editorial on February 24, 1873:

A certain Dr. Loomis is entirely satisfied, in his own mind, that he can sit on the apex of Mount Hood, the loftiest mountain in America, and carry on an animated conversation with another "scientific gent" perched in a similar manner on the Alps. The Doctor agrees to perform this feat by means of electricity, it is true, but without the aid of vulgar wires. He will simply use the strong current of electricity with which a certain stratum of the atmosphere is charged, by the concentration at one point, by means of ingenious apparatus at the opposite point, and perfect communication is effected.

We have not heard yet whether there are to be any stations in the low districts, under this plan. It would be a fatal objection to the popularity of the system if people had to go to the top of Mount Hood, Chimborazo, Popocatepetl, or to the crests of the Himalayas and Andes to send their despatches. But possibly that is why the Doctor got permission to use electricity in any way, so that he might establish a connection by wire between civilized districts and the company's regular peaks. Then if one wished to communicate with a friend on Mount Hecla or Mount Blanc, he would simply telegraph in the usual way to the nearest *aërial station*, and thence it would fly by the electrical stratum to the desired point. Indeed, the possibilities wrapped up in this wonderful system of telegraphy are endless, and take a strong hold of the imagination.

But, after all, where is the sense in laughing at any theory or invention in these days? We ought to learn better by experience, and Senator Anthony gave the scoffers a fitting rebuke when he quietly answered those who ridiculed the Doctor's scheme by allowing that he had never heard of a more impractical idea in all his life, unless it might be that of the telegraph system of Professor Morse.

Dr. Loomis's ambition floundered upon the rocks of destiny. He died broken-hearted, unsung, and un-

honored in 1886. Some time before his death he made the following remarks to his brother. They are indeed pathetic:

“George, I know that I am regarded as a crank, perhaps a fool, by some, and as to the latter possibly I am, for I could have discarded this thing entirely and accumulated a few thousand dollars and then be considered a success. But the time will come when this discovery will be regarded as of more consequence to mankind than was Columbus’s discovery of a new world. I have not only discovered a new world, but the means of invading it, not with little frail boats of human build, but with the ‘invisible chariots of the Almighty.’ I shall never realize anything from it, neither money nor fame—as to fame I care nothing; so the world gets the benefit of it. As to money, I only want it for my family. They have necessarily been neglected more or less while I have devoted the best energies of my life to this, the grandest conception that ever occupied a human mind. My compensation is poverty, contempt, neglect, forgetfulness. In the distant future, when the possibilities of the discovery (as I see them) are more fully developed, public attention will be directed to its originator; and the congressional records will furnish the indisputable evidence that the credit belongs to me. But what good then? Still, there is a present satisfaction in knowing that some time the proper credit will be given. In the meantime, others will reap the benefit in worldly wealth and worldly honors. Monuments will be



reared to their memory—costly monuments—in token of the world's appreciation of their genius. I ask but a rose-bush to mark my grave, affording a brief resting-place for passing song-birds, and I have a feeling that I shall even then be conscious of their carolings.”

A United States patent covering a radio telegraphic system was issued to Professor Dolbear of Tufts College in March, 1882. Dolbear's system was fundamentally a radio one. Although it was highly interesting from a purely scientific point of view, it did not offer a solution to the problem of message transmission without wires. Dolbear did, however, make a close approach to the method that was later developed by Marconi. He overlooked one thing that later crowned Marconi's efforts with success. Dolbear did not use electric oscillations of high frequency. We shall learn later what is meant by electric oscillations of high frequency.

Sir William Preece, who was engineer-in-chief of the postal telegraph system of England, made a very serious attempt to abolish the use of wires some time before the work of Hertz and Marconi. Preece utilized a magnetic induction system. In 1898 a regular installation was established at Lavernock Point on the mainland and at Flatholm in Bristol Channel. The distance covered was 3.3 miles. Like Dolbear, Sir William overlooked the necessity of using high-frequency oscillations. It would seem that Lodge, Dolbear, and Preece had the happy faculty of playing around a puddle without getting their feet wet.

A patent filed on June 2, 1896, in the patent office of Great Britain covered "improvements in transmitting electrical impulses and signals and in apparatus therefor." The inventor of this apparatus was Signor Guglielmo Marconi. He had developed the apparatus covered by the patent on his father's estate near Bologna. That patent was the foundation of all of Marconi's great work; it was the corner-stone of a new science.

The apparatus that Marconi employed in his early experiments was crude and ungainly, but it worked; and after all that was the important thing. His success was brought about by the use of high-frequency electric currents. Marconi's detecting apparatus was also ingenious. He used what was known as a "coherer." The principle of the coherer had been discovered in 1866 by S. A. Varley. The coherer consisted simply of a glass tube with two little metal rods in it. Metal filings were placed between the two rods. When an electric current passed through the filings between the rods, the tiny metal pieces would tend to become a coherent mass. In this way the electrical resistance of a local circuit was lowered and the current would be allowed to pass more freely. Marconi had his troubles with the coherer, which required constant and painstaking attention. When the filings cohered they would fail to de-cohere with sufficient rapidity. Marconi overcame this trouble with a little kicking device which he called a de-coherer. This was a great step forward, and it greatly increased the practicability of his apparatus.

Between the years 1896 and 1898 Marconi worked like a Trojan, for he was a natural-born experimenter of the most persevering variety. He went to England and submitted his plans to Sir William Preece. Preece at once recognized the significance of Marconi's improvement and he consented to collaborate with him in the further development of the apparatus. A transmitting station was set up in a room in the general post-office. Messages were sent to an improvised station one hundred yards distant. Some time later, a message was transmitted 8.7 miles between Lavernock Point and Brea Down. In these experiments kites were used to hold the transmitting and receiving aërials aloft.

During the year 1897 some important trials were carried on at Spezia, Italy, at the request of the Government. The astounding distance of twelve miles was covered. By July, 1908, Marconi's apparatus had been developed to such an extent that it was used to report the yacht-races at the Kingston regatta. The distance of twenty miles between the sending and receiving station was successfully bridged.

"And how far do you think a despatch could thus be sent?" Marconi was asked in 1897 by an interviewer from "McClure's Magazine." "Twenty miles," replied Marconi, promptly. "Why do you limit it to twenty miles?" he was again asked. "I am speaking within practical limits," he said, "and thinking of the transmitter and receiver as thus far calculated. The distance depends simply upon the amount of the excit-

ing energy and the dimensions of the two conductors from which the waves pass."

The last sentence proves that Marconi fully understood the possibilities of his system. He knew at the time that the distance covered was simply a matter of the amount of energy that he pumped into the ether. The more power he used in sending his signals, the farther they would go.

Radio history moved rapidly between the years 1898 and 1901. The first flash of human intelligence was wafted across the ocean without the use of wires in 1901. It was sent from Poldhu, Cornwall, England, to St. John, Newfoundland. The message, for such it can be called, was made up of a series of the letter "s". "S" had simply been decided upon as a test signal. The distance covered by that first historic message was approximately 1800 miles. The apparatus used in sending the message was entirely experimental and unsuited for dependable communication.

It was not until 1908 that Marconi's first transatlantic radio station was opened for the use of the general public. The time that elapsed between 1901 and 1908 had been taken up in developing the apparatus to a point where it would stand up successfully to meet the demands of commercial service. The equipment used was highly inefficient, and energy was wasted lavishly in the transmission work. The messages, however, were received except in stormy weather. When a heavy electrical storm interposed itself between two stations, communication was well-nigh impossible.

After Marconi had blazed the trail in commercial radio, a host of other investigators plunged into the subject and great numbers of important contributions were made to the art. The power of transmitting stations was increased and the sensitivity of receiving apparatus was greatly improved.

When the year 1912 arrived radio telegraphy had reached such a stage that it was necessary to establish the International Radio Telegraphic Conference. This conference drew up regulations to secure uniformity of practice in radio service. As a result of the conference, laws were established by the foremost maritime nations requiring that vessels of certain size carry suitable wireless equipment and trained operators.

Before the year 1914, several transatlantic stations were in operation, and what was then known as the Marconi Wireless Telegraph Co. of America (now the Radio Corporation of America) established a trans-Pacific service by opening powerful stations in California and Honolulu. A year later the American Telephone & Telegraph Co., working in conjunction with the Western Electric Co., succeeded in transmitting the human voice from Washington to Paris by radiophone. A distance of 3700 miles was spanned. The voice was also carried from Washington to Hawaii over the astounding distance of 5000 miles.

On November 5, 1921, the greatest of all radio stations was opened. It represents the highest perfection of the radio art. With it America will be able to carry on simultaneous communication with no less

than six countries. It has aptly been called "Radio Central," and it is located on Long Island fifty miles from New York. In its receiving equipment, Marconi's first unsatisfactory coherer is replaced by the ultra-sensitive vacuum tube, and his crackling induction coils have been replaced by purring Alexanderson alternators.

It is gratifying to know that America has taken the lead in this new art of communication which annihilates distance so effectively. America is to-day the "radio central" of the world, thanks to the untiring efforts of her engineers and technicians and to the unfailing support that has been given to them by her financiers.

The public never took a great interest in radio telegraphy until the year 1921 when broadcasting was begun at Pittsburg. This marked the beginning of a new American institution. Although broadcasting had been attempted before, it was not successful, and it was left for R. C. Rypinski and Frank Conrad, both of the Westinghouse Electric & Manufacturing Co., to give this new public service the proper impetus and guidance. Although the idea was born and fostered in Pittsburg, it spread rapidly throughout the country. The newspapers were quick to realize the importance and far-reaching possibilities of radiophone broadcasting and they at once supported the idea. Within eight months' time, radio telephony was a commonly discussed subject; the public pounced upon it as though it had been a thing that it was waiting for.

## CHAPTER II

### THE "HOW" AND "WHY" OF RADIO

**R**ADIO has always been a black art to the layman. There is no reason why this should be so. There are many things more difficult to understand than radio, and there are many things less interesting to learn about. Many persons have the idea that radio telegraphic and telephonic impulses are made up of blue-white flashes that jump off the aerial. Some people's knowledge of radio can be compared with the old Irish woman's knowledge of submarines. Her son Tim was in the navy. "Poor Tim," she sighed; "down in that submarine with nothing but that ould perryscope to breath through!"

We have often heard wireless and electromagnetic waves alluded to. We are all familiar with waves on the water, and there is no reason why we should not become familiar with waves in the ether. Radio or electric waves are waves produced in the ether. Now, what is this ether about which we have heard so much? It might be said that ether is almost as nearly pure nothingness as anything that can be imagined. Ether was really invented by scientists as a matter of convenience. It allowed them to account for many things in a theoretical way. The ether we might call the "missing link of science."

A few years ago, when scientists really began to

grapple with the subject of light, they reached a stumbling-block. Light did not travel through the air. What did it travel through? It was regarded as a disturbance of some kind in a medium of some sort. The necessity for an intangible, all-pervading substance to account for the phenomenon of light was apparent. The ether was born out of pure imagination. It might be said that there is a certain agency which we know must exist and that we have called that agency ether. For the sake of understanding, let us look upon it as being as far removed from a gas as a gas is from a liquid. Then, we must remember that ether is all-pervading. The whole world is saturated with it; the world is like a sponge soaked in ether. There is nothing that ether cannot penetrate.

Now that we have digested the ether, let us learn more about the mysterious ether-waves. When a stone is dropped into a quiet pool of water, little wavelets spread out from the source of the disturbance in all directions. The length of a single wave would be the distance from the top of one wave to another. This would be what is called the "wave-length." In the present case, the wave-length might be one and one half inches. If a larger stone should be dropped into the water there would be a greater splash, and the wave-lengths of the resulting waves would be longer. Ocean waves have a length ranging from fifty to two or three hundred feet.

From this analogy we can deduce two things. One is, that the wave-length *will depend upon the number of*



*waves passing a given point in one second.* In other words, the wave-length depends upon the frequency. The larger waves might have a frequency of about one a second while small waves may have frequencies as high as ten or fifteen a second. We can readily understand that the more waves crowd into a given space, the smaller the wave-length must be. If one hundred waves pass a given point in one second they will have a wave-length one half the length of fifty waves that would pass the same point in the same time, provided, of course, that the speed of the waves in both cases was the same. Let us pass on to the next paragraph firm in our conviction that the length of waves depends upon their frequency.

We can assume that waves are produced in ether just as they are produced in water. We can have splashes in the ether with resulting waves just as we have splashes in the water. However, waves cannot be set up by dropping a brick in the ether, because the brick is already soaked in ether. Some other means must be used for setting up a "splash." In the case of electric waves, heavy electric discharges are used. In other words, ether waves are set into motion by what we might call an "electric brick."

Before passing on to a more detailed explanation of the propagation and detection of electric waves, let us stop for a moment and consider other kinds of ether-waves. Scientists have good reason to believe that all waves in the ether are electric. This means that light and heat waves are electrical in nature. The

mathematical side of the proof offered for this assumption has been rather thoroughly worked out. Light, radio, and heat waves differ only in length. Waves used in radio are extremely long. Heat-waves are shorter, and light-waves are still shorter. We might liken the scale of electric waves to the keyboard or scale of notes on a piano. The bass notes produce sound-waves (we must not confuse sound-waves with ether-waves) of considerable length. As we go on up the scale, the waves keep growing shorter and shorter and the pitch or frequency higher and higher. We can compare radio-waves with the bass notes of the musical scale. As we go up the scale, the waves keep getting shorter until they produce a sensation of heat. If the frequency is increased, visible light-waves are set up. As we pass from one end of the visible spectrum to the other, or from red to violet, the frequency increases until a point is reached where the sensation of light is lost. This brings us into the dark or invisible portion of the spectrum where ultra-violet and X-rays abide. The figures that express the frequency and wave-length of etheric disturbances are astounding. Electric waves vibrate from 10,000 to 30,000,000 times a second. Heat and light waves are created when vibrations of from 3,000,000,000,000 to 3,000,000,000,000,000 are produced. These figures mean little or nothing to us since they are far beyond the range of even the best imagination. It would take quite a mental acrobat to dash back and forth after a wave vibrating 30,000,000 times a second.

This matter of understanding ether-waves leads us into many byways. Fortunately they are not blind alleys and we can always find a way out. It will now be necessary to consider an alternating current. Many of us use alternating current in our homes for lighting purposes. What is known as direct current also comes into some use. There is a simple difference existing between alternating and direct current. A direct current flows continuously in one direction like water flowing through a pipe. An alternating or oscillating current does not do this. It flows first in one direction and then in the other; it has a to-and-fro motion. In fact, it can be said that an alternating current "vibrates," and when a thing vibrates it always does so at a certain frequency. The alternating current that we use in our homes is said to be of low frequency. In some cases it darts back and forth as often as fifty times a second and in other cases it reaches a speed of 120 times a second. The frequency of an alternating current may be increased by suitable means. As the frequency goes up, up, and up, the current grows wilder and wilder in its action until it is rushing madly back and forth several hundred thousand times a second. When this condition is reached the current is said to be of "high frequency." Such currents are used to generate radio-waves.

A high-frequency current is so frisky that it becomes unmanageable and leaps off into space. In other words, it leaves the wire or circuit through which it is flowing and jumps out into the ether, taking on the

form of an electric wave. The frequency of these electric waves will be equal to the frequency of the current that produced them. Marconi discovered that these high-frequency currents had the peculiarity of jumping out of their circuits. For that reason wireless telegraphy was not a success with low-frequency current.

As youngsters, we all played with jumping-jacks. The little monkey was so arranged on the stick that it would jump back and forth as rapidly as we wanted it to. If we could have attached the monkey to a machine that would have speeded up his movements, a point would have been reached where the speed would have been so great that the monkey would have left the stick. That is just what happens to a high-frequency alternating current. It oscillates so rapidly that it loses its hold upon material things and leaps off into the intangible ether.

It was mentioned before that the length of an ether-wave depends upon the frequency of the current producing it. If the frequency is extremely high, the resulting ether-waves will be short, and if the frequency of the current is low, the ether-waves produced will be long. We have a good analogy in sound. High-pitched waves are short and low-pitched waves are longer. The frequency of an alternating current depends entirely upon the electrical properties of the circuit that it is produced in. First and foremost, it depends upon the amount of wire in the circuit. Roughly speaking, we can say that the frequency of a current produced in a circuit consisting of ten feet

of wire will be double that of a current produced in a circuit with twenty feet of wire. A schoolboy would know that if both the currents were traveling at the same speed, it would take the one traveling in the twenty-foot circuit twice as long to get around as it would the one in the ten-foot circuit. Therefore the frequency in one case would be greater than the frequency in the other. From this we deduce that frequency depends largely upon the "inductance," and we can look upon the word inductance as meaning simply the amount of wire in a circuit. If we had too much wire in a circuit or too much of this inductance, the current would take such a long time to get around that it would lose its ambition and fail to go through the acrobatic performance of leaping into space.

There is another property of an electric circuit that is quite as important as that of inductance. It is what is known as resistance. Every moving thing, even electricity, meets with resistance. When water flows through a pipe, it meets resistance. When a ball rolls down a hill, it meets and overcomes a certain amount of resistance, which tends to retard its motion. Electricity flowing through a wire meets with resistance, and this resistance will depend upon the nature of the metal that makes up the wire, the size of the wire, and its length. The size of the wire is important because it is known that water will flow with much greater freedom through a large pipe than through a small pipe. The same holds true in the case of electricity flowing through a wire. If the wire is very

small, its resistance will be high. If it is large, its resistance will be low. High resistance is a deadly enemy to high-frequency current, since it has a tendency to "choke" or hold the current back. When the resistance is too great, the current loses a great deal of its ginger and snap, and it cannot dart back and forth as rapidly as it could under better conditions.

There is still another property of electric circuits which influences the frequency of currents flowing through them. This is what is known as electrical "capacity." Capacity is a troublesome thing to deal with, and we are going to forego the pleasure, if it can be called such, of delving into this circuit property. For the present we shall let capacity be but a name. We shall explain it later under more favorable conditions.

We are getting deeper and deeper into our subject. A few moments ago we were wading. Now we are swimming. Let us hope that we shall not drown. There is only one way to understand a subject, and that, to mix the metaphors a little more, is to take the bull by the horns.

We are now going to consider the actual apparatus employed in producing electric waves or splashes in the ether. Before going into this aspect of the subject, let us look at the accompanying sketch for a few moments. Here we will see what is known as a key, an induction-coil, a spark-gap, an aërial, and a "ground." The key is merely a hand-manipulated switch. Its principle is the same as that of the switches

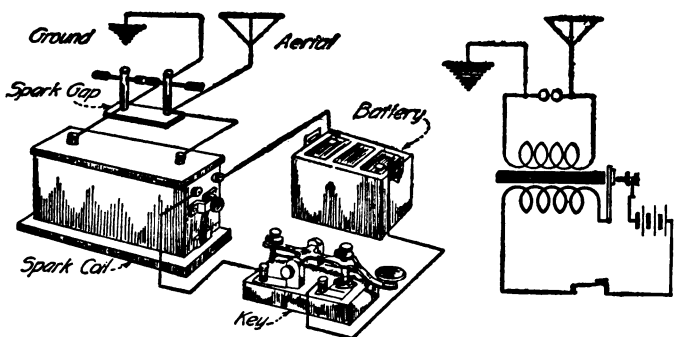

The instruments necessary for a simple radio telegraph transmitter.  
 Diagram of connections is shown at the right

### DAMPED WAVES.

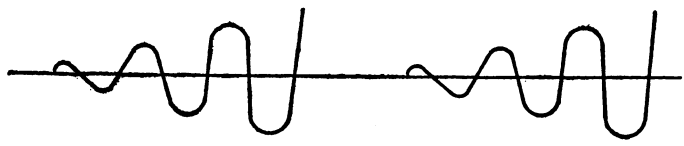

### UNDAMPED WAVE

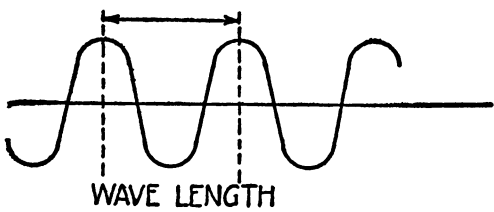
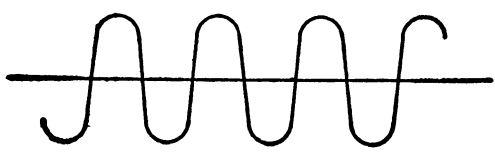

A diagrammatic representation of damped and undamped waves.  
 The meaning of wave-length will be gathered from the bottom diagram





that we use in controlling our electric lights. It is arranged in the form of a lever so that dots and dashes can be formed. When the lever is pushed down, the circuit is "closed" and current from the battery flows into the induction-coil. We do not need to know the inner workings of the induction-coil. We can simply look upon it as a device used to increase or "step up" the voltage of an electric current. We may take a current with a voltage of five and increase it to fifty thousand. It would not be misleading to regard an induction-coil as an electric pump producing a high pressure. When a current comes forth from the high-voltage side of the induction-coil it has a good deal of vigor and sting to it, as any amateur wireless telegrapher can testify who has had the misfortune to come in contact with the terminals of such a coil.

As the high-voltage or high-pressure current comes forth from the induction-coil, it rushes into what is known as a condenser. This condenser bears no relation to condensed milk or condensed steam; it is an electrical device all the way to its back-bone. A condenser is merely a receptacle that will hold just so much electricity. In other words, it has a definite "capacity." This is where that property, capacity, enters the argument. When a condenser becomes "filled" it acts in a peculiar manner. The rapidity with which it is filled will depend, of course, upon its capacity. A large condenser takes longer to fill than a small one. In any event the fraction of a second that is required to fill the average condenser is exceedingly

small. When the condenser becomes brimful of electric charges it runs over, and the charges rush across the spark-gap in the form of a bluish discharge. A condenser has two sides to it, a positive side and a negative side. When the positive side of the condenser becomes filled, it rushes across the spark-gap as heretofore described, and all of the charge suddenly jumps into the negative side. This fills the negative side to capacity, and the charges scamper out again into the positive side. This process of rushing to and fro is continued until the charges die out, until all their energy is consumed. They start out with great gusto, snapping back and forth across the gap until they are absolutely fatigued. A condenser, when once fully charged, can discharge and *recharge itself many thousand times in the space of a single second*. Again our imagination bumps into a stone wall.

Here the reader is going to say to himself, "Aha, the condenser is merely a device used in producing high-frequency alternating currents." That hits the nail on the head. The condenser is simply a producer of high-frequency currents. These currents rush wildly around what is known as the "closed oscillatory" circuit. That is a high-sounding phrase, and for our purpose it would do just as well to call it a circus-ring.

It does not take a wise man to see that the speed with which the currents whirl back and forth around the circus-ring depends upon the size and nature of the wire (resistance), the length of the wire (inductance),

and size of the condenser (capacity). If we wanted currents of extremely high frequency and a correspondingly small wave-length we should use a very small condenser and a small amount of extra-large wire. The condenser would not take long to fill, and the charges or currents produced would have great freedom in darting back and forth.

At this point we shall have to stretch our imagination; we shall have to resort to a somewhat occult process. Now that we have the currents whirling around in the circus-ring, we have to get them out into what is known as the "open oscillatory circuit." If we should go into an explanation of the actual process that takes place in the transfer of this current from one circuit to another, our enthusiasm for the whole subject would suffer a considerable amount of cooling off. It is sufficient to say that the high-frequency currents are "induced" or "lured" into the open or aërial circuit. They are still going at the same speed because the aërial, or open circuit, is supposed to be tuned to the closed circuit. If it should not be, there would be a hitch in the process and the currents could not be induced to leave the first circuit so enthusiastically.

Here we are now, with our high-frequency current rushing around in the aërial circuit. What happens? The aërial circuit is like an open door that leads out into the ether. Here the high-frequency currents walk out into space. And they walk fast, one wave biting the heel of the next at a speed of no less than

186,000 miles per second. We have heard of the speed of greased lightning, but greased lightning is slow when compared to wireless waves. So terrific is their pace that they are able to encircle the earth several times in the space of one second.

The simple wireless transmitter that has just been described produces what are known as "damped" waves. By damped we do not mean wet. To understand the meaning of a damped wave, we must go back to the condenser, since this is responsible for creating such waves. We learned that the condenser produced currents that gradually faded out as they rushed back and forth from one side of the device to the other. In the parlance of radio, they "damped out." This damping out effect is noticeable in the waves the currents produce in the ether. The waves begin by swinging back and forth in a lively fashion, and then they gradually fade away and another one starts. A damped wave-train is represented in the insert in the drawing. Many thousands of these little wave-trains are produced in the space of a second. Yet there would be a distinct break between them if our ears were only able to hear it.

An undamped wave is continuous. There is no fading-out effect. An undamped wave is absolutely resolute in its purpose. It begins with a certain swing and it maintains that swing until it is cut off entirely. It is not chopped up into little bits like damped waves. Continuous or undamped waves are gradually but surely replacing the other variety. They

are produced by very special apparatus that cannot in any way be confused with the crude instruments that we have just been considering.

There is what is known as the arc method of setting up ether splashes. Waves propagated by an arc transmitter are of a continuous nature. We all know what an arc-light is, but few of us know how it works. If two carbon rods are connected to a source of controlled current, an arc will be produced between them when their ends are touched and drawn apart. The arc produced is one of the hottest things imaginable, producing a temperature as high as 7500 degrees. This is mentioned merely as an interesting point, since its heat has nothing to do with its action as a producer of electric waves. Once the arc is established, current will continue to pour across the heated gap. The arc, used alone, will not disturb the ether a great deal, but will remain peaceful and passive. When a condenser is connected around it or "shunted across it," as the radio men say, things begin to happen. The arc is no longer passive. It immediately begins to charge the condenser, and when the condenser becomes filled it discharges. This discharge of the condenser, however, is different from its discharge when it is used in connection with an induction-coil. If direct current is used in with the arc, a continuous discharge will be produced by the condenser. If the condenser is properly connected to an aerial, a smooth series of orderly waves will shoot forth. The wireless man refers to these as C.W. — this means continuous waves.

There is another method of producing continuous waves that is worthy of attention. We learned some time ago that the high-frequency current that produced electric waves differs from the alternating current we use in our homes only in the matter of frequency. Our low-frequency currents which we use for power purposes are produced by generators. Those of us who are curious have often peered into the windows of power stations to see the big alternators, as they are called, doing their duty. As radio developed, engineers reasoned in this way: Why not use a mechanically driven alternator to produce high-frequency currents? If this could be done, the unsatisfactory induction-coils, condensers, transformers, and hissing arcs could be abolished. The thing was easier said than done. There are certain mechanical and electrical problems of a very discouraging nature that had to be overcome. First and foremost, an alternator producing a high-frequency current would have to be run at a terrific speed. It is very easy to run a small machine at a high speed, but when it came to large power producers like those that would have to be used in a long-distance wireless transmitter, the problem was an ugly one. That old enemy, centrifugal force, pokes its head in and asks for an accounting. A heavy piece of machinery, brought up to high speed, is very likely to fly to pieces, carrying everything with it, including those who may be standing about. The friction problems in the bearings are also enormous. Yet, if such a machine should be used it could be hooked up to the

## THE "HOW" AND "WHY" OF RADIO 67

aërial and waves could be sent forth directly. The efficiency of such a machine would be far beyond the arc or spark system.

Engineers worked on this problem for a number of years and finally what seemed impossible was accomplished. Ernst F. W. Alexanderson, an engineer of the General Electric Co., succeeded in overcoming all the great problems that had interfered with the development of a high-frequency alternator. He produced a machine of such great power that it is able to send waves out so full of energy that they are used to carry

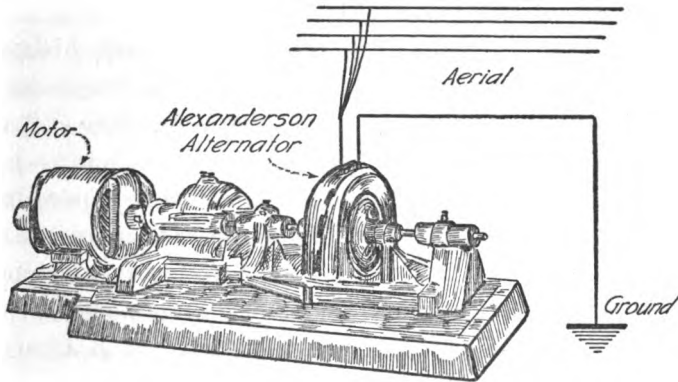

The Alexanderson high-frequency alternator now used in trans-oceanic radio communication.

on continent-to-continent communication. The Alexanderson alternator is a triumph of engineering. Hundreds of thousands of dollars were spent in its development. The bearings that had to be produced to accommodate its rapidly revolving shaft have no

likeness in the world. Its rotating member had to be machined to less than a hair's-breadth of accuracy. Then a method of driving this rotating member had to be invented. Large motors operating at this speed were out of the question. That brought up the necessity of connecting the driving motor to the alternator through a train of gears. This train of gears increased the speed in the same manner that speed is increased on the kitchen egg-beater. The Alexanderson alternator is used to-day in many of the American trans-oceanic stations. Its faithful performance in the transmission of intelligence has reflected much credit on the engineering wisdom of its designer.

And there is still another method of producing these continuous waves. Here we get our formal introduction to what is known as the vacuum tube. The vacuum tube is an interesting little thing. So interesting and marvelous it is, indeed, that we are going to devote a whole chapter to it in a later part of the book. At that time we shall see how it comes in for its share of glory in the production of those much-sought-for continuous waves. For the present let us rest with the knowledge that vacuum tubes are capable of producing continuous waves.

This is the seventh inning. Let us lay down the book and stretch, for we are immediately going to get into another very interesting part of radio. Now that we have got the waves out into the ether, we must catch them. Producing electric waves is only half of the battle. After they are produced they have to be



detected. That reminds us of the story of the curious woman who questioned an operator on shipboard. When she was told that radio waves travel 186,000 miles a second, she said in astonishment, "My goodness! How do you ever catch them?" They are, however, not so elusive as one might think.

We must take the trouble of looking at the sketch of the receiving apparatus. First, we shall notice the aërial and the ground. From this we come to understand that an aërial and a ground are necessary in receiving and transmitting. We shall see connected to the aërial what is called a "tuning-coil." A wireless man would call it a "tuning inductance," but we cannot afford to be so exacting in our choice of terms. On the tuning-coil, we shall notice a slider, which is used merely to adjust the amount of wire used. If the slider is in an intermediate position, half of the wire of the tuning-coil will be active and half will be inactive. We learn it in this way, that half of the wire will be in the circuit and half will be out. Let us look upon the tuning-coil as an instrument with which we add wire to the aërial. It is simply a matter of adjusting the amount of wire used in this particular part of the circuit. When a wireless wave comes along, it will do one of two things. It will either dash into the aërial or it will give it the "cold shoulder" and go about its business of eating up space. If the aërial is tuned to the oncoming wave, the latch-string will be out and the wave cannot refuse the invitation to enter.

This tuning-in operation is a mystery to most new-

comers in radio, and yet it is as easy as a-b-c. The wave-length of radio-waves is measured in meters. A meter is 39.37 inches. A wave 200 meters long would be 39.37 multiplied by 200. If a 200-meter wave is approaching an aërial, there is only one way to induce it to come in; we must have 200 meters of wire in our circuit. It must be remembered that we are speaking in general terms here. If we had a condenser in our aërial circuit, it would influence the receptivity of the system. We must not confuse this condenser with the condenser used to set up oscillations. We can conclude that capacity in the form of condensers changes the wave-length of a receiver. Receiving condensers are made adjustable so that circuits can be tuned with them.

In the case under consideration, the condenser and the tuning-coil will be adjusted until the "inductance" and the "capacity" are the equivalent of 200 meters of wire. The wire would have to be of a certain size. If it were too small, the resistance would choke off the oscillations before they could enter. We can leave the subject, understanding that a radio-wave is coaxed into an aërial by adjusting the aërial through modification of the amount of wire and the capacity until it is able to accommodate the incoming wave.

What would happen if a 300-meter wave came into contact with an aërial tuned to 250 meters? If the tuning were sharp, the 300-meter wave would go right by, since there would be no inducement for it to enter. We could not expect to get a horse to sleep in a pony's

stall. If the tuning were sharp, we should not be bothered with interference. If the tuning were not sharp, a 260-meter wave might come along and wander in. Then there would be two signals and we should not get an intelligent response.

The matter of wave-length is important, as we have seen. The Government saw this, too, some time ago. When amateur radio first began, the experimenters were allowed to send their messages on any wave-length and with any power. Their wave-length grew so that they interfered with the commercial stations. Then a law was passed that limited the amateur to a transmitting wave-length of 200 meters, so that he could not interfere with business traffic. He is free to adjust his receiving apparatus to any wave-length. Commercial stations use waves from 300 meters up to 18,000.

Now that we have induced the electric wave into the aerial system, what are we going to do with it? It is caged up, it is ours, but how are we going to make this intangible thing "speak"? We shall be surprised to learn that once the electric wave is in the circuit it is no longer a wave but an actually detectable current of electricity. It began at the distant transmitter as a current of electricity, and it ends as a current of electricity. But the current is extremely feeble. It is so feeble, indeed, that ultra-sensitive instruments must be used to measure its magnitude.

The current flowing in the aerial circuit is induced into secondary or closed circuit in the sketch.

We shall assume that this closed circuit has also been tuned so that it is resonant with the other circuit. In the second circuit we see what is known as a detector. This is used in conjunction with an ordinary telephone receiver. It is the function of the detector to doctor the currents up in such a way that

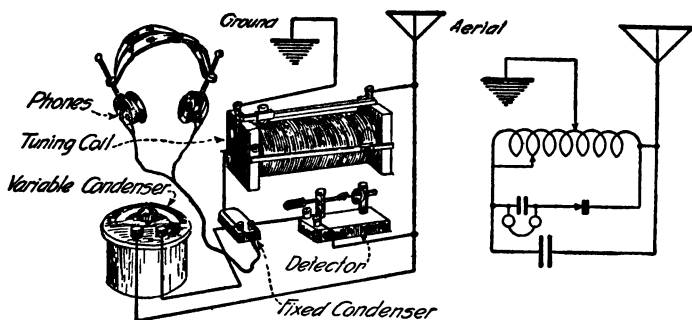

The instruments used in a simple radio receiving outfit.

they will be audible in the telephone receivers. Here they will cause little humming noises like the buzz of a bee.

The detector is important and interesting. To understand its importance we must first appreciate the fact that we have an alternating current of high frequency flowing through the circuit. If this to-and-fro current should be allowed to pass directly into the telephone receiver it would cause its diaphragm to vibrate at such an extremely rapid rate that no audible sound would be produced. When vibrations go beyond 32,000 a second, the human ear will not respond to them. That is where the detector enters the case.

The detector is simply made up of a little crystal, such as galena or carborundum, held in a metallic cup with a tiny spring or wire resting on its surface. This crystal acts in the same manner as a water check-valve. A check-valve on a water pipe will allow water to pass freely in one direction, but it cuts off its passage in the opposite direction. The crystal does the same thing to high-frequency electric currents. They can go freely in one direction, but they cannot turn around and return. Of course, they turn around and try to return, but the half that tries to return is entirely cut off. We have, as a result, what is known as an intermittent direct current, which is made up of little impulses all going in one direction. This is due to the fact that the other part of the high-frequency current traveling in the other direction is cut off. From this we can see that the frequency of the current, so far as its vibratory effect is concerned, is greatly reduced. It is brought from an inaudible frequency to an audible frequency, and then it is allowed to pass into the telephone, where it will produce a humming sound that can be heard. This is the way in which the dots and dashes produced by the key of the distant operator are heard at the receiving station.

Before passing to the next chapter there is one thing that we must keep in mind. Radio messages travel in all directions. If a station is able to transmit fifty miles, all the receiving stations within that distance that have properly attuned equipment will receive the message.

## CHAPTER III

### RADIO TELEPHONY

**J**UST as Bell's telephone followed Morse's telegraph, so did radio telephony follow radio telegraphy. When Stephenson was chugging along in his first locomotive, little did he dream that chain lightning would ultimately drive the iron horses; and when Bell listened to the human voice over the early telephone lines, he probably did not realize that it would some day be possible to carry on conversation without wires. One thing leads to another; the brook flows into the creek, the creek flows into the river, and the river flows into the ocean. Science never stops. Before radio telegraphy was perfected, radio telephony was anticipated. Every day the spirit voices of radio are about us. When we sit in the easy chair at home or when we walk on the streets, the voices of radio are rushing past us at a prodigious speed of 186,000 miles a second. They whisk by us carried on that intangible, all-pervading ether. To hear them we must have an electric ear made up of coils, detectors, head-phones, and so on.

Before delving into the subject of radio telephony, it will be well to pause a few minutes and briefly consider the outstanding principles of voice transmission over copper wires. How is a man in San Francisco able to hear the voice of another man in New York?

The fact of the matter is that the man in San Francisco does not hear the voice of the man in New York. The New York man's voice is translated into electrical impulses and these impulses are carried along the wire to the distant receiver, where they become audible.

The two most important parts of the telephone are the transmitter and the receiver. We speak into the transmitter and we hold the receiver to our ear. If we can come to understand the operation of these two comparatively simple devices, we shall have a knowledge of the fundamental principle of the telephonic transmission of sounds.

When we speak into a telephone transmitter, the sound-waves that our vocal organs set up impinge against a thin metal diaphragm. Sound-waves are quite tangible, and when they strike the diaphragm they bring to bear upon it a momentary pressure. In this way the diaphragm is set vibrating in sympathy with the voice of the person speaking.

Back of the diaphragm there is placed a little compartment full of carbon granules, and these little granules are inserted in the telephone circuit. As the diaphragm of the transmitter vibrates, it lightly pinches the little grains of carbon together. This "pinching effect" happens many hundred times a second. A student of electricity would immediately understand that to pinch these loose grains together would have the effect of producing a better electrical contact between them, and this would in turn lower the resistance they would offer to the current passing

through them. With this simple carbon grain arrangement, then, we are able upon an electric circuit to impress current fluctuations that correspond to the human voice. We might say that we cause the current to vibrate. At the distant station this vibrating current enters the receiver, and here it produces an audible sound by causing another diaphragm to vibrate in unison with the diaphragm of the transmitter. This is an extremely simple process, and how important it is!

In wireless telephony, instead of sending these voice vibrations over a conducting wire, we must send them over the ether. We still find use for the telephone transmitter and receiver. In wire telephony, it is important that direct currents be used. By direct current we mean smooth, one-way current that will carry the voice without distortion.

Early attempts were made to transmit the human voice through the ether with ordinary spark wireless systems. In the previous chapter we saw the difference between damped and undamped waves. We know that a wireless transmitter which sets up splashes in the ether by a discharge of sparks passing across the spark-gap produces what are known as damped waves. We might say that they are discontinuous waves. These discontinuous waves are ripples in the ether that are entirely disconnected. If we should insert a telephone transmitter into a spark wireless system, we could cause these little ripples to fluctuate in accordance with the impinging sound-waves against



the diaphragm; but this would avail us nothing, and the reason is quite evident. The voice-waves are uninterrupted. How, then, can we hope to superimpose these voice-waves upon the discontinuous ripples? The waves, as far as they go, will carry the voice, but what happens to the "blank" or "still" spaces between the waves? This part of the voice is lost because there is nothing to carry it, and it is therefore futile to attempt to transmit the human voice with a spark transmitter.

Continuous or uninterrupted waves must be used in radio telephony. If the voice is properly superimposed upon such waves, they will carry it faithfully to its destination wherever that may be. In continuous waves, we do not have these troublesome little interruptions.

In a previous chapter we learned something of continuous-wave transmitters. For instance, an ordinary arc when shunted with a condenser will produce continuous waves. Then there is the Alexanderson alternator and the little vacuum tube, which we are going to consider at length in a later chapter. If we place a telephone transmitter in the proper part of a continuous-wave transmitter, we can cause the voice to alter the waves in such a way that it will be reproduced in the telephone receiver of the distant receiving station. In fact, we impress the voice upon these waves in much the same manner that we impress it upon the continuous current in a wire telephone circuit. Engineers call this impressing process "modula-

tion"; they say that the waves are modulated and it is only during the last few years that we have learned the secret of good modulation.

In a small, low-powered wireless telephone transmitter, modulation can be carried out simply and serenely. Not so in high-powered stations where heavier currents are handled. Here the telephone transmitter is entirely inadequate. When it is used on a wire telephone, comparatively weak currents are surging through it. In a powerful wireless telephone transmitter, it would be called upon to handle extremely heavy currents—so heavy, indeed, that they would burn the little carbon granules together, which would at once render the device inoperative.

Early engineers in wireless telephony struggled with this problem of modulation for a number of years. At that time the problem lay in the development of a telephone transmitter that would handle heavy currents without "packing." In most of these experiments, the arc was used as a source of waves. In some cases a number of telephone transmitters were connected up and arranged in such a way that a person could speak into all of them at one time. This was done so that the heavy currents could be divided between the transmitters. This arrangement was at first encouraging, but it ultimately proved to be a makeshift of the most discouraging order.

Professor R. A. Fessenden was one of the most successful of the first experimenters in the art of radio telephony. Fessenden was a hard worker who helped

to make very interesting radio history. In 1901 he applied for a patent on "improvements in apparatus for the wireless transmission of electromagnetic waves, said improvements relating more especially to the transmission and reproduction of words or other audible signals." As early as 1908 Fessenden constructed a high-frequency alternator, and, using this in connection with a special telephone transmitter, he was able to carry on radio telephonic communication over a distance of six hundred miles. Duddell, Poulson, Bell, Dubilier, De Forest, Collins, Majorana, Vanni, Moretti, and Valluri all made valuable contributions to radio telephonic communication.

The bugbear of modulation which had greatly interfered with the progress of wireless telephony was finally overcome by the application of that little jack-of-all-trades, the vacuum tube. The vacuum tube is constructed in such a way that it is able to cause a very weak current to handle and control a heavy current. Therefore, if the telephone transmitter is placed in the weak current circuit, the heavy current can be made to obey perfectly. When the transmitter is spoken into and the weak current vibrates, the heavy current will vibrate in unison with it.

The research work that led up to the successful application of the vacuum tube to radio telephony was carried out by a number of experimenters. This is not the opportune moment to outline that work.

As yet radio telephony is not a competitor of wire telephony. It is to be looked upon more as an acces-

sory to wire telephony. The radio telephone is fast becoming an important part of our system of wire telephony. It is, in a way, growing into that vast network of copper threads that covers this and other countries. It will be used to bridge gaps that could not be covered by telephone cables. To-day we can go to our telephone and call another subscriber on

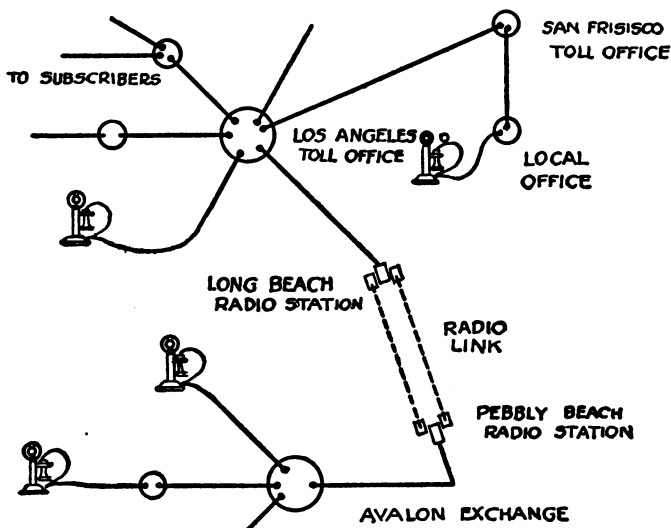

A diagram showing the radio link between the Avalon and Los Angeles telephone exchanges.

Santa Catalina Island, which is about thirty miles off the Pacific coast. The connecting link between the exchange at Long Beach, California, and the exchange at Avalon, Catalina, is covered by radio. We should be connected to the exchange at Long Beach. If we spoke into the telephone transmitter, say in New York,

our voice would be carried along the wires to Long Beach. Here it would pass into a wireless telephone transmitting apparatus, at which point it would step out into thin ether, to journey three and one half miles to a wireless receiving station in Pebbly Beach, on the island. At this point the speech currents set up in the apparatus would be shot back into the telephone lines and carried to the exchange at Avalon, Catalina, and from the exchange they would pass into the receiver of the listener. If the person in New York did not know of the radio link he would not have the slightest suspicion that his voice was being carried part way on the wings of the ether. Two-way communication is carried on just as it is carried on over conventional telephone lines. The installation of this system is by no means an experiment. It is to-day part and parcel of the telephone system of this country.

## CHAPTER IV

### RECEIVING FROM THE BROADCASTING STATIONS

**H**OW can I hear the radiophone concerts?" is the question of the day. This chapter will be devoted entirely to this subject.

The aërial is the first thing to consider. There is much misunderstanding about aërials. Aërials especially suitable for reception from the broadcasting stations should be made up of about 125 feet of wire. These should be put up as illustrated on page 85. When a single wire aërial of this type is used, no soldered connections will be necessary, since the end at which the lead-in is taken off can simply be looped through the eyelet of the insulator, twisted around itself several times, and carried to the lead-in insulator. Soldered connections on aërials should be avoided as much as possible, since there are few tinkers who know how properly to handle a soldering copper.

If an aërial with a length much greater than 125 feet is put up, trouble will be had in tuning to a point low enough for the broadcasting stations which now operate on a wave-length of 360 meters. In this connection we must remember that the ground wire is always considered as a part of the aërial. If the ground lead is too long, the natural wave-length of the aërial will be so great that the concerts cannot be tuned in. This

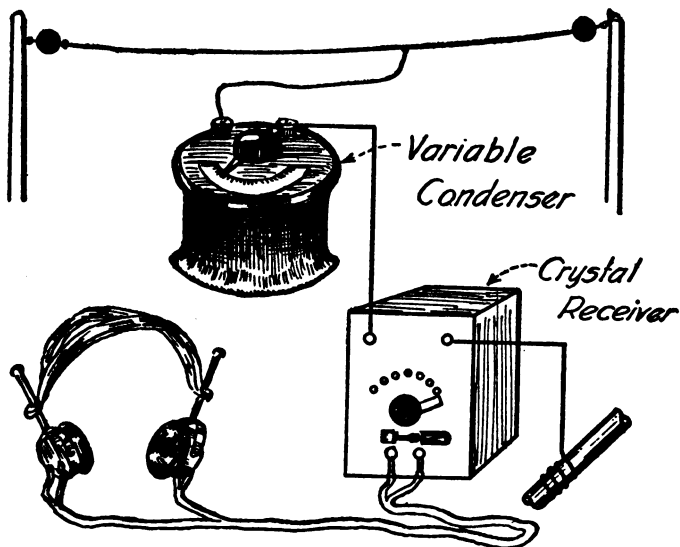

How a variable condenser is connected between the aerial and receiving outfit to reduce the wave-length.

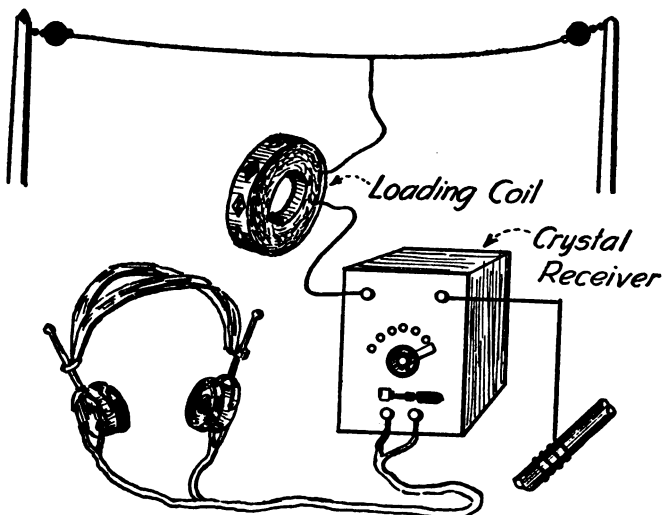

How a loading coil is connected between the aerial and ground of a crystal receiver to increase the wave-length.

condition can be remedied by simply placing a variable condenser between the aërial and the receiving set as illustrated. This condenser, when connected in such a way, will reduce the wave-length range of the outfit. This simple remedy can be applied only when crystal receiving outfits are used.

The average crystal receiver cannot tune much beyond 1000 meters, when connected to a single wire aërial with a total length of 125 feet. If the user wishes to tune beyond this point, he can use what is known as a loading-coil. The loading-coil can be made by winding a few turns of No. 22 wire around a wooden or cardboard form, or it can be purchased ready for use. The loading-coil is simply made up of a few feet of wire which is connected in series with the aërial and the receiving outfit. This arrangement increases the length of the aërial and thereby increases the wave-length range of the station. When such coils are used, the outfit can reach out after the code signals and other stuff on higher wave-lengths.

The kind of wire used in an aërial is very important. Pure iron or steel wire is entirely unsuited for this purpose, since it offers too much resistance to the passage of high-frequency currents. Pure copper wire is well suited from the electrical point of view, but it is usually too soft and breaks under strain. Nothing is more discouraging than to look out of the window in the morning and see the aërial down. There is now on the market an ideal wire for aërials, which is a combination of steel and copper. It is copper wire with a



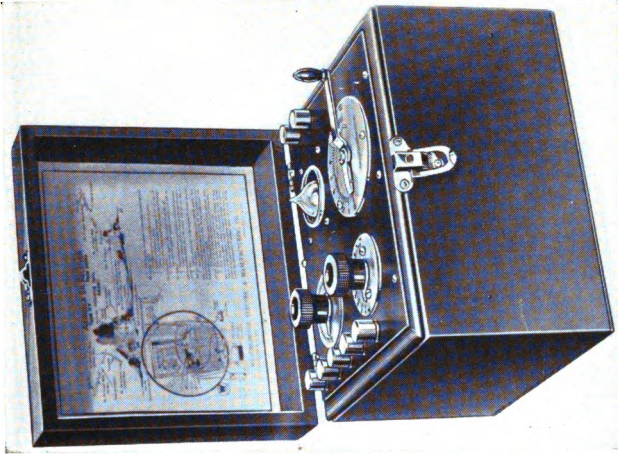

A simple vacuum tube receiver which operates from a single dry cell



A de luxe receiver of the phonograph type. This receiver has but one adjustment



steel core. It is both electrically and mechanically good. The steel gives it strength and the copper gives it conductivity. Radio currents always travel on the surface of the conductor, and, therefore, this copper surface, which is welded on the steel core, allows weak currents to pass through it with virtually no loss. The purchaser should make sure that he does not buy a wire that is only copper-plated. The

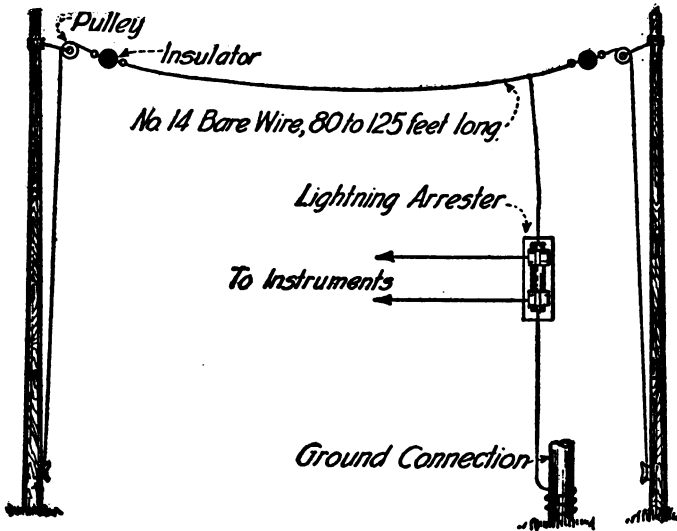

Constructional details of a simple one-wire aerial.

copper scales off this wire very easily, leaving nothing but a rusted center. In the product previously referred to, the copper is permanently held to the surface of the steel. No wire smaller than No. 14 gage should be used in the construction of an aerial.

The ground connection of a radio receiver is also important. It can be made with the same wire that is used for the aërial. No wire smaller than this is permissible. The ground wire is connected to water or steam pipes. The pipe should first be scraped scrupulously clean. This can be done with a piece of emery cloth. What is known as a ground clamp can be attached to the pipe. Such a clamp can be obtained from any dealer for a few cents. There is a nut on it to accommodate the ground wire.

The lightning-arrester is also connected directly between the aërial and the ground. A lightning-arrester must be used, not only as a protection to the receiving apparatus, but as a protection to the property as well. If a heavy electrical discharge should strike the aërial the lightning-arrester would carry it safely off to the ground and no damage would result.

A crystal receiving set is the most simple and inexpensive that can be purchased. Such receivers range in price from fifteen to twenty-five dollars. Their receiving range is, of course, limited. Under the most favorable conditions broadcasting stations can be heard for a distance of twenty-five miles with instruments of this type. Ordinary telephone receivers must be used, since loud speakers can only be satisfactorily operated in connection with the more expensive vacuum tube outfits. More than one telephone head-set can be used with crystal receivers, and if this is done the receivers should be connected together in series as illustrated.

There is one best way of operating a crystal receiving set. The beginner must first learn how to take care of his detector. The detector is a very sensitive instrument. A crystal of the mineral galena is used in it. Bearing on this crystal there is a small phosphor-bronze wire called a catwhisker. The surface of the galena is searched with this wire until the most sensitive

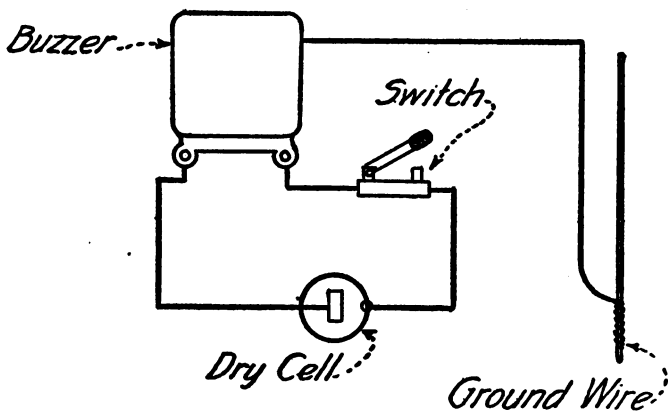

Details of a buzzer testing outfit used in the adjustment of crystal detectors.

spot is found. The most sensitive spot will be indicated by the audibility of the response in the telephone receivers.

It is difficult to adjust the detector without some sort of an auxiliary device that will set up local signals. Such a device is shown in the illustration. It is commonly called a buzzer tester. An ordinary buzzer is connected to a small switch and a dry cell. A wire is then attached to the contact-point of the buzzer and

this is carried to the ground wire. Several turns of this wire are then wrapped around the ground wire. The wire running from the buzzer should be insulated so that no actual metallic contact will be made between the two. When this device is used to adjust the detector, the head-phones should first be placed over the ears. Then the switch controlling the buzzer is closed. When this is done the hum of the buzzer will be heard in the head-phones. The little catwhisker is then carefully lifted and brought in contact with various parts of the crystal. As this is done the sound produced in the telephone receivers will vary. When some spots of the crystal are touched the sound will be weak, and when other parts are touched it will be louder. The spot that will produce the loudest sound in the telephone receivers is used. When this is found, the detector is in adjustment and the outfit is ready for reception.

Before passing on to the manipulation of the rest of the receiver, it will be well to say something about the care of crystal detectors. It must be remembered that the detector does not hold its adjustment permanently, and it may have to be adjusted two or three times during the course of an evening. The operator of the outfit must also refrain from touching the sensitive surface of the crystal with his fingers. This leaves a thin layer of grease, no matter how clean the hands may be. This invisible film offers a high resistance to the passage of weak currents, and the sensitivity of the detector is thereby decreased. If the crystal must be

handled it should be done with a small pair of tweezers.

As time goes on the crystal will become insensitive. Dust and dirt will accumulate on its surface and adhere there. This foreign matter can be removed by giving the crystal a bath in alcohol or ether. The sensitivity of the surface can also be restored with a few strokes of a fine file. This will take the top crust off and expose a new surface. It is also well occasionally to clip the end off the little catwhisker with a pair of shears. This produces a clean point of wire which will make a good electrical contact with the surface of the galena.

Aside from the crystal there is only one other adjustment to be made on the complete receiving outfit. This is the adjustment of the tuning-coil. This may be done by turning the knob or by pulling the slider back and forth over the sliding rod. In the case of a knob, the knob is revolved until the music or speech comes in with maximum loudness. In the case of a slider, the slider is simply pulled back and forth until the best position is found. So much for the simple crystal receiver.

If anything better than the crystal receiver is desired, the enthusiast will have to invest in a vacuum tube outfit. Such outfits may be purchased with only a single vacuum tube. They may cost from thirty-five to seventy-five dollars. They will receive up to a distance of fifty miles from the broadcasting station. It will be necessary to purchase a storage battery with such outfits. There is one exception to this rule, since there is an outfit on the market now in which a dry

cell is used to light the filament of the vacuum tube. All other outfits require a storage battery.

When the storage battery is connected to the vacuum tube receiver, the filament rheostat, which is plainly marked, can be adjusted until the filament in the vacuum tube is a dul red. The outfit is then tuned

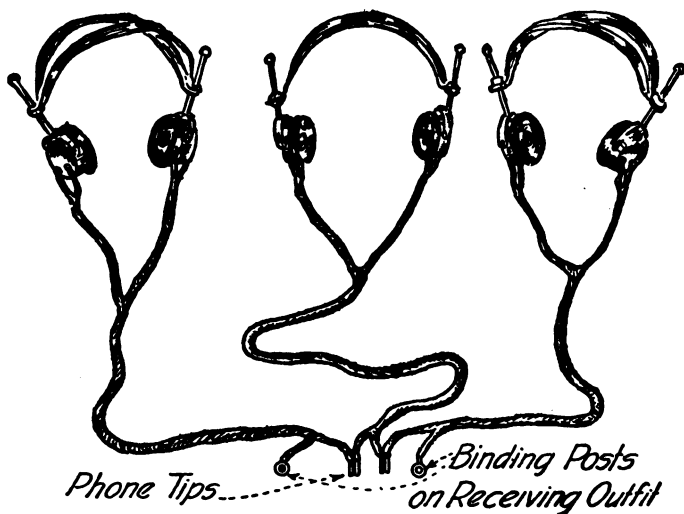

How telephone receivers should be connected when more than one pair are used.

until the maximum response is heard in the telephone receivers. Further adjustment can then be made on the filament rheostat, and this may or may not increase the audibility.

The filament should not be burned at a point of unnecessary brightness. This will do nothing but shorten the life of the tube. Many beginners make the mistake of thinking a vacuum tube is an electric light



with a candle-power rating. For best results, single vacuum tube receivers should be of the regenerative type. The regenerative system allows one vacuum tube to take the place of several. If such a receiving outfit is used within a few miles of a broadcasting station, a simple loud speaker can be attached to it. Many novices prefer to attach a horn to their telephones. The heavier types of loud speakers, which require a special type of storage battery for their operation, cannot be used with a simple vacuum tube outfit of this nature.

It is well not to handle vacuum tubes unnecessarily, and the receiving outfits equipped with them should not be handled roughly or subjected to jars. The vacuum tubes break easily and they are costly. The beginner should also refrain from making experiments with his vacuum tubes without expert advice.

Besides the storage battery, a "B" battery will be necessary for a vacuum tube outfit. Care should be taken to see that the "B" battery is connected to the receiving outfit in the proper manner. The positive pole of the "B" battery is also connected to the plate of the vacuum tube. All these connections will be clearly marked on the receiving outfit, and the novice will do well to follow them religiously.

When a regenerative vacuum tube receiver is used, the simple remedy for wave-length problems, which has been previously described, cannot be applied. If a loading-coil or variable condenser were placed between the aërial and such an outfit the corresponding changes

would have to be made in the regenerative circuit. Most manufacturers, however, supply special devices for use with such equipment.

When the novice desires something more elaborate and more sensitive than the single vacuum tube receiver, he usually purchases an outfit with a two-stage amplifier. This may cost anywhere between \$75 and \$130 without the necessary accessories, such as storage battery, "B" battery, head-phones, and loud speaker. The complete outfit may cost in the neighborhood of \$175. The two-stage amplifier outfit will receive under favorable conditions up to a distance of from 300 to 350 miles. Three vacuum tubes are used; one functions as a detector and the other two as amplifiers. Two-stage amplification outfits are specially suited to loud speakers.

Those who wish to have the very best in radio will want to install a phonograph type of receiver. Such outfits range in price from \$200 to \$500 and more. They employ as many as eight vacuum tubes. Such outfits have an enormous receiving range and they reproduce the broadcasted music and speech with great volume. It is often possible to use the indoor type of aerial with this outfit if the broadcasting station is not too far away. This type of aerial is illustrated on page 113.



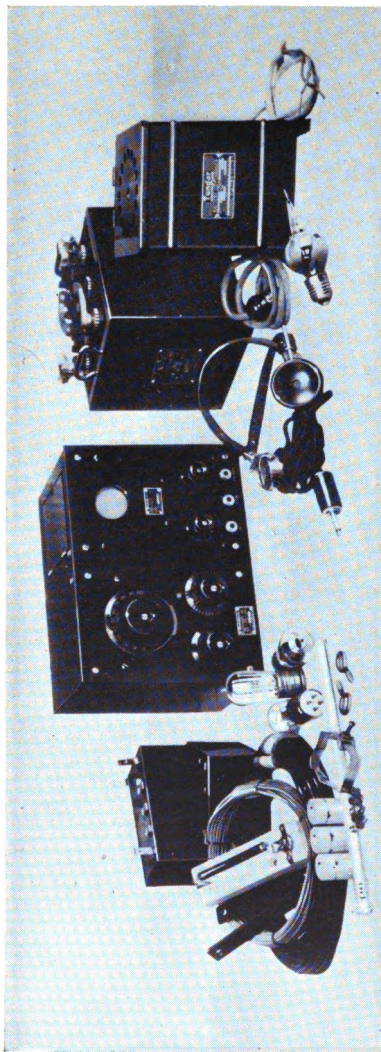

Complete set of apparatus necessary for a two-stage amplifying receiver. The auxiliary apparatus pictured follows: Storage battery, "B" batteries, three vacuum tubes, charging outfit for storage battery, telephones, aerial wire, lightning arrester, and insulators. A loud speaker can be used in place of the telephones

## CHAPTER V

### RADIO AS A HOBBY

**R**ADIO is the master hobby. It is more than a hobby: it is a malady to which thousands of men are extremely susceptible. "Radiomania" to-day has about 500,000 victims in this country, and the list is growing. There is no age-limit. It is not uncommon to hear a little chap of ten years talking about tuning-coils, detectors, and the like. Neither is it astonishing to see old men who have fallen victims to the allurements of the art.

In the early days of radio, no governmental restrictions were placed upon work of any kind. The amateur telegraphers thrived under those conditions. No limit was put on the wave-length of their transmitters, and no limit was placed upon the power of their outfits. Many of them would take a keen delight in filling up the ether with all kinds of jargon. Some did it just for the pleasure of hearing the spark of their five-kilowatt transformer crash across the gap. The more noise the merrier. The ether was one grand bedlam.

This species soon became a nuisance. Armed with a powerful transmitting apparatus, he would "talk back" in the most defiant manner to any licensed operator who dared to ask him to stop sending for a

few moments to prevent interference. His ugly spark, which had a tone something like the Klaxon horn, would fairly bellow with indignation.

In 1912 the Government made an effort to squelch amateurs of this kind, and a law was passed which is still in force. It laid down a number of very reasonable conditions regarding the rights of the amateur and experimental operator. It provided that a power of more than one kilowatt should not be used in amateur transmitting stations. Now, a power of one kilowatt is no mean amount of energy. Seven hundred and forty-six electric watts represent one horsepower, and therefore a kilowatt is close to one and one half horsepower. This amount of power was to be used only in stations that were located five miles away from a naval station. A station located within five nautical miles of a naval station was restricted to a power of one half of a kilowatt. The amateurs with the "big gun" sparks were disappointed, and they had no one to blame but themselves.

The law further provided that it should be necessary to have an operator's license if a station should be capable of transmitting over the boundary lines of the State in which it should be located. To obtain one of these licenses, which are issued in first and second grade form, it is necessary to be able to transmit and receive a certain number of words a minute. Under the Radio Communication Laws of the United States, the country is divided into nine districts. Every amateur station that is licensed is given a number or

call that corresponds to the district. For instance, in Chicago and vicinity the call is begun with 9. It may be 9 GC or 9 EE.

Nowadays with the increased sensitivity of receiving apparatus even the smallest transmitters are able to send messages over considerable distances, and it is advisable to obtain a license, even though very small transmitters are used. The license costs nothing and every amateur radioist should be proud to have a certificate of Uncle Sam's approval hanging in his station. All the necessary information regarding station licenses can be obtained by addressing a letter of inquiry to the radio inspector of the district in which the applicant is located. Of course, no license is necessary for receiving stations. The various districts and headquarters follow:

First district . . . . .	Boston
Second district . . . . .	New York
Third district . . . . .	Baltimore
Fourth district . . . . .	Norfolk
Fifth district . . . . .	New Orleans
Sixth district . . . . .	San Francisco
Seventh district . . . . .	Seattle
Eighth district . . . . .	Detroit
Ninth district . . . . .	Chicago

After stations are licensed they are listed in a book entitled "Amateur Radio Stations of the United States." This book is published by the Department of Commerce, bureau of navigation, and copies of it may be obtained from the Superintendent of Documents, Government Printing-office, Washington. A charge

of fifteen cents is made. This book gives the name and address of the owner of the station, the call letter, and the power of the transmitter.

Since receiving stations cannot become a nuisance no restrictions are placed upon them. The owner of a receiving set can have an aerial miles long if he wishes, and he can employ the most elaborate and costly apparatus without applying for a license. The radio law has only one thing to say about a receiving station. It states clearly that operators of stations must not reveal messages they receive from commercial stations. This is simply a protection to those who transact business by radio.

About all the authors can hope to do in this chapter is to give a start to those who would like to make a hobby of radio. That is all the true hobbyist needs. To describe all the interesting things a radio amateur or "ham" can do would easily fill a book larger than this one.

Radio is a potentially creative hobby. It appeals strongly to that inventive instinct which every normal individual has. We all love to build things up, to produce new combinations. Radio offers an unlimited opportunity to exercise the creative faculty. There is no set way in which a given number of receiving or transmitting instruments may be connected up. There may be the one best way, but every amateur has his own pet "hook-up," as the method of connecting the apparatus is called. Any hobby that allows this wide range of experimentation is alluring. In radio there



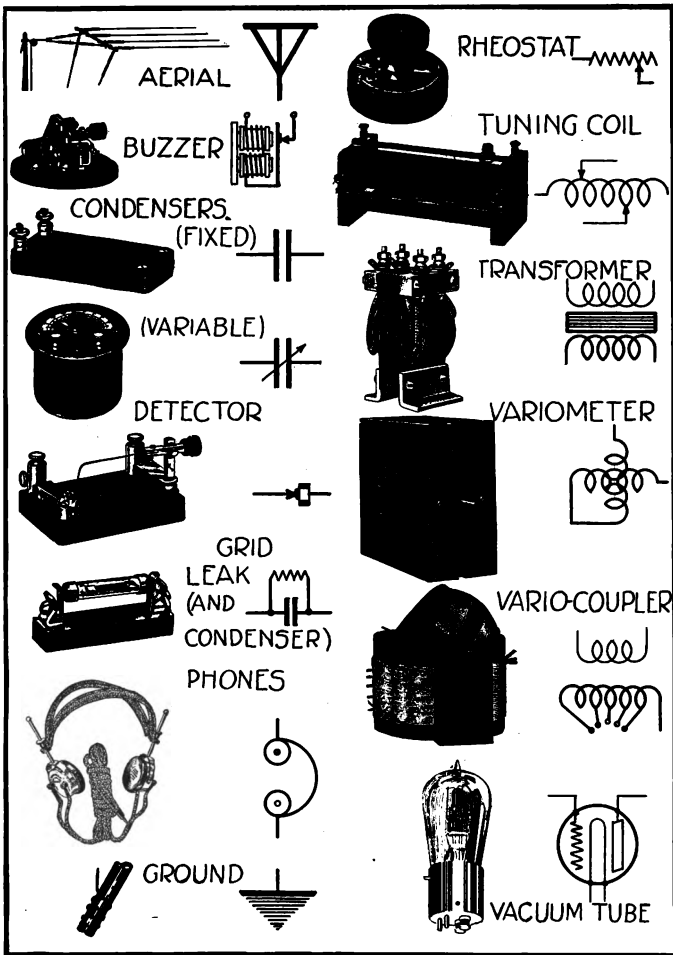

Instruments used in radio receiving outfits and the diagrammatic symbols

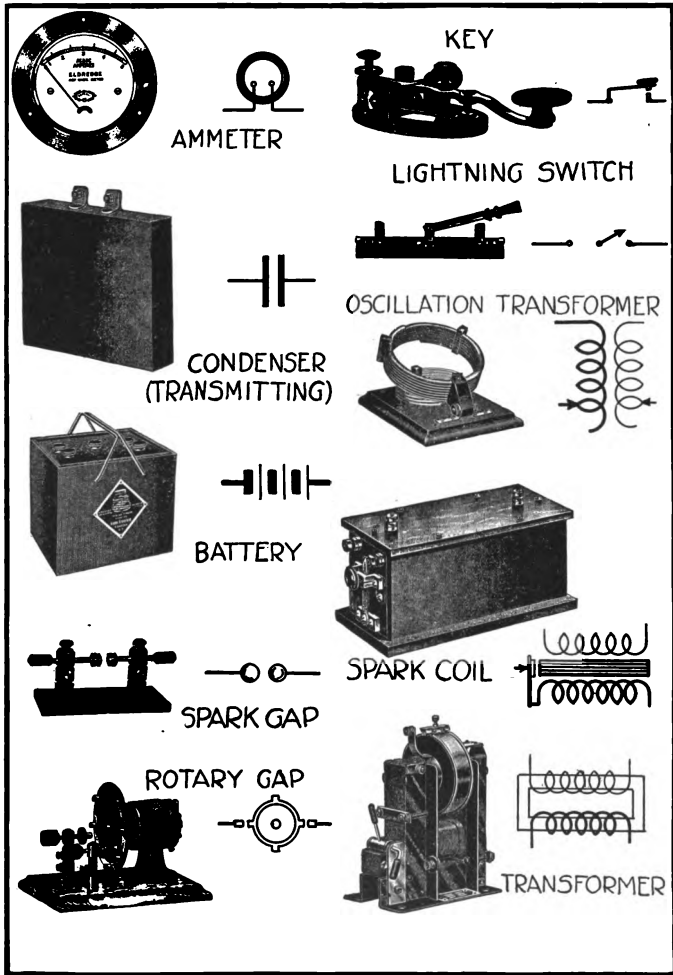

Instruments used in radio transmitters and their diagrammatic symbols

is an unending variety of different things that can be tried. An amateur may work all evening connecting his apparatus up in a new way. Then, when all the rest of the people in the house are in bed, he will experiment with it to see whether or not it is better than the one he previously had. His intense interest in the outcome of his experiment is quite natural. He has created something new and he wants to see how it works. He is exactly like the man who has his little workshop to which he can sneak away after dinner and make things just for the pleasure of making them. The relaxation this affords is refreshing. It will add years to the life of any man.

Radio amateurs are a clannish lot. They love to get together and talk shop. As a result of this, local radio clubs are numerous. There are few communities that do not boast of at least one radio organization. A club room is found, and here the meetings are held semi-monthly. Lectures are arranged, code practising classes are formed, and sooner or later the club has its own station. The democratic spirit of the radio clubs is truly American. New members are always welcome. There is usually only one necessary qualification and that is an interest in radio.

There are also two well-known national associations of radio amateurs. One is the American Radio Relay League with headquarters at Hartford, Connecticut. The other is the National Amateur Wireless Association. These bodies have been organized largely for the purpose of relaying messages. An amateur station

owner in Boston can start a message which will eventually find its way to a person in another station at San Francisco. In the transmission of such a message twenty-five or thirty other stations may participate. The relaying of messages is one of the most fascinating diversions of radio.

When the word amateur is mentioned, many people wrongly believe that it is a name given to any person who dabbles with things in a purely unprofessional manner. There are many amateur athletes who are better than the professionals. They simply do not capitalize their attainments. There are many amateur radio operators who could give cards and spades to most professionals. This was demonstrated during the latter part of the year 1921 when the American Radio Relay League held its transatlantic amateurs' test. Several amateurs succeeded in spanning the watery wastes between America and England with transmitters that required little more power than a cluster of several forty-watt electric lights. The amount of energy used was but an insignificant fraction of that employed in the commercial transatlantic stations. Of course the conditions were favorable and an ultra-sensitive receiver was used on the other side. But with all of these considerations, it was enough to make the engineers of the large stations blush with shame. Percy Hiram Maxim, president of the American Radio Relay League, said, "These tests mean the coming of the day when Americans can carry on unrestricted conversation with their cousins across the sea."

Since the successful spanning of the Atlantic Ocean by small power transmitters was such an epoch-making event, it is fitting that the operators of the triumphant stations be mentioned. They follow:

Robert Miner, Hartford, Connecticut . . . . .	1 RU
Perry Briggs, Hartford, Connecticut . . . . .	BFG
Minton Cronkrite and E. H. Armstrong, Greenwich, Connecticut . . . . .	1 BCG
John Dibalsi, New York City . . . . .	2 FD
H. G. Barber, Brooklyn, New York . . . . .	2 PP
C. E. Tribe, Yonkers, New York . . . . .	2 BK
Arnold Brillhart, Yonkers, New York . . . . .	2 DN
H. H. Beveridge, Riverhead, Long Island . . . . .	2 EH

The stations operated by these men were models of efficiency.

A wireless amateur's trouble always starts with the construction of his aërial. Much can be said about aërials, but there is not room to say it on these pages. It is upon the aërial that much of the efficiency of the station depends. An ideal aërial for amateur use is illustrated in the sketch. In setting out to build an aërial, we must keep in mind that it is necessary to insulate it from everything it touches. An aërial is, in a way, an island of copper wire hung in the air. The quality and number of the insulators used to keep the aërial electrically "tight" will depend upon the power of the transmitting apparatus that we employ. The greater the power used, the more care must be taken with the insulators if we are to expect our station to operate with maximum efficiency. Aërials intended

only for receiving purposes do not have to be so thoroughly insulated.

Since the dimensions and height of the aërial affect the wave-length of a transmitting station, we must take care that the aërial is not too large, or we shall be "in Dutch" with the inspector when he comes around with his little wave-meter. There is a simple rule which will allow us to escape the wrath of the

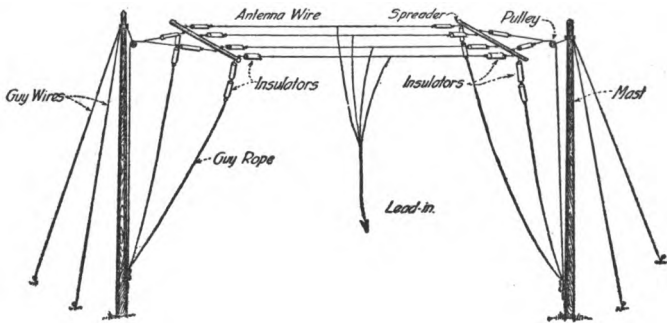

Constructional details of a large four-wire aërial suitable for general amateur use.

inspector. For two-hundred-meter transmission, the length of the aërial plus its height should not exceed one hundred feet. This holds true for the "T" type of aërial which is illustrated. It will be easy to understand that the height of an aërial affects the wave-length of a transmitter, since the length of the lead-in wire to the instruments is determined by the height. The lead-in wire must be considered as part of the aërial, and if it is too long the wave-length cannot be held down to two hundred meters, which is required by law.

The small aërial that is necessary for transmission with restricted wave-lengths does not lend itself to long-distance reception from the large commercial stations that employ long waves. Many amateurs who have plenty of space at their disposal like to put up separate receiving aërials. These are usually made up of a single wire several hundred feet long. It is placed as high in the air as possible, the higher the better, but since the higher the amateur goes with his aërial the deeper he must go into his pocket, many must remain satisfied with a height of fifty or seventy-five feet.

A simple one-wire aërial suitable for receiving from the broadcasting stations is also shown.

When the aërial is put up, the joints of the aërial wires must be made with the greatest care. They should first be scraped scrupulously clean and then soldered. After this is done the joints should be wrapped in friction tape to prevent corrosion. Copper-weld or phosphor-bronze wire should be used in the aërial. Soft copper wire, although electrically good, often breaks when subjected to slight strains.

It is necessary thoroughly to insulate the lead-in wire where it enters the building. We must come to look upon the lead-in wire as a bridge which connects the aërial (the island) with the instruments. What are known as lead-in insulators can be purchased from our radio dealer, and these will give service that cannot be expected from a makeshift. The energy lost at the lead-in transmitter subtracts just so much from the

efficiency of the station. If a bad, leaky insulator is used, we might easily lose as much as 50 per cent. of our transmitting energy. We must keep in mind the fact that electricity always takes the path of least resistance. If it can sneak out to the ground through a faulty insulator, it will do so.

A radio receiver and transmitter must be "grounded." By this we mean that a connection must be established with Mother Earth. Every wise amateur realizes the importance of a good ground connection and he spares no effort in getting what he wants. Those who are careless are satisfied with simply driving a stake into the ground or making a rough connection with the steam or water pipes. If the steam or water pipes are scraped clean a good connection may be made to them by the use of a device known as a ground clamp. This is a little clamp that is made especially for this purpose and can be purchased for a few cents. In places where water or steam pipes are not available for this purpose a very good ground can be made by burying an old copper wash-boiler filled with charcoal.

Now that we know a little more about aërials and grounds than we did, let us devote our attention to receiving apparatus. Any of the outfits described can be used to receive from the radiophone broadcasting stations. About the simplest kind of a practical receiving outfit is made up of a single-slide tuning-coil, a crystal detector, a fixed condenser, and a pair of headphones. These instruments are connected according to the diagram. Let us call this Receiving Outfit



No. 1. An outfit of this nature has its limitations. The beginner will immediately ask, "How far can I receive with a station like this?" It would be like

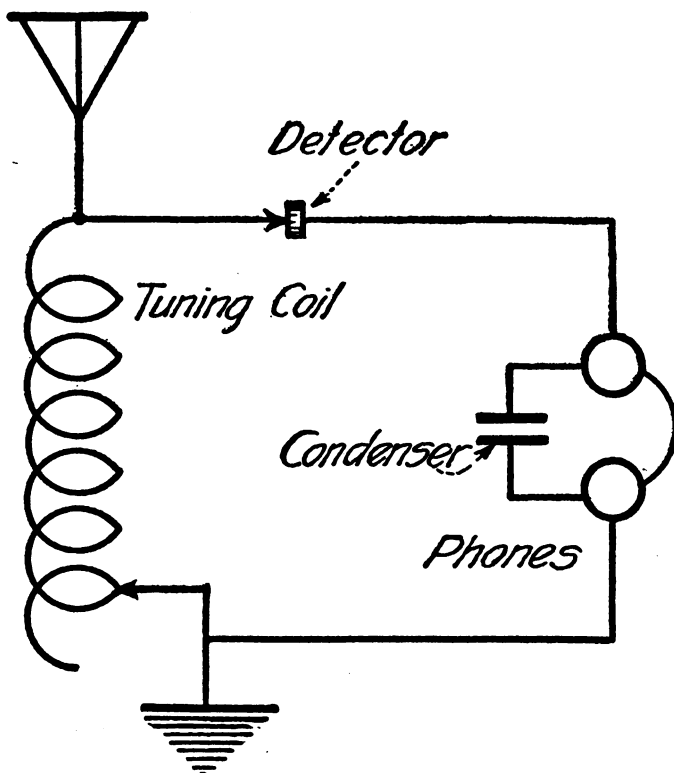

Connections of crystal receiving outfit No. 1.

asking how far the whistle of a boat or the roar of a cannon could be heard. For an outfit of given sensitivity, the distance over which it will be able to receive will depend entirely upon the power and distance of

the transmitting stations. Then, too, atmospherical conditions affect reception a great deal. All of these things must be considered.

The little receiving outfit just described can be

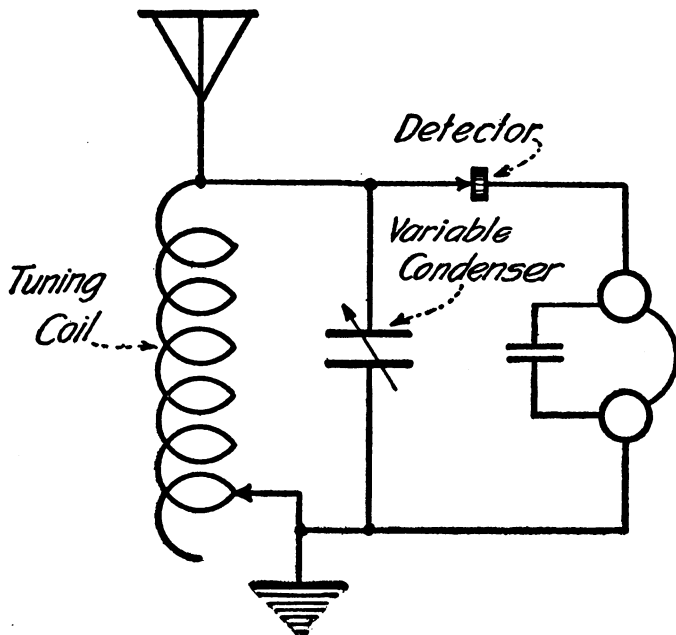

Crystal receiver outfit No. 2 with a variable condenser.

greatly improved by adding to it what is known as a variable condenser. This is seen in Receiving Outfit No. 2. A variable condenser is one which has a set of stationary and movable plates, the movable plates being sandwiched in between the stationary ones. By moving the plates the capacity of the condenser can be adjusted, and in Chapter II we were

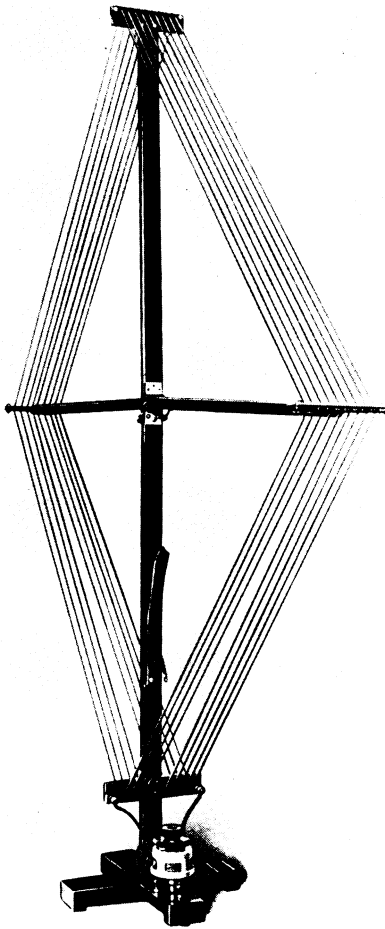

An indoor or loop type of aerial



told that changing the capacity of a wireless circuit affected its wave-length. With this in mind it will be easy for us to understand that the variable condenser will help us to tune in signals. The variable condenser is operated by simply turning the knob on the top. If this is done while the sliders on the tuning-coil are moved to various positions signals will eventually be heard if the detector is in a sensitive condition.

While dwelling on the subject of simple receiving outfits, it might be well to say something about the detector. Various minerals can be used in them, but the beginner will find that galena is very satisfactory. No matter what kind of a crystal or mineral is used it should not be handled with the fingers. Such handling will cover the mineral with an invisible layer of greasy matter, which will greatly reduce its sensitivity.

The beginner should use the greatest care in selecting the telephone receiver that he is to use. The telephone receivers are to a radio receiving set what an engine is to an automobile. It is in the receivers that the delicate processes of changing weak little currents into audible sounds takes place. If these currents are not handled efficiently by the receivers the outfit will be robbed of its sensitivity.

Receiving Outfit No. 3 introduces what is known as a loose coupler or a tuning transformer. This is really made up of two tuning-coils, one sliding within the other. In the parlance of radio we say that the coils are "inductively coupled." Such coupling has the effect of increasing the selectivity of the outfit. The

side of the receiving transformer that is connected to the aërial is called the primary. The other side is called the secondary. The secondary slides into the primary so that the "coupling" between the circuits can be varied. This sliding is always done during tuning. The primary and secondary of the transformer

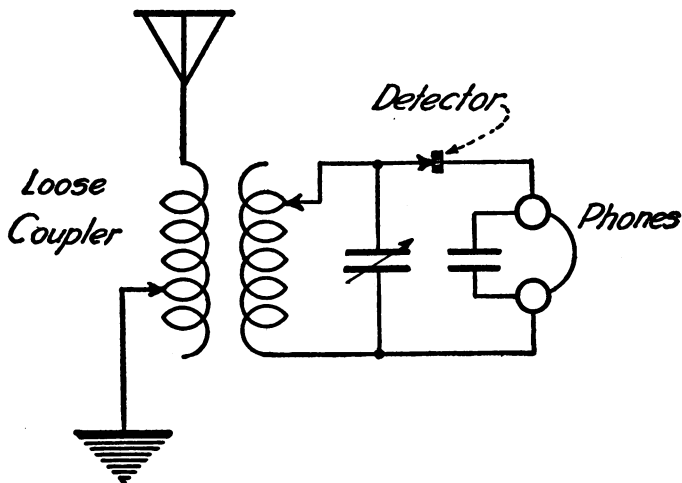

How the loose coupler is used in receiver No. 3.

must always be adjusted as well as the variable condenser.

By adding another variable condenser to the outfit we shall have Receiving Outfit No. 4, which has a still greater selectivity than the one just described. By greater selectivity, we mean that we are able to tune out unwanted stations more easily.

The receiving outfits just described can be connected up in many different ways, although the connections

shown will probably give as good results as any. Connecting and disconnecting, however, are part of the hobby of radio, and every amateur starting out with these simple instruments will want to experiment a

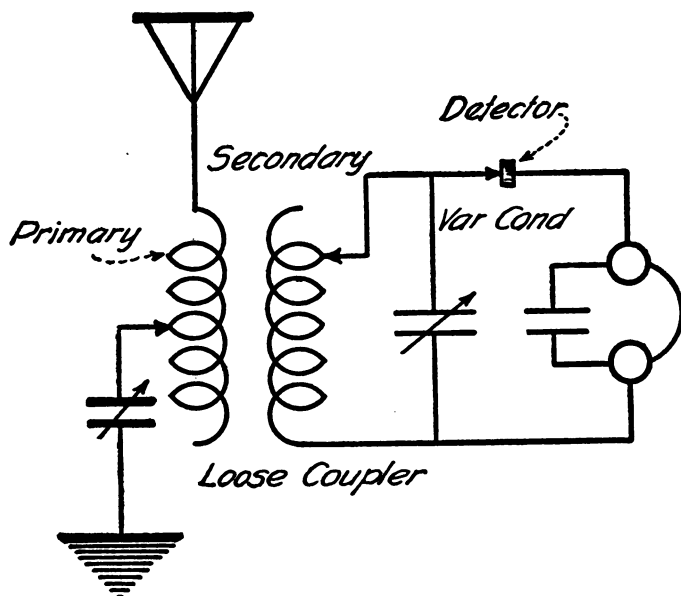

How two variable condensers are used in receiver No. 4.

little by trying various hook-ups. This is advisable, since it is only by work of this nature that we gain experience. Following books will not do us a great amount of good. We must roll up our sleeves and do things ourselves. What if certain of our experiments are failures? Experience is made up largely of failures. Then there is much satisfaction to be gained from a successful experiment.

Every true radio "ham" reaches a point in his career where he wants to replace his crystal detector with a vacuum tube. He gets what we might call the long-distance fever. Not satisfied with merely re-

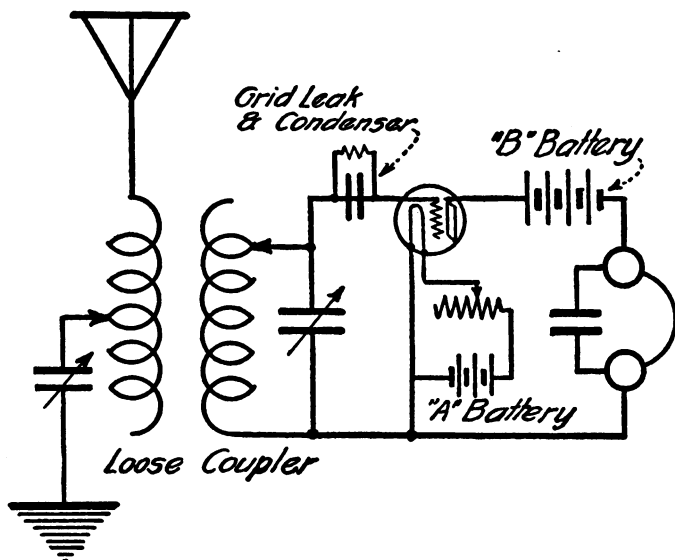

A simple vacuum tube receiver employing the grid leak and grid condenser. This is receiving outfit No. 5.

ceiving local messages, he wants the whole world for his field. Of course, increasing the sensitivity of a receiving apparatus will bring a greater number of broadcasting stations within "talking distance."

Although there is nothing difficult about operating simple vacuum tube receivers, they differ greatly from ordinary crystal detectors. Therefore it will be wise for us to start out with a simple circuit and a single



tube so that we can play around with the thing awhile and become familiar with it. We shall call this Receiving Outfit No. 5, and if we refer to the diagram of connections we shall see that the vacuum tube adds little complication to the outfit. To operate the vacuum tube we must first light the filament. We

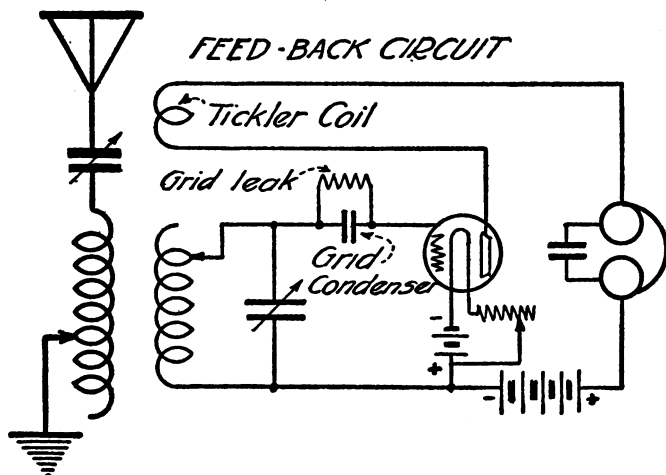

• Connections for a regenerative vacuum tube receiver No. 6.

then adjust the rheostat to regulate the current passing through the filament. It is best not to burn the filament too brightly, since this does not always bring the best results and it shortens the life of the tube. After we set the tube in operation the tuning transformer and variable condenser are manipulated and the signals tuned to maximum loudness. When this is done the filament rheostat of the vacuum tube can be further adjusted. With the signals in the head-phones

to be guided by, it will be an easy matter to bring the tube to its most sensitive point.

With Outfit No. 5 we shall be able to hear stations that were previously beyond the grasp of our equipment. Having mastered this outfit we shall quite naturally want to pass on to a better one. We can then try our luck with a regenerative receiver, which we shall call Receiving Outfit No. 6. With this circuit we shall use the regenerative or feed-back feature developed by E. H. Armstrong. Our first experience with regeneration will convince us that Mr. Armstrong did a great deal for radio. This simple contrivance will greatly amplify the received signals. It will be observed that this circuit contains the grid leak which we will talk about in a later chapter. To operate this regenerative receiver we adjust the detector in the usual manner and then tune the signal in with the variable condenser, the ticker-coil, and the receiving transformer.

After we become thoroughly familiar with the Armstrong regenerative circuit nothing will disturb us. We become more daring as we progress; we gradually change from the timid novice into the seasoned "ham." We are ready to grapple with Receiving Outfit No. 7. Here we shall begin to learn something about the amplifying vacuum tube. A glance at the diagram of connections will show us that the tuning devices of the circuit are exactly like those of the previous receiving outfit. The first vacuum tube is known as the detector tube, while the two that follow are called amplifier tubes. All the tubes function on the same principle,

but the amplifying tubes are made especially for this work.

Receiving Outfit No. 7 is a highly sensitive one. Its operation is comparatively simple. It is only necessary to adjust three filament rheostats instead of one. The careful observer will see that all three vacuum tubes take their filament current from a single source. This is usually a storage battery.

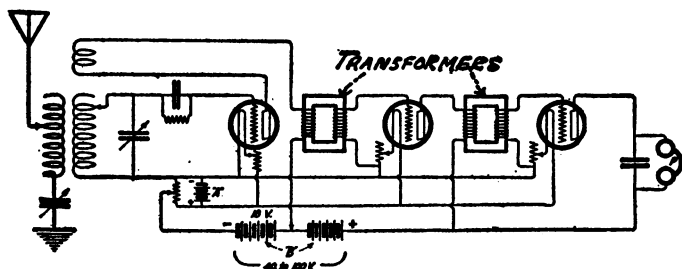

Connections for a two-stage vacuum tube amplifier using the regenerative principle. This is receiving outfit No. 7.

When we start out with vacuum tube amplifiers we do not need to end with two. We can go as far as we like. We can keep adding tubes until we get six or seven stages of amplification. When we get beyond a certain number of stages, however, we shall find that our troubles will multiply with each stage unless we are adept at operating tube circuits. The chances are that the average experimenter will not care to use more than four or five amplifying tubes. With such a receiving outfit there will be little left for him to desire.

What is known as radio-frequency amplification is now possible. We know that radio frequency means

beyond audibility. The currents in a radio receiving circuit are of radio frequency before they pass into the detector where they are reduced to audio frequency by the action of this device. In an ordinary vacuum tube receiving circuit, very weak signals affect the detector so slightly that there is little or no rectification, and consequently such signals cannot be heard. They are so weak that the vacuum tube, sensitive and helpful as it is, cannot rally them. Under conditions such as

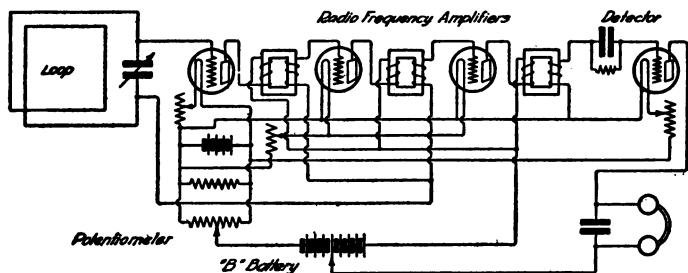

Connections for a radio-frequency amplifier using the loop or indoor antenna. This is receiving outfit No. 8.

these, audio-frequency amplification is not entirely satisfactory. Then, too, audio-frequency amplifiers have the bad habit of producing howling noises in the telephone receivers. Radio-frequency amplification almost entirely eliminates this trouble.

Receiving Outfit No. 8 illustrates the connections used in a radio-frequency amplifier. The currents, fresh from the aërial, pass into the vacuum tube amplifiers. This is not a detector tube but an amplifying tube. In the circuit shown, the currents pass through three of these amplifying tubes before they reach the



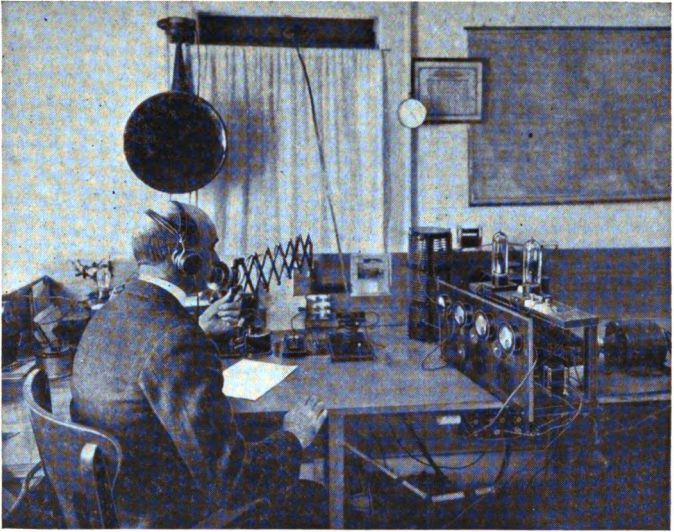

A typical amateur station equipped with a vacuum tube radiophone transmitter



A glimpse into the artist's room of a broadcasting station

detector tube which is placed at the end. Special transformers must be used between the amplifiers.

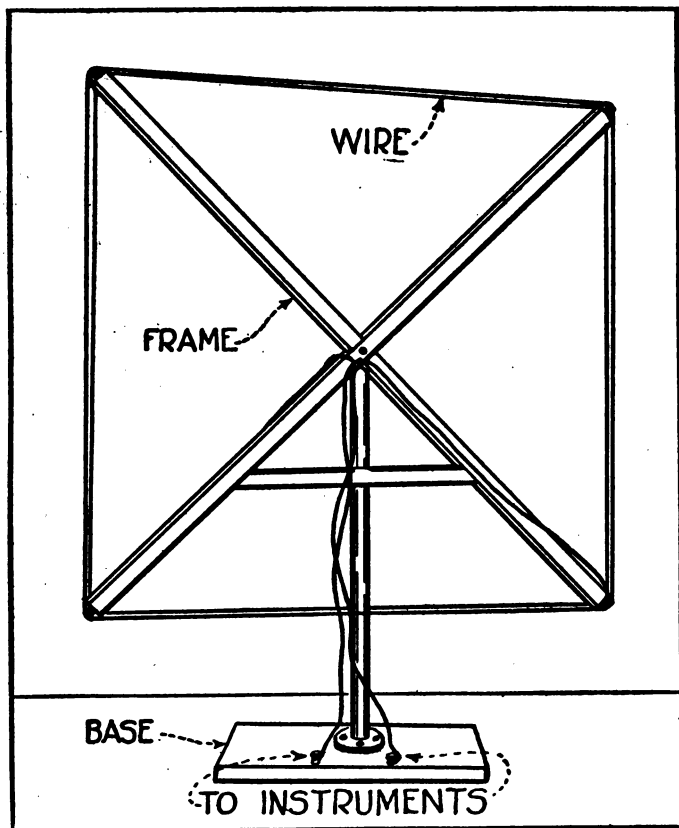

Construction of a loop antenna. It is made by winding several turns of wire around a four-foot frame.

Such transformers are wound especially for radio-frequency amplification, and the ordinary transformer will not serve the purpose.

The radio-frequency amplifier is the most efficient receiving device that has been developed so far. It is ultra-sensitive, with a great deal of emphasis on the ultra. So sensitive is it that a loop antenna can be used indoors for reception over very reasonable distances. The loop antenna is simply made up of several turns of

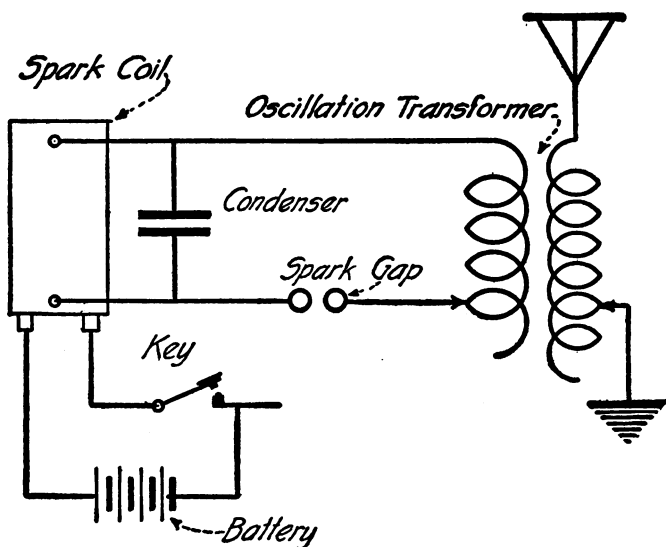

Transmitter No. 1. This is a simple outfit employing a spark coil.

insulated wire wound on a wooden frame. Loop aërials are usually so arranged that they may be turned on an axis. This is done because the loop has a directive action. It must be placed in a certain position to the oncoming wave before it will pick up the maximum amount of energy. This directive action is to be desired since it helps to eliminate interference from other



stations. Loud speakers will function well with radio-frequency amplifiers even when the receiving outfit is located a considerable distance from the broadcasting station.

A radio station that can only "hear" is like a mute. Stations to be complete must have not only "ears" but a "tongue." Let us now consider a few simple transmitting outfits. Transmitting Outfit No. 1 uses a spark-coil as a generator of the high-frequency currents. There is used in connection with the spark-coil a spark-gap, a heavy glass plate condenser, and what is known as an oscillation transformer. Every time the telegraph key in the primary circuit of the spark-coil is pressed a spark will flow across the gap and waves will be propagated.

When operating a little transmitting outfit like this we must be careful of one thing and that is accidental contact with the spark-gap while the coil is in operation. The voltage of the current created by the spark-coil is very high and it is able to give an uncomfortable shock, to say the least. Electricity is no respecter of persons. Any one coming in contact with a spark gap while it is in operation is certain to dance a merry jig.

If we want to graduate from the spark-coil class, we must get a transformer which will operate from the lighting circuit of the house. Transformers must be operated with alternating current, and before we buy one, we should make sure that the house is supplied with alternating current, and, if so, learn what the frequency of this current is. It may be twenty-five-

cycle or it may be sixty-cycle, and the transformer must be designed for a certain frequency. Transformers come in various sizes or powers. We can get a  $\frac{1}{4}$  K.W. transformer, a  $\frac{1}{2}$  K.W., or a 1 K.W.

Transmitting Outfit No. 2 includes, besides a transformer, a rotary spark-gap which is driven by an electric motor. The rotary gap gives the signal of the station a musical tone, and it also allows the signals to be read

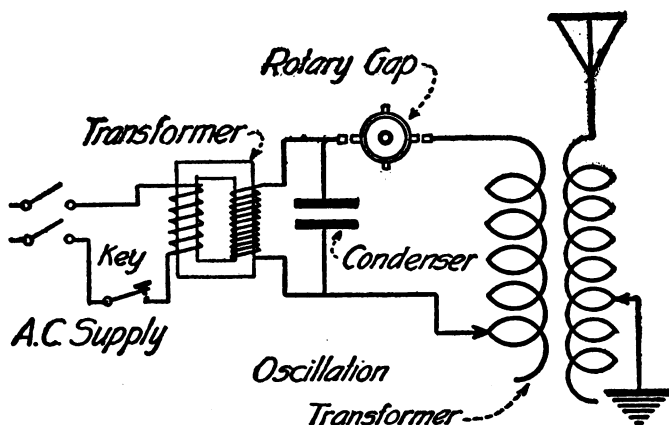

Transmitter No. 2. A powerful transmitter employing a transformer and operating from the electric light circuit.

with greater ease through interference. Instead of an inharmonious note that would sound something like scratching a match on the cellar wall, which would be produced if an ordinary spark-gap were used with the transformer, there is produced by the gap a pure high-toned musical note which is pleasant to the ear.

When we go to the electrical dealer to buy the parts for our transmitting outfit we should ask him to provide

us with the proper kind of rotary spark-gap, key, condenser, and oscillation transformer to be used with the transformer we buy. A condenser that would be suitable for a  $\frac{1}{4}$  K.W. transformer would probably be punctured with the power developed by a 1 K.W. transformer. In the same way a rotary spark-gap designed for use with a 1 K.W. transformer would be unsuitable for use with a  $\frac{1}{4}$  K.W. transformer. A key used in connection with a  $\frac{1}{2}$  K.W. transformer has a heavier current to break than one used with a  $\frac{1}{4}$  K.W. transformer.

The old spark-coil and power transformer sending station have had their day. They are both troublesome and inefficient. The transformer outfit is especially noisy in operation. For two-hundred-meter work the transformer is a great waster of energy.

The vacuum tube will serve us just as efficiently in the transmission of radio impulses as it will in the reception of these impulses. It is the little radio Jack-of-all-trades. The vacuum tube produces a high-frequency current and in this work it has no rival in efficiency. It produces a perfectly clear piercing note that can be read through static and other interference with the greatest ease. The transformer performs work with much bluster, but not so the little vacuum tube. It is a modest little worker, perfectly silent in operation, yet at the distant receiving station the strength of the signals it produces for a given amount of power would make a transformer appear rank in comparison. A vacuum tube transmitting outfit using ten or fifteen

watts of energy is often able to transmit signals over a greater distance than a transformer using as much as 250 watts, and the vacuum tube outfit would not cost a cent more than the transformer outfit, if as much.

We must not forget that the vacuum tube is a producer of continuous waves. All of the seasoned radio amateurs do not bother to say "continuous waves"; they always refer to them as "C.W." Thus, they call

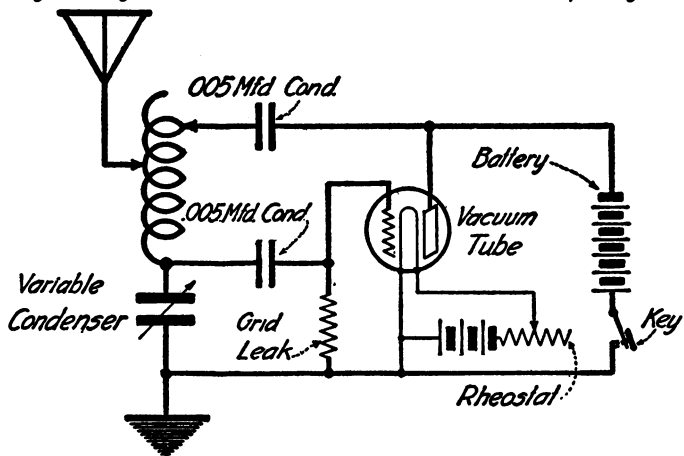

Transmitter No. 3. An outfit employing a single five-watt transmitting vacuum tube.

vacuum tube transmitters C.W. transmitters. Spark-coils or transformers, as we know, are used in damped or discontinuous wave transmitters.

A simple little vacuum tube transmitter suitable to begin with is illustrated as Transmitting Outfit No. 3. The vacuum tube used is made especially for transmitting purposes, and it is able to handle five watts of power. Such a tube costs little more than a receiving

tube, and if used carefully it will last for a long time. If we want to increase the power of such a transmitter we can add more tubes to it. Every time we add a tube we add five watts of power to the outfit. It is not advisable to use more than three five-watt tubes, however; since that would cost us nearly as much as a fifty-watt tube, which would be much more satisfactory to use, for, instead of having three tubes to watch we should only have one. If we want a more powerful outfit we

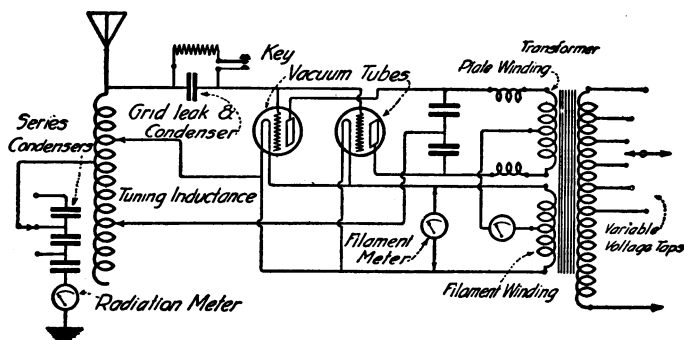

Transmitter No. 4. A ten-watt combination telegraph transmitter.

can get a 250-watt tube and keep adding 250-watt tubes until we have a full kilowatt.

With a few changes in the connections, or, in the case of higher powered outfits, with a few added instruments, we can eliminate the transmitting key and use in its place a telephone transmitter. We at once have a radio telephone outfit. This cannot be done with spark-coils or transformers. This is another advantage of the vacuum tube.

A very simple small-powered wireless telegraph outfit using two five-watt tubes is illustrated as Transmitter No. 4. The instruments used are standard and can be supplied by radio dealers.

There is a great deal of latitude for experimentation when vacuum tubes are used. The vacuum tube is a much more interesting device than the transformer or

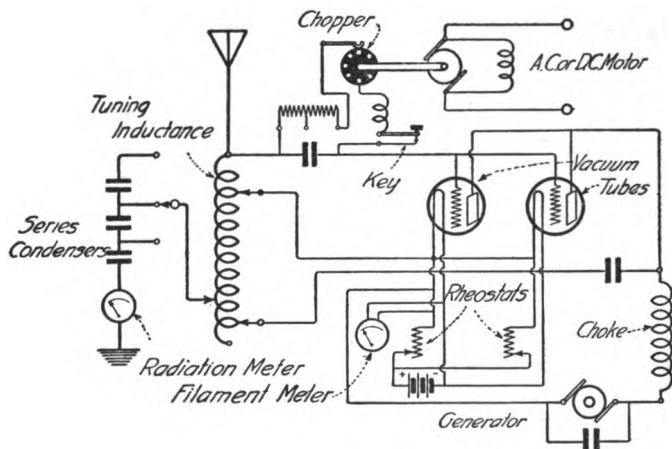

**Transmitter No. 5.** A radio telegraph outfit using continuous waves.

spark coil, and a greater number of different connections can be used. With a transformer transmitting outfit only three or four different connections can be used, but a vacuum tube can be connected up in many different ways, and when the amateur becomes familiar with the operation of vacuum tubes he can derive a great deal of pleasure from experimentation. As has been mentioned before, there is generally one best way

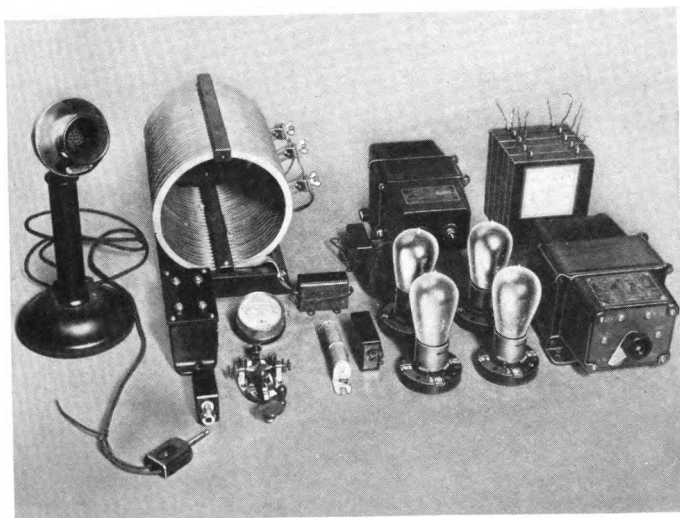

Necessary apparatus for a twenty-watt vacuum tube telephone transmitter



A radio amateur playing a game of checkers through the air





to connect an outfit, but in some cases it may be that there are two or more ways in which an outfit will perform with maximum efficiency.

Transmitting Outfit No. 5 also employs two fifty-watt tubes.

The few words that have been said about vacuum tube transmitters can only be considered a meager introduction to the subject. Only a few of the more simple outfits have been described. If the reader wishes to have more information along this line he should get in touch with his dealer or send for the catalogues of the vacuum tube manufacturers. In these catalogues he will find many suggestions and much operation data.

Now that various transmitting and receiving outfits have been described we shall learn how a single aërial and ground are used to serve both units of the station. To do this it will be necessary for us to purchase what is known as a double-pole double-throw switch. This is simply a single switch which takes the place of two. If we examine the drawing carefully we shall see that the receiving outfit is connected to the aërial and ground when the switch is in the left-hand position, and that the transmitting outfit will be connected to the aërial and ground when the switch is in the right-hand position. Thus when we are about to receive the transmitting instruments are entirely disconnected from the receiving instruments, and vice versa.

After the radio station is complete and ready for operation its operator should take the trouble to learn the code. If he is a real enthusiast he won't think it a

trouble at all to learn the language of dots and dashes. If he attends the meetings of a wide-awake wireless club, he will be afforded the opportunity of joining a code class. If he is unable to take advantage of such privileges, a small buzzer practice set can be purchased which will help a great deal in memorizing the various characters. The buzzer set is simply a key and a little buzzer which is operated by a single dry cell. The use of this device will not only make the user more familiar with the code characters but will also teach him to send correctly.

Learning to receive is more difficult than learning to send. Many of the amateurs like to fill the ether with messages because they are pleased with their ability to manipulate the key. They can send beautifully from fifteen to twenty-five words a minute, but their receiving is atrocious. That is a mistake. They should not let their sending get ahead of their receiving.

We can learn to receive only through familiarity with the code characters. The more we practise with the characters the easier it will be to understand them. When we begin we shall only be able to receive two or three words a minute or less. By "sticking to it" this speed will gradually be increased until we reach fifteen or twenty words a minute. We can then "talk" with the best of them. Commercial operators seldom go over twenty-five words a minute and more usually send around twenty.

There are on the market to-day a number of automatic code transmitters. These devices will transmit



messages to us automatically and at varying speeds. They can be adjusted to send from three words a minute to forty words a minute.

If we are to have a reputation among the radio fraternity for good sending, we must practise faithfully with the key, to develop a good "sending fist," as the boys call it. If we have a poor "sending fist" only our closest friends will "talk" to us, while if we send accurately we shall be more popular with the general crowd. In practising the code characters on the key, it should be borne in mind that a dash is three times longer than a dot. We should also try not to send in a jerky fashion. If the learner makes an early effort to send uniformly and with precision he will have little trouble with his sending when he reaches the higher speeds.

On the preceding page we may see what is known as the International Morse Code and Conventional Signals. This is the universal wireless code and the one we must learn if we are to listen in on all the big commercial stations. The amateurs also use this code unless they have radio telephone transmitters. Even the owners of radio telephone transmitters like to be able to receive in code so that they will not be denied the pleasure of hearing what the big commercial stations have to say.

Unless the beginner acquaints himself with the list of abbreviations used in radio communication, he will hear very mysterious messages. He may hear one "ham" say to another, "Your signals are very QSA."

He may also hear, "QRZ," "QRU," "QRW," "QRO." The list of abbreviations is given on another page. An examination of this page will show us just what the various letter combinations mean. ✓

When we become deeply interested in radio as a hobby we should not hesitate to get acquainted with the rest of the "hams" in our town or neighborhood. By doing this we can take advantage of other people's experience and we can progress more rapidly with the perfection of our station. That is the ambition of every dyed-in-the-wool amateur. Getting acquainted in radio is very easy. All we need to do is go out and walk the streets until we find a house with an aerial on it. If it is a good aerial with high poles, and carefully strung wires we can rest assured that it was put up by a brother "ham" and it is just like a welcome sign on the door. We can walk right up and knock and ask for the "fellow who owns the radio." He will be glad to see us because we can talk with him about variometers, microhenries, radio frequencies, and all the other mysterious terms that make up the language of the hobbyist.

The authors wish to say that although introductions of this nature are to be encouraged they are not without their perilous side, at least for the beginner. Every "ham" has some different notions about hook-ups and apparatus, and it is his favorite sport to win over other "hams" to his way of doing things. Sometimes he is right and sometimes he is wrong. After all it is best that we do a little experimenting ourselves because ✓

the real enjoyment we get out of this work will come in blazing our own trail rather than following somebody else's. When Bill Smith warns us that resistance-coupled amplifiers or loop antennæ are the "wrong dope," we should not take him too seriously, keeping in mind the fact that "what is one man's meat is another man's poison."

When we get our station in operation and learn how to handle the code (provided we do not have a telephone station), we shall have plenty of opportunity to get acquainted. This will be specially true if our spark is good to listen to and our sending is passable. The radio fraternity greets with open arms any new member who has a good clear note and a respectable "sending fist." From that moment, our list of friends will grow rapidly. Some of them will be miles away. We can get from the official call-book the calls of stations that should be within our range. We can then call them until we get an answer. Every time we get an answer we have a new friend. He will want us to tell him all about our outfit, where we are, and so on, ending up with, "Awfully glad to hear you, O.M. (old man). Read you through a great deal of QRM. Spark is bully. Will call you at eight to-morrow night."

As time goes on we shall want to join one of the relay leagues, like the A.R.R.L., with headquarters at Hartford, Connecticut. We can then take part in many of the interesting relay programs that are carried out during the winter time. The A.R.R.L. divides the country up into a number of districts and each district

has its manager. It is the duty of this manager to report the activities of his district each month to the league headquarters, and this is then published in the official organ of the organization. The following is a typical report from one of the managers:

#### Atlantic Division

##### C. H. Stewart, Manager

Southern N. J., M. Frye, D.S.—It has been noted that there is very little activity in this section, due to the fact that many stations' operators are away on their vacations.

Long Island, H. Collins, D.S.—Consistent work is being carried on with New England States and cities south to Savannah. Messages to northern New York and Chicago are cleared occasionally. Stations doing this good work are 2 ZL, 2 AJW, 2 OE, 2 CY, 2 WM, 2 ZV and 2 JU. 2 ZL, 2 AJW, and 2 ZV are CW while others mentioned stick to the spark. 2 AJW handled 72 messages, while 2 EL has 74 to his credit and 2 JU 45.

Brooklyn, N. Y., F. A. Maher, D.S.—2 ARY, 2 RM, 2 DO, 2 WB, and 2 PF are all on the job doing their best to clear traffic with the following number of messages handled: 2 ARY, 159; 2 WB, 20; and 2 RM, 17. 2 TS will take the place of 2 CS.

Western N. Y., Benzee Bros., D.S.—146 messages have been reported for this district. 8 AWP leads with 56 to his credit. City Manager Young reports no traffic for Elmira, due to heavy QRN. City Manager Woodworth reports three good CW transmitters in Syracuse. No reports from Niagara Falls, Lockport, or Jamestown.

New York City, E. A. Cyriax, D.S.—398 messages were handled in this section, which must be considered good in view of the fact that QRN was extremely heavy. 2 XK with his CW topped the list with 464; 2 DI, 189; 2 ACT, 63; 2 BCF, 17; 2 BNL, 5; and 2 TC, 1. 2 DI, 2 XK, and 2 CT have been clearing traffic to and from First, Third, and Eighth district stations. 2 XK and 2 ACT have a regular schedule with 4 GL and 8 DE on CW.

Northern N. J., F. B. Ostman, D.S.—This was a banner month for this section with 535 messages to our credit. We have a bunch of operators who still think that the spark is *the* transmitter and still have to be shown otherwise, basing their contention on the number of messages handled by sparks as compared with CW as shown below. Sparks: 2 BG, 148; 2 OM, 97; 2 UK, 30; 2 AXB, 30; 2 ARB, 41; 2 SQ, 19; 2 OX, 10. CW: 2 BBN, 28; 2 RU, 26; 2 GC, 17; 2 RR, 8; 2 ANZ, 6. Probably if some one will explain why four times as many messages were handled by spark as by CW when QRN is at its worst, CW having a reputation for cutting through it, 2 BG and his gang will be convinced. 2 UK, 2 AWL, 2 AXB, 2 BG, and 2 RU deserve much credit for their excellent work in handling traffic. An all-CW route is being formed from the metropolitan district to Philadelphia and shore points. CW stations wishing appointments please communicate with the D.S. at once. 2 UE and 2 AWL are also handling traffic for Philadelphia and the west.

Hudson Valley, C. E. Trube, D.S.—Traffic is moving regularly except to the north, where relaying is at low ebb. 2 BK, 2 DA, and 2 BM are back and will keep traffic moving to the north when they get under way again. This will complete our Hudson River route to Albany. 2 UA is handling the bulk of the traffic, assisted by 2 DJ, 2 DN, 2 BFZ, and 2 HJ. Messages handled as follows: 2 DJ, 60; 2 DN, 125; 2 BFZ, 104; 2 HB, 3; 2 BK, 7; 2 UA, 110; total, 399. On his first night our 2 BK cleared messages to seven districts. 2 OA is back on the job after much effort to quit the game.

Capital District, F. H. Myers, D.S.—There has been but little activity in this district due to QRN and because the Hudson River route has been open. Traffic could not get to New York City except on rare occasions. 2 AWF is doing the bulk of the relaying, but no report as to the number of messages handled has been received. No reports received from Schenectady or other cities.

District of Columbia, F. M. Baer, D.S.—3 ZY has 160 messages to his credit for the month. The bulk of this was handled with 2 XK and 4 GL. 3 KM and 3 XF have combined their in-



terests and will keep continuous watch at 3 XF. 3 IW is back with CW. Little activity in Baltimore—3 OU reports only 15 messages. No other reports have been received as regards traffic. QSS tests were conducted between Baltimore and Hagerstown, and Baltimore and Washington. The reports were turned over to Mr. Kruse for investigation. 3 EM has been overhauling his station. 3 APT has turned to CW. 3 AJD, 3 CT, 3 ER, and 3 TN have been favoring the gang with concerts.

“Hams” can have a good deal of fun playing games by radio. The favorite is checkers, since this game lends itself to manipulation by radio very nicely. Each of the contesting stations is provided with a checker-board and a complete set of checkers. Each space on the boards is numbered. It is customary to start from the lower left-hand corner and number from left to right until the top of the board is reached. The numbers on the two boards must correspond exactly. When one contestant makes a move, he radios the move to the other, who makes the same move on his board. In this way each contestant knows the status of the game. Cheating is hazardous, since the one who cheats will be found out when his opponent reaches the checker which has been moved unfairly. His board will show it to be in its proper position. It is needless to say that chess can be played by radio as easily as checkers. When the code is used a game of checkers can be played in half an hour, but of course chess fiends like to let the cobwebs form between moves.

In picking up the newspapers nowadays, it is not uncommon to see a head-line like this:

#### AMATEURS AID FLOOD VICTIMS

Portable Station Erected at Scene Brings Prompt Aid to Citizens of Hatch, New Mexico

About six o'clock in the evening, August 17, 1921, a terrific cloudburst broke over the mountains to the southwest of the peaceful Rincon Valley in New Mexico. The next day rumors drifted down that it had caused a destructive flood, washing away towns, farm-houses, crops, and stock. A rescue party was immediately formed and provided with portable wireless equipment operated by local amateurs, who gladly volunteered their assistance. When they arrived upon the scene they immediately flashed back a list of the supplies that were needed and other valuable information that helped to alleviate the suffering of those who had been made destitute by the wild water.

This was not the first case on record where amateurs have rendered valuable assistance in time of need. With a hobby like radio there are times when we can save human lives.

## CHAPTER VI

### RADIO FOR THE TRAVELER AND VACATIONIST

**N**OWADAYS, no matter where we may go for our vacations, the long arm of radio will reach out to us and bring news, music, and entertainment. The laughing voice of Jolson or the warblings of Galli-Curci will mingle with the crackling of the fire and the lonesome sound of the crickets. The gods were indeed kind and benevolent when they placed radio at the disposal of the vacationist.

Those who have already been inoculated with the "radio-mania" bacillus do not need to be convinced of the great value of a portable radio outfit for the vacation period. The beginner will ask, "What kind of an outfit shall I take? What kind of an aerial shall I put up? Where shall I make my ground connection, and how can I recharge my storage battery?"

The type of outfit to be carried depends upon two things: the distance separating the camp from the nearest broadcasting station and the transportation facilities. The ordinary crystal receiver will be found entirely inadequate where distances of more than twenty-five miles are to be covered. So far as transportation is concerned, however, the crystal receiver has everything in its favor. It is light and cannot

easily be harmed by jolts or jars. If a camp site is chosen where a high aërial can be erected and a good ground connection made, fairly good results can be expected. In New York and other large cities the effective range of receivers of any kind is greatly reduced by the presence of steel-framed buildings, which absorb a large percentage of the radiated energy. Out in the open this obstacle is not encountered, and, in general, much better results will be had.

Campers will find it advisable to choose a site with a considerable space of open territory about them. Like steel-framed buildings, thick forests also absorb part of the energy of the radio impulses that pass over them.

The aërial can be made up of a single copper wire from one hundred to 125 feet long. The tallest tree should be picked out, and the steeple-jack of the crowd can be sent up to attach the aërial rope to its top. The aërial wire should not be allowed to touch the branches of the tree. This can be avoided by using enough rope in connection with the aërial wire so that it will be clear of the branches. If another tall tree is near by the opposite end of the aërial can be attached to this.

The question of a good ground is very important, since the success or failure of the camp receiver hinges largely upon this. If a body of water is near by a long metal rod or piece of pipe can be driven down into the soft mud near the shore. The metal should be scraped scrupulously clean before the ground wire is wrapped around it. The results will be disappointing if the rod is not driven into moist ground. Since the installation



*International*

**The radio receiver takes the monotony out of fishing**



is temporary, it will not be necessary to solder the ground connection. If a few turns of friction tape are wrapped tightly around the connection it will prevent corrosion for several weeks.

Those who wish to take something better than a crystal receiver with them will find an almost made-to-order substitute in the vacuum tube receiver that uses but a single dry cell for the tube. The ordinary vacuum tube receiver that employs a storage battery presents a knotty transportation problem. It would take an ambitious camper to tackle this load unless he had a conveyance of some sort. The single dry-cell outfit referred to is ideal in every respect. If it is taken, two or three extra dry cells should be carried with it. If a fresh "B" battery is carried it will probably last for the duration of the trip.

How disappointing it would be to pack a vacuum tube receiver and to reach our destination sixty miles from nowhere only to find that our vacuum tube did not "vacuum" because the filament had been broken en route! There would certainly be much gnashing of teeth, and many unkind things would be said about vacuum tubes in general. This disappointment can be avoided if care is taken in packing the tube. The tube or tubes should be suspended in a cardboard or wooden box. When packed in this manner the shocks incident to traveling will be absorbed and the precious filament will not be called upon to withstand sudden strains or jars. Those who do not believe that this precaution is necessary are going to be deprived of the

pleasure of receiving from the broadcasting stations when they reach their destination.

It is well to consider the matter of lightning protection at this point. In place of lugging a heavy lightning switch along, the writer would advise putting the aërial up in such a way that it can be lowered when not in use. If two small pulleys are used, this is a simple matter. When the aërial is up and the receiving set is not in use, it should be entirely disconnected to minimize the danger of heavy static discharges surging through the instruments.

The man who decides to spend his vacation at the wheel of his car will certainly want to tuck a little receiver away under the seat. When he makes an overnight stop at the roadside he can pull it out, rig it up in twenty minutes, and be ready for receiving. This man has an advantage over the man who strikes off into the wilds on foot. He can take a storage battery along and use an outfit with several stages of vacuum tube amplification if he wishes. If the voltage of the battery drops below the critical point he can connect it up to the car's charging outfit and bring it back to a healthy condition. The automobilist is pleasantly situated so far as conveniences for radio are concerned.

The matter of an aërial is nothing to worry about. This can be placed upon a wooden spool or reel and unwound when needed. The car should be stopped near some body of water where a piece of copper about two feet square can be thrown in for the ground. The ground wire should be soldered to it. The automobilist



should take the same precaution with his vacuum tubes that the camper takes. While the car is in motion they should be taken out of their sockets and placed in shock-proof boxes. There is at least one outfit on the market which has its vacuum tube sockets mounted on a shock-absorbing fixture. If such an outfit is used it will not be necessary to build special boxes.

"Can I place an aërial on my car and receive while I am traveling?" an overzealous bug will ask. This can be done and has been done, but it is impossible to receive over any great distance. The aërial must of necessity be small and the ground connection inadequate. The latter is usually made by dragging a long wire after the car. It must also be remembered that the noise of the engine does not add to the convenience of receiving under these conditions.

The motor-boat owner is as well situated as the automobile owner as far as radio is concerned. Weight does not need to worry him much. If his boat is provided with electric lights he will find it an easy matter to recharge his "A" battery from the usual source. In the case of the absence of an electric light system a small direct-current generator can be belted to the engine to feed current to the storage battery when it begins to get weak. An aërial of two or three strands running the length of the average small cruiser will do nicely. The ground connection can be made by throwing a few square feet of sheet metal overboard with the ground wire soldered to it. If the engine is not running the ground connection can be made to it. Woe be to

the receiving set that is grounded on the engine while the ignition system is in operation.

As a carrier of radio the motor-cycle has no apologies to offer to the motor-boat or automobile. The motor-cyclist does not have to go without this new convenience. He, too, can carry a small vacuum tube outfit with him if he wishes.

There is no reason why those who go to the farm or a mountain hotel cannot take a little receiving outfit along with them. The farm would be more popular with many of us if there were an opportunity to get a little fresh news once in a while. The newspaper habit is a strong one and it is hard to break. How nice it would be to sit out under the old apple-tree and listen to a broadcasting station passing out the daily news!

## CHAPTER VII

### THE VACUUM TUBE

**T**HE vacuum tube was born into the radio family about six years ago. Since that time it has become an instrument of boundless utility. Some one has said that it means to radio what the lever means to mechanics, and that is rather close to being true. Wireless development is centering more and more about the vacuum tube.

The story of the vacuum tube is indeed an interesting one. Fully to understand its operation it will be necessary for us to consider briefly the modern concept of matter which has become known as the electron theory. This may sound like beating around the bush, but it is really quite necessary if we are to know the how and why of the vacuum tube. Before the birth of this theory, which bids fair to solve the enigma of matter, chemists believed that all matter was built up of little bricks which they were pleased to call atoms. A molecule is made up of two or more atoms. In 1896 the little electron made its *début*. "And what is an electron?" you ask.

Molecules are small things, to be sure. Even the most powerful ultra-microscopes are unable to bring them within range of our vision. Atoms are still

smaller. Sir Oliver Lodge has said that there are as many atoms in a glass of water as there are glasses of water in the Atlantic Ocean. This comparison does not do anything toward helping our imagination. Trying to imagine the size of an atom is something like trying to imagine the end of space. We simply have to rest satisfied that they are very small.

At one time the atom reigned supreme as the smallest of the small, but when the electron was ushered in, the atom was regarded as a giant in comparison. Atoms, like shoes, are ranged in sizes. The atom of hydrogen, for instance, which is one of the ninety-two elements that make up everything upon this earth and in the heavens above it, is the baby of the atom family. The atom of helium is next, and so on through the list of ninety-two elements until we come to the great atom of uranium, which is the fattest of the atom family. ♣

Man is by nature an inquisitive being. When the chemists of old said that an atom was an atom and nothing but an atom, solid and eternal, indivisible and unchangeable, certain persons did not agree with them. They reasoned that the atom was not the smallest particle, and a series of investigations which extended over a number of years led to the discovery of that elusive little particle, the electron.

Atoms are made up of electrons: it is an incontrovertible fact. What is more startling than this, however, is the fact that electrons are pure negative electricity. If we have retained any of the impressions received back in the physics class at high school, we

know that there are two kinds of electrical charges, positive and negative. We also know that like charges of electricity (negative and negative, or positive and positive) repel each other, while unlike charges (positive and negative) attract each other. We must keep in mind, then, that the electron is a unit or particle of pure negative electricity.

The inquisitive, thinking reader is going to say: "Wait a moment here. There is a hitch in your theory. How can you build atoms with these negative particles when they repel each other?" This is not a hitch in the theory, but to answer this question we must introduce what is known as the proton, which is a positive nucleus or sphere in the center of each atom and which holds the electrons of each atom within its influence. From this we can build up a mind-picture of an atom. The electrons revolve rapidly about the positive center, traveling in regular orbits. Their speed is prodigious. If we can think of an electron shooting across the Atlantic Ocean in a small fraction of a second, we can gain some idea of their speed.

The electron theory is scientifically beautiful, and it accounts for many things that have heretofore been quite mysterious. The weight of each element depends entirely upon the number of electrons that go to make it up. The atom of hydrogen, which is the smallest and lightest known, has but one electron, and its proton is just positive enough to hold this single electron within its grasp. The atom of oxygen has sixteen electrons in its make-up and its proton is powerful enough to take

care of this large family. The atom of uranium has no less than 239 electrons in it.

With the electron theory the chemist is able to account for chemical activity between the various elements. The physicist pointed out the way. He told the chemist that chemical activity was simply the result of an interchange of electrons between the various atoms. In some atoms the positive charge or proton dominated, and in others the negative charges or electrons dominated. We might also put it in this way: Some atoms have too few electrons, while others have too many. Thus when an electro-positive atom comes in contact with an electro-negative atom chemical action will result; there is an interchange of electrons and a chemical compound is formed. So much for chemistry.

What has all this to do with the vacuum tube? This we shall soon see. It was in 1883 that Thomas A. Edison discovered what has since become known as the "Edison effect." While this prince of inventors was experimenting with his electric lights, he noticed that the space about a heated filament or wire became a conductor of electricity. His inquisitive mind led him into further research, and he also discovered that the heated space in the vicinity of the wire conducted electricity with much more facility in one direction than in the opposite direction. Technically speaking, the heated space was found to possess unilateral conductivity or asymmetric resistance. For once in Edison's life he failed to find a practical application for this



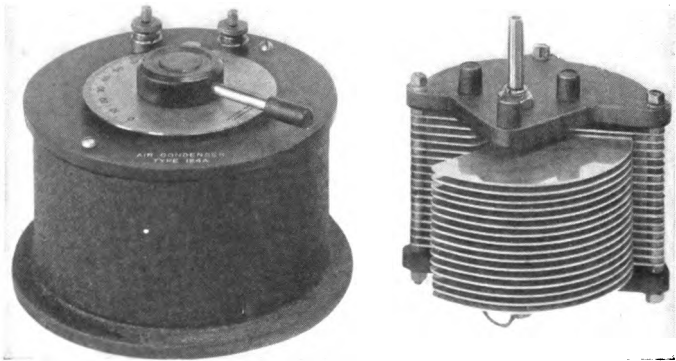

The type of variable condenser used in radio receiving circuits

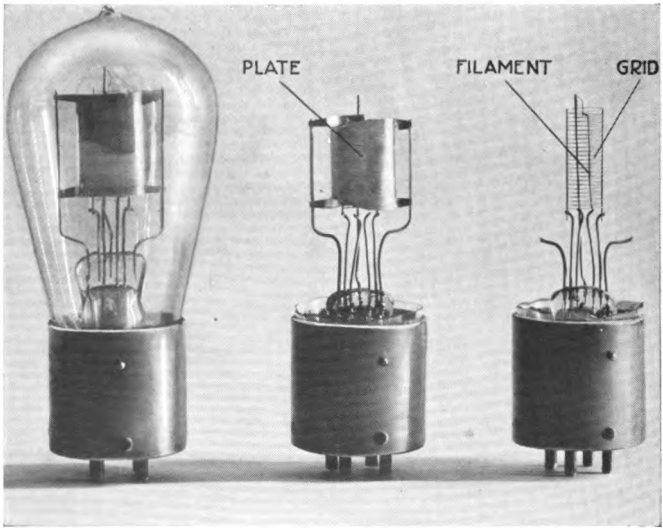

The various parts of a vacuum tube



discovery. Edison did not know what electrons were at that time and he could not therefore account for the phenomenon. He was satisfied to conclude that a heated space about a wire was a unidirectional conductor of electricity. To-day we can account for it with the electron theory.

When we boil water we set the molecules to dancing and some of them "jazz" so energetically that they step off into the air in the form of steam. The water evaporates. If we heat a poker in a hot fire it will become red-hot. When we do this the electrons get the "jazzy" feeling and some of them leave their atoms and jump off into the surrounding space. It is these electrons on the rampage that give the space about a heated body the property of unidirectional conductivity.

It was at first thought that this conductivity was due to the electrons ionizing the surrounding gas. For our purpose it will be only necessary to know that an ionized gas is one that is rendered conductive. Langmuir of the General Electric Co. laboratories exploded this theory when he showed that the property of unilateral conductivity was exhibited in sensibly perfect vacuums, the vacuums being full of "nothingness."

Although the Edison effect was investigated by several experimenters, Dr. H. A. Fleming of London was the first to find a practical use for it. At the time of Fleming's invention of the vacuum valve, the devices used in the detection of wireless waves were

extremely crude and inefficient. The Fleming vacuum valve was little better, but it at least opened up a line of research which has since led to much benefit. The vacuum tube is now one of the most sensitive detecting instruments known to man.

Fleming brought out his oscillatory valve, as he called it, in 1904. He was entitled to call it a valve,

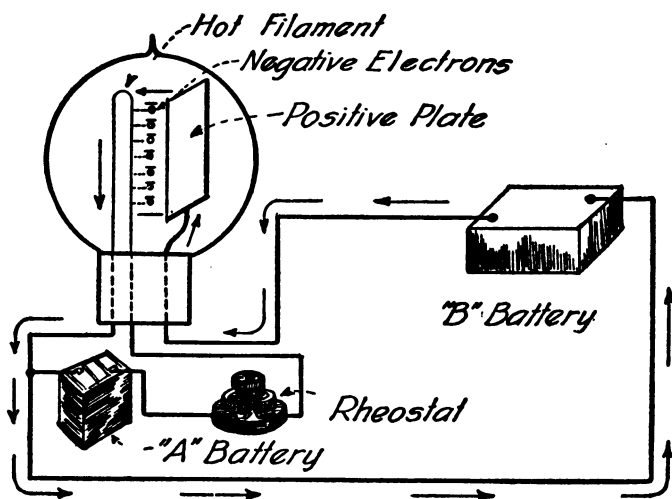

Diagram showing principle of the two-element vacuum tube.

since it allowed a current of electricity to pass in one direction only. That is what a valve does. The valve on an automobile tire allows air to go in but it does not allow it to turn around and come out. If we did not have such devices we should not have pneumatic tires. The oscillatory valve or vacuum tube, unlike the automobile valve, allows electricity to enter and

to pass out so long as it behaves itself and continues in the same direction without changing its mind.

The operation of a simple two-element vacuum tube will be understood by referring to the accompanying sketch. Here we see that the filament is kept heated by a battery, and the current from this battery is regulated by a rheostat or variable resistance. By regulating the current passing through the filament we can regulate its temperature, and this in turn controls the electrons that evaporate from its surface. It is quite natural that the conductivity of the space about the filament will depend upon the number of electrons that gain their freedom. The hotter the filament becomes, the greater the conductivity will be up to a certain point.

If we look again at the little drawing we shall find that there is a battery connected to what is known as the plate in the vacuum tube. If we look closely we shall also see that the positive pole of the battery is connected to the plate and the negative pole to the filament. Under these conditions the plate in the vacuum tube is positive. It is not difficult for us to understand that the plate attracts the negative electrons as they leave the hot filament. The attractive force of the plate will depend upon the voltage of the battery. If the voltage is high, the electrons will be jerked away from the filament with great speed. If the tube is to function properly it is necessary that this plate be adjusted to the proper potential. If the potential is too low, the electrons become lazy and

congregate in a cloud about the filament. The space around the filament thus accumulates a charge of negative electricity. This charge becomes so powerful that it pushes back other electrons that desire to come forth. Radio technicians call this the space charge. If the conductivity of the intervening space between the plate and the filament is to be kept at the proper value, the plate must have a positive charge strong enough to keep these electrons from loitering about the filament. At any definite filament temperature, a certain number of electrons are emitted every second and these must be carried away. Puddles on the road dry up quick on a windy day because the water vapor that rises from them is constantly swept away by the wind. The electric field created by the positive plate can be looked upon as an electric wind that "blows" the electrons away from the filament as fast as they are free. It is not really a blowing process, since the positive plate, so to speak, sucks the electrons away.

How is this vacuum tube to be used in radio? That is what we set out to learn. In Chapter II we were told that crystal detectors were used to render high-frequency radio oscillations audible. It will be remembered that we said the mineral crystals used in the detector had the property of unilateral conductivity. In this they are similar to the vacuum tube but not so efficient. When a high-frequency current surges through a detector, the half passing in one direction passes freely while the other half is entirely cut off. This action is illustrated in the accompanying

sketch. Such rectification has the effect of cutting the frequency of the incoming oscillations in half. Thus they are changed from the inaudible to the audible. A vacuum tube, when used as a detector for reception purposes, does precisely the same thing.

Let us study the illustration showing the vacuum tube in use in a radio circuit. Here the signals or

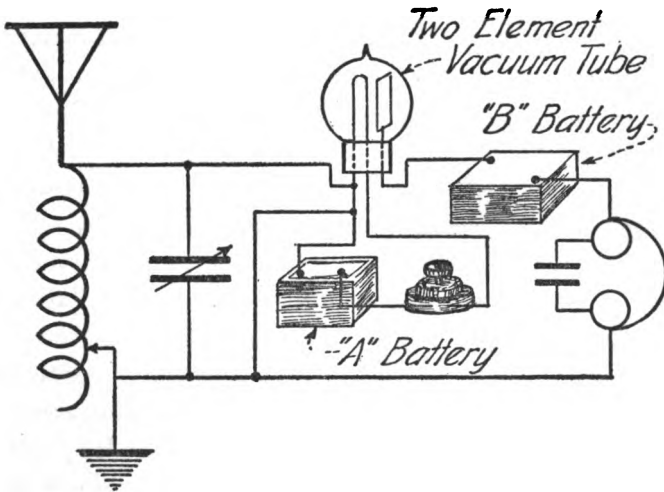

How the two-element vacuum tube is connected in a radio receiving circuit.

high-frequency currents from the distant station come pouring down the aerial into the tuning-coil. Both the tuning-coil and the variable condenser are used in adjusting the circuit so that it will respond to the incoming wave. After the circuit is tuned, the high-frequency currents rush along to the vacuum tube. This device allows half of the cycle of the incoming

high-frequency currents to flow freely from the plate to the filament, but it effectively prevents the other half of the cycle from doing so. The current that does go through causes a large increase in the current that flows through telephones. The disappointed half of the cycle, which the vacuum tube so successfully chokes off, causes a small decrease in the telephone current. Thus we see that the current passing through the telephones is made up of a number of impulses coming very close together. This causes the diaphragms of the telephone receivers to vibrate in sympathy at an audible rate.

When the old two-element (plate and filament) vacuum tube was used, certain adjustments had to be made before it was brought to a point of maximum sensitivity. The potential or voltage of the battery connected to the plate had to be adjusted so that the plate would draw the electrons away from the filament at the proper speed. The current flowing through the filament also had to be adjusted so that just the proper amount of electrons would be available. These adjustments brought about the maximum response in the telephone receivers.

Although Fleming's valve was an improvement and a step in the right direction, it nevertheless left much to be desired. It was left for Dr. Lee De Forest to add the third element to the vacuum tube. This he called a grid, and he placed it between the filament and the plate as illustrated in the sketch. The addition of this element at once changed the vacuum

tube from a makeshift with a doubtful future into a practical device capable of rendering efficient service.

The insertion of the grid, while not affecting the basic operation of the tube, gave it greater sensitivity and greatly increased the scope of its usefulness. Dr. De Forest's grid was nothing but a little piece of wire bent in a zigzag fashion. It is surprising what a little piece of wire like this can do when it is put in the right place.

If we have followed the reading matter closely, we picture the two-element vacuum tube of Fleming's as a device with a red-hot filament which generates electrons (negative particles) that are at once carried away by a positively charged plate that is simply a piece of sheet nickel. In our mind's eye we can picture these little electrons jumping from the filament and sweeping across the space to the plate. Now, what is going to happen when we place the grid between the plate and the filament and connect the vacuum tube up as depicted? Electrons are picayunish little things, and we can rest assured that the insertion of the grid is going to disturb them.

Before going further with our explanation of the three-element vacuum tube of Dr. De Forest, let us pause a moment to consider the current terminology that is used in connection with vacuum tubes. If we want to understand radio we must become initiated into the radio tongue, which is indeed the newest of languages.

From the description of electric circuits that was

given us in Chapter II, we shall immediately see that three independent circuits are used with a vacuum tube receiving outfit. We see that one circuit involves the tuning-coil, condenser, filament, and the grid. This is called the grid circuit. If we examine the diagram closely, we shall see that there is another circuit which involves the plate, the high-potential battery, the telephones, and the filament. This is called the plate circuit. There is also the filament circuit to be considered, but this simply contains the necessary battery and rheostat that supply the filament with the proper amount of current.

The grid circuit is often referred to as the input circuit. We shall at once see the logic of this, since the weak currents that are received from afar come in over this route. They cause the vacuum tube to function, and it in turn develops an output current. The high-potential battery which keeps the little plate of the vacuum tube positively charged is usually called the "B" battery, while the battery that supplies current to light the filament is called the "A" battery. With these terms in mind, we shall continue our journey into the realm of the vacuum tube.

Let us assume that a high-frequency radio current is flowing in the input or grid circuit. We know that such currents change their direction many times a second. As a result of this rapid reversal of the current, the little grid is first charged negatively and then positively, keeping pace with the changing current. It has a very busy time of it. It is much busier than



the chameleon walking over plaid cloth or the much-alluded-to one-armed paper-hanger.

From what we have previously learned, we shall see that the current is continuously flowing in the plate or output circuit which contains the telephones. This current will be a unidirectional one. It will flow from the positive side of the "B" battery through

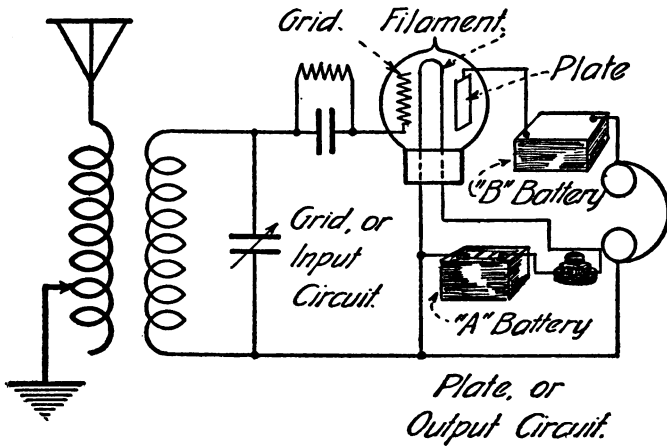

How the three-element vacuum tube of De Forest is used in a receiving circuit.

the telephones, across the space between the filament and the plate, and back into the negative side of the battery. Since this current is uniform and non-pulsating, no sound will be produced in the telephone receivers. Let us keep this fact in mind.

Now we are all ready to understand the action of this mysterious little grid. Here it is, interposed between the plate and the filament, with its charges

changing rapidly from positive to negative. We now know enough to understand that something is going to happen to this stream of negative electrons at the instant the grid is negatively charged. The negative charge of the grid is most certainly going to have a "pushing back" effect upon the electron stream. This will, in turn, cause a serious interruption in the uniform current that is passing through the plate or output circuit. When the high-frequency current flowing in the input or grid circuit again changes its direction, the grid will lose its negative charge and become positively charged. Again something happens. The electrons shooting off the filament, instead of being retarded or repelled by it, are attracted by it, and they pass on with renewed vigor and with increased speed to the plate. It is easy to see that the current passing between the filament and the plate meets less resistance when the grid is positively charged and hence there is an increase in the current passing through the telephones. This increase of current is periodical, keeping pace with the changing charges of the grid. The current in the output or plate circuit keeps flowing in one direction, *but it loses its uniform nature*. Every time the grid becomes positive, the plate current builds itself up and there is as a result of this an indication in the telephones. Thus the incoming signals are made audible. Since only one half of the high-frequency current flowing in the grid input circuit affects the current flowing in the plate or output circuit, the effect is in general the same as that produced by a rectifying

crystal. The frequency of the incoming "vibrations" is cut in half and thereby made audible. The vacuum tube is unlike the crystal detector in that we do not actually hear the incoming radio currents, but simply the effect they produce upon the local circuit.

Radio engineers have always looked upon the vacuum tube as a little trigger of a sort. When the trigger of a revolver or a shotgun is released, it sets off the detonating cap of the bullet. The energy that is required to operate the trigger is insignificant when compared with the amount of energy that is released by the exploding powder. In the same way the little "trigger" currents in the grid circuit of the vacuum tube are insignificant when compared to the increases that they cause in the current flowing in the plate or output circuit of the tube. From this we see that the vacuum tube is also an amplifying device, since the current that is released by the grid is greater in strength than the high-frequency current that causes the changing charges on this member. The response is far greater than that which could be produced by the high-frequency currents if they were acting directly upon the diaphragms of the telephone receivers.

The function of any detecting device like that of a vacuum tube or rectifying crystal is that of making a radio-frequency current produce an audio-frequency effect. We have been told before that a radio-frequency current "vibrates" or "oscillates" so rapidly that it is inaudible. A crystal detector, for instance, simply cuts off one half of these oscillations and pro-

duces a unidirectional, pulsating current of audio frequency. Hereafter when we hear the wireless men chattering about audio frequency and radio frequency we shall know what they mean. All we need to know is that we cannot hear radio-frequency currents, while we can hear audio-frequency currents.

Now we are going to deal again with damped and undamped oscillations. There appears to be no possibility of relaxation for those who would understand the mysteries of radio. We leave one dilemma and bump into another. We will remember that damped oscillations are those that gradually fade out. They are produced by radio telegraph transmitters of the spark type. If the vacuum tube detector is to be made responsive to such oscillations we must insert in the grid circuit what is known as a grid condenser. Our previous introduction to the condenser left us with the understanding that it was a device capable of stirring up electrical currents in the form of charges. When a condenser becomes charged to capacity it takes upon itself the task of discharging. In the diagram on the next page we shall see where this grid condenser is placed. The function of the grid condenser is to store up the currents which are rectified by the valve action which takes place between the grid and the filament. Each group of incoming oscillations charges the grid condenser. When the charge reaches a certain point, it either leaps off through the vacuum tube itself or through what has become known as the grid leak. This grid leak is like a hole in a

barrel that would allow the water to run out only after the barrel had been filled with water to a certain definite level. Each grid leak is really a piece of high resistance material. They are usually made by simply marking a pencil line upon a piece of cardboard. After the condenser becomes charged to a certain point, the potential of the charge is great enough to cause the stored-up current to leak through the resistance. Thus the accumulative effect of a whole group of incoming oscillations is allowed to act upon the vacuum tube.

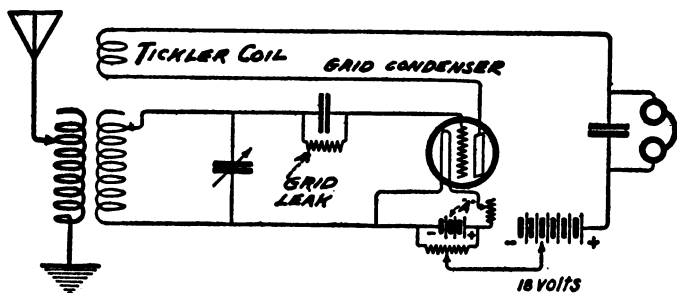

A tickler-coil or regenerative receiver with grid leak and grid condenser.

It is in this way that the output current or the current passing through the plate circuit is varied with the frequency of the distant transmitter. The diagram of connections showing the grid condenser is one that can be used to receive either damped or C.W. signals.

Those of us who are observant will see in the circuit just referred to an extra coil which has not yet been explained. This innocent-looking little coil forms the basis of a patent that has had a profound effect upon the radio art. A few years ago Edwin H. Armstrong,

who is to-day one of the greatest authorities on the vacuum tube, discovered what has since become known as the principle of regeneration. We have seen how a variation of the grid charge changes the strength of the plate current. A very slight change in the grid charge brings about a relatively large change in the plate current. If we could increase this charge of the grid above or below the maximum value that is supplied by the incoming radio signals, a still greater change would take place in the plate circuit. Armstrong found a way of doing this.

If we are to get what follows, we must adjust our spectacles and put on our thinking caps. We know that the plate current varies in step with the frequency of the incoming signals. It will be seen that if this plate current can be impressed upon the grid circuit in step with the incoming signals the charge of the grid will be increased. This increased charge on the grid will in turn cause a greater effect in the plate current. This is the principle of regeneration.

The coil shown in the diagram of the regenerative circuit is called a tickler-coil. It is this coil that inductively connects the plate circuit with the grid circuit. The current flowing in the plate circuit will pass through the tickler-coil. In this way part of the changing current in this circuit is inductively impressed upon the grid circuit.

It is difficult to realize how much the regenerative principle has increased the efficiency of vacuum tube receivers. We can gain some idea of the value of this



are called amplifiers. There is placed between the tubes a tiny transformer. It would take a long time to outline the function of the transformer and the outcome would be uncertain. We shall have to be satisfied with the understanding that the amplifying tubes are always connected through transformers. We do not need to know much about the construction of these transformers, since they can be purchased ready-made along with the vacuum tubes and other necessary parts.

The circuit just referred to has what is known as two stages of amplification. Each amplifier tube is a stage. More than two stages can be used, but the authors would not advise a beginner to be too ambitious when it comes to using vacuum tubes. More than two stages of amplification will require the services of a person who is thoroughly familiar with the technique of vacuum tubes. The beginner will find it easy to handle two stages of amplification, but he should become thoroughly familiar with an outfit of this nature before he attempts to go further. If he tries to progress too rapidly, results will be disappointing, and, of course, the fault will seem to lie not with the operator but with the apparatus. That is always the case. A poor workman always finds fault with his tools.

The vacuum tube is not only a detector of radio currents but a generator as well. When functioning in this manner it works silently and efficiently. It is able to convert a direct current into a high-frequency



radio current which is able to set up ether splashes. The vacuum tube is indeed a Jack of all radio trades. In the not far distant future, a few transmitter vacuum tubes, or power vacuum tubes as they are called, may take the place of much of the elaborate mechanism that is now employed in the radio station.

## CHAPTER VIII

### THE VACUUM TUBE IN VARIOUS RÔLES

**WE** have all been amused by the quick-change vaudeville actor who first appears as a doddering old man. Leaving the stage for an instant he reappears as a gay youngster, an old woman, or one of the characters of Dickens or Shakespere. The little vacuum tube is also a rapid change actor. We see it in one place making measurements in the millionths of an inch and the next time we hear of it, it is amplifying sound-waves that deaf people may hear, or it may be amplifying heartbeats of a patient so that several physicians may diagnose the case. Unlike the usual Jack-of-all-trades, it masters everything it does.

Imagine a steel rod a half-inch in diameter and twelve inches long. Imagine this rod held horizontally with one of its ends in a vise and a fly on the opposite end. The fly bends the rod to a measurable extent! A measuring device sensitive enough to record this bending of the rod is almost beyond conception. It is difficult for us to believe that a twenty-five-cent piece laid on a table top would bend the table top to a measurable extent. Such measurements fall within the range of the newly developed ultra-micrometer.

The sensitive element of the ultra-micrometer is the vacuum tube, and the credit for the development of

this device must go to Professor John J. Dowling of the University College of Dublin, Ireland. Dowling, aided by the vacuum tube, has placed in the hands of the world a measuring device so extremely sensitive that it brings us into the realm of molecules and atoms. The sun Betelgeuze is about 354,000,000,000,000,000 miles from the earth. Let us compare this distance with one five-hundred-millionth of an inch. Our imagination is helpless when faced with such figures. In one case man's unit of measurement, the inch, is hopelessly large; in the other case its smallness makes it utterly insignificant. A millionth is a thousandth part of a thousandth part. A millionth of a mile would be less than one seven-hundredth of an inch. With these staggering figures in mind, let us set out to see how the vacuum tube measures one five-hundred-millionth of an inch. A diagram of Professor Dowling's apparatus is given. It may appear somewhat formidable, but its operation can be easily understood with the knowledge of vacuum tubes and radio circuits that we have accumulated. In Chapter II we learned how very important a condenser is in a radio circuit and how its presence affects the electrical properties of a circuit. We were told that the "capacity" depended not only upon the size and number of the plates used but upon the distance between them as well. In case of a condenser made up of two metal plates separated by air, the capacity will be increased as the plates are brought closer together.

Professor Dowling's ultra-micrometer is nothing more or less than a condenser made up of two plates. This

condenser is connected with a vacuum tube in such a way that the slightest change in the distance between the two plates of the condenser will be recorded upon a galvanometer or measuring instrument. If the distance between the plates is changed as little as one five-hundred-millionth of an inch, the vacuum tube

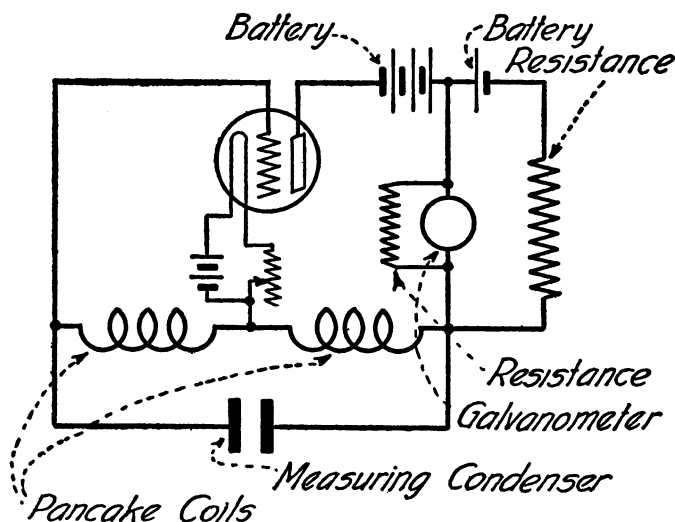

How the various instruments used in the ultra-micrometer are connected.

will detect this change and cause the indicating instrument to function. When one of the plates of the condenser is depressed to the slightest extent an electrical change takes place which, though extremely small, has the most profound effect upon the delicate little vacuum tube.

Thus the vacuum tube has given man a measuring device with stupendous sensitivity. In the physical

laboratory it will help the physicist to measure values that have heretofore been beyond the range of the instruments he had at his disposal. Its value as a weighing device has already been demonstrated. We can readily see that even the slightest weight placed upon one of the plates will cause it to approach the other one. The decrease of weight of a kilogram when raised one meter has been observed. The engineer will find use for the ultra-micrometer in measuring stresses, and the botanist has already employed it in measuring the "growth pulses" of plants.

The little vacuum tube is also doing a great humanitarian work. It is helping deaf people to hear; it is to the deaf what eye-glasses are to those with defective eyesight. For years scientists and inventors have labored to help those unfortunates who have lost part or all of their hearing. Earl Hanson, the able young inventor who is mentioned elsewhere in these pages, was the first man to develop a practical device for hearing which employed the vacuum tube.

We must come to look upon the vacuum tube as a potential amplifier. By this we mean that it is able to make strong electric currents from weak ones—it amplifies and builds up. For years electrical science has been in need of just such a device.

The old ear-trumpet used by the deaf had the effect of amplifying sound-waves. The vacuum tube amplifies them also, but in a different manner. A simplified diagram of the "Vactuphone," as it is called, is given. The sound-waves first impinge upon the diaphragm of

the telephone transmitter. In this way they are impressed upon an electrical current. This current is not in itself sufficient to operate a telephone receiver in a way that would allow the average deaf person to hear. But when the little vacuum tube is placed between the telephone transmitter and the telephone receiver it greatly amplifies the original current and sends it

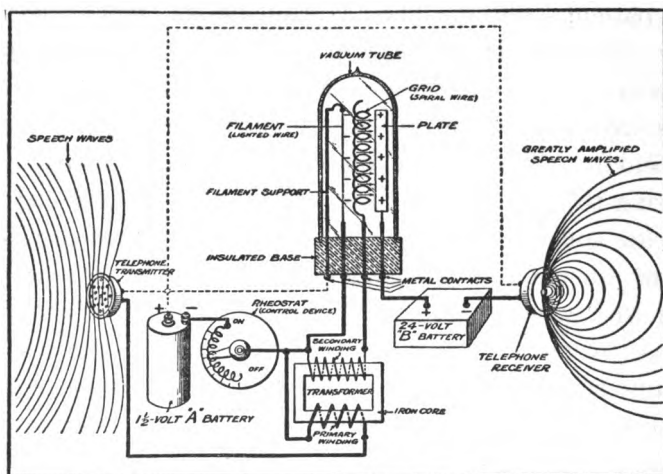

A diagrammatic explanation of the operation of the vacuum tube amplifier for the deaf.

forth to the telephone receiver, which produces sound-waves of considerable intensity. This receiver is held to the deaf person's ear, and if there is any hearing left at all the afflicted person can enjoy the benefits of hearing. So efficient is this little device that a person with normal hearing will find it very uncomfortable to hold the receiver to his ear when the apparatus is adjusted to a point of maximum sensitivity.

Through the aid of the vacuum tube it is now possible for a physician in New York to listen to the heart-beats of a patient in San Francisco. Again the vacuum tube appears in an unexpected place. Major-General Squiers of the United States signal corps made some extremely interesting experiments along this line during the year 1920. He placed a telephone transmitter on a patient's chest. The transmitter was connected to several audition amplifying tubes and a powerful loud speaker. The beats of the heart pounded forth in sledge-hammer fashion from the horn of the loud speaker. They were almost deafening. Instead of using the loud speaker the current carrying the heart-beats could have just as easily been fed into the ether with vacuum tube transmitters. It would be possible in this way for a heart specialist to diagnose a heart case by radio. Every beat would reach his ears faithfully reproduced. In many ways the vacuum tube stethoscope is much more efficient than the ordinary one. The vacuum tubes are able to pick up and greatly amplify sounds and disturbances that are small enough to lie safely beyond the range of the old-fashioned instrument.

Will the heart specialist of the future sit in his offices and diagnose his cases by radiophone? That is not so remote as we may think offhand. A specialist, aided in this way, would be able to treble his capacity. The local doctor would simply carry out his instructions and answer his general questions concerning the condition of the patient.

After we drink a cup of coffee, smoke a cigarette, or find a ten-dollar bill our heart quickens its pace. It responds faithfully to many of the emotions. The vacuum tube is able to cause the changing action of the heart to be visibly recorded upon a strip of photographic paper. Few of us know that the heart produces an extremely weak current of electricity at every beat. When vacuum tube amplifiers are used in this way they are connected to two plates full of salt water. The patient's hands are placed in the salt water. Every time the heart beats it pumps a tiny current from the body into the water. The amplifiers pick this current up, add more to it, and pass it along to a powerful electromagnetic device, finally causing a tiny mirror to move in sympathy with the heart-beats. A thin pencil of light falls on this mirror and is reflected from it to a moving photographic film. Every time the heart-beat causes the mirror to move, the beam moves with it, and the path of the beam is impressed upon the photographic film. Thus a record of heart action is made possible.

Engineers have found a very important application for the vacuum tube in long-distance wire telephony. When we talk from New York to Chicago our voice passes through a great number of these little vacuum tube boosters. As a result of this, the voices of the persons talking are as clear and distinct as though they were located in the same city. Oil from the oil-fields of Pennsylvania is pumped several hundred miles to the refining station. Every few miles there is a pumping



station which pushes the pressure of the oil up and keeps it flowing merrily on its way. We can look upon the vacuum tube as a little pump that pushes the voice-carrying currents and prevents them from getting weak. People are amazed to-day at the clarity of the voice when they are talking over great distances. "Just as clear as though we were a block apart," is a common expression. Most of us can remember when we could barely hear over any great distance. Among other things, the vacuum tube has given us better telephone service.

Like high-pressure water pipe lines, high-voltage power transmission lines spring leaks and part of the current is wasted by flowing off into the ground. This wastage of current is sometimes brought about by a cracked insulator on the poles. A few years ago it was almost impossible to discover these leaks when they did occur. As a result, a comparatively large part of the valuable current leaked away. The vacuum tube is making it easier to find these leaks, thereby allowing us to practise thrift. A sensitive vacuum tube radio receiving outfit is placed on a motor-truck. This truck follows the high-voltage transmission lines, and when a leak is approached, the sensitive vacuum tube produces an audible sound in the telephone receivers, worn by the operator of the equipment. A crack in an insulator that could not be seen from the ground is readily detected by the vacuum tube if any considerable amount of current is leaking across it.

The vacuum tube has been a potential aid to pseudo-

mental telepathy. The more gullible among us have often been dumfounded at a demonstration of "thought transmission" at a theater. Such acts were few and far between before the vacuum tube was developed into a practical device. Nowadays we have all kinds of mystery acts. Sometimes we see a "psychic" Hindu pacing the stage and pulling thoughts right out of the air, so to speak. Members of the audience are asked to write messages upon slips of paper and these messages are then collected by the Hindu's assistant, who disappears with them back stage. The Hindu bravely blindfolds himself and with much gusto promises to read every message word for word.

If we could see under this worthy's turban we should find concealed there a pair of telephone receivers. We should also find a little vacuum tube amplifier on his person, together with the necessary dry batteries. Concealed in the bottom of his shoes we should find two coils, and under the rug, which he paced so frantically, we should find another loop of wire, and this loop would be connected to a telephone transmitter and a few batteries located in the mystic's dressing-room. Here his twenty-dollar-a-week assistant would be pouring the messages he had collected in the audience into the telephone transmitter as fast as he could read them. His words would, of course, be audible in the telephone receivers under the Hindu's turban, and to the surprise of the audience he would read over their messages. This is a case of the vacuum tube gone wrong, but it

does tend to show us the multitude of uses to which it can be put.

Who would think that it would be possible for a vacuum tube to help an automobilist find his way on a stormy night in a strange country? By the use of an ingenious contrivance invented by a New York man, this is now possible. A small electric cable would follow the roadway, and a high-frequency alternating current would pass over this cable. This current would be broken up into characteristic dots and dashes or signals by an automatically driven sender located at one end of the line. Every road would be characterized by a certain combination of signals. For instance, the road between New York and Boston might be marked by two dots and two dashes. The wire at the side of the road would carry these signals constantly, day and night. If an automobile carrying a small coil of wire on its hood passed along the road the coil of wire would pass through the invisible magnetic field set up by the signal currents, and it would in turn have induced in it a very weak current. This current would be shot through a few vacuum tube amplifiers and passed on to a recording device on the dash. Here the signals would appear visibly. By constantly watching the dash instrument the driver could tell whether or not he was on the right road. How pleasant it would be to speed along without having to worry about the right road! If this device ever does come into wide use, we shall have nothing to thank but the vacuum tube.

Not long ago a man spoke into a telephone trans-

mitter in Chicago, and his voice was carried by wire to Naponach, New York, which is a little hamlet in the Catskills. Here the voice currents were amplified with vacuum tubes and passed into huge wooden horns. The voice coming from the horns could be heard for a distance of four miles. The man's voice in Chicago was multiplied ten billion times.

## CHAPTER IX

### THE LONG ARM OF RADIO

**N**IKOLA TESLA said not long ago that within twenty-five years crewless ships would find their way between the ports of the world guided only by the invisible arm of radio. Tesla is not a dreamer; he is a scientific prophet. Perhaps we shall not have radio-controlled ships in the time he mentioned, but the day will come when the pilots of vessels will never leave the shore.

All of this seems wonderful and daring to us to-day, but wonder is a somewhat fugitive emotion. That which is wonderful to-day is commonplace to-morrow.

Since the days when radio was an infant art, inventors have sought to control mechanisms over great distances through the use of ethereal impulses. As a result of this effort a new art, the art of radiodynamics, has been born. By radiodynamics, we simply mean the control of mechanical devices by ether-waves.

When we have heard of radio-controlled automobiles, steamships, and aëroplanes, many of us have believed that the actual power used to operate these devices was transmitted through the ether. That is a wrong impression. In the case of a radio-controlled automobile, for instance, the driving power of the auto-

mobile is carried with it. Radio is used only to exercise control over the driving power carried by the automobile. We must always keep in mind the fact that radio-waves themselves produce extremely weak currents in the receiving instruments which entrap them and they are quite powerless to produce movement in any mechanical devices. By suitable means, however, these weak waves can be caused to release local energy. It is this principle of operation that is used in all radiodynamic devices.

A glance at the accompanying diagram, together with careful reading of the few following paragraphs, will enable us to gain a comprehensive understanding of this wonderful art which holds out such promise for the future. The device to be described simply represents the general plan of operation. There are a number of different systems, and it would be unwise for us to consider them all when an understanding of one will suffice to give us the general idea.

The radio impulses which control the distant mechanism are sent with an ordinary transmitter. At the distant station they are picked up by the aerial and carried to the sensitive receiver. The signals pass into the receiver, where they are detected and amplified with vacuum tubes. In this process the original weak currents set up in the receiving apparatus by the radio signals release local energy which is added to them. We might look upon a vacuum tube amplifier as a physician whose duty it is to administer health-giving tonics to incoming signals so that they will be made

strong enough to operate what is known as a relay. In most cases one doctor is not enough, and a large number of vacuum tube amplifiers are required to build the currents up to sufficient strength. After the rejuvenated current passes through the receiving and amplifying apparatus, it pours through what is known as a relay.

In a relay race one athlete runs a certain distance until he meets another member of the team and then stops. The second member then begins running and runs until he meets a third member and so on. A relay is a device that does virtually the same thing with electric currents. Although the amplified current coming from the vacuum tubes of the receiving outfit is much more powerful than the original current, it is still comparatively weak, and it is only able to cause a response in a sensitive and delicately adjusted relay. When the current passes into the relay it "energizes" it, as the technicians say. By energizing it we mean it makes the iron core of the relay more intensely magnetic than it was before the arrival of the currents. When the magnetism of the relay is increased its pulling power is also increased. This increase in the pulling power of the relay causes it to draw to it what is known as the armature. This armature is nothing more or less than a delicately pivoted steel lever carrying at one of its ends a small contact point. When the lever is pulled toward the magnet, this contact point strikes another contact point and completes a separate electric circuit. Thus we see that the relay

is, in effect, an automatic switch operated by a weak current and controlling a heavier current.

When the weak-current relay closes the circuit a current of considerable strength can be made to flow in the second circuit. The more powerful the current in the second circuit, the heavier the relay must be, and there is, therefore, a limit to the amount of current that can be controlled by the first relay. In some instances, where heavier mechanisms are controlled, it is necessary to have a string of several relays between the receiving apparatus and the devices to be controlled. Each succeeding relay is heavier than the preceding one and in this way very powerful currents can be controlled by a weak impulse. This system is also used in the remote control of powerful radio transmitting stations. The distant operator presses a small hand key and a great flood of energy spreads out from the aerial of the station. The operator controls this energy with comparatively weak currents. If his key were used to "make" and "break" the powerful currents that surge into the antenna it would be melted instantly.

To prevent confusion the authors have shown only one relay circuit in the diagram. When the little relay causes current to flow in the second circuit, this current passes through an electromagnet which is similar to the magnet on the relay, except that it is larger and more powerful since it is designed to take care of heavier currents. Its pulling power is also proportionately greater. This magnet pulls a lever



down which has, mounted on its ends, a little finger. This finger makes contact with a ratchet-wheel. We do not have to be of a mechanical turn of mind to understand that every time the lever is pulled down the ratchet-wheel will move. The ratchet-wheel carries with it an arm which makes an electrical connection with the various contacting points located within the

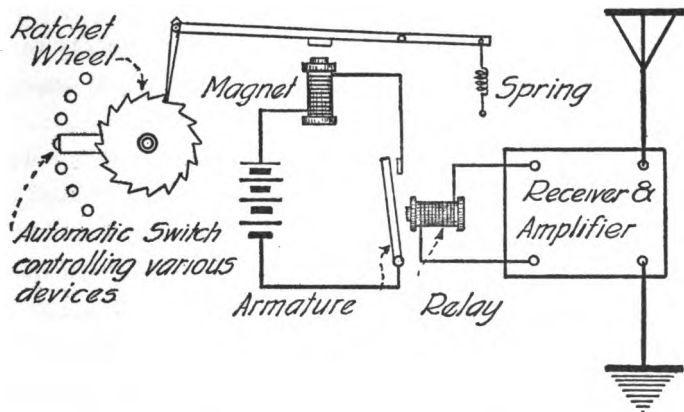

This diagram illustrates the principle of radiodynamics.

sweep of the circle it describes. Every time a radio impulse is received, the relay passes it on to the large electromagnet where it is translated into motion, causing the ratchet-wheel to take a step forward. If the distant operator knows how many teeth there are in the ratchet-wheel he can send the required number of impulses to make it stop on any one of the contacting points. It will be seen that these contacting points may be made to control various circuits. One circuit may contain a motor, another a light, a bell, or a magnet.

During 1921 the United States navy conducted epoch-making experiments with radio-controlled battle-ships. The old *Iowa* was equipped with radiodynamic control devices. We have all heard of the *Flying Dutchman*, that mythical, crewless ghost of the seas. The old *Iowa* was all of this, except that she was not in any sense mythical. This famous old ship, once the navy's pride, had naught to do but silently obey her invisible commander. Think of it; over 11,000 tons of steel controlled by an insignificant whiff of energy that would not injure an able-bodied fly!

The Hammond system of radiodynamic control was installed on the *Iowa*. This was done, not only to demonstrate the practicability of such a system, but to give it a trial under conditions of mimic warfare. Bombing aëroplanes were instructed to drop dummy bombs upon the radio ship, and it was the task of the distant radio commander to elude the bombing planes. His will was law with the old ship. She would turn to port or starboard, speed up or slow down, without the slightest hesitancy.

The Hammond system of radiodynamic control works on the general principle that has just been described. In fact, at the present time there is no other way that a radio control system can work. The Hammond system is highly perfected and contains many details that we could not possibly consider on these pages.

A number of changes had to be made in the power equipment of the *Iowa* before she could be made sub-

ject to radio control. She carried engines that developed a total of 11,800 horsepower. These gave her a speed of seventeen knots an hour. The old Scotch boilers were quite naturally coal-fired, since they were installed long before the use of oil was thought of. Although the word "impossible" has to be used with care these days, it can be said that the control of coal-fired boilers by radio presented very knotty problems. The navy, therefore, decided to install oil burners on several of the *Iowa's* boilers. Controlling the flow of oil is simply a matter of operating the valves. The radio control of valves is comparatively simple. A system was finally developed which allowed the distant commander to exercise perfect control over the intensity of the fire under the *Iowa's* boilers.

Next, certain modifications were made in throttles of the ship so that they could be conveniently manipulated with the long arm of radio. By the aid of an electric valve, which controlled a source of compressed air, the big ship could be slowed down in twenty seconds and her speed increased to the maximum in the space of three minutes. She responded just as though human hands were working at her throttles.

The points thus far mentioned have to do solely with the propulsion of the ship. In order to manoeuvre her, which was one of the most important considerations in connection with the bombing tests, it was necessary that the steam steering engine be under as complete radio control as the main engines. By the steering engine we mean the engine that moves the

huge rudder from side to side. In small ships this is, of course, done with the pilot wheel, but in larger ships the rudder is so heavy that a special engine is required to move it. Ordinarily this engine is controlled with a wire rope transmission from a steering-wheel on the bridge to a shaft which operates the engine control valve. In place of the pilot wheel control, a small electric motor was installed and connected by a chain drive to the control valve shaft of the steering engine. This motor was provided with an automatic reversing contactor or controller which was operated through the radio control panel or automatically through what is known as a gyro-clutch. When the motor turned in one direction, the valve would be operated and the engine would turn the rudder until an impulse was received which would stop it. The gyroscopically controlled clutch functioned when it was desired to keep the ship to a certain course.

The *Iowa* was truly a crewless ship. During the bombing tests she was entirely abandoned; there was not a living creature aboard. Several miles away, her commander on the *Ohio* controlled her. For two hours she responded faithfully to every guiding impulse.

We can readily appreciate what a tremendously vicious weapon a radio-controlled ship would be in war, especially if submerged. Laden with thousands of tons of high explosives, it could nearly level a city. We have only to recall the terrible Halifax disaster to appreciate fully the terrific damage that can be wrought by the explosion of any great amount of TNT.

There would be many other uses for such a ship in war time. It is apparent that radio control might eliminate loss of life in such operations as the British undertook when they sunk ships at Zeebrugge and Ostend to bottle up the German submarines.

If we can control the movements of great ships by radio, why cannot the tiny torpedo be controlled in the same manner? In fact, the radio torpedo is no longer a dream but a reality. The next war, if there be any, will see radio-controlled torpedoes dashing to their mark with deadly precision. Unlike the torpedo of to-day, which travels unerringly in a straight line, the torpedo of the future will pick out its prey and strike it if it has to travel in circles to do so. The present-day gyro-controlled torpedo travels with dogged persistency in a perfectly straight line. If its prey manages to get out of its path it passes on harmlessly. The torpedo of the future will have intelligence; it will be able to "see" its prey and follow it wherever it may go.

The year 1921 will ever be looked upon as marking the second birth of wireless. Great things came to pass in that year. Radio went forward with unparalleled rapidity. The radio control of ships, once a dream, became a reality. Radio Central, the super-power station which brought the entire world under its electric wings, was put into operation. Radio telephony came into extended use and brought with it the broadcasting station. And, to top all these history-making events, Eduoard Belin, a Frenchman,

succeeded in transmitting a photograph of President Harding across the Atlantic.

The apparatus used by Belin in the radio transmission of photographs is ingeniously simple, considering the miracle that it has been able to perform. It is so simple, in fact, that the authors feel that it can be understood by the average layman, even though he is not especially apt at solving Chinese puzzles. We shall begin by considering the diagram, (page 179), where the various devices that comprise both the transmitting and receiving apparatus are shown.

The picture to be transmitted is prepared in a special way and mounted upon the revolving cylinder of the transmitter. By certain treatment that does not necessarily interest us, the picture is produced in relief. By relief, we mean that some parts of the picture are raised more than others. The light values of the photograph control the process that produces the relief effect. By this we mean that the light and dark parts of a picture are of different heights on the cylinder. Thus the height of any particular spot in the picture will depend upon its shade.

Part of the Belin transmitter reminds us of the old cylinder phonographs. As the relief picture is revolved, there travels along its face a fine point or stylus which is fastened to a carbon microphone transmitter. We can liken the stylus to the needle of the phonograph. The microphone transmitter is very similar to the transmitter used on telephones. In Chapter III we briefly considered the operating fea-

tures of the ordinary telephone transmitter. We saw that sound-waves of various intensities impinging

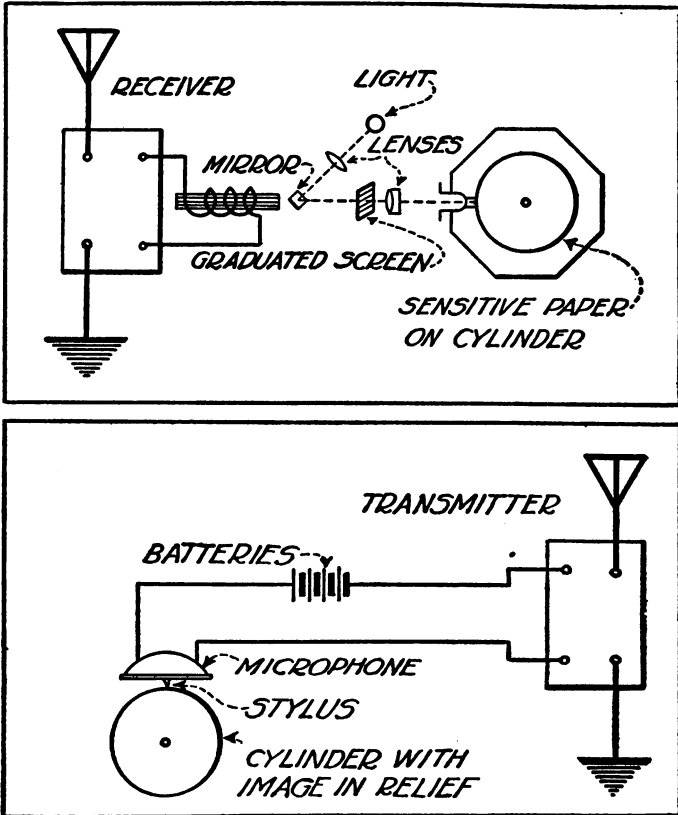

A diagram of the transmitting and receiving apparatus used in the Belin system.

upon the diaphragm of the transmitter would cause electrical changes to take place in the circuit through variations in resistance. The transmitter used in

connection with the Belin apparatus translates the picture upon the cylinder into electrical impulses. As the needle or stylus passes over the relief picture, the carbon grains in the transmitter are subjected to varying degrees of pressure caused by the uneven surface. When a particularly high spot in the relief pictures comes in contact with the stylus, the diaphragm of the transmitter will be pressed back, and this in turn reduces the resistance of the electric circuit and allows more current to pass. As the cylinder carries the picture under the stylus, every part of the picture is reached. It is in this way that the picture really controls the wireless transmitter and the waves are sent forth. Instead of modulating the waves with the voice, they are modulated with the photograph, and the photograph is translated into a series of ethereal impulses, which are picked up by the distant receiving apparatus.

Now that we have the transmitting apparatus clearly in mind let us pass on to the description of the receiver, which is a trifle more complicated. If we keep our thinking caps on, however, we shall at least be able to receive a faint impression of its outstanding features.

The signals from the transmitter are received with ordinary receiving apparatus. After being suitably amplified they are passed along to an electromagnetic device called an oscillograph. For our purpose we can look upon the oscillograph as a huge electromagnet which is very cordial in its treatment of very weak currents. The varying impulses in the large electro-





The photograph of President Harding that was flashed across the Atlantic Ocean from Annapolis to Paris

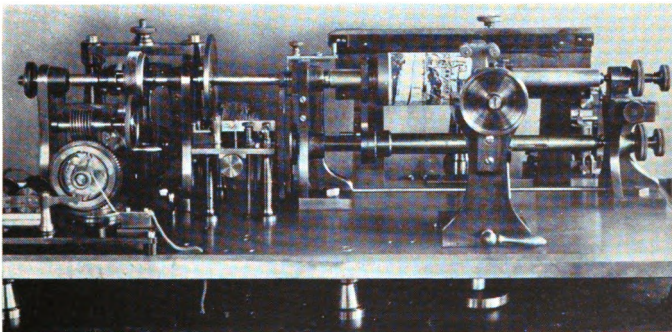

A close-up view of the Belin photographic transmitter used to send the picture shown above



magnet which have been set up by the revolving picture on the distant cylinder act upon a tiny mirror which is delicately suspended on two thin vertical silver wires. The little mirror vibrates in sympathy with the pulsations passing through the large electromagnet. When a particularly high spot of the relief picture in the distant transmitter comes under the stylus, the carbon grains in the transmitter will be subjected to considerable pressure and the resistance will drop. In the receiving apparatus this causes a very perceptible effect and the little mirror would make an exceptionally large dip.

An intense beam of light, after passing through several lenses, falls upon the vibrating mirror. The beam is reflected from the mirror through a small screen and a lens. The screen is a graduated one; that is, it is opaque or impenetrable to light at one end and highly transparent at the other. The change from opaqueness to transparency is effected gradually. As a result the screen represents many different values of transparency.

The beam of light which falls upon the screen from the vibrating mirror moves in only one plane. If it moves, say upward, into a less transparent section of the screen, the light is rapidly cut off, and if it moves in the opposite direction to a more transparent section of the screen, more light will pass. Thus, the light and dark spots of the distant relief picture are sorted out at the receiver by the aid of this little screen, which causes light of varying intensity to pass through the

lens to the sensitive photographic paper revolving in the dark container. The lens between the screen and the photographic paper is placed there to keep the light beam in a certain path, regardless of the movements of the mirror. The light beam, after passing through the screen, is forced to take a definite route to the photographic surface. The lens simply steadies the beam.

The drum and the dark cylinder which carries the sensitive photographic paper revolve in synchronism with the drum that carries the relief picture at the distant transmitter. Special apparatus, which cannot be described in these paragraphs, is used to bring about this synchronous movement of the two cylinders. After the transmission of the picture or photograph is completed the photographic paper is taken off the receiving cylinder and developed.

The transmission of photographs by wireless is as yet an infant art, although it has supplied us with some real thrills. What ten years will do toward changing the status of the Belin apparatus or the many other similar devices is difficult to foresee. The question has been asked, "Must we abandon dots and dashes?" If the transmission of handwriting could be made rapid and cheap enough there would be no need to employ the code. That such an apparatus would have a profound effect upon our social and business life there can be no possible doubt. Already the French courts have recognized the validity of a radio signature. In the future a diplomat will probably

be able to attach his signature to a treaty even though he be thousands of miles distant.

The newspapers will find the radio photographic transmitter of the greatest value. At present, little time is lost in the transmission of news items, but the photographs to illustrate these items must depend upon the mail, which is slow compared with the telegraph. During the Dempsey-Carpentier championship fight, an effort was made to send a photograph of it to a Paris newspaper. It failed through lack of sufficient time for preparation. This incident did serve, however, to point out the tremendous value of such a service.

With the development of radiodynamics it is quite natural that some experimenters should make an attempt to operate a typewriter wirelessly. That has been tried on a number of occasions, and the late systems show much promise of success. The English Creed radio typewriter has been surprisingly successful, and is the only one that has been able to stand up under the strain of commercial application.

Like all radiodynamic devices, the Creed typewriter, which is similar to a wire telegraphic printing machine, is used in connection with a sensitive radio receiver. The messages that are to be automatically transcribed by the machine are first tuned in to maximum loudness. The messages are sent in the form of dots and dashes.

Contrary to what might be believed, the incoming messages do not affect the printing machine directly. The dots and dashes must first be recorded on a paper

tape. This tape is perforated with little holes in such a manner that it will exercise control over the electrically driven typewriter after the message has been received. The method of producing the perforated tape is very ingenious. The incoming impulses acting through a relay control a small pneumatic punching device. As the tape passes through this, the incoming

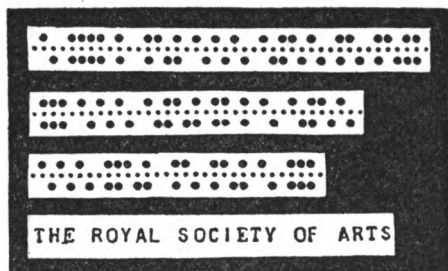

A sample of the perforated tape produced by the Creed automatic radio typewriter. A translation of the message is shown at the bottom.

dots and dashes are recorded upon it. The little punching machine holds no interest for us since it is purely mechanical. Only its main valve is controlled by radio. This valve, which is of the sliding type, is arranged on the end of a lever. The movement of this lever from side to side is caused by the incoming dots and dashes. Thus the dots and dashes are recorded upon the paper tape passing through the pneumatic perforator. The tape issues from the automatic perforator, and passes through the electric controls of the automatic typewriter. As the perforated tape passes through this device little contacting members close the circuit every time a perforation passes. The combinations or perforations represent certain letters of the alphabet. For instance,

dots and dashes are recorded upon it. The little punching machine holds no interest for us since it is purely mechanical. Only its main valve is controlled by radio. This valve, which is of the

if the combination of dots and dashes representing the letter "L" come along, this letter will be struck on the typewriter.

The future of any radio printing machine will not be particularly exciting. It will fill a need to be sure, but that need will not be any greater than that which is filled now by the ordinary printing telegraph in use throughout the world.

Radio control has also been extended to vehicles. A number of experimenters have made noteworthy contributions to this side of the art. During a radio convention in New York in 1921, F. M. Glavin of Tuckahoe, New York, demonstrated a small radio-controlled wagon which obeyed him more faithfully than the average well-behaved dog. It would start, stop, and turn about with a precision that was marvelous. It was operated in virtually the same way as the great battle-ship *Iowa*; that is, the same basic principle was used.

Experiments with radiodynamic-controlled vehicles on a larger scale have been carried out at the McCook Field of the engineering division of the air service at Dayton, Ohio. Visitors at the field were dumfounded at the gyrations of a three-wheeled rubber-tired vehicle which was seen dashing about between the buildings and the aëroplanes. It had no visible means of control, and yet it was traveling about in the busiest fashion just as though it had a certain amount of ground to cover. When it approached a group of people it would blow its horn menacingly, and then when the crowd

was about to disperse to avoid being struck by it, it would stop short with screeching of brakes, make a sharp turn to the right or left, and start off in another direction.

An examination of the interior of the car showed an amazing confusion of batteries, switches, wires, vacuum tubes, relays, and so on. The most interesting feature of the vehicle was a selector with which various combinations of dots and dashes, sent out by the controlling station, were decoded. It was in this way that the various devices carried by the car were controlled. A certain combination of dots and dashes blew the horn, another combination stopped the car, still another turned it to right or left, and so forth. The car was also controlled from an aëroplane, thus bringing about the possibility of a dreadful new weapon of warfare. Imagine land tanks filled with TNT. and "driven" by an aëroplane into a city or town and exploded.



## CHAPTER X

### WORLD-WIDE RADIO

**L**ITTLE copper threads are nation builders. The telephone and telegraph wires that make every home, office, industry, and city part of a vast system of communication and the submarine cables that radiate in divers directions from our shores have done much to make this nation. A man rushing into a telephone booth or passing a telegram over a counter seldom stops to realize what a tremendously important thing communication is. The annihilation of space and time in the transmission of intelligence is a basic thing in the progress of the world.

The future prosperity of this country is closely connected with our communication problem. This has been doubly true since the war, when the United States changed its position from that of a debtor to that of a creditor nation. To-day we hold a dominating position in the finance of the world. Our merchant marine, once an insignificant consideration, is now a potential commercial instrumentality the success of which depends upon an independent system of communication. A business man who cannot talk conducts his business with great difficulty, and a nation that cannot talk to other nations sufficiently, cheaply, quickly, and privately is in a poor position to offer competition.

As we glance back over the history of telegraphic communication through the medium of submarine cables, we are at once impressed with the dominating position gained by Great Britain in the early days and held by her at the present time. When the cables of the world were laid, she realized the importance of having the lines pass through London. Her success in the execution of this policy is something that overshadows the control of the Suez Canal and the Rock of Gibraltar. The cable map shows that cable lines from every corner of the civilized world end at the British Isles or pass through them.

The commercial advantage enjoyed by Great Britain through cable control is difficult to reckon in dollars and cents. It is quite natural that the commercial interests of England avail themselves of the many opportunities that are made possible through the control of world communication. No economist would dare to say that Great Britain would have been able to attain and hold her position as the chief factor in international commerce had she not made the British Isles the nerve-center, so to speak, of nation-to-nation communication.

The late war, which brought complete disaster to the cable system that had been laboriously built up by Germany, contributed greatly to the success of British monopoly. Although the German communication system was a weak competitor, it had nevertheless grown to be no mean factor in world-wide communication.

Great Britain has to-day instantly available a vast





The interior of the transatlantic operating room of the Radio Corporation at Broad Street, New York City

amount of information relating to the export and import business of the United States. In this connection it is interesting to quote Newcomb Carlton's statement made to the Senate subcommittee some time ago. "Ten days after messages have been transmitted our copies of them are turned over to the British secret service, which copies they keep for twenty-four hours and then return. No exception is made and the American official despatches, like the despatches of all other countries, to and from England, are included, but I have reason to believe that no examination is made of them. I have been assured that the official messages are not even inspected, but they are in the physical possession of the authorities while other messages are being inspected."

To-day documentary evidence exists which proves that Great Britain did take undue advantage of her position during the war in gaining commercial secrets relating to the trade of her rivals. The War Trade Intelligence Department made a report to the British Foreign Office during 1917 which contained priceless information regarding conditions of the American metal market. This document was printed and broadcasted to the British metal interests. It is known that the report, insidious in its nature and far-reaching in its effects upon our own industry, had no bearing upon Germany's desperate efforts to smuggle contraband metal past the blockade. This report emphasizes the astounding nature of the British espionage system conducted in connection with the cables that either

terminated or found their way through the British Isles.

Exclusive of the United States, the cable systems of the other nations of the world are relatively unimportant, and the messages passing over them come under British surveillance in either a direct or indirect manner. If the cables do not pass through the British Isles, they touch British territory or cross British-owned cables.

The laying of American cables has progressed rapidly, and this country to-day takes its position second to Great Britain. Great Britain was wise enough to plan her cable supremacy when that system was in its infancy, and she to-day controls an octopus-like structure of copper wires that has its tentacles securely fastened on all the great ports of the world. In the early days of submarine telegraphy, Great Britain controlled the world's output of gutta-percha, which afforded her a considerable advantage in carrying out her plans.

When all is considered we really cannot blame her for her policy. We were more or less asleep at the time and she was wide awake. The situation as it exists to-day, however, is a subtle danger to the extension of our foreign trade. Although we have stretched our cables to the shores of South America, we are forced to do most of our foreign business through channels of communication that are controlled by our most potent rival for foreign trade.

The new day of communication is here; radio has

come to help us out of our dilemma. With the advent of radio, America has been offered an opportunity not only to strengthen her position in world communication but to make herself the world center of communication. Although the intensive application of radio telegraphy and telephony will not for many years to come enable this country to offset the advantages held by Great Britain, it will nevertheless prevent our rival from dominating radio as she has dominated cable communication.

Until a few years ago the application of radio to commercial business was controlled by the British Marconi Co. and the Marconi Wireless Co. of America. Great Britain, true to her traditions, saw to it that the Marconi Wireless Co. of America was a subsidiary of the British company which was licensed to do business here in America. After the advisability of a government owned radio system was considered and rejected, a new American concern supported by some of our strongest financial interests was organized to give America that control over its communications which it so badly needed. The first step in this organization was to purchase the British holdings in the American Marconi company. Then, with the consent of the stockholders of the latter concern, it absorbed the American Marconi company. At last the United States was in control of one of its most vital commercial assets. The newly-formed corporation entered into negotiations with the British Marconi Co. concerning radio communication throughout the entire world.

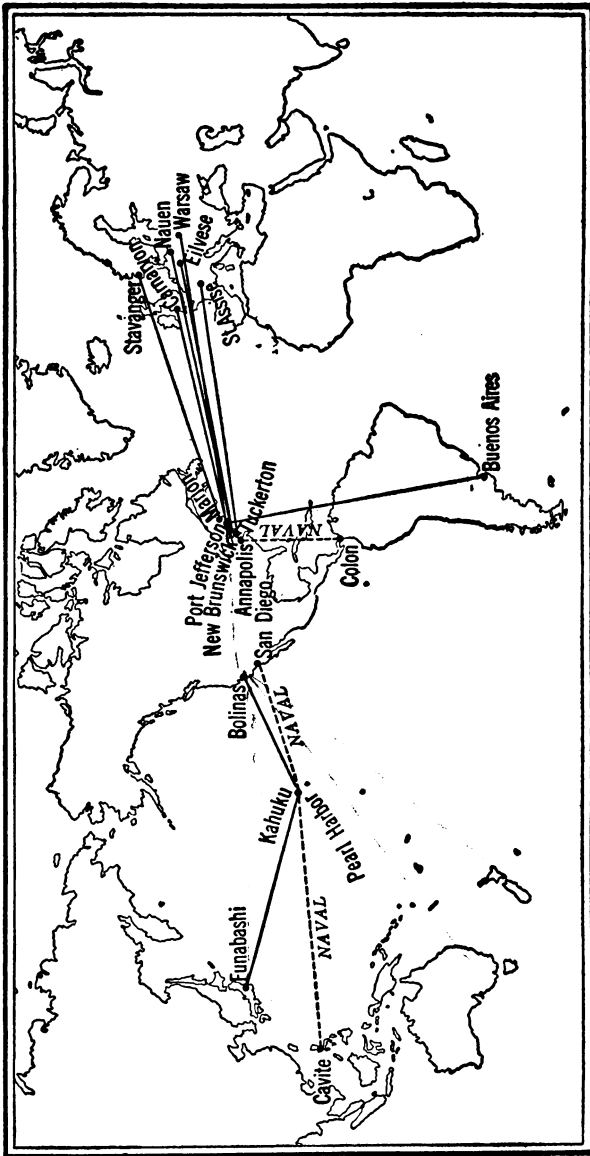

Courtesy of Journal American Institute of Electrical Engineers.

The American radio plan for transoceanic communication.



Our present plan for radio communication is an ambitious one. Its completion will give the United States a leading position in the commercial affairs of the world. We are planning our radio system with considerable shrewdness and with the intention of taking every advantage offered by our geographical position. Owing to technical difficulties that now present themselves, American radio engineers do not believe that radio will ever scrap the cables of the world. Although the writers are not without technical knowledge regarding radio problems, they do not feel inclined openly to dispute the decisions of our learned technicians who have done so much to help America in its communicating problem. Constant contact with engineers, however, has led the authors to believe that the engineers often lack imagination and foresight and that they are inclined to overlook possible future developments that may overcome present difficulties. The many engineers and scientists who passed Alexander Graham Bell's booth at the Philadelphia Exposition smiled and pitied him. They, too, failed to appreciate the fact that future development would bring the telephone to the important place it now holds in the affairs of the world. It is not idle speculation to say that all of the cables of the world will be scrapped unless some genius increases their carrying capacity by multiplexing them. When that day is reached, America will no doubt hold an enviable position in the communication system of the world.

Fortunately we have been quick to see the possibili-

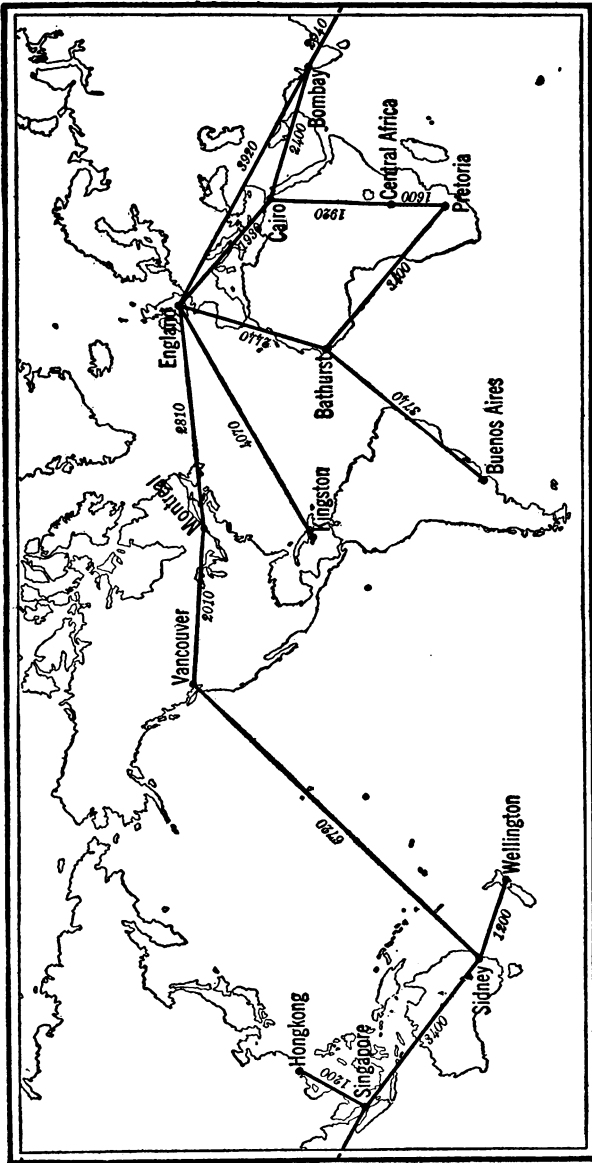

Courtesy of *Journal American Institute of Electrical Engineers.*

The first English plan for world-wide communication.

ties of radio telephony and telegraphy. American engineering talent has enabled this country to take the lead in the development of the art. Our engineers have not worked alone. Commercial and governmental interests have applied the new developments as fast as they have been brought about and, as a result of this concerted effort, this country has available to-day tremendous facilities for international radio service. The swift progress of the new art, since the first feeble message was flung across the ocean by Marconi in 1902, has culminated in enabling this country to divert 15 per cent. of its traffic over radio circuits. It is difficult for the layman to realize what 15 per cent. of the traffic of a country of the size of the United States means.

Radio offers a distinct advantage over the more cumbersome submarine cable. It forms an invisible bond between the nations of the world. Indeed, it is a great and powerful binder of the peoples of the earth. An ocean cable runs from one landing-place to another. It can be easily cut in times of war, and if it is not cut the impulses passing over it can be censored by its owners or by those who happen to be in command of the ports at which it terminates. Invisible radio waves pouring over the face of the earth cannot be cut. It is humanly impossible to interfere with them in the slightest way. When a radio message is sent it may reach all parts of the world. If it is transmitted in code it may be confidential, and if it is transmitted in plain language it is available to the world at large. As Ernest F. W. Alexanderson of the Radio Corporation

of America has aptly declared, "It is not an exaggeration to say that the emancipation of the human spirit was begun with the invention of the printing-press and has found its fulfilment in radio communication." Radio not only makes the transmission of ideas from man to man and from nation to nation independent of any frail material carrier such as a wire, but above all it renders communication independent of any brute force that might be used to isolate one part of the world from another.

In 1913 the first British imperial scheme for world-wide communication took definite form. At that time the "All-Red Chain" was planned. It had its birth in the offices of the British Marconi Co. and was later submitted to the British Government for approval. It was finally adopted, and some work was done along the lines of the plan decided upon before the war began. The work was discontinued in view of the serious situation Great Britain faced. The discontinuance of this plan led to rather serious differences between the British Government and the Marconi company, which lost a vast sum of money. Afterward, however, the claims of the Marconi company were allowed in part, and the British Government made suitable financial restitution.

During 1919 and 1920, after the war clouds had cleared away, the British government committee again took up the subject of the imperial radio scheme. After mature consideration the committee recommended a plan that was not as ambitious as the original

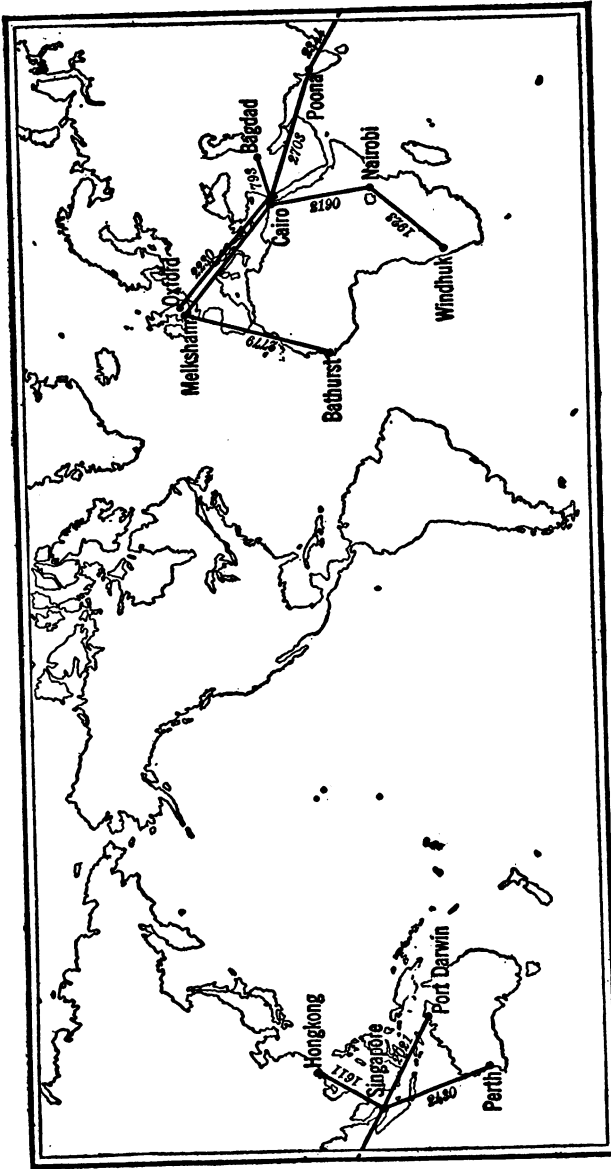

Courtesy of *Journal American Institute of Electrical Engineers.*  
 The present English plan for a world-wide radio system.

one. In the later plan the western hemisphere is virtually neglected. The average span is shorter, and London is not directly connected to the more distant points without the use of relay stations. A glance at the new map illustrating the British imperial scheme shows stations at Hong-Kong, Singapore, Port Darwin, Perth, Bagdad, Cairo, Poona, Mairobi, Windhuk, and Bathurst. The new system will be government owned and operated. The plan is now being carried out, although a very small portion of it has been finished.

France is fully determined not to remain far in the rear in the general plan of world-wide radio communication. That her activity in this respect is ambitious is really realized when it is said that she is to have no less than five direct radio connections with North and South America. One of these will connect her with Canada, one with the United States, one with Central America, and two with South America. Aside from these valuable connections she will reach out to South Africa, Scandinavia, and China. The French plan is notable for its long spans, which will necessitate powerful stations. Only part of the French program has been carried out. Unlike Great Britain, France seems to be laying great stress upon Central and South American traffic.

The German imperial scheme of 1913 for world radio communication was one that took into account commercial as well as military considerations. The Germans' dream was shattered by the war. It was

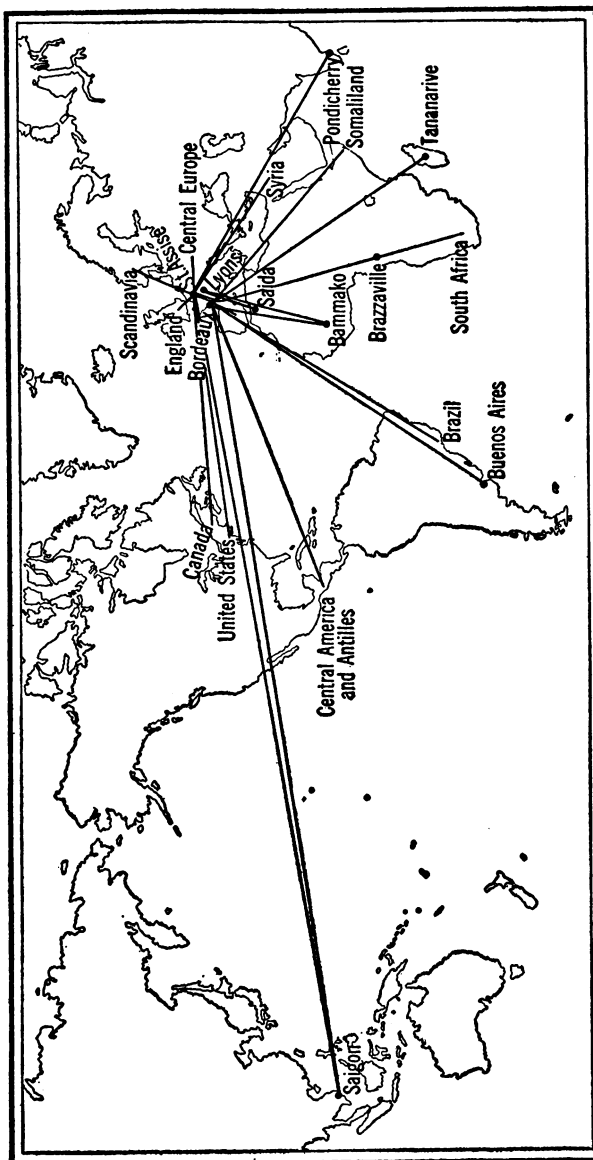

Courtesy of *Journal American Institute of Electrical Engineers.*

The French radio plan.

ingenious, however, to say the least, and it was carefully planned to give maximum benefit with minimum expenditure. At the time the war began there were two powerful German-owned stations in America. One of these was at Sayville, Long Island, and the other at Tuckertown, New Jersey. At the present time, Germany's only arm of communication worth considering is the transoceanic station located at Nauzen.

The American plan for world-wide communication is nearly completed. As this book goes to press every station planned is either in operation or under construction. The American scheme is preëminently a commercial one, and it will do much to make this country independent of foreign-controlled communication channels. We already have eight transoceanic stations in operation. For transatlantic work we have transmitters at Marion, Massachusetts; Port Jefferson, Long Island; New Brunswick, New Jersey; and Tuckertown, New Jersey. For trans-Pacific communication there are transmitters at Bolinas and San Diego, California, the latter station being for naval purposes. The navy also controls the powerful transmitters at Arlington, Virginia, and Annapolis, Maryland. The Bolinas station was built for communication with another American station at Kahuku, Hawaii, whence messages can be relayed to Asiatic points. The American system is notable for its long spans, a condition brought about to some extent by our geographical position and the lack of American possessions.



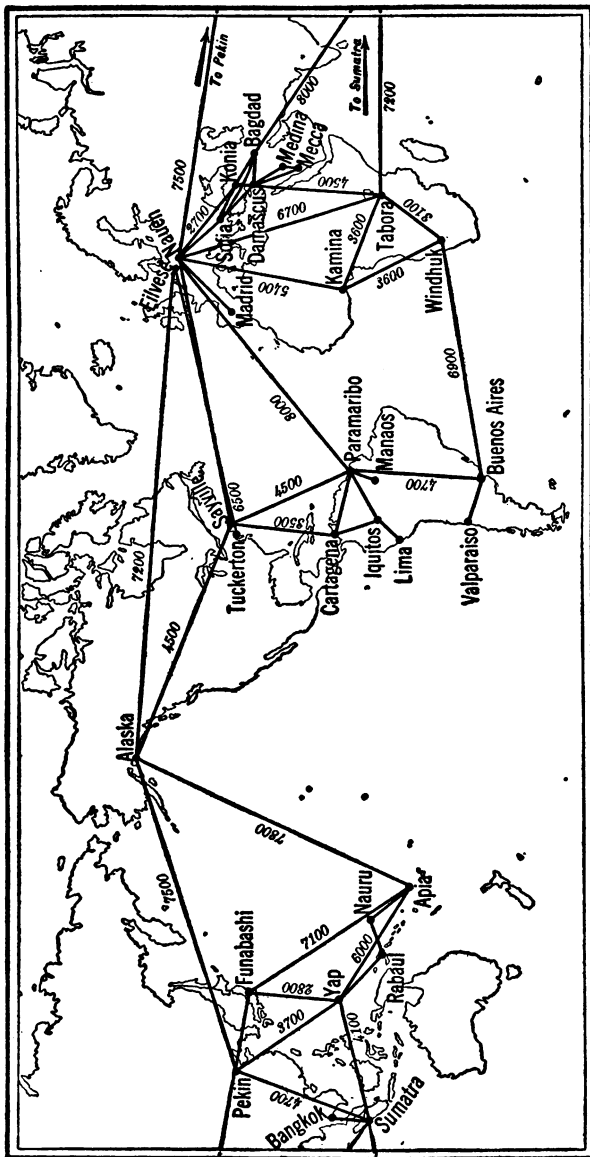

Courtesy of *Journal American Institute of Electrical Engineers.*

The pre-war German plan for a world-wide radio system.

The use of powerful transmitters to cover long spans without depending upon relay stations is a thing to be desired.

The super-power radio station erected at Port Jefferson, Long Island, can be looked upon as one of the greatest achievements in the history of communication. It is more than a radio station; it is a colossal instrumentality for the spreading of American intelligence throughout the world. It is able to breathe hundreds of horsepower of electrical energy into the ether of space. With it America's voice can be heard in every civilized country on the face of the earth.

This station has been called Radio Central, and rightly so, for under its bristling antenna wires there are located no less than six independent transmitters. Each transmitter is used to establish communication with a certain country. One enables Radio Central to reach out to Norway, another to Poland, another to France, another to South America, another to England, and the last to Germany. This is indeed world-wide communication on the grandest scale.

The economic factors that brought about the construction of Radio Central as the practical solution of the problem of long-distance communication are nearly the same as those that created the central electric power station, since that provided for the full utilization of plant facilities by allowing the equipment to be shifted from one service to another to meet various demands. Electric power is carried forth from a power station over a number of circuits. The

electrical equipment of the station is flexible enough to allow this current to be diverted to the circuits where it is most needed. When a storm darkens a city, the power station operators are on their toes watching their indicating instruments on the switchboards. Every

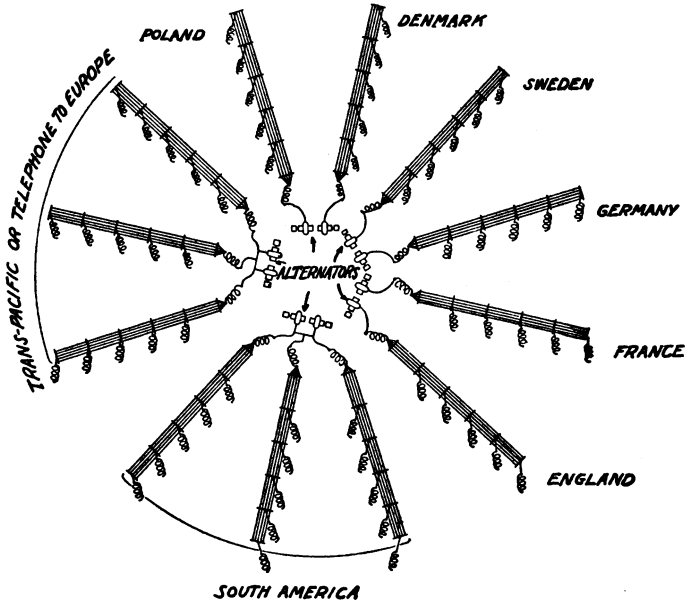

The aerial system used at Radio Central.

light that is turned on in the office or home increases the load, and while one or two little lights do not mean anything, the hundreds of thousands of them that may be turned on in a city like New York increase the load tremendously.

While this problem is not exactly duplicated in long-distance radio communication from central stations,

it is nevertheless approached. For instance, while it is winter in the northern hemisphere, the radiating power used in European communication can be much reduced, since cold weather facilitates transmission. During the winter months static interference is at a minimum. At this time South American traffic requires maximum radiation because summer conditions exist in the southern hemisphere. Under these conditions Radio Central can divert some of its radiating power from the European to the South American circuits. Aside from this, there will also be daily fluctuations in traffic load which will occur at different hours owing to geographical longitude. The peak load of European traffic will occur at different times than the South American and western traffic. The central station is flexible enough to meet fully this changing demand for service.

Radio Central is a gem of engineering skill. No less than seventy-two steel towers 410 feet high will hold its aerial wires into the sky when it is completed. What a thrill one receives standing at the base of a tower looking up through its center at the moaning wires above! The aerial system will majestically spread itself over ten square miles of terra firma. It will be divided up into twelve legs or spokes. At the time of the preparation of this manuscript one of the transmitting units is in daily use. The building which houses the two 200-K.W. Alexanderson alternators and their auxiliary devices has been so constructed that further additions can be easily made to accommodate

the new equipment that will be added later as the other spokes of the station are completed. The power-houses containing the transmitting apparatus are located in the hub of the wheel formed by the aerial system. Each aerial unit or spoke is three miles long, and twelve of the great steel towers hold it up.

A wireless transmitting and receiving station must get a grip on the ground as well as in the ether. The gigantic aerial system of Radio Central makes a beautiful contact with the ether. The ground contact is no less perfect, for 450 miles of copper wire have been buried. One can realize what a tremendous job the building of a station like this is when it is considered that the digging of a trench 450 miles long is only one of the incidents of its construction.

A competent engineering staff is necessary to keep a large station in service, and for the convenience of this staff there has been erected at Radio Central a beautiful community house. The married men have separate bungalows. No expense is spared to make life comfortable for those who stand guard over the intricate mechanisms assembled in the power-house. A layman wandering about Radio Central and coming upon the community house would immediately ask, "Is that where the operators live?" He would be surprised when he was told that the men who handled the code-forming keys are seventy miles from the station.

The modern station used in world-wide communication is remotely controlled. The real operating-room for Radio Central is in the heart of New York's financial

district. Here, comfortably seated in a large room in a Broad Street building, are the operators whose duty it is to transmit and receive intelligence. This room is connected by wire with the switchboards in the transmitting-room of the distant station. An operator, pressing a small key at Broad Street, sends a comparatively weak impulse over the connecting wires, and this impulse upon reaching the switchboards surges through a small relay. This relay, in turn, operates another heavier relay and this allows a flood of energy to pour off into the ether from the aërial wires.

In the radio stations of old the aërial wires were charged or excited only at the instant the key was pressed. This is not so at Radio Central. The aërial wires are constantly charged, and electric waves of a definite length are being pushed off into space continuously. These waves, however, are more or less a by-product. There is used in connection with each antenna a large inductance or coil of heavy wire. When the operator's key at Broad Street is pressed, it short-circuits this large coil of wire, and this will change the length of the emitted waves. The operator then simply calls into use the standard wave-length of the station and side-tracks the by-product waves. This is really an ingenious way of getting around a very difficult problem.

It is very difficult to control 200 kilowatts of power with a sending key, since interruption of a circuit carrying such heavy electrical currents causes disastrous sparking.

As the operator at Broad Street manipulates his key or uses his automatic transmitter, which employs a perforated tape, he can hear his own message. He has adjusted over his ears a pair of head-phones which are connected to a small receiving outfit tuned to respond to the waves emitted by that particular branch of Radio Central that is being controlled. Thus if the operator makes a mistake he can instantly correct himself, and if anything happens with the transmitting apparatus he is at once aware of it. The value of this listening was well demonstrated to one of the writers when he was standing in the transmitting-room of the big New Brunswick station. A surge in the power line came along unexpectedly, as surges often do, and the circuit-breaker that controlled the motor driving the Alexanderson high-frequency alternator flew open. The speed of the alternator immediately dropped, and of course the frequency of the current that it was producing dropped with it. The operator at Broad Street who controlled this circuit was sending a message to Cardiff, Wales, at the time, and he immediately knew that something was wrong, for he stopped sending. The engineers at the station, who are constantly watching for things of this nature, jumped into action, and for a few seconds there was lively hustling. In less time than it takes to tell it the engineers had the speed of the alternator back to normal, and the operator continued his sending.

The facility of the remote control system was demonstrated at the time the first branch of Radio Central

was opened to the public. An automatic transmitter was placed on President Harding's desk. The tape wound up on its spool contained a message for the entire world. By pressing a small key the President threw this little device into action. The message on the tape was sent humming over telegraph wires that were connected with a little relay to one of the switchboards at Radio Central. As a result of this little effort on the part of the President, the following message was laid down in every corner of the earth:

The White House,  
Washington,  
United States of America.

To be able to transmit a message by radio in expectation that it may reach every radio station in the world, is so marvelous a scientific and technical achievement as to justify special recognition. It affords peculiar gratification that such a message, from the Chief Executive of the United States of America, may be received in every land, from every sky, by peoples with whom our nation is at peace and amity. That this happy situation may ever continue, and that the peace which blesses our own land may presently become the fortune of all lands and peoples, is the earnest hope of the American nation.

WARREN G. HARDING.

November 5, 1921.

Owen D. Young, in an address delivered to those who were present at the official opening of Radio Central, said:

"If there be any thrill, and there is a very great thrill in this occasion to me, it is not because of the great technical achievements which have made this station possible. It is not because of the work done,







great as it is, by these constructors of the station, but it is that to-day America is able to lay down in her name, in twenty-eight countries of the world, this message from the President of the United States."

So far nothing has been said about the receiving equipment of Radio Central. Practice has shown that it is inadvisable to place a receiving station in proximity to powerful transmitting apparatus. The heavy currents induced in the delicate receiving instruments would be so great as to render simultaneous transmission and reception impossible. For that reason, the receiving station of Radio Central is located sixteen miles away from the transmitting apparatus. It is provided with an independent aerial designed especially for reception purposes. Although the messages are tuned in and actually received at the receiving station, they are not translated there. They are fed into wires which terminate at Broad Street, and when they reach this point they are automatically recorded on a moving tape or directly translated upon a typewriter by an experienced operator.

If a wire telegraph operator fails to catch a word of a message he is able to "break in" on the sending operator at the distant instrument and ask him to send that particular part of the message over again. We will be somewhat surprised to learn that this is also possible in radio work. Each receiving operator is provided with a telegraph key, and this key controls the transmitter. If the operator fails to understand a part of

the message he interrupts the transmitting operator at the far-distant station.

For the present at least world-wide radio has nearly reached the end of its tether. Radio stations must operate on independent wave-lengths. If two powerful stations were operating on the same wave-length it would be virtually impossible for a receiving station to distinguish between the two messages. One message could not be invited in without inviting the other, and the net result would be what would amount to no message at all: there would just be a confusion of dots and dashes. To avoid this state of affairs, each station must have a wave-length all its own. We might say that its voice is given a certain pitch. Since there is a lack of good selectivity in our receiving apparatus the wave-length of one station cannot be very close to the wave-length of another. For instance, if one station were transmitting on a wave-length of 600 meters and another on 605 meters it would be difficult to tune the 600-meter station in without tuning the 605-meter station in if they were both operating at the same time.

Allowing for a certain range of non-active wave-lengths between the various wave-lengths allotted to the large commercial stations of the world, there is a limit to the available frequencies. The supply of wave-lengths left for use must be conserved until our radio technicians supply us with more selective receiving apparatus. Some very important work is being done along these lines to-day, and the time must come

when the slightest change in the electrical constants of a wireless receiving circuit will enable it to distinguish between two signals of almost the same wave-length. When that day comes we can build as many high-powered stations as we like.

The nations of the world, realizing the serious shortage of commercial wave-lengths, have come together on a common-sense basis and agreed on a policy of friendly coöperation rather than one of insane competition. Theretofore, Germany, England, France, and the United States were going to erect stations in Argentina. Each country, not to be outdone by the other, was to erect its own station. The situation was absurd. Four stations were planned to do the work of one. One good station could handle all of Argentina's business, and the plans for four were made when the world badly needed the wave-lengths that were going to be wasted. It was not only going to be a waste of wave-lengths but a waste of capital and human energy. Representatives of the four nations assembled to discuss the question, and, as a result of this discussion, it was decided to erect one international station in Argentina. That was the logical plan, and it was gratifying to note that we are capable of intelligent coöperation in this connection. As a result of this conference, a similar international station will be erected in Brazil.

World-wide radio stations are a tremendous asset to any country. One does not have to be an economist to understand this. Radio not only does its part in

furthering the commercial interests of a country but it is also valuable from the point of view of international politics. While Premier Briand of France was attending the Washington arms conference he was kept constantly informed by radio of French domestic affairs. At that time France had what might be called a radio-controlled governing body. We do not have to hark back very far in our own history to recall to mind President Wilson's memorable voyage on the *George Washington*, when he kept in touch with Washington with a powerful radiophone.

Unlike the cable and telegraph systems, radio reaches out to the most remote corners of the earth. Alaska keeps in touch with the rest of the world by radio, and the fiercest storms that rage cannot isolate it from the rest of the world so long as it employs this invisible link. Even little Albania, one of the newest republics of Central Europe and one of the oldest seats of civilization, has installed a wireless station which enables it to carry on communication with its neighbors. Poor China, although quick to place her hope and confidence in radio, has had a hard struggle to avail herself of it. The stations that she now has are foreign-owned. China's radio policy is being juggled about too much by international politics.

## CHAPTER XI

### RADIO ON THE SEVEN SEAS

**L**ONG ago Carthage was the clearing-house for merchandise gathered by her argosies from every country within the known limits of the world. At that time ship owners were obliged to commit their ventures to the hands of captains. They had no knowledge of their gains or losses until their vessels returned home. In fact, this condition continued down to the beginning of the nineteenth century. The advent of the submarine cable changed it to some extent, but it was not until radio came that the owners of cargo ships were able to keep in constant touch with their captains, agents, and customers in every corner of the world.

Many persons are inclined to look upon radio simply as an aid to safety on the sea. Of course its value in this respect cannot be disputed; but, on the other hand, the part radio plays in commerce over the high seas is of tremendous importance. Mercantile marine companies and ship owners in general, not only on the seas but on the Great Lakes as well, can keep in constant touch with their vessels. The ability to divert steamers from one port to another effects considerable reduction in operating expenses. By the use of radio, steamers can be directed to various destinations and many

days of unnecessary travel can be saved. Considering that the average small cargo steamer has an operating expense of about \$1000 a day while plying between ports, it will be seen that anything radio can do that will prevent unnecessary travel will aid greatly in reducing expenses. During the coal shortage of 1918 and 1919, it was often necessary to divert vessels from one port to another to prevent them from being held up indefinitely by a lack of coal at the original destination.

The captain of a modern steamer does not have to make wild guesses about the weather he is going to experience. Every day he can obtain the weather reports from the powerful government station at Arlington. The value of this service cannot be overestimated. He can also receive the time signals from the same source. Each day at noon and at 10 P.M., seventy-fifth meridian, immediately after the time signal, the Arlington station broadcasts such information relating to safe navigation as is furnished by the hydrographic office during the preceding twenty-four hours. Information concerning wrecks, derelicts, ice, and other dangerous obstructions to navigation is broadcasted.

The radio communication laws of the United States provide that "It shall be unlawful for any steamer of the United States or any other foreign country navigating the Ocean or the Great Lakes and licensed to carry, or carrying, fifty or more persons, including passengers and crew or both, to leave or attempt to leave any port



of the United States unless such steamer shall be equipped with an efficient apparatus for radio communication, in good working order and capable of transmitting and receiving messages over a distance of at least one hundred miles day or night." The law also goes on to provide that this equipment must be in charge of two or more licensed operators. The adoption of this law and the laws of other countries was brought about when it was realized that radio was absolutely indispensable to sea travel. A number of years ago an international radio convention was held, and at that time what is now known as the International Morse Code and Conventional Signals was adopted. With this code a French operator can talk to a Spanish operator or an Italian to an American. By the use of certain letter combinations that have an international significance they are able to carry on a limited conversation. It is often wondered how an Italian or a French operator can "talk" under these circumstances without resorting to gesticulations. They seem, however, to get on beautifully.

A business man on a vessel anywhere between Liverpool and New York, or between Boston and Havre, for that matter, may get the ups and downs of the "Street" by radio. The radio stock-ticker is an actuality. It may save some men a fortune by allowing them to direct the operations of their broker in their behalf. Such a ticker would have at least spared one man the shock of bankruptcy. Years ago Leonard Jerome decided to visit Europe and enjoy some of his money.

When he set foot in Liverpool he was penniless, although he did not know it. While he was in mid-ocean a Wall Street smash ruined him. He was caught unawares and had absolutely no opportunity to use his judgment. To-day a financier can carry on his gambling, even though he be isolated physically.

It is not at all impossible to send medical aid by radio. A short time ago the operator at a large radio station at police headquarters in New York received the following message from the steamship *Sherman*: "Man bleeding to death on S.S. *Sherman* off Statue of Liberty. No doctor aboard. What shall we do?" The operator at headquarters immediately sent forth this inquiry: "What's the trouble?" "Heavy casting crushed leg," came flashing back from the ship's operator. Fortunately the policeman operating the radio set was an expert at first aid. He immediately instructed the ship operator to make a tourniquet and place it above the injury. After despatching these directions he called one of the police-boats by radio and directed it to the *Sherman*. He then telephoned to Old Slip Station and Broad Street Hospital. When the police-boat got to Pier A with the injured man aboard, an ambulance and surgeon were waiting.

There have been a number of cases where the lives of men have been saved by medical advice sent by radio. In fact there is now a radio station at the Seaman's Church Institute on South Street, New York, from which any vessel plying the seas may obtain free medical services. This is the first dispensary of its kind in



A typical ship station



the world. It is able to reach ships half-way across the Atlantic. Any vessel sending forth the signal HDKE HDKE, which will mean, "Help wanted for an individual," will immediately be answered. This call has been given precedence over any other radio message except SOS.

The life of the captain of a tramp steamer off the Florida Keys was saved by medical information sent by radio. The captain became seriously ill with ptomaine poisoning. Through information received from a doctor on shore, the men on board were able to administer an antidote to keep the captain alive until the vessel reached the nearest port, where it was met by an ambulance. These are only two of a few cases where information sent by radio has saved men's lives.

The arctic or antarctic explorers can find good use for radio. The auxiliary schooner *Bowdoin*, used by Captain Donald B. MacMillan, the arctic explorer, is equipped with a powerful wireless outfit. This enables the exploring party to receive daily news reports from the civilized world that they leave behind. At times it will also serve its purpose to call aid. Captain Roald Amundsen, discoverer of the south pole, will make radio part of his equipment on all of his future explorations.

Formerly the seal hunters of the Great Northland severed all connection with civilization when they set off on their perilous journeys. Oftentimes their ships were crushed in the ice-floes and they were left to perish in the storms. Nowadays it is quite different, thanks to

radio. The newspapers of St. John, Newfoundland, publish messages every day that tell just where the ships are and the progress of the seal catching. In the event of an accident to a vessel, aid can be rushed forward immediately.

During the World War the German submarine commanders could not understand how the vessels of the allied nations could find their way into port without a light on board and without depending upon buoys or other visible guides. The system used, although not strictly radio, is so closely connected with it that a mention of it is justifiable in these pages. A cable was laid at the bottom of the navigable part of the harbors. One end of this cable was connected with a generator of 500-cycle alternating current. We all know that a wire carrying a current sets up a magnetic field which spreads out. Each vessel was provided with two coils, one on each side. As these coils cut through the magnetic lines of force created by the current in the cable, currents were induced in the coils. By suitably amplifying these weak currents with little vacuum tubes, they were made audible enough to be heard in telephone receivers placed over the pilot's ears. When the signals in the telephones were of maximum loudness, the pilot knew his vessel was directly over the cable, and in this way he was able to guide the ship safely into port. This wonderful system, which was in use in a number of ports, was perfected by Earl Hanson, a young radio expert who has done more than his share to help increase the usefulness of radio.

It is now possible to tell from exactly which direction radio waves are coming. This is done with a device known as a radio compass. Its operation is simple and effective. The compass itself is nothing more or less than a small aërial wound on a wooden frame about four feet square. We might look upon it as a "concentrated" aërial. Radio men call this form of aërial a "loop." The aërial frame turns upon an axis. As it turns a pointer carried with it plays over a calibrated scale. This scale corresponds to a compass. As the loop antenna is turned on its axis a position will be reached where the incoming message will attain maximum loudness. It has been found that if the position of an aërial bears a certain relationship to the incoming wave, it will act more efficiently than it would if it were placed, say, ten or fifteen degrees away from that position. With this simple arrangement it is possible to determine the direction of a message within a very small percentage of error.

The radio compass is coming into use more and more on the sea. There is no need to determine the direction of a message for the mere sake of the information. Let us assume that a dense fog is hanging over a port and that the captain of a vessel fifteen or twenty miles out wishes to learn his exact bearings. The vessel carries a radio compass, and on the mainland there are three small transmitting stations three or four miles apart. By bringing the compass to the three positions where it responds most effectively to the signals of the three different stations, the operator can immediately deter-

mine the exact position of the vessel. He knows that the signals from Station No. 1 are approaching him from a certain point of the compass. With a map of the port before him, he takes a piece of string which terminates at Station No. 1 on the map and lays this in such a posi-

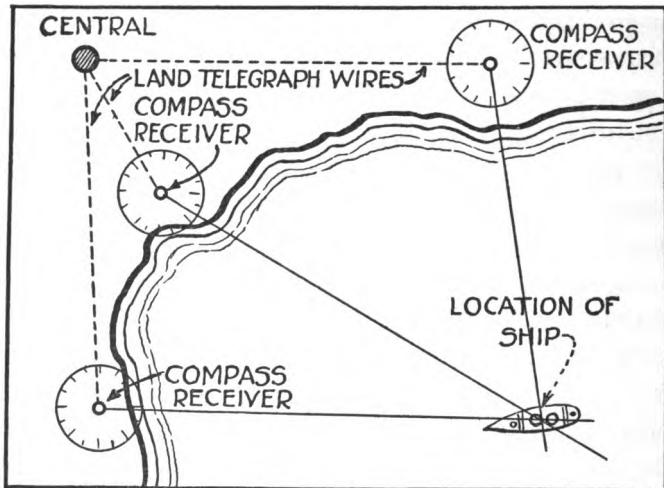

Showing how the radio compass functions.

tion that it will correspond to the direction of the message he received. He follows out this course with the other two stations and it will be seen that his vessel will be located at the point where these strings cross one another.

This system of fog signaling has been put into operation by the bureau of lighthouses of the United States Department of Commerce. It bids fair to give navigators for the first time means of taking accurate bearings



of invisible lighthouses and light-vessels which they may use for a leading mark in a fog. Thus radio has again demonstrated its value as a saver of life and property on the high seas. The radio compass is accurate to one and one half degrees on an average.

In the days of old when a vessel set out to cross the ocean it became isolated from the rest of the world. If a heavy sea buffeted it about and imperiled the lives of those it carried, there was nothing that could be done to insure safety. Signal torches were often lit at night, but they were effective only at comparatively short distances. To-day a radio distress signal can spread itself over the entire ocean in the twinkling of an eye. The modern ocean greyhound is in constant touch with the land it left behind and the land it is approaching. Every day a newspaper is published on board from news received by radio. The base-ball scores are picked up and posted.

In the not-far-distant future a man in mid-ocean may be called to the telephone to speak with his office or home. This is not an idle dream: it is being done every day on a non-commercial scale. It is simply a matter of making the necessary arrangement before our telephone service will be extended to the sea. How wonderful it will be to go to the telephone and ask the operator to connect us with the *Mauretania* two days out!

The distress call on the sea is made up of the letters SOS. There have been many amusing explanations of this combination of letters in circulation. They have

been said to mean "Save our ship," and in the old days the CQD in the mind of the layman meant "Come quick, danger." The fact of the matter is that these letters are not used to indicate any words. They are simply a combination of letters internationally agreed upon to represent the danger signal. When an operator on a vessel sends forth an SOS the entire ether becomes still. All transmitting is stopped to prevent possible interference. The sending operator, after sending the signal a specified number of times, sends the latitude of the vessel. The operators of ships near by then report their positions, which are in turn given to the captain of the vessel in distress. He then tells his operator to summon one or more of the ships "standing by."

No fiction is more stirring than the sea rescues in which radio has played a part. Thousands and thousands of souls have been saved from watery graves. The first great rescue that demonstrated the tremendous value of radio telegraphy on the sea was carried out in 1909 when the *Republic* received a fatal blow from the *Florida*. It was a cold, foggy night in January. The *Republic's* hull was badly smashed and she was in a sinking condition. Her wireless man, John R. Binns, immediately sent the CQD that made him famous. The radio room had been damaged by the impact and, to add to the terror, the lights went out. Binns stuck to his post, however, and coolly went on operating his transmitting and receiving outfit. A land station at Siasconset, Massachusetts, was the first to respond to Binns's appeal for help. This station in turn notified

a revenue cutter, the *Acushnet*, the *Baltic*, the *Lorraine*, and the *City of Everett*, which were all within a short distance. As a result of Binns's message, every soul on board was saved.

The story of the rescue of the passengers of the *Prinz Joachim* is equally interesting. On a thick night she grounded on the beach on a remote island of the Bahama group. Her first call was heard in the New York station of the owners of the vessel, which was atop a sky-scraper in lower Broadway. In a few minutes all of the land stations along the Atlantic coast were searching for near-by steamers. Within a very short time a vessel that happened to be passing in the vicinity was rushing to the scene. On board the *Prinz Joachim* there was none of the terror which might have spread through the ship's company before the days of radio. Every one placed his faith in the radio apparatus and its operator, and that faith was justified. William Jennings Bryan happened to be on board, and he made one of his characteristic speeches. Amid laughter and applause he suggested that they start a republic on a desert island near by and consider him a candidate for president. A few hours later the passengers were taken from the *Prinz Joachim* by another vessel and carried on their way.

On the Great Lakes freight steamers are despatched and directed like railroad trains. Vessels plying on these lakes are rarely out of direct communication with their owners. The Great Lakes, too, have been the scene of many thrilling rescues. There is one instance

on record where the president of a ship company personally directed the rescue work when one of the company's vessels was in great danger. A detailed account of the many timely rescues that have been made through the aid of radio would easily fill a book of the size of this one. At a single stroke radio has saved the lives of fifteen hundred people.

The radio cabin is usually located on the top deck in the vicinity of the funnel. It is placed in this position so that it will not be likely to be damaged in case of collision. The operators are usually men of sterling character and possessed of no little amount of technical skill. To the average passenger the radio operator is something like a magician.

To-day a person in any part of the country where a telegraph station is located can file a radiogram to a person on a transoceanic vessel. The vessel merely has to be designated. No matter what part of the sea it may be on it will be found, radio telegraphically speaking, and the message delivered to the proper person. Many people have the impression that a message of this nature is costly. This is by no means true. A charge of only a few cents a word is made.

## CHAPTER XII

### RADIO IN THE HOME

**A** SHORT time ago radio was a hobby with young men and boys who had a hankering to dabble with wires, bolts, coils, spark-gaps, and the like. To-day radio is an institution. The ether is one vast concert and lecture hall. There is a continuous program to which every citizen of the United States is privileged to listen.

Many decades ago the organ entered the home. After the organ had its day the piano came. And then the phonograph was ushered in; one dollar down and a dollar a week fashion. Although the phonograph is still with us, the moving-picture machine has taken a place by its side. The modern, up-to-date home has a radio telephone, and what a potential, entertaining device it has proved to be!

The radio telephone owes no apologies to the phonograph, nor does it bid to replace or outdo it. There is little comparison between a phonograph and a radio telephone receiver. Some day, no doubt, the radio telephone will replace the phonograph entirely. In supplying our phonographs with music we must go to a shop and buy it "canned." With our radiophone we catch it fresh. But it is not the mission of the radiophone merely to bring music to the home; this

is probably the least of its services. We cannot go to our phonograph and have it supply us with the baseball returns of the day, the weather forecasts, stock-market reports, or a speech by the mayor of our town. The radiophone is one of the most potent educational devices that have ever entered the abode of man. It marks the birth of a new era of education.

To be able to lounge in the easy-chair at home before the fireplace and pull spirit voices out of the cold wintry sky is a luxury fit for the gods. Yet it is a luxury within the reach of all. To-day a man can walk into an electrical supply shop, a department-store, or a phonograph establishment and come out with a package containing a complete radiophone. It will be already assembled so that it can be put into use immediately. There will be no hammering, sawing, or screw-driving necessary for its installation. The little box containing the apparatus can be placed on the living-room table, since it is neither unsightly nor clumsy. The works of Homer, Shakspeare, Dickens, and Maupassant have always graced the living-room tables of intelligent people, and now the great book of radio can be added. It is the most interesting of all. There is no subject that is not between its pages.

Citizens' radio, or radio in the home, is so new and so startling that the average man is confounded by it. To him radio has always been a black art, the mystery of mysteries. It is difficult for him to believe that it is now possible to bring such a wonderful in-

strument into his home and that he can operate it without first becoming steeped in the technicalities of the art. The case was well put in an article which appeared in a recent popular magazine. The writer said, "Up to the instant when I thrust a wire into the air and pulled down somebody's jazz, I thought radio was something like a fire-extinguisher or a life-boat—an emergency apparatus for a ship to use in case of accident, but of no immediate use to folks like me." Many persons who could greatly enjoy the entertainment afforded by the radiophone are in exactly this frame of mind. The thing is all so new and wonderful to them that they cannot realize its simplicity.

If a man can operate a phonograph—and who cannot operate a phonograph these days?—he can operate a wireless telephone receiving outfit. He does not need to know the difference between a crystal detector and a cream-separator. It is simply a case of turning the knob and listening to the music or news as the case may be. When he turns the knob he does not need to know what is going on inside of the box. The spring motor inside the phonograph drives the turntable, but few persons give it a thought. The fact of the matter is, they don't need to. When they break the spring or when the governor gets out of order, they can call in their repair-man and have it mended.

"If I am to buy a radiophone," asks Mr. Average Man, "who is going to be kind enough to supply me with all the speeches, music, and news that you talk about? Will I have to pay for it or is it free?" It is

certainly free, free as the air we breathe. Some of the larger manufacturers of home radiophones have gone to the great trouble and expense of installing powerful wireless telephone broadcasting stations. These stations are strategically located so that the musical and educational program that they broadcast will be available to every person having the necessary receiving instrument. Be it Hiram Jenkins of Hayville, Oklahoma, or Izzy Katz of the Bronx, he is welcome to the entertainment if he has the requisite receiving apparatus, and it does not make a bit of difference where he buys it or where it is manufactured.

At every broadcasting station there is a beautifully appointed artists' room where famous entertainers are invited to speak, sing, and play to their silent, non-applauding audiences. To-night it may be Mary Sundelius, Mabel Garrison, Heifetz, or Eddy Brown, and to-morrow we might hear Signor Fausto Cavallini or Al Jolson. To-morrow afternoon it may be Mrs. So-and-So from the domestic science department of the local high school speaking on subjects relating to cooking, and Mr. Brown may taste a new dish the same evening of which Mrs. Brown learned over the radiophone. When Mrs. Jones goes calling on Mrs. Smith now, she takes her cretonne-covered headphones along with her, so that she can plug them in on Mrs. Smith's apparatus. Then when they sit and chat or sew, as women do, they can listen to the music. Incidentally, who would dare to underestimate the value of the radio telephone as a gossiping medium?



The artists, speech-makers, or lecturers at the broadcasting station simply speak or play into a microphone or telephone transmitter. This is connected directly to a vacuum-tube wireless transmitter, which is usually located in another room. From this point the voice currents surge through the aërial, where they are flung off into space to be picked up by thousands of people. The voice of radio balks at few barriers. It sweeps over the lonely mountain hut or the tramp steamer cutting its way across the Atlantic through the darkness of the night.

How odd it would seem to lull the baby to sleep with a radio lullaby? Yet it has been done. In Schenectady, an enterprising nurse-maid had a radio receiver attached to baby's carriage so that wherever Mary went the radiophone was sure to go. It proved serviceable, and no doubt the policeman in the park thought it was a great idea.

When bedtime comes for the older children who have passed the lullaby stage, the stories from the Man in the Moon come rushing in. This is something that even Jules Verne left out of his repertoire. And what wonderful stories the Man in the Moon does tell! Nowadays the father does not have to make up a bear-story before the children go to bed, nor does the mother have to think up a fairy yarn. The Man in the Moon, kind, gentle fellow, saves them all this trouble. He knows all about the *Gingerbread Man*, the *Wizard of Oz*, the *Swiss Family Robinson*, and *Alice in Wonderland*.

Then, after the children are all huddled away under the covers, the father gives the tuning knob a few twists, and in comes the late news. It may be the result of a prize-fight in New York or it may tell of some railroad wreck or other fatality. If it is near election-time it may be a local candidate for mayor making a speech.

Every great national event is now being broadcasted. In fact, the progress of the Dempsey-Carpentier contest was sent from the ring-side. There the reporter, huddled close to the ring, spoke into the telephone transmitter that was connected to a radiophone broadcasting station some distance away. To the breathless listeners came the words, "Seven, eight, nine, ten." Carpentier was out. Jack Dempsey was still the world's champion. Those who were "listening in" at the time could hear the ring of the gong. They did not have to wait for the newspapers. The result was brought to their ears in the twinkling of an eye. The ninety thousand persons who witnessed the fight in the arena were only one third of the number that "witnessed" it by radio.

We can now go to the radiophone and obtain advice concerning our health and well-being. We can learn about vitamins, proteins, fats, and albumens. The Government is the manager of this very thoughtful service, which was opened some time ago, and Surgeon-General Cummings spoke from his office in Washington into the radiophone. This service is now broadcasted semi-weekly. In his opening address Surgeon-General

Cummings said: "It is the belief and the hope of the United States public health service that this semi-weekly message will be the means of bringing to an ever-increasing number of people simple facts of personal hygiene and sanitation and general advice concerning health habits, which will be of assistance in preventing the more common but scarcely less dangerous diseases." The resources of radio for the spreading of educational facts have scarcely been drawn upon. It is particularly pleasing that the United States public health service should be the first health service in the world to inaugurate a radio information bureau.

No less a person than Mary Garden, the director of the Chicago Opera Co., helped to inaugurate the first radio grand opera service. In the auditorium at Chicago there are placed a number of telephone transmitters. These are connected to the radio telephone broadcasting station a few blocks away, and as *Samson* paces his cell or as *Marguerite* sings, their voices can be heard in thousands of homes. In fact the clanking of *Samson's* chains and the applause of the pleased audience can be heard as well.

Many of the radio enthusiasts who listen to such stars as Lydia Lipkowska singing the "Snow Maiden" of Rimsky-Korsakoff or McCormack singing "Mother Machree" lament because they cannot keep these gems. The radiophone of the near future may accommodate them, for it may take the form of a combined reproducing device and radiophone receiver. In that event all we shall need to do will be to throw a little

switch, and the incoming music can be listened to and "canned" for future use by a simple recording device. In fact, this is entirely possible now if the radio enthusiast cares to go to the trouble of buying one of the simple home recording devices now on the market.

There is at last a way to become independent of the newspaper weather reports. The radiophone offers this opportunity and the Government is responsible for all the information received that has to do with the weather.

What man in the world does not think that he has the most accurate watch that was ever assembled? He takes a keen pride in telling people that it lost two tenths of a second in a whole month. If he had occasion to set his watch by the clock in the observatory at Washington, he would probably be keenly disappointed in the supposed hair-splitting accuracy of his timepiece. With a radio telephone he could hear the actual ticks of the nation's most accurate clock, and at the proper instant he would receive a signal that would tell him exactly what time it was.

When we go to the theater we get a program. We can also have a program of the wireless concerts. Here, for instance, is a day's program for the residents of New York and vicinity.

#### FRIDAY

- 10:00-10:15 *Résumé of the news of the day; musical selections.*
- 10:55-11:00 *Weather forecast for New York and New Jersey.*
- 11:00-11:15 *Musical program.*
- 12:00-12:15 *Résumé of the news of the day; musical selections.*

- 1:00- 1:15 Résumé of the news of the day; musical selections.  
2:00- 2:05 Musical program.  
2:05- 2:10 Marine news.  
2:10- 2:20 Musical program.  
3:00- 3:15 Résumé of the news of the day; musical selections.  
3:55- 4:00 Weather forecast for New York and New Jersey.  
4:00- 4:15 Musical program.  
5:00- 5:15 Résumé of the news of the day; musical selections.  
6:00- 6:15 Résumé of the news of the day; musical selections.  
7:00- 7:30 Man in the Moon story.  
7:30- 7:45 Very soft music in harmony with Man in the Moon story.  
7:45- 7:50 Broadcasting of suppliers of receiving equipment.  
7:55- 8:03 Tuning for regular evening program.  
8:05- 9:15 General news; résumé of foot-ball games; music and artists.  
9:55-10:00 Arlington time.  
10:03-10:06 Weather forecast for New York and New Jersey.  
10:06-10:07 WJZ. Good night.

Radio is dangerous in that it may make us lazy. We are very apt in taking advantage of new conveniences. Street-cars make us lazy, automobiles make us lazy, and the telephone makes us still lazier, but what should we do without them? The fact of the matter is that they may make a lazy man more lazy, but at the same time they allow the ambitious citizen to accomplish more work. The radiophone even allows us to "go to church" on Sunday at home. We can sit at home on a rainy Sunday morning and listen to the minister or priest with the greatest facility. The idea is by no means far-fetched. It is in actual practice. The radio parson is here to stay; at the present writing there are a number of them. Dr. C. B. Wells

of Wichita, Kansas, was one of the first men to use this unique method of disseminating the word of God. Every Sunday he conducts several services by wireless, which are heard by hundreds of people in the vicinity. The radio amateurs thereabouts call him the first and original "sky pilot," and this is literally true. The radio church enjoys advantages that the conventional church does not have. A man who had not gone to church in ten years tuned in one of Dr. Wells's sermons, and he was caught unawares. The sermon was entitled "Love One Another." Here is the letter that Dr. Wells's sermon elicited from this accidental member of his congregation:

Dear Sir:

I was listening in to-night and working a number of hams<sup>1</sup> when I heard for the first time your Q. S. T. I tuned the old receiver in until you were very Q. S. A. and copied your sermon. Say, O. M., that's the first sermon I have listened to for ten years. I am station agent here for the —— Railroad, and four years ago I acquired the radio bug, put up an aërial, and constructed a receiver. Sure enough, I soon got the wireless fever in real shape, sat up nights until long after midnight. For some time everything went O. K., but after a while the late hours became an old story to Friend Wife and she accused me of neglecting her and the baby. Well, maybe I did. So I laid off for a while, but alas I could not keep away from the old set. Well, O. M., the story is a long one, and to cut it short, the wife and baby left me. They now live with her mother over on the other side of the town. Yes, I guess I love them all right, but I sure love to hear the old "sigs" come in. I am wondering to-night what I am made of. Your sermon, O. M., sure did bore a hole in me. I will listen in for your sermon next Sunday.

<sup>1</sup> Radio amateurs are known as "bugs" and "hams."

Some time later there was another sermon on the subject, "And a Little Child Shall Lead Them." It brought forth the following letter from the man with the domestic troubles:

My dear Radio Preacher:

Last night I listened in as usual and copied your sermon, which was very Q. S. A. That was sure some sermon. Never before thought I would have any use for preachers, but I have changed my mind. Your sermon reached the right spot in my heart if I have one. Say, O. M., I must confess when I finished copying your Q. S. T. I was a mess. I bawled like a kid. Well, I'll tell you, I threw the old receiver on the table and beat it for the Methodist Church a couple of blocks away. The preacher had just started his sermon, and strange to say, his subject was "Home, the Sweetest Place on Earth." I tell you, O. M., I just swallowed that sermon whole, and after the service I went down in front and took the old preacher aside and told him my story. Well, we talked it over and then we went over to my mother-in-law's house. My wife had not gone to bed yet. We had a little prayer together, and to-day we are all back in our little home again, the three happiest kids you ever saw. And, best of all, radio did it. Well, I guess you have had enough of this so  
Good-by.

The Rev. H. A. Van Winkle, pastor of the First Christian Church of Oakland, California, is another Christian radio enthusiast who believes strongly in the radiophone. Standing on the top of an Oakland building he delivers his Sunday morning sermons' to thirty-two congregations in the State of California, each congregation being provided with a radiophone receiver and loud speaker. Incidentally about one thousand radio enthusiasts who customarily spent their Sundays tinkering with their apparatus were forced

to spend an hour "at church." They listen to the church quartet, organ, and all.

We have in this country to-day what is known as the First Radio Church of America. Its pastor is Dr. Richard Jayward, well-known lecturer. It is non-sectarian, and any one can "attend" who has a radio receiver. This very same church is doing an excellent humanitarian work by making arrangements with various hospitals so that the bedridden patients may enjoy the inspirational words that are sent out.

Now that we have had a glimpse into the world of radio, let us devote a few minutes to the question of installation. As has been said before, a man may go into a supply store and come out with a complete radio receiver in a single package. It may be a simple one costing from fifteen to twenty-five dollars, or it may be a more elaborate apparatus costing from forty to two hundred and fifty dollars. At any rate, the package, no matter what may be the cost of the apparatus it contains, has wrapped up in it a liberal portion of wholesome fun, entertainment, and education.

It is the general belief of the layman that a large number of unsightly outside wires are necessary for the complete success of a radiophone. The fact of the matter is that an outside aerial is not at all necessary if a radio broadcasting station is within a reasonable distance. If it is in the same town and there are no high steel buildings, the aerial can be strung in the attic like a clothes-line. In fact, there is no objection to its serving a dual purpose. The directions given



with the radiophone receiver tell us that we should suspend it on insulators or non-conductors so that it will not make electrical contact with other objects. A lead wire is carried down to the "radio box," and another ground wire is run to the steam radiator or water-pipe, which is scraped to insure a good electrical contact. With this, the installation is complete. It only remains, then, to adjust the little detector and turn the tuning knob. The head receivers are placed over the ears, and the tuning knob is turned until the music reaches its maximum loudness. Then we know that we are in tune; the wave-length of our receiver is regulated to match the wave-length of the sending station.

If an outside aerial is constructed, high poles are not necessary, since a single wire can be run from the top of the house to a tree, or it can be arranged under the wainscoting.

Not a few persons think that the installation of a wireless receiver makes it necessary for them to learn the language of dots and dashes. Nothing could be further from the truth. Listening over the radiophone is like listening over the telephone. Many novices like to learn the code "just for the fun of it," so that they can listen in on some of the regular commercial messages. Indeed, the learning of the code is a fascinating study that is certain to reward an enthusiast with no small amount of pleasure.

"Do I need a license to operate a radio telephone receiving station?" is a question frequently asked by

those interested. Licenses are not required for receiving purposes. It is only necessary to have a license for transmitting purposes, and few people outside of the dyed-in-the-wool "hams" wish to transmit. If a radio receiving station is used it is not even necessary to register it. There are no restrictions whatever placed upon the reception of messages at any time from any place, except in time of war.

The low-priced radio telephone receiving outfits must be used with a head-set. In some cases, where a powerful transmitting station is near by, two or three head-sets can be plugged in on the same apparatus so that several persons can listen. It is desirable to emphasize at this point the importance of buying radio apparatus equipped with good head-sets. A radio telephone receiving apparatus, no matter how costly or how cheap it is, is no better than the headphones used with it. It is the head-phone that converts the weak currents into audible signals, and if they are inefficient much of the necessary strength will be lost.

"How can I make this music available to the whole family and eliminate the use of the head-set?" it is asked. This is no problem at all: he can go to an electrical shop and get a better outfit—one provided with vacuum tubes which will amplify the incoming impulses. Then he can hook a loud speaker up to his outfit, and the music can be heard by the whole household. When "The Livery-stable Blues" come pouring in, those who wish to do so can dance to its strains. Dancing to radio music is quite commonplace these days.

On the New Year's eve of 1922, those in the vicinity of New York who had radio receivers heard the old year pass out and the new year come in by radio. A turn of the knob brought in the sweet sound of chimes from the still ether. This may mark the beginning of a noiseless New Year eve. We do not mean noiseless in every sense of the word; we simply mean that the noise will be taken out of the air and put into the ether.

The possibilities of radio broadcasting are so alluring that the authors feel inclined to be cautious regarding its future. Although their enthusiasm runs at high pitch they feel that they could very easily underestimate the far-reaching nature of future developments. Who, ten years ago, dared to predict the broadcasting that we have to-day? What man to-day dares to predict what will happen in the future? That radio broadcasting will allow a single man's voice to be heard by every person in the United States does not admit of doubt. The next Presidential inauguration address will be heard by every one who owns a radio telephone receiver. The next President will speak into a number of telephone transmitters. These transmitters will form parts of telephone circuits that will lead to various broadcasting stations throughout the country. The words spoken will probably be carried to ten or fifteen broadcasting stations. In this way the entire country will be covered. Any celebrity, no matter what part of the country he may be in, will be able to talk to the country at large if there is a telephone line near him. He will not have to be at a radio broadcasting station. The telephone system of

the country can carry his voice to as many broadcasting stations as are necessary. Nothing will be out of the reach of radio.

In the future we may sit in our homes and listen to the proceedings of some trial of national importance. When radio enters the court-room, justice will have to be more cautious in the course it takes, since there may be hundreds of thousands of listeners. And why should not the House of Representatives and the Senate have a radio broadcasting station so that the people of the country could listen in on the discussion of the business affairs of the nation? We should probably have less quibbling and more action if this should be brought about. If a politician knew that his constituents were listening to his very words he would feel more inclined to carry out his campaign promises.

This is the story of wireless telephony in the home. The authors regret that they cannot get the thrill of radio into these pages. Paper and ink are poor mediums to use in describing the enthralling experiences that come to those who possess radio telephone receivers. Reaching out into the vast depths of space to gather in intelligence that can be listened to at the fireside is a pleasure of the rarest variety. What it means to the future of home life it is difficult to foresee. Radio must take its place as a home builder, and it will no doubt strengthen the home as an institution. Why should n't it? It is able to bring into the home entertainment that has heretofore had to be sought outside.

## CHAPTER XIII

### RADIO ON THE FARM

**W**E can picture in our mind's eye a cozy little farmhouse nestled between the snow-covered hills of northern Wisconsin. The smoke from its fireplace is rising lazily into the wintry night, and the ruddy glow in its windows tells of the cheeriness within. In days gone by this little home and its occupants were entirely isolated from the busy centers of the country. Now the farmer and his family can sit and listen to the grand opera in Chicago or to the late news that would otherwise take two days to reach them. The market and weather reports come humming to their ears. The invisible link of radio brings the whole world to their fireside.

The day of the "rube" is past. Fifty years ago farmers were still farmers with long whiskers, hay-seed in their hair, and all that. They could n't be anything else, since they were entirely out of touch with the thickly populated centers of the country. For that matter, the small towns and villages were populated by "rubes" for the same reason. Then the telegraph, the telephone, the newspaper, the magazine, the phonograph, the automobile, the moving-picture, and the mail-order catalogue came. As a result of all these things, the farmer became a well-informed man.

He was no longer called upon to remain out of touch with the affairs of the world. To-day there is no small town. The people of Fulton, New York, or Hicksville, Illinois, are almost as up-to-date and modern as the people in New York or Chicago.

The radiophone will establish a still stronger link between the cities and the rural districts. A man with a radiophone receiver in Philadelphia has no advantage whatever over another man with a receiver in the farming districts of Pennsylvania or New Jersey. Radio reaches them both at the same time. It has no favorites. It is just as faithful to one as the other. The great broadcasting stations in operation were by no means put up simply to amuse and educate the city people. The radiophone will allow the farmer to keep up to the minute on the vital questions of politics, economics, and general news. In fact, a farmer with a radiophone will have a distinct advantage over the city man who does not have one. The farmer will be able to receive his late news reports at 9:30 o'clock, while the city man will be forced to wait for the morning paper.

The farmer was not mentioned in the chapter entitled "Radio In The Home" for the good reason that radio really means more to him than to the city man. It is not only a part of his entertainment and education but a part of his business as well. Every farmer is a business man. He has to be. He not only tills the soil, but he must develop and use his business sense in disposing of his produce. With market prices changing

rapidly the farmer in the past has always been kept at his wits' end to know when to sell. Often he would lose no small amount by selling a day or two sooner than he should, and in some cases he would lose by selling too late. It was not his fault. He simply had to gamble. The market information of the United States Department of Agriculture constantly preached to the farmer, "Know your markets." Since its organization, the bureau of markets has unremittingly endeavored to make it possible for farmers and shippers of farm products to know their markets even as men in other businesses know theirs. Various methods have been developed and applied so that organized farmers who grow and ship in large quantities have been able to keep themselves fully informed during the shipping seasons of conditions in competing areas and on the large markets of the country.

The bureau of markets, in trying to keep the farmer informed, found itself face to face with a difficult problem. Through the medium of the telegraph, the telephone, and the rural newspaper it did its very best in establishing a service. When radio reached the point where it could be applied practically, the bureau of markets was quick to realize its possibilities and at once pressed this powerful disseminator of news into service.

To-day the radiophone is the farmer's stock-ticker. It should be just as important to him as the stock-tickers are to a broker in his Wall Street office. The bureau of markets now has in operation a radio market

news service that covers a band of territory from six hundred to eight hundred miles wide, extending from the Atlantic to the Pacific coast. Radio stations at Washington, St. Louis, Omaha, Cincinnati, North Platte, Nebraska; Rock Springs, Wyoming; and Elko, Nevada, which are owned and operated by the Post-office Department in connection with its aërial mail service, are also used by the bureau of markets in sending out the market-grams. The market news in the West relates largely to live stock, wheat, and corn, while the news of the East relates more to fruit and vegetables, although every item that is of interest to the farmer is broadcasted. Grain quotations are being sent from Omaha, St. Louis, and Washington.

The benefit derived from the radio market news service depends upon the use the farmers of the country make of it. The reports are literally in the air and just as free as the air, and it is the business of the farmers to pull them down and make use of them. The Department of Agriculture has gone to a great deal of trouble and expense in making this news available to the farmer through radio, and it is nobody's fault but his own if he continues to lose money on the sale of his wares through ignorance of market conditions.

The Missouri State board of agriculture has been very active in extending radiophone service to the farmers of that State. The market news received by the State market bureau off a leased wire of the United States bureau of markets is broadcasted at Jefferson City. The board of agriculture is also doing



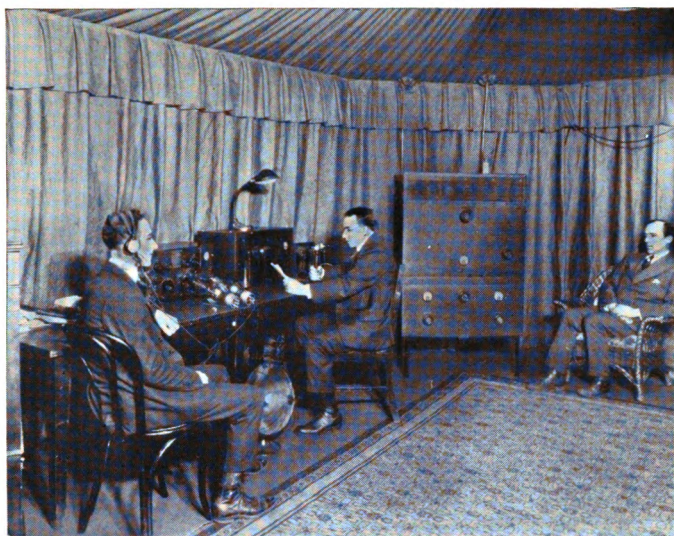

**Interior of a broadcasting station**



**Farmer listening in for market reports**



important missionary work among the farmers in educating them not only to the value of the radiophone but also to its operation and use. To make it possible for the farmers to realize the maximum value from the State radio service the established radio amateurs have been organized, and in each locality there is an amateur to receive and copy the news. This, however, is not as satisfactory as direct communication with the farmer himself.

It will take the farmer some time to become familiar with this new idea. It took some time for him to learn to twist the magneto crank on the telephone, and it will no doubt take him some time to learn to twist the tuning knob on the radio receiver. In general, it can be said that the farmer is taking advantage of the radiophone more rapidly than he took advantage of the wire telephone. This is easy to understand, since the wire telephone was the first scientific instrument to enter the abode of the farmer. The radiophone will be the second, and the second is always accepted with less hesitation than the first.

The farmer does not have to operate this "new-fangled thing" in every instance. If there are boys or girls in the family in their teens they can learn to operate the device in a surprisingly short time.

When the farmer installs a radiophone receiver he can obtain from the Department of Agriculture pads of printed forms which will greatly facilitate the work of receiving.

At 12:15 P.M. hears "QST, QST, QST," which means

"All listen." This is followed by "9 XM, 9 XM, 9 XM." This is followed by the signal "AD." These same letters in parentheses on the first line of the printed form show the farmer that his pencil is in the right place, and that he is about to receive the live stock market report for "CHGO," meaning Chicago. The next signal may be "AC." Reference to the printed form tells him that this means "Hogs, estimated receipts for to-day." Next may come "AF." This refers to the state of the market. A typical comment may be, "Fairly active, ten to twenty-five higher. Packing and mixed hogs up most. Pigs steady."

Then follows: "HG [meaning top] \$8.25; AH [meaning bulk of sales] \$7.25 to \$8.25; AK [meaning heavy weight 250 pounds up; medium, good, and choice] \$7.60 to \$8.20." Before a quarter of an hour has passed the farmer has his whole report, and he has it several hours ahead of the city man who waits for the newspaper. He can also keep ahead of the buyer who comes around to purchase his product.

Since spoken letters are apt to be misunderstood because of similarity of sound, the operator instead of saying "A" says "able." In place of "B" he says "boy" and so on. If he uses the letters "BD," meaning "good choice and prime beef steers," he says, "boy dog."

As a practical illustration of this market service, a case of a New York State farmer can be cited. He was about to make a shipment of potatoes. His son had installed a radiophone receiver and it was his

practice to receive the daily reports. He noted a change in market conditions and advised his father. As a result of this change the sale of the potatoes was held up for a few days and a considerable sum of money was saved by waiting for more favorable conditions.

With the farmers the weather is a favorite topic. The subject brings to mind these familiar lines:

“Well, Duncombe, how will be the weather?”  
“Sir, it looks cloudy altogether,  
And coming across our Houghton Green,  
I stopped and talked with old Frank Beane.  
While we stood there, sir, old Jan Swain  
Went by and said he knowed 't would rain;  
The next that came was Master Hunt,  
And he declared he knew it would n't.  
And then I met with Farmer Blow;  
He plainly said he did n't know—  
So, sir, when doctors disagree,  
Who 's to decide it, you or me?”

Weather is a very important matter with the farmer. An extra inch or so of rainfall at the proper time may add thousands of bushels to the harvest, or a few degrees higher temperature may bring to the potato grower a lot of extra money. As an expert of the weather bureau says:

The way the wind blows is sometimes more important than the cost of farm labor. Crop yields are controlled by the amount of sunshine, rainfall, and heat received, and all farm operations are fostered or hindered by the prevailing weather.

The weather is a source of anxiety, from the time of the preparation of the soil for seed until the last harvest is gathered. And

even then the producer's worry is not over because the weather may hinder the movement of his wagon or truck to the freight station.

Every morning and evening at eight o'clock two hundred weather stations in the United States are busy making observations of the wind, air pressure, temperature, clouds, humidity, and rainfall during the preceding twelve hours. Within five minutes' time after these observations are completed, a telegraph message in code giving the essential weather facts for each of the two hundred localities is filed at the local telegraph office. By the use of an ingenious circuit system these reports are transmitted to the central office at Washington and to about 180 other important weather bureau offices in various parts of the country.

These reports are as accurate as it is humanly possible to make them. "Did the weather man hit it right to-day?" is a familiar question. Some days he goes wide of the mark, to be sure, but we can forgive him for these occasional mistakes when we learn his forecasts are 88.4 per cent. accurate. No big storms have occurred along the coast and Great Lakes without warnings twelve to twenty-four hours in advance.

The farmer with a radiophone outfit has the added advantage of learning the weather forecasts for his particular district almost as quickly as they are formulated. "Of what great value are weather reports to a farmer?" you ask. There are many operations on the farm that depend upon impending weather conditions. "How are the roads to market to-day, muddy, snow-filled,

frozen, or good?" "Is the temperature down the line safe for shipping produce to-day?" "Will next week be good haying weather?" "Will the orchard heaters be needed to-night?" "How high is the river to-day?" "Will it be safe to spray to-morrow?" "I want to cut my seed crop to-morrow; how about it, Mr. Weather Man?" These are only a few of the questions that the weather man is called upon to answer. If he can answer these by radiophone his answers will do maximum good, since radio eliminates delays.

The sugar plantations of Cuba have found an important use for radio. These plantations are very large, and the radiophone is able to do many things for the plantation owner that cannot be done by the wire telephone. The plantations have, in some instances, very odd zigzagging boundary lines. One owner's property may, in effect, be a large peninsula into the adjacent property. The severe competition between various plantation owners makes it highly speculative for one owner to extend his telephone wires over the property of another owner. If he zigzags his lines to follow his boundary, the amount of wire and the number of poles necessary are greatly increased. In most instances the increased costs make an installation prohibitive in price.

The sugar plantation owners have applied radio telephony to their problems with great success. Small outfits ranging in power from fifty to one hundred watts have been sufficient to meet their needs for reliable communication. Before the radio telephone, much

time was wasted by the tugs that towed the cane-laden barges simply because the owner could not communicate with the tug pilot. It was necessary to use a fast launch to overtake the tug and deliver the orders. The radiophone is now used to deliver such messages.

Hiram used to be called from the field to dinner with the old cow-bell. It is said that a Florida farmer now uses the radiophone. He carries a small receiver with him to the fields. At twelve o'clock he goes to the radiophone, and his wife tells him at what time he may expect dinner.

Science placed a wonderful instrument in the hands of the farmer when it gave him the radiophone. He will be able to profit by it as few people can. Radio is the last step in making a city of the country.



## CHAPTER XIV

### RADIO IN THE NATION'S BUSINESS

**B**USINESS is quick to adapt new developments to its needs. To overestimate the value of the telegraph and telephone as business aids would be difficult. Likewise it is now difficult to appreciate fully what radio will mean to business in the future. Radio is a versatile art; it appears in unexpected places. First it is bringing the heart-beats of a patient to a doctor's ears over miles of space, and then it is carrying on its phantom wings a photograph across the Atlantic Ocean.

This chapter will be devoted to the application of radio to business within the nation. The chapter on "World-wide Radio" described the application of radio to international business. The national aspect of the subject is interesting, to say the least. Radio is so universally applicable and so inexpensive in its maintenance and operation that the owner of a corner fruit-market can take advantage of it as well as a fifty-million-dollar corporation.

Big business has long since found a use for radio. A number of years ago several large companies with factories in various parts of the country found it advisable to install radio stations. They provided a safe and rapid means of communication which continued in

service in bold defiance of all weather conditions. Radio telephony is more rapid than correspondence and less expensive than wire telephony over long distances. If two plants were located only twenty-five or thirty miles apart it might be advisable to install a private telephone wire or to lease a wire from the local company, but when distances much beyond this are to be covered the advantage is with radio, since the cost of maintenance of a telephone line would be greater than the cost of a radio telegraph or telephone system.

Inter-plant radio is in its babyhood. Within the next three or four years we can safely expect very remarkable developments along this line, which will probably help to bring that much-longed-for day when the president of any large company can sit in his New York office and constantly direct by word of mouth his various factories in different parts of the country.

Who would expect to find radio in use in the New York Consolidated Stock Exchange? And yet it is there and there to stay. And what a wonderful place this is for radio to receive its business training! Before the exchange was "radioized," it was necessary for an employee to use a megaphone to relay transactions from tickers to the chalkers in order to place them on the board. Although this operation is as rapid as it is humanly possible to make it, there are times when reports of transactions do not appear on the boards for a few minutes, and during this lapse of time large sums may be lost.





Using radio in a German brokerage office



One of the radio stations of the New York police department

The chalker, equipped with his portable radio outfit, makes a curious-looking spectacle. The aërial wires are strapped over his shoulders in two small loops, and these are connected to a little transformer and sensitive ear-phones. The aërial follows the balcony from end to end. The chalker has no tuning or fussing to do with the apparatus. It responds instantly to any voice impulses that come over the concealed aërial.

Those of us who have visited the Consolidated Stock Exchange know that all transactions made in the institution are sent forth by a single operator in the center of the floor. It is physically impossible for him to despatch information any faster than he can punch the key of the automatic transmitter which he operates. When business is brisk and transactions are rapidly made, the results reach him faster than he is able to handle them. The loss of a few minutes time on his part may wreck a man or cause a suicide. The spoken word is instantaneous in its effect, and the chalkers, through the use of the radiophone, receive their directions on the spur of the moment.

That radio will some day replace the stock ticker, there can be no possible doubt. The German Government, alive to the importance of radio telephony, has built and distributed 1500 standardized receiving outfits which have been placed in various banks and business houses throughout the republic. These receiving sets are more than stock-tickers; they can do things that the stock-ticker cannot do. Every important market report received from America can be broadcasted throughout

Germany in a very short time. The great value of this service cannot be denied.

Our own banks, strange to say, have not taken advantage of radio as they should. A few of them have been alert to its possibilities, and several have installed radio telephone and telegraph service in their various branches. Some day in the near future, perhaps, our larger financial institutions will decide to avail themselves of the many opportunities offered by this thoroughly practical means of communication.

How beautifully radio can assist a phonograph shop to sell records! A number of alert dealers have installed small radiophone transmitters, and every day they play the latest hits and selections so that the countryside may listen. After their broadcasting they receive telephone and mail orders for certain of the records they play. This is an intensely practical way of doing business by radio, since it saves the customer a trip to the store. Why go to the store when the music can be brought to the home? A post-card or telephone call will bring any record parcel-post C.O.D. The person owning a radiophone receiver can call up the dealer and ask him to play certain records that have been selected from the catalogue. The dealer not only enjoys a very convenient method of doing business but also obtains considerable advertising. Shopping by radiophone has its advantages.

During the latter part of 1921, when the business tide was at low ebb in this country, Roger W. Babson, America's famous business statistician, spoke to 35,000

persons through the ether. His talk was very practical, and it contained many hints that any business man would have been glad to hear. "When Shall We Return to Prosperity?" was Babson's topic, and his speech was historic in that it was the first practical business address to be broadcasted by radio. The incident was revolutionary and it opened up an entirely new field of activity. Some day every chamber of commerce and Rotary Club in the country will be able to listen to the speech of a single man "somewhere in the United States."

Many large contractors in the West have put their faith in radio. During the past, when engineers and workmen struck out into the wilderness to erect a new power station on some mountain stream or an irrigation dam to feed the water-starved soil of the Western plains, they were entirely cut off from the home office. The erection of a temporary telephone line was not only inadvisable but impossible. It has been found that radio meets every need, and now the officials of these companies can have placed on their desks each day a report of the progress made.

The Southern California Edison Co., in extending its system of generating plants in the Big Creek and San Joaquin River districts, found it necessary to maintain reliable communication between Cascada, the construction headquarters at the end of the railroad, and two other points farther back in the mountains. The natural obstacles between these two places and the headquarters were such as to make telephone engineers

emphatic in their belief that the task of establishing wire communication was quite beyond them. Radio telephony was resorted to and was used with great success.

Shippers in the United States lose more than \$100,000,000 worth of merchandise annually through thieving, misdirecting, and careless handling. A radio system to reduce this great loss has been established by a New York clearing-house company. With radio stations in thirty-five American cities, this clearing-house will have at its disposal a potent instrumentality for tracing goods that have gone astray in transit on the railways. Radio appears here as a money saver and an efficiency maker. There appears to be no end to its business possibilities.

In considering radio as an aid to business, it is well to review the subject of inter-city communication. If corporations can find use for radio there is no reason why it cannot be used to carry on the business between city governments. Already New York, Cleveland, Detroit, and Chicago have established an inter-city radio system, and many other cities will have them as quickly as politicians can be convinced of their value. The mayor of one town can exchange ideas with the mayors of other towns, and the various city departments can cooperate in a way that has heretofore been impracticable.

Police departments have been able to do very effective work in tracing thieves and criminals by means of the ether. The New York police radio



station has begun broadcasting the descriptions and numbers of stolen automobiles. These broadcasts are sent at 7:30 and 11:30 each evening, and arrangements have been made with a number of amateurs in several surrounding cities to copy the descriptions and information for their local police. Already this system has proved its value in apprehending automobile thieves operating in the metropolitan districts. A thief may be cunning and he may move fast, but radio can match his cunning; and as for speed—!

The Chicago police department, not to be outdone by the New York police, has installed radio stations in several police automobiles used by the rifle squad for capturing automobile bandits and murderers. The automobiles, although traveling at forty miles an hour, do not interfere with the transmission and reception of messages to and from the police headquarters at City Hall. Thus radio is a powerful weapon to curb crime.

If police departments can use radio, why cannot fire departments press it into service? The fire chief of Trenton, New Jersey, has a transmitting and receiving outfit in his car. By the use of a twin outfit in the fire department headquarters, he is able to send directions back while he is at large conflagrations or on his way to them. Although he is physically in one place, he is mentally in two. Radio allows him to add to his efficiency. The fire chiefs of other cities have been quick to see the possibilities of radio, and many similar outfits have been installed.

In connection with the use of radio by fire departments, there is an interesting story told about the New York police-boat *John F. Hylan*. The *John F. Hylan* was cruising past East Sixtieth Street when her radio operator saw a blaze near the river. He immediately called the sergeant in charge of the radio station at police headquarters, who at once notified the fire department. Within a very few minutes two trucks, three engines, two fire-boats, and two battalion chiefs were on their way to the fire.

Uncle Sam finds use for radio in more than one way in his many-sided business. Radio is a great help in fighting forest fires. Fires originating in our national forests exact a toll ranging from \$25,000,000 to \$40,000,000 annually. Statistics in possession of the United States forest service indicate a direct relation between the despatch of a fire-fighting crew to the scene of the blaze and its resultant levy on woodland resources. Once a fire is discovered, the information must be speedily communicated to the suppression forces. The forest service has many fire stations, and these are now being provided with radio for rapid communication. Experiments have been made with aëroplane patrols equipped with radio, so that a fire can be located and the news flashed back to a station in the shortest possible time. If radio can cut several million dollars off our losses from forest fires, it can certainly be considered a valuable achievement.

An enterprising vaudeville circuit of New York has decided that radio can be of great assistance to it in

establishing communication with its theaters throughout the country. The general manager sitting in his New York office will be able to hear the actual performance as well as to receive daily reports by word of mouth from the theater managers. Here again the radiophone stands ahead of the wire telephone. Such a plan would be possible with the wire telephone, but many things that are possible are not feasible. The cost of leasing land wires for a purpose similar to the one just outlined would be prohibitive. With radio it is quite different. The cost is reasonable and the result positive. Radio has long since passed beyond the experimental stage. A business house can install radiophone apparatus knowing beforehand just what it may expect in the way of service.

Radio is a natural aid to the hotel business. A surprising number of hostelries in America have established radio stations as a convenience to their guests. The passengers on a steamer two days out of New York can reserve a room by radio, and guests in the hotel have the privilege of using the apparatus in their social and business affairs. One hotel in Atlantic City holds a radio concert every evening for its patrons.

It is now proposed to equip taxicabs with small receivers and to despatch messages to them by radiophone. Each cab would have a definite call, and with this system a central despatching office could direct cabs to pick up passengers at various points. Here again radio is able to fill a need that is beyond the wire

telephone. It would seem that at present, at least, the radiophone is not replacing the wire telephone, but is simply doing things that the wire telephone cannot do.

The possibilities of radio as an advertising medium have not yet been dreamed of. Advertising on the printed page cannot be compared with the value of advertising delivered by the human voice. The still voice of type is no rival for the living voice that can be transmitted by radio. An advertiser using radio could have an audience that would make the circulation of some of our largest magazines seem small. In the not far distant future it will be possible for a single man to talk to the entire country. Let us assume that there are fifteen broadcasting stations distributed in such a way that their waves will cover the entire country. Through the use of existing telephone lines the transmitting apparatus in these various broadcasting stations can be connected to a single telephone instrument in a home, office, or auditorium in any city of the United States, or in Canada, for that matter. Thus, a man speaking into this instrument would have his voice carried to the fifteen stations by wire, and from these points it would be flung out into the ether, where it could be heard by millions of people.

The purely business side of radio is alluring, to say the least. Its many ramifications cannot be covered in this popular treatment. We have read enough about its present applications and future possibilities, however, to know that radio will some day be as valu-

able an asset to business as the telephone and telegraph are at present.

Within a very short time a business man will be able to call his office from a moving train. A great number of experiments have been made with radio telephony from railroad coaches, and the results have been very encouraging. The following is taken from a report made by David W. Richardson, concerning a radio-phone test from a coach of the Lackawanna Limited, which runs between Jersey City and Buffalo:

All those who are interested in radio remember back before the war in 1914 when the Lackawanna Railroad instituted the world's first wireless communication from a moving train to stations located in the principal cities along the route. Considerable success was achieved with the apparatus then available, but the war came along and further development ceased for the time being.

It was not until March 22, 1922, that tests were again started with better equipment and the advantage of recent developments in receiving apparatus. The first test made was with a temporary one-wire antenna on a single car, on a short run out to Morristown, New Jersey. On this run, using regenerative circuit, a detector and a two-step amplifier, amateurs along the way were copied, and WJZ at Newark, New Jersey, was received with considerable strength at a distance of about twenty-five miles.

Two days later another temporary antenna was installed on two seventy-foot cars lying in the yards at Hoboken. A fifteen-watt radiophone transmitter was tested, and with better receiving apparatus we were heard nine miles out from the Hoboken yard. The receiving results were remarkable. Many stations were copied.

Among those which came in best were 3 AHN, readable some fifty feet from the loud speaker, 1 ARY, readable all over the car, 9 ZL on CW, readable seventy feet from the loud speaker, 9 XI on CW, readable at forty feet, and 5 EA. In fact, every district except the sixth and seventh was heard from some time during the evening. This proved conclusively that reception was possi-

ble even with a low antenna, only six inches above the top of the cars.

A test on Sunday, March 26, gave, however, still more gratifying results. A buffet-car was equipped with three 4½-inch six-wire cages, one on each side and one in the center. The same fifteen-watt 'phone set was installed and a detector two-step amplifier, in conjunction with a regenerative set, was used. This car was placed in the Lackawanna Limited, leaving Hoboken at 10:20 A. M.

Underneath the iron superstructure of the terminal, a few local amateurs were picked up, and one or two radiophones, readable on the loud speaker. After leaving the terminal there was a great increase in signals, and as the Bergen tunnel in Jersey City was approached, many local amateurs were picked up. Inside the Bergen tunnel, which is 4283 feet long and ninety feet underground, one or two CW stations and several ships were heard distinctly. Upon emerging from the tunnel, signal strength increased with a "bang." Going through Newark and the Oranges, various tests on the transmitting set were conducted and no effort was made to receive. Upon reaching Stroudsburg, Pennsylvania, a telegram waited there informing us that the 'phone messages had been received several times along the route. From Stroudsburg, climbing up the Pocono Mountains, tests on the receiving set were made, with no special results. Local amateurs, ships, and 600-meter stations were copied. Various tests and changes were made in the transmitter, and, upon reaching Elmhurst Dam, all apparatus seemed to be in good working condition, namely, the receiving set had been protected from the jarring of the train, an amplifier tube which had a loose element in it was replaced, and the transmitting set radiated 7/10 amperes into the antenna.

One or two long calls on CW were given, followed by calls by voice. When about ten miles from Scranton, following a long call on voice, 8 ARI, on 197 meters was clearly heard calling by voice, "Hello, DL; hello, DL; hello, Lackawanna Limited. I am receiving your voice very clearly. Please come in and give your location." The Lackawanna Limited was then coming down the mountains at about sixty-five miles an hour, through ravines and cuts and through tunnels. There were hills on all sides, and one

## RADIO IN THE NATION'S BUSINESS 263

would suppose it to be a most inauspicious radio location. Communication was then established with 8 ARI and conversation was kept up until the Limited had arrived in Scranton. The signal strength of 8 ARI in Scranton was such that many people gathered in the special car could hear everything said. It is to be remembered that only a one-car antenna was being used during this test.

While in Scranton, 8 RH and 8 BUW were both worked, and, upon leaving Scranton, bound for New York, a message was sent to "The Scranton Times" from Mr. Foley, superintendent of telegraph and wireless of the Lackawanna Railroad, via 8 BUW. It was interesting to note that when 8 BUW was repeating the message for verification, the limited passed through a tunnel and the effect in this particular tunnel was hardly noticeable, although it must have been several hundred feet long. Steady two-way 'phone conversation was carried on until about twelve miles out, when, going around a mountain, 8 BUW was completely lost and was not picked up until the train had ascended to a large lake. Going along this lake there was a marked increase in signals, and the following stations were listed: 8 ADQ, 8 BUW, and 8 AOE. From then on the log of the trip was as follows:

TIME	STATION	REMARKS
5:15	2 BRB	Just readable
5:20	1 RX	QRK
5:25	2 BK	QSA, had been hearing him before but did not get call
5:35	1 RX (again)	QSA

(We were now going about sixty miles per hour and were in the Poconos, some thirty or forty miles from Scranton.)

5:37	WJZ	Faint
5:38	1 YZ (?)	Very faint
5:45	1 ARY	Loudest station so far
5:46	3 MT (?)	Very faint
5:47	2 BM	QRK
5:48	2 BY (?)	Not sure
6:00	1 RX	Very QSA

(Now passing over plain, and signal strength much stronger.)

## 264 THE COMPLETE RADIO BOOK

TIME	STATION	REMARKS
6:15	1 CNI	QRK
6:20	1 BQL	QRK
6:40	1 GM	Very QSA
7:05	2 AHU	QSA
7:10	1 ADL (CW)	Very QSA
(6:50	2 ACY	QSA near Blairstown, New Jersey.)

Telegrams were received at Stroudsburg that our voice had been heard for twenty miles out from Scranton, and that our position report had been received by CW while passing Elmhurst Dam, ten miles away.

We were now down near Mountain View, New Jersey. WJZ very QSA; can be heard all over the car from the Phonetron. 2 LE (?) or 2 LA concert in Jersey City very QSA too. Long-distance completely blotted out by interference from local amateurs, and 2 FP was so loud that he could be copied in the next car.

WJZ was then carried all the way into Hoboken, for the benefit of those who liked to listen to the music. One of the passengers wished to speak to his wife at Lyndhurst, New Jersey, who, he said, was listening on his radio set to the WJZ concert, and so DL was tuned to 360 meters and the passenger broadcasted his message in the hope his wife, who was within a mile from the railroad, would pick it up. He has not informed us whether she did or not.

In the way of an experiment, perhaps the most interesting data gathered was that of the effect of location on signals. Nearly all previous theories seemed to be confirmed, except that of immediate proximity of rock, steel bridges, and bodies of earth. Very little difference could be noted whether the railroad ran through a steep cut, thirty or forty feet deep, or was on the level. Whenever the train went through a thickly wooded piece of land, where the trees were high, all long-distance signals faded out entirely. The nearness of a body of water or a stream, even though small, seemed to greatly increase signal strength. The position of the antenna in regard to the station from which we were receiving was another important factor, for often, going around a curve, on a perfectly level plain, would make one set of stations completely fade out and bring in another.



As mentioned before, small contours in the earth's surface, when they were not wooded, seemed to have little effect, but the location of a mountain immediately between the train and the stations in a certain locality would cut out the signals entirely. This was evident very strongly when we lost 8 BUW while rounding a mountain. But then, again, we could hear him when higher up on a plain. The best signal strength of all was when passing on a high embankment across a bare plain. This seemed even better than the proximity of a lake. Of course, all these observations are those from only two trips, but yet they seemed to hold true in nearly every case.

## CHAPTER XV

### RADIO IN THE AIR

**R**ADIO is an indispensable aid to air travel. It is just as necessary in the air as it is on the sea. It offers the only practical means of maintaining communication with points on the earth below.

Before the war little valuable work had been done in aëroplane radio. The army and navy had carried on a few experiments, and some independent experimenters had taken it upon themselves to do some research work. Although some progress was made, radio in the air was highly impractical at the opening of the war. Then things began to happen. The aëroplane needed radio badly, and the technical talent in the allied and enemy countries was mobilized to investigate the problem. As a result of this concerted effort, aëroplane radio went ahead in one mighty bound. Within a few months' time communication from the air was changed from an uncertainty to a certainty. The development was one triumphal march.

The application of radio to aircraft presented a problem that was quite unlike anything that had heretofore been attempted. A radio station, whether on land or sea or in the air, requires for its operation electrical power, transmitting and receiving apparatus, an aërial, and a ground. On the land or on the sea where ample electrical power is available, where an

aërial can be put up on masts, and where a ground connection can be obtained with the greatest ease, a radio station can be erected with facility. In the air we find that conditions are different. The space available in the aëroplane, or any aircraft for that matter, is limited. In an ordinary two-passenger aëroplane this is especially so, since all the apparatus must be stored away in the fusilage. With a ship or land station no attention need be paid to weight, and this consideration does not enter into the design of the apparatus. In the air, weight means a great deal. The outfit must be made as light as possible, since every pound of weight helps to reduce the speed and efficiency of the machine. Therefore an aëroplane transmitter and receiver must be made with minimum size and minimum weight. At the same time it must be highly efficient and easy to operate. All of the necessary switches, plugs, knobs, and meters that require the attention of the operator must be readily accessible.

At first the source of power to be used for aëroplane transmitters offered a perplexing problem. Storage batteries were used, and they were found entirely unsatisfactory. Some work was done on the development of small generators that could be driven from the shaft of the aëroplane engine. Although the Germans favored this type of power plant, the allied engineers found it unsatisfactory in many respects. In place of it they developed a wind-driven generator. This little generator, encased in a stream-line shell and with

a four-blade wind propeller attached to its shaft, was placed underneath one of the wings with the propeller pointing in the direction of flight. The rapid forward movement of the aëroplane, which seldom travels at a speed of less than eighty miles an hour, caused the wind propeller on the generator shaft to revolve rapidly. The generator attained speeds ranging from 3000 to 4000 revolutions a minute. The generator unit weighed but eighteen pounds and delivered 600 volts to the vacuum tube transmitters. The use of this device at once solved the power problem.

The aëroplane aërial is unlike those used on the ground. Of course they function in the same manner, but their physical make-up is quite different. Even the layman can understand that it would be impossible to use a conventional aërial system on an aëroplane traveling at a speed of one hundred miles an hour. Masts to support the aërial are not only quite unnecessary, but could not be carried. Efficient transmitting and receiving are done in the air with a long piece of wire dangling from the machine. The wire has a weight attached to its free end so that it will be kept as taut as possible without offering any great drag on the forward motion of the machine. The aërial when not in use is wound up on a reel by the operator. With this reel he can let out as much or as little wire as he thinks necessary. At times he may use three hundred feet, and at other times he may use only one hundred feet. The aërial is always wound up before landing.

Although such an aërial has proved to be very efficient from the purely electrical point of view, it is not all that is to be desired from the mechanical point of view. It is obviously an encumbrance on a fighting machine. During the latter part of the war, aërials were developed that could be permanently attached to the framework of the machine. Although they were not quite as efficient as the dangling type of aërial they were more satisfactory in general.

Before the close of the war, and since that time, much work has been done with the radio goniometer or radio compass on the aëroplane. We learned in Chapter VI that the radio compass is really a loop or coil aërial mounted in such a way that it can be rotated to meet the various points of the compass. Although this type of aërial is highly inefficient as a transmitting device, it serves its purpose admirably in receiving work where it is desired to find the exact direction of a transmitter from which a message is coming.

The compass is a great aid to the air-man. If he is flying high with clouds or a fog below him, the radio compass will enable him to keep his bearings with perfect ease. The operator uses his transmitting apparatus and asks a ground station to send specified test signals for two or three minutes. During this time he adjusts his aërial compass to a point where the signals are of maximum loudness. He then jots down the number of degrees indicated by the pointer and immediately asks another station to send the test

signals. In some instances he asks a third station to help him. With these data he is then able to calculate his exact location.

The layman will be puzzled to know how a "ground" is established on an aëroplane. Some may think it is necessary to dangle a second wire so that it will drag along the ground. This is quite unnecessary, although aëroplane radio would be much more efficient if it were possible to establish a ground connection of this nature. Fairly good results, however, are obtained with what is known as a "capacity ground." This is brought about by connecting the transmitting and receiving apparatus with the engine bracing wires and other metal parts of the aircraft.

One of the main duties of aircraft during war, and one in which wireless plays an important part, is that of observing artillery fire, or what is commonly called "spotting." In this coöperation between aircraft and artillery, wireless is indispensable. In the early days of the war coöperation was attempted by indicating targets by dropping smoke-balls or firing colored signals over them. This method was slow and unsatisfactory, as signals could not be seen very far, and the correction of the ranging by a very limited number of signals was not satisfactory. When radio apparatus became available, great advances were made, and the success of aërial observation was assured. Large numbers of squadrons of aëroplanes were distributed along the whole front to coöperate with artillery. Pilots and observers were trained in the methods of

observing and correcting artillery fire and were taught a little radio telegraphy and Morse code to enable them to report targets and maintain communication with artillery units while correcting their fire. Machines for this purpose were mostly equipped with small spark transmitters with an average range of about ten miles. The power of these sets was intentionally kept low to enable as large a number of machines as possible to work on a small sector without interfering with similar machines working in neighboring sectors, or being interfered with by them. Each heavy or siege battery was equipped with a small field set capable of maintaining communication with the aircraft. When a target was observed, a battery was called up by radio and given the position of the target by means of its coördinates on a map ruled in squares. In a few minutes fire was opened on the target, and corrections sent in simple code from the aëroplane to the battery. With practice, gunners and aërial observers soon became very skilled and quick in ranging by this method, and most successful artillery work was achieved. When necessary, more than one battery engaged the target, and trained observers were able to correct the fire of several batteries at the same time. Arrangements also existed whereby, when a certain signal was sent by the aëroplane, the concentrated fire of a large number of batteries could be obtained at once on a target of special importance, such as a body of enemy troops, a railway train, collection of transport, or similar "fleeting" target. Radio

has proved its value for work of this nature and will continue to be necessary in warfare as the best means of communication between aircraft and artillery, for with modern long-range guns correct observation of the fall of rounds is only possible from an observer hovering over the target. In future, radio telegraphy may be replaced by wireless telephony for this purpose. This would allow more intimate communication between the observer and the battery commander.

A second important use to which radio in aircraft was largely put during the war was in connection with long-range reconnaissance flights and bombing expeditions. In carrying out duties of this nature, aircraft flew many miles beyond the enemy front line, and obtained "intelligence" in the course of a three or more hours' flight which it was often essential to report at once without waiting till the whole flight was completed. For example, movements of enemy troops behind the line, concentrations of transport or rolling-stock, lighted enemy aërodromes seen during night flights, good bombing targets, etc., were matters of strategic importance of which immediate knowledge was necessary if action was to be taken in time; this information was best sent during flight by wireless to certain land stations erected for the purpose at suitable headquarters. The supreme importance of rapid communication in reporting enemy movements and dispositions is more fully realized under moving battle conditions during a large advance or retreat such as took place in the initial and final stages of the war in



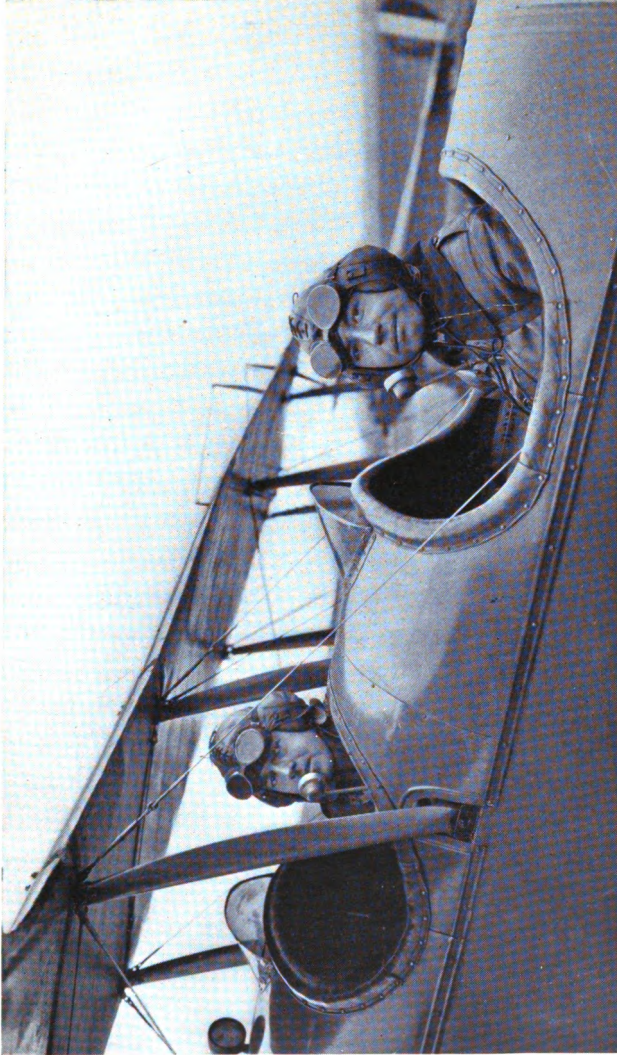

**Aéroplane equipped with a radio telephone transmitter**



France, and also in the final phases of the campaign in Palestine.

Aircraft engaged in long reconnaissance were first equipped with spark transmitters. Such transmitters were able to maintain dependable communication up to a distance of one hundred miles. With the development of the vacuum tube and vacuum tube continuous wave transmitters, the old spark sets were gradually superseded by transmitters of this type. The continuous wave vacuum tube transmitters are eminently suited for aëroplane use. A longer distance can be covered for a given power and the signals are more easily read through interference. Not only this, but the signals can be more sharply tuned.

When the vacuum tube came, the possibilities of using the wireless telephone in connection with aëroplanes loomed up, and a great deal of research work was conducted. As a result of this, aëroplane telephony was brought to a high state of perfection. Telephony from an aëroplane leaves nothing to be desired; it is much more satisfactory than the code system. The development of aëroplane radio telephony went forward in the face of the most discouraging obstacles. Those who have been aloft in an aëroplane know that it is not a quiet place. Quite the reverse: it is a bedlam of noise. Our experience with the wire telephone is enough to convince us that the problem of eliminating noise interference on aëroplane radiophone sets was no small one. When an aëroplane is rushing through the air at one hundred miles an hour amid the continu-

ous ear-splitting roar of a high-power engine, communication of any kind is carried on with difficulty. This is especially true of radio telephony, which is very sensitive to disturbing noises. The troubles in receiving were overcome by the use of a helmet which contained the telephone receivers. These were carefully encased in felt padding with a shield or sheet of lead over the outside. In this way the receivers were thoroughly protected from external acoustic disturbances.

It was quite impossible to employ the ordinary microphone transmitter in connection with the radio-telephone sending apparatus. With this type of transmitter the terrific noises of the engine would make effective communication impossible. Unlike the head receivers, the transmitter could not be protected without providing the operator with a diving suit, since it was quite necessary, of course, that he should breathe. This brought up the problem of perfecting a new type of transmitter that would effectively modulate the continuous waves created by the oscillating vacuum tubes. After much patient and industrious research on the part of a few very able experimenters, the difficulties were surmounted and there came forth from beyond the closed doors of the research laboratory a perfect transmitting microphone for aëroplane use. It was quite insensible to the loud noises produced by the engine and yet responsive to the modulations of the human voice. After the appearance of this transmitter the engine could roar, snort, cough, and sputter

with all its might without interfering with the transmission of speech.

The use of radio telephony in the air obviates the necessity of the operator learning the code. It not only does this, but it also speeds up the transmission of messages, which is very desirable when the aëroplane is used in war.

An aëroplane equipped with radio telephone or telegraph apparatus is not only able to communicate with stations on the ground or on the sea, but it is also able to communicate with air stations.

Most of the foregoing developments have arisen from the demands of a war in which science has played a great part, and the high state of perfection attained in all types of aircraft radio work in so short a time has been largely due to the pressure of war conditions.

But such developments do not end with the war. Radio is as essential to civilian aircraft in peace time as it is to aircraft during war; it is as necessary for the safety of an aircraft and its passengers as it is for the safety of an ocean liner and her passengers. Since the armistice considerable use has already been made of aircraft radio. Radio telephony was used with success on the Folkestone-Cologne aërial postal route, and on the London to Paris air route (still in use); radio telegraphy and telephony have been largely and successfully used on several long demonstration flights by large aëroplanes, flying-boats, and air-ships. The most important of these was the flight made in July, 1919, by the air-ship *R-34* from England to America

and back. Her radio equipment included a continuous wave transmitter for long-range work, a low-power spark transmitter for communication with ships, direction-finding apparatus, a radio telephone, and receiving apparatus with vacuum tube amplifier. The results were highly satisfactory, and some remarkable ranges were obtained. During the whole flight the air-ship was in communication with stations on this side, or on the other side, of the Atlantic. Weather reports prepared by meteorologists in London were transmitted to her every few hours throughout the flight, and proved of great value. Signals were exchanged with the radio station at St. Johns, Newfoundland, over a distance of more than 1700 miles. This was the first real test of long-range radio communication with aircraft, and the results obtained surpassed all expectations. They have demonstrated what can be accomplished, and indicate what may be looked for in the future. If civil aviation is to become the success it deserves to be, one can look forward to the days when the world will be traversed by aërial routes over which aircraft (both heavier and lighter than air) will fly by day and by night, properly equipped with radio telegraph and telephone apparatus, by means of which communication will be maintained with the ground, receiving weather reports, warnings, and instructions when necessary, and guided by night and in cloud by a chain of wireless stations acting as "beacons" for direction-finding.

The mail planes of the United States postal service

have been using radio since this service was started. A string of land stations has been established, and it is the purpose of these stations to render all possible assistance to the postmen of the air. Official orders are not only delivered in this manner, but the pilots are also warned of approaching storms so that they can get to an altitude where they will be out of danger.

When the *NC-4* made its historic flight across the Atlantic Ocean, its radio equipment was at all times in touch with either the naval radio station at Bar Harbor, Maine, or the stations of the various destroyers that were assigned to "stand by." The *NC-4* broke all long-distance records for aëroplane transmission when its operator succeeded in covering a distance of 1400 miles. Considering the limited power of the equipment used and the size and nature of the aërial this was indeed a remarkable accomplishment.

In the future when the great passenger dirigibles and aëroplanes come into wide use we shall have our newspapers of the air as well as newspapers of the sea. This has already been done. The London to Paris machines have printed what was known as the "Aërial Mail" in French and English. The news was received by radio, of course, and the machines carried a miniature printing plant which was able to turn out a number of copies in a very short time.

## CHAPTER XVI

### RADIO AND THE NEWSPAPER

**T**HE use of radio in the collection and dissemination of news might be numbered among its business applications. The relation of radio to the newspaper, however, has become so important during the last few months that it is deemed advisable to devote a complete chapter to this phase of the subject.

Radio is really a competitor of the newspaper. It is, indeed, a menacing competitor. With it news can be accumulated and distributed with a rapidity that the newspaper cannot approach. The newspaper is nothing but a medium of communication. With radio it is possible to transmit news to hundreds of thousands of people in an instant. This the newspaper cannot do.

The modern newspaper is an institution which has required many years for its development. It cannot be torn down at a single stroke, to be sure. The newspaper will probably remain just as popular as it is to-day for years to come, but the time will arrive when radio will run the printed page a merry race. Every wise newspaper editor realizes this, for he has lived to see radio grow from a scientific plaything to a powerful instrument of commerce.

Radio is not going to stand still. What is wonderful and new to-day is history to-morrow. Dreams rapidly



mature into realities. The era of pocket wireless is yet to come. To-day it is possible to carry a receiver about in a coat pocket, but it is not exactly practicable. Such an outfit cannot be relied upon to function efficiently under all conditions. Within five years there may be a different story to tell. How pleasant it would be to ride or walk home with our pocket receiver tuned to get the late news!

The newspaper is a powerful influence. It may make peace or it may drive nations to war. It is a molder of public opinion. It can build up prejudices or tear them down. It can make presidents or dethrone kings. It can precipitate revolutions or quell them. But there is one thing that the newspaper cannot do; it cannot stand in the way of progress. If radio is to be a competitor of the newspaper, there is but one thing that the newspaper can do and that is to embrace this new art of communication. If radio is fostered by the newspaper it will grow up more or less under its direction and there will be evolved a new method of distributing news. It would be folly to predict that the printed page will disappear altogether, since it does many things that are quite beyond radio. So far newspapers have been quick to cooperate with radio broadcasting plans. Whether this policy is prompted by foresightedness or whether it originated in a circulation manager's office is a matter of conjecture. In any event the newspapers have taken the right step in holding out a friendly hand to the radio. Radio can help the newspaper grow, and help it to

better the service that it gives to its readers, and at the same time the newspaper can be a great factor in helping radio to grow. Radio and newspapers should go hand in hand, and the partnership would be certain to prove beneficial.

In the cities where radio broadcasting stations are operating, the newspapers have coöperated in a practical manner to make the broadcasting program a success. In some instances the newspapers are actually helping to supply the programs, and they have taken a considerable part in the active management of the stations. The newspapers that are not fortunate enough to be located near a broadcasting center are in many cases providing their readers with a service column. Some papers have gone so far as to make a large investment to erect their own broadcasting station.

Much of the world's news is collected by radio. Radio has competed with the cable in this respect, just as it is competing with the cable in handling regular commercial traffic. Radio is also matching the cable rate, and even bettering the cable rate at times. Transatlantic news now costs seven cents a word, and there is no delay in transmission. Although our Western facilities for the collection of news by radio are ample at the present time, we are badly crippled in the East. On the Pacific side there is but one cable connecting the United States with the Far East, and until recently no wireless service was operated by a private corporation. The cable is little more than useless; and when it is operating it is congested with

business, and delays of several days in transmission are not infrequent. The demands made upon the single private radio station for general commercial traffic makes it impossible for that station to handle news matter except at a prohibitive rate. It must be understood, of course, that the normal business rate is far too high for news despatches, which must be sent as cheaply as possible. These conditions induced Congress in June, 1920, to grant authority for the use of the navy wireless facilities for the transmission of commercial and news messages between points which could not be served by privately-owned stations. This plan made it possible to establish a low rate for news transmission. Under the authority granted by Congress, the navy announced a rate for news messages of six cents a word from San Francisco to Manila and three cents a word from San Francisco to Honolulu. As a result of this service three westbound daily news reports from San Francisco to the Far East sprang into existence. The desirability of steadily improving our radio facilities for communication with the Far East was strikingly demonstrated during the arms limitation conference at Washington. Naturally there was a desire on the part of Japan and China to be kept in full touch with the proceedings at the conference. Every available means to get news through was used, and, owing to the terrible demands made upon the available channels, the results were very disappointing. In some instances, China and Japan received news four days late. A misunderstanding in

the transmission of a news letter that had to do with the Shan-tung question created a riot in China. This is mentioned, not because a riot is anything new in China, but merely to bring out the importance of ample facilities.

One New York newspaper operates its own receiving apparatus, so that the transatlantic news reports sent from France, Germany, and England are picked up almost within the roar of the presses. This paper subscribes to the transatlantic service of the Radio Corporation of America. It does its own receiving simply to eliminate the time that would otherwise be lost in making delivery through the regular channels. This receiving station has been operated for three years, and the service it has rendered has been entirely commensurate with its cost of installation and maintenance. The high-speed messages that come pouring through the ether from across the watery wastes pass into the receiving apparatus, surge through vacuum tube amplifiers, and then rush into a special telephone receiver that is connected directly to a phonographic recording device. As the sensitive wax record revolves, the incoming radio impulses are effectively "canned." The operator simply adjusts his apparatus to a point of maximum sensitivity and then switches on his recorder. By having two recorders the message can be led from one machine to another when one record is full. After the recording is done the message can be reproduced at a convenient reading speed. In case static interference breaks up the thread of a message

the newspaper has but to call up the receiving operator of the Radio Corporation and the complete text of the message can be had.

A small radiophone equipment can be of great value to a newspaper in collecting local news. Some time ago a Los Angeles paper conducted very interesting experiments with radio. An efficient radiophone transmitter and receiver were installed in the editorial offices of the paper. A portable outfit was loaded on an automobile and turned over to the star reporter. He immediately set forth with his "newsy nose" in quest of something exciting. In his travels he went to the amateur fishing section of Santa Monica Bay. He arrived just in time, as good reporters have a habit of doing. There was a battle royal on between the amateur fishermen and the crew of a fleet of professional fishing-boats that had just anchored. Thus radio handled its first fish-story.

Although this method of news reporting was entirely satisfactory so far as operation was concerned, the apparatus necessary to establish reliable communication between the operator and the home office was so cumbersome as to render it somewhat impractical. It will not be long before more experiments will be made and better results achieved. As our transmitting and receiving apparatus becomes more efficient it will be reduced both in weight and size, and the time will come when a reporter will be able to keep in touch with the city editor by the use of an outfit that will be no larger than a good-sized camera.

Montreal newspapers took advantage of radio in

reporting the yacht races on Lake St. Louis in 1921. A small power boat was fitted up with a transmitting apparatus. It then made its way to the scene of the races and the results were telegraphed back to the editor. The story was in type and printed before the boat returned.

Large news associations and press services have always found it a problem to supply the smaller newspapers with up-to-the-minute service. Many of the smaller papers have to be satisfied with getting news late, since they cannot afford to subscribe to the more rapid service.

W. G. H. Finch, a Buffalo inventor and radio engineer, has perfected an automatic radio telegraphic recorder which has solved this problem. The device is extremely simple and inexpensive, and the smaller newspapers can easily afford to install a complete outfit. The receiver is entirely automatic in its operation and the messages are faithfully reproduced on a paper tape. In fact, the Finch system also makes it possible to use an automatic typewriter.

“The London Daily Mail” experimented with radio as a news-collecting device some time ago, and, so far as the knowledge of the author goes, the system is still in use. A portable transmitter and receiver is placed on an automobile, and this travels from place to place, always in search of news. If there is a big fire or a subway accident, the car speeds to the scene and remains there, keeping the editorial offices informed of every development.

Radio and the newspaper are natural allies. It is to be hoped that they will march forward together. A new era for the dissemination of news is in the making. The next ten years will bring results that cannot be predicted at the present time. No man can foresee exactly what is going to happen. In any event the newspaper must stand by radio.

## CHAPTER XVII

### WHO'S WHO IN RADIO

**R**ADIO has had its heroes, its romances, and its masterful pieces of research like all of the other great American industries. Many different workers have made valuable contributions to the art and not a few have died unsung and unhonored. The authors have decided that this chapter shall not only give honor where honor is due, but shall also give the reader a glimpse into the lives of those men of our own country who have devoted themselves to what promises to be the greatest American institution.

#### E. F. W. ALEXANDERSON

E. F. W. Alexanderson is the inventor of the famous Alexanderson alternator. In developing this machine Mr. Alexanderson successfully overcame one of the most perplexing problems of radio engineering. The Alexanderson alternator is now used in most of the transoceanic radio stations. Mr. Alexanderson is also the inventor of the magnetic amplifier, which has made many things possible. His contributions to radio literature have been of the most important nature. He now occupies the post of chief engineer of the Radio Corporation of America.

He was born in Upsala, Sweden, in 1878, and was



educated at the University of Lund, Sweden, and at the Royal Institute of Technology, Stockholm.

#### EDWIN H. ARMSTRONG

Edwin H. Armstrong is one of the outstanding figures in radio. He is the inventor of the Armstrong regenerative circuit, which has been the most important development since De Forest added the third element to the vacuum tube. He served two years in the American Expeditionary Force in France as captain and as major in the signal corps and as technical chief of the radio laboratories; and he was made a chevalier of the Legion of Honor. He is a member and director of the Institute of Radio Engineers and consulting radio engineer and co-worker of Professor M. Pupin in the Hartley Research Laboratory at Columbia University. He was born in 1890 and holds the degree of electrical engineer from Columbia University, which he received in 1913.

#### M. C. BATSEL

From 1915 to 1917 M. C. Batsel was engaged in very important research work, making measurements in capacity and inductance for the United States bureau of standards at Washington. He also did important work in the study of alternating current phenomena for the bureau. From 1917 to 1920 development work in connection with vacuum tube receiving and transmitting apparatus occupied his time. This was done for the army signal corps. He is at present designing engineer

of receiving apparatus for the Westinghouse Electric & Manufacturing Co.

**ELMER E. BUCHER**

Elmer E. Bucher has had rich experience in the wireless field. He joined the De Forest Wireless Telegraph Co. as experimental engineer in 1903. In 1907 he joined the Wireless Telegraph Co. as installation and experimental engineer. He was the first to interest the Young Men's Christian Association in the teaching of radio. He joined the Marconi Wireless Telegraph Co. of America in 1912 as instructing engineer, and later he became director of the Marconi Institute, which he organized. He is the author of many books relating to wireless and is the holder of many patents pertaining to the art. He was technical editor of "Wireless Age" during the period from 1913 to 1918. He was born at Akron, Ohio, in 1885 and was educated at an academy in Oberlin, Ohio. At present he is sales manager of the Radio Corporation of America.

**REAR-ADMIRAL W. H. G. BULLARD, U. S. N.**

Rear-Admiral W. H. G. Bullard is a specialist in electrical engineering. He was the first superintendent of the Naval Radio Service, 1912-16; delegate plenipotentiary of the United States at the international conference for the safety of life at sea, London, November, 1913; in charge, on behalf of the United States navy, of the radio operations contained in the series of experiments carried out between the Eiffel Tower and



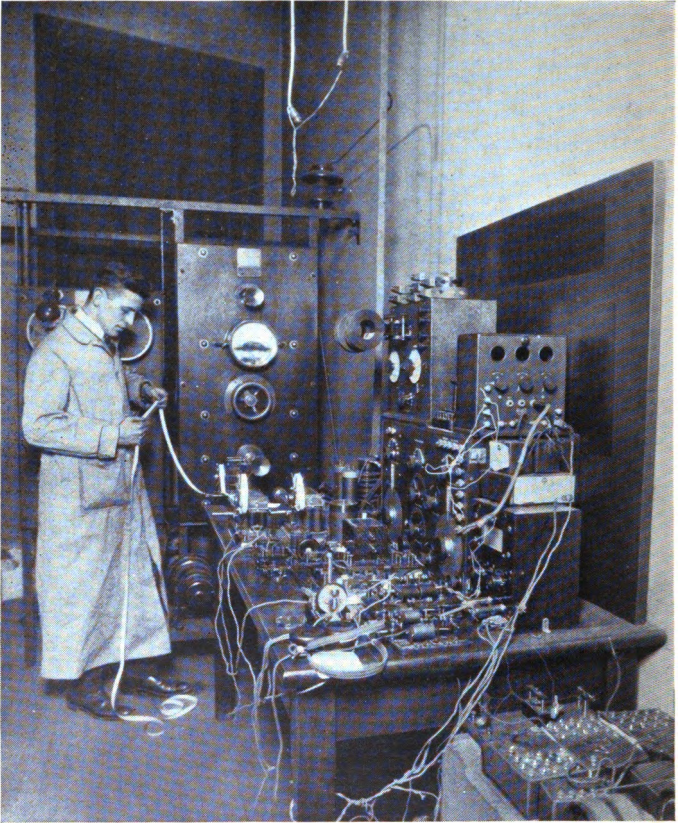

**W. G. H. Finch reading the news from an automatic tape recorder which he developed for newspaper work**

Arlington to determine longitude by means of wireless telegraphy. He was born in 1866 in the State of Pennsylvania and was graduated from the United States Naval Academy in 1886.

**PROFESSOR E. L. CHAFFEE**

Professor E. L. Chaffee has conducted courses in physics and radio telegraphy at Harvard, and has engaged in research and consultation work in radio telegraphy. He is the author of a number of papers dealing with electric oscillations and their analysis, etc. During the war he was engaged in developing radio apparatus with which he experimented in France in 1918. He was born in 1885 at Somerville, Massachusetts, and was graduated from the Massachusetts Institute of Technology with the degree of bachelor of science in electrical engineering in 1907. He was awarded the degree of master of arts in physics by Harvard University in 1908, and the degree of doctor of philosophy in 1911.

**GEORGE H. CLARK**

George H. Clark was one of the early workers in wireless. He was first in the employ of the Stone Telephone & Telegraph Co., for which he worked as a collaborator of Professor John Stone. He entered the employ of the Navy Department at Washington in 1908, where he was made general technical supervisor of naval projects and installations. He also prepared specifications for standard apparatus. He joined the

Radio Corporation of America in 1919. He was born in 1881, and was graduated from Massachusetts Institute of Technology as an electrical engineer in 1903.

#### LOUIS COHEN

Louis Cohen was on the scientific staff of the bureau of standards, 1905-09, and was chief of the research department of the National Electric Signaling Co., 1910-12. He has been in consulting practice since 1912 and is professor of electrical engineering in George Washington University. He is especially interested in electrical oscillations. He is the author of numerous papers dealing with the problems of wireless telegraphy and other kindred subjects. He was born in 1876 and was educated at the Armour Institute of Technology, the University of Chicago, and Columbia University.

#### FRANK CONRAD

Frank Conrad joined the Westinghouse Electric & Manufacturing Co. while a mere boy. His constant association with the trained technical men under whom he worked and his insatiable appetite for knowledge soon made him an engineer of high standing. He went into radio as a hobby and soon became one of the country's foremost experts. He did valuable work during the war in designing a combination transmitting and receiving set for the United States signal corps, and he also developed an extremely small but practical wave-meter. Mr. Conrad is one of the pioneers of broadcasting. It was he who coöperated with Rypinski

in establishing the first successful broadcasting station at Pittsburg. Conrad attacked and solved many of the technical problems that had to do with broadcasting and receiving. He is responsible for the design of all Westinghouse receivers and is the inventor of numerous devices. At present he is with the Westinghouse Electric & Manufacturing Co.

#### RAY CUMMINGS

Ray Cummings was at one time expert radio aide at the Navy Department, Washington. From 1917 to 1919 he was in charge of the design of spark transmitters for ship use at the bureau of steam engineering, Washington. From 1919 to 1921 he was in charge of arc, spark, and vacuum tube transmitter development and design in the laboratory of the navy yard at Washington. At present he is in the vacuum tube transmitter section of the radio engineering department of the General Electric Co. at Schenectady. He was born in 1891 at Lancaster, Pennsylvania, and received the degree of electrical engineer from Columbia University in 1907.

#### DR. LEE DE FOREST

Before Dr. Lee De Forest added the third element to the vacuum tube, this device was little more than an improvisation. Dr. De Forest's radio career has been an eventful one. As early as the summer of 1901 he undertook to report by radio the international yacht-races off Sandy Hook. He was the first to use the alternating current generator and transformer instead of the

induction-coil and unsatisfactory interrupter. In 1905 he designed and equipped the first long-distance navy wireless stations at Key West and Colon. During the year 1906 he developed the three-electrode vacuum tube, which put wireless development ahead fifty years at a single stroke. The addition of this third element or grid had a profound effect upon the wireless art. He was born in 1873 at Council Bluffs, Iowa, and in 1906 received from the Sheffield Scientific School of Yale University the degree of doctor of philosophy. The degree of doctor of science was conferred by Syracuse University in 1919. He was awarded the cross of the Legion of Honor in recognition of services rendered France by the three-element vacuum tube during the war. He received a gold medal and diploma at the St. Louis Exposition in 1904, and likewise at the Panama-Pacific Exposition at San Francisco in 1915. He is at present engaged in commercial research work in Berlin, Germany.

#### GEORGE SCARLETT DE SOUSA

George Scarlett De Sousa is both a technician and a man with sound business judgment—a rare combination. He entered the employ of the old Marconi Wireless Telegraph Co. of America in 1904, when the industry was in its infancy. He served as traffic manager of this organization from 1910 to 1918, when he became treasurer of the Radio Corporation of America, which absorbed the old company. He was born in 1884. He is a member of the Institute of Radio Engineers.



## WILLIAM DUBILIER

William Dubilier is a consulting engineer and inventor who has devoted much time to wireless telegraph, telephone, and high-frequency experiments. Since 1904 he has been a consulting radio engineer and principal of the Dubilier Electrical Syndicate, Ltd., London, England, and of the Dubilier Condenser Co., New York. He is inventor of the Dubilier mica condenser, and has obtained more than 150 patents and applications for wireless apparatus. He was born in 1888, and is now president of the Dubilier Condenser Co.

## LIEUTENANT WILLIAM A. EATON

Lieutenant William A. Eaton's radio work began in the United States navy in 1904. He assisted in the installation of the famous Arlington radio station at Arlington, Virginia. In 1914 he was assistant to Dr. L. W. Austin at the naval radio laboratory, bureau of standards. He developed there the capacitive back-coupling circuit for producing regenerative oscillations with the vacuum tube detector. He also developed other improvements in vacuum tube circuits which were put into use by the navy. From 1916 to 1921 he was in charge of the radio testing shop at the Washington Navy Yard. Here he developed the Eaton uni-wave key for arc transmitters. At present he is radio officer of the experimental radio battle-ship *Ohio*. He was born at Kanning, Kings County, Nova Scotia, in 1883, and was graduated from the Bliss Electrical School at Washington in 1903.

## LLOYD ESPENSCHIED

Lloyd Espenschied began his career as a radio amateur and later was a radio operator at sea. He studied at Pratt Institute and after graduating became assistant engineer of the Telefunken Wireless Telegraph Co. of America. He later came to the engineering staff of the American Telephone & Telegraph Co., specializing in radio. He participated in long-distance wireless telephone experiments in 1915 as the engineer who did the receiving at Hawaii in the Hawaii-Arlington radio-telephone transmission tests. Mr. Espenschied has made a special study of radio wire carrier transmission. His contributions to the radio art are substantial and numerous. A great many patents bear his name.

## REGINALD AUBREY FESSENDEN

Reginald Aubrey Fessenden was inspecting engineer to the Edison Co. at New York in 1886. He took up teaching work and conducted classes in physics and electrical engineering at Western University in 1892, became professor of electrical engineering at Western University, Philadelphia, 1893, and became special agent to the United States weather bureau in 1900. He has devoted much attention to a system of wireless telegraphy known by his name, and has also carried out important experiments in wireless telephony. He has been a contributor of articles on wireless telegraphy and telephony to many technical journals. He was born at Milton, Canada, in 1866, and was educated at New York and at Port Hope, Canada.

## DR. ALFRED NORTON GOLDSMITH

Dr. Alfred Norton Goldsmith's name has been linked with radio for a number of years. A record of his research work would fill volumes. His scientific career began as tutor in physics at the College of the City of New York. He later was made instructor, assistant professor, and associate professor of electrical engineering. Subsequently he became a consulting engineer for the Atlantic Communication Co. and the General Electric Co. The Marconi Wireless Co. afterward engaged him as director of research; and he now holds the same post with the Radio Corporation of America. He is a fellow of the American Institute of Electrical Engineers, American Physical Society, and Institute of Radio Engineers, and a member of the American Association for the Advancement of Science. He has made valuable contributions to radio telegraphy and telephony, photo-physics, precision measurements, and the transmission of canal rays through thin partitions. He received the degree of bachelor of science from the College of the City of New York in 1907, and that of doctor of philosophy from Columbia University in 1911.

## JOHN HAYS HAMMOND, JR.

John Hays Hammond, Jr., is a master of the subject of radiodynamics, or the control of distant mechanisms by radio impulses. His system of radio control was used in the test with the battle-ship *Iowa*. He has

invented a radio-controlled torpedo for coast defense and many other radio devices. Mr. Hammond is also the author of many books and articles on this subject. He was born in San Francisco, and was graduated from the Yale University Sheffield Scientific School in 1910. He received the degree of doctor of science at the George Washington University in 1919.

#### EARL C. HANSON

Earl C. Hanson is a young man with a long list of radio inventions to his credit. His research work began when he was a mere boy. This was in the early days of radio, when, as Mr. Hanson says, "one stayed up all night listening to arc-lights and other strays." Probably Mr. Hanson's greatest and most important invention is the piloting cable used in guiding vessels and aëroplanes through fogs. This is described elsewhere in this book. In an effort to help his mother, who was afflicted with subnormal hearing, Mr. Hanson developed what he later called the Vactuphone, wherein a vacuum tube plays an important part. The Vactuphone is now in wide use. Mr. Hanson was one of the first men to experiment with radio telephoning from a moving train. He is the inventor of a long wave radio system, and of a vacuum tube electrotherapeutic device that was developed in collaboration with Wendell L. Carlson. An underground radio system has also been developed by Mr. Hanson. He was educated at St. Andrews College, Toronto, Canada.

## L. A. HAZELTINE

Although trained for mechanical engineering, L. A. Hazeltine is now professor of electrical engineering in the Stevens Institute of Technology at Hoboken, New Jersey. Professor Hazeltine is recognized as one of the foremost authorities on vacuum tubes and their various uses. In 1917 he read a paper before the Institute of Radio Engineers which for the first time gave in English the general mathematical theory of oscillating vacuum tube circuits. He served during the war as consulting engineer of the radio laboratory of the Washington Navy Yard. He there designed a number of very successful receiving outfits for naval use. He has had taken out several patents covering improvements in radio apparatus. He was graduated from the Stevens Institute of Technology in 1906 with the degree of master of engineering.

## RAYMOND E. HEISING

In 1915 the powerful government radio station at Arlington, Virginia, was used in a series of epoch-making experiments. The human voice was carried on the wings of radio from Arlington to Honolulu. The scientific world stood aghast. The apparatus used was designed, developed, and operated by Raymond E. Heising, who was then a man of twenty-six. He later developed and designed the radio system used in the signal corps aëroplane sets during the war. He also designed the submarine chaser sets, which so many landlubbers were called upon to operate.

Heising is a patentee with many important radio inventions to his credit. His research work and papers on modulation in radio telephony are looked upon as the most important contributions to this phase of the art. In 1921 Mr. Heising was awarded the Morris Liebmann prize by the Institute of Radio Engineers.

Mr. Heising was born in 1888 at Albert Lea, Minnesota, and was educated as an electrical engineer at the University of North Dakota. He is now connected with the research department of the Western Electric Co.

#### JOHN V. L. HOGAN

John V. L. Hogan began his wireless career as chief laboratory assistant to Dr. Lee De Forest, who was at that time in the midst of his work of developing the grid vacuum tube receiver. Mr. Hogan, as a colleague of Dr. De Forest, participated in the direction and operation of the first radiophone broadcasting station over which bulletins and music were transmitted on daily programs. He later served as telegraph superintendent of the National Electric Signaling Co., and afterward as chief of the operation, inspection, and erection department. He served in the capacity of chief research engineer with the International Radio Telegraph Co. He was later made manager with executive supervision over the design, manufacture, and sales operations of the company. Mr. Hogan holds the rights to various United States and foreign patents of importance which have to do with radio

telephone and telegraph apparatus. He is the author of many books and articles on the subject of radio science. He is past president of the Institute of Radio Engineers, and is connected with many other scientific societies. He was born in Philadelphia and was graduated from the Sheffield Scientific School of Yale University.

COMMANDER STANFORD C. HOOPER

Commander Stanford C. Hooper is in charge of radio material, construction, supply, and development in the bureau of steam engineering attached to the United States navy. He began his career as telegraph operator for the Southern Pacific Co., afterwards going to the Postal Telegraph Co. He entered the naval academy at Annapolis, Maryland, on September 6, 1901, where he was graduated on January 31, 1905. He served as midshipman on the cruiser *Chicago*, the destroyer *Perry*, and the monitor *Wyoming*. He became ensign in 1907, lieutenant in 1910, lieutenant-commander in 1915, and commander in 1918. He was instructor in electrical engineering, physics, and chemistry at the United States Naval Academy in 1910-11, and fleet radio officer of the Atlantic fleet in 1912-13, taking part in the capture of Vera Cruz, Mexico. Early in the war he acted as observer in Europe. He was in charge of the radio division, bureau of steam engineering, Navy Department, 1915-17. After commanding the destroyer *Fairfax* in the Atlantic during the war he returned to take up duties in the Navy Department

## 300 THE COMPLETE RADIO BOOK

in 1918. He was born in 1884 at Cloton, California, and was educated at San Bernadino.

### ALBERT W. HULL

Albert W. Hull is master of the vacuum tube. He is the inventor of the dynatron and the magnatron, vacuum tube devices used in radio. The research work of Mr. Hull has greatly multiplied the use of pure electron discharges. He is the author of a number of important papers on the subject of X-rays and electron tubes. A modest, hard-working research engineer, he has been with the General Electric Co. since 1914. Before that time he was instructor in physics at Worcester Polytechnic Institute.

Mr. Hull was born at Southington, Connecticut, in 1880. He received the degree of bachelor of arts at Yale University in 1915 and the degree of doctor of philosophy in 1909.

### LESTER L. JONES

Lester L. Jones studied two years in Switzerland and Germany. He was a test engineer with the Wireless Improvement Co. in 1913, inspector of radio materials at the Brooklyn Navy Yard in 1914, and then expert radio aide, for testing, installing, and designing radio transmitting equipment. He was a member of the standardization committee, Institute of Radio Engineers. He installed a high-power arc transmitter at the Guantanamo naval



station in 1915. He was transferred to the Washington Navy Yard for the design and construction of naval receiving equipment during the World War. In 1918 and 1919 he was research assistant to Dr. A. N. Goldsmith, and chief research engineer in the E. J. Simon Organization. In 1919 he devoted a year to public accountancy to broaden his business knowledge. Since then he has been consulting engineer for the Electrose Manufacturing Co., Intercity Radio Co., Dubilier Condenser Co., Pacent Electric Co., Commercial Cable Co., etc. He is president of Danziger-Jones, Incorporated, and a member of the Institute of Radio Engineers. He was born at New York in 1891.

#### FREDERICK A. KOLSTER

Frederick A. Kolster was assistant to John Stone Stone in 1902-08. He took an active part in wireless engineering up to 1912, joined the scientific staff of the United States bureau of standards in 1912, and has since been closely associated with the radio work of the United States Government. He is the inventor of the direct reading decimeter and other devices. He is a fellow of the Institute of Radio Engineers, and was an attaché to the delegation representing the United States in the London international radio convention in 1912. He is a member of the American Institute of Electrical Engineers and of the Cosmos Club at Washington. He was born in Geneva, Switzerland, in 1883, and was educated at Harvard University.

## L. R. KRUMM

L. R. Krumm is a well-known figure in the radio field. He is superintendent of marine installations for the International Radio Telegraph Co. He has been chief radio inspector of the United States Department of Commerce, and during the war served as a lieutenant-colonel in the signal corps, being in charge of all the radio operations of the American Expeditionary Force.

## DR. IRVING LANGMUIR

The name of Langmuir will always be associated with the vacuum tube. Dr. Irving Langmuir's pioneer work in electronics led him to form a complete theory of the pure electron discharge. His work made possible the development of many types of vacuum tubes. The vacuum tube was a mysterious device before Langmuir blazed his trail. Before entering the research laboratory of the General Electric Co., where he is now assistant director, Dr. Langmuir was instructor in chemistry in Stevens Institute of Technology at Hoboken, New Jersey. He has been awarded the Nichols Medal by the American Chemical Society, the Hughes Medal by the Royal Society of London, the Rumford Medal by the American Academy of Arts and Sciences, and the Faraday Medal by the Faraday Society.

He was born in Brooklyn in 1881, was graduated from Columbia University in 1903 with the degree of metallurgical engineer, and studied three years under Professor Nernst at the University of Goettingen,

from which he received the degree of doctor of philosophy.

#### JOHN M. MILLER

John M. Miller is a physicist who has devoted his time to research work and the advancement of the radio art. During the years between 1907 and 1919 he was associate physicist and physicist of the United States bureau of standards. His later work was done with the bureau of engineering of the Navy Department. He has published papers on the theory and measurement of antennæ and thermionic vacuum tubes which are regarded as valuable contributions to the science. He was born in 1882 at Hanover, Pennsylvania. He received the degree of bachelor of arts at Yale University in 1904; and the same university made him a master of arts in 1907 and a doctor of philosophy in 1915.

#### EDWARD J. NALLY

Edward J. Nally is president and director of the Radio Corporation of America and of the Pan-American Wireless Telegraph & Telephone Co. He was a pioneer in different modes of communication in America. He began as a telegraph messenger boy in St. Louis, and later was chief clerk to the superintendent at Minneapolis. He was appointed assistant general superintendent of the Postal Telegraph-Cable Co., at Chicago, in 1890, and served this company for twenty years, being elected first vice-president and general manager at New

York in April, 1907. He left in 1913 to accept the office of vice-president and general manager of the Marconi Wireless Telegraph Co. of America, which he organized for commercial service; and in 1914 he opened a commercial wireless circuit between the United States and Hawaii, which in 1916 was extended to Japan. He was born in Philadelphia in 1859.

#### M. PAYNE

M. Payne's radio career dates from the year 1902, when he conducted experiments in wireless transmission and reception from an automobile. This was in the days of the Rumkoff coil. Mr. Payne has had wide experience with various types of radio equipment, and operated many of the stations that were famous in the earlier days. He is now associated with the Radio Corporation of America as assistant treasurer.

#### GREENLEAF WHITTIER PICKARD

Greenleaf Whittier Pickard has made a special study of wireless telegraphy and telephony and has taken out many United States and foreign patents for wireless inventions. He began his radio work at Blue Hill Observatory, Milton, Massachusetts, in 1899 under a grant from the Smithsonian Institution. He became associated with Harry Shoemaker in 1901, and was on the engineering staff of the American Telephone & Telegraph Co., 1902-06. He developed a practical system of radio telephony, obtaining successful speech transmission without wires in 1902. From 1906 until the

present time he has been connected with the Wireless Specialty Apparatus Co. as consulting engineer. He practises extensively as patent expert in wireless patent litigation. He is a fellow of the American Institute of Electrical Engineers, a member of the American Chemical Society, a member of the Society of Chemical Industry, and a member of the Institute of Radio Engineers. He was born at Portland, Maine, in 1877, and was educated at Westbrook Seminary, Lawrence Scientific School, Harvard, and the Massachusetts Institute of Technology.

DR. MICHAEL L. PUPIN

Among Dr. Michael L. Pupin's first original work may be mentioned the development of electrical resonance before the introduction of wireless telegraphy. Patents issued to him on electrical selectivity were licensed to the Marconi Wireless Telegraph Co. in 1903. He has worked extensively in the development of his inventions in connection with telephones and telegraphs, and many of his improvements are known by his name throughout the world. He has been engaged in the development of a new method of electrical selectivity to be used in connection with wireless telegraphy. He has also been engaged in research work in wireless telephony. He was born in Hungary in 1858 and came to the United States in 1874. He studied at Columbia and was graduated in 1883, continuing his studies at Cambridge, England, and at Berlin. He became professor of mathematical physics at Columbia in 1891.

## BRIGADIER-GENERAL EDGAR RUSSELL

Brigadier-General Edgar Russell was instructor and assistant professor in the department of chemistry and electricity in the United States Military Academy from 1893 to 1898. He was made chief signal officer of the army, serving in that capacity until 1915. He developed artillery electric fire-control apparatus and portable army radio equipment. He was War Department delegate to the national radio conference of 1912, and was brigadier-general and chief signal officer of the American Expeditionary Force in France from 1917 to 1919, in charge of military telegraph, telephone, and radio work. He is the possessor of the Distinguished Service Medal, is a companion of the British order of the Bath, and commander of the French Legion of Honor. He was born in 1862, and was graduated at the United States Military Academy in 1887. At present he is located at Fort Sill, Oklahoma.

## M. C. RYPINSKI

M. C. Rypinski is the man who fathered the first real broadcasting program of the Westinghouse Electric & Manufacturing Co. It was he who saw the vast possibilities of the scheme while working in collaboration with Frank Conrad, another Westinghouse engineer. Mr. Rypinski is a native of Texas, and received his primary and high school education in that state. He was graduated from Rose Polytechnic Institute, Terre Haute, Indiana, in 1897. From college he went to the General Electric Co., where he was soon made assistant

to the chief of the standards laboratory, in which post he had charge of all electrical testing apparatus used in the Schenectady works, including the design, maintenance, and operation of this apparatus, the maintenance of laboratory standards, and the laboratory development of all apparatus of an instrument nature intended for commercial exploitation. He has made a number of inventions applying to electrical measuring instruments both for the General Electric Co. and for the Westinghouse Co. During the war Mr. Rypinski was chairman of the instrument manufacturers' committee and member of the transformer manufacturers' committee, both of which coöperated with the Government in the standardization and supply of electrical apparatus. He has been active in the work of national organizations, such as the National Electric Light Association, American Institute of Electrical Engineers, Illuminating Engineering Society, Electric Power Club, and Associated Manufacturers of Electrical Supplies. He was a charter member of the executive committee which organized the commercial section of the National Electric Light Association. A close student of literature on the subject of electricity and kindred matters, Mr. Rypinski was at one time recognized as one of the leading authorities and lecturers in this country on the subject of color photography and the little known subject of color music.

#### HARRY SADENWATER

Harry Sadenwater's radio career began in 1908 when he became an amateur operator. After serving for

some time as commercial operator, he became instructor of radio and assistant radio inspector for the United States Department of Commerce. He served in the navy as radio officer from 1917 to 1919. While in the naval aviation service he took part in the development of the naval aircraft radio equipment. This work resulted in the perfection of the first two-way radio telephonic connection between aircraft in flight and shore stations. He was communication officer of the naval seaplane *NC-1* during the first transatlantic flight. He is now in charge of radio field applications for the radio engineering department of the General Electric Co. He was born in 1894 in Brooklyn.

#### DAVID SARNOFF

If there is one man who understands both the technical and the business sides of radio, that man is David Sarnoff. He began his radio career when little more than a boy, serving as radio operator at ship and shore stations. He was apt at analyzing situations and at laying the foundation for a future in the wireless art. Promotions from operator to chief engineer, assistant traffic manager, contract manager, commercial department manager, and finally to general manager of the Radio Corporation of America, came rapidly. Trained as an electrical engineer at Pratt Institute, and with a rich business experience for a background, Sarnoff is a unique figure in the wireless field. His knowledge of wireless traffic, and his successful management of the problems connected with it, have allowed him to make



valuable contributions to the literature of the subject. He was born in 1891.

#### MAJOR-GENERAL GEORGE OWEN SQUIER

Major-General George Owen Squier is one of the most prominent figures in radio to-day. His army career began in 1887 when he was assigned to duty at Fort McHenry, Baltimore. A born physicist with a passion for experimenting, he became very friendly with the great scientists, Roland, Remsen, and Newcomb at Johns Hopkins University, and studied under them. There he formed lasting friendships and laid the foundation for his later inventions, which marked him as one of the world's leading investigators. He made noteworthy researches in electrochemical effects due to magnetization, the Sine wave system of telegraphy and ocean cabling, polarizing, photo-chronograph, tree telephony and telegraphy, multiplex telephony, and telegraphy over open circuit bare wires laid in the earth or sea. He is probably best known as the inventor of wired wireless. He represented the War Department as technical adviser of the American delegation at the international conference on electrical communication at Washington in 1920. He represented the Department of State at the sessions of the provisional technical committee of the international conference on electrical communication at Paris in 1921. He was expert assistant to the American commissioners representing the Government of the United States in the conference on the limitation of armament

at Washington in 1921, and was delegate to the international radio telegraph conference at London in 1912. He was awarded the John Scott Legacy medal and the Elliott-Cressen medal, both from Franklyn Institute. He was also awarded the Franklyn medal by the same institute. He was decorated with the insignia of knight commander of the order of St. Michael and St. George, the distinguished service medal of the United States army, and the Italian decoration of commander of the order of the Crown. He was born at Dryden, Michigan, in 1865, and was graduated from the United States Military Academy at West Point in 1887.

#### A. STEIN, JR.

A. Stein, Jr., associated himself with radio work in 1903, serving until 1910 as radio engineer. He was commercial engineer for the District & Printing Telegraph Co. from 1910 to 1916. He joined the Marconi Wireless Telegraph Co. in 1916, and served as chief engineer and works manager at the works at Roselle Park, New Jersey. At present he is managing engineer of the radio engineering department of the General Electric Co., Schenectady.

#### JOHN STONE STONE

John Stone Stone was an experimentalist in the research laboratory of the American Bell Telephone Co. in 1890-99 and made investigations of telephones without wires in 1892. He was consulting electrical engineer and expert of the Ladd Wireless Telephone

Syndicate, experimenting on directional signaling, in 1899. He was retained in 1900 by the Stone Wireless Telephone Syndicate, and in 1902, when the Stone Telegraph & Telephone Co. was organized. He is the author of many papers on wireless. He has been granted more than one hundred United States patents in the radio field and a correspondingly large number of foreign patents. He is fellow of the American Academy of Arts and Sciences, fellow of the American Association of Advanced Science, fellow and past president of the Institute of Radio Engineers and member or associate of various other societies. His investigations have been principally directed along the lines of eliminating interference in wireless telegraphy. He studied at Columbia and Johns Hopkins universities

#### A. HOYT TAYLOR

A. Hoyt Taylor is a physicist and radio expert. He was at one time professor of physics and director of the radio station at the University of North Dakota. He was a lieutenant in the naval reserve in 1917, and was district communication superintendent of the Ninth, Tenth, and Eleventh naval districts. He was transatlantic communication officer in 1917-18, and is now a commander engaged in research and development work in connection with aircraft radio. He is the author of numerous papers on electrical measurements and radio subjects. He was educated at Northwestern University, receiving the degree of doctor of science, and holds the degree of doctor of philosophy

## 312 THE COMPLETE RADIO BOOK

in electrical engineering from the University of Goettingen, Germany.

### HAWLEY OTIS TAYLOR

Hawley Otis Taylor is a radio physicist. He was instructor in physics at Cornell University from 1907 to 1913 and later became research physicist for the National Electric Signaling Co. and special adviser to the Submarine Defense Association. He devised signaling methods by means of which enemy scouts could make known their presence. He later investigated means for static reduction and developed an acoustic telephone while serving in the capacity of radio engineer in the signal corps of the army. He became consulting physicist to the United States bureau of standards in 1919. At present he is in charge of the electrical department for the rehabilitation of ex-service men at Franklin Union, Boston. He has made many valuable contributions to the radio art. He was born in 1876 at North Derby, Vermont. He received the degree of bachelor of arts from Cornell University in 1909 and that of doctor of philosophy in 1913.

### WILLIS H. TAYLOR

Willis H. Taylor is both a capable radio engineer and a patent lawyer, having ably defended several very important patents. He served two years with the American Expeditionary Force in France as captain and chief of the radio division of the signal corps, and cited for exceptionally meritorious service. He was

born in 1894 and received the degree of mechanical engineer from Stevens Institute of Technology in 1915.

#### NIKOLA TESLA

Nikola Tesla is one of the foremost of the world's electricians. He was graduated from Karlstadt in 1873. He devoted study to electrical investigations, and went to the Polytechnic School at Gratz, where he prepared for work as a professor of mathematics and physics. He visited America in 1882, when he captured the attention of the whole world with his fascinating experiments on high-frequency electric currents. Since 1890 he has devoted himself to studies of alternating currents of high frequency and very high potentials. He was born at Smiljan, Sika, Dalmatia, in 1857.

#### A. VAN DYKE

A. Van Dyke entered the radio field in the earlier days, making his *début* in 1911. He performed a great deal of important research work for the National Electric Signaling Co., which was at one time a very important factor in the wireless field. He also did important research work on high tension currents for the Western Electric Co., after which he served as an instructor in engineering at the Carnegie Institute of Technology at Pittsburg. Mr. Van Dyke is now in charge of the development and design of radio receiving apparatus in the General Electric Co. laboratories. He was graduated from Yale University in 1911 as an electrical engineer.

## ROY A. WEAGANT

Roy A. Weagant studied physics under Sir Ernest Rutherford and first became interested in radio through witnessing some of his experiments with Hertzian waves. He gained engineering experience with the Montreal Light, Heat & Power Co., the Westinghouse Electric & Manufacturing Co., and the De Laval Steam Turbine Co. He took up commercial wireless work in 1908, and entered the service of the Marconi Wireless Telegraph Co. of America in 1912, where he soon rose to the position of chief engineer. He is a fellow of the Institute of Radio Engineers and a former member of its board of directors and standardization committee. He is the inventor of a novel method of eliminating static interference. He was born at Morrisburg, Ontario, Canada, and was educated at Stanstead College, Stanstead, Quebec, and at McGill University, Montreal. He was graduated in 1905 as an electrical engineer. At present he is an engineer with the Radio Corporation of America.

## W. C. WHITE

There are very few men in this country who really understand vacuum tubes. W. C. White is one of them. Nine years of his life have been devoted to the development, design, and engineering of vacuum tubes in the laboratories of the General Electric Co. A number of very valuable patents have been issued in his name. The work of Mr. White is well known in

the radio field and he has earned for himself an enviable reputation.

Mr. White was born in Brooklyn in 1890. He received the degree of electrical engineer from Columbia University in the class of 1912.

## CHAPTER XVIII

### QUESTIONS AND ANSWERS

**W**HILE serving as radio editor on the staff of a large New York paper, one of the authors has been called upon to answer many radio questions. A great number of these questions were asked over and over again, since they had to do with problems that virtually every enthusiast meets with sooner or later. It was thought that a collection of the most pointed and common questions together with their correct answers would be a great help to the beginners who read this book. The following questions and answers have been chosen with care:

**Q.** Can one use the same "A" battery for both the detector and the amplifier?

**A.** You can use the same "A" battery for the detector and the amplifier. If we had to buy a separate storage battery for each, vacuum tube amplifiers would not be as popular as they are nowadays.

**Q.** Can I use a 2000-ohm receiver with a 3000-ohm receiver? How shall I connect them?

**A.** These receivers can be used together. Receivers, however, should be on the same ohmage. Connect them in series.



**Q.** I have a crystal receiving outfit. Can I use a fire-escape for a ground?

**A.** Don't use a fire-escape for a ground. Fire-escapes are not connected with the earth in any way and therefore cannot be used for the purpose.

**Q.** I have heard a great deal about using radiators as ground. Why can't they be used as aërials as well?

**A.** This is impossible. A radiator is grounded through the pipes and therefore will not function as an aërial.

**Q.** Can I remagnetize my receivers on an alternating current circuit using a large electromagnet? Will I have to use a resistance in the circuit?

**A.** You are going to ruin your receivers if you attempt to use the alternating current circuit with them. The electromagnet you have is useless for the purpose. Better send your head-phones back to the manufacturers to have this done.

**Q.** Is No. 18 cotton-covered wire too large to use on a tuning-coil? I want to make a coil for 360-meter stations.

**A.** No. 18 wire is not too large, but you will need a larger form to wind it on.

**Q.** When should a variable condenser be placed in the ground lead? In the receiving circuit? In the lead-in?

**A.** A variable condenser is placed either in the ground or antenna lead either to lengthen or shorten the range of wave-lengths the receiver will respond to. If the condenser is placed in series with the antenna

or ground, the wave-length range will be decreased, and if placed in parallel or across the antenna inductance the wave-length range will be increased.

**Q.** I have made a crystal receiving set consisting of a detector, tuning-coil, fixed condenser, variable condenser, and receiver. All I can hear is a humming sound. My antenna is sixty-five feet. Will lengthening the aërial remedy the condition?

**A.** No. Lengthening the aërial will not remove the hum. Are you sure that you have your set correctly connected? A hum may be caused by a neighboring conductor through which flows alternating current. Perhaps your antenna is running parallel to a power line. In that case, place your antenna at right angles to the line.

**Q.** Will I have to scrape the insulation off my aërial wire? Will the same wire answer the purpose of a lead-in, and can the same wire be used in connecting a set? In making a tuning-coil can I use a two-inch tube instead of a three-inch tube? Can I use a wooden block in a tuning-coil?

**A.** You will not have to scrape the insulation for your aërial wire. You can use the same wire in connecting the instruments if you wish. But you will find that ordinary lamp cord is very good to use in connecting up a receiving instrument, since it is flexible. There is nothing to prevent you from using a two-inch tube for a tuning-coil. You can use a block for the tuning-coil if the corners are rounded off. Don't use a block with sharp corners.

**Q.** What is the largest number of feet of wire that can be used in a one-wire aerial. Does it make any difference whether the aerial points north or south, east or west?

**A.** A single-wire aerial 125 feet long will serve nicely in receiving the broadcasted music. As far as the direction of the aerial is concerned you will have all points of the compass at your disposal.

**Q.** Is it safe to touch galena with the bare fingers? Can a large piece be broken up and the pieces placed in the detector cup together? How many connections are there on a double-slide tuning-coil?

**A.** Galena should be handled as little as possible with the bare fingers. The natural oil on the hands will cover the surface of the crystal and render it less sensitive. This oil must be removed, and this may be done by bathing the crystal in alcohol or ether. Crystals may be broken up and the new surface used, and as many crystals as desired may be mounted together in the detector cup. The double-slide tuning-coil has three connections: the beginning of the winding is connected to the antenna and to the detector; one of the sliders is connected to the ground and the other to the head-phones.

**Q.** Would the following equipment give good results with a suitable aerial and ground for receiving the broadcasting stations? Three-thousand-meter loose coupler, variable condenser, and crystal detector? Would I get better results by substituting a variometer for the variable condenser or by using honeycomb coils

with a standard three-coil tuning receptacle? Can a standard short-wave regenerative set consisting of two variometers and a vario-coupler be used with a crystal detector?

A. You would also need a pair of telephone receivers in the above equipment. You do not tell what you mean by a "suitable" aerial and ground, but the 3000-meter loose coupler is far too large to tune in the 360-meter broadcasting waves efficiently. Since you have not told where the variable condenser is located it is difficult to tell whether it can be replaced by the variometer. If the variometer replaces the variable condenser in the antenna circuit it will have the effect of increasing the wave-length. If the condenser is across the secondary winding it should be left there. You have apparently the wrong impression regarding regenerative receivers. The thing that permits the circuit to operate as a regenerative receiver is the vacuum tube and the method of connection. Therefore a crystal detector is not commonly used in a regenerative circuit. If you use the three-coil mounting with a vacuum tube there is no doubt that you will get better results. You will find it more convenient, perhaps, to use the two variometer and vario-coupler arrangement with a vacuum tube instead of the honey-comb coils, if you intend receiving on short waves only.

Q. How can a receiving outfit be grounded on a bicycle? Can the frame of the bicycle be used?

A. You will have to be satisfied with a poor ground

connection if you expect to receive while you are riding. Try dragging a copper wire after you. The metal frame of the bicycle will not do.

**Q.** How can you use a dry cell to test out radiophone receivers?

**A.** Soak a small piece of paper in water. Connect your receivers in series with the dry cell, leaving the circuit open. Then place the two wires in contact with the wet paper. If you hear a click in your receivers they are all right. Don't connect your receiver directly to the dry cell, for the current passing through them would be too heavy.

**Q.** I am going to take a small radiophone receiver with me this summer when I go camping. I am not going to be near water. How shall I make a good ground?

**A.** Drive an iron pipe down into moist earth or bury an old pan full of charcoal in moist earth. Solder your connection to the pan if possible. Go to a depth of at least five feet in either case. The deeper the better.

**Q.** Can a tuning-coil be wound on a tin can if the can is first covered with a layer of waxed paper?

**A.** No. Emphatically *no*. Never use a metal form for a tuning-coil.

**Q.** Can I attach one end of my aërial to a tree? Will the branches interfere?

**A.** The branches will interfere when they have leaves on them. Attach a rope to one end of the aërial so that the wire will clear the branches.

**Q.** Would you please tell me whether enameled wire is as good as insulated or covered wire in making a tuning-coil?

**A.** Enameled wire is insulated. You certainly can use this wire on your tuning-coil.

**Q.** Is a variometer better than a single-slide tuning-coil for receiving? Can I use this with a crystal detector?

**A.** A variometer is better than a single-slide tuning-coil if it is of the right size and design. This may be used with a crystal detector.

**Q.** Is a two-slide tuning-coil better than a single-slide coil?

**A.** A two-slide coil is much better than a single-slide coil. It may cost a little more, but the difference in price is offset by the difference in service rendered.

**Q.** Can an ordinary telephone receiver like those supplied with house telephones be used for a radio receiving set?

**A.** Such a receiver can be used, but it will not give the results that you might expect. Such receivers are generally wound to only seventy-five ohms, and it would therefore be advisable to purchase a 2000-ohm receiver.

**Q.** I have a four-wire aerial 100 feet long. I use this with a receiving tuner somewhat on the style of a loose coupler. With this I also use a crystal detector and two fixed condensers. I can hear Arlington well, but can hear no local music. Must I have a vacuum tube?

A. You cannot hear the music because you are unable to adjust your set to a point where it will receive the shorter wave-lengths used by the broadcasting stations. Try placing a variable condenser in series with the aërial and ground.

Q. Can I operate a six-volt vacuum tube detector on a four-volt storage battery with enough "B" battery? Can I use a loud speaker with a regenerative set employing one vacuum tube?

A. Your vacuum tube will operate at maximum efficiency only when used with a six-volt battery. A loud speaker can be used with a regenerative receiver.

Q. Will a loud speaker operate with a single vacuum tube?

A. If you have a good aërial and the broadcasting station is within a few miles, fairly good results will be had with a loud speaker that does not require auxiliary current.

Q. I am building a tuning transformer. I think I understand the method of connecting it up, but I am not sure of the size of the wire that is to be used for the primary and the secondary.

A. Use No. 22 cotton-covered wire on the primary and No. 28 on the secondary.

Q. When I tune with my variable condenser a point is reached where I cannot hear any signals. What is wrong? When I leave the condenser alone and tune only with the receiving transformer I hear well.

A. You probably have a short circuit in your condenser. The plates are evidently touching. It may

be only one plate that is a trifle out of true. Hold the condenser up to the light. You may be able to see the troublesome plate. If you do, straighten it out with a knife.

Q. Is a carborundum crystal as sensitive as galena?

A. No, galena has no apologies to make to carborundum so far as sensitivity is concerned. Galena is best for general amateur use.

Q. I have been unable to solder the joints of my aërial. What would you suggest as a substitute?

A. Scrape your wires clean and wrap them with tin-foil. Put friction tape over the tin-foil.

Q. Are 2000-ohm receivers as good as 3000-ohm receivers?

A. Much depends upon the construction of the receivers. For a given construction, a 3000-ohm pair of head-phones should be more sensitive than a 2000-ohm pair.

Q. A friend told me that a long ground wire increased the wave-length of a station. I argue no. Am I right?

A. Your radio education is sadly incomplete. Our friends are not always right, but in this case your friend was correct. If you are transmitting, keep your ground wire as short as possible.

Q. I have built a rectifier to charge my storage battery from the lighting circuit, but the results have been disappointing. I am using a solution of sodium bicarbonate. Anything wrong with this?

A. Go to the drug-store and get a few ounces of



ammonium phosphate. Make a saturated solution of this and use it in place of the solution you are now using.

Q. While listening last evening I heard a station sending the letter "V." It sent this signal for at least fifteen minutes. What did this mean?

A. The letter "V" is the standard test signal. When one station is testing with another this signal is used.

Q. I now have a receiving outfit, but I want to install a transmitter. My present aërial is 300 feet long. It is made up of three wires spaced two feet apart. Is this too large for sending?

A. Don't transmit with that aërial if you want to remain a friend of the radio inspector. Your wavelength would be far beyond the 200-meter limit.

Q. I have a crystal receiving outfit. Can I add a vacuum tube amplifier to it to strengthen the signals?

A. This has been done experimentally, but unless you are a wireless wizard we should not advise you to try it. The results would not please you. Better get a vacuum tube detector and sell your crystal receiver.

Q. I want to put up a powerful transmitting station with a one-kilowatt transformer. Will I need a license? Can I operate this from a direct current circuit?

A. If you don't know any more about radio than your question would indicate, we should advise you to leave powerful transformers alone. Remember

that "Rome was not built in a day." Spark-coils behave much better than transformers under the care of inexperienced hands. Don't be too ambitious. Yes, you will need a license to operate a transmitter. Address a letter to Radio Inspector, Custom-house, New York City. You cannot operate a transformer from a direct current circuit unless you use a motor generator, which is rather costly.

Q. Can the wave-length of a receiving outfit be adjusted without a tuning-coil?

A. Yes, it is possible to adjust a receiver to various wave-lengths without a conventional tuning-coil. Use a lattice-wound inductance (coil) and connect a variable condenser across it. Radio folks call this "shunting" a condenser across a coil.

Q. My head-phones will respond to the signals only when the cap is screwed to a certain tightness. What's wrong?

A. You have probably bent the diaphragm. Get a new one from the manufacturer. Incidentally, do n't fuss with your phones. Their sensitivity is very easily destroyed if the diaphragms are bent.

Q. Will a variable condenser increase my range?

A. A variable condenser will allow you to tune better. It will not increase your receiving range.

Q. Can I use two crystal detectors and a loud speaker?

A. No, this arrangement would not give you any amplification of the signals. It simply would not work.

**Q.** I have tried to receive the signals of the big commercial stations with an outfit that was sold especially for broadcasting work. I have not had any success. What is wrong? A friend told me my outfit would not respond to such long waves. Is he right? Can I buy an attachment of some kind that will allow me to receive from these stations?

**A.** Your friend was quite right. Yes, you can buy what is known as a loading coil for this work. This can be connected to your present outfit. Ask your dealer for such a coil, and tell him what stations you want to hear. The cost will be less than two dollars.

**Q.** Can the principle of regeneration be applied to crystal detectors?

**A.** How nice it would be if the principle of regeneration could be applied to crystal detectors! Unfortunately this cannot be done.

**Q.** Could I use a variable condenser across the phones? Would this help to eliminate static as well as a fixed condenser?

**A.** A variable condenser could be used for this purpose, but is unnecessary. A fixed condenser can be used, and it costs only a few cents. Why not do this and use your variable condenser where it is needed most?



## INDEX

- "A" battery, 148  
Aërial, function of, 63  
Aërial, large, 101  
Aërial, loop, 113  
Aërial, one-wire, 62  
Aëroplane radio, 266  
Alternating current, 57  
Alternators, high-frequency, 66  
American radio plan, 200  
Amplifier, radio-frequency, 112  
Amplifier, two-stage, 111  
Arc generator, 65  
Arrester, lightning, 86  
Avalon radiophone circuit, 80
- Battery, "A", 148  
"B" Battery, 91  
Belin photographic transmitter, 177  
Boaz telegraph system, 12  
British radio plan, 197  
Buzzer test, 87
- Capacity, 60  
Chappe semaphore, 10  
Circuit, closed oscillatory, 62  
Code, telegraph, 123  
Coil, induction, 61  
Coil, tickler, 154  
Coil, tuning, 70  
Compass, radio, 219  
Condenser, 61  
Condenser, discharge of, 62  
Continuous wave transmitter, 118  
Continuous waves, production of, 65
- Control, radiodynamic, 170  
Creed typewriter, 184  
Crystal detector, principle of, 72  
Crystal receiver, connection of, 103  
Current, alternating, 57  
Current, direct, 57  
Current, high-frequency, 58
- Damped wave, 64  
De Forest vacuum tube, 146  
Detector, crystal, principle of, 72  
Direct current, 57  
Districts, radio, 95  
Dolbear, Professor, work of, 47
- Edgeworth semaphore, 10  
Edison effect, 140  
Ether-waves, 53
- Fire telegraph, Greek and Roman, 7  
Fleming vacuum tube, 142  
Frequency of ether-waves, 55
- Games, playing by radio, 129  
Grounds, 102  
Ground telegraphy, 34
- Hertz, work of, 31  
High-frequency alternator, 66  
High-frequency current, 58  
History of the telephone, 22  
Hooke telegraphing system, 9
- Indian communication system, 4  
Inductance, 59  
Induction-coil, 61
- Kepler telegraphing system, 8

- Lightning arrester, 86  
 Lightning protection, 86  
 Loomis, Dr. Mahlon, radio work of, 35  
 Loop aerial, 113  
 Loud speaker, 91  
  
 Marconi, Guglielmo, work of, 48  
 Maxwell, James Clerk, work of, 31  
 Morse telegraphy, 16  
 Moth radio, 28  
  
 Newspaper radio, 278  
  
 Photographic transmitter, Belin, 177  
 Postal systems, 13  
 Preece, Sir William, work of, 47  
 Principle of receiving stations, 69  
  
 Radio and newspaper, 278  
 Radio Central, 200  
 Radio compass, 219  
 Radio districts, 95  
 Radio-frequency amplifier, 112  
 Radio in aeroplanes, 266  
 Radio in railroad trains, 261  
 Radio in stock exchange, 252  
 Radio telephony, development of, 74  
 Radiodynamic control, 170  
 Railroad trains, radio in, 261  
 Receiver, operation of, 88  
 Receiver, regenerative, 110  
 Receiving instruments, operation, 69  
 Regenerative circuit, 153  
 Regenerative receiver, 109  
 Resistance, electrical, 59  
  
 Semaphore, Chappe, 10  
 Semaphore, Edgeworth  
 Spark transmitter, 114  
 Stock exchange, radio in, 252  
 Submarine cable, laying of, 19  
  
 Telegraph code, 123  
 Telegraph, Morse, 16  
 Telephone, history of, 22  
 Telephone transmitter, 75  
 Telephony, radio, development of, 74  
 Test, buzzer, 87  
 Three-element vacuum tube, 146  
 Tickler coil, 154  
 Transmission, principles of radio, 60  
 Transmitter, Belin photographic, 177  
 Transmitter, continuous-wave, 118  
 Transmitter, spark, 118  
 Transmitter, telephone, 75  
 Transmitter, vacuum tube, 118  
 Tuning-coil, 70  
 Tuning, principles of, 70  
 Two-stage amplifier, 111  
 Typewriter, Creed, 184  
  
 Ultra-micrometer, 158-159  
 Undamped waves, 64  
  
 Vactuphone, 161  
 Vacuum tube, De Forest, 146  
 Vacuum tube, Fleming, 142  
 Vacuum tube receiver, connection of, 108  
 Vacuum tube receiver, operation of, 89  
 Vacuum tube, three-element, 146  
 Vacuum tube transmitters, 118  
  
 Wave-length, ether-waves, 54  
 Wave-length, increasing of, 83  
 Wave-length, reduction of, 83  
 Waves, damped, 64  
 Waves, ether, 53  
 Waves, undamped, 64