

R
A
D
I
O

How To Make
And Operate

R
A
D
I
O

How To Make
And Operate

Albert
Warren

James
John

Copyright
Copyrighted

1922

The Goldsmith Publishing Co.



1922
James
John

Radio for the Beginner

INTRODUCTION

In response to the tremendous interest in wireless, created by the erection of wireless telephone broadcasting stations all over the country, many styles of complete ready-to-operate receiving outfits have been developed. We have carefully selected certain of these sets, of a wide price range, which seem to combine the features of efficient service with simplicity of operation.

Radio communication is growing at a rapid rate with the establishing of an ever-increasing number of high powered radio stations in different parts of the world, and one of the latest developments, which seems to bid fair to open up a new departure in the radio field in general, is the wireless telephone.

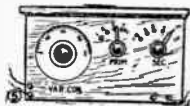

Up to a few years ago the experts could not accomplish a great deal with the radio telephone, but with the advent of the new vacuum tubes, which are now designed to transform quantities as great as $\frac{1}{2}$ kilowatt or more of alternating current power at 60 cycles, into radio-frequency power,

suitable for transmitting the human voice across many miles of space, a brand new era has been ushered in.

Every day there are radio concerts. Dance music and vocal selections, classical music and the latest popular "hits" are being sent out regularly by radio-telephone. Some of it is probably passing unheard through your own home.

All that's needed to make this music heard—and as near to you as your own phonograph—is a simple radio-receiving set.

There are dozens of these sets all made up and ready to use. There are scores of plans available for those who prefer to make up their own sets.



See that you get the right kind of 'phones with it. The distances over which you receive messages will depend entirely upon the efficiency of the various parts of your receiving outfit. Poorly made 'phones will make a good receiving set bad and a bad receiving set much worse. Everywhere one is met with the question "What sort of apparatus do I need to hear these radio concerts?" Or again, "What parts shall I buy to make a simple receiving set?"

If you want the hourly quotation on hogs from Chicago, an up-to-the-minute report on the weather and shipping

conditions in the Port of New York, a bedtime story to put the kids to sleep, a bit of jazz, the day's stock market, or a sermon to help you face with fortitude the call for the first quarter's income tax, help yourself. You can get almost anything any time by radio. All you need is a little wire to intercept the radio waves that carry the messages and a little receiver to translate them into sound.

If you are within fifteen miles of San Francisco, Los Angeles, Denver, Omaha, Kansas City, Wichita, Chicago, Cleveland, Buffalo, Boston, New York, Washington, or any of the larger cities, a receiver costing from \$3 to \$12 will be good enough to begin with. The dealer calls these "mineral detector sets." If you are farther away from a city where radio telephone transmitters are at work you will need a "vacuum tube" receiver. This costs from \$25 up, including the necessary batteries, tubes and phones. In either case you will need to put up a wire—the aerial—so that the radio waves can trickle down to your listening ear.

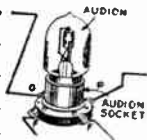

Here are call letters of stations broadcasting radio music, lectures, stories, grand opera, vocal and instrumental music, the stations being as follows:

<i>Westinghouse, Newark, N. J.</i>	<i>WJZ</i>
<i>Roselle Park, N. J.</i>	<i>WDY</i>
<i>Cleveland, Ohio</i>	<i>WHK</i>
<i>Pittsburgh, Penna</i>	<i>KDKA</i>
<i>Springfield, Mass</i>	<i>WBZ</i>
<i>Chicago, Ill.</i>	<i>KDY</i>
<i>Detroit, Mich.</i>	<i>WWJ</i>

Anyone within a radius of 100 miles of these stations by means of a simple apparatus can listen-in.

The news, the music, the stories, prayers and sermons, are put into the air by powerful transmitting stations where human voices and the notes of musical instruments are changed into radio waves that ripple away a thousand miles or more.

A mineral detector set is less sensitive than a vacuum tube set. As compared with the "v. t." apparatus it is like a man who is somewhat deaf. It takes more energy to affect his ear drums. So for the cheaper receivers the wire should be comparatively long—say 100 feet—in order to pick up sufficient energy to penetrate the receiver and make sounds loud enough for the ear to hear.

Herewith we present the complete plans and instructions for building a very simple and cheap radio receiving outfit which will enable one to listen to both radio code messages and to music and voice transmitted by wireless.



This radio set was designed by U. S. government experts and is scientifically correct. This radio outfit is what is known as a crystal-detector receiving set. It will enable one to hear music and voice within the area of a large sized city and to hear high power wireless telegraph stations within a radius of fifty miles.

The receiving set without the telephone receivers can be built for \$3.36 or less. Receivers will cost from \$1.50 to \$8. The better your receivers are the more efficient the set will be.

The aerial can be constructed for \$2.00 or less. The buzzer outfit will cost \$1.10. The buzzer is merely to help in posting the galena or crystal for a sensitive spot and is not necessary.

ESSENTIAL PARTS

Read the following directions carefully before buying your material or attempting to construct the set:

There are five essential parts: the antenna, lightning



switch, ground connections, receiving set and phone. The received signals come into the receiving set through the antenna and ground connection. In the receiving set they are converted into an electric current which produces the sound in the "phone." The phone is either one or a pair of telephone receivers worn on the head of the listener.

The purpose of the lightning switch is to protect the receiving set from damage by lightning. It is used to connect the antenna directly to



ground when the receiving station is not being used. Fire underwriters demand this. When the lightning switch is closed, thereby connecting the antenna to the ground, an antenna acts as a lightning rod and is a protection rather than a source of danger to the building.

The principal part of the station is the "receiving set." In the set described herein it is subdivided in two parts. The "tuner" and the "detector," and in more complicated sets still other elements are added.

THE ANTENNA

The antenna is simply a wire suspended between two elevated points. Wherever there are two buildings, or



a house and a tree or two trees, with one of them very close to the house, it relieves one of the need of erecting one or both antenna supports. The antenna should not be less than 30 feet above the ground and its length should be about 90 feet. (See Page 14.) While this figure indicates a three wire horizontal antenna, it is not important that it be strictly horizontal. It is, in fact, desirable to have the far end as high as possible. The "lead-in" wire, or drop wire from the antenna itself should run as directly as possible to the lightning switch. If the position of the adjoining buildings or trees is such that the distance between them is greater than about 40 feet, the antenna can still be held to a 90-foot distance between the insulators by increasing the length of the piece of rope to which the far end of the antenna is attached. The rope tying the antenna insulator to the house, should not be lengthened to overcome this difficulty because by so doing the antenna "lead-in" rod wire would be lengthened.

DETAIL OF PARTS

For parts mentioned in following paragraph refer to pages 14, 27 and 28 for detail.

Screw eyes sufficiently strong to anchor the antenna at the ends.

Pieces of wood $\frac{1}{2}$ or $\frac{3}{4}$ inch in thickness just long enough to allow antenna to swing clear of the two supports.

Six insulators are constructed. They should be made of any dry hardwood of sufficient strength to withstand the strain of the antenna; blocks about $1\frac{1}{2} \times 2 \times 10$ inches will serve. The holes should be drilled as shown on page 14, sufficiently far from the end to give proper strength. If wood is used the insulators should be boiled in paraffin for about one



hour. If porcelain wiring cleats are available they may be substituted for the wood insulators. If any unglazed porcelain is used as insulators, it should be boiled in paraffin. The regular antenna insulators on the market are made of insulating compound or porcelain and are usually very good but the two improvised types just mentioned will be satisfactory for an amateur receiving antenna.



A single block pulley may be used if readily available.

A piece of $\frac{1}{4}$ or $\frac{1}{2}$ -inch rope sufficiently long to fasten to screw eyes to support your antenna.

The antenna is in three pieces about 30 feet long between

the insulators. The wire may be No. 14 or 16 copper wire, either bare or insulated. The end of the antenna farthest from the receiving set may be secured to the insulator (E) by any satisfactory method, being careful not to kink the wire. Fan connectors can be used. Draw the other end of the antenna wire through the other insulator to a point where the two insulators are separated by about 30 feet, twist the insulator so as to form an anchor as shown on page 14. The remainder of the antenna wire which now constitutes the "lead-in" or drop-wire should be just long enough to reach the lightning switch.



Use a lightning switch. For a small antenna this switch may be the ordinary porcelain base, 30 ampere, single-pole double-throw battery switch. These switches, as ordinarily available, have a porcelain base about one to four inches. The "lead-in" wire is attached to this switch at the middle point. The switch blade should always be thrown to the lower clip when the receiving set is not actually being used and to the upper clip when it is desired to receive signals.

The ground wire for the lightning switch may be a piece of the same size wire as used in the antenna, of sufficient length to reach from the lower clip of the lightning switch to the clamp on the ground rod.

0

RADIO MANUAL

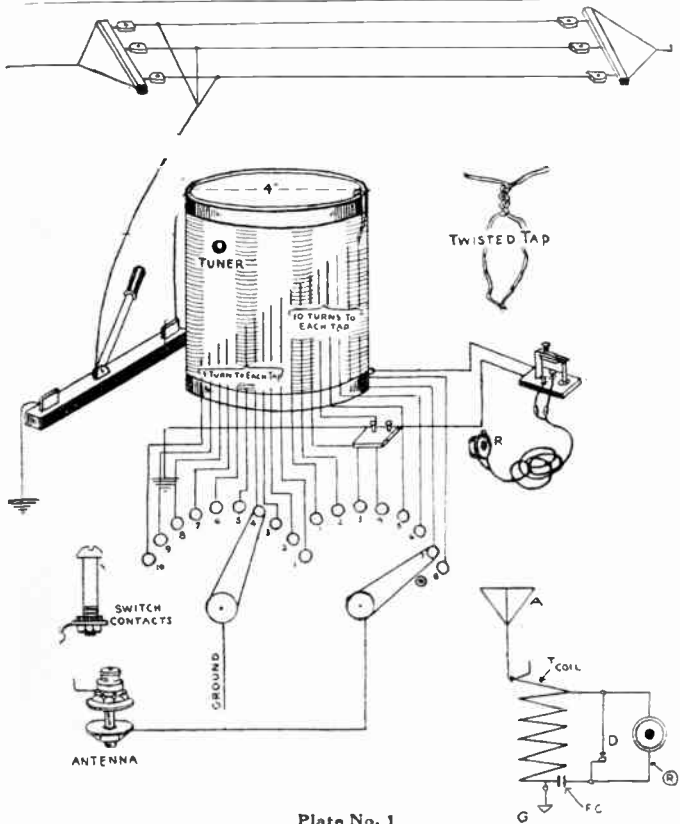

Plate No. 1

From *The Radio*

A good ground is a piece of iron pipe or rod driven three to six feet into the ground, preferably where the ground is moist, and extending a sufficient distance above the ground in order that the ground clamp may be fastened to it. Scrape the rust or paint from the pipe before driving into the ground.



A wire leading from the upper clip of the lightning switch through the porcelain tube to the receiving set binding post marked "antenna."

Use a porcelain tube of sufficient length to reach through the window casing or wall. This tube should be mounted in the casing or wall so that it slopes down toward the outside of the building. This is done to keep the rain from following the tube through the wall to the interior.

The radio receiving set should be installed in the part of the house nearest intake of antenna.

The receiving set is described in detail below.

A wire leads from the "antenna" binding post of the receiving set through the porcelain tube to the upper clip of the lightning switch. This wire, as well as the wire marked "ground" should be insulated and preferably flexible. A piece of ordinary lamp cord might be unbraided and serve for these two leads.

A piece of flexible wire leading from the receiving set binding post marked "ground" to a water pipe, heating system or some other metallic conductor to ground.

In case there are no water pipes or radiators in the room in which the receiving set is located, the wire should be run out of doors and connected to a special "ground" below the window, which shall not be the same as the "ground" for the lightning switch. It is essential that for the best operation of the receiving set this "ground" be of the very best type. If the soil near the house is dry it is necessary to drive one or more pipes or rods sufficiently deep to encounter moist earth and connect the ground wire to the pipes or rods. This distance will ordinarily not exceed six feet. Where clay soil is encountered this distance may be reduced to three feet, while in sandy soil it may be increased to ten feet. If some other metallic conductor, such as the casing of a drilled well, is not far away from the window, it will be a satisfactory "ground."

TUNER, DETECTOR AND PHONE

The detector and phone will have to be purchased. The tuner and certain accessories can be made at home.

TUNER (page 27)—This is a piece of cardboard or other non-metallic tubing with turns of copper wire wound

around it. The cardboard tubing may be an oatmeal box. Its construction is described in detail below.

CRYSTAL DETECTOR (page 27)—The construction of a crystal detector may be of very simple design and quite satisfactory. The crystal, as it is ordinarily purchased, may be unmounted or mounted in a little block of metal. For mechanical reasons the mounted type may be more satisfactory. It is very important, however, that a good quality of tested crystal be used. A galena crystal is more satisfactory for the beginner.



The crystal detector may be made up of a tested crystal, three wood screws, short piece of copper wire, a nail, set-screw type of binding post and a wood knob or cork. The tested crystal is held in position on the wood base by three brass wood screws as shown on page 17. A bare copper wire may be wrapped tightly around the three brass screws for contact. The assembling of the rest of the crystal detector is quite clearly shown.

PHONE (R, page 14)—It is desirable to use a pair of telephone receivers connected by a head band, usually called a double telephone headset. The telephone receivers may be any of the standard commercial makes having a resistance

of between 2,000 and 3,000 ohms. The double telephone receivers will cost more than all the other parts of the station combined.

ACCESSORIES—Under the heading of accessory equipment may be listed binding posts, switch arms, switch contacts, test-buzzer, dry battery and boards on which to mount the complete apparatus. The binding posts, switch arms and switch contacts may all be purchased from dealers who handle such goods or they may be quite readily improvised at home. There is nothing peculiar about the pieces of wood on which the equipment is mounted. They may be obtained from a dry packing box and covered with paraffin to keep out moisture.

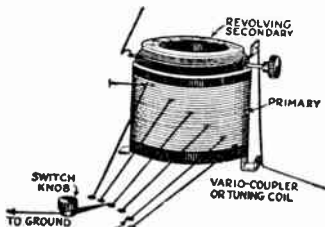

DETAILS OF CONSTRUCTION

The following is a detailed description of the method of winding the coil, construction of the wood panels and mounting and wiring the apparatus.

TUNER (See page 27)—Having supplied oneself with a piece of cardboard tubing 4 inches in diameter and about $\frac{1}{2}$ pound of No. 24 (or No. 26) double cotton-covered copper wire, one is ready to start the winding of the tuner.

Punch two holes in the tube about $\frac{1}{2}$ inch from one end as shown on page 27. Weave the wire through these holes in such a way that the end of the wire will be quite firmly anchored, leaving about 12 inches of the wire free for connections. Start with the remainder of the wire to wrap the several turns in a single layer about the tube tightly and closely together. After 10 complete turns have been wound on the tube hold those turns snugly while a tap is being taken off. This tap is made by making a 6-inch loop of the wire and twisting it together at such a place that it will be slightly staggered from the first tap. This method of taking off taps is shown quite clearly on page 14. Proceed



in this manner until 71 twisted taps have been taken off at every 10 turns. After these first 70 turns have been wound on the tube then take off a 6-inch twisted tap for every succeeding single turn until 10 additional turns have been wound on the tube. After winding the last turn of wire anchor the end by weaving it through two holes punched in the tube

much as was done at the start, leaving about 12 inches of wire free for connecting. It is to be understood that each of the 18 taps is slightly staggered from the one just above, so that the several taps will not be bunched along one line on the cardboard tube. See page 27. It would be advisable, after winding the tuner as just described, to dip the tuner in hot paraffin. This will help to exclude moisture.

UPRIGHT PANEL AND BASE—Having completed the tuner to this point, set it aside and construct the upright panel. This panel should be made from a piece of wood approximately $\frac{1}{2}$ -inch thick. The position of the several holes for the binding posts, switch arms and switch contacts, may first be laid out and drilled. The "antenna" and "ground" binding posts may be ordinary $\frac{1}{4}$ -inch brass



bolts of sufficient length and supplied with three nuts and two washers. The first nut binds the bolt to the panel, the second nut holds one of the short pieces of stiff wire, while the third nut holds the antenna or ground wire as the case may be. The switch arm with knob shown on page 20,

may be purchased in the assembled form or it may be constructed from a thin slice cut from a broom handle and a bolt of sufficient length equipped with four nuts and two washers, together with a narrow strip of thin brass somewhat as shown. The switch contacts (page 21) may be of the regular type furnished for this purpose, or they may be brass bolts equipped with one nut and one washer each, or they may even be nails driven through the panel with an individual tap fastened under the head or soldered to the projection of the nail through the panel. The switch contacts should be just close enough that the switch arm will not drop between the contacts, but also far enough apart that the switch arm can be set so as to touch only one contact at a time. The telephone binding post should preferably be of the set screw type as shown above and also on page 14.



INSTRUCTIONS FOR WIRING

Having constructed the several parts just mentioned and mounted them on the wood base, one is ready to connect the several taps to the switch contacts and attach the other necessary wires. Scrape the cotton insulation from

the loop ends of the sixteen twisted taps as well as from the ends of the two single wire taps coming from the first and last turns. Fasten the bare ends of these wires to the proper switch contacts as shown by the corresponding numbers on page 14. One should be careful not to cut or break any of the looped taps. It would be preferable to fasten the connecting wires to the switch contacts by binding them between the washer and the nut as shown on page 14. A wire is run from the back of the binding post marked

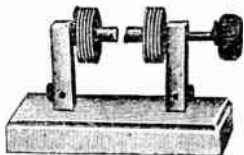

“ground” (page 14) to the back of the left-hand switch-arm bolt, and thence to the bottom of the left-hand binding post marked “phones.” A wire is then run from the bottom of the right-hand binding post marked (“phones”) to the bottom of the binding post (page 14), which forms a part of the crystal detector. A piece of No. 24 bare copper wire about $2\frac{1}{2}$ inches long, one end of which is twisted tightly around a nail (the nail passing through binding post), the

other end of which rests gently by its own weight on the crystal will do for the detector feeler. Then the bare copper wire which was wrapped tightly around the three brass wood-screws holding the crystal in place is led to and fastened at the rear of the right-hand switch-arm bolt, and thence to the upper left-hand binding post marked "antenna." As much as possible of this wiring is shown on page 14.



DIRECTIONS FOR OPERATING

After all the parts of this crystal detector radio receiving set have been constructed and assembled, the first essential operation is to adjust the little piece of wire, which rests lightly on the crystal, to a sensitive point. This may be accomplished in several different ways; the use of a miniature buzzer transmitter is very satisfactory. Assuming that the most sensitive point on the crystal has been found by the method described in paragraph below, "The Test Buzzer," the rest of the operation is to get the radio receiving set in resonance or in tune with the station from which one wishes to hear messages. The tuning of the receiving set is attained by adjusting the inductance of the

tuner. That is, one or both of the switch arms are rotated until the proper number of turns of wire of the tuner are made a part of the metallic circuit between the antenna and ground, so that together with the capacity of the antenna the receiving circuit is in resonance with the particular transmitting station. It will be remembered that there are 10 turns of wire between each of the first 8 switch contacts

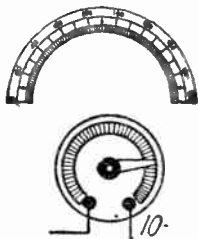

and only one turn of wire between each two of the other contacts. The tuning of the receiving set is best accomplished by setting the right-hand switch arm on contact (1) and rotating the left-hand switch arm over all its contacts. If the desired signals are not heard, move the right-hand switch arm to contact (2) and again rotate the left-hand switch arm throughout its range. Proceed in this manner until the desired signals are heard.

It will be advantageous for the one using this radio re-

ceiving equipment to find out the wave frequencies (wave length) used by the several radio transmitting stations in his immediate vicinity.

The Test Buzzer—As mentioned previously it is much easier to find the more sensitive spots on the crystal by using a test buzzer. The test buzzer is used as a miniature local transmitting set. When it is connected to the receiving set the current which is produced by the test buzzer will be converted into sound by the telephone receivers and the crystal, the loudness of the sound depending on what part of the crystal is in contact with the fine wire. To find the most sensitive spot on the crystal connect the buzzer to the receiving set as directed, close the switch (and if necessary adjust the buzzer armature so that a clear note is emitted by the buzzer), set the right-hand switch arm on contact point No. 8, fasten the telephone receivers to the binding posts marked "phones," loosen the set screw of the binding post slightly and move the fine wire to several different points of contact on the crystal until the loudest sound is heard in the phones, then tighten the binding post set screw slightly.*

*Radio News.

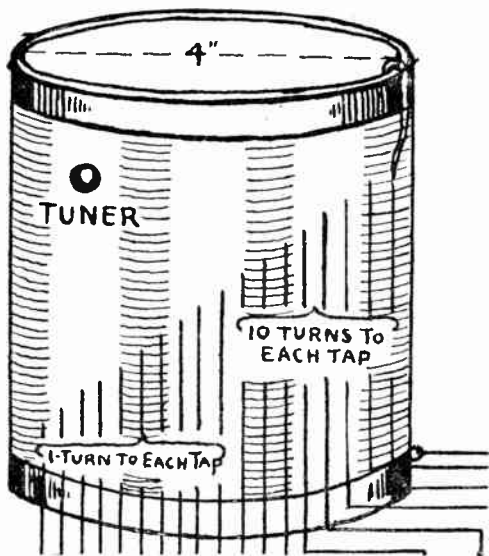

Plate II

Plans for bringing wires to the switch contacts

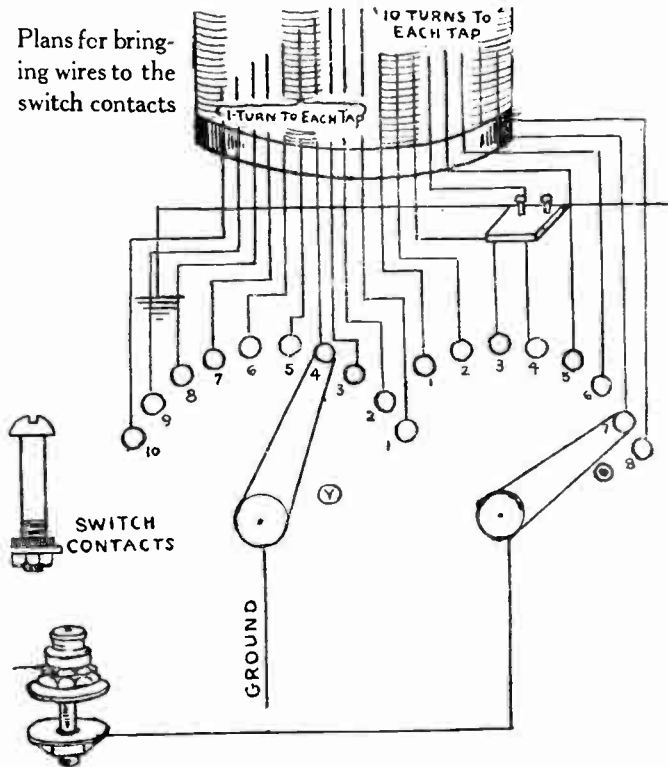

Plate III

Estimated Cost of Building the Set

RECEIVING SET

Quarter pound No. 24 copper wire, doubled cotton covered.....	\$.40
5 inches cardboard tubing, 4 in. in diameter.....	.15
2 switch knobs and blades complete.....	1.00
18 switch contacts and nuts.....	.72
18 extra nuts to fit switch contacts.....	.06
3 binding posts, set screw type.....	.45
2 binding posts, any type.....	.20
1 piece of galena.....	.35
3 wood brass screws, $\frac{3}{4}$ inch long.....	.03
	<hr/>
	\$3.36

Wood for base, 12 x 16 inches.

Wood for panel, $\frac{3}{4}$ inch thick, $4\frac{3}{4}$ x $8\frac{1}{4}$ inches.

Telephone receivers..... \$1.50 to \$8.00

ANTENNA

Antenna wire, copper, bare or insulated, No. 14, 100 to 150 feet, about	\$.95
Rope, $\frac{1}{4}$ or $\frac{1}{2}$ inch, 2 cents per foot.	
6 insulators, porcelain60
Lightning switch, 30 ampere battery switch45
1 porcelain tube05
Ground connection wire. (Same as antenna wire).	
1 iron rod or pipe	
	\$2.05

Radio Terms Defined

Twenty years ago a miracle was performed. Marconi dispatched his immortal message across the Atlantic without a connecting wire. Today, after twenty years of more or less languid interest, the whole world has taken up the art and by popularizing it has created a veritable "gold rush," a condition that is without precedence and a demand for radio equipment that the great manufacturing plants have been unable to meet. It extends from the Arctic to the Tropic, from the Fifth avenue residence to the slums, from the busy man's office to the forum. Radio is king.

Asbestos—An incombustible mineral having a fibrous texture. A poor conductor of heat or a good insulator for heat.

Ampere—Unit of electrical current.

Volt—Unit of electrical pressure.

Antenna—(see aerial)

Battery—A much abused word, being often used incorrectly for "cell." Careful distinction should be made between the two terms. A battery consists of two or more cells joined together so as to form a single unit.

Battery, Storage—Supplies constant current to heat filament in vacuum tube.

Brush Discharge—The brushlike appearance of luminous rays diverging from a pointed electrified body.

Cell—A device for producing current by chemical action.

Converter—A machine used to convert direct current to alternating or vice versa.

Counterpoise—An artificial ground. A large amount of sheet metal or wire spread out under the antenna and insulated from the ground.

Coupling—A non-metal connection between two radio-circuits formed by two coils of wire. One may be placed inside the other or near it.

Code—Combination of dots and dashes to form the letters of the alphabet.

Core—The steel or soft iron center of an electro-magnet.

Variable resistance—A resistance, the value of which can be changed without disconnecting from the circuit.

Voltmeter—Device for indicating voltage.

Condenser—(*Variable*)—A condenser of a variable capacity. Shortens wave to accommodate broadcasting stations.

Circuit—A complete metal path for conveying an electric current.

Cycle—Two complete alternations of an alternating current.

Crystal Detector—A device used to rectify the radio frequency currents to direct impulses which affect the diaphragm of the receiver.

Chopper—A motor driven interrupter used with C. W., transmitters.

Aerial—A long wire in which the electric impulses are induced by the electro-magnetic waves, sent out by a wireless or broadcasting station.

Inductance—By varying the number of turns on this coil the wave length of the circuit can be adjusted.

Vacuum Tube—Possesses the property of rectifying and amplifying electrical impulses to make them audible. Usually called Audion.

Transformer—A device for changing A. C. from one voltage to another. By increasing the ratio of turns in the transformer the current from the generator is raised to a higher potential.

Transmitter—Sound waves strike the metal diaphragm and the latter, by changing the pressure of carbon grains, allows more or less current to flow.

Storage Battery—Used to supply the power source at the

sending station. High power broadcasting stations use large generators.

Vario-Coupler—Changes the wave length of the receiving station to equal length of transmitter wave and links the receiving set with the Aerial.

Variometer—A variable inductance placed in plate circuit of vacuum tube to strengthen phone signals. It aids the variocoupler in adjusting the wave length to that of the sending station.

Dry or "B" Battery— $22\frac{1}{2}$ —45 volts; supplies current for vacuum tube plate.

Phones—Translate electrical waves into sound waves.

Inductance—The property of a coil which opposes any change in current.

Reactance Coil—A coil of wire with an iron core to give large induction in a small space.

Variable Coupling of Coils—Coils placed so the distance apart or the angle of the axis may be varied.

Alternating Current Generator—A generator giving a current or voltage which changes its direction at a rate proportional to the speed.

Crystal Detector—A device for rectifying feeble high frequency electrical impulses so that they will vibrate the telephone diaphragm.

SYMBOLS

Antenna  *op* 

 Ammeter

Alternating Current Generator 

 Battery

Crystal Detector 

 Direct Current Dynamo

Fixed Resistance 

 Fixed Condenser

Fixed Inductance 

 Fixed Inductive Coupling

Ground 

 Galvanometer

SYMBOLS

No connection of wires..... 

..... Reactance Coil

Transformer..... 

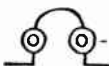
..... Telephone Receivers

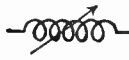
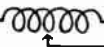

Variable Condenser..... 

 or ..... Variable Inductance

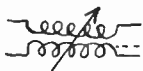
Variometer..... 

..... Variable Coupling of Coils

Variable Resistance..... 

..... ..... Vacuum Tube

Voltmeter..... 

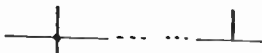
..... Wire Connections

Fixed Inductance—A coil without taps or means for varying inductance. Usually connected to the lead-in wire to increase the wave length of receiving circuit.

Ground—A place of zero electric potential. Usually the earth.

Ammeter—A device for indicating the amount of current which is constantly flowing in the circuit.

Fixed Condenser—A condenser having a fixed value of capacity, usually connected across the phones or across the crystal detector.

The Crystal -- Galena

The crystal is the very heart of a radio set, and on it depends the whole workings of a set. There are many minerals that may be used for the crystal; but up to the present time, galena is the best that can be obtained. Galena comes in many different grades, and it is impossible by inspection to tell the quality. The best way is to buy several large chunks and break them up with a hammer. Experiment with the pieces until a good piece is found. Do not handle the mineral any more than possible as a coating of oil forms on the crystal which will cause insulating qualities. This will cut down the sensitiveness of the crystal and may render it entirely inoperative.

The crystal cuts out every alternate half vibration and enables the telephone to respond to the radio frequency impulses. Two hundred meters is 1,500,000 cycles per second. The other extreme in radio frequency is found at the present time in Lafayette (Ly) at Bordeaux, France which sends out a wave which has only 13,630 cycles. There are many persons who can hear acoustic vibrations of this frequency and for them this 22,100 meter wave could be amplified at the receiver and put into specially designed phones with a

very small thin diaphragm and received *directly without any crystal or other "rectifier" such as the audion being used at all.*

The crystal causes the high frequency oscillations to pulsate in one direction only through the telephone. This gives a steady pull in one direction on the telephone diaphragm as long as the high frequency current continues uninterrupted. When interrupted at the sending station in the form of dots and dashes only an unsatisfactory series of clicks is received in the phone.

The transmitting telegraph current or received current must be interrupted at regular repeated intervals or cyclically as it is termed—at a high enough rate to give an audible singing vibration to the phone diaphragm. This can be done by a chopper at the sending end giving 1,000 interruptions per second or a chopper called a "ticker" at the receiving end.

Testing Trouble In Sets

One of the worst drawbacks the amateur faces is the proper connection of a set. In many cases, when a set has been finished and is set up it is found that the receiver fails to work. Every little connection may appear to be intact but—just one little loose wire makes the whole set absolutely useless for operation.

Troubles may occur most anywhere in the set; but the proper thing to do is to test the complete set: that is to say, each unit should be tested individually. Plate IV shows one method which may be applied. Insert in series with the coil to be tested, a buzzer and two dry cells. If the coil is not broken the buzzer will buzz; but if no buzz is heard, it is certain that there is a broken connection somewhere in the coil. Inspect the coil very carefully and, no doubt, you will locate your broken connection. If the coil is tapped and a switch arm with contacts are used, the method is the same. Testing condensers is somewhat different. Connect the condenser in series with the battery in the same manner as before, connect one side of the circuit to the movable set of plates, and the other side to the fixed set of plates. Continue now to turn the condenser, bringing

the movable plates inside the fixed plates. If any buzz is heard, then somewhere a short circuit is taking place, and the tester will have to examine it very closely again. As he turns, particular attention should be given in order to locate where the plates touch. If the short is found, the plate should be opened so as not to touch another plate. When no buzz is heard, the condenser is all right.

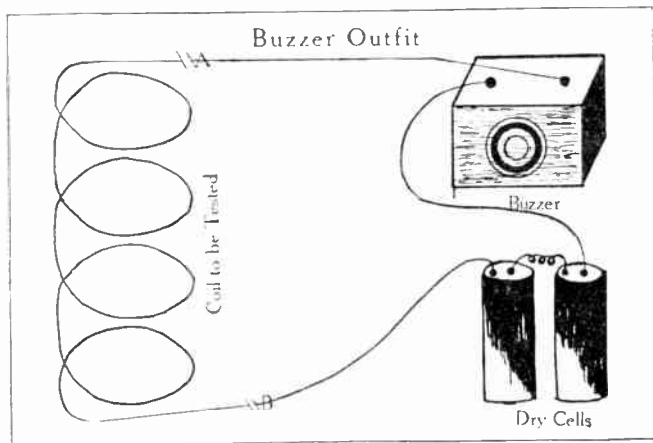

Plate IV

Locating Signals

Geological conditions and other factors not hitherto explained appear to have some influence on radio signals. Some locations appear to give better results for radio transmission and reception than others, without any obvious reason.

Better reception is accomplished with tube sets by careful variation of the tuning while using an excessive value of tickler coupling or plate inductance, i. e., just within the "hissing" region. Continuous wave telegraph signals will now be heard, and phone signals can be recognized by the steady, whistle-like beat note which their carrier wave produces. To "clear up" the voice or music, the tuning should be maintained to give the beat note the lowest pitch, while the regeneration is gradually decreased until the beat note just fades out, and the radio-phone signals alone remain. Distortion or whistling at this point is usually eliminated by a very careful further reduction in regeneration, with a slight readjustment of the tuning circuit for maximum signal intensity. A very careful adjustment of filament current will aid in eliminating disagreeable noises. The tuning of distant radio telephone signals is critical, and will be learned by the beginner only after some practice.

Grounding Switch

To avoid the accumulation of electrical charges on the antenna, and to prevent damage to the receiving set in case of nearby lightning, a protective device, which provides a direct path from the antenna to ground should be installed. This may be a small single pole throw switch, used to shunt across the receiving set when not in use, or still better, single pole double throw switch which disconnects the antenna from the receiving set and connects it directly to ground. For use with transmitting stations, the National Underwriters Regulations specify the use of a 100 ampere, 500 volt single pole, double throw switch, connecting to ground outside the building through a copper wire not smaller than No. 6, B. & S. guage. Complete grounding equipments suitable for transmitting sets or for large receiving antennae may be purchased from any radio supply house.

Care Of Head Sets

Now that we have head sets which cost from \$5 to \$18, care should be given them. They are delicate and easily put out of commission.

Do not open them. Any foreign substance between the diaphragm and frame or magnets will be detrimental to their efficiency. Do not handle them roughly or drop them. A good set of phones can be kept good for a long time, almost a lifetime, with proper care.

Treat 'em as you would your watch.

Useful Information

WATCH YOUR COILS IN BUILDING RADIO SET

Have you built a crystal receiving set and then been disappointed because it failed to work? Here's a tip from one of the pioneer radio fans.

"Most amateurs fail because they do not wind their coils properly. In winding coils they must follow instructions carefully. A properly wound coil is half the battle."

LIGHT POLES DANGEROUS AERIALS

Electric light and power companies and other organizations using high tension circuits are warning radio amateurs throughout the country to "lay off their pole lines." It is dangerous. Aerials attached to high tension line poles will pick up by induction enough of the high voltage "juice" to do a very good electrocution or start something that the fire department will have to finish. Wash poles, trees, chimneys are recommended but the fellow that uses a strange electric light pole is flirting with a quick trip through space.

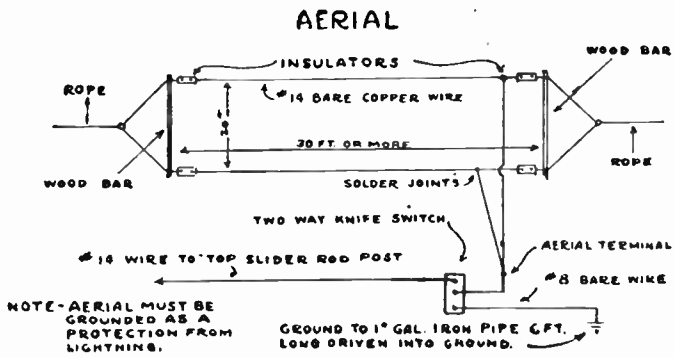

Plate V

Slide Tuning Coil Receiving Set

Everywhere people are clamoring for plans and information covering the radio-phone. It is realized that there is always a certain class who are interested and who are more or less limited in their means when it comes to the purchase of radio apparatus. For those who desire to experiment with a simple but fairly efficient type of receiving set, the apparatus here described will be satisfactory and is easily and cheaply constructed. It will suffice for the reception of broadcasted concerts, news and sermons up to a distance of thirty miles.

By the use of this sliding tuner, the receiving set can be adjusted to the wave-length of good code signals, and by the use of a condenser increase the sharpness of tuning. When used with a short range antenna, a set of this sort, having a crystal detector, will operate at a high efficiency.

Secure a cardboard tube 8" long, 4" in diameter and at a point $\frac{1}{2}$ " from end of tube make two small holes in which to fasten your wire. Allow 12" of wire at either end of coil for connections, one end of which is secured to binding post and top slider rod, the other with binding post which carries wire to ground. After coil is tightly wound the insulation must be removed at two points on coil this method is described in another paragraph.

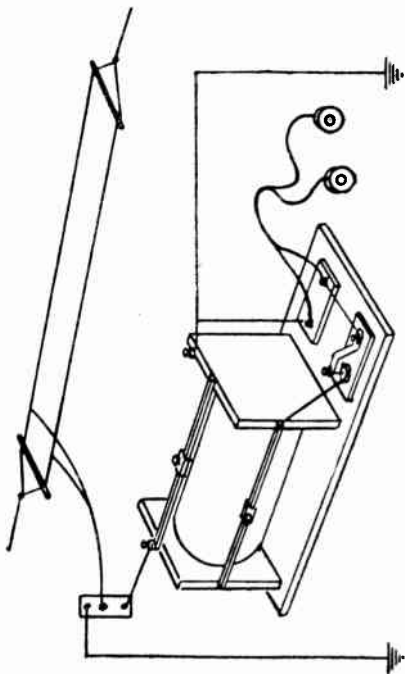

Plate VI

TO MAKE CONTACT WITH SLIDER

The insulation and the wire wound around a tuning coil must be removed. This is a tedious operation if only a knife is used for the purpose. A better plan is to nail two laths on one side of the tuning coil, spaced $\frac{1}{2}$ " , and scrape the insulation away by rubbing a wooden block covered with emery paper up and down in the groove formed between the two laths. The wooden block should be $\frac{1}{2}$ " high, 3" wide and 5" long. The emery paper should be glued on the longer side of the block. After the insulation has been scraped away, the laths may be removed.

The system is remarkably simple and effective. The insulation is easily removed with very little effort and comparative rapidity. The result is a straight and even line with ragged edges, and good contact is assured.

TO CONSTRUCT A SLIDER

Materials—Round brass rod of any length, and about $\frac{3}{8}$ " diam.; one piece sheet copper, 3.5" x $\frac{1}{2}$ " of sufficient springiness to suit; one steel ball about $\frac{3}{8}$ " diam.

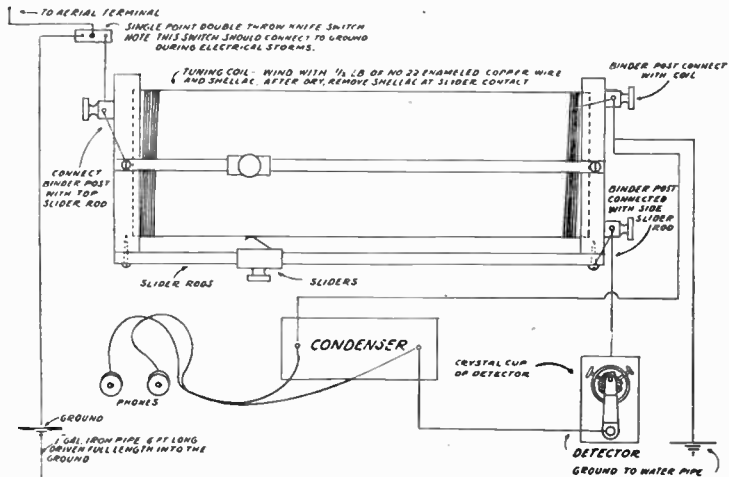

Plate VII

Instructions—First hammer the copper to make it springy, then bend it around the brass rod.

Fasten a wire along the length of the coil to keep the slider on the polished surface of the wire. Bore a hole in the copper at one end a little smaller than the ball, so that the ball will revolve without slipping through.

The slider is moved along the brass rod in either direction to vary the inductance. This may be done by holding the copper slide itself, or with a little adaptation, an insulated handle may be attached to the wire.

CONDENSER

The condenser is composed of four sheets of tinfoil, 2" x 4" with a small extension left for connecting several surfaces together. The material between the surfaces is paraffin paper and should extend $\frac{1}{4}$ " outside the edges of the tinfoil.

In order to assemble the condenser, lay one sheet of paraffin paper on a table or desk, place a metal sheet on it with the connecting strip extending over edge of paper. Then place another piece of paraffin paper on top of the tinfoil and follow this with another piece of tinfoil, having its connecting strip extending like the first. Continue this as-

sembling process until all the metal surfaces and paper are in their proper place and then fasten the assembly firmly together between cardboard plates wrapped with tape by any means at hand and immerse it in melted paraffin. Withdraw the unit from the paraffin and permit it to dry. It is then only necessary to make connection to the group of connecting strips, shown on each end of the condenser.

MATERIALS NEEDED

For Antenna and Receiving Set

Two pieces of wood $\frac{3}{4}$ x $\frac{3}{4}$ x 18 inches.	
Rope, $\frac{1}{2}$ inch, 2 cents per foot	\$.16
4 Insulators, porcelain40
Lightning switch45
1 Porcelain tube05
Antenna wire, No. 14, 150 feet95
1 Iron rod or pipe, 6 feet long	
$\frac{1}{2}$ Pound of No. 22 enameled copper wire80
8 Inches cardboard tubing, 4 inches in diameter20
5 Binding posts25
2 Slider rods, $\frac{1}{4}$ inch square, 9 inches long40
4 Brass wood screws, $\frac{3}{4}$ inch, (<i>do not use iron</i>)04
1 Sheet of tinfoil 6 x 36 inches and paraffin paper20
1 Crystal Detector90
Two sliders (<i>constructed as description on another page</i>)	
1 Board $\frac{1}{2}$ " x 5" x 14" 2 blocks of wood $\frac{1}{2}$ " x 4" x 5"	
8 Brass wood screws08
2 Round blocks $\frac{1}{2}$ " thick 4" in diameter	

Questions and Answers

Q.—Is it all right to use No. 18 insulated bell wire for antenna or must I scrape the insulation off? Is a one-pound coil enough?

A.—It is not necessary to scrape the insulation off the wire except at the point connected to the receiving set.

Q.—What is a fillister head screw?

A.—The round head of a screw with a slot, the top of which is slightly round.

Q.—What are escutcheon pins?

A.—A pin with a round head that is used to fasten thin pieces of wood.

Q.—Would any kind of varnish do for the insulating paint?

A.—Yes, if it has no carbon in it.

Q.—Explain how to connect a switch on the lead in.

A.—A large single pole double throw switch is fastened to the outside of the house at the point where the aerial wire enters. The aerial wire is then connected to the blade of the switch. A wire is then run from one terminal to the receiving set, another heavier wire is then run into the ground where it is connected to a piece of metal.

Q.—Which is the best mineral for this set?

A.—Galena.

Q.—Is the mineral good after being handled?

A.—Split off or scrape the surface after putting fingers on it if you find it less sensitive.

Q.—Can you get a vacuum tube detector run by a 32 volt lightning system?

A.—You can hook the tube to the storage battery that comes with the set at three cells for the filament and about twelve cells for the plate voltage.

Q.—Should you solder the galena to the cup?

A.—Yes. Use "Woods metal" or some low melting point alloy.

Q.—Will there be any advantage in attaching a battery to an Amrad crystal receiving set? If so, how many volts should be used and where should it be connected?

A.—There would be no advantage in using a battery with a crystal set. There is no way of increasing the amplitude of the signals when this type of detector is used. For longer range and louder receiving a bulb detector must be used.

Q.—How should I ground my set with a lightning switch which is single pole, double throw? I know the aerial lead-in wire goes to the center pole of the switch and one

end to the instruments and the other end to the ground, but how can the instruments be grounded?

A.—The aerial-lead-in should go to the center pole of the lightning switch; the lightning ground is attached to one end pole, and the wire to the set to the other end pole. This allows the set to be connected with the antenna or the antenna to be connected directly with the ground. This, however, does not ground the set. The aerial lead-in comes from the lightning switch to the proper place on the set and a separate wire goes to the ground from the set, not through the lightning switch.

Q.—May the lead-in wire be single or a double wire?

A.—Single wire is all right.

Q.—Is it necessary to ground a set if a lightning switch is used?

A.—Yes.

Q.—I have a place for my aerial 50 feet high and I have 100 feet of wire. Should I put up two 50-foot wires or one 100-foot wire?

A.—One wire, 100 feet long.

Q.—Could two aerials set at right angles to each other use the same supporting pole?

A.—This would be all right for receiving only. It would not work for sending sets.

Q.—I am making a cabinet. Is it a fact that no shellac must be used?

A.—No. It is all right to shellac the cabinet. It is not advisable to shellac the windings in the vario-coupler or variometers.

Q.—What is the distinction between the terms “radio” and “wireless?”

A.—The two terms are used interchangeably.

Q.—Will you kindly let me know if the radio receiving sets that one can purchase for \$25 to \$50 are reliable, and at what distance they will receive? What make would you advise? I am of moderate means and can't afford more.

A.—Yes, they are reliable. Distance will depend considerably upon your antennae. You ought to receive fifty miles and in some instances more.

Q.—Kindly tell me what the difference is between radio frequency amplification and audio frequency amplification.

A.—In radio frequency amplification the high-frequency current in the antenna is amplified before it is rectified. In audio-frequency amplification the rectified audible signals are amplified.

Q.—Which is the better for receiving waves under 700 meters with outdoor aerial?

A.—Better use the audio-frequency amplifier.

Q.—Will an audion bulb increase receiving range on a crystal set?

A.—Yes, you can amplify the rectified current received from your crystal set and increase your range with one stage of amplification.

Q.—Should the lead in wire be insulated?

A.—The lead-in need not be of insulated wire but it must be thoroughly insulated through the wall where it enters the building.

Q.—What do I need for an audion detector?

A.—An audion bulb and a socket, a variable resistance for the filament current, a six-volt battery, a thirty-volt battery, a small .0005 microfarad fixed condenser, a “grid-leak” resistance, and a variometer is needed for an audion detector.

Q.—How much louder will it make the signals than a crystal detector?

A.—As a detector, a good sensitive crystal is nearly as good as a bulb and is usually better for music. Better keep your crystal set and make up an amplifier.

The Variable Condenser

A variable condenser consists of a number of semi-circular metal plates arranged in two sets. One set is stationary; the other can be moved on a pivot so that they enter between the stationary plates but without touching them. All the stationary plates are connected and, likewise, the rotating plates. The plates may be of aluminum, brass, or any other metal that retains its shape.

The variable condenser supplies an electrical quantity called *capacity*. Radio circuits are made up of Inductance and Capacity. Tuning coils supply much of the inductance while condensers are depended upon to supply the capacity. Perhaps, a clearer idea of capacity would be gathered if a condenser were to be considered as a miniature storage-battery which catches and holds the minute electrical impulses until there are sufficient to make an impression on the head phones.

Strange as it may seem, it is not the metal plates in a condenser that hold the impulses but, rather, the air between the plates. When the impulses come in from the aerial and are transferred to the detector circuit by simple tuner,

loose coupler, variometer, or variocoupler, the sounds are made up of little trains of waves. These trains come in to the metal plates of the condenser, but they cannot jump across from one set of plates to the other. Thwarted at that, they are still able to strain or twist the air between the plates. This action is the same as is seen when a piece of soft rubber is twisted in the hands. So long as the pressure is maintained, the twist will remain; but if one hand is removed, the rubber returns to its former shape and size. In the condenser, the waves strain the air and the air holds the strain until it has stood all that it can. Then it "back fires," to use a common term.

front

Alfred

Irving

Alfred

