



Everybody's **RADIO MANUAL**

*How to Build and
Repair
Radio Receivers*

20 H.
(500 OHMS)

138 OHMS \times 115 V.
160 OHMS = 120 V.



EVERYBODY'S RADIO MANUAL

*How to Build and Repair
Radio Receivers*

PREPARED BY THE EDITORIAL STAFF
OF POPULAR SCIENCE MONTHLY

GROSSET & DUNLAP
Publishers NEW YORK
By arrangement with Popular Science Pub. Co., Inc.

COPYRIGHT, 1934 and 1942,
By POPULAR SCIENCE PUBLISHING COMPANY, INC.

All rights reserved

Printed in the United States of America

INTRODUCTION

RADIO servicing and set building can be both a fascinating pastime and a profitable spare-time business. Whether he uses his knowledge in constructing equipment for himself or in repairing receivers for his friends and neighbors, the experimenter will find that his time and study are well repaid.

It is the purpose of this manual to explain the operation of modern radio equipment and to suggest methods of dealing with common troubles that mar reception. Text and diagrams have been made clear and simple, so that they may be understood easily by the beginner.

An entire chapter has been devoted to the elimination of interference. Less than twenty percent of the crashes and crackles that disturb listeners are due to natural static. The rest come from man-made interference and may be eliminated or greatly reduced by following the suggestions given.

Another worth-while subject for the spare-time service man is the modernization of old broadcast receivers. In every neighborhood there are out-of-date sets that could be brought up to present-day standards by a little labor and a small investment in new parts. A special chapter describes the most common types of old-fashioned receivers and tells just what is needed to make them sound like new.

To aid the beginner in building up a complete home

radio workshop, suggestions are given for assembling the necessary tools and testing equipment. Much of this can be made at home or assembled from inexpensive parts.

For those who are bewildered by radio-circuit diagrams, a useful chapter translates the conventional symbols and tells how to interpret this picture-writing of the radio engineer. An appendix contains handy tables and other reference material.

Here, then, is your guide to pleasure and profit in radio repair and servicing. We hope that the book will prove so valuable that it will find a permanent place in your radio tool kit.

TABLE OF CONTENTS

INTRODUCTION	5
I. THE RADIO WORKSHOP	11
II. READING RADIO BLUEPRINTS	32
III. MEASUREMENTS, FORMULAS, AND DEFINITIONS	46
IV. SIMPLE RADIO TESTS	67
V. RADIO KINKS AND SHORT CUTS	79
VI. IMPROVING OLD BROADCAST RECEIVERS	109
VII. ELIMINATING INTERFERENCE	135
VIII. RADIO SERVICING AND TROUBLE SHOOTING	151
IX. THE SHORT WAVES	178
X. BUILDING ALL-WAVE AND SHORT-WAVE RECEIVERS	198
APPENDIX	241
INDEX	251

EVERYBODY'S
RADIO MANUAL

EVERYBODY'S RADIO MANUAL

CHAPTER I

THE RADIO WORKSHOP

MUCH of your success as an amateur experimenter and spare-time radio serviceman will depend on your equipment. It need not be elaborate or expensive, but it must include certain essentials.

First of all, you must have a place to work. This can be anything from an old table, in an empty corner of your attic, to a large shop built in your cellar. Its only requirements are that it have good light and a handy source of electricity or illuminating gas.

Where space is at a premium, the de luxe portable laboratory shown in Fig. 1 will answer the average amateur's needs. Made of easily worked white pine, it is light and durable. To be portable, it is designed to fit the table that graces the average kitchen.

Once in place, with its extension cord plugged into a near-by lamp socket or wall outlet, this kitchen-table bench provides all the features of a well-equipped electrical shop. At the rear, a narrow rack serves as a place for tools. A hardwood drill pad and a sturdy vise are always ready for instant use. And a double outlet

provides a convenient source of electricity for your soldering iron and power cords. Yet with all these fea-

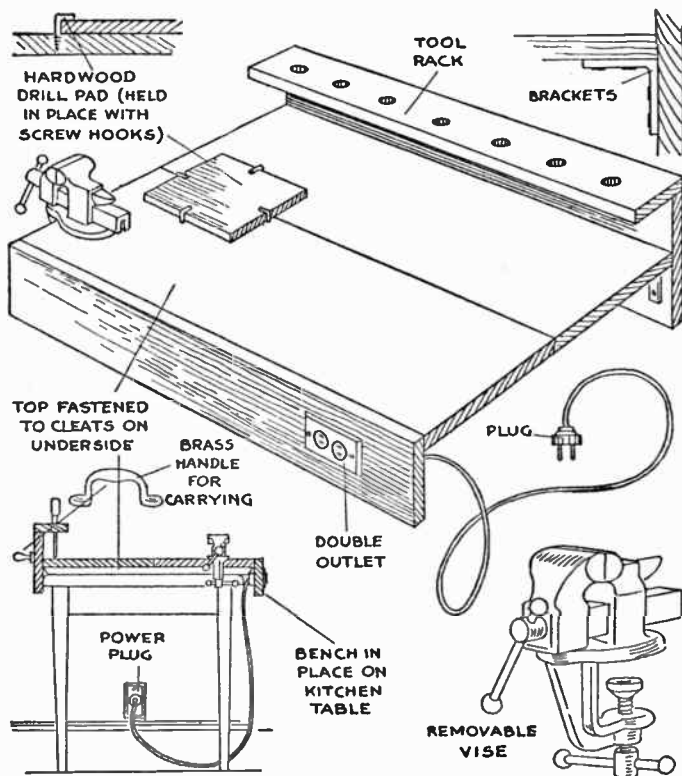

FIG. 1

tures, it is easily removed and can be stored in a closet when it is not in use.

The size of your particular portable bench will de-

pend, of course, on the dimensions of the table it is to fit. Overall, it should be longer and wider than the table with just enough room between the front and rear to slide easily over the edges of the top. To provide room for the double outlet, the front apron should be at least seven inches deep while the rear upright should be five inches deeper to support the six-inch wide tool rack. The top, made of several planks, can be fastened with brass screws driven through two-inch wide cleats spaced evenly across the underside.

When the bench is completed, it should be sanded smooth and the hardwood drill pad and vice fastened in place. The surfaces that show can be given several coats of varnish or varnish stain.

As for the tools to complete your radio workshop, they can be few in number and inexpensive (see Fig. 2). Most important of all, of course, will be your soldering iron. For general, all-around use, one of medium size and weight will be most practical. If current is available, it should be of the inexpensive electric variety, about 75 to 100 watts. If you have no electricity, an ordinary small-sized soldering iron, heated over the gas range or in the flame of a portable gas burner of the chemist's type, can be used.

Electric soldering irons having changeable tips are preferred by most radio workers. They are only a trifle more expensive than the ordinary type and provide the advantage of several sizes and shapes of tips for various types of work. Good soldering irons can be purchased for prices ranging from about \$1.50 to \$5. Above all, buy a good one. It is one piece of equipment you will use every time you work in your shop.

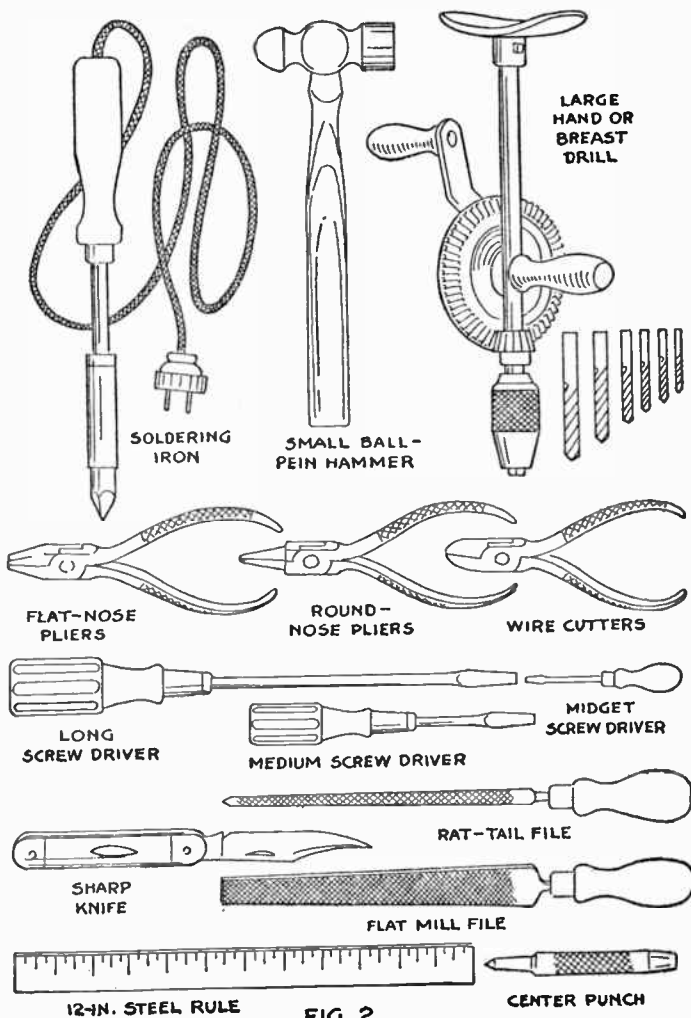
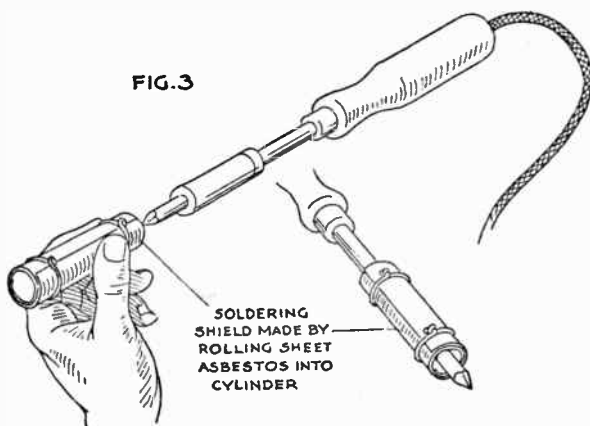

FIG. 2

No matter what make or style of iron you buy, however, the soldering shield shown in Fig. 3 will form a worth-while addition to it. Consisting of a sheet of thin asbestos loosely rolled to form a hollow cylinder to fit the iron, it will safeguard against accidentally burning the insulation on wires and coils when making



a connection deep in a crowded circuit. Incidentally, the shield also will serve as a booster when it is necessary to bring the iron up to heat quickly. However, it should not be left on the tip of the iron for long periods as it will cause the iron to overheat and may injure the heating element.

Besides your soldering iron, your other important tools will consist of an assortment of screw drivers and pliers. At least three good quality screw drivers should be included in every amateur's tool kit. One with a

long shank, another with a medium shank, and a third of the midget variety will meet the average demands. The midget tool will be particularly valuable for adjusting the countless set screws encountered on even the simplest receivers. If you wish to go to the added expense, your longest screw driver can be of the type fitted with a fully insulated shank.

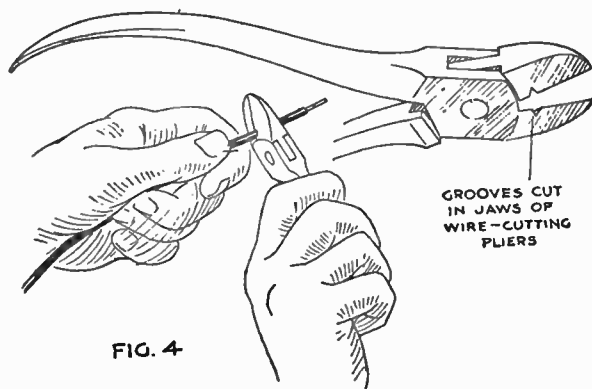

As for pliers, you should arm yourself with a pair of the flat-nosed type, a pair of the round-nose variety, and a good set of ordinary wire cutters. Then by altering the jaws of the cutting pliers as shown in Fig. 4 you can make them serve as insulation strippers as well as nippers.

To change your wire cutters, simply form a shallow groove or V-shaped notch at the same point in each groove or V-shaped notch at the same point in each cutting edge. This can be done easily with a square-edged oilstone. Make the grooves just deep enough to

take the diameter of the bare wire when the jaws are closed.

To skin the end of a piece of connecting wire with your stripper, simply place it in one of the notches, close the pliers, and pull the wire. The insulation will be sheared off easily and quickly without so much as marring the inner core. If your cutters have long blades, several sets of grooves to take various sizes of

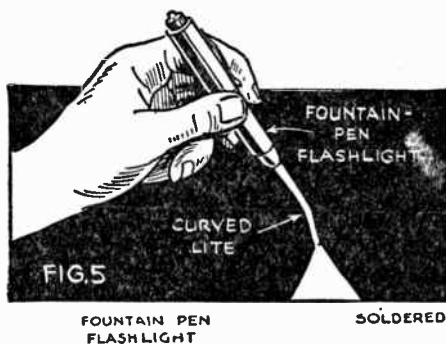

wire can be cut without interfering with their intended use. As shown in the illustration, the best location for these grooves is near the plier joint.

In addition to these tools, your kit should contain a center punch, a twelve-inch steel rule, a knife with a large and a small blade, a large hand drill with drills, a rat-tail file, and a small hammer. Although they are not absolutely necessary, a tap holder, a die holder, a set of taps and dies, a hack saw, and a burring reamer will form excellent later additions when finances allow.

If any amount of research and testing are to be done, your radio shop also should boast at least one good meter. For the present it will suffice to say that as soon as possible a high-grade milliammeter should be added to the equipment already listed. How this one meter can be mounted and made to serve for many important radio measurements will be described in Chapter III.

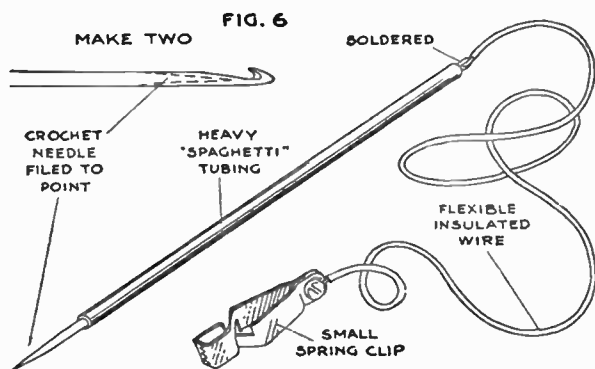

Another extremely useful tool is the trouble shooter's lamp shown in Fig. 5. It uses a new type of translucent plastic material which has the property of carrying light to the tip without wasting any at the sides. The curved plastic end is connected to a small fountain-pen flashlight, to direct light just where it is wanted and make inspection in crowded corners an easy matter. It will be particularly valuable for inspecting the undersides of soldered joints. Most radio stores carry the tool.

So much for the tools that are to be bought for

your radio laboratory. There are, however, various other tools that can be improvised to simplify your work.

Test prods, for instance, are an important piece of radio equipment that can be built easily as shown in Fig. 6. Sharpen the tips of two steel crochet needles and insulate the handles with wrappings of friction tape or lengths of spaghetti tubing. The lead wires, fitted with small spring clips, can be soldered to the outer ends of the crochet needles as illustrated in the drawing.

A novel bending jig and a circle cutter for metal, two more tools that the radio worker can make, will be described later on in the chapter under the heading, "Chassis Making."

The Art of Soldering

No other single operation plays a more important part in the building and repairing of radios than the process of soldering. Even in the simplest circuit, forty or fifty connections often have to be made. Careful planning, placing of parts, and neat wiring all go for naught unless the radio worker is a successful, as well as rapid, solderer.

To the inexperienced, the knack of soldering seems like nothing short of magic. Yet anyone who is handy with tools and willing to practice can master the art of making neat, professional-looking soldered connections.

Successful soldering depends on two things: patience and a good understanding of the uses of the various

tools and materials that go to make up the soldering kit. Roughly, your soldering equipment should consist of the soldering iron, the solder, a flux, some emery cloth, a knife, and a rough cut file.

The use of the soldering iron is obvious. It serves to heat the work and melt the solder. Next in importance beside the solder itself is the flux. Without it, a soldered joint would be impossible. Heated, it spreads over the cleaned surfaces to be joined and forms a protective coating that prevents the formation of oxides and allows the solder to form a bond. As to what flux to use, rosin, either solid or powdered, and a prepared paste are the favorites.

Two types of solder also are available to the radio craftsman—plain wire solder and flux core solder. Ordinary wire solder is solder and nothing else. Flux core solder, on the other hand, is a tube of solder encasing a thin core of flux. No outside flux need be used with flux core solder, as melting the wire with the tip of your iron provides melted flux as well as solder. Because it is easily used and eliminates one item from the soldering kit, flux core solder is preferred by many radio workers.

The first step in soldering is to clean and shape the tip of your soldering iron. This can be done with a file and emery cloth. It must be clean and free from pits and cuts. Remember, cleanliness is one of the most important factors in soldering.

When your iron has been shaped and cleaned you are ready for the "tinning" process. To tin an iron means simply to give it a protective coating of solder (see Fig. 7). When the iron has reached its soldering

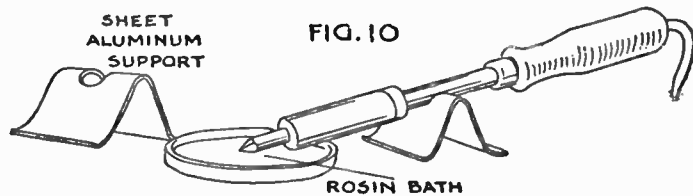
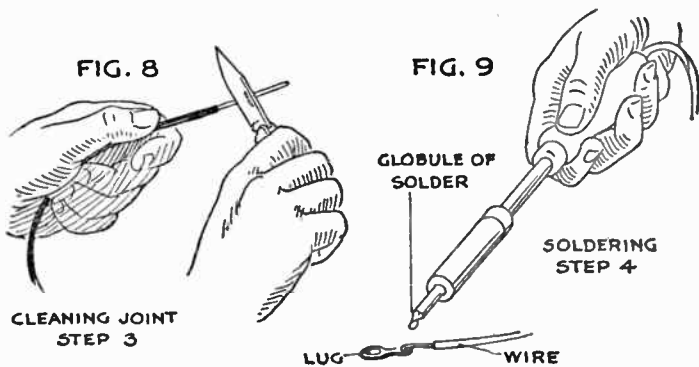
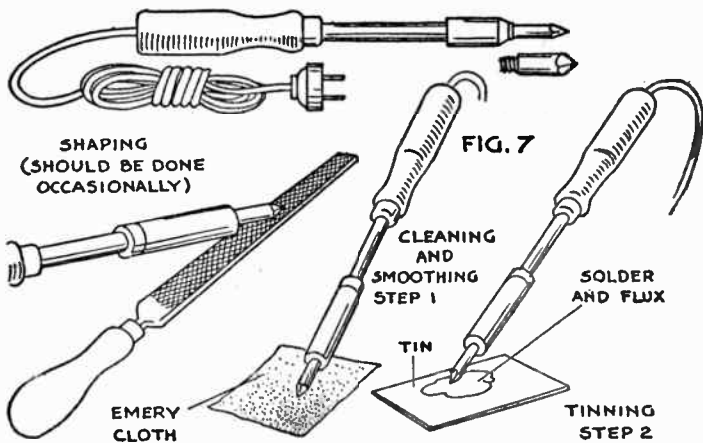

heat, dip it into the soldering paste or rub it on the rosin so that it will be well coated with melted flux. Then touch the heated tip to the solder. As it melts, the solder will form a tiny ball or globule on the tip of the iron. This then should be spread over the surfaces of the tip. Many radio workers do this by rubbing first one surface and then the other on a small square of tin. If flux core solder is used, both the flux and the solder will, of course, be applied at the same time.

Once your iron is tinned (indicated by a silvery coating on the tip), you can turn your attention to the parts to be joined. They too must be cleaned with a knife or emery paper, Fig. 8. For best results, tinned connecting wire and tinned connecting lugs should be used. If ordinary wire is used, you will find that a better joint will be formed if it too is tinned at the ends.

When the two parts to be joined have been placed together, apply flux to the joint. This can be done, if rosin flux is used, by touching the hot iron to the rosin and then to the joint. If paste flux is used, it will be best to touch each of the wires to the surface of the paste before twisting the joint. Use the flux sparingly; too much is just as bad as not enough.

To apply the solder, touch the tip of your iron to the end of the solder wire and pick up a small globule of the molten metal. Then touch it to the joint. Soon, the joint will be heated and the molten solder will flow over the parts or wires being joined. If a great deal of solder is required, it can be applied by holding the end of the solder wire at the point where the iron and the joint meet. Of course, if flux core solder is

used, both the solder and the flux will be applied to the joint in the same operation.

If you decide to use plain wire solder and rosin flux or a combined rosin core solder, the simple kink shown in Fig. 10 will protect the tip of your soldering iron and insure a good supply of flux at all times. It consists of a bath of rosin made by melting a small quantity of lump or powdered rosin and pouring it into the shallow friction top of a coffee can or a baking soda tin. By placing the tip of your heated iron on this flux pad between soldering jobs, you can prevent its tinned surface from burning off too rapidly.

No matter how careful you are, however, the tinning will in time become burned and pitted. For this reason, it is necessary to tin an iron periodically. A good plan is to reshape and retin it before each job.

Soldering Don'ts

Don't use a pitted or dirty iron.

Don't forget that overheating an iron causes the tinning to burn.

Don't remove any more of the metal than is necessary when reshaping the tip of an iron.

Don't forget to retin your iron occasionally.

Don't forget that dirt and metallic oxides are solder's worst enemies. If possible, use tinned connecting wire and soldering lugs.

Don't be hasty. Give the iron plenty of time to heat the joint and allow the flux to spread. Hold the joint together until you are sure the solder has cooled and hardened.

Chassis Making

If you do any amount of set building, you will want to mount the circuit on a professional-looking aluminum chassis. Although these can be purchased ready-made and drilled, you can save money by buying the flat sheet aluminum and bending and drilling it yourself.

Bending Aluminum: By building the simple bending jig shown in Fig. 11, your problem of chassis making will be greatly simplified. Resembling a cutter board for photographs or paper, it consists simply of an eighteen- by twenty-four-inch baseboard to which is hinged a two- by eighteen-inch hardwood arm. To protect the front or bending edge of the arm, a strip of steel or brass is fitted into a shallow recess.

The hinge for the arm should be of the long, door type so that it can be bent over the top of the arm and under the base as shown to provide a firm support. The hinge can be bent easily in your vise.

To provide an easy means of measurement, a scale should be fastened along the left edge of the base above the arm. This can be an ordinary wood rule fastened in place with brads or screws.

In using the jig, lift the hinged arm, place the sheet of aluminum cut to the desired width, flush against the scale so that the proper amount projects above the arm and fasten the arm in place with an ordinary C-clamp. Then using a sharp knife, or a nail filed to a sharp three-cornered point, scribe a line on the aluminum along the upper edge of the arm. Finally, bend the outer end of the aluminum up until it forms a

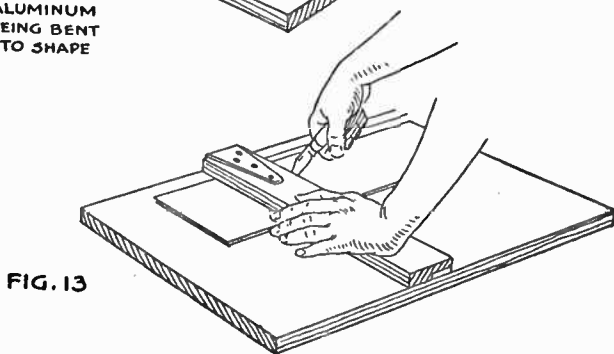
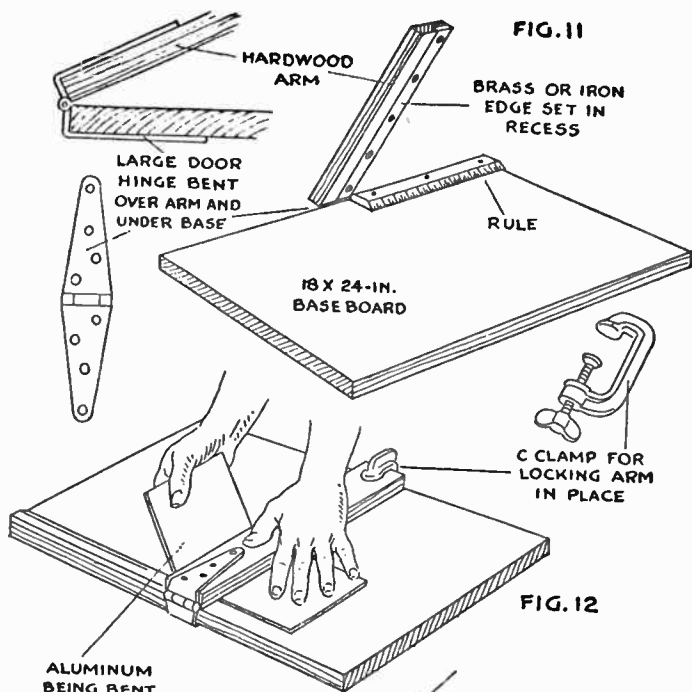

right angle or the exact angle desired. Repeating the process, make the second bend and the U-shaped chassis will be completed.

When bending the metal, apply the pressure evenly along the entire edge. If necessary, slip a flat board or a second sheet of metal under it to distribute the force. As the bend progresses, slide the support down toward the base of the bend to insure a square corner. Of course, thin sheet aluminum also can be bent to shape with the hands merely by clamping it between two boards placed in the vise. However, the resulting corner will not be as square as that obtained with the regular bending jig.

Cutting Sheet Aluminum: A bending jig of this type also can be used for cutting aluminum to the desired width and length. As shown in Fig. 13, simply place the sheet of metal in the jig so that the required amount projects above the arm and then, using a knife or a sharpened nail as before, scribe a deep line along the upper edge of the arm. Go over the cut several times. Then remove the sheet, turn it over, replace it under the arm in exactly the same position, and repeat the scribing process. If the scribed lines have been cut deep, bending the sheet up will break it in two. As a finishing touch, use a file or a sharp knife to clean up any rough edges that may result.

If special angular brackets are to be cut by this method, it will be best to fasten a sheet of paper under the aluminum when the first cut is made so that a tracing of the projecting end can be drawn. Then, when it comes time to turn the aluminum over and scribe the lines on the second side, the outlines can

be matched and the second cut made directly over the first.

Drilling Sheet Aluminum: Even the simplest aluminum chassis or panel will require holes for tube sockets, wire leads, shafts, and mounting bolts. In most

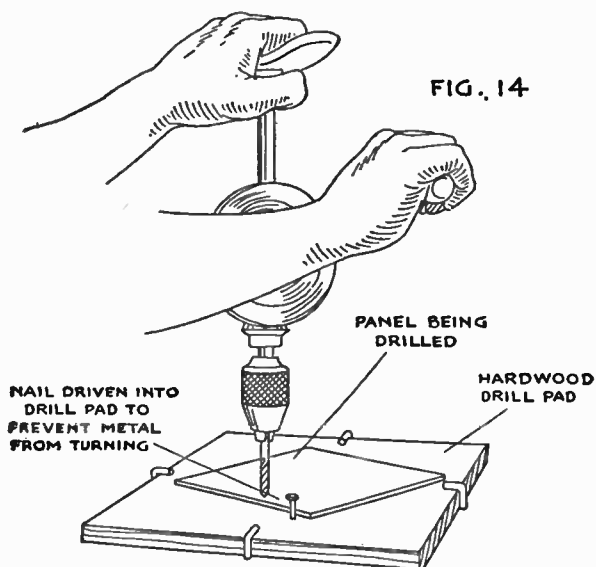

cases, it will be most convenient to drill these holes before the sheet is bent.

The small holes can be drilled with an ordinary hand drill. To protect the bench top, be sure to do all of your drilling on a hardwood drill pad (see Fig. 1). If the metal tends to turn with the drill, drive a nail or a small screw into the drill pad and allow

one corner of the sheet to bear against it as shown in Fig. 14.

When drilling medium-sized holes it is a good plan to clamp the aluminum between two pieces of thin wood, running the drill through all three. This will

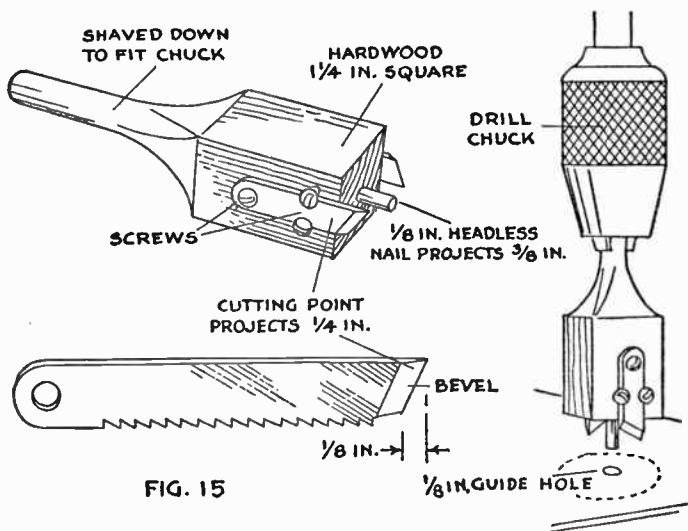

prevent the pressure of the drill from bending the metal and will eliminate all possibilities of burrs.

The holes for tube sockets (generally about one and one-quarter inches in diameter) will be too large for the ordinary hand or breast drills. However, these can be cut with a fine jeweler's saw, a motor-driven jig saw, or, better still, with the improvised circle cutter shown in Fig. 15. With this homemade tool, circular

holes can be cut in sheet aluminum up to one eighth inch in thickness. It is used in an ordinary brace or hand drill.

Since most tube socket holes will be one and one quarter inch in diameter, the homemade circle cutter can be designed for this size. First plane a stick of hardwood until it measures exactly one and one quarter inches square. Round one end as shown in the

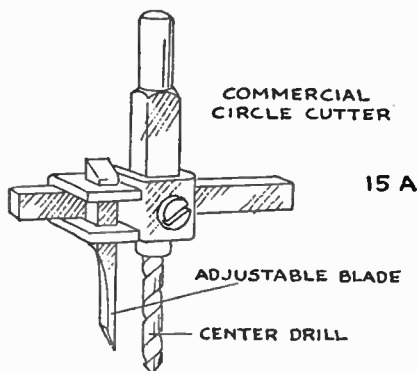

drawing, tapering it to fit snugly into the open jaws of your hand drill or brace. Then mark the square end with diagonal lines to find the center and bore a one-eighth-inch hole where they cross, making it one inch deep. Finally into this hole drive a headless nail, allowing it to project about three eighths of an inch.

The two cutter blades for the drill, placed on each side of the square, are made from a discarded hacksaw blade. Break a piece from each end so that it is about one and one quarter inches long and includes the eye. Grind the end of each piece as shown and

fasten them to opposite sides of the block with short screws driven through the eyes. Smaller screws driven in at the sides of the blades will serve to hold them rigidly in place.

To use the circle cutter, first drill a one-eighth-inch hole in the metal to coincide with the center mark,

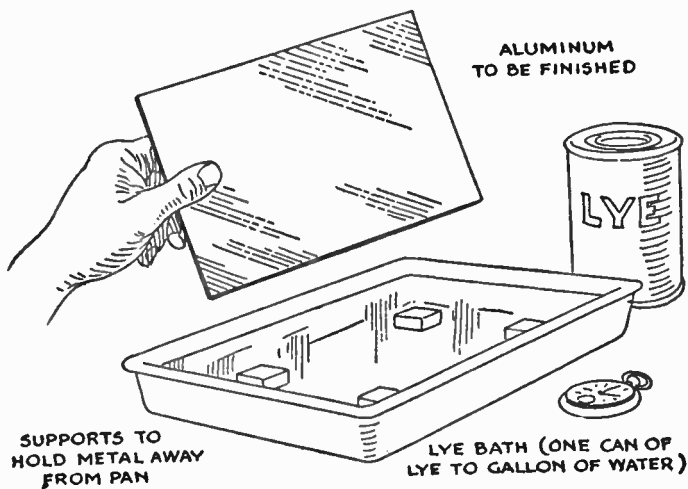

FIG. 16

slip the guide nail on the cutter into this center hole, and turn the brace or hand drill until the two blades are half way through the metal. Finally, reverse the sheet and continue the drilling from the other side.

Incidentally, commercial circle cutters of this type, having adjustable blades, can be purchased for a few dollars from any dealer in radio parts (see Fig. 15A).

Finishing Aluminum Panels: A satiny finish can be given aluminum panels, and for that matter any

aluminum parts, by soaking them in a bath of ordinary lye. (see Fig. 16). All that is required is a solution consisting of a full can of household lye dissolved in a gallon of water. Smaller quantities, of course, can be made by mixing the bath in smaller amounts of the same proportions.

Pour the lye solution into an enameled pan (a regular baking tin also will serve if the enameled pan is not handy) and then place the panel, thoroughly washed, in the bath. To keep the aluminum free of the bottom of the tray, rest it on four wood or metal supports as shown.

This method of finishing is not particularly critical but to obtain the best results the amateur should do a bit of experimenting with small pieces of aluminum before attempting a large panel. The bigger the panel, the longer will be the time required to obtain just the right finish. If the aluminum is exposed to the lye bath too long, a burned black finish will result.

When the metal has taken on a soft silvery appearance, lift it out of the solution with a pair of pliers and wash it thoroughly in cold water. Of course, all tool work should be completed on the panel before the finishing process.

Metal panels also can be finished by the amateur in the popular black crackle or crystallized effect if he desires. Prepared crackle lacquers can be obtained from radio parts supply houses. They are applied with a brush and on drying shrink and crack to give a baked-on enamel appearance.

CHAPTER II

READING RADIO BLUEPRINTS

LIKE the model maker or the woodworker, the amateur radio experimenter who builds sets or services receivers will work for the most part from blueprints and diagrams obtained from books and magazines. Differing from plans for a chair or a ship model, however, a radio drawing is made up of various space-saving symbols that must be understood if the circuit is to be followed intelligently.

In most cases, these symbols are nothing more than conventionalized pictures. Like the simple picture drawings of the early Indians, they are a representation made with the fewest number of lines to give the general appearance of the parts they represent. To experiment with radio without knowing its symbols and abbreviations is like trying to live in a country without knowing the language.

As shown in Fig. 17, the symbols that go to make up a radio diagram are neither numerous nor difficult to learn. Once the amateur has mastered their meaning and is able to visualize the parts they represent, even the most complicated circuit drawing becomes an easily followed series of simple pictures.

One of the best ways to learn these symbols is to associate them with the actual parts. As you con-

SYMBOL	NAME	PART
	ANTENNA	
	GROUND	
	FIXED CONDENSER	
	VARIABLE CONDENSER	
	GANG CONDENSER	
	ELECTROLYTIC CONDENSER	
	FIXED RESISTANCE	
	VARIABLE RESISTANCE	
	VOLTAGE DIVIDER RESISTANCE	
	3-ELEMENT VACUUM TUBE	
	R.F. PENTODE VACUUM TUBE	
	HEATER TYPE VACUUM TUBE	
	COIL	
	RADIO FREQUENCY CHOKE	
	FILTER CHOKE	
	AUDIO TRANSFORMER	
	PUSH-PULL AUDIO TRANSFORMER	
	POWER TRANSFORMER	

SYMBOL	NAME	PART
	VOLTMETER	
	AMMETER	
	MILLIAMMETER	
	IRON CORE COILS	
	I. F. TRANSFORMER	
	TRANSMITTING CRYSTAL	
	WIRES CROSS	
	WIRES JOIN	
	EARPHONES	
	MAGNETIC LOUDSPEAKER	
	DYNAMIC LOUDSPEAKER	
	SWITCH	
	KEY	
	MICROPHONE	
	PHONOGRAPH PICK-UP	
	BATTERY	
	CONDENSER AND GRID LEAK	
	BINDING POSTS	

FIG. 17

struct a circuit, place each part in its proper position on the blueprint and compare it with the symbol. Then practice drawing the symbols yourself until you can recognize them instantly. A few hours spent in learning how a radio diagram is drawn will be time saved when it comes to constructing a circuit from a blueprint.

Two symbols that will be found in almost every radio diagram are the conventionalized drawings used to indicate the ground and the antenna. Since the average antenna is simply a single wire rigged between two insulators and connected to the receiver by a single wire lead-in, the radio symbol is an inverted triangle representing the antenna wire with a vertical line drawn through the apex indicating the lead-in. Similarly, the ground connection, which generally is a pipe driven into the ground or some equivalent arrangement, is represented by a vertical line leading down to an inverted shaded triangle symbolizing the earth. Incidentally, this convention for a ground connection also is used many times to indicate a connection to the metal of the chassis. However, when this is the case it generally will be made clear by some form of note lettered on the blueprint (see Fig. 18).

Two types of condensers, fixed and variable, also will be found in almost every radio circuit. Since the essential parts of a fixed condenser are two metal plates separated by some form of insulation called the dielectric, its radio symbol consists simply of two heavy parallel lines drawn close together. On the other hand, if the condenser is adjustable (variable), it is indicated by making the lower line curved and supplying it with an arrowhead. In the variable condenser

symbol the curved line indicates the rotor or movable plates of the unit.

Incidentally, another, slightly different symbol is sometimes used to indicate a variable condenser. This

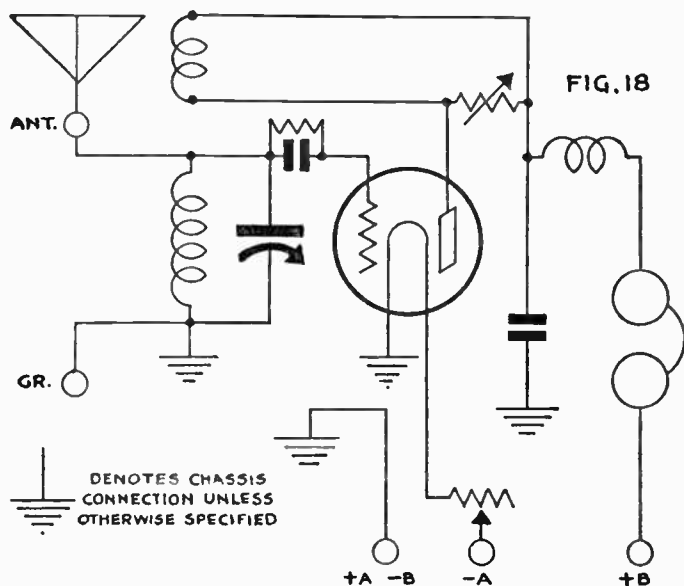

consists of the symbol for a fixed condenser supplemented by a diagonal line with an arrowhead (see Fig. 17). The difficulty with this type of symbol is that it provides no simple way of indicating which is the stator (stationary plates) and which is the rotor (movable plates).

In many circuits several condensers so connected that their rotors can be turned simultaneously with a single shaft control are used. These are called gang condensers and are indicated symbolically by dotted lines leading from the center of each condenser to a single horizontal line (see Fig. 17).

Resistances, which in one form or another play an equally important part in radio circuits, are represented by zigzag lines (see Fig. 17). Like condensers, resistances also take on two forms; being either fixed or variable. If the resistor is of the fixed type, it is symbolized by a plain zigzag line. If, like the variable condenser, it is adjustable, the zigzag line is supplemented by an arrow drawn through its center at an angle.

Variable resistances are used in two forms known as rheostats and potentiometers. In the rheostat, one connection is made to the movable resistance arm while the second is made to one end of the resistance winding. The potentiometer has three connections. One is made to the movable arm, another to one end of the resistance, and the third to the other end of the resistance.

Since the operation of the modern radio receiver or transmitter is based on the vacuum tube, its symbol will be encountered every time the amateur picks up a radio book or blueprint. It is represented in circuit drawings in a number of ways depending on the particular type and the number of internal elements it uses.

Simplest of all common radio tubes, is the three-clement filament variety. It consists mainly of a glass

envelope or bulb, a tiny wire filament, a coil of wire known as the grid, and a flattened cylinder of metal called the plate. The conventionalized symbol for this type of tube consists of a heavy circle representing the glass bulb enclosing a hairpin-shaped line indicating the filament, a zigzag line the grid, and a square the plate (see Fig. 17).

As the radio tube becomes more complicated so does its symbol. If it is of the heater variety, having an independently heated cathode instead of a filament, the filament lines are replaced by a U-shaped heater symbol and a line is drawn over the heater in the form of a hook to represent the cathode. The grid and plate are indicated as before.

If to this symbol, a cage of zigzag lines is added so that it encloses the square symbolizing the plate, it indicates that the tube is of the screen grid variety and the cage represents the screen. Symbols for still other tubes having more than one grid contain additional zigzag lines to indicate these parts.

Although it is impossible for the amateur to learn the exact symbol for every type of tube that is manufactured, since more than eighty different varieties are being made, he can, by memorizing the basic symbols for grids, screen grids, plates, heaters, and filaments, figure out the connections indicated by almost any drawing.

In simplified diagrams, the beginner may find that the tubes are indicated by a slightly different set of symbols. But this should give no trouble since the filaments in this case are generally drawn V-shaped,

the plates T-shaped, and the grids and screens as dotted lines.

In picturing the countless other radio parts that go to make up radio circuits, the symbols follow the same simple rules. A coil of wire, for instance, is represented by a spiral line drawn to look like a pulled-out spring. Two such coils drawn one on top of the other indicate a coupled radio tuning coil such as the usual type of plug-in coil employed in many simple receivers (see Chapter XI). A single coil, supplemented by the letters RFC indicates a radio-frequency choke.

If the part consists of one or more coils of wire wound on a metal core, the core is represented by three or four parallel lines drawn close together either through the coils, between them, or alongside of them. As an example, study the symbols for the audio transformer, power transformer, and filter choke.

Electric meters are indicated by small circles drawn around letters to indicate the type. For instance, a voltmeter is represented by a circle enclosing the letter V, an ammeter a circle enclosing the letter A, and a milliammeter the letters MA (see Fig. 17).

Simplest of all symbols, but at times the most confusing, are the conventions used to indicate whether or not two wires that cross each other in the diagram are connected. There are two systems of symbols used to distinguish wires that join from wires that merely cross. One way is to make a looped curve in one of the lines (wires) to indicate that it is bent over the other line (wire) and does not touch it. The other method is to let the lines cross but to consider that

they are not connected unless a dot is placed at the junction point.

In some radio diagrams you will find that a combination of the two systems is used, but a brief study of the lines generally will reveal what type of symbols the designer used.

Headphones and microphones (see Fig. 17) are symbolized merely by simplified pictures while loudspeaker drawings will vary with the type of speaker. A magnetic speaker having two connections, generally is represented by a spiral drawn around a single line projecting from the apex of a triangle drawn to simulate the cone. The dynamic speaker, on the other hand, consisting of a voice coil and a field coil is represented by two spirals, one representing the field winding and the other indicating the voice coil.

Radio Units

A theoretical wiring diagram is useful to the constructor only when it contains the necessary specifications for the parts. The type numbers of the tubes must be given, the number of turns for the coils must be indicated, and the values of resistances and condensers must be clearly labelled. For this reason it is imperative that the beginner learn the meaning of the various radio units used.

As in all electrical work, the most used units are volts and amperes. Because of space limitations, however, it is usually impossible to spell these words out. For this reason, the abbreviation "a" is used to indicate amperes and "v" for volts.

Since many radio measurements are extremely small, smaller voltage and amperage units are sometimes used. These are the microvolt, the microampere, the millivolt, and the milliampere. Being derived from the ordinary metric system, micro means one one-millionth part and milli means one one-thousandth part. Thus, one microvolt indicates one one-millionth of a volt while one milliampere represents one one-thousandth of an ampere.

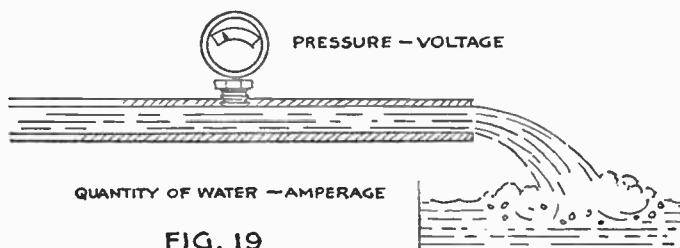

FIG. 19

A good way for the beginner to fix the electrical difference between volts and amperes in his mind is to understand the water analogy shown in Fig. 19. The amperage flowing in a circuit is the quantity of electricity flowing and can be likened to the amount of water passing through the pipes of a water system. Voltage, on the other hand, like the pressure of the water flowing, is the pressure of the electricity passing in a circuit.

Condensers are devices for storing electrical energy and their capacity for storing this energy is measured in farads. However, a condenser of one farad capac-

ity would be a large affair so that a smaller unit, the microfarad is the most common capacity unit used in radio work. Like the microvolt or the microampere, the microfarad is one one-millionth of a farad. Abbreviated to save space, it is written mfd. or merely mf.

A still smaller unit for condenser capacity is the micromicrofarad or one one-millionth of one one-millionth of a farad. By division, it is easy to see that the

PREFIX	MEANING	
DECI	ONE-TENTH PART OF	$\frac{1}{10}$
CENTI	ONE-HUNDRETH PART OF	$\frac{1}{100}$
MIL OR MILLI	ONE - THOUSANDTH PART OF	$\frac{1}{1,000}$
MICRO	ONE - MILLIONTH PART OF	$\frac{1}{1,000,000}$
MICRO MICRO	ONE-MILLIONTH OF ONE MILLIONTH	$\frac{1}{1,000,000,000,000}$
KILO	ONE THOUSAND TIMES	1,000 X
MEGA	ONE MILLION TIMES	1,000,000 X
DEKA	TEN TIMES	10 X

FIG. 20

micromicrofarad is one one-millionth as large as the microfarad. When abbreviated, the micromicrofarad is written as mmf. (see Appendix).

The fourth important electrical quantity is resistance—the ability of a circuit, a part, or a length of wire to resist the flow of current. The basic unit of resistance is the ohm generally abbreviated as the Greek letter omega (Ω). Since large resistances often are used in radio circuits, a larger resistance unit also is used. It is the megohm, representing one million

ohms. In its abbreviated form, the megohm is written merely as meg.

Incidentally, a table drawn up like that in Fig. 20 and tacked under the tool rack of his bench will help the amateur in finding out quickly what the prefixes micro, mega, milli, kilo, and micromicro mean when encountered on a radio diagram or blueprint.

Another quantity that must be specified on a radio diagram if it is to be of any use to the home experimenter is the number of turns of wire used on home-wound coils. The turns in most cases are specified as a number followed by the letter "t". The notation $17\frac{1}{2}$ t lettered next to a coil, for instance, indicates seventeen and one-half turns.

To be complete, the size and kind of wire also must be designated. In radio work, the gage can be assumed to be the Brown and Sharpe or American wire gage unless otherwise specified (see Appendix).

The wire used, in most cases, will be insulated and the type of insulation also should be specified either on the drawing or in the list of parts. Insulations vary from a coating of enamel to one or two wrappings of cotton or silk. In the specifications, they will be designated by the following abbreviations:

Single cotton covered	S. C. C. or SCC
Double cotton covered	D. C. C. or DCC
Single silk covered	S. S. C. or SSC
Double silk covered	D. S. C. or DSC
Single silk-cotton covered	S. S. C. C. or SSCC
Double silk-cotton covered	D. S. C. C. or DSCC
Enameled	Enam.

Aids in Reading Diagrams

One of the best ways to understand the workings of a circuit is to draw a simple picture wiring diagram after carefully studying the circuit diagram and deciding just what parts are required. A picture wiring diagram, consisting of pictures of the actual parts connected with bold pencil lines to represent wires, is

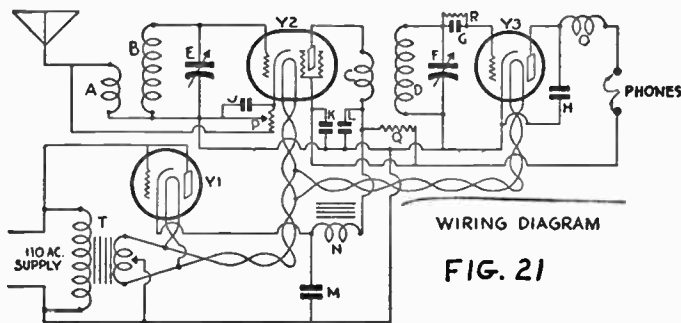

easy to follow and will be of great assistance in placing the parts and arranging the panel and chassis. In making a picture wiring diagram it is possible often to eliminate wires and simplify the connection by making one wire serve where two wires are shown in the circuit diagram. A picture diagram of this type is shown in Fig. 22. It corresponds to the circuit diagram given in Fig. 21. As an exercise in blueprint reading, draw a picture diagram from Fig. 21 and then compare it with Fig. 22 as a check on your knowledge of symbols.

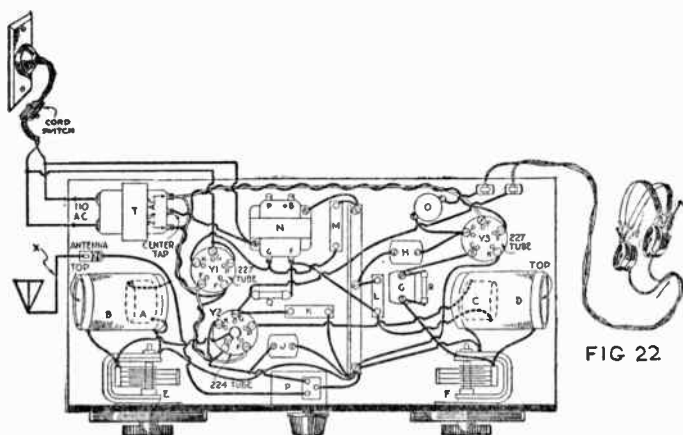

FIG 22

Arranging the Parts

The simplicity of a radio circuit and the ease with which it can be assembled and wired will depend to a great extent on the way in which the various parts are placed on the chassis and panel. For this reason, many amateurs desire to build a circuit bread-board fashion before attempting to mount it in its finished form.

Study the circuit and attempt to group the parts. A condenser and a resistance that are to be connected should be placed adjacent to one another. Short connecting leads are a desired feature in any circuit and especially in those designed to cover the short waves.

The same procedure should be followed in planning and laying out the panel. Controls mounted on the front panel should be placed at the right, at the left,

or in the center to match up with connecting parts. Phone or speaker terminals should be placed close to the audio end of the circuit while antenna and ground binding posts should be located near the coils and tuning condenser. If the circuit is to be battery operated, the battery terminals at the rear of the chassis should be as close as possible to their points of entrance into the circuit.

Checking Your Circuit

Once you have constructed your circuit, your first important job will be to check it for errors. Of course, the simplest way to do this is to compare it, wire for wire, with the original diagram or blueprint. However, by this method it is possible often to completely miss a connection or pass over the same mistake repeatedly without noticing it. A better way is to put your original circuit diagram away and with a pencil and paper make your own drawing of the circuit as you have wired it. This drawing then can be compared with the original circuit diagram. If any connections have been omitted or made to the wrong parts, the differences in the diagrams will make it possible for you to locate them quickly.

Above all, do not be in a hurry to connect your power supply in order to try the set out. A few minutes spent in checking the circuit is time well spent if by so doing you can avoid burning out a tube or ruining a coil.

CHAPTER III

MEASUREMENTS, FORMULAS, AND DEFINITIONS

FROM time to time in your radio work you will find it necessary to make certain electrical measurements. This will be particularly true if you extend

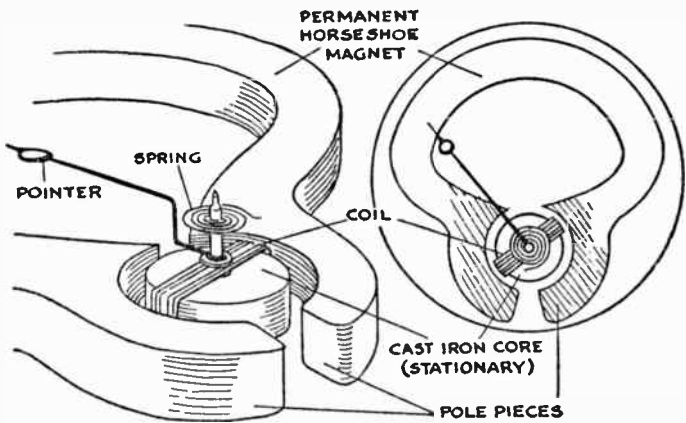

FIG. 23

your hobby into the spare-time servicing of ailing receivers. Unknown resistances must be made known, voltages must be measured, and various amperages must be tested. In this part of your work, the electric meter will serve as your yardstick (see Fig. 23).

Although various types of meters exist, the most important from the amateur's and serviceman's standpoint are the direct-current milliammeter and the direct-current voltmeter.

The Milliammeter: Physically, the direct-current milliammeter is the simplest type of meter. It consists of a delicate coil of wire fitted with a slender pointer

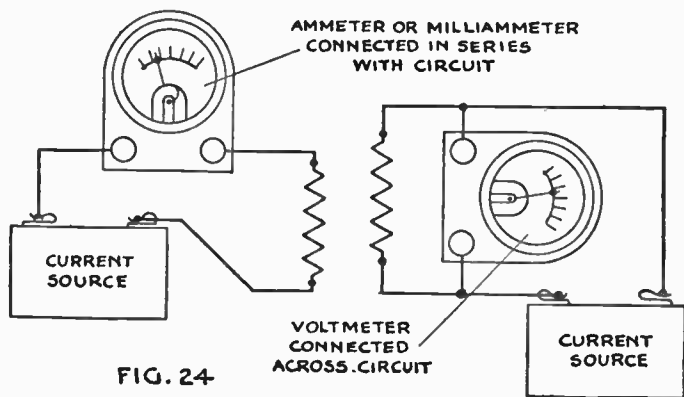

FIG. 24

and pivoted freely between the poles of a horseshoe-shaped permanent magnet.

In use, it is connected in series with the circuit in question. As the direct current flows through the windings of the coil, magnetic lines of force are set up by the wires and the coil becomes a miniature magnet having a north as well as a south pole. Being mounted between the poles of a permanent magnet, the coil turns to suit the repelling action of like poles and the attracting force of unlike poles. As more current flows through the coil, the lines of force become stronger,

and the turning of the coil becomes greater. Since the amount of deflection or turning of the coil is directly proportional to the amount of current flowing in the wire, the arrangement serves as an accurate gage of the relative strengths of electric currents.

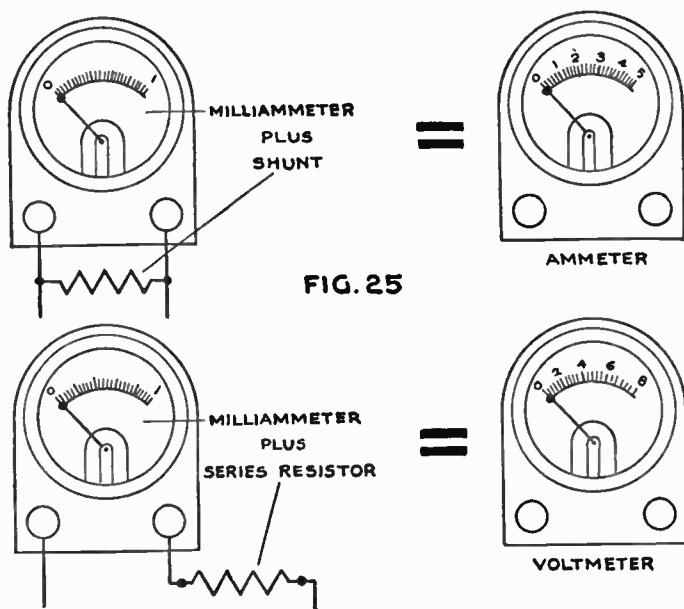

FIG. 25

Because the coil is composed of fine wires which can stand only small quantities of current, the milliammeter must be connected in *series* with the circuit and never *across* it, Fig. 24. Measurements made with a milliammeter are called milliamperes (1/1000 ampere).

The Ammeter: By adding a shunt resistance across the terminals of an ordinary milliammeter, as shown in Fig. 25, we can transform it into an ammeter. In the case of regular commercial ammeters, this shunting resistance often is a part of the meter case. Measurements made with an ammeter are called amperes (1,000 milliamperes), the standard unit for current. The ammeter is connected in *series* with a circuit.

The Voltmeter: Like the ammeter, the voltmeter also is an adaptation of the milliammeter (see Figs. 24 and 25). However, instead of a shunt, a series resistance is used to make the conversion. For example, a 0 to 1 voltmeter is nothing more than a standard 0 to 1 milliammeter having a 1,000-ohm series resistor connected to it while a 0 to 10 voltmeter has a 10,000-ohm series resistance, and a 0 to 100 voltmeter employs a 100,000-ohm series resistor. The voltmeter is connected *across* the circuit.

Extending Meter Ranges: Since the difference between milliammeters, ammeters, and voltmeters is merely the size and position of a resistance, it is a simple matter to alter the scale range of any meter simply by changing the value of the resistance.

For example, the range of an ammeter can be increased by connecting an external shunt across its terminals. The value of this shunt, depending on the range desired, can be calculated in the following way: Multiply the internal resistance of the meter (resistance of coil and built-in shunt) by the actual maximum reading of the meter's scale and divide the result by the difference between the maximum scale reading desired and the actual maximum scale reading (see

Fig. 26). This same formula can be used in figuring the value of a shunt for transforming a milliammeter into an ammeter.

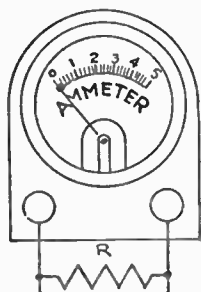

- S = ACTUAL SCALE
 D = SCALE DESIRED
 M = INTERNAL RESISTANCE OF METER (OHMS)
 R = SHUNT RESISTANCE

$$R \text{ (OHMS)} = \frac{M S}{D - S}$$

FIG. 26

In the same way, the range of a voltmeter can be increased. In this case, as already described, the resistance is not shunted across the terminals of the meter but is connected in series with it. To calculate

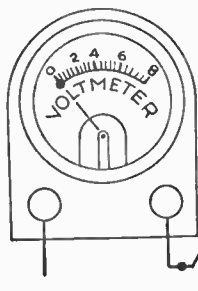

- S = ACTUAL SCALE
 D = SCALE DESIRED
 M = INTERNAL RESISTANCE OF METER (OHMS)
 R = SERIES RESISTOR

$$R \text{ (OHMS)} = \frac{D - S}{S} \times M$$

FIG. 27

the value of this resistance, divide the difference between the maximum scale reading desired and the actual maximum scale reading by the actual maximum scale reading and multiply the result by the resistance of the meter (see Fig. 27).

Of course, when the scale range of any meter has been increased through the use of shunts or series resistors, the actual scale reading by the pointer must be multiplied by a correction factor to obtain the actual value of voltage or amperage across the terminals. This factor will be equal to the new maximum scale reading divided by the original maximum scale reading.

Measuring Alternating Currents: Small alternating current readings also can be made with a direct-

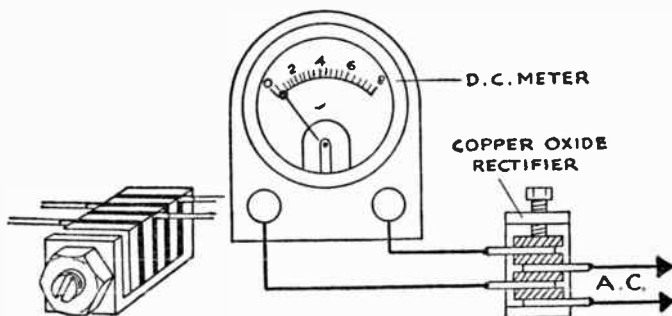
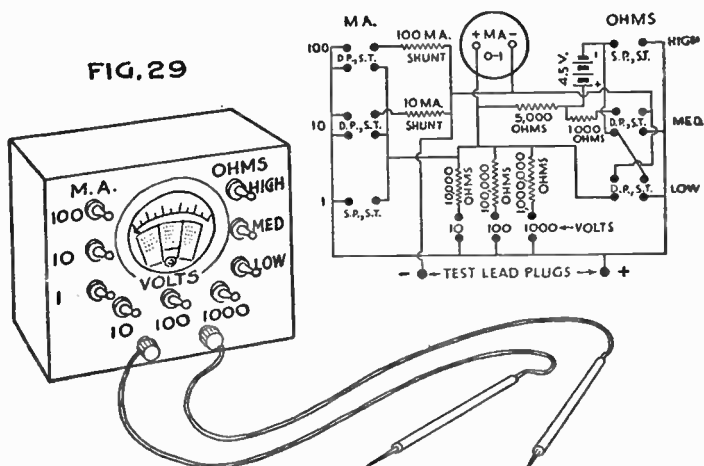

FIG. 28

current meter if a small copper oxide rectifier, such as shown in Fig. 28, is connected in shunt across the meter binding posts. Measuring less than an inch square, this useful dry rectifier consists of a series of alternate disks of copper and copper oxide. The action of the tightly clamped plates is to change the alternating current to pulsating direct current so that it can be measured by the direct-current instrument.

A Multi-Purpose Test Meter

By making use of the simple milliammeter and its various possible ramifications, the amateur can supply himself with an inexpensive multi-purpose test meter. By connecting this one meter as shown in the diagram of Fig. 29, he can measure voltages and amperages and



find the values of unknown resistances. No one piece of measuring equipment will prove more useful than this combination voltmeter, milliammeter, and ohmmeter.

Besides a D. C. milliammeter (0-1 MA), you will need five resistances; two shunts; two test plug jacks; a four and one-half-volt C battery; two single-pole, single-throw toggle switches; and four double-pole, single-throw toggle switches. Although the various

switches, the meter, and the resistances can be mounted on an open board, the test meter will form a handier unit if it is mounted in some sort of box or case, as shown. For this, the amateur experimenter can obtain an old composition box of the type used to house large meters.

The meter circuit, as shown by the diagram, is divided roughly into three parts—the switches and

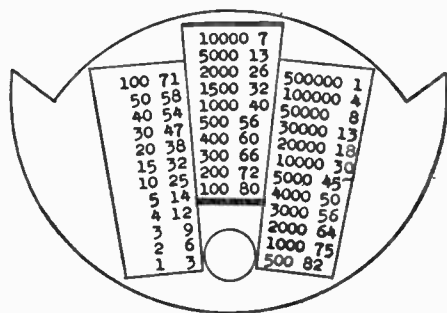

FIG. 30.

shunts which control the milliamperere readings, the resistances and switches for voltage measurements, and the resistances, switches, and C battery for finding resistance values.

The four- and one-half-volt battery, the resistances, and the shunts can be mounted inside the meter case. If resistances of the bobbin type are used, they can be stacked on brass bolts in the lower corners of the case. No matter what class of resistors are used, however, they must be wire wound and accurately calibrated.

To simplify the resistance readings taken from the 0 to 1 milliampere scale of the meter, a conversion table or scale must be used. Such a scale, *calculated for a 0 to 1 milliammeter having an internal resistance of twenty-seven ohms*, is shown in Fig. 30. It can be mounted directly under the meter glass where it will be in constant view.

Three tabulations of two columns each are given. One for the low readings at the left, one for medium readings in the center, and a third for high readings at the right. In each tabulation the left-hand column indicates the resistance in ohms for the corresponding meter reading in hundredths of a milliammeter shown in the right-hand column.

For instance, let us suppose that the low resistance switch is in use and the meter reads .54. Running up the right-hand column of the first tabulation, we find 40 opposite 54. This indicates that the resistance connected to the meter has a resistance of 40 ohms.

Voltage and milliampere measurements can be read directly from the original meter scale once the full range of the scale has been converted to agree with the switch in use. In each case, however, be sure to start with the larger value switch and work down. It will prevent accidentally overloading the meter and eliminate the possibility of harming its delicate mechanism.

Measuring Capacities

With the equipment described so far, three important electrical quantities—voltage, amperage, and re-

sistance—can be measured. There is, however, another important quantity that enters into radio circuits. This fourth quantity is capacity.

Although the accurate measurement of the capacity of a fixed condenser represents quite a problem as far as the amateur and his meager supply of equipment

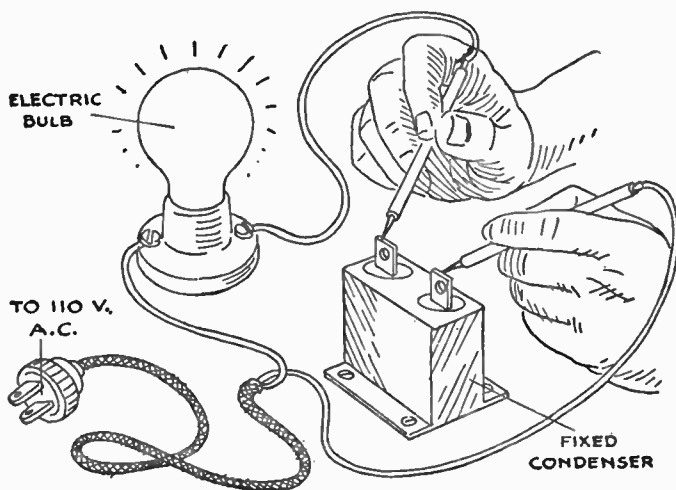

FIG. 31

are concerned, a simple test will allow a rough approximation that will serve in most cases.

A fixed condenser of any capacity placed in a circuit will prevent the flow of direct current without hindering the passage of alternating current. The amount of alternating current that will flow through the condenser depends on the voltage, the frequency of the alternation, and the capacity of the condenser.

These facts provide a simple way of obtaining a rough approximation where the capacity of a medium- or large-sized fixed condenser is required.

As shown in Fig. 31, all that is required are four electric light bulbs having ratings of ten, fifteen, twenty-five, and fifty watts; a set of test prods (see Fig. 6); a lamp socket; and a source of 110-volt alternating current. A few feet of ordinary lamp cord also will be needed for making the connections.

Connect the electric light socket to one end of the twisted lamp cord and attach an ordinary plug to the other end. Then cut one of the two leads between the plug and socket and to each of the free ends attach a test prod. With an electric light bulb in the socket and the plug inserted in the 110-volt supply, the lamp should light when the two prods are touched together.

The approximate capacity of a fixed condenser is determined by connecting the test prods to the terminals of the condenser in question and estimating the actual flow of current in the circuit by the relative glow of the light bulb. If, for example, the condenser being tested has a capacity of one-half microfarad, the ten-watt lamp will glow red and the glow of the fifteen-watt lamp when it is placed in the socket will be barely perceptible. If the condenser has a capacity of one microfarad, a fifteen-watt bulb will glow red and the twenty-five-watt lamp will glow a dull red.

Similarly, with a two-microfarad condenser, the twenty-five-watt lamp will glow a dull red and a three-microfarad unit will make the twenty-five-watt bulb glow bright red. To continue, a fifty-watt bulb will be

very dim with a four-microfarad condenser but will be bright red with a six-microfarad condenser.

If you have a supply of fixed condensers of various known capacities, try these tests over and over again until you can visualize the effect each has on bulbs of various wattages. Once you have established a definite relation, you will have little difficulty approximating the capacity of any large- or medium-sized condenser.

If on testing a condenser of any capacity, the bulb appears as bright as it is when the two test prods are touched together, it is an indication that the current is flowing full strength due to a short circuit or a blow-out in the condenser.

Identifying High Voltages

A similar kink can be used by the experimenter to find the approximate values of high voltages.

You may, for example, have on hand a power transformer that was installed originally in a factory-built set. Of course, the ideal and most nearly accurate way to determine the voltages available from its secondary would be to use a multi-range alternating-current voltmeter. However, lacking such equipment, you can readily identify each of the secondary windings with the aid of a few electric light bulbs.

Usually, a power transformer has a center-tapped high-voltage winding which may develop from 200 to 300 volts each side of the center tap. Between the outside terminals, a voltage as high as 600 volts may be expected. The first job will be to locate these three wires.

First, connect five or six fifteen-watt, 110-volt electric light bulbs in series, as shown in Fig. 32. Then attach a test prod to each end of the series arrangement. Finally, after making sure that all of the secondary wires are standing apart and are well insulated

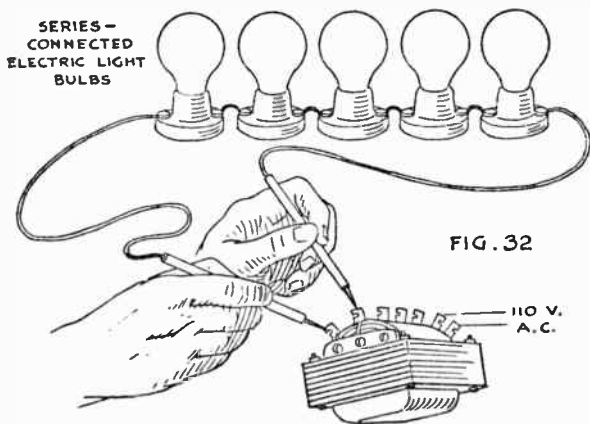

from one another, connect the primary of the transformer to the 110-volt lighting circuit.

Carefully touch the tips of your test prods to various pairs of wires extending from the secondary side of the transformer. When you hit the wires leading from the ends of the high-voltage winding, the series-connected bulbs will glow brightly. Then, touching one of these wires and the center-tap wire will cause the bulbs to glow only half as bright (indicating half voltage).

Once the high voltage windings have been located,

tagged, and insulated to avoid the danger of a shock, proceed to experiment by touching the remaining wires with your test prods. In making these lower voltage tests, however, a single two- or four-candlepower, six-volt automobile bulb should be substituted for the five or six 110-volt bulbs in the test prod circuit.

Calculating Resistance and Condenser Circuits

Since the average radio circuit consists principally of various fixed resistances and fixed condensers connected in a variety of ways, the amateur often will find it necessary to calculate the combined resistance or capacity of groups of parts. Calculations of this type will be particularly valuable when making substitutions for faulty units in a circuit. If the exact part is not available at the time, two or three units can be connected together in such a way as to give the desired resistance or capacity.

Three general types of connections are possible with a group of resistances or a group of condensers. They may be connected in series like a chain, in parallel like the rungs of a ladder across the uprights, or in a combined form called series-parallel. Figure 33 illustrates these various arrangements.

Calculating the Combined Value of Series Resistances: Computing the combined resistance of a group of resistances connected in series is one of the simplest of circuit calculations. The individual resistance values simply are added together to give the overall resistance. As an arbitrary example, if a 3,000-ohm, a 10,000-ohm, and a 3-megohm (3,000,000 ohms)

resistance are connected in series the combined resistance will be 3,013,000 ohms.

Calculating Resistance in Parallel: Parallel connected resistances present a slightly different problem (see Fig. 33). In this case, the overall resistance is not equal to the sum of the various values but to the reciprocal of the sum of the reciprocals. In other words, when four identical (equal) resistances are connected in parallel, the total resistance will be equal







CONNECTION	RESISTANCE		CONDENSER	
	DIAGRAM	FORMULA	DIAGRAM	FORMULA
SERIES		$R = R_1 + R_2$		$C = \frac{1}{\frac{1}{C_1} + \frac{1}{C_2}}$
PARALLEL		$R = \frac{1}{\frac{1}{R_1} + \frac{1}{R_2}}$		$C = C_1 + C_2$
SERIES-PARALLEL		$R = \frac{1}{\frac{1}{R_1 R_2} + \frac{1}{R_3 R_4}}$		$C = \frac{1}{\frac{1}{C_1 C_2} + \frac{1}{C_3 C_4}}$

FIG. 33

to only one quarter the resistance of one unit. The more resistance you connect in parallel, the more wires there will be for the current to flow through, and the more the total resistance of the circuit will be reduced.

Series resistances *increase* the total resistance of a circuit, while parallel-connected resistances *reduce* it. If a 100- and a 200-ohm resistance are connected in series the total resistance will be 300 ohms, but if they are connected in parallel, their total resistance will equal only 66 $\frac{2}{3}$ volts.

Condensers in Series: With a group of condensers connected in series (see Fig. 33), the effect is to *decrease* the overall capacity. The formula resembles

that used in the calculation of resistances in parallel—the overall capacity equalling the reciprocal of the sum of the reciprocals.

Condensers in Parallel: When condensers are connected in parallel, the effect is to increase the overall capacity. Like resistances connected in series, the total capacity equals the sum of the individual capacities.

Briefly then, condensers placed in series decrease the capacity, while condensers placed in parallel increase the capacity.

Series-Parallel Connections: In figuring the combined values of either resistances or condensers in series-parallel (see Fig. 33), both the series and the parallel formulas must be used. The make-up of the circuit in each case will decide in what order the calculations are to be made.

Ohm's Law

One of the most important formulas or rules in radio and electrical work is what is known as Ohm's law. It gives the relation between the voltage, the amperage (current), and the resistance in any circuit. Knowing any two of these values, the third and unknown can be found merely by simple substitution. How the law can be applied is shown graphically in Fig. 34.

Stated in words, Ohm's law says that the voltage (E, standing for electromotive force) in any circuit is equal to the amperage (I) multiplied by the resistance (R).

As an example, suppose a current of four amperes flows through a resistance of thirty ohms. Applying

Ohm's law and multiplying we find that the voltage is equal to 120 (4 x 30) volts.

In the same way, by using the formula in a slightly different form we can solve for either the resistance or the current, depending on which two of the three

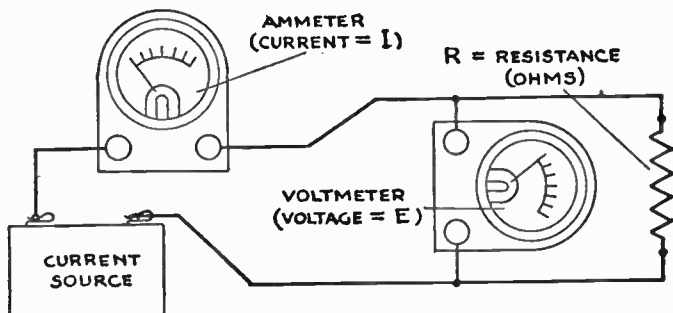

$$\begin{array}{rcl} \text{VOLTAGE} & = & \text{CURRENT} \times \text{RESISTANCE} \\ E & = & I \times R \\ I & = & \frac{E}{R}, \quad R = \frac{E}{I} \end{array}$$

FIG. 34.

quantities are known. Current then will be equal to the voltage divided by the resistance while the resistance can be found by dividing the voltage by the current. The three variations of this formula are given in Fig. 34.

Frequencies and Wave Lengths

The dimensions of radio waves issuing from a transmitter can be specified in two ways—as frequency or

wave length. As the names imply, wave length is the length of each radio wave from crest to crest, like the distance between the tops of two breakers as they roll into a beach from the ocean (see Fig. 35), while the frequency is the number of these waves that pass any one point in a second.

Since the speed of radio waves is fixed at approximately 186,000 miles or 300,000,000 meters a second,

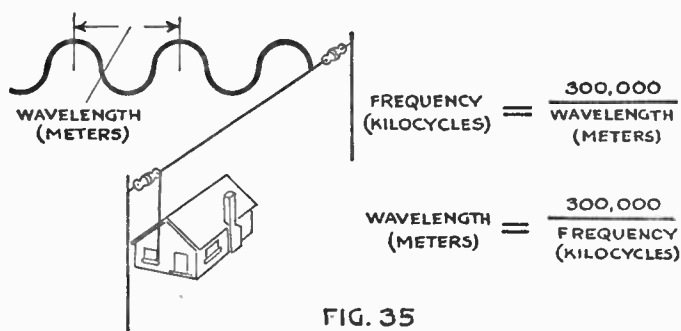

FIG. 35

it is obvious that there is a definite relation between the wave length and the frequency. Knowing how to convert from one to the other is particularly useful to the amateur experimenter, since both values rarely are given in the listings of stations.

For consistency, wave lengths are measured in meters and frequencies in kilocycles (1,000 cycles). When it is stated that a station has a frequency of 760 kilocycles, it means that in that particular wave, 760,000 waves pass any one point in a second. Since radio travels at a speed of 300,000,000 meters a sec-

ond, the wave length then must be equal to 300,000,000 divided by 760,000 or approximately 395 meters.

Expressed in simpler terms, the relation between frequency and wave length is as follows: Dividing 300,000 by the wave length in meters gives the frequency in kilocycles while dividing 300,000 by the frequency in kilocycles gives the wave length in meters (see Fig. 35).

Important Radio Definitions

Alternating Current—An electric current that reverses its direction periodically. Wires connected to an alternating current source are neither negative nor positive but become first one and then the other according to a definite cycle.

Audio Frequency—An audio frequency is any frequency within the range of audible sound. It differs from a radio frequency in being a vibration in air instead of in the ether. Audio frequencies are very much slower than radio frequencies. Deep, bass sounds have frequencies as low as 16 or 20 vibrations (cycles) a second. High shrill sounds may have frequencies as high as 25,000 or 30,000 a second.

Ampere—The standard unit for electric current. It is the amount of current that will flow in a circuit having a resistance of one ohm and fed by a voltage of one volt.

Choke Coil—A choke coil is a coil of wire used to present an obstruction to the passage of an alternating current.

Carrier—A transmitting station does not send out a single wave corresponding to the sounds that it intends to transmit. Instead, it sends out a fundamental wave, called the carrier wave, which has a uniform frequency, and superimposes the sound message on it.

Cycle—A cycle is one complete series of events. In the case of an alternating current, it is one complete set of positive and negative alternations.

Detector—The detector in a radio circuit is a device that stops one-half of the alternations of a radio-frequency wave and permits the other half to pass through. In other words, it is a rectifier that changes the high-frequency oscillations into a pulsating direct current which will operate earphones.

Direct Current—Unlike an alternating current, a direct current does not reverse. If two wires are connected to a direct-current source, one will remain positive and the other negative.

Farad—The farad is the unit of capacity. Since a condenser having a capacity of one farad would be large, smaller units, the microfarad ($1/1,000,000$ of a farad) and the micromicrofarad ($1/1,000,000,000,000$ of a farad) are used.

Frequency—The number of complete cycles that occur in one second.

Henry—The unit of inductance.

Impedance—Impedance is the opposition of an electrical circuit to the flow of alternating current.

Inductance—The property of a coil or circuit to store up electrical energy in electromagnetic form.

Ohm—The ohm is the unit of resistance. It is the amount of resistance that will allow a current of one ampere to flow under a pressure of one volt.

Radio Frequency—Any vibration faster than audio frequency is called a radio frequency. The wave sent out by a transmitter is a radio frequency.

Volt—The volt is the amount of pressure that will force one ampere of current through a resistance of one ohm. It is often referred to as the electromotive force.

Watt—The watt is the unit of electric power. It is calculated by multiplying the voltage of the circuit by its amperage.

Wave Length—The distance in meters between corresponding points in adjoining waves.

CHAPTER IV

SIMPLE RADIO TESTS

TRYING to locate wiring errors in a receiver can be difficult enough without complicating the problem by including a defective part in the assembly. For this reason it will pay the amateur to test each part before wiring it permanently into the circuit. This will be particularly true when old parts, salvaged from discarded sets, are used.

Fortunately the testing of the various parts that go to make up a radio circuit requires no great amount of skill or equipment.

Testing A Condenser: A fixed condenser can be tested by connecting it in series with a battery and a voltmeter as shown in Fig. 36. If the voltmeter shows a momentary deflection, the condenser is a good one. However, if a constant deflection is noted it is a sign that the condenser leaks. If the full voltage of the battery used in the circuit is registered by the meter, the condenser is short-circuited at some point.

Another simple test for a fixed condenser replaces the meter with a pair of earphones (see Fig. 37). The condenser in question is placed across the terminals of a small battery. Then, it is removed and the cord tips from a pair of earphones are connected in the battery's place. If a sharp click is heard in the earphone at the

CONDENSER TESTS

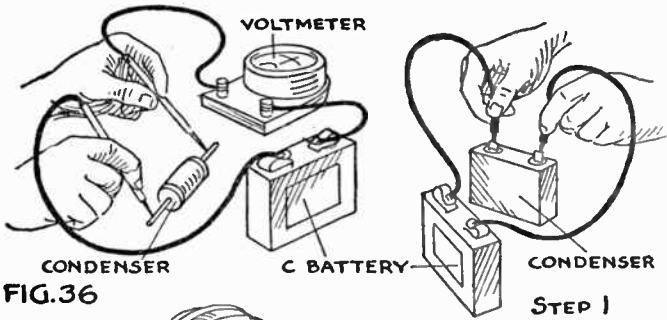

FIG. 36

FIG. 37



STEP 2

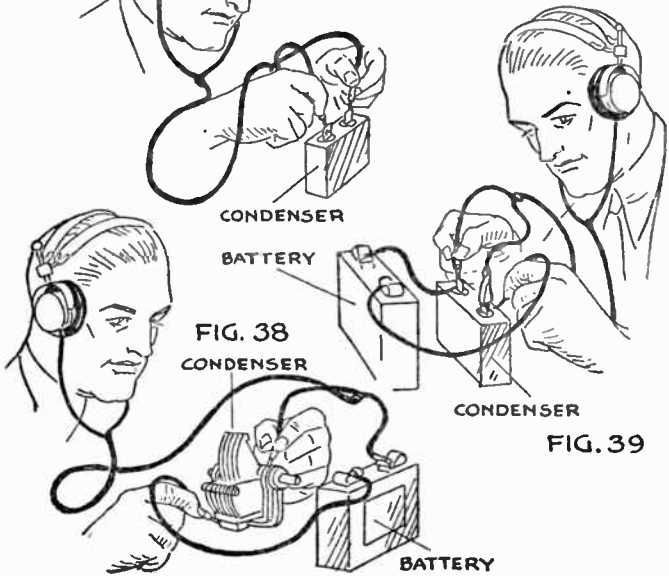

FIG. 38

CONDENSER

FIG. 39

instant the tips are connected, the condenser gives evidence of being in good shape.

As a final earphone test for a shorted condenser, connect the phone tips to the terminals of the condenser and connect one terminal of the battery to one of the terminals on the condenser. Then snap a wire from the other terminal of the battery to the second terminal of the condenser. If the condenser is completely short-circuited, there will be practically no click in the earphones (see Fig. 38).

Since a condenser in good condition will not pass direct current, the ohmmeter also can be used as a test. A leaky condenser will allow some of the current to pass and a slight deflection will be noted on the ohmmeter.

If you suspect that the plates of a variable condenser are touching at some point, connect the condenser in series with the headphones and a small battery, as indicated in Fig. 39. If the plates do touch at any point, an ear-splitting clatter will be set up in the earphones when the movable plates are turned.

Testing For Open Circuits: Tracing an open circuit sometimes is referred to as continuity testing. For this, some ohmmeter arrangement, such as shown in Fig. 40, presents the best check since the resistance, as well as the continuity of the wire, can be tested.

A pair of earphones connected to a small battery also can be used to check continuity. The two free ends of the series circuit are fitted with test prods, as shown in Fig. 41. The prods then can be touched to each side of the part being tested. If a click is heard in the earphones, it indicates that the current from

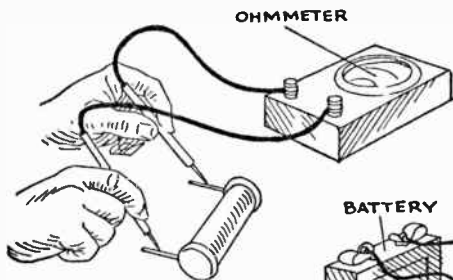

FIG. 40

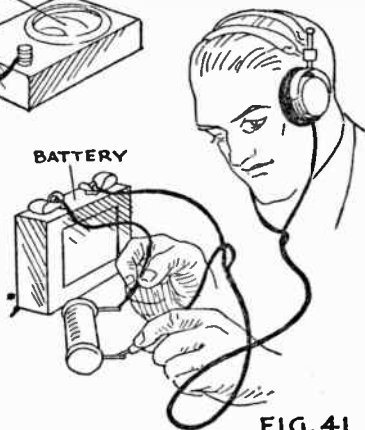

FIG. 41

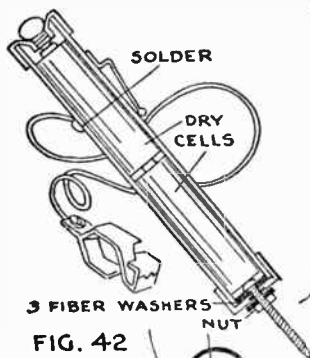

FIG. 42

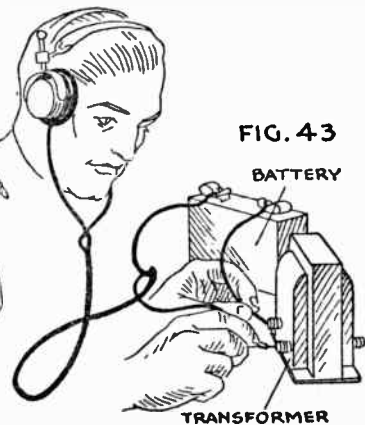
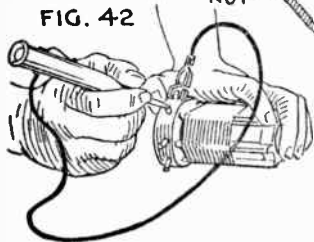

FIG. 43

TRANSFORMER

the battery is passing and that the part is in good shape. One difficulty with this test arrangement is that the faulty part being tested may be grounded at some point in which case the telltale click also may be heard.

Using a variation of this same arrangement, the experimenter can make a handy vest-pocket continuity tester from a small flash light of the fountain-pen type, Fig. 42. Besides the flash-light case and batteries, which can be purchased for very little, all that is required is a long brass machine screw and nut, a few fiber washers, a few feet of high-grade flexible insulated wire, and a spring battery clip.

As shown in the drawing, the machine screw, sharpened at the outer end is inserted through a small hole drilled in the closed end of the metal flash-light case. The head of the long screw serves as the contact for the lower end of the battery circuit, while the outer end, sharpened to a slender point with a file, serves as the test prod. A long flexible wire soldered to the flash-light case and terminating in a small battery clip serves as the second terminal.

To use the pocket tester, clip the wire to one terminal of the part to be tested and touch the pointed test prod to the other terminal. If the circuit is continuous, the lamp at the upper end of the flash light will glow.

One difficulty presents itself with a tester of this type, however. Since the initial voltage available from the battery is low, the current will be forced only through circuits of relatively low resistance. For this reason, while it will serve effectively in testing low-

resistance circuits such as coils, low-value resistors, etc., it will be of little use on units that are known to have a high resistance.

By supplying the point of the test prod with a simple leather sheath, the tester can be carried conveniently in your vest pocket. The wire can be coiled around the flash-light case.

Testing Transformers: If an audio transformer is thought to be defective, its windings can be tested for breaks by making use of the earphone-battery circuit which forms the basis of the condenser test. Hook one phone tip to the terminal of a small battery (a C battery will serve), connect the other battery terminal to one primary terminal of the transformer, and touch the remaining phone tip to the second primary terminal (see Fig. 43). If a good snappy click is heard when the contact is made and again when the contact is broken, you can be sure that nothing is wrong with the primary winding. Repeat the process to test the secondary. If the click is extremely faint or inaudible, the wire of that particular winding is broken at some point. As in all continuity tests, an ohmmeter also can be used to test transformers.

Power transformers can be tested by making use of the simple kink for identifying high voltages as described in Chapter III and illustrated in Fig. 32.

Testing Coils: Almost any of the continuity tests already described can be used to test radio-frequency coils, plug-in coils, and radio-frequency chokes for open circuits.

Testing A Dynamic Speaker: Among the possible electrical troubles that can befall a dynamic speaker

are a burned out field coil, a burned out or broken voice coil, and a loose connection.

SPEAKER TESTS

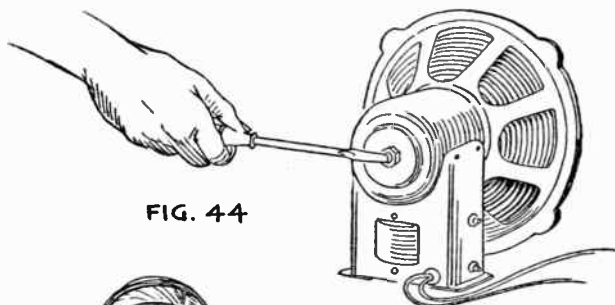

FIG. 44



FIG. 45

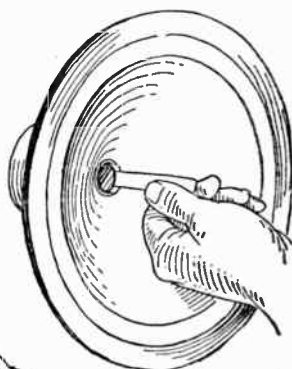

FIG. 46

If the field coil burns out, the speaker will continue to operate, but the volume will be much less, dropping so low that the signals can be heard only faintly even

when the volume of the receiver is turned full on. A sure test for field coil operation is to hold the end of a screw driver near the pole piece, either at the front or at the rear (see Fig. 44). It should be strongly attracted to it. If it is not, then either the field coil is burned out or there is a broken connection in the wires leading to the field coil.

A burned out voice coil on the other hand will completely silence the speaker. The simplest test for this ailment is to resort again to the battery and earphone test set (see Fig. 45). Connect the small battery and the earphones in series as before and touch the two free ends of the circuit to the ends of the voice coil. If you hear the familiar click-clack as you make and break the circuit, the coil is in good condition. If you do not hear it, the coil is broken at some point.

Loose connections in the speaker leads result in intermittent operation or in excessively noisy and irregular volume. Breaks in the circuit can be found by resorting to any of the continuity tests already described.

Another loudspeaker trouble that will ruin the tone of the unit is a warped or off-center voice coil. This can be detected by following the procedure shown in Fig. 46. There should be sufficient clearance between the pole piece and the inside of the coil to take a piece of ordinary writing paper. Cut a strip about a half inch wide, slip it into the opening, and test to see if it can be moved completely around the crack.

Testing Earphones: Earphones can be tested readily by touching one cord tip to one terminal of a small battery and snapping the other against the other bat-

tery terminal. A sharp click means the phones are in good condition. If you have no battery handy, place one of the cord tips in your mouth and touch the other

POLARITY TESTS

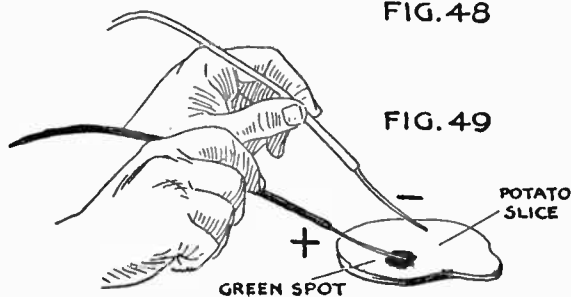
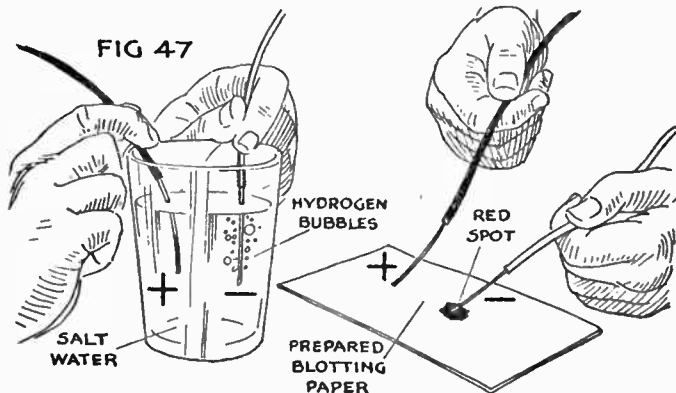

to a gold ring worn on your hand. A faint click will be heard if the earphones are in good shape.

Testing for Polarity: Very often, it is necessary to determine which of two wires carrying direct current

is the positive terminal. This can be done in several ways. A voltmeter, of course, is the obvious test. However, if one is not available, attach a copper wire to each of the terminals of the current source and immerse the uninsulated ends in a glass containing water to which a small amount of salt has been added. Hold them about an inch apart. As the electric current passes through the water and decomposes it, bubbles of hydrogen will collect around one of the wires. This will indicate the negative terminal (see Fig. 47).

By soaking ordinary white blotting paper in a solution of salt water to which a few drops of phenolphthalein solution have been added, regular test polarity paper can be made. The paper then can be allowed to dry and stored for future use. When the necessity of a polarity test arises, simply dampen the paper and touch the bare ends of the two wires to it as shown in Fig. 48. The area of paper surrounding the negative wire will turn red.

In another type of simple polarity test a fresh slice of raw potato replaces the prepared test paper. When the two wires are touched to the white of the potato, a green spot will appear around the positive terminal (see Fig. 49).

Testing A Ground: When an external ground, in the form of a length of pipe driven into the earth, is used, there is always some doubt as to its efficiency. A foot of pipe driven into ground that is continually moist will form a good ground while ten feet of pipe sunk in dry sandy soil will be ineffective.

If you have a 110-volt lighting circuit in your home, however, you can determine the effectiveness

accurately and easily. This test is based on the fact that one of the wires in all ordinary lighting circuits is at ground voltage while the other is at a potential of 110 volts with respect to the first wire or the ground.

The general arrangement used in making the ground test is shown in Fig. 50. It consists simply of connecting a wire to your ground, running it to one side of an

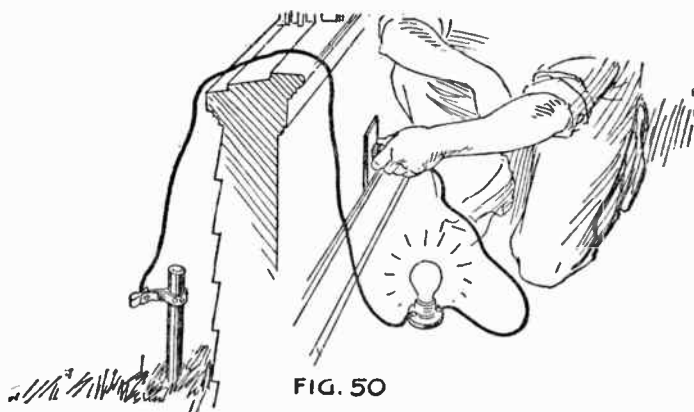

FIG. 50

electric light socket, and connecting the other side of the socket to one of the terminals on an ordinary electric cord plug.

Place an electric light bulb in the socket and push the plug into the nearest wall receptacle. If you do not have a wall receptacle, insert the plug into a screw receptacle placed in some near-by screw fixture. If the lamp fails to light, reverse it so that the plug connections are interchanged.

Should the light fail to glow in both cases, you can be sure that the ground will be of little use in radio

work. If, on the other hand, the bulb glows with normal brilliance with the plug in any one of the two possible positions, the ground should give good radio results. However, since the moisture content in the ground often varies with the temperature and the weather, it will be well to try this test on three or four different occasions before you give it your final approval.

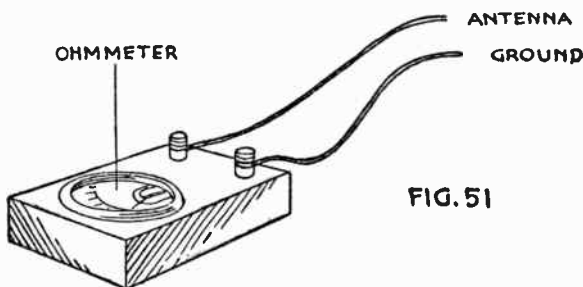

Testing an Antenna for Grounds: Once you have determined the efficiency of a ground, you can test the insulation of the antenna. To be most effective, the antenna, of course, should be free from any contact with the ground, no matter how remote. The test consists simply of substituting an ohmmeter for the antenna and ground terminals of the receiver as shown in Fig. 51. Since there should be no complete circuit between your antenna and ground, no reading should show on the ohmmeter.

CHAPTER V

RADIO KINKS AND SHORT CUTS

ALTHOUGH care and patience are the first rules of success in building sets and servicing them, time often can be saved by making use of simple kinks and short cuts.

Making a Duplicate Coil: Sooner or later in your radio work, you will want to substitute a tuning coil wound on a larger or smaller core than the one specified in the wiring diagram for the set you are building. You will then be confronted with the problem of figuring the correct number of turns to get the smaller or larger diameter coil to tune to the desired wave band.

Fortunately, the problem is not as complicated as it at first appears. If the change in diameter does not exceed twenty-five to thirty percent, the number of turns can be changed inversely in proportion to the change in diameter. For example, if the drawing or parts list for a particular set calls for a three-inch coil having fifty turns, a two- and one-half-inch form will require sixty turns while a four-inch coil will need thirty-seven and one half turns to give the same tuning results. In other words, simply multiply the number of turns on the specified coil by its diameter and divide

the result by the diameter of the coil form you wish to use (see Fig. 52).

Along the same line, there may be times when you will have a certain size wire on hand and will want to substitute it for a specified size. This also can be done provided the wire is not so large that it takes up more space than is available for the winding. However,

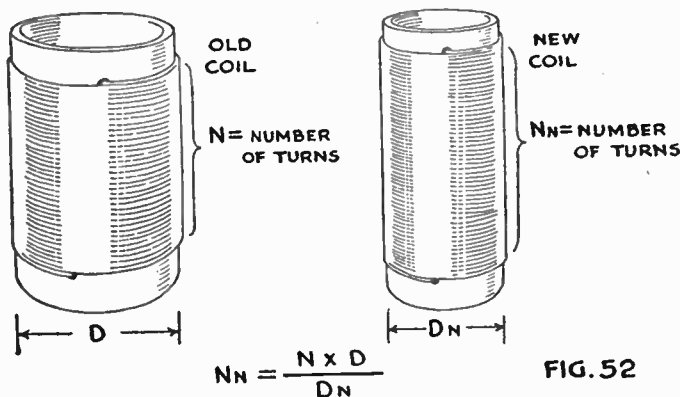

FIG. 52

since any form of computation for this change would be a complicated procedure, the amateur experimenter will do best to proceed by the method of trial and error. For any given diameter of coil form, the larger the size of the wire you use, the greater will be the number of turns required. If the specifications call for a No. 24 wire and you use a No. 22, it will be necessary to increase the number of turns to obtain the required tuning results. On the other hand, if a No. 26

wire is used in place of No. 24, decrease the number of turns. In winding a coil, make a few turns more than you estimate. Extra turns can be removed easily but additional turns cannot be added without bothersome soldering and patching. Simply experiment until you strike just the right number.

The type of insulation on the wire affects the specifications of the coil only so far as its relative thickness alters the spacing between turns. If there is a great difference in the thickness of the insulation used and that specified, it may be necessary to increase the number of turns slightly to make up for the decrease in induction caused by the wider spacing (see Appendix).

Space-Winding Coils: When a radio tuning coil is so wound that there is space between adjacent turns, the coil is said to be space-wound. This type of winding is often desirable on broadcast coils and almost essential on short-wave coils since it reduces the capacity. In most cases, space winding is specified as so many turns per inch.

Space winding can be accomplished in various ways. If an engine lathe is available, the coil form can be placed in the lathe and grooved with a thread-cutting tool for the proper number of turns per inch. The wire then can be wound accurately in the groove.

However, since few radio amateurs have access to an engine lathe, another simpler method generally is employed. This consists of winding a thread or cord on the coil form along with the wire as shown in Fig. 53. If the spacing between turns is specified, use thread or cord of that diameter. If the turns per inch are given, a few trials with strings of various diameters

will soon show you how to obtain just the right spacing.

Once the coil is wound, fasten the ends, carefully unwrap the string, and tack the wire to the form with rubber cement or collodion in several places to hold it

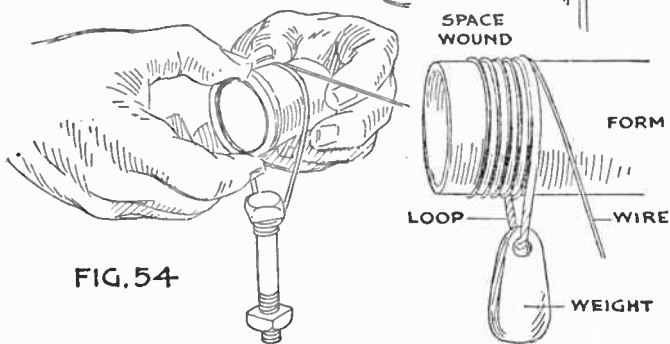
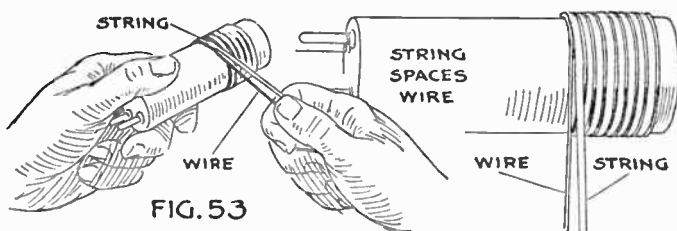

in place. Shellac often is specified for this work, but should be avoided if possible as it tends to increase the resistance of the coils when they are to be used for short-wave reception.

Another way to space-wind coils that is perhaps simpler and more effective is shown in Fig. 54. Instead of the spacing string described above, a simple

weighted loop hung over the coil form automatically separates the turns just the required amount. This eliminates the necessity of watching a spacing string as well as the wire and allows you to pay more attention to the winding of the wire.

When you have selected your wire, attach one end of it to the coil form at the point where the winding is to start and fasten the other end to some convenient anchor such as a door knob or a heavy chair. This will make it possible to hold the wire taut for the entire length of the winding.

The next step is to select a short length of flexible wire or heavy cord whose diameter is equal to the width of the spacing desired. Twist it to form a closed loop about eight inches long, fasten a small weight to the lower end, and slip the loop over the coil form.

When this has been done, you will be ready to proceed with the actual winding. Hang the loop over the form in such a way that it will follow the winding as the coil is turned. To do this, it will be necessary to have one full turn on the coil. Once in position, the loop, held taut by the weight, will space each pair of adjacent turns just the required amount. To insure accurate spacing, push each turn up flush against the spacing loop as the coil is turned. Your thumb nail will act as a good prod in this portion of the work.

When the coil reaches the required number of turns, lift the loop from the coil, fasten the wire, and proceed with the tacking process already described.

Making Plug-In Coil Forms: Although ordinary tube bases often are used as the forms of plug-in coils, the amateur can make a much neater form by using

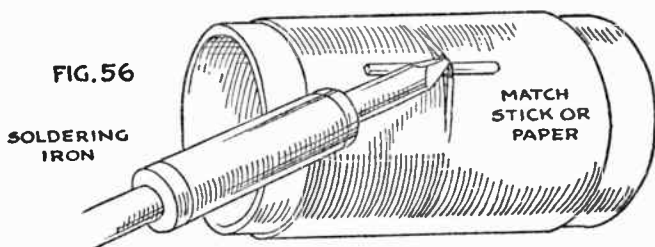
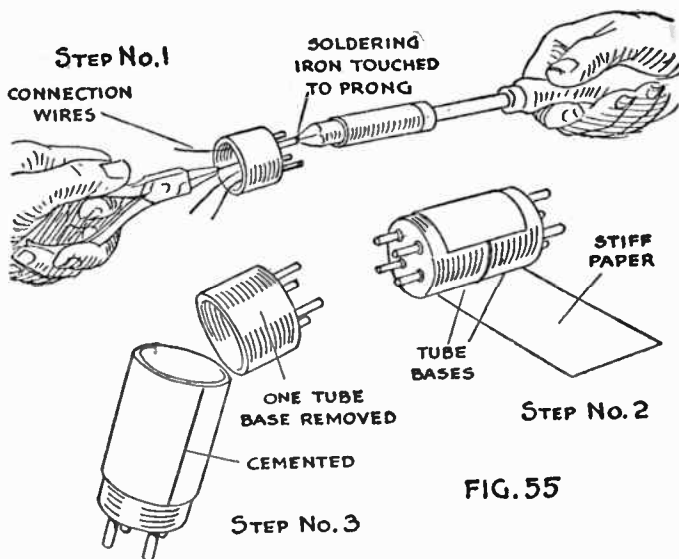

the kink illustrated in Fig. 55. Instead of winding the wire directly on the tube base as is frequently done, prepare a separate form by placing two tube bases end to end and wrapping them with a strip of stiff paper. The end of the strip should be cemented in place.

When the cement has dried, remove one of the tube bases, cement the paper form permanently to the other tube base, and stiffen it with a coat or two of lacquer or cement. Since the new form will be double the height of a single tube base it will provide more space for the windings.

As tube bases form a necessary part of homemade plug-in coils and adapter plugs, the amateur will have many occasions for removing the base from an old tube. To do this quickly, wrap the bulb of the burned-out tube in several thicknesses of cloth, place it on your workbench or any other hard surface, and strike it a sharp blow with a hammer or the handle of your screw driver.

To remove the fine wires that originally connected the various tube elements with the prongs, grasp each wire in turn with a pair of pliers and touch a hot soldering iron to the tip of the prong. The heat will soften the solder in the prong and the wire can be pulled out. Finally, fasten the new wires from the coil or cable as the case may be by simply reversing the process.

Remember, the prongs on a tube are not marked. To get the new wires in their proper prongs, hold the tube base over a socket and note the markings on the underside. The prong connections then can be marked with pencil directly on the composition base for future reference.

Soldering and Wiring Kinks

Soldering Coil Taps: When it is necessary to solder a tap to a coil, you can simplify matters by following

the suggestion given in Fig. 56. Simply lift the turn to be tapped and slip a piece of paper or a match stick under it at the point where the soldered joint is to be made. This will serve to raise the wire and will protect

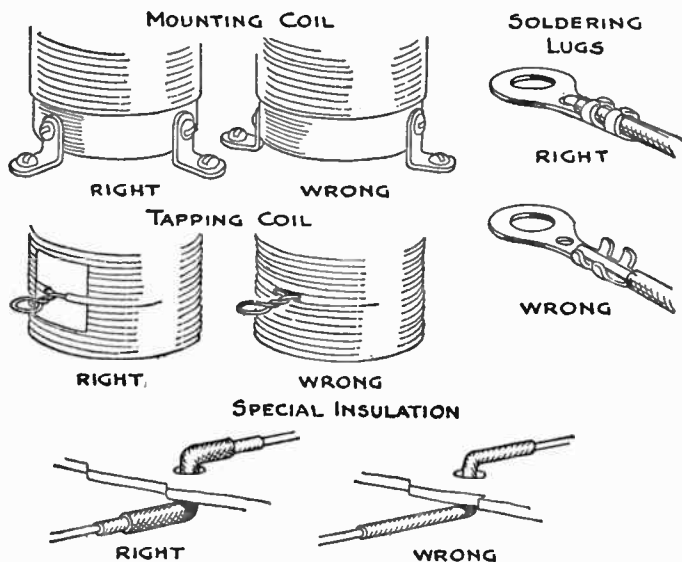

FIG. 57

the insulation on the adjacent turns from the heat of the iron. Remember, if you burn the silk or cotton covering on the wire, it will be transformed into carbon which is a conductor. If the insulation on several turns is burned, it will cause a short circuit.

Wiring Hints: Connecting the parts of a radio circuit in their proper order is only half the job of wiring

a radio set. There is a right and wrong way of doing everything and if a receiver is to operate efficiently, its many connections must be made correctly. A few of the more important jobs are shown in Fig. 57.

For example, a common method of mounting a coil is to support it on brass brackets. To supply a rigid support, these brackets should be mounted at right angles, not opposite each other. Often a single bracket will serve as a rigid mounting, but this is only true when the connecting wires are sturdy enough to add support.

Radio sets must be constructed to withstand a certain amount of vibration. If binding posts are used they should be tightened with pliers. When a wire leads through a small hole in the chassis, additional insulation should be furnished in the form of an eyelet clamped in the hole or a short length of insulating tubing should be slipped over the wire. The same holds true for the taps on coils. To prevent the twisted loop of the tap from chafing through the insulation on adjoining wires, slip a small square of paper under the connection.

A frequent source of trouble on homemade sets is a loose soldered connection at the point where a wire joins a soldering lug. Most soldering lugs are supplied with a hole just ahead of the clamps. The wire should be inserted in this hole before the clamps are bent into place and the solder is applied. The hole serves as an anchor for the wire and removes the greater portion of the twisting strain from the solder.

Where one wire joins another in a circuit, do not depend entirely on the strength of a soldered joint.

Twist one of the wires around the other and then apply the solder. If the open joint is in a position where it may accidentally come in contact with some other part or connection, play safe and apply insulation.

The maze of wires in any circuit can become so complicated that it will be difficult, once the set has

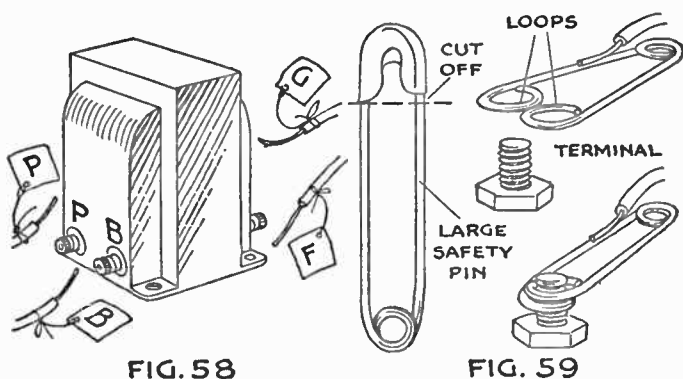

been wired, to trace through the circuit. For this reason, it will pay to use colored connecting wire whenever possible. By selecting a separate color for each individual circuit, tracing them is merely a matter of following colors. The following color code is used almost universally in set wiring: Yellow, +A; yellow and black, -A; red, +B maximum; red and maroon, +B intermediate; maroon, +B detector; black with red, -B; green, +C; and black and green, -C.

Tagging Connections: When a set goes dead and it is necessary to replace one of the parts, a great deal of confusion can be eliminated if the wires are tagged

as shown in Fig. 58. Disconnect the wires one at a time and to each tie a tag bearing some sort of identification. Then when the part is to be reconnected, a glance at the tags will tell you exactly where each wire belongs.

Experimental Binding Posts: Figure 59 shows an easily made connector clamp that will simplify any experimental work you may do. It is made from a

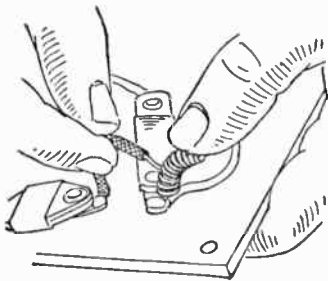

FIG. 60

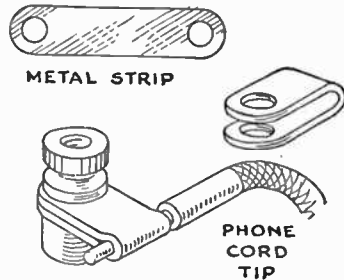

FIG. 61

safety pin with a wire lead soldered to one of the legs. Cut the end from the pin and bend the end of each leg into a loop. To use the connector, squeeze the pin until the loops coincide and slip them over the end of the screw or terminal to which the connection is to be made. As the legs spread apart when the pressure is removed, they will grip the terminal tightly.

Another type of experimental connector that will allow connections to be changed quickly is shown in Fig. 60. It consists of a short length of coil spring mounted by a screw passed through its end loop. Any

tightly coiled spring can be used or the amateur can make his own from brass spring wire. All that is necessary to make a connection to a binding post of this type is to push the spring to one side or the other. This will open the coils and allow the end of the connecting wire to be inserted. When the spring is released, the coils grip the wire tightly.

When a phone cord tip must be connected to an ordinary screw top binding post, the strip connector shown in Fig. 61 will form a handy addition. Made by drilling two holes in a short length of spring brass which is then bent U-shaped, it is slipped over the screw thread of the terminal. Then when the cord tip has been inserted in the loop, merely tightening down on the screw top will hold the tip in place.

Transformer Kinks

A Simple Transformer Repair: If one or both windings of an audio transformer have gone bad, a temporary repair can be made by following the connections indicated in Fig. 62. If on test (see Chapter IV), the primary circuit proves to be open, connect a 100,000-ohm resistor (A) across the P and B terminals of the primary winding and a fixed condenser (C) across the P and G terminals. The fixed condenser should have a capacity of from .006 to .01 microfarads. Try several and retain the one that gives the best results.

If the open circuit proves to be in the secondary winding, connect the condenser (C) as before but instead of the resistor A connect a resistor B having

a resistance of 500,000 ohms across the G and F terminals of the secondary. Incidentally, the value of this resistance can vary as long as it is not less than 100,000 ohms.

In both of these temporary repairs, the effect of connecting the condenser and resistance to the transformer

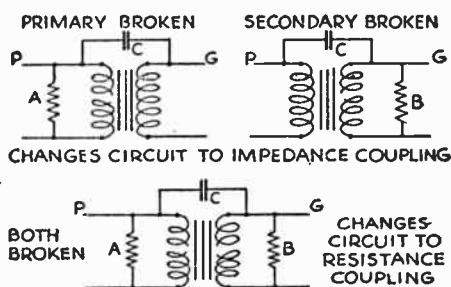

FIG. 62

terminals is to change the original transformer stage into an impedance-coupled stage. For this reason, there may be a slight reduction in volume.

If both windings prove to be open, connect all three units to the transformer; resistor A across the P and B terminals, resistor C across the G and F terminals, and the condenser B across the P and G terminals. This will convert the original transformer circuit into a resistance-coupled stage.

Designing A Simple Transformer: While the actual calculations involved in the designing of an accurate transformer may prove too complicated for the average amateur experimenter, he can, by following simple

rule-of-thumb methods, build a simple transformer that will serve to reduce his 110-volt A. C. house current supply to any desired value.

The most important rule in designing experimental transformers is to play safe. If errors are to be made, they should be made on the large side. Make the core a trifle larger than you believe is required, use more turns than you calculate are necessary, and use larger wire than your judgment dictates. Also, use plenty of insulation, especially between the primary and secondary windings.

Theoretically, the voltage that will develop (be induced) in the secondary wire of a transformer supplied with a given voltage will be directly proportional to the ratio between the number of turns of wire in the primary and the number in the secondary. For example, if a transformer, being supplied with 110 volts at the primary, has a primary winding of 800 turns and a secondary winding of 400 turns, the voltage induced in the secondary and available at its terminals will be equal to 400 divided by 800 multiplied by 110 which equals 55 volts. In other words, the ratio between the number of turns on the primary and secondary is equal to the ratio of the voltages.

In designing a transformer, the start is always made by knowing the alternating-current voltage available and the voltage desired. This immediately designates the ratio between the primary turns and the secondary turns.

Since the number of turns in each coil is inversely proportional to the cross-sectional area of the core on which they are mounted, it is a simple matter to decide

on a basic figure for the winding computations. A safe figure for the amateur design is seven turns of wire per volt for a core area of one square inch if the transformer is to be used for hours at a time. If the transformer is to be used only for short periods, four turns per volt for each square inch of core area will serve.

In any transformer, the voltage applied to the pri-

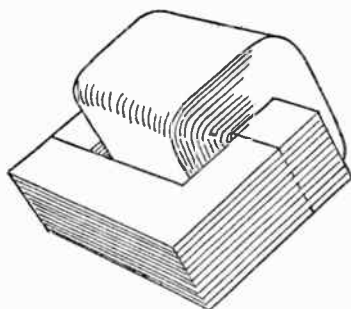

FIG. 63

mary multiplied by the current flowing in that winding is equal to the voltage developed in the secondary multiplied by the current flowing from the secondary. This relation is useful in determining the size of wire to use. Knowing how much current is to flow in the secondary, you can choose wire large enough for the job.

In choosing the core for your transformer, don't skimp. A core much larger than is actually required will work just as well and will reduce heating. The most efficient shape for a transformer core is of a rect-

angle with a cross member in the center on which the windings are placed. However, this is a difficult form for the amateur to handle; a plain square core, such as shown in Fig. 63, is easier to wind and, for average purposes, almost as efficient.

Antenna Kinks

Using A Light Socket As An Antenna: Although any radio receiver will be most efficient when connected to a regular antenna and ground system, the extreme sensitiveness of the modern set makes it possible to use various convenient substitutes as the aerial. How one such substitute, an electric light socket, can be used is shown in Fig. 64. While such an antenna will not, of course, bring in the signals with maximum strength it provides ample volume for ordinary reception.

Electrically, a light-socket antenna consists merely of a wire leading from the antenna binding post of the receiver to a small fixed condenser connected to one side of a lighted electric lamp. While this arrangement can be wired in various forms, the simplest method consists of connecting the antenna-post wire to one of the screw terminals on an ordinary socket in a table lamp. The ground wire then can be connected to the usual water pipe.

Another method of solving the antenna and ground connection problem is indicated in Fig. 65. In this arrangement the ground binding post on the receiver is left unconnected while the wire from the antenna post is connected to the nearest water pipe or radiator.

Curiously enough, in many cases, this simple system will give results equal to those obtained with the more elaborate light-socket antenna.

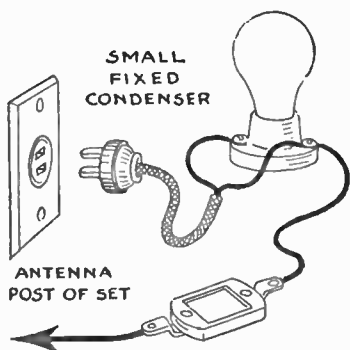

FIG. 64

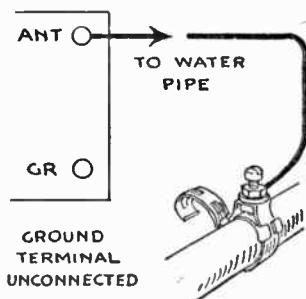

FIG. 65

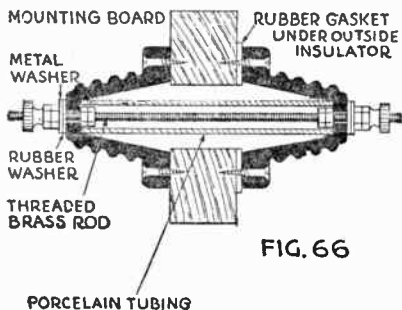

FIG. 66

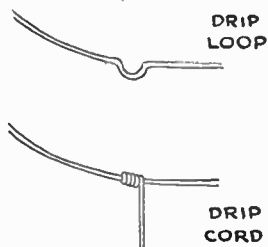

FIG. 67

Although it is difficult to predict the results that can be obtained in any locality with either of these antenna substitutes, they are worth trying if the use of a regular outdoor antenna is likely to be troublesome and difficult. If neither method gives the signal

strength desired, the next step is to try a simple indoor antenna. For this, the cheapest kind of bell wire or even the thin wire stripped from bell magnets will serve as well as the elaborate tapes and wire sold for the purpose.

In rigging an indoor antenna, best results will be obtained with the longest wire, measured in a straight line, from the antenna binding post of the receiver.

Double Antennas: Amateurs who like to experiment often erect two outdoor antennas, connecting them to the receiver through a single-pole, double-throw switch so that either wire can be used. In this case, it is best to rig the two wires at right angles so that all possible directions will be covered.

Lead-In Insulators: For the average receiver, the lead-in can be brought into the building in almost any manner as long as it is well insulated. The flexible tape lead-in strips serve this purpose very well and they are both inexpensive and easy to install. However, the owner of a short-wave transmitter must take particular pains to insure perfect insulation for his antenna feeder.

An inexpensive homemade transmitter feeder entering insulator is shown in the drawing of Fig. 66. It consists of simple parts that can be obtained at any radio store dealing in receiver and transmitter parts. Two small insulators of the stand-off type, fitted with a length of threaded brass rod, are mounted over a small hole bored in a 1- by 8-in. hardwood board cut to fit the window jamb.

The first step in making an insulator of this type is to remove the regular brass terminals from the

stand-off insulators. Then, when a suitable piece of threaded brass rod has been obtained, mount one insulator over the hole, insert the brass rod, slip a

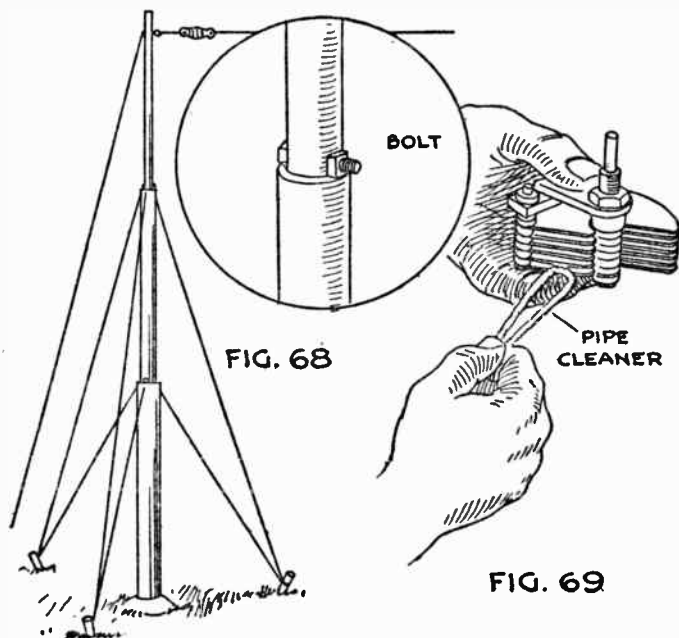

length of porcelain insulating tube over the rod, and finally drive the screws that hold the second insulator in place. The porcelain tube should be just long enough to fit between the insulators when they are fastened in place. To complete the insulator, place metal and rubber washers on the ends of the rod, screw lock nuts

in place, and finally add the ordinary threaded terminal nuts that came with the original insulators.

To prevent any great amount of water from reaching the switch, or the insulator if the switch is eliminated, bend a drip loop in the wire or tie a short length of cord to the wire as shown in Fig. 67. The drip cord will make a particularly valuable addition to the antenna system when a simple porcelain tube type of lead-in insulator is used.

Building An Antenna Mast: The popularity of short-wave distance reception has renewed interest in the long antenna rigged high on special masts. An easily erected mast for the amateur experimenter is shown in Fig. 68. Made of sections of pipe telescoped one inside of the other, it is particularly easy to build and is neat looking and sturdy.

First, select three sections of pipe. The smallest or upper section should not be less than $\frac{3}{4}$ -in. pipe size. The remaining sections should be of a size that will telescope easily. Then place the telescoped pipes in a hole five feet deep, fill in with concrete, and rig three guy wires to brace the lower or larger section.

Two men, working from ladders placed on opposite sides of the pipe, then should raise the top or smallest section until it has been lifted three-quarters of its length out of the middle section. A bolt slipped through a hole previously drilled for that purpose then will hold this section in place.

The middle or second section, which supports the top section, then can be raised and a second bolt used to hold it in place. Finally, with the three sections of the mast extended, guy wires previously connected to

the tops of each section can be anchored to stakes driven into the ground at suitable distances from the base of the mast. Three guys should be used on the bottom and middle sections while a single wire rigged to the rear will serve to counteract the pull of the antenna wire on the top section.

Three twenty-foot lengths will make a mast forty-five or fifty feet high. If pipes have been chosen that telescope easily, the entire job should not take more than an hour to complete once the preliminary work has been done.

One advantage of this type of antenna-mast construction is that the various pipe lengths can be painted before they are telescoped. Also, they can be lowered easily at any time for repainting or repairs.

Condenser Kinks

Changing Capacity of A Variable Condenser: The capacity of a variable condenser can be reduced simply by removing some of the plates. It is not necessary to remove both the stationary and the corresponding revolving plates. Remove either one type or the other, whichever is easiest. The reduction in capacity will be directly proportional to the number of plates removed.

Cleaning Variable Condensers: Variable condensers, salvaged from old receivers and stored away for future use, soon collect a thick coating of dust between their plates. Since dirt may alter the capacity of the unit, these condensers should be thoroughly cleaned before they are used again. How this can be done easily and quickly with an ordinary wire pipe cleaner is shown in

Fig. 69. Bend the cleaner U-shape, push it between adjacent plates, and move it around until all of the dust is removed.

Homemade Condenser Wrench: In order to adjust the balancing condensers on many modern super-

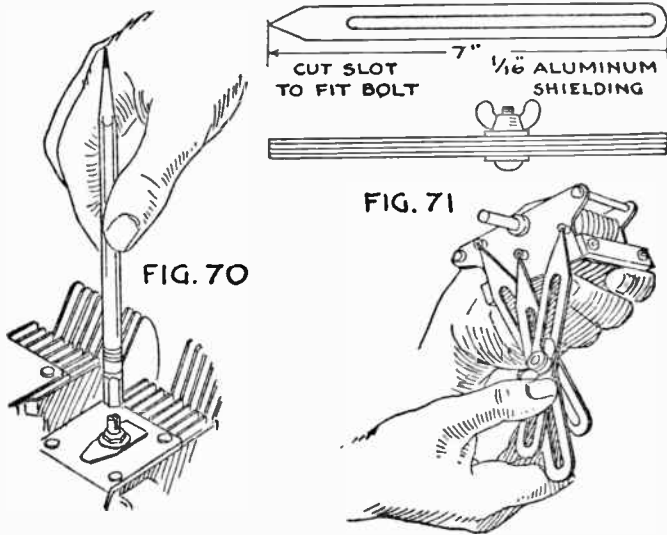

heterodynes, a special wrench must be used. If this wrench is not handy, you can make a substitute by altering the construction of an ordinary five-cent lead pencil of the hexagonal rubber-tipped variety (see Fig. 70). Remove the brass eraser fitting from the end of the pencil, dig out the eraser with the point of a knife, and finally, after reversing the fitting, force the end which originally held the eraser over the end of

the pencil. The hexagonal portion of the fitting then will be free and can be used as a wrench for the hexagonal adjusting nut. To safeguard against possible short circuits, wrap the end of the pencil with tape to cover the metal.

Making A Condenser Template: When fastening a variable condenser to a panel, it often is difficult to locate the centers for the holes to take the mounting

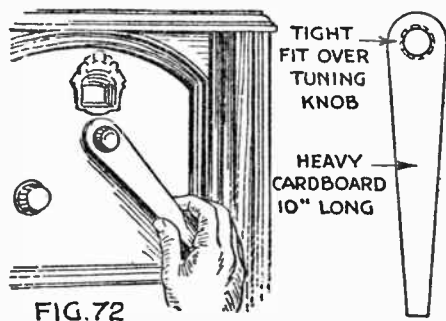

screws. To simplify the problem, the experimenter should provide himself with the easily made adjustable template illustrated in Fig. 71. It consists of three slotted arms cut from sheet aluminum fastened together by means of a wing nut and bolt. The arms should be at least seven inches long and about one half inch wide and the slots should extend the full length of each arm and be wide enough to take the shank of the fastening bolt.

To use the template, loosen the bolt, spread the arms so that their points coincide with the centers of the

mounting screw holes on the condenser, and then tighten the bolt. Once the template arms are locked in place, the center marks for the holes can be transferred to the panel by scribing around the points with a sharp nail or a knife. The apex of each V-shaped mark will indicate where the mounting holes are to be drilled.

Vernier Tuning Lever: A simple lever cut from cardboard to the shape shown in Fig. 72 can be used as a

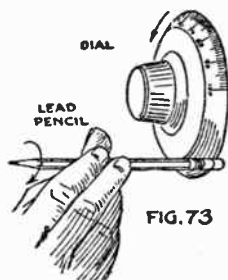

vernier tuning lever on short- and broadcast-wave receivers lacking high-ratio dials. The hole to take the knob should be cut so that it is slightly smaller than the knob. Slits cut so as to radiate from the center of the hole will serve as a clamp to hold the lever in place on the dial. A vernier lever of this type, made ten inches long, will increase the tuning accuracy of a small dial just about sixteen times.

Another simple vernier kink that can be used on home-built short-wave receivers fitted with an old-style direct-drive dial is shown in Fig. 73. Simply hold

an ordinary pencil at right angles to the receiver panel in such a way that the eraser rests on both the edge of the large dial and the receiver panel. Turning the pencil will make the eraser act as a cog to turn the dial a small bit at a time. If the eraser on the pencil has been used, the effect will be even greater since the point on the eraser will serve as a pivot.

Miscellaneous Kinks

Novel Telephone-Radio Switch: By adding a simple circuit to the antenna and ground posts of a radio receiver, its volume can be cut down at any distant point in the house by merely pushing a button. How this is done is shown in Fig. 74. Such an arrangement having its button mounted on or near the telephone table will provide an easy means of silencing a radio when the 'phone bell rings.

With the push-button switch open, the radio operates at full volume. However, as soon as the switch is closed, a short-circuiting connection is made across the antenna and ground and the volume is reduced. The actual amount that the volume is reduced will depend on the size of the small fixed condenser. To obtain the best results, try several values and retain the one that works best. Incidentally, in some cases, the circuit will operate best without any condenser.

In modern sets, equipped with automatic volume control, a dimming connection made to the antenna and ground posts may have no effect whatever on the volume. However, in such cases the same dimming effect can be obtained by connecting the circuit, minus

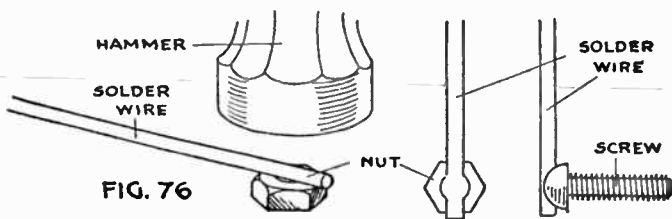
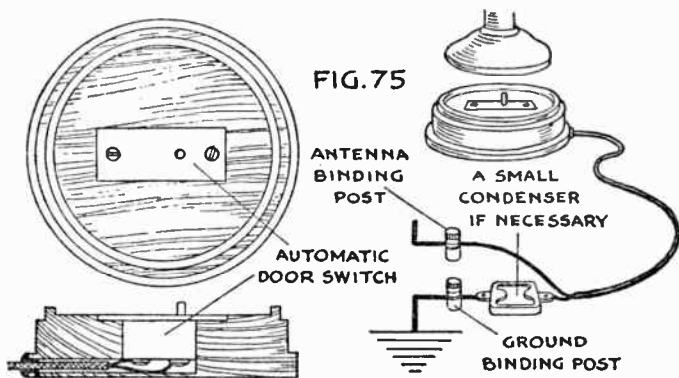
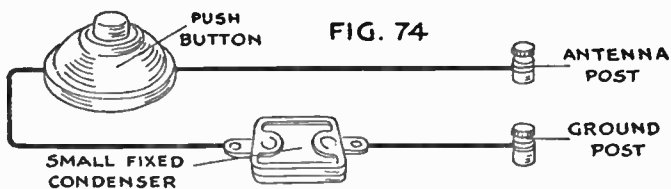

the condenser, across the voice-coil leads to the dynamic speaker.

By altering this dimming system slightly, as shown in Fig. 75, an automatic switch can be arranged that will reduce the radio's volume the minute the telephone instrument is raised from its table. An automatic door switch, of the type used to control a closet light, is recessed into a low wooden stand shaped to hold the base of the telephone. As long as the instrument rests on the switch, the circuit remains open. However, lifting the telephone allows the switch point to spring up, closing the circuit and reducing the volume. In use, the stand should be placed at the rear of the table so that the telephone must be lifted when used.

Holding Small Parts: As shown in Fig. 76, a short length of ordinary solder wire can be used to place a nut, a bolt, or some other small part in the depths of a crowded radio circuit. Simply lay the solder on the top face of the nut, screw, or washer and tap it lightly with a hammer or the handle of your pliers. The solder will become imbedded in the irregular surface of the part (in the slot in the case of a screw) and hold it tightly while it is lowered into place. When the job is completed a quick jerk will free the solder.

If a part is to be placed under some projecting unit, such as a condenser or a transformer, the solder wire can be bent to reach around the corners.

A piece of ordinary wire also can be used in the same way. Simply wrap the wire around the edge of the nut or screw. Once the part is in place, the wire can be pulled free.

Homemade Radio Cement: A useful nonconducting radio cement for the amateur's workshop can be made by mixing equal quantities of banana oil and collodion. It is excellent for mending loudspeaker cones and diaphragms and is equally useful as a coating for home-wound coils.

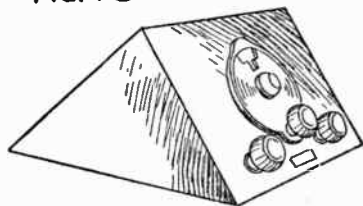
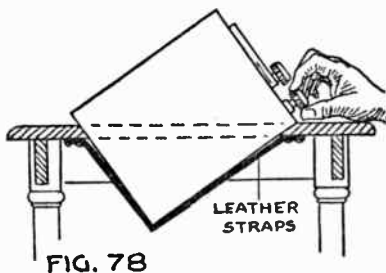
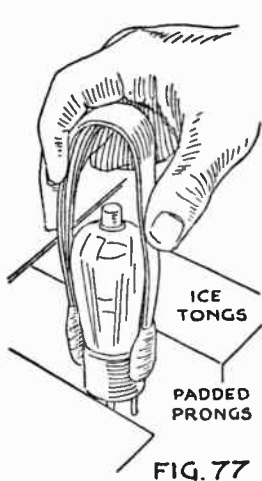

Tube Remover: Often, especially in the crowded cabinets of miniature receivers, it is difficult to remove the tubes when it is necessary to test or replace them. This is particularly true in cases where the tubes have been cemented in place by the manufacturers. Forcing the tube loose by gripping the glass dome may result in loosening the base. To avoid this possibility, the amateur can use a pair of ice tongs or plier-like potato lifters. As shown in Fig. 77, the prongs of the tongs

should be fitted with sponge rubber pads taped in place. When a tube is to be removed, simply lower the tongs over the tube and grip the base with the padded prongs. A steady tug will pull the tube free, all of the pressure being applied at the strongest part of the tube.

Novel Short-Wave Receiver Mounting: By mounting the boxlike cabinet of a short-wave receiver, as shown in Fig. 78, the amateur operator will find that he can tune more accurately with greater comfort. A rectangular hole is cut in the top of the table used to support the receiver and the cabinet set in so the front panel rests at an angle. Leather straps, fastened with screws to the underside of the table, can be used as a sling or cradle to hold the receiver. The rectangle should be as long as the cabinet and as wide as the diagonal of the ends. Besides making dialing easier, the angular position of the panel allows better illumination of the controls.

Insulation Stripper: Although the improvised strippers made from a pair of wire cutters as described in Chapter I, will serve for small connecting wire, the larger stripper illustrated in Fig. 79 will be ideal for larger diameter wire (lead-in wire, etc.). It is made by mounting a razor blade of the double-edged variety, having two holes, in a wooden handle. At the bottom of the handle, a semicircular groove serves to guide the blade along the insulation. Merely drawing it along the length of wire, splits the insulation so that it can be peeled off. Being mounted in a slot with two screws, the blade can be replaced easily when it becomes dull.

Rope for Antenna Halyards: Whenever a long, high

antenna must be rigged, the question of what to use for braces, guys, and halyards arises. The amateur can solve this situation, however, by soaking ordinary heavy clothesline in a bath of boiled linseed oil. Be-

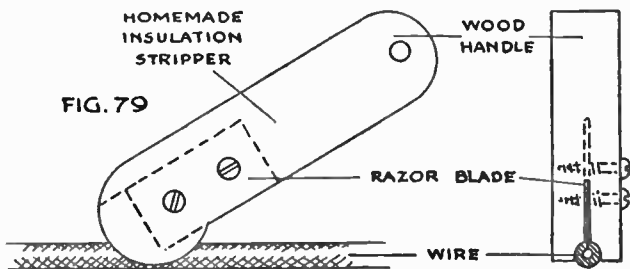

sides strengthening the rope, the oil will prevent the rope from shrinking in damp weather and placing too much strain on the antenna wire. Antenna rope made in this way will be just as strong as expensive metal cable and will have the advantage of being pliable.

CHAPTER VI

IMPROVING OLD BROADCAST RECEIVERS

HOW can I improve my radio set? The fact that thousands of set owners ask themselves this question every time they listen to a modern receiver, makes finding the answer a profitable business for the radio experimenter and spare-time serviceman.

In any neighborhood, particularly those in the rural and near-rural districts, a friendly inquiry will disclose a surprisingly large number of out-of-date receivers. By modernizing them in one way or another for a nominal service fee plus the cost of the parts used, you make your radio hobby pay dividends.

Rewiring a Battery Set for Alternating Current: One of the most valued improvements that can be made on an old battery receiver is to rewire it for alternating-current use. Many people in outlying districts are still using battery outfits bought before their homes were electrified. These sets in most cases can be converted easily and inexpensively into full-electric circuits. Then too, most of us who live in towns and cities have stowed away in our attic a set from the battery era that could be made to serve as that extra receiver for a summer cottage.

It would be impossible, without a great deal of

space, to show how to wire every possible circuit combination and make of receiver. Besides, the amateur need only master the basic rules to make a first-class A.C. rewiring job of any receiver.

To begin with, as far as the radio signal that enters any receiver is concerned, the action that takes place in each stage of the circuit is precisely the same whether the circuit is battery-operated or full electric. In each case a flow of tiny electrical particles called electrons inside of the tube causes the action. It makes no difference to the radio signal whether these so-called electrons come from a filament heated by the current from a battery or from an equivalent electrode called the cathode which is heated indirectly by a heater operating on alternating current at low voltage.

The main difference, then, between a battery tube and an A.C. tube is merely in the method of heating the filament to obtain the electrons. The grid and plate connections of equivalent battery-operated and alternating-current-operated tubes are invariably the same. The only basic difference is in the current supply system.

Let us suppose, for the purpose of explanation, that you wish to substitute a type '27 alternating-current tube for a type '30 battery tube. How this can be done in the various stages of a simple receiver is shown in Figs. 80-87.

Figure 80 shows the typical '30 socket hook-up as you will find it before you start the rewiring operations. The first step in the conversion is shown in Fig. 81. Remove the plate and grid wires, carefully tagging them for future identification, then clip the

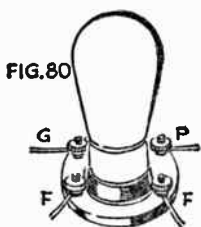

ORIGINAL BATTERY HOOK-UP

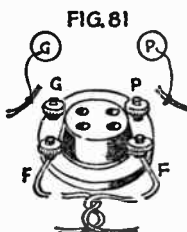

CUT AWAY SOCKET WIRING TAG G AND P WIRES - TWIST FILAMENT LEADS TOGETHER



FIG. 82

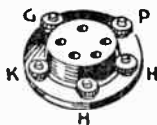

REMOVE OLD SOCKET AND REPLACE WITH Y-TYPE (FIVE PRONG)

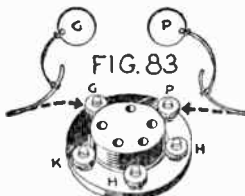

CONNECT TAGGED G AND P WIRES TO SIMILARLY MARKED TERMINALS ON NEW SOCKET

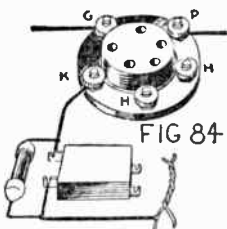

CONNECT K TERMINAL TO OLD FILAMENT WIRING BY WAY OF FIXED RESISTANCE AND CONDENSER (SEE TEXT)

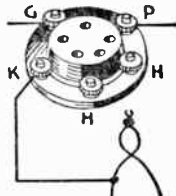

FIG. 85

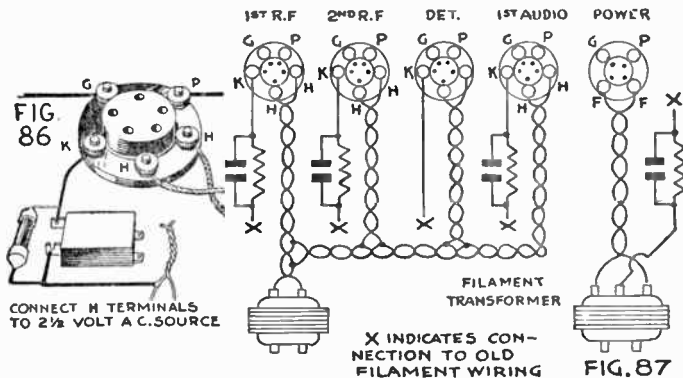

FIG. 86

CONNECT H TERMINALS TO 2½ VOLT A.C. SOURCE

FILAMENT TRANSFORMER

X INDICATES CONNECTION TO OLD FILAMENT WIRING

FIG. 87

filament wires and twist and solder them together to make a good connection. This will free the old '30 four-prong socket, which can then be removed and replaced with a modern socket of the five-prong type for the '27 tube, Fig. 82.

When the socket has been fastened in place, reconnect the grid and plate wires to their respective terminals as shown in Fig. 83. So far, the connections will be identical with those used on the original '30 socket.

What you do next, will depend on the position of the tube in the circuit. If it is a radio-frequency tube, the K terminal, indicating the cathode, should be connected through a 1,500-ohm resistance and parallel-connected .1 mfd. condenser to the old filament wiring as shown in Fig. 84. The old filament wiring now becomes the common —B lead for all tubes.

If the tube is the first amplifier stage, the same general arrangement of parts is used, but a 1 mfd. instead of a .1-mfd. by-pass condenser is connected across 1,500-ohm resistor. On the other hand, if the tube is the detector, the resistor-condenser circuit is omitted entirely, the K (cathode) terminal being connected directly to the old filament wiring (see Fig. 85).

When twisted leads from the two and one-half-volt secondary of the heater transformer have been connected to the heater terminals, as shown in Fig. 86, the conversion for the radio-frequency, detector, and first audio-frequency stages is complete.

Handling the final or power tube in the last stage of the receiver is not at all difficult. You will not even be bothered with changing the socket. Merely remove

the original filament wiring and substitute the new twisted heater leads that run to a separate heater winding on the same transformer that serves the type '27 tubes or to a separate heater transformer. The

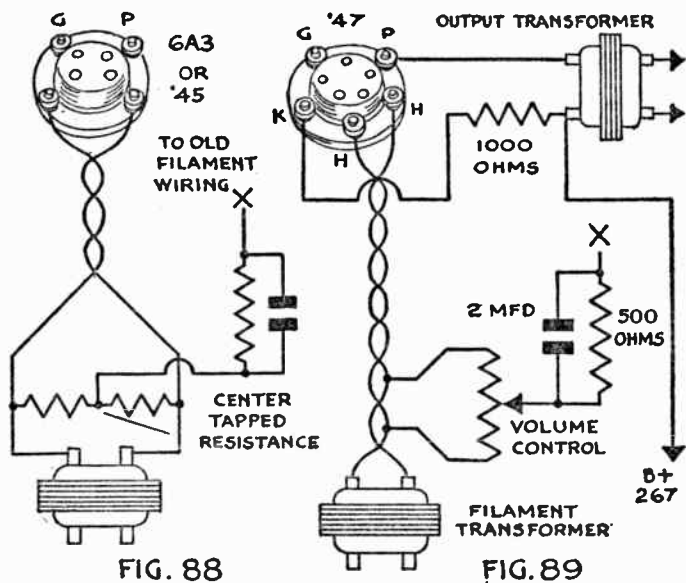

voltage delivered by this heater supply will depend on the type of power tube used. For a 6A3, the heater voltage should be 6.3 volts, while a '45 output tube will require 2.5 volts.

Finally, a biasing resistor should be connected from the center tap of the power-tube heater winding to the old filament wiring which now serves as the -B con-

nection. This resistance should have a value of 750 ohms in the case of a 6A3 tube or 750 to 1,000 for a '45 tube. It should be bridged by a 1-mfd. fixed condenser as in the partial diagram of the complete conversion shown in Fig. 87.

If the heater winding or transformer has no center tap, the same effect can be obtained by connecting a five- or ten-ohm center-tapped fixed resistance across the heater wires, as shown in Fig. 88.

If desired, a type '47 tube can be used in the power

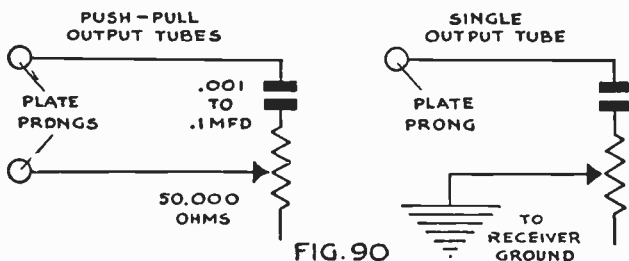

stage by making the connections shown in Fig. 89. In this case, as well as in the substitution of the '45, a new output transformer designed for the particular tube should be used.

Installing a Tone Control: By following the simple connections shown in Fig. 90, any broadcast receiver can be fitted with an efficient tone control at a cost of less than a dollar. The installation can be made without altering a single connection in the receiver circuit.

A tone control is just what the name implies—a means of controlling the tone of the sounds coming

from the speaker. In modern broadcast receivers, they are incorporated within the receiver circuit and terminate as a single knob on the panel.

In the auxiliary tone control shown, the circuit consists simply of a fixed condenser connected in series with a suitable variable resistor and placed across the output of the receiver. If the receiver has two output tubes connected in push-pull arrangement, the series-connected condenser and resistor can be wired directly across the plate prongs of the output tubes. On the other hand, if the receiver terminates in a single output tube, one end of the auxiliary tone-control circuit should be connected to the plate of the output tube and the remaining end should be wired to the ground binding post of the receiver.

The plate prong of an output tube can be identified easily by its position on the base. The arrangements of the prongs on four- and five-prong tubes are given in Fig. 91. These drawings show the bottoms of the bases with the tubes held upside down.

Once the plate prong has been found, loop the bared end of the connecting wire around it, replace the tube, and push it firmly into the socket to insure a good connection. Be sure that the insulation on the connecting wire extends down to the prong so that the bare wire makes contact only at the prong. If desired, special wafer adapters can be obtained from any dealer in radio parts for making these connections. Slipped over the prongs of the tube, as shown in Fig. 92, the connection is made to the plate prong through a convenient tab extending from the side of the adapter.

In the diagram, the variable resistor is indicated as

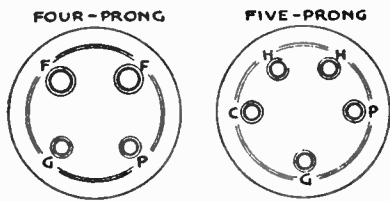

BOTTOM VIEW OF
TUBE BASES
FIG. 91

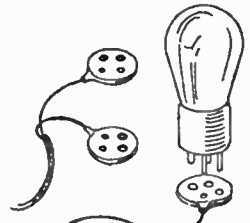

FIG. 92

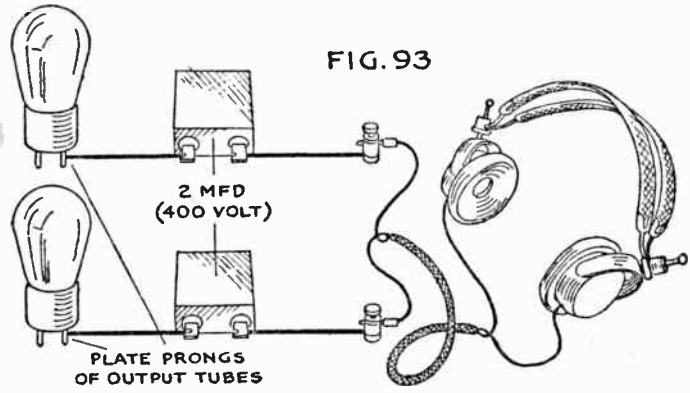

FIG. 93

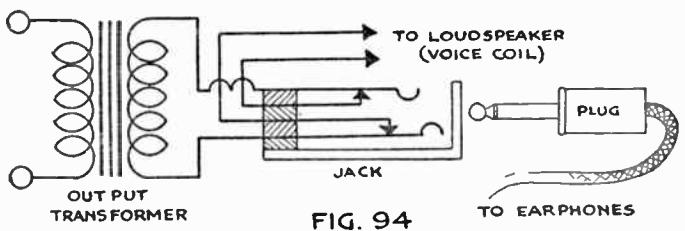

FIG. 94

having a value of 50,000 ohms while the condenser is valued at from .001 to .1 mfd. Because the best value for the condenser will vary with the type of output tube, a range of values has been given. First try the smaller value and then the larger and finally several intermediates, retaining the condenser that gives the best results.

When all of the resistance is placed in the circuit, the tone control will have little or no effect on reception. However, as the resistance is reduced, more and more of the high frequencies will be by-passed through the condenser instead of being allowed to pass on to the loudspeaker. By cutting out the high tones, the tone control in this position will accentuate the low notes.

If plenty of extra space is available, the variable resistor can be mounted directly on the panel. Lack of space will make it necessary to mount the resistor separately.

Adding Earphones to a Loudspeaker Set: To the distance fan as well as the partially deaf listener, earphones form an important receiver accessory. Strange as it may seem, few commercial receivers are fitted with an earphone outlet but it is a simple matter for the radio experimenter to supply one. How it is done, of course, will depend on the arrangement of the receiver circuit in question.

The simplest arrangement is shown in Fig. 93. The earphone leads are connected through fixed condensers to the plate prongs of the output tubes or to the primary terminals of the output transformer. A shorting switch placed across the voice-coil leads then can be

used to silence the loudspeaker when the phones are to be used independently.

Another easily installed earphone arrangement is shown in Fig. 94. An inexpensive jack is inserted in the voice-coil leads of the dynamic speaker. These wires can be traced easily by the fact that they lead to the base of the speaker cone (see Fig. 95). The earphones, fitted with a plug, can be substituted for the

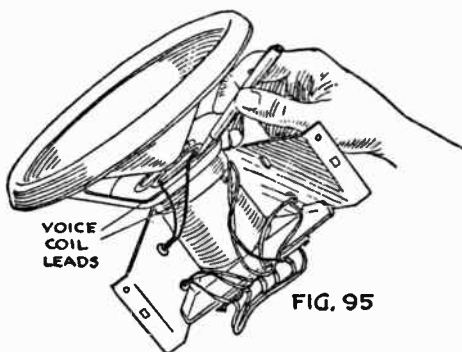

loudspeaker simply by inserting the plug in the jack. The plug will spread the two spring connections in the jack, disconnect the voice-coil leads to the speaker, and connect the earphones to the secondary of the output transformer.

Because a separate earphone-output transformer is used and the necessity of having a jack is eliminated, the earphone arrangement outlined in Fig. 96 will give superior results. In this case, a second transformer is connected through a simple single-pole, double-throw switch to the primary of the regular output trans-

former originally in the set. Throwing the switch in one direction sends the signals through the regular transformer to the loudspeaker while throwing it in the other direction shunts them off to the earphone transformer and earphones. Almost any three-to-one ratio audio transformer can be used for the earphone circuit.

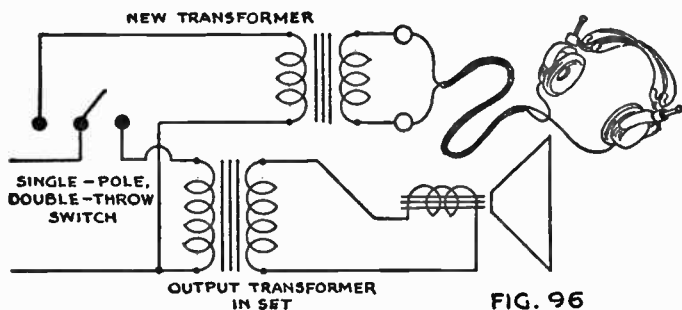

FIG. 96

Where the receiver employs an ordinary magnetic speaker, the earphones can be connected directly to the output in place of the speaker leads. Also, in any arrangement, any number of earphones can be connected to the receiver simply by wiring them in parallel.

Improving a Receiver's Tone With a Second Speaker: By adding a second speaker to the average commercial radio receiver, the amateur experimenter can imitate the tone obtained with modern dual-speaker outfits.

In high-grade commercial dual-speaker arrangements, two speakers are connected to the output of

the receiver, each speaker being designed to cover a definite portion of the entire frequency range. One speaker reproduces the high notes while the other

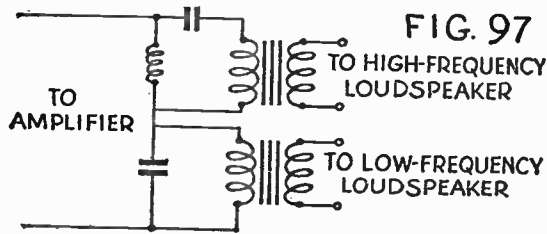
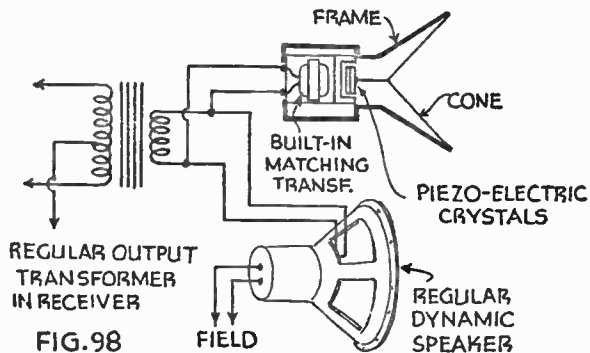

FIG. 97

brings out the low notes. To obtain this effect, a complicated system of filters, such as shown in Fig. 97, sometimes is used.



Although these commercial systems require special equipment developed as the result of experience and many experiments, there are other simpler and less

expensive dual-speaker arrangements that can be employed by the amateur. One of these, in which a commercial high-frequency speaker having a Rochelle salt crystal unit is connected directly to the voice-coil leads of the original speaker in the set, is shown in Fig. 98. This particular unit, which is relatively inexpensive, can be obtained fully equipped with a built-in im-

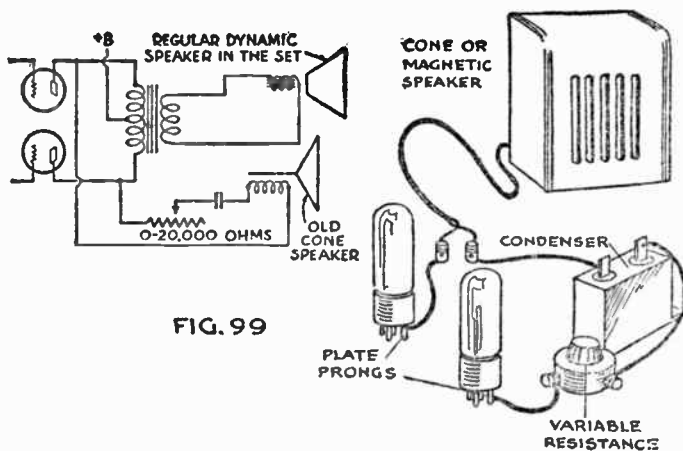

pedance-matching transformer to insure a balanced circuit.

The most novel and simplest dual-speaker hook-up as far as the amateur and his meager supply of equipment is concerned is shown in Fig. 99. Almost everyone has an old magnetic-type speaker stowed away in the attic; a last vestige of an old battery-operated, magnetic-speaker receiver. By connecting this speaker to the output tubes through a condenser-resistor circuit as shown, it can be made to serve as an improvised

high-frequency unit. The regular dynamic speaker in the set will furnish the low notes, while the auxiliary magnetic speaker will accentuate the high ones.

The arrangement as shown can be used without altering a single connection in the receiver. Two wires are connected to the plate prongs of the output tubes or to the primary terminals of the output transformer. These lead to the terminals of the magnetic speaker through a series-connected fixed condenser and vari-

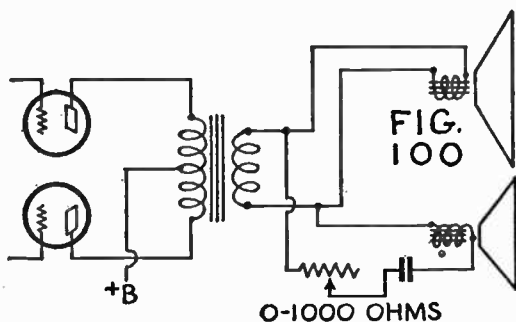

able resistor circuit. The resistor can be a 20,000-ohm potentiometer while the capacity of the condenser can be anything from .1 to 1 mfd. Try several values until you hit the one that gives the best results.

If two dynamic speakers are available, one being designed especially for high-frequency reproduction, the dual-speaker system shown in Fig. 100 can be used. The high-frequency speaker is connected in parallel with the regular speaker and a variable resistor and a fixed condenser are inserted in one of the leads. To simplify the drawings, the 110-volt power connections

to the field coils of the two speakers have been eliminated.

As with the tone control, the fixed condensers in these dual-speaker systems tend to pass the high frequencies more easily than the lower ones and for this reason the auxiliary speaker accentuates the higher tones.

It often happens that a second speaker is desired, not as an auxiliary unit to extend the tone range but

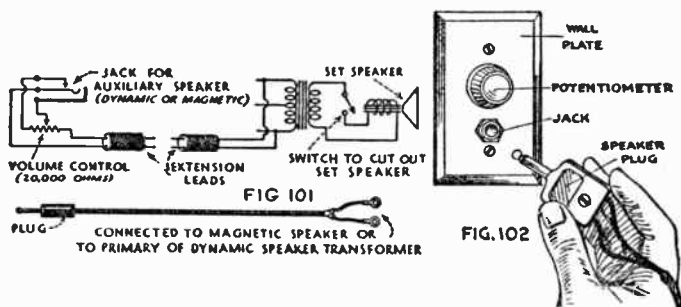

as a separate unit to be used at some point distant from the actual receiver. This is particularly so in a house where a speaker in the kitchen or the bedroom will be a convenient addition to the living-room set.

By salvaging the dynamic or magnetic unit from an antiquated receiver for which you have no more use, you can provide any receiver with just such a unit. Wiring the extension for the auxiliary speaker consists simply of making connections to the primary of the speaker transformer in the receiver. If the additional speaker is of the dynamic type this will have the effect

of connecting the transformers of the two speakers in parallel (see Fig. 101).

The extension wires leading to the second speaker jack can be ordinary twisted lamp cord run along the baseboards. If desired for safety, a 4-mfd. fixed condenser can be placed in each extension lead.

The jack and volume control indicated in the drawings should be mounted at the point where the second speaker is to be located. This can be arranged in the manner of wall plates recessed into the wall like an electric light switch or they can be mounted in a wood box (see Fig. 102). For convenience, the output can terminate in a three-contact jack, the lead to the speaker (either magnetic or dynamic) being supplied with a plug. If an ordinary double-contact jack is used, it will be necessary to use a potentiometer having a built-in switch so that the resistance will be cut out of the circuit when the auxiliary speaker is not being used.

If desired, the regular speaker at the set can be silenced by means of a switch placed either across the voice-coil leads or in one of the voice-coil leads.

Improving the Selectivity of a Receiver: Many old-style broadcast receivers, although lacking in selectivity, offer all that the owner desires in the way of tone, volume, and sensitivity. By adding a wave-trap or pre-selector circuit to a receiver of this type, the amateur experimenter often can improve reception and obtain some of the selectivity of the more modern outfit.

Simplest of all circuits of this type is the condenser and coil combination shown in Fig. 103. It consists of

a coil, having seventy-two turns of No. 22 wire wound on a three-inch diameter cardboard or composition form, connected in parallel with a .00025-mfd. variable condenser. If a larger condenser is the only one available, decrease the number of turns. By trial and error, you can find just the right size of coil for any condenser.

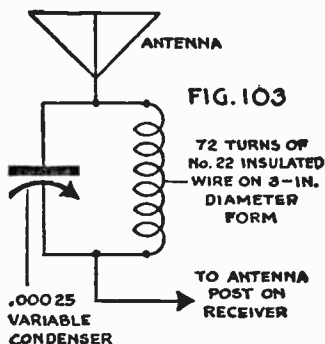

This type of wave trap is particularly useful in eliminating an unwanted station. With the wave trap in place between the antenna and the receiver-antenna terminal, tune the set for the best setting for the station you desire and then adjust the wave-trap condenser to eliminate the unwanted station. If the undesired station is very close to the receiving antenna, it will be best to shield the wave trap by placing it in an aluminum can.

The operation of a simple system of this type depends on the action of the variable condenser. The condenser is adjusted so that the circuit absorbs the signals from the unwanted station but allows the de-

sired signals to pass through to the receiver. There will be a slight decrease in volume when a wave trap of this type is used.

Another solution of the sensitivity problem is the more complicated pre-selector circuit shown in Fig. 104. Such a circuit has the effect of adding an additional train of tuned stages through which the signal must pass. As illustrated, it consists of a two-gang condenser (two .00035-mfd. sections), three home-

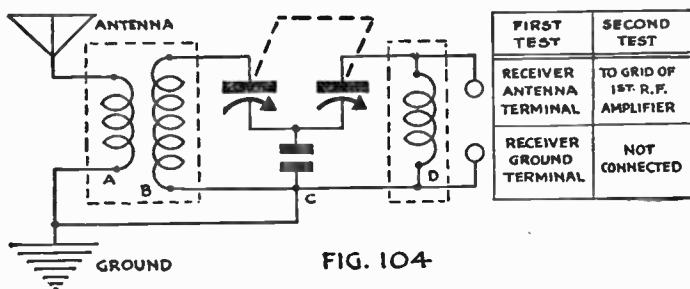

FIG. 104

made coils, a fixed condenser (.02 mfd.), and two shielding cans. The shielding cans are indicated as dotted lines.

Coils B and D are identical, consisting of sixty turns of No. 22 insulated wire wound on a three-inch diameter cardboard form. Coil A, wound over coil B, should have ten turns of the same wire.

In trying out the pre-selector, or pre-tuner as it is sometimes called, first connect the lead from the upper end of coil D to the antenna binding post on the receiver and the lower lead to the ground binding post, noting the results obtained. Then disconnect the two

leads, wire the upper lead to the grid connection of the first radio-frequency amplifier tube, and leave the lower lead unconnected. With some receivers, this second arrangement will give better results than the first. Try both and retain the set of connections that gives the best results.

Incidentally, better results will be obtained with a unit of this type if small trimmer condensers (3-35 mmf.) are wired across each of the tuning condensers in the two-gang unit. Also, a little experimenting with the value of the fixed condenser C may improve the operating qualities.

Adding a Phonograph Attachment to a Broadcast Receiver: The usefulness of any receiver can be widened by equipping it with a phonograph attachment. The connections required are simple, and the necessary parts inexpensive.

The basis of a radio-phonograph depends on the amplifying qualities of the audio amplifier in the receiver. The vibration picked up from the record by the needle is first transformed into electrical impulses by the pick-up head, then amplified, and finally converted into sound waves by the loudspeaker unit.

Our first problem then in wiring a phonograph attachment to a radio receiver will be to locate the audio amplifier. If you have, or can obtain, the wiring diagram of the set this will not be difficult. In any case, however, the audio portion generally can be found by tracing the various tubes that make up the circuit.

Figures 105 and 106 show two ways in which the pick-up can be wired to the audio amplifier. If the

first audio transformer can be found easily, the method of Fig. 105 should be used. The connections are simple and the arrangement allows the phonograph circuit to

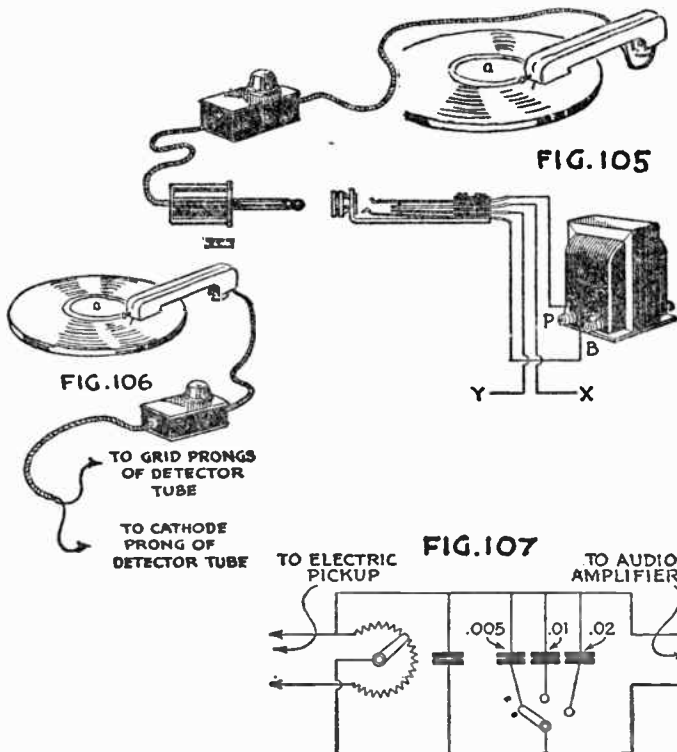

be cut in or cut out quickly and easily. Figure 106, on the other hand, shows a simple way in which the leads from the pick-up can be wired directly to the prongs of the detector tube.

In following the arrangement shown in Fig. 105, the original wires leading to the P and B terminal on the transformer should be cut and a jack so wired to the four resulting leads that inserting the plug substitutes the pick-up leads for the original-circuit leads X and Y. Similarly, with the plug removed the input leads X and Y should be automatically reconnected to the transformer primary to allow regular radio reception. When making the connections to the jack, take care not to twist the X and Y leads.

If, as is sometimes the case, the terminals of the audio transformer are not clearly marked, the P and B terminals can be identified easily by tracing the wiring. The P terminal of the first audio transformer is always connected, either directly or indirectly, to the P terminal of the detector-tube socket. Once you have found the P terminal, the position of the B terminal becomes evident since it is the remaining terminal on the same side of the transformer.

Volume control for record reproduction generally is obtained by connecting a potentiometer (sometimes by-passed by a fixed condenser) into the pick-up leads. The value of this variable resistance is not important. Any unit will work as long as its resistance lies somewhere between 10,000 and 50,000 ohms. In wiring the potentiometer, connect the pick-up leads to each end of the resistance. Then connect the output leads to the arm of the potentiometer and one side of the resistance. (See potentiometer connections in Fig. 107.)

If your pick-up unit produces loud needle scratches, these can be filtered out by using an arrangement of additional fixed condensers as shown in Fig. 107. The

switch arm allows either of the three parallel-connected condensers to be used.

What type of phonograph turntable is used will make little difference in the quality of the reproduction obtained. While an electrically driven unit will, of course, be convenient, a spring-wound unit, salvaged from an old phonograph, will serve the purpose. To use an old phonograph, simply remove the original tone arm and mount the electrical pick-up in its place.

One precaution when installing a phonograph attachment: Remember that the volume and quality you obtain will depend entirely on the audio amplifier in the receiver. If, as in many modern midgets, only a single stage of audio amplification is used, the results may be disappointing. In cases of this type, it will be best to build up a separate three-stage audio amplifier, wiring the output to the dynamic speaker in the set.

Experimenting With Automatic Volume Control: One of the most popular developments in the field of radio reception during the past few years was automatic volume control. Automatic volume control on a receiver is, in effect, much like the automatic governor on an engine. The automatic governor starts to close the throttle and cut off the power when a predetermined speed is reached. Automatic volume control on a radio receiver cuts down the radio-frequency amplification—the power of the circuit—when the signal reaches a predetermined level of volume. In this way, automatic volume control banishes fading and insures a signal of constant strength.

Although it is difficult to apply automatic volume control to a radio receiver that is already built, the

principle of automatic volume control offers a splendid field for experimentation by the amateur. Two simplified automatic volume-control circuits that can be used as a guide in this work are given in Figs. 108 and 109.

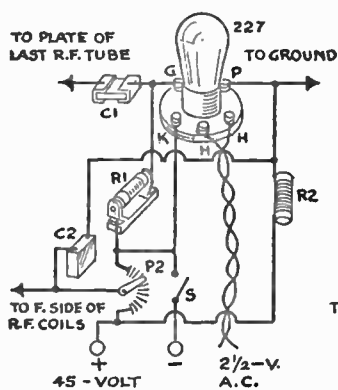

FIG. 108

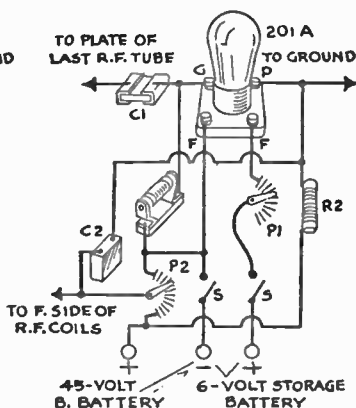

FIG. 109

The circuit shown in Fig. 108 employs an alternating-current tube type '27. It is an extra circuit that must be wired into the receiver, its function being to control the C-bias of the radio-frequency tubes and thus control the amplification or power of these stages.

In experimenting, the following specifications can be used: The condenser C₁ is a .0001-mfd. condenser. C₂ is a by-pass condenser which should have a value of from .5 to 1 mfd. R₁ is a 2-megohm resistance (grid leak). R₂ should have a value of from 75,000 to 100,000 ohms, while the potentiometer P₂ should have

a resistance of 50,000 ohms. The parts comprising this circuit can be mounted on a small board and placed in the radio set in such a position that the lead marked "to plate of last radio-frequency tube," is as short as possible. A long lead at this point will set up all sorts of complications.

Of course, it is assumed that in any case automatic volume control will be applied to a set only when it is a powerful unit with several stages of radio-frequency amplification.

The lead marked "to ground" should be attached directly to the metal chassis at the nearest point. The lead marked "to F side of radio-frequency coils" should be connected to each one of the radio-frequency coils by ungrounding the end that is normally grounded. Much better results will be obtained if each coil terminal is grounded through a .1- to .5-mfd. fixed condenser placed as close as possible to the position occupied by the originally grounded end of the coil.

In order to avoid further complications in the circuit, a separate forty-five-volt B-battery (or B supply) should be used for the automatic volume control (A. V. C.) circuit. Switch S serves to shut off the current from the potentiometer P₂ when the set is turned off. The two and one-half-volt heater lead can be connected to the two and one-half-volt circuit in the set.

For battery-operated receivers, the battery-operated automatic volume control unit shown in Fig. 109 should be used. With the exception of the tube, the tube socket, a rheostat, and the extra switch, the same parts are used.

It is necessary, of course, in this circuit to use a

separate A battery as well as a separate B battery. The rheostat P₁ is an ordinary filament rheostat having a resistance of twenty ohms.

In using either of these automatic volume control systems, it will be necessary to adjust the potentiometer P₂ so that tubes will be operating at their normal bias when no signal is being received by the receiver. Before applying an automatic volume control circuit, therefor, measure the plate current of any one of the radio-frequency tubes. Then after applying the automatic volume control, adjust the potentiometer P₂ so that the plate current of the same tube is exactly equal to that obtained before the automatic volume control system was connected. This adjustment should be made with the antenna post on the receiver connected to ground.

Using Thirty-Two-Volt Farm Circuit on Battery Sets: Set owners living in rural districts where the only source of electricity is a battery-operated lighting plant (thirty-two-volt D. C.) can make use of this current to operate the filament circuit of a battery receiver and thereby eliminate the need for a separate receiver A battery.

There are two ways of accomplishing this. The simplest and most satisfactory is to tap the farm battery itself, using just the right number of cells to give the filament voltage required. However, if the lighting plant is at some distance from the house this may not be practical. Under such conditions, the best arrangement is to use the full thirty-two volts and reduce it to the required value with a power rheostat.

If the receiver is of the five-tube, six-volt type, it

probably requires a current of one and one-fourth amperes. A rheostat to handle this current on a thirty-two-volt line should have a resistance of at least twenty-four ohms and a current-carrying capacity of not less than one and one quarter amperes. Connect the rheostat in series with the receiver plug. Then turn the set rheostat full-on and connect a voltmeter across the A-battery wires in the set. This connection should be a permanent one; the meter can be mounted conveniently on the front panel. When placing the plug in the lighting circuit be sure that the rheostat is always turned to its full-on position. Then gradually turn the rheostat until the voltmeter reads the required voltage.

Special rheostats for this purpose can be obtained from almost any dealer in radio parts. By specifying what you want to use it for, you will avoid errors.

CHAPTER VII

ELIMINATING INTERFERENCE

ALTHOUGH natural static is blamed for most of the crashes and crackles that mar radio reception, less than twenty percent actually are caused by this weird product of the atmosphere. The remaining eighty percent are the result of man-made interference, which being man-made can be controlled.

Everything electrical is a potential source of man-made static. The brushes of a motor, the vibrator on a battery charger or violet-ray machine, and a defective heating element all contribute their share to the thousands of noises that hamper clear reception. Even a worn commutator on a small electric fan motor can set up a racket in a near-by receiver that will rival the din of tons of coal tumbling down a metal chute.

Basically, man-made static has its source in the ordinary electric spark. Electric sparks, it has been found, are capable of setting up a mess of high-frequency oscillations not unlike the waves of a broadcast station. Radiating from the source like waves in a pond, they soon enter a radio receiver and become man-made static.

These high-frequency oscillations reach the receiver by three distinct routes; through the electric-light lines that feed the receiver and the sparking machine,

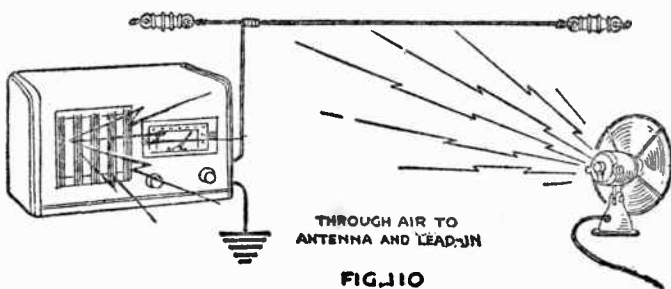
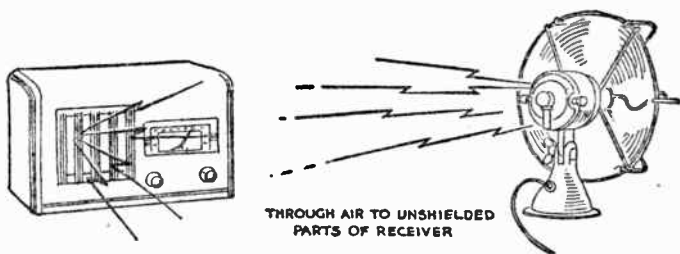
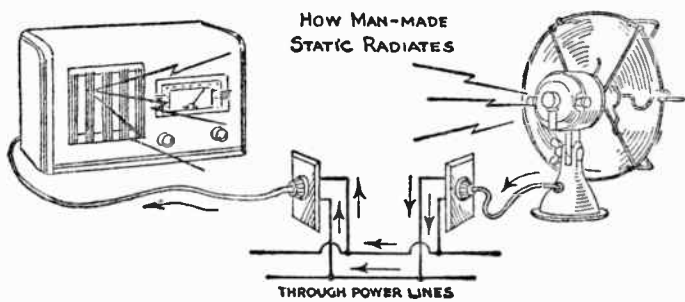

through the air to the unshielded parts of the receiver, and through the air to the receiver antenna and ground (see Fig. 110). Man-made static noises can travel for unbelievably long distances through house-lighting circuits while their effect through the air depends to a great extent on the distance and the intensity of the spark.

Obviously, one way to eliminate the result of an electric spark is to reduce its effect at the source. This can be done, in most cases, simply by connecting a small by-pass condenser circuit across the terminals of the interfering unit. The condenser will provide an easy path for the high-frequency oscillations and prevent them from being radiated. The size of the condenser, of course, depends on the severity of the spark.

A violet-ray machine, for instance, generally can be silenced by connecting a 1- or 2-mfd. condenser across its terminals. The condenser should be rated at a working voltage equal to about twice the voltage of the circuit.

A .25-mfd. condenser connected across the terminals of a small motor, on the other hand, generally will reduce the effect of any sparks originating in the brushes or commutator (see Fig. 111). In obstinate cases, a combination of condensers may be necessary to by-pass the unwanted oscillations. A combination of condensers and choke coils also can be used. The choke coils act as impedances to the high-frequency oscillations while the condensers by-pass them to the ground where they will do no harm.

Interference from the contact points on elevators

generally can be eliminated by connecting large condensers across the terminals. In most cases, condensers of at least 20-mfd. capacity will be required.

Before the filter can be applied to any interference-producing machine, however, it must be found. In this portion of the work the radio worker must play de-

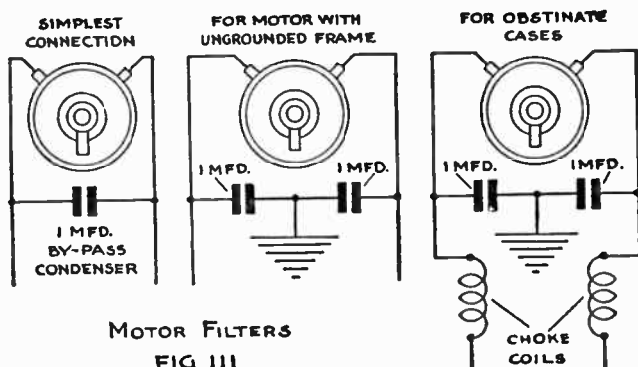

tective, adding one clew to another until the trail leads to the faulty unit.

Much can be gained by determining the time of day when the interference occurs. For example, if during the week, the noise is noticeable only between eight in the morning and five or six in the afternoon and is absent entirely on Sundays and holidays, it is probably being caused by some piece of machinery in a near-by store or shop. From this point on it then becomes a matter of scouting around until the source of the trouble is found. Almost every owner of a machine

or motor that is causing radio interference will gladly cooperate.

On the other hand, suppose that the noise starts about six or seven in the evening and continues until about midnight. This will indicate that it is caused by the mechanism operating some near-by flashing sign. If the noise occurs at night, but only on two or three nights in a week, it most likely is being caused by a battery charger.

Vacuum cleaners, sewing machines, fans, and other household appliances can be traced by the fact that they interfere for short times only, while an electric refrigerator will betray itself by the fact that it will set up interference at regular intervals during both the night and the day.

Knowing what noises are characteristic of the various types of interference-making machines also will assist the amateur in tracing trouble. A few of the more common ones are:

Crackling and Humming: Cash registers, drink mixers, elevators, electric refrigerators, electric fans, sewing machines, vacuum cleaners, and washing machines (dish and clothes).

Buzzing: Doorbells, dial telephones, elevators, oil burners, sewing machines, and vibrators.

Clicks: Elevators, flashing signs, defective heating elements, defective light bulbs, defective switches, flashing signs, and traffic signals.

Often, especially in crowded neighborhoods and apartment buildings, it is difficult to find the offending piece of machinery. In this case, the experimenter must proceed on a different tack. Instead of silencing

the interfering oscillations at the source, he must prevent them from entering the receiver even though they may succeed in reaching it.

Interference entering the receiver through the power lines can be eliminated by using the simple filter shown in Fig. 112. In design, it is identical with the

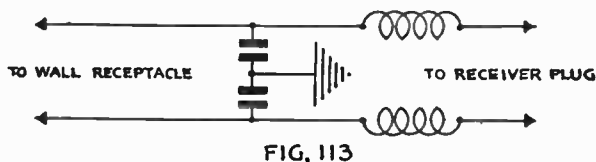
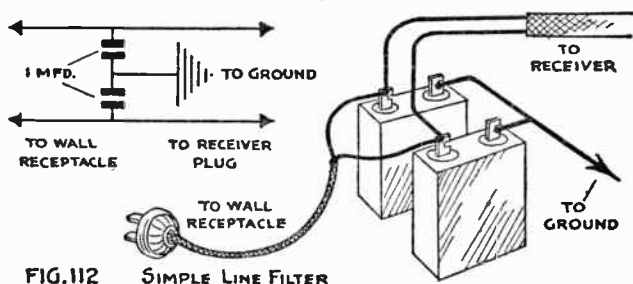

interference filter for motors, consisting of two fixed condensers (about 1 mfd.) connected across the power lines and to the ground. As shown, these can be arranged as a unit placed near the floorboard receptacle which feeds the receiver, the ground wire being connected either directly to some convenient ground or to the ground terminal of the receiver which in turn is connected to a water pipe or other ground.

Cases where the interference entering the receiver through the power lines is severe may require the more complicated filter circuit shown in Fig. 113. Again like one of the filters suggested for motors in Fig. 111, the condensers serve to by-pass or detour the high-frequency oscillations while the choke coils form a barrier.

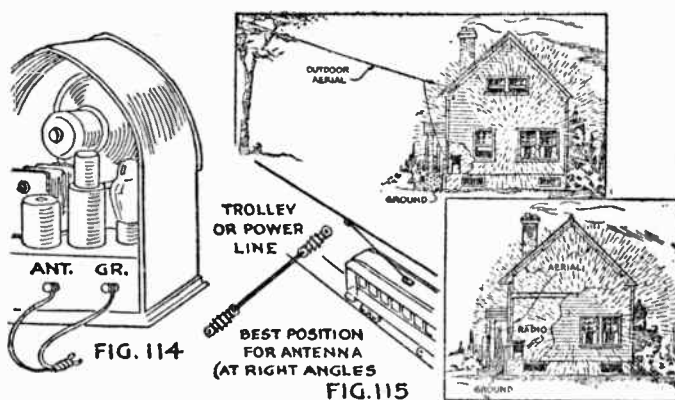

Often, the interference is of such a magnitude that it is radiated through the air. Man-made static of this type can easily find its way into a poorly shielded set, being picked up by the coils and various connections.

Although modern receivers are fully shielded, sets of an earlier period often lack adequate shielding. To test a set for shielding follow the test outlined in Fig. 114. First disconnect the antenna and ground leads from the receiver and with a wire or the metal shank of a screw driver connect the antenna terminal

to the ground terminal. This will have the effect of placing a shorting connection across the antenna coil of the receiver.

Finally, turn the volume control on the receiver to its full-on position and turn the tuning dial slowly. If no signal is heard, except perhaps the faint response of some high-powered station located near-by, you can be sure that the receiver has been carefully shielded. If signals are heard, it will be best to test out various shields on coils and tubes until the volume of the signal is greatly reduced.

It is in rigging the antenna, the third entrance that is many times open to the oscillations of man-made static, that the amateur can do the most toward eliminating interference.

In the first place, an indoor antenna is perhaps the worst type in localities where man-made static is troublesome. In most cases, a single horizontal wire rigged as high as possible and as far from obstructions as is practical will give the best results.

Under no conditions plan an antenna in a zigzag design. It will tend to reduce, rather than increase, the signal even though it contains more wire. It is far better to use a shorter wire. A short antenna, within limits, also will improve selectivity with, of course, a slight dropping off in signal strength.

Position and location of the antenna also have a great deal to do with the amount of man-made static picked up. If the interference is being produced by the overhead trolleys of a near-by electric car line, or defective insulators on a power (high-tension) line, some relief often can be obtained by rigging the an-

tenna at right angles to the radiating wires. If rigged parallel to the wires, it will present its largest possible front to the waves of man-made static.

Often, the effect of man-made static can be greatly reduced, especially when the static has its source in a house or building, by rigging the antenna as far away from the building as it is possible to get it. By increasing the length and the height of the antenna, more of it is extended beyond the radiating field of the interference. Figure 115 illustrates such an arrangement.

In many cases physical limitations make it possible to rig an antenna only in one direction and of one given length and height. However, where it is possible, it is always worth while to experiment with antennas strung in different directions and at various heights. A single wire strung horizontally often exhibits marked directional effects in respect to signal strength as well as man-made static. For this reason, try several and retain the best.

It may be well to point out also that there is no particular material that is best suited for an antenna wire. As long as it is sturdy and a good conductor, it will serve the purpose.

Since man-made static can enter the lead-in as well as the antenna wire proper, some consideration also should be given to this portion when attempting to eliminate interference. As a lead-in approaches a house, it gets nearer and nearer to the field of interference. To exclude the unwanted noises that radiate from the electrical appliances in every modern home,

anyone of a number of noise-reducing lead-ins can be used. Three such lead-ins are shown in Fig. 116.

Simplest of all interference-free lead-in systems is the shielded wire. Being sheathed in a metal case of

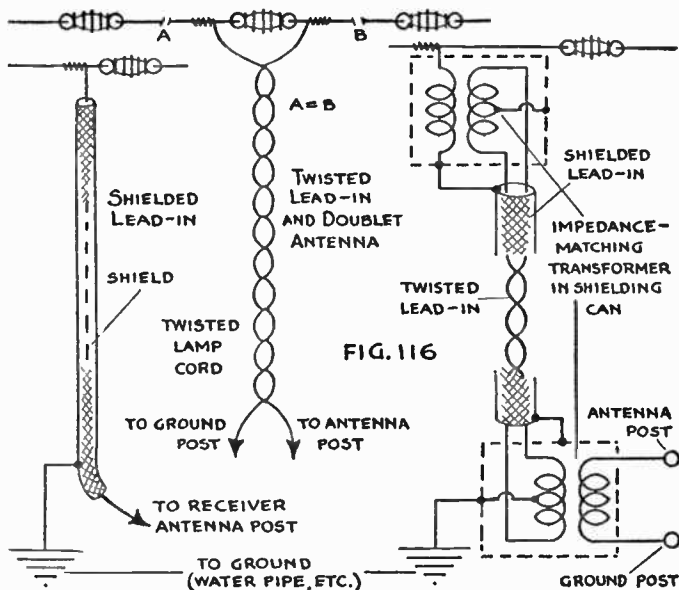

copper braid, it is protected from the radiations of man-made static. Any oscillations which reach it are quickly shunted to the ground by the shield before they penetrate to the inner wire which leads to the antenna post on the receiver. Unfortunately, a lead-in of this type presents various losses which may or may not prove serious. In cases where long lead-ins of this

type are used, signal strength on distant stations may be reduced. In addition, the selectivity of the system may be materially broadened. However, it is a system worthy of experimentation on the part of the amateur.

Another antenna system which is both simple and inexpensive consists of two identical antenna wires rigged horizontally in the same straight line. The two

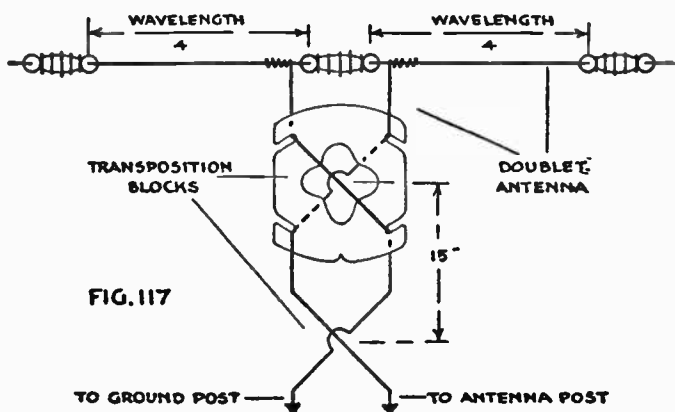

lead-ins, twisted together for their full length, are connected to the antenna and ground terminals of the receiver as shown in Fig. 116. No actual connection between the ground and the receiver is used.

The effect of these double antennas and twisted lead-in wires is to nullify the effect of any man-made static that may be picked up. The oscillations collected by one system (antenna and lead-in) are matched against those picked up by the other system with the result that each cancels the other and only the un-

adulterated radio signal reaches the receiver. In design this type of antenna system for the broadcast waves is similar to the doublet antennas often used in short-wave reception (see Fig. 117).

The most modern and perhaps the most efficient type of noise-reducing lead-in is the so-called transmission line variety. Like the first lead-in system shown in Fig. 116, it depends on the protecting qualities of a shield of copper braid. However, it also has two additional units—impedance-matching transformers—to reduce the losses that are always present in long lengths of shielded wire. One transformer is placed directly at the antenna while the other is mounted close to the receiver. The shielded length of double wire connects the two. To complete the shielding and close every possible entrance to the man-made static, the transformers also are shielded.

Transmission lead-ins, or transformer-coupled lead-in systems as they are sometimes called, come in a variety of different designs, but in each the general principle is the same. The secret of the underlying circuit lies in the fact that the voltage is reduced for its passage through the shielded lead-in wire and built up again at the receiver. Losses due to capacity in shielded lead-ins are far less at lower voltages.

Unfortunately powerful modern receivers have led the average set owner into the belief that the antenna has little effect on the quality of reception. Nothing could be further from the truth. Some idea of the effect of various types of antennas on signal and man-made static strength can be gained from Fig. 118.

At the left, below the receiver connected to the very short antenna symbolizing the type often used in apartments, are two heavy wavy lines. One indi-

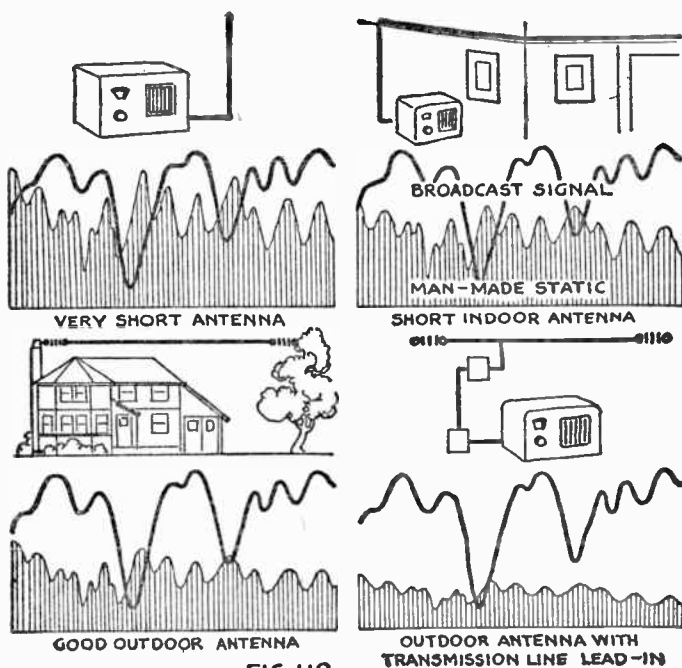

FIG. 118

cates the relative strengths of the radio-frequency oscillations from the broadcast station and the other the total strength of man-made static. Note how, when the receiver is made sensitive enough to get an adequate signal on the loudspeaker, the static reception also becomes stronger.

In the next drawing, a longer indoor antenna is illustrated. This longer wire brings in the waves from the desired station strong enough to allow the volume control to be turned down to a point where the noise level is materially less.

Proceeding to the left and below, Fig. 118, note what happens when a good outdoor antenna is used. The noise level in this case has shrunk to smaller proportion while in the fourth drawing, illustrating what happens when a good shielded lead-in system is used, the noise reaching the receiver is negligible.

Another reason for the use of an adequate antenna is that it enables you to reduce the self-generated noises in a receiver. All tubes produce a certain amount of hissing due to the flow of electrons from their filaments or heated cathodes but only those placed in the circuit ahead of the audio-amplifying stages create noise in the loudspeaker. A good antenna makes it possible to reduce the sensitivity of the receiver by turning down the volume control, with consequent reduction of the inherent tubes noises.

Noise-reduction is even more important in the operation of short-wave receivers. To obtain noise-free reception in the higher frequencies, the doublet type of antenna having a transposed lead-in, as shown in Fig. 117, is used by many amateurs. The effect is quite like that of the twisted lamp cord lead-in illustrated in Fig. 116. The noise oscillations picked up by one system are matched against the other by the transposed wires with the result that each cancels out the other.

In short-wave work, the doublet antenna usually is designed for operation with some particular frequency

—the length of each doublet being determined by the wave length (see notation on Fig. 117). However, although an antenna of this type will work most efficiently on the wave length for which it is designed, the rule is by no means rigid. A doublet designed for eighty meters, for instance, also will operate on the forty- and twenty-meter bands as well. Similarly, a forty-meter doublet will also bring in the twenty-meter stations.

In figuring the length of each doublet, simply decide on the maximum wave band to be covered, multiply the wave length in meters by 3.28 to convert it to feet, and divide by four. The result will be the length of each portion of the doublet in feet.

Although the two transposed wires of the lead-in can be connected into the receiver in various ways depending on conditions, the simplest is to wire them directly to the antenna and ground terminals of the receiver. Special antenna couplers also can be used in cases where the absence of a regular ground tends to cause noises. Suitable couplers as well as the transposing insulators can be obtained from any dealer in radio parts.

The amateur experimenter can make improvised transposing insulators if he desires, by making use of the composition used in manufacturing phonograph records. Simply soak the records in boiling water until they become soft. Then cut them up into two-inch squares and drill four holes near the corners for the lead-in wires. The wires can then be threaded through the holes criss-cross fashion as in Fig. 117.

Six Pointers On Noise-Free Reception

- 1.—Use a long, high, well-insulated antenna (outdoors) rigged at least ten or fifteen feet from the surface of the roof and never adjacent to any projections in the building which may contain electrical apparatus. Remember, once the high-frequency oscillations of man-made static have entered the antenna they cannot be eliminated. Place the antenna outside the zone of interference.
- 2.—If a ground is used, be sure it is a good one and take every precaution to prevent corrosion at the point where the ground connection is made. Too frequently, receivers are connected to the nearest piece of pipe with no thought given to the possibility that noise-producing machines also may be grounded to the same system between the receiver and the actual ground. To play safe, run a separate wire to the point where the water pipe enters the cellar wall.
- 3.—Use a well-shielded receiver.
- 4.—Use some type of noise-reducing lead-in in cases where man-made static is particularly bad.
- 5.—Use a filter circuit in the power supply to the receiver.
- 6.—Place filter circuits on all electrical appliances used in or near the home.

CHAPTER VIII

RADIO SERVICING AND TROUBLE SHOOTING

RADIO servicing operations can be divided roughly into two distinct processes: first, finding the trouble, and second, fixing it in the simplest and least expensive way.

In trouble-shooting ailing receivers, the amateur experimenter must assume the role of a doctor. He must be quick to recognize visible and audible symptoms, logical in following clues, and unflinching in his choice of remedies. Success depends on speed and accuracy.

Just as a doctor of medicine watches for telltale signs and reactions that will help him diagnose an illness, so must the radio serviceman be on the alert for symptoms that will instantly catalog the trouble. Past experience will be of help in this portion of the work. Each mysterious ailment that is remedied will make it just that much easier to find the next.

The beginner, however, will have no previous knowledge of radio's various ailments. For this reason, he must follow simple rules of procedure in lieu of experience.

Fortunately, not all troubles will prove as complicated as they may at first appear. Few radio owners are trained electrical experts and for this reason a surprisingly large number of your calls will prove to

be routine jobs where the trouble is self-evident to anyone who knows where to look.

For the most part, radio troubles fall into one of the five sharply defined classifications of radio ailments: no reception, weak reception, intermittent reception, distortion, and hums and noises. Each of these troubles or symptoms immediately place the cause within certain definite boundaries. A few of the more important causes of the five general radio troubles are as follows:

No Reception: Defective or disconnected power cord, grounded antenna, bad tube in rectifier or receiver, open coil or resistance, shorted coil, blown condenser, open transformer, shorted or open voice coil or field coil in dynamic speaker, and absence of broadcast signals from the station due to an S. O. S.

Intermittent Reception: Loose connection that is shifted by vibration and motion, resistance that opens when heated, antenna that is grounded when it swings in the wind, loose or corroded ground connection, variable condenser that short-circuits at various positions, and an old tube with loose elements that shift or short-circuit when they heat up or are subjected to vibration.

Weak Reception: Poor tube or tubes, shorted transformer or blown condenser in power circuit, open resistance or coil, shorted resistance or coil, open condenser, and loudspeaker troubles.

Distortion: Wrong voltages in plate circuits, tube or tubes going bad, faulty bias circuit (shorted bias condenser or bias resistance), tuning condensers not tracking, and speaker trouble.

Hums, Crackles, and Noises: Man-made static (see Chapter VII), tube failing, open condenser in filter circuit of power pack, loose connection in grid circuit, loose or corroded ground connection, partly grounded antenna wire, defective volume control, condenser leaking, defective voltage divider in power pack, defective speaker, and natural static.

Step-by-Step Servicing

Once the amateur experimenter has familiarized himself with the various receiver ailments and their possible causes, his next step should be to develop some form or plan to follow when trouble-shooting a receiver. Time will be saved, and often unnecessary work will be eliminated.

First of all, he should list the symptoms of the ailing circuit. Of course, if the receiver fails to operate there will be very few telltale clues to be considered. On the other hand, if the complaint is either "weak reception" or "intermittent reception," merely listening to the receiver may suggest the cause or causes of the trouble.

If the set fails to function entirely, there are two possible causes that can be checked without even touching the receiver. These are the antenna and the power supply.

The second step, then, when a set fails completely is to see that the antenna is connected and that it is not grounded. The third step should be to make sure that the receiver is being supplied with current. If it is a battery-operated outfit, check the batteries and their

connections. If it is all all-electric, inspect the plug and power cord that connects the receiver with the house lighting circuit.

If the electric lamps near the receiver light when their switches are turned, it is safe to assume that current is available at the wall receptacle and that no fuses are blown. The next problem is to learn whether or not the current available at the wall plug is actually

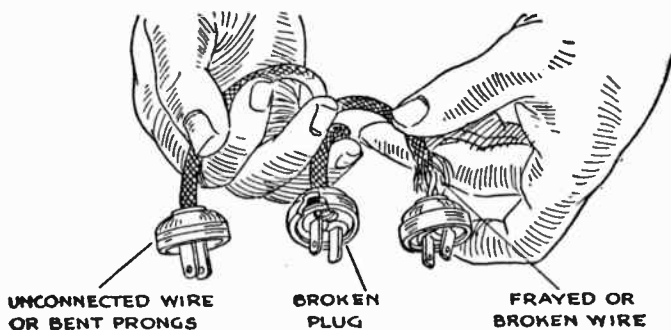

FIG. 129

reaching the receiver. Figure 129 illustrates a likely source of power-cord trouble—a broken or defective plug.

When these outside connections to the receiver have been tested, the serviceman can be sure that the trouble lies within the circuit itself. The next step is to turn on the receiver.

The operation of any radio receiver is dependent on its tubes. A burned-out tube can be found by inspection when the set is turned on, as it will fail to

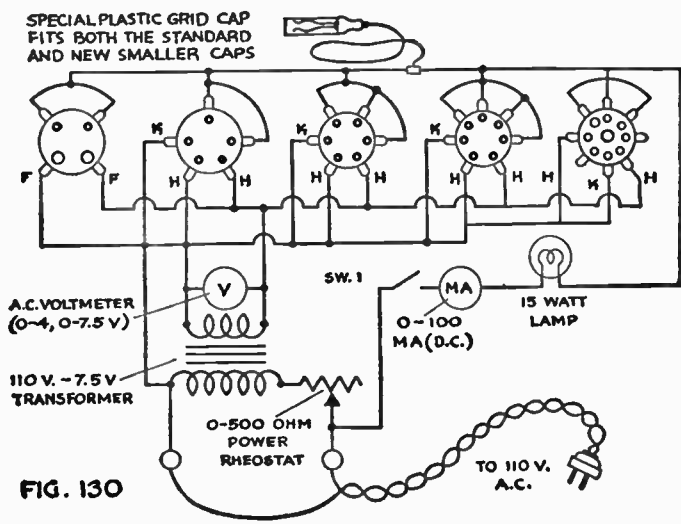

FIG. 130

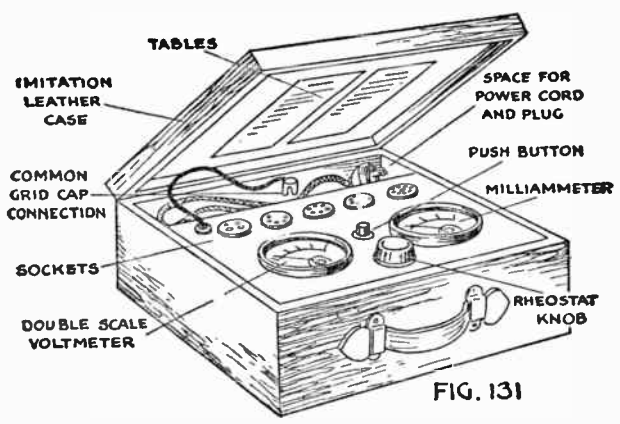

FIG. 131

glow. A tube failing with age, on the other hand, will glow as usual even though it is not functioning as it should. Complete tube failure is easily found and remedied but a gradually failing tube may produce a number of vague troubles that make it difficult to discover.

A failing tube often can be found by the process of substitution. Replacing first one tube and then another until the set operates as it should will soon indicate which one of the tubes in the receiver is at fault.

A Simple Tube Checker: To differentiate accurately between good tubes and worn tubes, some form of tube-checking circuit must be employed. Although many elaborate tube checkers are sold for use by servicemen, the amateur experimenter can make an inexpensive yet highly efficient unit by following the simple wiring diagram shown in Fig. 130.

The homemade tube checker consists simply of five sockets to take care of the variety of tubes used in receiver construction, a two-scale A.C. voltmeter (0-4 and 0-8), a filament-heating transformer (7.5-volt secondary), a 500-ohm power rheostat rated at 75 watts, a single-pole, single-throw push-button switch, a 15-watt tungsten-filament electric lamp, an 0-100 milliammeter (D.C.), a grid-cap connector, and some connecting wire. The five sockets are a medium four-prong, a medium five-prong, a small six-prong, a small seven-prong, and an octal eight-prong. They should be of the below-the-panel connection type and, therefore, five holes of about $1\frac{1}{8}$ -inch diameter must be drilled in the mounting panel.

As shown in the schematic diagram, the plate, grid,

and additional grid connections on each socket are tied (connected) together. Basically, only four connections from the circuit are made to each socket. These include the cathode (on sockets B, C, and D), the filament or heater, and the combined grids and plate. Naturally, since the circuit must operate when a tube is placed in any one of the four sockets, the socket connections are placed in parallel.

To control the available filament voltage, the 0- to 500-ohm power rheostat is placed in the 110-volt primary of the filament transformer. Although in this position, the variable resistance will give smoother action, it is also possible to control the voltage by placing the rheostat in the secondary. Because the voltage in the secondary never will exceed seven and one half volts, the rheostat placed in this position can be smaller.

Since the serviceman will need this tube checker when he makes his service calls, it will be well to place the circuit in some sort of covered case. Suitable cases, such as shown in Fig. 131, can be purchased from almost any radio supply house for a dollar or so. By planning the switch and socket panel, a recess can be supplied to take the power cord and plug. Of course, if the circuit is to be used only in the laboratory, it can be mounted bread-board fashion or on a convenient vertical test panel.

In order to master the operation of the tube checker, the amateur first should test out a number of new tubes whose conditions are known to be good. In this way, he will arrive at standards that will be

of assistance in determining whether or not a suspected tube is giving the service it should.

The first step is to place the tube in the proper socket and to connect the common grid cap if one is required. Then plug the power cord into the nearest 110-volt A. C. wall outlet or socket and adjust the rheostat until the voltmeter across the transformer primary indicates the specified filament voltage for the tube being tested. The rheostat should be at its full-on position when the power plug is inserted and gradually reduced to bring the voltage up to the required point. Should the rheostat accidentally be left in the low-resistance position, the excess voltage may blow the tube. As a precaution, it will be well to paint some sort of red marker on the rheostat knob to serve as a reminder.

When the filament voltage has been adjusted to the proper point, push the switch button in the combination grid and plate circuit, holding it down just long enough to take the milliammeter reading and note whether or not the meter needle holds its reading. When testing an old tube, should the reading waver, gradually rising, it indicates that the tube is gassy and probably is causing trouble.

When making this reading, do not hold the push-button switch (SW1) down any longer than is necessary. If held down more than two or three seconds, it may materially weaken the tube.

Once the reading has been made, adjust the power rheostat to reduce the filament voltage gradually. Take readings of the milliammeter at intervals and note when the plate-grid circuit current starts to fall

off materially. In a new tube, you will find that the filament voltage can be reduced more than twenty-five percent without any great change in the milliammeter reading. If a tube is in fair condition, a reduction of twenty-five percent in the filament current should not cause a corresponding decrease in the milliammeter reading of more than ten percent. By testing various tubes of known condition, however, the experimenter soon will formulate standards that will assist him in selecting the good from the bad.

Besides checking the electron emission of tubes, this circuit also will give an automatic check on the internal condition of the tube. Should a short circuit exist between any of the elements and the cathode, the fifteen watt lamp will indicate it by glowing brightly. If switches are placed in the various individual grid circuits, short-circuit tests also can be made for the grid circuits. If opening any one of the switches does not cause a decrease in the milliammeter reading it is a good sign that one or more of the elements is short-circuited.

As a guide in using the tube checker, the amateur should paste various tube tables under the cover of the cabinet where they will be visible for instant use. A table showing the specified filament voltages for the various tubes will make it an easy matter to adjust the power rheostat to the required initial position. Also, a table of standards compiled after the new tubes known to be good have been tested, will be helpful in making comparisons. When an unknown tube is being tested, a quick glance at the standard table will

TABLE OF STANDARDS

TUBE TYPE NUMBER	FILAMENT VOLTS		MILLIAMMETER	
	FROM	TO	FROM	TO
201 A	5	3	30	26

FIG.132

A 4-PRONG TUBE BASE	B 5-PRONG TUBE BASE	C 6-PRONG TUBE BASE	D 7-PRONG TUBE BASE	E 8-PRONG TUBE BASE
2A3	24A	41	6A7	6C5 x
01A	27	42	6B7	6F6 x
10	35	43	6F7	6F7
112 A	36	57	59	6J5 x
26	37	58		6J7 x
30	38	75		6K7 x
31	39	77		6K6-GT
45	56	78		6K8
50		85		6L6
71-A		89		6V6 x
32		2A5		
34		6C6		
		CD6		

FIG.133

*GLASS EQUIVALENTS (DENOTED BY PREFIX G OR GT) CAN ALSO BE TESTED

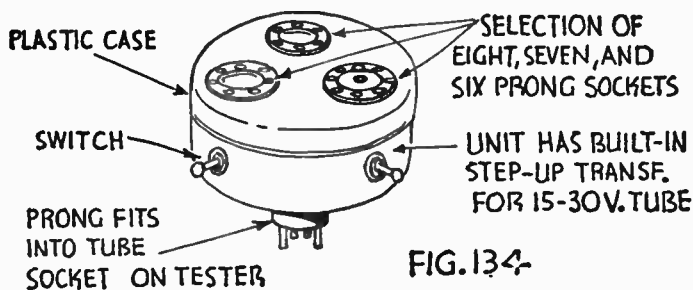

FIG. 134

show what reduction should be possible in the filament voltage for a specific milliammeter reading, Fig. 132.

In order to check high-voltage tubes such as the 2Z5Z, 12Z3, 25Z3, etc., there is available on the market an adapter which is shown in Fig. 134. Containing a built-in filament transformer and switch, it not only provides the necessary high filament voltages, but makes it possible for old tube checkers to check these tubes as well. This adapter is plugged into the '24 socket of the tube tester. Its transformer primary obtains its current (at 2.5 volts) from the heater prongs of the socket. Its secondary is designed to deliver 10, 13, 14, 15, 25, or 30 volts to the filament of the tube under test, so that it makes possible the testing of all high-voltage filament-type tubes.

Although only five sockets have been provided in the tube checker, the fact that the plate and all grid elements are connected together makes it possible to test a variety of tubes (see Fig. 133). By buying

or improvising a tube adapter similar to that shown in Fig. 135, almost any type of tube can be tested.

Once the tubes in a receiver has been tested and found to be in working order, the serviceman can turn his attentions to the internal circuit. With the tubes exonerated, it is safe to assume that the trouble lies in a defective part or a loose connection.

Voltage Tests: Since the pulse of any radio receiver

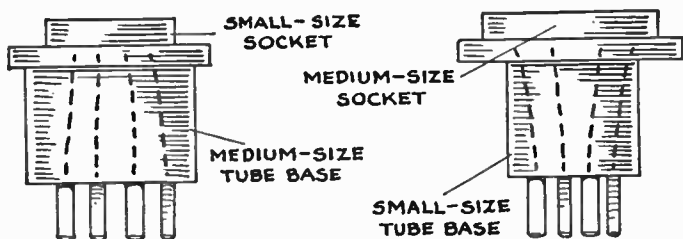

FIG. 135

is its many voltages, the electrical measurements of its various circuits can be used to trace the cause of internal trouble. A defective part, a loose connection, or a broken wire is quickly revealed by the fact that it alters the voltage of the circuit with which it is associated. Once the ailing portion of the circuit is uncovered, it is merely a question of discovering which of two or three possible units is responsible for the trouble.

Because of the crowded compact circuits used in most modern receivers, it would be a hopelessly difficult task to attempt making voltage measurements

across every individual part in the circuit. The fact that these voltages are available at the various tubes in the circuit, however, simplifies the problem. The serviceman can employ the circuit connections made to the socket of each tube in making his measurements.

If the circuit to be tested employs the common form of three-element heater type tube, four circuits terminate at the tube socket. They are the grid circuit, the cathode circuit, the heater or filament circuit, and the plate circuit. Voltage measurements made in each of these circuits will immediately reveal any faulty part or connection. Of course, in making voltage tests of this type, the readings of the voltmeter placed across the various circuits will mean nothing if the required voltages are not known. For this reason, the serviceman must be equipped with the voltage data for each receiver he tests. These tables generally can be obtained from the manufacturer or from special manuals featuring service data and wiring diagrams for every popular commercial receiver.

In a three-element heater-type tube, two voltmeters will be necessary to make the various measurements.

Since alternating current is used as a heater supply in the three-element heater-type tube, an alternating-current meter as well as a direct-current meter will be necessary in making the measurements of the various circuits. The alternating-current meter can be connected directly across the heater terminals as shown in Fig. 136 to check the heater voltage.

In measuring the voltages of the plate and grid circuits, a multirange direct-current meter will best meet

the requirements since its range can be adjusted to suit the maximum voltage. To measure the plate voltage, the meter should be connected across the plate

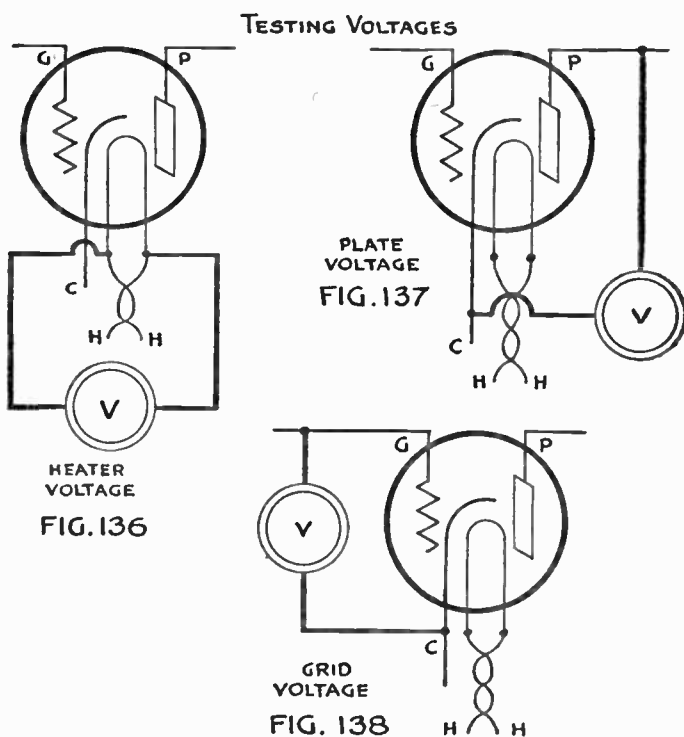

and cathode terminals of the tube (with the tube in operation), while the grid voltage can be measured by placing the meter across the grid and cathode terminals. (See Figs. 137 and 138.) Any variation from

the normal specified in either of these voltages will indicate that some part in that particular circuit is either open or shorted.

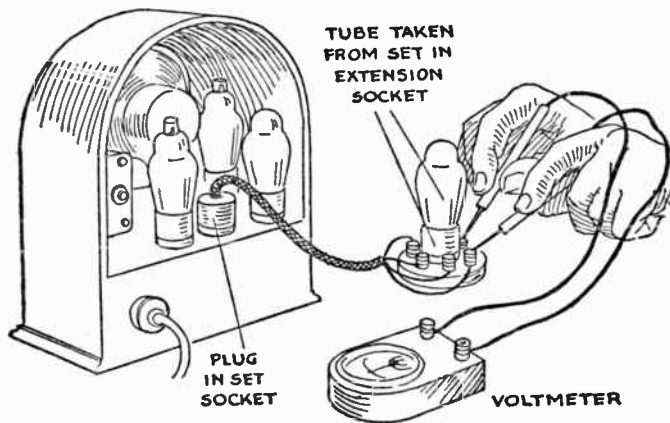
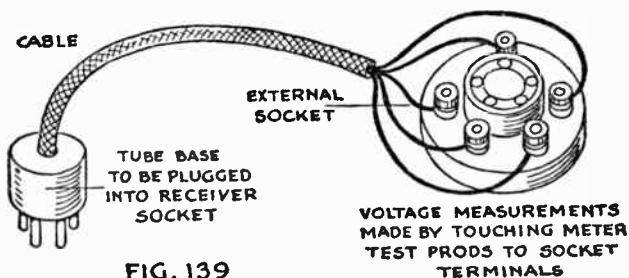

If the tube being tested is of the screen grid variety, still another circuit, the screen grid circuit, will be present. Voltage measurements for the screen grid circuit can be made by placing the meter across the cathode and screen grid terminals of the tube. In all

circuit measurements in a tube, with the exception of the filament or heater, the cathode forms one side of the circuit.

Although these various circuit voltage tests can be made by touching the tips of a pair of test prods connected to the meter to the various prong terminals on the underside of the tube socket, such a procedure would mean that the entire chassis would have to be removed from the cabinet and turned upside down. A simpler way is to use some form of test extension similar to that shown in Fig. 139.

The test extension consists of an open socket of the older variety having outside terminals connected through a four-, five-, six-, or seven- wire cable, depending on the tube being tested, to an ordinary tube base. The cable wires should be soldered to the prongs in the tube base and as an added touch, the tube base can be filled with sealing wax or paraffin and supplied with a suitable handle.

To test a tube's circuits, remove the tube in question from the receiver, plug it into the external socket, and plug the tube base plug into the vacated socket in the set. The tube then will continue to operate as part of the receiver but being extended away from the receiver will present an easy means of making the various voltage measurements. The various meters can either be connected directly to the socket terminals or they can be used with test prods. Of course, if the tube is of the type having a grid cap, an extension, consisting of a grid cap, wire, and small spring clip, must be supplied.

In analyzing a receiver by this method, the voltage

of each tube should be checked until the faulty circuit is uncovered. By a series of simple tests, the faulty unit in that particular circuit then can be traced by the various tests outlined in Chapter IV. Some of the defects that will make a part inoperative are as follows:

Condensers: Shorted, blown (punctured dielectric), or open.

Resistances: Shorted or open. May open or short only when the heat generated expands the wires.

Coils: Open, shorted, or grounded.

Chokes: Open or shorted. May open or short only when the heat generated expands the wires.

Transformers: Open or shorted. Loose laminations in core also can cause trouble.

Tubes: Failing from age, completely burned out, loose elements that may either vibrate or short circuit, or microphonic.

Dynamic Speaker: Burned-out voice coil, burned-out field coil, loose connection, loose voice coil, warped voice coil, loose or split diaphragm, or off-center voice coil.

Switches: Dirty or bent contacts.

Test prods and various standard parts also can be used in tracing difficulties in a receiver circuit (see Fig. 140). Suppose, for instance, that the voltage tests tend to indicate that one of the resistance units in one portion of the circuit has failed. One way of making sure is to connect a large-sized variable resistance having a range that can be varied from approximately zero to 5,000 ohms to a pair of test prods. Set the variable resistance to the approximate value of

the resistance (see Appendix for color code used on commercial resistances) and touch the test prods to each end of the suspected unit.

If your guess is correct, the current which cannot

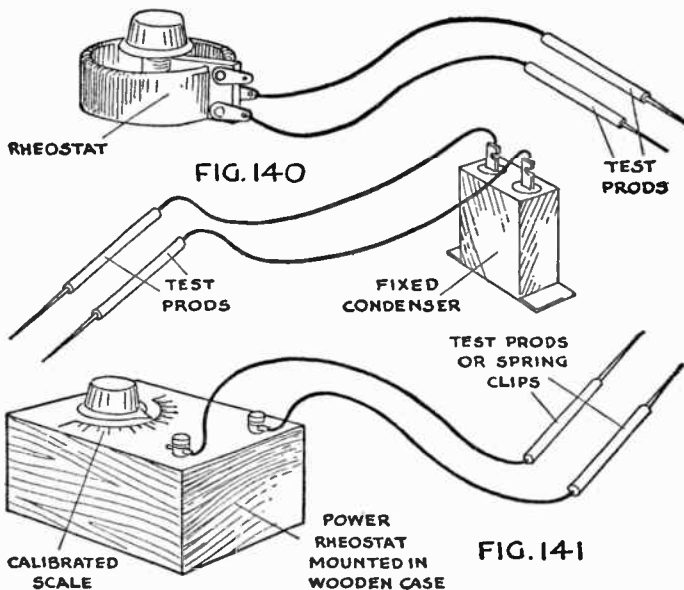

flow through the burned-out unit will pass, by the way of the test prods and external resistance, and the receiver circuit will assume normal operation. If, on the other hand, the addition of the variable resistance merely supplies a second path for the current no noticeable effect will be produced.

Of course, it must be borne in mind that fixed resist-

ance also often become short circuited either internally or to the chassis of the receiver. In this case, the direct substitution test may have little or no effect. For this reason, if direct substitution fails, the next step should be to remove the resistance entirely from the circuit and substitute another of the same specifications.

This same general method of substitution also can be used in finding faulty fixed condensers. A condenser may become either short-circuited or open-circuited. An open-circuited condenser is one in which an internal connection has opened. This has the same effect as disconnecting the condenser from the circuit.

A short circuit indicates that the insulation between the various plates that give the condenser its capacity has given out and allows the current to flow across from one plate to another. A short-circuited condenser in a circuit will function the same as a direct connection made with a piece of wire.

If a spare condenser is connected across the terminals of an open-circuited condenser, the spare condenser will function in place of the one in the set. On the other hand, if the condenser is shorted, placing the spare condenser in series with the suspected unit will cause the receiver to operate. If both of these condenser tests give negative results, it is safe to assume that the condenser is in good operating condition.

In making condenser tests, it will be a wise precaution to use a test condenser having a high-rated working voltage. A small, low-voltage condenser may be short-circuited if you attempt to substitute it for one of the filter condensers in the power circuit.

Incidentally, by using an ohmmeter similar to the one described in Chapter III, the amateur experimenter can calibrate a high-grade variable resistance that will simplify resistance substitution tests. Simply connect the variable resistance to the ohmmeter terminals and turn the control arm. By noting the various resistance values shown on the meter for different positions of the control, a fairly accurate calibration can be obtained (see Fig. 141). Once calibrated, the unit then can be used to determine the resistance of a faulty unit in the receiver. Connect the variable resistance across the suspected resistance and, starting with the full resistance in the circuit, turn the control to reduce the resistance until the receiver operates as it should. The resistance value shown on the calibrated dial of the variable resistance then will give approximately the correct value for the faulty resistance.

Ordinary earphones also can be used to find trouble in the circuits of a simple receiver. Suppose, for instance, that a careful inspection shows no breaks in the wiring and no open connections. Connect the earphone cord tips in place of the regular P and B terminals of the first audio transformer. If you hear signals, it indicates that whatever trouble exists is in the audio amplifier end of the set and not in the radio-frequency or detector stages. Shift the phone tips to take the place of the P and B terminals of the second audio transformer. If the signals are heard much louder, you can forget the first audio stage and concentrate on finding out what is wrong with the last or power stage.

The Modern Set Analyzer: Out of the simple voltage tests described in the early part of this chapter has grown the modern set analyzer. Although all the important voltage tests can be made with the simple extension plug and voltmeters illustrated in Fig. 139,

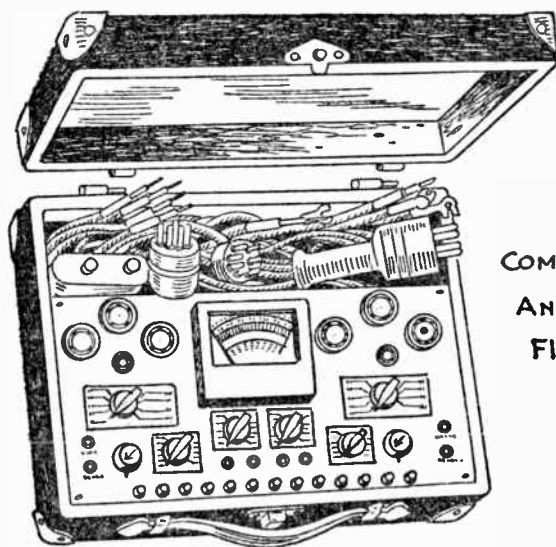

COMMERCIAL
SET
ANALYZER
FIG. 142

the well-equipped service man uses the commercial test set shown in Fig. 142.

Basically, the analyzer is nothing more than a series of tube sockets so arranged with single and multiple switches that the voltage readings of any circuit for any type of tube can be made easily and quickly. Instead of connecting the meters directly to a single

socket, merely pushing buttons on the test panel inserts a single meter into the various circuits. As before, the actual circuit connections to the tube are made through a multi-wire cable connected into the receiver through a plug having the right number of prongs for the tube in question.

In the larger and more expensive set analyzers, output meters, as well as test oscillators, often are included in the same case with the test sockets and meters. Also, many expensive service analyzers incorporate complete tube-checking facilities.

Mysterious Ailments: As a serviceman becomes more and more experienced, he will catalog in his mind many mysterious types of troubles that often cannot be traced by the usual methods. In this case, common sense and logic will be of more value than tube checkers and set analyzers.

Many times, the real seat of the trouble is far removed from the receiver circuit itself. For example, every rattle and rasp that issues from a loudspeaker is not necessarily due to some defect in the loudspeaker or the receiver. In some cases, especially on the lower notes and tones, rumblings and bothersome rattles can be traced to nothing more than vibrating ornaments or bric-a-brac placed on near-by tables or on top of the receiver itself.

If a close search of the surroundings fails to reveal any outside object that may be causing the noise, an inspection should be made of the speaker cone. If it appears to be tight, center your attentions on the area surrounding the voice coil. Often a slight, almost im-

perceptible, buckling near the center will cause noises the source of which is hard to find, Fig. 143.

Even chassis parts can be the cause of many speaker noises. Loose-fitting coil shields and tube shields in particular have been found to cause many

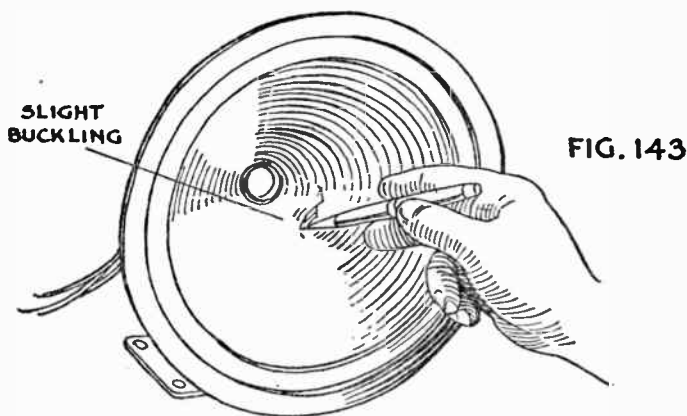

FIG. 143

mysterious types of sputterings and crashings blamed on circuit failure or tubes.

If loud scratchings and crackles bellow from a loud-speaker when the volume control is adjusted, it may mean nothing more than a bent or dirty wiper arm on the variable resistance. The same applies to dirty wiper connections on the rotors of variable tuning condensers. Inspect both possibilities before ripping a receiver circuit apart.

Poor ground connections are another source of mysterious rattlings and rumblings. Often they are con-

fused with the noises caused by a poor connection. In some cases, it may be found that a receiver will sputter every time some one walks across the floor. At first thought, this would tend to show a loose connection but a closer inspection may reveal that it is caused by the vibrations of the radiator that forms the ground. The trouble often is traced to a piece of metal lathing in the ceiling. Being exposed, it rubs against the riser pipe to the radiator every time the heating unit sways.

Another mysterious trouble makes it important that old tubes be tested in a tube checker only after they have been allowed to heat up under actual operating conditions in the receiver. This places the tube at its normal working temperature and reveals any circuits or elements that may short circuit or open up only when the parts become heated. Tubes may check perfectly when cold and yet fail to give results when they heat up.

Retracking Receiver Condensers: While most radio receiver ailments will require the replacement of some defective part, there is one complaint—loss of sharp tuning qualities—that requires not a new part but the careful adjusting of an old one.

In the modern multi-stage receiver, sharp tuning is obtained only when all of the tuned stages synchronize or “track” exactly alike. Although every manufacturer takes precautions to see that this condition exists when the receivers leave his factory, vibration through use or the haphazard work of some serviceman often causes the settings to change.

It is this slight difference in tracking accuracy in the various stages which usually accounts for the dif-

ference in the performance of two receivers otherwise identical in construction.

The final adjustment of tracking usually is done by the aid of miniature vernier condenser plates attached to the side of each section of the condenser (see Fig. 144). The synchronizing or tracking adjustment of

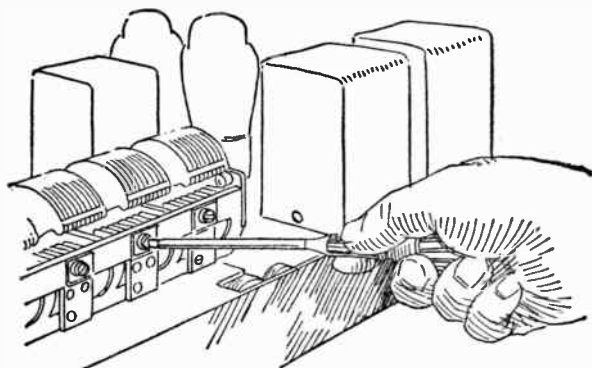

FIG. 144

these vernier condensers should be made as close to 200 meters or 1,500 kilocycles as possible.

Before any adjustment is made, the first job is to determine by test which of the stages is out of track or, in other words, is not tuning at the same point as the remaining stages. This can be done in the simplest and best way by the amateur by means of a flat plate made by mounting an old variable condenser plate on a wood or composition handle (see Fig. 145). Tune in some station near the lower end of the dial. Turn the volume control until a medium strength signal is re-

ceived and then move the dial a fraction of an inch below the point where the station is heard best.

Next, the metal plate should be rested so that it touches the condenser shaft close to a stationary plate. There should be a gain in signal strength as the plate

FIG. 145

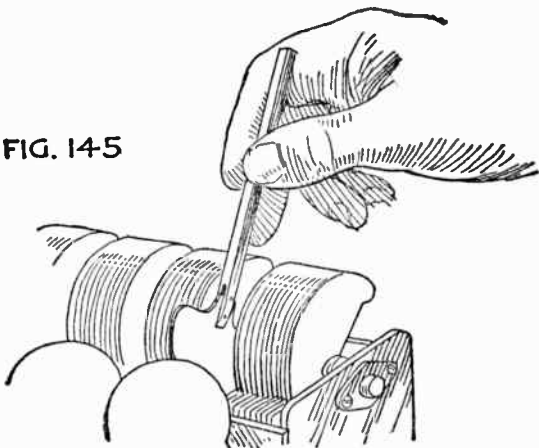

is moved closer to the stationary plate and this gain should be approximately the same for each tuned stage if the auxiliary plate is held in approximately the same position.

If the plate reduces the signal strength instead of increasing it, or causes no appreciable difference, then that particular stage is tuning too high and the adjusting screw on the small vernier condenser (see Fig. 144) should be moved out (unscrewed) to reduce the capacity. As a precaution, the initial position of the

screw should be noted so that it can be reset if by some chance the operation becomes confused.

Although to be accurate, such tracking adjustments should be made by connecting a carefully designed test oscillator circuit to the receiver, the construction of such a circuit is bothersome and expensive. Besides, if the spare-time serviceman is careful, he can obtain excellent results with tools limited to the homemade auxiliary test plate and a screw driver. However, the amateur should be sure of his adjustments before attempting to retrack an actual receiver circuit. Hit or miss adjustments are almost sure to make the tracking worse instead of better.

As in any servicing operation, the serviceman should exercise both judgment and patience. Haphazard work is as inexcusable in the radio field as in any other and haste will spoil more jobs and waste more time than careful planning and management. Develop a simple set of servicing rules and radio troubles will disclose themselves automatically by the reactions they cause in the various tests.

CHAPTER IX

THE SHORT WAVES—A NEW FIELD FOR THE RADIO EXPERIMENTER

EXPLORING the short waves is radio's latest hobby. In them, the listener finds thrills galore since the higher frequencies literally buzz with the activities of thousands of stations.

Although many of the transmissions are in code, both amateur and commercial stations in Europe as well as in America transmit phone messages and programs that form thrilling entertainment for the fan who has not mastered the meaning of dots and dashes. In fact, the police calls alone can furnish hours of adventurous fun.

In the average radio fan's mind, the words "short-wave radio" conjure up pictures of unbelievably long distance reception made possible by circuits that are both complicated and costly. Nothing could be further from the truth, however. Basically short-wave radio is just another form of radio and is no more complicated or difficult to understand than the science of ordinary broadcasting. It is merely a question of frequency. Short waves are extremely rapid electrical vibrations while the broadcast waves are slower.

Normally, broadcast transmissions are carried on at frequencies that range from 550 kilocycles per second

up to 1,500 kilocycles. Some idea of the rapidity of these vibrations can be gained by comparing them with the oscillations, or vibrations, of ordinary sixty-cycle (six hundredths of one kilocycle) alternating current. On the other hand, short-wave radio transmissions are carried on at frequencies as high as 14,000 kilocycles while experimental work often ranges as high as 400,000 kilocycles per second.

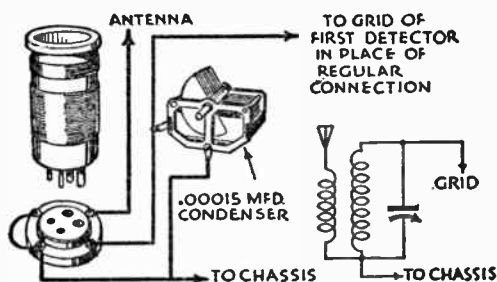

FIG. 14-6

Fundamentally, there is little difference between a set designed for broadcast use and one arranged to bring in the shorter waves. The basis of any radio transmitting or receiving outfit is the tuned circuit. In the short-wave set as well as the broadcast receiver, this consists of an electrical capacity in the form of a variable condenser and an electrical inductance in the form of a coil of wire. It is in the size of this condenser and the number of turns contained in the coil of wire that the difference between a broadcast tuner and a short-wave circuit lies.

Although special receivers give the best results, they are not absolutely necessary to enjoy the thrills of the short waves. The experimenter, armed with a few simple kinks, many times can alter a regular broadcast receiver to bring in the adventures of the police, aviation, and amateur phone bands.

The Short-Wave Adapter: The simplest way to obtain this result with a modern superheterodyne broadcast receiver is by way of the simple adapter circuit shown in Fig. 146. It consists of an additional, or auxiliary, tuning circuit which is attached directly to the grid of the first detector tube. The original connection in the set is broken and the lead from the adapter substituted. The second lead from the output of the adapter is wired to the chassis of the receiver or to the ground terminal.

As shown, the adapter consists of a coil, which can be of the plug-in type if desired, and a condenser. When wired into the broadcast circuit, this arrangement merely substitutes a short-wave tuning circuit for the one that already exists in the broadcast set.

If the regular police and aviation bands as well as the local amateur phone stations are to be covered by the adapter, a regular 160-meter plug-in short-wave coil used in connection with a variable condenser of the right capacity will serve. The connections are plainly shown in the diagram. If desired, the unit can be installed permanently in the regular receiver cabinet and supplied with a single change-over switch that will make it possible to use the combination either for broadcast or short-wave reception.

If no short wave coil is handy, the amateur can

wind his own from scraps of wire and a one-and-one-quarter-inch form. The coil can be of the plug-in variety or of the type wound on a simple cardboard form and mounted with an L-bracket to the baseboard.

To cover the portion of the shorter waves that borders the broadcast band, the two-winding coil should consist of a fifteen-turn primary and a fifty-three-turn secondary. The primary of No. 26 silk-covered wire should be spaced approximately one sixteenth of an

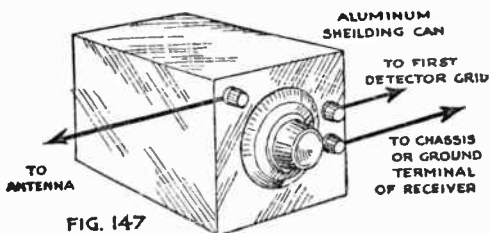

FIG. 147

inch from the No. 22 silk-covered secondary. Both the primary and the secondary should be close-wound.

Although the circuit can be mounted open, best results, with a minimum of interference, will be obtained if the short-wave tuning unit is mounted in a small aluminum shielding can (see Fig. 147). The connections to the grid of the first detector tube and the chassis also should be kept as short as possible to prevent broadcast pick-up.

Incidentally, if the broadcast receiver is equipped with automatic volume control, the lower connection from the short-wave tuning unit should be made to the corresponding end of the regular first detector input coil instead of to the chassis as indicated. This will

place the condenser and coil in the proper relation to the rest of the circuit.

In tuning the adapter, the dial of the broadcast receiver should be set permanently at approximately

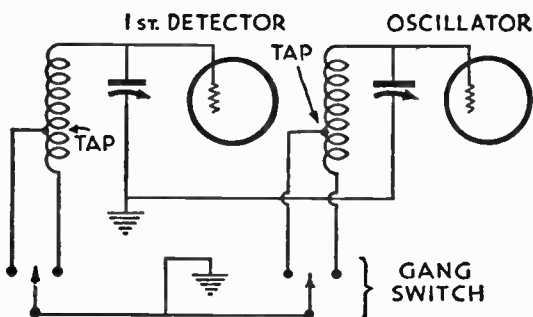
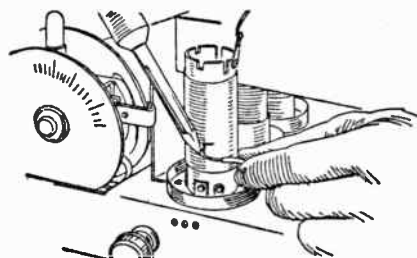

FIG. 14-8

912½ kilocycles if the intermediate frequency is 175 kilocycles or 770 kilocycles if the intermediate frequency is 460 kilocycles. Once the broadcast receiver is adjusted the short-wave tuning is accomplished with the adapter condenser. If in doubt as to the inter-

mediate frequency of any particular receiver, try various settings until the adapter operates.

Many modern broadcast receivers are sold equipped for use on the police and 160-meter amateur phone bands. On such receivers, a flick of a switch, conveniently mounted on the front panel, serves to change the circuit from ordinary broadcast to short-wave reception. In most cases, this switch, used in connection with a series of taps, serves to reduce the number of turns on the various coils in the regular broadcast circuit. This system follows the simple rule of tuned circuits; namely, that to tune to a higher frequency either the number of turns on the coil must be reduced or the capacity of the tuning condenser decreased.

Although wiring such a switch into a commercial superheterodyne receiver would be a delicate job for the beginner in radio, the experienced amateur and spare-time serviceman should have no difficulty in making a system of this type work. It is necessary only to find the various coils, tap their secondaries as shown in Fig. 148, and wire the leads obtained to a convenient gang-type switch mounted on the front receiver panel. The switch should have as many pairs of contacts as there are coils and taps.

The connections which serve to reduce the sizes of the coils by shorting out some of the windings are made at the ground ends of the secondaries. Following the rule regarding tuning systems, the number of turns to be cut out will depend on the increase in frequency desired. For example, if a change from the lowest regular broadcast frequency of 1,500 kilocycles to the police and 160-meter amateur phone (approximately

2,000 kilocycles) bands is desired, it means a change of 500 kilocycles, or an increase of one third. To alter a receiver coil to correspond with this change, the tap connection should be placed at a point approximately one third of the way up the full winding from the grounded end of the coil. These taps should be placed on the radio-frequency, oscillator, and first-detector coils.

In most cases, these various coils can be found by removing the cylindrical shields that spot the chassis of the receiver and tracing the connections and wires. For safety's sake, however, it will be both helpful and time-saving to obtain a circuit diagram and chassis layout of the receiver. These can be obtained from the manufacturer directly or from service manuals.

As with the simple adapter illustrated in Fig. 146, however, there is one precaution that must be followed in wiring a short-wave switch arrangement. If the receiver is equipped for automatic volume control the wiring of the short-wave switch will differ slightly. In receivers of this type, the switch arms should not be connected to a common ground as shown in the diagram, (Fig. 148). Instead, the contact arms for the radio-frequency and detector-coil tap switches should be wired to the proper point in the automatic volume control circuits. How this connection should be made can be determined by following the wiring of the original leads from the bottom ends of the coils.

When installing a short-wave switch, the necessity for long leads to the switch points may upset the tracking of the circuits. For this reason, the tuning of the receiver should be checked (see Chapter IX). By re-

tracking if necessary, the readings of the receiver dial on the broadcast band can be maintained at their original values. Of course, if direct readings are desired on the short waves a special calibrated dial will have to be installed. Commercial receivers having this arrangement, generally have a double set of divisions on

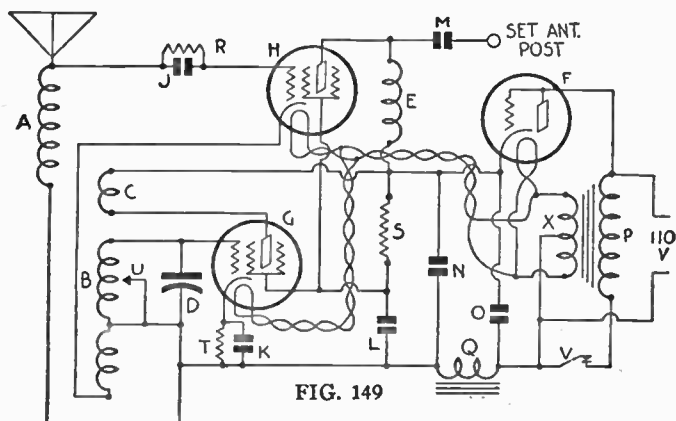

their dials—one for broadcast readings and the other for the section of the short-wave band that is covered.

The Superheterodyne Short-Wave Converter: One of the best ways to make use of any broadcast receiver, having at least two and preferably three screen grid tubes, is to employ the all-electric (A.C.) superheterodyne converter illustrated in Fig. 149. A word of warning, however. The converter does not amplify short-wave signals. All that it does is convert the signals into a form suitable for amplification by the regular broadcast circuit. If the broadcast set is lack-

ing in radio-frequency amplification no worth-while results can be obtained.

Before attempting to assemble the circuit, the amateur will save time and be able to proceed more intelligently if he knows just what happens to the short-wave signals as they course through the wires and parts of the converter.

The unit makes use of three tubes, a type '27 and two type '24's. Also, as shown in the diagram, it requires four outside connections, two to the 110-volt alternating current lighting circuit, one to the antenna, and the fourth to the antenna binding post on the broadcast receiver. The ground for the system is obtained through the regular ground terminal on the set.

As the short-wave signals come down the antenna lead, they are first picked up by the type '24 tube in socket H. This tube, operated in an untuned circuit, does no segregating of signals but merely rectifies them and passes them on. In its operation, it treats all signals alike.

The type '24 tube in socket G is the oscillator tube. It is in a continuous state of oscillation, the frequency of these oscillations being controlled by the tuning circuit consisting of the condenser D and the coil B. When this tuning circuit is adjusted so that the frequency of the oscillations of tube G is close to the frequency of the incoming rectified radio waves flowing in the plate circuit of tube H, the two frequencies interfere with each other and produce what is called a beat frequency. This beat frequency oscillates at a rate equal to the difference between the two frequencies.

By adjusting the tuning circuit (by means of the variable condenser D), this difference between the two frequencies, or in other words the beat frequency, can be brought within the limits of the broadcast frequency range to which the regular receiver is tuned. The beat frequency then is amplified by the broadcast circuit and issues from the loudspeaker. Since the various frequencies can be set between wide limits, the broad-

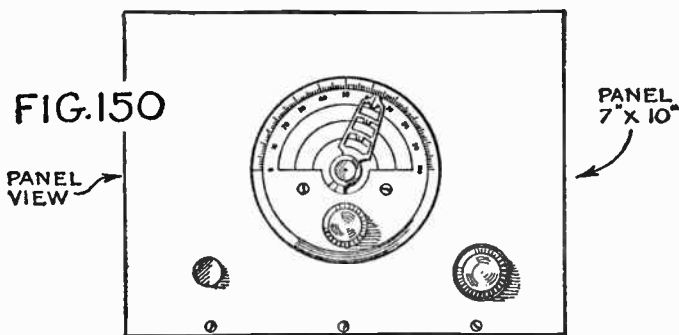

cast receiver should be tuned to some point on the dial where broadcast signals are at a minimum. A few trials will soon show what broadcast setting is best for any particular broadcast receiver.

Because it requires only a few inexpensive parts, is self-contained, and consists of a circuit that is far superior to most commercial converters on the market, this superheterodyne circuit can be used as a money-maker by the experimenter. Hundreds of radio listeners who care little or nothing about the technical side of radio are looking for just such a unit. With it,

they can use their favorite receiver that is still giving good service on the broadcast band on the new short-wave bands as well.

The following parts are required in the construction:

A.—Radio frequency choke (grid-leak mounting type) specified for short-wave work. See note.

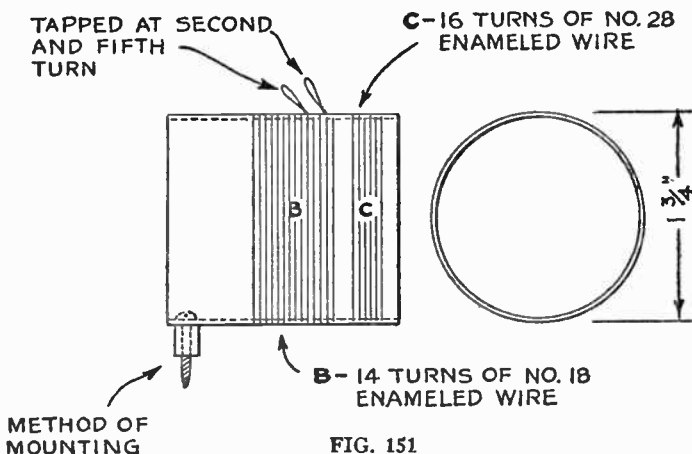

FIG. 151

B.—Oscillator coil, fourteen turns of No. 18 enameled or cotton-covered wire on a three-inch form tapped at the second and fifth turns (see Fig. 151).

C.—Coupling coil, mounted on same form as coil B and one eighth inch from it, sixteen turns of No. 28 enameled or cotton-covered wire (see Fig. 151).

D.—Variable condenser, .0002 mfd.

E.—Radio-frequency choke, 85 millihenries.

F.—Five-prong socket for type '27 tube (rectifier).

- G.—Five-prong socket for type '24 tube (oscillator).
H.—Five-prong socket for type '24 tube.
J.—Grid condenser, fixed, .00025 mfd.
K.—Fixed condenser, .1 mfd.
L.—Fixed condenser, .2 mfd.
M.—Fixed condenser, .00035 mfd.
N.—Electrolytic condenser, 8 mfd.
O.—Electrolytic condenser, 8 mfd.
P.—Step-down heater transformer capable of handling the requirements of three two- and one-half-volt tubes and having center-tapped secondary.
Q.—Filter choke, 30 henries inductance.
R.—Resistance, grid leak, 20,000 ohms.
S.—Fixed resistance, 20,000 ohms, same as R.
T.—Fixed resistance, 150 ohms.
U.—Battery type panel switch.
V.—110-volt type panel switch.
Miscellaneous.—Panel and baseboard (any convenient size, not metal), tuning condenser dial, power cord and plug, screws, solder, wire, cardboard or composition form for combination coil B and C, binding posts, etc.

Note: If desired, the radio frequency choke coil A can be wound at home. It consists simply of 125 turns of No. 38 enameled wire on a three-eighths-inch diameter wood or cardboard core. A wood dowel will serve as a very efficient core.

As a study of the wiring and picture diagrams of Figs. 149 and 152 will show, the type '27 tube in socket F serves as the rectifier and together with the filter system composed of the electrolytic condensers N and O and the filter choke Q furnishes the converter

with B current. Incidentally, additional money can be saved by using the secondary winding of an audio transformer in place of the choke Q. Simply make the connections specified to the G and F terminals of the transformer.

The size of the baseboard and panel for the converter unit are of no particular importance so long as the general arrangement outlined in the picture-wiring diagram is followed. Lay out the parts approximately as shown. As a guide, the panel can be 7 by 10 in. and the baseboard 7 by 9 in.

In wiring the circuit, start with the filament heating circuit. To avoid interference, the connections from the secondary of the heater transformer must be made with twisted cord as indicated. The center tap of the transformer secondary should be connected to the side of the power line that is wired to the grid and plate terminals of the type '27 tube in socket F. As stated before, this serves as the rectifier tube. The heaters of the three tubes are connected in parallel so that each tube receives its required two and one-half volts.

In wiring this circuit as well as any short-wave circuit make all connections as short as possible. Too much resistance, especially in the grid circuits of the tubes can cause trouble. Check each lead several times before the actual soldered connection is made and be sure that a good resistance-free bond is made.

When the completed circuit has been checked against the picture diagram several times, the converter is ready for its first trial. Place the tubes in the sockets, connect the antenna to the proper terminal on the converter, and wire the terminal labelled "to

antenna post of receiver" to the receiver antenna post. Finally plug the power cord into a convenient wall outlet or near-by socket.

Turn on the receiver and close the converter switch V. Allow a minute or so for the tubes to heat up and then turn the converter condenser slowly. With the tap

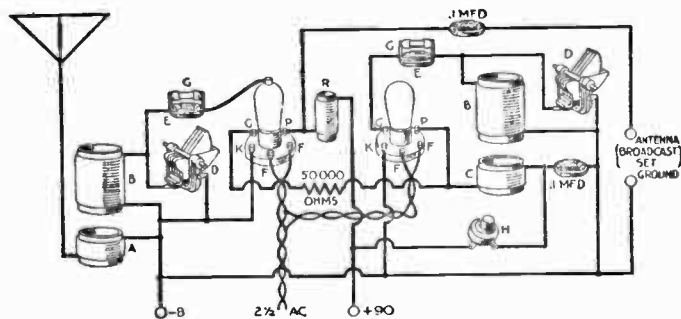

FIG. 153

switch U in the open position, several chirpings should be heard in the loudspeaker. Wherever such a noise is heard, it indicates a station and if the dial is turned slowly and carefully the point will be found where the chirp ceases and the station comes in. Since accurate tuning is necessary best results will be obtained if some sort of vernier dial is used.

If the first trial is disappointing and no chirps are heard, it indicates one of two things—either some connection is wrong or else the type '24 tube in socket G is not oscillating. Generally interchanging the type '24 tubes will produce results. If not try another tube and

also check the connections to the tuning coil C. Often reversing the power plug will have some effect also.

With the switch U open, the converter should cover from sixty to 130 meters. With the switch U closed, the lower range from twenty to sixty-five meters will be covered. If it is desired to extend the range higher than 130 meters, two or three turns of wire should be added to coil B.

A less efficient and also less expensive superheterodyne short-wave converter is shown in the detector-oscillator circuit of Fig. 153. This circuit eliminates the necessity of a rectifier tube but in its place requires batteries. The heaters of the type '27 tubes used are connected to the secondary of a regular two- and one-half-volt filament heating transformer.

Besides the values noted, parts having the following specifications will be needed in the construction of the circuit:

A.—Antenna coil, four turns of No. 28 enameled wire on a one-and three-eighths-inch form.

B.—Grid coils; (thirty to sixty-eight meters) thirteen turns of No. 14 enameled wire, (sixty-eight to 130 meters) thirty-four turns of No. 28 enameled wire, (130 to 250 meters) sixty-seven turns of No. 28 enameled wire. Coil B should be wound on same forms as coils A and C and spaced one quarter of an inch from the other coil.

C.—Tickler coil; (thirty to sixty-eight meters) seven turns of No. 28 enameled wire, (sixty-eight to 130 meters) twelve turns of No. 28 enameled wire, (130 to 250 meters) twenty turns of No. 28 enameled

wire. Coils C should be placed on same forms as coils B.

D.—Variable condenser, .00014 mfd.

E.—Fixed condenser, .0001 mfd.

G.—Grid leak resistance, 2 meg. (try higher values also).

H.—Variable resistance, 50,000 ohms.

R.—Radio frequency choke designed for short-wave work.

For convenience, the two sets of coils can be mounted on plug-in coil forms. Since the required diameter is approximately one and three-eighths inches, built-up tube bases can be used as convenient forms (see Chapter V).

The various parts can be assembled in any arrangement that is convenient. Only one condition must be fulfilled—the two coils should be placed some distance apart. No shielding is necessary.

As shown in the diagram, connections are made to the antenna and also to the antenna and ground binding posts of the receiver. As with the first converter described, the broadcast receiver is tuned to some quiet spot on the dial and the short-wave tuning is accomplished by means of the converter condenser.

If for any reason, the coils as you wind them do not cover the range of frequencies desired, they can be adjusted to suit merely by increasing or decreasing the number of turns.

Short-Wave Tuning: Unfortunately, the tuning of any type of short-wave equipment, whether it be a converter or a regular receiver, requires a certain amount of care. At first, the short-wave listener may

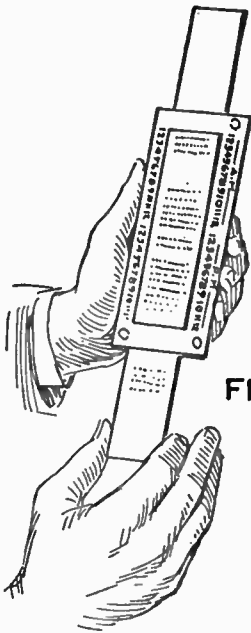
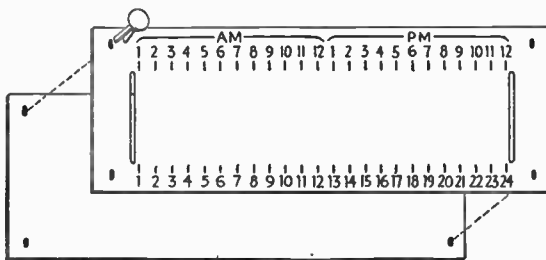

FIG. 154



INDO-CHINA
SHANGHAI
TOKYO
HONOLULU
US PAC TIME
U.S. MT TIME
U.S. CER TIME
U.S. EA TIME
NEWFOUNDLAND
GREENLAND
ENGLAND-SPAIN
FRANCE
GERMANY-ITALY
FINLAND-GREECE
ARABIA
PERSIA
INDO-CHINA
SHANGHAI
TOKYO
HONOLULU
U.S. PAC TIME
U.S. MT TIME
U.S. CER TIME
U.S. EA TIME

be disappointed with the results he obtains, but as he masters the slow technique required more and more stations will be logged.

An up-to-date knowledge of station schedules is important, especially when trying to find foreign broadcasting stations. Also, remember differences in time exist in the various countries. When it is six o'clock in the evening in New York, it is eleven o'clock in the evening in London and three o'clock in the afternoon in Los Angeles.

Because these time changes play such an important part in successful foreign reception, it will pay the amateur to construct the simple time-conversion scale illustrated in Fig. 154. It will form a time-saving addition to his station list and log book.

Resembling a slide rule, the converter consists of two scales made from stiff cardboard or Bristol board. The narrower scale is movable and slides in slits cut in each end of the larger scale. A third piece of cardboard, fastened to the back of the wider scale with brass paper fasteners is added for stiffness.

In laying out the various scales, simply follow the drawings. The base scale should be laid out first, since the placing of the names on the movable scale will depend on the spacing of the numbered divisions. The upper divisions are numbered from one to twelve in two steps (1 to 12, 1 to 12), while the lower divisions are numbered from one to twenty-four consecutively. The upper scale is for regular time while the lower scale represents Greenwich time.

In use, the movable scale is set so that the scheduled time for the program or broadcast desired appears op-

posite the name of the country in which the station transmitting is located. The converted time then appears opposite the names of the other localities on the movable scale. Since time differences exist only between points located on different meridians (there being a difference of one hour between every fifteen degrees) any two cities on the same north and south line will be on the same time. Of course, in various parts of the United States, it is necessary also to take into account the differences caused by Daylight Saving Time.

It must also be remembered that the theoretical change of date in the world takes place in the Pacific ocean just East of the Hawaiian Islands. In other words, when it is ten thirty in the evening in Honolulu on the seventeenth of June, the scale will show four o'clock in the afternoon for Indo-China. However, since the change of date takes place just East of Honolulu, it will be four o'clock in the afternoon of the next day (June eighteenth). Always read down when going West to East and up when going East to West.

CHAPTER X

BUILDING ALL-WAVE AND SHORT-WAVE RECEIVERS

SINCE the proof of any hobby is in the doing, the experimenter's greatest thrill and satisfaction will come from the construction of simple radio receivers.

Years ago, when radio was young, homemade broadcast receivers were the primary interest of the set builder. Today, however, a new order is in fashion. The popularity of the short waves and the low cost of good factory-built broadcast sets have shifted the amateur's attentions to a new group of circuits designed to cover the short waves.

Outwardly, there is little difference between the broadcast set and the average short-wave receiver. In their simplest form, both employ the usual tuning unit, consisting of a variable condenser and coil, a vacuum tube or tubes, and other small parts. It is in the specifications of these parts and the method of using and mounting the tuning coil, however, that the two circuits differ.

Short-wave sets must cover narrow bands of widely separated frequencies and for this reason no single tuning coil could be designed that would operate satisfactorily over the desired range. To overcome this, a set of coils is used, each being temporarily inserted in

the circuit to alter it for the band desired. Because these coils are connected by means of a convenient multi-pronged plug resembling the base of a tube that is plugged into a socket, these coils have become known as *plug-in coils*.

One-Tube Short-Wave Receivers

Although various types of circuits are used for short-wave reception, the simplest type from the standpoint

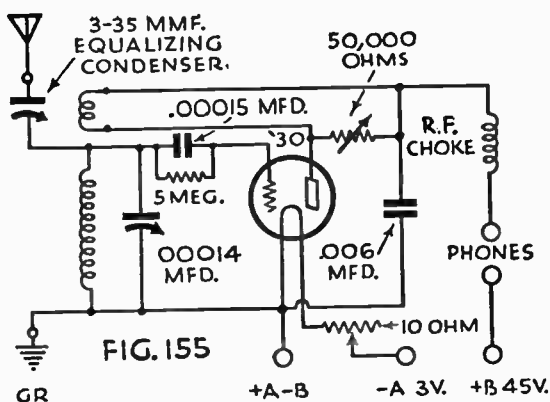

of low cost and ease of construction is the so-called regenerative-detector variety. Such a circuit, arranged in its simplest one-tube form, is shown in Fig. 155.

If you have yet to build your first short-wave receiver, this simple circuit will serve as a fine starting point. It is easy to build, easy to operate, and inexpensive. Besides, it will furnish an introduction to the theory of the regenerative-detector type of hook-up.

By comparing the diagram with the radio symbols described in Chapter II, you will find that the circuit consists simply of a set of plug-in coils (indicated by the pair of spirals drawn one above the other), a variable tuning condenser (.00014 mfd., midget), a low-drain type '30 two-volt vacuum tube, a small trimmer or balancing condenser, a fixed condenser (.001 mfd.), a 50,000-ohm potentiometer, a small 10-ohm rheostat, a grid condenser and grid leak, and a radio-frequency choke coil designed for use on the shorter waves. Two four-prong sockets, one for the tube and the other for the plug-in coils, also will be necessary. If desired, the circuit at first can be mounted bread-board fashion and later assembled on a simple type of U-shaped chassis similar to that suggested in Fig. 161.

This circuit, like all regenerative-detector circuits, gets its name from the fact that the rectified radio signals available at the plate of the vacuum tube are fed back again into the grid circuit by means of coupling. This feed-back increases or builds up the plate voltage and, of course, amplification is gained. The signal is made to amplify itself again and again until finally, the tube builds up and breaks into violent oscillation.

Naturally, if allowed to run wild, this regenerative action would become objectionable and all that was gained by the feed-back would be lost. For this reason, some sort of regeneration control must be employed. In the case of the circuit in Fig. 155, this control is obtained by means of the 50,000-ohm potentiometer placed across the leads to the tickler coil.

In building such a circuit, follow the diagram. The parts are clearly indicated and no difficulty should be encountered with the wiring. Constructed in the form shown, the radio signals first pass through a small condenser before they are routed through the tuning cir-

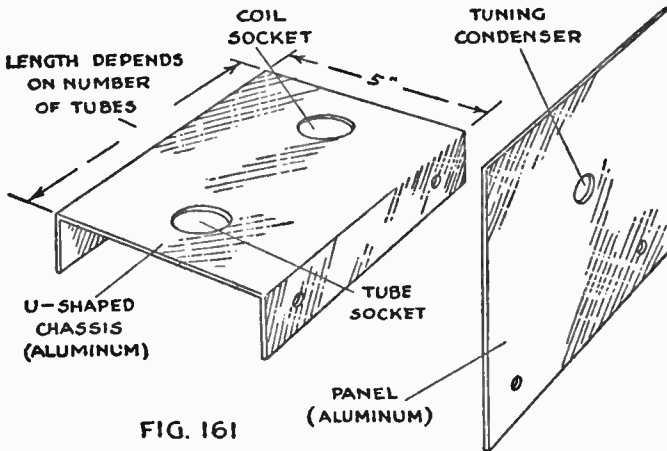

FIG. 161

cuit and thence to the tube and tickler coil. This small condenser, rated at from 3-35 mmf., serves to balance the antenna with the circuit. Without it, the arrangement would tend to be unstable each time the antenna wire moved in the wind.

Basically, this antenna condenser consists simply of two metal plates separated by a square of mica and provided with an adjusting screw which serves to move the plates nearer together or further apart thus alter-

ing the capacity. Such condensers can be purchased ready-made from any dealer in radio parts. Generally they are sold under the name of balancing or trimmer condensers.

If an aluminum chassis is used in mounting the circuit, the connections can be simplified by making the metal of the chassis and panel serve as the common —B and +A lead. In other words, instead of connecting a separate wire to the ground terminal, the lower end of the grid coil, the tuning condenser rotor (movable section), the plus filament wire, and the lower end of the .001 mfd. by-pass condenser, simply run the external ground connection to the metal chassis and connect the grid coil, condenser, filament, and .001 mfd. condenser directly to the chassis and panel. This will eliminate a number of wires and soldered connections. Also, it will eliminate the necessity of insulating the condenser shaft, ground terminal, and —B+A terminal from the metal panel.

For the plug-in coils, the beginner will do best by employing a commercial set recommended for use with a .00014-mfd. tuning condenser. They are carefully constructed and designed and can be purchased for very little. Of course, if desired they can be wound on built-up tube bases by following the winding specifications given in the table of Fig. 158. Great care should be taken to see that the windings are made close together and that the tickler windings itself is spaced correctly from the grid winding.

Figure 156 shows the circuit diagram for a similar type of regenerative-detector short-wave circuit. With

the exception of two parts, this circuit is exactly the same as that shown in Fig. 155. Compare the two and the difference will be evident. In the tickler circuit, a .00014-mfd. variable condenser is used in place of the 50,000-ohm potentiometer and the .001-mfd. fixed condenser. In this case, the variable condenser serves as a combined by-pass condenser and regeneration control.

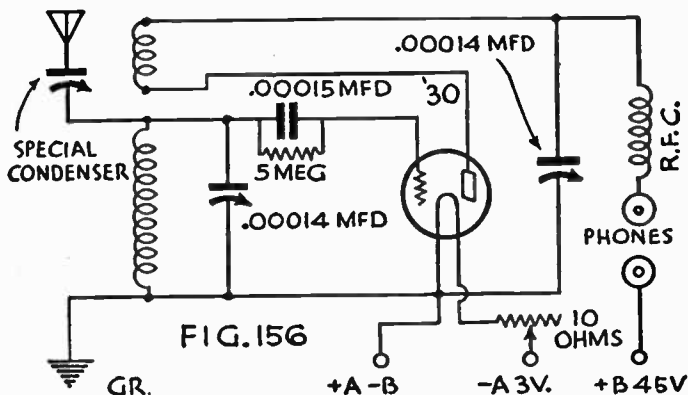

The second change consists of the use of a regular small capacity variable condenser in the antenna circuit instead of the 3-35 semi-fixed type of trimmer condenser. Although small capacity condensers of this type can be obtained (.00002 mfd.), the amateur can make his own simply by removing all but three plates (two stationary and one movable) from the frame of a variable condenser salvaged from some old circuit.

Like the circuit of Fig. 155, this arrangement also can be mounted on the simplified chassis of Fig. 161

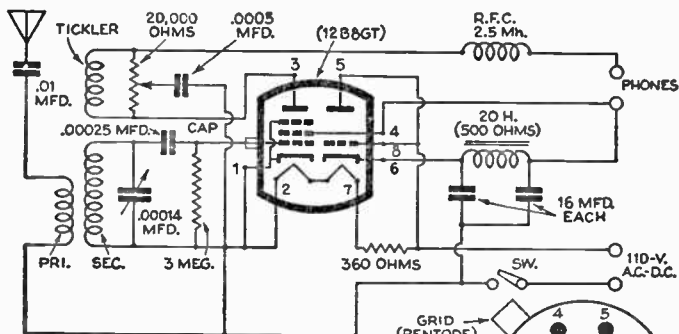

BOTTOM VIEW OF SOCKET

FIG. 157

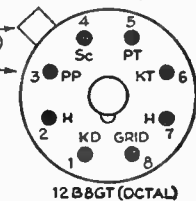

12B8GT (OCTAL)

COIL (METERS)	GRID WINDING (TURNS + WIRE)	TICKLER WINDING (TURNS + WIRE)
15 - 40	3 TURNS OF N° 18	4 TURNS OF N° 28
40 - 90	8 TURNS OF N° 18	10 TURNS OF N° 28
90 - 220	24 TURNS OF N° 22	15 TURNS OF N° 28
220 - 550	80 TURNS OF N° 28	15 TURNS OF N° 28

WIRE SHOULD BE SINGLE - COTTON - COVERED

FIG. 158

TUBE-BASE COIL (BUILT-UP)

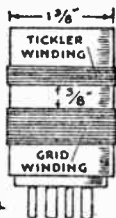
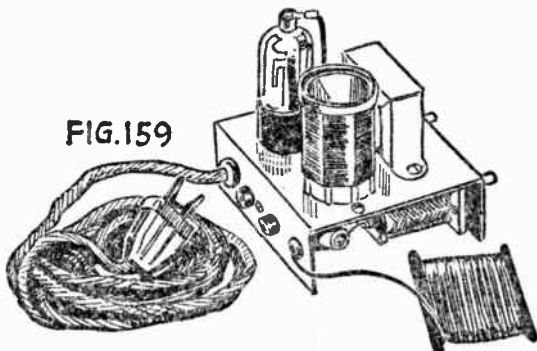

FIG. 159



and can be used with commercial plug-in coils or with those whose specifications are given in Fig. 158.

Simple A.C.-D.C. Short Wave Receiver

The next step up in the short-wave receiver scale is this one-tube A.C.-D.C. receiver. Such a circuit, is shown in Fig. 157. Beginners who want to try their hand at building an electric radio will find this one-tube A.C.-D.C. set to be just the type of receiver for their needs. It is easy to build, and with a good outdoor antenna, it will pull in stations from South America and Europe almost any evening.

Tracing the circuit from the antenna, the signals enter the set through a .01-mfd. paper condenser to the primary winding of a 6-prong plug-in tuning coil. The secondary winding of this coil is tuned by means of a midget, .00014-mfd. variable condenser. A set of plug-in coils gives complete coverage for all wave bands.

The signals then enter the grid of the detector portion of the dual tube (12B8GT) by means of a .00025-mfd. mica condenser and a 3-meg., 1/2-watt resistor.

Signals from the plate of the detector then go to the headphones through the tickler winding and a 2.5-mh. plate choke. A 20,000-ohm potentiometer across the tickler winding controls the amount of feed-back, or regeneration, between the tickler and secondary windings.

The second portion of the tube consists of a triode, which rectifies the alternating house current so that only direct current reaches the plate of the detector. Filtering, to eliminate hum, is carried out by the 20-h. choke and the two 16-mfd., 150 volt electrolytic condensers.

A Versatile Three-Way Portable

In the last few years a new type of radio has once more become popular. It is the battery-operated portable receiver which is entirely self-contained down to the antenna and power supply. New low-drain tubes and smaller parts have been the main reasons for the renewed interest in this type of receiver — plus the thrill of being able to receive music and other radio entertainment directly on beaches and picnic grounds. The new portables are light enough to be easily carried about and have the added advantage of being able to play off the house current while in use at home thus saving the batteries for outdoor use. The circuit for one of these sets is shown in Fig. 160.

It is perhaps one of the most versatile receivers that has ever been described. It goes a step further in usefulness when compared with the three-way portables now on the market. These portables work on their own battery power supply when used outdoors in the garden or on the beach and on either A.C. or D.C. current when used indoors.

However, as practically all portables are covered in some sort of striped canvas cloth, they look out of place when brought indoors and used, for example, on a mahogany table in the living room. Portables are also bulkier than A.C.-D.C. receivers, and it is unfortunate, whenever a portable is played indoors, to have to use a large case holding a battery supply which is not being used.

All these disadvantages have been overcome in the design of the portable receiver described on these pages. It operates on either batteries, A.C. or D.C. current.

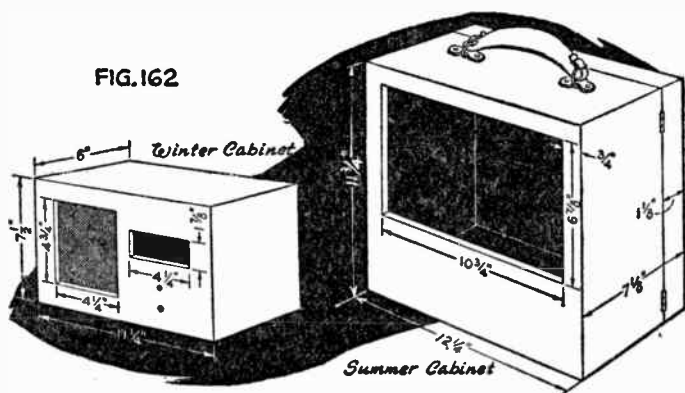

When carried outdoors it is housed in an attractive, striped canvas cabinet with its own battery supply in the lower compartment of the case. But when it is used indoors the receiver proper (which is housed in a walnut cabinet) is taken out of the canvas-covered cabinet and plugged into any convenient A.C. or D.C. electric outlet. The set as it now appears in its compact, polished walnut cabinet, looks like any standard A.C.-D.C. receiver and is as usable on a small night table as in the living room or dining room. (See Fig. 162.)

The circuit of this unique portable is an improved four-tube battery superheterodyne using a 1A7GT as combined oscillator and first detector, a 1N5GT as I.F. amplifier, a 1H5GT as combined second detector—AVC—first audio and a 1A5GT as power amplifier and output tube. The 1A5GT feeds into a 5-inch permanent magnet (PM) speaker through an output transformer of the universal type. Besides the four tubes just mentioned,

the set has a fifth tube which is used solely to supply the set with the necessary 6-volt "A" current (the filaments of the tubes are in series) and the 100 volt "B" voltage for the plates and screens of the tubes.

This fifth tube, called the rectifier, has a 117-volt heater which works directly off the house current without any additional "dropping" resistors. One side of the tube supplies "A" current through a 2,500-ohm, 10-watt adjustable resistor and a 60-milliamperere pilot bulb (located at the back of the set).

The pilot bulb acts as a fuse and saves the filaments of the battery tubes from damage. It does not operate when the set is worked off batteries. Plate current to the tubes is supplied through a 3,500-ohm, 1-watt resistor and two electrolytic condensers, one rated at 24 mfd., 150 volts, the other at 40 mfd., 150 volts.

The two iron core I.F. transformers are peaked at 455 kilocycles and are compact in size, being only $1\frac{1}{4}$ inches square and $3\frac{1}{4}$ inches high. Iron core transformers give almost twice the amplification of the air core so that one I.F. stage using iron core transformers is the equivalent of the two I.F. stages using air core transformers.

On the back of the 1-megohm volume control is a D.P.S.T. switch plate that turns off either the battery supply or A.C.-D.C. current, depending on which type of power supply is used.

Whenever the user wishes to remove the receiver from its portable cabinet and run it off the house current, it is necessary first to remove the four prong battery supply plug from the socket behind the chassis.

The 8 x 5 inch loop antenna is placed behind the

cabinet and is held in place by three small nails or screws. The speaker is attached directly to the front of the cabinet and not to the chassis.

Wireless Record Player

Inexpensive and simple to build, this "wireless" record player may be used, without connecting wires, with any type of alternating-current, radio receiver. Equipped with a microphone that can be quickly plugged in, the

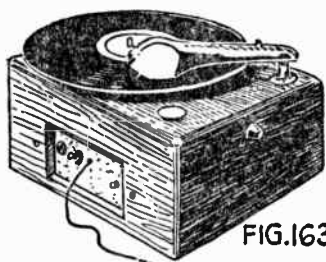
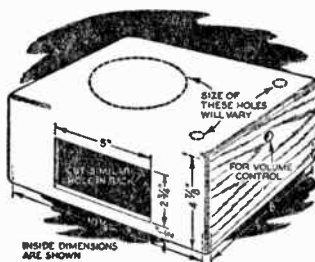

FIG.163



record player also will let you do your own announcing through the radio loudspeaker. The record player plugs into a convenient floor outlet, and is ready to operate as soon as its two tubes have warmed up. (See Fig. 163.)

Essentially, it is a tiny transmitter tuned to a frequency around 550 kilocycles, or any unused spot at the upper end of your radio's tuning dial. The power of the little transmitter is of course very weak, and the distance it may be placed from the set for use depends upon the sensitivity of the receiver. With a powerful superhet, the instrument could be taken into an adjacent room. When atmospheric conditions are

6A7, as a combined modulator and oscillator. Two 6,000-ohm 1-watt resistors, and two 16-mfd. electrolytic condensers are used for filtering the rectified current from the 25Z5. The circuit is shown in Fig. 164.

To obtain the best results with the carbon-type microphone recommended, a suitable transformer with a 200-ohm primary is used in conjunction with a 4½ volt "C" battery. The battery fits snugly inside the cabinet. Care must be taken to follow the exact values of the fixed condensers and resistors specified in the wiring diagram and, under no circumstances, ground any of the wiring to the chassis or panel. This is to prevent any possibility of shock should the user accidentally touch the chassis of the receiver while holding the pick-up. Standard A.C.-D.C. antenna wire can be used for the aerial of the transmitter, which may be approximately twenty-five feet long and may be left lying along the floor as near as possible to the antenna lead of the receiver.

The wooden cabinet measures 4⅞" by 8" by 10¼". A rectangular piece, 2¼" by 5", should be cut out of the front panel and a similar ventilator opening should be cut from the opposite side and covered with a brown silk cloth. The pick-up and turntable are mounted on top of the cabinet, with the combined volume control and switch placed at the side.

Home Recorder

The fun that may be had with this home recorder (Fig. 165) is unlimited. Extremely versatile in operation, it will enable anyone to record radio programs, to record home programs, to boost the volume on weak

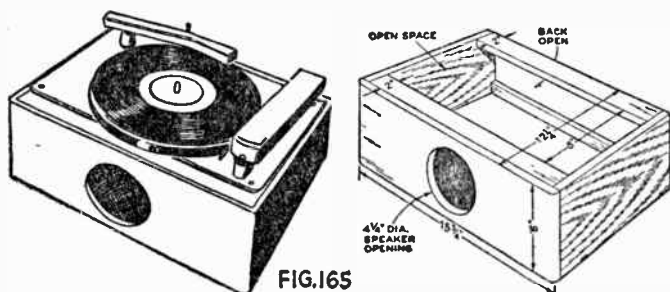

stations and to play regular phonograph records.

The recording unit on top of the cabinet is very reasonably priced. It consists of a record-cutting mechanism with a concealed feed screw situated underneath the base plate, a high-impedance crystal play-back pick-up, a powerful induction-type self-starting motor, a pick-up rest, and a base plate. The unit will cut records up to 10" in diameter and will play records up to 12" in diameter. Circuit is shown in Fig. 166.

A compact three-tube amplifier is used with the home recording unit, and is installed just inside the back of the cabinet on a steel, cadmium-plated chassis measuring 2" by 7" by 7". Output from the amplifier is fed into a good quality of 5" permanent-magnet speaker mounted in the front of the cabinet. The rear of the cabinet is left open to ventilate the tubes and motor.

The amplifier proper outside the rectifier consists of a high- μ triode, resistance-coupled to a beam power pentode. These two tubes provide all the power needed for either recording or playing records. A 250,000-ohm variable resistor controls the volume for pick-up or mi-

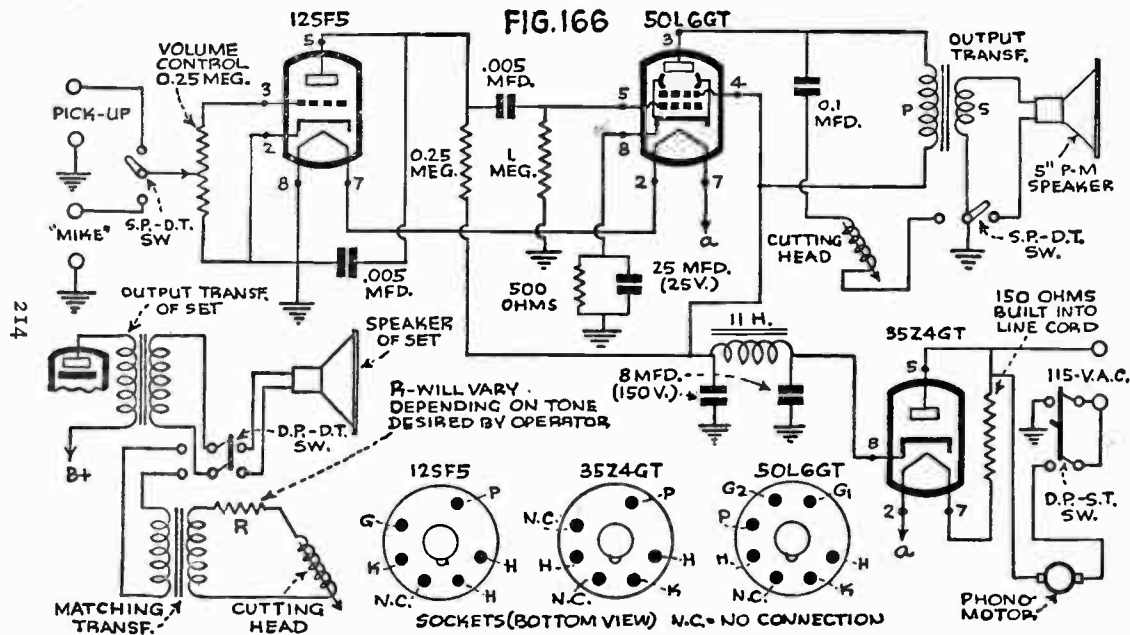

crophone. The voice current for recording is tapped off the plate circuit of the audio output tube through a .1-mfd. tubular paper condenser.

Three toggle switches mounted on top of the chassis regulate the various operations of the instrument. Although an A.C.-D.C. amplifier is used, the motor will operate only on alternating current, so that the unit must not be used on direct current.

For recording radio programs, the microphone is switched on and placed before the speaker of the radio receiver. In this manner, a permanent recording, right in one's own home, of a favorite dance tune or a historic speech can be made.

If better quality is desired in recording off the air one should connect the cutting head directly to the output of the radio receiver through a special matching transformer.

For best results the radio must not be played too loud, as distortion will occur on the record. The correct volume can best be found by trial and error. When this has been obtained it is a good idea to "monitor" future recordings in order to keep volume constant. To monitor a recording, headphones are plugged in across the cutting-head circuit.

In recording a voice or home program directly, the microphone should be placed close to the source of the sound. It is advisable first to make a test through the speaker. When the results are satisfactory, switch in the cutting head and record on the blank disk.

A good crystal microphone may be obtained for about six dollars, complete with a desk stand, a 7' cable, and a spring protector around the cable at the microphone.

The unit may also be used, as already stated, to boost the volume on weak stations by placing the microphone as close to the receiver's speaker as possible and using the amplifier in the home recorder to increase the volume further.

Inexpensive FM Receiver

Another development of the last few years is frequency modulation or staticless radio as it is sometimes called. The term frequency modulation is usually abbreviated to FM. Reception quality with an FM receiver is exceptionally high. Before building an FM receiver it would be wise to find out if there is an FM transmitter within 50 miles of your home. Due to the ultra-high frequencies used in FM (41-44 megacycles) signals cannot be picked up at greater distance.

The circuit of an inexpensive and easily built FM receiver is shown in Fig. 167. It is not just another FM converter but a complete eight-tube FM receiver, and it can be built for about \$27. Very compact, it is mounted in a cabinet usually sold for four-tube receivers.

A simplified version of the original FM circuit is used, a circuit so rapidly becoming standard that a kit of low-cost components has been put on the market. These parts, used in this design, are a set of three FM coils (antenna, RF, and oscillator), three special FM I.F. transformers peaked at 4,300 kilocycles, a discriminator transformer, also peaked at 4,300 kilocycles, and a three-gang tuning condenser, each section having a capacity of 7-22 mmfd.

The main difference between a standard broadcast

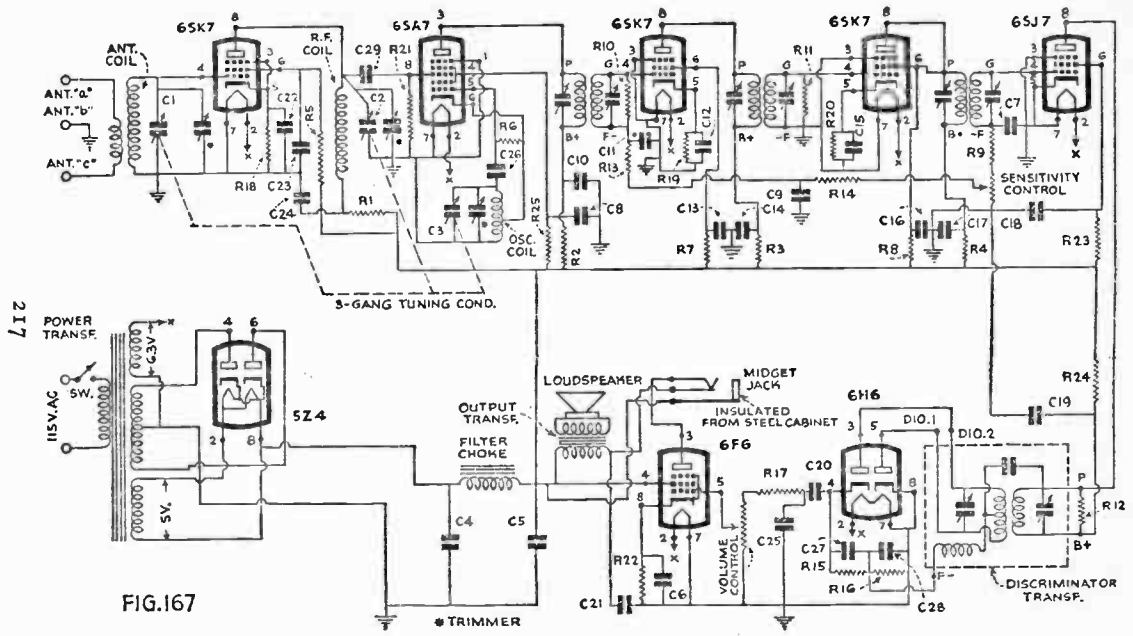

FIG. 167

superhet and an FM superhet is the use of a limiter tube and a "discriminator" stage. Otherwise this FM receiver consists of the usual RF stage (converter stage) and two I.F. stages (second detector and audio stage). The "discriminator" stage makes possible the detection of FM impulses and discriminates against standard or amplitude-modulated impulses.

In an FM receiver all grid and plate leads must be as short as possible, especially in the RF and converter stages. The layout here allows short leads between the tube prongs, condensers, coils, etc. The 10,000-ohm, 1-watt loading resistors across the secondary windings of the coils stabilize and balance the I.F. circuits. An elaborate decoupling system in each plate and screen lead of the first five tubes eliminates feed-back between the circuits which would cause oscillation. The rectifier tube and circuit deliver 250 volts at about 60 milliamperes.

It is difficult to align an FM receiver, and a dependable dealer will do it for you. Those who are ambitious, however, and can obtain a signal generator can do it at home. Align the discriminator transformer by applying a signal of 4,300 kilocycles to the grid of the 6SJ7 and connecting an 0-1 ma. meter with a 100,000-ohm resistor in series with the meter across the 6H6 cathode. Adjust the secondary trimmer of the discriminator until a movement of the meter's needle is noted. As the trimmer is tuned, the meter will go plus or minus, either side of the resonant frequency. Set the trimmer so the meter reads zero voltage. The primary trimmer of the discriminator transformer is adjusted to the maximum reading when it is connected between the center tap of

the transformer and ground. (Consult diagram, Fig. 167.)

To align the I.F.'s the same 0-1 ma. is connected in series with the grounded side of the 50,000-ohm variable resistor (sensitivity control). By-pass the meter with a .02-mfd. condenser, and apply a 4,300-kilocycle signal to the grid of the preceding 6SK7. Tune the transformer for a maximum reading on the meter. Apply a signal

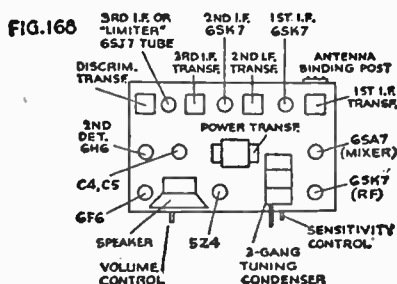

to the next 6SK7 and repeat the procedure. To align the trimmer condensers on the three-gang tuning condenser, tune in a station and adjust each trimmer, by ear, until the station is received at maximum volume.

If the set is located within ten to 15 miles of an FM broadcasting station, a short piece of wire (about ten feet) connected to point "b" on the antenna binding post will suffice, but for best results a special doublet FM antenna should be connected to "a" and "c" on the binding post.

There are two important points about FM reception to keep in mind. First the discriminator stage will not operate satisfactorily unless a sufficiently strong signal

reaches the grid of the 6SJ7. Secondly, the range of FM is limited to about 50 miles.

The five-inch permanent magnet speaker does not do justice to high-fidelity FM reception. It is better to buy one of the high-fidelity speakers now sold for FM reception and use the small speaker just for speech or for monitoring the reception.

High-Fidelity Amplifier

Extremely versatile, the 10-watt audio amplifier shown in Fig. 169 may be used with either a crystal or magnetic pick-up for playing recorded music, with a crystal microphone for public-address work, as an amplifier for a high-fidelity tuned radio-frequency or superhet tuner, or as an amplifier for use with the FM receiver described on page 216.

The amplifier employs a unique output, two different types of tubes being used in a push-pull circuit. A 6AD7G is used on one side of the circuit (see Fig. 170), while a 6F6G is used on the other. The pentode section of the 6AD7G, however, has the same characteristics as the 6F6G, and the triode portion of the 6AD7G is used as a phase-inverter tube. No push-pull audio transformers are used. Instead, the first audio stage (6SJ7) is resistance-coupled to the push-pull output stage.

The input is fed through a .005-mfd. mica condenser and 500,000-ohm volume control to the grid of the 6SJ7. This tube is one of the newest types, using the single-end construction where the grid cap has been eliminated from the top of the tube — the grid being

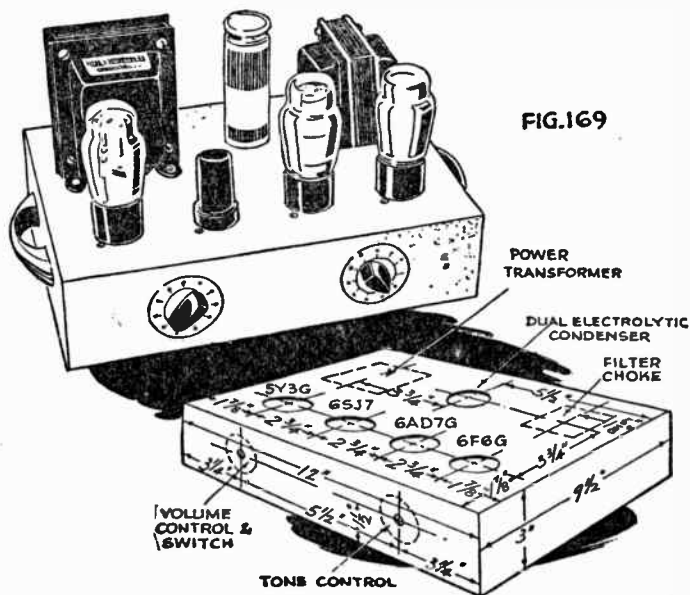

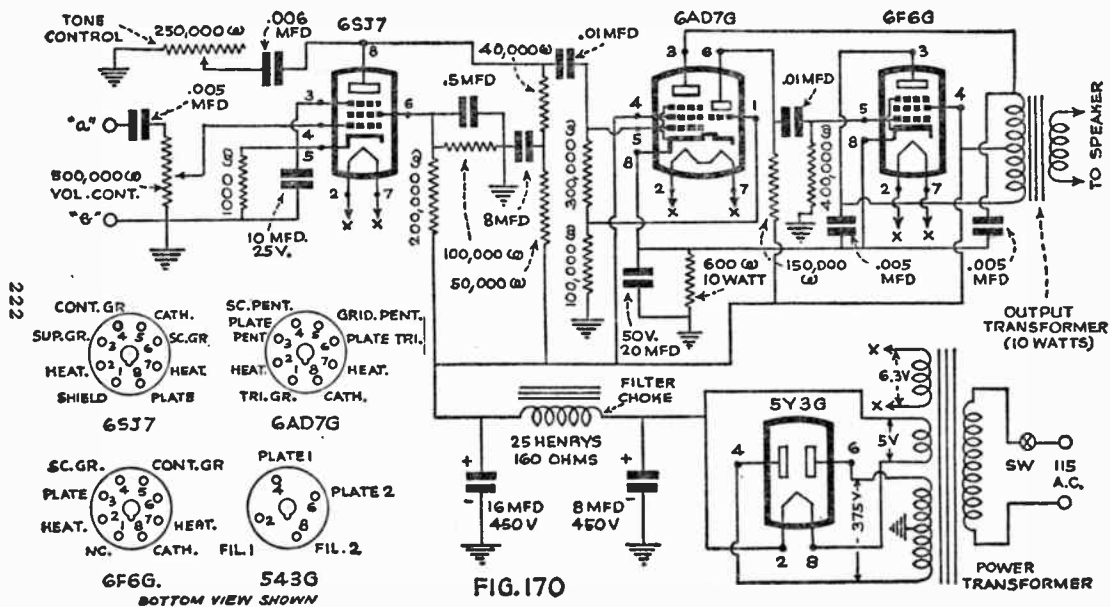

was considered necessary, as these are reproduced by the amplifier to their full value.

The plate and screen-grid circuits of the 6SJ7 are elaborately decoupled to avoid feedback. This helps to reduce hum and instability in the amplifier. An adequate filtering system is also used in the rectifier circuit — the 350-volt output from the 5Y3G full-wave rectifier being filtered by the 8-mfd. and 16-mfd. 450-volt electrolytic condensers and the heavy-duty, 25-henry filter choke. This choke is rated to pass 140 milliamperes. The power transformer, operating on 110 to 115-volt A.C. only, has three secondary windings: a 6.3-volt winding rated at $3\frac{1}{2}$ amperes for the tube heaters, a 5-volt winding rated at 3 amperes for the rectifier's filament, and a high-voltage winding rated at 375 volts, 90 milliamperes. The power transformer is fully shielded to protect the windings and to reduce hum pick-up to a minimum.

In connecting the high-fidelity audio amplifier with the FM receiver described on page 216, the power tube (6F6) in the receiver will have to be removed from its socket and a short piece of shielded hook-up wire connected to the control-grid pin (No. 5) on that socket. The other end of the wire is connected to terminal "a" on the amplifier, while the braided shielding on the wire is connected to terminal "b." The shielding on the wire will also have to be grounded to some point on the chassis of the FM receiver.

The speaker should be at least an eight-inch model — preferably 10 or even 12 inches. It should be a permanent-magnet type with a voice coil of 6-8 ohms. It should be mounted on a good-size baffle (40" square)

or a properly designed cabinet. There are several special console-type speaker cabinets available which are especially useful with high-fidelity speakers. In selecting one of these for use with the amplifier, the set builder may be governed by his individual taste and requirements. Dimensions of the chassis and positioning of parts are given in Fig. 169.

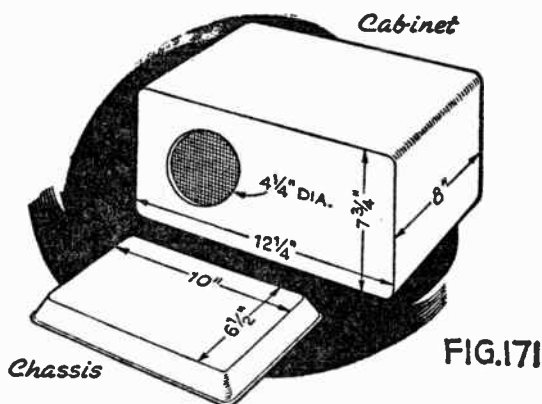

FIG.171

Inexpensive Loudspeaker Set

The receiver shown in Fig. 171 might be called "the Economy Three," for it cost only \$4.06 to build the original set, not including the value of the wood for the cabinet, which was salvaged from the workshop scrap pile. It was an easy receiver to build; the hand-wound coils were easy to make, and the parts fitted nicely into the chassis with plenty of room to spare.

The chassis (Fig. 171) was purchased for ten cents

tifier—and provides sufficient pep to operate a loud-speaker. Because magnetic speakers are generally sensitive to weak signals, one of that type was chosen. It cost 93c.

The homemade coils are quite easy to wind as illustrated in Fig. 173. Before going into the actual construction details, however, there is one important point that must be remembered: In making the coils, adhere strictly to the specifications, such as the size of the wire, the length of the antenna attached to the antenna coil, the distance between the coils, etc.

First cut out two round cardboard disks, one $2\frac{3}{4}$ " in diameter and another $3\frac{1}{4}$ ". Then divide each form into seven equal sections and cut a slot down each line about $\frac{1}{8}$ " wide to within $\frac{5}{8}$ " of the center. On the smaller form wind 55 turns of No. 30 double-cotton-covered magnet wire. Pass the wire first over one section and then under the next—alternating as you go round. When finished, this will be the antenna coil. The larger coil is the tickler coil and consists of 60 turns of the same wire. In checking the number of turns, add the turns on two adjacent sections. In other words, a coil of 55 turns will have twenty-seven windings on one "rib" and twenty-eight on the next.

The coils are mounted on the chassis by means of a brass machine screw $2\frac{1}{2}$ " long and two brass-tubing spacers, $\frac{1}{4}$ " in diameter. The tickler coil should be placed nearest the chassis and 1" from it. The antenna coil should be placed $\frac{3}{4}$ " above the tickler coil.

The cabinet, whose dimensions also are given in the drawing, can be made of any wood that you may have in your scrap pile. It has an open back, and the chassis

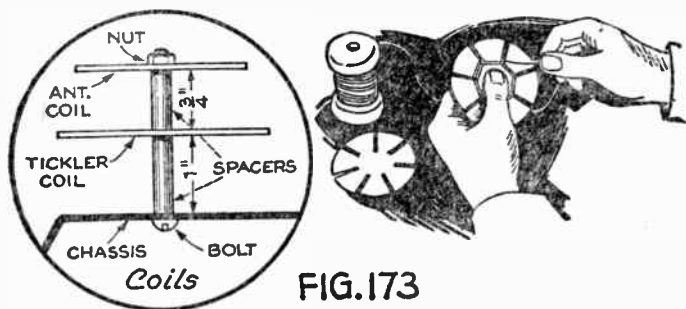

FIG. 173

can be conveniently held in place with two screws driven into the baseboard.

A 25' antenna should be used and it can be left on the floor or hung out of a window. Rubber-insulated stranded wire works well. If a longer antenna is desired, a .00005-mfd. fixed mica condenser must be inserted in the antenna lead.

By adding to or reducing the number of turns on the antenna coil, the set's range can be varied to receive stations just below or just above the broadcast band.

Light-Beam Transmitter

Code messages that can be detected only with a specially built receiver may be sent with the light-beam transmitter shown in Fig. 174. With a 3- or 4-cell flashlight, preferably of the type with which the light rays can be focused into a spot, messages can be sent up to 200 feet. By increasing the voltage of the buzzer cir-

cuit from $7\frac{1}{2}$ to $22\frac{1}{2}$ volts and using a more powerful light, this range can be increased.

The transmitter (Figs. 175, 177) works on the same principle as a radio broadcast transmitter. The light waves from the flashlight act as the carrier wave, and

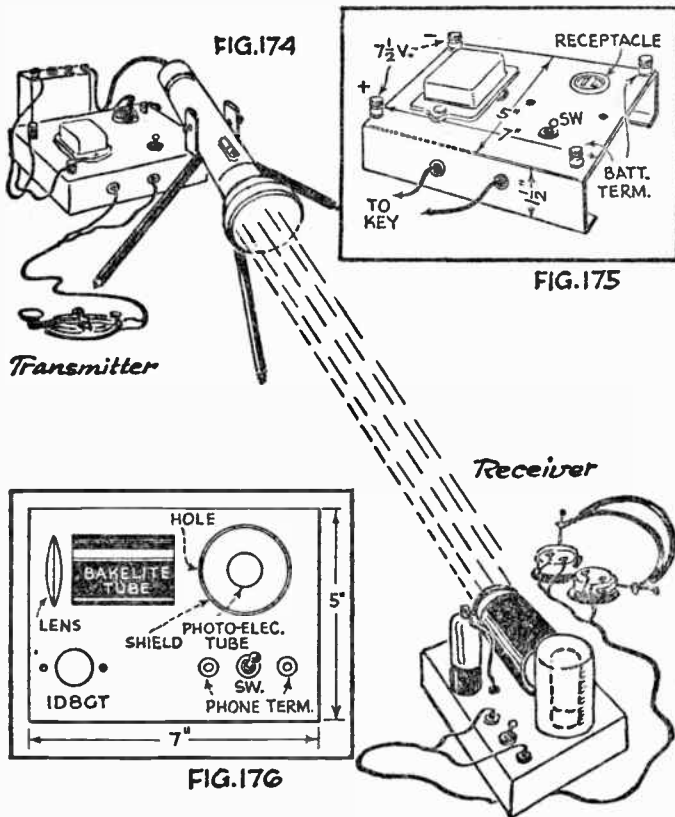

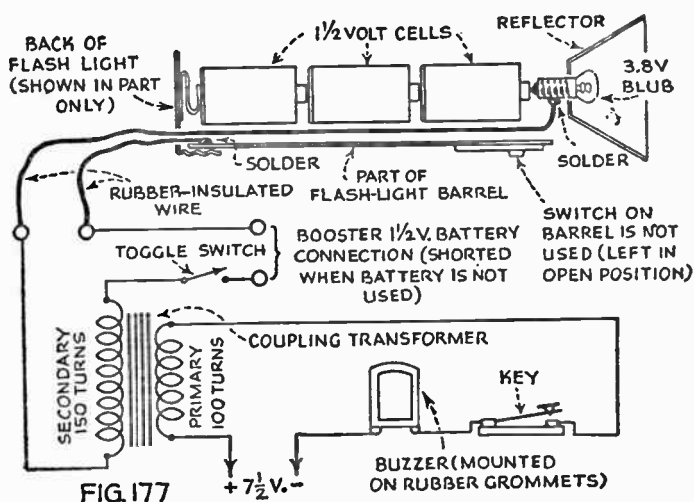

the code signals tapped out on the telegraph key are superimposed on this light beam. Light variations forming the message are invisible, and to all appearances the rays from the flashlight form a steady beam.

With this device, messages can be sent through windows, foliage, or anything that allows at least part of the light beam to reach the receiver.

A gas-filled photoelectric tube is used as a detector in the receiver (Figs. 176, 178) and this is followed by a two-stage, resistance-coupled audio amplifier. The photo cell transforms the modulated light beam into sound which is amplified by the audio stages.

As a matter of fact, any good audio amplifier can be used after the detector stage. Care must be taken, how-

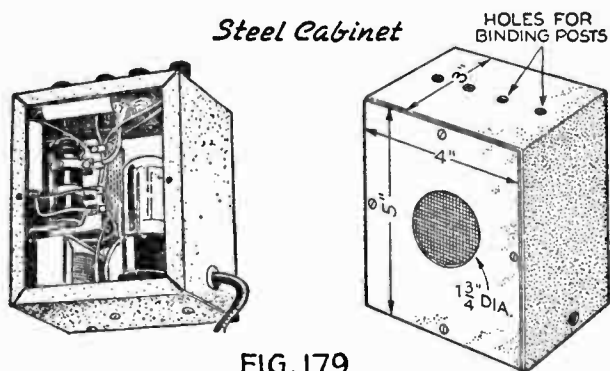

FIG. 179

To make the coupling transformer used in the transmitter, use an iron core made from an old chisel or a hollow iron shaft about $\frac{1}{2}$ " in diameter. Around this wind 100 turns of No. 24 d.c.c. wire and then another 150 turns of the same wire to form the primary and secondary windings.

Electric "B" Supply for Portables

This compact "B" power pack, no larger than a standard-size portable "B" battery, is a highly useful radio accessory (see Fig. 179). It is small enough to fit in many of the modern battery portables and may be used to replace "B" batteries in small table receivers of either the tuned radio frequency or regenerative types, for hum-free reception.

An adjustable bleeder circuit is wired across the output of the rectifier (Fig. 180), and the connections are brought out to four insulated binding posts on top of the cabinet. The bleeder circuit consists of a 10,000-

ohm semi-variable wire-wound resistor with two sliders for adjusting the intermediate voltages. As shown in the diagram, the circuit is adjusted to give 130, 90, and 30 volts at the different taps when connected to a set drawing about 15 milliamperes plate current.

The 117Z6GT rectifier tube is connected directly across a 117-volt power line without the use of resistors. A $1\frac{3}{4}$ " ventilating hole should be drilled in one side of the cabinet. Cabinet dimensions are given in Fig. 179.

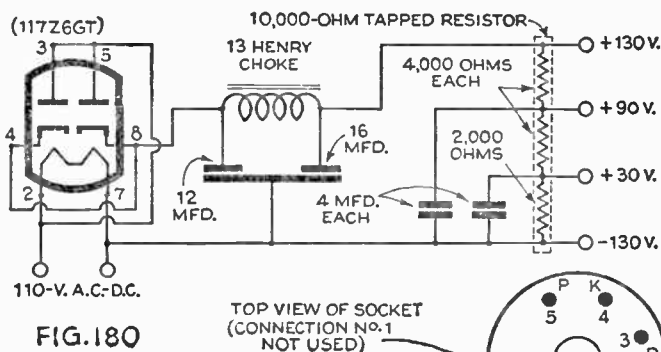

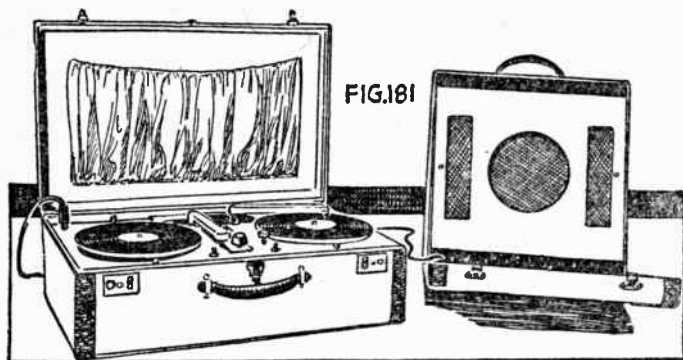

Dual-Turntable Phonograph

All sorts of entertainment possibilities are opened with this easily built twin-table phonograph (Fig. 181). If you are a music lover, it will allow continuous reproduction of your favorite symphonies and operas. If you like nonstop music for dancing, it will supply that. And if your hobby is home movies, it can be used to provide realistic fade-in and fade-out accompaniments and sound effects for your favorite films. Complete and housed in two pieces of luggage for easy carrying, the outfit can be built for \$35.

The containers for the equipment consist of a standard 26" week-end bag and a standard hatbox, matching in color and design. Into the large case go the two self-starting, A.C. motors with 9" turntables, two crystal pick-ups, and the 4-watt amplifier system with fader and tone control. In the hatbox is the 8" permanent-magnet speaker, provided with a 25' length of

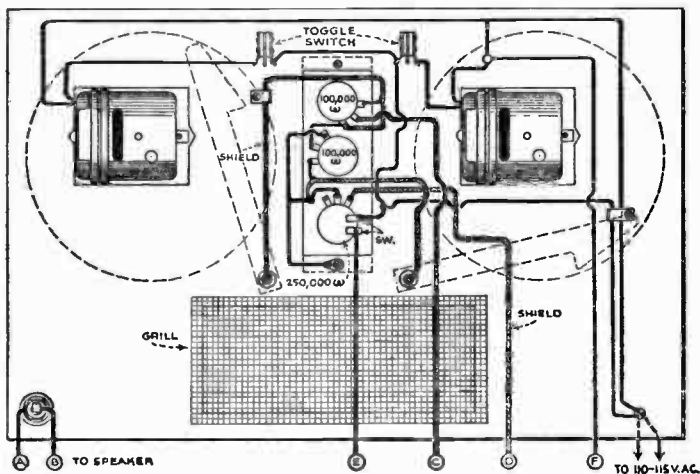
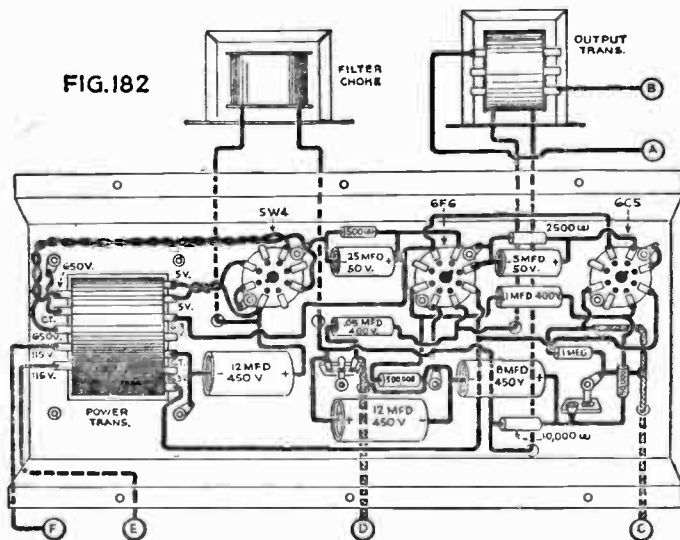

FIG.182



heavy, rubber-covered cable so that the speaker can be placed beside a movie screen. At one end of the table is a microphone-type plug which fits into the jack at the motor panel.

On the motor panel (Fig. 182), which is a $\frac{1}{2}$ " by $15\frac{7}{8}$ " by $24\frac{7}{8}$ " sheet of plywood, are mounted two S.P.S.T. toggle switches for starting or stopping the two phonograph motors. The motors should maintain a constant speed of 78 revolutions per minute at all times.

Above the three-tube amplifier seen in Fig. 182 is an opening $3\frac{1}{2}$ " by 10" and protected by a piece of cane sheeting $4\frac{1}{2}$ " by 11". The cane sheeting may be obtained at any large hardware store. It should have a coating of black enamel paint to prevent rust and enhance the general appearance of the equipment.

On a small black-crackle aluminum panel, $2\frac{1}{2}$ " by 6", are mounted the two fader controls regulating the output of each pick-up, the tone control, and the amplifier on-and-off switch which is mounted on the 250,000-ohm tone control.

The fader controls are two 100,000-ohm variable resistors connected in series between the control grid of the input triode and ground. Across these is a 1-meg., 1-watt carbon resistor. (Fig. 183.)

The 6C5 is resistance-coupled to the 6F6 pentode by means of the 50,000-ohm, 1-watt resistor, the .1-mfd. coupling condenser, and the 500,000-ohm, 1-watt grid resistor. Amplification is ample with the crystal pickups used to operate the 6F6 at its maximum output of $3\frac{1}{2}$ to 4 watts.

The power transformer has three secondary wind-

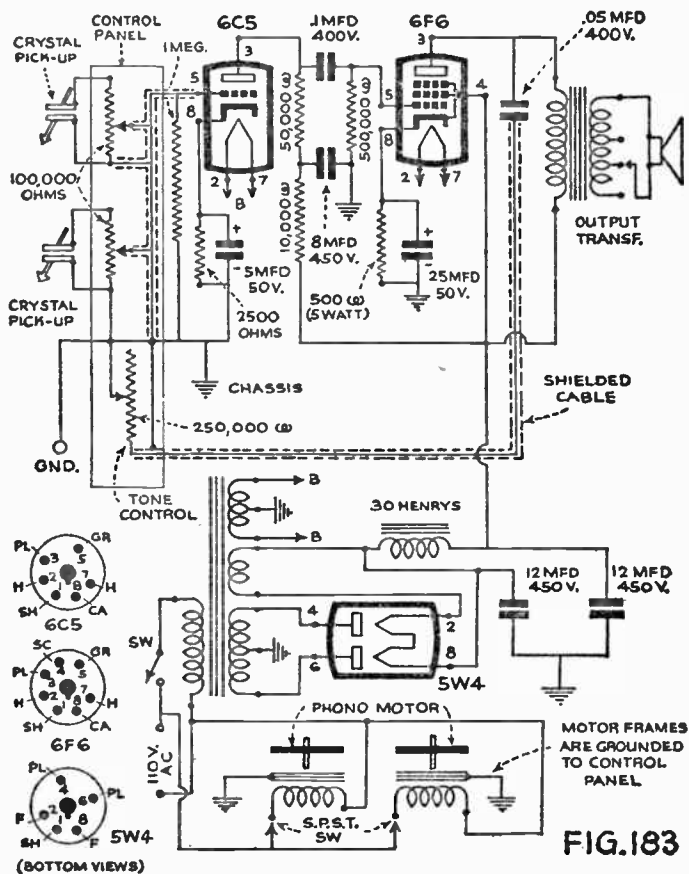

FIG. 183

ings—300+300 volts at 60 milliamperes, 5 volts at 2 amperes, and 6.3 volts at 2.5 amperes. A 30-henry choke, rated to pass 75 milliamperes, and two 12-mfd. electrolytic condensers constitute the filtering circuit. A 10,000-ohm, 1-watt resistor in the plate circuit of the 6C5 and by-passed by an 8-mfd. electrolytic condenser stabilizes the amplifier and prevents feed-back.

A high- μ triode (the 6F5) may be substituted for the 6C5 if greater volume is desired. However, the output of this amplifier, with the 6C5, is ample even for a small dance hall. If needle scratch is noticeable, an inexpensive scratch filter may be connected in the output of each pick-up unit. The filters can be mounted beside the motors under the motor panel.

Instantaneous changing of the records is possible with the twin pick-up units, one record being readied while another is playing. For home-movie work, records or parts of them can be faded in or out at will. And, if desired, a sound-effects recording may be played simultaneously with an instrumental recording.

The following records are suggested for use with home-movie scenes:

For ocean scenes, Debussy's "La Mer" and Mendelssohn's "Fingal's Cave." For western scenery, Ferde Grofe's "Grand Canyon Suite" and "The Plains" by Bernard Rogers. For pictures of children, Debussy's "Children's Corner." For country scenes, "Pastoral Symphony" by Beethoven. For industrial scenes of shipyards, railroad terminals, or factories, "Ironworks" by Mossolow, or "Steel Mills" by Ferde Grofe.

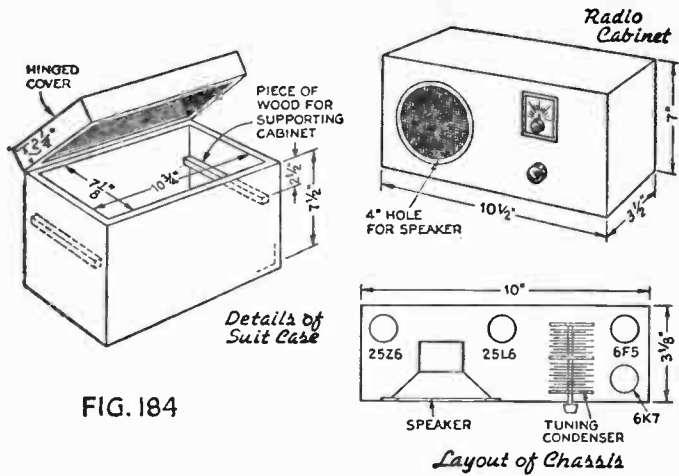
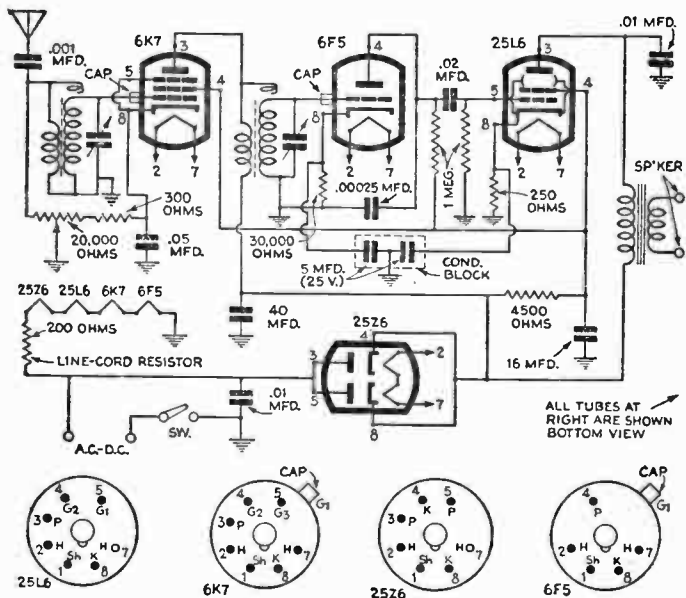

FIG. 184



Week-Ender's Radio

Providing good volume and selectivity, the compact four-tube A.C.-D.C. receiver illustrated in Fig. 184 will appeal to week-end travelers who like to take their radio entertainment with them, for it is more than just an ordinary portable set. Besides its own cabinet, it has a neat overnight luggage carrier into which it slips, along with your toilet articles and the few apparel necessities for a short trip. You can build the suitcase and its radio-cabinet "tray" yourself, according to specifications on the drawing, or have them made up at your luggage shop.

Although a standard, four-tube, tuned-radio-frequency circuit is used, changes have been made to increase the set's efficiency. Iron-core coils, for example, are used because of their greater selectivity and higher gain; while in the detector stage a high- μ triode replaces the conventional high-frequency pentode. The triode provides better quality and can be operated to give a high signal output without distortion. For the output tube, a new beam power pentode, a 25L6, was chosen. Care must be taken to use a cathode resistor of proper value.

Instead of a filter choke, a 4,500-ohm, one-watt resistor is employed to save space and keep down the cost. To avoid overheating the resistor, the plate current of the 25L6 tube is taken directly off the cathodes of the rectifier. To eliminate any possibility of hum due to this arrangement, a high-capacity (40-mfd.) electrolytic condenser must be used for filtering this part of the rectifier circuit.

A five-inch electrodynamic speaker was chosen instead of the usual permanent-magnet type, as the former costs less and is more sensitive to weak signals.

In laying out the chassis and cabinet, arrange the parts so that the receiver will be shallow enough to fit in the "tray." The tuning dial and knob harmonize with the color of the fabric, while brass locks and hinges were selected so that they would not rust. As the panel of the radio extends above the open suitcase, it is a simple matter to lift the set in and out.

APPENDIX

The following tables and data will be of value to both the amateur experimenter and the serviceman.

STANDARD RESISTANCE COLOR CODE

Color	First or Second Figure	Number of Cyphers
Black	0	None
Brown	1	0
Red	2	00
Orange	3	000
Yellow	4	0000
Green	5	00000
Blue	6	000000
Violet	7	————
Gray	8	————
White	9	————

To simplify the marking of commercial resistors used in factory-built receivers, the above color code has been decided upon as a standard. In place of actual figures indicating the resistance value, the color code uses colors and unless the significance of these colors is known it will be difficult to choose the right value for replacement parts used in servicing and re-building commercial receivers.

Three colors are used in the color code as indicated by the sketch below. The meanings of these colors is indicated in the table above. The body color, which is the main color of the resistance unit, indicates the first

figure in the resistance value. In a similar manner, the color used on the tips of the unit is called the tip color and indicates the second figure in the resistance value. The ciphers to be placed after these first two significant figures are indicated by the dot color. In some cases, a narrow band of color instead of a dot is used.

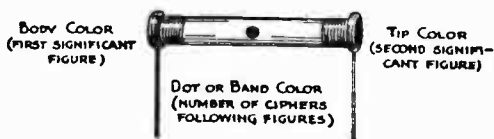

Suppose, for instance, that a certain resistance has a brown body, green tips, and a yellow dot. According to the table, the brown body indicates that the first figure in the value is 1. The green tips, on the other hand, indicate a second figure of 5 while the yellow dot signifies that there are four ciphers (0000) after the figures. Combining them, the resistance value is 15,000 ohms.

WIRE TABLES

Diameters and Resistances of Copper Wire

B & S Gauge	Diameter Inches	Resistance Ohms Per 1000 Ft.
0	0.3249	.09827
1	0.2893	.1239
2	0.2576	.1563
3	0.2294	.1970
4	0.2043	.2485
5	0.1819	.3133
6	0.1620	.3951
7	0.1443	.4982
8	0.1285	.6282
9	0.1144	.7921

WIRE TABLES—Continued
Diameters and Resistances of Copper Wire

B & S Gauge	Diameter Inches	Resistance Ohms Per 1000 Ft.
10	0.1019	.9989
11	0.09074	1.260
12	0.08081	1.588
13	0.07196	2.003
14	0.06408	2.525
15	0.05707	3.184
16	0.05082	4.016
17	0.04526	5.064
18	0.04030	6.385
19	0.03589	8.051
20	0.03196	10.15
21	0.02846	12.80
22	0.02535	16.14
23	0.02257	20.36
24	0.02010	25.67
25	0.01790	32.37
26	0.01594	40.81
27	0.01420	51.47
28	0.01264	64.90
29	0.01126	81.83
30	0.01003	103.2
31	0.008928	130.1
32	0.007950	164.1
33	0.007080	206.9
34	0.006305	260.9
36	.005	414
38	.004	660

Note: These diameters are the outside measurements of bare copper wire. To obtain the diameters of insulated wire, the following constants should be added to the figures given above:

Enamel	Add .002 in.
Single cotton	Add .006 in.
Double cotton	Add .01 in.
Single silk	Add .002 in.
Double silk	Add .004 in.

These constants and values will be helpful in determining the gage sizes of wire in coils, chokes, etc.

WAVE-LENGTH—FREQUENCY CONVERSION TABLES

Wave Length (Meters)	Frequency (Kilo-cycles)	Wave Length (Meters)	Frequency (Kilo-cycles)	Wave Length (Meters)	Frequency (Kilo-cycles)
1	300,000	135	2,222	310	967
2	150,000	140	2,144	320	937
3	100,000	145	2,069	330	909
4	75,000	150	2,000	340	882
5	60,000	155	1,935	350	857
6	50,000	160	1,875	360	833
7	42,860	165	1,818	370	810
8	37,500	170	1,765	380	789
9	33,333	175	1,714	390	769
10	30,000	180	1,667	400	750
15	20,000	185	1,622	410	731
20	15,000	190	1,579	420	714
25	12,000	195	1,538	430	697
30	10,000	200	1,500	440	681
35	8,571	205	1,463	450	666
40	7,500	210	1,429	460	652
45	6,667	215	1,395	470	638
50	6,000	220	1,364	480	625
55	5,454	225	1,333	490	612
60	5,000	230	1,304	500	600
65	4,615	235	1,277	510	588
70	4,286	240	1,250	520	576
75	4,000	245	1,225	530	566
80	3,750	250	1,200	540	555
85	3,529	255	1,177	550	545
90	3,333	260	1,154	560	535
95	3,158	265	1,132	570	526
100	3,000	270	1,111	580	517
105	2,857	275	1,091	590	508
110	2,727	280	1,071	600	500
115	2,609	290	1,034	610	491
120	2,500	295	1,017	620	483
125	2,400	300	1,000	630	476
130	2,308			640	468
				650	461

To find the corresponding frequency for any wave length or the wave length for any frequency, simply find the known value and note the corresponding figure in the remaining column.

These values have been figured by the wave length-frequency formula:

$$\text{Frequency (kilocycles)} = \frac{300,000}{\text{Wave length (meters)}}$$

CONTINENTAL CODE

A	•••	N	••••	1	••••••••
B	•••••	O	••••••••	2	•••••••••
C	•••••••	P	•••••••••	3	••••••••••
D	••••••••	Q	••••••••••	4	•••••••••••
E	•••••••••	R	•••••••••••	5	••••••••••••
F	••••••••••	S	••••••••••••	6	•••••••••••••
G	•••••••••••	T	•••••••••••••	7	••••••••••••••
H	••••••••••••	U	••••••••••••••	8	•••••••••••••••
I	•••••••••••••	V	•••••••••••••••	9	••••••••••••••••
J	••••••••••••••	W	••••••••••••••••	0	•••••••••••••••••
K	•••••••••••••••	X	•••••••••••••••••		
L	••••••••••••••••	Y	••••••••••••••••••		
M	•••••••••••••••••	Z	••••••••••~•••••••••		

PERIOD	-----••••••••
COMMA	-----•••••••••
INTERROGATION	-----••••••••••
COLON	-----•••••••••••
SEMICOLON	-----••••••••••••
EXCLAMATION	-----••••~••••••••
PARENTHESIS	-----•••••••••••••
QUOTES	-----••••••••••••••
BAR INDICATING FRACTION	-----•••••••••••••••
BREAK (DOUBLE DASH)	-----••••~••••••••
INVITATION TO TRANSMIT	-----••••••••
WAIT	-----•••••••••
RECEIVED (O.K.)	-----••••••••
END OF MESSAGE	-----••••••••••
END OF TRANSMISSION	-----••••••••••••

When learning the code, the amateur will do well to memorize the letters by sound rather than by sight. For instance, a dot becomes "dit" and a dash "darr." In sound then, the letter A is dit darr.

In actual transmission, the dash interval should be made three times longer than that allowed for a dot. The space between letters should be equal to three dots and the space between words equivalent to five dots.

IMPORTANT CODE ABBREVIATIONS

C	Yes.
N	No.
GA	Resume sending.
JM	If I may send, make a series of dashes. To stop my transmission, make a series of dots.
MN	Minute or minutes.
NW	I resume transmission.
OK	We agree.
UA	Do we agree?
XS	Atmospherics.
CFM	Confirm.
ITP	The punctuation counts.
REF	Referring to.
RPT	Repeat.
SIG	Signature.
TFC	Traffic.

COMMON RADIO ABBREVIATIONS

a	Ampere.
A. C.	Alternating Current.
A. F.	Audio Frequency.
Ant. or An.	Antenna.
CW.	Continuous Wave.
D. C.	Direct Current.
D. P. S. T.	Double-pole, single-throw switch.

D. P. D. T.	Double-pole, double-throw switch.
S. P. S. T.	Single-pole, single-throw switch.
S. P. D. T.	Single-pole, double-throw switch.
Gr. or G.	Ground.
I. F.	Intermediate Frequency.
Kc.	Kilocycle (1,000 cycles).
Kw.	Kilowatt (1,000 watts).
ma.	Milliampere.
mfd. or μ fd.	Microfarad.
mmf. or $\mu\mu$ f.	Micromicrofarad.
μ h.	Microhenry.
μ v.	Microvolt.
Ω	Ohm.
meg. or $m\Omega$.	Megohm.
R.	Resistance.
t.	Turns.
v.	Volt.
R. F.	Radio Frequency.
e. m. f.	Electromotive Force.
A. V. C.	Automatic Volume Control.

METRIC SYSTEM

1 Millimeter001 Meter0394 Inch
1 Centimeter01 Meter394 Inch
1 Decimeter1 Meter	3.94 Inch
1 Meter	1 Meter	39.37 Inch
1 Decameter	10 Meters	32.808 Feet
1 Hectameter	100 Meters	328.08 Feet
1 Kilometer	1000 Meters	3280.8 Feet
1 Mile	5280 Feet

CONVERSION UNITS

Centimeters \times .394 = inches.

Circular mils \times .785 = square mils.

Cubic centimeters \times .061 = cubic inches.

Cubic meters $\times 35.314 =$ cubic feet.

Feet $\times .305 =$ meters.

Horsepower $\times .746 =$ kilowatts.

Horsepower $\times 33,000 =$ foot pounds per minute.

Inches $\times 2.54 =$ centimeters.

Inches $\times 1,000 =$ mils.

Kilometers $\times .6214 =$ miles.

Knots $\times 1.152 =$ miles.

Knots per hour $\times 1.152 =$ miles per hour.

Miles (statute) $\times 1.15 =$ miles (nautical).

Miles $\times 1.609 =$ kilometers.

Mils $\times .001 =$ inches.

Watts $\times .00134 =$ horsepower.

FIGURING FILAMENT RESISTANCES

By following a simple application of Ohm's Law, it is an easy matter to calculate the size of the variable resistor to be placed in the filament circuit. When heaters of filaments are connected in parallel, the required resistance in ohms is equal to the difference between the supply voltage and the rated voltage of the tube type, divided by the *total* rated filament current for the tubes.

Example: Two type '30 tubes in parallel with a three-volt filament supply.

$$\text{Resistance (ohms)} = \frac{3-2}{2 \times .06} = \frac{1}{.12} = 8.3$$

For series-connected filaments or heaters, the resistor value in ohms is equal to the supply voltage

minus the *total* rated voltage (sum) of the combined tubes divided by the rated amperage of the tube type.

Example: Two type '30 tubes connected in series with a six volt supply.

$$\text{Resistance (ohms)} = \frac{6-4}{.06} = 33.3$$

WHAT THE TUBE NUMBERS MEAN

According to the latest system of numbering tubes, each figure in the label indicates an important specification of the tube. For instance, the first two digits specify the filament or heater voltage. Voltages below 2.1 are identified by the digit 1. For filament voltages between 2.1 and 2.9, the figure 2 is used while the figure 3 indicates a voltage between 3 and 3.9. Thus, the type number of a two-volt tube begins with the digit 1, a two- and one-half-volt tube with the digit 2, and so on.

Following the first digits in each type number for each tube is a letter of the alphabet. This is the serial letter and indicates the tube's use. Rectifiers start with the letter Z and work back through the alphabet while other tubes begin with the letter A and work down in the usual way.

The number directly following the serial letter indicates the number of active elements in the tube.

Example: Tube type 25Z5

25 indicates the filament voltage.

Z indicates that the tube is a rectifier.

5 indicates the number of elements.

Examples: Tube type 2A5

2 indicates 2.5 volt filament or heater.

A indicates that the tube is an amplifier or detector.

5 indicates that there are five elements.

INDEX

- Abbreviations, 246, 247
- Adapter, short-wave, 180
 - tube, 162
 - wafer, 115
- Aerial, see antenna
- Alternating current, definition, 64
 - measuring, 51
 - rewiring for, 109
- Aluminum, bending, 24
 - cutting, 26
 - drilling, 27
 - finishes for, 30
- Ammeter, connecting, 49
 - construction of, 49
 - extending range of, 49
 - symbol for, 33, 38
- Amperage, definition, 40, 64
 - measuring, 49
- Amplifier, high-fidelity, 220
- Antenna, abbreviation for, 246
 - double, 96
 - doublet, 148
 - drip loop for, 98
 - halyards for, 107
 - indoor, 96
 - kinks, 94
 - light socket, 94
 - mast for, 98
 - planning a, 142, 146
 - short-wave, 148
 - symbol for, 33
 - testing, 78
 - water pipe, 94
- Audio amplifier, locating, 127
- Audio frequency, definition, 64
- Automatic volume control, 130
- "B" supply for portables, 231
- Bath, lye, for aluminum, 31
 - rosin, for solder, 23
- Bench, portable, 12
- Broadcast waves, 178
- Capacity, changing, 99
 - combined, calculating, 60
 - measuring, 54
 - testing, 169
 - unit of, 40
- Cement, how to make, 106
- Chassis, making a, 24-30
- Choke coil, definition, 64
 - symbol for, 33, 38
 - troubles, 167
- Circuit, arranging, 44
 - calculating, 59
 - checking, 45
 - following a, 32
 - open, test for, 69
- Circle, cutter for, 28-30
- Code, color, for resistances, 241
 - color, for wire, 88
 - continental, 245-246
- Coils, cement for, 106
 - duplicate, making, 79
 - mounting, 86, 188
 - plug-in, form for, 83
 - space-wound, 81
 - symbol for, 33
 - taps, soldering, 85
 - testing, 72
- Color code, resistance, 241
 - wire, 88

- Condenser, earphone test, for, 67**
 functions of, 40, 69, 117
 leaky, 67
 mounting, 101
 ohmmeter test for, 69
 retracking, 174
 short-circuited, 67
 symbol for, 33
 template for, 101
 testing, 67
 troubles, 167
 types of, 34
 variable changing capacity of,
 99
 variable, cleaning, 99
 voltmeter test for, 67
 wrench for, 100
- Connections, experimental, 89**
 making, 22
 receiver, simplifying, 44, 202
 symbol for, 33
 tagging, 89
- Continuity, testing for, 69**
- Conversion, units for, 248**
- Converter, short-wave, 185**
- Crackle, cause of, 139, 153**
- Current, alternating, 64**
 direct, 65
 measuring, 49
- Cutter, circle, 28**
- Cycle, definition, 65**
- Definitions, radio, 64**
- Detector, definition, 65**
 regenerative, 200
- Diagnosing troubles, 151**
- Diagram, adapter, 179**
 converter, 185, 192
 one-tube receiver, 199, 203
 picture, 43, 44, 180, 190
 tube checker, 156
- Direct current, definition, 65**
 measuring, 46
- Distortion, cause of, 152**
- Doublet antenna, 148**
- Drilling, aluminum, 27**
 pad for, 11, 27
- Dual speakers, 119**
- Earphones, installing, 117**
 symbol for, 33
 testing, 74
 testing continuity with, 68
 testing set with, 170
 testing voice coil with, 74
- Electric motor, silencing a, 137**
- Electric "B" supply, 231**
- Farad, definition, 65**
- Field coil, symbol for, 33**
- Filament resistance, calculating,
 248**
- Filter, electric motor, 137**
 high-frequency, 119
 power line, 140
- Finishes, aluminum, 30**
- Flux, soldering, 20-22**
- FM Receiver, 216**
- Formula, condenser connection,
 61**
 filament resistance, 247
 meter conversion, 50
 Ohm's law, 61
 resistance connection, 59
 transformer, 92
 wavelength-frequency, 63
- Frequency, audio, 64**
 definition, 65
 formula for, 63
 radio, 66
- Greenwich time, 196**
- Ground, abbreviation for, 246**
 symbol for, 33
 testing, 76
- Henry, definition of, 65**
- Holes, drilling, 27**
 template for, 101
- Home recorder, 213**
- Hum, cause of, 139, 153**

- Impedence, definition, 65
 Inductance, definition, 65
 Installing, A.C. tubes, 109
 earphones, 117
 phono attachment, 127
 pre-selector, 126
 remote speaker, 123
 second speaker, 119
 telephone-radio switch, 103
 tone control, 114
 wave trap, 124
 Insulation, kinds of, 42
 stripper for, 16, 107
 Insulator, lead-in, 96
 transposition, 149
 Interference, eliminating, 135
 filters for, 137
 how it enters receiver, 137
 noises, meaning of, 139
 sources of, 135, 139
 station, eliminating, 124
 testing for, 138, 141
 tracing, 139
 Intermittent reception, cause of, 152
 Irons, soldering, 13

 Jig, bending, for metal, 24

 Key, symbol for, 33

 Lamp, trouble shooter's, 18
 Lead-in, noise reducing, 144
 shielded, 144
 Lead-in, transformer-coupled, 146
 transmission line, 146
 transposed, 148
 twisted, 145
 Light-Beam Transmitter, 227
 Loudspeaker, auxiliary, 123
 cement for, 106
 filter for, 119
 high-frequency, 119
 receiver, inexpensive, 224
 piezo-electric, 121
 symbols for, 33
 testing, 72
 troubles, 73, 167, 173

 Man-made static, cause of, 135
 Mast, antenna, 98
 Measurements, amperage, 49
 capacity, 54
 conversion units for, 247
 resistance, 52
 voltage, 49
 Meters, construction of, 46
 converting, 49
 extending ranges of, 49
 formulas for, 50
 how connected, 47-49
 multipliers for, 49
 multi-purpose, 52
 radio, 18, 46
 rectifier for, 51
 shunts for, 49
 symbols for, 33, 38
 testing with, 68, 78, 156, 162
 Metric system, 247
 Microphone, symbol for, 33
 Milliammeter, construction of, 47
 how connected, 47
 symbol for, 38
 Motor, noises from, 139
 silencing, 137
 Multipliers, meter, 49

 Noises, man-made, 139
 receiver, 153
 reduction of, 135, 153
 suppression of, 137
 Noises, tube, 148
 types of, 139
 Numbers, tube, 249

 Ohm, definition of, 41, 66
 measuring, 52
 Ohmmeter, how to make, 52
 Ohm's law, 61
 Open circuits, testing for, 69

 Panels, cutting, 26
 drilling, 27
 finishing, 30
 laying out, 44

- Parts, arranging, 44
 small, holding, 105
 testing, 67
- Phonograph, dual-turntable, 233
- Phonograph attachment, installing, 127
 scratch filter for, 129
 symbol for, 33
 turntable for, 130
 volume control for, 129
- Picture diagram, general, 43
 short-wave adapter, 180
 short-wave converter, 190
- Plate prongs, locating, 115
- Pliers, 16
- Plug, defective, 154
- Plug-in coils, forms for, 83
- Polarity, testing for, 75
- Portable receiver, three-way, 207
- Power line, filters for, 140
- Prefixes, metric, 41
- Pre-selector, building a, 126
- Prods, test, 19
- Radio frequency, definition, 66
- Radio workshop, bench for, 12
 planning a, 11
 tools for, 13
- Receiver, adding earphones to, 117
 adding phono attachment to, 127
 adding second speaker to, 119, 123
 adding tone control to, 114
 altering for short waves, 180
 analyzing, 151
 automatic volume control for, 130
 improving selectivity of, 124
 novel mount for, 107
 one-tube, 199, 203
 retracking, 174
 servicing, 153
 silencing for telephone, 103
 testing shielding of, 141
 testing voltages of, 162
- Receiver, trouble shooting a, 151
 rewiring for A. C., 109
- Reception, broadcast, 178
 noise free, 150
 short-wave, 178
- Record player, wireless, 210
- Recorder, home, 212
- Regeneration, controlling, 200, 203
- Resistance, calculating, combined, 59
 calculating, filament, 248
 color code for, 241
 symbol for, 33
 testing, 167
 troubles, 167
 types of, 36
 unit of, 41
- Retracking, 100, 174
- Rheostat, symbol for, 33
- Selectivity, improving, 124
- Servicing, radio, 153
- Shielding, testing, 141
- Short waves, 173
 A.C.-D.C. receiver for, 205
 adapter for, 180
 antenna for, 139
 converters for, 185, 193
 one-tube receiver for, 199, 203
 tuning for, 194
- Shunt, calculating meter, 49
- Solder, applying, 22
 fluxes for, 20
 how to, 19
 types of, 20
- Soldering iron, 13
 cleaning, 20
 shield for, 15
- Static, man-made, 135
 tinning, 20
 natural, 135
- Switch, short-wave, 183
 symbol for, 33
 telephone-radio, making, 103
 troubles, 167
- Symbols, radio, 32

- Symptoms, 152
 distortion, 152
 interference, 138, 139
 intermittent reception, 152
 loudspeaker troubles, 73
 mysterious, 172
 noises, 152
 no reception, 152
 weak reception, 152
- Tables, metric, 41, 247
 wave length-frequency, 244
 wire, 242
- Taps, insulating, 87
 soldering, 85
- Template, adjustable, 101
- Testing, antenna, 78
 capacity, 169
- Testing coils, 72
 condensers, 67
 continuity, 69
 earphones, 74
 grounds, 76
 interference, 138, 141
 lamp for, 71
 loudspeakers, 72
 polarity, 75
 prods for, 19
 resistance, 167
 shielding, 141
 transformers, 57, 72
 tubes, 156
- Three-way portable receiver, 207
- Time, converting, 196
 European, 196
 Greenwich, 196
- Tone control, installing, 114
- Tools, radio, list of, 14, 15
- Transformer, design for, 91
 emergency repair for, 90
 symbol for, 33
 testing, 57, 72
 troubles, 167
- Troubles, broadcast receiver, 151
 choke coil, 167
 condenser, 167, 174
- Troubles, locating, 67, 151
 loudspeaker, 73, 173
 mysterious, 172
 resistance, 167
 transformer, 167
 tube, 167
- Trouble shooting, lamp for, 18
 meter for, 52
 procedure, 67, 151
 test lamp for, 71
 test prods for, 19
- Tube, base, removing wires from, 85
 checking, 154
 noise due to, 148
 numbering system for, 249
 removing, 106
 sockets, cutting holes for, 28
 substituting, 110
 symbol for, 33, 36
- Tube, tester for, 156
 testing voltages of, 162
 troubles, 167
 trouble caused by, 148, 152, 153
- Tuning, vernier, 102
- Variable condenser, altering, 99
 cleaning, 99
 mounting, 101
- Voice coil, locating, 118
 testing, 74
 symbol for, 33
- Voltage, definition, 40, 66
 divider, symbol for, 33
 high, identifying, 57
 measuring, 49, 162
- Voltmeter, construction of, 49
 connecting, 49
- Voltmeter, extending range of, 50
 symbol for, 33, 38
- Wave length, definition of, 66
 formula for, 63, 244
 tables, 244
- Wave trap, building a, 124
- Weak reception, cause of, 152
- Winding, coil, 79, 81

- Wire, broken, testing for, 69**
color code for, 88
cutters, 16
insulating, 87
resistance of, 242
sizes of, 242
- Wire, skinning, 17**
symbols for, 33, 38
tinning, 22
- Wireless record player, 210**
- Wiring, hints on, 85, 86**
- Week-ender's radio, 239**