

THE
RADIO
MANUAL

STERLING

SECOND
EDITION

D. VAN NOSTRAND
COMPANY, INC.

THE
RADIO
MANUAL

STERLING

SECOND
EDITION

D. VAN NOSTRAND
COMPANY, INC.

THE
RADIO MANUAL

*FOR RADIO ENGINEERS, INSPECTORS, STUDENTS,
OPERATORS AND RADIO FANS*

By

GEORGE E. STERLING

*Radio Inspector, Radio Division, U. S. Department of Commerce
Member, Institute of Radio Engineers*

Edited by

ROBERT S. KRUSE, E.E.

*Radio Consultant, Technical Editor and Writer,
Formerly Technical Editor of QST*

SECOND EDITION



NEW YORK
D. VAN NOSTRAND COMPANY, INC.
250 FOURTH AVENUE

COPYRIGHT, 1928, 1929, BY
D. VAN NOSTRAND COMPANY, INC.

All rights reserved, including that of translation
into foreign languages, including the Scandinavian

| | |
|--|----------------------|
| <i>First Published,</i> | <i>October 1928</i> |
| <i>Second Printing (before publication),</i> | <i>October 1928</i> |
| <i>Third Printing,</i> | <i>December 1928</i> |
| <i>Fourth Printing,</i> | <i>February 1929</i> |

| | |
|------------------------|-----------------------|
| <i>Second Edition,</i> | <i>September 1929</i> |
|------------------------|-----------------------|

PRINTED IN THE UNITED STATES OF AMERICA

LANCASTER PRESS, INC.
LANCASTER, PA.

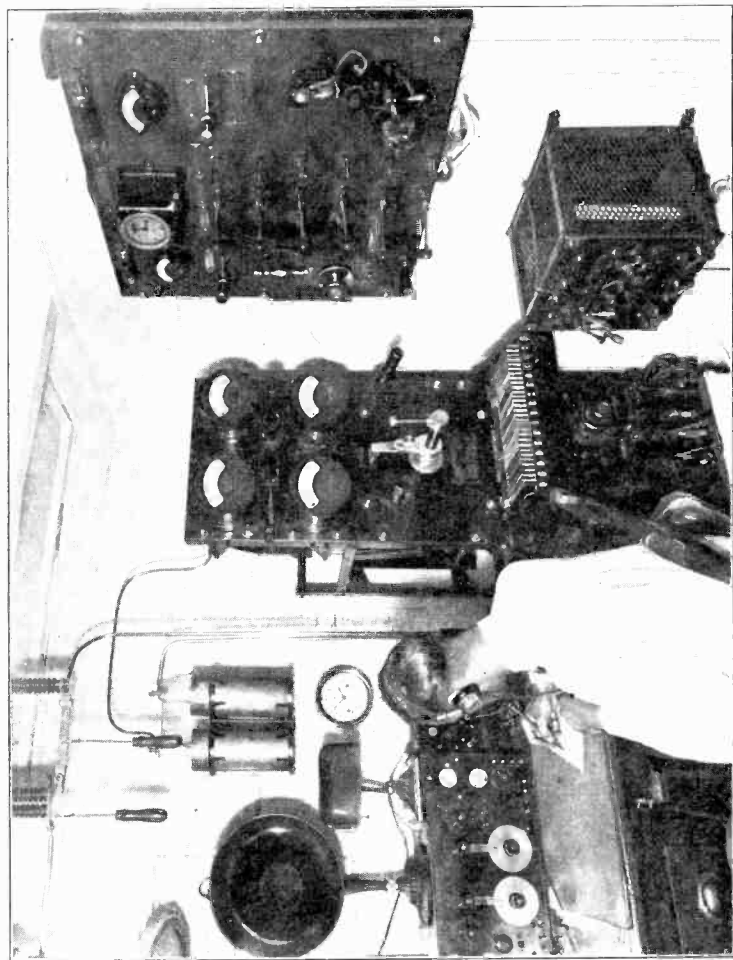

A Radio Station Aboard Ship.

(Frontispiece)



PREFACE TO SECOND EDITION

This edition of The Radio Manual has been dedicated to the same purpose as that of the first edition, which is to serve as a guide and text book for those who expect to enter the radio profession as engineers, inspectors, servicemen, or as operators of commercial, broadcast, or amateur stations. Much of the material will also be of interest to the radio fan.

The same plan of study which met with such popular approval in the first edition has been maintained. This plan provides for several chapters dealing with elementary electricity, the ever present dynamo, battery, and vacuum tube and the underlying principles of their most common combinations. An effort has been made further to clarify these discussions so that they may be understood without previous knowledge of electricity. This is done in the belief that such understanding as they attempt to give is imperatively necessary before the practical forms of apparatus can be understood easily or operated to best advantage.

Prior to the first edition of The Radio Manual it was necessary for the prospective operator to consult a number of books in order to cover the subjects included in the license examinations. The enactment of the International Radiotelegraphic Convention of 1929 made it necessary for the Radio Division of the Department of Commerce to increase the scope of these examinations. The student was thus further embarrassed. It has been the aim of the author to take up all the various subjects which the student may expect to encounter during examination, and as far as possible to anticipate his operating problems thereafter.

The author has had some years of experience as an examining officer in the Radio Division and in examining hundreds of applicants has observed that the greatest number of failures occurred amongst those students who attempted the miracle of ignoring technical ground work and instead to scrape past the examination by repeating parrot-fashion the replies given in those extraordinary "quiz books" which purport to prepare for license examination. The complete lack of background of such students is even more apparent when they are required to locate troubles and make repairs. The author urgently advises slow and thoughtful study of the elementary chapters contained herein. It is less damaging to save time on the later chapters.

Much contact with operators has also shown the author that in the course of the customary transfers from ship to ship and from ship to shore or broadcast stations new apparatus will surely be encountered and that very much help can be obtained from representative circuit diagrams, operating and maintenance instructions and the like. Much of this has therefore been included.

The utility of Chapter 19 is obvious since the operator has frequent need of a knowledge of the Ship Act, the Radio Act of 1927, and the International Radiotelegraphic Convention of 1929. Questions of law or procedure arise frequently, especially in operating aboard a vessel engaged in international service and the text of these three documents are not elsewhere available together.

This edition differs largely from the first in deference to changes in the radio art and in order to introduce certain improvements in the text. No good reason for cataloguing these changes seems evident, and the reader or reviewer may therefore consider the second edition by itself. Where omissions, uncertainties or errors are encountered a correction or suggestion will be appreciated. It may be sent to the author or editor in care of the publishers.

The author desires to express his thanks to the various commercial firms, laboratories, branches of the Federal Government and individuals for their aid and for the use of material and photographs.

G. E. S.

TABLE OF CONTENTS

| | PAGE |
|---|------|
| PREFACE TO SECOND EDITION | vii |
| INTRODUCTORY | I |
| CHAPTER | |
| 1. Elementary Electricity and Magnetism | 3 |
| 2. Motors and Generators | 55 |
| 3. Storage Batteries and Charging Circuits | 82 |
| 4. Theory and Application of the Vacuum Tube | 110 |
| 5. Fundamental Circuits Employed in Vacuum Tube Transmitters | 174 |
| 6. Modulation Systems and Associated Apparatus | 210 |
| 7. Wavemeters, Piezo-Electric Oscillators, Wavetraps and Field Strength Measuring Apparatus | 248 |
| 8. Marine Vacuum Tube Transmitters | 259 |
| 9. Radio Broadcasting Equipment | 317 |
| 10. The Arc Radio Transmitter | 408 |
| 11. Spark Transmitters | 432 |
| 12. Commercial Radio Receivers and Associated Apparatus | 448 |
| 13. The Auto-Alarm | 473 |
| 14. Radio Direction Finders | 495 |
| 15. Aircraft Radio Equipment | 525 |
| 16. Amateur Short Wave Apparatus | 569 |
| 17. Practical Television and Radio Movies | 597 |
| 18. Radio Interference | 637 |
| 19. Radio Laws of the United States and International Telegraphic Conference | 672 |
| 20. Handling and Abstracting Traffic | 741 |
| APPENDIX 1. U. S. Naval Stations Schedules | 766 |
| APPENDIX 2. Short Wave Schedules | 769 |
| APPENDIX 3. Kilocycle-meter Conversion Table | 771 |
| APPENDIX 4. Important Articles Taken from the Interna- tional Conference of Safety of Life at Sea, 1929 | 781 |



INTRODUCTORY

In its earliest infancy a radio communication system consisted of a simple transmitter of the spark discharge type and a receiver employing a coherer or crystal detector. Messages were transmitted by interrupting the spark discharges so as to form the letters of the Morse telegraph code. At the receiving end the operator heard the dots and dashes as buzzes and by properly training his ear he could recognize the sequence of the buzzes and write them down as letters of the alphabet and consequently, decipher the message. By this method operators were able to send and receive messages at the rate of 10 to 40 words per minute. The range of such systems was limited to a hundred miles or so. It constituted a radio telegraph system in its simplest form.

Even today such systems are still in occasional use although there are many improvements over the old methods and apparatus. In addition, vacuum tubes, arcs, and high frequency generators are employed for telegraph transmission. Not only do these transmitters operate as slowly as ten words per minute, but many operate automatically at speeds as high as 150 to 200 words per minute.

In some instances, the radio waves radiated from the antenna of modern vacuum tube transmitters have been recorded after having passed two or three times around the world. More important than the increase in extreme or record ranges has been the exceedingly large increase of dependable ranges which depend not only on power but also on improved understanding of the phenomena which take place during the flight of a signal from transmitter to receiver.

During the late years, scientists and engineers have made many other uses of radio wave transmission and reception other than radio telegraphy. Among such applications may be counted the navigation of ships and aircraft (radio direction finders, radio beacons and reed course indicators), transmission and reception of educational matters, news, music and other forms of entertainment (broadcasting), transmission and reception of dramatic scenes, radiomovies, photographs and handwriting (radiomovies, television and facsimile systems) and finally, the application of radio waves to locate deposits of ore and oil in the earth (geophysical research).

In each and every system the operation of the radio apparatus is based upon fundamental electrical and magnetic principles. Therefore, in a book devoted to the treatment of such systems as previously mentioned, it is fitting to begin the first chapter with elementary electricity and magnetism in order that the student can understand something of the nature, actions and their relation to each other. In the following chapters an attempt is made to explain the relation of electricity and magnetism to radio phenomena and finally a number of radio systems are described in some detail.

CHAPTER I

ELEMENTARY ELECTRICITY AND MAGNETISM

1. **Electricity and Matter**—One often hears an expression among laymen such as—"No one knows what electricity is"—and the statement usually concludes with "scientists know only how to use it." On the contrary, scientists and physicists not only know how to use electricity but they are able to tell exactly its nature and composition and to explain its relation to matter. In fact, more is known about electricity than about anything else in nature and that knowledge of electrical phenomena has served as a key to unlock doors leading to knowledge in other matters which completely eluded us before.

Matter is today regarded as composed of minute bodies called atoms. These atoms are exceedingly tiny and even the most powerful microscope cannot show us an atom nor even a thousand of them grouped together. We become aware of them entirely through ingenious indirect experiments the story of which is an enchanted romance itself. It is most unfortunate that we have not the time to tell it here.

2. **Protons**—A proton possesses opposite electrical characteristics from that of an electron. Protons are considered then as particles of positive electricity. A body having a deficiency of electrons, that is, having more protons than electrons is said to be positively electrified.

3. **Electrons**—Each atom is composed of many minute particles called electrons and protons. These electrons and protons are exactly alike in all atoms, no matter whether it be an atom of iron, one of lead, one of mercury, of potassium, or any one of other seventy-six elements known to chemistry.

In every case, an electron, when detached from its atom shows none of the properties of ordinary matter. In other words, it will not react chemically with other electrons to produce a new substance. An electron separated from an atom of iron would be precisely the same as an atom separated from an atom of gas such as hydrogen, oxygen. Electrons are always considered as particles of negative electricity. The reason for this is, that for many years physicists have been in the habit of speaking of positively-electrified and negatively-electrified bodies. When the electron was first

discovered it was found that it could be freed by attracting it with a positively-electrified body, whereas, it was repelled by one negatively electrified. However, at this date physicists consider a negatively-electrified body as one in which there is an excess of electrons, that is, within one atom there are many more electrons than there are protons.

4. Arrangement of Electrons and Protons within an Atom—Each kind of atom has its own particular arrangement of electrons and protons. However, in each atom there appears to be at the center a compact group containing all the protons and some of the electrons, therefore, it exhibits a positive charge. This is the nucleus of the atom. Farther out from the nucleus are a number of scattered electrons. Each electron moves in its own orbit. There are always enough electrons surrounding the uncharged atom to neutralize the excess number of protons in the nucleus. In its normal uncharged state the atom exerts no force on charged bodies in its vicinity. However, if an electron is separated from an atom, for instance, by a collision, a free electron will be strongly attracted by the positively charged atom and it will combine with it thus restoring the atom to its normal uncharged state.

The recombining of a free electron with a positively charged atom does not occur instantly because the electron does not drop into the place of the missing electron and stop suddenly. Instead, it oscillates before setting down and in most cases the frequency of its oscillation is such that the wave motion produced in the surrounding ether is of a frequency which can be seen by the eye and is therefore called light. Incidentally, the rate of oscillation depends on the substance, that is, the kind of atom we are watching and therefore atoms of different kinds radiate different colors of light. This color is characteristic of that substance, and one of our most useful methods of identifying substances depends on such characteristic radiation as the intense orange red of neon when excited by an electric current as in the familiar advertising signs.

In any body in which the electrons and protons are equal will be electrically neutral, that is, it will be neither negatively or positively electrified. This is the normal condition of all bodies. In other words, they are uncharged.

From the above paragraphs three general statements can be made as follows:

A body having an excess of electrons is said to be negatively electrified or charged.

A body having a deficiency of electrons is said to be positively electrified or charged.

An uncharged body is one in which the electrons and protons are equal in number.

a. Charging a Body by Friction—A very simple example of frictional electricity can be shown by the old experiment of tearing a sheet of paper into small bits and picking them up by means of a hard rubber rod which has been well rubbed with a piece of woolen cloth or fur. If the rod is clean, the day dry (and preferably cold), and the paper thoroughly dried by heating, one will find the bits of paper to jump to the rod and cling there with surprising enthusiasm. The friction between the rod and wool produced a charge on each. In other words, electrons were removed from the wool by friction and remained on the rubber rod. As already stated, however, the electrons added to the rod do not change its atomic structure neither is there any change made in the atomic composition of the wool by removing electrons from it. Nevertheless, from an electrical standpoint the rod now has a surplus of electrons and is therefore negatively charged while the wool having lost electrons, has less than its normal number, and is therefore positively charged.

b. Relation of Charged Bodies—When the negatively charged rubber rod is brought near the bits of paper the extra electrons on the rod are attracted by a lack of electrons on the paper. Whenever in any body the number of electrons are not equal it is natural for shifts and readjustments to occur until an uncharged condition is attained. In this particular case the paper lacked electrons and was therefore positively charged and the surplus electrons on the rod tried to equalize the unbalanced condition.

The space surrounding the charged rod and paper was subject to a strain enabling it to act on the charged paper with a force which in this case was attractive, as manifested by the small bits of paper jumping to the rod. The moment they touched the rod the electrons and protons in each body became equalized and the attractive force disappeared.

Another simple experiment can be performed by the use of a bit of pith from a corn stem and a glass rod. The pith from the corn stem should be whittled into fine bits by a razor blade. Now if the glass rod is rubbed vigorously with a piece of silk and then brought close to the pith, it will be noticed that the pith is attracted by the glass rod. Allow the glass rod to touch the pith ball. The ball has now become charged with electricity of the same polarity as that of the rod. It acquired the charge by contact. It will now be noticed that the rod repels the pith ball. The condition now exists where like charges repel.

From these experiments one can make the following statements relative to the relation of charges.

1. Unlike charges attract. (Positive and negative charges attract each other.)

2. Like charges repel. (A negative charge repels a negative charge, likewise a positive charge repels a positive charge.)

3. Whenever a charged body is acted upon by another charged body so as to produce a force, either attractive or repulsive, the space surrounding the charged body is subject to a strain or stress. The space in which this stress occurs is called the electric field. It is sometimes called an electrostatic field.

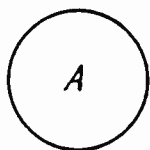

FIG. 1. Un-charged Body.

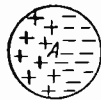

FIG. 2. Body A Charged by Electrostatic Induction from Charged Body B.

The strength of the electric field extends in all directions from the body, the strength of the field decreasing with distance.

c. **Induced Charges**—Consider the case of the uncharged pith ball. Let it be represented in its uncharged condition as in figure 1. When the charged glass rod was brought near the pith ball the negative electrons on the rod as indicated by *B* of figure 2 repelled those on the side of the pith ball nearest the rod giving that side a deficit of electrons on a positive charge as indicated by the small circle *A*. The other side to which the electrons rushed has a negative charge. Removing the glass rod allows the electrons to flow back into their proper place, thus discharging the body. The charge produced on the pith ball is called an induced charge.

The arrangement shown in figure 4 will permit that body to hold more than its ordinary amount of electrons. The lines represent two conductors and the space between the lines a non-conductor. If the conductors are charged, it will be seen that they attract and bind each other and hence, the conductors are

able to hold a greater number of electrons than they could if they were not near each other but at entirely different places. It is a general rule that a negatively charged conductor can hold more electrons if there be nearby another conductor which is charged

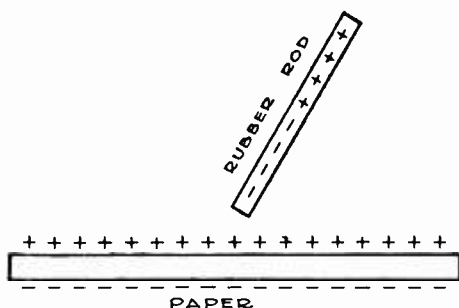

FIG. 3. Electrons Drawn to Upper Side of Paper by Charged Glass Rod.

positively at the same time. Such an arrangement of two oppositely charged conductors is called a condenser, because it permits us to concentrate, or condense, a large amount of electricity

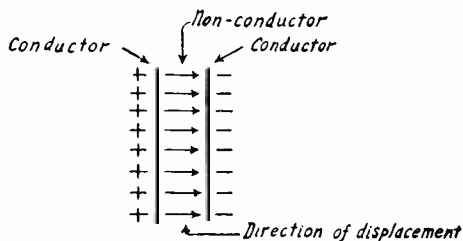

FIG. 4. A Charged Condenser.

on each of the two conductors. Familiar forms of condensers consist of copper or tinfoil separated by mica insulation. An equally familiar form uses air insulation and makes one plate (or set of plates) movable so as to vary the capacity, which is the name used for the ability of the condenser to hold electricity. Such a condenser illustrates the point that the capacity increases as the two conductors approach each other.

5. Potential—When we speak of electric potential we mean electrical pressure. When more electrons are crowded upon a conductor its potential rises in just exactly the same manner that the pressure in an automobile tire rises when more air is crowded into it. It will be seen later that just as we can produce air pressure by rotating centrifugal pumps or by ordinary plunger pumps so also we can produce electrical pressures by a variety of means including batteries and generators. We have already seen

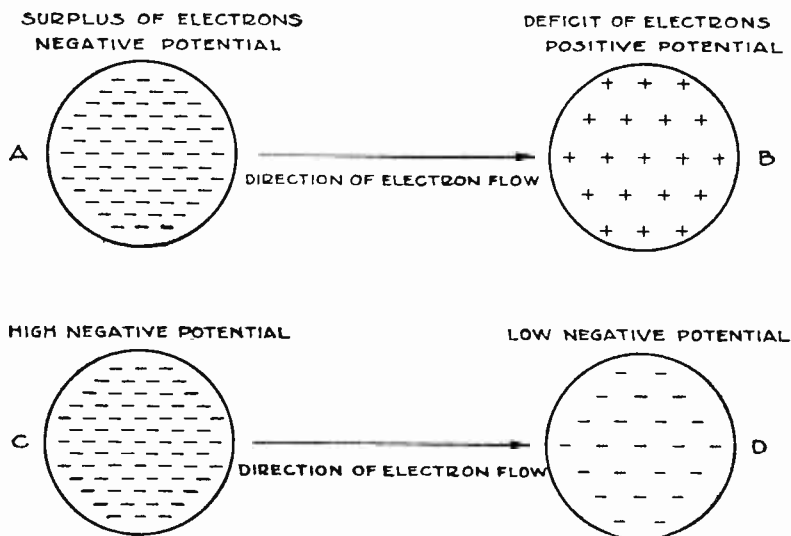

FIG. 5. Creation of Electron Flow by a Difference in Potential.

how a small electrical pressure can be created by rubbing a glass rod with a silk cloth and how this pressure tends to drive electricity from one point to another so forcibly as to carry light substances with it. We will see later how the pressures created by batteries and generators will cause large currents of electricity to flow and thereby to operate all the machinery of radio transmission and reception.

a. Electrons and Difference of Potential—Consider a pair of bodies charged as shown in the top portion of figure 5 as *A* and *B*.

A has an excess of electrons, thus it has a force trying to discharge electrons—it has a negative potential. *B* has a deficit of electrons, thus it has a force trying to attract electrons—it has a positive potential. If given a path, electrons would flow from *A* to *B*. Consequently the flow of electrons would constitute a flow of electric current, as electrons really are the current. The number of electrons flowing from *A* to *B* would depend upon the difference of potential between *A* and *B*. The electrons would continue to flow until there was no longer a difference of potential, that is, *A* and *B* would then have the same number of electrons.

Consider the pair *C* and *D*. Both have a negative potential, but *C* has a larger negative potential than *D* as it has relatively more electrons than *D*. Hence, there is a difference of potential equal to potential *C* minus potential *D*. If given a path, the electrons would flow from *C* to *D* and the movement of electrons would constitute a flow of current from *C* to *D*.

6. Lightning a Movement of Electrons—When a cloud and the earth are oppositely charged there is a possibility of a lightning discharge occasioned by the readjustment of electrons in order to restore the cloud to an uncharged condition. The readjustment or movement of electrons must wait until the cloud obtains sufficient charge to make the electrons leap through the air between earth and sky, depending upon which is positively charged.

6a. The Lightning Flash—As the charges on earth and cloud are increased or one moves close to the other a difference of potential is created sufficient to permit the electrons to stream from one body to the other. In their passage an electron may collide with uncharged molecules of air, as the result of which an electron may be separated from a neutral molecule. The molecule which has thus lost an electron becomes positively charged and in this state is called an “ion.” The free electron knocked off from the molecule follows the other electrons and the ion proceeds in an opposite direction. With the electrons moving in one direction and the ion in the opposite there is a possibility of another collision, that is, another electron will collide with an ion and the electron combines with the ion, thus restoring the molecule to its uncharged state. As explained in a previous paragraph the free electron does not instantly recombine with the positive ion but instead oscillates before settling down and the frequency at which it oscillates is such as to produce a wave motion which can be seen by the eye as a flash of light. Several thousands of such collisions occur during

the discharge period and consequently the intensity of the flash is enormous.

6b. Direction of Current and Electron Flow—Before the discovery of the electron, scientists assumed that the flow of current was from the point of positive potential to the point of negative potential. At this date, however, all scientists agree that the electrons in motion are the current and therefore current flows from a negative to a positive potential. Later on it will be shown how well this fits in with the explanation of the movement of electrons in a vacuum tube.

7. Electromotive Force—The difference of potential between two bodies or between two points of the same body is measured in volts. Because a difference of potential will always cause a current to flow, provided a path is furnished, it is also called electromotive force (e.m.f.); the force of which makes the electrons move. Therefore, a volt is the unit of e.m.f.

8. Current—Current strength, that is, the number of electrons moving per second is measured in amperes.

9. Conductors and Non-Conductors—In order for a current to flow a path must be furnished for the electrons. A body that permits electrons to move about in it is called a conductor. A body in which all the electrons are not free to move is called a non-conductor. Other names for a non-conductor are insulator, or dielectric. Different bodies permit different degrees of freedom and hence there are various grades of conductivity. If the electrons are very free to move they find little opposition in their passage, i.e., they encounter little resistance. If the electrons are not free to move they find much opposition to their passage, i.e., they encounter a high resistance.

10. Resistance—The property of matter by which it opposes the passage of electrons is called resistance. The resistance of a column of pure mercury 106.3 centimeters long, weighing 14.4521 grams, at a temperature of 32 degrees Fahrenheit is one ohm. It is called an ohm because the first man to investigate resistance was Simon Ohm. Since the resistance of any metal rises when the metal is heated our "standard ohm" must always be measured at the same temperature and for this there has been chosen the temperature of 32 degrees Fahrenheit as stated above (zero degrees Centigrade).

The resistance of a conductor depends upon the kind of material in the conductor, the length of the conductor, the cross-sectional area, and to some extent upon the temperature of the conductor. To be exact, it increases directly with the length of the conductor

and decreases with an increase of cross-sectional area. In radio it also increases with an increase of frequency.

11. Production of an Electric Current—From the foregoing discussion it is seen that a current will flow along a conductor if there is a difference of potential created. The current will be maintained if the difference of potential is maintained. Take a zinc rod and a copper rod and immerse them in sulphuric acid. Test the ends of the copper and zinc for charges and it will be found that the copper has a positive charge and the zinc a negative charge. Therefore, a difference of potential exists. Connect the copper and zinc by a wire and a current will flow. Disconnect the wire and test the copper and zinc again. The result will be the same. That is to say, this combination will maintain a difference of potential and hence will produce a steady current.

The sulphuric acid eats the zinc (chemical action) and gives it electrons, taking them away from the copper. Such an arrangement is called a cell. See figure 6. Two or more cells together are

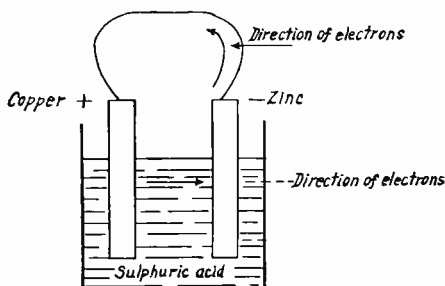

FIG. 6. Primary Cell.

called a battery. There are many combinations of materials that will give the same result. The combination always consists of two dissimilar metals and an acidic or basic solution. The voltage of such a cell is never more than 2 volts. Such cells are called primary cells. The difference between a primary cell and a storage battery lies in the fact that the primary cell cannot be renewed by passing an electric current through it while a storage battery can. Zinc is employed in all cells, other than storage cells, in common use. It is always the negative pole or terminal. The positive pole is usually copper or carbon.

12. Series and Parallel Connections—Cells may be connected in series or parallel. When connected in series the resultant voltage

is the sum of the voltage of each cell. When connected in parallel the resultant voltage is the same as that of any one cell. The rule is to connect cells so that the resistance inside the cells is equal to

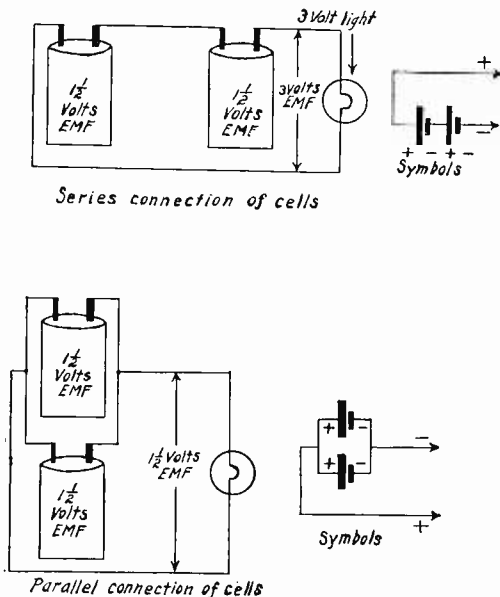

FIG. 7. Series and Parallel Connection of Cells.

that outside the cells. Using storage batteries this rule resolves itself into the following fact: The only time batteries are used in parallel is when current, taken all from one battery, would be so large as to damage the battery.

13. Application of Ohm's Law—The value of volts, amperes and ohms are so taken that the following statement, known as Ohm's law, is true: amperes = volts over resistance or the three forms of Ohm's law may be shown as follows:

| Standard Units | Formulas | Examples |
|---|-------------------|---|
| $\text{Amperes} = \frac{\text{Volts}}{\text{Ohms}}$ | $I = \frac{E}{R}$ | 5 Amps. = $\frac{10 \text{ Volts}}{2 \text{ Ohms}}$ |
| Volts = Ohms \times Amperes | $IR = E$ | 5 Amps. \times 2 Ohms = 10 Volts |
| $\text{Ohms} = \frac{\text{Volts}}{\text{Amperes}}$ | $R = \frac{E}{I}$ | 2 Ohms = $\frac{10 \text{ Volts}}{5 \text{ Amps.}}$ |

14. Resistances—Resistances connected in series have a greater resistance than any one alone. Their total resistance is the sum of the separate resistances.

Formula

$$R = R_1 + R_2 \quad (\text{resistances in series}).$$

Two resistances connected in parallel have a smaller total resistance than either of them. If they are of equal values, the total resistance is one half of the resistance of one. If there are three resistances of equal values the total resistance would be one third of the resistance of one.

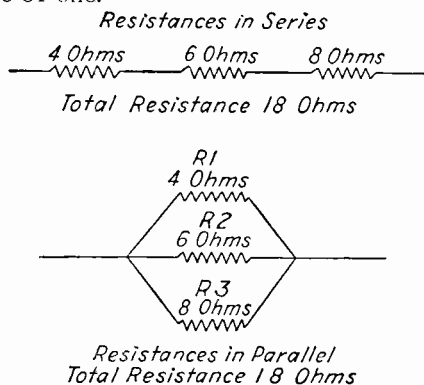

FIG. 8. Series and parallel connection of resistance.

When the resistances are of unequal values their total resistance is computed as follows:

$$R = \frac{1}{\frac{1}{R_1} + \frac{1}{R_2} + \frac{1}{R_3}}$$

where R = the total resistance.

Example: Resistances of 4 ohms, 6 ohms and 8 ohms are placed in series. Their total resistance is $4 + 6 + 8 = 18$ ohms. Connected in parallel their total resistance is:

$$R = \frac{1}{\frac{1}{4} + \frac{1}{6} + \frac{1}{8}} = \frac{1}{\frac{13}{24}} = 1.8 \text{ ohms.}$$

It is now clear that two or more resistances in parallel will conduct an electric current more freely than one.

It should be remembered that Ohm's law is true for the whole or any part of an electrical circuit. However, it will be seen later that Ohm's law is not applicable to all radio circuits.

15. Effects of Current—The passage of current through a conductor can be determined by two principal effects:

1. Heating effect.
2. Magnetic effect.

When a current of electricity flows through a conductor, it encounters frictional resistance and a certain amount of energy is transformed into heat. The heat generated increases directly as the resistance; also the heat generated increases directly as the square of the current, and the time during which the current flows. This is expressed:

$$J = I^2 \times RT$$

(where J is the joule, I the current, R the resistance and T the time in seconds).

The joule is defined as that amount of energy which is expended during one second, by current of one ampere flowing through a resistance of one ohm. The joule per second is the practical unit of electrical power which has been named the watt.

Since power is the rate of doing work per unit of time, one watt per second would equal one joule. The power may be also expressed in the units of electromotive force and current strength. The power in watts in a given circuit in which direct current is flowing is equal to the product obtained by multiplying the current in amperes by the electromotive force in volts or:

$$\text{Watts} = I \times E.$$

The magnetic effect may be described as follows: Figure 9 shows a coil of wire wound around a soft iron bar and carrying a steady current furnished by the battery. While the current is flowing the bar will be found to have acquired the power to attract pieces of small steel or iron. If the current from the battery is broken the bar will not have the power of attraction for the iron or steel. Thus the current flowing through the solenoid has given it a new property called magnetism, and since it has this property only when the electric current flows it is called an "electromagnet."

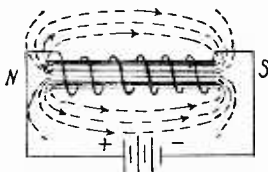

FIG. 9. Electro-Magnet.

If the soft iron bar is replaced by a bar of hard steel and the current is permitted to flow through the solenoid for a considerable length of time it will be found that the steel retains the property of attraction long after the circuit is broken from the battery. A piece of magnetized steel which retains its magnetism is called a "permanent magnet."

It will be found that the iron likewise has retained the property of attraction, but to a smaller degree than that of the hard steel. The steel is said to have a high degree of "retentivity," while the iron has but little retentivity.

The lines of force retained by a piece of iron after the magnetizing current has been turned off are called the "residual lines of force" and the iron is said to have "residual magnetism." Residual magnetism plays an important part in the operation of some types of generators which will be described later.

If a permanent magnet is dropped into a box of iron filings it will be noticed that there are two places on the steel magnet to which the iron filings cling most strongly. These places are near the ends of the bar and are called the "poles" of the magnet.

The poles always appear in pairs and are named north poles and south poles, because of the following fact: If the magnet is suspended in such a way that it is balanced and free to turn around



FIG. 10. Suspended Magnet Attracted by Earth's Magnetic Pole.

in a horizontal plane as in figure 10, it will be noted that the magnet will always come to rest pointing in an approximate north-south line. The same end or pole will always point northward; this is called the north or north seeking pole while the other end is called the south or south seeking pole.

The following experiment will indicate the power of attraction and repulsion of the poles of magnets. The north pole of the suspended magnet will be repelled when approached by the north pole of the other magnet; likewise, the south pole will be repelled when approached by another south pole, whereas if the north pole is approached by a south the suspended magnet will be attracted. Again if the south pole of the suspended magnet is approached by a north pole the suspended magnet will again be attracted. From

this experiment it will be found that like poles repel; unlike poles attract. This clarifies somewhat a statement in the preceding paragraph wherein it was noted that the end of the magnet pointing toward the earth's north pole was the north seeking pole. It is commonly called the north pole of the magnet, but according to the theory of attraction and repulsion of the poles of the magnet a north pole could not be attracted by the earth's north magnetic pole.

16. Angle of Declination—A magnet balanced upon a pivot and free to swing in a horizontal plane is called a compass. It takes a north and south direction. This is explained by saying that the earth has effective magnetic poles. These effective magnetic poles are near but do not exactly coincide with the geographical poles. Hence, there is an angle between true north and the direction which the compass points, magnetic north. This angle is called "angle of declination."

17. Magnet Field—If the field surrounding a magnet were to be examined it would be found to consist of definite closed lines.

The lines are called the magnetic lines of force. The magnetic lines of force start at a north pole and pass through a south pole back to the north pole. See figure 11. They make various routes depending upon the magnetic substance near them but they always come back to their source. The space through which they pass is called the "magnetic field."

18. Permeability—Whether a body will be acted upon by a magnet depends upon its ability to carry magnetic lines of force. This property of carrying lines of force is called permeability. Different kinds of iron have different degrees of permeability. The magnetic strength of an electromagnet or solenoid varies as the product of the amperes passing through the conductor and the number of turns or commonly called the "ampere turns." For example 100 amperes through 50 turns of wire gives the same result as 20 amperes through 250 turns, for 100×50 and $20 \times 250 = 5000$.

The magnetic strength of such a coil is also dependent upon the permeability of the iron; that is to say, the iron, in effect, increases many times the lines of force.

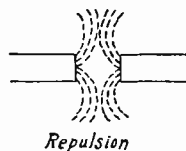
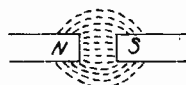
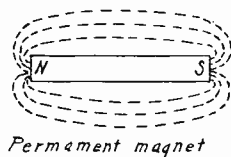

FIG. 11. Relation of Fields of a Magnet.

19. Theory of Magnetism—The following experiments and results give the base for a theory of magnetism. Take a magnet and strike it. The magnetism gradually disappears.

Take a bar magnet, cut it into pieces. Each piece will be found to be a magnet, no matter how small it is.

Take a magnet and heat it. The magnet becomes very much weaker and eventually loses its magnetism.

Take a piece of steel and stroke it with a magnet. The steel will become a permanent magnet.

Now when it is remembered that heat is caused by rapid vibration of the small particles of which a body is composed and that the final division of the magnet is also these small particles, it is easy to draw the conclusion that these small particles are magnets. The small particles are called molecules and hence this is known as the "molecular theory of magnetism."

It is not thought that these molecules are magnets sometimes and at other times not magnets. It is thought that these molecules are magnets always. If iron molecules are always magnets, why is it that a piece of iron is not always a magnet?

Consider the diagram of figure 11a. The small lines represent the molecules. It is seen that if they are arranged in a disorderly way the lines of force emanating from one molecular magnet go to the nearest south pole of another molecular magnet and so on back to their origin without going outside of the iron bar. Hence, there are no magnetic lines of force outside of the iron bar. Therefore, it is not a magnet.

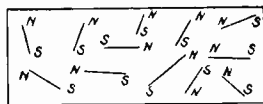

FIG. 11a. Arrangement of Molecules in Iron Bar Not Magnetized.

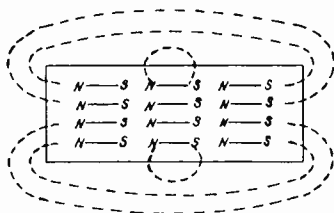

FIG. 11b. Arrangement of Molecules when Iron Bar is Magnetized.

If the iron bar is stroked by a magnet the molecules arrange themselves in an orderly manner as shown in figure 11b. The magnetic lines of force emanating from one molecular magnet pass to the next one and then to the next and to get back to their source

must go outside of the iron for they cannot double back on themselves. Hence, the iron bar is now a magnet.

20. Voltmeters and Ammeters—The fact that an electric current is always surrounded by a magnetic field is used in the construction of voltmeters and ammeters. The simplest kind of an ammeter is made by placing a compass in the center of a coil of wire. The deflection of the needle is greater, the greater the strength of current.

Another type of ammeter and the one most commonly used is made by having the magnet stationary and the coil movable. The moving coil principle was developed by a French scientist named D'Arsonval and is spoken of as the D'Arsonval movement. Figure 12 shows the arrangement of this instrument.

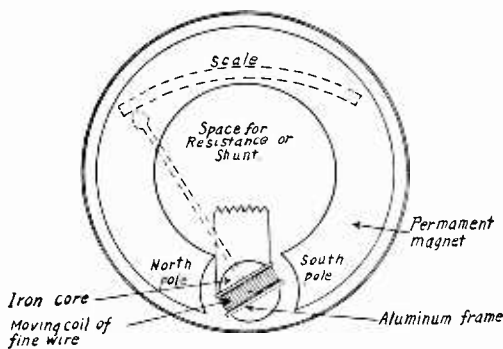

FIG. 12. Ammeter with D'Arsonval Movement.

Between the pole faces of a permanent magnet is placed an iron core, allowing a gap between it and the pole faces large enough to permit an aluminum frame to swing freely. On this frame is wound a coil of very fine wire, through which a certain percentage of the current to be measured passes. As this current passes through the coil, the latter becomes an electromagnet with north and south poles, which are immediately affected by the north and south poles of the permanent magnet. Obeying the magnetic law that like poles repel and unlike poles attract, the north end of the electromagnet is drawn toward the south pole of the permanent magnet and vice versa—which means that the aluminum frame is swung around and the pointer attached to the frame travels across the scale. Every meter of this type is in reality a millivoltmeter (millivolt— $1/1000$ of a volt) as the coil

is built in such a way that a small current flowing through it causes the action described.

Permanent magnets can be weakened by jarring and age; hence, makers of really good meters use carefully aged tungsten steel magnets.

21. Use of Shunt and Multiplier—A voltmeter is always shunted (connected in parallel) across the load whose voltage is to be measured. It is made with an extremely high resistance sometimes connected externally or when possible within the meter case. This resistance takes only a small current.

The ammeter is always connected in series with the load. It has a low resistance. In some ammeters only a constant fractional part of the total current passes through the coil, the remainder being conducted by the shunt which is calibrated for the particular ammeter.

An example will describe how these resistances and shunts are calibrated.

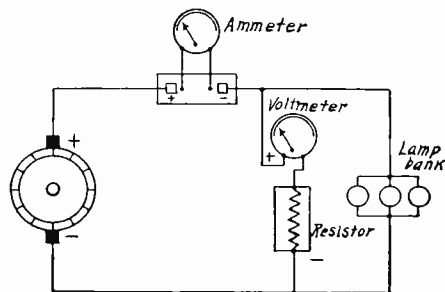

FIG. 13. Method of Connecting Voltmeter and Ammeter. Voltmeter Employing Resistor and Ammeter Employing Shunt.

If there are 10 feet of fine wire on the aluminum frame having a resistance of 1 ohm per foot, the total resistance is 10 ohms.

The frame is then set in position and it is found that 1/10 volt (100 millivolts) is necessary to send the pointer across the scale, i.e., the frame moves through approximately 10 degrees because of the magnetic pull exerted. Then according to Ohm's law $I = .100/10 = .010$ ampere, which is the amount of current used under .100 volt pressure to cause full scale deflection, and the balance must be used in resistance.

For an ammeter capable of measuring 5 amperes the current is permitted to flow through a shunt and just enough is permitted to flow through the coil to cause a full scale deflection. Suppose

it is desired to construct a 5-ampere meter. The start is made with a small meter, for instance, a .01 ampere (1/100 ampere) meter. The maximum current that it is desired to measure is 5 amperes. This can be done by splitting the current so that only 1/100 of an ampere goes through the meter while 4.99 amperes go around through another path. Figure 13 shows such an arrangement. The resistance of the other path, called a shunt, must accordingly be 1/499 of the meter resistance.

22. Telephone Receivers—The telephone receiver is an application of the property of magnetism. The telephone receiver, as used for ordinary telephone work, consists of a case holding a permanent horseshoe magnet, two coils of wire and a soft iron diaphragm, the latter being clamped by its rim with its plane at right angles and close to but not touching the poles of the permanent magnet. The extensions on the permanent magnet are fitted with bobbins which are wound with many turns of fine wire. The diaphragm is left free to vibrate except at its rim. The distance from the pole pieces to the diaphragm is normally fifteen thousandths of an inch (.015 inch).

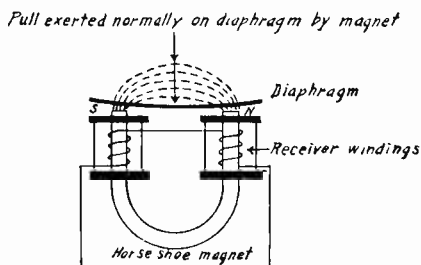

FIG. 13a. Construction of Telephone Receiver.

The action of the receiver is as follows: The permanent magnet attracts the diaphragm of the receiver, holding it under a steady attraction. If a varying or alternating current passes through the coils of the receiver, the strength of the magnet is varied. The pull on the diaphragm is therefore varied and if the changes in the current passing through the coils are rapid they will cause the diaphragm to vibrate accordingly.

Thus if the current passing through the coils is varied at the frequencies used in speech the diaphragm will vibrate accordingly reproducing the voice of the speaker.

The diaphragm is lacquered on one side and enameled on the

other. The lacquered side should be toward the magnet. As the efficiency of a receiver depends greatly upon the smallest practical air gap which is considered with the vibrations of the diaphragm, the side nearer the magnet is covered with a coat of lacquer, which is much thinner than the coat of enamel on the other side. The lacquer and enamel serve to protect the diaphragm from rust. The pole pieces of the magnet are lacquered for the same purpose.

As the receiver has a permanent north and south pole, current flowing in a given direction will either increase or decrease the strength of both poles, at the same time the coils being connected so as to accomplish this.

The distinctive features of telephone receivers for radio work are lightness of the moving part and the employment of a great many turns of the wire around the magnet poles. The lightness of the moving parts enables them to follow and respond to rapid pulsations of current. The large number of turns of wire causes a relatively large magnetic field to be produced by a feeble current. The combined effect is to give a device which will respond to very feeble currents.

The resistance of the windings of each of a pair of receivers for radio work is seldom less than 500 ohms, the values of resistance being measured with direct current. For radio work the windings of the two receivers constituting a pair are almost always connected in series.

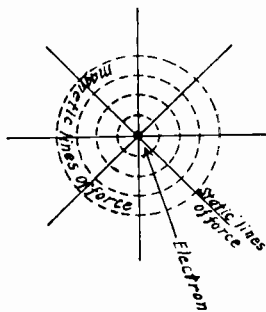

FIG. 14. Electron in Motion Produces Magnetic Lines of Force.

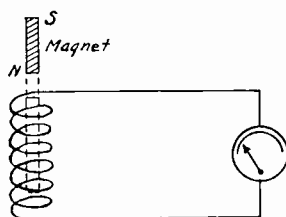

FIG. 15. Production of Current by Electro-Magnetic Induction.

23. Induction—A great discovery in electricity was the fact that a magnetic field in motion would cause a movement of electrons; that is, the production of current. The following experiment will illustrate this fact.

Take a coil of wire as in figure 15, drop a magnet end first through the coil. The needle of the milliammeter will move, indicating the presence of a current. It will quickly come to rest. Draw out the magnet. The needle moves again; but this time in the opposite direction. Reverse the magnet and repeat above. It will be noticed that the needle moves but in the opposite direction to its movement before the magnet was reversed. Use two magnets. The needle moves farther than with one magnet. Try moving the magnet faster and slower; the faster it moves the more the needle moves—i.e., the stronger the current. Notice that a current flows when and only when there is relative movement between the magnet and the coil. Try moving the coil instead of the magnet—the results are the same.

Substitute a piece of unmagnetized steel for the magnet. There is no current. The difference between the magnet and the steel is that the magnet is surrounded by magnetic lines of force. These experiments show that whenever a conductor is cut by magnetic lines of force there is a current produced. A current was produced by "electromagnetic induction."

Investigate further by having a current produce the magnetic lines of force and they in turn producing a current. Substitute an electromagnet for the magnet used in the previous experiment. Arrange a circuit as in figure 16. Press the key. The milliammeter

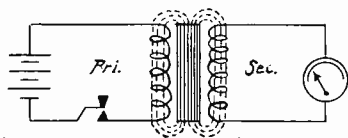

When a current is started or stopped in the primary circuit an EMF is induced in the secondary by electro-magnetic induction.

FIG. 16. Production of Current in a Secondary Circuit by Electro-Magnetic Induction.

needle moves in one direction and then comes to rest. Break the current by means of the key—the m.a. needle moves in the opposite direction and then comes to rest.

Insert an iron core in the coil of wire. The results are similar but the current induced is much stronger. In this experiment the conductor has been cut by magnetic lines of force. The circuit with the key is called the primary circuit—the other circuit, the secondary circuit, making the circuit in the primary allows a current to pass in it which sets up a magnetic field. This magnetic

field building up from the wire outward cuts the secondary, thus causing a current. When the primary circuit is broken the magnetic field collapses, and the secondary is again cut by lines of force, but this time going in the opposite direction.

All these experiments produce current by electromagnetic induction. The facts of electromagnetic induction may be summed up in the following way:

Whenever variable magnetic lines of force cut a conductor, or a closed circuit made by a conductor, there is an e.m.f. created in the conductor whose direction is such as to oppose the e.m.f. that produced it. The value of this back e.m.f. is proportional to the rate of change of the lines of force.

24. Self-Induction—Consider the circuit shown in figure 17. Close the key and a current will flow through the circuit. This

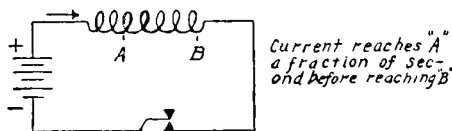

FIG. 17. Counter E.M.F. of Self-Induction.

current does not flow instantaneously so that it reaches a point *A* before it does *B*. The current passing through the turns of the coil sets up magnetic lines of force which cut the turns of wire producing an e.m.f. whose direction is such as to oppose the passage of the original current in the circuit. When the key is opened the lines of force collapse on the coil inducing an e.m.f. in the same direction as the original current and will try to keep the current flowing. Induction in the same circuit is called "self-induction."

25. Mutual Induction—Mutual induction is the interaction between two circuits by which a changing current in one sets up

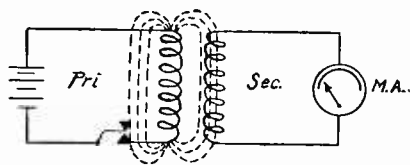

FIG. 18. Induced Current by Mutual Induction.

through electromagnetic induction a current in the other. Consider the circuit in figure 18. Whenever a current is started,

stopped, or varied in the primary coil, the magnetic lines of force set up around it cut the winding of the secondary, inducing an e.m.f. in the secondary circuit. A transfer of electrical energy has taken place between two circuits which have no electrical conducting path between them. Induction between two separate circuits is called "mutual induction."

The mutual induction of two given circuits depends upon the size and construction of the circuits themselves, their distance apart, their relative positions in space, and the nature of the material between them. All these factors necessarily affect the magnetic flux interlinked with both circuits. The effects of mutual inductance fall off rapidly as the distance between two circuits is increased. Mutual inductance is measured in the same unit as self-inductance.

Mutual inductance is of particular importance in radio circuits. The phenomena of mutual inductance are the essential principles involved in the operation of many different types of electrical apparatus, of which some are considered in the following pages.

26. Inductance—Inductance is defined as that property of a circuit which opposes a change in the flow of current through it. Inductance is electrical inertia.

Opposition to a change in the flow of current depends upon the amount of self-inductance, or upon the amount of self-inductance and mutual inductance combined. Every circuit possesses self-inductance, but only a circuit a part of which is a primary coil possesses mutual inductance. The inductance of a circuit is, therefore, the amount of self-inductance it possesses plus any mutual inductance which it may also possess. The unit of inductance is the "henry."

A circuit has an inductance of 1 henry when a current changing at the rate of 1 ampere per second induces an e.m.f. of 1 volt.

At radio frequencies where small values of inductance are employed the unit is subdivided and expressed as follows:

- 1 milli-henry (m.h.) — .001 h.
- 1 micro-henry (μ . h.) — .000001 h.
- 1 centimeter (cm.) — .000000001 h.

In self-induction this e.m.f. is set up as a counter e.m.f. in the circuit itself; in mutual induction, it is set up in the secondary circuit. In either case its effect is to oppose any change of flow of current through the circuit and is the measurement of opposition to that change. In any given conductor, the time it takes the current to build up to its maximum or to decrease to zero is influenced by the opposition to its increase or decrease in strength, that is, it is influenced by the inductance of the conductor. The

greater the inductance, the longer the time required for the current to reach its maximum strength.

The inductance of a circuit conductor, coil or of any apparatus is a property of that thing just as resistance is one of its properties. The impressed voltage does not affect the inductance. A conductor has inductance whether current flows in it or not.

27. Practical Forms of Inductors—The most commonly employed inductance at radio frequencies consists of a single layer coil wound as an air core solenoid. Other forms consist of multi-layer coils either in the form of spider web or honeycomb coil, so called on account of their peculiar construction.

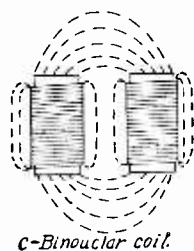
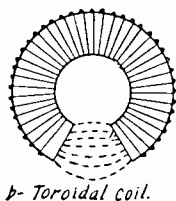
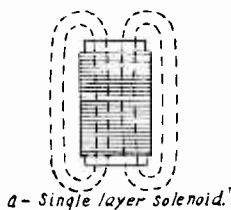

FIG. 19. Practical Forms of Inductance Coils Showing Electro-Magnetic Field Surrounding Each.

More recently there have appeared the toroidal and the binocular coil, so called from their shape. The extent of the magnetic field can be greatly restricted by altering the shape of the coil. By bending the coil into the shape of a "toroid" as *b*, figure 19, the field or magnetic flux is circulated around the center of the coil and confined to the limits of the coil.

Another scheme used to confine the magnetic field of a coil is what is called the "binocular coil." This form of coil is shown as *c*, figure 19. Here the coil is broken in two with the two halves placed side by side, the windings of each being connected in series. The flux passes through one half and returns through the other half. Both the toroid and the binocular type coils are used in modern radio receivers and their purpose is to confine the magnetic fields of the coils to prevent their reaction on earlier stages in the line of amplification.

28. Iron Core Inductance—This form of inductor is made by winding many turns of wire on an iron core. The core may be

of the open or closed type. An iron core inductance acts as an impedance to the flow of alternating or pulsating current. It is usually found in circuits of audio frequency. It ranges in value from 1 henry to 200 henrys in inductance. The use of such coils will be shown in later chapters.

29. Capacity Effects—When water is poured into a container the pressure in the container depends on how high the level of the water is raised; the pressure will be directly proportional to the quantity of water put into the container, and inversely proportional to its size and shape. The size and shape will qualify what might be called the capacity of the container. If the container is connected to a tank containing water, a discharge will flow into it until the levels or pressures are the same in both, and the greater the capacity of the container the more water will flow in to equalize the pressures.

30. Dielectric Current—Similarly, if a perfect insulating material, with no other conductors near it, is charged by connecting it by contact or by a wire to a source of e.m.f., a charge will flow into it until the two are at the same potential. A small sensitive indicator of current connected in figure 20 will show a sudden

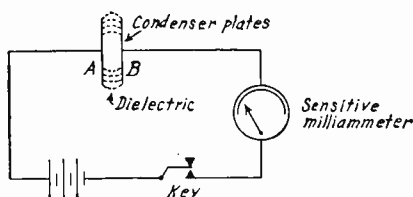

FIG. 20. Production of Displacement Current in a Condenser.

deflection each time the key is closed and will soon return to zero. The momentary flow of current is due to the production of an electric strain or displacement of electricity. This is resisted by a sort of elastic reaction of the insulator that may be called electric stress. On account of this reaction of the electric stress, the electric strain due to a steady applied e.m.f. reaches a steady value, and the current becomes zero. When the electric strain is allowed to diminish a current again exists in the opposite direction. A current of this kind, called a "displacement current," exists only when the electric strain or displacement is changing. When considering the existence of electric strain or displacement in an insulating material the material is called a "dielectric" and the displacement current is sometimes called a "dielectric current." The electric displacement is a movement of electrons with the positive electrons of each molecule of the substance gathered at one end and the negative at the other. A dielectric in such a strained condition possesses a charge of electricity and is sometimes called electricity in "electrostatic" form or electricity at rest.

31. Condensers—A condenser is constructed of several conductors placed parallel to each other and separated by an insulator called the dielectric. It usually takes the form of one metallic plate or set of plates joined together and separated from a similar plate or set of plates by a dielectric of glass, ebonite, paraffin, oil, mica or air.

The capacity of a condenser depends on:

- (a) The area of the plates.
- (b) The distance between the plates.
- (c) The material of the dielectric.

If an experiment is made of the effects of glass and air as the dielectric of a condenser, it will be found that the glass increases the capacity 6 to 10 times as much as the air.

The "dielectric constant" of a substance is, therefore, its effect when used as a dielectric as compared with an air dielectric. The following table shows the dielectric constants of various materials used as insulators in condensers.

| Material | Dielectric Constant |
|---|---------------------|
| Air | 1.0 |
| Glass | 4.0 to 10 |
| Mica | 4.0 to 8 |
| Hard Rubber | 2.0 to 4 |
| Paraffin | 2 to 3 |
| Paper, dry | 1.5 to 3 |
| Paper (Treated as used in cables) | 2.5 to 4 |
| Moulded Insulating Material, Shellac base | 4 to 7 |
| Moulded Insulating Material, "Bakelite" | 5 to 7.5 |
| Transformer Oil | 2.5 |
| Water, distilled | 81.0 |

A wide variation is seen in the values given for some substances. The different grades and kinds of different materials vary considerably in many of their physical properties, including their electrical properties. For instance photo glass as used for plates has a higher dielectric constant than that of plain window glass. Moulded insulating material known to the trade as bakelite has a much higher dielectric constant than other substitutes commonly spoken of as moulded "mud."

If the voltage applied is from a source of alternating current, the values of the dielectric constant may differ considerably from the values of direct current. This is particularly true if the alternating current has a very high frequency, such as used in radio communication.

Dielectric materials are not perfect insulators, but do have a very

small conductivity. A charge in a condenser will be slowly dissipated if allowed to stand with its terminals disconnected. This is called the "leakage" of the condenser. A condenser of which the dielectric is moulded "mud" or paper which has not been treated will sometimes discharge due to leakage within a few minutes. The lower the degree of conducting the longer the charge will remain in the condenser.

The thinner the dielectric, everything else being equal, the greater the capacity. The breaking down potential for a dielectric depends on its thickness as well as on the material; consequently, the thickness of the dielectric which must be used in a condenser depends on the potential strain it will be required to stand as well as the material used in the dielectric. Thus, the dielectric strength is measured by the voltage which will break down the insulation of unit thickness of the material. The values vary according to the shape of the electrodes between which the dielectric is placed. Thus, when capacity is increased by decreasing the thickness of the dielectric for a given potential, there is a certain thickness for each dielectric that may be used and the best dielectric has not necessarily the highest dielectric strength.

The larger the capacity of a condenser the more charge is required to bring it to a given potential. Thus, the potential is directly proportional to the charge and inversely proportional to the capacity as in the water analogy, or in the symbols.

$$E = \frac{Q}{C} \quad \text{or} \quad C = \frac{Q}{E} \quad \text{or} \quad Q = C \times E,$$

E = potential,

Q = quantity or charge,

C = capacity.

Unit capacity would be that of a condenser which is raised to unit potential by unit charge. The practical unit of capacity is called the "farad." A condenser whose capacity is one farad would be raised to a potential of one volt by a charge of one coulomb. A farad is far too large a unit for ordinary purposes and the following sub-divisions are generally employed in practice as follows:

I. " μ fd." = .000001 farad,

*I " $\mu \mu$ fd." = .00000000001 farad.

(* Sometimes written "pfd" mean pico farad, will probably replace micro-micro-farad.)

32. Dielectric Hysteresis—If a charged condenser is discharged and left undisturbed for, say, 30 seconds, a small second discharge can be obtained from it, and sometimes a third one. This is due to the fact that when charged the strain across the dielectric causes the charges to leave the plates and really settle on the surface of the dielectric, through which they are bound by electric lines of force, or ether strain in the dielectric. When the opposite sets of plates are suddenly discharged through a circuit joining them, such as a wire or a spark gap, the following electrons rushing around the circuit neutralize the positive and negative charges but some are still left straining across the dielectric, trying as it were to get across that way instead of taking the easier path that has suddenly been provided for them; the dielectric does not entirely recover from the strain when the discharge takes place. The charge which flowed out instantaneously upon discharge is called the "free charge." The charge which flows out the second or third time is called the "absorbed" or "residual charge." In condensers made with oil or well-selected mica for the dielectric, absorption is small. This absorption is manifest by heat in the dielectric and represents a loss of energy.

33. Series and Parallel Connection of Condensers—Condensers may be connected either in series or in parallel. If connected in parallel, the combined capacity is equal to the sum of their capacities, or:

$$C = C_1 + C_2 + C_3.$$

Connecting them in parallel is equivalent to adding the plate areas. If three condensers of similar construction each having a capacity of $.004 \mu$ fd. are connected in parallel, the resulting capacity would be $.012 \mu$ fd.

If three condensers are connected in series the resulting capacity is less than one alone. If the condensers have equal values of capacity, their combined capacity is obtained by merely dividing the capacity of one by the number of condensers in series, but if they have unequal values, the resulting capacity is equal to the reciprocal of the sum of the reciprocals or,

$$C = \frac{1}{\frac{1}{C_1} + \frac{1}{C_2} + \frac{1}{C_3}}.$$

If three condensers of $.004 \mu$ fd. are connected in series, the resulting capacity would be $.0013 \mu$ fd. If three condensers of

.002, .003, and .004 μ fd. were connected in series the resulting capacity would be .00092 μ fd.

The voltage that several equal condensers in series will safely stand is as many times greater than the voltage of one as there are

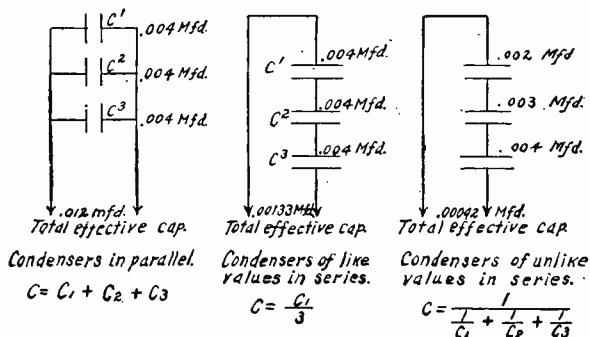

FIG. 21. Series and Parallel Connection of Condensers.

condensers in series. Advantage of this is often taken in building condensers for high voltages. Using this principle, a .004 μ fd. condenser to stand 20,000 volts can be made of twenty 1000-volt sections of .08 μ fd. each, all connected in series.

Transmitting condensers are sometimes protected by having a safety gap mounted on their terminals. The gap is so spaced that should the condenser be subjected to an excessive voltage a discharge will take place across the gap, thus lowering the potential of the condenser and preventing a rupture of the dielectric.

It has been shown that a condenser when first connected to a charging source has zero potential, and as the current flows, the voltage rises until the voltage of the condenser is equal to the voltage of the charging circuit; the flow of current then stops. If the charging potential is decreased, the condenser will start to discharge and current will flow out in the opposite direction to which it was charged. The voltage of the condenser tends to set up a back pressure which tends to drive the charging current back. The effect of capacity in a circuit increases the time required to obtain a maximum flow of current through the circuit. Inductance in a circuit tends to prolong the flow of current while capacity tends to extinguish it or hold it back. The effects of counter e.m.f. of inductance and capacity produce a great effect on the flow of alternating current.

34. **Alternating Current**—An alternating current differs from

a direct or steady current due to the fact that it is changing in direction and strength.

From zero potential it starts to flow in one direction; reaching a maximum value it gradually returns to zero potential, only to flow again but in the opposite direction, reaching a maximum value in this direction and again returning to zero potential. This constitutes what is called one complete cycle. Each cycle is composed of two alternations. One alternation is the flow of current in one direction starting from zero rising to a maximum value and returning to zero again. The highest value of current reached during an alternation is called its amplitude. The number of complete cycles occurring during a second of time is called the frequency of the current. Thus a 500-cycle generator produces 1000 alternations of current per second. The process is conveniently pictured by what is commonly called a "sinewave" as shown in figure 22.

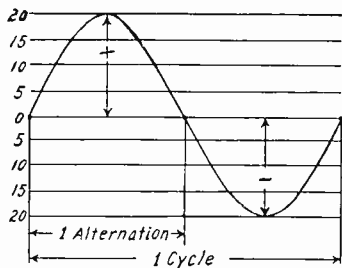

FIG. 22. Curve of One Complete Cycle of Alternating Current.

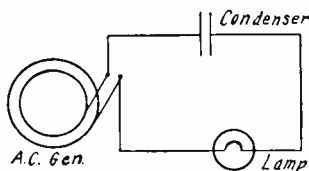

FIG. 23. Condenser in Series with A.C. Circuit.

It can be shown that the voltage and current curves of an alternating current may be irregular or distorted in form and if pictured graphically will show besides the fundamental, other frequencies which are multiples of the fundamental and are known as harmonics. If a harmonic is double the frequency of the fundamental it is known as the second harmonic; if three times, the third harmonic and so on. The fundamental is known as the 1st harmonic. Harmonic frequencies are quite common to radio frequency currents as will be shown later.

Alternating currents having a frequency below 10,000 cycles per second are called audio frequency currents and those above 10,000 cycles are called radio frequency currents.

An alternating current can flow in a condenser in the form of a

dielectric current. An alternating e.m.f. in a circuit with a condenser will have the effect of allowing the current to flow through the condenser. Consider the arrangement as shown in figure 23. A very small lamp and a condenser of at least 20 micro-farads are connected in series with an alternating current generator. As long as the circuit is closed the lamp will be lighted indicating the passage of current.

If direct current was applied to this current the lamp would be lighted only momentarily such as when the circuit was closed or until the condenser was charged to the same e.m.f. as the applied e.m.f. With an alternating e.m.f. in the condenser circuit the alternating current is constantly flowing into and out of the condenser to keep the voltage between the plates equal to the instantaneous value of the applied e.m.f. The current is largest at those moments when the applied e.m.f. is changing most rapidly, it is zero at the moments when the e.m.f. is for a moment stationary at its maximum values.

35. Impedance—The flow of direct current through a given circuit is opposed only by the ohmic resistance, but the flow of alternating current is opposed by the counter e.m.f. of self-induction as well as ohmic resistance. The effect of self-induction in a direct current circuit is only momentary, the effects being observed only when the current is changing in value such as would occur when the circuit is closed or opened. Consider the circuit as shown in figure 24. The presence of the choke coil retards the

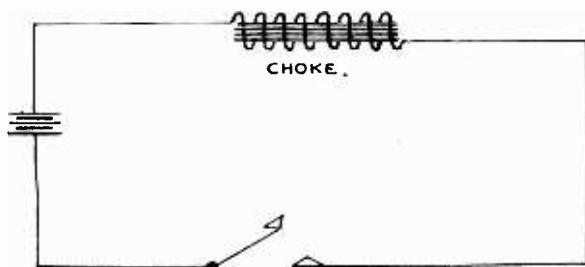

FIG. 24. Reactance Coil.

flow of current when the key is closed and tends to prolong it after the key is opened. If the battery were to be replaced by an alternating current generator there would be a constant opposition to the alternations of current, i.e., the counter e.m.f. self-induction of the choke would retard an alternation from reaching its maxi-

imum amplitude and would also tend to delay it from falling to zero. The counter e.m.f. of self-induction is called reactance and as it is a certain form of resistance it is convenient to measure it in ohms. The combined opposition of reactance and ohmic resistance is called impedance (expressed as Z) and it also is measured in ohms. However, the combined resistance, or impedance of a circuit in which there are values of reactance and ohmic resistance is not found by adding the values of each but expressed as follows:

$$\text{Impedance or } Z = \sqrt{R^2 + X^2}.$$

Where R = resistance of circuit in ohms.

X = reactance of circuit in ohms.

The counter e.m.f. occasioned by a circuit loaded with inductance is termed "inductive reactance." It is expressed:

$$\text{Inductive reactance} = 6.28 \times NL.$$

N = frequency in cycles per second.

L = the inductance in henrys.

From the formula it can be seen that the higher the frequency the greater will be the inductive reactance. At radio frequencies (frequencies in excess of 100,000 cycles) the reactance of a given coil reaches high values.

The counter e.m.f. occasioned by a condenser in series with an alternating current is called capacity reactance. It is expressed:

$$\text{Capacity Reactance} = \frac{1}{6.28 \times NC}.$$

N = frequencies in cycles per second.

C = capacity of condenser in farads.

A condenser offers less obstruction to the flow if the alternations are rapid than if they are slow.

36. Phase Displacement—If an alternating current circuit is composed of resistance only the current and voltage sinusoids reach their maximum points at the same instant and simultaneously pass through zero. By introducing inductance in the circuit the current curve reaches the maximum at a time later than does the voltage curve, the interval of time depending on the value of the inductance and the frequency of the circuit. This difference in time is called phase displacement. Such a circuit is said to have a "lagging phase." See left hand drawing of figure 25.

If a condenser was placed in the same circuit and capacity reactance predominated the opposite condition would exist, that is, the current would "lead" the voltage, reaching its maximum at a

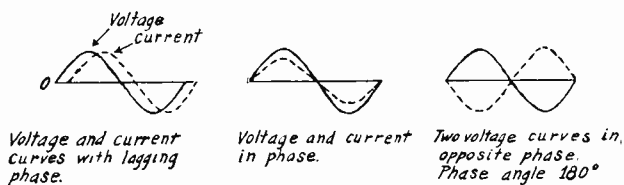

FIG. 25. Curves Showing Lagging and Leading Phases.

time before the latter. A circuit of this type is said to have a "leading phase."

Difference in phase is nothing more than difference in position in the cycle. Phase displacement is expressed in terms of the degrees of a circle, i.e., an alternating circuit current is said to have an angle of lag of a certain degree depending upon the constants of the circuit.

The effect of phase displacement on the power of the circuit is to reduce the value of power for the same value of current and voltage as compared to the power in a purely resistance circuit. Whenever an alternating current load contains reactance elements, then the product of E and I does not give the power put into that load. This product must be corrected by being multiplied by the "power factor" which is always smaller than one and is usually

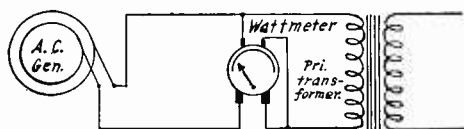

FIG. 26. Wattmeter Connections.

given in percent. Since one generally does not know the power factor it is therefore best to use a watt-meter which makes the multiplication and correction automatically.

37. Single and Polyphase Alternating Current—An alternating current having but one e.m.f. is known as a single phase current. An a.c. having two more e.m.f.'s differing by a fixed amount is called a polyphase current.

If three conductors were spaced on an armature 120 degrees

apart and revolved between the poles of a U magnet there would be generated in the conductors three e.m.f.'s differing in phase by 120 degrees. If the three conductors are connected to an external circuit the system would be known as a three-phase circuit.

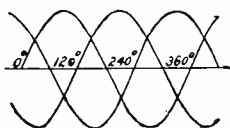

FIG. 27. Voltage Curve of Three-Phase Alternating Current.

38. Effective Value of Alternating

E.M.F. and Current—In order to determine the effectiveness of an alternating current the root of the average square (r.m.s.) of the instantaneous values of current is taken and is expressed in terms of the strength of a given direct current which would produce the same power or heating effect.

Example: If 10 amperes of direct current pass through a resistance of 2 ohms the power of the current converted to heat will be I^2R or $10^2 \times 2 = 200$ watts.

If an alternating current is passed through the same resistance and is adjusted as to strength that 200 watts are consumed in heat there will be 10 amperes of alternating current flowing.

The effective value of alternating current is .707 of the maximum value per alternation. The maximum value of the current in figure 22 is 20 amperes. Its effective value is $20 \times .707 = 14.14$ amperes. The current rises and falls uniformly between the value of + 20 amperes and - 20 amperes, producing the same heating effect as a direct current of 14.14 amperes.

The maximum voltage per alternation of an a.c. circuit is 1.41 times the effective value. The maximum voltage per alternation in 110 volt a.c. circuits is then 155 volts.

Commercial alternating currents are usually of sine form at the generator although many things can happen after that to distort the wave form. Alternating current meters read in "effective value," or "direct current equivalent," so one needs no mathematics to determine the effective values of such currents.

39. Hot Wire and Thermo-Couple Ammeters—Radio frequency currents are measured by the heating effect of a piece of wire or strip of metal. Such instruments are called "thermal ammeters." They are divided into two classes called "hot-wire" and "thermo-couple" ammeters.

The hot-wire ammeter depends for its action upon the expansion of a metal wire when it is heated. Figure 28 illustrates the principle. The wire AB is connected with the radio frequency current. The resistance of the wire is such that it will stretch when heated by the r.f. current. The spring S exerts a pulling action on the slackened wire through the thread T . The resultant mo-

tion causes the needle *N* to move over the scale. The degree of movement depends upon the amount of current flowing in the wire *AB*. The scale is calibrated in amperes so that the position of the needle shows directly how large the current is.

The thermo-couple ammeter depends for its action on the e.m.f. produced by heating two dissimilar metals. The value of e.m.f. depends on the combination of metals and ordinarily increases directly as the temperature is increased.

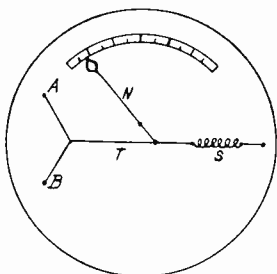

FIG. 28. Principle of Hot-Wire Ammeter.

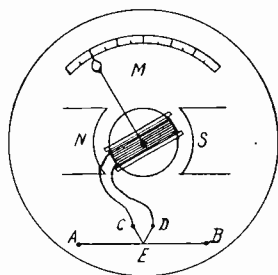

FIG. 29. Principle of Thermal Ammeter.

The theory of operation can be explained by referring to figure 29. The two dissimilar metals *C* and *D* make contact with the hot wire *AB*, in which the radio frequency current is flowing. The e.m.f. produced by the heat at the junction *E* is communicated to the direct current ammeter *M*. As previously explained, the heat due to given number of amperes of alternating current is the same as that of an equal number of amperes, direct current. A deflection of the needle of the ammeter indicates the effective value of current as alternating current meters of radio frequency variety read in "effective value" just as do ordinary 60-cycle or 500-cycle instruments.

40. Skin Effect—The resistance offered by a wire to radio frequency current is not the same as for a direct current. The resistance increases with frequency. Radio frequency currents are conducted only on the surface of the wire, hence, it is the surface area and not the cross-sectional area which is the most important in determining the resistance to currents of high frequency. Stranded wire or tubing, or metal strip is often used in connecting up radio apparatus, because the same amount of copper has much more surface in such shapes than when it is formed into solid wire. It should be remembered, however, that it is possible to carry this

to extremes. It is common for radio amateurs to use large strip copper where there are only small currents. There is no point in this and it needlessly complicates the apparatus.

41. Frequency Meters—The speed of induction motors, motor generators and other alternating current apparatus depends on the frequency of the supply circuit. Change in frequency is accompanied by a change in speed. Changes in frequency cause corresponding changes in the reactance of circuits, which may be a considerable disadvantage. A consideration of these facts leads one to appreciate the need for a reliable frequency meter.

Weston frequency meters are found on the switchboards of almost all radio transmitters of the spark type. They are employed in the power circuit of transformers at frequencies of the order of 500 and 1,000 cycles per second and are known as the resonant type of frequency meter, model 355, type 2.

The type 2 instrument is self contained, i.e., the reactors, resistors and condenser are contained within the instrument case.

Figure 30 illustrates diagrammatically the electrical circuits of the instrument. The vertical field coils designated as 1 are connected to the line through a resistor R , a condenser C , and two protecting reactors, $X-1$ and $X-2$. The horizontal field coils 2 having a reactor X in series with them, the coils and the reactor are shunted by the condenser C .

By referring to figure 30 it will be seen that the current which passes through the reactor X traverses field coils 2. This is a lagging current. It produces in coil 2 a magnetic field tending to hold the needle in a plane perpendicular to the coils. This lagging current also traverses coil 1.

The current which passes through the condenser C likewise traverses coils 1 but this is a leading current. The resultant of the lagging and leading currents in coils 1 produces a magnetic field tending to displace the needle from the normal position.

When the frequency is lower than normal the lagging component of the current in coils 1 preponderates because of the decrease in reactance of reactor X and the increase in reactance of condenser C . Therefore, the effect of the resultant current in coils 1 is to deflect the needle to the left of its normal position.

When the frequency is higher than normal the leading component of the current in coils 1 preponderates as the reactance of X is increased and that of C decreased. The resultant current now causes the needle to deflect to the right of its normal position.

At normal frequency the effect of the fundamental of the cur-

rent passing through coils 2 is very greatly magnified by the circuits 2, X , C , becoming resonant.

Because of this the current passing through coils 2 is very large while what passing through coils 1 is only the small line current. Thus the action of coils 2 on the needle is so great and that of coils 1 so small that the needle remains in its normal position. The resonant feature enables a large torque to be obtained with a very small current being taken from the circuit.

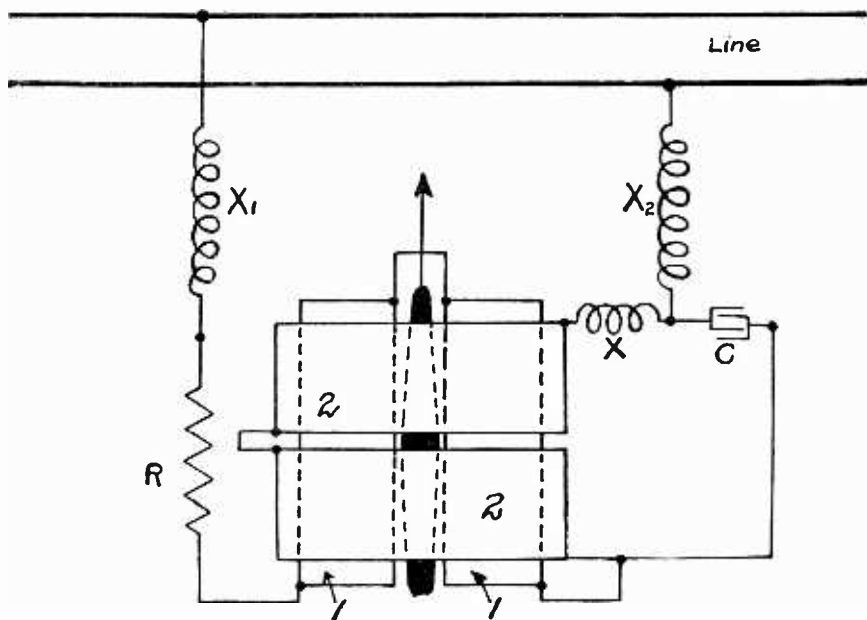

FIG. 30. Circuit of Frequency Meter.

Because the resonant circuit amplifies the effect of the fundamental only and the reactors $X-1$ and $X-2$ together with the resistor R prevent the passage of harmonics through the field coils 1, this instrument is not at all affected by distorted wave form, indicating with the same degree of accuracy on a sinusoidal wave form or on a wave having practically a rectangular form.

Model 355, type 2, instruments are designed for a normal voltage range from 110 to 220 volts, with an overload capacity, which allows the voltage to reach 350 volts without injuring the instrument. This renders the instrument suitable for use on radio

telegraph sets when the open circuit is high but the operating voltage considerably lower.

42. Resonance in Alternating Current Circuits—By the proper selection of inductance and capacity values in an alternating current circuit the counter e.m.f.'s can be made to balance and the reactance therefore reduces to zero. The circuit then acts as if neither inductance nor capacity were present and the flow of current is governed solely by the ohmic resistance. When this condition exists the circuit is said to be a resonant circuit as the frequency of the circuit corresponds to the frequency of the current flowing in the circuit. The frequency at which this occurs is called the "resonance frequency." Every combination of capacity and inductance has its reactance equal to each other at some frequency or other, which is usually a frequency different from the one that it is desired to work at. Therefore, it is convenient to have either the inductance or the capacity or both variable so that the "resonant frequency" can be adjusted to that desired.

The inductive and capacity reactance will be equal in such a circuit if the following condition exists:

43. Inductive Reactance = Capacity Reactance, or

$$6.28NL = \frac{I}{6.28NC} .$$

44. Reactance Coils—Reactance coils consisting of several turns of insulated wire wound on an iron core are connected in series with alternating current circuits at commercial frequencies to either secure resonance at a certain frequency or to provide an inductive reactance whereby the current flowing in the circuit is retarded. The reactance of such coils is made variable by either providing taps on the windings connected to a suitable switch or the reactance value can be changed by moving the core in and out of the windings.

Reactance coils having air cores are employed in radio frequency circuits and are known as radio frequency choke coils. The reactance of such a coil is very high at such frequencies. They are used to prevent the flow of radio frequency currents in some branch of the circuit.

The reactance of a given coil at radio frequencies may be of such a high value that little or no current would flow unless a certain amount of capacity was inserted in the circuit in the form of a condenser. By making the values of both inductance and capacity variable the inductive reactance can be made to equal the

capacity reactance and then the current will build up to large values. If a condenser of .00015 farad were connected in series with a 60-cycle alternator the capacitive reactance would be:

$$\begin{aligned} \text{Cap. Reactance} &= \frac{I}{6.28 \times 60 \times .00015} \\ &= 17.6 \text{ ohms approx.} \end{aligned}$$

If resonance were desired in such a circuit it would be necessary to insert an inductance of .046 henry approx. as:

$$6.28NL = \frac{I}{6.28NC}$$

Substituting,

$$6.28 \times 60 \times .046 = \frac{I}{6.28 \times 60 \times .00015}$$

In order to transfer energy from one circuit to another by magnetic induction as is done in radio telegraphy and telephony the circuit to which energy is to be transferred must be in resonance with the first circuit.

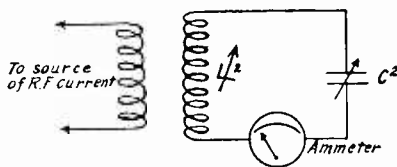

FIG. 31. Showing How Resonance is Obtained in an Alternating Current Circuit.

It can be adjusted to resonance by trying different values of inductance and capacity until the current indicating device of the second circuit shows a maximum deflection.

The process of adjusting the circuits to resonance is called "tuning." Figure 31 shows the arrangement of two radio frequency circuits electromagnetically coupled whereby they can be tuned to resonance by choosing different values of inductance or capacity.

45. Alternating Current Transformers—There are two kinds of alternating current transformers commonly employed in radio telegraphy and telephony. The purpose of one is to change or

transform alternating current of low voltage and comparatively large current to alternating current of higher voltage and smaller current or vice versa.

The transformer which is used to produce a higher voltage is called a "step-up" transformer. A transformer used to produce a lower voltage than the input is called a "step-down" transformer.

The step-up transformer is employed to produce high voltages to charge condensers in a spark system for radio transmission. It is also used to produce high voltages for the plate supply of vacuum tube transmitters. The step-down transformer is used to operate the filaments of vacuum tubes.

46. Construction—An alternating current transformer consists of two windings so placed as to have appreciable mutual inductance. The winding or coil to which the input power is delivered is called the "primary" and the winding which delivers the "output" to the load circuit is called the secondary. These windings are placed over an iron core which is common to each and increases their mutual inductance.

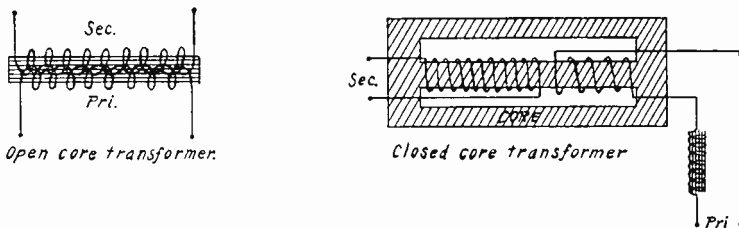

FIG. 32. Open and Closed Core Transformers.

In some transformers the path of the magnetic flux is partly through the air; such a transformer is called an "open-core" transformer. A transformer on which the magnetic flux is entirely through iron is called a "closed core" transformer. The two different types are shown in figure 32. A closed core transformer has a very small leakage flux. Very little flux exists in the air surrounding the core due to the complete path of high permeability offered by the closed core. Usually the primary consists of several coils or "pies" connected in series and placed directly over the center of the iron core with strips of wood to space the winding from the core in order to allow ventilation.

The secondary also consists of several pies connected in series

and slipped over the primary with an insulating tube between them.

Transformers having air cores are employed at radio frequencies. The mutual inductance of such windings of an air-core

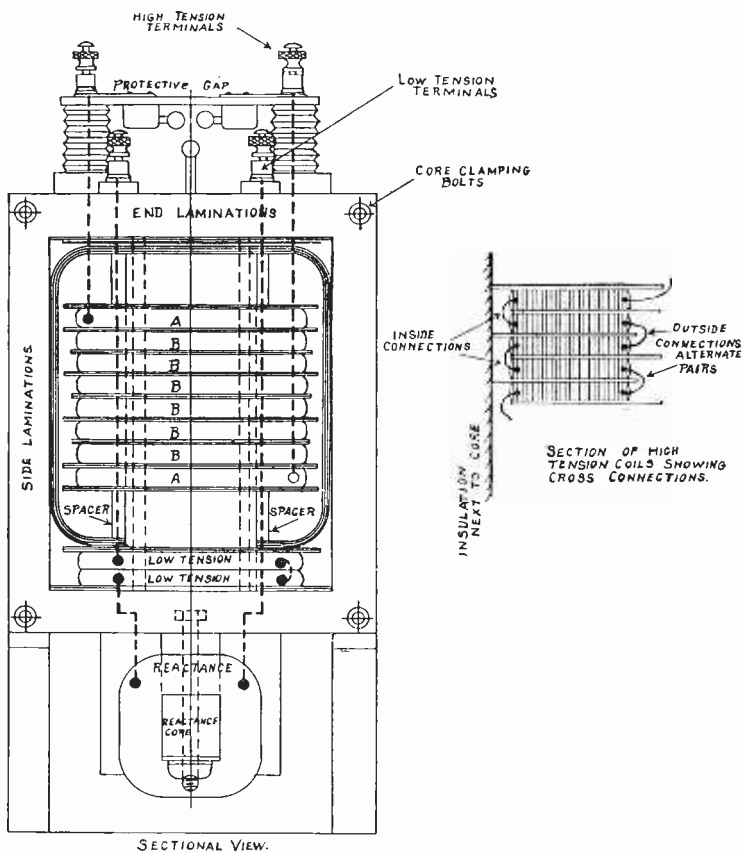

FIG. 33. Sectional View of Closed Core Transformer.

transformer is comparatively small. At low frequencies the efficiency of such transformers is very low. If such transformers

were to be employed at high powers it would become very expensive.

The core of an alternating current transformer employed at 60 cycles is constructed of many thin sheets or laminations of silicon steel. By the use of silicon steel laminations the losses due to eddy currents are reduced and the transformer can be operated at higher flux densities than one which is not laminated.

47. Ratio of Transformation—If the primary of a step-up transformer has 100 turns and the secondary 1000 turns, the turn ratio is expressed as 1 to 10.

When an e.m.f. of 200 volts is applied to primary an e.m.f. of 2000 volts will be induced in the secondary, and if the primary current is 50 amperes, the secondary current will be 5 amperes. From this it can be seen that the larger the number of turns on the secondary as compared to the primary the larger will be the voltage induced in the secondary, and if the voltage is stepped up the current is reduced or will have a smaller value than that of the primary. The secondary of a step-down transformer, therefore, has fewer turns than the primary but the wire must be larger.

48. Transformer Operation—The primary circuit of the transformer is connected in series with a source of alternating current which magnetizes the iron core, periodically causing a varying flux to flow through the iron core in accordance with the alternations of current. The variable flux cuts the windings of the secondary, thereby inducing an e.m.f. in this winding, and if the secondary is a closed circuit a current will flow. The current will flow in the secondary in such a direction as to tend to cause a magnetic flux in the core in a direction opposite to the direction of the flux caused by the current flowing in the primary. The flux existing in the iron core must be of sufficient magnitude to induce in the primary winding a back e.m.f. of the same value as the terminal voltage. In order to maintain the flux constant, the current flowing in the primary winding must increase to a value such that the increase in the primary ampere-turns is sufficient to overcome the opposing magnetic effect of the secondary ampere-turns. This reduces the effective inductance of the primary to such a value that sufficient primary current is available in order to maintain a constant flux; when the load is on the secondary the effective inductance of the primary becomes quite small.

49. Losses—The principal losses in a power transformer are of two kinds, the "copper losses" and the "core or iron losses." The copper losses in the primary and secondary windings are equal to the current squared times the resistance. The "core losses" are

of two kinds, the first of which is the "eddy current" losses due to currents induced in the iron core. By the use of laminations in the core the eddy current loss is considerably reduced. Due to

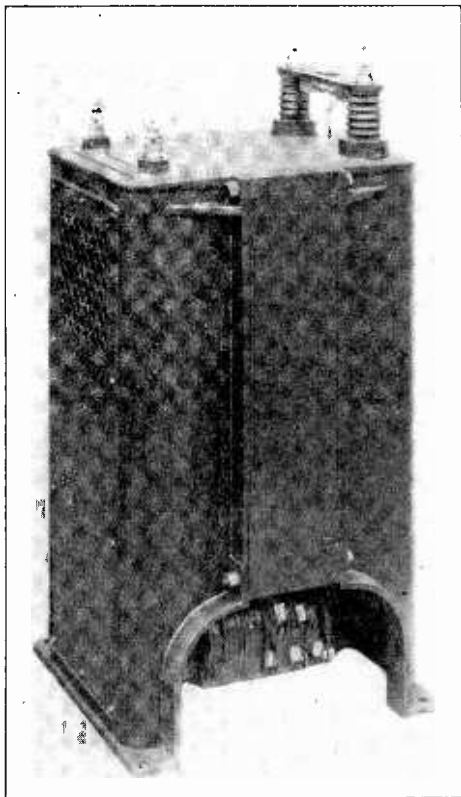

FIG. 33a. 2 KW. 500-Cycle Transformer. (American Transformer Co.)

the constant reversals of magnetism within the core considerable energy is expended in changing the positions of the molecules of the iron laminations. This expenditure of energy is known as the "hysteresis" loss. The core losses occur as long as a voltage is applied to the primary and are nearly the same whether the secondary is delivering a load current or not.

50. Cooling—The losses in a transformer represent electri-

cal energy converted into heat. Some means must be provided for dissipating this heat, or the temperature of the transformer may rise, until it is destroyed. Radio transformers of small size are usually cooled by simply being exposed to the air. The exposed surface of the winding is sufficient to dissipate the heat. Large transformers are cooled by immersing the windings in oil.

51. Reactance Regulator—The low frequency power circuit of a radio spark transmitter is usually adjusted so that it is resonant at frequency. This prevents the note of the transmitter from “mushing” when the key is closed. It is accomplished by connecting a reactance coil in series with the primary windings of the transformer. Such a reactance is either variable in steps or is of a fixed value and adjusted at the factory by the manufacturer.

52. Method of Connection of Two-Phase and Three-Phase A.C. Transformers¹—Two-phase circuits nearly always have four wires and are equivalent to two single phase circuits in which the currents have the same frequency and always preserve a definite phase relation to each other. Both phases are used for motors, half the power being drawn from each phase so that the same

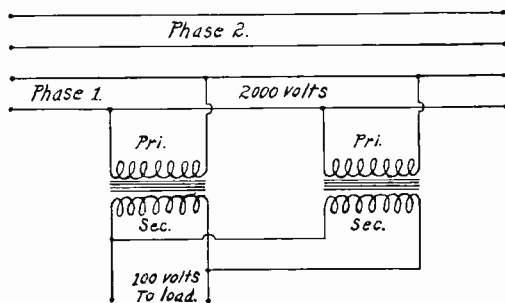

FIG. 34. Parallel Connections of Step-Down Transformers to Two-Phase Current.

transformer capacity must be connected to each phase. For lamps, the transformers are connected the same as to single-phase circuits, care being taken to divide the load between the two phases as nearly equal as possible. If two transformers are connected in parallel, both primaries must be connected to the same phase as in figure 34. If connected to different phases secondary currents will

¹This paragraph by courtesy International Textbook Company, Copyright. Used by permission.

be out of phase and local currents will circulate through the secondary coils, resulting in waste of energy and unnecessary heating.

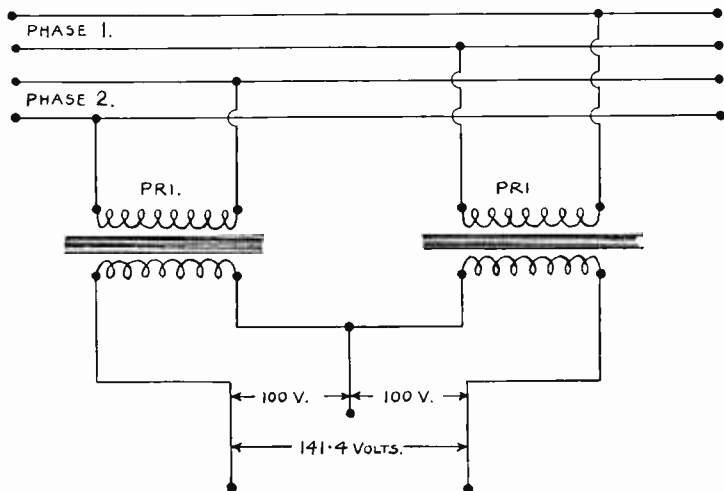

FIG. 34a. Two-Phase, Three-Wire System.

The secondaries of a pair of transformers may be connected in series with one primary connected to each phase of the line circuit, thus forming a two-phase, three-wire secondary system.

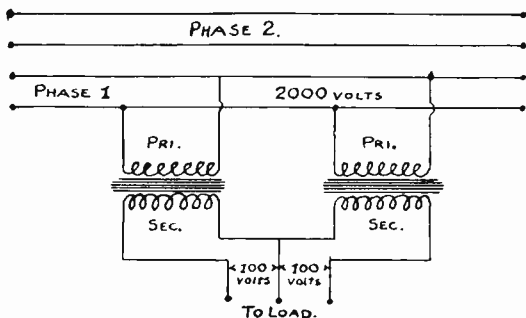

FIG. 34b. Secondaries in Series and Primaries Connected to Same Phase.

See figure 34a. This method is seldom used, since the voltages on the two sides of such a system are easily unbalanced.

The secondaries may be connected in series and both primaries connected to the same phase as in figure 34*b*, forming the regular three-wire secondary system. The voltage between the outside secondary wires is the sum of the voltages on the two sides.

53. Three-Phase Circuits—When three transformers are connected as in figure 35, two coils are in series across each phase. This is called a *Y* or star connection. When the primaries are connected *Y*, the secondaries are usually connected in the same way.

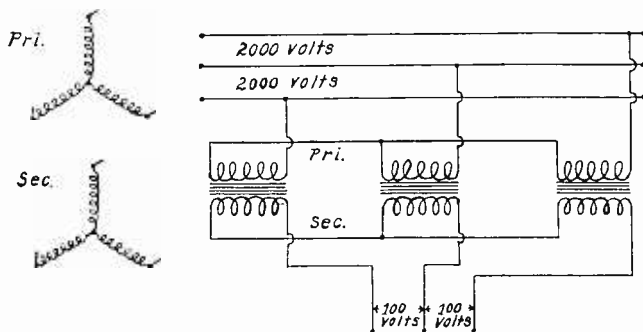

FIG. 35. "Y" or Star Connection of Three-Phase Transformers.

The terminals of the transformers may be connected, as in figure 36, thus forming a delta Δ or mesh connection.

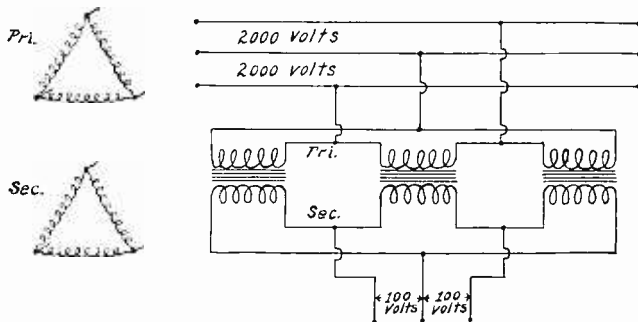

FIG. 36. Delta (Δ) or Mesh Connection of Three-Phase Transformers.

In special cases, the primaries may be connected delta and the secondaries *Y* of the same transformers. Figure 37 shows such

connection, as employed in radio telephony for producing high voltages for the plate supply of rectifier tubes which after rectification and filtering is used as the d.c. supply to the other tubes of the transmitter.

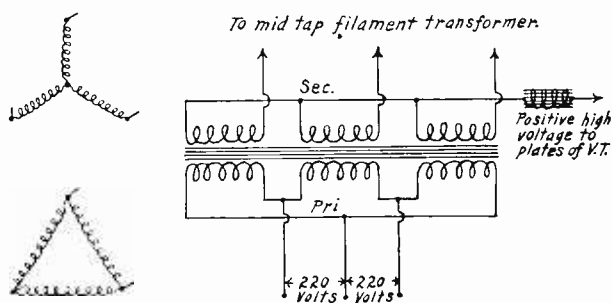

FIG. 37. Delta Connection of Primaries and Star Connection of Secondaries as Used for Plate Supply for Radio Transmitters.

54. Induction Coil—High voltages for charging the condensers of spark transmitters may be obtained from the secondary of an induction coil.

An induction coil is operated from direct current. It is limited in the amount of power that can be used. The vibrator on such coils requires very careful adjustments in order to produce a steady spark note. Such coils are still in use on vessels as the emergency apparatus and are operated from an auxiliary storage battery usually of 24 volts.

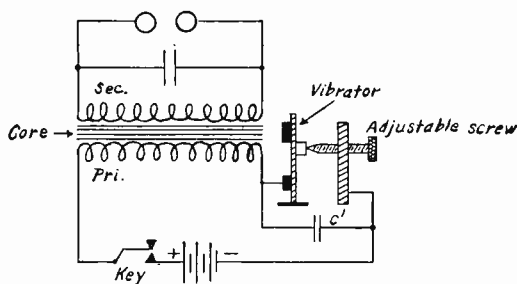

FIG. 38. Induction Coil.

55. Construction and Operation—The coil is constructed of two coils wound on an open core of soft laminated iron. The

primary has few turns of large wire and the secondary many turns of fine wire. Connected in series with the primary is an adjustable vibrator fitted with a soft iron armature and so constructed that it can be attracted by the magnetic flux of the iron core. Each time the vibrator is attracted by the core it is thereby drawn away from the stationary contact through which the primary circuit is brought to another contact mounted on the vibrator itself. Thus the movement of the vibrator breaks the primary circuit, stopping the primary current. The magnetism of the core now collapses suddenly, thereby inducing a momentary current surge in the secondary. When the magnetism of the core has died out the vibrator is released and thereupon flies back again completing the primary circuit. The core then becomes remagnetized and the whole thing happens over again a considerable number of times per second. The frequency of operation depends upon the weight of the vibrator and the stiffness and length of the spring. An interrupted current flows through the primary as long as the key is closed. The changing primary current produces a variable magnetic flux which cuts the turns of the secondary and a current will flow due to the e.m.f. induced in the secondary windings. The current in the secondary flows in one direction as the current is made and as the current is broken it flows in the opposite direction. As the current breaks much faster than it makes, the induced e.m.f. is much higher on the break. This is caused by the self induction of the primary winding.

56. Radio Frequency Waves—Radio communication is the setting up of waves in the ether and the receiving of these waves at some point distant from the sending station. Consider the waves

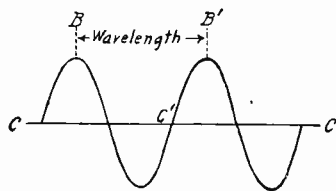

FIG. 39. Graphical Representation of Water Waves.

that are produced on the surface of a body of water as represented in figure 39. The straight line C represents the surface of the water when it is at rest. The curves represent the surface of the water at some distant point. The tops of the curves are the crests or highest points reached by the waves. One complete wave extends from C to $C-1$ or from B to $B-1$. The distance from C to $C-1$ or from B to $B-1$ is called the wave length and in radio is always indicated by the Greek letter λ called lambda.

A wave length then is the distance from any point on a wave to the corresponding point on the next wave.

Water waves are carried along by water. Water is their medium. Radio waves are carried along by the medium called ether. Light and heat waves are also ether waves. The speed of all etherical waves is the same, viz.: 186,000 miles (300,000,000 meters) per second, but the wave length of each is different. In the water waves the wave length was found to be the distance from the crest of one wave to the crest of its successor. Radio waves are measured from one maximum of electric or magnetic force to the next maximum.

There is a definite relation between the length of a wave and its velocity. The following experiment will confirm this. Stand on the shore and estimate the length of the water waves as they pass by. Assume the distance from crest to crest of a wave to be 12 feet. The number of waves passing per second is 10 and is called the frequency of the waves. What is the velocity? If each wave is 12 feet long and 10 pass per second the velocity must be $12 \times 10 = 120$ feet per second. This is a general rule and can be expressed: $V = \text{Number or frequency} \times \text{Wave Length}$.

57. Wave Length—It has already been stated that radio waves travel 300,000,000 meters per second. The velocity never changes. Substituting in the formula stated above the wave length of the radio waves can always be determined if the frequency is known. The length of radio waves is always expressed in meters. Likewise if the wave length is known the frequency of the waves can be determined as follows:

$$F = \frac{V}{\lambda}, \quad \lambda = \frac{V}{F}$$

Example: What is the frequency if the wave length is 300 meters?

$$F = \frac{300,000,000}{300} = 1,000,000.$$

The frequency of radio waves is expressed in cycles per second. The frequency of the waves in the problem above is 1,000,000 cycles per second. With the development of short wave lengths (wave lengths less than 100 meters), by the amateur experimenters, the expression of frequencies in cycles of such waves necessitated the use of large numerals. It is more easily expressed in kilocycles or megacycles. 1 kilocycle = 1,000 cycles, 1 megacycle = 1,000,000 cycles. The frequency of 1,000,000 cycles can then be expressed as 1,000 kilocycles or 1 megacycle.

Referring again to figure 39, it will be noted that the waves are divided into two parts: One above the straight line and the other below it. In one part the water has moved upwards, in the other the water has moved downwards. This is true of all waves. The maximum value that the wave moves upward or downward is called the amplitude of the wave. It is the amplitude of a wave that determines how much energy the wave contains.

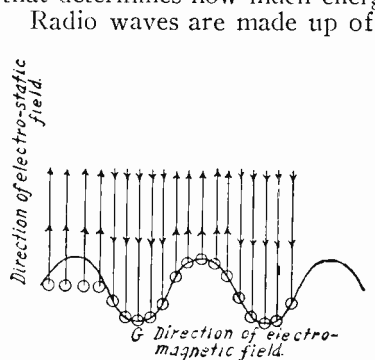

FIG. 40. Components of Radio Wave Showing Direction of Movement.

one direction and then in the other. The same is true of the electro-magnetic wave.

58. Antenna System—In order to produce electro-magnetic and electro-static waves in the antenna system and have them radiated into space it is necessary to excite the antenna by connecting it to a source of alternating current. A 60-cycle alternator such as produces house current would not do. In order to secure resonance in such a circuit, it would require an antenna of tremendous dimensions. The radiation from such an antenna would be negligible at a frequency of 60 cycles. The frequency of the alternating current in the antenna must be very high in order for the radiated waves to produce any distant effect in a receiving antenna circuit. The frequency of the alternating current necessary to produce radio waves is between 10,000 and 600,000,000 cycles, per second. The radiation from a vertical antenna of a single wire is illustrated in figure 41. It is called a Marconi antenna. Marconi made the first use of grounded antennas. The wires of an antenna are considered one plate of a condenser and the ground the other. If the antenna of figure

41 is connected to a source of radio frequency current the field of the antenna and earth is surrounded by lines of force, which die away when a discharge current flows, and are set up when the

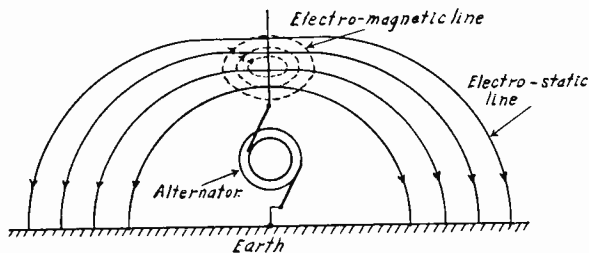

FIG. 41. Radio Waves Surrounding Grounded Antenna.

charging current flows; thus an increasing or decreasing electric strain is identified with a current in one direction or the other resulting in a wave motion.

As already stated the wave motion consists of an expanding static field which is accompanied by a magnetic field, both being radiated at right angles to each other and to the direction of propagation.

The natural or fundamental wave length of an antenna is determined by its height, length, the number of wires, and its geometrical shape.

The higher the antenna, the more the energy radiated. The natural wave length of the antenna is the wave length without any inductance coils or condensers in series with it. In order to operate the antenna at a wave length below the fundamental wave length it is necessary to employ a condenser in series with the antenna. The wave length of an antenna is increased by adding inductance at its base. Every antenna has a certain amount of distributed inductance and capacity. The inductance of the wires forms the distributed inductance. The distributed capacity is formed by the wires acting as one plate of a condenser and the ground the other. The capacity of the condenser thus formed is dependent upon the length and number of wires in the antenna and the distance between each wire, as well as the height of the antenna above the ground. When another capacity is connected in series with the capacity of the antenna the same effect is produced as two condensers in series. The capacity is thereby reduced. The fundamental wave length can be calculated directly from the dimensions but as such formulæ are too complicated for the average operator

they will not be shown here. However, an approximation can be made as follows: For a simple vertical grounded antenna, the approximate fundamental wave length is 4.2 times the total length of the antenna in meters including lead in. When four wires are employed in the flat top the constant 4.4 should be used.

The various methods employed to excite an antenna will be shown in a later chapter devoted to short wave length transmission as used by amateurs.

59. Damped Waves—The waves as illustrated in figure 42 are called damped waves. It should be noted that the waves

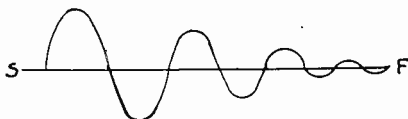

FIG. 42. Damped Waves.

diminish in amplitude, i.e., each succeeding wave has a smaller amplitude than the preceding one. All the waves from *S* to *F* comprise one wave train. A mechanical analogy will illustrate the production of a damped wave train. Hang a weight on a spring balance, pull the weight down and let it free. It will vibrate up and down and gradually come to rest. The moving weight will set up waves in the air which cannot be heard (sub-sonic), but these waves are of exactly the same character as the motion that produces them. The motion of the weight is gradually decreased due to friction and finally it comes to rest. The waves produced in the air by movement of the weight are exactly as shown in figure 42. They are of decaying amplitude. The radio waves produced by spark transmitters employed in connection with mobile telegraphy are also of decaying amplitude and are called damped waves. The production of such waves and their effect on a radio receiving antenna will be shown in a later chapter.

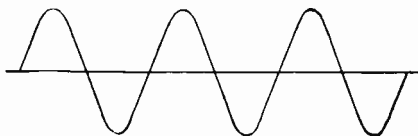

FIG. 43. Undamped Waves.

60. Undamped Waves—Waves in which the amplitude remain constant are called undamped or continuous waves (C.W.).

The following experiment will illustrate how a wave train of constant amplitude can be produced. The same spring balance and weight is used for this experiment. Pull the weight down and let it free. When it has gone up to its highest part and is starting downward again, tap it just hard enough for it to go down to the first, lowest position. Do this each time it starts downward. Its motion and hence the waves set up by it can be represented by figure 43. The amplitudes of all waves are the same. It is an undamped wave. In order to make it undamped or continuous it was necessary to add energy by tapping it at the proper time. Undamped waves have certain advantages over damped waves.

The production of undamped radio waves by both the vacuum tube and arc will be taken up in succeeding chapters.

CHAPTER 2

MOTORS AND GENERATORS

1. **The Alternating Current Generator**—The magneto such as is used for producing current for operating polarized telephone ringers is the simplest form of an alternating current generator.

Referring to figure 44, the following takes place: Magnetic lines of force are flowing across the field from the N. to the S. pole of the permanent magnet. To induce an e.m.f. in the rotary coil it must move through the lines of force, and in *A*, the maximum number of lines is passing through the coil. The number of lines does not change until the armature has passed beyond this position as shown in *B* and the voltage is zero. As the armature rotates a

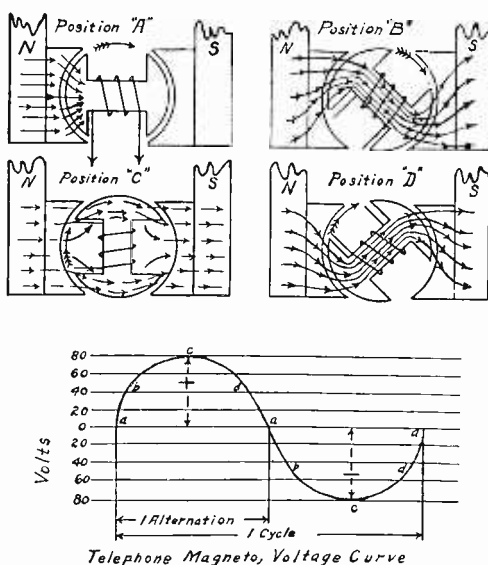

FIG. 44. Generation of Alternating Current by Telephone Magneto.

little beyond *B* the lines begin to change and voltage builds up until *C* is reached, when the remaining lines of force are shortened

out of the coil and the rate of change of the lines is the greatest and the voltage will be at a maximum.

When the *D* position is reached the lines of force pass through the coil in the opposite direction and the voltage drops to zero. The induced e.m.f. in the rotating armature produces an alternating current, for while the armature is passing from the position *A* to the position *B*, a plus or positive current is generated if the North pole is on that side and from *C* to *D* a minus or negative current is generated because the wire there is subject to the influence of the South pole. The curve shown is a sine curve as explained in a previous paragraph on alternating current. A machine generating a single alternating current is called a "single phase" machine. Generators used exclusively for spark transmitters are generally single phase.

Commercial alternators do not depend on U magnets but have field poles; the poles carry coils on a frame, which are wound alternately in opposite directions so that the current flows about the turns in opposite directions, giving the poles alternately North and South polarity. The field poles are excited by being connected to a source of direct current which is controlled by a variable resistance so as to weaken or strengthen the field depending upon

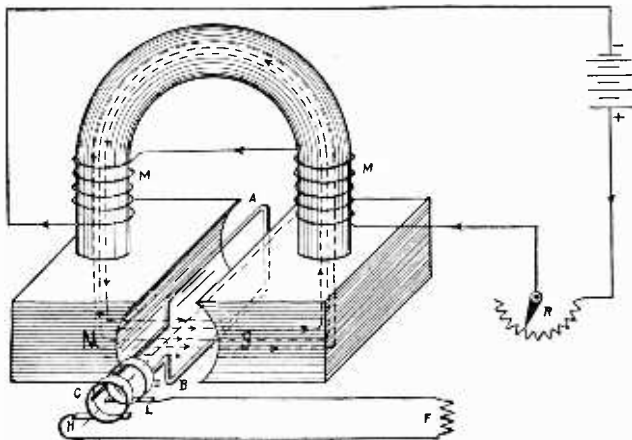

FIG. 45. Fundamental A.C. Generator.

the load on the generator. See figure 45. This variable resistance is called the field rheostat. The armature consists of several coils so connected that the voltage induced in one coil is added on to

that of the next coil. In small machines the armature terminals are connected to the collector rings which rotate with the armature. Current is taken from the collector rings by means of carbon brushes which make continuous contact with the collector rings.

On the inductor type of alternator both the armature and field windings are stationary. The rotating element is called the inductor and controls the variable magnetic flux as will be shown later.

Modern generators of large capacity have a rotating field and slip rings. The armature is the stator.

2. Inductor Type of Alternator—The inductor type of alternator is employed considerably in connection with radio telegraphy. As mentioned before its field magnets and armature are both stationary. The rotating element called the inductor is constructed of a mass of iron with many teeth or pole pieces cut in the same. The passage of each tooth or pole piece by a field and armature coil generates a complete cycle of e.m.f. whereas with alternators of either the revolving armature type requires the passage of two poles to cause a cycle.

The principle of operation of an inductor type of alternator is shown in figure 46. A considerable gap separates the stationary

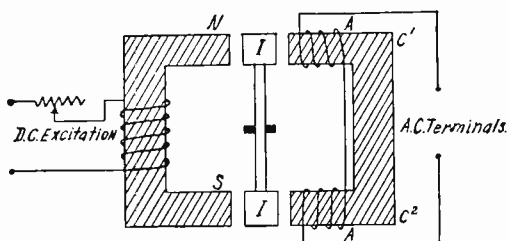

FIG. 46. Production of Alternating Current by Inductor Type of Alternator.

field and armature magnet. In this gap is the iron inductor I . It is free to revolve in a direction as to pass away from the reader and through the page. When the inductor is in the position shown between N and C_1 , and S and C_2 , there is a certain magnetic flux due to the direct current excitation furnished externally. When the inductor is not in the position shown there are long air gaps in the magnetic circuit which have a very much smaller permeability than the iron conductors. The flux is therefore considerably less. The increase and decrease of magnetic flux in the coils AA

due to the rotation of I sets up an alternating e.m.f. because any change in the flux inclosed by a circuit sets up an e.m.f. in the circuit (see Electro-Magnetic Induction) in the one direction while the flux is increasing, and in the opposite while it is decreasing.

Inductor types of alternators are constructed to generate a frequency as high as 200,000 cycles per second. This high frequency is obtained by having 200,000 inductor teeth pass a given point every second. This result can be obtained only by having a great many teeth on the rotor and driving it at a very high speed. Inductor types of alternators used in spark systems of radio telegraphy are usually designed to generate a frequency of 500 cycles per second.

3. Determination of Frequency—The frequency of an alternator may be determined by the formula:

$$F = \frac{N \times S}{120}.$$

F = Frequency in cycles per *second*.

N = Number of field poles.

S = Speed of armature in revolutions per minute.

In commercial practice the frequency of the generator is increased by increasing the speed of the armature as the field poles are fixed.

The voltage of the generator may be increased by increasing the speed of the armature or by increasing the strength of the magnetic field of the field poles as already stated. Generally the latter procedure is employed as increasing the speed of the armature will increase the frequency whereas increasing the field strength makes no change in frequency.

4. Direct Current Generator—Since the current in a generator armature is always alternating it is necessary to employ a commutator to convert it into direct current. The function of the commutator is explained as follows: The coil in figure 47 is revolved in a uniform magnetic field producing an e.m.f. in the armature winding, as in the generation of alternating current. But if each end of the coil is connected to a half cylinder of metal on which rests a stationary brush $B +$ or $B -$, then as the loop is rotated the connection to the external circuit is reversed every half revolution, and the pulsations of current are always in the same direction. The brushes are adjusted so that contact is made

to the next metal segment when the current in the armature is zero and about to reverse.

In figure 47 the armature coil $A-B$ is turning in the direction of the arrow and in the position shown under the A side of the field magnet generates an e.m.f. in such a direction that the segment D has a positive polarity which makes contact with the positive brush $B+$. The current in the external circuit flows from the positive brush $B+$ through the load back through the negative brush $B-$ to the negative side of the armature coil. As the armature passes a quarter revolution the armature coil will be moving along the flux and not cutting it, so there will be no e.m.f. Each brush

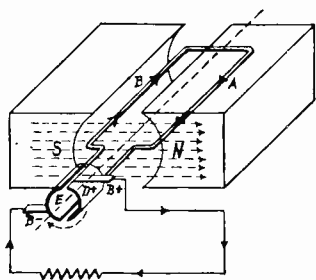

FIG. 47. Fundamental D.C. Generator.

will be just in the act of passing from one segment to the other.

After half a revolution of the B side of the armature coil, that B side of the armature coil that was under the South ($-$) pole of the field magnet is now under the North ($+$) pole and generates an e.m.f. which is opposite from its original direction but in the same direction as the A side when under this pole.

Thus the segment E is now positive polarity as it is making contact with the brush $B+$ and the current again starts to flow from the brush $B+$ through the load back to the brush $B-$. In the external circuit the current always flows in the same direction, though in the armature coil the current is alternating.

The voltage curve of such a generator is represented graphically in figure 48. Due to the variation in voltage such a current is

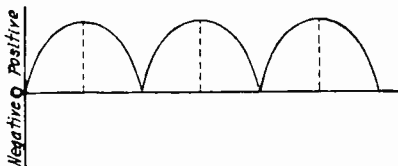

FIG. 48. Voltage Curve of Fundamental D.C. Generator.

said to be pulsating instead of alternating. The current is flowing in one direction all the time but is of an uneven value. In commercial generators enough armature coils are employed so as to

deceive one into believing that a maximum e.m.f. is generated all the time. Each coil is connected to its own two segments and the coils are also so connected that the currents in each overlap so that the resultant current is of practically constant value. The commutator of such a machine consists of bars of copper, slightly wedge-shaped, separated by thin insulating sheets of mica, the whole assembled in the form of a cylinder held together by strong end clamp rings. The segments are insulated from the clamps by suitably shaped rings, usually of molded mica insulation. Connections leading to the armature conductors are soldered into slots in the segments, which commonly have lugs or "risers" for the purpose, extending upward at the end toward the armature.

Direct current generators on shipboard are usually driven by an upright steam engine coupled directly to the generator.

Excitation—An alternating current generator requires a source of direct current to excite the field windings. When the current for the field comes from an independent source the machine is said to be *separately excited*.

Direct current generators are so connected that excitation is secured from their own generated armature current.

5. **Shunt Wound Generator**—The circuit of a shunt wound generator is shown in figure 49, where the terminals of field wind-

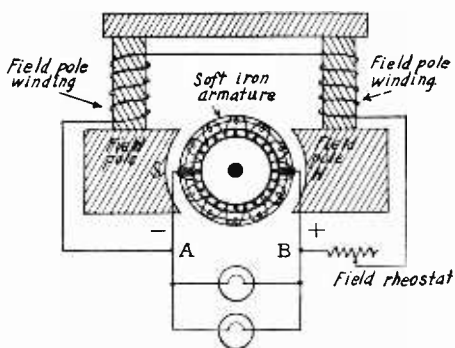

FIG. 49. Circuit of Shunt Wound Generator.

ings are connected across the armature terminals at points *A* and *B*. The shunt field poles are wound with many turns of fine insulated wire. The number of turns is governed by the magnetic flux required for the correct excitation of the machine. Only a small portion of the current generated by the machine flows through the

high resistance shunt windings. (The strength of the current flowing through the field windings can be regulated by the resistance called the generator field rheostat.)

When the armature of this type of machine is first rotated it has to depend upon the residual magnetism of the field poles to generate its initial current. Residual magnetism as already explained is the magnetism resulting from the magnetic lines of force retained by soft iron after once being magnetized.

As the armature is rotated the residual lines of force cut the coils of the armature, generating therein a feeble current which flows through the shunt field windings, and increases the number of lines of force cutting the armature coils. This induces a stronger current in the armature conductors which continually adds to the strength of the field until the normal voltage of the generator is established. The complete process usually requires from 10 to 50 seconds. After the generator attains its normal speed, the voltage across its terminals may be raised or lowered by the generator field rheostat. Increasing the resistance of the field rheostat decreases the generator terminal voltage. Decreasing the resistance of the field rheostat allows more current to flow in the field windings and increases the generator terminal voltage.

6. Series Wound Generator—The field windings of a series wound generator are connected in series with the armature. All the current generated by the armature must pass through the field windings; therefore it is necessary to employ large wire in order to handle all the current without heating since the current is large. Thus the necessary ampere turns are secured by virtue of having a large number of amperes and comparatively few turns of wire. The current in passing through the field windings strengthens the weak field due to residual magnetism and the normal voltage of the generator is soon attained. Figure 50 shows the circuit of a series wound generator.

7. Compound Wound Generator—The field magnets of a compound wound generator are wound with two sets of coils, one set being connected in series with the armature and external circuit. The function of the series winding is to strengthen the magnetic field by the current taken through the external circuit, and thus automatically sustain the voltage under variations of a load. Figure 51 shows the circuit of a compound wound generator.

8. Voltage Characteristics of Shunt, Series and Compound Wound Generators—When shunt excitation is used, if the external load is increased, the potential difference at the armature terminals is reduced. The effect of the reduced terminal voltage is

to reduce the current of the shunt field windings resulting in a weakened field. With an increased load the armature current increases as the shunt field current decreases; hence the terminal voltage falls off considerably.

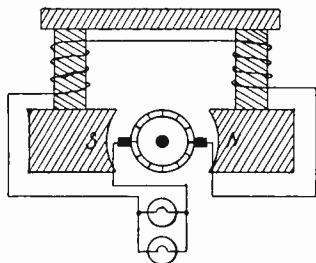

FIG. 50. Circuit of Series Wound Generator.

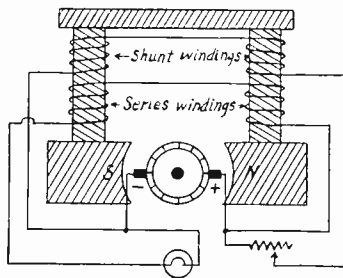

FIG. 51. Circuit of Compound Wound Generator.

With series excitation the condition is very different. When there is no load on the generator, only the weak residual magnetism of the iron pole pieces is available, and the terminal voltage is consequently very small. As the load increases larger values of current flow through the series field windings permitting a greater e.m.f. to be generated. The greater the current taken by the external circuit, the greater will be the voltage.

The compound wound generator gives a more constant voltage on circuits of varying load than is possible with a generator with either shunt or series windings. As the external load of a shunt generator is increased, the potential difference at the armature terminals will fall, but in the case of the compound wound generator, this fall of e.m.f. is counteracted by the series winding, the current which flows in it increasing with load and causing the terminal voltage to rise. The number of turns of each winding and the relative strength of current are proportioned so that a practically constant pressure is maintained under varying load.

Each type of generator has its special uses. For instance, the exciter for an a.c. generator of a radio set can be a shunt generator because the load does not change much. Incandescent lamps require a very steady voltage that is not changed when some of them are turned on or off. A compound generator meets this requirement.

9. Regulation—The relation of the voltage on no load to the

voltage on full load of a generator is called *regulation*. It is found by the formula :

$$\text{Regulation} = \left(\frac{V_0 - V_f}{V_f} \right) \times 100 \text{ percent.}$$

Where V_0 = voltage at no load,
 V_f = voltage at full load.

A small percentage regulation means that the voltage remains very nearly constant when the load is changed. A high percentage means that the voltage drops considerably on load and the machine therefore has poor regulation. Example: Consider a spark transmitter whose a.c. alternator no load voltage is 300 volts. The key is closed and the voltage drops to 270 volts. Substituting in the above formula

$$\left(\frac{300 - 270}{270} \right) \times 100 \text{ percent} = 11 \text{ percent approx.}$$

10. Failure of Generator Field to Build Up—If the initial current generated due to residual magnetism does not excite the field poles in the direction of the residual magnetism, the field will not build up and will be noted by a low or no voltage reading of a voltmeter connected across the output terminals of the generator. The following test will indicate if the magnetism of the field poles is opposite to that of the residual magnetism. Connect a voltmeter across the output terminals and note voltage with *field circuit open*. This reading may be only a volt or two and is the voltage generated due to residual magnetism. Close the field circuit and take another reading of the voltmeter. If the voltage has decreased the connections to the field circuit are wrong and they should be reversed. After reversing field, start generator up again and if the fields are correct the machine should build up to normal voltage. Failure to generate may be due to other causes such as dirty brushes, or commutator, loose connections or loss of residual magnetism. Residual magnetism can sometimes be restored by permitting the current from a battery or other generator to flow through the field circuit for a few hours.

11. Reversal of Polarity of Generator—It sometimes happens especially on ships' generators that while the auxiliary batteries are on charge the generator is stopped by an engineer on duty without first removing the load from the machine. Unless the charging circuit is protected by circuit breakers the battery

will start to discharge through the generator resulting in a reversal of the residual magnetism. When the machine is again started the reversed residual magnetism reverses the polarity of the generator brushes, thus reversing the direction of the field current and making it agree with the new direction of the residual magnetism. This will allow the generator to build up, but the polarity will be reversed. The residual magnetism can be again reversed so that the generator will have its normal polarity by sending a current from another generator or a battery through the field in the proper direction. This is accomplished by connecting the positive terminal of the battery to what is now the new positive terminal of the generator and the negative of the battery to the negative of the generator. The brushes should be lifted or removed during this operation. A battery of 6 to 12 volts will sometimes accomplish the correct result. If the reversal does not take place immediately upon first test the battery should remain connected to the fields for an hour or two.

12. Ground Indicators—Ground indicators in the form of two lamps in series with the midpoint grounded are sometimes installed on switchboards. Figure 52 shows the connections of

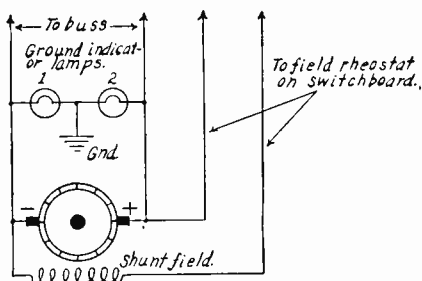

FIG. 52. Circuit of Ground Indicator on D.C. Generator.

such indicators. Normally the two lamps in series will light dimly. Should a ground occur on either leg of the circuit one of the lamps would light to full incandescency. For instance, assume the positive leg of the circuit in figure to become grounded; this will short circuit lamp number 2, and lamp number 1 would then be directly connected across the generator terminals and would be lighted to normal brilliancy.

13. Electric Motors—There is no essential difference between a motor and a generator. The structure of both is identical but the function is reversed. The motor converts electrical power

into mechanical power. Direct current motors are of three types, shunt, series and compound, so called from their winding characteristics. Motors operating from alternating current are of two types, the induction and the synchronous motor. There are special combination motors operating from either d.c. or a.c. This type is known as a universal motor. They are seldom employed in conjunction with radio and for that reason will not be treated here.

14. D.C. Shunt Motor—The fundamental operating principle of a motor is as follows: When a current is flowing through a conductor in a magnetic field there is a force that tends to push the conductor across the field. The conductor will move in a direction at right angles both to the direction of the field and to the direction of the current. For example: If the plane of a coil lying between the poles of a magnet is parallel to a magnetic field, and a current is passed through the coil, it will tend to turn or take up a position at a right angle to the magnetic field. If the current is reversed when it has reached this position, the coil will continue to revolve.

The action of the motor can be explained by the diagram in figure 53. The current flowing through the armature windings

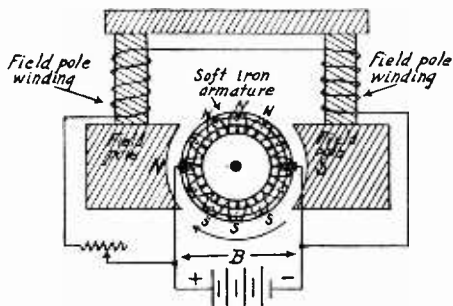

FIG. 53. Circuit of D.C. Shunt Motor.

from the battery B is in such a direction that the lower half of the armature coils is magnetized and has a South pole and the upper half a North pole. The upper half will then be attracted by the South field pole and repelled by the North field pole. The lower half will be attracted by the North field pole and repelled by the South field pole.

The action will be continuous, because, as the top of the armature moves toward the South field, the commutator acts to main-

tain the flow of current in the same direction as before, consequently the upper half of the armature is always a North pole and the bottom a South pole. Thus the armature is made to revolve when supplied with current.

Compare the circuits of the shunt wound generator in figure 49 and shunt wound motor in figure 53. They are fundamentally the same. If the shunt wound generator was charging batteries and the engine was shut off, the generator would continue running providing the battery circuit was large enough and had no circuit breakers. The ammeter in such circuit would show a current in the opposite direction. The battery is discharging and operating the generator as a motor exactly as described in the previous paragraph.

15. Direction of Rotation—If the connections from the battery were reversed at points *A* and *B* in figure 53, it would have no effect on the direction of rotation. The armature would still continue to rotate in the direction of the arrow. Reversing the connections from the battery would reverse the polarity of the flux in both the armature and the field poles. The North field pole would become a South field pole and South field pole would become a North field pole. Likewise the armature South pole would become a North pole and the South pole of the armature a North pole. The same power of attraction and repulsion between like and unlike poles would result with no change in direction of rotation. In order to change the direction of rotation the *flow of current must be changed in either the armature or field poles, but not in both*. For example: In figure 53 reverse the field poles only. The North pole is now a South pole and the South pole a North pole. The direction of armature current has not been changed, therefore the upper half is still a North pole and lower half a South pole. The North pole of the armature being attracted by the new South pole, rotation begins opposite to the arrow or counter clockwise, where before, as shown by the arrow, the direction of rotation was clockwise. The same thing would have happened if the armature windings had been reversed instead of the field windings. The general practice is to reverse the current in the armature, rather than in the fields.

16. Counter Electromotive Force—As soon as the armature of a motor starts to rotate, an e.m.f. is induced in the armature windings of such polarity as to oppose the e.m.f. that started the motion. The back pressure or voltage is known as counter electromotive force and governs the speed of a motor. The value of counter e.m.f. is proportional to the speed of the armature, the

number of armature wires and strength of the magnetic field. The faster the armature turns the greater the counter e.m.f. becomes. It cannot turn so fast that the counter e.m.f. is as great as the line voltage, because then the two would balance: there would be nothing to make the current flow through the armature, and consequently no pull to keep it turning. If the motor is placed on a load the speed falls off and consequently the value of the counter e.m.f. falls off. The current in the armature is increased as the back e.m.f. falls off and the motor automatically regains speed of sufficient value to drive the load.

The field magnets are always of the same strength, regardless of the load, because the current around them depends only on the line voltage and the resistance of the field coils. It is entirely independent of the current in the armature.

Thus the speed of a motor supplied with direct current at constant voltage varies directly with the counter electromotive force and in any given machine the stronger the field, the slower will be the speed of the armature. The strength of the field can be regulated externally by a variable resistance in series with the field windings. This variable resistance is called a motor field rheostat. If the resistance of the field rheostat is *decreased* more current flows through the field windings, thus increasing the field strength, consequently the *speed of the motor is reduced*. If the resistance of the motor field rheostat is *increased* the magnetic field is weakened resulting in an *increased speed of the motor* up to a *certain point*, or until the increased speed of the armature increases the counter e.m.f. to such an extent as to cut down the armature current. If the motor field rheostat accidentally burns out or should any open circuit occur in the shunt field the armature will develop terrific speed. The centrifugal force becomes great enough to burst the windings of the armature, therefore requiring expensive repairs to the machine. If upon starting such a motor the circuit breakers trip, fuses blow or excessive current taken by the motor is noted, the machine should be stopped at once and investigation made to determine if the field circuit is properly connected and not open.

From the above it can be seen that the advantage of a shunt wound motor is that it is self regulating and maintains a fairly constant speed under varying load.

17. Starting Resistance—The resistance of a motor armature is small. If the line voltage was applied directly to the armature terminals excessive current would flow which might injure the commutator or burn out the armature windings. The counter

e.m.f. developed by rotation is what keeps the armature current from becoming excessive. When the motor is first connected to the line it is not rotating and there is no counter e.m.f. Some other way must be found to limit the amount of armature current until the machine can attain sufficient speed to generate the required amount of counter e.m.f. This is accomplished by connecting a variable resistance in series with the armature and gradually reducing it as the motor gains speed. A device whereby the resistance is regulated is called a starter. A diagram of a shunt wound motor with hand starter or starting box is shown in figure 54.

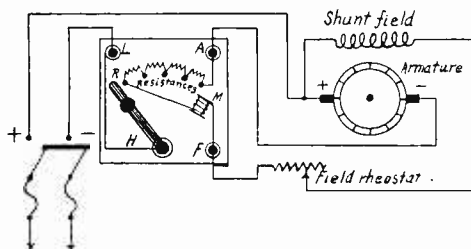

FIG. 54. Cutler-Hammer Hand Starting Box Connected to Shunt Wound Motor.

The action of a typical hand starter is as follows: As the handle *H* makes contact with the stud on the first resistance *R*, the armature circuit is completed with all the starting resistance in series, thus limiting the armature current, and the motor starts slowly. The motor field circuit is completed through the windings of the magnet *M* and the motor field rheostat. As the handle moves toward the full running position, the motor gains speed, likewise the value of counter e.m.f. is increased. When in full running position with all the resistance of the starting box cut out, the motor is generating a counter e.m.f. of such value as to permit the full line voltage to be applied directly to the terminals of the armature. No change has been made in the strength of the field magnets by the operation of the starter. The holding magnet *M* holds the handle in the full running position unless demagnetized by interruption of the d.c. supply or an open in the field circuit. Should the d.c. line be interrupted the handle flies back to the off position requiring the motor to be started in the normal manner. Should the handle fail to fall back excessive armature current would flow when the line voltage is restored, resulting in damage to the machine as explained previously. Should the field circuit

develop an open circuit the magnet is again demagnetized, thus releasing the starting handle and preventing the motor from attaining an excessive speed.

If a motor is started too slowly the starting resistances will overheat and burn out. If started too rapidly the fuses in the d.c. line will melt, or excessive armature current will flow, tripping the circuit breakers. It should require about 15 seconds to start motors used in connection with radio transmitting apparatus.

18. Automatic Motor Starters—It is often desirable to install

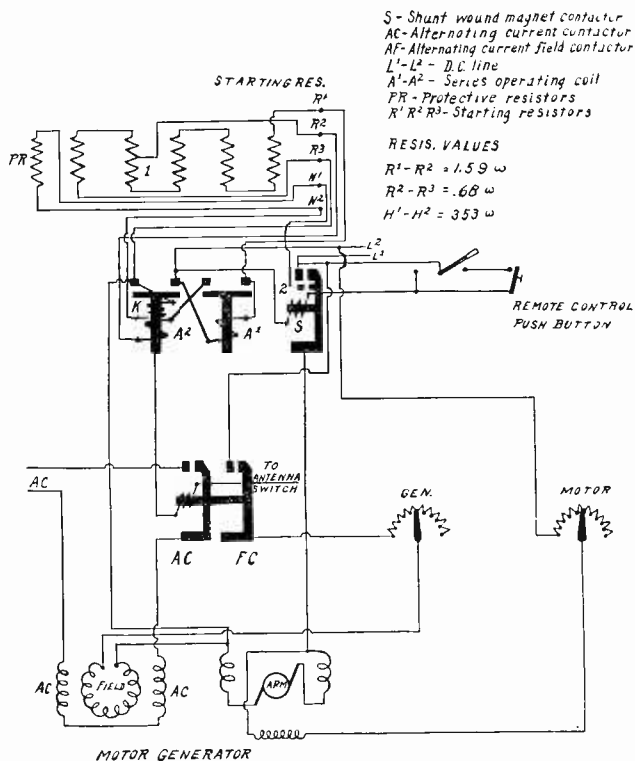

FIG. 55. Circuit of the Electric Controller and Mfg. Co. 2 KW. 120-Volt Automatic Starter.

the motor generator of a radio transmitting set at a point remote from the radio room in order that the noise from its operation will

not interfere with the reception of radio signals. In instances of this kind automatic starters are employed, which are controlled from a distant point by pressing a small button or closing a small switch. The automatic starter solenoid and resistances sometimes are a part of the transmitter panel in the operating room and controlled by a start-stop switch mounted close to the antenna send-receive switch on the operating table. The motor generator is usually mounted in an iron box over the top of the engine room and accessible to the operator for care and maintenance.

The complete circuit of one type of the automatic starter of The Electric Controller and Manufacturing Company is shown in figure 55. This type of starter has been used extensively in connection with Navy Standard 2 K.W. spark transmitters, as installed on vessels of the United States Shipping Board and other privately operated vessels.

This push button automatic starter consists of: One type S counter-weighted shunt wound magnetic contactor for closing the main circuit; two type A series wound magnetic contactors for short circuiting the starting resistor; 1 resistor box; and 2 terminals used in wiring the apparatus.

The shunt wound contractor is of standard form, having a shunt wound coil which stands full line voltage continuously without protection and which when energized moves the main contact arm on to stationary contact, thus making circuit to the motor. The contactor has a magnetic blowout to aid in rupturing the arc when opening the circuit. The main arm of the contactor is provided with an auxiliary control circuit contact to make and break the circuit for the shunt holding coil of the last accelerating contactor. The main arm is also counter-weighted to prevent closure of the arm when the contactor is moved out of vertical position.

The series contactors are of the vertical plunger type and are so constructed that an excess of current through the series operating coil will not lift the plunger, in fact will keep the plunger in the open position until the current value has been reduced to such a value that will lift the plunger and contact disk into contact with the contact brushes, thus short circuiting out part of the starting resistance.

19. **The Construction** of this series contactor is shown in figure 56, in which *A* is the operating coil, connected in series with the motor; *B* is the cast iron case, making the magnetic circuit; *C* is the plunger carrying the contact disk, *D*, at the top, which in the closed position makes contact with the contact brushes *E*; *F* is the adjusting plug; *G* is the operating air gap; *H* is the lock-out air gap; and *I* is the shunt holding coil.

20. **Operation of Series Magnetic Contactor**—If current of a higher value than the operating value of the contactor is caused to flow through the series operating coil *A*, an upward pull is exerted on the plunger *C*, due to the flux in the operating air gap *G*, but

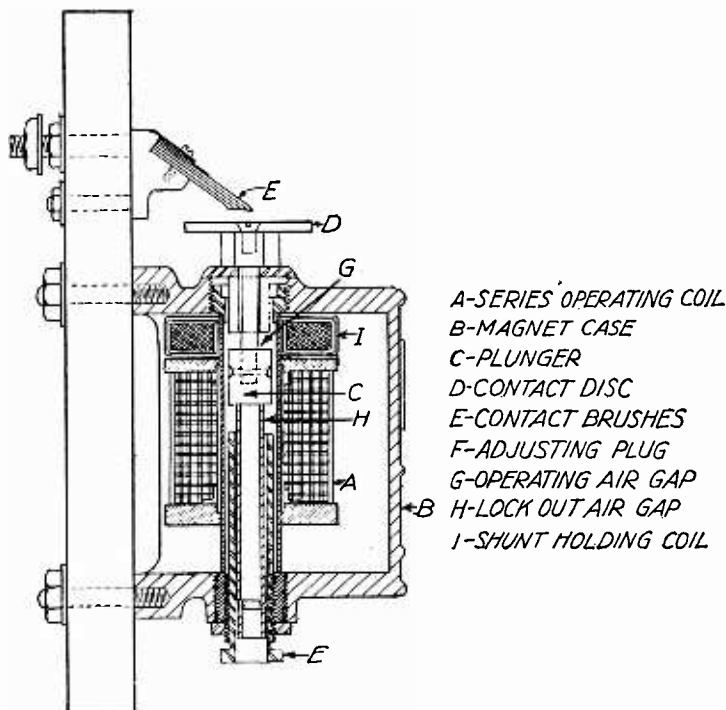

FIG. 56. Type A Series Magnetic Contactor Employed with Automatic Starter.

there is also a downward pull on the plunger due to the flux through the lock-out air gap *H*. This flux in air gap *H* is due to the fact that the steel stem extension on the lower part of the plunger *C* is over-saturated by the flux through air gap *G*. As the current is reduced the flux through air gaps *G* and *H* is reduced until the steel stem of plunger *C* can carry practically all of the flux in air gap *G*; at which time the downward pull at air gap *H* is greatly reduced and the upward pull at air gap *G* is sufficient to overcome the downward pull and the weight of the plunger, thus pulling the

plunger to its closed position with contact *D* against the contact brushes *E*.

The value of current at which the plunger lifts can be increased by increasing the length of air gap *H*. This is done by screwing the adjusting plug *F* farther out of the case. Or the plunger can be made to lift at a lower value of current by screwing the adjusting plug farther into the case, thus decreasing the air gap *H*.

An increase of current through the series coil after the plunger has lifted only tends to hold the plunger more firmly in the closed position. A reduction of the current through the series coil to about 15 percent of the normal value, or an interruption of the current, will cause the plunger to drop to the open position.

A shunt holding coil *K*, figure 55, is provided on the last accelerating contactor of each starter. This coil is connected in series with a protective resistor unit *PR*, and they receive full line voltage upon closure of the contactors. At the same instant the series coil is shorted out of circuit and the shunt coil will hold the contactor closed until its circuit is opened.

The resistor box contains the resistor units used for accelerating and the protective resistor unit for the shunt holding coil. The box is of sheet steel with asbestos board cover carrying necessary terminals.

The wiring diagram in figure 55 shows that when the remote control push button is closed the circuit is completed through the shunt wound magnetic contactor *S*, which moves the contactor arm establishing the circuit through the starting resistors *R*₁, *R*₂ and *R*₃, and the operating coil *A*₁ of the first series contactor. As soon as the current has dropped to a predetermined value this contactor closes, short circuiting the first step of the resistance at point 1 and closing the circuit of coil *A*₂ of the last accelerating contactor. When the current has again dropped to the proper value this contactor closes, shorting out all of the starting resistance and both series operating coils. The first accelerating contactor drops open but the last accelerating contactor is held closed by the shunt holding coil *K*, which is connected across the armature upon closure of the shunt contactor at point 2 and receives full line voltage upon closure of the last accelerating contactor. The motor continues to run until the shunt contactor is opened by de-energizing its coil. Opening the shunt contactor also opens the circuit to the shunt holding coil of the last accelerating contactor which opens.

The starter is adjusted to accelerate a direct current motor in the shortest possible time and yet keep the current peaks down to

50 percent over normal full load. If the motor is lightly loaded the time of acceleration may be very short, the accelerating contactor closing almost immediately after closure of the main contactor, but if the motor is heavily loaded, several seconds may elapse between closure of the series contactor.

With certain adjustments on the accelerating contactors it might be possible that these contactors will refuse to close if the circuit to the motor has been opened when the motor was running at maximum speed and immediately closed again, thus allowing the motor to continue to run with the starting resistance in circuit. If this is the case, the accelerating contactors will close immediately when the load is thrown on the motor by closing the alternating current circuit.

21. D.C. Series Motor—The field coils of a motor may be wound with thick wire and connected in series with the armature, so that the same current flows through both. It is then called a series motor.

The operating characteristics of a series motor are considerably different from those of a shunt motor. They do not run at a very constant speed, but run very much more slowly when heavily loaded. At the lower speeds they develop a large torque. They are used to advantage on street cars where high turning effort is wanted for starting a load. They are of no use in radio where a constant speed motor is required.

22. Motor with Differential Field Winding—It has been explained how the speed of a motor is increased or decreased by variation of magnetic field and any reduction of the field flux of a given machine will increase the speed of the motor. By the use of a differential field winding, as the external load is increased, the strength of the shunt field is decreased, resulting in restoring the machine to its normal speed. The manner in which this is accomplished is shown in figure 57, where the field winding of the motor is two distinct sets of coils. One is the normal shunt winding connected across the input terminals of the machine and the other a series winding connected in series with armature. The windings of the series coils are so arranged that any flux produced by the series windings is opposite in polarity to that of the shunt winding. A suddenly applied load will tend to slow the armature down, resulting in a reduction of the counter e.m.f., and an increased armature current will flow.

The increased armature current flowing through the series coil produces a magnetic flux opposite to that produced by the shunt

field resulting in a differential and therefore weaker field which restores the motor to normal speed.

A field rheostat is connected in series with the shunt field of a differential field winding for variations of speed control.

By the use of a differential field winding, motors may be designed to give very close speed regulation and are, therefore, very desirable to drive a.c. generators for radio telegraphy.

23. Alternating Current Induction Motor—It has been explained how a current flowing through a coil produces a magnetic field. If a set of coils is arranged in the form of a two-phase or three-phase field and connected to an alternating current having two or more phases, it will be noticed that a compass needle placed within the field will start to spin around and will continue to do so as long as the coils are energized. The effect is as if the needle of the compass were under the magnetic influence of a magnet with its poles sliding along the face of the field.

The action of an induction motor can be explained by comparing it to a transformer in which the stator is the primary and the rotor is the secondary. Both have poles and these tend to repel each other. Because the stator field revolves it drives the rotor before it at a speed which is almost the same as the rotating field at no load but which is reduced by any load applied to the motor shaft, or any resistance put into the secondary (rotor circuit).

Speed Control—The speed of the rotor of an induction motor depends upon the construction of the stator and the frequency of the alternating current. In the simplest form there is no connection between rotor and external circuit. However, some types of induction motors have the rotor fitted with slip-rings to provide connection to an external resistance which controls the speed of the machine. This is usually accomplished by providing the rotor with a three-phase Y-connected winding and connecting a variable resistance, in series with each phase, as shown in figure 58. By means of the three-pronged arm, the resistance in series with each phase of the rotor winding can be varied from the full amount to zero, thus varying the speed from minimum to full speed.

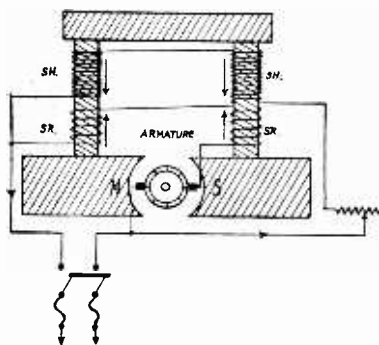

FIG. 57. Motor with Differential Field Winding.

The terms "squirrel cage rotor" and "wound rotor" are often used to describe rotors; the first means the simple kind with conductors of plain bars of metal and no slip-rings or other moving

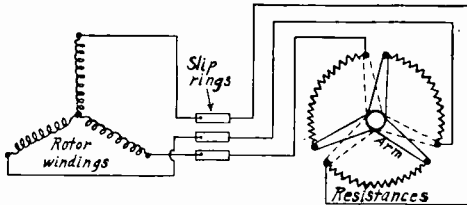

FIG. 58. Speed Control Connections of Three-Phase Induction Motor.

contacts, the second means the kind having coils like an armature and fitted with slip-rings.

An induction motor cannot be started on single-phase current but will operate on the same if started somehow. One way of starting an induction motor is by the use of a "phase splitter." The armature has two sets of coils, one having more inductance than the other. Due to difference in reactance of the two coils the currents flowing in the two are not in phase. The motor starts then as a sort of two-phase machine. After it gets up to speed the starting winding is disconnected either by a two-way switch having a starting and running position or by an automatic centrifugal cut-out in the motor.

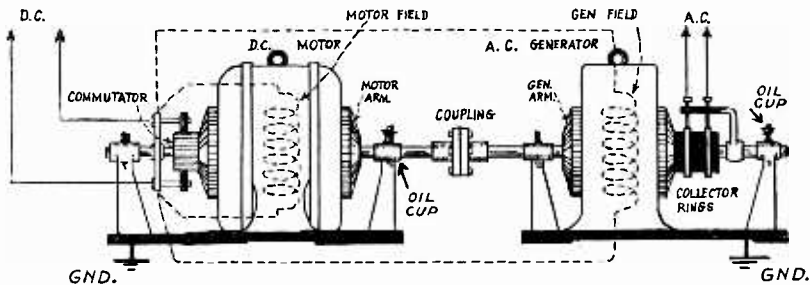

FIG. 59. General Construction of Motor Generator.

24. Motor-Generators—Direct current is the only available power supply on practically all ships. In order to operate the power transformer of a spark transmitter it generally is necessary to use an alternating current. Arc and tube transmitters require direct current voltages considerably higher than those provided by the ship's dynamo. When electric current is to be had, but not in the

form needed, the change can be made easily by a motor-generator. This combination, as usually employed on shipboard, consists of a direct current motor and an alternating current generator coupled together on a common iron base. In the case of the arc or vacuum tube transmitter the combination may consist of a direct current motor and a direct current generator which provides d.c. voltages considerably higher than that available from the ship's dynamo. In broadcasting stations the combination may be an a.c. motor coupled to a d.c. generator. Such machines usually have four bearings,

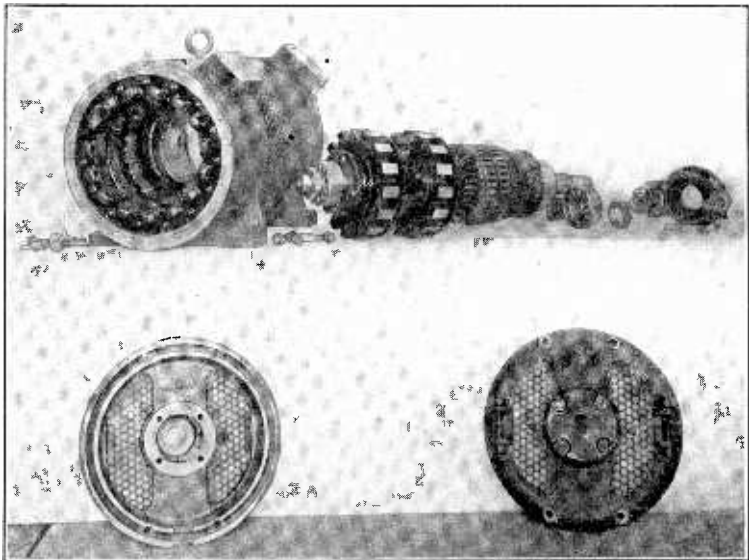

FIG. 60. Exploded View of Crocker-Wheeler 2 KW. Motor Generator with Inductor Type of Alternator.

two for the motor armature and two for the generator armature. In the case of a shipboard installation the field of the generator is excited from the direct current of the ship's dynamo. Field excitation is controlled by a generator field rheostat. Figure 59 shows the general construction of a motor generator. Motors and generators have been described. Each unit can be thought of by itself, without regard to the other. Some automatic starters employed in connection with motor generators have the wiring so arranged that the field of the alternator is not closed until the motor is in fully running position. This prevents the operator from putting

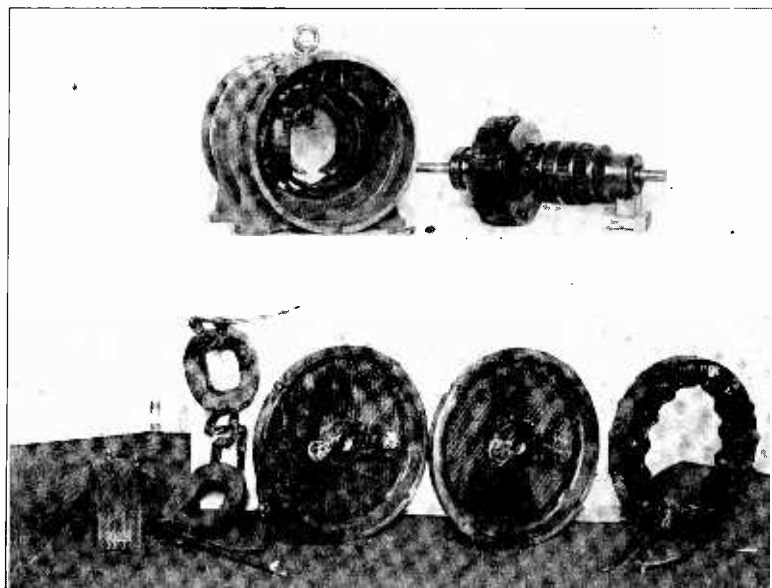

FIG. 61. Exploded View of Crocker-Wheeler 2 KW. Motor Generator with Alternator of "Wound Type."

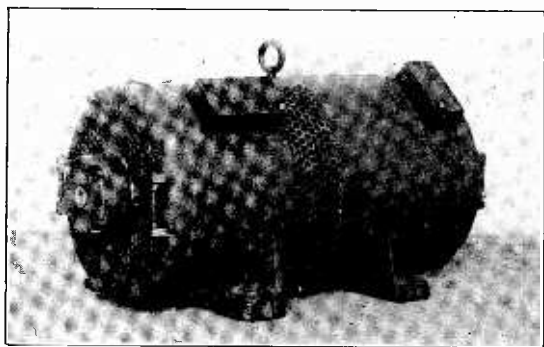

FIG. 62. Assembled Motor Generator.

a load on the machine until the motor gets up to normal speed. Various types of motor generators and their application to a particular transmitter will be described in the succeeding chapters.

25. Rotary Converters—If connections are made to a pair of collector rings from opposite sides of a two-pole d.c. armature, one can take off an alternating current. Since this armature is now able to supply either a.c. or d.c. from the same winding one naturally suspects that it might be possible to *feed in* a.c. at one end and take off d.c. at the other. This is actually possible and such a machine is called a “rotary converter.”

The rotary converter shown in figure 63 has a single winding on one armature for both alternating and direct current. Direct current from an external source enters the armature *A* through

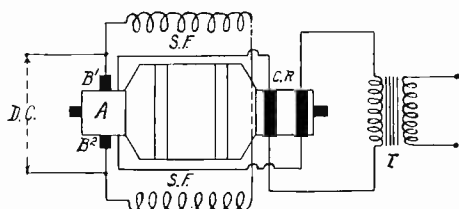

FIG. 63. Fundamental Circuit of Rotary Converter.

the brushes *B1* and *B2* and also flows through the shunt field *SF*, causing the armature to revolve in the usual way. Taps are taken off the commutator segments directly underneath the brushes and are connected to collector rings *CR* on the opposite ends of the shaft, the circuit continuing through the primary of an a.c. transformer *T*. The voltage of the alternating current will be a maximum when taps to the collector rings are underneath the brushes and minimum when midway between the brushes. As the armature revolves the current taken from the collector rings will flow in the opposite direction and therefore, as the armature revolves, an alternating current can be taken from the armature, the frequency of which varies with the speed. The a.c. voltage of the converter is increased by increasing the speed of the armature, but the frequency of the current increases simultaneously. When such a machine is run as a direct current motor and used to supply alternating current it is spoken of as an “inverted rotary converter.”

26. Dynamotor—A dynamotor is employed to change direct current at one voltage to direct current at another voltage. This is very convenient on small yachts and pleasure craft where from

a small battery of low voltage a high voltage from 300 to 1000 volts can be produced to supply the plates of a vacuum tube transmitter. The dynamotor has two separate armature windings placed

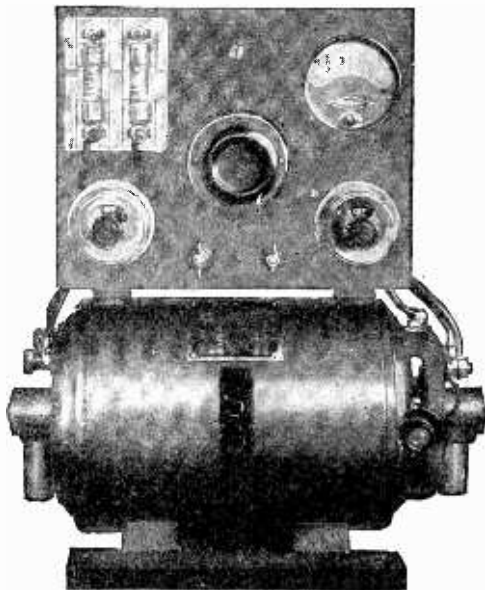

FIG. 64. Esco Dynamotor and Switchboard.

on a common rotor core. One acts as a motor, the other as a generator. There is but one frame and one set of field magnets. The two windings are connected to commutators at opposite ends of the

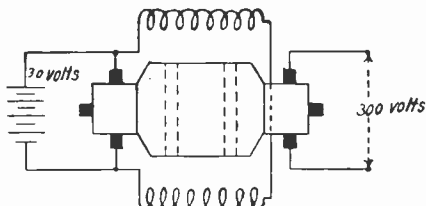

FIG. 64a. Fundamental Circuit of Dynamotor.

shaft. The ratio of voltage is fixed when the machine is built, so the output voltage depends on the voltage applied. The field coils receive current from the same source as the motor armature. Fig-

ure 64 shows the picture of such a machine and figure 64a the fundamental circuit.

27. **Protective Devices**—Some means must be provided in a radio transmitter to prevent the radio frequency currents from flowing back into the power leads and thence into the motor and generator windings resulting in damage to the same.

The low voltage wires are usually run in metal conduit and the conduit connected to earth. In some installations lead-covered wires are provided and the lead sheathing of all wires is tied together and then grounded. The high frequency currents are induced in the surface of the conduit or lead-covering and are effectively grounded and thus no harm results to the power machinery.

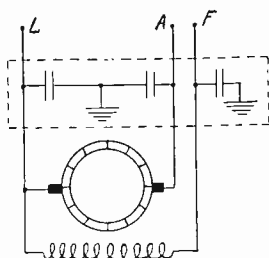

FIG. 65. Protective Condensers Connected across Motor Terminals.

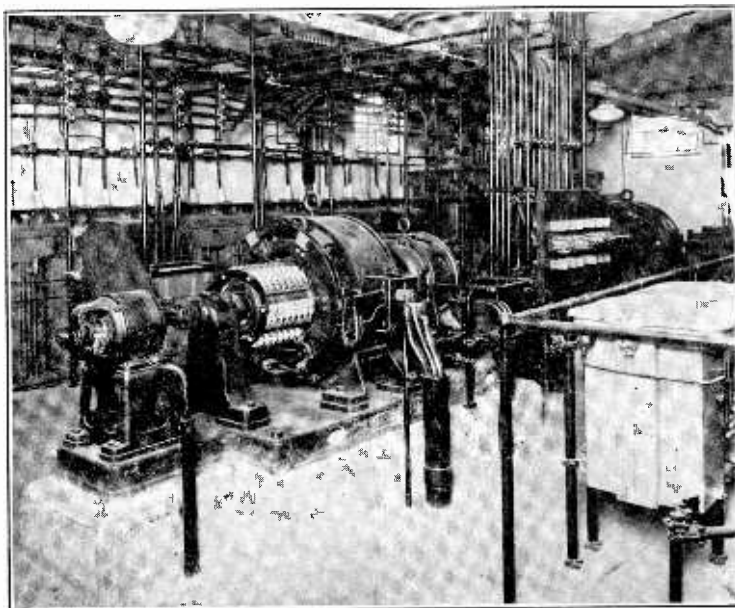

FIG. 65a. Power Plant of Modern Broadcasting Station (WJZ).

Protective devices are also used to protect the power machinery in the form of two condensers in series and connected across the power leads with the mid tap of the condensers grounded.

The high capacity condensers offer a path of low impedance to the induced radio frequency currents and they are thus conducted to ground.

These condensers are usually of $1/2$ or 1μ fd. capacity each and are connected in the following circuits:

- (1) In shunt to motor armature.
- (2) In shunt to motor field windings.
- (3) In shunt to generator armature.
- (4) In shunt to generator field windings.
- (5) In shunt to d.c. feeders entering radio room.

Protective condensers of a motor generator are usually made up as a unit and mounted directly on the frame of the machine. Each terminal of the machine is connected to a condenser and the other terminal of the condenser is connected to the frame of the machine which is grounded by a lead connected to the transmitter ground.

In the succeeding chapters the care necessary for each particular machine supplied with the radio transmitting apparatus is taken up in detail and for that reason the general care and maintenance of motor generators will not be taken up in this chapter.

CHAPTER 3

STORAGE BATTERIES AND CHARGING CIRCUITS

1. Auxiliary Power Requirements—Under the United States Radio Law of July 23, 1912, known as the Ship Act, an auxiliary power supply is required to operate the radio transmitter in an emergency. This power supply must be independent of the vessel's main power plant and be of sufficient capacity to enable the transmitting set to be operated for at least four hours to send messages over a distance of at least one hundred nautical miles day or night.

On American vessels subject to this Act, the independent power is in most cases a set of storage batteries of sufficient capacity to operate the main transmitter over a period of time in excess of that required by law. This requirement of the law is complied with in other instances by the installation of an auxiliary generator driven by a gasoline engine. The auxiliary power plant is automatically started and stopped by a system of relays and contactors.

It is the purpose of this chapter to describe the construction, operation and maintenance of the different types of auxiliary power equipment.

2. Storage Batteries—Under the heading of Elementary Electricity we have seen how the primary battery created a difference of potential by immersing two dissimilar metals in an acid or alkaline solution. The difference of potential caused a current to flow in a completed metallic circuit. Such a battery will furnish current until all the chemical action possible has taken place. The battery has then become "dead." To produce another flow of current it is necessary to obtain new plates and new electrolyte.

In a secondary or storage battery, neither the plates nor the electrolyte need be renewed. The storage battery differs from the primary battery in that when it has given out all the energy which the chemicals enable it to supply, instead of requiring new elements, the cell can be completely regenerated or brought back to the original condition by passing a current into it in a direction opposite to that in which the flow took place on discharge. The charging current simply reverses the chemical action and restores the plates to the same composition as before the discharge.

A storage battery does not act as a storage place for electricity as its name implies, but the chemical action that takes place when the battery is charged changes the composition of the active mate-

rials of the plates so that when they are connected together by a conductor, sufficient difference of potential exists to cause a current to flow. The current flow, or discharge of the battery, reverses the chemical action that took place when the battery was charged until finally the character of the plates is such that no difference of potential exists and the battery is discharged.

3. The Edison Cell—The Edison storage battery differs in electrical characteristics, chemical action and mechanical construction from any other battery.

4. Electrolyte—The potash electrolyte is composed of pure distilled water combined with a 21 percent solution of *potassium hydrate* mixed with a small portion of *lithium hydrate*. It has a specific gravity of approximately 1.200 at 60 degrees F. after being thoroughly mixed by charging. This reading should be taken one hour after discontinuance of charge to allow for dissipation of gases.

The specific gravity of the cells changes but little with charge and discharge and therefore is of no value in determining the charged or discharged condition of the cell. However, throughout the useful life of the cell the electrolyte gradually weakens and for this reason specific gravity readings are of value to determine when a renewal of solution is necessary. The low limit of specific gravity is 1.160 and is usually accompanied by a temporary loss of capacity and sluggishness.

5. Plate Construction—The *positive plate* is made up of many perforated steel tubes into which has been packed, under heavy pressure, alternate layers of nickel hydrate, the positive active material and nickel flake. Each tube is reinforced by eight seamless steel rings. The *negative plate* is composed of a steel grid supporting many perforated nickel-plated steel pockets. Iron oxide, the negative active material, is loaded into these pockets, which in turn are secured to the grids by means of hydraulic pressure of 120 tons.

6. Chemical Action—The fundamental principle of the Edison storage battery is the oxidation and reduction of metals in an electrolyte which neither combines with nor dissolves either the metals or their oxides. Although the electrolyte is decomposed by charge and discharge, it is reformed again in equal quantities and therefore its density and conductivity remain the same over a long period of time. The active materials of the plates are insoluble in the electrolyte, therefore, no chemical decomposition takes place therein.

The chemical reactions in charging are (1) the oxidation from a

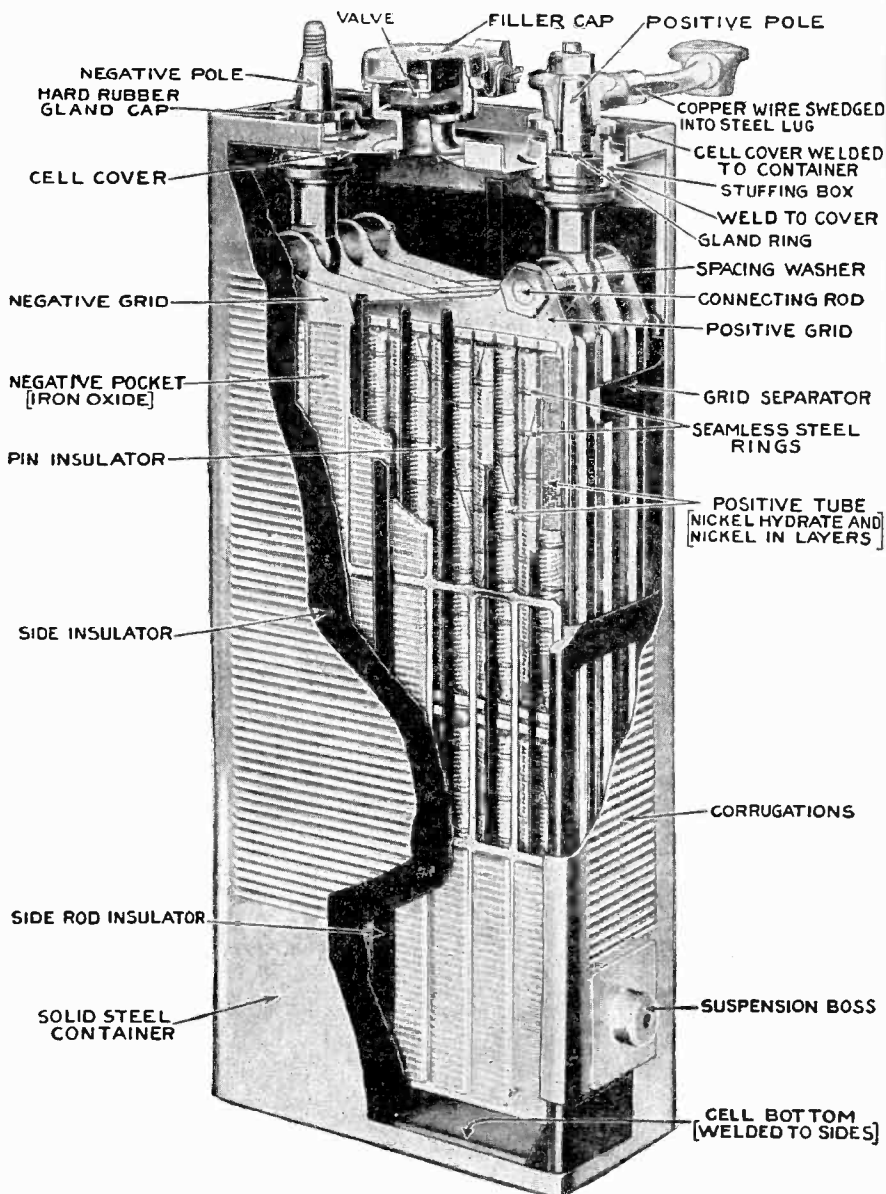

FIG. 66. Sectional View of Edison Storage Battery.

lower to a higher oxide of nickel in the positive plate and (2) the reduction from iron oxide to metallic iron in the negative plate. The oxidation and reduction are performed by the oxygen and hydrogen set free at the respective poles by the electrolytic decomposition of water during the charge.

The discharge of the cell is simply the reversal of the above reactions, the hydrogen reducing the higher oxide of nickel to a lower oxide, and the oxygen oxidizing the iron to iron oxide.

7. Container—The container is made of high grade steel which is oxy-acetylene welded. Each battery consists of two or more cells connected together by nickel-plated copper connectors fitted with a tapered steel lug which fits the terminal post of each cell. Each lug is held in place by a hexagonal nut. Each cell fits into a specially constructed wooden tray so arranged that the containers which are conductors will not short-circuit the battery.

The Polarity of the Positive Terminal of an Edison battery is designated by a red bushing and a plus sign (+), stamped on top of the container. The negative terminal is indicated by a black bushing with no sign on the container.

A *filler cap* of special construction is provided in the center of the cell to enable watering and to allow for the escape of gas. It is of such construction that the cell can be tipped to an angle of 45 degrees without spilling the electrolyte.

8. Voltage—The fully charged voltage of an Edison cell when discharging at the 5-hour rate is approximately 1.4 volts per cell.

The average discharge voltage at the 5-hour rate is 1.2 volts per cell.

The discharged voltage at the 5-hour rate is 1.0 volt per cell.

9. Installation—The Edison battery may be installed in any part of the vessel; however, in most marine installations the battery is located either in a special room adjoining the radio operating room or in a well-ventilated box placed on the boat deck. In several installations the battery has been placed in one corner of the operating room and carefully housed in with screens for ventilation.

The Edison battery requires no lead-lined compartment and gives off no noxious fumes during charge. A dry location is preferable, if too warm; excessive evaporation of electrolyte may result. The battery box need not be lined but should be absolutely water proof to prevent salt spray and other impurities from striking the cells.

Edison batteries are generally shipped fully charged. This is

indicated by a red label accompanying the battery and indicates they are ready for immediate use.

A green label indicates that the cells are not charged and that they require an overcharge at the normal rate before being placed in service.

10. Height of Solution—Upon receipt of the battery the height of the solution should be tested by use of the glass tube shipped for that purpose.

One half inch is the proper height of the solution above the top of the plates for all types of Edison batteries in marine use except the high type cells. The proper height of the solution in the high type cells is 3 inches above the top of the plates for the A type and 2 1/4 inches for the B type.

11. Testing Height of Solution—Insert tube until the tops of the plates are touched, close the upper end with the finger and

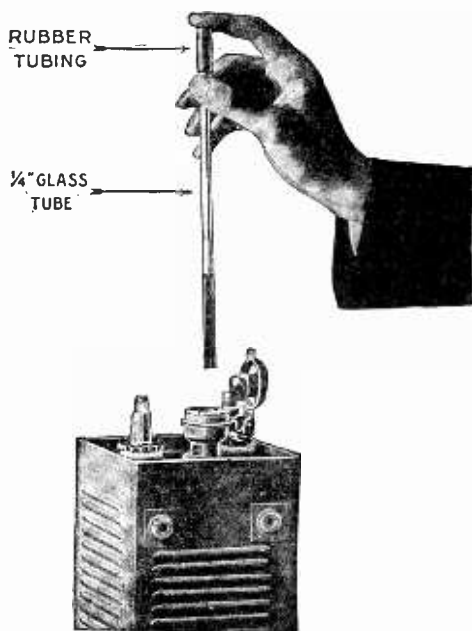

FIG. 67. Testing Height of Solution.

withdraw the tube. The height of the liquid in the tube indicates the height of the solution above the top of the plates.

A glass tube reasonably walled, about 8 inches long and not less than 3/16 inch inside diameter with ends cut straight and smooth, may be used for this test in event none is supplied. A short length of rubber tube forced over one end and projecting about 1/8 inch will prove a good finger grip.

12. Refilling Battery—If the plates are visible above the top of the solution or if the packing case or surrounding materials show a rusty stain, it is an indication of spilled electrolyte and thus loss must be replaced preferably with Edison storage battery "Standard Refill Solution" or lacking this, with "Standard Renewal Solution." Lacking either of these, pure distilled water should be added until the solution is brought to the proper height.

When the level of the solution is only a small amount below the proper height, fill with pure distilled water.

13. Maintenance of Edison Battery—The Edison battery requires a minimum of attention; however, by observing a few simple precautions the operator can be assured of maximum capacity from the battery in time of emergency or disaster.

1. To charge, the positive of the charging source should be connected to the positive terminal of the battery. No great damage will result to an Edison battery if it is left discharged or if charging polarity is reversed, except to temporarily reduce the capacity of the battery.

2. If battery is in compartment or box, open cover of same before charging.

3. Make sure solution is at the proper level.

4. The correct charging voltage should be 1.85 times the number of cells in series.

5. It is well to remember that a marine battery of 90 or more cells is broken up into parallel banks of 45 cells or more for charging. This is accomplished by a 3- or 4-pole double throw switch on the charging panel.

Do not exceed charging rate as specified under electrical data, for the type of battery in use. Where discharge is less than 80% of normal discharge rate, charging may be done at a rate of 125% times the discharge rate employed. 80 to 90 degrees is the normal temperature for maximum efficiency.

Frothing indicates too rapid charging or too high level of solution.

6. Never put lead battery acid into an Edison battery or use utensils that have been used with acid.

Operators on vessels using both Edison and lead cells should

take special precautions not to use the hydrometer syringe of the lead batteries to fill Edison batteries.

7. Never add anything to the electrolyte of battery to prevent freezing. It is nearly impossible to freeze the alkaline solution and no permanent injury is caused by the severest cold.

8. Keep cells clean and vent caps free from crystals or potash salts which are liable to accumulate on cells.

9. Cell tops of marine batteries have a coating of brownish wax (rosin vaseline compound). If this is removed it should be replaced either with rosin vaseline or liquid vaseline.

10. Batteries should be removed from box or compartment from time to time and inspection of cells and compartment made. Make sure no water has accumulated in box or compartment. Remove all dirt and other foreign substances that may have accumulated which may in time short-circuit and damage battery.

11. It is very seldom that a battery is totally discharged in marine service and may become sluggish due to lack of work. If this condition is noted the battery should be completely discharged to zero at normal rate and then short-circuited for one or two hours. Follow this by an overcharge. If the condition is pronounced, this procedure should be repeated; 15 hours at the normal rate is considered an overcharge for the marine batteries, providing they have been discharged and short-circuited to zero voltage.

12. *On charge, and immediately following charge, all storage batteries give off hydrogen gas. Inasmuch as this gas is explosive in the presence of a spark or open flame, extreme care should be taken:*

- (a) *that no spark or open flame be permitted near the battery or its compartment.*
- (b) *that if battery be put in any other container or cabinet, such container or cabinet be adequately ventilated to allow a rapid dissipation of gas.*
- (c) *that all connections be kept tight to eliminate the chance of sparking due to loose connections.*

14. **Charging a Storage Battery**—In order to charge a storage battery it is necessary to connect the positive terminal of the battery to the positive terminal of the charging source, and the negative terminal of the battery to the negative terminal of the charging source.

The voltage of the charging source must always exceed the maximum voltage of the storage battery because the voltage of the battery exerts a back e.m.f. on the charging voltage. If the back

e.m.f. of the battery is greater than the charging voltage, no charging current will flow.

A variable resistance is usually connected in series with the charging circuit to regulate the amount of current flowing into the

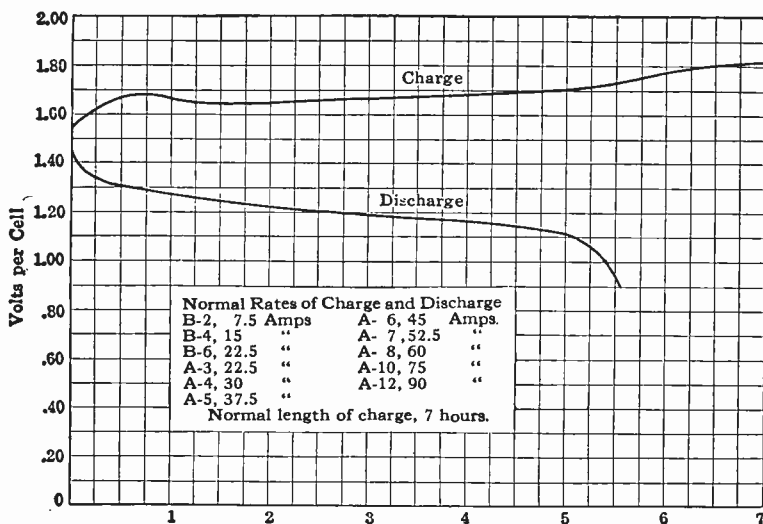

FIG. 69. Characteristic Curve of Charge and Discharge of Edison Battery.

battery. The correct resistance to be inserted in such a charging circuit can be computed from Ohm's law. Assume it is desired to charge a 5-cell A-8 Edison battery by the constant current method from a d.c. line whose voltage is 110. The charging rate as specified by the electrical data accompanying the battery is 60 amperes. Inasmuch as a voltage of 1.85 per cell is required to maintain normal rate at the end of charge the 5 cells in series will require 5×1.85 volts or 9.25 volts at the end of charge. Inasmuch as a voltage of approximately 1.5 per cell is required to obtain normal rate at the beginning of charge the 5 cells in series will require 5×1.5 or 7.50 volts at the beginning of charge.

Ohm's law is modified to read:

$$R = \frac{E - e}{I},$$

E = supply voltage,

e = battery voltage,

I = normal charging rate,

$$R_1 = \frac{110 - 7.50}{60} \text{—resistance in ohms to obtain normal rate at beginning of charge.}$$

$$R_2 = \frac{110 - 9.25}{60} \text{—resistance in ohms to obtain normal rate at end of charge.}$$

It will, therefore, be seen that in order to maintain normal rate throughout the entire charging period a resistance will be required which will be variable between the limits of R_1 and R_2 . A lamp bank provides a convenient method of adjusting the correct charging rate to a battery. A bank of this type is shown in figure 70. In order to increase the charging rate it would be necessary to increase the number of lamps connected in parallel. To decrease the

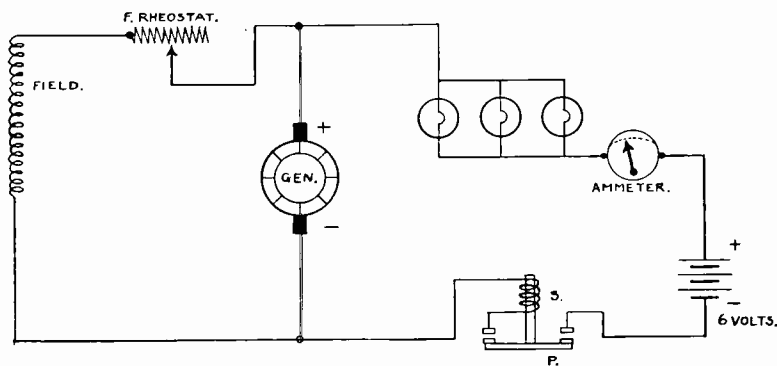

FIG. 70. Charging Circuit with Lamp Bank Resistance and Underload Circuit Breaker.

charging rate the number of lamps in parallel should also be decreased. If lamps of high or low voltage are employed the charging rate would increase or decrease respectively. More recently there are procurable resistance coils which can be conveniently screwed into a lamp socket. This type of resistance has sufficient current carrying capacity to replace several lamps which would otherwise be necessary in order to secure the same charging rate.

A protective device in the form of an underload current breaker is usually employed in charging circuits. In event the charging

voltage is cut off or drops below that of the battery, the circuit is interrupted, preventing the battery from discharging through the generator, which usually results in a reversal of the residual magnetism of the field poles, and consequently the output of the generator.

Referring to figure 70 the solenoid *S* is connected in series with the charging current. The magnetic flux created by this current holds the plunger *P* in position to complete the circuit. Should the generator be shut down while charging, the solenoid *S* would be immediately demagnetized and the plunger would drop out, thus interrupting the battery charging circuit.

15. Determination of Polarity—The polarity of the charging voltage may be determined by four different ways:

1. By a direct current voltmeter of the movable coil type.
2. By an electrochemical polarity indicator.
3. By the use of a raw potato.
4. By dipping the terminals of the charging mains in a glass of plain or salt water.

Direct current voltmeters of the movable coil type have the correct polarity marked on the binding posts.

If connected properly to a source of direct current the needle will move in the correct direction on the scale indicating the voltage of the mains but if connected improperly the needle will move off the scale in a direction to the left of the zero position. The wire connected to the positive terminal of the voltmeter is the positive terminal of the mains and the other, of course, the negative terminal.

Chemical polarity indicators are composed of a chemical composition within a glass tube provided with terminals; when connected to a source of direct current the positive terminal turns blue.

Sticking the wires momentarily into a raw potato with about an inch or two separation, provides a path for a small current to flow which decomposes the starch of the potato causing that portion of it surrounding the positive terminal to turn blue.

When the terminals are dipped in a glass of plain or salt water, bubbles will appear at the negative terminal.

16. Charging a Battery when the Voltage Exceeds that of the Generator—It has already been stated that in order to charge a battery the charging voltage must exceed that of the battery. The majority of batteries employed aboard ships as an auxiliary power supply have a total voltage of 120 volts or more. Usually the Edison batteries in such installations have 90 or more

cells, whereas the lead plate batteries have 60 cells. In order to charge such batteries from the ship's dynamo, which usually generates 110 volts, the battery is split into two banks and the two banks are charged in parallel. When placed on discharge they are connected in series. This is accomplished by either a three-pole or four-pole double-throw switch. The three-pole double-throw switch is employed on the charging panels built by the Smith-Meeker Engineering Company for Edison battery installations. The four-pole double-throw switches are employed with all types of lead plate battery charging panels.

17. Lead Plate-Sulphuric Acid Battery—In general, the lead plate-sulphuric acid cell consists of lead plates immersed in a dilute sulphuric acid solution. If two plates were immersed in a dilute acid and then connected to a charging current it would soon be noted that the character of the plates had changed. The plate through which the current entered the solution, called the positive plate, would be brown in color due to the formation of the chemical peroxide of lead on its surface. The other plate or the one by which the current left the solution would become light gray by the formation of pure lead on its surface. Now if the charg-

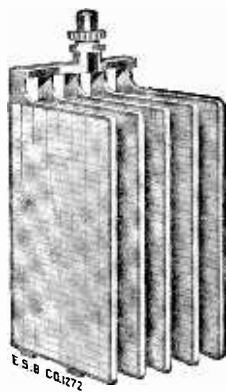

FIG. 71. Negative Plates of Lead Battery.



FIG. 72. Positive Plates of Lead Battery.

ing current be disconnected and a voltmeter be connected in the external circuit, it will be found that the cell will have become a

source of voltage and current, and that this current will flow in the reverse direction from the charging current.

18. Cell Construction—The average commercial cell is made by "pasting" the active elements into lead grids. After the grids are cast, they are pasted with oxides of lead made into a paste of special composition which sets, in drying, like cement. The plates then go through an electrochemical process which converts the material of the positive plate into brown peroxide of lead and that of the negative plate into gray, spongy lead.

Both the positive and negative plates are provided with an extension or "lug" and they are so assembled that all the positive lugs come at one side of the container and all the negative lugs at the other, thus enabling each set to be burned together with a connecting strap, giving one positive and one negative pole. The burning is done by a hydrogen flame, which melts the metal of both lugs and strap into an integral union. There is always one more negative plate than positive, the outside plates of the grids being negative. The straps are made of hard lead alloy and are provided with posts to which the cell connections are made.

19. Separators—To prevent contact between adjacent plates, separators made of light pieces of wood, vulcanite or other material are placed between them. The wood separators used in one type of battery are grooved on the side which goes against the positive plate to allow for circulation of the electrolyte and the escape of the gas generated when charging. To prevent the highly oxidized positive plate from charring the wood, and also to check the washing away of the positive material, due to vibration and the gassing on charge, a thin sheet of perforated hard rubber is placed between the positive plate and the wood separator.

20. Electrolyte—The electrolyte for the cell is a dilute sulphuric acid. Sulphuric acid is usually sold and shipped in the concentrated form. It is an oily, syrupy liquid, and much heavier than water. In purchasing the acid for this purpose care must be taken to specify that it be free from iron and other impurities. To prepare this acid for use in one of the cells, one part of acid is added to about four parts of water. *Never add water to the acid.* since the chemical action of this combination is quite violent and there is danger of the steam from the water throwing acid on the hands or clothes of the operator. The acid must be slowly added to the water while constantly stirring the mixture. This process must be carried on in a clean glass, earthenware or lead container. If placed in an ordinary metal container, chemical action will start at

once between the acid and the metal and the electrolyte will become contaminated.

21. Use of Pure Water—Only approved water should be used to mix with the acid and to replace that lost by evaporation. Distilled (but not merely boiled) water is approved. Water taken from wells, springs or rivers is often satisfactory, but should not be used unless approved. Never transport or store water in any metallic vessel (lead excepted) and keep receptacle clean and covered, to keep out impurities. Glass, earthenware, rubber or wooden receptacles that have not been used for any other purpose are satisfactory. If water is drawn from a tap, it should be allowed to run a few minutes before using it.

22. Containers—The jar or container for portable batteries is usually of a hard-rubber compound; but larger batteries, which are used in a fixed position, are generally contained in glass or lead-lined tanks. The plates rest on stiff ribs or ridges in the bottom of the jar or container, allowing space for the accumulation of sediment.

23. Hydrometer—In mixing the electrolyte the correct proportion of water and acid can be exactly determined by test with the hydrometer. The hydrometer is a small glass tube closed at both ends and weighted at one of them. The hydrometer floats in the fluid and displaces the fluid more or less as the fluid is more or less dense. Thus, the density of the fluid can be read at the point where the "water line" of the fluid meets the graduated scale of the tube. The density of pure distilled water in terms of specific gravity scale is 1.000 at 70 degrees Fahrenheit. The specific gravity of the concentrated sulphuric acid is far above this and the water and the acid must be properly combined until the specific gravity of the combination is of the correct value for the particular type of battery. Since the temperature of the electrolyte has its effect upon the density of the electrolyte, the readings must be taken at approximately 70 degrees Fahrenheit, or else corrections for temperature must be applied. The general rule is to add .001 to the hydrometer reading for each 3 degrees above 70 degrees F., and to subtract .001 for each 3 degrees below 70.

24. Baume Hydrometer—Some foreign countries do not use the specific gravity hydrometer in taking the density of the electrolyte. The Baume hydrometer is the same as the specific gravity hydrometer except that the scale readings are calculated from different constants.

For liquids heavier than water:

$$\text{Sp. Gravity} = \frac{145}{145 - \text{Baume degrees}},$$

$$\text{Baume degrees} = 145 - \frac{145}{\text{Sp. Gr.}}$$

Example: What is the Sp. Gr. of the electrolyte of a cell that shows a Baume reading of 29 degrees?

$$\text{Sp. Gr.} = \frac{145}{145 - 29} = \text{Sp. Gr.} = 1.250.$$

The specific gravity of a lead plate sulphuric acid cell increases with charge and decreases with discharge; therefore, the gravity readings are of considerable value in determining the charged or discharged condition of the cell.

25. Voltage Characteristics—The voltage of a lead cell is dependent upon the amount of dissimilarity in chemical action between the two plates. It is therefore dependent on the state of the solution and the active material of the plates. It is also dependent on state of charge and whether battery is on charge, or open circuit or on discharge. It is independent of the size of the plates or their number connected in parallel and of the distance between the plates in the liquid. The open-circuit voltage of a lead-acid cell is approximately 2 volts. The open-circuit voltage, however, does not indicate the state of charge. When the lead cell is being discharged at its normal rate, usually given by the manufacturer on the name plate, the voltage at its terminals gradually falls from approximately the open-circuit value to about 1.7 volts, at which point practically the complete capacity of the battery has been delivered. It is not desirable to continue the discharge beyond this point, except when the cell is delivering current at much more than the normal rate; for example, at 10 times the normal rate of discharge it is permissible to continue the discharge until the voltage of the cell has fallen to about 1.4 volts per cell. The average voltage which the cell can maintain during discharge varies with the rate of discharge and the construction of the cell. The average voltage will be about 1.95 volts when discharging at the normal rate. As the cell discharges the specific gravity of the electrolyte decreases. For many types of portable batteries the cell is considered discharged when the specific gravity has fallen to 1.140.

26. Unit of Capacity—The capacity of a storage battery is rated in ampere-hours. The ampere-hour is the unit employed to

express the equivalent quantity of current represented by current of one ampere flowing through a given circuit for an hour of time. The ampere-hour capacity of a cell depends for the most part upon the amount of active surface of the plates exposed to the solution. It is therefore proportional to the area and the number of plates.

27. Ratings—The normal discharge rate of a battery is usually obtained by dividing the total ampere-hour capacity of the battery by the normal continuous discharge rate. If the battery is discharged at the normal discharge rate it will give its normal ampere-hour capacity by the time it reaches its discharge voltage limit. If discharged at less than its normal discharge rate it will give more ampere-hour capacity and if discharged at more than its normal discharge rate it will give less ampere-hour capacity. A battery of 210 ampere-hour capacity with a normal discharge rate of 21 amperes can be expected to last for 10 hours if discharged at its normal rate. If discharged at only 7 amperes it will last more than 30 hours, whereas if it were discharged at 30 amperes it would reach its discharge voltage limit within less than 7 hours.

28. The Ampere-Hour Meter—This instrument is of particular advantage in denoting the state of charge or discharge of a battery. It is in the form of a small motor connected in series with the charge and discharge of the battery and operates a pointer which moves over a dial calibrated in ampere-hours. The speed at which the motor operates depends upon the amount of current entering or leaving the battery. It is so constructed that a revolution counter connected to the motor records directly in ampere-hours the quantity of electricity passing through the meter. When the battery is fully charged the pointer on the dial reads zero. As the battery is discharged the pointer moves in a clockwise direction toward the full scale reading. A red pointer on the meter is usually placed at the number corresponding to the capacity of the battery with which the meter is employed. When the rotating pointer reaches this point it is an indication that the full ampere-hour capacity of the battery has been utilized and it should be placed on charge. As the battery charges the pointer moves in a counter-clockwise position and just before reaching the zero or fully charged position the pointer makes contact with a projection that operates a set of contacts which causes the underload circuit breaker to trip, disconnecting the battery from the charging source. This type of meter runs slower on charge than on discharge so as to allow some necessary overcharge.

29. Discharge Voltage Limits—The discharge of a battery must be stopped when it has reached the discharge voltage limit which depends—upon the type of cell, the concentration of the acid, and the rate of discharge. The discharge voltage limit when given on the battery name plate is for the normal discharge rate.

A battery discharged at a high rate can be carried to a lower voltage limit than a battery discharged at a long low rate. During high rates of discharge the chemical reactions in the cell are very rapid, forming sulphate in the outer layers of the active material of the plates, making it difficult for the acid to reach the interior portions of the plates and increasing the internal resistance of the cell, causing the voltage to drop quickly. It may be allowed to drop lower than during either a long low or an intermittent rate discharge, since at a low rate the acid reaches the interior portions of the plates, reduces them to sulphate, and when the voltage limit is reached there is very little capacity left in the plates. In a short or high discharge to the voltage limit only a fraction of the capacity of the cell is withdrawn, although the voltage is carried lower than during a long low discharge, when the cell is more nearly exhausted.

30. Chemical Action During Charge and Discharge—When a cell is fully charged the negative plate is lead sponge, Pb, and the positive plate is lead peroxide, PbO_2 , the specific gravity of the electrolyte (sulphuric acid, H_2SO_4 , and water, H_2O) is at its maximum between 1.210 and 1.220 (marine radio batteries, Sp. Gr. higher for some other types), temperature 70 or 80 degrees F. Chemical energy is stored in the cell in this condition.

If the cell is put on discharge the H_2SO_4 of the acid is divided into H_2 and SO_4 . The H_2 passes in the direction of the current to the positive plate, and combines with some of the oxygen of the lead peroxide and forms H_2O ; the SO_4 combining with the liberated Pb of the positive plate to form lead sulphate. The SO_4 also forms lead sulphate, as the negative or lead sponge, Pb, plate. As the discharge progresses both plates are finally reduced so that they contain considerable lead sulphate, $PbSO_4$. The water formed has diluted the acid lowering the specific gravity of the electrolyte; when the plates are entirely sulphated current will cease, since the plates are identical, and any electric cell requires two dissimilar plates in the electrolyte. In common practice, however, the discharge is always stopped before the plates have become entirely reduced to lead sulphate. The lead sulphate that has formed by the acid in contact with the plates is more bulky than the lead sponge or lead peroxide just as copper sulphate on copper, or iron

rust on iron, is more bulky than the amount of copper or iron eaten away. The lead sulphate, on account of its increased volume, fills the pores of the active material until finally near the end of discharge, the circulation of acid in the pores of the plates is retarded due to the increased bulk of the lead sulphate. Since the acid cannot get into the plates to maintain the normal action, the cell becomes less active, as indicated by the drop in voltage.

To charge the cells direct current is passed through the cells in a direction opposite to that of discharge. This current passing through the cells in the reverse direction will reverse the action which took place in the cells during discharge. It will be remembered that during discharge the acid of the electrolyte went into and combined with the active material, filling its pores with sulphate and causing the electrolyte to become weaker. Reversing the current through this sulphate in the plates restores the active material to its original condition and returns the acid to the electrolyte. Thus, during charge the lead sulphate, $PbSO_4$, on the positive plate is converted into lead peroxide, PbO_2 , while the lead sulphate on the negative plate is converted into sponge lead, Pb , and the electrolyte gradually becomes stronger as the SO_4 from the plates combines with hydrogen to form acid, H_2SO_4 , until no more sulphate remains and all the acid has been returned to the electrolyte. It will then be of the same strength as before the discharge and the same acid will be ready to be used over again during the next discharge.

Since there is no loss of acid, none should be added to the electrolyte.

31. Object of Charging—The acid absorbed by the plates during discharge is, during charge, driven from the plates by the charging current and restored to the electrolyte. This is the whole object of charging.

32. Charging Methods and Gassing—A battery can be charged at as high a rate as desired until it starts gassing. When fully discharged, but not overdischarged, it can absorb current at the highest rate. As the charge progresses, the plates can no longer absorb current at the same rate and the excess current goes to form gas. In a battery which is charged or nearly charged, the plates can absorb current without excessive gassing only at a low rate, and a high charge rate will be almost entirely used in forming gas, resulting in high temperature and wear on the plates.

33. Overcharge—Persistent overcharging not only tends to wash out the positive active material, but also acts on the positive grids, sometimes giving them a scaly appearance.

34. Injurious Effects of Local Action—There is another chemical action which takes place in any battery, termed "local action." This is going on all the time whether or not the battery is in use, and during all states of the charge. The lower the state of charge, the more injurious are the effects of local action, and the higher the density of the electrolyte used the more vigorous its action. The temperature of the electrolyte also has an effect on the local action—the higher the temperature the greater the effect. In addition to causing a battery to lose its charge, local action produces a lead sulphate of a different composition from that produced by electro-chemical action. The lead sulphate produced by local action is of a much harder texture than that produced by normal electro-chemical action and has a whitish crystalline appearance. It also has a high resistance and is insoluble in sulphuric acid. On account of the nature of this material, if allowed to accumulate on the active material to any appreciable extent, it will cause an increase in the internal resistance of the battery and a reduction in its capacity. This sulphate also tends to cause the plates to bend and buckle if allowed to go unchecked, because it continues to increase in volume as long as there is any sulphuric acid in the electrolyte. This is more noticeable where the sulphate has once gained foothold. In such cases the ordinary amount of charging will not bring the density of the electrolyte up to the proper specific gravity, and as the natural tendency of the repair personnel will be to add electrolyte, a trouble which has already gained headway will be aggravated.

35. Treatment to Remove Sulphate Produced by Local Action—If this injurious sulphate is not allowed to get too great a headway, it may be removed by long low-rate chargings. This method requires considerable time and is expensive, but is the only practicable one that can be employed without removing the elements and scraping them. Scraping the plates is objectionable, because in so doing a quantity of the active material is unavoidably removed with the sulphate, which naturally reduces the capacity of the battery. This sulphate forms not only on the surface of the plates, but also in the active material beneath the surface. The only proper course to follow is to take the necessary precautions to prevent as far as possible the formation of this sulphate to any appreciable extent. This can be done by remembering that local action is dependent upon the state of charge, the density, and the temperature of the electrolyte, the lower the state of charge and the higher the density and temperature the more injurious the effects. The local action thus far discussed is a natural conse-

quence under the conditions mentioned, even though the electrolyte is pure, but if impurities are introduced, a multiplicity of chemical actions will be set up which will have a disastrous effect on the plates.

36. Buckled Plates—Buckled plates are plates which have been bent and warped out of shape. Lead, like most all material, will expand under the action of heat, but it has a very low elastic limit, and once expanded, it will remain in that condition. If the temperature is kept below 110 degrees F. there will be no trouble from this source. Most buckled plates are caused by continued overdischarge or lack of charge.

37. Height of Electrolyte—The height of the electrolyte should be kept at the correct height above the tops of plates at all times. This height varies with different makes and types of batteries, but in general it should be kept as high as will allow the battery to be charged without overflowing; that is, without causing the electrolyte to run out at the filling tubes while charging.

38. Maximum Gravity and Equalizing Charge—By maximum gravity charge is meant, as the term implies, charging the battery until the density of the electrolyte reaches its maximum specific gravity. The object of the maximum gravity charge is to offset the effects of local action and to bring all the cells into step with each other in regard to state of charge. Instructions for carrying out maximum gravity and equalizing charge are usually given by the manufacturer.

39. Trickle or Floating Charge—A method of charging a battery held ready for emergency work or a battery out of service is what is known as a "trickle or floating charge." With this method a small charging current is passed *continually* through the battery. This low rate of charge will keep batteries in good condition with minimum attention. The only precautions to be observed are that reasonably good ventilation is provided and that water is added at sufficiently frequent intervals to prevent the plates from becoming uncovered. If the system is designed to keep the battery fully charged automatically, its operation should be checked periodically until it is certain that the system is not giving too much nor too little charge. If the cells gas continually, the battery is receiving too much charge. If the gravity continues to drop, the battery is not receiving enough charge.

For a battery which is on trickle charge 24 hours every day, if the adjustment is correct the voltage directly at the battery terminals will be between 2.10 and 2.30 volts per cell and should average very close to 2.15 volts per cell. If it is continually below

2.10, the charging is insufficient. If continually above 2.20 it is excessive. (These values are correct for batteries whose full charge gravity is 1.200-1.22—but not for other batteries.)

There is a wide-spread impression that a lead and acid battery held ready for emergency should be given periodical cycles of discharge and charge in order to maintain its normal capacity. If such a battery is kept on a trickle or floating charge, at the required rate, when not in use, it will be fully charged and capable of delivering its maximum capacity at the normal discharge rate during an emergency.

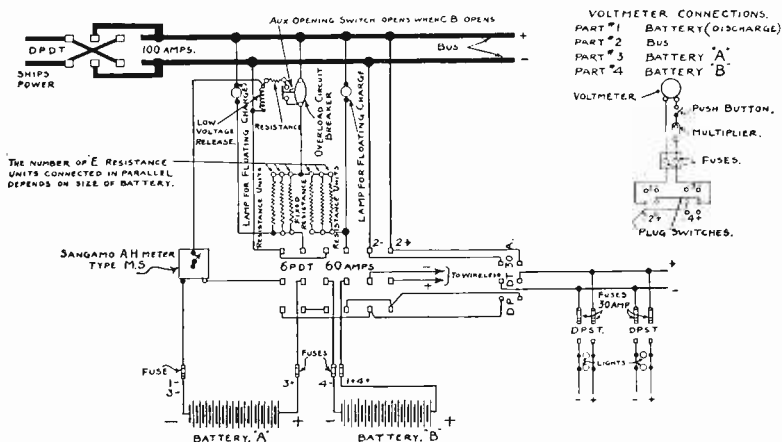

FIG. 73. Diagram of Exide Storage Battery Company's Switchboard.

40. Exide Storage Battery Switchboard—The ship's power circuit is connected through the large upper double-pole double-throw switch which is so connected that in case of the reversal of the polarity of the ship's power the same relation between the power bus and the battery can be obtained by reversing the switch. The circuit breaker is equipped with overload, low-voltage release, and automatic trip operated by the ampere-hour meter.

41. Operation—First determine that the power bus switch is closed in the proper direction by observing whether the voltmeter reads when the plug switch is in the lower left-hand receptacle. If it does not read, reverse the power bus switch, then ascertain that the two halves of the battery are also properly connected by taking readings in the upper and lower right-hand receptacle. The voltmeter circuit is normally open and a push but-

ton switch is provided on the switchboard for closing the circuit when it is desired to take a voltage reading. This precaution is taken to prevent inductive effects incidental to the operation of the radio outfit damaging the meter.

42. To Charge the Battery—Close the circuit breakers at the time, holding up the plunger of the low voltage release coil, and then close the 6-P.D.T. switch to the left. This will place the respective halves of the battery on charge through the charging resistances on the back of the board. The red pointer on the ampere-hour meter should be set at the numbering corresponding to the capacity of the battery in use. The black hand of the ampere-hour meter indicates the state of discharge of the battery at any time. As soon as the charge is started the black hand will begin to move towards zero and the charge should be completed when it reaches zero. When the black hand reaches zero it makes a contact which opens the circuit breaker by means of the automatic trip, thus automatically cutting off the charge. For the equalizing charge; or if for some other reason the battery requires an over-charge, it is necessary to remove the cover from the ampere-hour meter, or, by the use of a key furnished with the same, and turn the black hand to the proper point. (As determined by reference to the battery instructions.)

If when the battery is charging the ship's power circuit fails, the low voltage release will open the circuit breaker, preventing the battery from discharging back into the bus. The battery can be used for supplying current in such an emergency as described under "Discharging the Battery."

43. To Float the Battery—With the 6-P.D.T. switch closed to the left and the circuit breaker open, the charging circuit through the resistance units will be open, but the battery will be receiving a floating charge through the two lamps mounted in the upper corners of the switchboard. This is intended to be the normal condition of operation; i.e., battery fully charged and floating, with circuit breaker open, and 6-P.D.T. switch closed to the left, the radio circuit is connected direct to the bus. When the battery is floating or charging, the lights cannot be operated from it, and the lower double-pole double-throw switch should then be closed to the left. The feeder switches for the various light circuits can be opened or closed, as desired.

44. To Discharge the Battery—With the circuit breaker open, close the 6-P.D.T. switch to the right. With the battery discharging the lights can be operated from either the bus or the bat-

tery by closing the small lower double-pole double-throw switch to the left or right, respectively.

Whenever the ship's dynamo is shut down care should be taken to open the radio circuit switch on the ship's switchboard.

45. Operating Exide Batteries in Emergency Radio Service on Ships—Keep the battery and surrounding parts dry and

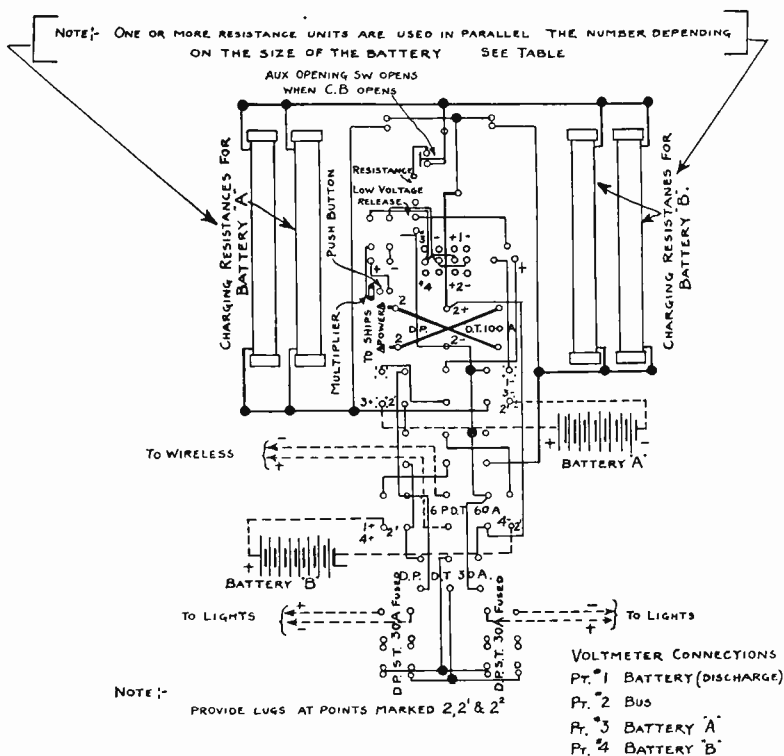

Fig. 74. Back View of Wiring of Exide Storage Battery Switchboard.

clean. If electrolyte is spilled or if wood trays (or compartments) are damp with acid, apply a solution of cooking soda and water, then rinse with water and dry; do not allow soda solution to get into cells. Soda solution or ammonia will neutralize the effect of acid on clothing, cement, etc.

46. Replacing Evaporation—Do not allow the surface of the

electrolyte to get below the top of the separators; keep it above by adding sufficient suitable water to each cell as often as necessary. Do not fill higher than 1/2 inch above the top of the plates. In cold weather the time to add water is at the beginning of a charge, so that gassing will insure thorough mixing and any danger of the water freezing be avoided. It will never be necessary to add new electrolyte, unless some should be spilled. Never transport or store water in any metallic vessel (lead excepted) and keep receptacle clean and covered, to keep out impurities. Glass, earthenware, rubber or wooden receptacles that have not been used for any other purpose are satisfactory. Only suitable water should be used for replacing evaporation. Distilled water is suitable. Rain water is usually satisfactory, if obtained on a clean roof in a clear atmosphere, but care should be taken to allow the rain to flush the roof before catching the water.

47. Pilot Cell—The specific gravity of all cells in series on discharge and charge falls and rises together, so that the gravity reading of the electrolyte of one cell, known as the "pilot cell," will indicate the state of discharge or charge of the series as a whole. As the battery is divided into two parallel series for charge, a pilot cell in each half is necessary.

48. Discharging—The system is laid out with the idea that the battery is to be discharged only in emergencies.

49. Discharge Limits—In emergency, little if any permanent harm will result if the battery is discharged to the full amount that it will give (provided that it is immediately recharged) but overdischarging as *a constant practice will soon result in permanent damage.*

50. Floating—The battery is to be floated at all times, except when charging or discharging. When floating, both lamps on battery, switchboard will burn dimly. If either lamp goes out, immediately replace it with another of proper rating.

In order to check the generator polarity and to guard against the battery becoming accidentally discharged through the reversal of the generator, read the voltmeter frequently with the voltmeter plug in opening marked "Bus." If the polarity has changed, throw over the switch marked "Reversing Switch."

The system is designed to keep the battery fully charged and its operation should be checked every week or so until it is certain that the system gives neither too much nor too little charge. With proper adjustment, the specific gravity of the pilot cell will remain practically constant (within 5 to 10 points if level of electrolyte is kept the same height) and the cells will not be gassing. If the

cells gas continually, the battery is receiving too much charge. If the gravity continues to drop, the battery is not receiving enough charge. Adjust the charging current if necessary by changing the floating lamps, using higher wattage to increase rate or lower wattage to decrease. Make another check after a week or so, repeating until it is certain that the system gives neither too much nor too little charge. The adjustment can then be considered correct and will only require occasional checking.

51. Charging—After discharges of any kind totaling one-tenth capacity or more, immediately put the battery on charge and combine the charging until the black hand of the ampere-hour meter has returned to zero. Once each month, preferably during fair weather, charge the battery. Move the black hand of the ampere-hour meter back, halfway to the red hand, and charge until the "pilot cell gravity" and the voltage of each side have remained constant for one hour and all cells have been gassing or bubbling freely for the same length of time. This means that, under normal conditions, the charge will be of about two hours' duration. When charging, keep the bus voltage at 110 volts as, if it is low, the charging rate will be reduced and the time required to charge correspondingly increased. For example, a bus voltage of 100 volts reduces the charge rate one-third and therefore increases the time 50 percent; a 90-volt reduces the rate two-thirds and triples the time.

Raise the covers of the battery box during this charge and *never bring a lighted match or other exposed flame near the battery as this might cause an explosion.* Keep the vent plugs in the cells. Do not remove them during charge except to take specific gravity or temperature readings. After the charge, reset the black hand of the ampere-hour meter to zero.

52. Specific Gravity of Electrolyte—The normal specific gravity of the electrolyte should, with the cells fully charged, be between 1.260 and 1.295 for all marine types with the exception of type MVS, for which it should be between 1.200 and 1.220.

It will never be necessary to add new electrolyte, except in connection with replacing actual loss of electrolyte due to spillage or similar causes. Before adjusting low gravity by adding acid, first make sure charging will not raise the gravity. To do this, continue charge until specific gravity shows no rise, and then for five more hours. Never make a gravity adjustment on a cell which does not gas on charge. To adjust low gravity, add new electrolyte of 1.300 specific gravity instead of water when replacing evaporation until the gravity at the end of an equalizing charge

is up to 1.260 (1.200 for type MVS). Then stop adding electrolyte and replace all further loss from evaporation with suitable water. Do not adjust higher than 1.260 (1.200 for type MVS) and do not add electrolyte of higher gravity than 1.300 directly to the cells.

53. Impurities—Impurities in the electrolyte will cause a cell to work irregularly. Should it be known that any impurity has gotten into a cell, it should be removed at once. In case removal is delayed and any considerable amount of foreign matter becomes dissolved in the electrolyte, this solution should be replaced with new immediately, thoroughly flushing the cell with water before putting in the new electrolyte.

54. Broken Jar—If a jar should become broken, do not allow the plates to dry. If there is no extra jar on hand, remove the cell (either with or without its jar) from the circuit, immerse it in a wooden bucket filled with water and keep it covered with water until ready to reinstall it.

55. Indications of Trouble—The chief indications of trouble in a cell are:

(a) Falling off in gravity or voltage relative to rest of the cells.

(b) Lack of gassing on charge.

If a battery seems to be in trouble, the first thing to do is to give it a charge. Then take a gravity reading of each cell. If all the cells gas evenly on the charge and the gravity of them goes above 1.225 (1.180 for type MVS), most likely all the battery needed was the charge; otherwise, record all gravities less than this, resume charge and continue until three consecutive half-hourly readings of the gravity of all these cells show no increase for any of them. Then make gravity adjustment on those which are still below this and which are gassing. Before making an adjustment, determine whether the jar is cracked by adding water to the proper height and allowing cell or jar to stand several hours, noting whether level falls. If a jar is changed, charge it. If a cell will not gas on above charging, investigate for impurities.

If in doubt as to whether the electrolyte contains impurities, a half pint sample should be submitted for test. The Electric Storage Battery Company will analyze and report on, free of charge, samples received at its works (Allegheny Ave. and 19th St., Philadelphia, Pa.) with transportation charges prepaid; provided the battery in question is an Exide.

Battery Charging Panel—A small battery Charge-Discharge panel is shown in figure 75. This is a typical small panel as furnished with the radio equipment of a vessel fitted with a low power

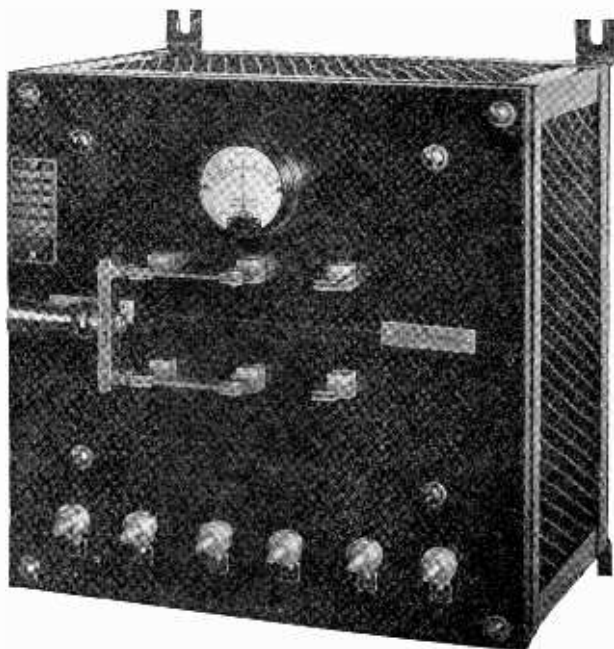

FIG. 75. Battery Charge-Discharge Control Panel.

emergency transmitter. The two storage batteries connected in series, as illustrated in figure 76, furnish power to operate a motor generator. The generator develops AC voltage for the plate transformer of the vacuum tubes.

Referring to figure 75 the double pole double throw switch when thrown to the left places the batteries on charge directly from the ship's power. The charging current is regulated by fixed resistors on back of the panel. The switch is thrown to the right to discharge the batteries. The ammeter on the front of the panel indicates to the operator whether or not the battery has the correct charging polarity and the rate of charge and dis-

charge. When not on charge or discharge the ammeter needle reads zero on the center of the scale. On the left side of zero the scale is marked "Charge" and on the right side of zero it is marked "Discharge." When the batteries are placed on charge

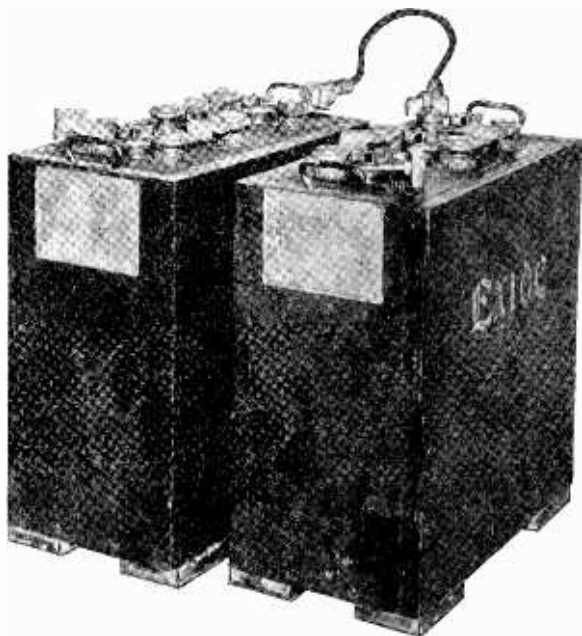

FIG. 76. Lead Plate Batteries Used for Auxiliary Power Supply.

and the charging polarity is correct the needle will move to the "Charge" side of the scale. If the polarity is reversed, it will move to the "Discharge" side and the switch should be immediately opened.

On small charging panels of this type no protective circuit breakers are provided and the operator is required to take the batteries off charge whenever the ship's dynamo is shut down. If this is not done, the batteries will discharge through the windings of the dynamo, possibly resulting in reversal of the polarity of the machine when it is again started. This is discussed in detail in paragraph II on page 63.

CHAPTER 4

THEORY AND APPLICATION OF THE VACUUM TUBE

Construction—The vacuum tube as employed in radio consists of a glass vessel similar in shape to the ordinary house lamp but exhausted to a higher degree of vacuum. Within the glass tube are three important elements known as the filament, grid and plate. They are insulated from each other and electrical con-

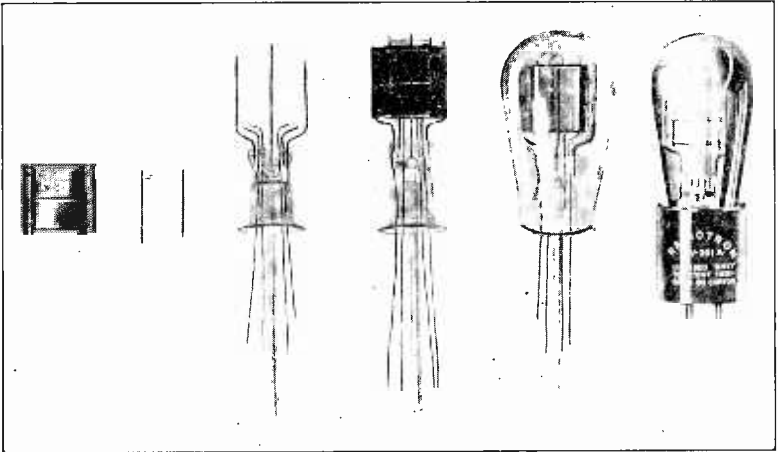

FIG. 77. A Vacuum Tube in Various Stages of Assembly.

nections to each are made by bringing out leads through the glass stem of the tube to the composition base upon which terminal pins are mounted. The base of the tube is constructed to fit into a device called the socket. The socket is provided with contacts that engage the terminal pins when the tube is placed in it. Binding posts on the socket make electrical connection to the contacts and provide means of connecting the elements to an external circuit. Two binding posts are provided for the filament and one each for the grid and plate.

i. Thermionic Electronic Emission—All substances are made of electrons. Electrons as described in the first chapter are

negative particles of electricity. Consider a piece of metal. These small negative particles move about in the metal taking zigzag paths in all directions. Their velocity of motion depends upon the temperature, increasing with temperature. If the metal is heated the electrons attain sufficient velocity to fly off the surface, exactly as the components of water when it is boiled. The heated filament in the vacuum tube is in this manner a source of electrons. A little study further will show that special types of filaments will give off many electrons without requiring much power for heating.

The filaments are usually constructed of tungsten wire. The number of electrons thrown off by such a filament will be greatly increased if certain chemicals are added to the tungsten wire at the time of manufacture. Such chemicals as thorium, barium and strontium are used for this purpose and are either drawn with the wire or cemented upon it. Vacuum tubes having thorium drawn with the tungsten wire are known as thoriated filaments. Those having a coating of barium and strontium are called oxide or coated filaments. Tubes having thoriated oxide filaments operate at much lower temperature than those having plain tungsten and but little light is thrown off. They are sometimes called dull emitters. Variable resistances to regulate the current are usually connected in series with the filament circuits.

Just as water will boil more enthusiastically if the generated steam is pumped away and a vacuum maintained, so will more electrons come off the filament if the free ones are constantly drained away by the attraction of a positively charged plate. The plate is constructed of nickel and surrounds the filament and insulated from it. A positive charge is placed on the plate, by connecting it to the positive terminal of a "B" battery or d.c. supply. The filament of the tube is usually heated by connecting it to a battery called the "A" battery or by a.c. from the lighting circuit by use of a stepdown transformer. The negative terminal of the "B" battery is connected to one terminal of the "A" battery. The positively charged plate attracts the free negative electrons and they are transported through the space between filament and plate. This stream of electrons from filament to plate furnishes a connecting

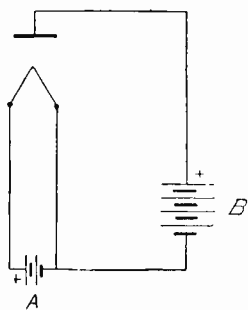

FIG. 78. Connections of "A" and "B" Battery to Vacuum Tube.

medium or path for a current which flows from the "B" battery to the filament, from filament to plate and plate to "B" battery.

It should be noted that the electron flow is indicated as the current flow. This is in accord with the present-day theory that electric current is electrons in motion.

If the plate potential was made negative, that is, if the connections to the "B" battery are reversed, the electrons would be repelled and little or no current would flow. If the battery "B" were replaced by an alternating current generator, the electrons would be attracted during the positive alternation and current would flow only during this half cycle. On the negative alternation the electrons would be repelled. Thus the tube acts as a rectifier allowing its current to flow in one direction and not in the other. Vacuum tubes as rectifiers have an important application in radio circuits as will be described later.

2. Use of A.C. Vacuum Tubes—Although alternating current has been used successfully in operating the amplifier and oscillator tubes of transmitters it is only of late that this method has achieved success with receiving tubes. The chief drawback has been the a.c. hum caused by grid-and-plate effect. If the grid return is made to the negative *B* and one side of the filament as in usual practice, the a.c. component of the filament voltage from the step-down transformer will act on the grid and plate of the tubes exactly as a signal voltage, thus producing a loud 120-cycle hum. By connecting the grid return to the mid-point on a potentiometer this hum can be balanced out on the amplifier tubes. However, this is not adaptable to the detector with grid condenser and leak operation, as it is susceptible to any stray low frequency electric disturbances. In order to eliminate the hum from the detector tube, a heater-cathode method is employed. As already explained, heating the filament is necessary in order to cause it to emit electrons. With the heater-cathode method electrons are emitted by another strip of metal placed close to the filament and heated by it. Such a vacuum tube has five prongs, the two filament connections, the cathode, plate and grid. The grid return is made to the cathode and is therefore not subject to the a.c. reversals of current, thus eliminating the hum.

3. Action of the Grid—Between the plate and the filament is the wire grid. The grid is much closer to the filament than the plate and hence a charge on the grid has much more effect on the flow of electrons than would a similar charge on the plate. A

small negative charge on the grid would repel the electrons and hence oppose their flow to the positive plate. On the other hand a positive charge on the grid would assist the flow of the electrons and more current will flow through the tube. Thus the grid acts as a valve to regulate the flow of current in the tube.

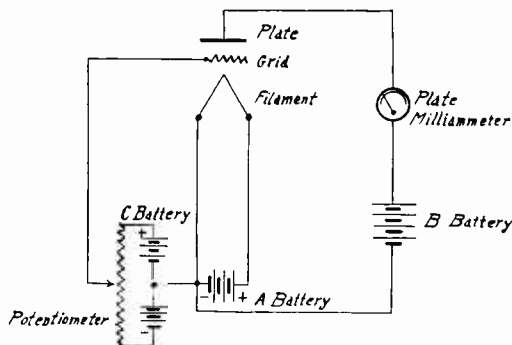

FIG. 79. Arrangement for Varying Grid Potential.

In the arrangement of figure 79 it is possible to demonstrate how small variations of grid potential are sufficient to produce large changes in the plate current. Referring to figure 79 it is possible to vary the potential on the grid by the potentiometer connected across the terminals of the battery "C." If the grid is made negative in respect to the filament electrons will be repelled by the grid resulting in a decrease of plate current as indicated by the milliammeter connected in the plate circuit. By varying the potentiometer the grid potential may be made sufficiently negative to stop the flow of plate current entirely. On the other hand by making the grid positive, electrons are attracted by both the positive grid and plate resulting in more electrons being drawn to the plate which will be manifest by an increased plate current.

4. Characteristic Curve—By plotting the different values of grid voltage against plate current the characteristic curve of the plate current is secured. Figure 80 shows such a curve. Characteristic curves may be also secured by plotting grid voltage against grid current; also plate voltage against plate current with a fixed grid potential. The values obtained by these methods are very useful when combined with values of the apparatus to be used with the tubes.

A study of curve *A* in figure 80 will show that with a fixed

plate voltage, as the grid voltage is made positive, the plate current gradually increases. A limit is finally reached whereby an increase in grid voltage produces no increase in plate current.

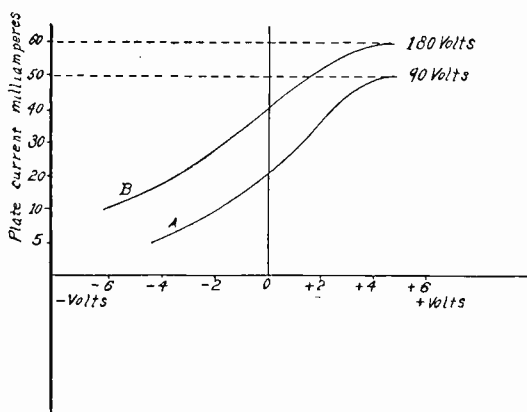

FIG. 80. Characteristic Curves of a Vacuum Tube.

Thus a limiting value or saturation point is attained by the plate current. A positive potential on the grid assists the attainment of this saturation point caused by the grid absorbing more electrons. This absorption causes a small grid current to flow from grid to filament, filament to battery "C," battery "C" to grid. The total electron flow is the sum of plate and grid current. The only way in which the plate current can be further increased is by either increasing the filament temperature or by increasing the plate voltage (curve *B*).

5. Detector Action—The three electrode vacuum tube may be used as a detector of radio frequency currents by employing the properties of the tube when worked at the curved portion of the plate-current grid voltage curve or by the properties of the tube when worked at the curved portion of the curve showing the relation of grid voltage and grid current.

The first method consists of establishing a normal grid voltage of sufficient value to operate the tube at that part of the characteristic curve whereby the radio frequency voltages communicated to the grid cause unequal changes in the plate current. Figure 81 shows the connections necessary to employ this method of detection. The antenna is connected directly to the inductance. The circuit is tuned to resonance with the desired transmitting station

by the condenser $C-1$. The battery "A" heats the filament of the tube. The "B" battery and telephone receivers are connected across the plate and filament of the tube. The direct current of the "B" battery flows through the telephone receivers. The con-

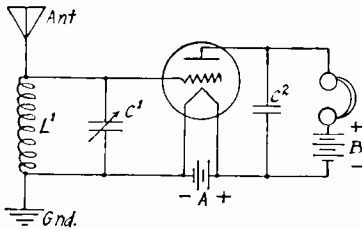

FIG. 81. Vacuum Tube Detector Circuit.

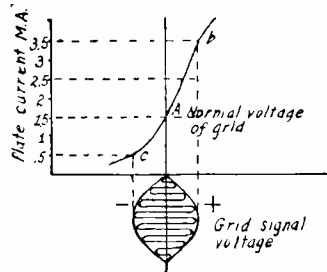

FIG. 82. Curve Showing Operation of Vacuum Tube as a Detector.

denser $C-2$ by-passes the radio frequency components that are present in the plate circuit. The circuit is tuned to incoming signals and the radio frequency voltages built up across the tuning condenser $C-1$ are impressed on the grid of the tube. For a positive alternation the plate current increases to the point b and on the negative alternation of the same amplitude the plate current is decreased to c , as shown in figure 82. Thus the average plate current is increased during the duration of a signal voltage. The fluctuations of plate current occur at radio frequencies corresponding to the frequency of the incoming signal. Due to the high inductance of the windings in the telephone receiver the radio frequency variations of plate current cannot flow through them, but are by-passed by the capacity of the windings and the condenser $C-2$. Only the average value of plate current flows through the receivers causing the diaphragm to vibrate at an audio frequency dependent upon the number of wave trains per second.

This method of detection is sometimes employed using a "C" battery to place a high negative voltage on the grid. The "C" battery of 3 or 4 volts is connected in series with the grid with the negative terminal next the grid. The positive terminal is connected to the tuned circuit. The high negative potential permits the tube to be worked on the lower bend of the characteristic curve. However, there is no change in the action other than the effect of each wave train which reduces the plate current more than it is increased. As before, the plate current is varied at a radio

frequency rate resulting in an audio frequency vibration of the diaphragm of the telephones for each wave train.

6. Condenser and Grid Leak—The rectifying action of the tube with condenser and leak requires a positive bias on the grid for best results. Figure 83 shows the arrangement of apparatus employing this form of detection.

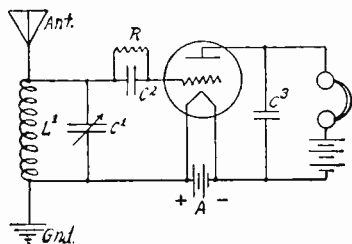

FIG. 83. Vacuum Tube Circuit Employing Grid Leak and Condenser.

One side of the grid leak resistance is connected to the positive side of the "A" battery through the inductance $L-1$. The action would be the same if the resistance was connected directly between grid and positive filament. In some circuits this is absolutely necessary since there is no other circuit back to the filament. The flow of steady grid current through this resistance places a positive bias on the grid of a few tenths of a volt with respect to the negative end of the filament. The rectifying action is accomplished by operating the tube on the curved portion of the grid current curve and the straight portion of the plate current curve. The action is as follows: During the positive alternation of the radio frequency oscillation the plates of the condenser $C-2$ connected to the tuned circuit $L-1$ $C-1$ become positive—the other plates become negative robbing the grid of some of its electrons; thus the grid becomes positive and electrons pass to it from the filament.

During the negative alternation of the radio frequency oscillation, the plates of the condenser $C-2$ connected to the tuned circuit $L-1$ $C-1$ become negative—the other side becomes positive and hence the grid becomes negative. No electrons are added but none are thrown off as the grid is not heated. The net result of the whole oscillation is to lower the potential of the grid. The effect of each oscillation then is to decrease the potential of the grid (by adding electrons). This effect is cumulative so that each wave in a wave train adds to the effect of the preceding wave. The result of the passage of the wave train is that the grid potential is reduced. The reduction of the grid potential causes a reduction of the plate current. This occurs every time a wave train passes and hence there is a pulsating current of wave train frequency through the telephones. Wave train frequency is audio frequency, so the signal is heard. (See figure 84.) The grid leak does not allow the escape of the electrons from the grid while the

$L-C$ circuit is oscillating. In the comparatively long time between wave trains, electrons on the grid escape through the grid leak and the grid regains its normal potential.

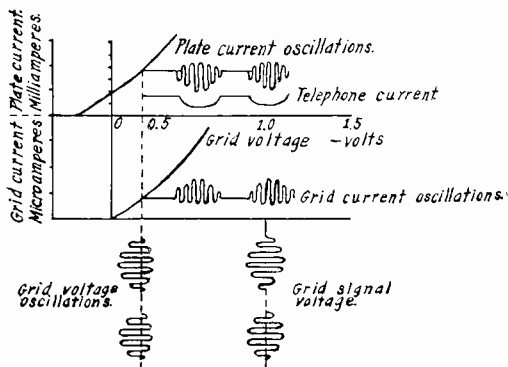

FIG. 84. Action of Vacuum Tube as Detector with Grid Leak and Condenser.

If strong signals are to be received or if static is strong, the value of the grid leak resistance cannot be too high or the charges will not leak off between wave trains, but for weak signals the leak resistance can be made much higher. The usual value of the grid condenser is .00025 mfd. and of resistance 2 to 5 megohms for strong signals and up to 10 megohms or more for weak signals.

7. Vacuum Tubes as Amplifiers—It was shown in the preceding paragraph that a vacuum tube acts as a detector or rectifier because an alternating voltage applied to the grid circuit produced unsymmetrical oscillations in the plate current. At the same time it is acting as a detector it is also acting as an amplifier—that is, oscillations of greater power are produced in the plate circuit for a given alternating voltage in the grid circuit than would be produced by the same voltage applied directly to the plate circuit.

The small voltages acting in the grid circuit simply act as a valve to control large values of current in the plate circuit furnished by the "B" battery.

To use the valve as an amplifier it is desirable to have the grid voltage of such value that on the positive alternation of the oscillation the plate current is increased as much as it is decreased during the negative alternation, otherwise distorted amplification will result. In order to secure undistorted amplification it is necessary

to operate the tube on the straight portion of its plate-current grid-voltage curve. Sometimes a "C" battery is necessary in order to fix the normal grid voltage at the center of the straight portion of

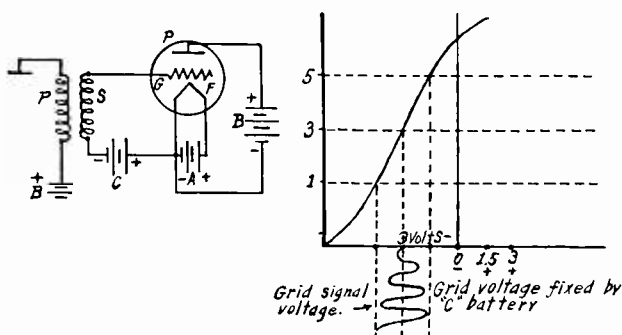

FIG. 85. Curve Showing Condition Necessary for Undistorted Amplification in Vacuum Tube.

the characteristic curve. The addition of the "C" battery also increases the life of the "B" battery but does not necessarily give more amplification.

Vacuum tubes are employed to amplify both radio and audio frequency oscillations.

8. Audio Frequency Amplification—There are several uses for audio frequency amplification in its application to radio. One of the most important of these is at a broadcasting station. Here a device called the microphone receives the sound waves from the voice or musical instruments and converts them into audio frequency currents. These audio frequency currents are too feeble to properly impress themselves upon the radio frequency currents which transport them through space in the form of waves; therefore the feeble audio frequency currents must be amplified by an audio frequency amplifier of special construction called a speech amplifier.

At a radio receiving station the audio frequency signals produced in the plate circuit of the detector tube can be heard by connecting a pair of telephones in series with the plate circuit. However, if it is desired to increase the strength of these signals whereby they are more easily distinguishable it becomes necessary to employ an audio frequency amplifier.

An audio frequency amplifier increases the power output of a receiver whereby it is possible to enjoy the program from a broad-

casting station on a loud speaking device such as a horn or cone designed for that purpose.

9. Characteristics Required of Audio Frequency Amplifier—Sound waves vibrate at the rate of approximately 30 to 15,000 cycles per second. The average human ear cannot hear vibrations below 16 cycles nor above 15,000 cycles. In radio broadcasting it has been found that a band from 30 to 7,000 cycles is ample for excellent transmission. Therefore it can be seen that an audio frequency amplifier employed either as a speech amplifier at the transmitting station or as an audio frequency amplifier at the receiving station must have certain characteristics whereby all these frequencies can be reproduced without distortion. (See curve, figure 85-a.)

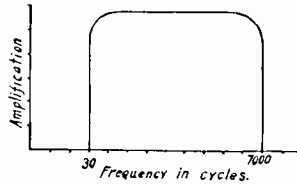

FIG. 85a. Characteristic Curve of Ideal Amplifier.

Audio frequency amplifiers designed for radio telegraph code reception do not require such frequency characteristics. An amplifier designed to give maximum amplification from 60 to 1,000 cycles is sufficient for this class of service.

10. Amplifying Systems—There are three principal methods of coupling vacuum tubes in an amplifying system. They are known as transformer coupled, resistance coupled and impedance coupled. The schematic circuits of each are shown in figure 86. These methods of coupling are also applicable to a radio frequency amplifier, the only change being in the sizes of the inductances and capacities employed. Each method has its advantages and disadvantages.

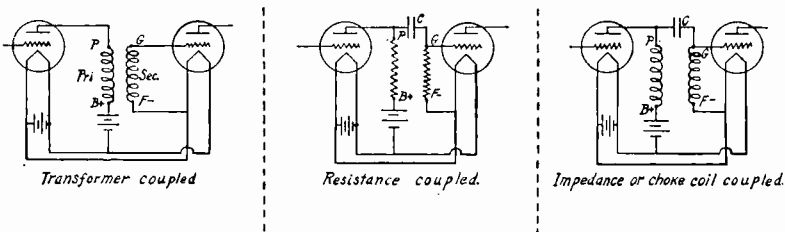

FIG. 86. Methods Used to Couple Vacuum Tubes in an Amplifier.

When a number of tubes are connected together in an amplifying system it is spoken of as a cascade or multi-stage amplifier.

If two tubes are employed in this way it is called a two-step amplifier, three tubes a three-step amplifier, and so on.

Of the three forms of coupling the transformer coupling is by far the most commonly employed primarily for the reason that two stages of transformer coupling may equal or exceed in amplification that secured by a three-stage resistance or impedance coupled amplifier. Transformer coupling is subject to distortion which may result in large values of amplification at high frequencies and very small values at the lower frequencies. However, with the improved design by certain manufacturers of audio frequency transformers there are procurable on the market several different types which produce even values of amplification of practically all audio frequencies employed in radio broadcasting.

Resistance and impedance coupled amplifiers of proper design amplify all audio frequencies to the same degree. Of the two methods the resistance coupled is the least efficient. Larger values of "B" battery are required on the plate of each tube to compensate for the voltage drop through the coupling resistors. The amplification per tube is less than the amplification constant of the tube (explained in a later paragraph) and is somewhat below that procurable by either of the other two methods.

The most general type of amplifier coupling employed at broadcasting stations to amplify the feeble currents from the microphone is the impedance coupled amplifier. The use of impedances in the plate circuit permits smaller "B" battery voltages to be used. Usually the inductances of the plate and grid coils are very high, thus permitting the voltage ratio to remain high throughout the greater part of the audio frequency band. The d.c. resistance is relatively low; therefore it is not necessary to employ higher plate voltages than are used with transformers. The gain per stage in amplification cannot exceed the amplification constant of the tube but does exceed somewhat that of the resistance coupled amplifier.

11. Amplification Constant—Resistance and impedance coupled amplifiers are limited in amplification per stage by what is known as the amplification constant of the tube. Amplification constant (expressed by the small Greek letter "mu," μ) is an expression of the ability of a vacuum tube to amplify voltages. For example, the plate current of a tube may be 4.5 milliamperes at 40 volts with a normal grid voltage of .4 volt. If the grid voltage is increased to 1.4 volts the plate current will rise to 5.9 milliamperes or slightly over 1.4 milliamperes per volt change. Now if on the other hand the grid voltage is left unchanged at .4 volt and the plate voltage is increased to 60 volts the plate current will be

increased to 8.5 milliamperes, a change of .2 milliampere per volt. Thus it can be seen that a volt added to the grid makes 7 times as much change in the plate current as a volt added to the plate voltage would. This number, which represents the relative effects of grid voltage and plate voltage upon plate current, is called the amplification constant of the tube. A tube having a high amplification constant is known as a "high mu" tube.

Thus a resistance or impedance coupled amplifier of three stages employing tubes having an amplification constant of 7 would have an over-all gain of approximately 6^3 or 196. However, with transformer coupling there is obtained a voltage step-up which is approximately equal to the turn ratio and for example in the case of a 1 to 3 transformer an over-all amplification for a single stage of 3 times 7, the tube constant, or about 21. The over-all gain obtained from two stages of amplification would be 21 squared or 441. Thus more amplification is obtained with two tubes employing transformer coupling than can be obtained with three tubes of the same type in a resistance or impedance coupled amplifier.

12. Plate Impedance—There is another electrical characteristic of the vacuum tube that has to be taken into consideration when figuring on its amount of amplification available from an amplifying system. This characteristic is known as plate impedance. The plate impedance is the opposition offered to the flow of an alternating current in the output or plate circuit of the tube. Its value determines the maximum power output which can be obtained from a tube. Its value varies with the voltages on the filament, grid and plate.

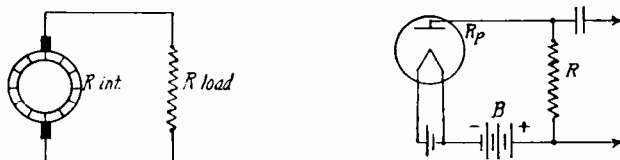

FIG. 87. The Output Rule—Showing that when Load Resistance is Equal to Internal Resistance Maximum Output is Obtained.

In considering the power output of a vacuum tube the resistance of the load to which it is coupled has considerable bearing. This can be easily explained by applying the rule governing the output of a direct current generator connected to a load. Referring to figure 87, the direct current generator is connected to the load marked R-load. The armature of the machine has a

certain resistance which is indicated by R_{int} (internal resistance). When the load resistance (R-load) is equal to the internal resistance (R_{int}) the generator will give its maximum output. If the load resistance is higher the current drops off and the generator does less work outside.

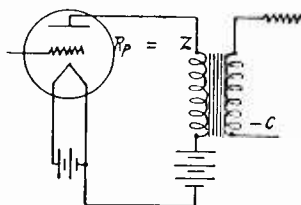

FIG. 87a. Output Rule Applied to Transformer Coupled Amplifier.

Now if the same rule is applied to a vacuum tube amplifier it will be found that the tube gives the most output when the load resistance R is equal to the plate impedance R_p . However, the application of this rule may result in serious frequency distortion when a tube having an extremely high plate impedance is connected to a trans-

former of high impedance. (Explained very clearly by Kruse in QST, April, 1927, Radiotron CX-340-UX-240.)

13. Mutual Conductance—The value of mutual conductance of a vacuum tube is an expression giving the degree of merit of the tube as an amplifier, detector, oscillator, etc. It is always desirable to have the mutual conductance as large as possible. The amplification constant is dependent upon the structure of the grid and its position relative to the other electrodes while the plate impedance depends upon the amplification constant and the surface areas of filament and plate.

As the usual practice is to vary the plate current by varying the grid potential the mutual conductance gives a measure of this effect. If the amplification constant and plate impedance are known the mutual conductance can be found by the equation:

$$\text{Mutual conductance in micromhos} = \frac{\text{Amplification constant}}{\text{Plate impedance}},$$

or

$$g = \frac{\mu}{r_p}.$$

Thus it can be seen that a tube having a high "mu" and low plate impedance will have considerable merit as an amplifier.

14. Transformer Coupling—Audio frequency amplifying transformers are usually of the closed core type having a primary and secondary winding insulated from each other. By winding the secondary with more turns than the primary, the voltages communicated to the grid of the tube to which the secondary is

connected can be considerably increased resulting in greater amplification per tube than is possible with either resistance or impedance coupling. The turn ratio of audio frequency transformers is of the order of 1 to 3, 1 to 6, 2 to 5; usually not running higher than 1 to 10.

Figure 88 illustrates the connections of a two-stage audio frequency amplifier arranged to amplify the audio frequency fluctuations of plate current produced in the detector tube plate circuit of a radio receiver.

Referring to figure 88 the plate of the detector tube is connected to the terminal marked *P* on the primary of the first transformer. The terminal marked *B +* is connected to the positive 45-volt terminal of the 90-volt "B" battery as this is the usual value for best operation of the detector tube. The secondary terminal marked *G* of the transformer is connected to the grid of the first amplifying tube. The other secondary terminal marked *F -* is connected to the negative three-volt terminal of the "C" battery, so as to operate the tube on the steepest part of its characteristic curve as well as to conserve "B" battery.

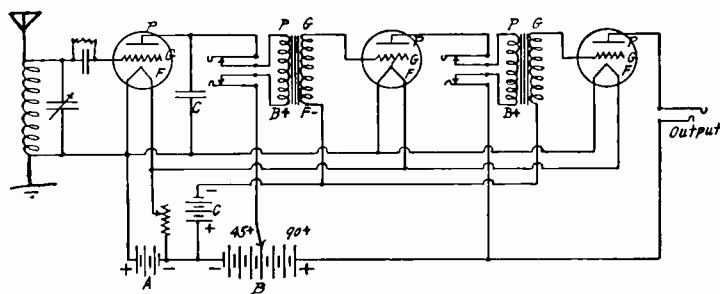

FIG. 88. Detector and Two-Stage Transformer Coupled Audio Frequency Amplifier.

Note: The correct value of bias voltage for a particular tube is usually furnished by the manufacturer.

The plate circuit of the second tube is connected to the primary of the second transformer as in the first, but the *B +* is connected to the positive 90-volt terminal of the "B" battery as this is the usual voltage employed to operate the first amplifier tube with transformer coupling. The secondary of the transformer is connected to the grid of the second amplifying tube with the filament return connected to the negative "C" battery. The plate circuit

of the last tube is connected in series with loud speaker and 90-volt "B" battery.

Jacks are frequently provided in the plate circuit of each tube so that the loud speaker or telephones may be plugged in either the detector circuit, first stage amplifier, or the last stage.

The condenser *C* is connected directly across the plate and filament circuit to by-pass the radio frequency currents present in the detector plate circuit, otherwise they would be choked out by the reactance of the primary winding of the first transformer. The addition of the condenser serves to increase the strength of the signals and prevents distortion.

15. Operation—If no signal is heard there is only the steady plate current through the primary of the transformers, therefore no magnetic flux surrounds the windings and there is no e.m.f. induced in the secondary windings. When the grid of the detector tube is actuated by a signal voltage it produces fluctuations of an audio frequency in the primary circuit of the first transformer. The fluctuating current flowing in the primary produces a magnetic flux which cuts the windings of the secondary, producing an alternating e.m.f. therein which is communicated to the grid of the first amplifying tube. The alternating e.m.f. on the grid produces symmetrical variations of plate current in this tube. The plate circuit of the second tube in turn transfers the amplified fluctuations to the grid of the third tube where another gain in amplification is secured.

The amplification is gained by the small expenditures of grid power in each tube acting as a relay which controls the power available from the "B" battery. The alternating grid voltage on each successive tube is always higher than that of the preceding one, resulting in large variation of plate current, and a larger e.m.f. is built upon the secondary of each transformer as the energy is transferred from one tube to the next.

16. Distortion in Audio Frequency Transformers—There are two principal forms of distortion in an audio frequency amplifier. They are known as frequency and harmonic distortion.

The first, frequency distortion, usually is the result of the distributed capacity of the windings making it resonant at some frequency of the order of seven to fifteen thousand cycles. This results in tremendous amplification at these frequencies producing unnatural tones in the loud speaker or phones and often causes the tubes to oscillate at an audio frequency.

The quality of reproduction from a transformer subject to this form of distortion can sometimes be improved by connecting a

high resistance or condenser across the grid and filament terminals of the secondary windings.

Frequency distortion in the form of loss of the lower frequencies may be caused by insufficient primary of transformer or insuffi-

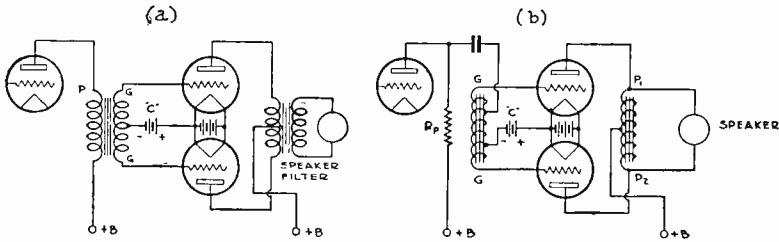

FIG. 89. Push-Pull Amplifier.

cient turns in the choke of an impedance coupling, the effect in both cases being that the impedance is not sufficiently matched to the tube plate to constitute a successful load, hence the tube is unable to put power into it.

Harmonic distortion is the creation of frequencies that are multiples of the fundamentals. A 500-cycle tone may be fed into the amplifier and at the output there will be not only the 500-cycle tone but perhaps its second harmonic, a 1000-cycle tone, or perhaps even other such frequencies which are multiples of the original tone. This form of distortion may be caused by the saturation of the iron core. By employing a good grade of iron in the core and by proper design of the transformer this form of distortion can be made negligible. Harmonics are also created when a tube is overloaded.

Push-Pull Amplification—The arrangement of vacuum tubes in the circuits of figure 89 constitutes what is known as a push-pull amplifier. Such an arrangement has several advantages, one of which is that greater undistorted output is obtainable than that which would be available from a single tube. The harmonic frequencies generated in the plate circuits cancel out and thus frequency distortion is eliminated.

The arrangement of "b" is a development by Kendall Clough. It will be noted that the first V.T. has a plate resistor and not the familiar winding of the primary of a transformer. Consequently there is no iron core to be magnetized by the plate current and again frequency distortion is prevented at this point.

The manner of connecting the speaker across the terminals of the plate choke coil in the last stage should be noted. When two power tubes are used having the same characteristics (passing the same current) the ends of the windings P_1 and P_2 are at the same DC potential. This permits the speaker to be connected to these terminals without danger of burning out its windings by large values of plate current. The expense of blocking condensers ordinarily used with a choke coil condenser speaker filter is dispensed with. The circuit has several other advantages not within the scope of this chapter.

17. Resistance Coupling—A resistance coupled amplifier consists of an arrangement of vacuum tubes so connected that the signal to be amplified is fed into the grid circuit of the first tube transferred from the plate circuit of this tube by means of resistance and capacity coupling, on to the grid circuit of the next tube, and so on to the output of the last amplifier, to which the loud speaker is connected.

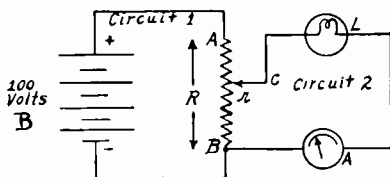

FIG. 90. Theory of Resistance Coupling.

Before considering the circuit of such an amplifier it would be well to consider the theory of coupling energy from one circuit to another by means of a resistance. Referring to figure 90 the resistance R is a voltage divider, also known as a potentiometer. The resistance R is connected in series with the battery B in circuit. Current flows through the circuit BR producing a drop in potential along the resistance. There is also another circuit consisting of a lamp and ammeter in series (circuit 2). If circuit 2 is connected across a small portion of R in circuit 1, the lamp in circuit 2 will light and the ammeter will record the current drawn from circuit 1. Circuit 2 is coupled to circuit 1, for there is a transfer of energy from 1 to 2. The circuits are coupled together by means of the coupling resistance R , which is common to both circuits. The total voltage across the AB is equal to battery, i.e., 100 volts. This value is obtained when the movable contact C has been moved to A . The lamp L will then light the brightest and the

ammeter will read its highest value of current. As the contact is moved towards B , the voltage drops between B and the contact decreases as indicated by the brilliancy of the light and decreased reading of A . When the contact is at B the potential difference is zero and the light will go out. The potential difference between B and the movable contact is proportional to the amount of resistance between them. As long as there is a difference of potential between B and the movable contact a current will flow through the circuit LAr .

Applying this theory to the resistance coupled amplifier shown in figure 91 the action is as follows: The voltages acting in the plate circuit of the first tube are coupled to the grid of the second tube by the resistance R_p which is common to both circuits. The condenser C is not essential as far as the coupling is concerned but is necessary to prevent the positive potential of the "B" battery from reaching the grid of the tube. It offers a low impedance

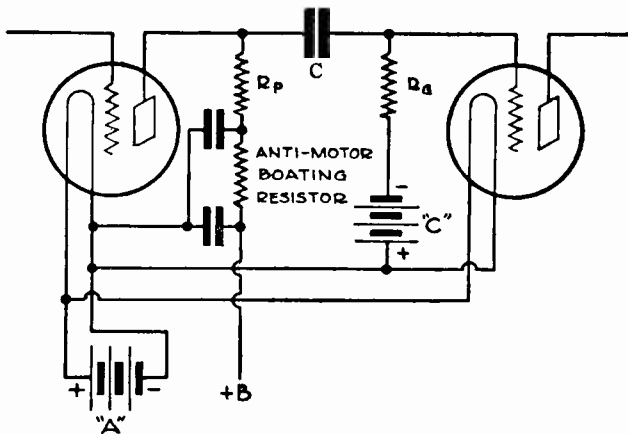

FIG. 91. Resistance Coupled Amplifier.

path to the alternating signal voltages to the grid of the next tube. The resistance R_G allows the negative electrons to leak off from the grid. It also permits the application of the proper "C" battery bias required for best amplification.

On account of certain losses in the coupling circuit the total voltage developed in the plate circuit of the first tube is not avail-

able for the grid of the second tube. One of these losses is represented by the voltage used up in the plate coupling resistance R_p . This resistance usually has a d.c. resistance of 100,000 to 250,000 ohms, the value depending upon the type of tube and "B" battery voltage employed. The plate voltage applied divides across the coupling resistance and the tube in the ratio of resistance of one to the resistance of the circuit. The total impedance of the tube circuit compared to the coupling resistance is small and as a result most of the "B" battery goes to waste in the coupling resistance R_p . The "B" battery voltage employed in the resistance amplifier must therefore be kept high as it is impossible to reduce the value of plate resistance without reducing the voltage available for the grid of the second tube which means reduced amplification.

The insulation resistance of the stopping condenser C must be kept high, otherwise a positive bias will be introduced from the "B" battery to the grid of the next tube. A positive bias will start a grid current resulting in reduced amplification and distortion. Condenser C usually has a capacity of .05 to 1 mfd. depending upon the stage of amplification in which it is used. If too small its impedance to low frequencies is tremendous and the bass notes are lost. If too high the time required to charge and discharge becomes so great that serious distortion is produced on strong signals.

When provided with non-inductive resistors and large capacity coupling condensers the resistance coupled amplifier will amplify uniformly over a wide band of frequencies.

Such amplifiers are used extensively in television transmission and reception as it is frequently necessary to amplify frequencies ranging from 16 to 20,000 cycles.

"Motor-Boating" in Resistance Amplifiers—Quite frequently resistance coupled amplifiers become unstable and start oscillating at a low frequency rate. These low frequency oscillations are heard in the phones or speaker as a sound resembling that heard from an exhaust of a two cylinder motor boat, thus the phenomenon is termed "motor-boating."

"Motor-boating" can be prevented by connecting extra resistors in series with the plate resistors. The arrangement is shown in figure 91.

The values of these resistors usually are of 10,000 to 100,000 ohms. Their values are best determined by experimenting until the amplifier is stabilized.

18. Impedance Coupling—The most general type of ampli-

fier coupling device employed at broadcasting stations for the amplification of the feeble microphone currents is the impedance coupled amplifier. It has the advantage of a very uniform frequency amplifying characteristic. Like the resistance coupled amplifier it is limited in amplification per stage by the amplifica-

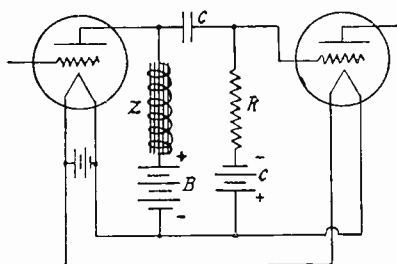

FIG. 92. Impedance-Resistance Amplifier.

tion constant of the tube. The gain per stage, however, is somewhat higher than that secured with a resistance amplifier of the same number of tubes.

The circuit shown in figure 92 shows the arrangement of an impedance coupled amplifier as commonly employed for radio reception. The impedance coil Z prevents the flow of alternating current through the "B" battery and must therefore have a high enough inductance to choke back the low as well as the high frequencies. The condenser C performs the same functions as in the resistance coupled amplifier, that is, passes the variations of plate voltage to the grid of the second tube and prevents the "B" battery from applying a positive bias to this grid. The resistance R supplies negative bias to the grid of the tube and also permits the negative electrons accumulated on the grid during a positive swing of signal voltage to leak off, thus preventing the tube from blocking.

The values of C and R are of the same values as employed in resistance coupling. The value of impedance Z is made as high as practically possible in order to make the voltage ratio high. Its d.c. resistance is relatively low and therefore it is not necessary to employ such high values of "B" battery as are necessary with resistance coupled amplifiers.

In some types of impedance amplifiers the grid leak resistance is replaced by another impedance coil similar to the plate impedance, thereby making what is sometimes called a "double imped-

ance" or "impedance-impedance" coupling to distinguish from the impedance-resistance type previously discussed. The impedance of this coil to alternating signal voltages is high but its direct current resistance is low. This permits the grid charges accumulated on strong positive swings of the signal voltage to easily leak back to the filament. In the case of a resistance connected in this branch of the circuit it is necessary it keeps its value very high in order that the grid may receive the full value of signal potential impressed across it. If too high the grid becomes blocked or free. This causes the amplifier to block or "motor-boat." The choke coil has a relatively low direct current resistance and a high

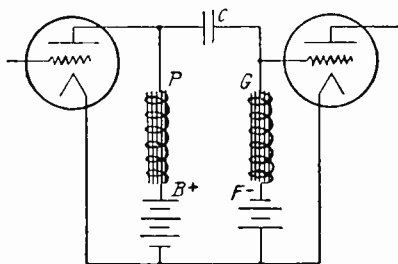

FIG. 93. Impedance-Impedance or Double Impedance Amplifier.

impedance to alternating currents at audio frequencies and thus permits the grid charges to leak away easily so that blocking or motor-boating does not occur on strong signals. An arrangement of this circuit is shown in figure 93.

Another arrangement consists of winding the plate and grid impedances on the same iron core. The ratio of the windings is 1 to 1. The highest voltage that can be communicated to grid of a tube employing straight resistance or impedance coupling is the voltage drop in the external plate circuit of the preceding tube. This is always less than the voltage directly in the plate circuit. By placing the windings on a common core the arrangement has the advantages of a gain in voltage by virtue of the mutual inductance between the plate and grid coils. The two windings are so arranged that the capacity between them is small. A coupling or stopping condenser is connected between the two windings at their high potential ends. The system has many of the advantages of ordinary impedance coupled amplifiers, with additional advantage of giving higher voltage ratio.

19. Radio Frequency Amplification—Amplification of the radio frequency currents before detection is called radio frequency amplification. Enormous gain in the amplification of weak signals can be accomplished by this method which generally means an increased range of reception. This may be explained as follows: The telephone current produced by a detector circuit rectifying signals from a spark or radio telephone transmitter is closely proportional to the square of the radio frequency voltage which acts on it. From this it can be seen that even a small amount of radio frequency amplification means a considerable increase in the rectified current of the detector. Assume an amplifier capable of amplifying either the radio or audio frequency currents 7 times. Employing it as a radio frequency amplifier will give an output of 7 squared or 49 times, whereas if it is employed as an audio frequency amplifier it can only amplify the detected signal 7 times. Thus there is much to be gained by such a method of amplification. It will also be shown how selectivity is gained by the use of cascade radio frequency amplifier of several tuned circuits.

The diagrams in figure 94 illustrate the most common methods of coupling radio frequency amplifiers which are, untuned r.f. transformers, tuned r.f. transformers and the variometer method.

The untuned method usually consists of a transformer having a primary and secondary winding of 1 to 1 ratio. It usually has an air core but when employed for amplification of frequencies of approximately 30 or 40 kilocycles, the core may consist of thin laminations of iron which tend to make the transformer tune broadly, i.e., accept a wide band of frequencies. In order that such transformers function over a wide band of frequencies the coupling is made close and frequently resistance is kept high by winding the transformer with fine wire or even resistance wire. The dis-

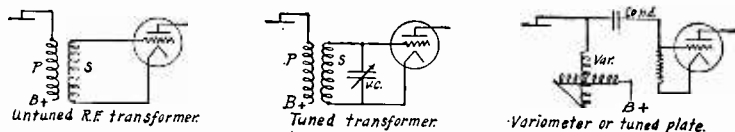

FIG. 94. Methods Used to Couple Vacuum Tubes in Radio Frequency Amplifiers.

tributed capacity of the windings produces a resonant circuit which results in small amplification at frequencies other than the resonant frequency. In order to employ such transformers to cover the broadcast band of frequencies corresponding to the band 200-600

meters, it is necessary to use in successive stages unlike transformers having different frequency characteristics so as to secure a fair degree of uniform amplification.

Tuned radio frequency is a very desirable method of coupling several tubes in a cascade amplifier. One of the greatest advantages is the gain in selectivity; the tuned circuits being very efficient at the frequency to which they are tuned and inefficient at all other frequencies. The more tuned circuits there are the greater becomes the selectivity. Very soon, however, practical limits are reached and the whole system becomes unstable. A brief study of the action of a tuned r.f. amplifier will show the reason for this instability which usually results in self-oscillations and reduced amplification.

Figure 95 shows the connections of a single stage of tuned r.f.

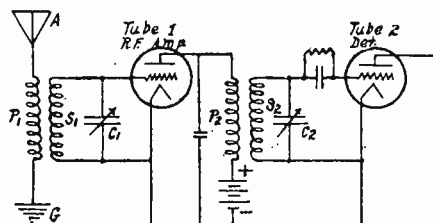

FIG. 95. Theoretical Circuit of Tuned Radio Frequency Amplifier.

preceding the detector tube. The antenna circuit transfers its energy to the secondary circuit by the coupling existing between the primary and secondary of the first r.f. transformer. The secondary circuit S_1 impresses on the grid of the tube 1 the signal of a frequency to which it is tuned. A magnified current is produced in the plate circuit of this tube which is transferred into the second tube by the second r.f. transformer. The secondary S_2 being tuned to resonance at the desired frequency accepts it and passes it on to the grid of the second tube where it is detected. As the condenser C_2 tunes the circuit to resonance it will be noticed that a whistle is produced which seriously interferes with the desired signal. In other words, the amplifier has become instable and the first tube has started generating self-sustained oscillations. These oscillations or radio frequency currents are generated regardless of the presence of the signal and continue as long as the secondary of the second r.f. transformer is tuned to the same or approximate frequency as the first r.f. transformer. Before proceeding to the means of preventing this effect we must explain the effect.

Self-sustained oscillations arise in one way by energy being re-transferred from the plate circuit to the grid of the same tube by electrostatic capacity existing between these two elements. Although of small value this internal capacity has a tremendous effect on the vacuum tube as a r.f. amplifier. The manner in which this re-transfer of energy takes place can be explained by referring to figure 95. The primary P_2 is magnetically coupled to the secondary S_2 . A coil such as P_2 when closely coupled to a tuned circuit such as S_2, C_2 will undergo a change in its apparent inductance to a given frequency as the tuning of the circuit S_2, C_2 is varied. Suppose that the frequency of the current through the primary winding is that corresponding to 300 meters or 1,000 kilocycles per second. As the tuning of the secondary is gradually varied from 200 to 600 meters the inductive reactance of the primary to the 300-meter current will rise continuously until the secondary tuning arrives at 300 meters where the reactance will reach a peak value. As the secondary wavelength is increased beyond this value, the reactance of the primary to the 300-meter current will again drop off. If resonance is approached from either side the rise in inductive reactance of coil P_2 will build up a voltage on the plate and grid inter-electrode capacity (the small capacity existing between plate and grid elements within the tube) tending to force a current back into the input circuit (grid circuit) which aids the current already there, and correspondingly larger variations of plate current are produced. The amplitude of the voltages and currents will be built up until the losses in the circuit due to expenditure of power are equal to the total input. This process of feeding back power from the plate circuit to the input circuit is known as *regeneration*. Regeneration is very desirable in the circuit, providing it is under control, as it means increased output, but in this particular case it is not yet under control and as the secondary circuit is tuned to resonance or approximate resonance the amount of power becomes so great that it more than equals the power lost in the resistance of the input circuit and the tube will be capable of supplying all its own losses and will then start to generate self-sustained oscillations. The frequency of these oscillations will be approximately that to which the S -1, C -1 circuit is tuned. It is therefore clear that unless this feedback is under control it will be impossible to secure maximum amplification, as at any time the circuits are resonated self oscillations will start causing severe distortion in reception and rendering the receiver almost useless. Self oscillations are most likely to

occur at the lower wavelengths (higher frequencies) as the small value of inter-electrode capacity offers a low reactance path to currents of these frequencies resulting in greater feed back.

Self oscillations are also caused by energy being re-transferred from one circuit to another by the electrostatic and electromagnetic coupling existing between the different coils and wiring of the circuits. In the circuit of figure 95 the field surrounding coil *S-2* will react somewhat on the coil *S-1* and undesired feed-back will occur.

The methods used in eliminating oscillations may be classified into three groups. In one group an attempt is made to damp out the oscillations by making the amplification less efficient. In another group there are special arrangements to balance out whatever intercouplings do exist. In another group it is aimed to reduce to a minimum all stray magnetic and electrostatic intercouplings.

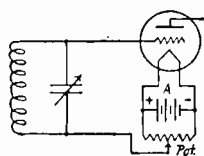

FIG. 96. Controlling Regeneration by Potentiometer Method.

20. "Lossier" Methods—A grid potentiometer connected as in figure 96 is a "losser" method and comes under the first group mentioned above. When the movable slider of the potentiometer is adjusted so that the grid is sufficiently positive, the grid attracts enough electrons so that oscillation cannot take place. Making the grid positive decreases the amount

of signal voltage as the grid to filament path provided by the electrons moving to the positive grid acts somewhat as a leak or short circuiting path. It also means increased "B" battery consumption as well as distortion produced by the changing grid-filament resistance of the tube.

Another lossier method is shown in figure 97 in which a series resistance is connected directly in the grid circuit. This resistance, usually of 300 to 700 ohms, tends to damp out the amplitude of the signal oscillations and accordingly the variations of plate current are never sufficient to produce a feed-back that could start self oscillation.

Regeneration can also be controlled by a rheostat in the filament circuit of the radio frequency tube. By proper adjustments of resistance the tube can be kept just under the oscillation point. This constitutes a lossier method as it is usually necessary to operate the tube below its

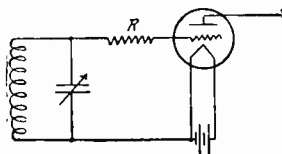

FIG. 97. Lossier Method with Series Grid Resistance.

normal filament voltage to stop oscillations which means reduced amplification.

Still another method is by reducing the coupling between primary and secondary. This can be done by limiting the number of turns on the primary or by increasing the distance between the coils. The disadvantage of this method lies in the marked decrease in the transfer of energy from one stage to the next with an increase of wavelength. This disadvantage has been eliminated in one commercial amplifier by placing a portion of the plate coil on the condenser shaft so that it rotates inside the grid coil of the succeeding stage in such a manner that the rotating portion of the plate coil opposes the coupling from the fixed portion of the low waves (higher frequencies where the amplifier is most unstable) and adds to the coupling at the high waves rotating with the condenser through its 180 degrees of revolution. The circuit arrangement is shown in figure 98.

21. Feed-Back Prevention and Compensation—The second class of methods of control strikes at the source of the regenerative feedback and involves either the prevention of current flow through the plate-grid capacity or the compensation of the effects upon the input circuit of this current flow.¹

"This class of methods falls into two groups. In one group, as exemplified by the Rice circuit, and many others which have come into commercial use under the general name of 'Wheatstone bridge circuits,' the input circuit of the stage is isolated from all reactions from the output circuit by connecting the input and output circuits as conjugate arms of an a.c. Wheatstone bridge of which the grid-plate capacity forms one arm. The grid, plate, and filament electrodes form three terminals of the bridge and the fourth terminal is some point in the circuit network of the stage which is maintained at a potential different from that of any of

¹The treatment of stabilization of radio frequency amplifiers with the exception of a few paragraphs is taken from Dr. L. M. Hull's article entitled "Anti-Regenerative Amplification," published in QST, Jan., 1924. It is by courtesy of Dr. Hull and QST that the author has been permitted to quote from it.

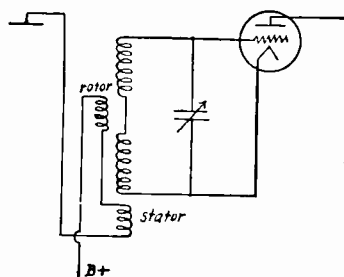

FIG. 98. Hassel's Method of Variable Coupling.

these electrodes. In the second group, as exemplified by the Hazeltine 'Neutrodyne' circuit two of the bridge arms are coalesced through the use of a close mutual inductance coupling in either the grid or the plate circuit; there is no fourth terminal, and the input and output circuits have one terminal in common, namely the filament."

22. Reversed Tickler—The simplest method of the first group is shown in figure 99. It is known as the reversed feed-

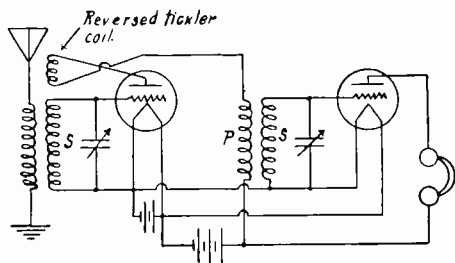

FIG. 99. Tuska's Reversed Feed-Back Circuit.

back or reversed tickler circuit. It consists merely of the addition to inter-electrode coupling between plate and grid circuits of an additional magnetic coupling through the tickler coil. The connections to this coil are made opposite (reversed) with respect to those of the feed-back coil in the Armstrong circuit, so that this magnetic coupling tends to suppress regeneration instead of aid it, thus directly opposing the coupling through the plate-grid capacity. It is utilized commercially in the Tuska "Superdyne." An inherent disadvantage of this form of control is that it involves balancing an inductance against capacity and hence the degree of compensation varies quite rapidly with the wavelength of the received signal.

23. Hazeltine's Neutrodyne Method—The second circuit of this group is the development of Prof. Hazeltine and named by him "neutrodyne," a method of neutralizing capacity coupling in triode (three electrodes) amplifiers. It suggests the "neutralization of a 'force,' the tendency of the triode to oscillate."

The circuit is shown in figure 100. The neutralizing capacity C_N is connected from the grid to the high potential terminal of coil L which is so coupled to the transformer $T-2$ that the voltage across

L is just opposite in phase and bears a constant ratio to the voltage across T_2 regardless of the wavelength to which T_2 is tuned. By proper choice of C_N the current through C_1 can be made to introduce into T_1 a voltage which opposes and just balances that produced by the current through C_1 .

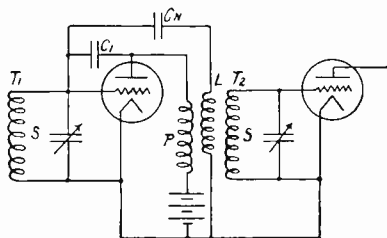

FIG. 100. Hazeltine's Capacity Coupling Method of Neutralization.

In practically applying the arrangements of figure 100 to amplifiers, the coil L may be used wholly for neutralization purposes; but it is convenient to use it also as one winding of an amplifying transformer, thus making a third coil unnecessary. Figure 101 shows how this may be accomplished in a conventional neutrodyne circuit employing a tuned two-stage radio frequency amplifier and detector with capacity coupling neutralization of the forms just described. As shown by Prof. Hazeltine, the neutralizing capacities are in part inherent, existing between the coils and condensers of adjacent stages, and in part added by condensers. These condensers are of very small capacity and are conveniently made in the form of an insulated wire inside a metal tube. The secondary

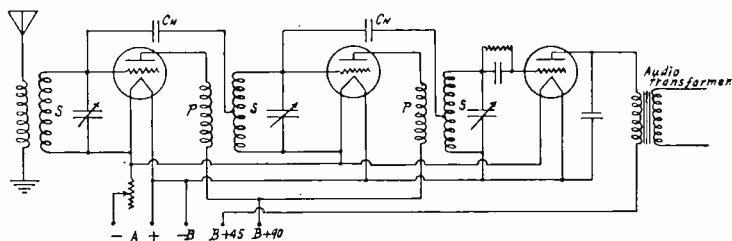

FIG. 101. Conventional Neutrodyne Circuit.

coils of the transformers are preferably wound outside the primaries and so screen away some of the coupling capacity otherwise existing between the primary coil of one stage and the sec-

ondary circuit of the preceding stage. This screening effect is advantageous, as it reduces the capacity to be neutralized. The coils of different transformers are arranged to have no magnetic coupling.

The adjustment of each neutralizing capacity is made experimentally by tuning in some strong signal and then turning out the filament of the tube whose capacity is to be adjusted, but leaving the tube in the socket. If the neutralizing capacity is not correct, the circuits on each side of the tube will have capacity coupling, which will transmit the signal. This method of adjustment was devised by Mr. H. A. Wheeler.

If the radio frequency amplifier circuit is adjusted by this method no regeneration exists, as radio frequency variations in the voltage of the plate with respect to the filament produce no radio frequency variations of the voltage of the grid with respect to the filament. If the capacity of the condenser C_N is increased beyond the point necessary to completely eliminate the incoming signal, the voltage induced on the grid will tend to destroy any amplification resulting from the use of a tube.

It is not necessarily desirable to completely neutralize the effect of regeneration as has been described. Stronger signals will be obtained with the same number of tubes if the capacity of C_N is increased only to the point where the amplifier ceases to produce radio frequency oscillations. The regeneration remaining will also tend to increase the selectivity of the system. If too much regeneration remains distortion may result from excessive selectivity or other reasons.

24. History—Historically the first application of the principle just described was in eliminating capacity coupling between the primary and secondary circuits of a radio receiver (SE-1420 described in a later chapter in this book) designed by Prof. Hazeltine for the U. S. Navy and developed in the Washington Navy Yard in 1918. This receiver was to have a wide range in wavelength (about 250 to 7,500 meters) and emphasis was laid on the necessity of preventing interference from short wavelengths when receiving signals of long wavelengths, such interference frequently taking place through capacity coupling. The first steps were the more obvious ones of arranging the circuits so that exposed parts were at or near ground potential and of enclosing the primary and secondary apparatus in separate metal compartments. However, the primary tuning coil and the secondary coupling coil had to be electrostatically exposed to one another in order to obtain the necessary magnetic coupling.

The arrangement adopted in the SE-1420 is illustrated in figure 101a. The large coil is the primary tuning coil; L_1 is the coupling coil; and L_2 wound outside of L_1 is the neutralizing coil. The inherent capacities from the high potential end of L_1 to various parts of the primary coil are represented by C_1' and C_1'' ; the corresponding neutralizing capacities are C_2' and C_2'' . These various capacities have a constant ratio, on account of the similar exposure of L_1 and L_2 to the primary coil. Hence it is necessary only to give the proper number of turns relative to L_1 in order to satisfy the relation for a balance which is:

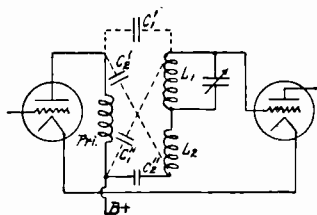

FIG. 101a. Arrangement of Neutralization of Capacity Coupling between Primary and Secondary Circuits in Navy Radio Receiver SE-1420 Developed by Hazeltine.

$$\frac{N_1}{N_2} = \frac{C_2'}{C_1'} = \frac{C_2''}{C_1''}$$

Since L_2 is outside of L_1 it also has a direct screening action, making C_1' , C_1'' smaller than they otherwise would be, and smaller than C_2' , C_2'' . Hence L_2 requires fewer turns than L_1 . The proper number of turns N_2 was determined experimentally by putting the coils at right angles (so as to eliminate magnetic coupling) and adjusting N_2 until no signal was transmitted.

While studying the theoretical limitations of amplifier circuits in 1918, Prof. Hazeltine realized that a most serious limitation was the tendency to oscillate by reason of regeneration through the coupling capacity between the grid and plate. The higher the amplification attempted, as by reducing capacities and losses and by increasing the secondary turns, the greater would be the regenerative effect. It then occurred to him that the principle of capacity coupling neutralization previously worked out for the SE-1420 receiver would be applicable. It proved very successful and is considered one of the greatest contributions made to the operations of tuned radio frequency amplifiers.

25. Wheatstone Bridge Circuits—The second group of methods in which overcompensation is impossible makes use of the properties of the alternating current Wheatstone bridge: If a bridge be arranged with four arms, which may be capacities, inductances or resistances, and the bridge is properly balanced, then an alternating voltage impressed between either pair of opposite

points of the bridge can produce no voltage drop between the other pair of opposite points of the bridge.

Figure 102 illustrates an application of the principle in the Rice circuit. The filament terminal of the tube, instead of being connected to the lower end of the input circuit T_1 , is connected to an

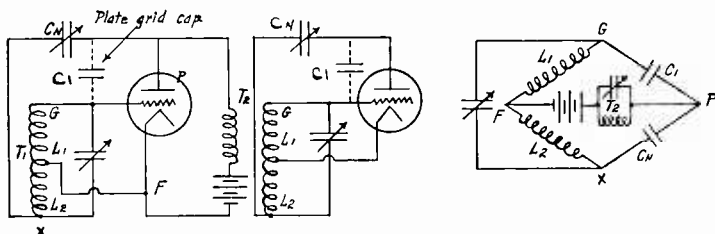

FIG. 102. Rice Circuit Employing Wheatstone Bridge Circuit for Stabilizing a Radio Frequency Amplifier.

intermediate point which divides the inductance of this circuit into two parts, L_1 and L_2 . The lower terminal of the input circuit is connected through a small fixed condenser C_N to the plate. The terminals G and X of the input circuit and terminals P and F of the output circuit are two pairs of opposite points of a Wheatstone bridge leaving two inductive arms and two capacitive arms. The inductive arms are L_1 and L_2 , which serve also as elements of the tuned input circuit T_1 . The capacitive arms are C_N and C_1 . The bridge is balanced for a given magnitude of capacity C_1 by placing the filament tap that inductance L_1 bears the ratio to L_2 that capacity C_N bears to C_1 . Thus if C_N is made equal to C_1 the filament connection can be brought permanently to the center of the inductance coil T_1 . It is best in constructing this circuit to connect the filament lead permanently near the center of the coil and vary C_N until a balance is reached. C_N can then be locked. The proper value of C_N will seldom be greater than 15 micro-microfarads. When the bridge is balanced in this way T_1 is electrically isolated from T_2 since all retroactive currents through C_1 are exactly compensated in T_1 by opposing currents through C_N . This permanent compensation is independent of the wavelengths and of the tuning circuits T_1 and T_2 when the bridge is balanced. It is also independent of the internal resistance and amplification factor of the tube. The amplifying action of the tube is the same as before. When a received signal is brought into T_1 the resulting voltage across the L_1 portion of the coil is impressed on the grid and a magnified copy of the currents in T_1 is maintained by the tube in

T_2 . The tube is now a true one-way repeater, however, and no reaction by these currents upon T_1 is possible.

A second compensated circuit of this type is shown in figure 103. Here the arms of the Wheatstone bridge are all capacitive. C_N is an external fixed condenser, forming the arm adjacent to C_1 . L is a radio frequency choke coil and provides a metallic grid

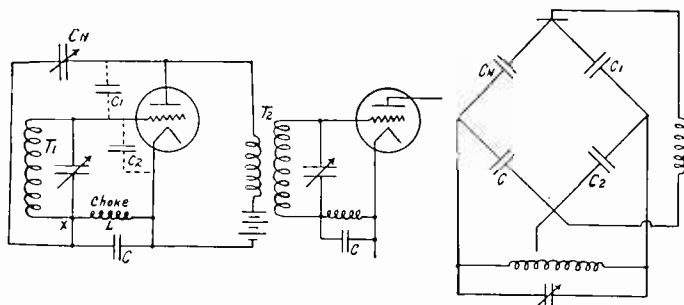

FIG. 103. Bridge Circuit with Capacitive Arms.

return path. The condenser C in shunt to it serves as another arm of the bridge adjacent to C_2 . C_2 may be an external condenser but it is convenient to use for C_2 merely the internal capacity of the tube between grid and filament, hitherto unmentioned. Thus the only extra circuit elements that are necessary are the fixed coil L and the condenser C which can be adjusted and then set.

Similar other combinations of inductance with capacity and resistance with capacity in the four arms of the bridge are possible, all of which permit a balance which is independent of the frequency. Those previously shown are typical and perhaps the most practicable.

In the group of methods which aims to reduce stray fields several principles are utilized. To reduce electrostatic coupling the different coils of the radio frequency transformers may be placed at such angles as to reduce the coupling to zero. This method is employed in neutrodyne circuits.

The different radio frequency stages may be placed in separate screened compartments. This method of shielding has proved very successful in several radio broadcasting receivers.

The geometric form of the winding will also greatly influence both fields. Thus a toroidal coil has a much smaller external magnetic field than a single cylindrical coil. Similarly the "figure eight" coil has a reduced external field. Many variations of these

principles are employed in radio receivers, all of which have the advantage of retaining selectivity and sensitivity while still eliminating self-oscillation.

26. The Shield-grid Tube—The four-electrode tube provides another and entirely different method of attacking the r.f. amplifier problem. Being internally shielded it has little or no inherent feed-back "through the tube," hence needs only screening between the circuits leading to and from the tube to secure non-oscillating performance. This sort of tube is a special subject in itself and will be treated later in the chapter.

27. Variometer or Tuned Plate Coupling—The tuned impedance as a method of coupling in radio frequency amplifiers consists of a variable impedance in the output circuit of each amplifier tube, this impedance usually taking the form of a variometer, or coil shunted by a variable condenser. Theoretically this method of coupling permits large values of amplification at a given wavelength, due to the comparatively high peak value when the plate circuits are tuned to the given wavelength. Practically, however, it is practically impossible to tune several such stages to resonance without producing oscillation. This method of coupling between radio frequency stages is not used at present to any extent whatever and no further discussion will be made of this method.

28. Use of Regenerative Amplification—The principle of regeneration can be applied directly to a vacuum tube detector circuit and will result in enormous increase of signal strength due to the amplifying action produced. To secure this amplification it is necessary to provide a feed-back which will be in phase with the voltage acting on the grid. This is the reverse of the method described in tuned r.f. amplification, where it was shown that a voltage opposite in phase was fed back to counteract the effects of regeneration in order to stabilize the amplifier. The circuit of a regenerative detector circuit is shown in figure 104. The explanation of the amplifying action is as follows: Oscillations in the tuned secondary circuit are applied to the grid through the condenser C' and produce corresponding variations in the direct current of the plate circuit, the energy of which is supplied by the battery B . This plate current flows through the tickler coil L_3 , and by means of the mutual inductance between L_3 and L_2 some of the energy of the plate oscillations is transferred back to the grid circuit so that it is in step with the original voltage and adds to it. The increased voltage produces amplified grid oscillations which, by means of the grid, produce larger variations in the plate current, thus still further reinforcing the oscillations of the system.

Simultaneously with this amplification the regular detecting action goes on; the condenser C is charged in the usual way, but accumulates a charge which is proportional, not to the original signal strength, but to the final amplitude of the oscillations in the grid current. The result is a current in the telephone much greater than would have been obtained from the original oscillations in the circuit.

The connections between L_2 and L_3 must be so made that their mutual inductance is of proper sign to produce an e.m.f., which

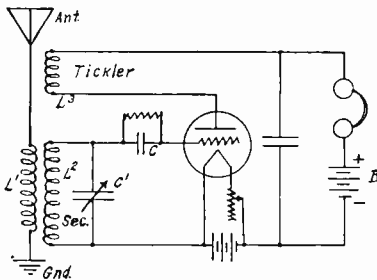

FIG. 104. Regenerative Detector Circuit.

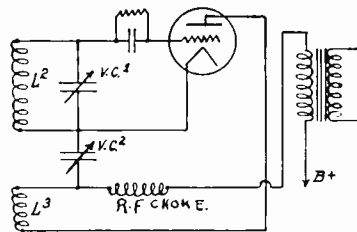

FIG. 105. Capacitive Control of Regeneration.

will aid the oscillations instead of opposing them. Various modifications of this method are used. The plate coil L_3 may be tuned by a variable condenser; or a variometer may be connected in the plate circuit in place of the coil L_3 . When a tuned plate or variometer method of regeneration is used the feed-back to the grid occurs through the inter-electrode capacity of the tube and by stray capacities or magnetic coupling between grid and plate circuits.

Another method of controlling regeneration is shown in figure 105. This method employs a combination of both inductance and capacity in series; the value of the latter being variable. It is employed considerably in short wave receivers and provides an easy and smooth control of regeneration. The radio frequency choke coil in series with the plate inductance L_3 and primary of the transformer prevents the radio frequency currents from being bypassed by the distributed capacity of the windings and allows them to be controlled by the variable condenser V.C., which controls the amount of feed-back. Besides this any of the usual regeneration methods may be converted into "resistance control" by em-

ploying a fixed tickler inductance and capacity with a variable resistance in shunt to the same.

29. The Vacuum Tube Oscillator—It has been stated in previous paragraphs that the vacuum tube would produce self-sustained oscillations dependent upon the feed back from plate to grid circuit. In the cases previously discussed a certain amount of feed back or regeneration was desirable and in one case (C.W. detector) this was carried to the point where the tube would oscillate. However, there are several other very important ways in which a vacuum tube can be utilized if it can be made to oscillate, i.e., become a generator of radio frequency currents.

Referring to figure 104—if the tickler coil L_3 is coupled very close to L_2 the greater will be the regenerative action. If the coupling is increased still further a “plop” will be heard in the phones which indicates that the tube is oscillating. The same thing has occurred as in the radio frequency amplifier; the energy fed back from the plate to the grid current is more than enough to supply the losses in the grid circuit and the tube becomes capable of producing self-sustained oscillations. The direct current furnished by the “B” battery is converted into alternating current of a definite radio frequency. The frequency of the oscillations is dependent upon the values of L_2C_1 in the tuned grid circuit. There are numerous circuits in which a vacuum tube may be connected so as to produce radio frequency currents. The only requirement for sustained oscillations is that the r.f. voltage induced in the grid circuit must vary the plate current through an amplitude which supplies to the external or coupling circuits power sufficient to maintain this r.f. voltage in the grid circuit.

The circuit shown in figure 105-a is one which is used quite extensively for transmitting purposes. The method by which it generates radio frequency oscillations is explained as follows:

When the key is closed the plate voltage is applied to the current from the high voltage battery B which starts a feeble oscillatory current in coil and condenser circuit LC . The plate circuit is directly coupled to the oscillatory circuit inductance by the condenser C_3 . The grid also is coupled directly to the opposite end of the inductance by the condenser C_2 . The oscillatory currents flowing in the LC circuit produce a voltage drop across the induc-

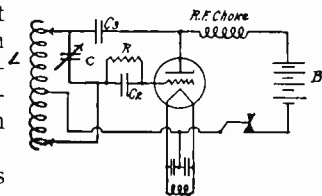

FIG. 105a. Vacuum Tube Radio Frequency Oscillator Circuit.

tance on account of its reactance to radio frequency currents. The voltage drop is communicated to the grid by the condenser C_2 . This alternating voltage on the grid varies the plate current at a radio frequency rate which changes the internal plate impedance of the tube. Changing the plate impedance establishes a radio frequency voltage between filament and plate. This voltage is impressed on the oscillatory circuit through the condenser C_3 and is in step with the original voltage which means that the original alternating grid voltage is increased in amplitude. The increased grid voltage will produce still greater variations of plate current and correspondingly higher radio frequency voltage between the filament and plate. The building up process continues until the vacuum tube cannot supply enough power to the oscillatory circuit

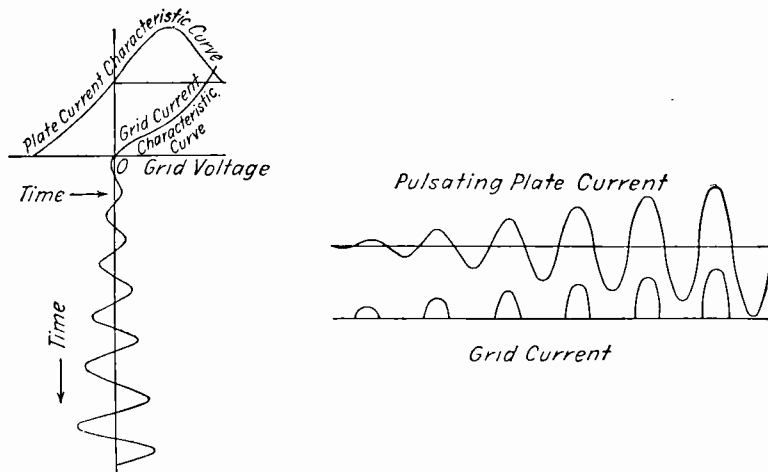

FIG. 106. Characteristic Curve of Vacuum Tube Employed as a Generator of Sustained Oscillations.

to increase further the amplitude of the oscillations. A glance at figure 106 will show that as the grid voltage increases it gradually increases the pulsating plate current. The grid finally builds up to a voltage that will no longer increase the plate current due to the fact that the plate current cannot pass beyond the saturation point and, as it flows only in one direction, it cannot pass beyond

the zero line. Thus the oscillations are maintained at a constant amplitude. The oscillations generated by such a system are known as undamped, sustained or continuous oscillations. The frequency of oscillation is dependent upon the values of L and C .

The radio frequency choke coil prevents the radio frequency currents in the plate circuit from flowing back to the filament through the "B" battery. The condenser C_3 , sometimes called the plate blocking condenser, prevents the "B" battery from being short circuited by the inductance L and also provides a low impedance path for the r.f. currents to the oscillatory circuit. The resistance R is used to place a negative bias on the grid with respect to the filament.

There are other circuits employed in conjunction with a vacuum tube for generation of radio frequency currents. They will be discussed in the next chapter.

30. Harmonic Frequencies—The sinusoidal voltage impressed on the grid of the generator circuit does not make equal changes of plate current during a cycle on account of the curvature of the characteristic plate current as shown in figure 106. This causes the current wave in the plate circuit to depart somewhat from the sinusoid and become distorted resulting in a generation of frequencies other than the natural period of the oscillatory circuit. Assume that the circuit in figure 105 is oscillating at a fundamental frequency of 500 kilocycles (600 meters). If a wavemeter is coupled closely to the inductance L and tuned to 1,000 kilocycles (299.8 meters) a deflection of the current indicating device on the wavemeter will be noted. This frequency which is twice that of the fundamental (one-half the wavelength) is the second harmonic. Likewise there will be found other frequencies at three and four times the fundamental (one-third and one-fourth wavelengths) and upward. It is impossible to obtain a reading on the current indicating device of the wavemeter at these high frequencies, but with an oscillating receiver capable of tuning over a wide band it is possible to identify them. The 2d, 3d, 4th, 6th, 8th, etc., are even harmonics. The 3d, 5th, 7th, etc., are the odd harmonics.

EXAMPLES OF HARMONIC FREQUENCIES.

| Fundamental or 1st Harmonic Frequency K/cys. | 2d Harmonic Frequency K/cys. | 3d Harmonic Frequency K/cys. |
|--|------------------------------|------------------------------|
| 1000 (299.8 m. ¹) | 2000 (149.9 m.) | 3000 (99.9 m.) |
| 350 (856.6 m.) | 700 (428.5 m.) | 1050 (285.5 m.) |
| 210 (1428 m.) | 420 (713.9 m.) | 630 (475.9 m.) |

¹ M-wavelength in meters.

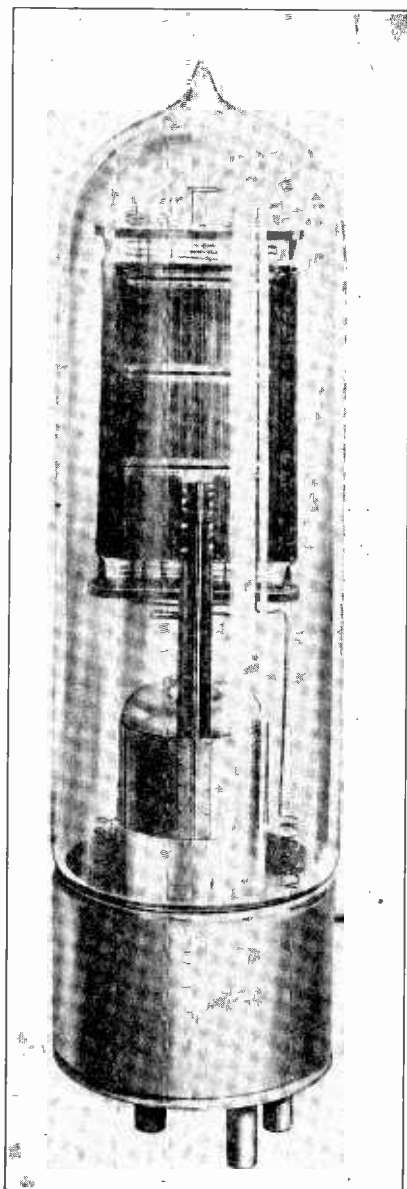

FIG. 107. Western Electric 250-Watt Power Tube.

It should be noted that harmonics are not generated by such an oscillator at frequencies below the fundamental (wavelengths higher than 600 in the example previously cited). However, it is possible to be listening in at a frequency of one-half the fundamental (twice the wavelength) at which a station is transmitting and still hear signals from such a station. This usually occurs when the detector tube in the receiver is itself oscillating. Although the detector tube may not be oscillating other tubes in the set may be oscillating feebly. The second harmonic of the tube oscillating in the receiver is "heterodyning" or beating with the fundamental frequency of the transmitter making the signals audible to the listener.

Elimination of Harmonic Frequency—Harmonic frequencies emitted by a transmitting station besides being a waste of power, cause interference at times to other services occupying frequency bands in which the harmonics fall, therefore, every means of preventing their radiation is resorted to, such as inductive coupling, tank circuits, with loose capacitive coupling to the antenna, master oscillator—power amplifier circuits and impedance circuits in the plate leads tuned to the interfering harmonic frequency. It is almost impossible to prevent radiation of harmonics, but by the methods just mentioned they can be greatly reduced in magnitude thus reducing the range of their interference considerably.

31. Method of Power Rating of Vacuum Tubes—Vacuum tubes used as oscillators or amplifiers in this country are rated by their output. In foreign countries they are usually rated by their input. The power input in watts to a tube is computed by multiplying the plate voltage by the effective plate current during an oscillation. The energy used in heating the filament is not considered. Example: The 203-A radiotron rated as a 50-watt tube when operated at 1,000 volts d.c. plate voltage shows a plate current of 125 milliamperes (.125 of an ampere).

$$\begin{array}{rcl} \text{Watts equal } E \times I, & & \\ \text{"} & \text{"} & 1000 \times .125, \\ \text{"} & \text{"} & 125. \end{array}$$

The usual power output in watts of this tube if it were connected to an antenna circuit for radiation would be the antenna current squared times the resistance of the antenna circuit. *Example:* The antenna current with this tube may read two amperes. The resistance of the antenna circuit may be 12 1/2 ohms. The power expended in the output circuit is:

$$\begin{array}{rcl} \text{Watts equal } & I^2 \times R, & \\ \text{"} & \text{"} & 4 \times 12\frac{1}{2}, \\ \text{"} & \text{"} & 50. \end{array}$$

To find the efficiency of converting the direct current power into alternating current power it is only necessary to divide the watts expended in the output by the watts expended in the plate circuit. Example:

$$\begin{array}{rcl} \text{Conversion efficiency equal} & \frac{\text{watts output}}{\text{watts input}}, & \\ \text{"} & \text{"} & \text{"} \quad \frac{50}{125}, \\ \text{"} & \text{"} & \text{"} \quad .4 \text{ or } 40\%. \end{array}$$

Thus 75 watts were lost in converting the d.c. power into a.c. power. It will be found that this power was expended in the grid current and in heating the plate of the tube. The example given is very conservative. Considerably greater efficiencies are very generally obtained.

32. Reduction of Grid Current by Grid Bias—The grid current may be considerably reduced by connecting a "C" battery in the grid circuit. The grid voltage is made negative in respect to the filament, thus reducing the grid current and hence the power dissipated by the grid. Another method by which the grid is made negative in respect to the filament thus decreasing the grid current is by inserting in the grid lead a condenser shunted by a resistance. The condenser offers a low impedance path for the grid radio frequency currents. The resistance is connected to the negative terminal of the high voltage plate supply and the voltage drop across this resistance places the correct negative bias on the grid of the tube.

33. Safe Plate Dissipation—It has been shown that a considerable amount of power was lost by heating the plate of the tube. The power lost in this way is called plate dissipation and is rated in watts. The electrical data accompanying each power tube shows what the value of this dissipation should be. The tube should always be operated at a high enough efficiency so that the difference between the input and the output does not exceed the rated safe continuous plate dissipation.

Example: A UV--203-A Radiatron has a power rating of 50

watts. Its safe plate dissipation is 100 watts. Operating at normal load the watts input would be:

| | |
|---------------|-------|
| Plate Voltage | 1000 |
| “ Current | .125 |
| Watts Input | 125 |
| “ Output | 50 |
| | <hr/> |
| “ Dissipated | 75 |

If the grid leak resistance is of the correct value and current carrying capacity the power expended in the grid-filament circuit can be omitted and the 75 watts considered as the plate dissipation. The normal plate dissipation has been shown as 100 watts for this type of tube, therefore the tube is being operated 25 watts lower than its maximum rating. Operating the tube at more than its normal safe plate dissipation without an attendant increase in power output may result in damage such as reduced electronic emission. If operated over a period of time the excessive heating of the plate may liberate gases from the metal which will be manifest by a milky white smoke within the tube. The tube is then said to be “soft” and is of no further use in this condition.

34. Water Cooled Power Tubes—If some means such as water cooling is used to carry away the heat energy dissipated by the plate, the output may be materially increased. The majority of power tubes from 1 K.W. upward are water cooled. Figure 108 shows a water cooled tube used in radio broadcasting. Water cooling is accomplished by placing a water jacket around the plate of the tube to which a rubber hose is attached. A motor-driven pump supplies a constant stream of fresh water through the hose to the bottom of the water jacket. An outlet is provided at the top of the jacket for the return path of the water. The fresh water and rubber hose provide the insulation between the plate and other low potential parts of the circuit.

Filament Construction of Power Tubes—The power tubes manufactured by the General Electric Company for the Radio Corporation of America have either a tungsten or thoriated tungsten filament. The thoriated or XL type of filaments provide a high filament emission at a low operating temperature combined with low power consumption and long life. The power tubes manufactured by the Western Electric Company have either a tungsten or oxide coated platinum filament. The use of an oxide filament provides ample filament emission at cherry red tempera-

ture. For maximum tube life filaments should always be operated at the lowest voltage consistent with satisfactory operation of the transmitter. In case of all tubes equipped with thoriated filaments, the end of the useful life of the tube is usually reached before the filament burns out. A tube may have lost its emission and be useless even though the filament lights and it is not otherwise defective.

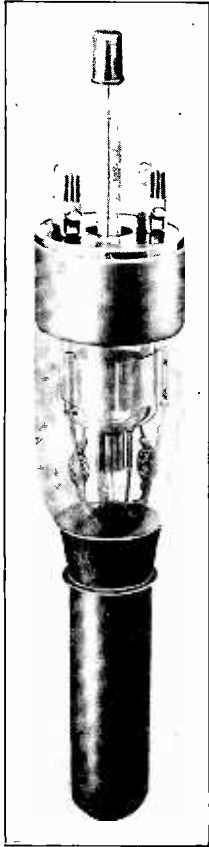

FIG. 108. Western Electric 5-K W. Water-Cooled Power Tube.

Reception of Undamped Oscillations—In order to receive undamped oscillations some method must be employed whereby they are broken up into audio frequency groups, otherwise they will not be detected by either a crystal or vacuum tube detector and no response will be heard in the telephone. The diaphragm of the telephone is unable to vibrate at such high frequencies and, even though it did, no sound would be heard by the operator as the vibrations would be above audibility. The manner by which these undamped oscillations are made audible is known as the heterodyne method of reception. This method consists of combining with the received radio frequency wave another locally generated radio frequency wave of the same amplitude but of a different frequency. The two frequencies acting upon each other produce what is known as a "beat" frequency which is the numerical difference between the two frequencies. The principle of beat frequencies can be explained by the phenomenon which is produced when two keys close together on a piano are struck simultaneously. Due to the fact that the frequencies of the two keys are nearly the same the listener will hear a periodic increase and decrease in the intensity of the sound as the waves from one key add to, then neutralize the waves from the other.

If the undamped wave of a distant radio telegraph station transmitting at a frequency of 500,000 cycles (599.6 meters) is combined with another locally generated undamped wave of the same amplitude but of a frequency of 501,000 cycles and the combina-

tion passed to a detector there will result an audio frequency alternating current of 1,000 cycles per second. Likewise if the locally generated frequency was 499,000 cycles there would be produced after detection a beat frequency of 1,000 cycles. Thus it can be seen that a beat frequency is produced whenever the local generated frequency is tuned above or below the received signal. If the beat frequency is not more than 16,000 cycles it will produce an audio response in the telephones of the detector circuit. If of more than 16,000 cycles the beat frequency will be detected but will be beyond the limits of average audibility.

In other words a beat frequency is produced whenever the received waves are heterodyned by a local oscillator of different frequency. The beat frequency produced may be either an audio or a radio frequency depending upon the numerical difference of the two frequencies.

If the local generated frequency is tuned to exactly the same frequency as the received signals there is, of course, no beat frequency and the condition of "zero beat" is said to exist. This means of receiving has also been termed "homodyne" method. It is sometimes employed in the reception of modulated waves. Extreme care must be exercised by the operator to keep the two frequencies in tune. The slightest change in the capacity of the tuning circuit such as by the hand of the operator brought close to the tuning elements will result in the production of a beat frequency making the signals unintelligible.

35. Autodyne Method of Reception—The autodyne or self-heterodyne method makes use of the regenerative detector circuit wherein the feed-back is increased until the oscillations are produced as has been explained earlier in the chapter. The frequency of the oscillations are determined by the tuned grid circuit. By slightly detuning the grid circuit the frequency of oscillation is changed without tuning the received signal and there is produced a beat frequency corresponding to the difference between the frequency of oscillation and the signal frequency. The amount of detuning required to produce a beat frequency is not large and makes but slight decrease in the amplitude of the received signals. Autodyne reception of undamped waves is employed very successfully from $3/4$ to 20,000 meters.

As explained by S. Ballantine,¹ the merit of the system of autodyne reception of undamped waves depends upon the stability of the oscillations in the circuit. With tickler coil arrangement, the sensitivity is closely proportional to the rate at which the average

¹ Radio Telephony for Amateurs, by S. Ballantine.

plate current changes with a slight change in the tickler coupling. This will depend to a large extent upon the stability of the oscillating state, and as a general rule it can be said that anything that can be done to make the oscillations less stable will increase the intensity of the beat note. For this reason the feed back should not be increased much above the point at which oscillation starts.

36. Heterodyne Method of Reception—The heterodyne (other power) method requires a local external oscillator so arranged that the radio frequency currents generated by it are coupled to the grid or plate circuit of the detector tube. The use of the separate source of oscillations has the advantage over the autodyne method that the beat frequency can be produced without changing the tuning adjustments of the receiving circuit. Figure 109 illustrates a simple receiving circuit connected so as to receive undamped waves by the separate heterodyne method. The filament return of the detector circuit has a few turns placed in an inductive relation to the grid coil of the oscillator (indicated in diagram as "pick up" coil) so as to couple some of the energy of the oscillator to the detector circuit.

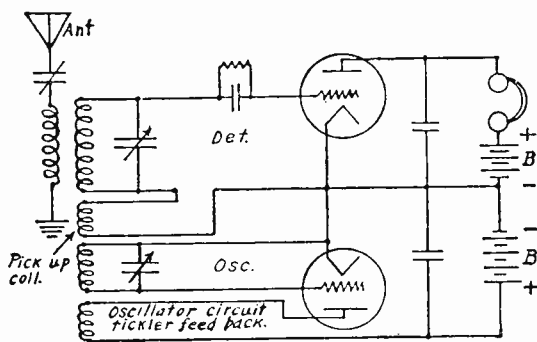

FIG. 109. Simple Heterodyne Circuit.

The most valuable feature of the heterodyne method of reception is the gain in signal strength and selectivity.

In both the autodyne and heterodyne methods the amplitude of the beat frequency, correspondingly the telephone response, is directly proportional to the amplitude of the incoming oscillations. The relation of direct proportionality for beat reception is in contrast to the detection of spark or modulated signals where the response is proportional to the square of the signal strength. Em-

ployment of beat reception insures equal amplification of weak and strong c.w. signals, whereas the employment of ordinary detection of spark or modulated waves produces a gain in the strength of the strong signals and a reduction in that of the weak signals. When it is considered that the signals from a continuous wave transmitter decrease inversely as the square of the distance the advantages of continuous waves is quite apparent.

Interference is minimized because even slight differences in frequency of the waves from other sources result in notes either of different pitch or completely inaudible. By suitable adjustments of the oscillator the beat frequency can be made to equal that corresponding to the resonant frequency of the transformer employed in the audio frequency amplification system thus permitting high amplification of that particular frequency with an attenuation of other frequencies resulting in a gain of selectivity. It is sometimes easier to copy a weak signal through interference such as "static" by employment of the beat method of reception. Assume the static discharges produce a signal voltage three times as strong as that of the signal which it is desired to receive. By employment of the beat method of reception in which the response is directly proportional to signal voltage the static discharges will be three times as strong as the desired signal. However, if the ordinary method of detection is used wherein the response is proportional to the square of the signal voltage the static discharges will be nine times as strong as the signal.

37. Double-Detection Receivers—It has already been explained how and why radio frequency amplifiers become increasingly unstable as the wavelength at which they are operated is decreased. A long wave radio frequency amplifier is much more stable and amplifies somewhat more. Realizing these facts Maj. E. H. Armstrong conceived the idea of employing a high wavelength (low frequency) amplifier of fixed tune and by the principle of beat frequencies changing the incoming high frequency (low wavelength) to that suitable for the amplifier.

Figure 110 shows the schematic arrangement of a superheterodyne. It will be noted there are two detectors, and for this reason the system is sometimes called the double detection method of reception. The second oscillator shown is only necessary when it is desired to receive continuous wave signals. Due to the large values of amplification possible with a superheterodyne it is only necessary to employ a loop or short length single wire antenna as the pick-up device. Increasing the length of the outside antenna will give an increased signal strength but at the same time in-

creasing the noise level as well as decreasing the selectivity. Regarding the decrease in selectivity this will be especially notice-

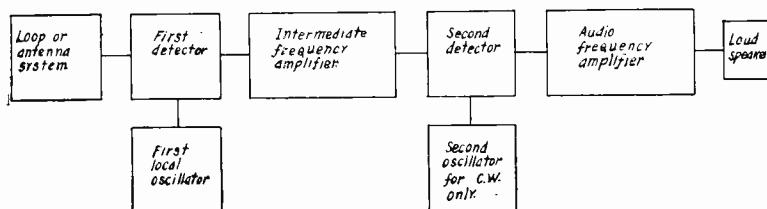

FIG. 110. Schematic of Double-Detection Receiver.

able when operating a "super" in an area surrounded by several local stations.

The Frequency Changer—The frequency changer of a "superheterodyne" consists of the first detector and local oscillator. The detector may be operated by the "C" battery method or by the use of a grid leak and condenser. The frequency of the oscillator is always controlled by a variable condenser.

The purpose of the oscillator in the "superheterodyne" is to provide a source of local radio frequency energy differing in value from the incoming signal frequency by the frequency to which the intermediate amplifier is tuned. The oscillator circuit employed should have a reasonable uniform output over the whole band of frequencies at which the super is operated, should be free from harmonics and have an oscillator condenser which can be operated without trouble from body capacity.

If the oscillator output is not uniform the receiver will be more sensitive at one end than at the other. Again if the output is too great, distortion in the form of a loud hissing or rushing sound will be heard with the signal. This is especially objectionable when it is desired to receive speech or music. If the oscillator emits harmonics it will be noted that a station may be heard, at several different settings of the oscillator condenser.

The operation of a "superheterodyne" oscillator seems to mystify the average broadcast listener, especially the fact that it is possible to bring in a station at more than one setting of the oscillator dial. Some listeners seem to think it is a fault of the transmitter. The reason can be explained as follows: Normally there are two places relatively close together on the oscillator dial at which the station may be heard. Consider the intermediate frequency amplifier designed to amplify at a frequency of 40 kilocycles (40,000

cycles, 6,663 meters). In order to receive a signal from a transmitter operating on 1,000 kilocycles (299.8 meters) it would be necessary to tune the oscillator to 40 kilocycles above or below 1,000 kilocycles, that is, 1,040 or 960 kilocycles, either of which when combined with the incoming frequency and detected will produce a 40 kilocycle beat frequency. Thus it can be seen that if the oscillator is tuned to either 1,040 or 960 kilocycles the station will be heard. In order to explain why the station can be heard at other settings of the dial it is necessary to consider the harmonic frequencies generated by the oscillator. As already described a vacuum tube oscillator will generate besides the fundamental frequency other frequencies which are multiples of the fundamental. In this particular case consider the wavelength dial as set at the point where the 1,000 kilocycle station is heard. Now readjust the oscillator dial as if to receive a higher wavelength station until at some point on the dial the station operating on the 1,000 kilocycles is heard. This will probably occur when the movable plates of the condenser are almost in, that is, at nearly maximum capacity. If the frequency of the oscillator were to be measured at this point it will probably be 520 kilocycles. Now the second harmonic of 520 kilocycles is 1,040 kilocycles and it corresponds to the frequency at which it was necessary to set the oscillator originally in order to produce a beat frequency of 40 kilocycles. It is then obvious that the second harmonic of the oscillator is combining with the incoming frequency to produce the beat frequency which the intermediate amplifier accepts for amplification. If the oscillator were to be tuned to a still higher wavelength another point on the dial will be noted where the station is heard again. This frequency when measured will be 480 kilocycles the second harmonic of which is 960 kilocycles. This frequency corresponds to the other original setting of the oscillator necessary to produce the correct beat frequency. It is not always necessary to leave the wavelength dial set to note the effect just described. As the two dials are tuned together while searching for some particular station, the oscillator might arrive at some frequency whereby its harmonics may produce the desired beat frequency with a local station and although the wavelength dial may be considerably off from the frequency of the station its signals will be heard. This usually indicates a high resistance tuned input circuit and is aggravated somewhat when the superheterodyne receiver is operated on an outside antenna.

In figure 111 are shown two of the most popular types of oscillator circuits. The coupling coil is employed to transfer energy from the oscillator to the first detector. This coil is generally

placed in the grid circuit of the first detector, next to the grid, or in the grid return to the filament although it can be placed in the plate circuit. The writer has found by experiment that the best

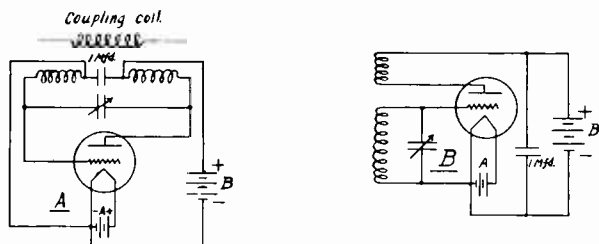

FIG. 111. Oscillator Circuits Used with Double-Detection (Superheterodyne) Receivers.

results are secured by placing it in the filament return circuit. By devising a means of loosening the coupling as the wavelength is decreased a considerable gain in sensitivity at the shorter wavelengths results. This is especially so when the oscillator circuit *B* is employed.

The oscillator circuit of *A* in figure 111 consists of a split winding of two equal sections, the tuning condenser being connected to the outside terminals of the coil, in parallel with the grid and plate of the oscillator tube. The high capacity condenser connected across the low potential ends of the coil serves to by-pass all high frequency currents around the plate battery.

This circuit has the advantage of having a fairly uniform output throughout the broadcast frequency range. It has several disadvantages, the main one of which is its body capacity effect. It will be noted that the rotary plates of the tuning condenser have to be connected either directly to the grid or the plate of the tube. If the rotary plates are connected to the plates of the tube, the trouble from body capacity will be decreased but not eliminated. If a variable condenser in which the shaft is not a part of the circuit is used, the body capacity effect can be entirely eliminated. The position occupied by the tuning condenser subjects it to the full plate voltage and should it become short circuited the plate battery will be run down and if the negative "B" is connected to the positive "A" battery all the tubes in the set will burn out. This may be averted by connecting a fixed condenser of .005 mfd. capacity or higher in series with the oscillator condenser. The capacity of the latter compared to the former is so great as to have but little if

any effect on the tuning and acting as a blocking condenser in case of a short circuit.

The circuit of *B* is the familiar regenerative detector circuit except that the plate or tickler coil is fixed. The coil is coupled close to the grid coil so that the tube oscillates throughout the entire broadcast frequency range. The variable condenser across the grid coil controls the frequency of oscillation, the rotary plates being connected to the low potential end of the coil the circuit is free from the effects of body capacity. The output of this circuit is not quite so uniform as that of *A*. Both circuits will produce harmonics in about the same amount.

The frequency changer circuit as employed in the Western Electric Double-Detection Receiver type 4-C is shown in figure 112.

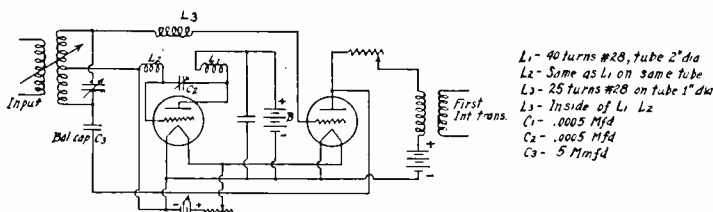

FIG. 112. Frequency Changer Employed in Western Electric Type 4-C Double-Detection Receiver.

The small condenser marked Bal.Cap. helps to stabilize the first detector at the same time providing a limited amount of regeneration in the circuit. The coupling coil is in the grid circuit of the first detector.

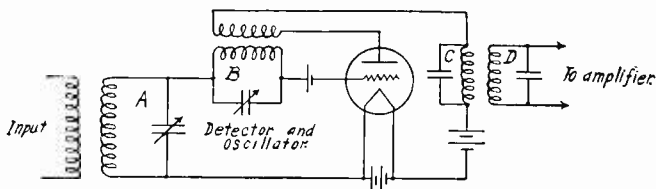

FIG. 113. Fundamental Circuit of the Oscillator and Detector of Second Harmonic "Superheterodyne."

In the earlier type of superheterodynes the first detector was made to function as both detector and oscillator. The general arrangement is illustrated by figure 113. In this circuit *A* is tuned to the incoming signal, circuit *B* is tuned to one-half of the in-

coming frequency plus or minus one-half of the intermediate frequency and the circuits *C* and *D* are both tuned to the intermediate frequency. There are created in the circuit a number of harmonics. The second harmonic combines to produce beats with the incoming signals of the desired intermediate frequency. On account of the fact that circuits *A* and *B* are tuned to frequencies differing by approximately 100 percent a change in the tuning of one has no appreciable effect on the tuning of the other.

Due to the variety of harmonics different stations repeated at several different places on the dial. The system is rarely used at this date except for reception of telegraph signals at wavelengths below 30 meters where it is most useful.

The Ultradyne—"Ultradyne" is the name that has been applied by the late Robert LeCault to a special form of double-detection receiver devised by him and first described in Radio News.

In the Ultradyne, figure 114, the first detector does not receive its supply from the "B" battery but instead operates with an alternating current plate supply. This alternating current is of radio frequency and is supplied by an oscillator of the usual type.

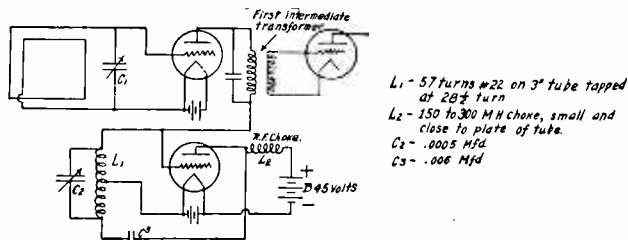

FIG. 114. Fundamental Circuit of Frequency Changer of Ultradyne.

The incoming frequency and the oscillator frequency are combined in the plate circuit of the first tube and by plate rectification a beat frequency is produced. As reported by many experimenters the circuit is especially sensitive to weak signals.

38. The Intermediate Frequency Amplifier—The intermediate frequency amplifying transformers as used in superheterodynes consist of the condenser-tuned air-core transformers, fixed air-core transformers, or fixed iron-core transformers.

At short wavelengths condenser-tuned air-core transformers are entirely satisfactory. At long wavelengths, such as 10,000 meters they will tune too sharp resulting in serious distortion. An analysis of the transmitted wave of a radio broadcasting transmitter will

show that besides the carrier frequency there is present a band of frequencies twice as wide as the highest modulating frequency obtained from the microphone. Thus if the highest frequency obtained from the microphone is 7,000 cycles the band occupied by the radiated wave is 14,000 cycles wide. In other words, the carrier frequency is modulated 7,000 cycles each side of its assigned frequency. Assume the carrier frequency of a broadcasting station to be 1,000 kilocycles or 1,000,000 cycles. When modulated the space occupied by the transmission will extend up to 1,007,000 cycles and down to 993,000 cycles. Converted to wavelength these side band frequencies correspond to 297.7 and 302 meters. The band occupied for transmission extends then from 297.7 to 302 meters, a total width of 4.3 meters. The width of the band necessary to transmit modulated frequencies extending to 7,000 cycles is always 14,000 cycles (14 kilocycles) but the width expressed in meters will depend upon the wavelength of the carrier. Assume the air-core condenser-tuned transformers were to be used at an intermediate frequency of 10,000 meters or 29.98 kilocycles. In order to amplify the modulated frequencies up to 7,000 cycles would require that the transformers accept a band of frequencies extending from 36.98 to 22.98 kilocycles or when converted a wavelength band 6,800 meters wide. Therefore it can be seen that a sharply tuned transformer would not do as the side bands would be cut off and distortion would result. At 1,500 meters or less the desired characteristics could be realized as the wavelength band necessary to include all the side band frequencies would be only 20 meters wide. However at such frequencies the whole system may be unstable and it will be necessary to prevent oscillation by one of the methods previously discussed.

Fixed air-core transformers may be tuned by the distributed capacity of the coils. The distributed capacity of the winding and their inductance form a circuit which is resonant to a given band of frequencies. Although tuning somewhat broader than condenser-tuned air-core transformers they are used to best advantage when operated at a high frequency or low wavelength. When special constructional details are employed to reduce the distributed capacity of the windings they may be operated at 40 to 60 kilocycles with success.

Iron-core transformers possess the ideal characteristics desired in an intermediate transformer. The iron-core helps to broaden the tuning thus permitting the advantageous use of a low intermediate frequency which means high amplification with stability. However, if tuned too broad the curve overlaps into the audio fre-

quency band (below 10,000 cycles) and the transformer will be noisy. This is illustrated by the curve *B* of figure 115.

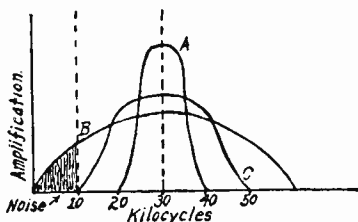

A - Too sharp, cuts off part of side bands
B - Too broad, lets through some noises.
C - Ideal Curve

FIG. 115. Frequency Amplification Characteristics of Intermediate Frequency Amplifier.

Sometimes it is convenient to provide a condenser-tuned transformer in the first or last stage of an intermediate frequency amplifier employing iron-core transformers in order to sharpen the tuning. This arrangement is known as the "filter circuit." It is designed to be resonant at the intermediate frequency of the amplifier.

The second detector usually employs the standard grid leak and condenser. The grid condenser should have a value of .0005 to .001 mfd. to permit the easy passage of the low intermediate frequency currents.

The audio frequency amplifier may consist of any of the standard systems of amplification such as transformer, impedance or

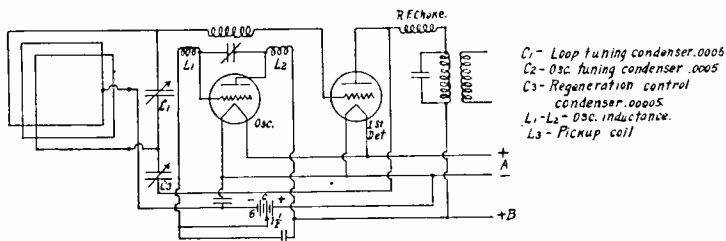

C - Loop tuning condenser .0005
*C*₂ - Osc. tuning condenser .0005
*C*₃ - Regeneration control condenser .0005
*L*₁ - *L*₂ - Osc. inductance.
*L*₃ - Pickup coil

FIG. 116. Regeneration with Tapped Loop.

resistance coupling. The addition of a stage tuned radio frequency amplification ahead of the first detector gives somewhat

increased gain in signal strength at the same time increasing the selectivity of the tuner and prevents the energy from the oscillator from being radiated. Regeneration in the first detector circuit can be accomplished by providing the loop or coupling coil with a center tap and connecting the plate of the detector tube to the loop or coil by a .00005 mfd. condenser as in figure 116. If the primary of the first intermediate frequency amplifier is tuned by a condenser the energy that should be fed back by the .00005 condenser will be by-passed and no regeneration will result. The

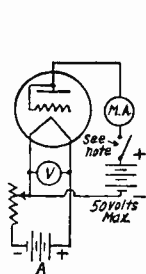

Note: Close switch just long enough to get reading on milliammeter after tube has been inserted in socket and filament voltage adjusted to rated value (Disregard change in filament voltmeter reading which will occur when emission current flows). Test for shorted elements before taking emission readings or use protective device.

FIG. 117. Emission Test Circuit.

remedy for this condition is a radio frequency choke in the lead from the plate of the detector tube next to the primary terminal of the first intermediate transformer.

39. Reactivation of Thoriated Tungsten Filament Receiving and Rectifying Tubes—The filament condition of a tube may be most readily judged by an emission test using the circuit shown in figure 117. The voltages specified should not be exceeded. Higher voltages will permanently damage the vacuum and may even result in a burnout. If the emission is above the minimum value specified below, the tube is in good condition and does not need reactivation. If equipment for reading emission is not available a simple test for the two most widely used tube types can be made on the customary tube test set which measures plate current. This circuit is shown in figure 118.

For UX-199 or CX-299 tubes, set the plate voltage at 45 volts with the grid connected to the negative filament, set the filament voltage at 3 volts and read the plate current. *Momentarily* increase the fila-

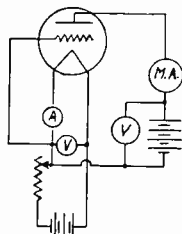

FIG. 118.
Plate Current
Test Circuit
(Zero Grid
Voltage).

ment voltage to 3.5 and read the plate current. If the plate current increases more than .2 milliamperes, the filament is not fully active and the tube may be improved by the reactivation process.

For UX-201-A or CX-201-A tubes, the same value of the plate voltage (45) is used but the plate current is read with the filament voltage set at 4 and 6. An increase of more than .2 milliamperes in the plate current indicates that the tube may be improved by reactivation.

If the tube will not return to normal after reactivation treatment it is proof that the tube has either served its normal life or has been so heavily overloaded that the thorium content has been exhausted or the vacuum impaired.

TABLE OF EMISSION CURRENT AND REACTIVATION VOLTAGE.

| Type No. | Filament Voltage | Plate Voltage | Minimum Emission | Maximum Reactivation Voltage | Maximum Flashing Voltage |
|------------------------|------------------|---------------|------------------|------------------------------|--------------------------|
| UX-199 or CX-299 . . . | 3.3 | 50 | 6 m.a. | 4.0 | 12 |
| UX-120, CX-220 | 3.3 | 50 | 15 m.a. | 4.0 | 12 |
| UX-201-A, CX-301-A . | 5.0 | 50 | 25 m.a. | 7.0 | 18 |
| UX-200-A, CX-300-A . | 5.0 | 50 | 12 m.a. | 7.0 | 18 |
| UX-171, CX-371 | 5.0 | 50 | 50 m.a. | 7.0 | 18 |
| UX-210, CX-310 | 6.0 ¹ | 100 | 100 m.a. | 10.0 | — |
| UX-213, CX-313 | 4.0 ¹ | 100 | 50 per anode | 7.0 | — |
| UX-216B, CX-316B . . | 6.0 ¹ | 125 | 100 | 10.0 | — |

If the tube will not return to normal after reactivation treatment, it is proof that the tube has either served its normal life or has been so heavily overloaded that the thorium content has been exhausted or the vacuum impaired.

Methods of Reactivation—The following methods will generally restore the emission, that is reactivate, tubes which have been overloaded and also, at times, will reactivate, for short additional usage, tubes that have dropped in emission at the end of normal life. The exact process which gives the best results depends upon the nature and extent of the overload to which the tube has been subjected.

Tubes which have been subjected to only a slight overload may be reactivated by a very simple process. This consists in

¹ Emission of these tubes read at voltages below rated values.

Note: In taking emission readings the current may begin to fall off. Test should not be continued long enough to cause this to happen.

burning the filament, with the plate voltage disconnected, at the voltage listed in the table under the heading "Reactivation Voltage." This process speeds up the "boiling out" of the thorium from the body of the wire while at the same time the surface evaporation is very slow when plate voltage is not applied. The length of time required to reactivate a tube by the treatment is one-half to one and one-half hours, depending largely upon the length of time and extent to which the tube has been subjected to excessive voltage. At the end of thirty minutes burning, test the tube as explained above. If the emission shows improvement continue the treatment until test shows the tube to be above minimum passing limit.

Tubes which have been badly overloaded may not improve under this process, and a "flashing" voltage must be used, as outlined below:

First burn the filament for 10 to 20 seconds at the voltage shown in the table under the heading "Flashing Voltage." Then burn the filament under the process described above, using the voltage listed as "Reactivation Voltage." Read the emission at the end of 30 minutes and if not restored, continue to burn the filament up to 2 hours, taking readings every 30 minutes. If two hours treatment does not restore the emission or greatly improve it, it is proof the tube cannot be reactivated.

No plate voltage is ever applied during reactivation.

The applied voltages should always be controlled by a suitable voltmeter.

A small percentage of tubes reactivated by the use of flashing voltages may be expected to burn out during treatment.

Rapid reactivation, sometimes within ten minutes, can be accomplished by the use of voltages higher than those recommended above. This process very materially shortens the tube life and such reactivation is generally not permanent. Furthermore, the use of higher voltages greatly increases the percentage of tubes that burn out and the filament is frequently poorer at the end of the treatment than at some earlier period. Reactivation by the "while you wait" process cannot be recommended.

Reactivation Equipment—Alternating current from the lighting supply is most convenient and can be stepped down to the proper voltage by a toy or bell ringing transformer, such as G.E. Type No. 236093, which is provided with two-volt taps from 4 to 22 volts. The circuit diagram is shown in figure 119. As a.c.

voltmeters require considerable current they should not be left permanently in circuit parallel with the tubes.

If alternating current is not available d.c. supplied by storage batteries may be used. The flashing voltage may be obtained from

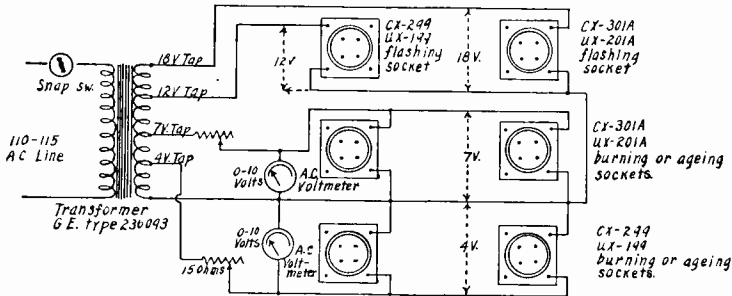

FIG. 119. Alternating Current Reactivating Apparatus and Circuit.

a storage "B" battery of the larger sizes. Only one tube should be flashed at a time on a "B" storage battery and the battery must be left fully charged. See figure 120.

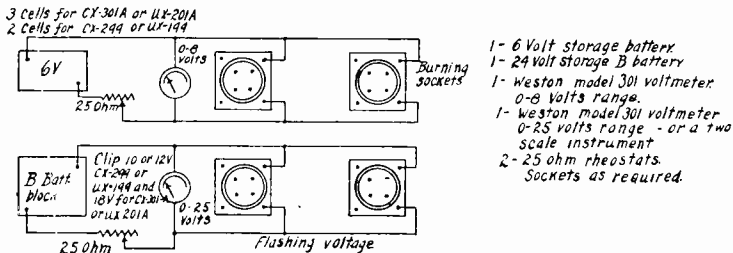

FIG. 120. Direct Current Reactivating Apparatus and Circuit.

Normal Operation Precautions—If it is necessary to reactivate tubes each month or at frequent intervals, it is proof that the tubes are being overloaded, and in such cases better service will be obtained if the following precautions are observed:

1. Do not burn filament at voltages in excess of the rated filament terminal voltage: Keep the filament rheostat set as low as possible, or use a reliable voltmeter.

2. Do not use high plate voltages unless "C" batteries are provided. With types C-299, CX-299, UV-199, UX-199 and CX-

301-A, UV-201-A and UX-201-A better life is obtained, and "B" battery current drain lessened when a voltage of 67 1/2 volts or less is used in the plate circuit in case no "C" battery is provided.

3. Be careful when changing battery connections to see that battery polarities are not reversed. If the leads connecting filament heating (A) or grid biasing (C) battery are reversed, signals and music may still be heard, but they will be faint and distorted. Such a reversed condition often causes the operator to turn the filament to a high setting, thus injuring the tubes without appreciably improving results. Always check battery connections after making any change.

4. If an insensitive tube and a tube in perfect condition are operated from the same rheostat, there will be a tendency to overload the good tube in order to obtain operation from the poorer one. The poor tube should be reactivated or replaced. Here also the use of a reliable filament voltmeter will save overloading the tubes.

5. When using C-299, CX-299, CX-220, UV-199, UX-199, UX-120 types and a filament voltmeter is not available, the operation of the set may be checked as follows: Connect *only two* fresh dry cells in series for use as the filament heating (A) battery. The rheostats may now be turned on full and if the set and tubes are operating correctly, satisfactory reception will be obtained. If results are not satisfactory check over batteries, battery connections, antenna connections and tubes. When the trouble is located, satisfactory reception will be obtained with two fresh cells.

40. General Comment—Many of the standard types of tube rejuvenators use excessive voltage with the frequent result that the tube is permanently damaged or has its useful life shortened. This is especially true with C-299, CX-299, CX-220, UV-199, UX-199 and UX-120 tubes. With these tubes the second burning voltage should not exceed 4.0 volts.

The voltages specified in the table are the maximum which should be used. The use of a voltmeter to set the applied voltages to the proper values is essential to obtain proper results.

Tubes which have internal shorts between elements cannot be reactivated and it may be convenient to check for such conditions with a pair of phones and a dry cell. When the tube is not lighted there should be an open circuit between the grid and all other elements, between the plate and all other elements, and a closed circuit through the filament.

Tubes in which the vacuum is impaired cannot be reactivated. This is usually indicated by a filament current reading above rated value. If considerable air is present in the tube, the filament will not light up at all unless the filament voltage is raised well above normal, in which case the filament may burn out.

Cunningham tubes type C-11, CX-12, CX-12 and CX-200 and Radiotron tubes type WD-11, WX-12, UX-112 do not use thoriated tungsten filament and cannot be reactivated.

41. Testing Tube UX-300A or CX-300A Detector Tubes—
The UX-200A or CX-300A tube is designed only for service as a detector and differs from other types in that it contains an alkali vapor. The formation of the vapor occurs during the first three minutes after the tube is lighted, during which period the tube characteristics change rapidly causing variations in readings of plate current and performance of the tube when operating in the radio receiving set. As soon as the tube has warmed up, or at the end of about three minutes, the readings become uniform and no further changes occur. As a result of this action, readings taken during the period of change are variable, and of no value. However, since the change does not usually begin until the tube has been in the socket about one minute, it is possible to make a quick test immediately after it has been placed in the socket, otherwise, the readings should be taken at the end of three minutes.

Tests on the UX-300A or CX-300A should be made at a plate voltage of 45 volts and no higher voltage should be used. Since it is designed for detector service only, a thorough test of the tube requires considerable equipment. Plate current readings, such as taken in the ordinary test sets, *indicate only the condition of the filament and cannot be depended upon as a test of detector sensitivity*. For that reason the best practical test of the tube is a check of the operation obtained under actual service conditions in a receiver, a weak incoming signal being preferable. Quick tests made during the first minute will usually suffice, but if any doubt as to the satisfactory performance of the tube arises, it should be allowed to burn the full three minutes before completing the test.

A plate current reading obtained with this tube when used in a receiver set with a grid condenser and grid leak is quite different from that obtained in a test set. Under usual conditions the plate current is approximately 1.0 m.a., varying only slightly from this value whether the grid return is connected to the negative or to the positive filament. The difference in readings as compared with those obtained in a test set is due to the fact that the grid

current furnished by this tube is sufficient to establish a voltage drop in the grid leak equivalent to the use of the grid biasing voltage of 2 or 2 1/2 volts.

Under service conditions a hiss is frequently produced at the time the changes in plate current above noted are occurring. If a milliammeter is placed in a detector plate circuit, it will be noted that the initial reading is perhaps 1.0 milliampere remaining at this value during the first minute, while during the second minute the plate current gradually increases to 2.0 or 3.0 m.a. It is during this change that the hiss sometimes occurs. The plate current then returns to a value close to the initial reading and the tube thereafter will operate quietly.

There are several reasons for not testing this tube at voltages higher than 45, the first being that it does not represent the operating conditions, and secondly that grid biasing voltages are often applied when testing at the higher voltages. Because of the high amplification constant of the tube the plate current will be practically blocked at 90 volts plate, if the ordinary voltage of minus 4 1/2 volts is applied to the grid the reading obtained being a fraction of a milliampere.

When a test of the filament conditions or for shorted elements only is desired, the readings obtained from the ordinary type of two meter test sets will be found satisfactory. Sample readings obtained on this test are given below:

| Plate Voltage 45 Grid return first to minus F then to plus F | Filament 5.0 | |
|---|---------------------------------------|------------------------------|
| | Average Plate Current. Grid to - F | Average Plate Current to + F |
| UX-300A, CX-300A (Cold under 1 min.) | 1.6 m.a. | 6.1 m.a. |
| UX-300A, CX-300A (Hot after 3 min.) | 2.1 m.a. | 6.2 m.a. |

42. Reactivation of Power Tubes—In case of severe overload resulting in overheating of the tube the electron emission may decrease and oscillations may not start when the key is closed. Unless the overload has liberated a large amount of gas the activity of an XL filament may be restored by operating the filament at a voltage about 20 per cent above normal for ten minutes. The plate and grid voltages should be disconnected during the process of reactivation. If the emission fails to return to normal the tube may be flashed and "aged." This process consists of operating the filament of the tube at a voltage about 50 percent above normal for one-half of a minute and then reducing the operating voltage

to about 20 percent above normal from two to fifteen minutes. The plate and grid voltages are disconnected during the process. If the emission has not been brought back at the end of two minutes the aging process may be continued. However, if the emission does not return at the end of ten or fifteen minutes of ageing further attempt at reactivation may be considered useless. At the conclusion of each ageing process the normal grid and plate voltages should be applied and test made to see if the tube will oscillate. Extreme care must be exercised during the process or the filament will be ruined permanently. A table is shown on the following page giving the best values for flashing and ageing for the standard tubes in use.

Note: Reactivation is applicable only to those tubes having thoriated filaments.

TABLE OF BEST FLASHING AND AGEING VALUES FOR POWER TUBE REACTIVATION.

| Type of Tube | Normal Filament Voltage | Flashing Voltage | Flashing Time | Ageing Voltage | Ageing Time |
|---------------|-------------------------|------------------|---------------|----------------|-------------|
| UV-203-A..... | 10 | 20 | 30 Sec. | 12 | 2 Mins.+ |
| UV-204-A..... | 11 | 22 | 30 Sec. | 13 | 2 Mins.+ |
| UX-210..... | 7.5 | 15 | 30 Sec. | 9 | 2 Mins.+ |
| UV-211..... | 10 | 20 | 30 Sec. | 12 | 2 Mins.+ |
| UX-213..... | 5 | 10 | 30 Sec. | 6 | 2 Mins.+ |
| UX-216-B..... | 7.5 | 15 | 30 Sec. | 9 | 2 Mins.+ |
| UX-852..... | 10 | 20 | 30 Sec. | 12 | 2 Mins.+ |

43. The UX-222 Screen Grid Tube—The UX-222 (CX-322) is a distinct departure from the conventional type of the three-element radio tube. The usual characteristic and performance obtained from this tube are made possible by the introduction of a second grid, which extends between the usual grid and the plate and is carried over outside the plate. Thus the plate is completely shielded or screened from the control grid by the second grid.

When operated as a four-element tube a voltage of approximately 22 to 45 volts is applied to the screen grid, and a higher voltage (90 to 135 volts) is applied to the plate.

Filament—The filament is rated at 3.3 volts with a current consumption of .132 ampere. When used as a 3.3-volt tube from a 6-volt battery connect a 20 to 30 ohm rheostat in series with one side of the filament. If parallel with 5-volt tubes; connect a fixed resistance of 15 ohms in series with the filament of the

tube. It may be then connected in parallel with other 5-volt tubes, operating from a common rheostat. If placed in the negative lead a tap at 10 ohms will provide 1.3 negative bias for the control grid.

The input or control grid connection is brought out at the top of the bulb. The connection to the screen grid is made to the regular grid connection on a standard socket.

There are several ways in which this four-element tube may be utilized in radio receiving and transmitting circuits the most advantageous of which is as a radio frequency amplifier. When so used the most important advantage gained is elimination of all feed-back through coupling between grid and plate, due to low capacity, these elements, the interelectrode capacity having a maximum of .025 microfarad. It is possible to obtain a voltage amplification of 25 to 50 per stage in the broadcast range as compared with the usual range of 5 to 12 per stage with three-element tubes.

In the operating range the plate current does not vary appreciably with changes in plate voltage, this being due also to the screening effect of the second grid. As a result the amplitude of the plate current change, caused by a signal voltage impressed on the grid is scarcely affected by an increase in load resistance. Thus it is of advantage to use a very high resistance or impedance in the plate circuit, in order to obtain high voltage amplification.

The voltage amplification depends only upon two factors:

1. The mutual conductance (g) of the tube, which determines the amplitude of the plate current change, resulting from a signal voltage impressed on the control grid and—
2. The load impedance. The voltage across the output load is directly proportional to the load impedance since the amplitude of the signal current, with moderate loads, remains unchanged with an increase in impedance. This is unlike the condition with three-element tubes, where an increase in load resistance results in a decrease in the amplitude of the signal current.

At low rate frequencies 50 to 100 kilocycles, it is possible to build up a very high load impedance by using a tuned plate circuit, and a voltage amplification of 200 per stage is obtainable. At broadcast frequencies it is not possible to obtain a sufficiently high load impedance to realize maximum voltage amplification, and the values quoted above represent average results (25 to 50 per stage).

The desired high load impedance may be obtained by the use of a tuned plate circuit, but it may be preferable to use a transformer connection with a ratio of 1.1 or slightly lower so that low fre-

quency disturbances do not reach the grid of the succeeding tubes and to facilitate the use of ganged condensers for uni-control.

Although the internal shielding prevents feed-back through the

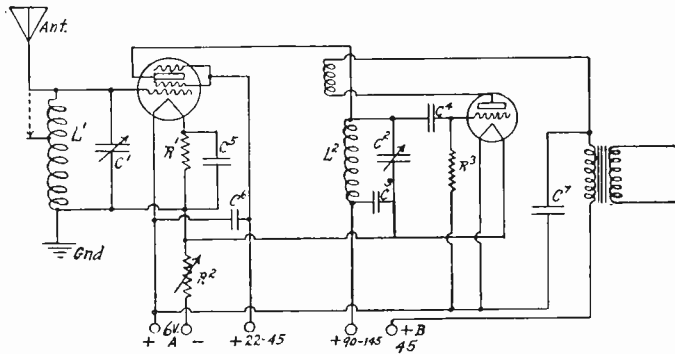

FIG. 121. Typical Screen Grid Tuned Plate R.F. Amplifier Circuit.

tube inter-electrode capacities, this is only one source of coupling between stages, and it is also necessary to shield the input circuit from the output circuit. The tube itself should be shielded, especially if the voltage amplification is high, by placing a metal cap over the tube, extending to the base, and connection must be pro-

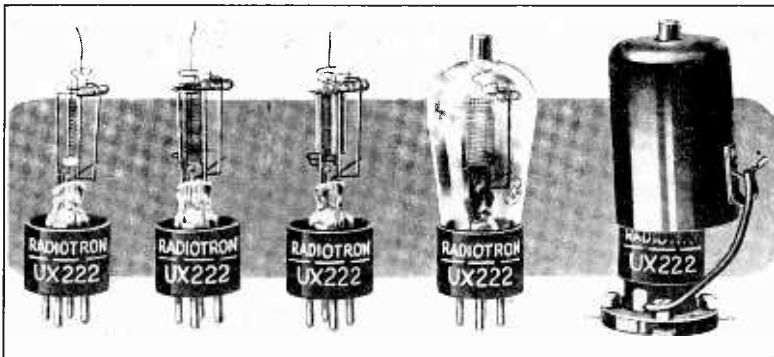

FIG. 122. UX-222 Screen Grid Tube in Various Stages of Assembly.

vided at the top. This shield may be constructed of lead or tin foil and encircled around the shape of the tube.

The UX-222 as an Oscillator—One of the greatest difficulties in making V.T. oscillators operate at a constant frequency is that the tuned circuit does not entirely fix the frequency. One of the reasons for this is that the tube capacities such as plate-grid capacity permits feed-back or grid excitation through the tube. The forcible removal of this feed-back by the introduction of the shield grid permits the control of feedback by external means that are under better control with a possibility of smoother and steadier operation. The output of the 222 is of course small and at this time permits of only experimental work. However in the end it may lead to transmitting oscillators which are somewhat more free from the undesired effects spoken of.

Reverse-Current Effect—One type of oscillator possible with the 222 tube does not use the ordinary principle of feed-back from plate to grid but instead takes advantage of reverse-current effect caused by secondary emission from the plate. The electrons passing from the grid strike the plate with sufficient violence to cause it to emit secondary electrons. If the grid is made positive with respect to the plate these secondary electrons will be attracted by this positive element. If the electrons striking the plate have sufficient velocity, the number of secondary electrons emitted will be large enough to cause electrons to flow out of this conductor instead of into it, thus reversing the direction of current. The device will then have the falling characteristic of the arc. As the plate potential is increased the current is decreased. A vacuum

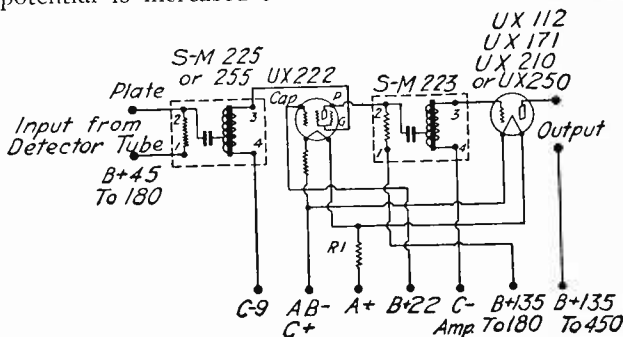

FIG. 123. Use of UX-222 Tube as First Stage Audio Amplifier with Space Charge Connection Followed by Silver-Marshall 223 Hi-Mu Transformer.

tube having this negative resistance characteristic can be used for the production of continuous waves. The tube and the circuit can be connected in several ways and have the advantage of being able

to use untapped coils without ticklers and tuned by a single condenser. The 222 tube at present confines this use to laboratory work as its output is in very small power.

As an Audio Frequency Amplifier—The tube may be used as an audio frequency amplifier with resistance or transformer coupling. The screen grid voltage should be lowered to compensate for the voltage drop in the load unless a high plate voltage is available. With this connection a voltage amplification of 35 per stage may be readily obtained with perfectly flat frequency characteristic down to 50 cycles and below.

A.C. Screen Grid Tubes—Since the appearance of the UX-222 similar tubes have been marketed by many manufacturers and in addition the C.E. Co. of Providence, R. I., has marketed a tube known as the AC-22 in which the filament is operated on alternating current. The necessary electron emission is not obtained from the filament but from an "emitter" close to and heated by the filament. The rest of the structure and the general performance are similar to that of the UX-222.

Other A.C. Tubes—While almost any vacuum tube may be operated with a.c. filament supply when used in a transmitter or last audio stage (see figure 267*a*) there have recently appeared tubes designed for a.c. filament supply throughout the receiver. Typical of these are the UX-227 which (like the AC-22) uses the filament as a heater for a little "thimble" emitter and the UX-226 in which the filament is short and thick so that the voltage variations across it and the heat fluctuations during the cycle are not serious except in the detector socket where it is necessary to use a d.c. tube or one of the 227 type. The 226 type is connected like a d.c. tube except that plate and grid returns are not to one end of the filament but to a center-tapped resistance placed across the filament. The 227 type has the returns made to the "thimble," the a.c. filament having no connection with the r.f. circuits.

Double-ended a.c. tubes have long been built by Kellogg and others. They are of the thimble type as are the Arcturus tubes. The latter have a thimble surrounding a filament but unlike other thimble tubes the "emitter" is connected to one end of the filament. The design of the tube has been so worked out that the a.c. hum which one would expect does not follow.

CHAPTER 5

FUNDAMENTAL CIRCUITS EMPLOYED IN VACUUM TUBE TRANSMITTERS

1. **Grid Excitation**—As described in the discussion of generation of radio frequency oscillations, some means must be provided for feed-back or coupling from plate to grid in order to maintain oscillations. It may be accomplished by one of two methods. Either inductive or capacitive coupling may be used. In commercial practice these methods are known as Hartley, Meissner or Colpitts circuits. They may feed direct to the antenna or feed through one or more stages of a radio frequency amplifier known as the "power amplifier." The first two named make use of the inductive grid feed-back, whereas the Colpitts circuit depends upon capacitive feed-back. The grids of the power amplifier tubes may be coupled to the oscillating (exciter) circuits in any one of a wide variety of ways.

2. **The Hartley Circuit**—Figures 124 and 125 show the

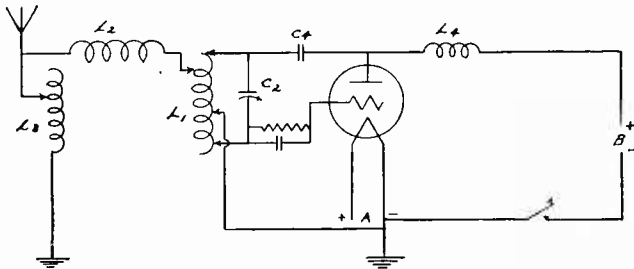

FIG. 124. Hartley Circuit with r. f. Line to Antenna.

Hartley circuit. The grid and plate turns are made variable so that adjustments can be made for correct grid excitation. The filament is connected at or near the middle of the inductance. If

the number of turns from filament to grid is made greater than the number from filament to plate, a higher feed-back will result with a corresponding increase in plate current.

The portion of the coil between the filament clip and plate clip is referred to as the "plate coil." The part between the filament clip and grid clip is called the "grid coil." On making adjustments to this circuit if it is found that the plate current is higher than the normal rating the plate lead should be moved farther away from the filament.

The variable condenser C^1 in figure 125 permits precise control of the frequency. The relation of the grid tap to filament allows

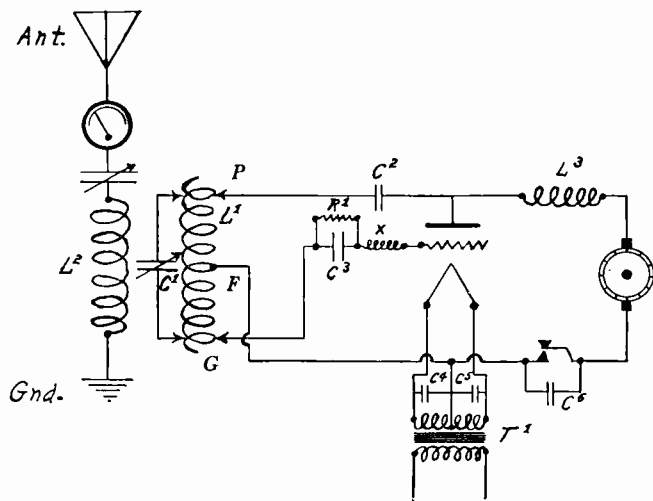

FIG. 125. Hartley Circuit Inductively Coupled to Antenna.

a rough variation in frequency. Moving the grid farther away from the filament decreases the frequency or vice versa.

The condenser C^2 prevents the high voltage generator from being short-circuited through the inductance L^1 but allows the radio frequency currents to pass from plate to inductance. The condenser C^3 prevents the high negative potential from the plate supply generator reaching the grid and also allows the radio frequency voltages to pass through. The function of the resistance R^1 is to place a negative bias of the correct potential on the grid of

the tube thereby reducing the grid current and hence the power dissipated by the grid circuit. Condensers C^4 and C^5 by-pass the radio frequency currents across the secondary of the filament transformer T^1 . Condenser C^6 prevents severe arcing which would otherwise occur when keying a 1000- to 2000-volt negative supply line. The radio frequency choke coil L^3 prevents the radio frequency currents reaching the armature of the high voltage generator. Should this occur it would result in a rupture to the insulation and consequent damage to the machine. The small radio frequency choke coil X in the grid circuit close to the grid of the tube prevents the generation of ultra high frequency or "parasitic" oscillations. By preventing the generation of these parasitic high frequencies (wavelengths in the vicinity of 20 to 60 meters) the plates of the tubes are made to operate much more coolly and the losses in the circuit are greatly reduced.

3. Meissner Circuit—Figure 126 shows a simplified arrangement of the 3 coil Meissner circuit. It has only one tuned cir-

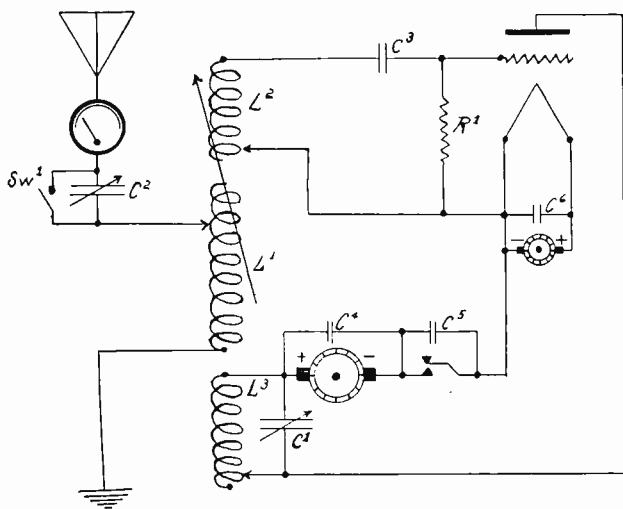

FIG. 126. Meissner Circuit with Series Plate Feed.

cuit, the antenna circuit. However, the circuit is not suited to wavelengths below 60 to 100 meters as the plate and grid circuits then fall into tune. Inasmuch as the antenna circuit controls the

frequency of oscillation of this type of transmitter every precaution must be taken to support rigidly both antenna and counterpoise as well as all lead-in wires. This will prevent a shift of frequency which would occur at each change of capacity, such as produced by the swaying of the antenna in a wind.

Referring to the diagram it will be noted that the plate circuit is tuned by a variable condenser C^1 . This condenser does not tune the circuit but merely acts as a control of the load taken by the tube depending upon the amount of capacity in use.

When the key is closed the plate voltage is applied through the inductance L^3 . Starting the plate current through L^3 induces an e.m.f. in L^1 which in turn induces an e.m.f. in grid coil L^2 . The voltage acting on the grid produces a corresponding change in the plate current. The pulsating plate current flowing through L^3 induces an e.m.f. in the antenna inductance L^1 and radio frequency oscillations start, the frequency of oscillations being determined by the constants of the antenna circuit. A r.f. voltage is induced in the grid circuit which produces correspondingly larger variations of plate current and the action is repeated. Radio frequency currents are generated as long as the key is closed.

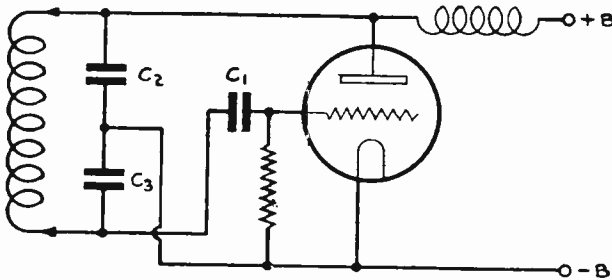

FIG. 127. Colpitts Shunt Feed Circuit.

The plate and grid currents are regulated by the number of turns employed in their respective coils. For this reason each coil is usually tapped so as to secure the maximum output with minimum plate and grid current. Variable condensers are sometimes employed to tune both plate and grid coils. Another ar-

range employs four coils. The additional coil is placed in the antenna circuit. One is coupled closely to the plate coil, the other to the grid coil.

4. Colpitts Circuit—It was stated at the beginning of the chapter that Colpitts circuit depended upon capacitive excitation of the grid. Figure 127 shows an arrangement of this circuit. In this case the voltage drop across condenser C_3 provides the grid excitation. In some cases where a high capacity tank circuit is used the frequency of the circuits is changed by varying the number of turns of inductance rather than by tuning the circuit with a variable condenser.

Tuned Grid—Tuned Plate Circuit—The arrangement in figure 127a is very popular among amateurs. Oscillations are

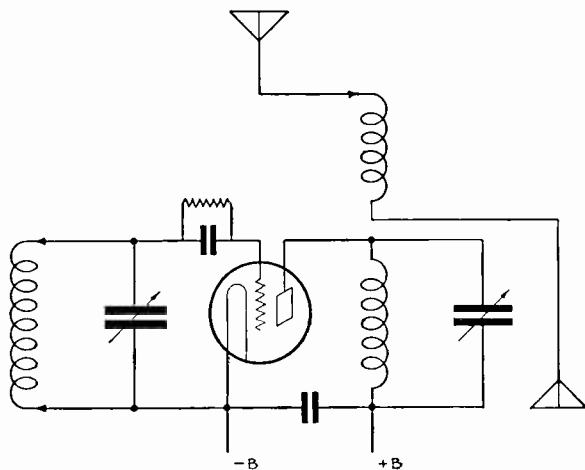

FIG. 127a. Tuned Grid-Tuned Plate Circuit.

generated in the tube by tuning the plate circuit to resonance with the grid circuit and feeding the exciting voltage back to the grid through the inter-electrode capacity of the tube. Usually the coils of both circuits are placed so as to have but a small amount of mutual induction.

It has been determined that the circuit having the lowest L/C ratio will be the frequency determining circuit, therefore, in this circuit the capacity of the condenser tuning the plate circuit should be of a large capacity. This will prevent any detuning effects by the coupling of the antenna circuit to the circuit.

5. Shunt and Series Feed—Two methods of supplying the voltage to the plates of the tubes have been shown. The shunt or parallel supply in the Hartley figure 125, and Colpitts figure 127. The series feed is shown in the Meissner circuit, figure 126 and tuned-plate, figure 127a. In both shunt and series feed the radio frequency and direct current leave the plate together. In both the currents split apart before getting to the generator. In shunt feed the split is made at the *plate* side of the plate coil, in series feed it is made after the two have gone through the plate coil together. In any case both d.c. and r.f. rejoin again at the filament.

When shunt feed is employed it is necessary to include a radio frequency choke coil in series with the plate supply lead. Should the choke coil in this lead fail to function the radio frequency currents will be induced in the windings of the generator possibly rupturing the insulation and resulting in damage to the machine. As an added precaution to prevent this, r.f. chokes are sometimes placed in both negative and positive plate supply leads. The choke in the positive lead is always connected close to the plate binding post of the socket, at right angles to, and as far removed from the inductance as possible.

The r.f. currents of the plate circuit find an easy path to the inductance through the plate blocking condenser which also prevents the plate supply unit from being short circuited by this coil. Plate blocking condensers are designed to withstand several thousand volts more than are normally used. As an added precaution fuses are placed in the plate supply leads. Frequently an overload relay is provided in the positive lead which will trip and interrupt the circuit if the overload, or short circuit occurs.

6. Coupling the Energy to Antenna—There are three general methods by which the r.f. energy is coupled to the antenna to be radiated. They are:

1. Direct coupling,
2. Inductive coupling,
3. Capacity coupling.

Other methods of feeding the antenna are discussed in chapter XIV.

In a direct or conductively coupled circuit the antenna system is connected directly with the same inductance to which the plate, grid and filament are connected. Figure 128 shows such an arrangement. The capacity of the antenna system is connected directly across a portion of the tuning inductance and therefore is one of the frequency determining elements of the circuit. Any weather conditions effecting a change in the capacity of the an-

tenna system will likewise cause a change in the radiated frequency.

If the antenna were to fall down or ground accidentally the tube would stop oscillating and draw a heavy overload. The same effect

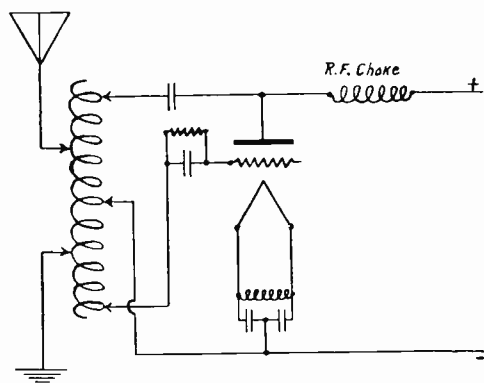

FIG. 128. Hartley Circuit Directly Coupled to Antenna.

takes place to some extent in a rain or snow storm or if the insulators become covered with ice.

A transmitter employing direct coupling would operate very inefficiently on shipboard especially during bad weather and heavy seas. Obviously such coupling is seldom employed in commercial transmitters.

7. Inductive Coupling—This method of coupling is accomplished by placing two coils in an inductive relation to each other. The transfer of energy is accomplished by an alternating electromagnetic flux or field surrounding the primary coil. The secondary or antenna coupling coil is placed near or inside of the primary so that part of the alternating flux surrounding the primary will flow through the secondary. The circuit shown in figure 125 is inductively coupled to the antenna. The primary coil is sometimes called the tank circuit inductance. The secondary is called the antenna coupling inductance. Sometimes an antenna loading coil is necessary in order to tune the transmitter to long wavelengths. This coil is connected in series with the coupling coil and antenna.

Inductive and loose coupling should not be confused. The an-

tenna may be capacitive coupled and still have a loose coupling depending upon the value of the coupling condenser.

8. Adjustment of the Inductively Coupled Circuit—The primary circuit is first tuned to the desired frequency. Before proceeding with this adjustment the secondary should be loosely coupled to the primary. The antenna and ground connections should then be disconnected. It is best to start with low power. Referring to figure 125, the condenser C^1 is varied until the primary circuit is oscillating at the desired frequency. The filament clip F is usually connected near or at the center of the inductance and the plate clip P and grid clip G varied until the correct feed-back is secured to start oscillations. More turns are usually included from F to P than from F to G . If the grid is too close to the filament the tube will not oscillate well; if it is too far away F the tube efficiency will be bad. Usually 2 or 3 plate turns are used for each grid turn. The variable condenser C^1 should always be connected inside of the plate and grid clips. The fewer the turns included between the condenser clip increases the amount of condenser capacity required (Hartley circuit). This will tend to steady the output of the tube.

If the clips are improperly adjusted excessive plate current will be indicated by the plate milliammeter. If no milliammeter is connected in the plate circuit the color of the tube plate is the best indication of correct plate current. Excessive plate current causes heating of the plate to a light red or white heat. When operating normally the plate will show just a cherry or dull red.

A wavemeter coupled loosely to the primary inductance will indicate the wavelength at which the primary circuit is oscillating.

If the capacity of the condenser C^1 is reduced to zero and the wavelength as measured is too high the number of turns shunting C^1 should be decreased. If on the other hand with the condenser set at its maximum capacity the wavelength is too low more turns should be included in shunt to C^1 . In making these adjustments it might be noticed that for a certain setting of C^1 the tube stops oscillating or draws a heavy overload. This is indicated by a sudden rise of plate current or excessive heating of the plate. The capacity of C^1 should be varied at once until the tube starts oscillating normally as indicated by a sharp drop in the plate current or the change of color of the plate from light red to dull or cherry red.

The Hartley circuit oscillates easily and no difficulty should be encountered in making adjustments to the desired frequency and keeping the plate current within its normal operating value.

With the primary circuit oscillating at the desired frequency the power may be increased to normal value.

The antenna and ground can now be connected to inductance L^2 . Upon starting to resonate the two circuits the inductance L^2 should be coupled fairly closely to L^1 . The turns on L^2 are varied until the antenna radio frequency ammeter indicates maximum current. Resonating the two circuits should be accomplished with the key closed. A test should now be made by transmitting dots and dashes in the usual way. It may be noticed that the radio frequency ammeter in the antenna circuit does not follow the key or tends to lag behind the same. A measure of the radiated frequency may show that it is a few meters off from that to which the primary circuit was tuned. This is caused by too close coupling.

When the circuits are too closely coupled the circuit has two frequencies at which it is capable of oscillating. The transmitter may therefore, oscillate at one frequency for some time and suddenly when keying start to oscillate at another frequency.

As the coupling is loosened by increasing the distance between the primary and antenna inductance the two frequencies at which the transmitter may oscillate approach each other and at a given value of coupling these two frequencies coincide.

The value of coupling at which this occurs is called "Critical Coupling." When this value is attained the transmitter oscillates at only one frequency.

As the coupling is further loosened the current in the antenna circuit is decreased resulting in lowered efficiency. It is therefore necessary to operate the transmitter or at immediately below the value of critical coupling in order to secure maximum power in the antenna with good frequency stability.

In some commercial transmitters where several different frequencies are employed in transmission a small coupling coil of few turns is used as L^2 and external loading coils are used to tune the antenna circuit to the desired frequencies. A loose coupling may be employed in this way by keeping the position of the primary and coupling coils fixed and employing only enough turns in the coupling coil to obtain maximum transfer of energy. The loading coils are the tuning inductances.

The shifting from one frequency to another is accomplished by one operation from the front of the control panel. During this operation the antenna is connected to the correct position on the loading coils and at the same time the condenser C^1 engages the correct number of turns in shunt to it for that particular frequency.

9. **One-Wire Feed Lines**—It is frequently convenient to place the antenna at some distance from the transmitter and to connect them by a radio frequency feed line. It is convenient here to

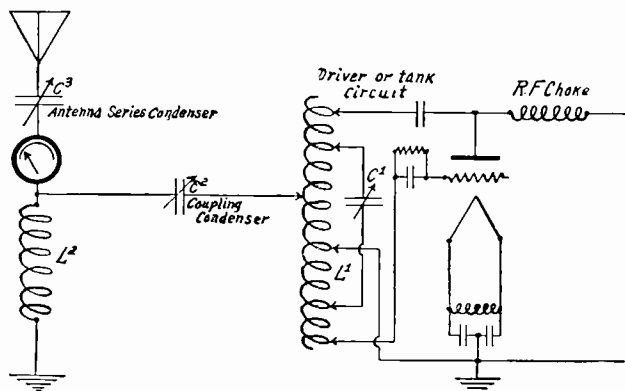

FIG. 129. Hartley Circuit with r. f. Line to Antenna. (Capacitive Coupling Control.)

show how a one-wire feed line may be used with a normal Hartley circuit. In figures 124 and 129 such connections are shown and the coupling between the primary and the antenna is in each case provided by a sort of link circuit which can be traced as follows. From the ground through the antenna inductance (L^3 in figure 124 and L^2 in figure 129) through the line with its series reactance (L^2 in figure 124 and C^2 in figure 129), thence through L^1 to filament and back to ground. The line is usually not resonant; hence the series reactance (L^2 of figure 124 or C^2 of figure 129) device is not exactly a tuning unit but rather a coupling control. It is definitely not a "coupling coil" or "coupling condenser" nor is it proper to call such systems "impedance coupled" or "capacity coupled."

10a. **Adjustment of One-Wire Feed Systems**—Disconnect the feed line and tune the primary circuit as previously described. Now connect the feed line with all of L^2 (figure 124) or very little of C^2 (figure 129) in circuit. Watching the antenna ammeter, resonate the antenna by adjustment of the antenna inductance and condenser. A milliammeter in the plate supply lead of the tube will assist considerably. Now increase the setting of series condenser C^2 (figure 129) or decrease the inductance of L^2 (figure

124). Slight readjustment of primary or antenna tuning may be necessary to maintain the correct frequency. As the series reactance in the line is decreased a point is reached at which the tube ceases oscillating. Less than this amount of coupling must be used by either increasing the series reactance or moving the feeder tap toward the filament on L^1 . Resonance between the primary and antenna circuits is indicated in the usual way.

While the use of a condenser as in figure 129 is more convenient it has been found that harmonic frequencies are radiated freely and to suppress them the circuit of 124 is recommended.

It is possible to operate an antenna at its fundamental by eliminating all condensers and inductances from the circuit and supplying it through a one-wire feed line tapped on at a point removed from the ground connection by about 28 per cent of the antenna length. For a straight ungrounded antenna the feed point should be 13.9 per cent of the antenna length from the center. The figures are due to Byrne, Windom, and Everitt of Ohio University.

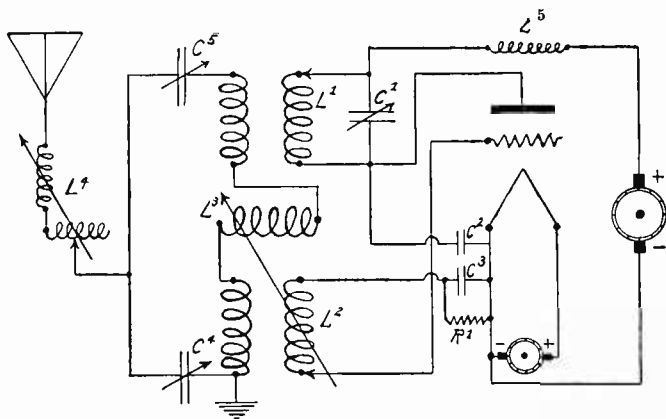

FIG. 130. Modification of Meissner Circuit with Capacitive Coupling to Antenna.

10b. Capacity Coupling—Because one-wire feed systems are often mistakenly called “capacity coupled” when working as in

figure 129 it is thought advisable to show a *true* capacity coupled system in figure 130. The coupling is due to condenser C^4 which is *common to the antenna circuit and the primary tuned circuit*. As its capacity is made smaller the voltage across it rises and therefore the coupling increases. This adjustment simultaneously tunes both primary and antenna circuits which must be corrected by C^5 and L^4 . With due regard to the avoidance of short-circuits any type of oscillator may be capacity coupled to any antenna since it is almost always possible to add a series condenser common to both circuits.

11. Transmitters with r.f. Amplification—It is desirable in some transmitters to use the main vacuum tubes as r.f. amplifiers supplied by a small oscillator. This is usually done for one of two causes, (a) to permit the use of a special oscillator circuit which it is not practical to apply to the large tubes or (b) to permit modulation at a low power level so one does not need to amplify the speech or music up to the level of the final set output. Device (b) is obviously saving of power while device (a) permits the use of crystal control, stiff oscillator circuits not practical for large powers or battery-driven oscillators (see Burgess Battery Co. engineering circulars).

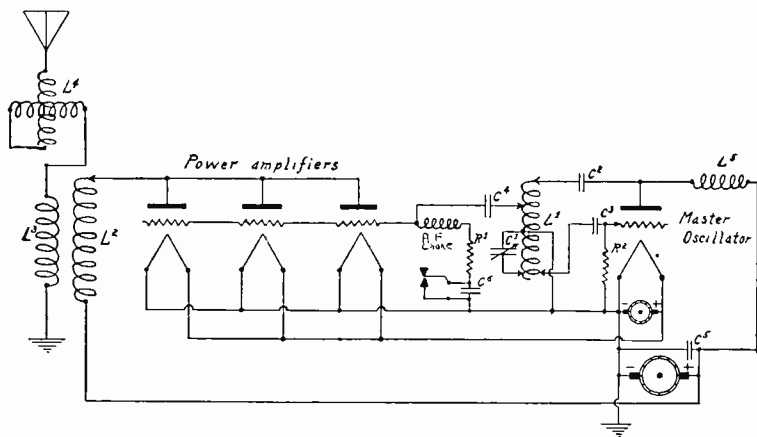

FIG. 131. Oscillator Driving Three Amplifier Tubes.

A study of the diagram will show that the master oscillator (exciter) tube is connected in a Hartley shunt feed circuit. The

condenser C^1 is used to tune the circuit to the frequency desired. Condenser C^4 is the coupling condenser and is connected to the inductance L^1 and to the grids of the power amplifier tubes. By providing a variable connection from C^4 to L^1 permits the grids of the amplifiers to be properly excited.

The amplified radio frequency currents in the plate circuits of the power amplifier tubes flow through the inductance L^2 which is in inductive relation to the antenna coupling coil L^3 .

By the use of the variometer L^4 the antenna circuit is tuned to resonance with the power amplifier frequency until maximum antenna current is obtained. Changes in the values of L^2 and L^3 have no effect upon the frequency of the waves radiated by the antenna but only of the amount of power transferred between the two circuits.

As the turns in the primary inductance L^2 are decreased, the step-up ratio of the transformer is increased and therefore the load is increased. In any tube circuit if the load resistance is too great the plate current will be high without any attendant increase in antenna current. To determine the best adjustment it is advisable always to start with a minimum number of turns in antenna inductance L^3 and gradually increase the number until the proper loading is obtained but never to the point where an increase of plate current does not increase the antenna current.

It is possible to use a much larger value of coupling than if the tubes were self excited, therefore, a greater transfer of energy to antenna circuit results.

However, the advantages of the master oscillator-power amplifier circuit fail to appear if the power amplifier grid puts more than 20 percent load on the master oscillator. Two identical tubes may be used to advantage.

A variation of this arrangement consists of a master oscillator which supplies grid excitation to one or more intermediate amplifiers through a condenser as C^4 . The plate circuits of the intermediate amplifiers are in turn coupled to the grids of the main amplifiers through a similar condenser. The antenna circuit is coupled to the main amplifiers as shown in the drawing.

A neutralizing condenser is frequently employed to prevent reaction of the amplifier on the master oscillator through the internal capacity of the amplifier tubes. The principle involved is like that employed in the Hazletine neutrodyne receiver as described in the previous chapter. By connecting a small variable condenser from a point of correct potential on L^1 to the plates of the amplifier tubes a voltage is fed back opposite in phase to that existing across

the internal capacity of the tubes effectively neutralizing the tendency to oscillate. This permits the amplifier tubes to be fully excited without danger of generating self oscillations.

12. Master Oscillators with Piezo-Electric Crystal Control of Frequency—The quartz crystal which has attracted considerable interest of late as a frequency standard depends for its action on what is known as the piezo-electric effect.

If a section of a quartz crystal is placed between two electrodes having a difference in potential the crystal becomes shortened or lengthened.

The piezo-electric phenomena are reversible, that is to say that as an electric field alters the size of the crystal so can alteration in size of the crystal produce an electric field in the crystal.

A quartz crystal prepared as a radio frequency oscillator may be round or rectangular in shape. Rectangular crystals have the advantage of being cheaper to make and will control a greater radio frequency output without cracking or chipping.

There are three frequencies at which a quartz crystal is capable of oscillating. One frequency corresponds to what is known as the X dimension, one to the Y dimension and the other to a frequency which is between the X and Y frequency and is termed the coupling frequency.¹

The frequency of vibration of a quartz crystal is very constant. When connected in a circuit with a small vacuum tube it acts as an oscillator, the frequency of which depends wholly upon the mechanical vibrations of the piece of crystal. A frequency thus produced is accompanied by numerous harmonics. These harmonics are produced in a plate circuit of the tube and not in the crystal. By making the inductance large in comparison with the capacity the harmonic frequencies will be increased considerably both in magnitude and number. The wave form of the fundamental frequency in the vacuum tube is not sinusoidal, but distorted, thus indicating the presence of harmonics. By employing a large inductance in the plate or phase adjusting circuit a means is provided for matching impedance at harmonic frequencies with that of the plate filament circuit of the vacuum tube due to the fact that such a coil system responds to a wide band of frequencies. This matching of impedance provides a maximum generation of power at the harmonic frequencies. The fundamental frequency and harmonics can then be used for frequency standards for cali-

¹For further information relative to dimensions and fundamental frequencies of quartz crystal oscillators see proceedings of The Institute of Radio Engineers, January, 1927, article by A. Crossley entitled "Piezo-Electric Crystal Controlled Transmitters."

bration purposes. The application of the piezo-electric crystal as a frequency standard is becoming quite universal.

It has been found that the frequency of any crystal is subject to change with temperature and for absolute constancy of frequency it is necessary that some method be employed to control the temperature either directly or indirectly to the crystal. One method is to place the crystal in a hermetically sealed container and by use of a thermostat and heating unit in this container maintain the crystal at a pre-determined temperature.

The quartz crystal oscillator may be employed to check the frequency of a radio transmitter. The crystal can be ground to the desired size whereby one of its natural frequencies of vibration corresponds to the assigned frequency of the station. The emitted wave of the transmitter can be then adjusted to "zero beat" with the natural period of the crystal. If desired the crystal can be cut so that its fundamental frequency differs by 500 or more cycles from the assigned frequency of the station and thus the operator can by listening in, compare the beat frequency from time to time during operation and determine if the transmitter has shifted from its correct frequency.

When the crystal is employed by this method such a station is said to be "crystal checked" rather than crystal controlled.

However, the method is subject to an error and for this reason it is desirable to first adjust or check the transmitter with a reliable wavemeter. Assume that the assigned frequency of the station is 640 kilocycles and that the crystal is ground to produce a 500-cycle beat frequency (640.5 kilocycles).

It is therefore apparent that if the transmitter was oscillating at 641 kilocycles there would still be produced a 500-cycle beat note with a 640.5 kilocycle crystal. Obviously the transmitter frequency would be one kilocycle higher than that at which it was desired to transmit.

To use the crystal as a means of frequency control of a transmitter it is necessary for the crystal to be cut so that its natural frequency or one of its harmonics corresponds exactly to the frequency it is desired to transmit.

The amount of power that a crystal can directly control is limited and for this reason it is necessary to start the crystal oscillating by placing it in the grid circuit of a vacuum tube of small power. The frequency thus generated by the crystal can be amplified by exciting the grids of tubes of higher power and the amplified energy fed to the antenna.

Atmospheric conditions may change the capacity of the antenna

system but the transmitted frequency remains constant as controlled by the crystal.

Figure 132 shows the general arrangement of a crystal controlled power amplifier circuit. A transmitting tube of small power

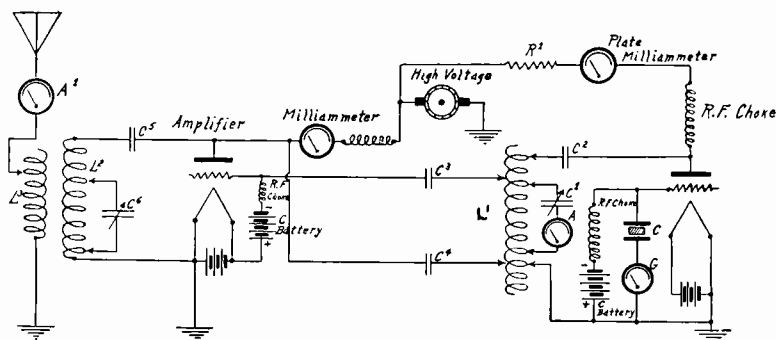

FIG. 132. Crystal-Controlled Oscillator Driving an Amplifier.

is used to start the crystal oscillating. If excessive plate voltage is used on the oscillator tube the crystal will develop heat and possibly explode.

Referring again to figure 132 the crystal C is placed between two electrodes which are connected to the filament and grid of the tube respectively. A thermo-galvanometer is also sometimes connected in series with the crystal to assist in adjustment. The battery C provides the proper negative bias on the grid of the tube. A radio frequency choke in series with the "C" battery and grid prevents radio frequency currents from flowing through the "C" battery and aids in starting oscillations. By correct adjustments of inductance L^1 and condenser C^1 the necessary feed-back is secured to start the crystal oscillating. The grid of the power amplifier is excited by the voltage drop across condenser C^3 which is connected near the plate tap on inductance L^1 . The condenser C^6 and inductance L^2 permit the amplifier circuit to be tuned to resonance with the crystal frequency. Negative bias to the amplifier grid is provided by a "C" battery. A radio frequency choke coil prevents r.f. currents from flowing through the battery.

The neutralizing condenser C^4 prevents reaction of the amplifier on the crystal. It is advantageous to isolate each circuit by shielding which permits complete neutralization.

The inductance L^3 permits the antenna circuit to be adjusted for maximum output.

13. Frequency Doubling Power Amplifier—To employ the quartz crystal as a means of frequency control of a transmitter designed to operate on the high frequencies in the neighborhood of 6000 kilocycles would necessitate grinding the crystal until it was extremely small and thin. Such a crystal would be difficult to handle. Figure 133 shows an arrangement whereby this diffi-

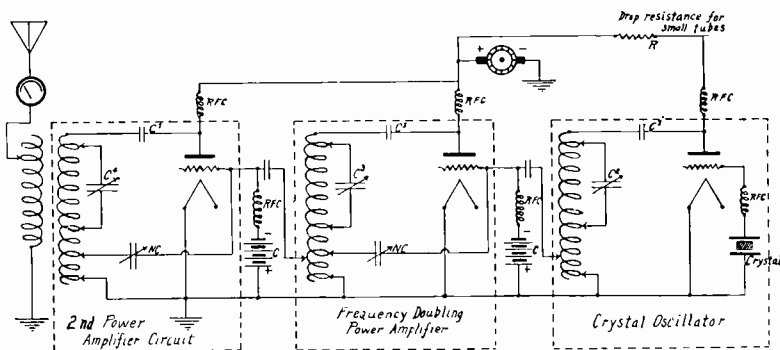

Fig. 133. Crystal Control with Frequency Doubling Amplifier.

culty is overcome. A large crystal is used as a fundamental oscillator. The frequency thus generated excites the grid of the second tube, the plate circuit of this tube is tuned to twice the fundamental frequency of the crystal oscillator.

This new frequency, which is the second harmonic of the crystal oscillator, is amplified and the amplified energy is then transferred to the antenna circuit to be radiated.

This method is employed considerably by amateurs in their transmitters operating on high frequencies.

14. Filament Supply—The drawings of the different circuits show that the filaments of transmitting tubes may be heated from either alternating or direct current.

Transmitters designed for telegraphy alone usually employ alternating current whereas radio telephone transmitters employ direct current.

Alternating current is preferable as the life of the filament is prolonged. It is rarely used on radiophone transmitters due to the objectional a.c. hum accompanying the modulation. When a.c. is used it is generally derived from a small step down trans-

former provided with a mid-tap. Across each half of the output windings a condenser is employed to by-pass the radio frequency currents thus preventing them from puncturing the insulation of the windings.

When the filament supply is provided by a generator or storage batteries a polarity reversing switch is sometimes installed. This permits the plate current to be returned through one side of the filament for half the period of operation. Where no switch is provided it is best to connect the negative of the plate supply to the positive side of the filament.

If the negative side of the plate supply is connected to one side of the filament at all times an inequality in filament current results due to the plate current flowing through one side of the filament. This causes one side of the filament to operate at a higher temperature than the opposite side and results in the filament burning out at the point of excess current while the remainder of the filament is only partially used. By the use of the polarity switch mentioned in the previous paragraph the wear on the filament can be divided thus prolonging the life of the tube.

A filament voltmeter is provided on all commercial transmitters. The voltage at which the filaments should be operated is sometimes indicated by a red mark or arrow on the scale of the instrument.

Usually there is provided with each transmitter an instruction book wherein the operator may learn the normal operating voltage for the tubes in that particular set. At no time should the filament voltage exceed that in the electrical data accompanying the tube.

Operating the filament at an increased voltage of 5 percent will reduce the life of the tube by half, whereas, if operated at the same percentage below normal the life of the filament will be doubled. However, if the filament is operated too far below normal the tube will heat excessively and the efficiency of the transmitter will be reduced.

Source of Plate Supply.

15. Storage Batteries are used to supply the high plate potential for tubes employed in radio telephone transmitters. Such an installation usually consists of many "B" batteries of 45 volts each, connected in series to secure the voltage desired, a series parallel connection being used for charging.

16. Motor Generator—The most practical method for production of high plate voltage up to and including 2400 volts is

from a direct current generator driven by either an a.c. or d.c. motor. Such generators are so designed that the output voltage is constant on load.

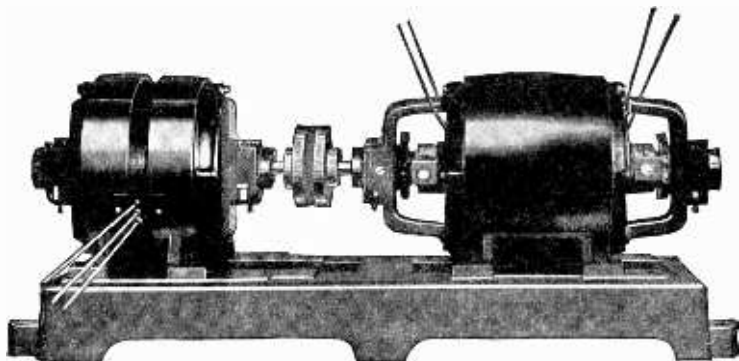

FIG. 134. Esco Motor Generator Supplying Plate and Filament Power for a Vacuum Tube Transmitter.

Direct current generators of this type when operating under normal conditions have three sources of disturbance, which if not eliminated greatly impair the quality of voice and musical transmissions. These disturbances are called the commutator ripple, slot ripple and the noise of moving contact.

The Commutator Ripple is explained as follows: Armature windings consist of a series of coils wound around the armature, forming one large coil with taps brought to commutator segments. During rotation the brushes make contact with one segment and then the next in line. As the brush leaves one segment and passes to the next the voltage changes slightly. The resultant fluctuation in voltage is known as the commutator ripple or whirl.

Slot Ripple—The space between each coil of the armature is called a slot. As each slot passes a field pole there is a slight interruption of the field at this point. Each surge in the field slightly changes the value of the voltage induced in the coils. The resultant disturbance is known as slot ripple.

The Noise of Moving Contact is due to the infinitesimal sparking caused by microscopic unevenness in the surfaces of the commutator and the brushes.

To eliminate these disturbances filter circuits consisting of capacity or inductance or combinations of both are inserted in the supply line.²

² The Electric Specialty Co., 201 South Street, Stamford, Conn., manufacturers of high grade motor generators, dynamotors and rotary con-

For voltages exceeding 1000 there are usually provided two armatures winding connected in series. A filament current generator is sometimes provided and is coupled to same shaft. The filament current also provides a means of exciting the fields of the high voltage generator. A field rheostat is usually provided to permit adjustment of plate voltage.

The motor driving these units is either a d.c. or a.c. machine, depending upon the local supply line. If no d.c. is available a separate exciting generator is also coupled to the motor.

Dynamotors—On low power sets such as on a yacht or small pleasure craft a small dynamotor may be employed.

This consists of a self-contained motor generator unit, the primary of which uses direct current at voltage from 6 to 110 volts. The secondary voltage varies 350 to 1000 volts d.c.

17. Vacuum Tube Rectifiers—Vacuum tubes employed for rectification of alternating current have two elements, namely, the filament and plate. Some such tubes have two plates. Those having one plate are called half wave rectifiers and those having two plates, full wave rectifiers. The half wave rectifiers are employed for high voltages such as used in transmission. They are employed to rectify the alternating current voltages ranging from 110 volts to 24,000 volts. One is usually employed on each side of the cycle, thus permitting full wave rectification.

Where a single phase a.c. supply is used it requires an elaborate filter circuit to completely eliminate the a.c. hum in order that

FIG. 135. A Western Electric High Voltage Half-Wave Rectifying Tube.

such a system may be used successfully for radio telephone transmission. For continuous wave transmission alone the filter reverts for radio transmission, publish a small pamphlet entitled, "Esco Filter Facts" which they will mail to anyone making application for the same. The student who is interested further in the study of filters for generators should secure this pamphlet.

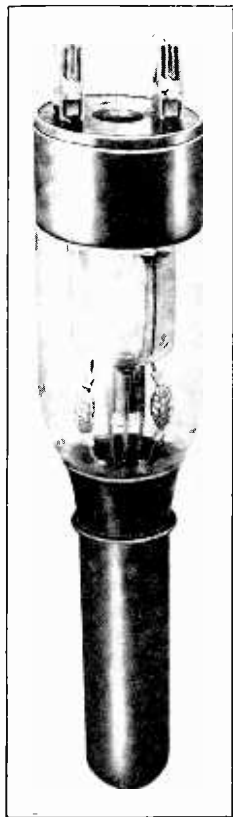

quirements are not so elaborate. Vacuum tube rectifiers of a.c. are employed in practically all radio telephone transmitters of 5 K.W. and upward in power.

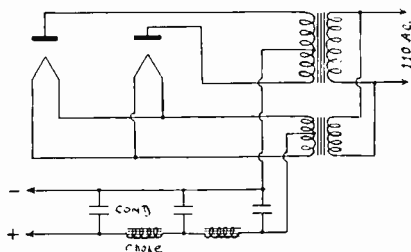

FIG. 136. Arrangement for Full Wave Rectification of A.C. with Two Half-Wave Rectifier Tubes.

The general arrangement of filter circuit as employed with a two-tube full wave rectifying system is shown in figure 136.

18. Chemical and Mercury Arc Rectifiers—Rectifiers of this type are employed considerably by amateurs but are seldom encountered in commercial radio transmission.³

19. Continuous Wave Transmission—The oscillations generated by a vacuum tube having a direct current plate supply such as from a d.c. generator, rectified and filtered a.c. or a high voltage battery, are of a sustained nature or constant amplitude. When these oscillations are heterodyned at the receiver by an oscillatory detector tube or separate oscillator, they produce a pure liquid note in the telephones. The emission from such a transmitter is called a continuous wave. Figure 137 shows the characteristic of a continuous wave. It should be noted that it is a continuous oscillation of a constant amplitude.

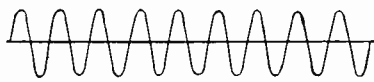

FIG. 137. A Continuous Wave Train.

It is sometimes noted that signals are heard from a nearby C.W. station on a non-oscillating vacuum tube or a crystal detector. This is usually caused by disturbances of the plate generator modulating the oscillations at an audio frequency, usually the result of a poor

³ For further information on these types of rectifiers see "The Radio Amateur's Handbook," published by the American Radio Relay League, Hartford, Conn.

filter, or poorly designed machine. A dirty or uneven commutator surface will aggravate this condition.

Where the plate supply is rectified a.c. it may be caused by the a.c. component passing through the filter and thus modulating the output at a frequency dependent upon the frequency of the supply mains.

If the plate supply is secured from batteries no signals will be heard by a non-oscillating detector when continuous waves are being transmitted with the exception perhaps of the key clicks. It may be possible too, that the signals may be heterodyned by an unknown source such as from another receiver in the immediate vicinity or possibly a tube oscillating feebly in the operator's receiver.

20. Interrupted Continuous Waves—It is sometimes desirable to transmit waves from a continuous wave transmitter so that they will be audible at the receiving end on a non-oscillating vacuum tube of crystal detector. This may be accomplished in one way by the use of the chopper which breaks the continuous waves up into audio frequency groups. The chopper consists of a wheel of metal construction with insulating studs set in its face. Wiping contacts or brushes are provided to make contact with the metallic segments in the wheel. When it is desired to transmit C.W. signals the chopper brushes are short circuited. The wheel is fastened securely to the shaft of a motor. The speed at which the motor turns and the number of segments in the wheel determine the frequency at which the continuous waves are broken

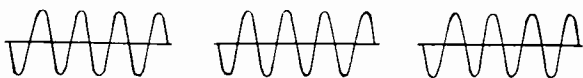

FIG. 138. Interrupted Continuous Waves (ICW).

up into audio frequency groups. Figure 138 illustrates the character of interrupted continuous waves (I.C.W.).

Figure 139 illustrates one method of connecting a chopper to a transmitting circuit so as to produce interrupted continuous waves. It will be noted that the antenna inductance has several of its turns shorted by the chopper during a revolution of the wheel. This causes the wavelength to be altered a few meters several times each revolution resulting in a continuous musical note being produced in the receiver, without the aid of locally generated oscillations.

The chopper is also connected in series with the grid of the oscillator tube, thus permitting the undamped waves to be broken up into audio frequency groups.

21. Half Wave Self Rectifying Transmission—

Figure 140 shows a method of employing $\frac{1}{2}$ cycle of alternating current as the plate supply of a vacuum tube transmitter. A study of figure 140 will show that from a 500 cycle supply the plate will be positive 500 times per second. Thus the tube oscillates 500 times per second corresponding to the positive alternations. During the negative alternations the tube is idle. An antenna connected to such an oscillating system would radiate energy the wave form of which is of varying amplitude and in groups of 500 per second. As these groups are within the audio range of the human ear and headphones the dots and dashes made would be audible on a receiver fitted with a non-oscillating vacuum tube or crystal detector.

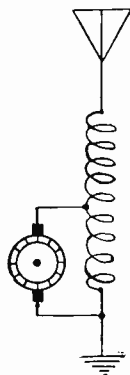

FIG. 139. Arrangement of Chopper for Producing Interrupted Continuous Waves.

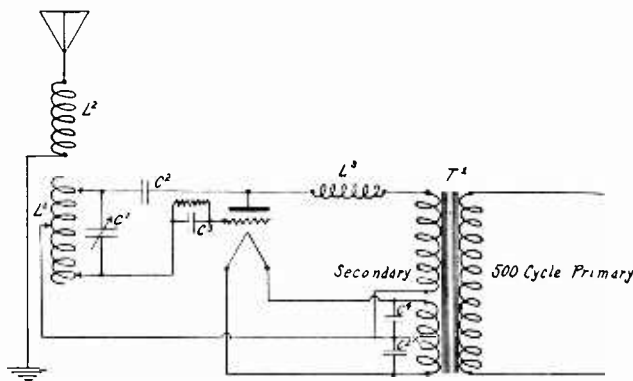

FIG. 140. Half Wave Self-Rectifying Transmitter Circuit.

22. Full Wave Self Rectifying Transmission—By the employment of two tubes connected to the secondary of a plate transformer it is possible to utilize both sides of the alternating current

cycle. In this arrangement it is necessary that the plate transformer have a mid-tap. The schematic arrangement is shown in figure 141. One tube oscillates during the first half of the cycle and the other tube on the second half of the cycle.

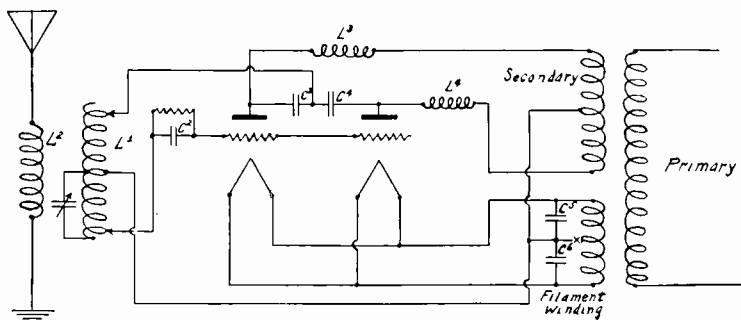

FIG. 141. Full Wave Self-Rectifying Transmitter Circuit.

In the case of the tube on one side of the cycle it is noted that a group of oscillations occur every $1/500$ of a second. With a tube on each side of the cycle a group of oscillations occur every $1/1000$ of a second. The radio frequency oscillations are periodically reduced to zero or in other words the oscillations radiated by the antenna system are completely modulated by the frequency of the a.c. supply.

The heterodyned signals from such a transmitter is very pleasing to the ear if the frequency of modulation happens to be in the neighborhood of 500 cycles.

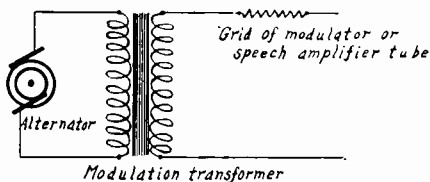

FIG. 142. Tone Modulation from an Alternator.

23. Tone Modulation—It is possible to periodically modulate the generated radio frequency currents by impressing upon

them a tone within the audible range. Figure 142 shows an arrangement whereby an alternator is used to modulate the radio frequency oscillations generated by a vacuum tube. By the use of a one-stage audio frequency amplifying circuit the modulated plate current is amplified considerably before acting upon the radio frequency oscillations.

The schematic diagram of figure 143 shows the schematic diagram whereby a vacuum tube is made to oscillate an audio

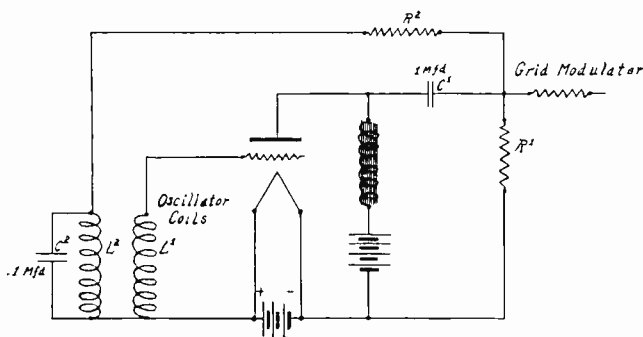

FIG. 143. Vacuum Tube Audio Frequency Oscillator.

frequency, the same being used to modulate the radio frequency output of an oscillator. The constants of the audio frequency oscillating circuit are of such values that a 500 to 900 frequency is produced.

Circuits have been devised whereby it is possible to generate simultaneously both audio and radio frequency oscillations from the same tube. Such an arrangement being quite critical in adjustment it is seldom used in commercial transmitters.

24. Methods of Keying—In commercial practice the most common methods of keying are :-

1. Breaking the negative high voltage lead either directly by hand key or by a relay fitted with extra heavy contacts and connected to an auxiliary key.

2. A system is shown in figure 144. If the key is open the plate current is forced to pass through resistance R^1 . It should be noted that the tapped point of this resistor is grounded and not the negative side of the 1000 volt plate supply. Since the grid return is connected to the tapped point on resistance R^1 any cur-

rent flowing in R^1 causes a bias to be placed on the grid. Therefore, when the key is opened a large bias stops oscillation due to the total plate current flowing and subsequently a holding bias exists due to the smaller current maintained through resistance R^1 by the generator.

3. When the plate supply is secured from an alternating current transformer as in self-rectifying circuit the key is usually placed in the low voltage primary circuit. It should be understood that a separate filament transformer or other means of heating the filaments must be provided in order to do this.

25. Antenna Resistance Measurements—If the antenna resistance is known it is helpful in determining the efficiency of the transmitter. Antenna resistance comprises three distinct resistances which are measured in ohms. They are radiation, ohmic and dielectric absorption.

Radiation resistance is the most useful. Energy lost by this resistance is instrumental in producing the signal at a distant station. Therefore, it is this quantity multiplied by the square of the antenna

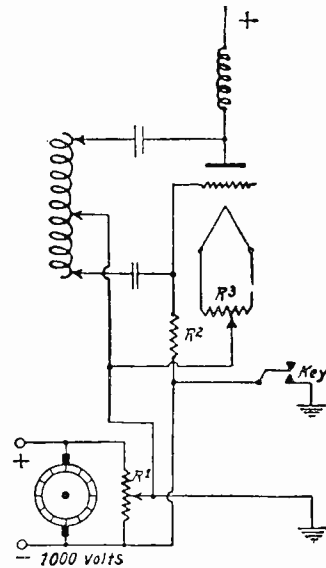

FIG. 144. A Method of Keying by Supplying and Removing a High Negative Bias to the Grid of a Vacuum Tube R.F. Amplifier.

current that determines the power of the radiated waves.

The power delivered to an antenna is equal to the square of the antenna current multiplied by the effective resistance. The resistance must be measured at the same part of the antenna as the current. Thus it can be seen that by comparisons of the power delivered to an antenna to the power that is actively radiated it is possible to determine the efficiency of the radiating system. Also it will show at what wavelength it is best to operate on.

Radiation resistance of an antenna depends upon its effective height, shape and the wavelength at which it operates. It is at a maximum at the fundamental and decreases rapidly as the antenna is loaded.

Ohmic resistance is not useful. It is due to heat losses by the

current flowing in the antenna wires, ground wires, and condensers comprising the open circuit. The value of this resistance remains practically constant over the whole wavelength range.

Dielectric absorption also represents another power loss. It is due to imperfect dielectrics within the field of the antenna such as masts, guys, trees and if on shipboard the smoke stack of the vessel. The value of this resistance increases in proportion as the antenna is loaded.

For the practical purpose of securing the power input to the antenna the three resistances are combined and called the total antenna resistance.

Figure 145 shows how the different resistances are distributed for an antenna having a fundamental wavelength of 300 meters. The following numbers correspond to:

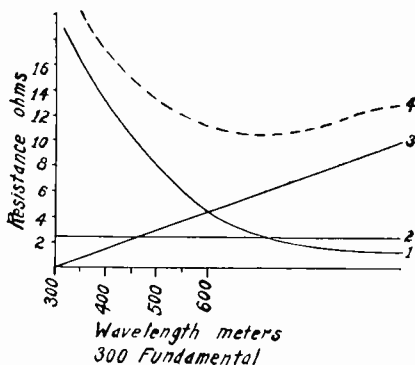

FIG. 145. Antenna Resistance Curves.

(1) Radiation resistance, (2) ohmic resistance, (3) dielectric absorption, (4) total or effective resistance.

There are two methods by which the antenna resistance may be measured. They are known as the resistance variation and resistance substitution methods.

The variation method consists of inserting a known resistance in series with the antenna and noting the values of the antenna current at different wavelengths and plotting these values as a curve. The arrangement apparatus is shown in figure 146.

The driver circuit must be coupled very loosely to the antenna circuit. A switch is provided for shorting out the known resistance. All the apparatus that is included in the open circuit should

remain in the circuit in order to measure the resistance under actual working conditions.

In order to measure the resistance at the fundamental wavelength of the antenna the natural period of the antenna system must be found. This is done by connecting the antenna directly

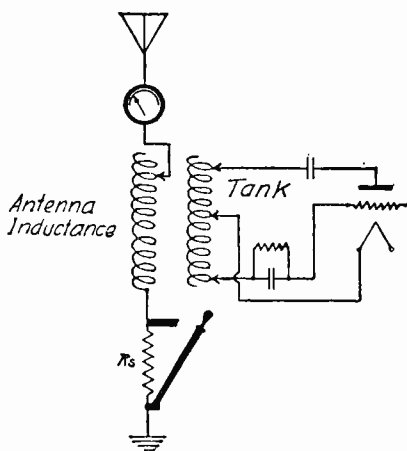

FIG. 146. Arrangement for Measuring Antenna Resistance by the Variation Method.

to the ground or counterpoise. If a grid current milliammeter is included in the driver circuit a pronounced dip of the needle will be indicated when the driver is in resonance with the natural frequency of the antenna system. If an antenna milliammeter is included in the antenna circuit it should indicate its maximum deflection when the grid meter makes its lowest dip. The deflection of the grid meter should be gradual as resonance is approached on either side. A very sharp dip of the needle with a sudden turn to its normal position indicates too close coupling between driver and antenna circuit. The coupling should be still further loosened until there is absolutely no reaction between the two circuits. A powerful driver separated by several feet from the antenna is necessary if accuracy is desired.

After determining the fundamental wave length of the antenna its resistance at this frequency can be measured.

The antenna current at resonance is noted and then the known resistance is put in series with the circuit and the antenna current

read again. The driver adjustment should not be disturbed when the resistance is inserted in the circuit. The resistance of the antenna circuit is then coupled by substituting:

$$R_a = \frac{R_1}{\frac{I}{I_2} - 1}$$

R_a = Antenna resistance

R_1 = Value of known resistance

I = Antenna current before resistance was inserted

I_2 = Antenna current after inserting known resistance in circuit.

Readings can then be taken at 5 and 10 meters apart from below the fundamental (by inserting series condenser) to two or three times this wave. A curve can then be plotted as previously shown.

Humps in the curve indicate resonance circuits within the field of the antenna at the wavelength at which the hump occurs.

If the bend in the curve is exceptionally high it probably indicates a high resistance ground. If the curve at the right of the bend goes up very steep, it indicates excessive dielectric absorption probably due to the proximity of trees and houses.

Measurement of an antenna resistance by *substitution method* consists of coupling the driver circuit to a dummy or artificial antenna circuit comprising inductance, capacity and a calibrated variable resistance. The circuit of such measurements is shown in figure 147.

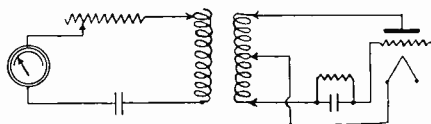

FIG. 147. Arrangement for Measuring Antenna Resistance by the Substitution Method (Artificial or Dummy Antenna).

To measure the resistance of the antenna at a given wavelength the process is as follows:

Adjust transmitter to power desired and resonate antenna circuit. Measure wavelength to see if it is correct. Record antenna current as R_a . Couple artificial circuit loosely to tank circuit and with no change in power adjust artificial circuit to same wavelength as driver. The antenna inductance can be used in the dummy in

place of a separate coil this permitting a more accurate computation of total antenna resistance. The antenna and ground leads should be disconnected. When dummy circuit is tuned to same wavelength as tank circuit the variable resistance in dummy circuit should be varied until the radio frequency current is the same as R_a . The value of resistance in use when the same value of current is noted is approximately that of the antenna circuit. The resistance of the dummy circuit can be recorded as R_d substituting in the formula the antenna resistance:

$$R_a = \frac{I_d^2 \times R_d}{I_a^2},$$

R_a = Resistance of antenna,

I_d^2 = Current in dummy,

R_d = Resistance in dummy,

I_a = Current in antenna.

The artificial antenna circuit is also useful for testing purposes without the necessity of radiating a strong wave. Supposing it was desired to find out what antenna current to expect when 500 watts of power was delivered to an antenna having a resistance of 10 ohms. Substituting in the formula

$$I^a = \sqrt{\frac{P}{R_a}},$$

or

$$I^a = \sqrt{\frac{500}{10}} \quad \text{or} \quad I^a = 7.07 \text{ amperes,}$$

P = Desired antenna power,

R_a = Antenna resistance,

I^a = Antenna current.

Another example of the use of these values is as follows: Supposing it was desired to adjust the same transmitter to 750 watts output at the same wavelength. The transmitter should be adjusted until the antenna current was

$$I^a = \sqrt{\frac{P}{R_a}} \quad \text{or} \quad \sqrt{\frac{750}{10}} \quad \text{or} \quad I^a = 8.66 \text{ amperes.}$$

Proof:

Watts in antenna = $I^2 \times R$,

Watts in antenna = $8.66^2 \times 10$,

Watts in antenna = 749.9.

If 750 watts were put into the antenna and 450 watts were shown as energy lost by radiation the remaining 300 watts would be lost in heating the wires, ground connection, dielectric absorption surrounding the wires and by eddy currents induced in nearby wires and metal masts.

26. General—When starting up a tube transmitter for the first time, the operator should first light the filament at a voltage below normal, gradually building it up by decreasing either the resistance of the filament rheostat or by decreasing the resistance of the filament generator field.

The tubes should be allowed to warm up 20 to 30 seconds before applying the plate voltage. If means are provided, start operations with about half of the normal plate voltage and gradually build it up to normal operating value. Should any trouble occur such as condensers flashing over, excessive and rapid heating of the plate, or potential breakdown to any other parts of the circuit the power should be instantly cut off and all parts of the apparatus gone over.

If a defective coil or condenser is found it should be replaced by a new one and operation of the transmitter renewed exercising the same precautions previously outlined.

If all the meters read normally and antenna current is indicated the power may be increased to the maximum rating of the tubes.

Where several tubes are operated in parallel it is best to start with one tube first. After oscillations are established the other tubes may successively be added to the circuit. Readjustment of power, both filament and plate, will be necessary with the increased load.

Due to the added capacity of the other tubes it may require a slight adjustment of the primary condenser or a movement of the plate or grid clips a fraction of a turn to establish oscillations. The wavelength should be checked when normal operation is attained.

If several tubes are operated in parallel, difficulty may be encountered through failure of the tubes to divide the load or failure to develop normal output.

To remedy the first difficulty individual grid leaks and condensers should be tried. If possible the grid leak resistances should be adjusted in steps. Then, if one tube tends to take more than its share of the load, the grid leak resistance of that tube must be increased.

If normal output is not obtained, then probably the tubes are

generating ultra-high frequency oscillations. This may be overcome by making all grid and plate leads of the same length. In addition to this a small radio frequency choke coil should be inserted in each grid lead as near to the grid terminal of the socket as possible. The choke may be made up by winding in a single layer from 15 to 20 turns of number 24 or 26 D.S.C. wire on a form one inch in diameter. Each choke should have the same number of turns. An inductive resistance of approximately 15 ohms may be used in place of the choke coil to suppress generation of these parasitic oscillations.

The operator is cautioned not to expect double or triple the antenna current for each tube added. With normal plate voltage the antenna *power* will be increased in proportion to the number of tubes providing the efficiency remains the same. The antenna *current* is increased in proportion to the square root of the number of tubes. Therefore the antenna current to be expected is equal to the original antenna current times the square root of the new number of tubes, divided by the square root of the original number of tubes or:

$$I_n = I \times \frac{\sqrt{\text{new number of tubes}}}{\sqrt{\text{old number of tubes}}}$$

If one tube is in use and another is added it will be found that the antenna current is approximately 1.4 times that shown for one tube.

In circuits employing full wave self rectification those tubes acting on one side of the cycle only are computed as the power rating of the transmitter. Assume one 250-watt tube on each side of the cycle of a transmitter. The power output is computed as one tube alone. It will probably be somewhat higher than the normal rating of the tube.

27. General Suggestions for Locating and Correcting Trouble in a Tube Transmitter—If the tube fails to oscillate it is usually indicated by:

- (a) High or no plate current.
- (b) Excessive and rapid heating of the plate.
- (c) Grid leak remains cool.
- (d) Failure of the current indicating device on a wavemeter to register when placed in an inductive relation to primary circuit and varied within a band of frequencies at which the primary circuit is supposed to be oscillating.
- (e) Antenna radio frequencies ammeter fails to indicate cur-

rent providing the circuits have been previously resonated.

Failure to oscillate may be due to:—

1. No voltage reaching the plate usually indicated by no reading of plate current milliammeter or by the failure of the plate to heat as the key is closed.

An opening in the plate milliammeter will prevent the high voltage from reaching the plate.

All choke coils from the source of plate supplies should be tested for open circuits or grounds.

Condensers should be tested for short circuits or potential breakdowns of the dielectric. A potential breakdown may not be visible from the outside, but the operator, may by attentive listening, hear a steady or interrupted sparking or arcing when the plate voltage is applied. If a plate milliammeter is provided it will jump suddenly each time a breakdown flashover occurs.

2. **Open Grid Circuit**—Usually indicated by reduced or no plate current. Grid leak fails to warm up as plate voltage is steadily applied. Test each tube and grid circuit separately such as grid leak, ultra high frequency choke coil.

3. **Lack of Sufficient Feed-Back to Grid**—This is corrected by moving plate and grid clips, trying them on different turns always including more turns from filament to plate than from filament to grid. Vary capacity of tuning condenser through full value of minimum to maximum capacity for each new adjustment of the clips.

High Resistance Contact of Clips on to Inductance—Clean clips and inductance with fine sand paper or emery cloth. Make sure all clips are making positive contact to correct turn of inductance. Make sure that clips are correctly placed so as to make contact only on one turn and not short-circuit those on either side.

4. **Radio Frequency Choke Coil Lacks Sufficient Turns (Parallel Feed)**—The natural period of an untuned r.f. choke coil should be greater than the longest wavelength at which the transmitter is expected to operate. If choke coil heats excessively it is an indication that it is wound with wire of too small a size or possibly the transmitter is oscillating at the fundamental or a harmonic frequency of the choke coil. A larger size choke coil should be tried.

A test can be made as follows to determine if the choke coil is preventing the radio frequency currents from feeding back into the plate supply current.

With a screw driver having a well insulated handle, touch the terminal of the coil nearest the plate with the metal end of the

screw driver. This will cause sparks to fly as an indication of the radio frequency energy providing the tube is oscillating. Tap the opposite terminal of the choke leading to the high voltage supply. If the choke is functioning correctly no snappy sparks will be observed. If sparks are observed it is best to remove the choke and replace with another having a larger inductance.

To make this test the operator must take every precaution to insulate himself from the ground and to be sure that the object with which he makes the test is insulated from his hand. It is not advisable to make this test with a transmitter employing voltages in excess of 1000 volts.

5. Defective Tube—If the tube shows a yellowish, white smoke in the interior when the filament is heated it is an indication that air has leaked into it thus destroying its vacuum.

Possibly an overload has liberated a large amount of gas from the metal plate. Usually indicated by a purple glow in the interior near the plate when the high voltage is applied.

If the tube has been subjected to an overload for a long period of time the filament may have lost its normal emission. This is generally indicated by a reduced reading of the plate milliammeter. Where several tubes are operated in parallel it will be necessary to test one at a time for oscillation. Failure to show normal plate current or to oscillate is a good indicator that the tube needs re-activation.

6. Grounds—It sometimes happens that ground or potential breakdown will not occur until the plate voltage has built up to half or full voltage. This is usually indicated by successive blowing of fuses or tripping of the circuit breakers in the plate supply leads before the voltage reaches a maximum value. The defective wire should be located and the ground cleared or the wire replaced by a new one.

This may often be found in lead-covered wire caused by the lead sheathing breaking and cutting through the insulation to the conductor inside, thus grounding the circuits. Any circuits run with this kind of wire and not at ground potential should be tested out with battery and phones or voltmeter to ascertain if this has occurred.

It sometimes happens that in soldering copper lugs to the conductor within a lead-covered wire that insufficient sheathing is removed and as a result the shoulder of the lug makes contact to the lead covering resulting in a short circuit or ground. This trouble is rather difficult to locate as it is the usual practice to tape up the shoulder of the lug to the lead covering after completion of the soldering.

Only by testing one circuit at a time can the defective wire be located. It may be necessary to substitute one or two new leads before the trouble is finally eliminated.

Substitution for Defective Parts.

28. Condensers—Where a condenser is blown and no spare is available it is sometimes possible to remove one from some other part of the circuit where it is not so essential and try it in place of the defective one.

Coils—Defective coils can usually be removed or the defective portion shorted out. If the insulating material on which the coil is wound has become charred due to arcing over or burning, cut away insulation if possible, or cut winding and remove sufficient turns to clear the defective part of coil support.

Grid Leak Resistance—Most any type of non-inductive resistance from 4,000 to 10,000 ohms will do in an emergency providing it has sufficient current carrying capacity. A grid leak can be constructed from a piece of rubber hose 12 inches long, filled with water and plugged at each end. Wire electrodes can be inserted through the plugs making contact with the water at each end. If the resistance is too high add a little salt or washing soda. A glass jar similar to a fruit preserving jar can be used in lieu of the rubber hose. One electrode can be stationary and the other variable so that adjustments to the correct value can be made.

Burned Out Filament Transformer or Generator—Connect enough storage batteries in series to give the desired voltage at which the tubes operate. If the filament transformer is burned out it will be necessary to disconnect all wires running to the mid-tap and connect them to the positive side of the filament battery. If the filament d.c. generator is defective disconnect the leads from the output terminals of the machine and connect the battery.

In searching for trouble it should be done systematically. It is generally possible to immediately isolate the trouble, that is, to locate it in some unit of the equipment such as the motor generator, filament transformer, fuse blocks, sockets or switches, etc.

Frequently it is possible to still further isolate the trouble, as for example in the radio transmitter, it is possible to determine whether it is a defective tube, open grid circuit or a potential break-down, of condenser.

By keeping in mind the function of each part of the transmitter the trouble can soon be located and a remedy applied.

TRANSMITTING TUBE DATA

| Manufacturer | Type Number | Signal Corps Number | Navy Number | Rating (Watts) | Safe Continuous Plate Dissipation (Watts) | Fila-ment Volts | Fila-ment Am-peres | Type of Filament | Plate Volts | Plate Current (Milli-amps.) | Screen Grid Volt-age | |
|-------------------------|------------------|----------------------|-------------|-----------------|---|-----------------|--------------------|------------------|-----------------|-----------------------------|----------------------|---|
| General Elec. Co. (RCA) | UV-202 | — | — | 5 | 12.5 | 7.5 | 2.35 | Tungsten | 350 | 50 | — | |
| | UV-203 | — | — | 50 | 100 | 10.0 | 6.5 | Tungsten | 1,000 | 150 | — | |
| | UV-203A | — | — | 50 | 100 | 10.0 | 3.25 | XL-Tungsten | 1,000 | 140 | — | |
| | UV-204 | VT-8 | CG-1860 | 250 | 250 | 11.0 | 3.75 | Tungsten | 2,000 | 250 | — | |
| | UV-204A | VT-22 | — | 250 | 250 | 11.0 | 14.75 | XL-Tungsten | 2,000 | 250 | — | |
| | UV-205 | VT-10 | CG-916 | 250 | 250 | 20.0 | 3.85 | XL-Tungsten | 2,000 | 250 | — | |
| | UV-206 | — | — | 1,000 | 350 | 11.0 | 14.75 | Tungsten | 10,000 | 40 | — | |
| | UV-207 | — | — | 20,000 | 10,000 | 22.0 | 52.0 | Tungsten | 15,000 | 1.7 amp. | — | |
| | UV-208 | — | CG-1971 | 5,000 | 1,500 | 22.0 | 24.5 | Tungsten | 15,000 | 225 | — | |
| | UX-210 | — | CG-1353 | — | — | — | — | — | — | — | — | |
| | UX-211 | — | — | — | 50 | 100 | 7.5 | 1.25 | XL-Tungsten | 350 | 150 | — |
| | UX-851 | — | — | — | 1,000 | — | 11.0 | 3.25 | XL-Tungsten | 2,000 | 100 | — |
| | UX-852 | — | — | — | 75 | 100 | 10.0 | 3.25 | XL-Tungsten | 2,000 | 75 | — |
| | Western Electric | 220-B (water cooled) | — | — | 10,000 | 10,000 | 22.0 | 42.0 | — | 3,000 | 650 to 1,500 | — |
| 212-D | | — | — | 250 | — | 14.0 | 6.0 | Oxide | 1,500 | 175 | — | |
| 211-D | | — | — | 50 | 65 | 10.0 | 3.0 | Oxide | 750 to 1,000 | 65 | — | |
| 205-D | | — | — | — | — | 7.0 | 1.35 | Oxide | 350 | 40 | — | |
| 215-A (peanut) | | — | — | — | — | 1.25 | — | Oxide | 22½ det. | 1 to 3 | — | |
| DeForest | 222-A | — | — | 5,000 to 10,000 | — | 21.0 | — | — | 9,500 to 10,500 | 500 max. | — | |
| | Rectifier H | — | — | 60 to 100 | — | 10.0 | 2.35 | — | 500 to 3,000 | 40-50 | — | |
| | UX-866 | — | — | — | — | 2.5 | 5.0 | Oxide | 2,000 | 600 | — | |
| | UX-865 | — | — | — | 15 | 7.5 | 2.0 | Thoriated | 500 | 21 | 125 | |
| | UX-860 | — | — | 100 | 100 | 10 | 3.25 | Thoriated | 2,000 | 100 | 500 | |
| | UX-861 | — | — | 750 | 400 | 11 | 10 | Thoriated | 3,000 | 250 | 750 | |

G. E. Screen Grid Tubes
" "

CHAPTER 6

MODULATION SYSTEMS AND ASSOCIATED APPARATUS

Perhaps the best method of approaching the subject of modulation in radio telephony is first to review briefly the electrical principles which govern the operation of an ordinary land telephone. The electrical processes which are involved in these two types of communication systems are similar and a clear understanding of the elementary principles of the land telephone is essential in order to properly grasp the fundamentals of radio telephony. The treatment of the subject of modulation will therefore be as follows: First, an explanation of the process of modulation in the land telephone; second, modulation of the radio telephone; and finally, the voice will be followed from the studio to the antenna, giving a detailed description of the associated electrical equipment.

1. **The Simple Land Telephone**—The simplest arrangement of a land telephone consists of a microphone, a telephone receiver and a battery connected in series as shown in figure 148. A mov-

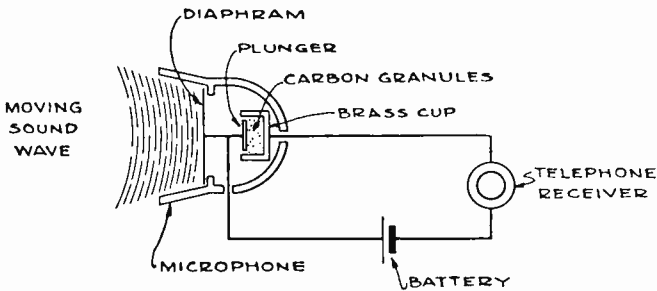

FIG. 148. A Simple Telephone Circuit.

ing sound wave, composed of alternate regions of air in the state of condensation and rarefaction, impinges upon the diaphragm of the microphone causing the diaphragm to vibrate at the frequency and amplitude of the sound wave. These vibrations are transmitted to a plunger which is rigidly fastened to the diaphragm but

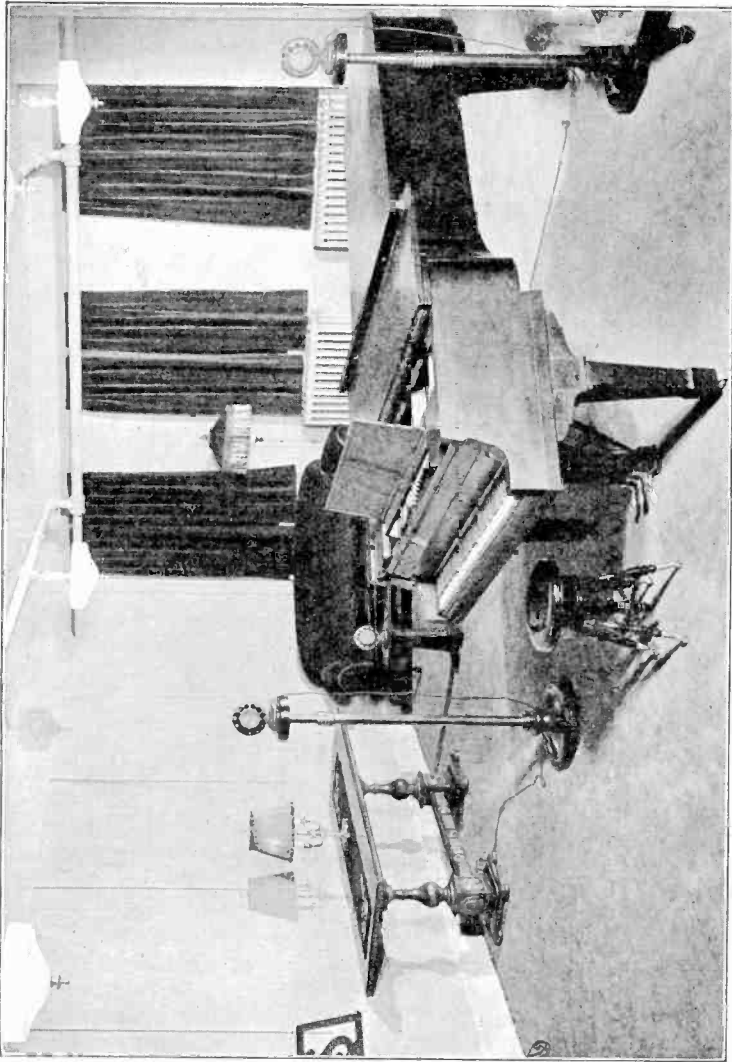

FIG. 148a. Studio of Broadcasting Station WBAL at Baltimore, Md.

free to move within the brass cup which contains a small amount of loosely packed carbon granules. The vibrations of the plunger alternately increase and decrease the pressure exerted on the carbon granules and thus varies the resistance of the electrical path between the plunger and the brass cup which forms part of the telephone circuit. As a result, the magnitude of the current flowing in the telephone circuit is varied at a frequency and amplitude in accordance with the impinging sound wave. This varying current, in passing through the telephone receiver, is converted back into a sound wave similar to that impressed upon the microphone.

The electrical phenomena involved may be represented graphically as illustrated in figure 149, which shows how the telephone

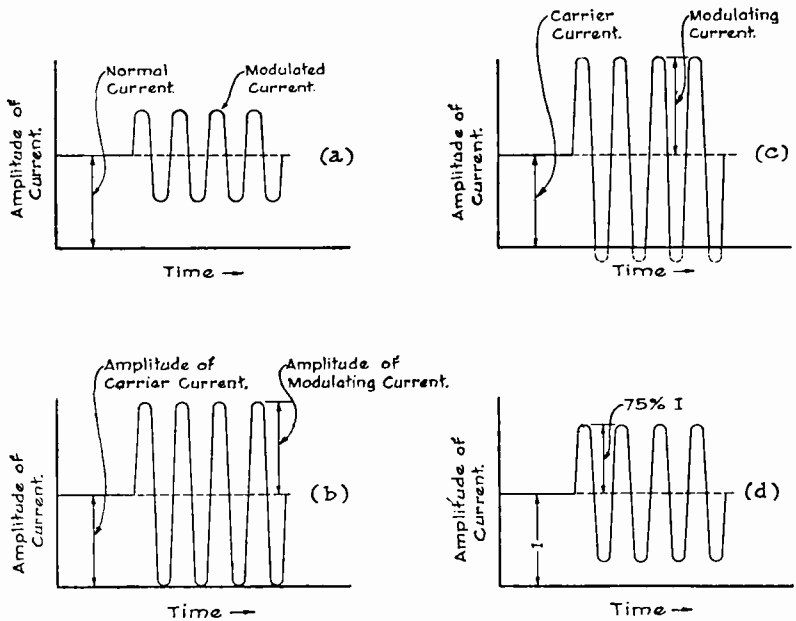

FIG. 149. Graphs Showing the Modulation Process in a Simple Telephone Circuit.

circuit current is made to vary when a sound wave impinges upon the microphone diaphragm. The sound wave is represented by the variations in the normal value of the current. The process during which these variations are superimposed upon the normal

value of current is called modulation and the telephone circuit current is said to be modulated. The normal value of current which is modulated is called the carrier current because it is the agency which makes possible the transmission of the sound wave in the form of current variations. The variations themselves are frequently called the modulation or the modulating current since the modulated carrier can be considered as being composed of two components, the normal or carrier current and the varying or a.c. component produced during the modulation process. The magnitude of the modulating current as compared to carrier current definitely limits the ability of the carrier to properly transmit the superimposed modulation. For example, in figure 149*b* the modulating current is equal in value to the carrier current. Should the modulating current exceed the carrier current, the graphical picture would be as shown in figure 149*c* which indicates that distortion will take place because of the cutting off of the lower peaks of the modulating current wave. The most efficient use of the carrier wave is accomplished when the modulating current is just equal to the carrier current. This mode of operation is called 100% modulation. In the case of figure 149*a*, where the amplitude of the modulating current is equal to one half of the carrier current the percentage of modulation would be 50%. The percentage of modulation present may be computed by expressing the ratio of the modulating current to the carrier current in percent. Figure 149*c* illustrates a case of 75% modulation. A carrier current having a high percentage of modulation is said to be deeply modulated whereas in the case of a low percentage the modulation is said to be slight. From the standpoint of making efficient use of a given carrier current a high percentage of modulation is desirable, providing it does not exceed 100%. When this figure is exceeded, the carrier is said to be over-modulated and distortion will be present.

2. The Simple Radio Telephone—In the case of a simple radio telephone transmitter system, the battery of the land telephone is replaced by a CW generator and the telephone receiver by the radio receiving set. The high frequency current supplied by the generator to the antenna is converted into electromagnetic waves, which, in passing the receiving antenna are converted back into a high frequency current. This current, though perhaps infinitesimally small in magnitude as compared with the antenna current at the transmitter, conforms exactly in frequency and proportional amplitude with the transmitting antenna current. Therefore, any change that we may make in current at the trans-

mitting antenna will be faithfully reproduced on a smaller scale at the receiver. In other words, to all intents and purposes we may consider the antenna current at the transmitter to be a carrier current since any variation in its value will be accompanied by similar variation at the radio receiving set.

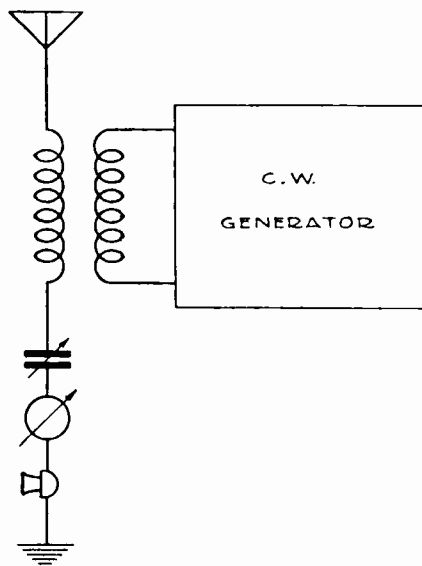

FIG. 150. A Simple Way of Modulating a CW Carrier.

The simplest way to vary the antenna current is to insert the microphone directly in the antenna circuit as shown in figure 150. Since the antenna current must necessarily pass through the microphone, its value will be determined to a certain extent by the microphone resistance. A sound wave impinging on the microphone diaphragm changes the microphone resistance and thus produces modulation of the antenna current.

The electrical phenomena may be represented graphically as in the case of the land telephone. Figure 151 illustrates how the antenna current is made to vary as the resistance of the microphone changes due to an impinging sound wave. It will be noticed that amplitude of the carrier current is symmetrical both above and below the zero line; the reason for this lies in the fact

that both the positive and negative halves of the r.f. cycle are affected alike by the changes in microphone resistance. Figure 151a illustrates the condition of 50% modulation while figure 151b is that for 100%.

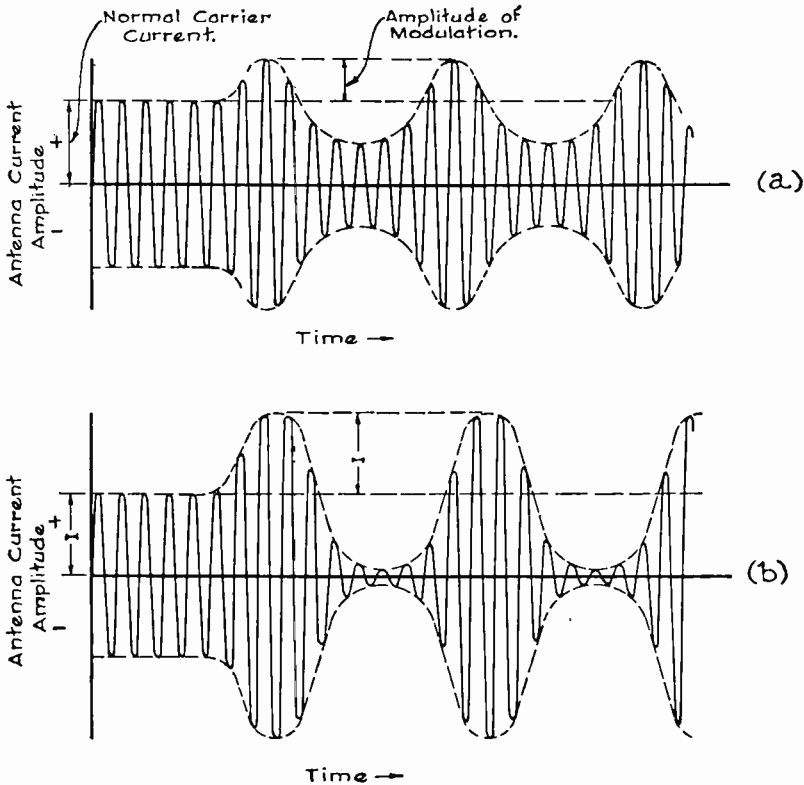

FIG. 151. Graphs Showing Modulation of a CW Carrier Current.

The scheme of modulation illustrated in figure 150 is sometimes called the absorption system because the antenna current is modulated by absorbing from it an amount of power which varies with the speech input to the microphone. Two modifications of this scheme, shown in figure 152, are in common use. The circuit change consists in coupling the microphone to the antenna instead

of placing it directly in series with the antenna circuit. In figure 152a the coupling is conductive while in figure 152b it is inductive. Such an arrangement provides improved operation because matching of the microphone resistance to the antenna resistance is made possible, whereas in the series connection of figure 150 this adjustment is impossible. The proper coupling is ascertained experimentally, by listening to the transmitter with a radio receiver. The scheme shown in figure 152b is widely used by amateurs

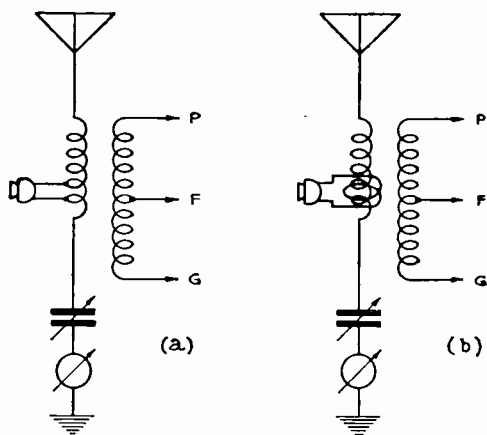

FIG. 152. Connections for Absorption Modulation.

for modulating low power CW telegraph transmitters and is popularly known as the absorption loop method of modulation. The microphone is placed in series with a few turns of insulated wire which are closely coupled to the antenna inductance. When speaking into the microphone the resistance of the loop circuit is varied and energy is absorbed from the antenna at speech frequency. The percentage of modulation obtainable is of a low order. The scheme is limited to transmitters of small power output because of heating of the microphone due to the absorbed power.

3. Classification of Modulation Systems—The absorption scheme of modulation is a poor one when viewed from the electrical efficiency standpoint because it operates on the power output of the CW generator. This mode of operation can be compared to a loaded dc generator whose output voltage is varied by changing the value of a resistance in series with the generator armature.

A better way to accomplish the same thing would be to operate on one of the factors which governs the magnitude of the generated voltage, for instance, the armature speed of rotation or the magnetic field strength. In the case of CW generator using an oscillating vacuum tube, the antenna current (and hence the power output) can be varied by changing any of the following factors: (1) the filament voltage; (2) the grid bias voltage; (3) the d.c. plate voltage; (4) the grid excitation voltage. Of these four factors only the last three are of practical interest. These form the basis of two general systems of modulation, namely: grid bias modulation and plate modulation.

4. Grid Bias Modulation—A practical example of a grid bias modulation is the so-called Logwood circuit illustrated in figure 153. The oscillating tube uses the conventional series feed

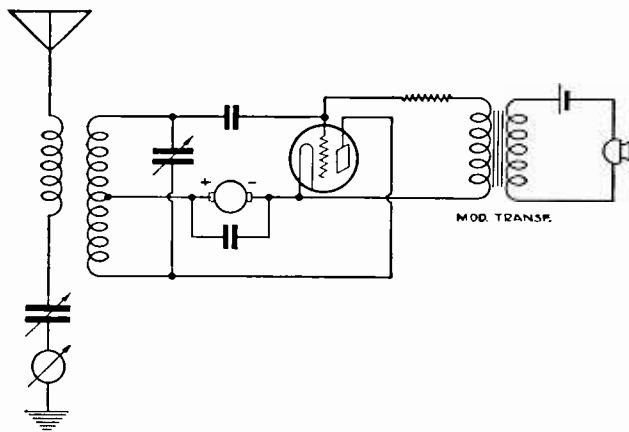

FIG. 153. Schematic Diagram Showing Practical Application of Grid Bias Modulation System.

Hartley circuit. The tube generates its own bias by means of the grid condenser and grid leak; the rectified grid current in flowing through the grid leak producing the necessary bias voltage. In series with the grid leak is the secondary of a transformer, the primary of which includes a microphone and battery. When the microphone is spoken into, an audio frequency voltage is induced across the secondary of the microphone transformer which alternately adds to and subtracts from the generated grid bias voltage. This audio frequency variation of the grid bias results in corre-

spending changes in amplitude of the antenna current and thus accomplishing modulation. The system is not capable of deep modulation because the tube has a tendency to stop oscillating at those periods when the grid bias is excessively negative, for example, when the audio frequency voltage is momentarily negative and hence increases the bias voltage above its normal amount. By careful adjustment of the grid leak and the load on the tube a fair percentage of modulation may be obtained. Because of the necessary care in adjustment and the fact that antenna current does not change proportionately with changes in grid bias under conditions of deep modulation, this system of modulation is not in popular use.

5. **Plate Modulation**—Figure 154 illustrates one of the forms of plate modulation. In this case the secondary of the micro-

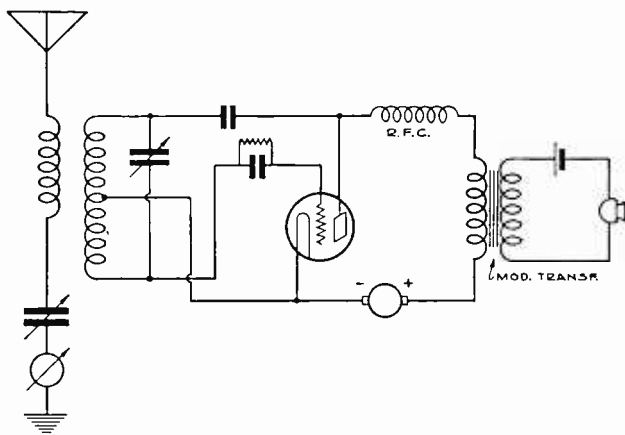

FIG. 154. Schematic Circuit Showing the Simplest Form of Plate Modulation.

phone transformer is placed in series with the plate supply generator. The audio frequency voltage which is induced in the secondary winding when speaking into the microphone alternately increases and decreases the plate voltage. Since the antenna current is practically proportional to the plate voltage at all times, modulation of the antenna current is accomplished.

The circuit diagram shown in figure 154 is practical only for lower power work, 5 watts at the most. The limitation lies in the fact that when the microphone transformer voltage adds to the

plate supply voltage the microphone circuit must supply power to plate circuit of the oscillating tube. Since the audio frequency power which the microphone circuit is capable of furnishing is extremely small, some form of power amplifier is necessary when employing plate modulation in conjunction with a high power oscillator. A suitable circuit which accomplishes this is illustrated in figure 155. The audio frequency voltage induced across

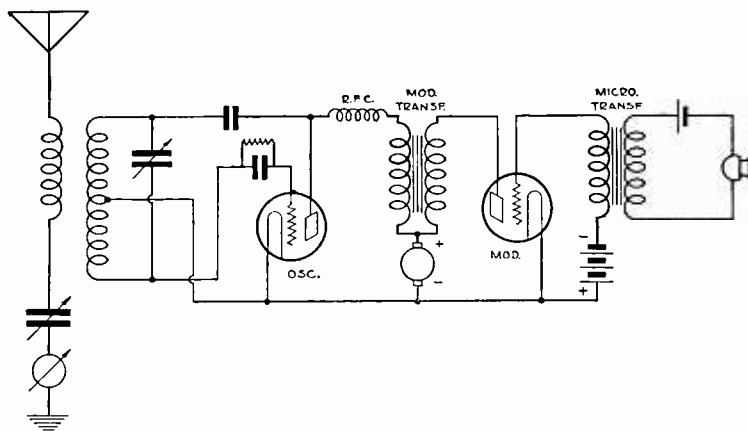

FIG. 155. Schematic Circuit Diagram Showing Plate Modulation in Which an Audio Amplifier or Modulator is Used.

the secondary of the microphone transformer is impressed across the grid circuit of a power amplifier, which is popularly called the modulator. The plate voltage for this tube, as shown, is obtained from the same generator that supplies the oscillator tube. The audio frequency voltage that is generated in the plate circuit of the modulator is transferred to the plate circuit of the oscillator by means of the modulation transformer.

Instead of using transformer coupling between the oscillator and modulator tube, impedance coupling may be employed as illustrated in figure 156. The coupling impedance in this circuit is commonly called the modulation choke coil. In adjusting this particular circuit it should be borne in mind that the modulator is simply a power amplifier that is feeding the plate circuit of the oscillator tube. Since for maximum power output the external impedance of a power amplifier should be equal to its internal impedance, it is evident that for best operation the plate current to both oscillator and modulator should be equal.

The circuit arrangement of figure 156 is popularly known as the Heising or constant current system of modulation. However, it must be distinctly understood that the Heising system falls under

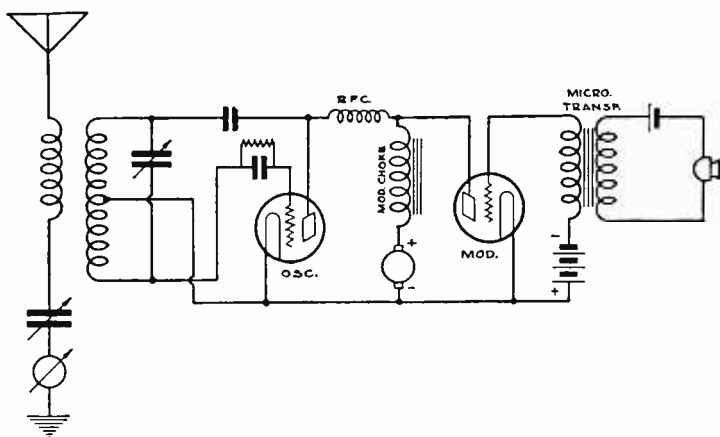

FIG. 156. Schematic Diagram Showing the Heising System of Plate Modulation.

the classification of plate modulation. A common version of the electrical phenomena which takes place during modulation in this particular circuit is as follows: Referring to figure 157, the bat-

*ILLUSTRATION OF TRANSFER OF ENERGY BETWEEN
MODULATOR AND OSCILLATOR TUBES IN A CONSTANT
CURRENT SYSTEM OF MODULATION*

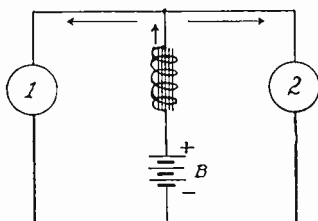

FIG. 157. Illustration of Transfer of Energy between Modulator and Oscillator Tubes in a Constant Current System of Modulation.

tery *B* furnishes current to both the oscillator and modulator tubes 1 and 2. The iron core inductance comprising the modulation

choke keeps the sum of these two currents constant. Under normal conditions, when no modulation is taking place the resistance of the modulator tube is equal to that of the oscillator tube so that the total current flowing through the choke divides equally between the two tubes. During modulation, when the resistance of the modulator is reduced due to a momentary lowering of the negative potential on its grid, the modulator current will increase. At the same time the oscillator current must decrease since the sum of the oscillator and modulator currents is kept constant by the choke. On the other hand, when the resistance of the modulator is increased because of a momentary increase in its grid potential, the modulator plate current will decrease. At the same time the oscillator plate current must necessarily increase because the sum of the two currents is kept constant. The variations in plate current of the oscillator results in similar variations of the antenna current thus accomplishing modulation.

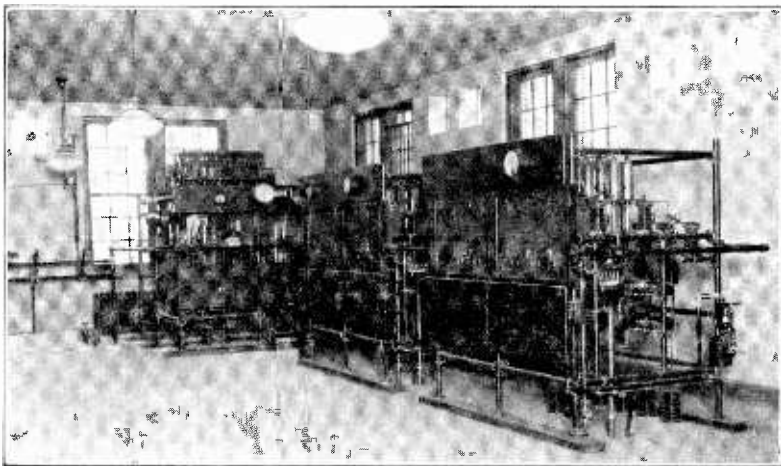

FIG. 158. 50-KW. Oscillators and Constant Current Modulators (WJZ).

6. Plate Modulated Oscillator with r.f. Amplifier—Should more antenna power be desired the oscillator and modulator may be made larger or else the output of a small plate-modulated oscillator may be amplified by means of an r.f. amplifier. The two

systems will be compared later. The circuit shown in figure 159 illustrates a practical form of this system.

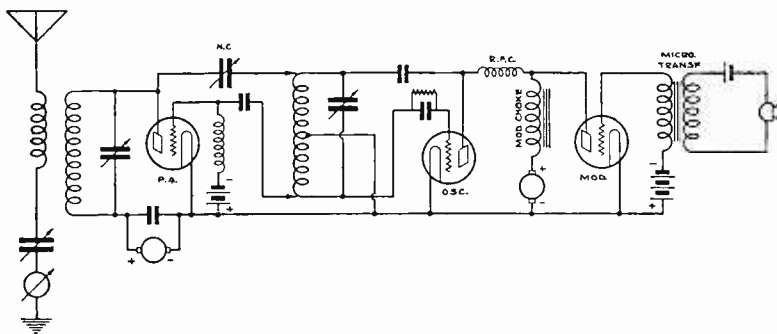

FIG. 159. Schematic Circuit Showing Plate Modulation System with Radio Frequency Amplifier.

The power amplifier obtains its exciting voltage from a self-oscillating tube which acts as a master oscillator. This master oscillator is plate modulated by using the Heising system of modulation. Upon speaking into microphone the tank circuit current and voltage of the master oscillator is varied "in an audio frequency manner" exactly as in figure 155. This modulated r.f. is faithfully repeated by the power amplifier and fed to the antenna at a higher power level.

7. Low Power and High Power Modulation—The plate system of modulation was explained by considering the modulator tube to be operating on the plate circuit of an oscillator tube. Plate modulation may also be used in a master oscillator-power amplifier circuit by modulating the plate circuit of the power amplifier. A practical circuiting arrangement is shown in figure 160. Comparing figure 159 to figure 160, it will be noticed that aside from the addition of the power amplifier the only change is that of transferring the modulator tube and its associated modulation choke coil from the plate circuit of the oscillating tube to the plate circuit of the r.f. power amplifier.

In the case of figure 160 the modulator operates on plate circuit of the power amplifier, the master oscillator not being modulated.

In the case of figure 159 the modulator operates on the plate circuit of master oscillator, the power amplifier receiving a modulated exciting voltage from the master oscillator. Plate modulation is

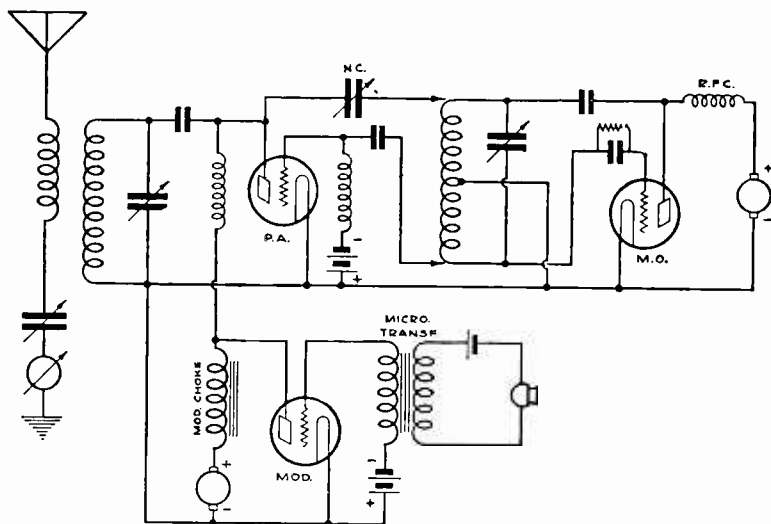

FIG. 160. Schematic Circuit Diagram Showing Plate Modulation of the RF Power Amplifier.

used in both cases but the application is different. In order to distinguish between these two circuit arrangements the terms high power (high level) and low power (low level) modulation have been recently introduced. A high power modulation circuit is one in which modulation occurs in the tube that is coupled to the antenna. A low power modulation circuit is one in which modulation occurs in any tube, other than the one feeding the antenna. Figure 161 illustrates the difference between the circuit arrangements by means of box diagrams.

An attempt to draw a critical comparison between high power and low power modulating circuits would make a long story and only a brief discussion of the high points will be summarized. From the standpoint of power conversion efficiency, based on power input to power output of a complete transmitter, the two systems are about equal. The low power modulation system has a greater factor of safety in regards to the operating conditions

imposed upon the power amplifier tube or tubes; the plate voltage is never greater than that continuously applied. In high power modulation the plate voltage necessarily varies during the modulating process and is twice the normal value when 100% modulation of carrier exists. Such an operating condition is liable to cause tube failure due to voltage breakdown. It is less difficult to obtain good transmission of all audio frequencies in low power than in high power modulation. On the other hand, it is much easier to adjust a high power modulated circuit than a low power one. In this country both types of circuits enjoy about equal popularity, although lately there is a decided trend toward low power modulation as exemplified by the Western Electric Company's radio telephone transmitters.

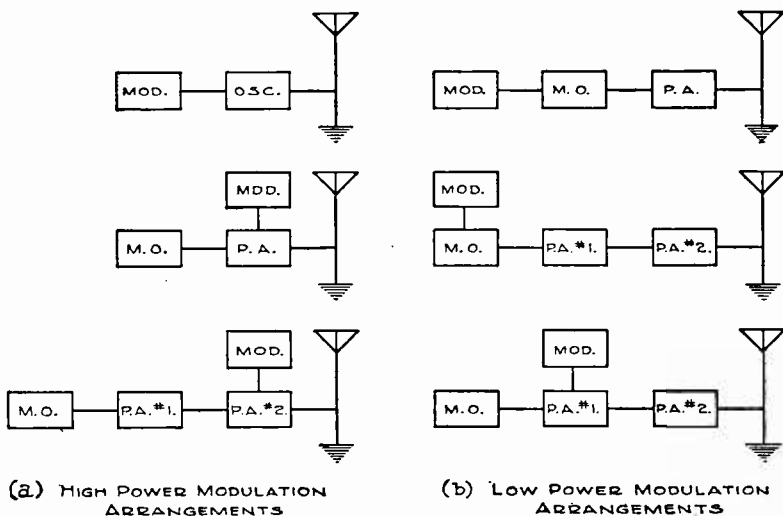

FIG. 161. Box Diagram Showing Difference in High Power and Low Power Modulation.

Relative Number of Modulator and Oscillator Tubes—It has been pointed out that when using plate modulation, the most desirable operating condition is obtained when the modulator tube works into an impedance equal to its plate impedance, in other words, the modulator current should be about equal to the plate

current of the tube being modulated. For purposes of discussion let it be assumed that the tube being modulated is a power amplifier. Since both modulator and power amplifier are working under the same plate voltage and plate current, the power furnished to the plate circuits of both tubes are equal. Normally, the power supplied to the modulator must be dissipated in the form of heat at the plate of the tube. In the case of the power amplifier only a fraction of the supplied power is dissipated in the form of heat, the remainder is delivered to the antenna in the form of radio frequency energy. Since the efficiency of a properly adjusted power amplifier is about 65% it is evident that only about one third of the power supplied to the power amplifier appears in the form of heat at its plate, the other two thirds being radiated from the antenna, or dissipated in the tank circuit. If but one modulator and one power amplifier are being used, this is equivalent to stating that three times as much power must be dissipated at the modulator as at the power amplifier. Therefore, if similar tubes are used there should be at least three modulator tubes to each power amplifier tube if the latter is to be worked at its full rated power. The efficiency of a self-oscillating tube is in general slightly less than that of a power amplifier and it may be possible to obtain satisfactory operation using two modulators.

8. 100% Modulation—Methods of obtaining 100% modulation are of interest from the standpoint of transmission efficiency since this mode of operation makes full use of available high frequency carrier current. Even with 100% modulation of the carrier only one-third of the total high frequency power is transmitted in the form of useful modulation, the other two-thirds being transmitted in the carrier. When the modulation has a value of 50%—quite a reasonably high value for good telephony—the useful power is only one-ninth of the total power radiated. In other words, an increase in modulation from 50 to 100% is equivalent to a three fold increase in radiated power.

The necessary condition for obtaining 100% modulation in the plate modulation system requires that the plate voltage of the tube being modulated be varied from zero to twice the normal value. The antenna current during modulation will therefore also vary from zero to twice its normal value since it is proportional to the plate voltage. The plate current on the tube being modulated will also go through these variations since its value is proportional to the plate voltage. As a result it is necessary for the plate cur-

rent of the modulator tube to go through a similar variation though in the inverse order, that is, when current on the tube being modulated is twice its normal value the modulator plate current will be zero and vice versa. This mode of operation introduces serious distortion and is therefore not used in high quality circuits. Probably the best way to avoid the difficulty is by using a higher plate voltage on the modulator tube than on the tube being modulated. There are several ways of accomplishing this end, for example, by using a separate plate supply in series with the plate lead to the modulator or using two entirely separate plate generators for both modulator and the tube being modulated, the plate circuits being coupled by means of a transformer. Possibly the most practical form of applying the modification, from the standpoint of economy, is to use a single common plate supply and to lower the plate voltage of the tube being modulated by means of series resistor in its plate circuit. Two possible arrangements of the idea are illustrated in figure 162a and 162b. The value of the resistor R is so chosen that the plate current of the tube being modulated, in flowing through the resistor, produces a voltage drop of about 15 to 20% of the normal plate voltage. Since it is not desired to have the same drop in the audio frequency output of the modulator the bypass condenser C is used to feed the audio frequency voltages from modulator plate to amplifier plate without making them go through the resistor R . The capacity of con-

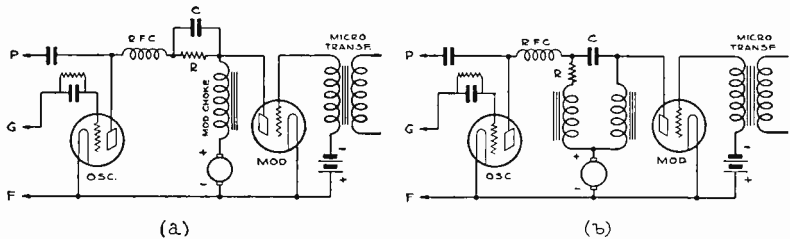

FIG. 162. Schematic Circuit Diagram Showing Two Means of Obtaining 100% Modulation.

denser C should be large enough so that its reactance is low in comparison to the resistance of resistor R at the low audio frequencies to be transmitted. For high quality transmission its value will be of the order of 4 microfarads. The arrangement of

figure 162a is the most practical arrangement in adapting 100% modulation to a transmitter using the ordinary plate modulation system since it is only necessary to add a condenser and resistor. The modification of figure 162b is more elaborate since the customary Heising choke coil is replaced by two others, one of which carries current to the modulator whereas the other carries current to the tube being modulated. This arrangement is advantageous since it is usually easier to construct suitable choke coils of low current carrying capacity than those of high current carrying capacity. It is possible to wind both coils on a single core and by properly choosing the direction of winding to balance out any magnetic saturation of the iron core due to the flow of direct current. However, this type of construction is not yet in general use in this country.

The diagram of figure 163 illustrates a portion of the schematic

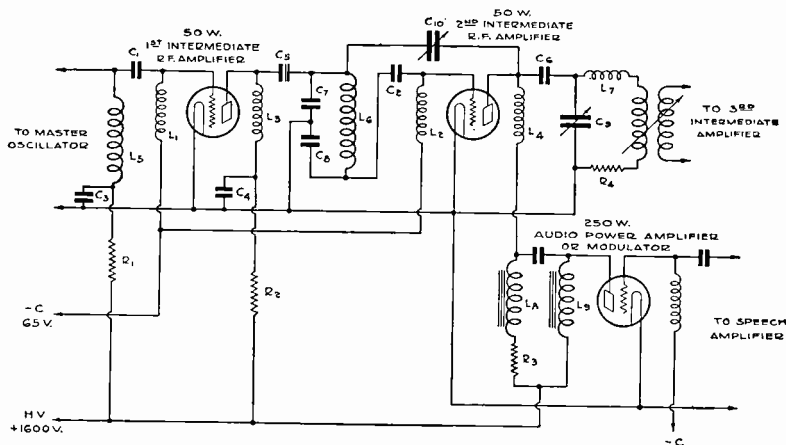

FIG. 163. Schematic Diagram Showing 100% Modulation System Used in a Western Electric Transmitter.

diagram of a Western Electric Company's 5 KW telephone transmitter Type 105-C and is introduced at this point for the purpose of showing a commercial application of the arrangement for obtaining percentage of modulation approaching 100%. The circuit falls under the low power modulation classification because the modulator tube works into the plate circuit of the second intermediate amplifier. The modulated r.f. current is amplified by

the third intermediate amplifier. The second intermediate amplifier is plate modulated by the audio power amplifier or modulator. Deep modulation, approaching 100%, is obtained in this stage by using the double choke arrangement of figure 162*b*. A single 250-watt tube is used in the modulator to modulate the 50-watt second intermediate amplifier tube instead of using two or three tubes of the 50-watt size. This design provides a wide margin of safety in regards to heat dissipation in the modulator and permits operation of the second intermediate amplifier at its full power output and plate voltage rating. If 50-watt tubes were used in the modulator, it would be necessary to operate the intermediate amplifier at a plate voltage below normal and would thus limit the power output to a value lower than the rating. The purpose of the other circuit components is as follows: The r.f. grid chokes L_1 and L_2 serve to keep r.f. currents from backing down into bias supply. The r.f. plate chokes L_3 and L_4 serve a similar duty for the plate supply. Condensers C_1 and C_2 are grid isolating condensers and are used for the purpose of keeping the bias voltage from being applied to the tank circuit inductances L_5 and L_6 . Condensers C_3 and C_4 are by-pass condensers. Condensers C_5 and C_6 are plate blocking condensers. The condensers C_7 and C_8 serve as the tank tuning condensers for the tank circuit of the first intermediate r.f. amplifier. C_9 serves a similar duty for the tank circuit of the second intermediate r.f. amplifier, the tank inductance being L_7 . C_{10} is the neutralizing condenser for the second r.f. amplifier. The resistances R_1 , R_2 , and R_3 are used for the purpose of reducing the plate supply voltage of 1600 volts to 1000 volts, the rated value for the 50 watt tubes. The iron core chokes L_8 and L_9 , together with the condenser C and resistor R_3 form the circuit modification for obtaining deep modulation. The resistance R_4 serves as a loading resistance for the tank circuit of the second r.f. amplifier. Its function is to provide a high constant load so that the additional load imposed by the third r.f. amplifier, due to increase in its grid current during modulation, will not cause distortion. This artificial loading of the tube is essential because distortionless plate modulation can only be obtained under constant load conditions. By making the variable load (produced by variation in grid current during modulation) small in comparison to an artificial fixed load, satisfactory operation is obtained.

9. Frequency Modulation—In all of the modulating systems described in the preceding paragraphs the signal was impressed upon the antenna current by varying its normal value in accordance with the frequency and intensity of the signal. In other words,

modulation was accomplished by varying the amplitude of the carrier current. This method of modulation is therefore often referred to as amplitude modulation. It is also possible to accomplish modulation by keeping the amplitude of the carrier current constant but varying the carrier current frequency. In order to distinguish this form of modulation from the usual amplitude modulating systems, the term frequency modulation has been introduced. A CW telegraph transmitter in which the dots and dashes are sent out by interrupting the antenna current can be classified under amplitude modulation since the signal is being transmitted by varying the amplitude of the antenna current. On the other hand, a CW transmitter using a compensated keying scheme would fall under the classification of frequency modulation since the signal is transmitted by periodically varying the frequency of the antenna current.

A practical circuit arrangement for transmitting an audio frequency signal by means of frequency modulation is illustrated in figure 164. The audio signal is amplified and applied to an

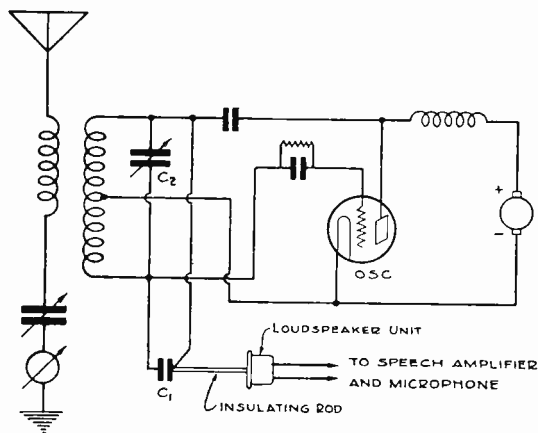

FIG. 164. A Simple Arrangement for Accomplishing Frequency Modulation.

ordinary loudspeaker unit the vibrations of the armature being transmitted to one plate of a small condenser by means of an insulating rod. The variation of the spacing between the plates of the condenser C changes its capacity at an audio frequency

corresponding to the sound wave striking the microphone diaphragm. Since C forms a part of the tank circuit capacity of the oscillating tube, the emitted frequency will vary in accordance with the applied sound wave.

Frequency modulation may also be applied to crystal controlled transmitters. It is a well-known fact that the frequency of a crystal is dependent to a certain degree upon the electrode spacing of the crystal holder. By varying the electrode spacing at an audio frequency rate it is possible to accomplish frequency modulation. A practical circuit arrangement is illustrated in figure 165. In this case the armature of the loudspeaker unit is fastened to

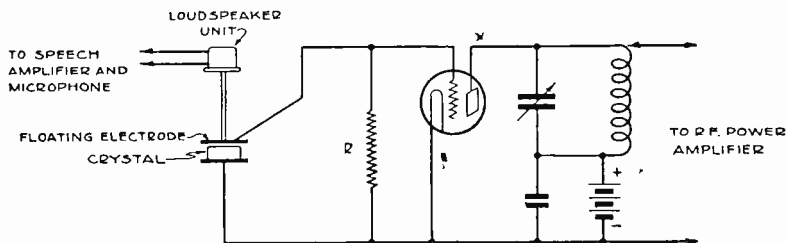

FIG. 165. Schematic Diagram of Arrangement for Producing Frequency Modulation of a Crystal Oscillator.

the upper or floating electrode of the crystal holder by means of an insulating rod. During modulation the position of the upper electrode moves in the vertical plane at an audio frequency rate corresponding to the sound wave striking the microphone.

Reception of frequency modulated signals compared to the reception of amplitude modulated signals differs chiefly in regards to the detection of the signal itself. The ordinary vacuum tube detector is a voltage operated device, and demodulation of an amplitude modulated carrier is only made possible because the carrier voltage varies. The voltage of a frequency modulated carrier is constant in value and since the vacuum tube detector is a voltage device demodulation is not possible unless some arrangement is made for converting the frequency fluctuations into voltage variations. A sharply tuned resonant circuit is capable of performing this function, the efficiency of conversion being depending upon the sharpness of tuning. It would seem that any ordinary receiver would therefore be suitable for receiving frequency modulated signals since a tuned circuit is usually asso-

ciated with the detector tube. Such is the case, providing, the circuit tunes sharply as in a regenerative receiver adjusted close to the point of regeneration or a receiver employing a number of radio frequency amplifying stages preceding the detector tube. A crystal detector receiver would work very inefficiently because of its broad tuning. In adjusting a receiver for the reception of frequency modulated signals it is essential to tune a trifle off resonance from the normal carrier frequency otherwise the efficiency of conversion from frequency modulation to amplitude modulation is poor. If adjusted exactly to resonance considerable distortion will be present.

10. Instability of Carrier Frequency—Whenever the plate voltage of a self-oscillating tube is changed there is an appreciable change in the generated frequency due primarily to the change in the plate impedance of the tube. This condition may be aggravated by a poor choice of circuit constants as for example, a high L/C ratio in the tank circuit. It is therefore evident that any self-excited tube that is being plate modulated will shift in frequency during the modulation process. The variation in the frequency of the carrier will be most severe during deep modulation at which time the plate voltage is being changed over wide limits. The wobbling or rapid shifting of the carrier frequency constitutes a form of distortion and is termed "frequency wobulation" or dynamic instability. A transmitter suffering from dynamic instability can be identified in most cases by its broad interfering wave which is oftentimes noticeable even though the modulation be slight.

In order to prevent dynamic instability it is essential that modulation take place in some tube other than the one determining the carrier frequency. This requirement indicates the necessity of master oscillator power-amplifier circuits for use in high quality transmitters. Modulation of such circuits is accomplished by working the modulator in conjunction with one of the RF power amplifiers. Even in this type of circuit it has been found undesirable to modulate the RF power amplifier immediately following the master oscillator because of reaction between the modulated power amplifier on the master oscillator causing dynamic instability. This reaction may be caused by stray magnetic coupling between amplifier and oscillator, by improper neutralization of the amplifier or by audio frequency variations which act by changing the voltages in the oscillator circuit. In modern practice these effects are minimized by using a separate power source for

the oscillator and by following it with one or two stages of screen grid amplification to act as "buffer stages."

11. Side Bands—In any system of modulation, the modulation process is accompanied by the production of new frequencies other than the carrier frequency but having a definite relationship to it. These additional frequencies are called side frequencies for an obvious reason. In amplitude modulation, where a single audio frequency is being transmitted, two side frequencies are produced one of which has a higher value than the carrier while the other has a lower value. In order to distinguish between these two, the first is called the upper side frequency and the second the lower side frequency. The upper side frequency can be calculated by taking the numerical sum of the carrier frequency and the audio frequencies that is being transmitted; the lower side frequency is determined by taking the difference. For example, if the carrier frequency is 1000 kc and the audio frequency 1 kc, the upper and lower side frequencies would be 1001 and 999 kc respectively.

In frequency modulation, there is theoretically an infinite number of side frequencies produced. These side frequencies can be calculated by considering the single audio frequency being transmitted as having an infinite number of harmonics. For example, the upper side frequencies for a 1000 kc carrier and a 1 kc audio frequency would be 1001, 1002, 1003, etc. The lower side frequencies would be 999, 998, 997, etc. The production of so many side frequencies puts a definite limit to the usefulness of frequency modulation because of interference with stations transmitting on carrier frequencies not far different from the frequency modulated station.

During the transmission of speech or music, the audio frequency varies from instant to instant, in fact, several frequencies may be present at the same time. This of course means that the side frequencies vary in value after the same fashion. The frequency space occupied by these side frequencies is called a side band. Accordingly, we have what are called the upper and lower side bands.

12. Single Button Microphone—A typical microphone as employed in the ordinary house telephone is shown in figure 166. The front and rear electrodes, the granular carbon and mica washer which is associated with the front electrode are all mounted in a cup, the mica washer being clamped in position and fastened rigidly to the front electrode leaving this electrode free to vibrate.

The rear electrode is fastened rigidly to the bridge. The granular carbon is placed between the front and rear electrode so as to be in contact with both. The carbon chamber is never completely filled. The diaphragm is fastened directly to the stud of the front electrode, and is held in position by two damping springs. These springs are also to prevent the diaphragm from vibrating at its natural period, instead of at the periodicity of the sound-waves striking it.

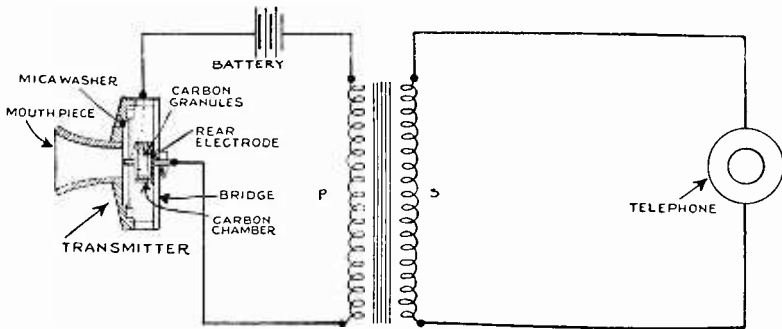

FIG. 166. Details of Telephone Transmitter Circuit.

Operation of Microphone—The operation of the microphone is as follows: Normally the current flows from battery to the front electrode through the granular carbon to the rear electrode, and back to the other side of the battery. (See figure 166.) This circuit has a certain resistance. When the microphone is spoken into or sound waves otherwise created, the diaphragm will vibrate, the pressure on the carbon granules will change and the resistance of the microphone will vary thereby causing a current to flow in the local transmitter circuit.

13. Double Button Microphone—The carbon type of transmitter employed in radio broadcasting studios differs somewhat in construction from that described, but the principle of operation is the same. In ordinary conversation it is only necessary for the telephone microphone to convert from sound vibrations into electrical impulses with frequencies ranging from 200 to 2,000 cycles per second, whereas the studio microphone must convert all the voice and musical frequencies ranging from 16 to 7,000 cycles per second. Such a microphone is shown in figure 167.

This type of microphone is employed with Western Electric Broadcasting equipment and is known by its trade name as "West-

ern Electric No. 373 W. Transmitter." It is of the double button carbon type, the diaphragm of which is of duraluminum .002 of an

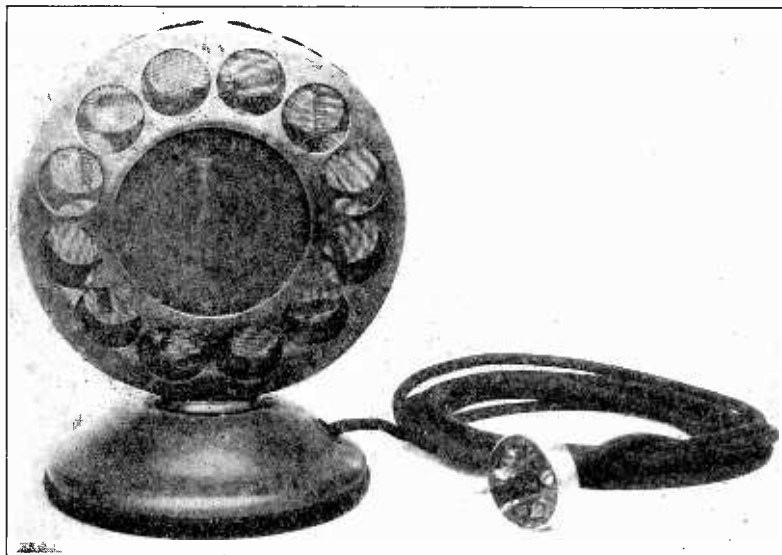

FIG. 167. Western Electric No. 373-W Transmitter (Double-Button).

inch thick and is so stretched and dampened that its frequency response curve is flat from about 1,000 to 6,000 cycles. On each side of the diaphragm is a gold plated area against which the carbon rests. The carbon is held in place by means of a felt ring separated .003 of an inch from the diaphragm and as the smallest carbon granules are about .005 of an inch in diameter they stay in place. As the sound waves strike the diaphragm they compress the carbon in one button and loosen it in the other, thereby changing its resistance. By the arrangement of the push-pull action, distortion is minimized and the output increased.

The microphone circuit is shown in figure 150. The current through each button is regulated by the potentiometer in shunt to the 12-volt battery. It is essential that the resistance of each button is balanced, otherwise the output will be distorted.

One disadvantage of the carbon microphone is the hiss produced by the carbon itself when current is flowing through it.

14. Condenser Type of Microphone—The condenser type of microphone makes use of the principle of a variable capacity actuated by sound waves. It consists of two plates having an air dielectric. One plate of the condenser is usually a steel plug while the other plate, which is the diaphragm, is made of duraluminum of approximately .0018 of an inch thick. The diaphragm is stretched nearly to its elastic limit in order to make its resonant frequency above audibility. The plug and diaphragm are separated about .0015 of an inch.

Usually a change of approximately 200 volts is maintained on the condenser by means of a battery. When the sound waves strike the diaphragm and cause it to vibrate the electrical capacity of the condenser is varied which in turn changes the voltage applied to the grid of the amplifying tube.

15. Description of Western Electric Condenser Transmitter (known as No. 394-W Transmitter with No. 47 or 48 Amplifier)—Construction of the Transmitter—The transmitter consists essentially of a very thin duralumin diaphragm tightly stretched in front of a perfectly flat plate and spaced from it only .001 of an inch. The outside air is excluded from the space between the diaphragm and the plate and effects from variations in atmospheric pressure are taken care of by a compensating diaphragm at the rear of the plate. One side of the compensating diaphragm is in contact with the outside air while the other side through holes in the plate is in contact with the space between the plate and diaphragm. The latter will compensate for a variation in pressure of approximately 3 inches of mercury either side of normal pressure at sea level.

This highly desirable feature and the fact that the diaphragm is not required to motivate resistance varying material results in consistently high quality reproduction at all times.

The Condenser Transmitter (known as No. 394-W Transmitter with No. 47 or No. 48 Amplifier) will respond to frequencies of from 40 to 6000 cycles with practically uniform efficiency. This means that no appreciable distortion is introduced. The transmitter is equally effective in any location because of the fact that its high quality performance is not affected by changes in barometric or climatic conditions except as already stated or unless the temperature is below 20 degrees Fahrenheit.

16. Construction of the Amplifier—The amplifier is especially designed for the function it is to perform in relation to the transmitter. A transmitter operating with a minimum of inherent noise and no distortion requires that the first stage of

amplification possess these same characteristics. Incidentally it may be stated that the first stage of amplification is the most important because the output is amplified less and less in the stages subsequent to the first.

Application of this principle has been made in designing the No. 47 and No. 48 type Amplifiers, with every quality characteristics and practically free from tube and amplifier noises. The vacuum tube used (Western Electric No. 239-A) is also designed to reduce tube noises to a minimum.

All the component parts of the amplifier are mounted within a cylindrical or a square case, depending upon the design of the instrument as a whole. There must be available a six-volt battery to furnish filament current for the vacuum tube and a source of two hundred volts DC to furnish a polarizing potential for the transmitter and the plate voltage for the vacuum tube.

17. The Magnetic Microphone—A magnetic microphone is one in which the impinging sound wave causes generation of an audio frequency voltage in a coil or conductor placed in a magnetic circuit or field. An ordinary telephone receiver may be made to act as a magnetic microphone. A sound wave impinging upon the soft iron diaphragm causes it to vibrate and thus vary the reluctance of the magnetic circuit. This action results in a variation of the number of magnetic lines of force threading the telephone windings. The variation of magnetic flux induces a voltage in the telephone windings, the frequency and amplitude of this voltage conforming with the impinging sound wave.

Any loudspeaker, whether of the electromagnetic or moving coil type, may also be used as a microphone. In the electromagnetic type the action is sensibly the same as in the ordinary telephone receiver. In the moving coil type of speaker (popularly called the dynamic speaker) the sound wave causes motion of the moving coil by the action of the sound wave on the speaker cone to which the moving coil is rigidly fastened. An audio frequency voltage is induced in the moving coil due to the coil cutting the existent magnetic field of the field magnet.

In general, loudspeakers do not make good microphones because they are not designed for the purpose. A popular form of magnetic microphone used in England has a small coil fastened rigidly to a flexible stretched diaphragm similar to that used in the double button carbon microphone. The coil is placed in a permanent magnetic field so as to cut magnetic lines of force when it is set in motion. The impinging sound wave causes the dia-

phragm and its associated coil to vibrate, thus producing an audio frequency voltage.

18. Operation of Carbon Microphones—There are certain terms used in the operation of carbon microphones to describe conditions peculiar to this type of microphone. Burning is a rapid, transitory, and usually irregular resistance fluctuation occurring in the microphone. It is evidenced by a frying or sputtering noise frequently heard on some radio stations. Breathing is a slow and for the most part a periodic variation in the microphone resistance. It may be of a relatively large magnitude and is not in general audible. Packing is a condition caused by excess mechanical pressure between points of contact or by adherence between points of contact resulting from excess voltages. It is evidenced by decreased resistance and sensitivity of the microphone. A form of packing may also be caused by excessively loud musical passages. This form of packing is called blasting.

19. Speech Amplifier—The feeble currents produced in the microphone circuit are not sufficiently powerful to modulate the radio frequency energy generated by the radio transmitter, therefore, a speech input amplifier must be interposed between the

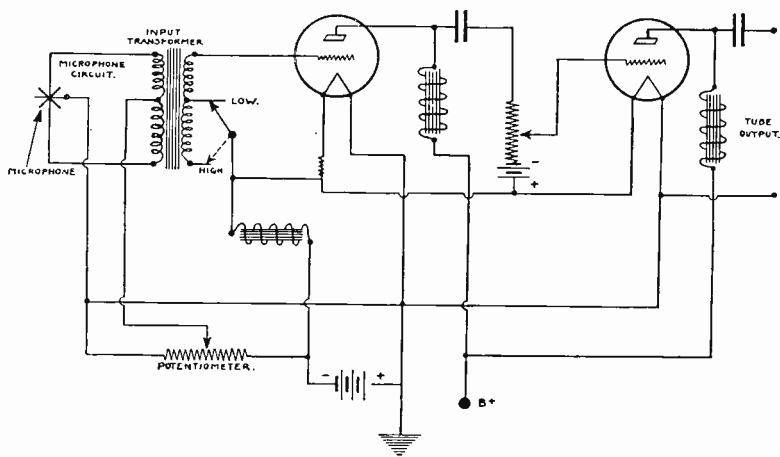

FIG. 168. Schematic Microphone and Speech Amplifier Circuit.

microphone and transmitter. This amplifier takes power in the form of direct current from batteries and converts it into alternating currents of speech and musical frequencies which produce

the form of the microphone currents exactly, but which are sufficiently increased in amplitude to be of service in controlling the radio transmitter. The schematic of such an amplifying arrangement is shown in figure 168.

10. Definition of Transmission Unit—In the transmission of electrical energy which is eventually converted into sound, it becomes necessary to have a measuring unit which bears a relation to the sensitivity of the human ear. Telephone engineers have worked out such a unit known as the transmission unit (T.U.).¹

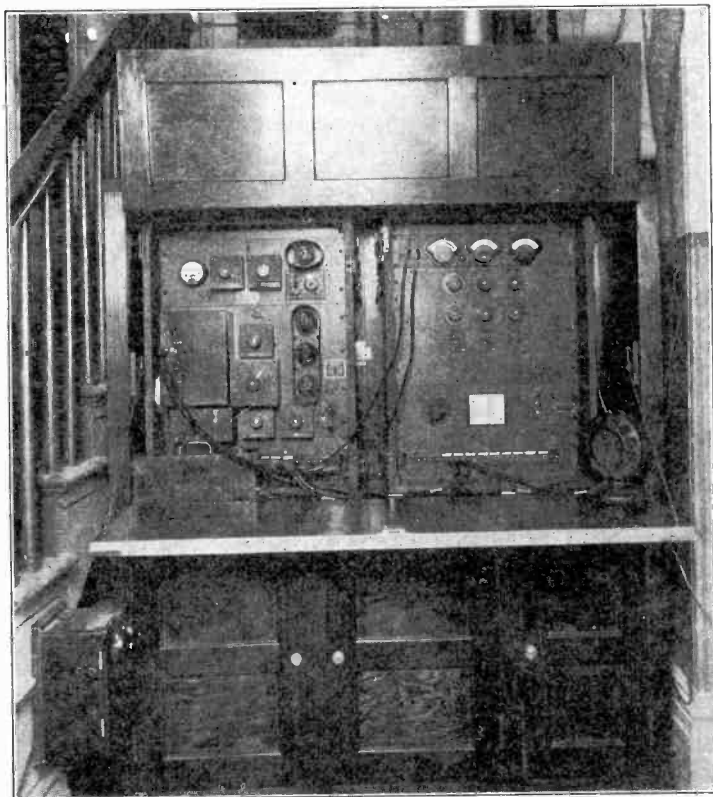

FIG. 169. Portable Pick-Up Apparatus Employed in Broadcasting.

¹ The new name for the Transmission Unit is to be known as the Decibel, abbreviated "DB." The prefix Deci signifies tenth. The new name honors Alexander Graham Bell. It was adopted at the assembly of Interna-

It is possible for the ear to just distinguish the difference between two powers that differ in intensity by one T.U.

Consider two audio frequency amplifiers whose power output is 800 and 1,000 milliwatts, respectively. It would appear from these figures that the amplifier of 1,000 milliwatts would give a considerable increase in volume over that of the 800 milliwatts amplifier. However, this would not be so as the difference between the two amplifiers could hardly be detected by the ear. Referring to the formula of T.U. the ratio of the two powers is:

$$\frac{1000 \text{ Milliwatts}}{800} \text{ or } 1.25 \text{ to } 1.$$

Consulting a table of logarithms to base 10 it will be found that the common logarithm is 0.097. Substituting in the formula for T.U.

$$\begin{aligned} \text{T.U.} &= 10 \times .097, \\ \text{T.U.} &= .97. \end{aligned}$$

Therefore, the difference being less than one T.U. no perceptible difference will be detected in the two amplifiers.

21. Volume Indicator—The volume indicator is employed as a part of the control apparatus of nearly all broadcasting equipment to indicate the volume level of the program at the output of the speech amplifying apparatus which feeds the modulator tubes. Indication is given by a sensitive galvanometer in the plate circuit of a vacuum tube. The grid of the tube is energized by

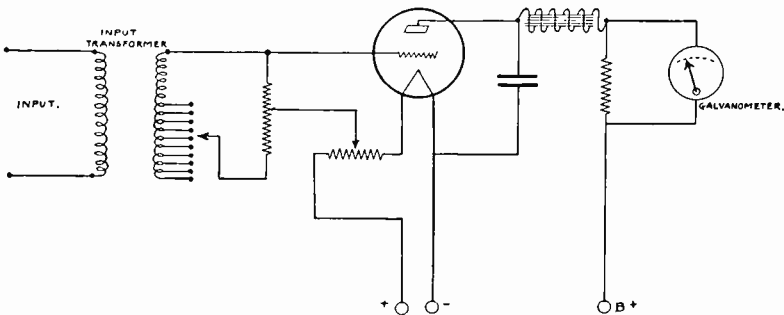

FIG. 170. Schematic of Volume Indicator.

tional Advisory Committee of long distance telephone engineers at Como, Italy.

the output of the speech amplifier. A potentiometer is employed to permit adjustment of the negative grid bias. A level measuring key for large steps and a level measuring switch for small steps connected in the grid circuit are calibrated directly in transmission units from zero level of volume. By adjustment of these keys the volume level at the input can be determined as indicated by a certain deflection of the galvanometer in the plate circuit of the tube. If the volume level is too high as indicated by the T.U. readings the correct adjustment can be made at the speech amplifier until the level is at the value desired.

Other methods of measuring the volume level make use of an a.c. voltmeter transformer coupled to the modulator tubes or a radio frequency pick up of the output which is rectified and coupled to a meter the scale of which is calibrated directly in transmission units.

Equalization of Telephone Lines—When it is desired to pick up a program from a point remote from the radio transmitter certain additional apparatus is necessary such as vacuum tube line amplifiers distributed at certain points in the line connecting the pick up apparatus and radio transmitter.

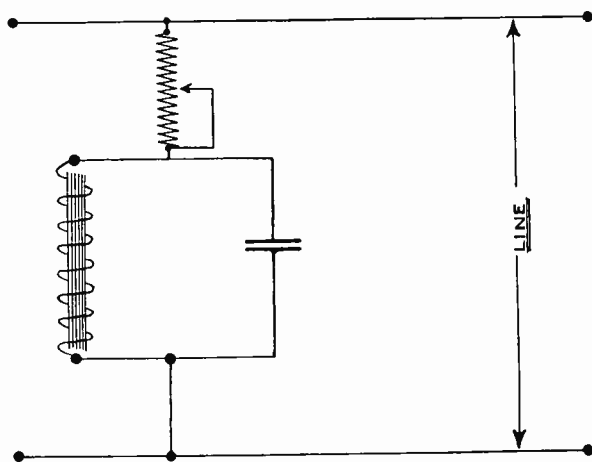

FIG. 171. Schematic of Equalizer.

Telephone lines possess a certain amount of distributed capacity by virtue of the "condenser effect" between the adjacent wires. Obviously the longer the lines the greater will be the capacity of the condenser thus formed. It has been shown that capacity

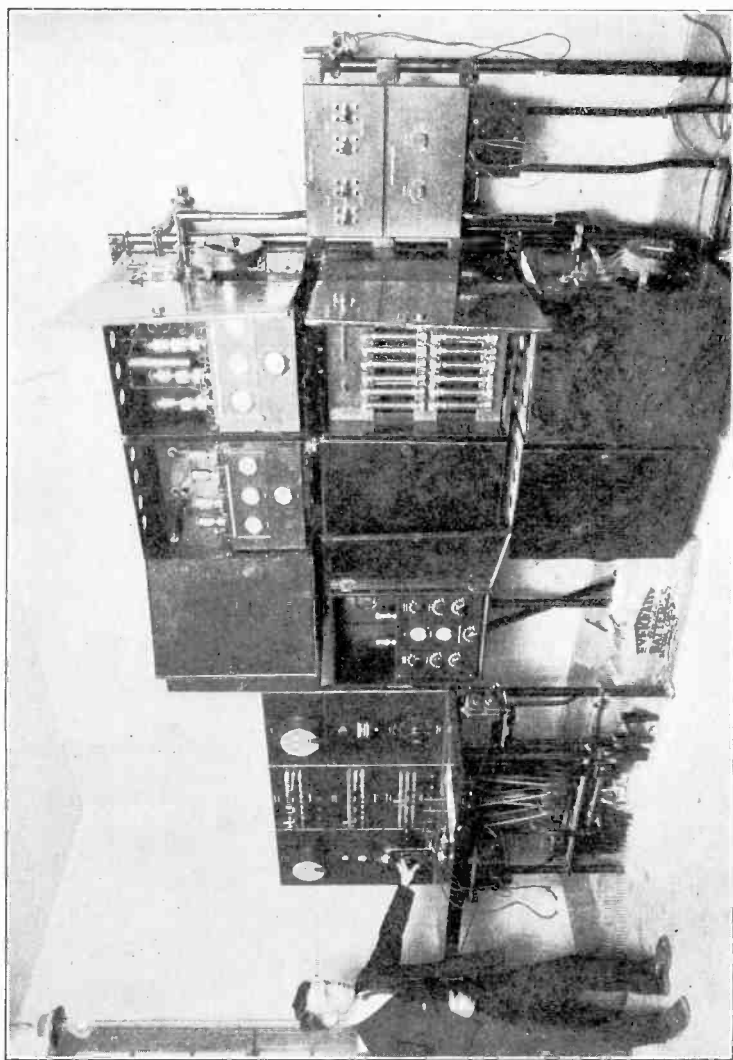

FIG. 172. Line Amplifiers and Equalizers Employed at WJZ, Bound Brook, N. J., to Amplify Program Received by Wire from Studio in New York City.

reactance decreases with increased frequency and capacity, naturally then, when a program is carried over telephone lines the amplitude of the alternating current comprising the voice and musical frequencies will be attenuated and the higher the frequencies and longer the lines, the greater will be the loss or attenuation factor. Unless some means are provided at the transmitter for reducing the low frequencies to a value comparable to that of the high frequencies marked distortion of the program will result as the low frequencies will predominate.

It is possible to correct the frequency characteristics of the line by means of an equalizer. This device is composed of a variable resistance connected in series with a parallel circuit of inductance and capacity and the whole network connected across the line to be equalized as shown in figure 171. The operating characteristics of the equalizer are such that it offers a low impedance path to the low frequencies and a high impedance to the high frequencies. By adjusting the resistance of the circuit it is possible to reduce the low frequencies to the same level as that of the high frequencies received over the line. Since the amount of equalization varies with the length of the line it is evident that each particular line must be treated as an individual case as for instance a short line will require very little equalization, whereas, a long line would require very careful adjustment of the equalizer in order to obtain a flat frequency transmission characteristic. In fact, several equalizing networks are necessary to properly equalize a long line.

Prior to transmitting a program the lines are equalized by sending out a signal of definite frequency and known strength. The level is measured at the receiving end by means of the volume indicator. The process is usually started by transmitting a 100-cycle note and increasing the frequency of the note at intervals of 100 cycles until 5,000 cycles are reached. These signals must be received at a predetermined level and all frequencies should be received with almost equal strength. If any undue loss or gain is experienced at any particular frequency or band of frequencies the same can be corrected by the equalizer. Adjustments are made until a flat characteristic curve is obtained thus ensuring equal transmission of all frequencies throughout the musical range.

Audio frequency amplifier or repeaters are placed at certain places along the circuit in order to boost the signals due to the loss encountered by the d.c. resistance of the line. These amplifiers amplify all frequencies to an equal degree. The amplification or gain of such amplifiers is adjustable and is carefully measured and regulated.

22. Line Pad—When broadcasting from a remote point it may be desirable to have the volume level equal to that when using the studio microphone. The transmitter and amplifiers used at the remote point may boost the level far above that of the studio level in order to have signal above the noise level. It then becomes necessary to insert an artificial line in the circuit having all the characteristic of an actual operating line, thus reducing the level to the value desired. (See figure 173.)

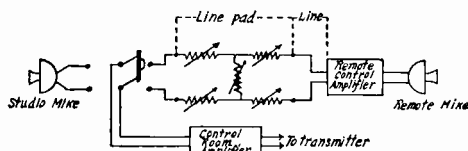

FIG. 173. Schematic Arrangement of Line Pad.

23. Duties of a Broadcast Control Operator—The duties of a control operator are best described by Carl Dreher, Staff Engineer of the National Broadcasting Company in an article entitled "Broadcast Control Operation" appearing in the Proceedings of "The Institute of Radio Engineers," Volume 16, No. 4. The latter part of this article deals particularly with control operating and putting a program on the air and the following text is taken verbatim with due acknowledgment to the source.

"The function of the control operators, whether in the field or at the studio, is partly coördinative, as in connection with inter-studio contact and switching, and partly regulative, in that it is found necessary to compress the natural volume in variation of speech and music, which may be as high in some cases as 60 T.U., into a compass of about 40 T.U., if overloading is to be avoided on the one hand and noise interference on the other. The operator makes up this 20 T.U. difference, in extreme cases, by bringing up his gain control carefully on low passages. Some vocal artists who have adapted their renditions to the requirements of broadcast transmission take care of this themselves by avoiding extreme pianissimos or by swaying back and forth as they sing, approaching the microphone during pianissimo portions and withdrawing during fortissimos. The former procedure may also be followed by orchestras. The rule is for the operator to handle the gain control as little as possible, but to regulate it when necessary to avoid overloading or the loss of low passages. The volume indi-

cator galvanometer should flicker slightly during the peaks of low passages and rise to the maximum of 30-40 scale divisions during the loudest intervals. Gain regulation must be confined to one place, which is logically at the point of control nearest the origin of the program. The field operator therefore assumes the function of changing the level when necessary, in the case of field program, the studio operator in the case of studio programs, and the transmitter operator only in the event of serious line irregularities or careless operation which may endanger the radiation of the program at his end.

With regard to the placing of performers in the studio for the best musical balance there is some difference of opinion as to the proper arrangements. In general the non-technical studio staff wishes to place the musicians conveniently (for them) and to move microphones freely. The engineers, on the contrary, prefer a fixed position for the microphones, necessitating the grouping of musicians to secure the best musical balance. On this basis the microphone position is fixed according to the acoustic characteristics of the room. In studios which have not been highly damped it is frequently found that standing waves set up at certain frequencies between reflecting surfaces manifest themselves in their various interferences as rattling sounds following an initial impulse. It is possible, by placing a small rug on the floor near a wall drape, to form a space relatively free from such acoustic disturbances, in which the microphone will pick up a program with greater freedom from disturbing transients and distortions in reproduction. This amounts to stating that optimum microphone placing is a function of the studio characteristics and should be left to the judgment of the electro-acoustic experts, not to that of musicians, who, as a class are lacking in scientific qualifications. Musical balance then becomes a problem in placing instruments with reference to the fixed microphones and standardizing on the best positions. This responsibility may devolve on a musician especially delegated to the task, or on the announcer if he has musical training, or on a committee of musicians and musically-experienced technical men capable of listening critically and objectively to loud speaker reproduction. It is often helpful to allow the conductor of an orchestra to listen, during rehearsals, to the monitoring reproduction, either while his men play without him or under the baton of an assistant. The questions of orchestral balance involve many factors of musical taste, imagination, individual auditory characteristics, and imponderables, which make agreement difficult at best. The problems involved are complex

and their full discussion would require a separate paper on the acoustic and musical principles underlying them.

In a broadcast station all program matters are laid out beforehand and printed schedules detailing the artists, announcers and announcements, selections, timing, and studio arrangements are distributed to all personnel concerned. The chances of a slip-up are further reduced by the fact that all program "features" are carefully rehearsed and timed beforehand. While this system does not contribute to spontaneity it has been found the only means of running off a complicated program with dispatch and reliability, especially in chain broadcasting. The function of the operating personnel, under such arrangements, is reduced, save in emergencies, to following routine previously established.

Communication between studios is maintained by means of telephone systems. The operator in the control room associated with each studio, and seated within sight through a double-glass window, is in touch with the other studio by means of a breast transmitter and single head-band receiver. He is thus in a position to converse with the other operator while continuing to monitor the program going out through his own studio. It is his duty to keep the other operator informed of the progress of the program and to warn him some minutes before a change from one studio to the other is due. Generally head-receiver facilities for listening to the program in another studio are also provided for the announcers, and in the more intricate set-ups of chain broadcasting it is necessary to devise complicated systems of mechanical switching whereby the announcer picks up his station on visual signal from the control room, by pressing buttons which actuate telephone relays and make the necessary circuit changes, which are, however, supervised by the operators, who sit before similar control boxes and are in a position to correct switching errors made by the announcers.

The preliminary procedure of field broadcasting gives a good idea of the precautions taken to prevent breaks in program continuity. Generally two broadcast pairs are provided, in addition to an order pair for speech communication only. The routine is as follows:

1. The field operator, having set up his microphones and amplifier, calls in on the order pair one hour before program time and talks to the control operator at the station.
2. The field operator tests all microphones by talking into them with the central operator listening.
3. The field operator sends test talk or preliminary program material over both regular and emergency broadcast circuits.

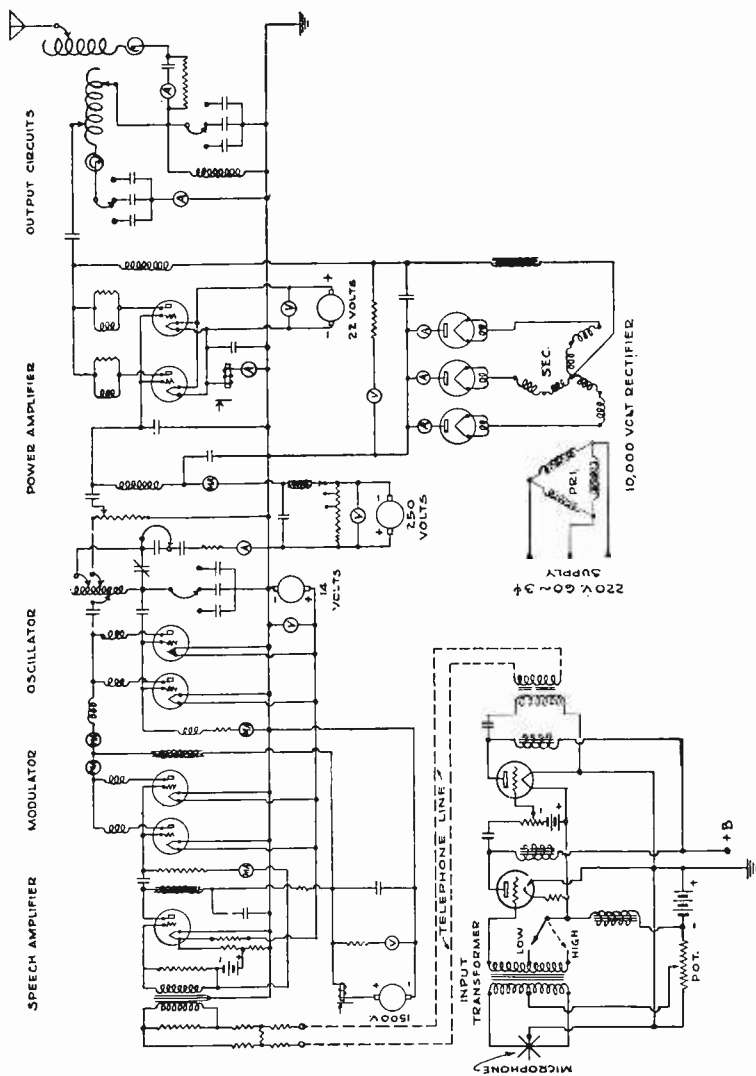

FIG. 174. Diagram of Western Electric 5-A Transmitter. (This Diagram is accepted for the U. S. Department of Commerce Examination for Broadcast Grade of Operator's License. The Schematic Circuit of Western Electric Receiving Outfit Type 6004-C should be shown with it. See Chapter 12, fig. 248.)

4. The station operator raises the gain of his amplifier 20 T.U. and listens closely for cross-talk from the order wire in his monitoring speaker, if this is available, while the field operator talks on the order wire, the input to the field amplifier having been cut off.

5. The field operator synchronizes his watch with the station operator, who takes time from a master clock system.

6. Ten minutes before program time the field operator sends room noise or preliminary program to the station for check of continuity of the broadcast circuit. This is kept on to within two minutes of program time.

7. At program time the field operator is told over the order wire, "Take it away" ["It" referring to the program] immediately after the broadcast trunk has been connected to the station amplifier input. He gives the signal to his announcer, who is generally within reach of a hand signal, and the remote program starts. Communication is then maintained throughout the program by the two operators for the purpose of criticism of quality and the affecting of any necessary changes.

All such circuits have been previously equalized (as previously described) by means of an audio oscillator sending out tones at a known frequency and level, with an amplifier and volume indicator showing the levels received at the station end.

In chain broadcasting similar procedures are followed, the principal difference being that contact between the originating station and the chain is maintained by telegraph. The originating station controls procedure entirely, since obviously with a multiplicity of stations receiving a program unity can be secured only by such a system. The method of making local announcements has been described previously. The fifteen-second intervals in the program left for the announcements are indicated to the chain stations by telegraph a sufficient time before each pre-arranged gap. The individual stations then cut the line input to their amplifiers and turn over to their local microphones, scurrying back to the chain before the fifteen seconds are up. Test tones are sent out by the head station to the network and the volume indicator readings at the points of reception telegraphed back to the key station, give a necessary check on wire conditions, possible need of re-routing circuits, etc. All the problems of high-quality telephony, as well as specialized broadcasting procedures, are involved. After each program the syndicate stations wire in reports as to technical quality, entertainment value, and the like."

CHAPTER 7

WAVEMETERS, PIEZO-ELECTRIC OSCILLATORS, WAVETRAPS AND FIELD STRENGTH MEASURING APPARATUS

1. **Wavemeters**—The wavemeter or frequency meter is a device employed to measure the length or frequency of radio waves either at their source or at a receiving station remote from the transmitter. It is sometimes constructed so as to be used as a transmitter of feeble intensity emitting electro-magnetic waves of a known length or frequency. In this way it can be used to calibrate a radio receiver. Other uses of a wavemeter are to measure the inductance of a coil, the capacity of a condenser, the fundamental wavelength of an antenna, or the decrement of waves radiated by an antenna.

Construction—A wavemeter is a calibrated closed oscillatory circuit, having inductance and capacity, either or both of which are variable. The general circuit diagram of a wavemeter is shown in figure 165, which consists of a fixed inductance L , and a variable condenser C . Usually there are several inductance coils which may be substituted for one another, thus giving the meter a large wavelength range. A resonance indicating device is usually included with the other elements of the circuit.

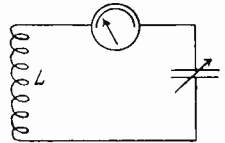

FIG. 165. General Wavemeter Circuit.

Requirements—The fundamental requirements of such a meter are that it is capable of maintaining its calibration over a considerable period of time. This requires a minimum of variation in the inductance of the coils and in the capacity of the condenser for any particular setting. The general construction must be such that the parts and wiring will not become displaced. It must have low resistance in order to obtain rapidly changing deflections of the resonance indicating device with small changes of condenser adjustment. The resistance is kept low by employing a variable condenser of good design and using inductance coils with sufficiently large wire properly spaced.

Variable Condenser—In order that the capacity of the var-

iable condenser remain constant for any particular dial setting special attention must be given to its construction. The plates should be of sufficiently heavy material so that they will not become bent, and they must be rigidly supported. A condenser giving close spacing between the fixed and moving plates is undesirable because a slight shifting in the position of the rotating shaft will produce an appreciable change in capacity. The bearings must have large wearing surface so designed that there is no end play in the shaft. The dial must be secured to the shaft in such a manner that there is no possibility of loosening. A pigtail connection to the rotary plates is essential preferably with insulated flexible wire. If bare wire is used the calibration is liable to error caused by the turns of the pigtail touching each other as the rotary plates are turned. The condenser should have unimpeded rotation through 360 degrees as the use of stops is likely to shift the position of the rotary plates.

The dial of the wavemeter condenser is usually of metal having engraved over one-half of its circumference evenly spaced divisions which divide the dial into 100 equal parts or into 180 degrees. In order to secure precision the dial readings are arranged so that a reading to one-tenth of a division of the dial is possible. This is accomplished by a vernier scale.

Theory—It has already been explained that when oscillations are set up in a circuit and if another oscillatory circuit is placed so that they have mutual induction the first circuit will transfer energy to the second. If the frequency of oscillation of the latter circuit is the same as that of the first or driving circuit considerable transfer of energy will take place and if a current indicating device is included in the second circuit it will show a maximum deflection. As the frequency of the second circuit is decreased above or below the frequency of the driving circuit the deflection of the current indicating device will fall off.

If the second oscillatory circuit containing the current indicating device is provided with a graduated scale as previously described the wavelength or frequency of oscillations may be read directly from the scale or by consulting a calibration curve, the reading being taken at exact resonance. When such a device is calibrated in wavelengths it is called a wavemeter and when calibrated in frequency a frequency meter.

Expressing the capacity of the wavemeter condenser at resonance in microfarads and the inductance of microhenries, as is commonly convenient, the fundamental wavemeter equation giving the wavelength in meters is:

$$\lambda = 1884\sqrt{LC}.$$

2. Measuring the Wavelength of a Transmitting Set—For the purpose of measuring the wavelength of a transmitting set, the wavemeter is usually fitted with a current indicating device such as a hot-wire ammeter, thermo-couple galvanometer or wattmeter, d.c. milliammeter and crystal rectifier, neon tube, flashlight bulb or with crystal rectifier and telephone receiver.

The various circuits are shown in figure 170. In operation the wavemeter is coupled loosely to the transmitting set and the ca-

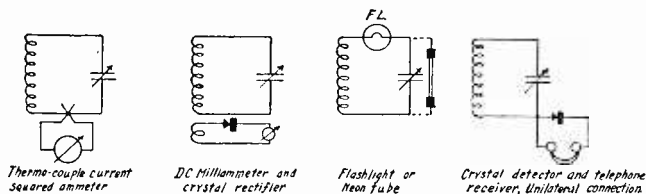

FIG. 176. Methods of Connecting Resonance Indicating Devices in Wavemeters.

capacity of the wavemeter condenser rotated until resonance is indicated by maximum indication of the current indicating device, that is, maximum deflection of hot-wire ammeter or galvanometer or milliammeter, maximum brightness of neon tube or flashlight bulb or maximum sound in the telephone receiver. The latter method is called measurement by means of maximum audibility. It will be noted that the crystal detector in this method is connected unilaterally. Sufficient energy is supplied to actuate the telephone receiver and the method has the advantage that the decrement of the wavemeter circuit is kept low, permitting sharp tuning and permits accurate calibration as the crystal detector and phone are not in the oscillatory circuit.

3. Use of Piezo Oscillator to Check Frequency of Transmitter—The use of the piezo oscillator is very useful and satisfactory to check the frequency of a transmitter, especially that of a broadcasting station, where the penalty for deviation from the assigned frequency by more than 500 cycles is sufficient to warrant cancellation of the station license.

When properly designed such a device delivers a particularly constant frequency and is unaffected by fluctuations in the station's power or degree of modulation.

4. Location—A convenient location is chosen for the oscillator in the operating room whereby frequency adjustments can be made to the transmitter while listening in with headphones. If

the piezo oscillator is too close to the source of power, its operation may be unsteady as evidenced by fluctuations of the needle of the milliammeter. If too far away, a beat note of satisfactory intensity will not be obtained.

5. Operation—When first placing the piezo oscillator in operation it is well to adjust the transmitter to the approximate assigned frequency with a wavemeter. This will ensure that the beat note obtained is that of the fundamental frequency and not by fractional harmonics.

After making the approximate adjustment of the transmitter with the wavemeter the rheostat of the piezo oscillator should be turned on. If the quartz crystal starts oscillating a beat frequency

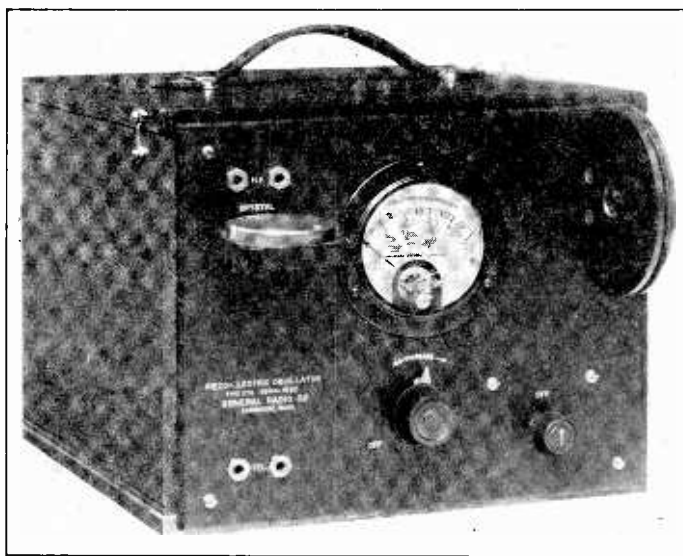

FIG. 177. General Radio Piezo-Electric Oscillator.

may be noticed caused by the interaction of the two frequencies. The frequency of the transmitter is then varied until a zero beat is produced; that is, the condition where the beat is no longer audible in the headphones of the piezo oscillator but reappears when the frequency of the transmitter is increased or decreased slightly. Zero beat is an indication that the transmitter is oscil-

lating exactly at the same frequency as the piezo oscillator. The operator should listen in at intervals to ascertain that the condition of zero beat is being maintained and also see that the piezo oscillator is generating. Otherwise, it may appear that a zero beat adjustment is being maintained when actually the frequency of the transmitter has shifted.

6. Failure of Piezo Oscillator to Generate—

1. Defective or discharged batteries.
2. Reversed polarity of batteries.
3. Defective tube.
4. Quartz plate sticking in holder. Overcome by shaking or tapping holder slightly.

7. Care—The quartz plate and holder should not be opened. The plate and holder should be used in the same position in which they were when the device was calibrated. Reversing the position may cause a slight change in frequency.

8. Wave Traps—Wave traps may be employed in conjunction with a radio receiver in order to eliminate an undesirable signal. When used with receivers at the transmitting plant of broadcasting stations they are tuned to offer a high impedance to the transmitter frequency and a low impedance to the frequency it is desired to receive, such as 500 kilocycles, the frequency employed in marine channels on which signals of distress are transmitted. Radio fans who experience interference from a local broadcasting station may employ one to advantage in order to eliminate the interfering signal.

Wave trap circuits may be divided into three classes, namely, rejector, acceptor and by-pass filter circuits.

The rejector circuit opposes the interfering signal, the acceptor circuit extracts energy from the interfering signal and prevents it getting to the receiver while the by-pass circuit offers it a path of low impedance to earth.

9. The Rejector Circuit—The rejector circuit takes two forms known as the shunt rejector and the series rejector. The most powerful of all wave traps is the shunt rejector as shown in figure 178. The shunt rejector prevents signals both above and below the wavelength to which it is tuned from being received. It is properly constructed with a large capacity and low loss inductance of few turns, the value of capacity predominating in the tuned circuit. The series rejector is shown in figure 179, and rejects the signals to which it is tuned from being received. The series rejector circuit is employed to advantage to eliminate signals from a local broadcasting station which might otherwise pre-

vent reception of other signals. A series rejector wave trap may be constructed by winding approximately 40 to 50 turns of No. 22 S.C.C. wire on a 3-inch form and tuning the same with a .0005 mfd. condenser.

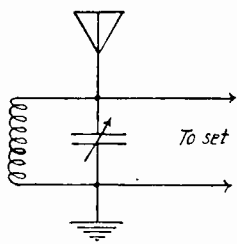

FIG. 178. Shunt Rejector Circuit—Rejects All but One Station.

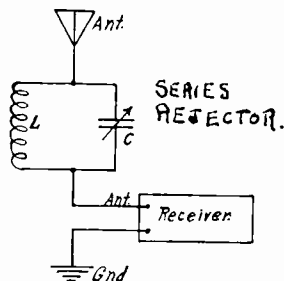

FIG. 179. Series Rejector Circuit—Rejects One Station Only.

When first placing this wave trap in operation the tuning condenser should be set at zero capacity or short-circuited. The receiver should then be tuned until the signal from the station it is desired to eliminate is at a *maximum*. The tuning condenser of the wave trap should then be varied and as the wave trap circuit approaches the frequency of the received signal it will gradually disappear and at exact resonance will be entirely eliminated or weakened so as to cause no interference. The wave trap condenser should be left in this position and the receiver then tuned until other desirable stations are heard. If the so-called "single circuit" receiver is used the tuning on the dials will be somewhat upset, i.e., the station will not come in on the same dial setting as before. Theoretically the rejector circuit has an infinite impedance at its tuned wave when the resistance of the circuit is zero. Therefore, a good grade of condenser and wire no smaller than that stated should be used so as to keep the resistance as low as possible.

10. **The Acceptor Circuit**—The acceptor or absorbing circuit is shown in figure 180. In this arrangement a tuned circuit is coupled to the antenna by a few turns of a coil connected in series with the antenna. The tuned or absorbing circuit is tuned to the wavelength of the interfering station. The energy from the interfering wave is thus extracted and builds up in the tuned circuit

an e.m.f. which opposes that due to the interfering signal and prevents the same from reaching the receiver.

The antenna coil should have no more than 10 turns tapped and wound directly over the tuned circuit inductance which have ap-

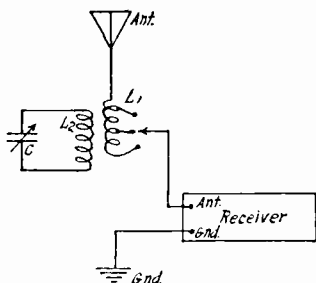

FIG. 180. Acceptor Circuit—Absorbs Energy from Interfering Frequency.

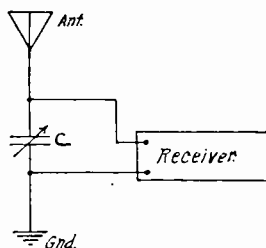

FIG. 181. By-Pass Filter.

proximately 35 turns of number 24 S.C.C. wire on a 3-inch form. The variable condenser should have a capacity at maximum of .005 mfd.

The condenser of the absorbing circuit is tuned until the interfering signal is eliminated, at the same time trying different values of $L1$ until the best filtering action is obtained.

11. The By-Pass Circuit—Referring to figure 181, the condenser C is so arranged as to offer a low reactance to all radio frequency currents and they are consequently by-passed to earth with the exception of the frequency to which the receiver is tuned. The reactance of the tuned receiver to the desired signal is much lower than that of the by-pass condenser; hence it receives a signal rather than the by-pass condenser.

The interfering signal which is different in wavelength is offered a greater impedance by the tuned receiver than the by-pass offers and consequently it is largely shunted to earth and causes no interference. The value of this condenser for ordinary broadcasting wavelengths can best be determined by trial, using a variable .005 mfd. condenser. Some of the incoming desired signal will be by-passed to earth resulting in a diminution in the intensity of this signal, however, the reduction in interference warrants this. A coil of 10 turns of No. 20 S.C.C. wire may be substituted in place of the condenser and will likewise produce excellent results. It

operates essentially on the same principle, i.e., the difference in impedance which it offers to the two incoming signals.

FIELD STRENGTH MEASUREMENTS.

12. Purpose—The measurement of radio field intensity enables one to determine the distribution of the field in various directions from the antenna system of a given transmitting station. In the case of a broadcasting station it shows the service area of broadcasting stations. It also shows the effects produced by locating stations in cities on or near large steel structures and the effects produced by locating stations in the open country away from steel structures or electrical networks. From the results of such measurements one may choose a desirable location for a transmitter in order to serve a certain area. This can be done in conjunction with a portable transmitter and field strength measuring apparatus.

13. Unit of Measurement—There are several different methods and types of apparatus employed in field strength measurements. The universally adopted unit of measurement is "volt per meter." The unit volt per meter is a large one, and for ordinary purposes it is more convenient to use "millivolts per meter" or "microvolts per meter."

Meter-amperes—The regulations of the International Radiotelegraph Convention require that the normal radiated power of a transmitter be expressed in meter-amperes; or lacking this, the height of the antenna and intensity of the current at the base of the antenna.

The expression meter-ampere is the unit of antenna current moment and is found by multiplying the antenna current by the effective height of the antenna in meters. The effective height is generally about 60 per cent of the mean height of the flat top above ground.

14. Derivation of "Millivolt Per Meter"—When oscillations are set up in an antenna there is created an electro-magnetic field surrounding the antenna. This field consists of two distinct parts: First, there is the field of electro-magnetic induction which rapidly dies out and usually cannot be detected at more than a distance of one wavelength or so from the transmitter; second, there is the field due to radiation which represents the energy of wave propagation.

As has been described in the previous chapter, this electro-magnetic field travels with the speed of light. The value of the field

strength at a distance from the transmitter is given by the formula :

$$E = \frac{188 hI}{\lambda r} \text{ millivolts per meter,}$$

where h = effective height of antenna in meters.
 I = current in antenna in amperes.
 λ = wavelength in meters.
 r = distance in kilometers.

The effective height is defined as the height of a vertical single wire having the same amount of current throughout its whole length, and giving the same field strengths at given distances. In the case of a transmitting antenna with one end grounded the current is unevenly distributed being at a maximum at the base and decreasing with height and reaching a minimum at the extremity. By keeping the effective height as high as possible a more even distribution of current is obtained and results in a maximum of radiation and therefore more millivolts per meter at a given distance. From the above the actual field strength from a transmitter at any given distance can be computed, provided there is no absorption of energy nor interference by waves bent back to earth from an ionized layer.

Actually there is absorption of the ground wave and a factor must be introduced depending on the wavelength, and on the nature of the ground and what is on it over which the wave travels. In the case of absorption the radiated energy is conducted to ground and therefore lost as far as being of any practical use is concerned.

A field strength of 1 millivolt per meter means that the potential difference due to the field between two points a meter apart on the same line of electric force is 1 millivolt. Consequently if a 1-kilowatt transmitter has a field strength of 20 millivolts per meter at a distance of five miles and a broadcast receiving antenna is erected having an effective height of 5 meters, there will be 100 millivolts of energy available for the receiver. The more sensitive the receiver, the greater will be the volume delivered by the loud speaker for a given signal strength.

15. Apparatus and Methods of Measurement—As previously mentioned, there are several different methods of measuring the strength of radio signals. Usually, the actual voltage across a given antenna is measured by the substitution method, which consists of substituting for the received signal a known locally-generated signal identical in frequency to the signal and of such magnitude as to produce the same receiver output as that resulting from the received signal. Under these simulated con-

ditions, the known locally-generated e.m.f. is equal to the voltage induced in the antenna by the signal. Usually, a loop antenna is employed with a superheterodyne receiver. The field strength is obtained by dividing the induced voltage by the effective height of the loop. (The effective height of a loop is defined as the height of an equivalent vertical wire having the same induced voltage.)

The magnitude of the locally-generated e.m.f. is usually obtained by passing a known current through a known impedance inserted at the loop center. The known impedance must be non-inductive so as to be independent of frequency and its value kept as small as possible. The minute known currents are obtained by attenuating measurable currents by known amounts through the use of suitable circuits. This system requires separate and thorough shielding between the local oscillator and the attenuating circuit in order to eliminate "pick-up" comparable in signal strength to the small induced voltage.

As shown by Friis and Bruce, in their paper entitled "A radio field-strength measuring system for frequencies up to forty megacycles," Proceedings of Institute of Radio Engineers, Volume 14, August, 1926, considerable advantage is obtained if a voltage of sufficient magnitude measurable by means of a tube voltmeter, is induced into the loop from the local oscillator. In conjunction with this, a voltage attenuator could be located elsewhere in the receiver proper. This would eliminate the undesirable "pick-up" from the local oscillator by the attenuator circuit and minimize the necessity of elaborate shielding of the oscillator.

This paper says, "furthermore, the search for an appropriate location for the voltage attenuator, beyond the loop, revealed the desirability of placing it on the output of the intermediate-frequency detector of a double-detection (super-heterodyne) scheme, with due regard for the limits of overloading of this tube. The importance of this arrangement should be emphasized. It means that the attenuator need operate at only the fixed intermediate frequency. Since this frequency has been selected as 300 kilocycles, great accuracy is possible without elaborate attenuator design, regardless of the signal frequency."

The intermediate frequency detector also serves a tube voltmeter actuating the d.c. plate circuit meter. The gain control or voltage attenuator is calibrated directly in voltage ratios; thus, a reading of 10,000 indicates that the input voltage to the attenuator is 10,000 times larger than the output voltage.

The procedure of operation of the apparatus shown in figure 181a is as follows:

TABLE OF PROCEDURE

- I. The receiving set is tuned to the incoming signal. The attenuator is adjusted until a convenient output deflection is obtained. This deflection is noted.
- II. (1) The local comparison oscillator is started and tuned to resonance with the receiving set.
(2) The attenuator is adjusted to make the output the same as in I.
(3) The input V to the grid of the intermediate frequency detector is determined (beating oscillator is off during this measurement).
- III. (1) The grid of the intermediate frequency detector is connected through L_0 to the local oscillator input as shown in figure above.
(2) The attenuator is readjusted to make output the same as in case I.

From this table we have

Voltage across half of the loop due to incoming signal

$$= \frac{V}{\frac{a_2}{a_1}} \text{ volts.}$$

Loop voltage step-up (the ratio of half of the loop terminal voltage to the induced voltage)

$$= B^* = \frac{a_2}{a}$$

Voltage induced in loop by comparison oscillator

$$= E = \frac{V}{B} \text{ volts.}$$

Voltage induced in loop by incoming signal

$$= \frac{V}{\frac{a_2}{a_1} B}$$

Attenuation Ratio
of Attenuator

a_1

a_2

a_3

As the paper progresses the authors discuss some refinements in the accurate measurement of the voltage set-up B of the loop.

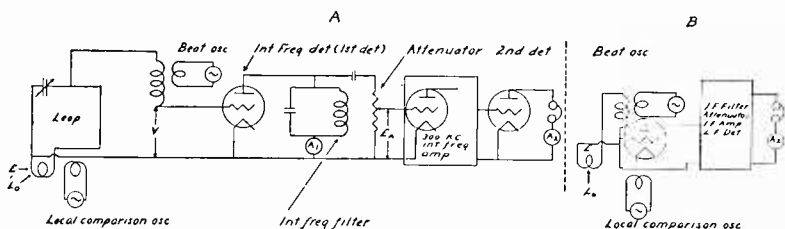

FIG. 181a. Diagram of Field Strength Measuring Apparatus.

* B = magnetic flux density.

It should be noted here that it is entirely unnecessary for the transmitter of the incoming signal to stop while measurements are being made.

CHAPTER 8

MARINE VACUUM TUBE TRANSMITTERS

1. **Introduction**—The radio service on vessels of the American Merchant Marine is carried on generally by radio service companies. These radio companies or corporations have contracts with the different steamship lines which are known as "Service" and "Rental" contracts. A service contract is entered into when the steamship company owns its own apparatus and desires that the radio service company maintain the apparatus, supply the radio operator and handle the abstracting of traffic on radiograms. Costs of major repairs and replacements are billed to the steamship company in addition to a fixed sum per month for the service as indicated above.

If the steamship company does not own any apparatus it may rent the same for so much per month by the means of a rental contract with the radio service company. The latter makes all repairs and replacements to apparatus as well as furnishing an operator, abstracting traffic and inspecting the apparatus on each arrival of the vessel at a large port.

In order to reduce interference to broadcast listeners and expedite traffic on marine radio channels these service companies have modified their apparatus used in mobile service by converting spark transmitters to vacuum tube operation. Meeting with much success from the start has led to the development of a transmitter employing the master oscillator power amplifier system for marine use. With such a transmitter, a steady pure continuous wave may be radiated and copied easily although the vessel may be rolling heavily due to high seas and strong gales.

This chapter deals entirely with such vacuum tube transmitters as manufactured by the General Electric and Westinghouse companies for the Radiomarine Corporation of America and sold or rented by them to different steamship companies.

It is the purpose of the following pages to give the student and operator a complete description of such transmitters as he might expect to find upon being assigned to a ship as radio operator. Several sets of nearly the same type are gone into in detail in order that the operator may use the same as a guide in maintaining

the apparatus in good working order and at the same time to assist him in quickly locating trouble and applying a remedy while at sea.

Short Wave Transmitter, Model ET-3655

1. General Information—This transmitter is intended primarily for marine service and consequently special attention has been paid to the design in order to provide maximum frequency stability under widely varying conditions. The circuit used is of the master oscillator power amplifier type with power amplifier feeding into a Hertzian antenna. ICW signalling is obtained by an audio frequency vacuum tube generator which modulates the carrier frequency of the transmitter.

The tubes required are:

- 1 UX-860 as Master Oscillator.
- 2 UX-860 as Power Amplifiers.
- 1 UX-860 as Audio Oscillator.

The transmitter operates on four wave bands covering the entire range from 23.4 to 150 meters. These bands are as follows:

- 23.4-36.6 Meters.
- 35.1-54 Meters.
- 50-90 Meters.
- 90-150 Meters.

The apparatus can be divided roughly into three parts as follows:

- A. The Radio Unit.
- B. Motor-Generator Set.
- C. Antenna System.

2. The Radio Unit—The radio unit contains everything necessary for taking power from the high voltage dc generator and delivering 200 watts of radio frequency energy to the radio antenna. The equipment necessary to do this is described below, together with the function of each part.

The dimensions of the whole unit are, width 21", depth 22", and height 45".

The frame is of 3/16" brass angle construction with corners re-enforced with gusset plates and brazed. The unit is divided vertically from front to rear by a brass panel extending from top to bottom. It is also divided by horizontal brass partitions into five compartments. These partitions add greatly to the frequency stability of the unit besides shielding the various circuits from each other and from outside inductive effects.

The sides are solid and of non-magnetic material. A spring supporting structure, upon which the base rests, provides resiliency to shock and vibration and permits rigid mounting of the tubes

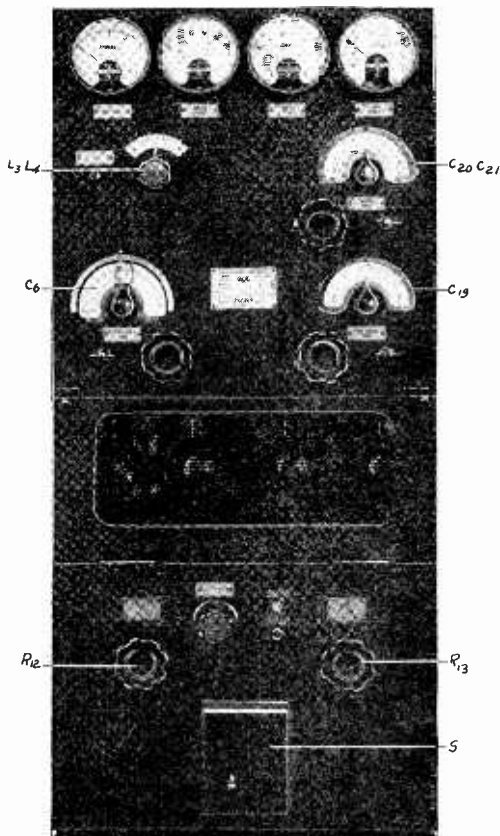

FIG. 182. RCA Short Wave Transmitter, Model ET-3555 (Front View of Radio Panel).

in the frame proper. It also does away with any spring or cushion mounting for the tubes. The connections between electrical components are rigid thus eliminating the possibility of frequency shift due to flexible leads. The front of the unit is a solid brass sheet except the doors which give access to the tubes. These are

perforated to permit observation of all tubes during operation of the set. This panel is finished in black lacquer and has the appearance of leather. All meters, tuning and power controls are mounted on this panel.

The antenna loading control is a five-point switch adjusted by a pointer and knob but all the others are of the back-gear vernier type. The control of the master oscillator is provided with an index scale, whereas the power amplifier and antenna tuning have a pointer without the graduated scale.

In the lower left hand compartment is the audio oscillator circuit consisting of a transformer, a block of three condensers, a signal selector switch, and a tone selector switch. There is also a plate power potentiometer screen grid resistor, keying relay resistor and plate generator field rheostat.

The signal selector switch in the ICW position closes the filament circuit of the audio oscillator tube. In the CW position it opens the filament circuit and also shorts the audio oscillating circuit. The various audio frequencies are obtained by varying the capacities of the audio oscillator circuit. This is accomplished by the three-position tone selector switch. The potentiometer is connected across the high voltage terminals and provides means of obtaining the necessary screen grid bias voltages without the use of separate generators. The audio oscillator tube is located on the same shelf as the master oscillator tube for convenience in tube replacement. It is of the UX-860 type.

The master oscillator circuit, including the two tubes just mentioned, is enclosed in the compartment immediately above the audio oscillator compartment. The arrangement of the various parts is such as to facilitate replacements and adjustments. The tubes are mounted directly back of the door. Above them is the master oscillator tuning condenser and at the rear of the compartment is a tuned circuit inductance coil. The tuning condenser is operated by a control knob mounted on the front of the panel and geared to the condenser by means of a 5 to 1 gear ratio. All the controls, panels, etc., are free from any voltage which might cause injury to the operating personnel. The keying relay, which has high voltage on it, is protected by means of an aluminum case which completely covers it. The complete equipment is protected from serious overloads and burnouts by a high voltage fuse in the base of the transmitter.

The master oscillator tube is of the type UX-860. It is a newly developed four element tube, having a rated plate voltage of 2000.

The circuit used is the conventional Hartley with parallel feed. Since the plate-to-grid capacity of this tube is almost negligible, frequency instability, due to variation in tube capacity, has been practically eliminated. Frequency wobbling also has been reduced

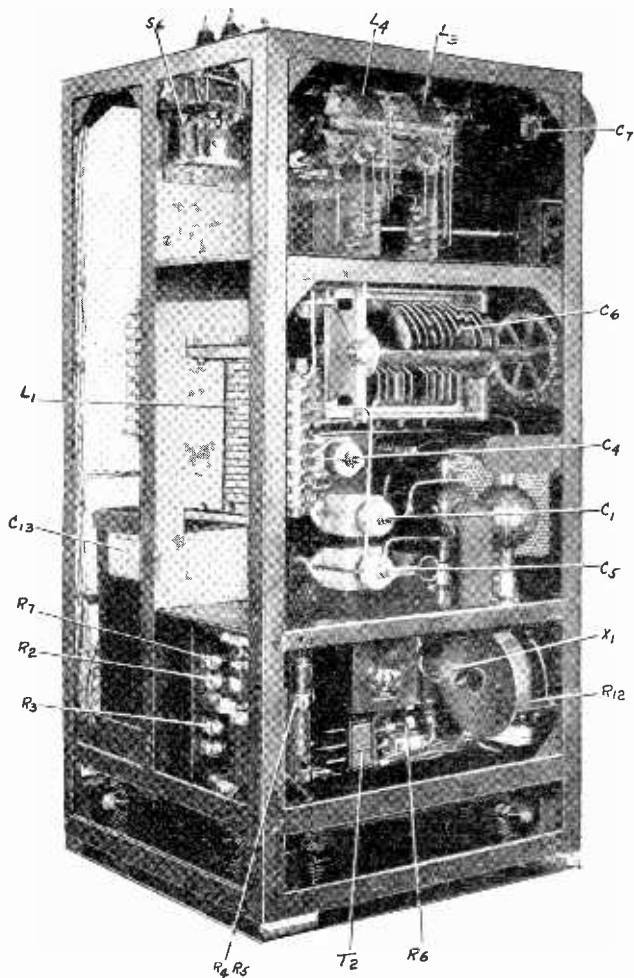

FIG. 183. Interior View of Model ET-3655 Short Wave Transmitter.

to a minimum by using pyrex insulated coils and rigid connecting wires.

The power amplifier circuit and antenna tuning condensers occupy the upper compartment on the right hand side of the frame. This compartment contains two UX-860 tubes, a power amplifier tuned circuit and the two variable antenna tuning condensers mounted on the same shaft and operated together. This equipment is arranged within the compartment so as to produce the minimum electrical coupling between units and is completely shielded against external electrical influences.

The power amplifier tubes are connected in parallel and operate on the fundamental frequency of the master oscillator. The plate to grid capacity of the tubes is very small and neutralization of the power amplifier is unnecessary. Any coupling due to common connections of master oscillator and power amplifier screened grids has been eliminated by a combination of impedance and resistance in series with these elements.

The lower right hand compartment contains a high voltage bypass condenser, high voltage fuse, voltmeter multiplier resistors, filament transformer, with its associated rheostat and the terminal board.

The antenna loading coil, current transformer, antenna change-over relay and two tap switches are mounted in the upper left hand compartment. The antenna loading coil is divided into two sections, the inductance of each section being varied by the tap switches operated simultaneously by a knob on the front of the panel. The two sections are closely coupled to reduce the effect of an unbalance.

3. Motor Generator Set—The motor generator furnished with this outfit is a dc. power set made up of a 2-hp., 110-volt, dc. motor, driving a 1-kw., 2000-volt dc. generator operated at 1750 rpm. The motor is supplied with slip rings from which 200 watts ac. power is obtained for the tube filaments.

4. The Antenna—The antenna used with this set is of the modified horizontal doublet type. For purpose of description, it may be likened to two inverted "L" type antennae with the vertical portions back to back and the horizontal portions extending in opposite directions from the vertical portion. The vertical portion, known as the transmission line, is transposed throughout its entire length to insure minimum radiation in this part of the antenna. (See figure 184.)

To facilitate accuracy in resonance adjustments and to reduce unbalance of the transmission line due to length of leads to antenna ammeter, a current transformer has been provided which is

so placed as to reduce unbalance to minimum and designed so as to give a variable transformation ratio. The steps on the transformer are arranged to give approximately 100%, 75% and 50% of actual measured antenna current.

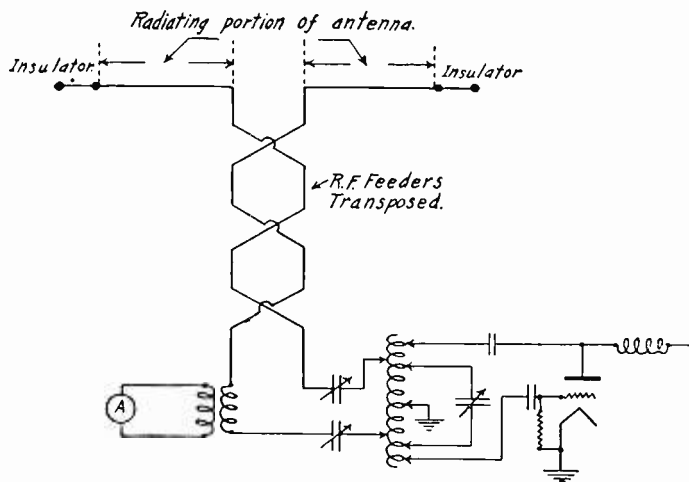

FIG. 184. Hertzian Antenna with Radio Frequency Feed Line.

This transmitter will also operate into a grounded antenna similar to that used on the long wave installations. In this case, it is only necessary to connect the antenna lead to the binding post closest to the front of the transmitter, having the transmitter thoroughly grounded. It probably will be necessary to increase the coupling by moving the antenna tap away from the ground connection on the power amplifier plate coil. When operating into a large antenna, the antenna will be oscillating on a harmonic; and as a result, the antenna current will be low. The tuning adjustments are made exactly the same as when operating into a horizontal doublet antenna.

Two magnetically operated relays are provided in the transmitter, one of which changes the antenna from the transmitter to the receiver, while the other closes the keying circuit. These relays are so interconnected that the keying relay circuit can only be completed when the antenna relay is in the "transmit" position. The antenna relay is placed in the left hand top part of the frame

near the antenna tuning components, whereas the keying relay is mounted on the front panel where it is convenient for inspection.

The keying is accomplished through a keying relay on the front of the panel. When the key is in the open position, a sufficiently high bias is applied to constantly block off the grids on both master oscillator and power amplifier.

In case it is desired to transmit ICW or modulated wave signals, an audio oscillator is provided which changes the tube grid bias at 500, 700, or 1000 cycle rate and hence gives the set an output having a corresponding characteristic tone.

5. Circuits—The master oscillator tuned circuit is made up of the inductance L_1 , the condenser C_6 , the plate coupling condenser C_5 , the grounding condenser C_4 , and the grid coupling condenser C_1 . The oscillator generates its own bias by passing the rectified grid current to ground through the resistor R_1 . The screen grid is by-passed to ground through the condenser C_2 and any radio frequency coupling and due to common screen grid leads is prevented by the combination choke and resistance X_1 and R_2 , and X_3 , R_9 . The filaments are by-passed to ground through the condenser C_3 . Grid bias for the amplifiers is obtained by passing the rectified grid current through the resistor R_8 . The audio oscillator is composed of the transformer T_2 with the three tank capacities C_{10} , C_{11} and C_{12} . The grid is coupled through the condenser C_9 and its bias is self-generated across the grid leak R_7 . The screen grid is by-passed through the condenser C_8 and the screen grid bias is passed through the resistor R_3 . The power amplifier tuned circuit is composed of the inductance L_2 and capacity C_{19} . Plate power is supplied through the choke coil X_4 which prevents the radio frequency voltage from going to ground through the generator. The amplifier screen grids are by-passed by the condenser C_{17} . (See figure 185.)

Keying is accomplished by removing a high negative bias from the grids of all tubes. The grid leads are returned to the negative high voltage. Due to the voltage drop across R_4 there is a negative potential on all grids as long as the key is up. When the key is pressed it operates the keying relay and this shorts out the resistance R_4 , thus removing the high bias and allowing the circuits to oscillate. The capacity C_{22} and resistor R_{11} act as a spark suppressor for the keying relay.

The antenna is coupled conductively by means of clips spaced symmetrically on either side of the ground point on the power amplifier plate inductance L_2 . Tuning the antenna is accomplished by means of the capacities C_{20} and C_{21} and the inductances L_3 and

L_4 . The antenna ammeter M_4 is coupled to the antenna circuit by means of the coupling transformer T_3 .

Installation

6. General—The transmitter should be securely fastened to the desk or to a small stand by bolting through the holes in the base. The send-receive switch should be mounted in the radio room or in the engine room preferably with the line of shaft fore and aft rather than athwart ship. All wiring between the units should be in conduit or lead covered cable. The feed wires supplying the main dc or ac supply should be No. 8 or larger. The motor armature leads should also be No. 8 wire. All other leads should be No. 12 wire. The high voltage leads should be insulated for 2500 volts.

7. Tuning—CAUTION—Be sure that all preliminary tuning is done with reduced plate voltage. The voltage should not exceed 1000 volts for the original adjustments on the transmitter.

The master oscillator is adjusted to the desired frequency by setting the master oscillator variable condenser until an indication of the correct frequency is shown on whatever type of frequency meter is used. Then with the antenna disconnected, the power amplifier circuit is tuned to the frequency of the master oscillator circuit by adjusting the power amplifier tuning control until the plate current is a minimum. The antenna is next tuned by, first, connecting the antenna and then adjusting the antenna inductance and the antenna series condensers until the antenna current is at maximum.

The adjustment for the maximum efficiency should next be made. This requires an adjustment of coupling. The coupling is controlled by the position of two clips on the power amplifier plate circuit inductance. These clips are those on the leads from the two antenna series condensers. The closer the clips are to ground, the less will be the effective coupling. The coupling should first be reduced; and, if a decrease in plate current without being accompanied by a decrease in antenna current results, the coupling should be further reduced until the antenna current drops off with the plate current. If this condition happens on the first adjustment, the coupling should be increased, until further increase of coupling will not give an increase in antenna current proportional to the increase in plate current.

The audio oscillator may be adjusted to the desired operating tone frequency by means of a switch which governs the amount of capacity in the oscillator tank circuit. This switch is located

in the lower left hand compartment and is marked "500, 750, 1000," these figures being approximately the frequency of oscillation of the audio oscillator when the pointer is set to one of them. The audio oscillator modulates the power amplifier circuit by impressing an alternating voltage on the grid circuit of the power amplifier.

Keying is accomplished by removing a high negative bias from the grids of all tubes. The transmitter, antenna change-over relay, has an interlock in the keying circuit so that the transmitter cannot be keyed while the relay is thrown in the "receive" position.

After all adjustments for maximum efficiency and resonance have been made, the plate voltage can be increased to 2000 volts. Finally, the transmitter should be calibrated with all screens on. This calibration should be recorded and kept for reference.

8. Antenna—The power amplifier works into a Hertzian antenna of the type in which the transmission line determines the constants of the antenna system to a degree comparable with that part of the antenna which actually radiates. In essence, the arrangement is similar to two quarter wave antennae which are either flared or disposed horizontally in opposite directions at the ends but placed together for the remainder of the length running to the transmitter to form the transmission line portion.

Since the transmission line portions of the two antennae have currents in them 180 degrees out of phase and are placed close together and transposed, there is no material radiation from this part of the antenna system. To obtain a reasonable length of radiating length, the proportion of the horizontal or radiating part to the length of the transmission line or non-radiating part should be so chosen that the overall dimension of the horizontal part of the antenna corresponds to half the shortest wavelength at which the transmitter operates. Such a design infers harmonic operation, and, since the arrangement is essentially two quarter wave antennae, the lowest order of harmonic operation is the third. From the above discussion, it is apparent that the physical disposition of the antenna must necessarily be confined to limited dimensions. An example of the procedure necessary in determining the dimensions of an antenna for use on a known wavelength band is as follows: The fundamental wavelength is chosen so that it falls approximately in the middle of the known wavelength band. The antenna series condenser will reduce the natural period to the lower end of the band. The antenna inductance or loading coil will increase the natural period to the top of the band. The theoretical length of one-half of the antenna is then determined by

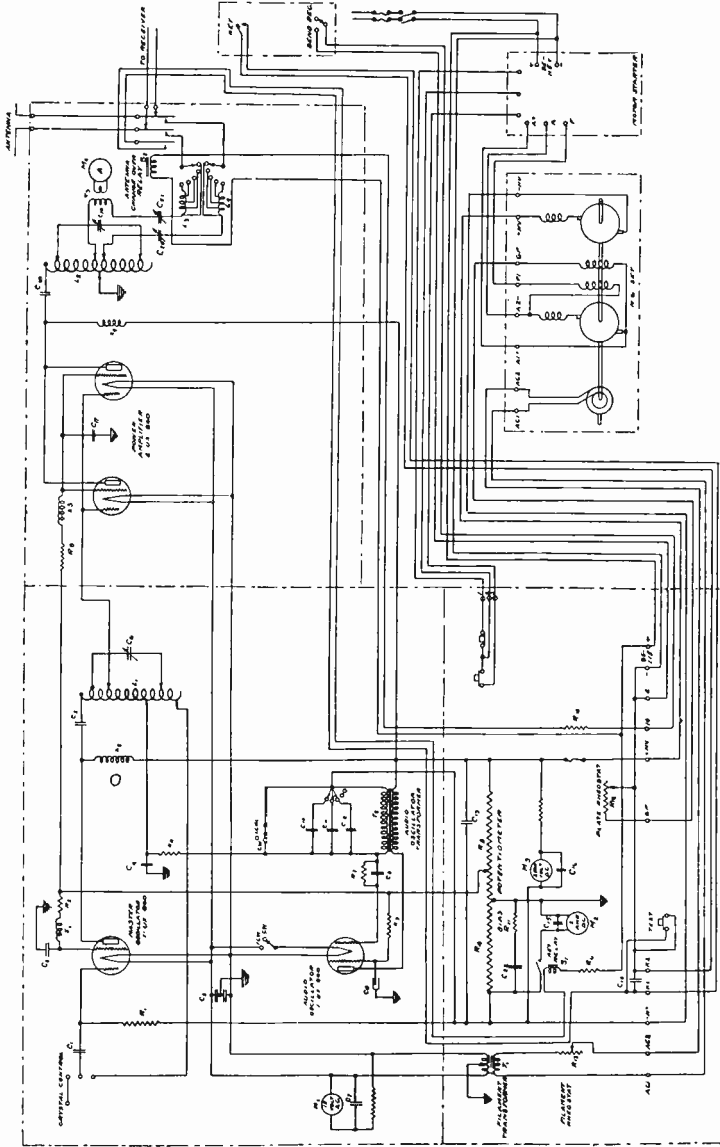

Fig. 185. Wiring Diagram Model ET-3655 Short Wave Transmitter.

taking three-quarters of the selected natural wavelength. Due to the capacity of the antenna to nearby objects, such as masts, stays, bulkheads, etc., the theoretical length will be greater than that actually necessary. Experience indicates that the ratio of the actual natural wavelength to the theoretical natural wavelength is in the order of 1.25; therefore, the actual length of one-half of the antenna will be the theoretical value divided by approximately the factor 1.25. One-half of the horizontal portion of the antenna will have a length of 25% of the wavelength at the lower end of the band. This dimension automatically determines all dimensions of the antenna. A sample calculation of an antenna for operation in the 26-36 meter band will be found in a later paragraph.

Since the transmitter is designed to operate over the very wide range of frequencies, the antenna resistances will vary greatly, and hence the antenna current will also vary to an extent which makes it impractical to use one antenna ammeter. To obviate the necessity of putting in different antenna ammeters for different wavelength bands, the transmitter has integral in its assembly a radio frequency variable ratio current transformer. The ammeter is calibrated uniformly from zero to 110 and serves merely as indication of maximum antenna current.

Operation

1. Adjust filament voltage to 10 volts and plate voltage to not more than 1000 volts. Turn CW-ICW switch to CW.
2. Set master oscillator control to scale reading as shown on calibration chart, for wavelength desired.
3. Turn antenna tuning condensers to a minimum.
4. Adjust power amplifier control until plate current is at minimum.
5. Adjust antenna inductance and antenna series condenser until antenna current is maximum.
6. Readjust power amplifier tuning control for minimum plate current.
7. Readjust antenna series condensers for maximum antenna current.
8. Slowly increase plate voltage to the maximum of 2000 volts, watching P.A. plate current meter, which must never read more than .5 ampere.
9. If it is not possible to increase plate voltage to 2000 volts without plate current exceeding .5 ampere, try a different adjustment of the antenna inductance (requiring a readjustment of the

antenna series condensers and possibly a slight retuning of the power amplifier control). The best adjustment for full power is that which gives maximum antenna current with plate current at .5 ampere, plate voltage at 2000 volts and with plates of the power amplifier tubes cool. Proper filament voltage is 10 volts, no more or not less. Operating the tube filaments at more or less than 10 volts will decrease the tube life. Maximum plate voltage is 2000 volts with key depressed.

10. The audio oscillator is used to modulate the output of the transmitter with a musical note having a frequency of 500, 750, 1000 cycles. The purpose of this modulation is to spread out the wave so that it is easier to tune. Its only use is in calling. It should not be used for working because the range of the transmitter will not be nearly as great on ICW as on CW.

The model UX-860 tube is a new type of four element tube designed to eliminate the necessity of neutralizing. The fourth element, called the screen grid, is placed between the plate and control grid. It is then by-passed to ground through a large condenser. The three element tubes need to be neutralized because of the capacity between the grid and the plate. Due to this capacity a voltage on the plate will be transferred in part to the grid and may cause oscillation. In the four element tube, any voltage on the plate may cause a voltage to appear on the screen grid, but as this is grounded no oscillation can result. There is a dc potential approximately one third of the plate potential, applied to the screen grid so that it does not impede the flow of electrons.

The filament of this tube operates on 10 volts, drawing 3.25 amperes. The normal plate voltage is 2000. Neither the normal filament nor plate voltage should be exceeded.

9. Starter—The motor starter is of the back contact push button control type. This unit should be mounted vertically near the motor-generator unit. Pressing the start button on the transmitter closes the starting contact on the starter. This button should be held down for two seconds until the motor has accelerated sufficiently to allow full voltage to be used. When the start button is released, a back contact on the start button closes the running contactor which shorts out the starting resistance. The plate voltage will be from 1000 to 2000 volts, depending on the position of the field rheostat. It is good practice to turn the field and filament rheostats to the right before starting so that the voltages will never be too high to start with.

10. Installation of Different Wavelength Bands—Three sets of coils are needed to cover the entire band from 23.4 to 150 meters. For the first two bands 23.4–36.6—35.1–50 the same coils suffice. The tuning coils L_1 and L_2 are wound with 9 $\frac{3}{16}$ turns of $\frac{3}{8}$ " copper ribbon on a hexagonal form which is 4 $\frac{3}{4}$ " in diameter across corner. The choke coils are space wound on 1 $\frac{1}{2}$ " micarta tubing. They have 80 turns. The tuning condensers C_6 and C_{14} have two stator sections and one rotor. The two stator sections are connected to the coils L_1 and L_2 for the band 26.3–36.6. One section of the condenser, that is, one stator section and the rotor are connected to the coils section and the rotor are connected to the coils L_1 and L_2 for the band 35.1–50 meters. For the 50–90 meter band new tuning coils L_1 and L_2 and new choke coils X_1 , X_2 , X_3 and X_4 are required. The tuning coils L_1 and L_2 are wound with 19 $\frac{5}{16}$ turns of $\frac{3}{16}$ " copper strap on a hexagonal form 4 $\frac{3}{4}$ " across corners. The choke coils X_1 , X_2 , X_3 and X_4 are wound on 1 $\frac{1}{2}$ " micarta tubing and have 120 turns. For this band, one stator section and the rotor of the tuning condensers C_6 and C_{14} are connected to the new coils L_1 and L_2 . About 16 turns of the new coils are required to tune with the condenser specified from 50 to 90 meters. For the 90–50 meter band a third set of coils is required. The coils L_1 and L_2 have 19 $\frac{5}{16}$ turns of $\frac{3}{16}$ " copper strap wound on a hexagonal form 5 $\frac{3}{4}$ " across corners. The choke coils X_1 , X_2 , X_3 and X_4 are wound on 1 $\frac{1}{2}$ " micarta tubing and have 182 turns each. For this band both stator sections of the condensers C_6 and C_{14} are connected together. This utilizes the maximum capacity of the condenser. This condenser should be connected across approximately 16 turns of the coils L_1 or L_2 .

The plate and grid taps on the oscillator should be put on the new coils so that the ratio of the turns from plate to ground and grid to ground is about 2 $\frac{1}{2}$ to one or 3 to one. The final position of the plate tap is that which gives the most stable operation for a minimum amount of plate current. The master oscillator should be adjusted with the plates of the amplifier tubes disconnected. In this case the meter M_2 reads only the plate current of the oscillator. This should be a minimum. In general, moving the plate tap closer to ground, that is, to the tap that connects the coil L_1 to the condenser C_4 will increase the plate current. For the amplifier the plate tap may connect to one end of the tank circuit L_2 , C_{14} . If, however, the amplifier will not load properly, the plate tap may be moved closer to ground (in

this case any copper tube connecting the coil L to the frame). This should increase the antenna current and the plate current. However, if the tap is too close to ground, the tubes will operate inefficiently as indicated by excessive heating of the plate. In general the ground connections on coils L and L should be approximately in the center of the coil.

The antenna load coil L_1 and L_2 are wound on a single hexagonal frame $4\ 3/4$ " across the corners. The coils are wound with No. 10 bare copper wire on pyrex insulators.

For the 23.4-36.6—35.1-54—50-90 meter bands a 9 turn coil is used. For the 90-150 meter band an 11 turn coil is used. There are five taps on each coil which are spaced as nearly uniform as possible in either coil.

Sample Antenna Calculation

26.3 to 36.6 Meter Band, Average wavelength = 31.15 meters.

$.75 \times 31.15 = 23.3$ M. = theoretical length of antenna.

$23.3 \times .8 = 18.65$ M. = approximate actual length.

$18.65 \times 3.25 = 61$ feet, approximate actual length.

Length of $1/2$ of flat top = $1/4 \times 26.3 = 6.575$ M.

$6.575 \times 3.28 = 21.6$ feet, length of one section of flat top.

Therefore, an antenna whose lead is in $61 - 21.6 = 39.4$ feet and whose overall flat top is 43.2 feet will be satisfactory for operation in the 26.3 to 36.6 meter band. The two lead in wires should be spaced about three inches apart and transposed every $2\ 1/2$ feet.

Maintenance

11. Motor-Generator—The motor-generator for 100 to 125 volts dc power is a two bearing unit. This ball bearing unit has a four pole compound wound 1750 rpm. motor with slip rings on the armature to provide 77 volts, 60-cycle single-phase power for filament lighting. The generator is a two-pole separate excited machine giving a potential of 2000 volts dc. The fields are excited by the 100 to 125 volt dc power.

The commutators of the motor-generator should be inspected occasionally to see that the brushes are not sparking excessively, or that the commutators are not cutting or burned.

Commutators must be kept clean and the brushes properly adjusted and fitted to the commutator. Wipe the commutator at frequent intervals (with the motor-generator stopped), depending

on the character of the service, with a piece of clean canvas cloth free from lint. Apply lubricant sparingly. A piece of paraffin rubbed lightly across the commutator surface will furnish sufficient lubrication. No other attention is required by the commutator which is taking on a polish and shows no signs of wear. A rough, raw, copper colored surface should be smoothed with a piece of sandpaper or fine sandstone ground to fit. In any case, the final smoothing should be done with fine (No. 00) sandpaper. When using paper or stone, lift the brushes and do not replace them until all grit is removed.

12. CAUTION—Never use emery cloth or emery paper on the commutator. Never attempt to make repairs to commutators or brushes while the machine is running, as the voltage on the generator end is dangerous. Turn generator over by hand, or open generator field.

The brushes are set in the neutral position at the factory and the bracket to which they are attached is doweled in position. This adjustment should not be altered as it is correct for either direction of rotation.

New brushes should be of the same make and grade as those shipped with the machine. Brushes should have only sufficient clearance in the box to slide easily.

For ac. power, and other than 100 to 125 volts dc. power the above mentioned motor-generator set is directly connected to a motor, the two machines being fastened to a common bedplate. Under these conditions the dc. motor of the motor-generator unit becomes a dc. generator and furnishes exciting current for the high-voltage generator fields, and keying relay; also alternating current is taken from the slip rings for filament lighting.

Ball bearing motors and generators are assembled and shipped with sufficient grease for a limited period of operation. The Texas Oil Company's grease—Marfak No. 3—or its equivalent is recommended.

Avoid using inferior greases. To be suitable for ball bearings a grease must be free from acid or alkali, also from abrasive material. It must be a good lubricant; must not separate into its compound parts, soap and oil; must adhere to the surfaces of the balls and raceways; must be of such a consistency that it will not flow out of the housing which encloses the bearings; and must have a high melting point and uniform consistency throughout a large temperature range. Avoid using too much grease. The

housing must not be more than two thirds full. At least once a year the grease should be removed and new grease supplied.

When the driving motor is not equipped with ball bearings, the oil wells and rings should be inspected at least once a month to see that they have plenty of oil.

13. Troubles and Causes—1. Pressing start button does not start motor-generator. Open main switch or defective main fuse. No line voltage or line voltage too low. Line voltage may be tested by operating telegraph key which will cause relay to work if line voltage is on.

2. Start button causes start contactor to close, but motor-generator set does not start. Burned out starting resistor on back of starting panel. Connection between starting panel and motor-generator set open. Frozen bearing on motor-generator set open. Frozen bearing on motor-generator set due to lack of oil.

3. Starter and generator satisfactory as indicated by plate voltage on radio panel but tube filaments do not light. Loose connection on filament transformer or terminal board. Defective brush on motor slip rings.

4. Set operates normally when key is down but tubes heat badly when key is up. Tubes are not blocking properly. May be due to low bias voltage caused by defective resistor in R_4 .

5. Tubes heat badly as soon as key is pressed. Master oscillator tube defective or exciter circuit not oscillating. Change the tubes and examine circuit for loose connections. Remove all but master oscillator from its socket. Master oscillator tube will still heat badly when key is pressed if tube or circuit are defective.

6. Amplifier tubes heat excessively when key is pressed. Amplifier circuit out of tune. Retune amplifier circuit.

7. Audio oscillator does not operate when switch is turned to ICW position and key is pressed. Examine connections to CW-ICW switch, also connections to transformer and condensers and condenser tap switch. One of the condensers may have broken down, or the vacuum tube may be defective.

Emergency Measures for Apparatus Failure

14. A. Insulation Break-Down—Charring of insulation resulting in continued arcing over and burning, cut away insulation if possible, otherwise cut winding and remove if possible, otherwise cut winding and remove sufficient turns to clear. Before cutting wire at each end of turns to be removed, make fast the

ends of the winding remaining by cord. Put in temporary jumper to close circuit. If insulation is at terminal blocks in switches, and arcover cannot be stopped by cutting away insulation, remove connections and complete circuit by temporary jumper.

B. Filament Voltmeter Inoperative—Reduce filament voltage until tubes begin to heat or antenna current drops rapidly. Then increase filament voltage slowly until tubes operate at normal temperature and antenna current is not rising rapidly.

C. Plate Ammeter or Voltmeter Inoperative—Maintain generator field rheostat not more than usual position and operate with tube temperature normal.

If plate ammeter is not functioning and other adjustments are to be made, insert a 50-watt, 110-volt lamp in place of ammeter and do not exceed full brilliancy.

D. Antenna Ammeter Inoperative—Adjust in accordance with tuning record card and observe plate ammeter for final resonance.

E. Filament Transformer or Filament Rheostat Burned Out—Disconnect filament transformer and rheostat and connect five cells in series of lead acid storage battery direct to the filament busses with leads to carry 20 amperes. The voltage of the battery is practically correct for the tube filaments without rheostat control.

F. Grid Leak Open—The grid leak of the master oscillator or power amplifier may be replaced by a resistance of 10,000 ohms. A column of water 12" long, in a rubber hose plugged at each end and having wire electrodes, will be satisfactory. If the resistance seems to be too high add a little salt or washing soda.

Parts List

Note—Reference numbers refer to schematic wiring.

| Circuit Symbol | Description |
|----------------|--|
| R_1 | Master oscillator grid leak, 10,000 ohms. |
| R_2 | Screen grid resistor, 10,000 ohms. |
| R_3 | Screen grid resistor, 10,000 ohms. |
| R_4 | Keying bias and screen grid potentiometer, 1, 40,000 ohms. |
| R_5 | Keying bias and screen grid potentiometer, 2, 40,000 ohms. |
| R_6 | Keying relay series resistor, 250 ohms. |

| | |
|----------|---|
| R_7 | Audio oscillator grid leak, 10,000 ohms. |
| R_8 | Power amplifier grid leak, 20,000 ohms. |
| R_9 | Screen grid resistor, 10,000 ohms. |
| R_{10} | Antenna relay series resistor, 250 ohms. |
| R_{11} | Spark absorber resistor, 62 ohms. |
| R_{12} | Generator field rheostat, 600 ohms. |
| R_{13} | Filament transformer rheostat, 16 ohms. |
| C_1 | Master oscillator grid condenser, .002 mfd. |
| C_2 | Screen grid grounding condenser, .02 mfd. |
| C_3 | Filament by-pass condenser, .1-.1 mfd. |
| C_4 | Master oscillator grounding condenser, .02 mfd. |
| C_5 | Master oscillator plate stopping condenser, .002 mfd. |
| C_6 | Master oscillator tuning condenser. |
| C_7 | Meter by-pass condenser, .006 mfd. |
| C_8 | Audio oscillator screen grid by-pass, cond. 2-1. mfd. |
| C_9 | Audio oscillator grid condenser, .5 mfd. |
| C_{10} | Audio oscillator tank condenser, .1 mfd. |
| C_{11} | Audio oscillator tank condenser, .5 mfd. |
| C_{12} | Audio oscillator tank condenser, .5 mfd. |
| C_{13} | Generator by-pass condenser, 3 mf. |
| C_{14} | Spark absorbing condenser, .5 mf. |
| C_{15} | Meter by-pass condenser, .006 mfd. |
| C_{16} | Meter by-pass condenser, .006 mfd. |
| C_{17} | Screen grid grounding condenser, .02 mfd. |
| C_{18} | Plate stopping condenser, .002 mfd. |
| C_{19} | Power amplifier tuning condenser. |
| C_{20} | Antenna tuning condenser. |
| C_{21} | Antenna tuning condenser. |
| T_1 | Filament transformer. |
| T_2 | Audio oscillator transformer. |
| T_3 | Antenna current transformer. |
| S_1 | Keying relay, model 18. |
| S_2 | Antenna changeover relay. |
| L_1 | Master oscillator inductance. |
| L_2 | Power amplifier inductance. |
| L_3 | Antenna inductance. |
| L_4 | Antenna inductance. |
| X_1 | Plate choke coil. |
| X_2 | Screen grid choke coil. |
| X_3 | Plate choke coil. |
| X_4 | Screen grid choke coil. |
| M_1 | Filament voltmeter, 0-15 volts, ac. |

| | |
|-------|------------------------------------|
| M_2 | Plate ammeter, 0-2 amperes, dc. |
| M_3 | Plate voltmeter, 0-2500 volts, dc. |
| M_4 | Antenna ammeter, 0-lamp RF. |

15. Model ET-3627-A 200-Watt Transmitter—The model ET-3627-A, 200-watt transmitter and associated equipment described in these instructions are designed primarily for ship-board installations or for other service where a compact radio telegraph transmitter is required. The equipment as normally supplied consists of the following component units:

1—200-watt transmitter, model ET-3627-A.

1—motor generator set rated: model 55-A-5, type M.C.C.; ball bearings. 2500 R.P.M. no load speed. Weight 390 lbs.

1—automatic starter CR-4012. 1½ H.P. 155 volts d.c.

1—Mesco No. 80 telegraph key.

16. Installing—The transmitter proper is designed for table mounting and has the following overall dimensions: Height, 40 inches; width, 21 inches; depth, 25 inches; net weight, 208 lbs.

The automatic starter is supplied for independent mounting and should be located as near the motor generator set as possible. This will result in short leads from line to the motor and will improve the overall regulation by reducing the voltage drop to a minimum.

Number 12 B. & S. lead-covered wire is recommended for leads running between the motor and automatic starter and number 14 B. & S. lead-covered wire may be used for the remaining external connections. The leads from the generator armature to transmitter should be insulated for 1,000 volts. The normal full-load current drawn from the line by the motor generator set when used with the ET-3627-A transmitter is approximately 11 to 12 amperes at 115 volts d.c. The load on the plate generator with this transmitter is approximately 550 watts. The generator is rated as 1.68 KW., amperes 1.4, volts full load 1,200 d.c.

The automatic starter is designed with adjustments so that the motor generator may be brought up to speed in a short time without subjecting the line or motor to excessive current. It is provided with two magnetic contactors, one of which closes first and connects the motor to the line through a suitable resistor. When the machine reaches a certain speed, the counter e.m.f. of the motor closes the second magnetic contactor which short-circuits the resistor, bringing the machine up to full speed. The second, or accelerating contactor, is the one near the base of the starter and is provided with a spring adjustment which determines

the time required for the contactor to close. If this spring is too loose, the starting resistance will be cut out of the circuit too soon,

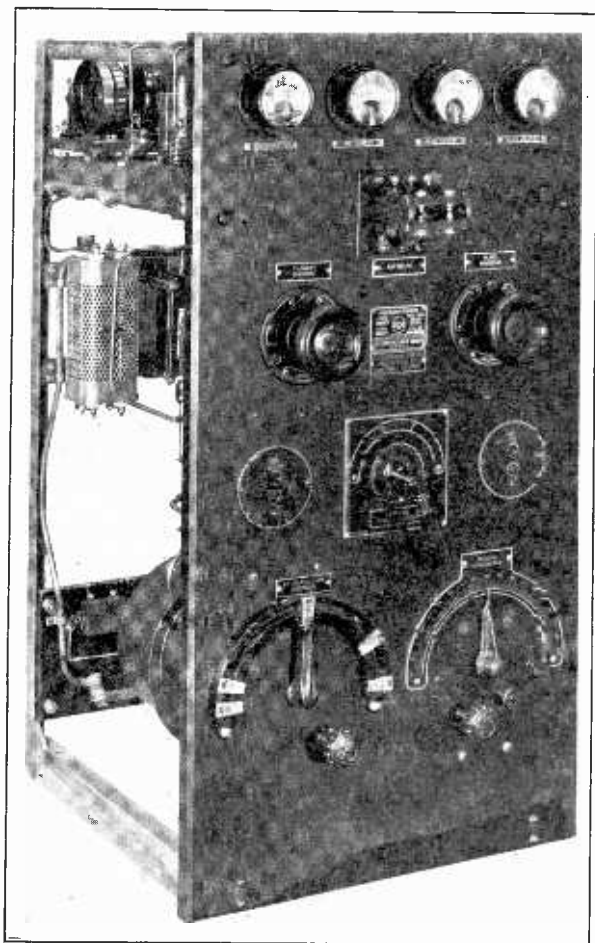

FIG. 185a. Model ET-3627-A Tube Transmitter.

while if too tight, the accelerating contact may fail to close. A few trials will enable a correct adjustment to be obtained by observing the acceleration of the machine when the start button is

depressed. Be sure to lock the adjustment screw with the lock-nut after the best adjustment has been determined. The line switch in the starting box should be fused with thirty ampere fuses.

The adjustments of the automatic starter should be made with the transmitting key open. The machine will then start with the filament load but without the plate load, as this is the normal operating condition.

17. Antenna Characteristics—The transmitter is designed to operate on an antenna whose characteristics fall within the following limits:

Effective capacitance .0004 to .001 mfd.

Effective resistance 2 to 10 ohms.

Fundamental wavelength 175 to 350 meters.

In general, an effort should be made to use an antenna whose capacitance is near the upper limit specified. On the higher capacitance antennas whose resistance is four ohms, 200 watts or more output may be obtained. On antennas of lower capacitance, and when the resistance is near the upper and lower limits specified, slightly less than 200 watts may be obtained.

18. Wavelength—A continuous wavelength range from 600 to 960 meters (500 to 312 KC.) is covered by the transmitter when used on the specified antennas.

19. Rating—The transmitter is rated on the normal output delivered to the antenna on CW. telegraph, namely, 200 watts.

20. Methods of Signalling—A push button switch mounted at the right side of the panel provides straight CW. and ICW. transmission. The latter is obtained by means of a motor-driven chopper.

21. Vacuum Tubes—Three model UV-211 vacuum tubes are used as follows:

1—UV-211 as master oscillator.

1—UV-211 as power amplifier.

22. Type of Circuit—The master oscillator, power amplifier type of circuit is used in the transmitter. A schematic diagram of the circuit is shown in figure 185*b*. The tuning of this type of circuit consists fundamentally of setting the master oscillator at the desired wavelength and then resonating the antenna circuit for maximum antenna current. The master oscillator variometer which is mounted in the lower left section of the panel is provided with a five-point positioning device, so that it may be calibrated for any five wavelengths within the band and the movable stops then locked at the correct places. At the same time, inter-

mediate wavelengths from five normal ones may be obtained easily by setting the pointer at the proper position.

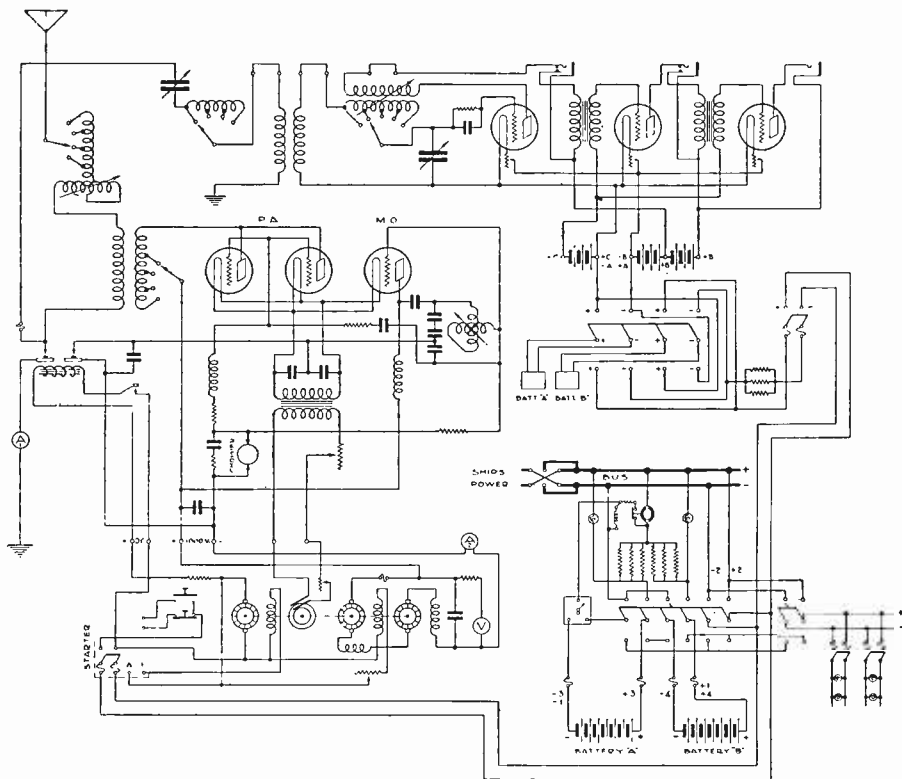

FIG. 185b. Circuit of Model ET-3627—A 200 Watt CW-ICW Transmitter, Master Osc., Power Amp. This Diagram is Suitable for Government Examination.

23. Adjusting the Transmitter—The antenna circuit is tuned by means of a four-point antenna inductance switch and the antenna variometer. The variometer is designed with sufficient range to overlap the taps on the coil so that continuous inductance range may be obtained.

The only adjustment to be made inside the transmitter is that on the antenna transformer plate winding. This winding has sev-

eral taps brought out to the micalex terminal board and is used to permit adjustment for maximum efficiency on the particular antenna with which the transmitter is to be used.

The following procedure is recommended for adjusting the transmitter :

1. Turn both rheostat knobs to the extreme right.
2. Start motor generator set by depressing the start push button.
3. Adjust filament voltage to 10 volts.
4. Adjust plate voltage to 750 or 800 volts (for preliminary adjustment) by means of the plate rheostat.
5. Place signal switch on CW.
6. Close the key switch which will start the master oscillator and adjust the master oscillator for the desired wavelength. It is not necessary that antenna current be obtained for this adjustment and the wavemeter should be coupled to the leads which are brought out from the shielded master oscillator compartment.
7. Tune the antenna circuit by means of the antenna variometer until a maximum reading is obtained on the antenna ammeter. The correct position of the antenna inductance switch must be determined by trial for this adjustment and for each operating wavelength. On the average low resistance antenna, the antenna tuning is very sharp with the ET-3627-A transmitter, and it is necessary to rotate the antenna variometer carefully to secure maximum output.

8. Raise the plate voltage to 1,000 volts, which is the normal working voltage, and observe carefully if all the tubes are operating without excessive plate heat.

Facing the transmitter panel, the tube at the left is the master oscillator and will ordinarily run with the plate cold or at a very low temperature. The remaining two tubes to the right of the master oscillator are the power amplifiers, and when delivering output to the antenna, should not show more than a dull red heat after the key has been depressed several minutes.

The plate ammeter on the transmitter panel should be used to secure the proper adjustment of the tap on the transformer plate winding. This tap should be adjusted so that when maximum antenna current is obtained at 600 meters, the total plate current does not exceed .6 ampere. On a low resistance, low capacitance antenna most of the plate winding will be required, while on higher capacitance antennas, and those of higher resistance, less plate inductance is required. Once the proper tap has been selected to give efficient operation on 600 meters it will hold satisfactorily for the entire wavelength band.

The plate voltage should be removed from the transmitter by shutting down the motor generator set whenever adjustments are made inside the transmitter.

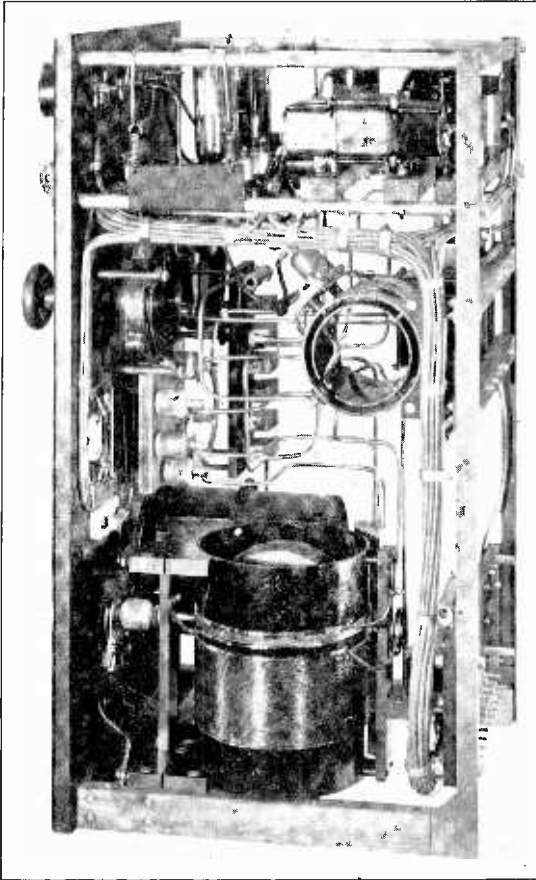

FIG. 185c. Side View of Assembly of Model ET-3627-A Transmitter.

The antenna transformer is designed to protect the tubes from overload during the tuning of adjustment, but for maximum tube life, it is recommended that the plate voltage be reduced to 700

or 800 volts when the transmitter is being calibrated. After the correct position of the master oscillator variometer has been determined and the positions recorded for the antenna inductance switch and the antenna variometer for the different operating wavelengths, changes from one wavelength to another can be made in a few seconds and the plate voltage can be maintained at its normal value of 1,000 volts. The filament voltage should be maintained at 10 volts at all times, higher or lower values being detrimental for long tube life.

A typical set of performance data obtained on a .0008 microfarad, four-ohm antenna with a natural period of 315 meters is tabulated below:

| Wavelength | Plate Amps. | Ant. Amps. | Ant. Watts | Ant. Var. | Ant. Ind. Switch |
|------------|-------------|------------|------------|------------|------------------|
| CW 600 | 0.59 | 7.1 | 201 | 55 degrees | 1 |
| ICW 600 | 0.39 | 4.75 | 91 | 55 " | 1 |
| CW 800 | 0.6 | 7.1 | 201 | 41 " | 2 |
| ICW 800 | 0.39 | 4.6 | 85 | 41 " | 2 |
| CW 960 | 0.61 | 7.25 | 210 | 102 " | 2 |
| ICW 960 | 0.41 | 4.6 | 85 | 102 " | 2 |

The second tap on the antenna transformer plate winding was used for the above readings.

The performance of the transmitter on a .0004 microfarad, four-ohm antenna is tabulated below:

| Wavelength | Plate Amps. | Ant. Amps. | Ant. Watts | Ant. Var. | Ant. Ind. Switch |
|------------|-------------|------------|------------|------------|------------------|
| CW 600 | 0.5 | 6.1 | 150 | 45 degrees | 2 |
| ICW 600 | 0.33 | 4.0 | 64 | 45 " | 2 |
| CW 800 | 0.5 | 6.4 | 164 | 70 " | 3 |
| ICW 800 | 0.32 | 4.0 | 64 | 70 " | 3 |
| CW 960 | 0.55 | 6.25 | 156 | 79 " | 4 |
| ICW 960 | 0.32 | 3.5 | 49 | 79 " | 4 |

The third antenna transformer tap was used for the above readings.

Occasionally an antenna will be encountered whose capacitance is about .0004 microfarad and whose resistance is from ten to fourteen ohms. Under these conditions, using the lowest plate tap on the antenna transformer, the tubes may not draw sufficient input and the plates will show but little heat. It is then permissible to increase the plate voltage to 1,200 volts, but no more, provided the plates of the tubes do not operate at more than a dull red heat, and provided the total plate current does not exceed .5 ampere. The full output of the transmitter will be obtained on high re-

sistance antennas if the foregoing instructions are carefully observed.

24. Adjustment of Break-in Relay—A special break-in relay is mounted on the front panel. The relay is provided with two pairs of contacts, the pair on the left, when facing the panel, being connected in series with the low side of the antenna circuit, and the pair at the right being connected in the "key" circuit of the transmitter. The radio receiver is connected to the antenna through the transmitter inductance whenever the left pair of contacts are open; when these contacts close, they short-circuit the input to the receiver, thereby protecting it from transmitter voltages. Careful adjustments of the relay contacts must be made in order to secure the proper time required in operation so that the receiver input is short-circuited by the antenna contacts before the key contacts, or the pair at the right, close. This is best done by adjusting the antenna contacts, or the left pair, so that they are separated by not more than $1/32$ of an inch. The "key" contacts should be separated by approximately $1/8$ of an inch. Then, when the transmitting key is depressed, the antenna contacts close first, but since one of them is spring mounted, they stay closed while permitting the "key" contacts to make. When the proper adjustment has been secured, no sparking will take place on the antenna contacts, and but very slight sparking on the "key" contacts. Silver is used on the antenna contacts and tungsten on the "key" contacts, and both should be kept clean and the faces parallel in order to secure the most efficient operation.

Care must be exercised in running the lead from the receiver fuse, which is mounted at the rear of the panel, to the receiver. This lead must not be coupled to the transmitter circuits, as otherwise voltages induced in it will affect the receiver even with proper operation of the break-in relay. A well-shielded receiver will provide the most satisfactory operation with the break-in system.

25. Care of Chopper—When the signal switch is placed in the ICW. position, one pair of contacts on the switch start the chopper motor and the other pair remove the short circuit maintained around the chopper during CW. transmission. The grid leak circuits of the master oscillator and the power amplifier tubes are broken by the chopper at the rate of approximately 1,000 times a second in order to produce ICW. telegraphy. The chopper wheel, therefore, breaks grid current and the brushes and the surface of the wheel should be maintained in good condition. The brush which bears on the chopper wheel proper is made of spring silver in order to secure good contact to the segments. It is held

against the wheel by a small coiled spring. Only sufficient pressure should be exerted by the spring to make good contact as excessive pressure will cause premature wearing of the silver brush. The best criterion of a suitable adjustment is to listen to the ICW. note in the receiver, using only sufficient pressure to secure a clear note. The second chopper brush, which is made of copper braid and bears on the brass collector ring, needs but little attention. The chopper wheel should be smoothed off occasionally with very fine sand paper (not emery cloth), taking care not to grind down the insulation faster than the contact segments. The collector ring should also be kept bright and clean by means of fine sand paper.

26. General Maintenance—The transmitter should be maintained in good condition at all times in order to secure efficient performance. The various connections in all circuits, particularly radio frequency circuits, should be kept tight and clean. Dust should not be permitted to accumulate on the antenna inductance or other units which operate at high voltage.

The ratings of the various condensers, resistors, and so forth, are given in the following list:

- A-1—Antenna ammeter 0-10 amperes, type DO-5.
- A-2—Plate ammeter 0-2 amperes, type DO.
- C-1—M.O. plate condenser UC-2226, .003 mfd.
- C-2—Filter condenser, each UC-490, 1 mfd.
- C-3—Filament by-pass condenser, each UC-487, .5 mfd.
- C-4—Key condenser, UC-2214, .015 mfd.
- C-5—M.O. plate blocking condenser, UC-2226, .003 mfd.
- C-6—M.O. plate condenser, UC-2219, .002 mfd.
- C-7—M.O. grid condenser, UC-2219, .002 mfd.
- C-8—Chopper condenser, UC-2226, .003 mfd.
- C-9—P.A. grid condenser, UC-1811, .0003 mfd.
- F-1—Plate fuse Cat. No. 230075, 2 amperes.
- F-2—Receiver antenna fuse, Cat. No. 219075, 1/2 ampere.
- K-1—Hand key, mesco No. 80.
- K-2—Break-in relay (key relay) T-2617362, G-1.
- L-1—Antenna variometer T-2854634, G-1.
- L-2—P.A. grid leak choke P-2805438, G-2.
- L-3—M.O. plate choke P-2805438, G-2.
- L-4—M.O. variometer T-2854618, G-1.
- R-1—P.A. grid resistance, QCK-1924014, 500 ohms.
- R-3—M.O. grid resistance QCK-1924014, 7500 ohms.
- R-4—P.A. feed resistance QCK-1924014, 150 ohms.
- R-5—Filament rheostat, Cat. No. 1916233, 20 ohms.

- R-6—M.O. parasitic resistor, QLK-2155993, 15 ohms.
R-7—Plate field rheostat, Cat. No. 1916249, 250 ohms.
R-8—Power amplifier parasitic resistor, QLK-2155993, 15 ohms.
R-9—Chopper resistor, QCK-1924023, 50 ohms.
R-10—Key relay resistor, QCK-1924014, 400 ohms.
S-1—Antenna inductance switch, T-2686071, G-2.
S-2—Start-stop switch, P-2873639, G-1.
S-3—Signal switch, P-2873639, G-2.
T-1—Antenna transformer, P-2873650, C-1.
T-2—Filament transformer, Y-1054, .125 K.V.A.
V-1—Filament voltmeter, 0-15 volts a.c.; type AO.
V-2—Plate voltmeter, 0-1500 volts d.c.; type DO.
Y-1—Chopper motor, model 28354, 1/50 H.P.
Y-2—Motor generator set, model 55-A-5.
Y-3—Motor starter, DL-1772869, G-10.

27. Operation and Care of High Voltage Generator. **Operation**—Before starting the generator for the first time:

1. See that the voltage on the generator name plate corresponds with the line voltage.
2. Check all connections to the generator with the wiring diagrams furnished with generator.
3. Make sure that the drain plugs are tight and that the bearings are properly lubricated.
4. If possible, turn the armature by hand to see that it rotates freely.

Before putting generator in service it is desirable to operate without load long enough to determine that there is no unusual localized heating and in order to check voltage, polarity, etc.

28. Care—High voltage generators are provided with enclosing covers to prevent coming in contact with the commutator or brush rigging of the machine. These covers, therefore, must not be removed or left off while the machine is in operation.

To insure the best operation, make systematic inspection *at least once a week*. Give the following points special attention.

29. Cleanliness—Keep both the interior and exterior of the generator free from water, oil, or dirt. Wipe the exterior and clear the interior with dry compressed air or a small bellows.

30. Oil Ring Bearings—Prevent excessive heating and wear of all bearings by proper lubrication, belt tension, and alignment. When bearings are unduly worn replace them.

Fill the oil wells with a good quality of clean, light mineral oil to the top of the oil fillers. Fill the oil wells through the oil fillers. To avoid incorrect oil level, never fill the oil wells when

the generator is running. After the generator has operated the first week, draw off the oil, pour fresh oil or kerosene through the bearings to wash out all sediment. Then refill. Before replacing the drainage plugs dip them in a mixture of red lead and shellac, then replace and tighten securely to prevent leakage. Refill the bearing at regular intervals, the frequency depending upon local conditions, such as cleanliness, severity or continuity of service.

31. Ball Bearings—A light grease or non-fluid oil should be used on motors for speeds up to and including 1800 R.P.M. For speeds above 1800 R.P.M. use a light mineral oil.

32. Grease Lubrication—The factory packs these bearings with grease which under ordinary operating conditions should suffice for about three months of continuous service. Unscrew the drain plug and make sure that this grease has not been removed. A short time after the motor has been put into operation it is good practice to remove the bottom drain plug to see if the grease has turned dark or fluid. If so, wash out the bearings with kerosene and pack with new grease. If the grease is put in under pressure, leave the bottom plug out and stop filling when grease starts to come out of the bottom plug hole. Inspect the bearings occasionally.

33. Oil Lubrication—Fill the oil wells through the oil fillers with a good grade of light mineral oil (not vegetable or animal oil) to the top of the oil fillers. To avoid incorrect oil level never oil the motor when running. A short time after the motor has been put into operation it is good practice to draw off the oil and pour fresh oil or kerosene through the bearings to wash out all sediment. Then refill. Before replacing the drain plugs dip them in a mixture of red lead and shellac, and then replace and tighten them securely to prevent leakage. Refill the oil wells at regular intervals, the frequency depending upon the local conditions, such as severity or continuity of service, cleanliness, etc.

34. Waste Packed Bearings—Pack waste from bottom of oil well to top of the lining, using a blunt stick in order not to cut yarn nor mar the lining and shaft.

Saturate waste with oil before packing.

Remove the drain plug after packing and pour a liberal quantity of oil over the waste and lining, allowing the excess to drain away thoroughly before assembling the drain plug.

Replace the drain plug, slushing it with a mixture of 50 percent red lead and 50 percent shellac, so that it cannot leak.

Pour into the top of the bearing a quantity of oil sufficient to fill it.

Be careful not to spill any oil on the outside of the bearing housing.

Reassemble the cover and thoroughly wipe the exterior of the bearing housing.

Use a good grade of machine oil.

Remove drain plug in refilling bearings, allowing old oil to drain off; pick up and repack waste to prevent its becoming matted and refill as above.

Refill the bearing at the end of the first month of operation under ordinary conditions of service and every three months thereafter, or as experience dictates. At long intervals, it may be necessary to remove the waste entirely and to clean the bearing thoroughly, inspecting it as to necessity for renewal and repack with clean waste. Use a good grade of wool yarn waste in these bearings.

35. Brushes—See that the brushes move freely in the holders and at the same time make firm even contact with commutator. The pressure should be between $1\frac{3}{4}$ and 2 pounds per square inch. Keep an extra set of brushes on hand. Fit new brushes carefully to the commutator. The position of the brush yoke should not be changed on commutating pole generator in order to improve commutation.

36. Commutator—Keep the commutator clean and maintain its polished surface. Ordinarily the commutator will require only occasional wiping with a piece of canvas or other non-linting substance.

37. Heating—Do not depend on the hand to determine the temperature of generators; use a thermometer. If there is any doubt about the safe operating temperature, take the temperature of the windings and confer with the nearest office of the company. Give full details.

38. Installation—When possible install the generator in a place that is clean, dry, well ventilated, and accessible for inspection and care.

Rigidly support and level the base of the motor generator set, wedging if necessary to secure true alignment of units. Undue vibration and unsuccessful operation may result, unless these instructions are followed.

The operating brush position is indicated by paint marks, one on the brush yoke and one on the bearing housing.

In installing high voltage generators, it is, of course, necessary that connections made to the generator be properly insulated, both from each other and from possible contact by the operator with line circuits. All wiring should be carefully installed in accordance with National Electric Code and any local requirements.

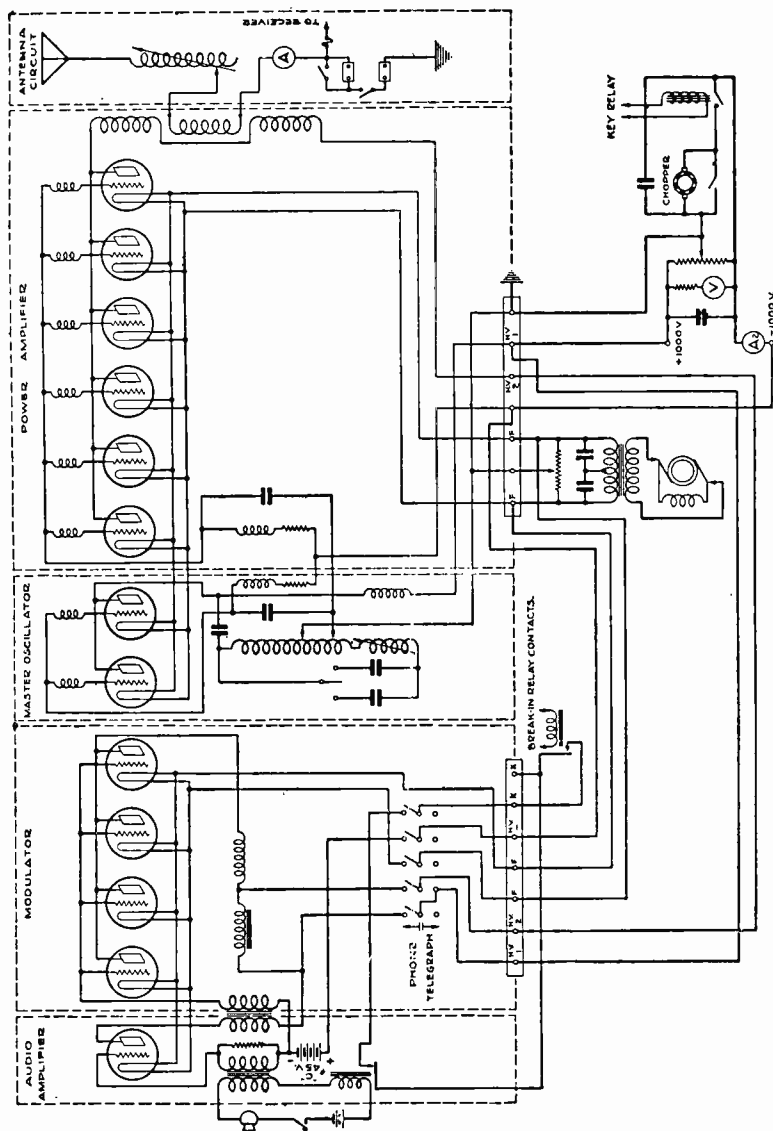

FIG. 186. Schematic Wiring Diagram of Model ET-3626-A Transmitter, 750-1000 Watt Master Oscillator with Power Amplifier and Model AT-829 Telephone Attachment.

Note: This diagram is suitable for Dept. of Commerce radio operator's examination should applicant be required to draw a master osc. power amp. with telephone attachment. The receiver, batteries and charging panel as shown in figure 185b should be added.

57. Details of the Model ET-3628 ACW Tube Transmitter
—The model ET-3628 transmitter consists of a 2-KW, P-4 or P-8

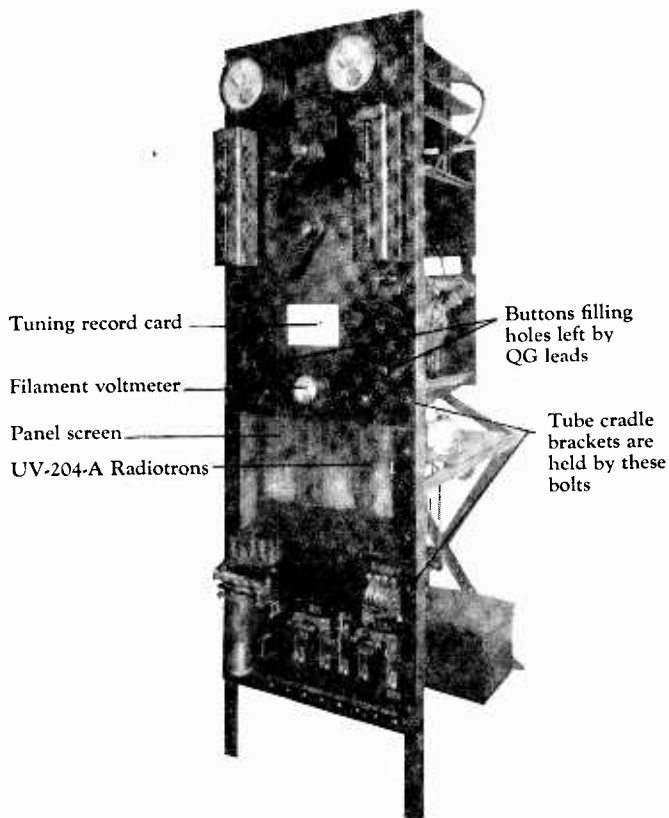

FIG. 187. Model ET-3628 A.C.W. Tube Transmitter.

spark transmitter which has been converted for tube operation. Two UV204-A Radiotrons are used in a self-rectifying "Split capacity" or Colpitt's circuit.

All connections to the motor generator and automatic starter are the same as for P-4 and P-8 spark sets. Keying is accomplished by breaking the primary circuit. Power regulation by means of a generator field and motor field rheostats is the same. A study of the diagram will show that the connections to the wattmeter and radiation ammeter remain unchanged.

The complete transmitter consists of the following apparatus:

1. The low frequency power apparatus and controls consist of motor and generator, field rheostats, 2 K.W. power transformer with mid-tapped secondary hand key, a.c. filament transformer and rheostat, wavelength changing switch, reactance regulator, the automatic starter and overload relay, rotary converter and filament transformer.

2. The meters on the panel, are radio frequency ammeter, wattmeter and a.c. filament voltmeter.

3. The motor generator is a 2-K.W. 500-cycle machine manufactured by either the Crocker-Wheeler or General Electric Co. A starting resistance and protective devices are provided. A small rotary converter is provided to supply a.c. current for filament heating.

4. The high frequency apparatus consists of the following: Two-plate radio frequency choke coils, two-plate blocking condensers, plate excitation condenser, grid excitation condenser, "tank" or primary inductance, coupling or secondary inductance, three fixed antenna loading inductances, variable antenna inductance, grid leak, grid leak ultra-r.f. choke coil, two-filament by-pass condensers and two UV-204-A Radiotrons.

5. Type I aerial change over switch. *Description of Apparatus*—The motor consists of a 4 H.P. 110-volt d.c. compound-wound motor directly connected to a 500-cycle a.c. generator. The motor is so constructed that it will operate on voltages varying from 95 to 115 volts with very little variation of speed. A field rheostat mounted on the panel regulates the speed of the motor within narrow limits.

The generator is of the rotating armature type and has a normal open circuit voltage of approximately 350 volts and a working or load voltage of 140 volts. This voltage can be varied by means of a rheostat which is mounted on the transmitting panel. This rheostat is in series with the generator field and permits varying the current throughout the field, which is excited from the direct current line.

An automatic starter permits the motor generator to be started and stopped from the operating table. A solenoid winding which

can be connected directly across the direct current line by pressing a starting button operates a plunger which moves in a vertical position, the acceleration being regulated by a piston drawn through a vacuum chamber. The speed at which the plunger moves may be varied by an adjustment screw attached to the base of the dash pot. The resistance coils in series with the motor armature are progressively cut out of the circuit. An extra contact is provided on the starter which closes the field of the generator after the motor has been brought up to field running position.

An overload relay is provided which opens the motor circuit when the current through the armature exceeds 35 amperes. Should the relay open the circuit the motor cannot be started until the start-stop switch is opened. It is then automatically closed so that the motor can be immediately started again when the start-stop switch is closed, unless there is a permanent short circuit on the line in which case the relay will open again.

The starter is fitted with an electrodynamic brake. When the plunger of the automatic starter opens, it automatically connects a resistance across the armature stopping the motor within ten seconds.

Two combined *protective devices and terminal blocks* are provided for the purpose of protecting the motor and generator windings from excessive potentials caused by induction from the radio frequency circuits. Each device consists of three mica condensers in one case. One terminal of each condenser is connected to the case, the other to a busbar or terminal bar on the cover. The device is screwed to the machine frame, which effectually grounds it. The terminal leads of the machine are brought out and connected to lugs on one end of the busbar. Leads to the panel are connected to lugs on the other end of the busbar.

The *transformer* is of the closed core type and is immersed in non-liquid oil. The primary is connected to the control panel by means of lead-covered wires which have their coverings grounded to the transformer case and to the panel frame. A mid-tap is provided on the secondary side which supplies high voltage of the correct polarity alternately to the two tubes. A safety gap is provided across the secondary terminals of the plate transformer which automatically prevents the use of excessive power.

The *plate blocking condensers* are of .001 microfarad capacity. They prevent the 500-cycle power from backing into the tank circuit; also furnish a low impedance path for the radio frequency currents in the plate circuit to the tank inductance. Safety gaps are provided on the plate blocking condensers.

The *plate excitation condenser* is of .002 microfarad capacity.

The *grid excitation condenser* is of .014 microfarad capacity.

The plate and grid condensers also comprise the tank capacity.

The *filament by-pass condensers* are each of 1 microfarad capacity.

The *choke coils* in the plate leads prevent radio frequency currents from entering the secondary of the transformer which would rupture the insulation causing the transformer to burn up.

The *choke coil* in the grid lead prevents the generation of ultra high frequency oscillations as explained in a previous chapter.

The *grid leak resistance* provides a path for the direct current from the grid which gives the proper negative bias.

The *primary inductance* is strip-copper wound edgewise in the form of a helix.

The *secondary inductance* consists of strip-copper wound edgewise in the form of a spiral.

The *coupling* is varied by means of changing the number of turns in the secondary inductance instead of by varying the distance between the primary and secondary coils. Usually not more than two or three turns are required on the secondary inductance for proper coupling. The same number of turns usually suffice for all wavelengths.

The *variable tuning inductance* in the antenna circuit is fitted with a sliding contact which can be revolved by a handle in the front of the panel, permitting the inductance to be increased or decreased until resonance is secured.

The *two fixed antenna loading coils* are connected in series with the variable coil and by the use of clips, on flexible leads the correct number of turns can be engaged in each coil for the wavelength desired. By connecting the correct number of turns in these two coils it is possible to make adjustments whereby resonance is secured on the variable coil within a turn or fraction of a turn for all wavelengths. Thus if the operator desires to shift from 600 to 706 meters it is only necessary to move the wavelength switch in the front of the panel and the correct number of fixed turns are engaged for that wavelength, the maximum radiation is secured with perhaps only a slight or no adjustment of the variable inductance. Five wavelength positions are provided.

The *Type I Aerial Change-over Switch* is fitted with the necessary contacts that when placed in the transmitting position performs the following operation:—

(a) Closes the field of the generator.

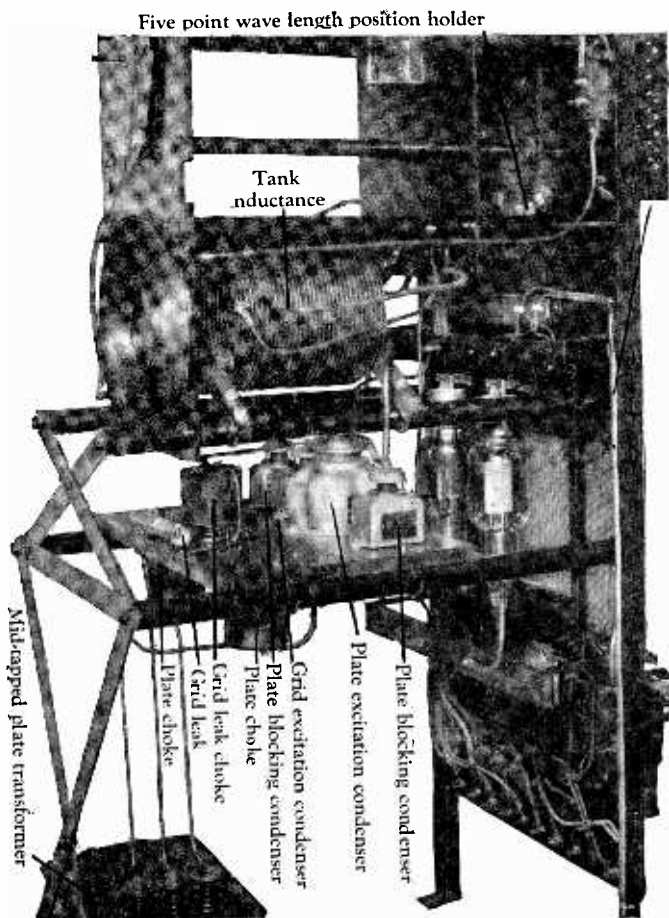

FIG. 188. Rear View of Model ET-3628 A.C.W. Tube Transmitter.

(b) Closes the primary of the plate transformer in series with the key.

(c) Starts the rotary converter that furnishes a.c. for lighting the filaments of the tubes.

(d) Starts and stops the motor generator in conjunction with the start-stop switch or allows motor to run while receiving.

(e) Opens the negative lead of the "B" battery circuit of the detector amplifier circuit thus preventing the radio frequency currents from burning out the audio frequency transformers.

(f) Connects the antenna to the variable loading coil of the transmitting secondary circuit.

When placed in the receiving position it:—

(a) Opens the field of the generator.

(b) Opens primary of plate transformer.

(c) Stops motor of rotary converter.

(d) Stops motor generator if desired.

(e) Closes negative lead of "B" battery circuit of receiver.

(f) Connects antenna directly to primary of receiver.

The numbered contacts stamped on the Type I switch usually connect to the following parts of the circuit:²

1. Terminal post 1 connects receiver to antenna.

2. Terminal posts 2 and 3 in series with negative "B" battery.

3. Terminal posts 4 and 5 spares.

4. Terminal posts 7 and 8 in series with the solenoid of automatic starter and also in series with start-stop switch if remote control is provided.

5. Terminal posts to 9 and 10 in series with the generator field. Also closes circuit starting filament rotary converter.

6. Terminal posts 11 and 12 in series with a.c. line to primary of transformer.

7. The base of the switch to ground by screw at the back.

8. Terminal post on top of the insulating tube marked "ANT. CKT" to the antenna lead.

9. Terminal post marked "OSC. CKT" to the antenna terminal of the transmitters.

The switch is in the sending position when the main switch blade is parallel to the base. In this position, it closes contacts 11 and 12 by short-circuiting the spring clips. The aerial is connected to the transmitter by the spring contacts on the "ANT. CKT" post making contact with the "OSC. CKT."

As the switch is thrown from the sending to the receiving posi-

² For converted tube transmitter only.

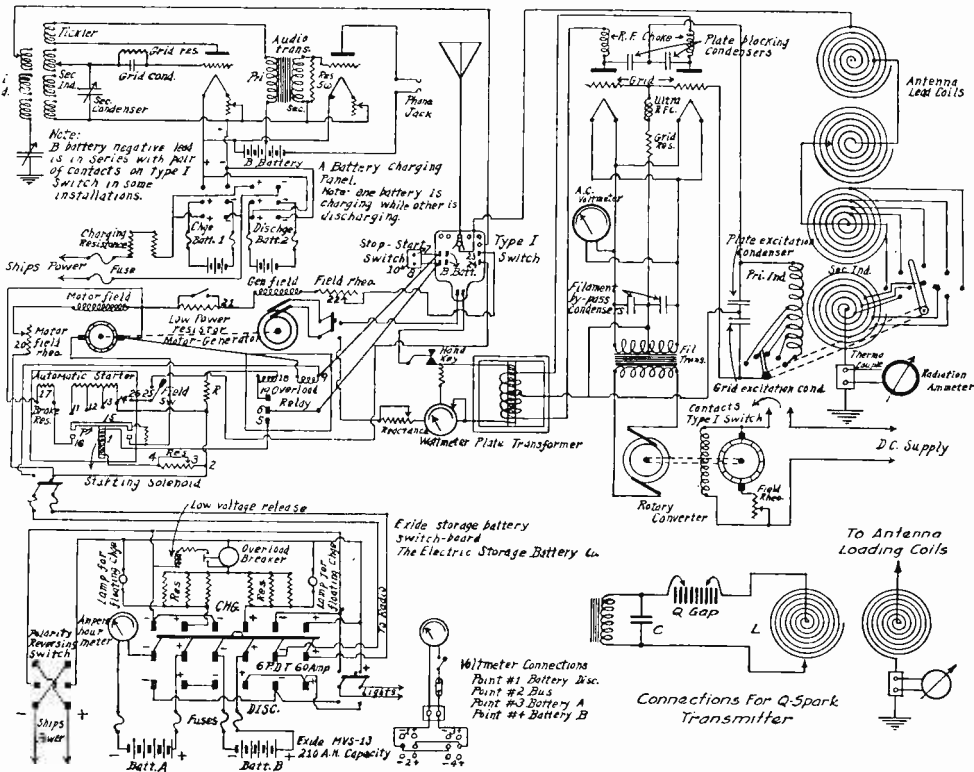

FIG. 189. Diagram of Model ET-3628 ACW Tube Transmitter. With Auxiliary Batteries, Charging Panel and Type 106-D Regenerator Receiver with I Stage Audio Frequency Amplifier.

Note: This complete diagram is acceptable for Commercial First or Commercial Second Class License examination should applicant be required to draw such a system. It can easily be arranged to show as a quenched spark system by leaving off center tap of plate transformer and connecting condensers in shunt to secondary and quenched gap in series with primary of oscillator transformer, as shown in lower right hand corner.

tion (main switch blade perpendicular with the base) the antenna is disconnected from the transmitter and connected to the receiver by the main switch blade opening the contacts at the top.

(*Caution.*) The contacts at the top consist of several fingers. They sometimes become bent in such a manner that to all appearances they seem to be disconnected from the copper tubing leading to the transmitting inductances when the switch is in the receiving position. A close inspection will disclose that one or more may still be making contact to the copper tubing. If this occurs the antenna is still grounded through the transmitting inductances. Signals may still be heard on the receiver but with considerable loss in audibility. It will also destroy the calibration of the primary receiver circuit.

The operator should also make sure that the fingers make good contact on to the copper tubing when the switch is placed in the transmitting position.

A study of drawing in figure 189 will show that the solenoid winding 1 of the automatic starter is connected to the positive pole of the d.c. line at point 2. The circuit continues through the resistance 3, by the switch 4, through the contacts 5 and 6 of the overload relay, through contacts 7 and 8 of the antenna switch, to a terminal of the winding 9, which is of negative polarity. Thus the solenoid winding *I* is connected in shunt to the d.c. line when either contacts 7 and 8 or the starting switch 10 is closed.

The switch 4 in shunt to the resistance 3 is automatically opened by the plunger *P* of the automatic starter when it is in full running position.

The resistance coils of the automatic starter, connected in with the d.c. line to the armature, are progressively cut out of the circuit at contacts 11, 12, 13 and 14 by the bar 15, when the circuit to the solenoid *I* is closed, the plunger *P* with the bar 15 moves in a vertical position, the acceleration being regulated by a piston drawn through a vacuum chamber when the contact is made between bar 15 and point 11, the circuit to the motor armature includes the entire set of resistance coils.

If upon starting the motor generator it may develop excessive speed which cannot be controlled by the motor field rheostat, it is apparent that the motor has no field. If allowed to run in this manner the overload relay should trip. In event it does not, the motor should be stopped at once to prevent injury to the armature.

The wires running to terminals 1 and 2 of the motor should be reversed and the machine started again. It will probably be found that the trouble has been eliminated and that the speed is

normal and can be controlled by the motor field rheostat. If the same trouble appears the field rheostat and field coils should be tested for an open circuit.

The trouble just described usually appears at the time of installation of a new transmitter.

The plunger of the automatic starter should be adjusted to reach the full running position within 12 seconds. A small regulating screw *P* in figure 190 is placed just underneath and in the center of the dash pot. If the screw *P* is turned to the right the plunger will move up slowly and if to the left rapidly.

When the circuit to the winding *I* is interrupted, either at point 10 or at the aerial switch contacts 7 and 8, the plunger *P* drops downward and through the medium of contacts 15 and 16, the resistance coil 17 is connected in shunt with the motor armature. The motor armature thus temporarily becomes a generator and owing to the power expended in setting up a current through the brake resistance 17 a powerful braking action is set up against the armature, bringing it to a quick stop.

The shunt field winding of the motor is connected in shunt to the d.c. line through the field rheostat 20. As the resistance is increased at 20, the speed of the motor increases, and consequently, the frequency of the a.c. generator.

The generator field winding is connected in shunt to the d.c. line through the low power resistance 21 and the generator field rheostat 22. The field circuit continues to the contacts 23 and 24 of the Type I switch, through the generator field switch 25, and finally to contact 26 of the automatic starter. The generator field winding remains open until the bar 15 attached to the plunger *P* of the automatic starter has touched point 26, when the bar of the automatic starter makes contact with point 14, the d.c. armature is connected directly to the main d.c. line.

The voltage of the a.c. generator may be increased by reducing the resistance of the generator field rheostat 22. It may be reduced by increasing the resistance of the field rheostat. Low values of a.c. voltage may be secured at the terminals of the generator by opening the switch in shunt to the low power resistance 21.

The overload relay has the magnet winding 9, which may be called the tripping magnet, and the second magnet winding 18, the holding magnet. If more than a predetermined number of amperes, usually 35 for normal working, flow through the winding 9, the lever 6 is drawn up, breaking the circuit of the solenoid winding 1, through contacts 5 and 6. Immediately afterward the

circuit through winding 18 and resistance is closed through contacts 6 and 19. This causes the lever 6 to be held in that position until either the main d.c. line switch or the starting switch 10 is opened.

When type *I* aerial switch is thrown to a transmitting position the motor generator is automatically started, provided the main d.c. line switch is closed. It will be brought to a quick stop when the antenna switch is placed in the receiving position, provided the starting switch 10 remains open. If the switch 10 is closed the motor generator can be kept in a continuous state of operation during the receiving period.

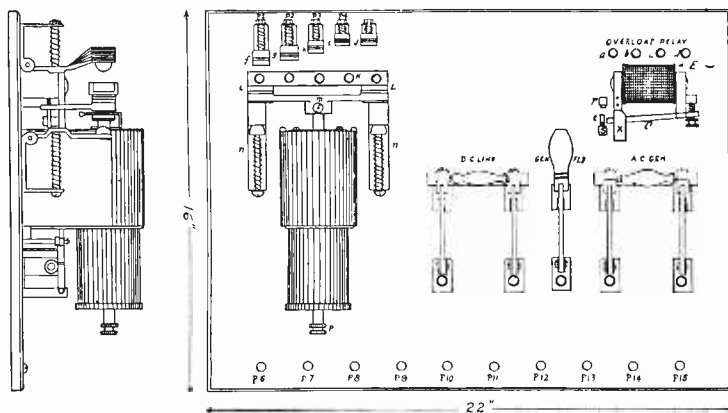

FIG. 190. Control Panel of 2-Kilowatt Automatic Starter.

The *overload relay* consist of an electro-magnet having an armature which has its distance from the poles of a magnet adjustable so that for each adjustment a certain strength of current is necessary to lift it. This armature operates a contact which, when in the down position, closes the circuit through a solenoid starter and when in the upper position, or after it has been lifted by the magnet, it engages the upper contact which closes a circuit through the holding winding, thus holding the lower contact open.

When the lower contact is opened, the circuit through the starter solenoid is opened, and this causes the plate *K* in figure 190 to drop and open the circuit through the motor armature. As soon as the control switch is opened the armature of the relay drops and closes the circuit through the starter solenoid, but as

this circuit is still open at the control switch, it is necessary to close the control switch again to start the motor generator.

The coil *E* is composed of two windings. One is called a series coil and is in series with the motor armature so that all the motor current passes through it. When this current becomes excessive the armature *G* is raised and the contact between *T* and *S* is broken. This in turn opens the circuit between *K* and *F* of the starter.

When the armature is raised, a contact is made between *T* and *R* which closes the circuit through the shunt winding on the magnet which holds up the armature *G* until the control switch is opened.

A plate *X* has a scale indicating the point to which the armature must be set for different values of current. The screw *U* regulates this position. The normal working position of this relay is for 35 to 40 amperes. When a short circuit of overload occurs and this relay is opened, all that is necessary to re-start the machine is, to open and close the control switch unless there is a permanent short-circuit on the line, in which case the relay will again open the circuit. The short-circuit must be located and removed.

The shunt coil should be connected to *A* and *B* and the series coil to *C* and *D*. If the terminals of the shunt coil should become reversed for any reason, the relay will not work properly. This condition will be indicated by failure of the shunt coil to hold the armature up. When a short-circuit or overload occurs the armature will vibrate slowly. If this occurs, the terminals of the shunt coil should be reversed at *A* and *B*.

To remove the armature of the motor generator for repairs the following procedure should be followed:

1. Remove bearing bracket from the generator end by loosening bolts and removing same.

2. Lift brushes from commutator and collector rings.

3. Pull out armature and make repairs or insert spare.

58. To Replace Armature—

1. Hold up oil rings so as to permit shaft to pass through bearings.

2. Insert armature, taking care not to score commutator or collector rings.

3. Replace bearing bracket, and make sure armature rotates free by turning same over by hand.

4. Fit brushes to commutator and collector rings.

5. See that oil rings are working properly and that bearings are thoroughly oiled.

It should be noted that the mica of the commutator of this machine is undercut about $1/32$ inch, and before it gets flush with the commutator bars, the mica should be cut out again. High mica will cause excessive sparking at commutator.

A small rotary converter and stepdown transformer supply alternating current for filament heating. The rotary converter operates directly from the 110-volt d.c. ship's power line and supplies about 70 volts, 60 cycles, a.c. to the primary of the filament transformer, which steps this voltage down to 11 volts for the tube filaments.

59. Operation—Cut in all filament rheostat and start filament rotary converter. See that filament voltmeter is indicating and that filaments of tubes are lighted. Set field rheostat controls with all resistance in and start the motor generator. Adjust filament voltage to 11 volts. Press key and adjust power to 500 watts as shown by wattmeter. Set wave change switch on wavelength desired and resonate open circuit by means of the variable inductance handle until maximum radiation is obtainable. The resonance point is sharp and the variable inductance must be adjusted slowly and carefully, otherwise, the resonance point may be passed over without noticing it. Increase power to amount necessary for efficient communication.

If the open and closed circuits are in resonance sparking across the safety gaps on either the secondary of the transformer or plate blocking condensers will occur when the power is increased to about 1,500 watts (1 1/2 K.W.). If the circuits are not in resonance sparking will take place even when low power is being used and no attempt should be made to increase the power until the two circuits are in resonance. With the average antenna, radiation of 10 to 12 amperes may be expected at about 1 1/2 K. W. No attempt should be made to use power in excess of 1 1/2 K.W. Make all adjustments for resonance on low power.

The filaments should be operated at not more than 11 volts and not less than 10 volts. If, on the other hand, the filament voltage is too low, the tube plates will overheat when the key is depressed even though normal power is being used. With transmitter in operation handling traffic and all adjustments properly made, the tube plates should not heat beyond a cherry red.

60. Maintenance—The filament rotary converter should be kept oiled and commutators clean. All parts of the transmitter must be protected from water and spray and kept clean and dry

at all times. The bakelite panel and rods and the treated maple boards used in the set should, in particular, be wiped off with a dry cloth every day. Should the transmitter accidentally get wet

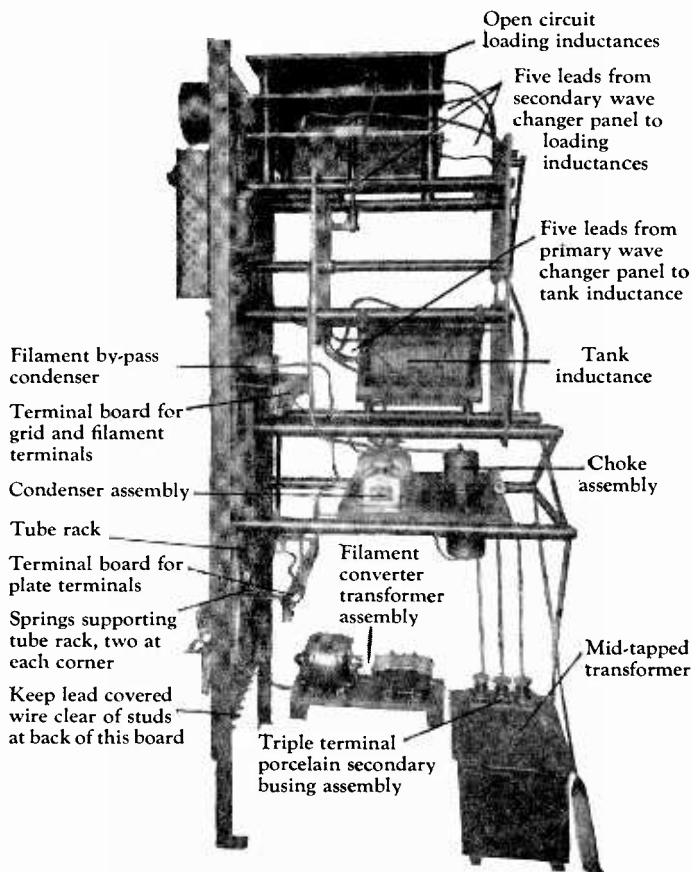

FIG. 191. Side View of Model ET-3628 A.C.W. Transmitter.

it should not be started until it has been wiped off and the insulation and choke coils have become thoroughly dry. The bearings of the 2-K.W. motor generator should be kept oiled and the commutators cleaned and free of sparking.

61. Troubles and Remedies—The circuit used is very stable

and can be relied upon to operate satisfactorily under all conditions where the apparatus is not defective, except two conditions, as follows:

1. The oscillations will not start when the key is closed if there is a poor connection in the tank circuit or an intermittent breaking down of the tank circuit insulation either to ground or in the condensers.

2. When the antenna coupling is too tight the maximum antenna current cannot be obtained as the tank circuit will shift frequently when approaching resonance of the antenna circuit.

When the antenna is small or the resistance very low, it will be found that the maximum output may not load the tubes to their full rating and, under these circumstances, no attempt should be made to increase the loading by overvoltage or change in circuits other than careful tuning and use of proper value of coupling.

62. Swinging Signals—Signals from these transmitters may swing slightly in rough weather due to the rolling of the ship, changing the antenna capacity. The antenna should be pulled taut to minimize this as much as possible. However, should excessive swinging be complained of, it will probably be because the secondary circuit is too closely coupled to the primary.

The coupling should be loosened by decreasing the number of turns used in the secondary of the oscillation transformer. Any change in the number of turns used in the secondary coil must be compensated for by a corresponding change in the aerial inductance to bring the set back into resonance.

63. Burned Out Plate Choke Coil—If no spare is available the grid leak choke coil, which is not essential to a satisfactory operation, may be removed from its place in the circuit and installed in place of the defective plate choke.

If this is done, the leads removed from the grid leak choke must be connected together to complete that circuit. The plate chokes and the grid leak chokes are exactly the same electrically and mechanically and are interchangeable. Another method of making temporary repairs is to use two 400-turn honeycomb coils connected in series, or an equivalent inductance, to replace a defective plate choke.

64. Set Fails to Oscillate or Tubes Heat Badly—Tighten all connections in tank and open circuits. See that wave change switch arms are making good contact. This is very important. See that sliding contact on antenna variable inductance is making good connections. Examine ground connections and see that they

are tight and clean. Check circuit with diagram to see that all connections are properly made. If trouble persists, change tubes.

65. Burned Out Filament Voltmeter—Reduce filament voltage until tube plates begin to overheat using normal power on the plate circuit. Then increase filament voltage slowly until tubes operate at normal temperature.

66. Burned Out Wattmeter—After circuits have been resonated increase power until satisfactory radiation is obtained or until sparking occurs at the safety gaps.

67. Burned Out Radiation Ammeter—Adjust aerial inductance in accordance with tuning record card and make final adjustment by watching wattmeter. Insert 40- or 50-watt light in aerial circuit. Operate at reduced power until circuits are in resonance as indicated by maximum glow of light. After securing resonance short out light and increase power.

68. Burned Out Filament Converter, Filament Transformer or Filament Rheostat—Disconnect all of these units and connect filament terminals directly to a five-cell lead-acid storage battery which will supply approximately the right filament voltage (10 volts). Leads formerly connected to the mid-tap of the filament transformer should be connected to the negative side of the storage battery.

The regular filament rheostat cannot be used with a storage battery as it will not carry the heavy current flowing directly in the filament circuit. However, the voltage of a five-cell storage battery should be so close to normal that no regulation will be required.

69. Burned Out Grid Leak—The resistance of the grid leak used on this transmitter is 4,000 ohms. Should the grid leak become burned out with no spare available, a suitable resistance could be made up from material available on board ship by using a piece of rubber hose about a foot long, filled with salt water and plugged at both ends with wires extending through the plugs at both ends and making contact with the salt water in the hose. A little experimenting with the length of the hose to be used should result in obtaining the proper value of resistance for satisfactory operation. Any suitable resistance having a value between 2,000 and 10,000 ohms may be used.

70. Filament Converter Fails to Start—In some cases the filament converter may not start immediately when the circuit is closed if maximum resistance is cut in with the filament rheostat. In such cases the armature of the converter should be turned over immediately by hand.

71. Trouble in One Side of Circuit Which Cannot be Repaired at Sea Due to Lack of Material—Spare tubes, a spare plate choke, spare grid leak and spare transformer secondary sections should be aboard at all times. If necessary, this set may be operated at reduced power with only one good tube, one good plate choke, one good blocking condenser, or only one side of the secondary of the power transformer. Should there be available only one good tube, one good plate choke, one good plate blocking condenser, or only one-half of the secondary of the plate transformer, the defective part should be removed from the circuit and the lead to the plate transformer on that side disconnected.

The set may then be operated at reduced power on one tube, with about half the normal radiation. If only one tube is used care should be exercised to reduce the filament voltage to normal.

In the event of irreparable damage, making it impossible to use even one side of the circuit, a "plain aerial" spark transmitter for emergency use only may be made by removing all connections from the three secondary terminals of the plate transformer and connecting the antenna to one outside secondary terminal of this transformer and the ground to the other outside secondary terminal. The safety gaps on the secondary terminals will then serve as a spark gap; necessary changes may be quickly made by disconnecting the flexible lead from the secondary of the oscillation transformer, lengthening this lead as much as necessary and connecting it to one side of the power transformer. The other side of the power transformer should then be connected to the piece of copper tubing leading from the secondary of the oscillation transformer to the thermo unit of radiation ammeter. This will tune the circuit and permit of reading the radiation on the radiation ammeter. It is very improbable that it will even be necessary to resort to the use of the plain aerial circuit and such circuit should never be used unless the vessel is in distress and the transmitter damaged so that it cannot be made to function normally.

72. Insulation—Porcelain, micalex, or glass antenna insulators should be used throughout with this type of transmitter. If other forms of insulation are used there is likely to be an excessive drop in radiation during wet weather.

UV-204-A Radiotrons—The UV-204-A tubes used in this transmitter are provided with a XL or thoriated filament.

The UV-204-A tube has a normal power rating of 250 watts output. The current required for filament heating is 3.85 amperes. The filament voltage must never exceed 11 volts. The use of a low voltage will greatly increase the life of the tubes. Satisfactory

operation should be possible at all times with the filament voltage adjusted to between 9 and 10 volts.

The terminals on the base of the transmitter are all numbered as well as the terminals on the motor-generator, starting resistances,

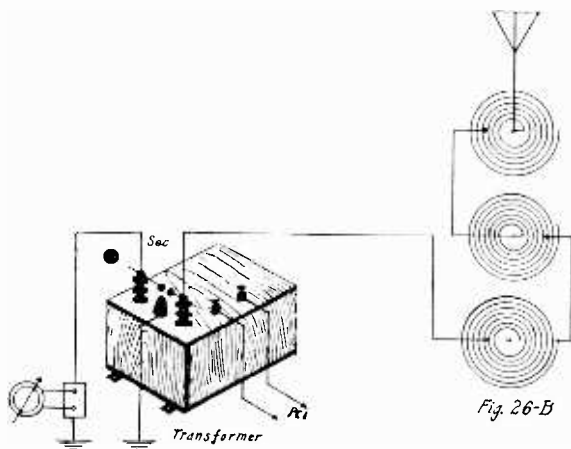

Fig. 26-B

Note

Adjust gaps so that discharge takes place between safety gaps of transformer and not from safety gaps to point projecting upward from case of transformer

FIG. 192. Connections for Plain Aerial Circuit in Emergency.

and type I switch. Lead-covered wires leading from these terminals run to the following connections.

Terminal post *P-6* on panel (two wires), one wire leading to *B-1* of starting resistances, one wire leading to terminal 2 motor.²

² The fifth contact of automatic starter closes generator field.

Terminal post *P-7* on panel to terminal post 1 of motor.

Terminal post *P-8* on panel to terminal post 3 of motor.

Terminal post *P-9* on panel to terminal post 8 of type I switch.

Terminal post *P-10* on panel to terminal post 7 of type I switch.

Terminal post *P-11* on panel to terminal post 5 of generator.

Terminal post *P-12* on panel to terminal post 10 of type I switch.

Terminal post *P-13* on panel to terminal post 9 of type I switch.

Terminal post *P-14* on panel to terminal one side of key.

Terminal post *P-15* on panel (two wires). One wire leading

to terminal post 11 on type I switch. One wire leading to primary of transformer.

Terminal post *P-16* blade of a.c. generator switch (two wires).

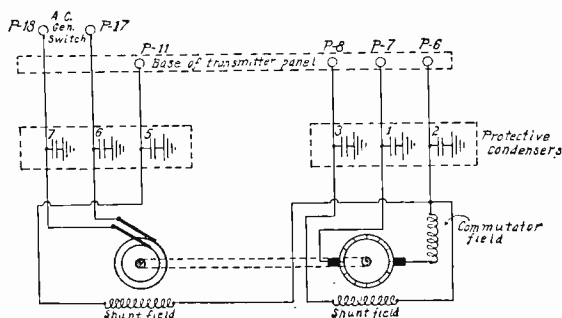

FIG. 192a. Internal and External Connections of 2-Kilowatt Motor Generator.

One wire leading to other side or primary of transformer. One wire to wattmeter.

Terminal post *P-17*—Contact of a.c. generator switch to terminal post 6 of a.c. generator.

Terminal post *P-18*—Contact of a.c. generator switch to terminal post 7 of a.c. generator.

Terminal post *P-19*—Contact of d.c. switch to d.c. line.

Terminal post *P-20*—Contact of d.c. switch to d.c. line and one side of filament rotary converter.

B-2 of starting resistance to dynamic brake contact of automatic starter.

R-1 of starting resistance to first contact of automatic starter.

R-2 of starting resistance to second contact of automatic starter.

R-3 of starting resistance to third contact of automatic starter.

R-4 of starting resistance to fourth contact of automatic starter.

73. Model ET-3650 Emergency Transmitter—The model ET-3650 (RT-30-A and RT-30-B) radio telegraph transmitter and associated equipment, described in this instruction book is designed primarily for installations on vessels where a low power emergency transmitter is required.

The operator is urged to study these instructions carefully in order to become familiar with the characteristics of the transmit-

ter and to permit him to secure maximum performance from the equipment at all times.

74. Component Units—Each transmitting equipment consists of the following component units:

For 12-Volt Power Supply

1 Radio transmitter, model ET-3650 (RT-30-A)

1 Motor-generator set rated:

Motor: model 3318, type SD, 12 volts, 2340 r.p.m.

Generator: model 3316, type SA, 350 cycles, 110 volts, 1.5 amp.

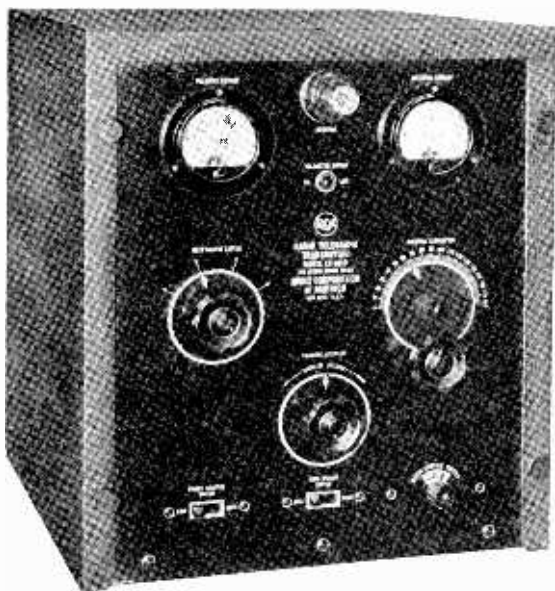

FIG. 193. RCA Model ET-3650 Emergency V.T. Transmitter.

For 110-Volt Power Supply

1 Radio transmitter, model ET-3650 (RT-30-B)

1 Resistor unit

1 Motor-generator set rated:

Motor: model 33319, type SD, 95/115 volts, d.c., 1.6 hp.

Generator: model 33317, type SA, 350 cycles, 110 volts, 1.5 amp., 2340 r.p.m.

75. Electrical Characteristics of the Transmitter—The transmitter is designed to deliver 25 to 50 watts of seven hundred and fifty cycle modulated power into an antenna whose characteristic fall is within the limits given below:

Effective Capacitance—.0006 to .0014 mfd.

Effective Resistance—4 to 10 ohms.

Fundamental Wavelength—225 to 450 meters.

76. Wavelength Range—The transmitter is designed to cover the wave band of 600 to 800 meters. Any one of four different wavelengths in this band is selected by means of a wave change switch.

77. Method of Signalling—ICW telegraph is the only method of signalling provided.

78. Vacuum Tubes—A total of four vacuum tubes type UX-210 as power oscillators are used in the transmitter.

79. Power Supply—The model ET-3650 transmitter is designed for operation on either a 12-volt d.c. or 110-volt d.c. power supply.

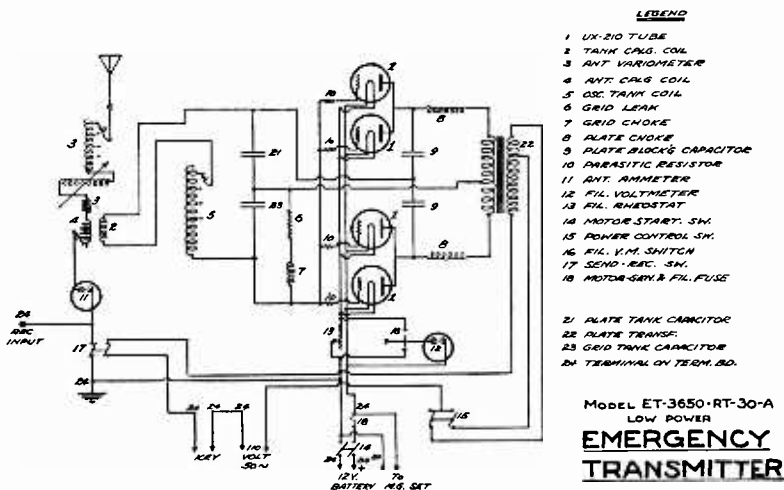

FIG. 194. Wiring Diagram of Model ET-3650 (RT-30-A) Transmitter. (12-Volt D.C. Supply.)

The model ET-3650 (RT-30-A) transmitter is designed for use on a 12-volt d.c. power supply while the model ET-3650 (RT-30-B) transmitter is designed for use on a 110-volt d.c. power supply.

Care should be exercised during the installation of the transmitter to make sure that the proper transmitter is used on the available power supply.

80. Transmitter Construction—The general construction of the transmitter may be understood by reference to the photographs included in these instructions. The various units are mounted either on the panel or frame work. Particular attention has been directed to secure a symmetrical arrangement of all units on the panel. The sides, back and top of the transmitter are provided with a detachable shield which makes the transmitter splash proof and also permits the transmitter to be close to a metal bulkhead without affecting the adjustments of the transmitter.

The four vacuum tubes are mounted on a cradle near the top of the set while all meters, switches and rheostats are mounted on the panel and controlled from the front of the panel.

The desired wavelength is selected by means of a wave change switch. This switch also selects the proper tap on the antenna loading inductance coil and the antenna circuit is resonated by means of the antenna variometer. All controls on the panel are marked according to the particular function that they perform.

All incoming leads to the transmitter are brought into a terminal board which is located on the right side of the transmitter. The main power supply line fuses are located on this terminal board. A send-receive switch is provided on the panel and wired to the terminal board, to permit quick change over from send to receive.

The antenna lead is brought out through a bushing in the front of the panel.

81. Installation and Wiring—A diagram of connections both internal and external for the model ET-3650 (RT-30-A) transmitter is shown in figure 194 while figure 195 is the diagram of connections for the model ET-3650 (RT-30-B) transmitter. The transmitter proper should be firmly bolted to the table by means of bolts which pass through the mounting holes in the base of the transmitter. The motor-generator set should be mounted as near the transmitter as is convenient.

The size of wire recommended for all external connections is given on the wiring diagrams. If the transmitter is mounted close to a wall or bulkhead it is desirable to leave sufficient slack in the leads to enable the transmitter to be pulled away slightly for accessibility.

82. Theory of Operation—Before considering in detail the procedure for adjusting the transmitter to any desired wavelength

within its range, it is well to understand the theory of operation of the various circuits involved. Reference will be made to schematic diagram figure 194 which is a schematic diagram of the type (RT-30-A) transmitter. The same circuit is used in both the (RT-30-A and RT-30-B) transmitter.

The circuit used is of the full wave self rectified, Colpitts capacity coupled type, inductively coupled to the antennae. A total of four UX-210 tubes as power oscillators are used, two on each half of the wave.

350-cycle power is supplied to the anodes of the radiotrons through the step-up transformer labeled 22 in figure 195. The

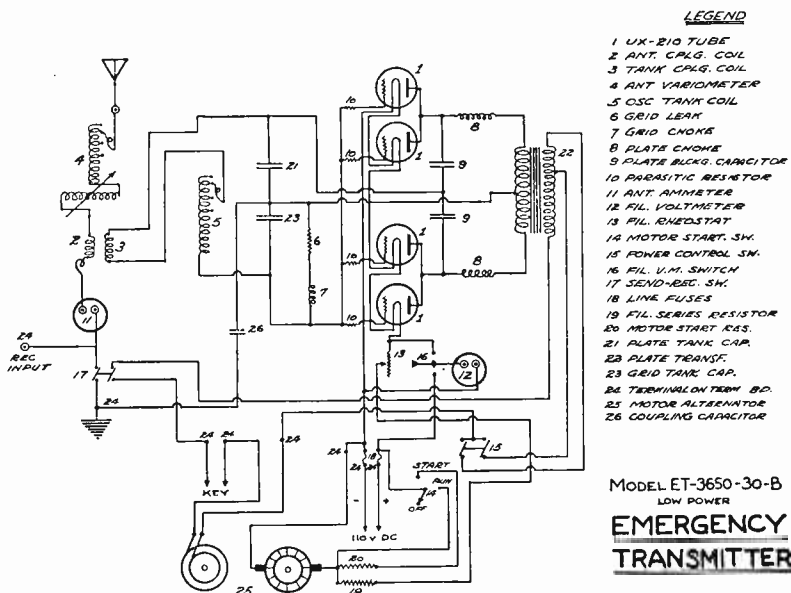

Fig. 195. Wiring Diagram of Model ET-3650 (RT-30-B) Transmitter. (110-Volt D.C. Supply.)

anodes are then capacity coupled through capacitors 9 to the tank circuit which is made up of capacitors 21 and 23 and inductances 5-5 and 2. The grid leak circuit is made up of inductance 7 and resistance 6. The antenna system is inductively coupled to the tank circuit by means of coupling inductance 3. The antenna system is resonated to the tank circuit frequency by means of variometer 4. A particular tap is selected on this variometer by

means of a wave change switch which also selects the tank circuit frequency. Resonance is indicated by means of antenna ammeter 11. The filaments of the Radiotrons are adjusted by means of rheostat No. 13 and voltmeter 12 indicates both filament and line voltage through the intermediary of switch 16.

The set is keyed by means of an external key connected in the primary of the plate transformer.

83. Adjustment of Transmitter—The following procedure is recommended for adjusting the transmitter to any frequency within the band of 600 to 800 meters. First remove the shield over the top and sides of the transmitter. This exposes all the variable elements of the transmitter which are required in order to adjust the wavelength to any definite value. It will be noted that a four-position wave change switch is provided which permits the wavelength of the transmitter to be rapidly changed from one definite value to another. For the purpose of simplicity the adjustment to only one definite frequency will be explained as the procedure for adjusting the transmitter to any other definite frequency will be the same.

First select the shortest wavelength that the transmitter has to operate on. Then place the wave change switch in position "A." Select the tap on the spiral wound coil that corresponds to the "A" position on the wave change switch and clip it on the coil. Next, on the antenna coupling coil located at the left rear of the set, place the link connection on the second tap of the coil. Power can not be placed on the transmitter and is done in the following manner; with the power control switch in the "Low" position, the send-receive switch in the "send" position and the voltmeter switch in the "Filament" position, place the motor starting switch in the "Run" position (Note—The type RT-30-A has only a single-step starting switch while the type RT-30-B has a two-step starting switch which should be advanced to the "Run" position after a period of 10 to 15 seconds had elapsed). This lights the filaments and starts the motor-generator. Now adjust the filament voltage to 7.5 volts on the 12-volt set and to 30 volts on the 110-volt set by means of the filament rheostat. The wavelength at which the transmitter is oscillating can now be measured with a wave meter and if found too high or too low the transmitter should be shut down by placing the motor starting switch in the "off" position after which the flexible connection on the spiral wound coil can be moved, either adding or diminishing the number of turns depending upon whether the wavelength has to be raised or lowered. Now select the flexible

connection on the wave change switch (bank nearest the panel) corresponding to the shortest wavelength and connect it to one of the taps on the antenna variometer. Resonate the antenna by means of rotating the antenna variometer and observing the antenna ammeter reading. One or two trials may be necessary before the proper tap on the antenna variometer is selected in order to resonate the antenna.

The tap on the antenna coupling coil may now be changed in-

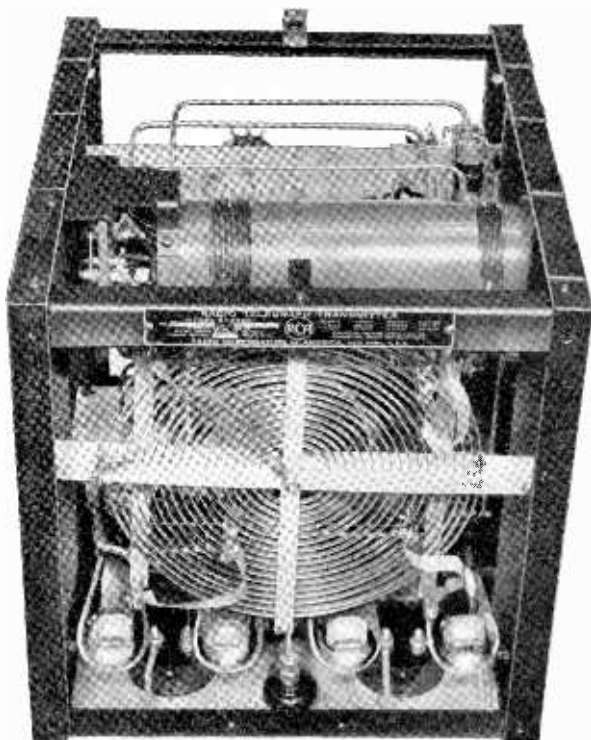

FIG. 196. Interior View of Model ET-3650 Transmitter.

creasing the number of turns in the coil until a point is reached where the antenna current breaks sharply when the antenna variometer is swung through resonance, after which it should be dropped back one tap.

Place the shield over the set and again check the wavelength. If found to be too high or too low remove the shield and decrease or increase the number of turns accordingly on the spiral-wound coil. The power control switch may now be placed in the "High" position but it is not recommended to use this position for general communication. The same procedure should be followed for adjusting the set to the remaining wavelength desired.

The operator should be careful to shut down the motor-generator every time he makes an adjustment of any kind on the inside of the set.

A typical set of performance data is shown in the following tabulation. It is understood of course that these readings hold only for the particular antenna characteristics specified and some variations from them will always be obtained in practice.

TYPICAL PERFORMANCE OF MODEL ET-3650 TRANSMITTER

| Wave-Length | Ant. Cap. | Ant. I High Power | Ant. L Low Power | Ant. Res. | Ant. Vario Tap |
|-------------|-----------|-------------------|------------------|-----------|----------------|
| 600 | .0006 | 2.4 | 1.8 | 8 | 2 |
| 676 | .0006 | 2.3 | 1.7 | 8 | 2 |
| 800 | .0006 | 2.3 | 1.6 | 8 | 5 |
| 600 | .0014 | 2.65 | 2.0 | 8 | 1 |
| 676 | .0014 | 2.55 | 1.9 | 8 | 1 |
| 800 | .0014 | 2.4 | 1.9 | 8 | 3 |

84. General Maintenance of Transmitter—The transmitter should be periodically inspected to make sure that all parts are operating in a satisfactory manner. The various connections should be kept tight and the switches operating smoothly. The bearings of the variometer should be lubricated occasionally with a light grade of oil.

85. Rating of Component Parts—In order to facilitate identification of any unit in the transmitter and to help in ordering renewal spare parts, the following list of component units is given.

When ordering parts, the model and type numbers of the radio transmitter itself should be given together with the complete designation as given in the following list.

- 1 Plate blocking and tank capacitor assembly model UC-2544.
- 2 Tank coupling coil T-7650601.
- 3 Antenna coupling coil T-7650601.

- 4 Antenna variometer T-7650602.
- 5 Oscillator tank coil T-7750600.
- 6 Grid leak style s89002 6000 ohms.
- 7 Grid choke T-7650603-G2.
- 8 Plate choke coil T-7650603-G2.
- 9 Grid parasitic resistors style 551969.
- 10 Antenna ammeter style CX N-605417.
- 11 Filament voltmeter (Type RT-30-B) style CX N-605608.
Filament voltmeter (Type RT-30-A) style CX-323839 12 volt.
- 12 Filament rheostat (Type RT-30-A transmitter) P-7750601.
Filament rheostat (Type RT-30-B transmitter) P-7750601.
- 13 Motor starting switch (type RT-30-A transmitter) style 551963 motor start switch (type RT-30-B transmitter) style 551966.
- 14 Power control switch style 551964.
- 15 Filament voltmeter switch style 552385.
- 16 Send-receive switch style 551965.
- 18 Filament fuse (Type RT-30-A transmitter) style 37170. Filament fuse (Type RT-30-B transmitter) style 37160.
- 20 Wave change switch T-7650604.
- 21 Plate transformer style S026K-679.
- 24 Model (F) .01 mfd. capacitor (used on type RT-30-B transmitter).
- 22-23 External resistor unit used only on Type RT-30-B style 551968.

CHAPTER 9

RADIO BROADCASTING EQUIPMENT

1. Introduction—During the last year or two considerable advancement has been made in the art of radio broadcasting. In fact, this branch of the industry has rapidly become specialized to a degree whereby the operation of the apparatus must be under the supervision of a competent engineer with properly trained assistants. For the benefit of those radiotelegraph operators who may be interested in entering this branch of the profession it may be well to say that radio broadcasting stations differ in practically every way from those stations designed for radio telegraphy. Instead of being concerned with the handling of messages through static and interference the broadcasting engineer and operator are engaged in the transmission of entertainment or educational material. The wires leading to the transmitter are telephone wires, not telegraph, and at the other end there is a microphone and amplifier instead of a key. It is the purpose of this chapter to provide a means whereby the student and operator may gain some knowledge of modern broadcasting operation. In order to do this the author has chosen to describe in detail the apparatus and procedure of operating a 5-kilowatt broadcasting transmitter and associated equipment. The reason for choosing this particular transmitter will be shown later.

2. Governmental Regulation—The operation of all broadcasting transmitters in the United States and territories is done in accordance with licenses issued by the Federal Radio Commission as provided by the Radio Act of 1927. The licensing authority prescribes certain regulations for operation in order to insure that the listening public will receive a maximum of service from each individual station.

One such regulation requires that the transmitter while in operation must not deviate more than 500 cycles from its assigned frequency. A violation of this regulation liables the owner of the station to cancellation of the station license.

3. Increased Service Range of Stations—The service range of a broadcasting transmitter may be defined in the following terms: The modulated signal from the transmitter must have an

audibility so as to be above the average interference level comparable to the music level of a phonograph record above the scratch noise of the needle. In engineering practice the signal strength of a station is measured by its field intensity in units of milli-volts or micro-volts per meter. A full discussion of the derivation of these terms and the method and apparatus used in field strength measurements will be found in a later chapter.

4. Commercial Accomplishments—Stimulated by such government regulations as shown above and by demands of the listening public for increased service range of stations, the various commercial companies engaged in the manufacture and sale of apparatus have abandoned the old apparatus and methods and in their stead have produced equipment which in operation insures stability of frequency, increased modulated power and, finally, improvements in transmission characteristics.

5. Piezo Crystal Control of Frequency—Radio engineers recognize that at this time the only method whereby a transmitter can be maintained on its assigned frequency with any degree of accuracy is by means of a piezo-electric quartz plate oscillator under temperature control. The piezo-electric quartz plate is generally mounted inside of heat insulated boxes the temperature of which is regulated by means of a heater and thermostat. This insures that the temperature of the quartz plates will be maintained within a fraction of a degree. A fractional degree change above or below the calibrated temperature of the quartz plate will mean less than 10 or 15 cycles shift in frequency. It can thus be seen that this small change is far in excess of the accuracy required by the Federal Radio Commission.

6. Increased Percentage of Modulation—Hereto before it has only been possible to obtain approximately 50 per cent modulation of the carrier frequency. When it is considered that the distant effect of broadcasting a transmitter is dependent for one thing upon the strength of the modulated signal, any accomplishment along the line of producing a higher degree of modulation will consequently increase the service range of a station. This is exactly what has been done in the latest type of equipment. The degree of modulation has been increased to such a value as to be spoken of as "100 per cent modulation."

The owners of stations fortunate enough to be operating with such modulating systems report considerable increase in transmission range together with uniformity of transmission of both voice and musical frequencies.

So widespread has become the interest in this new method of

modulation that one hears everywhere in the radio fraternity the talk of "100 per cent modulation."

7. Source of Developments—The developments mentioned in previous paragraphs have primarily come from Bell Telephone Laboratories (which are the research laboratories of the American Telephone and Telegraph Co. and the Western Electric Company), from the General Electric Company and from the Westinghouse Electric and Manufacturing Company. Space will not permit the story of the parts played by each in these developments—nor will it permit of detailed description of the various transmitters and associated equipment manufactured by each.

8. Reason for Describing One Particular Line of Equipment—In order to give the student and operator an insight into modern radio broadcasting it has been thought best to choose one example of the most generally used equipment (Western Electric) and to describe this type in such minute detail as to permit a good understanding of the various engineering and operating tasks involved from the time the carrier is placed on the air, the program transmitted, until finally the station is closed down. In this way it will be possible to show how adjustments are made for power and frequency, testing and equalizing the telephone lines between the studio and transmitter, picking up and amplifying the programs and, in case of trouble, locating the cause and making repairs and finally the proper procedure for properly maintaining and caring for the apparatus.

The author has chosen for description the latest Western Electric 5-Kilowatt Broadcasting Equipment known as type 105-C. This description is taken by permission, with slight alterations, from the manufacturer's book of instructions. The type number of all the apparatus and the peculiar language of the art have been left in the text so that the student or operator may have a better opportunity to read his way into the current practice.

I. Description of Apparatus

A. General—The 5-C Radio Transmitter is rated at 5 K.W. unmodulated radio frequency input to the antenna and will modulate this carrier power 100 per cent. It may be operated on any carrier frequency between 500 K.C. and 1500 K.C., which corresponds to any wavelength between 600 and 200 meters and is equipped with facilities for working into an antenna having a value of resistance, at the carrier frequency, of from 15 to 600 ohms inclusive.

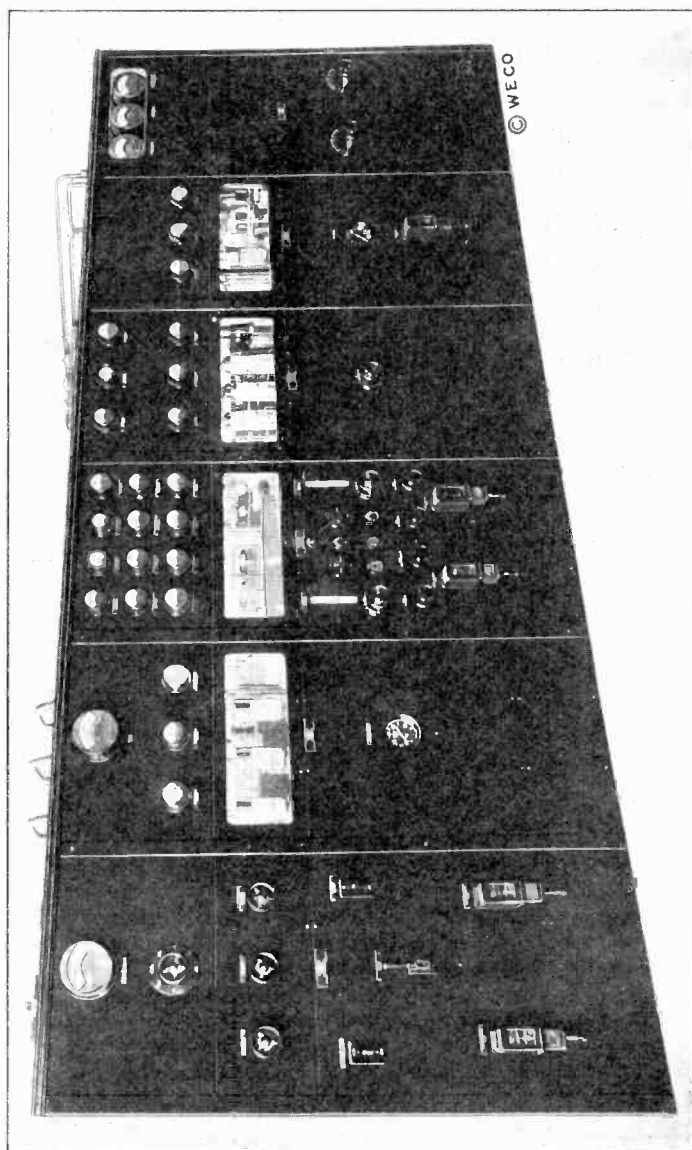

FIG. 197. 5-C Radio Transmitter Assembly.

Essentially, this transmitter consists of a low-powered radio-frequency oscillator, four stages of amplification which progressively increase in power, tuned circuits for transferring the output of the fourth or power amplifier to the antenna and the necessary apparatus for power supply. The oscillator is of the type whose frequency is determined by a piezo-electric element, thus insuring a high degree of stability in the carrier frequency. The modulating equipment is of a type which permits a much greater degree of modulation to be obtained than has heretofore been feasible.

A simplified schematic of the transmitter is shown in figure 198. In this circuit many of the control, protection and power supply circuits, as well as the filament circuits and the meters, have been omitted, but all of these features are shown on the complete transmitter schematic, and on the schematics of the units.

The transmitter is controlled by push-button switches on the panels. By operating a push-button on the A.C. Power Panel several relays are operated in the proper sequence, these relays in turn operating the component parts of the transmitter. The operation of a second button removes the power from all circuits.

The transmitter operates from a 220-volt, 60-cycle, 3-phase supply and consumes a power input of approximately 31 K.W. at a power factor of 92 per cent.

Adequate protection is afforded the operating personnel as the panels and the apparatus mounted on the front of the panels are either of the dead front type, or bakelite encased, or grounded; and the wire mesh fence is grounded. Opening the door in the side of the fence or any one of the windows operates safety switches which function to remove all high voltage from the transmitter. The equipment is also protected by fuses, overload relays and gaps.

This equipment, except for the larger pieces of apparatus such as the power transformer, the filter equipment and the rotating machinery, is mounted on six panel units designated as follows:

- No. D-87522—A.C. Power Panel.
- No. D-87523—Rectifier Unit.
- No. D-87524—Oscillator Unit.
- No. D-87525—Amplifier Unit.
- No. D-87526—Power Amplifier Unit.
- No. D-87527—Tuning Unit.

These units are lined up side by side to form the front of the transmitter assembly. The transformer and filter equipment are mounted on the floor behind the panel assembly and separated from

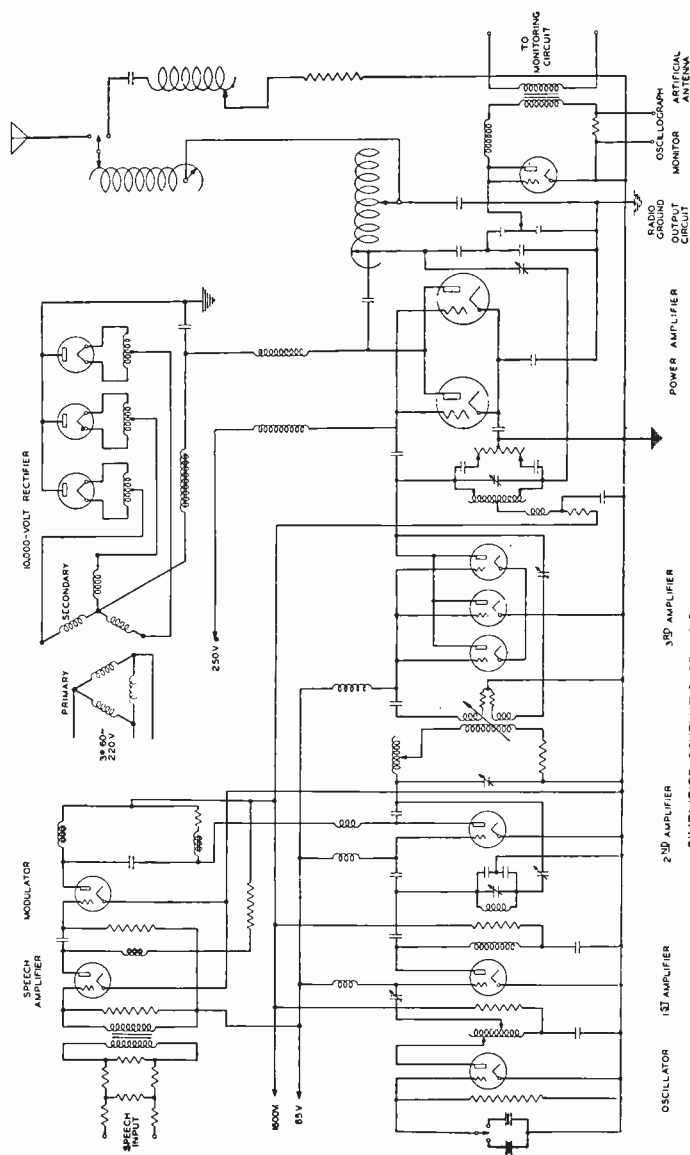

SIMPLIFIED SCHEMATIC OF NO.5-C RADIO TRANSMITTER

FIG. 198. Simplified Schematic of 5-C Radio Transmitter.

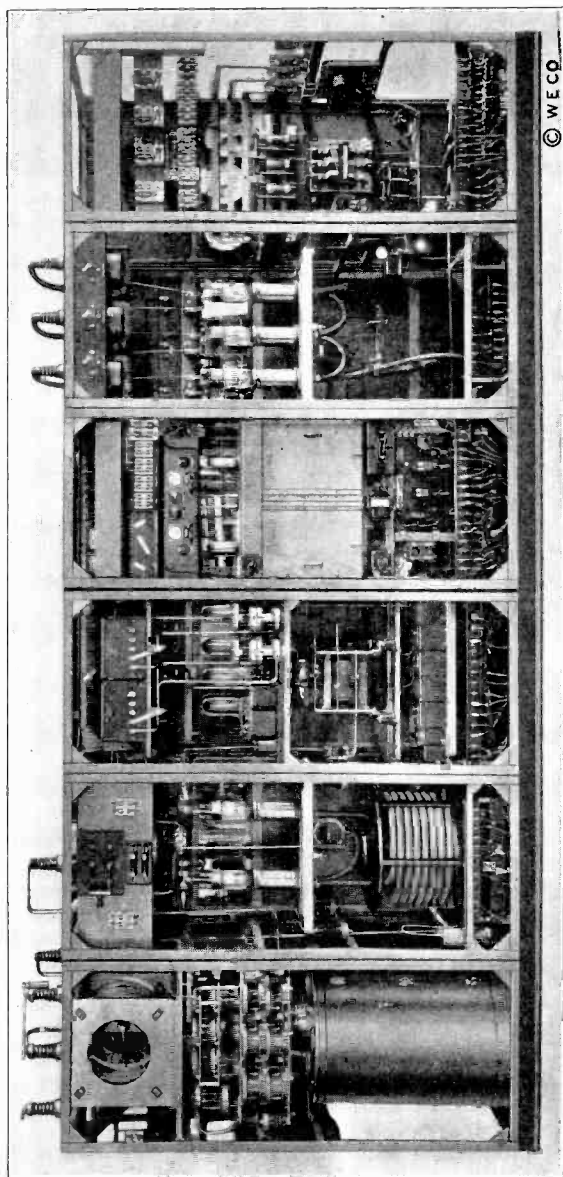

FIG. 199. Rear View of 5-C Radio Transmitter.

it by a passageway. A wire mesh fence with a door in one side encloses the entire assembly. A view of the assembly is shown in figure 198. A water pump, two air-blast radiators, an expansion tank and the necessary piping form a water-circulating system for cooling the high power tubes. This apparatus, together with the three motor-generators, is installed in a separate room in order to facilitate maintenance of the moving parts during operation and to isolate the noise and vibration of the rotating machinery.

B. D-87522 A.C. Power Panel—The No. D-87522 A.C. Power Panel contains the various relays and contactors used for controlling the distribution of the power supply to the various units in the set. The master control switch is located on the front of this unit.

C. D-87523 Rectifier Unit—The No. D-87523 Rectifier Unit contains three water-cooled rectifier tubes and associated meters and control apparatus. This unit, in conjunction with the power transformer and filter equipment mounted in the rear of the transmitter, forms a 10,000-volt rectifier to supply plate potential to the final or power amplifier.

D. D-87524 Oscillator Unit—The D-87524 Oscillator Unit contains the master oscillator and the first two stages of radio frequency amplification. This unit also contains control circuits for the d.c. generators used in connection with the transmitter and temperature control circuits for the piezo-electric oscillator.

E. D-87525 Amplifier Unit—The No. D-87525 Amplifier Unit contains the third stage of radio frequency amplification. It also contains an audio frequency amplifier and the modulating equipment.

F. D-87526 Power Amplifier Unit—The No. D-87526 Power Amplifier Unit contains the two water-cooled tubes and associated meters and apparatus for the final or power amplifier.

G. D-87527 Tuning Unit—The No. D-87527 Tuning Unit contains the tuned circuits for the power amplifier and circuits for transferring its output to the antenna. This unit also contains a monitoring rectifier used to check the quality of the output of the transmitter.

H. Transformer-Filter Assembly—The transformer-filter assembly consists of the apparatus mounted on the floor and pipe rack in the rear of the transmitter. This equipment includes the power transformer and filter equipment for the 10,000-volt rectifier and an artificial antenna for use while testing the transmitter.

I. Motor Generators—Of the three motor-generator sets

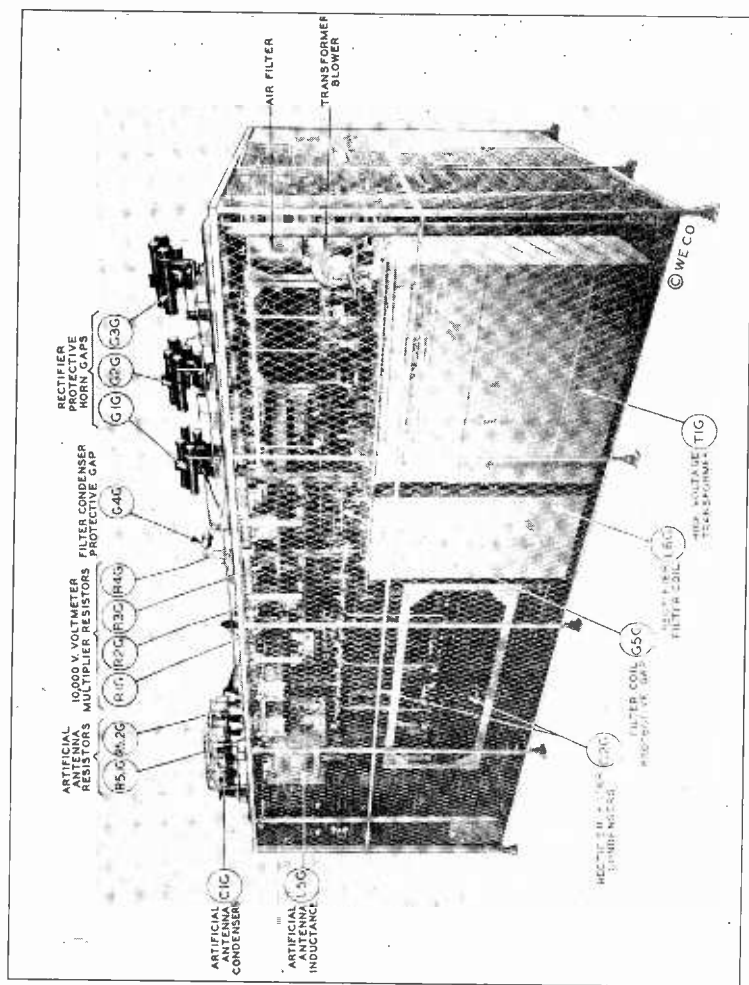

FIG. 200. Cage Back of Panels.

used as part of the transmitter, one has two generators: a 14-volt d.c. generator used to heat the filaments of the radiation cooled tubes, and a 1600-volt d.c. generator used to supply plate potential for the radiation cooled tubes. The 14-volt generator also supplies field excitation for the 1600-volt generator. The other two motor-generator sets have a single generator each one having a 22-volt d.c. generator which heats the filaments of the power amplifier tubes and the other having a 250-volt generator which supplies grid bias voltage for all tubes in the transmitter.

II. Description of Circuits

A. Control and Protection Circuits—The control and the protection circuits are so intimately connected that they may best be described together. It is the function of these circuits to control the application of power to the various units of the transmitter and to protect the transmitter from damage in case of the failure of any piece of apparatus. The larger portion of the relays, contactors, etc., which form part of these circuits are located in the a.c. power panel and the oscillator unit, although portions of these circuits are located in each of the other units.

The 220-volt, 3-phase power supply enters the transmitter at terminals 53, 54, and 55 on the a.c. power panel. From here the power goes to the main power disconnect switch $D4A$ and to the fuse cut-outs $F9A$. Beyond this point all power, except the power for the temperature control circuits which will be described later, is distributed through additional fuses to the various circuits.

The transmitter is started by the operation of the upper button of the master control switch $D3A$ located on the front of the a.c. power panel. Pushing this button closes a circuit from a battery through the window switches on the oscillator unit ($D9C$), the amplifier unit ($D1D$) and the tuning unit ($D2F$) to the master control relay $S5A$. If the windows in the front panels of the oscillator unit and the amplifier unit and the hinged panel in the front of the tuning unit are closed, this relay operates and locks up through one set of its contacts.

The second set of contacts closes the circuit to the control bus. Master control circuit fuses $F12A$ and branch circuit fuses $F1A$, $F2A$, $F3A$ and $F4A$ furnish fuse protection for these circuits. The operation of the lower button of the switch $D3A$ or the opening of any of the windows of the transmitter releases the master control relay $S5A$, thus removing power from the control bus and shutting down the transmitter.

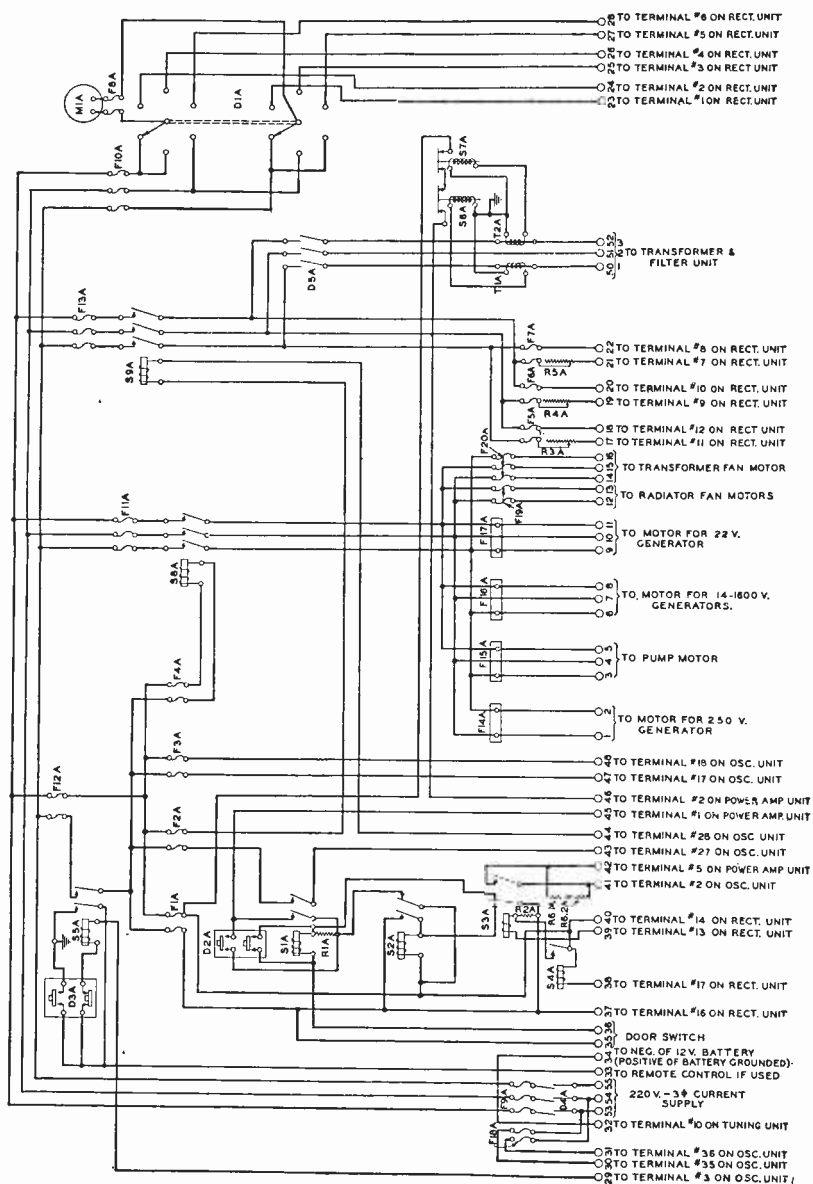

© WECO

FIG. 201. A.C. Power Panel Schematic.

Branch circuit I supplies power to operate the motor magnetic switch *S8A* which closes the power supply circuit to the motor-generator sets; the blowers for the radiators and for the high tension transformer, and the pump. Fuse protection for all motors is provided by the fuses *F11A*. Each motor circuit also contains either protector plugs (*F14A*, *F15A*, *F16A*, *F17A*) or fuses (*F19A*, *F20A*). The protector plugs are equipped with heat coils and fusible links. If one of the motors takes an excessive current for considerable time, the heat generated by the heat coil melts the fusible link and interrupts the power supply to that motor.

Branch Circuit II controls the application of the 1600-volt d.c. supply to the plates of the radiation cooled tubes. Relay *S1C*¹ is of the slow-acting type and does not operate until several seconds after the branch circuit is energized. The 1600-volt generator contactor *S3C* operates through the back contact of *S1C* during this delay. On closing, *S3C* operates the interlocking relay *S4C* through one of its sets of contacts. This relay closes and provides a holding circuit for *S3C*. *S3C* also closes two contacts which complete the 1600-volt generator armature circuit which is described in a later section. The circuit holding both *S3C* and *S4C* passes through one of the switches on the gate of the enclosure and also through the 1600-volt overload relay *S2C*. In case the gate is opened or an overload occurs in the 1600-volt circuit both *S3C* and *S4C* releases opening the 1600-volt circuit. Opening the gate switch or overload relay also opens the field circuit of the 1600-volt generator by releasing relay *S6C*.

The field of the 1600-volt generator is closed through one contact of the 1600-volt generator field circuit relay *S6C*. The winding of this relay, in addition to being in series with the gate switch and overload relay mentioned above, is in series with a set of contacts on *S4C*, the contacts of the time delay relay *S5C*, one of the contacts of the grid voltage relay *S7C* and the switch *D2C*. Relay *S4C* operates as previously outlined, closing its contacts immediately. The time delay relay *S5C* is connected across the armature of the 14-volt generator and is so arranged that it does not operate until 20 seconds after it has been energized. The purpose of this delay is to insure that the filaments of the radiation cooled tubes

¹ The last letter in the designation of all apparatus indicates the unit in which the piece of apparatus is located. The letter *A* indicates that the apparatus is located in the a.c. power panel, *B* in the rectifier unit, *C* in the oscillator unit, *D* in the amplifier unit, *E* in the power amplifier unit, *F* in the tuning unit and *G* in the transformer and filter assembly.

have had sufficient time to warm up before plate potential is applied. Relay *S7C* is connected across the armature of the 250-volt generator and operates as soon as this generator which supplies grid bias for all tubes has reached its normal voltage. *D2C* is a push button switch, normally in the closed position, mounted on the front of the oscillator unit and marked 1600-VOLT GENERATOR FIELD. Under normal operating conditions the contacts on the time delay relay *S5C* are the last of the series to close and relay *S6C* closes the field circuit of the 1600-volt generator 20 seconds after the master control button is pushed. In addition to closing the field circuit, relay *S6C* short-circuits a resistor *R4C* in the field circuit of the 14-volt generator to compensate for the added load of the 1600-volt generator field on the 14-volt generator.

Switch *D1C* (mounted on front of the oscillator unit and labeled 1600-VOLT GENERATOR ARMATURE) is provided so that the 1600-volt circuit may be opened without shutting down the transmitter. The OFF button is connected in series with the contacts of the overload relay *S2C* and opens the 1600-volt circuit in the same manner. If the 1600-volt circuit is opened by the switch, by the operation of the overload relay *S2C*, or by opening the gate to the enclosure, it may be closed again after normal conditions have been reestablished by pushing the ON button of *D1C* which short circuits the now open contacts of the *S1C* and provides a circuit for closing *S3C*.

Branch circuits IV control the application of power to the 10,000-volt rectifier and the power amplifier. Water protection relay *S3A* operates as soon as the control bus is energized, provided that the contacts of the water flow relay *S1B* are closed. The contacts of relay *S1B*, located in the rectifier unit, are operated by the motion of two opposing metal bellows. A Venturi tube forms part of the water circulating system in the rectifier unit and the difference in pressure established across two points in this tube by the water flow are transmitted through tubular connections to the bellows in the relay. This difference in pressure causes one bellows to expand and the other to contract, and this motion, through a multiplying lever, causes the relay contacts to open or close. As long as the flow of cooling water in the system is normal the difference in pressure in the bellows is sufficient to keep the contacts closed. Should, however, the water flow fall to a point where it is insufficient for cooling purposes the contacts open and break the circuit energizing *S3A*. If the cooling water becomes too hot, the contacts of the thermometer *S2B*, also located in the rectifier unit,

close a circuit through the winding of the temperature protection relay S_{4A} which short circuits S_{3A} , causing its release.

When S_{3A} operates it performs three functions: first, it opens a short circuit on the winding of relay S_{1A} ; second, it closes a circuit which operates the slow acting relay S_{2A} ; third, it closes the field circuit of the 22-volt generator, thus lighting the filaments of the power amplifier tubes. Relay S_{2A} locks up through its make contact but its break contact remains closed long enough to permit the rectifier control relay S_{1A} to operate and lock in its up position. The winding of relay S_{1A} is in series with the contacts of a second gate switch so that if the gate to the enclosure is open, this relay cannot operate. The locking circuit of S_{1A} is completed through the contacts of the overload relay S_{1E} on the power amplifier unit and the overload relays S_{6A} and S_{7A} on the a.c. power panel. The operation of any of these overload relays will release relay S_{1A} .

A second set of contacts on S_{1A} is part of branch circuit III. This circuit operates the rectifier magnetic switch S_{9A} and is completed through one set of contacts on the grid voltage relay S_{7C} and the contacts of the 10,000-volt time delay relay S_{8C} , both of which are located in the oscillator unit. S_{7C} operates as soon as the 250-volt generator reaches normal voltage. S_{8C} is energized by the 22-volt generator and is so adjusted that its contacts close 15 seconds after this voltage is applied. As in the case of the radiation cooled tubes, this allows the power amplifier tube filaments sufficient time to warm up before plate voltage is applied. When the last relay whose contacts form part of this circuit (normally S_{8C}) closes, switch S_{9A} operates and energizes the circuits supplying plate and filament voltages for the rectifier tubes. The relays S_{7C} and S_{8C} also protect the power amplifier against damage due to failure of the grid bias voltage or filament voltage.

The 10,000-volt rectifier may be shut off without shutting down the entire transmitter by pressing the lower button of the rectifier control push-button switch D_{2A} . This operation short-circuits relay S_{1A} , opening the circuit of the rectifier magnetic switch S_{9A} which returns to the non-operate position and disconnects the power supply from the rectifier. The rectifier may be again started by pushing the upper button of D_{2A} , which operates relay S_{1A} , closing the circuit to the rectifier magnetic switch S_{9A} .

B. Power Supply Circuits—1. Filament Circuits—The filaments of all radiation cooled tubes are supplied from the 14-volt generator. This generator also supplies field excitation for the

1600-volt generator. The output of this generator passes through a filter consisting of two No. 100-A condensers and one No. 125-A Retard Coil. The No. 100-A condenser is of the electrolytic type which supplies a large capacity in a relatively small space. This condenser derives its high capacity from a thin film which is formed electrochemically on the positive, corrugated aluminum electrode. This film serves as a dielectric between the conducting condenser fluid on one side and the aluminum anode on the other. The flat, negative electrode serves only to make connection to the condenser fluid. The capacity varies with temperature, at 75° F. the capacity being approximately 1000 mfd.

The No. 25-A Retard Coil has a laminated silicon steel core of the shell type and consists of two conductors wound side by side. When used in this filter the two windings are connected in parallel by strapping terminals 1 to 3 and 2 to 4. Under these conditions the coil has a current carrying capacity of 60 amperes and a minimum inductance of 4 milli-henries.

The output of this filter is connected to terminals Nos. 8 and 9 on the oscillator unit, terminal No. 9 being the positive terminal. After passing through the main fuses F_4C the circuit divides into four branches. The first branch through the fuses F_3C supplies current for the filament of the monitoring rectifier tube located in the tuning unit. The second branch, through terminals Nos. 10 and 11, supplies current for the filaments of the vacuum tubes in the amplifier unit. A third circuit within the oscillator unit supplies current for the filaments of the vacuum tubes in that unit. A third circuit within the oscillator unit supplies current for the filaments of the vacuum tubes in that unit. The fourth circuit, through the fuses F_5C , supplies current to the field circuit of the 1600-volt generator and operates the 1600-volt time delay relay S_5C . The voltage of the 14-volt generator is read on the voltmeter M_8C which is located on the oscillator unit.

The 14-volt generator is self-excited, one end of the field winding being permanently connected to the negative side of the armature and the other end of the winding being connected to terminal No. 7 on the oscillator unit. From the positive side of the armature the field circuit goes through the field rheostat R_5C , the resistor R_4C and back to terminal No. 7. When the relay S_6C closes the 1600-volt field circuit it also short circuits R_4C , thus raising the voltage of the 14-volt generator to compensate for the additional load on the 14-volt generator.

The filaments of the water cooled power amplifier tubes are

supplied from the 22-volt generator. This generator is supplied with a filter consisting of two No. 100-A condensers and a No. D-81278 Retard Coil. This coil is similar to the No. 125-A retard coil, but has a current carrying capacity of 90 amperes.

The output of this filter is connected to terminals Nos. 13 and 14 on the power amplifier unit, terminal No. 13 being the positive terminal. Two branch circuits are connected to the oscillator unit. The first of these circuits connects to terminals Nos. 25 and 26 on the oscillator unit and furnishes current for energizing the 10,000-volt time delay relay *S8C*. The second circuit connects to terminals Nos. 21 and 22 on the oscillator unit which connect to the voltmeter *M9C*. This meter is used to read the voltage of the 22-volt generator. The generator is self-excited, the field circuit being from the positive side of the 22-volt generator to the field rheostat *R2C* on the oscillator unit, then to one set of contacts on the relay *S3A* located on the a.c. power panel and then to the field of the 22-volt generator which is permanently connected to the negative side of the generator. The resistance *R6A*² connected across the contacts of relay *S3A* maintains the voltage of this generator at a low value when the contacts of *S3A* are open, thus eliminating any difficulty in building up the generator voltage due to the lack of a residual field.

2. *Grid Bias Circuits*—Grid bias for all tubes is furnished by the 250-volt generator. Its armature is connected to terminals Nos. 13 and 14 on the oscillator unit, terminal No. 13 being the positive terminal. This generator is self-excited, its field connection being made through terminal No. 15 on the oscillator unit and the field rheostat *R19C*. The armature circuit feeds a bank of potentiometers which reduce the voltage to values suitable for grid bias for the several tubes in the transmitter. The potentiometer *R17C* supplies grid bias for the tubes in the oscillator unit, the potentiometer *R16C* bias for the third amplifier tubes, the potentiometer *R15C* bias for the audio frequency amplifier tubes (speech amplifier and monitor) and the potentiometer *R18C* bias for the power amplifier tubes. *R15C*, *R16C* and *R18C* are equipped with switches which permit variation in the bias voltage supplied from these potentiometers. A filter circuit consisting of a series in-

² *R6A* actually consists of two resistors designated as *R6.1A* and *R6.2A*. Decimals have been used throughout the transmitter to denote component parts of resistors, coils, etc., which may be considered from the circuit viewpoint as one element. For example, the radio frequency choke coil *L2C* actually consists of two coils *L2.1C* and *L2.2C* which from the circuit viewpoint may be considered as a single coil.

ductance coil and a shunt condenser is used in connection with each potentiometer. The voltage of the 250-volt generator is read on the voltmeter *M7C*. The fuses *F7C* furnish protection for the grid voltage relay *S7C* and the voltmeter *M7C*.

3. *Plate Supply Circuit for Radiation Cooled Tubes*—Plate potential for all radiation cooled tubes, which include those in the oscillator, audio frequency circuits, and the first three amplifiers is supplied by the 1600-volt generator. Its armature is connected to terminals Nos. 40 and 41 on the oscillator unit, terminal No. 40 being the positive terminal. The positive side of this circuit passes through one set of contacts on the 1600-volt generator magnetic contactor *S3C* and the overload relay *S2C*. The circuit is from here connected to the plates of the various tubes in the oscillator and amplifier unit through appropriate series resistances and radio frequency choke coils which are described in connection with the individual tube circuits. The negative side of the circuit passes through another set of contacts on *S3C* and the high voltages fuse *F2C* to the negative side of the filament circuits which is grounded. The generator voltage is measured by the voltmeter *M1C* protected by the fuses *F1C*.

Field excitation for the generator is obtained from the 14-volt generator, the field circuit including the field rheostat *R3C* and the field disconnect *D3C*. This switch is intended to be used as a safety switch and should be opened when any one is working inside the enclosure. One side of the circuit which supplies current to the field passes through the contacts on relay *S6C* which closes the field circuit as outlined in the preceding section.

4. *Plate Supply Circuit for Water Cooled Tubes—10,000-Volt Rectifier*—The 10,000-volt rectifier which supplies the plate potential for the power amplifier consists of the apparatus mounted in the rectifier unit and the power transformer and filter equipment mounted as part of the transformer filter assembly.

The rectifier tubes *V1B*, *V2B* and *V3B* (Type No. 222-A) are of the water cooled type and are mounted in the rectifier unit. Filament current is supplied to these tubes through the transformers *T1B*, *T2B* and *T3B* each of which operates from one phase of the three-phase power supply. Taps, which are brought out to a terminal strip on the back of the unit, are provided on the primary windings of these transformers to compensate for high or low line voltage. The connecting strap used with these taps should be connected to the tap marked "normal voltage" for a line voltage of 220 volts, to the point marked "plus 5 per cent" for a

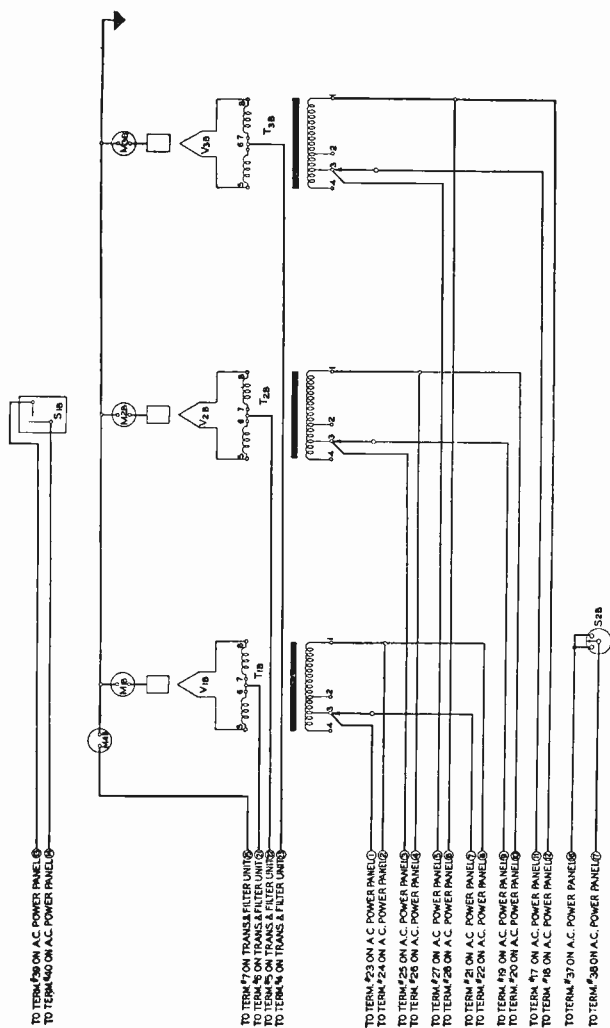

© WECO

FIG. 202. Rectifier Unit Schematic.

high line voltage and to the point marked "minus 5 per cent" for a low line voltage.

The voltage applied to each of the rectifier tube filaments may be regulated by means of the rheostats R_{3A} , R_{4A} and R_{5A} located on the a.c. power panel. One of these rheostats is connected in series with the primary of each of the filament-lighting transformers. By means of the voltmeter M_{1A} and the voltmeter switch D_{1A} , both of which are also located on the a.c. power panel, it is possible to read the voltage across fixed points on the primary windings of the filament-lighting transformers. The points on the transformer windings are so chosen that this meter reading will be 200 when the voltage across the tube filament is normal. This voltmeter and switch may also be used to measure the line voltage supplied to the transmitter.

The high voltage transformer T_{1G} in the transformer and filter assembly is delta connected on the primary side with taps on one end of each coil for ± 5 per cent line voltage adjustment and taps on the other end of each coil for control of the secondary voltage. These secondary voltage control taps are connected to the knife switches D_{1G} , D_{2G} and D_{3G} which are mounted on the slate panel on the front of the high voltage transformer. The secondary of the transformer is Y-connected with each leg connected to the mid-point of the secondary winding of one of the filament lighting transformers. This connection places the plates of the rectifier tubes at ground potential, thus eliminating the need of any hose coil in connection with the cooling system. The positive lead from the rectifier is taken from the mid-point of the Y and connected to the tubes in the power amplifier unit through a filter consisting of the filter coil L_{6G} and the condenser C_{2G} .

The rectified voltage is measured by the voltmeter M_{4B} on the rectifier unit in conjunction with a multiplier which consists of the resistors R_{1G} , R_{2G} , R_{3G} and R_{4G} mounted in the transformer and filter assembly. The rectifier current in each of the rectifier tubes is measured by one of the ammeters M_{1B} , M_{2B} and M_{3B} . The horn gap protectors G_{1G} , G_{2G} and G_{3G} are connected from each leg of the high voltage transformer to ground to protect the tubes and filament-lighting transformers from excessive voltages. The sphere gap protectors G_{4G} and G_{5G} protect the filter condenser and coil respectively, and the copper block protector P_{1G} protects the voltmeter M_{4B} . The rectifier tubes are protected against failure of the water supply by relay S_{1B} and against excessive temperature of the water by the thermometer S_{2B} . The

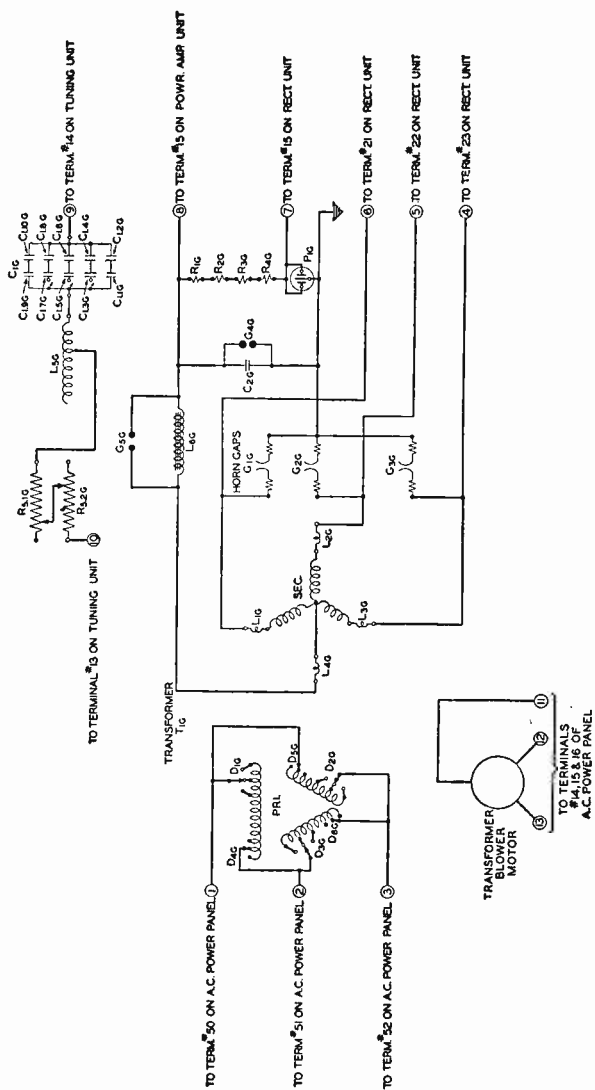

© W E C O

FIG. 203. Transformer-Filter Assembly—Schematic.

method in which these protective devices function is described in one of the preceding sections.

C. Temperature Control Circuits—The oscillator of the 5-C Radio Transmitter is of the type whose frequency is determined by a piezo-electric quartz plate. For maximum constancy of frequency, circuits are provided to maintain the piezo-electric element at a constant temperature. Figure 204 shows a schematic of the circuit used for this purpose. It consists essentially of a thermostat, a heater and a vacuum tube with a relay connected in its plate circuit. As the thermostat opens or closes, it changes the negative voltage applied to the grid of the vacuum tube. The resulting change in plate current is sufficient to operate the relay which opens and closes the heater circuit.

Two quartz plates are used in this transmitter. Each is contained in a separate heater box located in the oscillator unit. These boxes have independent temperature control circuits.

The assembly consisting of the quartz plate and its electrodes, known as a No. D-87781 Quartz Oscillator, clips into a mounting block, known as a thermal element, which contains the heater and thermostat of the temperature control circuit. A special thermometer, calibrated to an absolute accuracy of 0.1° C., fits into a groove provided in each thermal element, a right angle bend in the thermometer making it possible for the thermometer to lie flat in the holder mounted on the front of the oscillator unit. Each thermal element plugs into a socket in the bottom of one of the heater boxes. The quartz oscillator and thermal element may be lifted out as a unit, provided that the thermometer is first removed.

The remaining apparatus for the temperature control circuits is mounted on the temperature control panel located in the rear of the oscillator unit just below the panel upon which the fuse blocks are mounted. The power supply for these circuits is furnished from the transformer *T1C* through the snap switch *D11C*. The line leading to this switch is connected to the supply side of the main power disconnect switch on the a.c. power panel through the fuses *F18A*. This allows the temperature control circuits to be operated at all times regardless of whether the transmitter is in operation or not. This is necessary since it is intended that the quartz plates be kept at their proper operating temperature continuously and a period of one or two hours is required for the quartz plates to reach a constant temperature after the application of voltage to the temperature control circuits.

As the two temperature control circuits are identical it is neces-

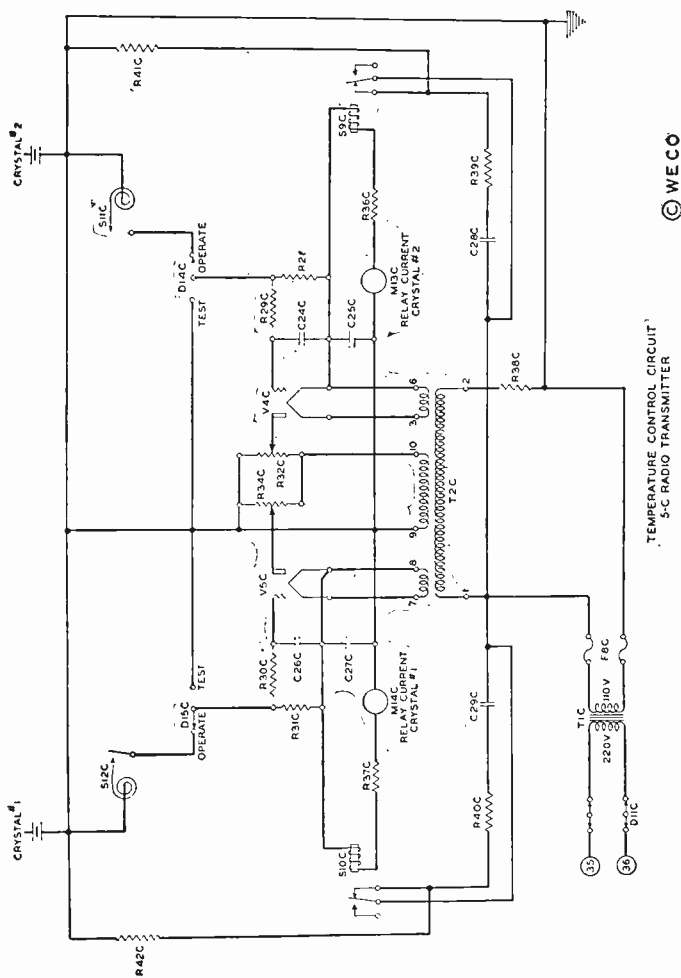

Fig. 204. Temperature Control Circuit—Schematic.

sary to describe only one circuit. Referring to the schematic in figure 204, V_4C is a No. 102-D Vacuum Tube whose filament and plate supply is obtained from the transformer T_2C . Its plate circuit is completed through the meter M_{13C} , the resistance R_{36C} and the relay S_9C . C_{25C} is a filter condenser which helps to smooth out the rectified alternating current in the plate circuit. When the contacts of the thermostat S_{11C} are opened, the grid is connected to the filament through the resistors R_{28C} and R_{29C} and is virtually at zero potential with respect to the filament. Consequently the plate current is high and this causes the contacts of the relay S_9C to close. When the contacts of the thermostat S_{11C} are closed, a negative bias equal to the DC potential drop across the resistor R_{36C} is applied to the grid of V_4C , thus reducing the plate current. This causes the relay to open. The opening and closing of the contacts of the mechanical relay S_9C controls a circuit through the heater R_{41C} .

When the temperature inside the heater box is less than the temperature at which the contacts of the thermostat S_{11C} close, the plate current through the winding of the relay S_9C is sufficient to cause the armature to close the contacts. This will close the heater circuit from one terminal of the secondary of the transformer T_1C through the heater R_{41C} to the other terminal of the secondary of T_1C . The heat produced by this heater raises the temperature of the quartz plate, the thermal element and the surrounding air in the heat insulated box. When sufficient heat has been added the temperature of the thermostat will rise to a value which will cause its contacts to close, reducing the plate current of V_4C as previously described. Relay S_9C will then open, breaking the heater circuit and stopping the addition of heat. The temperature of the quartz plate and the thermostat will gradually decrease as heat from the interior of the box is lost to the surrounding air and the thermostat contacts will separate. This opens the circuit which supplies grid bias to V_4C , increasing its plate current and causing S_9C to again close the heater circuit.

The resistance R_{29C} and the condenser C_{24C} connected in the grid circuit of V_4C form a delay circuit which prevents abrupt changes in the grid bias voltage. This eliminates any irregularity in operation which might be caused by chattering of the thermostat contacts due to mechanical vibrations. Sparking at the contacts of the relay S_9C is prevented by a shunt circuit consisting of the condenser C_{28C} and the resistance R_{39C} .

Detailed instructions for adjusting the temperature control ap-

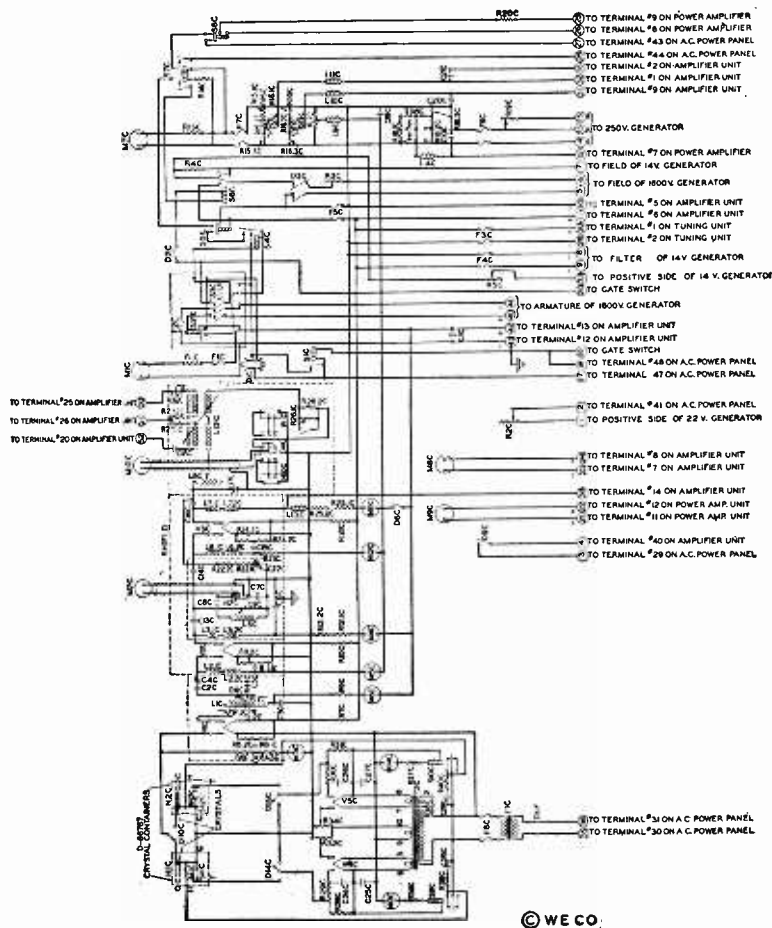

FIG. 205. Oscillator Unit—Schematic.

paratus for the temperature for which the individual D-87781 Quartz Oscillator used is calibrated are given under the section entitled "Adjustment of Apparatus."

D. Radio Frequency Circuits—1. Oscillator—The piezo-electric type oscillator of the No. 5-C Radio Transmitter is located in

a shielded compartment directly behind the panel of the oscillator unit. By opening the window of this unit and removing the oscillator tube $V1C$ located directly in back of this window, the cover of the shielded compartment may be raised, giving access to a bakelite panel on which are located the switches $D16C$ and $D17C$ which are used to adjust the oscillator circuit.

Referring to the schematic of the oscillator unit in figure 205, the oscillator will be seen to consist essentially of a 248-A vacuum tube $V1C$, either of the two piezo-electric quartz plates $Q1C$ or $Q2C$, and the inductance coil $L1C$. The output circuit of the oscillator is not tuned. The resistor $R6C$ acts as a grid leak for this tube, the meter $M3C$ measuring the grid current. The resistors $R43C$ and $R8C$ and the condenser $C1C$ form a noise filter. Similar noise filters are used on the first and second amplifiers. The plate voltage for the oscillator is obtained from the 1600-volt generator through the meter $M6C$ and the resistor $R9C$. Condenser $C3C$ is a radio frequency by-pass condenser. Two piezo-electric quartz plates are provided, the transfer switch $D10C$ (CRYSTAL SELECTOR) being provided so that either may be used at will.

The piezo-electric quartz plates are located inside the heat insulated boxes, one on either side of the compartment housing the coils and condensers for the piezo-electric oscillator. These boxes are designed so that the temperature of the quartz plates may be maintained to within a fraction of a degree. The plates themselves are cut from quartz crystals (specially selected for the perfection of their crystalline structure) by methods which insure their surfaces being plane and parallel to a high degree of precision. The finished plate is approximately 1 1/4" square and of a thickness determined by the frequency of operation. These quartz plates are mounted between two electrodes ground optically flat by the same method as employed in grinding the plates themselves, the upper plate being comparatively heavy, with a light springless connector to insure a constant pressure on the quartz plate. After final frequency adjustments have been made, each plate and its electrodes are enclosed in a dust-proof container. This assembly consisting of the quartz plate and its electrode is known as a No. D-87781 Quartz Oscillator.

Each No. D-87781 Quartz Oscillator is calibrated for a specified frequency at a specified temperature. Details of the adjustments necessary to maintain this temperature are given in the section entitled "Adjustment of Apparatus."

2. *First Amplifier*—The first amplifier uses a type 211-D vac-

tum tube $V2C$ and is contained in the right-hand shielded compartment in the rear of the oscillator unit. The radio frequency input to this tube is obtained from the oscillator through the fixed condenser $C2C$ and the variable condenser $C4C$. By changing the capacity of $C4C$ (FIRST AMPLIFIER INPUT) the amount of radio frequency voltage applied to the grid of this tube may be adjusted. Grid bias is obtained from the potentiometer $R17C$ through the meter $M5C$, the stabilizing resistor $R44C$, and the radio frequency choke coils $L2C$. The output circuit for this stage consists of the inductance coil $L5C$, the fixed condensers $C7C$ and $C8C$ and the variable condenser $C9C$. The output circuit is of a built-out type; that is, the ground connection is placed between the condensers $C7C$ and $C8C$ in order that two voltages 180 degrees out of phase may be obtained. The first of these voltages (that across $C8C$) is applied to the grid of the second amplifier tube while the second voltage (that across $C7C$) is used to neutralize the second amplifier tube. The plate voltage for this stage is obtained from the 1600-volt generator through the meter $M4C$, the resistor $R12C$ and the radio frequency choke coils $L3C$.

3. *Second Amplifier*—Modulation takes place in the second amplifier, the plate voltage of this tube being varied by the audio frequency output of the modulator tube which is located in the amplifier unit. This stage uses one type 211-D vacuum tube $V3C$ and is located in the left-hand shielded compartment in the rear of the oscillator unit. The radio frequency input is obtained from the first amplifier through the blocking condenser $C14C$. Grid bias is supplied from the same potentiometer as the grid bias for the first amplifier $R17C$, through the meter $M12C$, the resistor $R23C$ and the radio frequency choke coils $L6C$. The resistor $R23C$ acts as a grid leak, placing additional bias on the grid of the tube. The output circuit consists of the inductance coil $L8C$, the primary of the radio frequency transformer $L12C$, the resistors $R26.1C$ and $R26.2C$, and the variable condenser $C17C$. The resistors $R26.1C$ and $R26.2C$ are used to prevent the attenuation of the higher side-band frequencies and are also used in conjunction with the taps on $L8C$ to adjust the impedance of this circuit. The plate voltage is supplied from the 1600-volt generator through the disconnect switch $D6C$, the plate meter $M11C$, the resistor $R25C$, the modulation choke coil $L13C$ and the radio frequency choke coils $L7C$. This stage is neutralized by means of the variable condenser $C22C$, the resistor $R22C$ in series being used as a stabilizing resistance. A switch $D4C$ is provided so that while this stage is being neu-

tralized a special sensitive thermocouple H_{11C} may be connected in circuit in place of the regular thermocouple H_{10C} which is used in conjunction with the meter M_{10C} . During the process of neutralizing, the switch D_{6C} is opened to remove the plate voltage from the stage and the switch D_{5C} is closed to short-circuit the resistors $R_{26.1C}$ and $R_{26.2C}$. The radio frequency output of this stage is transferred to the third amplifier by means of a radio frequency transformer L_{12C} .

4. *Third Amplifier*—The third amplifier is located in the amplifier unit, whose schematic is shown in figure 206, and consists of three No. 212-D tubes V_{3D} , V_{4D} and V_{5D} operating in parallel. The grid circuit of these tubes is coupled to the second amplifier by means of the radio frequency transformer L_{12C} in the oscillator unit. This transformer has two secondaries, one supplying the excitation voltage to the grids of the tubes and the other supplying voltage for neutralizing the internal capacity of the tubes. The coupling between the primary and the secondary can be controlled from the front of the oscillator panel while the transmitter is in operation, thus changing the excitation supplied to the grids of the third amplifier tubes. This control furnishes a simple and continuous adjustment of the power output of the set.

Bias for this stage is obtained from the potentiometer R_{16C} through a filter circuit consisting of L_{10C} and C_{20C} in the oscillator unit. Switch D_{13C} on this unit serves to adjust the bias voltage according to the class of tube used in this amplifier. $L_{5.1D}$ and $L_{5.2D}$ are radio frequency choke coils used to minimize the radio frequency current in this circuit. The d.c. grid current is measured by the grid ammeter M_{4D} .

The output circuit of this stage consists of the inductance L_{1D} , the fixed condensers C_{1D} , C_{2D} , C_{3D} and C_{4D} , the variable condenser C_{5D} and the resistors $R_{1.1D}$ and $R_{1.2D}$. Coarse tuning adjustments are made by changing the arrangement of fixed condensers, by use of D_{2D} and D_{3D} , and by means of taps on L_{1D} . Fine tuning adjustments are made by means of C_{5D} from the front of the panel. The resistors $R_{1.1D}$ and $R_{1.2D}$ are used to prevent the attenuation of higher sideband frequencies and to adjust the impedance of this circuit. The thermocouple $H_{1.1D}$ in conjunction with M_{2D} measures the radio frequency current in this circuit.

Plate voltage for these tubes is supplied from the 1600-volt generator through the disconnect switch D_{4D} , the meter M_{1D} , the radio frequency choke coil L_{2D} and the resistor R_{11D} to the mid-

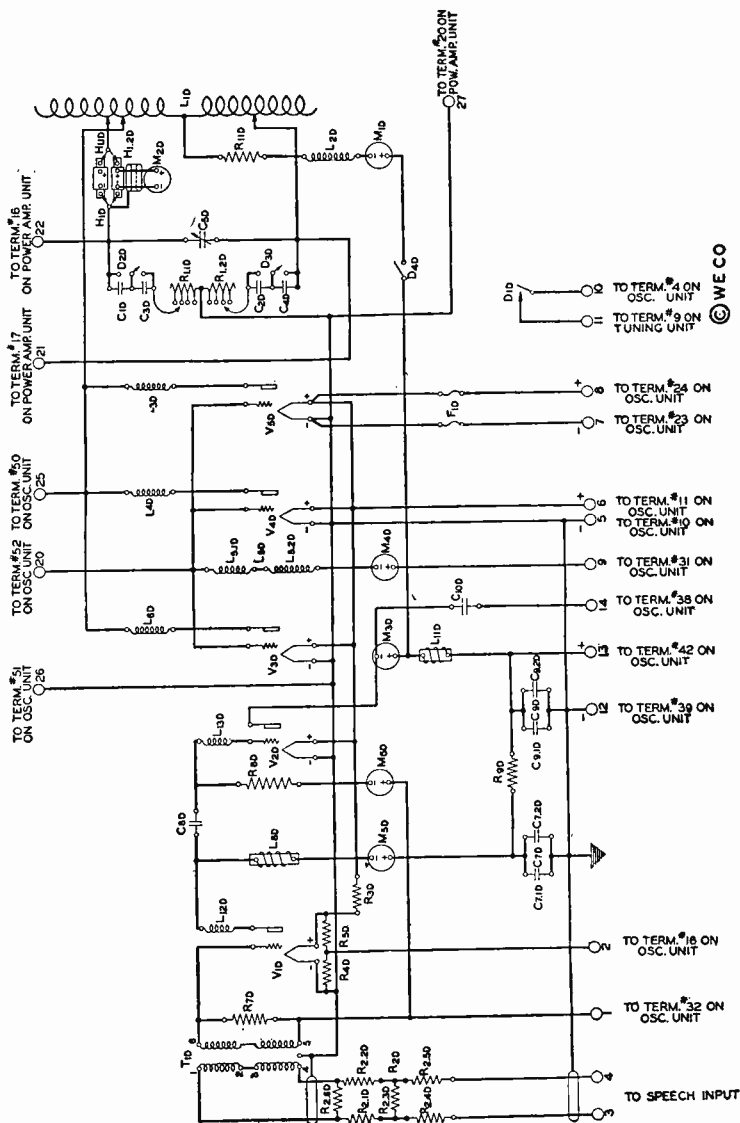

FIG. 206. Amplifier Unit—Schematic.

point of $L1D$. The internal capacity of $V3D$, $V4D$ and $V5D$ is neutralized by the condenser $C12C$ in the oscillator unit and one of the secondaries of $L12C$. While adjusting this condenser the sensitive thermocouple $H1.2D$ is used in conjunction with $M2D$ and the plate voltage is removed from the stage by means of switch $D4D$.

5. *Power Amplifier*—The apparatus which forms the final or power amplifier is located in the power amplifier unit and the tuning unit, the former unit containing the two water cooled tubes and their associated apparatus and the latter unit containing the tuned circuits which form the load circuit for this stage and which serve to transfer the energy output of this stage to the antenna. The schematics of these two units are shown in figures 207 and 208.

Two No. 220-B (water-cooled) vacuum tubes operating in parallel and designated $V1E$ and $V2E$ are used in this amplifier. The radio-frequency input voltage from the third amplifier is impressed on the grids of these tubes through the stopping condenser $C1E$. The negative grid potential is supplied from the potentiometer $R18C$ and the associated filter circuit, $L4C$ and $C10C$, in the oscillator unit, through the grid ammeter $M1E$ and the radio-frequency choke $L1E$. The condenser $C2E$, the resistor $R1E$ and the coils $L1.3E$ and $L1.4E$ form a shunt across the input circuit, placing sufficient loss in the grid circuit to insure stable operation. The filaments of the tubes are supplied from the 22-volt generator, whose armature is connected to terminals No. 13 and 14 on this unit. From these terminals the filament circuit goes through the fuses $F2E$ and the reversing switch $D1E$ to the tube filaments. Switch $D1E$ is provided in order that the current through the filaments may be reversed periodically to prolong the life of the tubes, as the plate current returns through one half of the filament when the switch is in one position and through the other half when the switch is reversed. The plate potential is supplied from the 10,000-volt rectifier through the radio-frequency choke $L3E$ and the stabilizing circuits $L4E-R2E$ and $L2E-R3E$. The plate current returns to the grounded terminal of the rectifier from the filaments of the power amplifier tubes through the plate ammeter $M3E$ and the overload relay $S1E$. $C3E$, $C6E$ and $C7E$ are by-pass condensers around this meter and relay. The output of these tubes is supplied to the tuned circuits in the tuning unit through the stopping condensers $C4.1E$ and $C4.2E$. $C5E$ is the balancing condenser for the power amplifier.

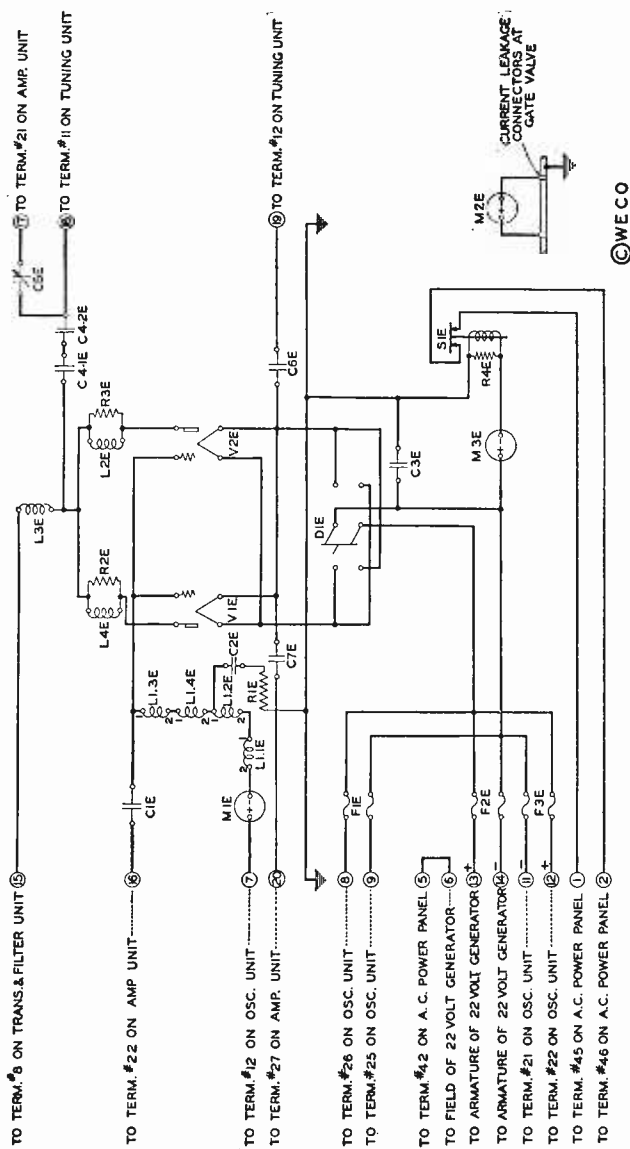

Fig. 207. Power Amplifier Unit—Schematic.

M_{2E} is a milliammeter which measures the leakage current in the water circulating system. Since the plates of the power amplifier tubes are operated at a potential of 10,000 volts above ground potential, a certain amount of leakage current will flow to ground through the water column depending on the character and amount of impurities in the water. The current leakage meter connects to metallic sections inserted in the rubber hose coil at the point where it enters the inlet valve on the power amplifier unit. A three-inch section of hose separates the two metallic sections and since the water in this section has a much greater electrical resistance than the ammeter which bridges it, practically all the leakage current flows through the meter. An excessive reading on this meter indicates that the water is no longer suitable for cooling purposes.

The apparatus in the tuning unit composes two tuned circuits known as the closed circuit and the antenna circuit. These two circuits are connected by a bank of condensers known as the coupling condenser.

The closed circuit, which forms a load circuit for the power amplifier, is formed by the coil *L_{1F}*, the tuning condensers *C_{5F}*, *C_{6F}*, *C_{7F}*, *C_{8F}*, *C_{9F}* and *C_{10F}*, and the coupling condensers *C_{1F}*, *C_{2F}* and *C_{4F}*, all located in the tuning unit. Links *D_{13F}*, *D_{14F}* and *D_{15F}* provide means for making changes in the tuning capacity, while the clip on *L_{1F}* provides a means for making large changes in the inductance of the circuit. Fine adjustment in inductance may be made from the front of the panel by manipulating the fine adjustment knob, which moves a sliding contact over the top three turns of *L_{1F}*. The coil *L_{1F}* is enclosed in a shielded compartment to reduce the circuit losses.

The antenna circuit consists of the antenna, the antenna loading coil *L_{2F}*, the coupling condensers *C_{1F}*, *C_{2F}*, *C_{3F}* and *C_{4F}*, and the radio ground system. As in the case of the coil *L_{1F}*, rough adjustments on *L_{2F}* may be made by means of a clip and fine adjustment by a knob on the front of the panel which moves a sliding contact over the end turns of this coil.

Coupling between the antenna circuit and the closed circuit is obtained by means of a common capacity, this type of coupling being helpful in reducing the radiation of harmonics of the carrier frequency. In order to provide the 5-C radio transmitter with facilities for working into a wide range of antenna resistances it was necessary to make this capacity widely variable. To meet this condition without sacrificing the current carrying capacity of

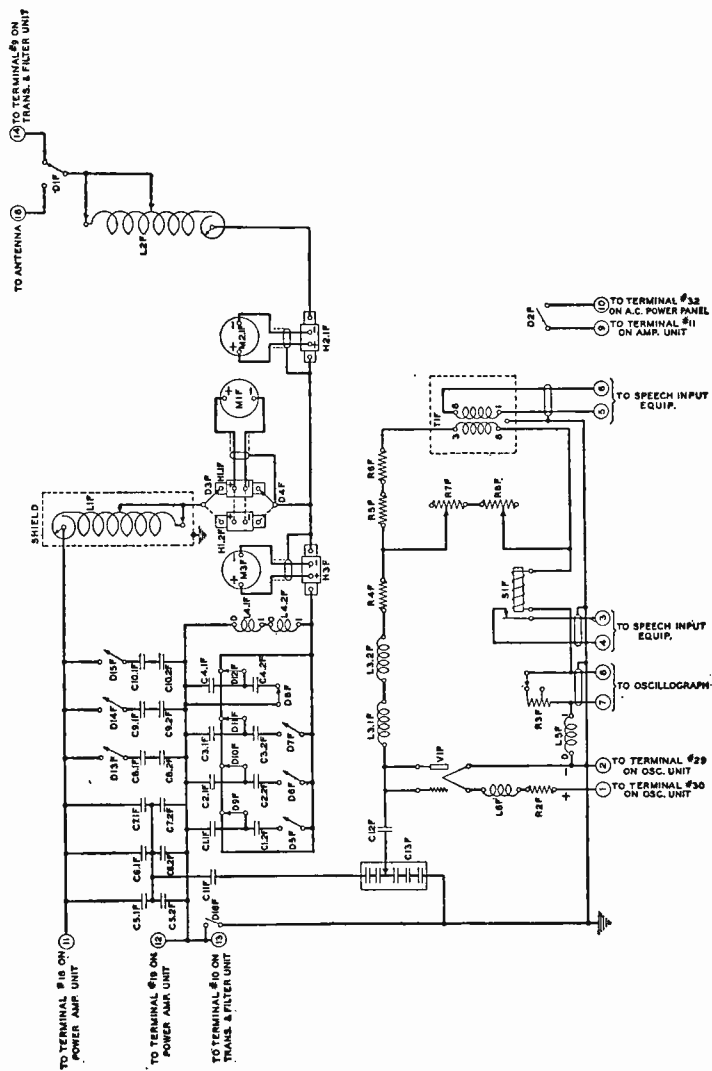

Fig. 208. Tuning Unit—Schematic.

the condensers, the coupling condensers have been so arranged that they may be easily removed from the tuning unit and condensers of other capacities substituted. Twelve condensers are provided for this purpose, of which any eight may be mounted in the unit at one time. The arrangement of the links D_5F to $D_{12}F$ is such that in the condenser banks C_1F , C_2F and C_3F either one condenser or two condensers connected in series may be used. In the bank C_4F either one condenser or two condensers connected in parallel may be used. The correct assembly of these condensers for any antenna and carrier frequency is given in the section entitled "Adjustment of Apparatus." The choke coils L_4F are connected across these condensers to relieve any stresses which may be set up due to leakage currents or static charges.

Currents in these circuits may be read by means of the three thermo-ammeters M_1F , M_2F and M_3F ; M_1F marked closed circuit current (IND), reading the closed circuit currents, M_2F the antenna current and M_3F , marked Closed Circuit Current (CAP), the current through the coupling capacity. This arrangement of meters helps to eliminate difficulties in tuning the antenna circuit when a high resistance antenna is used. The meter M_1F is also equipped with a sensitive thermocouple for use while neutralizing the power amplifier. This thermocouple, as are the thermocouples for the other meters, is located just back of the panel of the unit and may be reached through the hinged panel in the front of the panel. This hinged panel also gives access to the monitoring rectifier which is described in a later section.

6. *Artificial Antenna*—An artificial antenna is provided as a part of the No. 5-C Radio Transmitter so that routine tests and adjustments may be made without the necessity of radiating power. It consists of the variable inductance L_5D , the adjustable condenser C_1G and the adjustable resistance R_5G which are mounted on the pipe rack which forms part of the transformer-filter assembly. By adjusting these elements the artificial antenna is connected to one side of the double throw switch D_1F located in the rear of the tuning unit. The other side of this switch is connected to the antenna, thus allowing the output of the transmitter to be readily changed from the real to the artificial antenna.

7. *Monitoring Rectifier*—In order to enable the operator to check the quality of the program signal radiated from the transmitter, a monitoring rectifier is connected to the output circuit of the power amplifier. This rectifier is located on a shelf immediately behind the front panel of the tuning unit, access to this shelf

being obtained through a hinged panel in the front of the unit. The rectifier (see figure 206) consists of a 211-D tube $V1F$ with grid and plate connected together forming a "straight line rectifier." The input circuit to this tube consists of the condenser $C11F$ in series with a group of condensers $C13F$. These condensers are shunted across a portion of the tuning capacity and form a capacity potentiometer by means of which the amplitude of the voltage applied to the plate of the rectifier tube may be adjusted. The condenser $C12F$ acts as an audio frequency blocking condenser. The audio frequency circuit of the rectifier is formed by the radio frequency choke coils $L3F$, the resistances $R3F$, $R4F$, $R5F$, $R6F$, $R7F$ and $R8F$, the transformer $T1F$, the relay $S1F$, and the radio frequency choke coil $L5F$. The resistance network composed of $R4F$, $R5F$, $R6F$, $R7F$ and $R8F$ serves to insure a straight line rectifier characteristic and also serves as a means for adjusting the volume of the audio frequency output. $R3F$ acts as a shunt for terminals No. 7 and 8 to which an oscillograph may be connected if desired. The d.c. component of the rectified current is used to operate the relay $S1F$, whose contacts are generally connected to operate a signal light in the control room. The output of the transformer $T1F$ is connected to the monitoring amplifier of the speech input equipment.

E. Audio Frequency Circuits—The audio or speech frequency circuits consist of an input or speech amplifier and an audio power amplifier or modulator. This is located in the amplifier unit whose schematic is shown in figure 204.

1. *Speech Amplifier*—The audio frequency currents from the Speech Input Equipment enter the transmitter at terminals No. 3 and 4 on the amplifier unit, pass through the resistance network $R2D$ and the input transformer $T1D$ to the speech amplifier. The speech amplifier tube $V1D$ is a No. 211-D tube. Negative grid bias is supplied to its grid from the filter-potentiometer circuit consisting of $R15C$, $L11C$ and $C21C$ in the oscillator unit. Its plate supply is from the 1600-volt generator through the resistor $R9D$, the meter $M5D$ and the audio frequency choke coil $L8D$. Condensers $C7D$ and $C9D$ and resistor $R9D$ form a filter for the plate supply. This stage is coupled to the modulator by an impedance coupling consisting of the retard coil $L8D$ and the condenser $C8D$.

2. *Modulator*—The modulator consists of one No. 212-D vacuum tube $V2D$. The negative grid bias for the tube is obtained from the same filter-potentiometer in the oscillator unit which supplies bias for the speech amplifier. The grid circuit also in-

cludes the milliammeter $M6D$ and the grid resistance $R8D$. The grid bias is adjusted by means of switch $D7C$ on the oscillator unit according to the classification (by plate impedance) of the modulator tube, which is indicated by the number 1, 2, 3 or 4 etched on the base of the tubes. The plate supply is furnished by the 1600-volt generator through the modulator choke coil $L11D$ and the meter $M3D$. The audio frequency output of the modulator tube is impressed on the plate circuit of the second amplifier tube ($V3C$ in the oscillator unit) through the condenser $C10D$. This results in the plate voltage of the second amplifier being varied at audio frequency, thus modulating the radio frequency output of the second amplifier.

F. Water Circulating System—The water circulating system functions to dissipate the heat developed in the vacuum tubes used in the rectifier and power amplifier units. This system consists of a water pump, two air-blast radiators, an expansion tank, and the necessary piping and valves. The piping and valves will vary somewhat depending on local conditions. From the outlet of the pump the water enters the transmitter at the power amplifier unit and flows through the water jackets of the tubes in this unit and the rectifier unit, after which it flows through the radiators and returns to the inlet of the pump. The expansion tank is connected in the system to allow for expansion and contraction of the water with changes in temperature. The various valves and pipe connections provide means for filling and draining the system and for isolating certain sections so that repairs may be made. Valves are also located at the intake of the transmitter (in the power amplifier unit) and at the outlet of the transmitter (in the rectifier unit). These valves must be left open while the transmitter is in operation but must be closed whenever it is necessary to change any of the water cooled tubes.

From the inlet valve the water flows first to the water jackets of the vacuum tubes in the power amplifier unit. As the plates of these tubes are 10,000 volts above ground potential it is necessary that the water pass to and from them through a water column long enough to furnish a high resistance path to ground. This water column is furnished by the hose coil which is located below the tray which supports the tube sockets. From the power amplifier unit the water goes to the vacuum tubes in the rectifier unit. As the plates of these tubes are at ground potential no hose coil is necessary in this unit. The water then passes through the Venturi Tube located below the tray which supports the three rectifier

tubes. The Venturi tube in conjunction with the type 226-A Relay *S1B* serves as a flow operated protective device which automatically removes all power from the water cooled tubes in case the flow of water is stopped or reduced to below 70 per cent of its normal value. Two small pressure gauges attached to the Venturi tube allow the operator to check the flow of water in the system.

From the Venturi tube the water flows through the outlet valve which as a well attached containing a bulb which actuates the indicating thermometer located on the front of the rectifier unit. This thermometer *S2B* also acts as an electrical relay to stop the transmitter should the water become dangerously hot.

The waterpump is a rotary impeller, single stage pump of rugged, compact, and simple construction. It has but one moving part, a vane-edged disc called the impeller. Both suction and discharge openings are in the periphery. Vanes in the periphery of the impeller extend into the water channel, the shoulders of which on account of their proximity to the flat surface of the impeller cause a water seal to be formed, thus increasing and maintaining the pressure in the channel. The shaft to which the impeller is rigidly keyed revolves on two outboard radial thrust ball bearings which are lubricated by grease cups located on the bearing pedestals. A strainer is installed at the inlet to the pump to prevent dirt or other foreign matter from entering the channel or damaging the vane. This strainer should be inspected and cleaned regularly, following the instructions for cleaning found in the section on maintenance.

The heat absorbed by the water system is dissipated by the air blast radiators. The radiating tubes of these radiators are copper, wound with copper ribbon which greatly increases their radiating surfaces. The combination of this type of structure and the blast of air furnished by the motor driven fan makes possible a rapid dissipation of the heat contained in the water. The two radiators are connected so that one or both may be used at the same time.

The total capacity of the water circulating system, which varies somewhat with different installations, is somewhere between 35 and 50 gallons. Distilled water only should be used so as to minimize leakage currents from the plates of the power amplifier tubes and thus prevent unnecessary disintegration of the hole couplings due to electrolysis. Water from the house supply is also likely to leave deposits of scale on the anodes of the water cooled tubes which prevents proper cooling.

III. Adjustment of Apparatus

A. PROTECTIVE DEVICES

The protective devices requiring adjustment are listed below with a description of the proper adjustment for each.

1. A.C. Power Panel.

(a) *Primary Overload Relays—S6A and S7A*—These relays provide overload protection for the high voltage transformer through current transformers in the primary supply leads. They should be adjusted by means of the thumb screws at the bottom to the calibrated point marked 8. This corresponds to 64 amperes in the primary of the high-voltage transformer. These relays are equipped with air bellows at the top for slow action. The air escapement valve at the top of the bellows should be adjusted so that the contacts open two seconds after a heavy overload occurs. This adjustment is obtained when the contacts on the relay open two seconds after the plunger has been lifted as far as possible. The plunger may be lifted by means of a small stick about the size of a lead pencil. The time delay of two seconds is ordinarily obtained when the needle valve is approximately $2 \frac{1}{2}$ turns from the seated position.

2. Rectifier Unit.

(a) *Water Flow Relay—S1B*—This relay operates on control circuits in the a.c. power panel to remove all power from the water cooled tubes if the flow falls below 70 per cent of its normal value. It cannot be adjusted in the field and in case of failure must be removed from the transmitter and returned to the manufacturer for repair and readjustment.

(b) *Contact-Making Thermometer—S2B*—This gauge indicates the water temperature at the outlet valve. It is arranged with an adjustable contact which should be set so that the indicating arm makes contact with it when the temperature reaches 180° F. This contact operates on the relay circuits of the a.c. power panel to shut off all power to the water cooled tubes.

3. Oscillator Unit.

(a) *1600-Volt Generator Overload Relay—S2C*—This relay is in circuit with the plate supply to the air-cooled tubes to protect them from overloads. It operates on the control circuits of the oscillator unit to open the field and armature circuits of the 1600-volt generator when overload occurs. It is instantaneous in action

and should be adjusted by means of the thumb screw controlling its armature to operate on 1.5 amperes.

(b) *1600-Volt Time Delay Relay*—S5C—This relay operates on the control circuit of the 1600-volt generator field to keep the field circuit open until 20 seconds after the 14-volt filaments are lighted. The air escapement valve at the top of the relay and, if necessary, the armature weight at the bottom, should be adjusted so that the relay contacts close 20 seconds after the relay is energized by the 14-volt generator.

(c) *10,000-Volt Time Delay Relay*—S8C—This relay operates on the control circuit of the primary power supply for the rectifier to keep the rectifier from being energized until 15 seconds after the amplifier filaments are lighted. The air escapement valve at the top of the relay and, if necessary, the armature weight at the bottom, should be adjusted so that the relay contacts close 15 seconds after the relay is energized by the 22-volt generator.

4. Power Amplifier Unit.

(a) *Plate Overload Relay*—S1E—This relay provides overload protection for the plate circuit of the power amplifier. Its winding is connected to carry the amplifier plate current on its return from the filament to ground. Its contacts operate on the relay circuit of the a.c. power panel to shut off the rectifier. It is instantaneous in action and should be adjusted to operate on 1.75 amperes by means of the thumb nut at the bottom of the relay.

5. Transformer and Filter Assembly.

(a) *Rectifier Protective Horn Gaps*—G1G, G2G and G3G—One of these gaps is connected from each leg of the high-voltage transformer secondary windings to ground to protect the rectifier tubes and transformer windings from high voltages. Each gap unit includes high resistances connected in series to limit the current passing across the gap during flashovers. Each gap should be adjusted so that the clearance between gap points is $7/8$ inch.

(b) *Filter Condenser Protective Sphere Gap*—G4G—This sphere gap, set at .295 inch, protects the filter condenser from high voltages. The spheres should be kept clean and should be re-polished in case an arc crosses the gap.

(c) *Filter Coil Protective Sphere Gap*—G5G—This sphere gap protects the filter coil L6G from high voltages. The gap should be adjusted for a clearance of from $1/8$ inch to $5/32$ inch and the spheres should be kept clean and well polished.

(d) *Rectifier Voltmeter Protector*— P_{1G} —This protector is connected across the voltmeter on the rectifier unit and serves to prevent the application of high voltages to the instrument. It consists of copper blocks separated by mica strips with a very short air gap between the centers of the blocks. In case the voltmeter circuit from the voltmeter multipliers R_{1G} , R_{2G} , R_{3G} and R_{4G} in the transformer and filter assembly to the voltmeter on the rectifier unit becomes open a high voltage will occur across this gap breaking it down. In this case it will be necessary to clean the copper surfaces and it may be necessary to replace the mica strips.

B. TEMPERATURE CONTROL CIRCUITS

Two independent temperature control circuits are provided, one for each of the two heater units. All meters, relays, etc., associated with the temperature control circuit for the left hand box (facing the front of the unit) are marked in addition to their other designation "CRYSTAL NO. 1" and similarly all meters, relays, etc., for the right hand box are marked "CRYSTAL NO. 2." Either of these two circuits may be adjusted without affecting the adjustment of the other circuit.

If it should be necessary to change the temperature inside either of the boxes, adjust the thermostat by means of the knob located at the right of the thermometer for the box whose temperature it is desired to change. Push this knob in until it engages and turn in the proper direction as indicated by the markers HIGH AND LOW. One complete turn of this knob will change the temperature about 8° C.; for example, if the temperature of one of the boxes is 40° C. and it is desired to increase its temperature to 52° C., the control knob should be turned approximately $1\ 1/2$ revolutions in the HIGH direction. The final precise adjustment of temperature should be made after the oscillator has been in operation for at least half an hour as the temperature of the crystal will generally be about $1/4^{\circ}$ C. higher while the oscillator is in operation.

If proper attention is paid to cleaning the contacts of the relays on the temperature control panel, it will be unnecessary to readjust these relays. However, should occasion to make readjustment arise, the following procedure may be followed. In making any mechanical adjustments on these relays the operator should bear in mind that the switch marked HEATER SUPPLY controls the power input to both of the boxes. Hence, if it is desired to keep the quartz oscillator whose temperature control circuit is not being

adjusted ready for use, the power should not be shut off any longer than necessary.

1. Open the switch marked TEST SWITCH. Turn the HEATER SUPPLY switch to OFF position. Remove the cover of the HEAT CONT. RELAY and make the following mechanical adjustments:

(a) Turn the knurled knob at the bottom of the relay holding the biasing spring so that the spring does not bear against the armature.

(b) Adjust the right contact screw until it just makes contact with the armature. Adjust the left hand contact screw until the gap between it and the armature is a minimum of 0.003" and a maximum of 0.005" as measured with a No. 74-D gauge.

(c) Adjust each of the pole pieces so that the gap between it and the armature is 0.010", this gap being measured with the armature against the opposite contact screw and the lock nuts tightened. Use a No. 92-A gauge to set these gaps.

2. Turn the power supply on. Turn the RELAY CURRENT ADJ. dial clockwise as far as it will go. The RELAY CURRENT should be between .8 and 1.2 milliamperes. Slowly decrease this current by turning the RELAY CURRENT ADJ. dial until the current reaches .25 milliamperes. If the relay has been correctly adjusted mechanically, it will remain in the operated position.

Note—The relay is in the operated position when the armature is against the left hand contact screw. A 15-watt, 110-volt lamp connected between the left hand contact screw and the frame of the unit will act as convenient visual indication of the operation of the relay, this lamp lighting when the relay is in the operated position.

3. Turn the knurled knob at the bottom of the relay so that the spring fastened to this knob bears against the left hand side of the armature. Slowly turn this screw still farther until the pressure of the spring against the armature causes the relay to release.

Caution: Whenever any relay adjustments are to be made the power should be cut off by turning the HEATER SUPPLY switch to the OFF position, as there is a potential of 110 volts between the relay frame and ground.

4. Increase the relay current by means of the RELAY CURRENT ADJ. dial until the relay operates. Decrease the current until the relay releases and observe at what current this occurs. The relay should release when the current is reduced from a value sufficient to make the relay operate to a value of 0.25 to 0.35 milliamperes.

(a) If the release does not occur within these limits, change the

pressure of the biasing spring against the armature, decreasing the pressure if the release occurs before .35 milliamperes and increasing the pressure if the release occurs when the current is less than .25 milliamperes.

5. Beginning with a current less than 0.25 milliamperes increase the relay current until the relay operates and observe at what value of current this occurs. The relay should operate when the current is increased from less than the release value to a value of from 0.4 to 0.7 milliamperes.

(a) If the relay operates when the current is less than 0.4 milliamperes, screw out the right contact screw a slight amount (not more than a half turn) thus increasing the gap between it and the armature. If the relay does not operate until the current is more than 0.7 milliamperes, screw in the right contact screw a similar small amount. Only a small change in the gap will be found necessary to make the relay meet this requirement.

(b) Determine if the relay still releases at a current value between .25 and .35 milliamperes. If it no longer meets these requirements, change the pressure of the biasing spring until the relay releases when the current is reduced to a value within the limits.

6. Adjust the dial marked RELAY CURRENT ADJ. so that maximum relay current is obtained. Throw the TEST SWITCH to the TEST position. Observe the operation of the relay. Throwing the switch to the TEST position should decrease the current to less than .25 milliamperes, the relay should release and the test lamp, if one is used, go out. Open the switch. The relay current should increase to its previous maximum value, the relay should operate and the test lamp light.

7. Throw TEST SWITCH into OPERATE position. Remove the test lamp and replace the relay covers.

C. ADJUSTMENT OF RADIO FREQUENCY CIRCUITS

1. Tuning Procedure.

Warning: Always Open Switches D5A on the AC Power Panel and D3C on the Oscillator Unit When the Gate in the Fence Is Left Open or When Entering the Enclosure. These Safety Switches Are in the 10,000-Volt Transformer Supply and 1600-Volt Generator Field, Respectively.

(a) *Preliminary Adjustments*—Before starting the transmitter, adjust the coils and condensers in the oscillator, first amplifier, second amplifier and third amplifier in accordance with the data

given on the curves³ shown on page 147. Insert a D-87781 quartz oscillator in each thermal element, following the instructions accompanying the quartz oscillator and reprinted on a previous page. Except for the temperature of the crystals, the switches *D16C* and *D17C* are the only adjustments to be made on the oscillator. It should be noted that the lower set of curves shown on page 147 give the values of capacity, resistance and the number of turns to be used in each branch of the output circuit of the third amplifier; that is, the specified number of turns are to be used on each side of the center of the coil *L1D*; the specified value of resistance is to be used in both *R1.1D* and *R1.2D*; and the specified capacity is to be included in both of the two condenser banks, the bank consisting of *C1D* and *C3D* and the bank consisting of *C2D* and *C4D*. The plate tap on the output circuit of the third amplifier tuning coil is placed on the farthest turn to the right that is connected in circuit. Set both links of *D17C* on the same terminal. Open the high voltage transformer disconnect switch *D5A* located in the rear of the AC power panel. Turn the knob of the 1600-VOLT GENERATOR field rheostat as far as it will go in a clockwise direction. Set the THIRD AMPLIFIER INPUT control at minimum. Set the FIRST AMPLIFIER INPUT at about 3/4 full scale. See that switch *D4C* (the triple-pole double-throw switch located in the left hand shielded compartment of the oscillator unit) is thrown into the up position. Set the two flexible leads on the radio frequency transformer *L12C* to the tap shown on page 148; connect the high current thermocouple in circuit; and make sure that switch *D6C* is closed and *D5C* is open.

Note: Before starting the transmitter, the operator should be sure that the sensitive thermocouples used while neutralizing the second amplifier, third amplifier and power amplifier are not connected in circuit. These thermocouples should never be used except during the process of neutralizing the stage in whose output circuit they are connected and then the operator should make sure that plate voltage has been removed from this stage.

(b) *Tuning First and Second Amplifiers*—Start the transmitter by pressing the START button of the MASTER CONTROL SWITCH. Adjust the voltage of all generators except the 1600-volt generator to their normal values. Increase the voltage of the 1600-volt gen-

³ The several curves mentioned here and throughout the remainder of these instructions refer to curves contained in the Western Electric Instruction Book but not reproduced in this text as it was thought it would be of little interest to the student who is more concerned with practical operating instructions and procedure.

erator until sufficient current is indicated on the FIRST AMPLIFIER PLATE CURRENT meter and the SECOND AMPLIFIER PLATE CURRENT meter for the purpose of tuning. Adjust the control marked FIRST AMPLIFIER TUNING until resonance is indicated. Adjust the control marked SECOND AMPLIFIER TUNING until resonance is indicated.

Note: Resonance is indicated in all circuits except the antenna circuit by an adjustment for minimum DC plate current of the tube whose tuned circuit is being adjusted. In tuning the first or second amplifier, care should be taken that either stage is not tuned to the second harmonic of the oscillator. Should two points of minimum plate current be found with the coarse adjustment as specified, the one at which the dial reading is minimum (that is, the capacity of the variable condenser is maximum) is the correct setting for the stage.

(c) *Neutralizing Second Amplifier*—Shut down the transmitter by pressing the STOP BUTTON on the MASTER CONTROL switch. Open switch *D6C*, which is the link located on the back of the meter panel of the oscillator unit behind the SECOND AMPLIFIER PLATE CURRENT meter; close switch *D5C*, thus short circuiting the resistance *R26C*; and throw switch *D4C* down, thus connecting the sensitive thermocouple in circuit. Set the FIRST AMPLIFIER INPUT at its minimum value. Start the transmitter as before. Increase the FIRST AMPLIFIER INPUT to its maximum position or until the SECOND AMPLIFIER OUTPUT CURRENT meter reaches its full scale deflection. Neutralize the second amplifier by adjusting the SECOND AMPLIFIER BALANCING CONDENSER for that position at which the SECOND AMPLIFIER OUTPUT CURRENT meter reads a minimum.

(d) *Tuning Third Amplifier*—Shut down the transmitter. Throw switch *D4C* into the up position, connecting the high current thermocouple in circuit. Open switch *D5C* and close switch *D6C*. Start the transmitter and adjust the 1600-volt generator for 1600 volts. Adjust the FIRST AMPLIFIER INPUT until the FIRST AMPLIFIER OUTPUT CURRENT falls within the limits given on page 151 (W. E. Instruction Book). Increase the THIRD AMPLIFIER INPUT until sufficient current is read on the THIRD AMPLIFIER PLATE CURRENT meter for tuning purposes. Tune this stage to resonance using the THIRD AMPLIFIER TUNING CONTROL.

Note: It is preferable that the three tubes of the third amplifier be of the same class. The class number of a type 212-D tube is etched on the glass near the base and denotes the classification of the tubes according to plate impedance. This classification is in

no way a criterion of the quality of the tubes. If three tubes of the same class are not available, tubes of two *adjacent* classes may be used. Set the switch D_{13C} located on the panel in the rear of the oscillator unit according to the class of tubes used. If tubes of adjacent classes are used, set this switch on the tap corresponding to the highest numbered class. At the same time see that the switch D_{7C} is set in accordance with the classification of the modulator tube V_{2D} and that switch D_{8C} is set at 250. The transmitter should be shut down before changing the position of any of these switches.

(e) *Neutralizing Third Amplifier*—Shut down the transmitter. Open the switch D_{4D} , which is the link located on the back of the meter panel of the amplifier unit behind the THIRD AMPLIFIER PLATE CURRENT meter. Connect the sensitive thermocouple $H_{1.2D}$ in circuit in place of $H_{1.1D}$. Set the THIRD AMPLIFIER INPUT at minimum. Start the transmitter, and increase the THIRD AMPLIFIER INPUT until it is maximum or until the THIRD AMPLIFIER OUTPUT CURRENT meter reaches full scale deflection. Should it be impossible to obtain a satisfactory deflection of this meter at the maximum position of the input control, increase the number of turns on the secondary of the radio frequency transformer L_{12C} which is located in the left hand shielded compartment of the oscillator unit. This may be done by moving the flexible connector to a tap marked with a higher number. The two connectors, one of which is connected to each of the two secondaries of this radio frequency transformer, should always be connected to taps bearing the same number. Adjust the THIRD AMPLIFIER BALANCING CONDENSER until the current read on the THIRD AMPLIFIER OUTPUT CURRENT meter is minimum.

(f) *Tuning Power Amplifier and Antenna Circuit*—Shut down the transmitter. Replace the thermocouple $H_{1.2D}$ with the high current capacity thermocouple $H_{1.1D}$. Close the switch D_{4D} and set the THIRD AMPLIFIER INPUT at minimum. Next set the condensers and inductance in the tuning unit, making use of the information given on pages 148, 149 and 150 (W. E. Instruction Book). Page 149 shows the approximate coupling capacity plotted against the carrier frequency for low resistance antennae. The value of coupling capacity should be taken from the curve corresponding to the resistance of the antenna at the carrier frequency. The approximate coupling capacity for high resistance antennae may be obtained from page 150. Here the coupling capacity is plotted against antenna resistance. Use the curve

within whose frequency range the assigned carrier frequency falls. Arrange and connect the coupling condensers in accordance with the arrangement in Table I which has the nearest capacity to the value obtained from either page 149 or 150. Set the tuning condensers and the inductance $L1F$ in accordance with the data given on page 148. Remove the ground from the antenna and connect the antenna to the transmitter. Close switch $D5A$. Start the transmitter. Increase the THIRD AMPLIFIER INPUT until the POWER AMPLIFIER PLATE CURRENT meter on the power amplifier unit reads about one ampere. Adjust the CLOSED CIRCUIT INDUCTANCE—FINE ADJUSTMENT control for minimum POWER AMPLIFIER PLATE CURRENT. Increase the THIRD AMPLIFIER INPUT if necessary and adjust the ANTENNA CIRCUIT INDUCTANCE—FINE ADJUSTMENT control for maximum ANTENNA CURRENT. Retune the closed circuit for minimum plate current, and then retune the antenna circuit. This procedure, tuning first the closed circuit and then the antenna circuit, should be followed until the tuning of either of the two circuits produces a negligible change in the tuning of the other circuit.

Note: If a high resistance antenna is used, the tuning of the antenna circuit may be so broad that the point of maximum antenna current is indeterminate. In this case it will be necessary to utilize one of the alternative methods described farther on.

(g) *Neutralizing Power Amplifier*—Shut down the transmitter. Open the high voltage transformer disconnect switch $D5A$. Open the door in the front panel of the tuning unit and connect the sensitive thermocouple $H1.2F$ in circuit in place of the thermocouple $H1.1F$. Close the door and set the THIRD AMPLIFIER INPUT at minimum. Start the transmitter by pressing the start button of the MASTER CONTROL SWITCH. Increase the input to the power amplifier by means of the THIRD AMPLIFIER INPUT until this control is at its maximum, or until the CLOSED CIRCUIT CURRENT (IND) meter reaches full scale deflection. Adjust the balancing condenser $C5E$ located at the top of the power amplifier unit until the current on this meter is minimum. Shut down the transmitter. Replace the sensitive thermocouple $H1.2F$ with the high current capacity thermocouple $H1.1F$. Set the THIRD AMPLIFIER INPUT at minimum and close $D5A$.

(h) *Adjusting for Desired Power Output*—Start the transmitter. Increase the THIRD AMPLIFIER INPUT until approximately the desired power output is obtained in the antenna. This may be determined by adjusting for the correct antenna current as deter-

TABLE I.

| Coupling Capacity mfd | C ₁ F | C ₂ F | C ₃ F | C ₄ F |
|-----------------------|--------------------------------|--------------------------------|--------------------------------|--------------------------------|
| .015 | 1 .004 mfd. cond. | 1 .002 mfd. cond. | 1 .001 mfd. cond. | 2 .004 mfd. cond. |
| .014 | 1 .004 " " | 1 .002 " " | " " | 2 .004 " " |
| .013 | 1 .004 " " | " " | .001 " " | 2 .004 " " |
| .012 | 1 .004 " " | " " | " " | 2 .004 " " |
| .011 | " " | 1 .002 " " | 1 .001 " " | 2 .004 " " |
| .010 | 2 .004 " " | 1 .002 " " | 1 .002 " " | 2 .002 " " |
| .009 | 2 .004 " " | 1 .002 " " | 1 .001 " " | 2 .002 " " |
| .0085 | 2 .004 " " | 1 .002 " " | 2 .001 " " | 2 .002 " " |
| .0080 | 2 .004 " " | 1 .002 " " | " " | 2 .002 " " |
| .0075 | 2 .004 " " | 2 .002 " " | 2 .001 " " | 2 .002 " " |
| .0070 | 2 .004 " " | 2 .002 " " | 2 .001 " " | 2 .002 " " |
| .0065 | 2 .004 " " | " " | 2 .001 " " | 2 .002 " " |
| .0060 | 2 .004 " " | " " | 2 .001 " " | 2 .002 " " |
| .0055 | 1 ea. .002 and .004 mfd. cond. | 1 ea. .002 and .004 mfd. cond. | 1 ea. .002 and .004 mfd. cond. | 1 ea. .005 and .001 mfd. cond. |
| .005 | 1 ea. .002 and .004 mfd. cond. | 1 ea. .002 and .004 mfd. cond. | 1 ea. .002 and .004 mfd. cond. | 1 .001 mfd. cond. |
| .0045 | 1 ea. .002 and .004 mfd. cond. | 1 ea. .002 and .004 mfd. cond. | 1 ea. .002 and .004 mfd. cond. | 1 .005 " " |
| .004 | 1 ea. .002 and .004 mfd. cond. | 1 ea. .002 and .004 mfd. cond. | 1 ea. 0.02 and .004 mfd. cond. | " " |
| .0035 | 2 .002 mfd. cond. | 2 .002 mfd. cond. | 1 ea. 0.02 and .004 mfd. cond. | — |
| .003 | 2 .002 " " | 2 .002 " " | 1 .001 mfd. cond. | 1 .005 mfd. cond. |
| .0025 | 2 .002 " " | 2 .002 " " | 1 .001 " " | — |
| .002 | 1 ea. .002 and .001 mfd. cond. | 1 ea. .002 and .001 mfd. cond. | 1 ea. .002 and .001 mfd. cond. | 1 .0005 mfd. cond. |
| .00188 | 1 ea. .002 and .001 mfd. cond. | 1 ea. .002 and .001 mfd. cond. | 2 .001 mfd. cond. | — |

⁴ When two condensers are used in the condenser bank C₄F, they are connected in parallel.

When two condensers are used in the condenser banks C₁F, C₂F, and C₃F they are connected in series.

Note: It is recommended that no different combination of condensers from those given in the above table be used as there is danger of exceeding the current carrying capacity of some one condenser in the bank.

mined by the relation

$$I = \sqrt{\frac{P}{R}}.$$

In which I = antenna current in amperes.

P = power in watts.

R = antenna resistance in ohms (at the carrier frequency).

Check the tuning of all stages and by means of the THIRD AMPLIFIER INPUT adjust for the correct antenna current.

2. Alternative Methods of Tuning Antenna Circuit.

If the resistance of the antenna is high, it may be impossible to determine when the antenna current is maximum and recourse must be made to another method of tuning. Both of the alternative methods described below are based on current relations which exist in two parallel circuits, one containing a pure resistance (the antenna circuit when correctly adjusted) and one containing a pure capacity (the coupling condenser circuit). The first method is the more convenient and will be satisfactory in most cases. A few instances may arise where it is necessary to use the second method.

A. First Alternative Method—(a) Tune and neutralize the transmitter through the third amplifier as described in paragraphs (a) to (c) inclusive of the preceding section. Adjust the coupling capacity, tuning capacity and closed circuit inductance as described in paragraph (f) of the same section. Reduce the THIRD AMPLIFIER INPUT as previously described and tune the closed circuit for minimum POWER AMPLIFIER PLATE CURRENT.

(b) Tune the antenna circuit for the minimum *ratio* of the CLOSED CIRCUIT CURRENT (CAP) to the ANTENNA CURRENT. In other words, adjust the antenna circuit inductance to that value at which the quotient of the CLOSED CIRCUIT CURRENT (CAP) divided by the ANTENNA CURRENT IS MINIMUM.

(c) Retune the closed circuit for minimum POWER AMPLIFIER PLATE CURRENT. With this method it is not necessary to retune the antenna circuit.

(d) Shut down the transmitter. Neutralize the power amplifier as described in paragraph (g) of the preceding section. Start the transmitter and adjust for the desired output as described in paragraph (h).

B. Second Alternative Method—This method is based on the fact that the vectors representing the current through the induc-

tance $LI\omega$, the current through the coupling condensers and the antenna current form a triangle. When the antenna circuit has no reactive component, the angle by which the current through the coupling condensers leads the antenna current will be 90 degrees. When the antenna has a positive reactance, this angle is greater than 90 degrees and when the antenna has a negative reactance, this angle is less than 90 degrees. Simultaneous readings are made of all three currents and a factor computed which is proportional to this angle (or more strictly speaking, proportional to half the tangent of this angle). This factor will be unity when the antenna circuit is correctly adjusted. If the factor is not unity, more or less inductance is added to the antenna circuit until the factor becomes unity. The detailed method of procedure is as follows:

(a) Tune and neutralize the transmitter through the third amplifier as described in paragraphs (a) to (e) inclusive of the preceding section. Adjust the coupling capacity, tuning capacity, and close circuit inductance as described in paragraph (f) of the same section. Reduce THIRD AMPLIFIER INPUT as previously described in paragraph (f) of the same section. Reduce THIRD AMPLIFIER INPUT as previously described and tune the closed circuit for minimum POWER AMPLIFIER PLATE CURRENT.

(b) Record the simultaneous readings of the CIRCUIT CURRENT (IND), CLOSED CIRCUIT CURRENT (CAP) and ANTENNA CURRENT meters.

Let

$$\begin{aligned} I_{\text{ant}} &= \text{antenna current,} \\ I_{\text{ind}} &= \text{closed circuit current (ind),} \\ I_{\text{cap}} &= \text{closed circuit current (cap),} \\ S &= I/2(I_{\text{ant}} + I_{\text{ind}} + I_{\text{cap}}), \end{aligned}$$

compute the factor

$$F = \frac{(S - I_{\text{ant}})(S - I_{\text{cap}})}{S(S - I_{\text{ind}})}$$

When the antenna circuit is tuned to resonance, this factor equals unity. If the computed value is greater than unity, the antenna inductance should be decreased. If it is less than unity, the antenna inductance should be increased. The following data taken while tuning a 120-ohm antenna on 500 kilocycles will illustrate this method of tuning.

| Antenna Inductance | I_{ant} | I_{cap} | I_{ind} | S | $s-I_{ant}$ | $s-I_{cap}$ | $s-I_{ind}$ | F |
|--------------------|-----------|-----------|-----------|-------|-------------|-------------|-------------|------|
| 19 turns | 5.25 | 18.8 | 21.0 | 22.53 | 17.28 | 3.73 | 1.53 | 1.87 |
| 18 " | 5.45 | 19.5 | 21.1 | 23.03 | 17.58 | 3.53 | 1.93 | 1.39 |
| 14 " | 5.45 | 19.5 | 20.6 | 22.78 | 17.33 | 3.28 | 2.18 | 1.14 |
| 13 " | 5.55 | 19.55 | 20.6 | 22.85 | 17.30 | 3.30 | 2.25 | 1.11 |
| 12 " | 5.45 | 19.50 | 20.1 | 22.53 | 17.08 | 3.03 | 2.43 | .945 |

In this case the correct value of antenna loading inductance was found to be about 12 1/2 turns.

(c) Retune the closed circuit for minimum POWER AMPLIFIER PLATE CURRENT. As in the case of the first alternative method, it is not necessary to retune the antenna circuit.

(d) Neutralize the power amplifier as previously described in paragraph (g) of the preceding section. Adjust the transmitter for the desired output as described in paragraph (h) of the same section.

3. Adjustment of Artificial Antenna.

The artificial antenna is intended to be used in place of the real antenna for testing purposes and to be at all useful it must be adjusted to have the same reactance and resistance as the real antenna for the carrier frequency used. It is adjusted by trial, varying the resistance, inductance and capacity until the readings of the meters in the tuning unit are exactly the same when the antenna switch is in either position and with the same adjustments of the tuning unit. For low resistance antennae the resistance setting will be slightly below the effective resistance of the antenna. For higher resistance antennae it may be necessary to use a value of resistance somewhat higher than that of the antenna due to the effect of stray shunt capacity. The proper resistance is obtained by adjusting the arrangements of the resistance units or grids in the two resistance banks $R_{5.1G}$ and $R_{5.2G}$, each of these grids having a resistance of 44 ohms and a current carrying capacity of 2.5 amperes.

The following table shows connections of the artificial antenna resistances for different values of resistance.

Intermediate values of resistance may be obtained by using intermediate numbers of groups in series or by adding or subtracting grids from one of the groups. Care should be taken that the smallest group contains as many grids as the quotient of the antenna current divided by 2.5.

(d) *Typical Meter Readings*—All meters should now read within the limits specified in the following table when the transmitter is in operation. The table is intended to cover the whole range from 500 KC to 1500 KC. At any one frequency the meter readings should fall within the limits given but should not vary greatly from a single value at that frequency. If the meters on the tuning and power amplifier units do not indicate within the required limits, readjustment may be made with the following ideas in mind.

| Resistance in Ohms | Grids in Parallel in Each Group | Number of Groups Connected in Series | Resistance in Ohms | Grids in Parallel in Each Group | Number of Groups Connected in Series |
|--------------------|---------------------------------|--------------------------------------|--------------------|---------------------------------|--------------------------------------|
| 13.2 | 10 | 3 | 73.3 | 6 | 10 |
| 17.6 | 10 | 4 | 88.0 | 5 | 10 |
| 22.0 | 10 | 5 | 105 | 5 | 12 |
| 26.4 | 10 | 6 | 132 | 4 | 11 |
| 27.5 | 8 | 5 | 165 | 4 | 15 |
| 33.0 | 8 | 6 | 176 | 3 | 12 |
| 38.5 | 8 | 7 | 293 | 3 | 20 |
| 44.0 | 6 | 6 | 440 | 2 | 20 |
| 51.3 | 6 | 8 | 660 | 2 | 30 |

(a) The meter marked CLOSED CIRCUIT CURRENT (IND) should always read more than the meter marked CLOSED CIRCUIT CURRENT (CAP). If this condition does not hold, it is a sign that the antenna circuit is not correctly tuned.

(b) The amount of closed circuit current depends on the coupling capacity. Increasing the coupling capacity increases the closed circuit current as it introduces less resistance into the closed circuit. Conversely decreasing the coupling capacity decreases the closed circuit current.

(c) The power amplifier plate current depends on the impedance of the closed circuit. This current may be reduced by using a larger value of coupling capacity and increased by using a smaller value of coupling capacity.

(d) The radio frequency input to the power amplifier may be increased by increasing the coupling between the second and the third amplifiers by means of the THIRD AMPLIFIER INPUT control. Should insufficient input be obtained with this control at its maximum position, increase the number of turns on the secondaries of the radio frequency transformer *L12C* as previously described on page 360.

(e) If an oscillograph is available, a pure sine wave of some low frequency may be applied to the audio input terminals of the transmitter. Small variations may then be made in the coupling capacity until the best wave form, as viewed in the oscillograph attached to the monitoring rectifier, is obtained.

With a sustained tone supplied to the transmitter at the proper input level, as shown on the volume indicator of the speech input equipment, there should be a noticeable increase in the output currents of the second and third amplifier, the closed circuit current, and antenna current. In the operation of the speech input equipment no attempt should be made to draw grid current in the modulator tube, as complete modulation is obtained at a much lower level than that which causes grid current to flow, and over modulation will cause serious distortion of the speech and music.

TYPICAL METER READINGS

5-KW. OUTPUT UNMODULATED

AC Power Panel:

| | |
|---------------------------|---------------|
| Voltage phase A | 220 5% volts. |
| Voltage phase B | 220 5% volts. |
| Voltage phase C | 220 5% volts. |
| Voltage rectifier 1 | 200 volts. |
| Voltage rectifier 2 | 200 volts. |
| Voltage rectifier 3 | 200 volts. |

Rectifier Unit:

| | |
|------------------------------------|------------------------|
| Rectified voltage | 9.5 to 10.5 kilovolts. |
| Rectifier plate current no. 1 | .4 to .5 amperes. |
| Rectifier plate current no. 2 | .4 to .5 amperes. |
| Rectifier plate current no. 3 | .4 to .5 amperes. |

Oscillator Unit:

| | |
|------------------------------------|-------------------------------------|
| Oscillator plate current | 55 to 70 milliamperes. |
| First amplifier output current .. | See page 151 (W. E. Book). |
| Second amplifier output current .. | 1.0 to 1.6 amperes. |
| Second amplifier plate current . | 90 to 120 milliamperes. |
| Oscillator grid current | 0 to 3.0 milliamperes. ⁵ |
| First amplifier plate current ... | 50 to 100 milliamperes. |
| First amplifier grid current | 0 milliamperes. |
| Second amplifier grid current .. | 7 to 25 milliamperes. |
| 14-volt generator | 14 volts. |
| 1600-volt generator | 1600 volts. |
| 22-volt generator | 22 volts. |
| 250-volt generator | 250 volts. |

⁵ The end turns of *L1C* should be short-circuited by the thin link on *D17C* provided for that purpose, if the OSCILLATOR GRID current exceeds three milliamperes. Under no circumstances should the grid current be allowed to exceed four milliamperes as the quartz plate will be damaged by passing too great a current through it.

Amplifier Unit:

| | |
|-----------------------------------|--------------------------|
| Third amplifier output current . | 400 to 650 milliamperes. |
| Third amplifier plate current .. | 4.0 to 10.0 amperes. |
| Modulator plate current | 70 to 120 milliamperes. |
| Third amplifier grid current ... | 0 to 5 milliamperes. |
| Speech amplifier plate current .. | 35 to 50 milliamperes. |
| Modulator grid current | 0 milliamperes. |

Power Amplifier Unit:

| | |
|-----------------------|------------------------|
| Grid current | 10 to 50 milliamperes. |
| Leakage current | 0 to 18 milliamperes. |
| Plate current | 1.3 to 1.5 amperes. |

Tuning Unit:

| | |
|----------------------------------|-------------------|
| Closed circuit (cap.) current .. | 22 to 33 amperes. |
| Closed circuit (ind.) current .. | 22 to 33 amperes. |
| Antenna current ⁶ | |

IV. Maintenance

A. General—For best operation the 5-C Radio Transmitter must be kept free from dust and dirt. High pressure air is recommended for cleaning the apparatus inside the enclosure, but a soft clean cloth may be used with good results. Waste or oily cloth should never be used. Lemon oil is recommended as a polish for the front of the panel units. It should be used sparingly and wiped off with a soft cloth.

All nuts, bolts and screws should be examined occasionally and loose ones tightened. Also examine all electrical connections and tighten loose contacts if any are found. Trouble can often be prevented by such precautions.

B. Vacuum Tubes—Tubes should never be operated at higher voltages than those specified, as such operation shortens the life of the tubes and does not improve the operation of the equipment.

Water-cooled tubes should be removed from their sockets and the anodes cleaned occasionally to prevent scale from accumulating. If scale accumulates on the copper anodes, it may prevent proper cooling and interfere with the removal of the tubes from the socket.

The life of tubes in the power amplifier may be greatly pro-

⁶ Antenna current may be determined from the equation

$$I = \sqrt{\frac{P}{R}},$$

I = antenna current in amperes,

P = power output in watts,

R = resistance of antenna at carrier frequency in ohms.

longed by reversing the direction of the current in the filament circuit. Switch *D1E* on the power amplifier unit is provided for this purpose. It is suggested that this switch be thrown to one side on odd numbered days of the month and to the other side on even numbered days.

C. Motor Generators.

Caution: Make Sure That the Field Circuit of Generator Is Open Before Working on the Generator.

The commutators of all the generators should be cleaned daily with a cloth to remove oil and dust. They should also be cleaned about once a week with fine (No. 0 or 00) sandpaper, lightly applied. Do not use emery cloth or crocus cloth. The above operations will help to keep the generator noise at a minimum. Clean the oil and dust from all sets daily, giving attention to the brush holders (particularly on the high voltage generator) about once a week.

Inspect the brushes frequently and replace if necessary. They should be replaced when worn so short that there is danger of the brush spring resting on the brush holder. Check the lubrication frequently and if necessary replenish the oil supply with a good grade of machine oil. Also inspect the oil rings to see that they are rotating properly.

D. Water Circulating System—Only distilled water should be used in the cooling system. Under normal conditions a water-flow of from 6 1/2 to 8 gallons per minute should be maintained. This condition is fulfilled when the drop in pressure across the Venturi tube located in the rear of the rectifier unit is between 15 lbs. and 20 lbs. It should be noted that the top gauge on the Venturi tube reads either a pressure or a vacuum. When this gauge reads on the pressure side (to the right of "0") the drop in pressure is the difference in the two gauge readings. When this gauge reads on the vacuum side (to the left of "0") the drop in pressure is the sum of the two gauge readings.

The purity of the water in the system may be determined by the indication of the leakage current meter located on the front of the power amplifier unit. When this current exceeds 18 milliamperes, the conductivity of the water is too great and it should be replaced. In some installations connections have been made so that house water may be used in an emergency, but this should not be done unless absolutely necessary, as operating with house water is likely to leave deposits of scale in the system, to cause unnecessary dis-

integration of the hose couplings and to cause excessive power losses.

The table on page 144 (W. E. Book) gives instructions for the operation of the various valves and is self explanatory.

The water system is filled through a hose attached to valve *E*. Set the valves as given in table on page 144, place the hose in the container holding the distilled water and draw water into the system by running the pump. Fill the system until the expansion tank is from one-third to one-half full. Under normal operating conditions it will be necessary to add from 1/2 to 1 gallon of water per week to replace losses from evaporation and leakage.

Each of the two radiators is equipped with valves on both the inlet side and the outlet side. Either one or both of these radiators may be used depending on local conditions. Under average conditions one radiator will have sufficient heat dissipating capacity to keep the temperature of the water well below 180° F. However, during hot weather it may be desirable to use both radiators. In this case the valves for both radiators should be left entirely open.

The strainer on the intake of the pump should be inspected every day when the equipment is first put in operation. The condition of the strainer during the first few inspections will determine the frequency with which later inspections need be made. This strainer may be removed for cleaning by unfastening the top of the unit and lifting the strainer out. Valves *D* and *F* must be closed before opening the strainer compartment.

Check the lubrication of the pump motor bearings frequently. Use a medium cup grease in the grease cups on the pump bearing and give the cups a turn every few days. Keep the packing on both sides of the pump tight enough to prevent water leaks.

E. Antenna—Two or three times a year lower the antenna and thoroughly clean the insulators. Inspect the contacts and tighten nuts and bolts, if any are used on the antenna fittings. It is important that the antenna insulators be cleaned periodically, especially if there is much smoke in the air. Where smoke is present, soot collects on the insulators and produces high resistance ground leaks which reduce the efficiency of the antenna.

F. No. 100-A Condenser—If the installation instructions which are packed with each condenser have been carefully followed, and if the condensers are operated at normal temperatures and rated voltage, little or no routine maintenance is required for the 100-A condensers.

These condensers should be installed in a place where there is

free circulation of air, and where the room temperature may be maintained between 40° F. and 105° F. They should be used only on direct current circuits and operated at potentials not exceeding 33 volts. If it is necessary to disconnect a condenser from the circuit for more than one week, the film on the positive plate may deteriorate. To prevent this, the condenser should be connected across a source of normal operating voltage for one or two hours each week that it is out of service.

When a condenser has not been maintained in this manner it may pass a high current and give off gas when a potential is applied. If the cell is in this condition, it will be necessary to refilm the positive plate before putting the condenser back into service. This process is an emergency measure only and should not be substituted for weekly maintenance while the condenser is out of service, for allowing the film to deteriorate shortens the life of these cells. The refilming may be done by connecting the condenser in series with a 110-volt lamp rated between 50 and 100 watts across a supply of direct current having a potential equal to or slightly greater than that of the circuit in which the condenser is used. Care should be taken in doing this to be certain that the positive terminal of the condenser is connected to the positive side of the source of potential. The condenser should be allowed to remain connected in this circuit until the current flowing through it drops to a value of 50 milliamperes or less. This may, in some cases, take one or two days.

Care should be taken to keep the hole in the porcelain cover plugged with a cork and to have the groove of the cover set properly over the rim of the glass jar, the paraffin in the grooves maintaining the seal. Unless the air space above the oil is sealed to prevent air circulation, crystals from the evaporation of creeping condenser fluid will form on the supports above the oil.

Occasionally a gray precipitate will appear at the bottom of the jar. This is the result of a corrosive action which takes place on the positive or corrugated plates and their terminals. Such corrosive attack is particularly likely to take place if sufficient care has not been exercised in the installation of the condensers. The attack is not harmful unless the terminals of one of the positive plates are weakened sufficiently to allow the plate to drop against the negative structure. In the event of a short circuit of this nature, the condenser plates can be removed from the fluid, the remaining supports of the affected plate cut-off, and the damaged plate removed. The remaining electrodes may then be used until a new condenser is obtained. The change of capacity due to the

removal of one electrode is not sufficient to affect the filtering action of the circuit in which the condenser is connected, and after a plate has been removed the condenser may continue to operate indefinitely. However, the corrosive action may continue so that an additional plate must be removed, in which case the filtering action of the circuit would be materially affected.

G. Relays—Relay maintenance consists principally in keeping the contacts clean. Dust collects on the contacts in spite of the relay covers and sometimes causes a failure in the operation of an important circuit. Relay contacts in generator field circuits should receive special attention. Do not overlook the water flow relay *S1B*. Abrasives such as fine files or emery cloth should never be used on the contacts. In the case of badly pitted contacts, crocus cloth may be used, but the contacts should immediately be cleaned with carbon tetrachloride.

In order to insure unretarded action of the type PQ time delay relays, Neetsfoot oil should be applied to the bellows once every three months or oftener if necessary.

The contacts of the relays on the temperature control panel and the thermostat contacts should receive special care. At least once every two weeks they should be cleaned using the following procedure: Use carbon tetrachloride of the highest purity and some hard wood toothpicks flat on one end. Hold the contacts apart and deposit a drop or two of the liquid on them with the point of a toothpick. Dip the flat end of the toothpick in the liquid to a depth of one-fourth inch and rub back and forth two or three times between the contacts, which should now be closed with a slight pressure on the flat side of the toothpick.

Caution: The HEATER SUPPLY switch should be turned off when the relays are being cleaned, as there is a potential of 110 volts between the relay frame and ground. The liquid will soften any deposit that may have collected on the contacts and the rubbing will remove it. Hold the contacts open again and flush with a little of the liquid taken up on the clean point of the toothpick (not the end used for rubbing). This will wash off any loose particles that remain. The same toothpick should not be used for cleaning another set of contacts since the deposit removed from the first set might be left in the liquid and later be deposited on other contacts. Care should be taken to keep the liquid from coming in contact with the rubber studs, insulators, and windings as carbon tetrachloride has an injurious effect on these parts if applied frequently.

H. Air Filter on Power Transformer Blower—The fre-

quency with which this filter needs to be cleaned is dependent on local conditions but normally it need not be done oftener than once every six months. The tubular retaining bolt which holds down the cylindrical cover of the filter is perforated so that the filter may be conveniently cleaned by use of compressed air. Remove the small cap on the top of the filter and attach an air hose. Slowly turn the wing bolt around to the left for at least one revolution so that the cleaning blast will strike all portions of the inside of the insert. Always tighten the wing bolt and replace the small cap after each application of the air hose.

If compressed air is not available, the filter may be cleaned in the same manner, using an ordinary tire pump, or the insert may be removed and cleaned by gently tapping it. To remove the insert, unscrew the wing bolt on top of the filter and lift off the cover. Avoid handling the insert any more than necessary. Never brush the surface of the felt or wash it, as this merely tends to carry the dust into the pores of the felt.

I. D-87781 Quartz Oscillator—The D-87781 Quartz Oscillator as received, contains a piezo-electric quartz crystal which is padded with lens paper in order to facilitate shipping. This padding must be carefully removed in accordance with the following procedure before attempting to place the crystal oscillator into operation.

1. Remove the three outer screws clamping the crystal housing or cup to the base or lower electrode. In doing this care shall be taken not to separate the cup from the lower electrode as this will likely tear the foil connecting the upper plate or electrode and the center terminal of the cup.

2. Carefully invert the oscillator, taking care to keep the cup and lower electrode intact. Then remove the metal base or electrode. Remove the padding of lens paper between the crystal and the lower electrode. Carefully lift out the piezo-electric crystal by the edges of the crystal. **DO NOT TOUCH SURFACES OF THE CRYSTAL.**

3. Clean the crystal, crystal compartment and electrodes with the lens paper used as padding.

4. Replace the crystal and reassemble.

The quartz oscillator is now ready to be placed into operation. Care should be taken not to shake the D-87781 Quartz Oscillator unduly as there is considerable space for movement of the upper electrode, and careless handling of the quartz oscillator without the lens paper insertion in place may seriously injure the crystal.

If, for any reason, occasion should arise to clean the crystal, it may be done through the use of carbon tetrachloride and lens paper or other lintless material. If there is occasion to ship the D-87781 Quartz Oscillator, care should be taken to suitably pad the crystal before making shipment. The D-87781 Quartz Oscillator should then be placed in a carton containing adequate padding.

V. Operating Procedure

When the transmitter is not in operation it is advisable to ground the antenna to protect it against lightning. The safety switch *D5A* located in the rear of the a.c. power panel, and the safety switch *D3C* located in the rear of the oscillator unit, and the main power disconnect switch *D4A* located on the front of the a.c. power panel should also be left open. Before starting, it will be necessary to remove the ground from the antenna and close these three switches.

The transmitter may be started either with full automatic control or semi-automatic control. Under the first condition, pressing the start button will start all motors, light the filaments of all tubes, supply grid bias to all tubes, operate the 10,000-volt rectifier to apply plate voltage to the power amplifier, and finally close the 1600-volt generator field circuit, applying plate voltage to the radiation cooled tubes. When starting under semi-automatic control the transmitter follows the same procedure except that the 10,000-volt rectifier is not placed in operation and the 1600-volt generator field circuit is left open. These operations may then be performed by the operator independently. When considerable time has elapsed since the last broadcasting period it is good practice to start the transmitter with semi-automatic control, adjusting the filament voltages and allowing the filaments to burn for a few minutes previous to applying any plate potential. It is also good practice prior to starting to turn the rheostats for the 14-volt generator, 22-volt generator, and 1600-volt generator a few degrees in a clockwise direction, thus preventing the generator voltage from building up to an abnormally high value when the transmitter is started.

A. To Start with Automatic Control—Having removed the antenna ground and closed the safety switches, main power disconnect switch and the gate, press the **START BUTTON** of the **MASTER CONTROL** switch on the front of the a.c. power panel. When the generator voltages build up, adjust these voltages to their normal values. After the 1600-volt generator field relay has closed, adjust the **THIRD AMPLIFIER INPUT** until the antenna is the correct value for the desired power output.

B. To Start with Semi-Automatic Control—Remove the antenna ground, close the safety switches, main power disconnect switches and the gate as before. Press the OFF button of the 1600-VOLT GENERATOR FIELD switch located on the oscillator unit. Press the START button of the MASTER CONTROL switch located on the a.c. power panel and immediately after that press the OFF button of the RECTIFIER CONTROL switch also located on the a.c. power panel. When the 14-volt, 22-volt and 250-volt generator voltages have built up they should be adjusted to their normal value. Plate voltage may now be applied to the tubes in the power amplifier unit or to the radiation cooled tubes independently, voltage being applied to the power amplifier tubes by pressing the ON button of the RECTIFIER CONTROL switch and plate voltage being applied to the radiation cooled tubes by pressing the ON button of the 1600-VOLT GENERATOR FIELD switch.

C. Routine Meter Readings—All generator voltages should be checked and corrected if necessary at least once every fifteen minutes. After starting, the operator should check all meter readings and the crystal temperatures, looking for any irregularities. These meter readings and temperatures should also be checked regularly during transmission.

D. To Stop the Transmitter—The transmitter is shut down by pushing the STOP button on the MASTER CONTROL switch on the a.c. power panel. Under no condition should the operator stop the transmitter by use of the main power disconnect switch, as doing this is sure to damage the contacts of this switch. After stopping the transmitter, the antenna should be grounded, the safety switches *D5A* and *D3C* and the main power disconnect switch *D4A* opened.

After the transmitter has been started, should it be desired to remove plate voltage from the power amplifier, it may be done by pressing the OFF button of the RECTIFIER CONTROL switch. Should it be desired to remove plate voltage from the radiation cooled tubes, press the OFF button of the 1600-VOLT GENERATOR ARMATURE switch. Neither of these operations will affect any other part of the transmitter. Plate voltage may be reapplied to either group of tubes by pressing the ON button on the same switch.

E. Operation at Reduced Power—By reducing the THIRD AMPLIFIER INPUT the set may be operated at power outputs as low as 1 KW. No change in plate voltage or grid bias should be made while working at reduced power output.

F. Speech Input Equipment—The speech input equipment used in connection with the transmitter should be operated so as to deliver to the transmitter an input level of approximately —8 decibels. (The term decibel, abbreviated DB, has recently been adopted by international agreement to designate the unit formerly known as the transmission unit.)

VI. Location of Trouble

A. General—If this transmitter is subject to a regular and careful maintenance procedure very little trouble will be experienced. Should trouble arise an experienced operating personnel is a valuable asset as troubles which are baffling to a new operator often have causes which are obvious to the experienced operator. For this reason a new operator should endeavor to become familiar with the circuits, their functions and the location of the various pieces of apparatus, particularly fuses, as quickly as possible.

In case of trouble in any of the control or protection circuits the operator should remember that these circuits are interlocked so that the failure of one piece of apparatus often prevents other pieces from functioning. For example, should the field circuit of the 250-volt generator open, the 10,000-volt rectifier and the field circuit of the 1600-volt generator cannot be energized. The line diagram shown on page 105 will be found convenient for tracing these interlocking circuits. In case a piece of apparatus fails to operate the operator should first make certain that the previous interlocking circuits have operated and then examine the piece of apparatus for defects. Trouble with generators building up may sometimes be traced to dirty relay contacts in the field circuits. These should be cleaned regularly as outlined under *Maintenance*.

Trouble in the radio frequency circuits is usually caused by the improper adjustment of the circuits. The first step in case of trouble in these circuits should be to see that all adjustments are in accordance with the adjustments described in Section C of Part II.

It is not practical to attempt to describe every possible cause of trouble but the following list gives some of the more usual causes of trouble. It should be remembered that these are but suggestions.

B. Failure of Transmitter to Start—This may be due to no line voltage, an open or discharged battery operating the master control relay *S5A*. If the transmitter starts, but stops immediately, this may be due to the battery which operates the master

control relay *S5A* being almost discharged, thus being able to supply enough power to operate the relay but not enough to hold it up.

C. Failure of One of the Motors to Start—This condition is likely to be due to a blown fuse or thermal cutout in the motor circuit. The motors for the motor generators and the pump are protected by thermal cutouts which contain a heater coil and a fusible link. Should one of these motors draw any excessive current for any length of time the heat generated in the heater coils will melt the fusible link and open the circuit. All of these thermal cutouts use the same type fusible link, G. E. Cat. No. 167539, the difference in the current rating being determined by the construction of the heater coil. The motors for the radiator and transformer blowers are protected by cartridge fuses.

D. Failure of Power Amplifier Filaments to Light—This condition (unless tubes are burned out) is often an indication that the 22-volt generator field is open due to stoppage of the water circulating system. Check the inlet and outlet valves, making sure that these are not closed, and also look for any other closed valves in the system. This condition may also be caused by switch *D1E* on the back of the power amplifier unit being open, or by a blown fuse.

E. Failure of the Rectifier—If the filaments of the rectifier tubes do not light, the trouble is probably due to the failure of some of the preceding interlocking circuits. Check the voltage of the 22-volt generator and the 250-volt generator. If the filaments light, but no rectified voltage is produced, either the disconnect switch *D5A* on the back of the a.c. power panel or the switches on the high voltage transformer may be open. If two of the rectifier tubes light dimly and the third lights with normal brilliancy, one of the power supply fuses *F13A* is probably open. If one of the rectifier tubes does not light, one of the fuses *F5A*, *F6A* or *F7A* is probably open.

F. Failure of the Piezo-Electric Oscillator—If the oscillator is adjusted according to the instructions, there is no reason to expect failure of the quartz plate. If the quartz oscillator is removed at any time, care should be exercised in replacing it in the thermal element to make certain that it is seated firmly on the thermal element and in contact with it. If the quartz oscillator is not flat on the thermal element, there may be a difference in temperature between them which will cause a change in frequency of the crystal. If for any reason the oscillator should stop during

transmission, change to the other crystal by means of the CRYSTAL SELECTOR switch.

If the oscillator does not start when the transmitter is started, try shutting off the 1600-VOLT ARMATURE switch momentarily.

G. Failure of the Temperature Control Circuits—Should trouble develop in the temperature control apparatus and the temperature rise to an excessive value the operator should check the operation of the relay by throwing the TEST SWITCH to the TEST position. If the relay current decreases and the armature of the relay moves when this switch is thrown, the vacuum tube relay is functioning properly, and the trouble is probably due to the failure of the thermostat contacts to make contact due to dust between them. Clean the contacts as described in the section under *Maintenance*.

Should the temperature drop to a low value the trouble may be due to dirty contacts on the temperature control relay or to the relay being out of adjustment or the vacuum tube burned out. Trouble of this nature cannot be caused by any failure of the thermostat. The relay contacts may be cleaned as described in the section under *Maintenance*.

H. Reduced Signal Strength—Reduced signal, indicated by reports from radio listeners, when accompanied by reduced antenna current usually indicates either that connections in the ground or antenna leads have corroded, introducing a high resistance in the antenna-ground circuit, or that the antenna insulators are dirty, providing a high resistance leakage path to ground. When reduced signal strength is not accompanied by a change in antenna current it is probably due to seasonal or atmospheric conditions which are beyond the control of the operator.

I. Fuse Failure—Whenever a fuse blows, a thorough search should be made to locate the cause of trouble before replacing the fuse. If none is found, replace the fuse and apply power to the set, watching the meters and other apparatus in the circuit protected by that fuse. If the fuse blows a second time, the trouble should be found and rectified before replacing the fuse.

As each fuse protects some different circuit, fuse failures are often a convenient means of isolating troubles. The list of fuses given under Section VIII will be of assistance in locating troubles through fuse failures.

J. Open Filaments—Open filaments will not light and are readily located, except for the type 212-D vacuum tubes, which have parallel filaments. In these, one branch of the filament may

burn out while the other is still whole. This condition is indicated by low plate current, and the defective tube can be identified by the appearance of the filament when it is lighted.

VII. Spare Parts

The following spare parts are furnished as part of the 5-C Radio Transmitter:

- 30—General Electric Company fusible links, Catalogue No. 167539.
- 10—2 Ampere, 2500-volt fuses, D. & W. Catalogue No. 2760.
- 1—Ring per Detail 2, ESL-310847, Issue 4.
- 6—Gaskets per Detail 3, ESL-310847, Issue 4.
- 6—Gaskets per Detail 4, ESL-310847, Issue 4.
- 12—KS-6431 hose couplings.
- 12—Washers per Detail 1, ESA-318250.
- 1—Spare set of brushes for No. KS-5111 Motor-Generator.
- 1—Spare set of brushes for No. KS-5112 Motor-Generator.
- 1—Spare set of brushes for No. KS-5060 Motor-Generator.

The following additional spare parts are furnished with the 105-C Radio Telephone Broadcasting Equipment, of which the 5-C Radio Transmitter forms a part:

- 2—102-D vacuum tubes.
- 2—248-A or D-86737 vacuum tubes.
- 4—211-D vacuum tubes.
- 4—212-D vacuum tubes.
- 2—220-B vacuum tubes.
- 3—222-A vacuum tubes.
- 1—KS-6346 thermometer.

Spare parts should be kept readily accessible and clearly classified. It is important to prevent confusion of serviceable and un-serviceable material. Such confusion may cause unnecessary delay in broadcasting in case of trouble.

I. Description No. 8-B Speech Input Equipment

A. General.

The No. 8-B Speech Input Equipment is designed to be used at the studio location of a broadcasting installation, either when the studio and the radio transmitter are at the same location or when they are at points widely separated. It provides condenser trans-

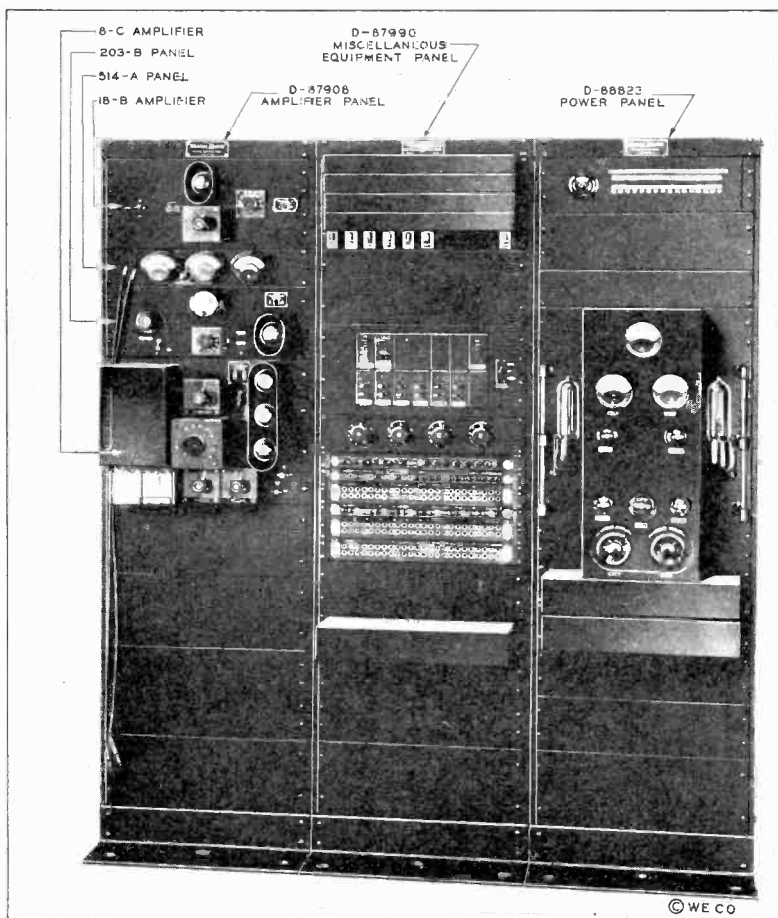

FIG. 209. 8-B Speech Input Equipment.

mitters for converting into electrical energy the sounds to be broadcast, and apparatus for amplifying the energy thus obtained to a suitable level before it is sent to the radio transmitter. A monitoring system is provided to enable the operator to control the amplifying apparatus intelligently. A studio control system is in-

corporated to facilitate switching of program circuits, together with an interphone system for communication between the control room and the studio. In addition there is included adequate power supply for the apparatus.

Essentially, this equipment consists of an assembly of apparatus on three panels to be located in the control room. In addition there are the condenser transmitters and studio control cabinet to be located in the studio, and the storage batteries with associated charging equipment. The panels mount the necessary amplifiers; the volume indicator used for visual monitoring; the meter panel for testing and adjusting the equipment; the condenser transmitter control and mixing circuits; the relays for switching and outside line signalling; the control panel for the studio control system; the jacks for switching and testing the equipment; the fuse panels for the battery circuits, and the high voltage rectifier with its associated resistances for supplying direct current to the plate circuits of the vacuum tubes of the amplifiers and of the volume indicator and for maintaining the necessary difference of potential between the plates of the condenser transmitters. The individual panels of this assembly and the units mounted on them are described in detail in subsequent sections. A front view of the three panel assembly is shown in figure 209.

The apparatus regularly furnished as part of the No. 8-B Speech Input Equipment provides for one studio only. The descriptive matter and the schematics contained in these instructions are presented on the assumed basis that three of the condenser transmitters will be installed in the studio and the fourth in the control room. For installations differing from the assumed standard, the schematics will be similar in general layout but will vary in detail according to the individual case. For instance, in the case of an installation having more than one studio, or in which the location of the condenser transmitters differs from the assumed arrangement, the circuit arrangements shown on the schematic of amplification and gain control circuits and the studio control system schematic can be considered as typical only.

B. Panel Assemblies.

1. *General*—In the descriptive matter which follows reference is made to position numbers. The system of designating mounting positions is as follows. The mounting positions are first numbered from left to right, looking at the front of the apparatus. If the

mounting has more than one horizontal row of mounting positions, those in the top row are numbered first as just described and the subsequent rows are numbered consecutively in the same way. If apparatus can be mounted on the rear of the mounting plate, the system of numbering is the same except that the positions are numbered from left to right looking at the rear of the apparatus. If both sides of the mounting are used, the mounting positions on the front are numbered first, and then the numbering is continued as described on the rear.

2. *No. D-87908 Amplifier Panel*—This panel consists of a framework on which are mounted the line amplifier (No. 8-C Amplifier), the monitoring amplifier (No. 18-B Amplifier), the volume indicator (No. 203-B Panel) and the meter panel (No. 514-A Panel). This panel is assembled as a unit and the input and output terminals of the apparatus are wired at the factory to a terminal strip at the rear of the panel to facilitate installation. Although not regularly furnished as part of this equipment, a power amplifier (No. 9-A Amplifier) and a volume control panel (No. 516-B Panel) for operating several loud speaking telephones in studios or reception rooms may be mounted on this assembly, and wiring is provided to care for the possible subsequent addition of these units. The input and output terminals of the amplifiers and the input terminals of the volume indicator are connected, when the equipment is installed, to jacks on the miscellaneous equipment panel described below, to facilitate testing and to provide flexibility of the equipment as a whole.

3. *No. D-87990 Miscellaneous Equipment Panel*—The No. D-87990 Miscellaneous Equipment Panel, like the Amplifier Panel, is assembled and wired at the factory.

At the top of the miscellaneous equipment panel are the mounting plates which mount the relays of the studio control system. Beginning at the top the first No. D-86778 Mounting Plate mounts six No. E-1997 Relays in positions 1 to 4 and 7 and 8. The relays in the first four positions are associated with the four condenser transmitter amplifier circuits, while the other two are used with the outside program line circuits. They are operated by non-locking push buttons designated "ON," which are contained in the No. D-85644 Apparatus Units, on the No. D-85650 Panel and in the No. D-86852 Control Cabinet. Each No. E-1997 Relay, when operated, connects the associated condenser transmitter amplifier circuit or outside program line to the input of the No. 8-C Amplifier and lights a signal lamp on the D-85650 Panel and in the No.

D-86852 Control Cabinet to indicate that the connection is made. In the unoperated position the relay disconnects the associated condenser transmitter amplifier circuit or outside program line

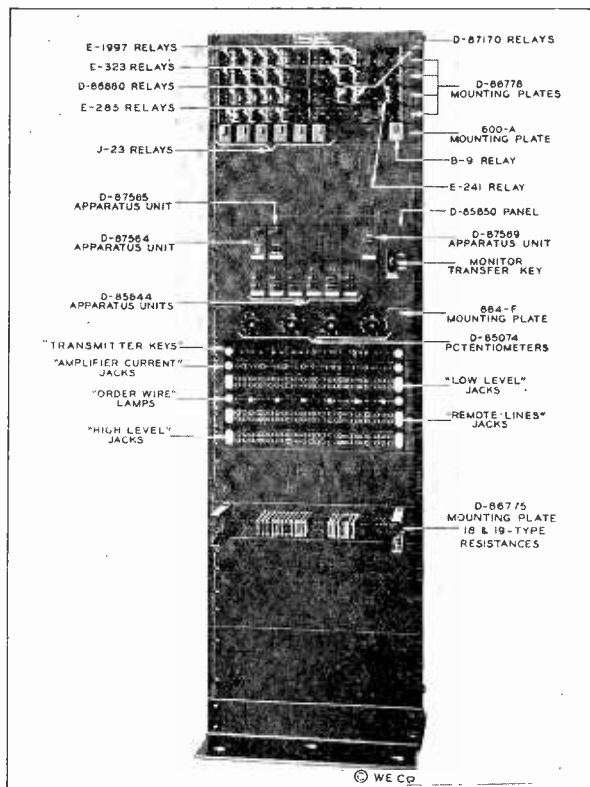

FIG. 210. D-87990 Miscellaneous Equipment Panel—Front.

from the input of the main speech input amplifier and connects in its place a resistance mounted on the No. D-86775 Mounting Plate, so as to keep the impedance of the circuit approximately constant regardless of the number of condenser transmitter amplifiers or outside line circuits connected.

The second No. D-86778 Mounting Plate mounts six No. E-323 Relays in positions 1 to 4, and 7 and 8. These relays, as mentioned

in the preceding paragraph, are associated respectively with the four condenser transmitter amplifier circuits and two outside program line circuits. They are operated by non-locking push buttons designated "OFF" which are contained in the No. D-85644 Apparatus Units on the No. D-85650 Panel and in the No. D-8652 Control Cabinet. Each No. E-323 Relay, when operated, breaks the locking circuit of the associated No. D-86880 (or No. D-87170) and No. E-1997 Relays, disconnecting the associated condenser transmitter amplifier circuit or outside program line as the case may be.

The third No. D-86778 Mounting Plate mounts four No. D-86880 Relays in positions 1 to 4, two No. D-87170 Relays in positions 7 and 8, and one No. E-241 Relay in position 10. The No. D-86880 Relays are associated with the four condenser transmitter amplifier circuits, while the No. D-87170 Relays are associated with the outside program line circuits. Both the No. D-86880 and the No. D-87170 Relays are provided with two windings, one for operating and one for locking. They are operated through their operating windings by non-locking push buttons marked "ON" contained in the No. D-85650 Panel. Once operated, they are locked through their locking windings and auxiliary contacts until their locking circuits are broken by the operation of the associated No. E-323 Relays, controlled by the "OFF" buttons of the No. D-85644 Apparatus Units. The No. D-86880 Relays may also be controlled from the No. D-85644 Apparatus Units of the No. D-86852 Control Cabinet in the studio. The No. D-87170 Relays can be controlled only from the No. D-85650 Panel in the control room, unless additional No. D-85644 Apparatus Units are provided in the No. D-86852 Control Cabinet. The reason for this arrangement is given in the section entitled "Operation."

When operated, each No. D-86880 or No. D-87170 Relay closes the operating circuit to the associated No. E-1997 relay, which when operated connects the desired condenser transmitter amplifier circuit or outside program line to the input of the No. 8-C Amplifier. Each No. D-86880 Relay, associated with a condenser transmitter amplifier circuit, when operated not only closes its own locking circuit and the operating circuit of the associated No. E-1997 Relay but, in addition, opens the circuit of the interphone signalling buzzer at the point where the associated condenser trans-

mitter is located, disconnects the loud speaking telephone at that point, and operates a supplementary relay to control the intensity of illumination in the studio if such a relay is used. The circuit of the signalling buzzer is opened to avoid the possibility of broadcasting the sound produced when this buzzer is operated. The loud speaking telephone is disconnected when a condenser transmitter in the same room is connected, to avoid acoustic singing through the loud speaking telephone, condenser transmitter and amplifiers. A floodlight control relay, when used, changes the illumination in the studio whenever a condenser transmitter in that studio is connected to the input of the No. 8-C Amplifier, as a warning that sounds in the studio will be amplified and broadcast.

On each No. D-87170 Relay is an extra pair of contacts which may be used, if desired, to close the operating circuit to a signal at the remote pickup point, as an indication that the associated switching relays are operated.

The No. E-241 Relay is operated whenever the speech input equipment is in operation until the "READY" key of the No. D-87569 Apparatus Unit on the No. D-85650 Panel is operated, at which time it releases. In the operated position this relay disconnects the output of the speech input equipment from the line to the radio transmitter so that no sounds can be broadcast from the studio location. When the No. E-241 Relay is released by the operation of the "READY" key mentioned above, the output of the speech input equipment is connected to the input of the radio transmitter and the green capped "READY" lights on the No. D-87569 Apparatus Unit of the No. D-85650 Panel and on the No. D-87567 Apparatus Units of the No. D-86852 Control Cabinet, are lighted to indicate that the station is ready for broadcasting. By releasing the "READY" key, or by pressing the non-locking "ARTIST CALL" button on the No. D-87567 Apparatus Unit of the No. D-86852 Control Cabinet the No. E-241 Relay may be operated at any time, thus disconnecting the output of the speech input equipment from the line to the input of the radio transmitter and extinguishing the "READY" lights. When this is done the speech input equipment may be used as a local public address system for giving out information from any condenser transmitter which is connected to the amplifiers, through loud speaking telephones in any reception rooms or studios where there are no condenser transmitters which are connected to the amplifiers, or for auditions of contemplated program material.

The fourth mounting plate is a No. D-86778 Mounting Plate,

mounting No. E-285 Relays in positions 1 to 4. Each of these relays has its winding connected in series with the filament of the vacuum tube in one of the condenser transmitter amplifiers, so that when the filament circuit of the amplifier is closed by means of the associated No. 406-M Key on the No. 367-A Key Mounting, the relay operates, and its contacts, in closing, light a red-capped lamp immediately to the right of the No. 406-M Key which has been operated, to indicate that the amplifier is in operation.

The fifth mounting plate is a No. 600-A Mounting Plate which mounts six No. J-23 Relays in positions 1 to 6 and one No. B-9 Relay in position 10. Both the No. J-23 Relays and the No. B-9 Relay are part of the signalling system of the order wire lines associated with the outside program line circuits. The secondary winding of each No. J-23 Relay is connected, in series with a No. 57-A Condenser mounted on the No. D-88823 Power Panel, across one of the order wire circuits. When the operator at a remote point wishes to call the operator at the control room he connects the far end of the order wire line to a source of 20-cycle ringing current, which operates the associated No. J-23 Relay. Once operated, this relay is locked through its primary winding and its own contacts by current from the storage battery. This operation of a No. J-23 Relay lights a white capped signal lamp in the No. 262 Lamp Socket Mounting directly over the jacks terminating the order wire line with which the relay is associated, thus indicating the call. The No. B-9 Relay is connected in series with the locking windings of the No. J-23 Relays and the signal lamps which are in parallel with them, so that it operates whenever one or more No. J-23 Relays are operated. The contacts of the No. B-9 Relay may be used to operate a buzzer in the control room telephone set, if such a buzzer is used thus audibly notifying the operator that a call is waiting.

Below the No. 600-A Mounting Plate is a blank mounting plate, below which is the No. D-85650 Panel which mounts the apparatus units of the studio control system which are located in the control room and a monitor transfer key.

A No. D-87564 Apparatus Unit is mounted in position 1 of this panel. This unit contains a key to lock and unlock the control for the control room, a red-capped lamp which indicates when this control key is in the "ON" position and a white-capped lamp which indicates incoming phone calls on the studio interphone system. No. D-87565 Apparatus Units are provided for in positions 2 to 5. One of these units is mounted in position 2 in the standard equip-

ment. This unit contains a locking key to lock and unlock the control for the associated point of control together with a red-capped lamp to indicate when this control is unlocked, and a push button to enable the control room operator to call the point with which this unit is associated. A No. D-87569 Apparatus Unit is mounted in position 7. This unit contains a key which controls the operation of the No. E-241 Relay mounted on the No. D-87990 Miscellaneous Equipment Panel, and a green capped lamp which is lighted when the circuit is completed from the line amplifier through the No. E-241 Relay to the line to the radio transmitter. No. D-85644 Apparatus Units are provided in positions 8 to 13. Each of these units contains two push buttons and a red-capped lamp. One of the buttons when operated completes the circuit to the No. D-86880 (or No. D-87170) Relay and the No. E-1997 Relay, so as to connect the associated circuit to the amplifiers. The other button, when pressed, closes the circuit to the No. E-323 Relay which opens the locking circuit to the No. E-323 Relay which opens the locking circuits of the switching relays. A red-capped lamp is also provided in each of these units to indicate when the associated relay circuit is operated. The remaining positions in this panel are equipped with No. D-86122 Apparatus Blanks.

A No. 479-G Key is provided at the right hand side of the No. D-85650 Panel to serve as the monitor transfer key referred to. This is a three-position lever unit key which locks in the position in which it is operated. This key may be used to switch the input of the monitoring amplifier from the output of the line amplifier to the output of a radio receiver or monitoring rectifier, or to disconnect the input circuit of the monitoring amplifier entirely.

Below the No. D-85650 Panel is a No. 884-F Mounting Plate on which are mounted the four No. D-85074 Potentiometers associated with the four condenser transmitter amplifier circuits. The output terminals of each condenser transmitter amplifier are connected, through jacks and relay contacts, to the input terminals of one of the four potentiometers. The outputs of the four potentiometers are connected in series to the input of the No. 8-C Amplifier. By means of these potentiometers it is possible to combine the outputs of two or more condenser transmitter amplifiers in any desired proportion, or to "fade" a program in or out on one channel without affecting transmission on the other channels.

Immediately below the potentiometers is the No. 367-A Key Mounting which contains four keys and five red-capped lamps.

The keys are used to turn on and off the filament circuits of the condenser transmitter amplifiers. Directly to the right of each key is a red-capped lamp which lights when the associated amplifier is turned on. The fifth red-capped lamp serves as a fuse-alarm and is so connected that it will light to indicate the burning-out of a No. 35-Type Fuse on the No. 204-A Panel of the No. D-88823 Power Panel.

Below the No. 367-A Key mounting is a No. 184 Jack Mounting designated the "AMP. CUR." jack strip, which contains eight jacks, two of which are associated with each condenser transmitter amplifier so that the filament and plate currents of any of the four condenser transmitter amplifiers may be measured.

Below the No. 184 Jack Mounting is the first No. 185 Jack Mounting designated the "LOW LEVEL" jack strip, which contains the jacks for switching and testing the low-level circuits; i.e., the local circuits on the input side of the No. 8-C amplifier. This jack strip contains the following jacks:

1. The output jacks for the four condenser transmitter amplifiers.
2. The input and output jacks for the four switching relay circuits which are associated with the four condenser transmitter amplifier circuits.
3. The input jacks for the four mixing potentiometers.
4. The jacks connected to the combined output of the four mixing potentiometers in series.
5. The input jacks of the No. 8-C Amplifier.
6. Two pairs of jacks which may be wired to the outputs of two additional condenser transmitter amplifiers.
7. Sixteen spare jacks which may be used for any special purpose desired.

Below the "LOW LEVEL" jack strip is a No. 367-A Lamp Socket Mounting which contains the signal lamps associated with the order wire lines.

The second No. 185 Jack Mounting is designated the "REM. LINES" jack strip, and contains the following jacks:

1. The jacks terminating the six outside program lines.
2. The jacks terminating the six order wire lines associated with the outside program lines.
3. The input and output jacks for the two relay switching circuits which are associated with the outside program lines.
4. The jacks of the order wire drop or signalling circuits.

5. The jacks connected to the order wire telephone set and to the 20-cycle ringing current supply.

The third No. 185 Jack Mounting is designated the "HIGH LEVEL" jack strip, and contains all of the jacks for switching and testing the high level circuits; i.e., the circuits on the output side of the No. 8-C Amplifier. This jack strip contains the following jacks:

1. The input and output jacks for the No. 8-C Amplifier.
2. The input and output jacks for the No. 18-B Amplifier.
3. The input and output jacks for the No. E-241 Relay.
4. The input jacks for the volume indicator (No. 203-B Panel).
5. The input jacks to the wire line to the radio transmitter.
6. The output jacks for the radio receiver or monitoring rectifier if used.
7. The input and output jacks for the monitor transfer key.
8. The jacks connected to the monitoring loud speaking telephone.
9. Jacks which are wired for use as input and output jacks for the No. 9-A Amplifier and input jacks for the No. 516-B Panel when these units are added to the speech input equipment.
10. The input and output jacks for the two 20-decibel artificial lines used with the outside program line circuits.
11. Eight spare jacks which may be used for any special purpose desired.

Below the jack mountings is a blank mounting plate. Below this blank mounting plate is a No. D-86775 Mounting Plate on which are mounted the following resistances:

1. Six resistances, associated with the six switching relay circuits as previously described.
2. Ten resistances arranged to form the two 20-decibel artificial lines referred to in the preceding paragraph.
3. A resistance which may be included in the filament circuit of a No. 4-D Radio Receiver so that the vacuum tube filaments of this receiver can be operated from the speech input equipment storage battery.

Below the No. D-86775 Mounting Plate is a No. D-87339 Mounting Plate mounting four No. 51 Terminal Strips which contain the terminals for all of the apparatus mounted on this panel.

The No. D-87990 Miscellaneous Equipment Panel is shown in figure 210.

4. *No. D-88823 Power Panel*—The power panel, like the amplifier panel and the miscellaneous equipment panel, is assembled on a framework at the factory. This panel, illustrated in figure 210a, contains the following apparatus associated with the power supply circuits of the speech input equipment:

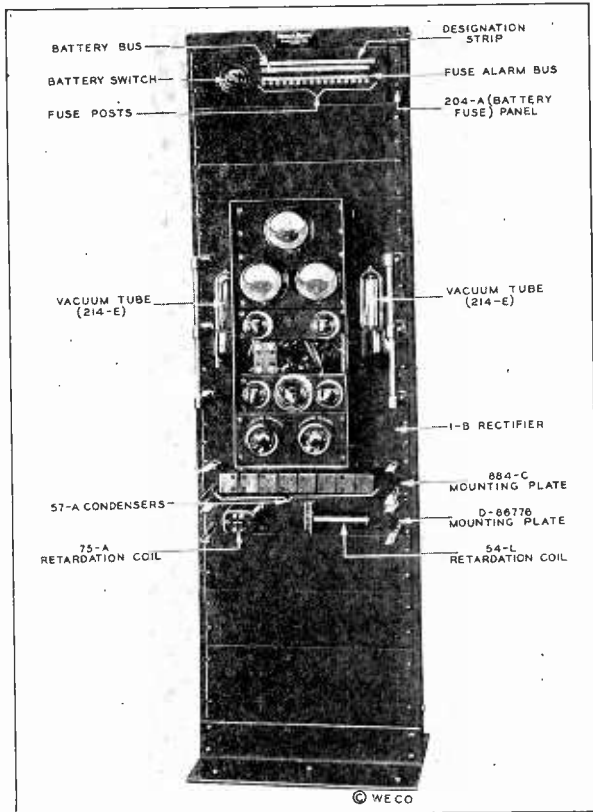

FIG. 210a. D-88823 Power Panel—Front.

(1) A No. 204-A Panel (battery fuse panel) containing the No. 35-Type Fuses for the circuits supplied from the equipment storage batteries and a switch for disconnecting the battery from these circuits. A fuse-alarm bus on the No. 204-A Panel is wired to the

red-capped fuse-alarm lamp in position 16 of the No. 367-A Key Mounting on the No. D-87990 Miscellaneous Equipment Panel. The No. 35 Type Fuses are so constructed that the burning of the fuse wire allows a contact finger which is a part of the fuse to make contact with the fuse alarm bus so that the fuse-alarm lamp will light whenever a fuse on the No. 204-A Panel burns out.

(2) A No. 1-B Rectifier for supplying high voltage direct current to the plate circuits of the vacuum tubes in the amplifiers and in the volume indicator and for maintaining the necessary difference of potential between the electrodes of the condenser transmitters.

(3) A No. D-86777 Mounting Plate on which are mounted eight Ward-Leonard resistances. Two of these resistances comprise a voltage divider or potentiometer for reducing the 350 volts from the output of the No. 1-B rectifier to a value suitable for the plate circuit of the vacuum tube in the volume indicator (No. 203-B Panel); two more resistances comprise another similar voltage divider for supplying a voltage suitable for the condenser transmitters and associated amplifiers, and the others are used as compensating load resistances to absorb the excess power delivered by the rectifier when the No. 9-A Amplifier is not used.

(4) A No. 884-C Mounting Plate on which are mounted nine No. 57-A Condensers. Six of these condensers are used in the order wire drop circuits, two are part of the auxiliary filter for the high voltage supply to the condenser transmitters and associated amplifiers, and the remaining one is in parallel with that part of the voltage divider or potentiometer, referred to in the preceding paragraph, which is connected in parallel with the plate voltage supply to the volume indicator.

(5) A No. D-86776 Mounting Plate on which is mounted the No. 54-L Retardation Coil, used to supply battery and ground to the interphone circuits, and the No. 75-A Retardation Coil which is part of the filter for the high voltage supply to the condenser transmitters and associated amplifiers.

C. Filament Power Supply.

1. *Batteries*—Two storage batteries, consisting of long-life glass jar cells of the type used in telephone exchanges, are furnished to supply power to the relays, signal lamps and vacuum tube filaments. These batteries have adequate capacity to operate the equipment for 18 consecutive hours out of every 24-hour period if the charge and discharge cycles are followed. In installa-

tions where the No. 9-A Amplifier is added to the equipment it will be necessary to provide additional ampere-hour capacity in the filament power storage batteries. This can be accomplished economically by the use of larger plate assemblies in the original glass jars. A typical battery installation, with one battery only, is shown in figure 211.

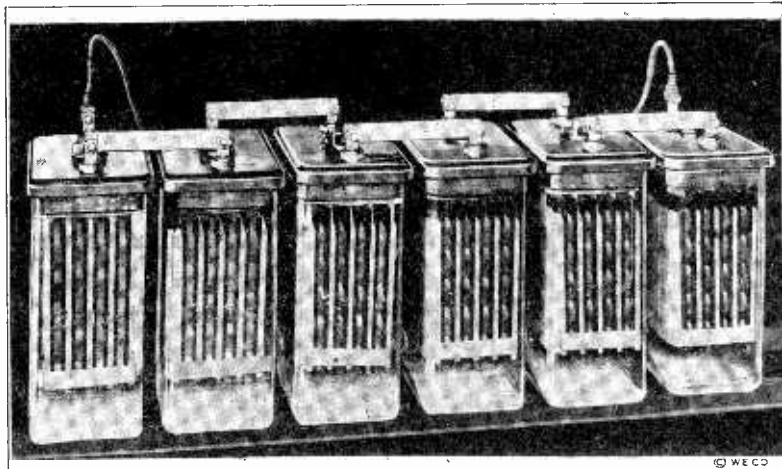

FIG. 211. Typical Storage Battery Installation.

2. *Charging Equipment*—A Tungar Rectifier of suitable capacity is furnished as part of the equipment for recharging the storage batteries. Two double pole, double throw safety switches are provided so that either battery may be connected to the charging equipment or to the discharge circuit or may be disconnected entirely. Also, if necessary, both batteries may be charged in parallel or, in an emergency, both may be discharged in parallel.

D. Condenser Transmitters and Associated Equipment.

Four condenser transmitters are furnished as part of the No. 8-B Speech Input Equipment, together with four amplifiers designed to work in conjunction with the condenser transmitters, and four transmitter mountings. Each transmitter mounting is designed to mount one condenser transmitter and one amplifier. Cords are provided for interconnecting the transmitter and amplifier and for connecting the amplifier to a base board outlet.

The condenser transmitter used is the No. 394 Transmitter, illustrated in figure 212. This transmitter consists essentially of a very thin tightly stretched metal diaphragm, mounted closely adjacent to but not touching a flat metal plate. The diaphragm and the plate are insulated from each other, and constitute the two electrodes of a small air dielectric condenser whose capacity is

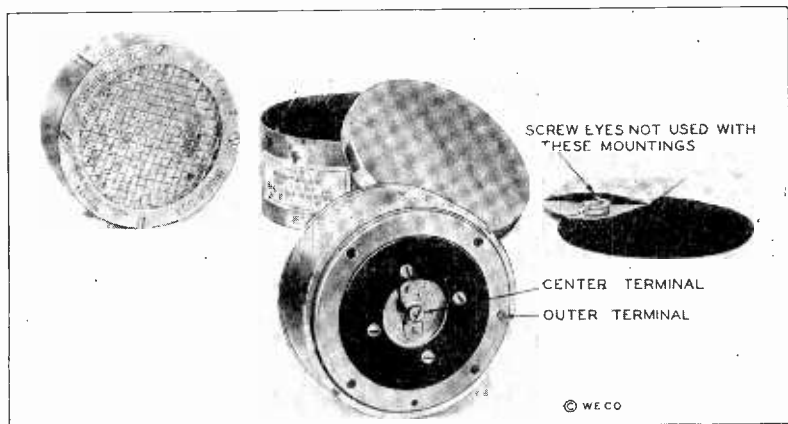

FIG. 212. 394 Transmitter and Shipping Box.

varied by sound waves striking the diaphragm. The air space between the diaphragm and the plate is separated from the outside air by a flexible compensating diaphragm which equalizes the air pressure on the two sides of the main diaphragm for any atmospheric pressure equivalent to not more than three inches of mercury above or below normal pressure at sea level.

As the condenser transmitter has an extremely high impedance it cannot be coupled directly to the input of the main speech input amplifier. The condenser transmitter amplifier is, therefore, used as an impedance translating device to operate between the high impedance of the condenser transmitter and the low impedance of the main amplifier input circuit, and at the same time to amplify to some extent the very small amount of power developed by the condenser transmitter. The condenser transmitter amplifier is supplied in two forms, differing in mechanical arrangement but

electrically identical. The No. 47-B Amplifier is shown in figure 212a and the No. 48-A Amplifier is shown in figure 212b.

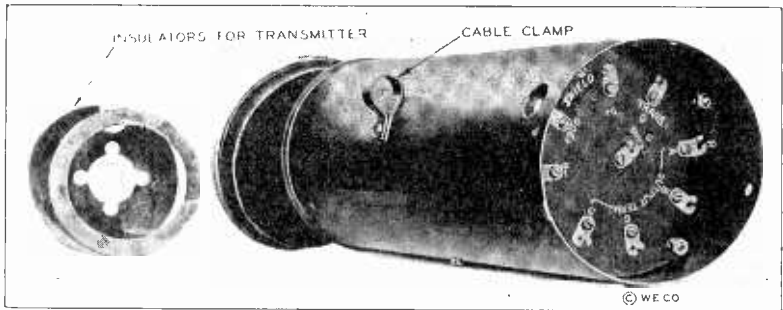

FIG. 212a. 47-B Amplifier.

The transmitter mountings supplied with this equipment are of two types, two of each type being furnished. The No. 7-A Transmitter Mounting shown in figure 213 is a cast aluminum mounting, finished in black lacquer and designed to be used on a desk or table.

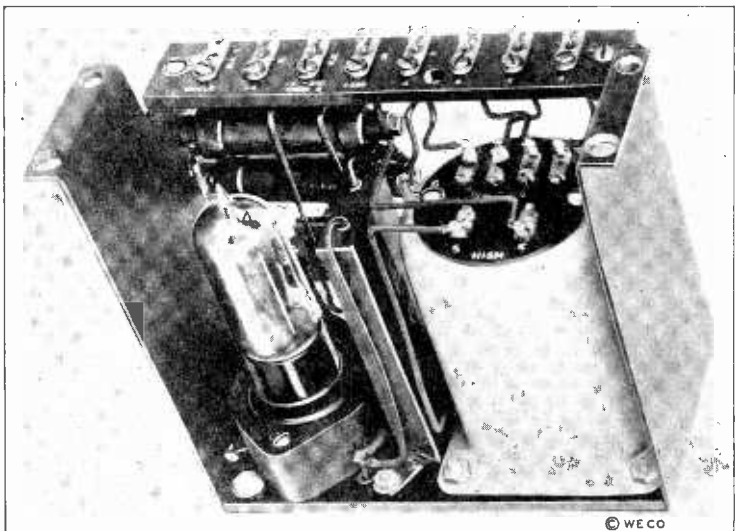

FIG. 212b. 48-A Amplifier.

This mounting mounts the No. 394 Transmitter and the No. 48-A Amplifier which are connected by a No. T2E Cord 4" long. The No. 8-A Transmitter Mounting shown in figure 214 is an adjust-

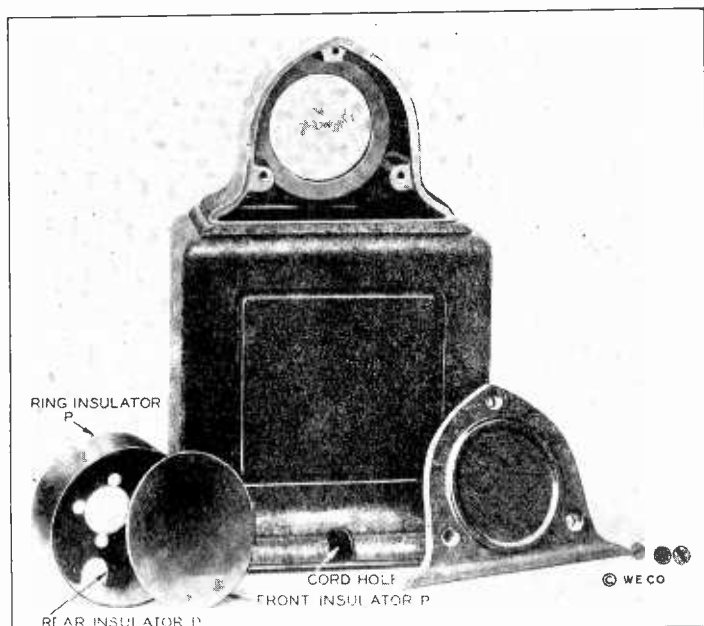

FIG. 213. 7-A Transmitter Mounting.

able floor type mounting finished in dull black japan. This mounting mounts the No. 394 Transmitter and the No. 47-B Amplifier which are connected by a No. T2E Cord 5" long. The complete assembly of transmitter and amplifier in either type mounting is connected to the base board outlet, which is a No. 369 or No. 370 Jack, by means of a No. M6B Cord 12' long terminated in a No. 253-A Plug.

A diagram showing the connection of the transmitter, the amplifier, the cords and the baseboard outlet is shown in figure 215.

E. Apparatus on Panel Assemblies.

1. *No. 8-C Amplifier*—This amplifier, illustrated in figure 216, is provided as the main or line amplifier to amplify the program

material from the condenser transmitters or remote program lines before it is sent to the radio transmitter. It is a three stage amplifier using a No. 102-E vacuum tube in the first stage and a No. 205-D vacuum tube in each of the other two stages. The filaments of the vacuum tubes are supplied from the equipment storage battery, through a 3-ampere fuse (No. 35-G Fuse) in position 1 on the No. 204-A Panel which is part of the No. D-88823 Power

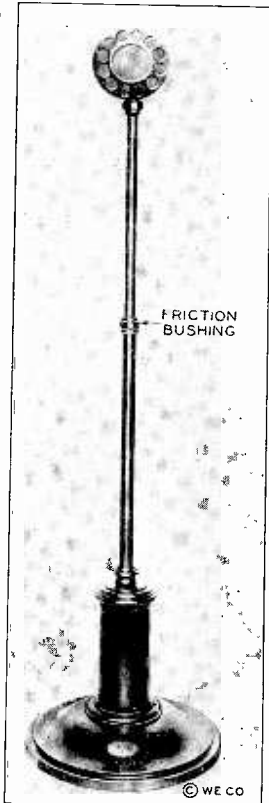

FIG. 214. 8-A Transmitter.

Panel. Filament rheostats to adjust the filament currents to the proper value are provided, together with jacks to receive the plugs at the ends of the cords of the No. 514-A Panel, so that both the filament and plate currents of each of the three vacuum tubes may be measured. Power for the plate circuits of the vacuum tubes in this amplifier is supplied from the "A" terminals of the No. 1-B Rectifier, and controlled by the upper left-hand switch on the rectifier. The plate circuit of the No. 205-D Vacuum Tube in the last stage is supplied with 350 volts directly from the output of the No. 1-B Rectifier. A voltage divider which is a part of the amplifier reduces the 350 volts from the rectifier to approximately 130 volts for the plate circuits of the No. 102-E vacuum tube in the first stage and the No. 205-D vacuum tube in the second stage.

A battery box on the panel of this amplifier holds six No. 703 Eveready dry batteries which supply 27 volts and 13.5 volts negative potential to the grids of the vacuum tubes in the third and second stages respectively. The grid of the first stage vacuum tube receives its negative potential from the voltage drop in a resistance in the negative filament lead of this vacuum tube.

A twenty-two step potentiometer, mounted on the front of the amplifier and connected in the grid circuit of the first stage vacuum tube, is the main gain control of the speech input equipment. In addition, a "HIGH-LOW" switch

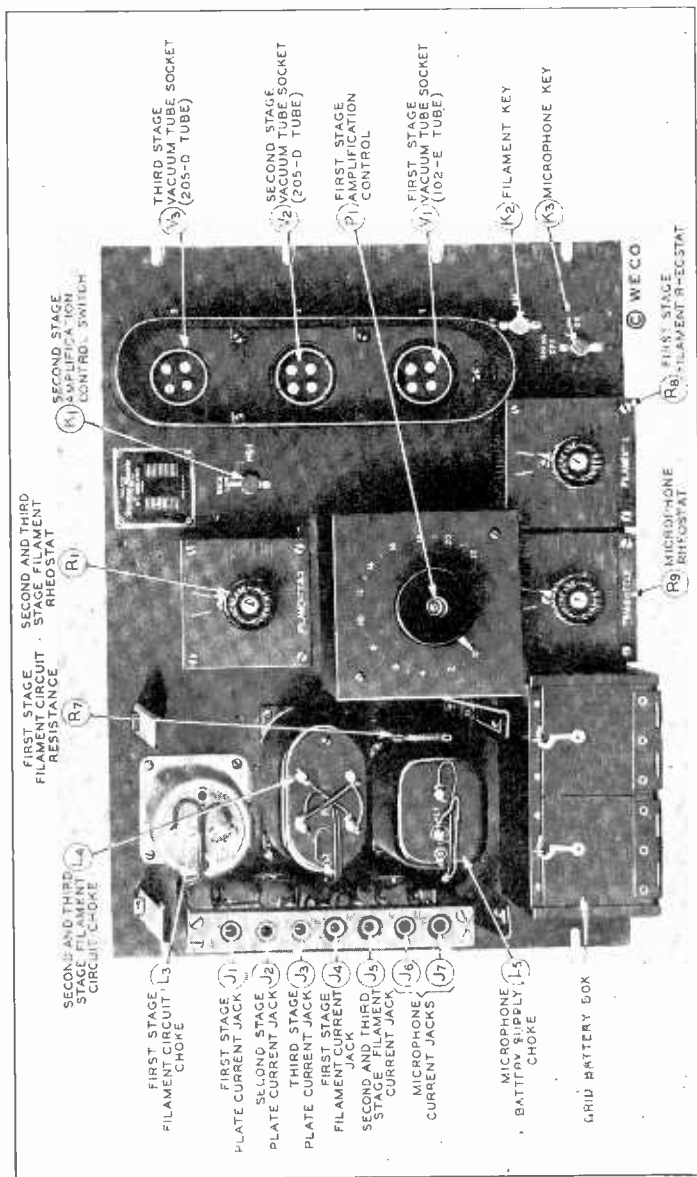

FIG. 216. 8-C (Speech Input) Amplifier.

on the front of the amplifier, associated with a two-step potentiometer in the grid circuit of the second stage vacuum tube, provides two ranges of adjustment for the main potentiometer. On the terminal strip at the rear of this amplifier the terminals marked "COIL OUT" are from the secondary of the output transformer, and are connected to the input of the volume indicator, to the input of the monitoring amplifier and through the contacts of the No. E-241 Relay to the wire line to the radio transmitter. The terminals marked "4" and "G" are connected directly in the plate circuit of the last amplifier tube, and are to be connected to the input of a power amplifier (No. 9-A Amplifier) when such an amplifier is added to the equipment. A simplified circuit of this amplifier is shown in figure 217.

2. *No. 18-B Amplifier*—The No. 18-B Amplifier is provided for monitoring. It is a single stage amplifier using one No. 205-D vacuum tube and is used to operate one or two No. 560-Type Loud Speaking Telephones. The gain control potentiometer of this amplifier permits adjustment of the output to a level suitable for monitoring when the output of the No. 8-C Amplifier is maintained at the level ordinarily used in supplying the radio transmitter. By means of the monitor transfer key on the No. D-85650 Panel of the No. D-87990 Miscellaneous Equipment Panel, the input of this amplifier may be connected either to the input of the radio transmitter or to the output of a radio receiver or monitoring rectifier.

The filament circuit of this amplifier is supplied through a two ampere fuse (No. 35-C Fuse) in position 3 on the No. 204-A Panel which is part of the No. D-88823 Power Panel. The plate circuit of this amplifier is supplied from the "C" terminals of the No. 1-B rectifier. As in the No. 8-C Amplifier, jacks are provided for measuring the filament and plate currents, together with a rheostat for adjusting the filament current to the proper value. Six No. 703 Eveready dry batteries are mounted in a battery rack on the rear of the amplifier to supply 27 volts negative potential to the grid of the vacuum tube.

3. *No. 203-B Panel*—The No. 203-B Panel is fundamentally a peak voltmeter. It is so designed that when bridged across a 500 ohm line or across an amplifier output circuit which is terminated in 500 ohms, it gives an indication of the power level at the point where it is bridged. This panel gives readings in terms of a unit known as the "transmission unit" (abbreviated "TU") which is used in telephone engineering to measure ratios of electrical power. The transmission unit has recently been named the "decibel" (ab-

breviated "db") by which name it is to be known in the future, so that in the discussion which follows it will be referred to as the decibel. The controls of the earlier No. 203-B Panels are designated in "TU," while the controls of the later model are designated in "db." It should be borne in mind that the decibel is identical, except in name, with the "transmission unit."

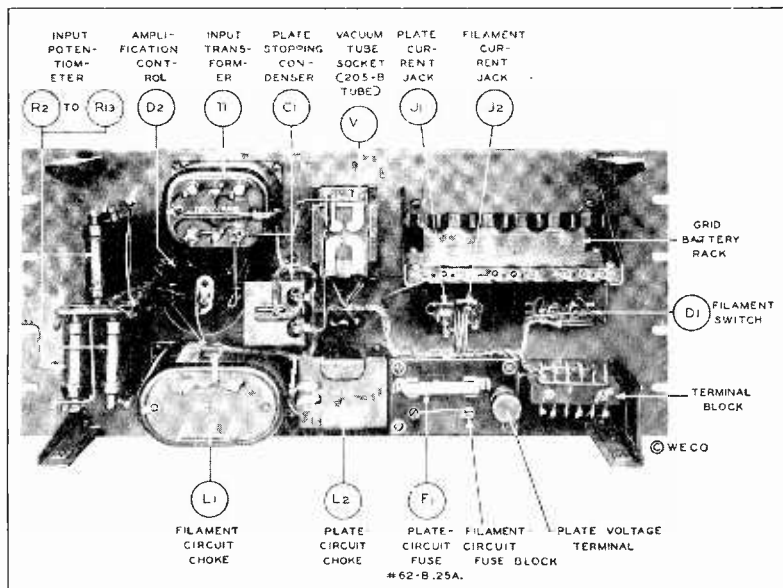

FIG. 218. 18-B (Monitoring) Amplifier—Rear.

For the benefit of those not familiar with the decibel the following description is included: Gain, loss and power level are measured in terms of a unit called the decibel. In the case of gain or loss the decibel is used to express the ratio of the powers at the output of the system due to a change in the circuit conditions such as the adjustment of potentiometer controls or the insertion or removal of amplifiers, transformers, etc.; or to give the ratio between the input power and the output power of a given device. When used in this sense it does not give any idea as to the amount of power involved but merely indicates the difference in power. The following table is printed to give the reader a quantitative idea of the relation which exists between decibels and power ratios.

| Decibels | Power Ratio | Decibels | Power Ratio |
|----------|-------------|----------|---------------|
| 1 | 1.26 | 10 | 10 |
| 2 | 1.6 | 20 | 100 |
| 3 | 2.0 | 30 | 1,000 |
| 4 | 2.5 | 40 | 10,000 |
| 5 | 3.2 | 50 | 100,000 |
| 6 | 4.0 | 60 | 1,000,000 |
| 7 | 5.0 | 70 | 10,000,000 |
| 8 | 6.3 | 80 | 100,000,000 |
| 9 | 8.0 | 90 | 1,000,000,000 |

By reference to an arbitrarily selected value known as the normal or zero level, the number of decibels above or below zero is used to indicate the actual power level. When used in this sense the number of decibels is not directly proportional to the electrical power involved (as it would be if the measurement were made in watts), but is roughly proportional to the sensation produced upon the ear when the electrical power is converted into sound by means of a telephone receiver. A difference of 1 db in the power supply to a telephone receiver represents approximately the smallest change in the volume of sound which the normal ear can detect.

The arbitrarily chosen value for the normal or zero level for this panel is .006 watts. The absolute values of power on this basis at various indicated levels are given in the following table.

| Decibels | Watts | Decibels | Watts |
|------------|---------|----------|-------|
| 10 | 0.00060 | 16 | 0.24 |
| 8 | 0.00095 | 18 | 0.38 |
| 6 | 0.0015 | 20 | 0.60 |
| 4 | 0.0024 | 22 | 0.95 |
| 2 | 0.038 | 24 | 1.5 |
| zero level | 0.0060 | 26 | 2.4 |
| 2 | 0.0095 | 28 | 3.8 |
| 4 | 0.015 | 30 | 6.0 |
| 6 | 0.024 | 32 | 9.5 |
| 8 | 0.038 | 34 | 15.0 |
| 10 | 0.060 | 36 | 24.0 |
| 12 | 0.095 | 38 | 38.0 |
| 14 | 0.15 | 40 | 60.0 |

The No. 203-B Panel uses one No. 102-D vacuum tube. The filament current of this vacuum tube is supplied through the 1 1/3

ampere fuse (No. 35-A Fuse) in position 2 on the No. 204-A Panel, mounted on the No. D-88823 Power Panel, and is regulated by the No. D-80777 Ballast Lamp mounted on the rear of the No. 203-B Panel. The plate potential for the vacuum tube is supplied from terminals "B" of the No. 1-B Rectifier through a potentiometer, comprising the resistances mounted in positions 4 and 8 of the No. D-86777 Mounting Plate on the No. D-88823 Power Panel, as mentioned in the description of the power panel. The No. KS-6359 Milliammeter mounted on the front of the No. 203-B Panel is the means by which the power level in the associated circuit is visually indicated. This is described in further detail in the section entitled "Operation." A schematic of this panel is shown in figure 219.

4. *No. 514-A Panel*—This panel is a meter panel, and is provided as a means of measuring the filament and plate currents of the amplifiers. It contains an ammeter and two milliammeters associated with two cords which are fitted with plugs for insertion into the current measuring jacks of the equipment. The ammeter reads currents up to four amperes, and the plug of the cord associated with this meter fits only the filament circuit jacks of the amplifiers. The two milliammeters associated with this meter fits only the filament circuit jacks of the amplifiers. The two milliammeters associated with the other cord have ranges of 100 and 10 milliamperes respectively. Normally the high range instrument is connected to the cord, but a push button is provided by means of which the low range meter may be substituted when the current is too small to be read conveniently on the high range meter. The plug of the cord associated with these meters is designed to fit the plate circuit jacks of the amplifiers, but is too large to be inserted in the filament circuit jacks of the amplifiers. This feature prevents possible damage to the milliammeters.

5. *No. 1-B Rectifier*—This rectifier is mounted on the No. D-88823 Power Panel. It is a single phase full wave vacuum tube rectifier which supplies direct current at 350 volts to the plate circuit of the amplifiers and to the voltage dividers which supply 130 volts to the plate circuit of the volume indicator and 200 volts to the condenser transmitters and associated amplifiers. This rectifier is designed to operate from an alternating current supply of either 110 or 220 volts, at any frequency between 50 and 133 cycles. It utilizes two No. 214-E Vacuum Tubes used as rectifiers, transformers for supplying alternating current at the proper voltages to the filament and plate circuits of these vacuum tubes,

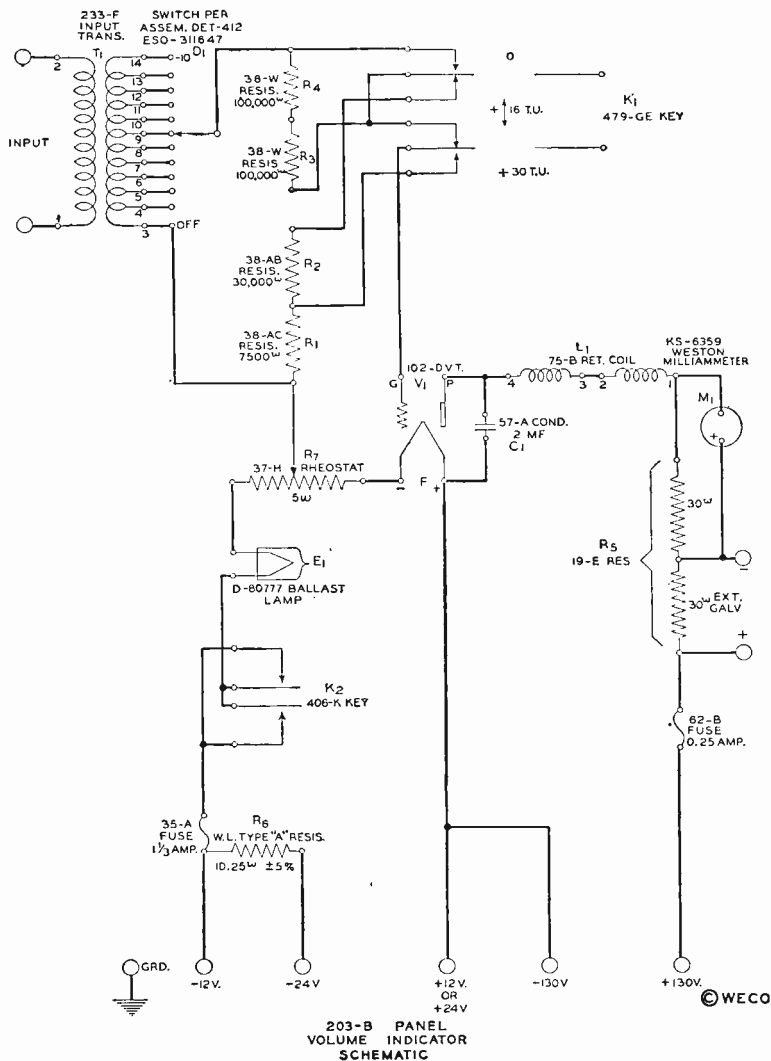

FIG. 219. 203-B Panel—Volume Indicator—Schematic.

and a filter for suppressing the alternating current components of the rectified output. Rheostats are incorporated to adjust the filament current of the vacuum tubes, and the alternating current voltage impressed on the rectifier circuit. Meters are also furnished for measuring filament current, the total direct current output and the output voltage of the rectifier.

A switch for starting and stopping the rectifier is so arranged that in the first position (FIL), it completes the power supply to the filaments only of the vacuum tubes. In the second position (PLATE), it also energizes their plate circuits. The third position of the switch (OFF), disconnects the power supply from the rectifier. This rectifier is arranged for four output circuits, each controlled by a small snap switch. Associated with the "OFF" position of each switch is a load resistance so that the load on the rectifier, and consequently its output voltage, will remain practically constant irrespective of the positions of the small switches. The back cover of the rectifier is provided with a safety switch so that the power supply to the rectifier is interrupted when this cover is removed.

When the rectifier power supply is 110 volts a.c. terminal 1 should be strapped to terminal 2 and terminal 3 to terminal 4 on both the filament and plate transformer terminal blocks. When the supply is 220 volts a.c. terminal 2 should be strapped to 3 on both terminal blocks.

The schematic of the No. 1-B Rectifier is shown in figure 220.

F. No. D-86852 Control Cabinet.

This control cabinet is to be located in the studio, and is a part of the studio control system. It consists of a No. D-86851 Signal and Control Unit mounted in a wooden cabinet which is so designed that the faces of the apparatus units contained in the signal and control unit are inclined at an angle of 45 degrees. The No. D-86851 Signal and Control Unit consists of an assembly of the apparatus units required to control, from the studio, the switching relays of the studio control system which are mounted on the No. D-87990 Miscellaneous Equipment Panel in the control room. The apparatus contained in the apparatus units is wired to a terminal strip at the rear of the signal and control unit.

Position 1 of the signal and control unit is equipped with a No. D-87568 Apparatus Unit. This unit contains a red-capped lamp which, when lighted, indicates that the control on the No. D-85650 Panel in the control room is unlocked to make the switching relays subject to control from this control cabinet, and a white-capped

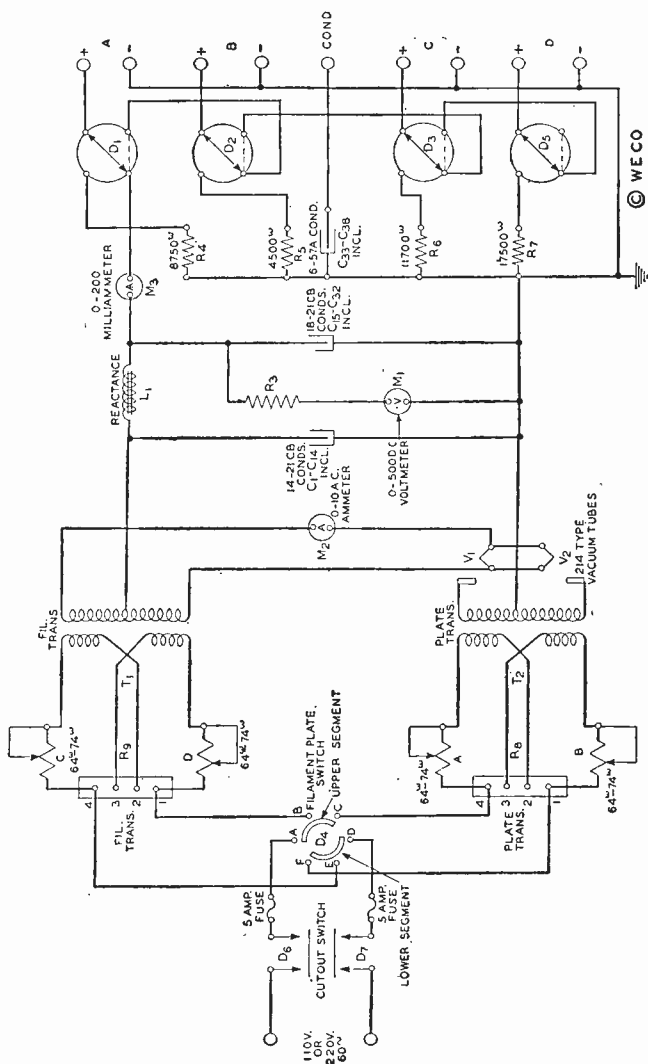

FIG. 220. 1-B Rectifier—Schematic.

4" RHEOSTATS "A & B" ARE OPERATED BY SAME HANDLE.
 4" RHEOSTATS "C & D" ARE OPERATED BY SAME HANDLE.
 ON 110V. CIRCUIT STRAP 1-2 & 3-4 ON EACH TRANS. TERM. BLOCK.
 ON 220V. CIRCUIT STRAP 2-3 ONLY ON EACH TRANS. TERM. BLOCK.

FIL. PLATE SWITCH
 POS. 1, FIL. A & B, D & E ARE CLOSED.
 POS. 2, PLATE A & B, C, D & F ARE CLOSED.
 POS. 3, OFF A & B, D & E ARE OPEN.

lamp which, when lighted, indicates an incoming call on the interphone telephone system.

Position 2 is equipped with a No. D-85647 Apparatus Unit. This unit contains a push button for interphone signalling, and a white-capped lamp which lights when the button is pressed. It also contains a red-capped lamp which is lighted when the control is unlocked for the control room.

Positions 3 to 5 are normally equipped with No. D-86122 Apparatus Blanks but wiring is provided for No. D-85647 or No. D-85644 Apparatus Units in these positions.

A No. D-87567 Apparatus Unit is provided in position 6. This unit contains a green-capped lamp which is lighted when the circuit from the line amplifier to the telephone line to the radio transmitter is completed through the No. E-241 Relay, and a push button designated "ARTIST CALL." This button, when pressed, operates the No. E-241 Relay so as to disconnect the output of the line amplifier from the telephone line to the radio transmitter. By this means, it is possible to use the amplifiers of the equipment as a local public address system if desired.

Positions 7 to 10 are equipped with No. D-85644 Apparatus Units. The function of these units has already been described. Positions 11 and 12 are equipped with No. D-86122 Apparatus Blanks.

The units in this cabinet are normally arranged so that multiple control of the switching relays is provided both at this cabinet and at the No. D-85650 Panel mounted on the No. D-87990 Miscellaneous Equipment Panel in the control room.

As previously noted, the descriptive matter and the schematics are presented on the assumed basis of one studio only. If more than one studio is equipped, additional No. D-86852 Control Cabinets will be used in the additional studios, and additional apparatus units will be required both in the No. D-86852 Control Cabinets and in the No. D-85650 Panel in the control room.

CHAPTER 10

THE ARC RADIO TRANSMITTER

1. **General Arc System**—A direct current arc transmitter is constituted of three essential parts, namely, the source of energy, the arc converter, and the oscillatory circuit.

2. **The Source of Power**—A direct current of a potential ranging from 200 to 1200 volts is required to furnish power for the operation of an arc transmitter, depending upon its size. Such current is usually supplied from a direct current generator driven by an electric motor or by an engine of some sort. Control of the power required from the energy source is secured through the utilization of an ordinary field rheostat for the generator mentioned. In some cases storage batteries have been utilized, but such instances have been very few and limited to small equipments.

3. **The Arc Converter**—Continuous undamped radio frequency oscillations are obtained in the arc transmitter by means of an arc converter, a device which changes direct current to a high frequency alternating current. The arc converter consists of a positive and a negative electrode enclosed within a chamber containing an atmosphere of hydrogen, or more commonly a hydro-carbon vapor such as alcohol vapor, the electrodes being so placed that the arc formed between them is acted upon by a powerful magnetic field.

4. **The Electrodes**—The electrodes in the modern type of arc converter are both made of copper and water cooled. In the past carbon and graphite have been used for the negative electrode with good results under rather limited conditions. It has been found, however, that the water cooled copper cathode gives much better operation over the wide range of conditions encountered on board ship.¹

5. **The Arc Circuit**—A simplified circuit of an arc transmitter is shown in figure 221. It is seen that power for the arc is supplied by a d.c. generator. The positive terminal of this generator is connected through a combined choke and arc magnet

¹ The use of a copper cathode is a development of the Federal Telegraph Company.

winding to the positive electrode or anode. The windings set up the magnetic field required to act upon the arc and also serves as a choke coil to prevent radio frequency currents from getting back into the d.c. generator. The anode is connected through an antenna loading inductor to the antenna while the negative electrode or cathode is grounded.

The antenna is in effect a condenser in which the net work of antenna wires is one plate and the ground is the other plate. It forms in conjunction with the inductance of the antenna loading inductor an oscillatory circuit across the arc converter. The capacitance of the antenna together with the inductance of the antenna loading inductor determine the frequency of the oscillations in the antenna circuit.

6. Use of Hydrogen Gas—In maintaining oscillations in the antenna circuit it is necessary for the arc flame in the arc con-

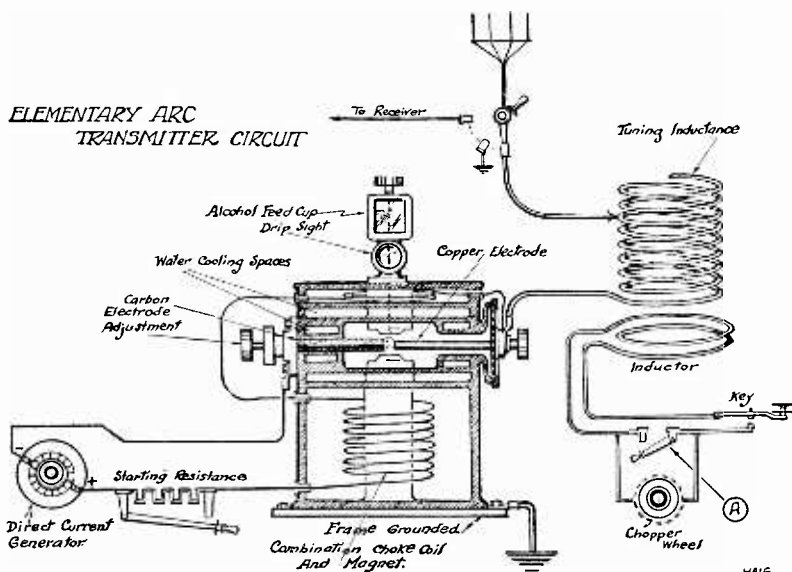

FIG. 221. Elementary Arc Transmitter Circuit.

verter to be extinguished once every cycle and the magnetic field acting as a magnetic blow-out is employed to assist in accomplishing this result. Hydrogen being the lightest and having the highest rate of diffusion of all known gases is used as the atmosphere in which the arc burns. This atmosphere is obtained

by the use of some hydrocarbon such as alcohol, kerosene, or city gas. On board ship it is generally found that alcohol is the more satisfactory than kerosene on account of requiring less cleaning of the chamber. The cathode or negative electrode is rotated to insure uniform wear and maintain steady arc operation.

7. Theory of Operation—Referring to figure 221, the capacity formed by the antenna system and ground is in shunt to the arc. When the electrodes of the arc are first placed in contact and then given the correct separation considerable difference of potential exists across the terminals. Accordingly a part of the current flowing due to the difference of potential existing across the electrodes charges the condenser formed by the antenna system and ground. As the condenser is charged the arc is robbed of some of its current. The smaller arc current allows the voltage across the arc to rise. The increase in voltage causes more current to flow into the condenser until the potential across the arc no longer rises rapidly with decreased arc current. Thus there is no longer potential available to charge the condenser, and hence part of the total current stops flowing into the condenser and the total current now flows through the arc, decreasing its potential and that of the condenser. Immediately the condenser discharges across the arc and due to the inertia of the oscillation current the condenser is charged in the opposite direction. It immediately begins to discharge and this time opposes the arc current. The opposing currents neutralize each other causing the arc to be extinguished. It immediately is reformed, which is the beginning of another cycle. Direct current is constantly supplied to arc by the generator allowing the oscillation to be maintained at a constant amplitude, thus during the time the arc is in operation continuous waves are radiated by the antenna. As stated previously the frequency of oscillation is determined by the capacity of the antenna to ground as well as the inductance of the tuning inductance. As the capacity of the antenna to the ground is ordinarily fixed, the control of frequency is accomplished by adjustments to the antenna inductance.

With a given potential applied across the arc the resistance of the antenna circuit must not exceed a critical value or otherwise no oscillations will be produced. This is equivalent to saying that for any antenna there is a critical voltage below which the arc will not oscillate. This critical voltage may vary somewhat with arc conditions. In general for steady operation it is necessary to use a potential substantially above the critical value.

8. Signalling Systems—As previously stated, while the transmitter is in operation there will be a continuous flow of un-

damped current in the antenna circuit unless means are provided whereby it may be broken up into dots and dashes constituting the signals of the telegraphic code. There are four general methods of accomplishing signalling as follows:

1. "Back Shunt" method.
2. Ignition Key method.
3. Compensation method.
4. Chopper method.

9. "**Back Shunt**" Method of Signalling—The essential units constituting this method of signalling are:

1. The Back Shunt circuit.
2. The Back Shunt Relay Key.
3. The Morse Hand Key.

During operation the arc is switched from the antenna circuit to a local oscillatory circuit by means of a suitable double contact relay key. The circuit as used with sets equipped with the back shunt method of signalling is outlined in figure 222.

When the movable contact of the back shunt relay key presses against the stationary contact which is connected to the antenna loading inductor, the radio frequency current flows in the antenna circuit, when the movable contact presses against the other stationary contact, the radio frequency current flows in the back shunt circuit and there is no current in the antenna because it is disconnected from the arc. The relay key is adjusted so that its movable contact makes connection with one stationary contact before it breaks with the other. This permits the arc to remain in constant operation while the current is transferred from the antenna circuit to the back shunt circuit. The back shunt circuit consists of a resistor, inductor and condenser all connected in series. The resistance of the back shunt circuit is made variable so that the radio frequency current may remain at the same value whether the arc is operating on the antenna circuit or the back shunt circuit.

In practice the back shunt relay key is operated by an electro magnet, which is in turn controlled by a standard Morse hand key. When the hand key is depressed the electro magnet becomes energized and the movable contact of the relay key connects the arc with the antenna circuit. When the hand key is released, a spring causes the movable contact of the relay key to connect the arc with the back shunt circuit. Current therefore flows in the antenna circuit only when the hand key is depressed.

10. **Ignition Key Method of Signalling**—In the "ignition key" method the arc is extinguished during the periods between

the dots and dashes by shunting it with a resistance. Figure 223 shows a circuit employing the ignition method of signalling.

When the contacts of the ignition key are open, the arc oscillates upon the antenna circuit in the usual manner. When the

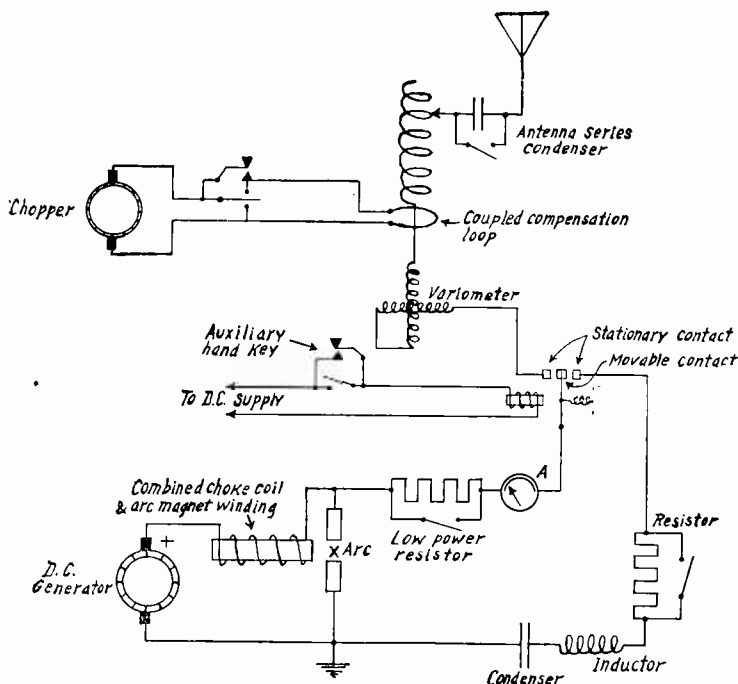

FIG. 222. Federal Arc Transmitter, Showing Circuits for Models "K" and "Q" 2-KW. "Back Shunt" Method of Signalling.

contacts of the ignition key are closed, the arc becomes shunted by the power absorbing resistor, which extinguishes it and stops all flow of radio frequency current in the antenna circuit. The ignition key contacts are located within the arc chamber in close proximity to the electrodes of the arc flame. When the ignition key contacts are opened, the flash which results is blown by the magnetic field into the gap between the electrodes and the arc flame becomes re-ignited. Current then flows in the antenna circuit. Signalling is therefore accomplished by alternately opening and closing the contacts of the ignition key and thereby alternately

igniting and extinguishing the arc flame. Energy is radiated by the antenna at but a single wavelength.

II. Compensation Method of Signalling—A “compensation method” of signalling is furnished with small sets for use in case trouble with the regular signalling system is encountered. In transmitting signals by the “compensation method” the length of the radiated wave from the transmitter is caused to vary.

There are two methods of varying the length of the outgoing wave which are in general use. Referring to figure 224, the con-

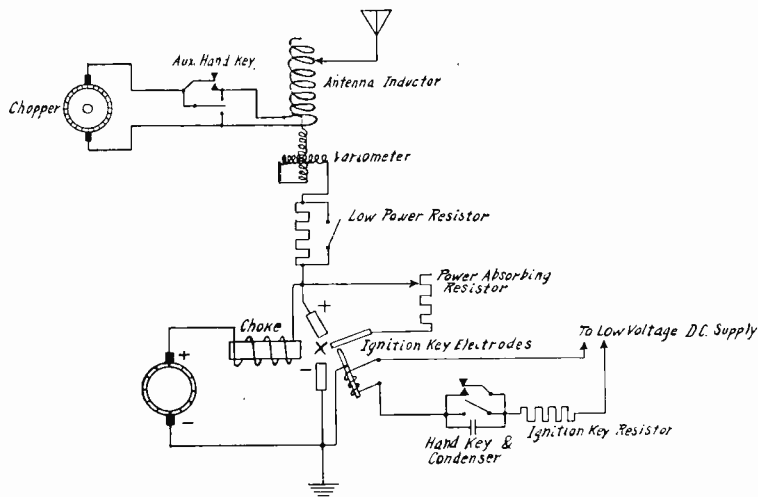

FIG. 223. Federal Arc Transmitter Showing Circuit of Model "X" 2-KW. Ignition Key Method of Signalling.

nection for signalling by the “straight compensation” method is shown in full lines in which the auxiliary hand key is connected around a portion of the antenna loading inductor. When the auxiliary hand key is depressed, the inductance of the antenna circuit becomes reduced and the length of the emitted wave therefore becomes shortened. Signalling is accomplished by operating the auxiliary hand key and thereby varying the wavelength. The receiving station must, of course, tune to receive on the shorter of these two outgoing waves.

The dotted lines in figure 224 show the “coupled compensation” method of signalling. In this, the auxiliary hand key is

connected to a loop which is inductively coupled with the antenna loading inductor rather than being connected directly to it.

When the auxiliary hand key is closed, the loop becomes closed, thereby making a short-circuited turn around the lower part of the antenna loading inductor. This action decreases the inductance of the antenna circuit and shortens the length of the emitted wave. This is accomplished by introducing mutual inductance between the short-circuited loop and the antenna loading inductor, giving

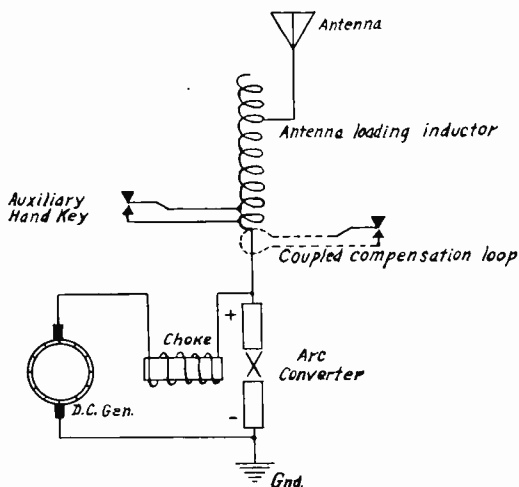

FIG. 224. Federal Arc Transmitter Showing Straight and Coupled Methods of Compensation Wave Signalling.

the same result as though connection was made directly in the antenna circuit. It has the advantage that the auxiliary hand key is insulated from the antenna circuit, thereby minimizing danger to the operator, and has the further advantage that sparking at the key contacts is reduced.

12. Signalling With Chopper—The frequency of the wave radiated by an arc radio transmitter is very high, much higher than can be heard by the human ear. In transmitting to a station which is receiving with a crystal or non-oscillating vacuum tube detector, it is therefore necessary to break up the radiated energy into wave trains of an audible frequency. This is accomplished by the chopper, which consists of a commutator wheel driven by a small motor. Referring to figure 223, the chopper commutator

wheel, when rotated, opens and short-circuits a "coupled compensation" loop at a speed which produces a resultant musical note in the receiver. The radio frequency energy is thus emitted at two wavelengths, as in case when using the auxiliary hand key, but the wavelength rapidly alternates between the maximum and minimum values. A continuous musical note is thus produced.

With the connections shown in figure 223, signals may be transmitted either by means of the auxiliary hand key connected in series in the circuit between loop and the chopper or by means of the "back shunt" or "ignition key" method of signalling. When the auxiliary hand key is used the radiated wave is broken into wave trains of audible frequency only when the key is closed and the receiver, therefore, gives no audible signal when the key is open. When the chopper is used with the "back shunt" or "ignition key" method of signalling, the auxiliary hand key is short-circuited by a small switch. The chopper is then effective whenever current is flowing in the antenna circuit and signalling is accomplished by permitting current to flow in the antenna circuit in accordance with the dots and dashes of the telegraphic code, as described in the paragraphs on the "back shunt" and "ignition key" methods of signalling. The small switch for short-circuiting the auxiliary hand key, when using the "back shunt" or "ignition key" method of signalling with chopper can be placed in another position to short-circuit the commutator of the chopper. This allows the auxiliary hand key to be used without breaking the signals up into audio frequency wave trains.

The chopper is used for wavelengths up to and including 800 meters. Signals transmitted by the "chopper" method may be received with the usual detector type of receiver in common use for receiving signals from damped wave transmitters. Also on shipboard the "chopper" method may be employed to signal a compass station and secure bearings. Signals of distress can also be transmitted on 600 meters so that they may be heard by all ships within range regardless of the method of reception in use.

13. Models "K" and "Q" 2-K.W. Federal Arc Radio Transmitters—The model "K" arc radio transmitter is for use on naval vessels and the model "Q" is for merchant ships. All the apparatus for the two sets is the same and the sets are identical in every way except for the range of the wavelengths employed.

With the model "K" sets, the chopper is used on waves below

952 meters. On 952 meters and above the set is operated as an undamped wave transmitter.

In the case of model "Q" sets for merchant ships, the chopper is used on all waves up to and including 800 meters. Above 800 meters the set is operated as an undamped wave transmitter.

14. Motor Generator—The direct current for the arc converter is furnished by a two-bearing Crocker Wheeler motor generator set which consists of 100-120-volt d.c. motor, directly connected to a shunt-wound, separately excited 2-K.W., 400-volt d.c. generator. The generator will deliver 2 K.W. at 250-400 volts and is wound for separate excitation from the 120-volt d.c. supply.

15. Motor Starter—The motor generator is started by means of a hand-operated motor starting panel. This is equipped with an overload circuit breaker which opens the motor supply circuit in case the current becomes excessive. The terminals on the starting panel are marked to insure proper connections.

To operate the motor starter, first close the circuit breaker, then move the switch arm *slowly* to the right, allowing the motor to attain maximum speed on each point. When the switch arm is in running position it is magnetically locked. It will be released in case of failure of the power supply or in case the circuit breaker is opened, either by overload or by hand. The motor may be stopped by tripping the circuit breaker or by opening the set supply switch on the arc control panel. The starter arm will be released automatically in either case. It should never be released by hand as this would damage the contacts.

When starting the motor, the switch arm should never be returned to the starting position unless the power supply circuit is opened. Failure to observe this point will result in damaged contacts on the starter.

16. Generator Field Rheostat—The power output of the arc converter is regulated by adjusting the voltage of the direct current generator by means of the generator field rheostat.

17. Arc Control Panel—The arc control panel is the switchboard through which connections are made between the arc converter and the direct current generator. It also carries a switch through which the entire transmitter is supplied with 110-120 volts d.c. On the panel are mounted:

1. The set supply switch and fuses.
2. The arc main line switch, with overload trip coil.

3. The arc starting resistor and shorting switch.
4. The d.c. ammeter for the arc circuit.
5. The d.c. voltmeter for the arc circuit.

18. The Arc Main Line Switch—This is a special quick break switch which connects the arc converter to the d.c. generator. It is provided with a trip coil which opens the switch in case of overload. The switch is non-closable on overload or short circuit.

When the handle of the arc main line switch is pushed down until it locks, the arc is connected to the generator through the ammeter and arc starting resistor. To open the switch, the operating handle should be raised until the switch trips. The arc starting resistor switch is operated in the same manner. It should be closed only after the arc has been started and is in operation. These two switches are interlocked so that both are opened whenever the arc main line switch is opened. The arc starting resistor is thus automatically placed in series between the arc converter and the generator whenever the main switch is opened to shut down the arc. The switches may be operated separately by opening the arc starting switch first and then the main line switch.

Care should be observed when shutting down the transmitter to open the various switches in the following order: First, the arc main line switch and starting resistor switch; and second, the set supply switch.

19. Arc Converter—The arc converter has nominal rating of 2 K.W. It is designed to operate on 250-400 volts d.c.

The magnetic circuit is of the closed type. Pole tips project into the top and bottom of the arc chamber. The steel outer shell of the arc converter forms a return path for the magnetic flux.

20. Anode Tip—The anode tip consists of a water-cooled tip supported by a suitable holder which is insulated from the arc chamber by means of a bakelite disc. The copper tip is brazed to a short piece of brass tubing and this unit, which is known as the anode tip, is renewable when it becomes worn after a long period of operation.

21. Care of Anode—In operation care should be taken to see that there is always a supply of water circulating through the anode and that there are no water leaks around the anode, as any water inside the chamber causes the arc to become unsteady.

Care should be taken to see that the anode tip is always properly aligned midway between the magnet poles.

The anode must always be connected through the arc series field winding to the *positive* terminal of the d.c. generator. If connected to the negative terminal it will melt very quickly when the arc is started.

22. Carbon—The carbon for the 2-K.W. arc converter is $\frac{1}{2}$ inch in diameter and 7 inches long. A special wrench and gauge for adjusting the carbon in the carbon holder are attached directly to one side of the arc chamber. The proper amount of projecting carbon for the most convenient operation will be automatically secured when this wrench and gauge are used for changing the carbon in position in the holder.

When the carbon and holder are placed in the arc converter, the carbon is slowly rotated by means of worm gear mechanism.

23. Alcohol Supply—An alcohol cup is mounted on top of the arc converter. This is provided with a needle valve and a sight feed glass by means of which flow may be adjusted and observed. The alcohol drip is controlled by a knob on top of the arc chamber.

24. Pressure Regulator—As alcohol is supplied continuously to the arc chamber during operation there will always be a certain amount of gas generated within the chamber. A hose nipple is provided by means of which the excess gas may be conducted through a short piece of hose to the unit called the pressure regulator.

The pressure regulator consists of an aluminum receptacle divided into two compartments by means of a rubber diaphragm. This diaphragm serves to maintain the gases within the chamber at approximately atmospheric pressure at all times. The pressure regulator is provided with an outlet through a hose nipple with a small opening. This opening permits the excess gases to slowly leak out from the regulator through a second rubber hose.

25. Care of Arc Converter—The main points to be observed in caring for the arc converter are as follows:

1. The chamber should be kept reasonably clean.
2. No water leaks, however slight, should be permitted inside the chamber. The anode tip connection and gasket should be tested whenever a new tip is installed.
3. The chamber should be kept air-tight. The surfaces of the upper and lower chamber sections should always be clean and the gaskets in good condition.

4. The bakelite anode insulating disc and its gasket should be kept clean.

5. The moving parts of the cathode should be cleaned and oiled occasionally.

26. Water Pump—A centrifugal pump is provided for circulating water through the various water-cooled parts of the arc converter. The pump is driven by a $\frac{1}{4}$ -H.P. 110-volt d.c. motor.

A set of worm gears connected to the shaft operates the carbon rotating mechanism on the arc converter.

27. Water Tank—A 15-gallon tank is provided as a container for the arc cooling water.

The tank is provided with three test cocks which may be used for approximately determining the water level.

28. Back Shunt Circuit Unit—The "back shunt" circuit unit consists of a bakelite panel upon which there are mounted an inductor, a condenser and a resistor. The inductor is a small coil of insulated copper wire. The condenser is a Dubilier Type C.D. 158 Mica Condenser, having a capacitance of .004 microfarad. The resistor consists of 2 Ward-Leonard Type D-10 resistance tubes connected in parallel. A switch is provided by means of which this resistor may be short-circuited when desired. An additional and variable resistance is obtained by placing a steel disc immediately in front of the inductor coil. When radio frequency current flows into the coil, eddy currents and hysteresis losses in the steel disc cause an increase in the resistance of the back shunt circuit. These losses are greatest when the disc is near the coil and are a minimum when the disc is screwed back away from the coil. The resistance may be varied by turning a knob which causes the disc to be screwed in and out from the coil.

29. In Operating the Set the resistance of the back shunt circuit should be adjusted so that the radio frequency current delivered by the arc converter remains constant whether the arc is upon the antenna circuit or upon the back shunt circuit. This adjustment of resistance is secured by screwing the steel disc in or out and by using the switch which short-circuits the fixed Ward-Leonard tube resistor.

30. Transfer Switch for Chopper and Auxiliary Hand Key—A single-pole, double-throw transfer switch is supplied in order that the coupled compensation loop around the bottom of the antenna loading inductor may be connected either to the chopper or the auxiliary hand key, or to the two in series. A name plate is supplied with this switch which may be mounted with it in order

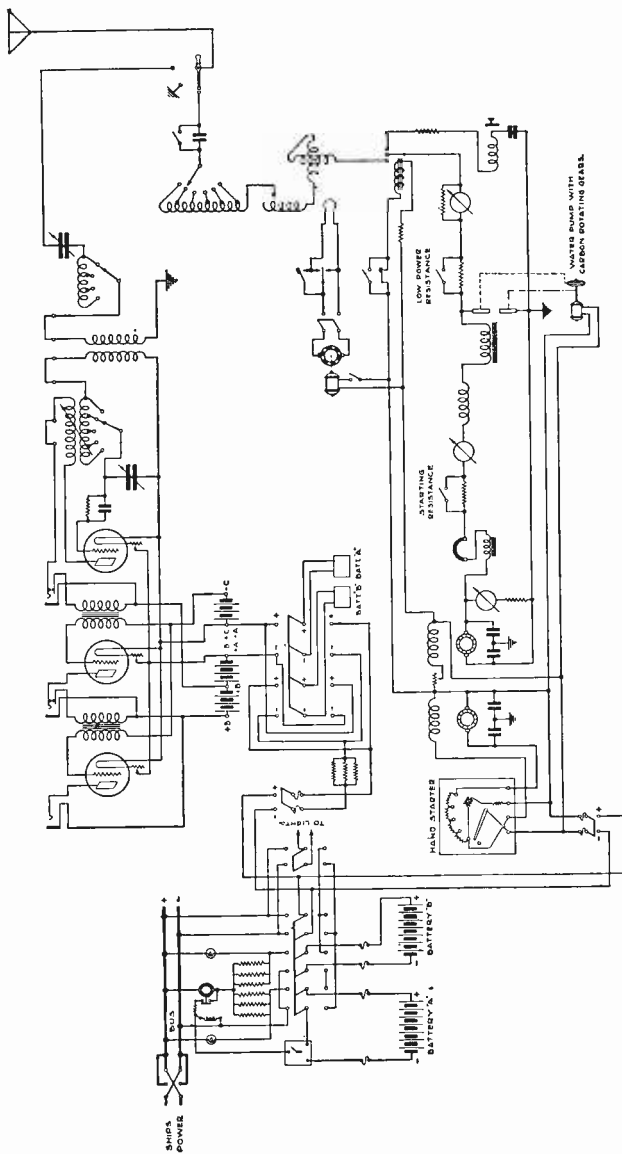

FIG. 225. Diagram of Model Q Federal Arc Transmitter together with receiver, "A" batteries, auxiliary batteries and charging circuit. This diagram is acceptable for radio operator's examination.

to indicate the proper position of the switch for each circuit combination. A wiring diagram of the coupled compensation circuit is included on this name plate.

31. Chopper—The chopper consists of a commutator wheel driven by a $\frac{1}{4}$ -H.P. 110-volt d.c. motor. Segments of the commutator wheel are connected at regular intervals to a central ring. The chopper brushes are so adjusted that they both make contact with these connected segments at regular intervals during the rotation of the wheel. The two brushes are connected through a suitable switch to the coupled compensation loop which is placed around the bottom of the antenna loading inductor. The commutator wheel serves to alternately open and short-circuit this coupled compensation loop. The chopper commutator wheel, when rotated, opens and short-circuits the compensation loop at a speed which gives a musical note in the receiver. The radio frequency energy is thus emitted at two wavelengths as when using the auxiliary hand key, but in this case the wavelength rapidly alternates between the maximum and minimum values.

The chopper commutator wheel should be cleaned with fine sand paper occasionally and the brushes and springs should be kept in good condition. The oil cup on the motor should be kept filled with good lubricating oil.

32. Note Varying Variometer—In order that the operator may be able to slightly vary the length of his outgoing wave while calling, a note varying variometer is supplied. This variometer consists of a stationary coil and a coil which may be rotated within the stationary coil. When the rotating coil is turned in one direction, the outgoing wave is lengthened; and when it is turned in the opposite direction the wave is shortened. By rotating this coil slightly first in one direction and then in the other, the operator is able to slightly vary the outgoing wave and thereby make his call heard by the receiver.

The variometer is connected directly in series in the antenna circuit between the antenna loading inductor and the relay key.

33. Antenna Low Power Resistor—In order that the antenna current may be reduced when communicating with a nearby station, a resistor is supplied which may be connected in series in the antenna circuit for operation on low power. A shorting switch is mounted on the bakelite cover of the unit. This switch is closed except when it is desired to operate on low power.

34. Send-Ground-Receive Switch—This switch provides the means of connecting the antenna either to the transmitter or to the receiver or to the ground.

Interlock contacts are provided on the switch for the 110-volt d.c. circuit which supplies the relay key and other auxiliaries.

The switch clips should be kept in good condition and the turntable upon which the rotating insulator is mounted should be oiled occasionally.

35. Operation of Model "K" or "Q" 2-K.W. Arc Radio Transmitter—Before starting the set for the first time, the various circuits should be tested to see that all electric connections have been made in the proper manner. The following steps should be taken:

1. Fill the alcohol cup and see that it feeds properly.
2. Fill the water tank $\frac{3}{4}$ full with fresh water.
3. See that the valves of the water tank are open and that the flow indicator indicates a circulation of water when the pump is started.
4. See that all moving parts are properly lubricated.

36. To Start the Set after a Long Period of Rest:

1. Close the set supply switch.
2. Place the send-ground-receive switch in the sending position. This should start the water pump and the carbon rotating mechanism which are supplied through the interlock contacts.
3. Start the motor generator by closing the circuit breaker on the starting panel and bring the motor gradually up to full speed. Adjust the generator voltage to be 250 volts by means of the field rheostat.

4. Start the alcohol flowing so that it may drip rather rapidly. Adjust the carbon on the arc so that there is about $\frac{1}{32}$ inch motion when the arc is struck.

5. Close the arc main line switch and strike the arc. Draw it out as long as possible without causing it to break. In starting for the first time, it will be necessary to keep the arc rather short for a minute or two until sufficient alcohol has been decomposed to give a partial hydrogen atmosphere in the chamber. As soon as the arc starts oscillating, the radio frequency ammeter will indicate current in the oscillating circuit and the arc should then be adjusted to obtain a maximum reading of this meter.

6. Close the arc starting resistor switch and adjust the arc for a maximum reading of the radio frequency ammeter. The alcohol flow may now be reduced to a few drops per minute and the generator voltage adjusted to obtain the desired antenna current.

37. To Transmit Signals—After the arc is operating, signals may be transmitted by sending with the Morse hand key. In

case radio frequency current through the back shunt circuit differs materially from that into the antenna circuit the resistance of the back shunt circuit should be adjusted so that the output of the arc converter is the same for both circuits.

38. Arc Adjustment—After the arc is in operation, it will only be necessary to make occasional slight adjustments of arc length. These adjustments are made to obtain a maximum reading of the radio frequency ammeter.

Only enough alcohol should be used to obtain full antenna current.

39. If the Arc Breaks—If the arc breaks or goes out it will be necessary to open the arc starting resistor switch and strike the arc again. In case the arc is struck without opening this switch, a short circuit will result and a trip coil will open the arc main line switch. It is then necessary to lift the handle of this arc and reclose the starting resistor switch.

40. To Stop the Arc for a Short Period—

1. Open the arc main line switch (this automatically opens the arc starting resistor switch).

2. Put the send-ground-receive switch in receiving position.

If it is desired to stop the motor generator, this may be done by opening either the set supply switch or the circuit breaker on the motor starting panel.

41. To Start the Motor after a Short Period of Rest—

1. Put the send-ground-receive switch in sending position and start the motor generator if it has been stopped.

2. Close the arc main line switch, strike and adjust the arc.

3. Close the arc starting resistor switch and adjust the arc.

42. To Shut Down the Arc for a Long Period of Rest—

1. Open the arc main line switch.

2. Open the set supply switch (this automatically releases the arm of the low voltage release coil).

3. Cut off the alcohol flow.

4. Place the send-ground-receive switch on send or ground as desired.

43. To Use the Chopper with the Back Shunt Method of Signalling—When it is desired to transmit signals on waves shorter than 950 meters by means of the chopper, the following procedure should be observed:

1. Throw the single-pole, double-throw transfer switch to the left and close the double-pole switch mounted on the chopper, thereby connecting the chopper to the coupled compensation loop on the loading coil.

2. Start the chopper motor by closing the snap switch.
3. Start the motor generator and arc converter in the usual manner.

4. Signals may now be transmitted by using the Morse hand key and back shunt circuit in the usual manner.

44. To Use the Chopper with the Auxiliary Hand Key—

1. Open the single-pole, double-throw transfer switch. Close the double-pole switch mounted on the chopper and start the chopper motor by the snap switch.

2. Connect the arc to the antenna circuit by closing the shorting switch on the Morse hand key.

3. Start the motor generator and arc converter in the usual manner.

4. Signals may now be transmitted with the chopper by using the auxiliary hand key.

45. To Transmit Undamped Wave Signals by Means of the Auxiliary Hand Key—When it is desired to send signals, using the auxiliary hand key without the chopper:

1. Throw the single-pole, double-throw switch to the right hand position, thereby connecting the auxiliary hand key directly to the coupled compensation loop on the antenna loading inductor.

2. Connect the arc converter to the antenna circuit by closing the shorting switch on the Morse hand key.

3. Start the motor generator and arc converter in the usual manner.

4. Signals may now be transmitted by the coupled compensation method with the auxiliary hand key.

46. To Change Wavelength—

1. See that the arc converter is shut down.

2. Change the antenna connection on the loading inductor to the terminal which is marked for the new wave.

3. Change the connection between the bare copper helix and the taps in the bottom layer of the loading inductor to the positions which are marked for the new wavelength.

47. Location of Trouble—If the arc flame will not strike at all—

1. Make sure generator is running and generating 250 to 400 volts.

2. Make sure arc main line switch is closed. Lift the handle and reclose the switch to be sure it is making contact.

3. See that the anode makes a good contact with its clip.

4. See that carbon is long enough. (Use gauge and wrench on side of chamber.)

5. Look for an open or loose connection in d.c. supply circuit from generator to arc converter unit.

6. Arc starting resistor tubes may be burned out.

7. See that arc field coil connections are good.

48. If the Arc Flame Burns without Producing Oscillations—

1. Make sure send-ground-receive switch is thrown to "Send."

2. Make sure of alcohol supply.

3. Make sure of connection from anode to antenna circuit.

4. Make sure of other antenna connections.

5. Try on both antenna and back shunt circuits.

6. Make sure the ground connection is good.

49. If the Arc Flame is "Fussy" and Antenna Current Low—

1. Chamber may not be air-tight, gaskets leaking.

2. Water in chamber, anode tip may be burned out, or gaskets leaking.

3. Antenna insulators may be dirty.

4. Poor connections in antenna circuit.

5. There may be water or alcohol in the chamber extension which holds the anode. Remove the anode insulating disc and see that there is no water there, and that the bakelite disc and rubber gaskets are clean.

In case the radio frequency ammeter is burned out, the arc flame may be adjusted by observing the d.c. ammeter as the direct current varies with adjustment in a manner similar to the antenna current.

50. Precautions—Do not touch any part of the antenna circuit when the equipment is in operation. It is much safer to stop the motor-generator and open the main supply switch when working on the apparatus. Contact with the 250- to 500-volt direct current may cause a painful shock, although it is not necessarily dangerous. Do not overload the transmitter beyond its maximum rating, which is 8 amperes for intermittent operation in the case of the 2-K.W.; and 12 amperes for intermittent operation in the case of the 5-K.W. transmitter.

Do not fill the alcohol container when the equipment is in operation.

Do not open the chamber or remove the carbon holder until two minutes have been allowed for the carbon to cool. Failure to observe this precaution may result in explosion, which, although not serious, should be avoided.

51. Type RH-1 2-K.W. Arc Transmitter of the Independent W.T. Company—This is a 2-K.W. arc transmitter designed for ship installations, where the antenna capacity is approximately .0012 microfarad, plus or minus .0007 microfarad. Such an average antenna will have an approximate fundamental wavelength of 450 meters and a resistance of 5 ohms at 600 meters. The motor generator and auxiliary apparatus are designed for 110-volt direct current operation, the usual supply source on ship-board.

Transmission of undamped oscillations is possible from 600 up to 2400 meters. Damped oscillations may be transmitted on wavelengths from 600 to 800 meters by using a modulating system which will be described further on.

52. Motor Generator—This machine is provided to convert the 110-volt ship mains to the high voltage necessary to operate the arc converter, viz.: 250 to 450 volts d.c.

With the proper care the motor generator will not give any trouble at all. On leaving the factory the ball bearings are filled with grease sufficient to last six months. About that time the bearings should be removed, washed in gasoline, and filled with grease again.

The commutator should be kept clean and smooth, using fine sand paper first, then washed with cheese cloth and gasoline. The brushes should bear evenly on the commutator bars without excessive friction.

53. To Remove the Bearings—When it is necessary to remove the bearings take off the outer bearing cap and, after disconnecting leads or brush rigging attached to the shield, remove the shield, leaving the ball bearing on the rotor shaft. Unscrew the butt clamps and remove them. Apply pressure evenly around the inner end of the inner race to force ball bearing off the shaft. When the bearing has been removed from the shaft it should be carefully wrapped up in clean paper to prevent any foreign matter from adhering to the grease. Before it is replaced the old grease should be washed off with gasoline and new grease replaced. In replacing the bearing, apply pressure at the outer end of inner race; never to the outer race, as this damages the bearing. A short piece of brass tubing and a babbit hammer are useful for this work.

A spare rotating element, motor field coil, generator field coil, brushes and brush holders, are provided in case of accident to any of the original parts. In substituting any of these items make

careful note as to how the original parts are assembled so as no difficulties will be encountered in replacing the new elements.

54. Arc Converter—When working near arc converter it is safest to shut down the motor generator, so that no injury will result to the operator by coming in contact with the high voltage direct current which could prove fatal.

The arc chamber should be kept free from soot. The anode insulating disc and gasket should be inspected from time to time and never allowed to become dirty enough to form a leakage path to ground. If they are allowed to "arc over" they will be ruined and will then have to be renewed. The whole set should be cleaned at least once a month.

It is very important that the arc chamber be gas- and water-tight. A small water or air leak in the chamber will cause the arc to be unsteady and the carbon to burn down rapidly. When the chamber is thoroughly tight, the carbon will probably build up slowly at the end; this depends on the chemical content of the hydrocarbon used. If the arc is taken apart, the gaskets on the shoulders of the poles should be examined and, if in poor condition, replaced by new ones before placing them against the bearing surfaces on the chamber.

When it is desired to replace an anode, first close the valve in the water circulation system. Unscrew the anode clamping ring, draw out the anode and set it on end tip upward. Remove the tip and its gaskets.

In replacing the old tip and inserting a new one, see that the bearing surface of the anode, the tip and copper gasket are clean, smooth and entirely free from grit and that the gasket is in good condition. Put the gasket and the tip in place and replace the tip nut. The anode should be examined and cleaned with gasoline, if necessary. Replace the anode in the arc chamber and tighten the clamping ring. See that the tip is lined up equi-distant from magnet pole tips. If it is nearer one than the other loosen the clamping ring and adjust the anode position. If the tip has not been squarely replaced on the end of anode, it will be necessary to remove the tip nut and see that tip is put on properly.

55. Water Cooling System—The cooling tank is cylindrical and has a large hole running vertically through the center providing additional cooling surface. The tank is filled from the inlet covered by a screw cap. The amount of water in the tank can be noted from the right gauge.

There is a pet cock to test the sight gauge and determine if it is showing the true water level. A valve is provided to open and

close the circulating circuit, as may be desired. A small red ball within the glass indicator rises to the top when the water is circulating properly and falls when water stops circulating.

From the circulation indicator the water runs to the anode and from the anode to the duct in arc chamber, through the duct to the top of the tank. To prime the pump it is only necessary to open the pet cock near the top and let the air out. Only *fresh* water should be used. The arc will not operate using salt water as it grounds the anode. The tank should be kept from $\frac{3}{4}$ to $\frac{7}{8}$ full at all times. During the winter alcohol mixed (1 part alcohol, 2 parts water) with the water should be used to prevent the cooling system from freezing.

56. Radio Frequency Circuit—The cathode, which is connected to the negative side of the generator line, is grounded. The anode is then connected through radiation ammeter through the low power resistor which is normally shunted by the shunting switch through the relay key to the absorbing circuit. When the relay key is in the down position, the anode is connected to the antenna loading inductance. In the 600, 800 and 2,400 meter adjustments it will be noted that there is simply an inductance in series with the antenna, the constants of this circuit equalling a frequency that gives the desired wavelength.

57. Absorbing Circuit—In signalling with the back shunt method the energy converted by the arc is diverted either to or from the antenna at a rate corresponding to dots and dashes. In the key-up position, the energy is diverted from the antenna by the relay key to an absorbing circuit, which consists of a .004 mfd. condenser, an inductor and combined iron plate resistor and absorbing resistor. The antenna ammeter is also thrown from the antenna circuit to the absorbing circuit by the relay key, so this meter reads the current in each circuit depending upon the position of the key. The iron plate resistor should be adjusted so that the direct current load is nearly constant when reading. If the resistor is improperly adjusted the absorbing circuit will draw more than the radiating circuit, causing the arc to be unsteady, especially on the lower wavelengths.

58. Modulating System—This consists of a $\frac{1}{4}$ -H.P. d.c. motor directly coupled to a large commutator used as a "chopper." Every sixth bar is connected together and brushes are located diametrically opposite each other. The two brushes are connected to a loop of Litzendraht which is in inductive relation to the antenna loading inductance and current is induced in this loop at times when it is shorted by the commutator circuit. The motor

runs at a speed of 1700 R.P.M. and this speed and number of bars correspond to 1000 short circuits a second or a 500-cycle note, approximately. These short circuits change the wavelength appreciably and reception on a crystal or audion detector is of a 1000-cycle tone.

59. Wave Change Switch—A wave change switch is provided which permits of transmission on four wavelengths. These positions are marked by number plates and have corresponding ratchet stops. To the right of a wavelength position is an intermediate point which provides connection directly to the rotating contact of the compensating inductance in order that, after having adjusted the antenna loading inductance by steps to an approximate value, the proper amount of compensating inductance may be exactly determined in a convenient manner as explained later.

60. Operation—

1. Place send-receive switch in receive position.
2. Close switches, main switch, motor generator control switch, arc striking switch, generator field switch, resistance output, and lower power resistance shunt switch.
3. See that loading coil leads are in approximate position, also leads running to compensating inductance.

4. Place wave change switch in 2400-meter position.

5. Placing send-receive switch in send position closes circuits which perform the following functions:

(a) Motor generator is brought up to full speed by the closing of main line contactor, and to the two contactors of the automatic starter.

(b) Simultaneously, the pump and carbon rotating motor are brought to full speed. The carbon should be rotating slowly and the sight feed on the water circulating will show the red ball, indicating that the pump is working.

(c) The main line contactor has closed, closing the high potential circuit. The arc striking relay works, striking the arc electro-magnetically through the arc striking mechanism. A few seconds after the arc is struck, the arc starting resistor is shorted. The hydrocarbon supply magnet has operated, supplying alcohol to the arc chamber, which is evaporated, and the vapor contains hydrogen which is necessary to maintain a steady arc. Too much alcohol will be indicated by a white vapor rising in the alcohol sight glass; too little by the arc being unsteady.

(d) The d.c. voltmeter reads the arc voltage; the d.c. ammeter reads the arc current, and the radio frequency ammeter the ab-

sorbing circuit current, and when the key is pressed down reads the antenna current.

When throwing the send-receive switch to the send position, the arc may not ignite upon the first inward thrust of the mechanism. This may be due to excessive spacing between copper and carbon elements, and the carbon should be adjusted to proper relation to the copper by the cathode adjustment knob which moves the cathode nearer the copper anode when turned counterclockwise.

The arc striking relay has an automatic action, and when the cathode strikes the anode and returns, if the arc does not ignite, the action is repeated again until it does ignite. Of course it should be assisted by adjusting the cathode by the cathode adjustment knob.

Lock the relay key by closing the hand key on the table and measure the wavelength being transmitted, making sure on all wavelengths that you are measuring the antenna circuit and not the absorbing circuit.

Assuming that the wavelength measured was 3300 meters and after cutting out one or more sections of the antenna loading inductance it was reduced to 2300 meters, the final adjustment would be made by throwing the wave change switch to the right of the 2400-meter position and tuning with the compensation inductance until the wavelength is exactly 2400 meters as indicated by the wave meter. After final adjustment is made by the variable arm on the compensating inductance, the 2400-meter lead from the lower half of the wave change switch is brought to the inductance in exactly the same point where the variable contact was. The wave change switch can then be moved to the other wavelength position and further adjustments made with the antenna loading inductance and compensating inductance in the same manner.

On 600 meters it is best to place as much of the total inductance required in the antenna loading inductance and as little as possible in the compensating inductance.

The relay key should be kept in good order; when adjusting for the up position the lower contacts should be compressed $1/16$ of an inch and a space left of $1/32$ of an inch between the upper contacts; the air gap between armature and field poles should be very small. In the down position the upper contacts are compressed $3/32$ of an inch and the lower contacts $1/16$ of an inch apart.

The commutators of motor, generator, pump motor, and modulation motor and modulator should be kept clean and smooth and also see that the brushes are wearing evenly.

The operator should always see that the circulation indicator is indicating when the set is in operation. The water tank should be kept full to the level indicated, and the alcohol feed reservoir full as it only holds enough alcohol for ten hours' continuous operation.

All moving parts should be lubricated and parts making electrical contacts, such as switch blades, contactors, etc., should be kept smooth and clean.

Every morning the apparatus should be dusted thoroughly with cheese cloth and cleaned with alcohol at least monthly.

The copper parts should be polished if they are not lacquered.

CHAPTER II

SPARK TRANSMITTERS

1. Oscillatory Discharge of a Condenser—The condensers of a radio transmitter may be charged by connecting them to a source of high voltage such as the secondary terminals of an induction coil or step-up transformer.

Consider the circuit of figure 226. The voltage of the secondary terminals of the transformer may be 10,000 to 30,000 volts. When the key of the primary circuit is closed a violent spark discharge

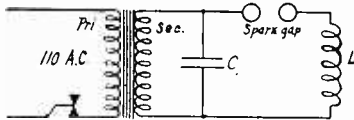

FIG. 226. Circuit for Production of an Oscillatory Discharge of a Condenser.

will take place across the gap SG . It will continue as long as the key circuit is closed. An analysis of the discharge will show that a radio frequency current oscillates through the condenser C and inductance L . If the frequency of the alternating current of the primary circuit is

500 cycles there will be a discharge for each alternation or 1000 spark discharges per second. This will result in the flow of 1000 groups of radio frequency oscillations through the discharge circuit LC .

A spark discharge such as that described will produce a series of cycles of alternating current of constantly decaying amplitude, such oscillations being called damped oscillations on account of this decrease in amplitude.

The discharge of a condenser is explained as follows: Referring to A in figure 227: Just previous to the first discharge the energy is stored in an electrostatic form in condenser C . The potential of the condenser finally becomes so great that the air dielectric between the gap S is broken down so that a spark jumps from one electrode of the gap to the other. The electrostatic field is now converted into current which flows through inductance L creating lines of force. After a time this inductance contains all of the circuit energy in its field, and because this field produces a potential difference across the terminals of the coil opposite in sign to the original voltage, the condenser commences to charge again in the opposite direction as in b . After the condenser is charged,

it discharges a second time. This process keeps repeating itself, the voltage reversing in sign at each charge and discharge.

Each charge is smaller than the one preceding as some of the energy is lost by the resistance of the circuit and the production of heat, light and sound. Finally the charge becomes so small

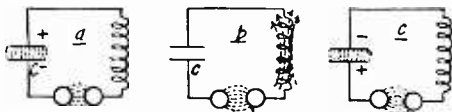

FIG. 227. Charge and Discharge of a Condenser.

that a spark can no longer bridge the gap and the oscillation current dies out. The frequency of the oscillations depends upon the size of the capacity and inductance employed. It may be calculated as follows:

$$f = \frac{1}{2\pi\sqrt{LC}},$$

where f is the frequency, or number of discharges per second, C is the capacity of the condenser in farads and L the inductance of the coil in henrys. The number of oscillations per single spark is a function of the total damping of the circuit, that is, if the circuit has many complete oscillations per single spark discharge the wave train produced is a low damping. If the oscillations ceased after a very few oscillations the wave train is said to be highly

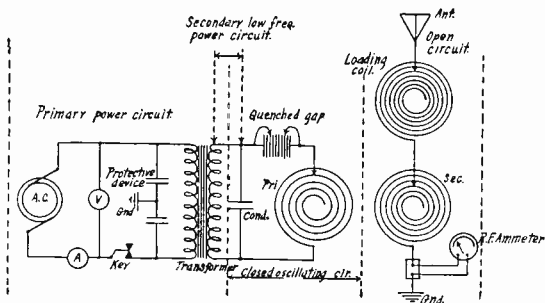

FIG. 228. Elementary Circuit of a Spark Transmitter.

damped; when the apparatus as shown in figure 226 is employed to generate radio frequency oscillations for the production of etheric waves, the circuit is denoted by the closed oscillatory circuit to distinguish it from the open or antenna circuit.

If the resistance of the oscillation circuit is too great the discharge of the condenser will not be oscillatory. This can be expressed as follows: If IR is greater than $2\sqrt{L/C}$ the circuit is non-oscillatory; if the resistance is $2\sqrt{L/C}$ the circuit is just oscillatory. If the resistance is less than $2\sqrt{L/C}$ the circuit will be oscillatory. In these equations R is expressed in ohms, L in henrys, and C in farads. In actual practice it will be found that the oscillation circuits do not have anywhere near the critical value of resistance. Neglecting the value of R the frequency of the closed circuit may be decreased by either increasing the capacity of C or increasing the number of turns in L . Usually the capacity of C is fixed and the turning of the closed circuit is done by varying the number of turns in L .

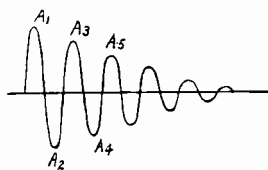

FIG. 229. Damped Oscillations with Constant Ratio of Decay.

2. Logarithmic Decrement of Oscillations—The oscillations of a damped wave train in such a circuit as has been discussed decay according to the law that the ratio of any oscillation to the one preceding is constant. This constant ratio is called the damping of the oscillation and the Napierian logarithm of the ratio of one oscillation to the preceding one is called the logarithmic decrement. Referring to figure 229 the amplitude of

A' is to A^3 as A^3 is to A^5 or in terms of logarithms

$$\frac{A'}{A^3} = \epsilon \delta,$$

where ϵ = base of the Napierian system of logarithms,
 δ = a constant termed logarithmic decrement.

Transposing, $\delta = \log \frac{A'}{A^3}$.

If the value of the logarithmic decrement is known the number of complete oscillations comprising a wave train can be determined before their amplitude has fallen below a certain fraction of the first oscillation. It has been found that if the oscillation radiated by a spark transmitter has less than 24 complete oscillations per single spark discharge such transmitter will emit a broad interfering wave. A decrement of .2 corresponds to such a wave train and the oscillations are said to be highly damped. A group of oscillations having many more than 24 complete oscillations would

have feeble damping. There are various formulæ for the calculation of decrement mathematically but fortunately there is manufactured a meter called the Kolster decrementer which gives a direct reading to the decrement of the emission from a spark transmitter. Such an instrument is employed by radio inspectors of the U. S. Government in their inspection of various types of mobile spark transmitters.

3. Spark Gaps—The purpose of the spark gap in a radio transmitter is (*a*) to act as sort of a valve to prevent the condenser discharging until it has reached a certain potential (*b*); then to allow the stored-up energy to break down the air gap and circulate through the closed oscillation circuit in the form of radio frequency oscillations (*c*) to restore the gap to its non-conducting state when the energy has been transferred to the antenna circuit.

There are three types of spark employed with commercial radio transmitters. They are:

- (1) Non-synchronous rotary gap.
- (2) Synchronous rotary gap.
- (3) Quenched gap.

The non-synchronous gap as employed with spark transmitters on vessels operated by the United States Shipping Board consists of an aluminum housing on which is mounted, at the upper portion, an insulating ring to which are attached twelve stationary electrodes of hard drawn copper. A rotating aluminum disc insulated from the shaft carries fourteen moving electrodes of h.d. copper. This rotating disc is driven by a shunt-wound motor connected to the radio auxiliary power circuit. The moving electrodes are rotated at a speed of 4000 R.P.M. and produce 5600 breaks per second. The gaps are enclosed by a ribbed aluminum cover with an observation hole protected by a red sight glass. The stationary and moving electrodes are arranged to be easily renewable.

4. Theory of Operation—This non-synchronous gap is designed so that a pure 1000 spark note is obtained and is accomplished by making the break frequency approximately 5600 per second, which is high as compared to 1000 per second. In consequence of this high break frequency it is always possible for at least one spark per alternation (500-cycle a.c. supply or 1000 alternations per second) to occur. If there should be several sparks per alternation, these must occur at the rate of 5600 per second. This higher discharge rate produces a musical tone which is inaudible as compared to the dominant 1000 spark tone, and therefore has no disturbing effect. Application of the Vernier

principle makes it possible to obtain this high rate. That is, the spacing of the revolving electrodes is less than the spacing of the stationary electrodes and because of this unequal spacing there are a number of sparks around the circumference of the gap, while one of the revolving electrodes is passing from one stationary electrode to the next one. In this gap 14 revolving and 12 stationary electrodes are provided. The following formula gives the spark frequency.

$$\frac{E_s \times E_r \times RPS}{2}$$

E_s is the number of stationary electrodes.

E_r is the number of revolving electrodes.

RPS is the number of revolutions of rotor per second.

2 is the factor which depends on the number of gaps in series.

In order to obtain satisfactorily the characteristics described above, the 500-cycle circuits must be adjusted to resonance. This adjustment is readily made when the 500-cycle circuit contains a reactance regulator with several steps; otherwise it must be accomplished by the speed of the motor generator.

5. Synchronous Rotary Gap—The disc of a synchronous gap is mounted on the shaft with the alternating current generator. The disc is fitted with as many rotating electrodes as there are

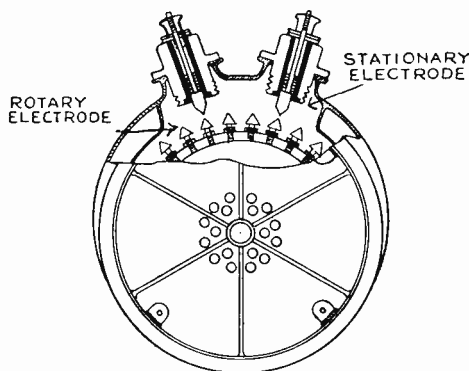

FIG. 230. Sectional View of a Synchronous Rotary Spark Gap.

field poles of the generator. If the frequency of the generator is 500 cycles the condenser will be charged and discharged 1000 times per second and will produce a musical pitch. Figure 230

is a back view of the rotary gap supplied with the R.C.A. 2-K.W. 500-cycle transmitters. There are two stationary and 30 rotating electrodes. The rotating disc is enclosed in a steel muffling drum which also acts as a support for the two stationary electrodes. This drum is designed so that it can be moved through an arc of approximately 25 degrees by an adjusting rod. This permits the adjustment for a synchronous discharge, that is, a discharge on the peak of an alternation, thus resulting in a musical spark note.

6. The Quenched Spark Gap—The quenched gap gets its name from the effects produced when a spark gap of this type is employed in the closed circuit of the transmitter. The ideal gap is one which permits the closed circuit to oscillate for a period of time sufficient for the oscillations in the antenna circuit to build up their maximum amplitude and then quench out those in the closed circuit.

Both the non-synchronous and synchronous gap permit a different degree of quenching providing the circuits are loosely coupled, the latter possessing this quality to a higher degree than that of the non-synchronous. The quenched gap has the further advantage of permitting a very close coupling between the primary and secondary circuits, while at the same time quenching the primary oscillations very strongly. This prevents the oscillations in the aerial circuit from being retransferred to the closed circuit which would cause two waves to be radiated as will be shown later. With proper quenching the primary circuit comes to rest after a few oscillations and the gap becomes non-conducting, thus preventing a retransfer of energy to the primary circuit.

The principal difference between the quenched gap and those just discussed is that instead of one or two spark gaps cooled by a rotary member we use many very small gaps in series, subdividing the spark into many short sparks.

The complete unit of a quenched gap usually consists of approximately 15 units of the self-cooled quenched type with silver sparking surfaces. Each unit is self-contained and may be renewed independently of the rest by hand. In removal of any one unit the circuit is automatically and instantly closed by the gap holder springs making contact.

Each gap unit consists of two annular brass discs secured by a central insulated bolt and separated from one another by an annular fish paper gasket. A brass washer and fish paper gasket serve to insulate the bolt and distribute the pressure.

The sparking surface consists of two annular silver rings spaced .013 of an inch apart. Cooling is effected by a rectangular

flange of copper fixed to the central plates. The quenching action of a gap depends largely upon the speed with which heat created by the spark can be removed and dissipated. The gasket when heated by operation makes the sparking chamber air-tight.

When a gap unit is first put in operation, the air enclosed and the spark cause a certain amount of oxidation of the silver sparking surfaces. When the gap has sealed, the spark reduces this oxide, and the surfaces regain the white color of pure silver. This seasoning process is usually carried out at the factory of the manufacturer. Therefore, a unit should not be opened until one is sure that it needs to be cleaned. A gap test rod, provided with the set, is used to short-circuit successive gap units. Active units will give a healthy snappy spark at the instant of making or removing the short-circuit. Inactive units will give only a small sluggish spark or even no spark at all.

The advantages of the quenched gap are: Noiseless in operation, has no moving parts, permits the use of low voltage transformers, allows maximum transfer of energy to the antenna circuit because of closer coupling and permits the radiation of a wave of low decrement.

The note of the quenched gap is regulated by variation of the number of gaps or regulation of generator voltage. If properly adjusted a synchronous discharge can be obtained resulting in a pure musical note.

7. Reaction of Coupled Circuits—The commercial spark transmitters on American vessels employ an oscillation transformer with inductive coupling to transfer the energy to the open circuit. It may be found that the energy is being radiated on two different wavelengths. For example, if the circuits are tuned to 600 meters it may be found with a wave meter that there is energy radiated on a wavelength higher than 600 meters and also on a wavelength lower than 600 meters. These two wavelengths are caused by the reaction of the lines of force of the secondary of the oscillation transformer in the antenna circuit upon the primary of the closed circuit and vice versa. The mutual induction of the two coils causes the effective self-inductance of the secondary coil either to increase or decrease, depending for the instant upon which of the two circuits is driving the other. The result is the radiation of the two waves. This represents an undesirable condition; as the receiver can only respond to one wavelength at a time, the energy in the other wave is lost. Interference is also increased as the transmitter is occupying two frequency channels.

This condition usually is caused by improper quenching of the

spark gap or too tight coupling between primary and secondary of the oscillation transformer. Usually by loosening the coupling the two waves will merge into one, thus permitting exact resonance between primary and secondary circuits.

8. Commercial Spark Transmitters—On vessels operated by the U. S. Shipping Board and several privately owned vessels one finds a type of transmitter known as the Navy Standard 2-K.W. set. Of the 2-K.W. transmitters the following types are found:

CK 617 Kilbourne & Clark Manufacturing Co.

CR 655 Wireless Specialty Apparatus Co.

CM 1080 Marconi Wireless Telegraph Co. (now R.C.A.)

CM 305 Marconi Wireless Telegraph Co. (now R.C.A.)

Types CK-617, CR-655 and CM-1080 are practically alike, having like power control panel, meters, circuit breakers, switches and automatic starters. The same is true of the wave changer which consists of oscillation transformer, loading coils, spark gap and condensers.

Type SE-1205A is another 2-K.W. set, but differs somewhat from the others in the arrangement of the power control panel. With this type a separate panel to control the charge and discharge of the storage batteries is used.

The motor generators are usually mounted on the engine room grating and remotely controlled by the operator. The automatic starter consists of a counterweighted shunt-wound magnetic contactor controlled by a push button for closing the main circuit and series-wound magnetic contactors for short-circuiting the starting resistors. A description and the theory of operation of this starter will be found in Chapter 3, Motors and Generators.

Inasmuch as the power apparatus comprising a spark transmitter such as motor generators, transformers, etc., have already been described in previous chapters, no further description will be given here.

9. Inductive Coupler—This consists of one fixed and one movable spiral of copper strip placed on a rectangular insulating frame formed by two end cheeks which are the base of the wave changing switch. The movable coil slides on a central guide and is actuated by a slotted bell-crank arm and handle placed to the right of the apparatus.

Tappings from primary and secondary coils are brought to contacts on the wave change switch and the primary terminals are connected to the radio transformer and condensers.

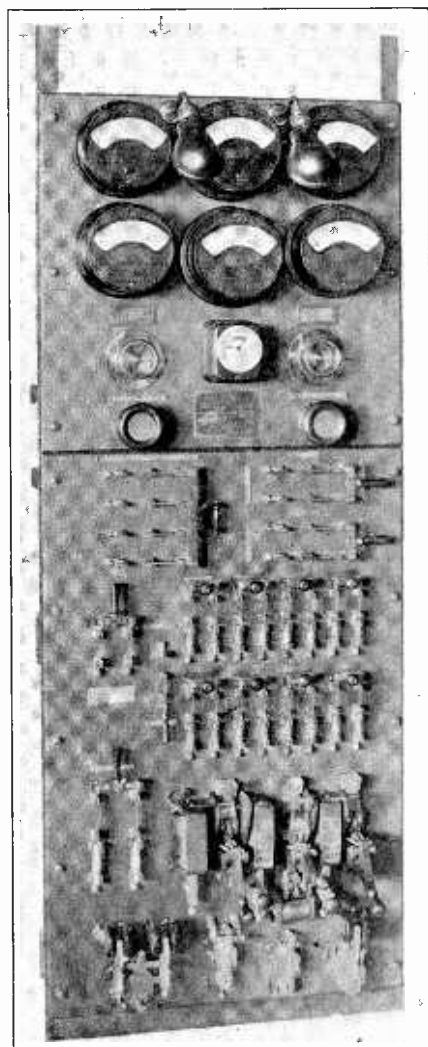

FIG. 231. Power Control Panel of Navy Standard 2-KW. Spark Transmitter.

The terminals of the secondary spiral are connected to the ground through the aerial ammeter.

10. Wave Change Switch—This consists of two rotating contact arms working over contacts arranged on two cheek plates of insulating material. The front switch has three contacts arranged on the upper semi-circle which connects with tappings, on the inductance spirals. The front switch arm is connected by a movable connector to the power change switch and spark gap.

The back switch has three contacts arranged on the lower semi-circle connecting with the tappings on the secondary inductance spiral. The back switch arm has two contacts diametrically opposite and these connect the lower fixed contacts with three others arranged on the upper semi-circle. These latter connect to the movable arms of the three antenna loading spirals.

The rear arm of the switch can be rotated independently of the front arm by loosening and sliding back the clamp bolt. This permits the varying of the secondary inductance independently of the primary, which is necessary at times when the antenna is affected by storm or accident.

11. Antenna Loading Coils—These consist of four spirals mounted directly above the inductive coupler and each is provided with a rotating contact finger which can be moved over the whole length of the spiral. Under normal operating conditions these coils are so connected that only three are variable, the fourth being connected as a whole in the circuit; by changing the bus bars this coil can be made variable as required by the characteristics of different antennæ.

12. Send-Receive Switch—This switch performs the following functions: In sending position:

- (1) Closes a break in the field circuit of the alternator.
- (2) Closes a break in the solenoid of the clapper switch on the switchboard.
- (3) Closes a break in the circuit which operates detector protective relay.
- (4) Closes one spare set of contacts.
- (5) Grounds the terminal which connects to the receiver primary.
- (6) Connects antenna to loading coil of transmitter.

In receiving position:

- (7) Opens contacts 1, 2, 3, 4, 5 and 6 as closed above.
- (8) Connects receiver lead to antenna.

The switch is in the sending position when the main switch blade is parallel to the base. In this position it closes contacts

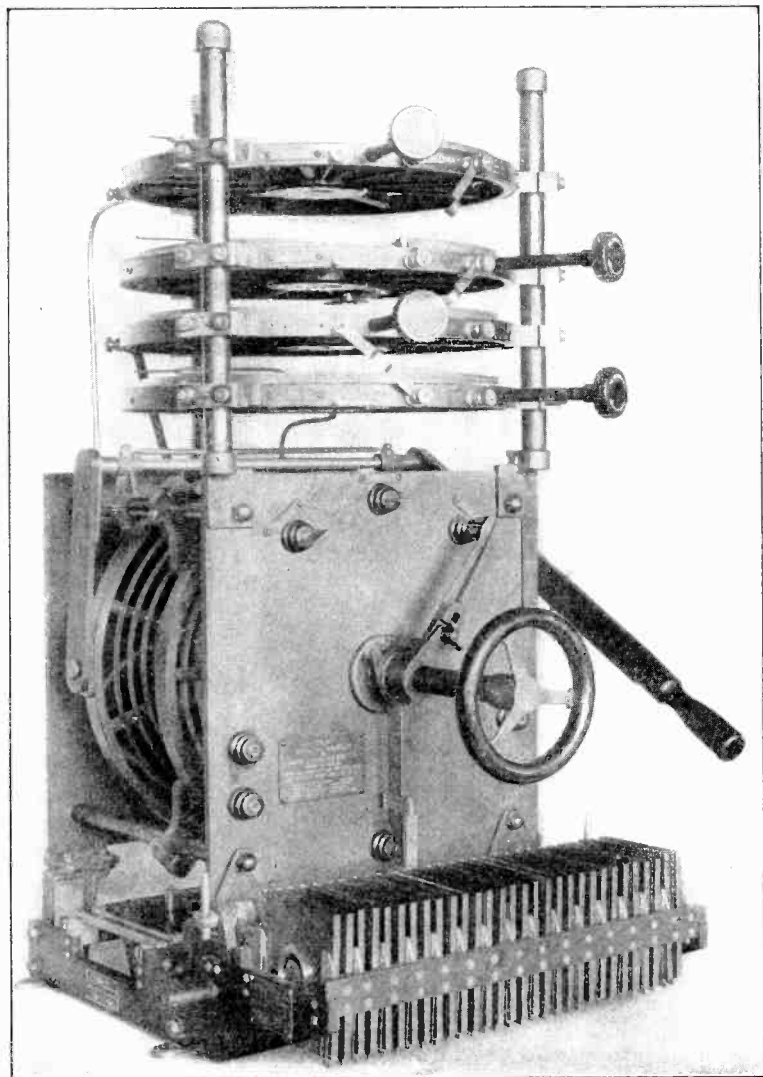

FIG. 232. Wave Changer—Oscillation Transformer, Load Coils and Quenched Spark Gap of Navy Standard 2-KW. Spark Transmitter.

11 and 12 by short-circuiting the spring clips. The aerial is connected to the transmitter by the spring contacts on the "Ant. C'C'T" post making contact with the "OSC. C'K'T" post. The generator field and spare circuit are closed by the contacts on the rotating cylinder.

13. Tuning the Transmitter—Start the generator by the remote control push button switch. Adjust the generator voltage to the lowest value and short-circuit seven or eight gaps by means of the clips on the gap switch rods. The gaps between a clip on the short arm and on the long arm are short-circuited when the clips make contact with the studs. Throw the antenna switch to the sending position and close the auxiliary switch on the switchboard. When this is done the clapper switch on the switchboard should close. Adjust the generator voltage till the gaps just spark over, and, with the antenna circuit grounded, proceed to tune the primary to the wavelengths desired. When the primary circuit is tuned wavelength markers should be placed on the primary inductance at the proper places. The primary leads should be clipped to the inductance at these marks. Then close the aerial circuit and proceed to tune the aerial circuit as follows:

On account of the fact that the unused turns of the oscillation transformer secondary and of the antenna loading inductances are short-circuited, and hence have an effect on the used turns, it is necessary to tune the longest wavelengths first, as the amount of inductance short-circuited is determined by the position of this slider.

Loosen the coupling as much as possible by pressing down on the coupling lever handle. Throw the wavelength switch to the highest wavelength point. Tune this wavelength by rotating the knob on the bottom loading coil till the aerial ammeter shows maximum current under these conditions. In case there is too much inductance in the circuit, change the connector between the first and second antenna loading coils so that the outside end of the first loading coil is connected to the middle of the second loading coil, instead of to the inside of that coil. Then tighten the coupling very slowly, watching the aerial ammeter constantly. It will be found that there are several coupling points which give maximum aerial current. All these should be marked on the coupling scale. Choose the point which gives the highest current value and vary the inductance in the aerial current to see whether it is possible to further increase the antenna current. When the highest current is found by this operation, tighten the coupling slowly again in order to find a closer coupling point which will

give a higher antenna current, or at least a maximum point. Retune the aerial circuit, adjust the coupling, retune the aerial circuit, and so on until the best result is obtained. If the gap is in perfect condition the note on this hump will be good; if not, it will be impossible to get a good note on this hump, and the previous hump should be used till the gap is in good condition. In all cases, several trials should be made in order to locate the best possible coupling point. When this is found, note the position of the coupling lever on the scale accurately.

Throw the wavelength switch to the next lowest wavelength and proceed to tune it in like manner and note the final position of the coupling lever for the best coupling point. Proceed in this manner over all the wavelengths desired, noting the best coupling points.

Then choose a position of the coupling handle which will be most convenient for all the wavelengths, probably that at which the lowest wavelength is in tune. If the coupling for any wavelength is tighter, that is, if the coupling coils are too close to each other, inductance must be added to the oscillation transformer secondary till the coupling is again at the chosen point. It must be remembered that when inductance is added to or subtracted from the oscillation transformer secondary, it must be subtracted from or added to the loading coils. This makes it necessary to go over all the adjustments again. When the set is finally tuned, it must be possible to change from one wavelength to any other simply by turning the hand wheel on the wavelength switch without further adjustment of coupling or aerial inductance.

14. Sparking of Loading Coils—The loading coils will spark considerably by the voltage built up in them if the proper distribution of the secondary inductance in each loading coil permits the variable contact to engage approximately the same number of turns. The secondary of the oscillation transformer will require more turns as the wavelength increases. A minimum decrement will result and the breakdown of insulation of the loading coils will be prevented.

In severe cases where the insulation of the loading coils has broken down and the adjustments as described above do not relieve the trouble it may be necessary to cut away portions of the insulation that are carbonized. If only small discharges have taken place the insulation should be cleaned and a light coating of vaseline applied. If it becomes impossible to eliminate sparking by these adjustments the transmitter should be operated at reduced power.

DEPARTMENT OF COMMERCE
BUREAU OF NAVIGATION
RADIO SERVICE

RADIO APPARATUS ADJUSTMENT RECORD

Name of Station I. M. I. A. Y.
 Date of Inspection October 24, 1925.
 Power 2 K. W.
 Name of Operator L. C. Herndon.
 Inspected by L. C. Herndon.
 Location Lowenstein
 Type of Equipment SPARK HAY. Std. ARC
 VACUUM TUBE
 Auxiliary Type and Source of Power Walt. sat. on battery G. M. I. V. C. P. 13. 210. A. H. S. C. P.

Adjustment of equipment as indicated on this record and approved by the Supervisor of Radio MUST NOT BE CHANGED without the authority of the Secretary of Commerce

ADJUSTMENTS FOR AUTHORIZED WAVE LENGTHS

| Factor | Wave Length | 706 | 800 | Wave Length | Factor |
|----------------------------|-------------|-------|------|------------------------------|--------|
| Primary condenser (M.A.) | .016 | .016 | .016 | Oscillator adjustment dial | |
| Primary turns | 2-1/2 | 5-1/8 | 4 | Oscillator circuit condenser | |
| Secondary turns | 6-1/2 | 7-2/5 | 8 | Frequency dial | |
| Loading coil No. 1 turns | 0 | 0 | 0 | Plate taps | |
| Loading coil No. 2 turns | 1 | 0 | 7 | Grid taps | |
| Loading coil No. 3 turns | 2 | 7 | 7 | Antenna tuning coil | |
| Loading coil No. 4 turns | 3 | 6-7/8 | 7 | External loading coil No. 1 | |
| Loading coil No. 5 turns | 4 | 6-7/8 | 7 | External loading coil No. 2 | |
| Loading coil No. 6 turns | 5 | 2 | 2 | Coupling Type | |
| Coupling Type | 5000.8 | 2 | 2 | Plate voltage | |
| Antenna current | 15 | 15 | 14 | Filament voltage | |
| Decrement | .035 | .03 | .05 | Filament current | |
| Wave Length | | | | Plate current (oscillator) | |
| Large loading coil turns | | | | Plate current (modulator) | |
| Small loading coil turns | | | | Antenna current CW | |
| Variable capacitor degrees | | | | Antenna current ICW | |
| Antenna condenser | | | | Antenna current PHONE | |
| Antenna current CW | | | | | |
| Antenna current ICW | | | | | |

Revised with 1-5-27 layout

FIG. 233. Department of Commerce Radio Apparatus Adjustment Record Showing Number of Turns Used in Inductance Coils for Various Wavelengths.

15. Final Adjustments—After all the wavelengths have been adjusted bring up the motor speed till the frequency meter shows 500 cycles. Then increase the generator voltage till the note breaks into a full 1000-spark note. If the power is low, cut in more gaps and raise the voltage till the wattmeter shows normal power and the note is clear. Readjust the motor speed, if necessary, till the frequency meter shows 500 cycles. It will then be necessary to go over the tuning again to see that the circuits are in proper resonance, and that the wavelengths are right. This retuning will help to clear up the note in case it was impossible to do it by means of the motor speed and generator voltage alone. When all the circuits are in exact resonance, when the motor speed is right, and the generator voltage has been adjusted properly, the note emitted by the transmitter will be a clear 500-cycle (1000-spark) note of good quality. If it is rough and scratchy, it is an indication that these circuits are not in proper resonance, or that the gap is not fully seasoned. It may be cleared up by a slight readjustment of the coupling or of the inductance in the aerial circuit or both.

16. Rotating Gap—If it is desired to use the rotary spark gap instead of the fixed gaps of the transmitter, it may be connected in circuit by proceeding as follows:

(1) Pull the single pole switch connecting the power change switch with the primary wave changing switch forward until it rests upon the fixed gaps; this will disconnect the fixed gaps from the circuit.

(2) The terminals of the rotary gap can now be plugged in either pair of terminals mounted on electrode insulators on each lower side of the primary wave changing switch.

(3) Close the D.P.S.T. switch marked "Radio Auxiliary," thus starting the motor.

The set is now ready to operate and can be adjusted and tuned in the same manner as the fixed gaps until the best note is heard and a maximum reading observed on the aerial ammeter.

17. Care of the Quenched Gap—Gap units are opened by removing the center bolt with the special wrench provided and then breaking the unit apart by a twisting movement. The sparking surfaces of an opened unit will indicate conditions as follows:

1. If the silver surface is black in color, there has been a breakage of air into the gap.

2. If the silver surface has a blue-black appearance, there has been a slight leakage of air and deposit of silver oxide.

3. If the silver surface has a brown color and is speckled or pitted, the gap has been overloaded.

4. If there are rough edges on the inner and outer circumferences of the sparking surface, the gap has been overloaded.

Gaps showing the first three conditions can usually be brought back to operating condition by running them for about twenty minutes with an input of about 75 per cent of the rated power, with new gaskets and with antenna disconnected. If the fourth condition exists, the rough edges can be scraped off with a knife, after which the gap can be restored as mentioned. If the unit has been operated for some time in a leaky condition, the deposits may be too thick to be removed except by the use of an abrasive. For this purpose use No. 000 sand paper pasted to a flat block of wood. Do not use the sand paper alone, as it is essential that the silver surface be kept true. Never use emery in any form. All blackening should be removed from the inside of the unit and from the bolt. Do not be too ready to open the unit. Remember that every cleaning removes a certain amount of silver, increases the gap length, increases the power which the unit must handle, and shortens its life.

Spark gaskets supplied with the set are selected for the proper thickness. It is well to be sure, however, that they lie between .041 and .039. The thickness of the gasket determines the length of the gap. If the gasket is too thick the power per gap will be too high and unnecessary heating and deterioration will result. If the gasket is too thin, the power will be low and it may not be possible to obtain rated output from the set.

To assemble a gap unit, lay the plate that has the tapped hole, silver side up, on the assembly base, with the alignment pins properly inserted. Lay a large gasket on the plate, centering it inside the pins. Lay the other plate on top, silver side down, and put a small gasket in the center bore. The gasket under the head of the center bolt is quite as important as the main gasket, and must not be forgotten. Insert the center bolt, bring it up as far as possible by hand, and screw home with the wrench. Remember that the unit was made for the average operator to use, and do not be too strong.

18. Seasoning Gap Unit—The unit is replaced in the rack by dropping it between the contact springs, and is tested and seasoned by running it for about an hour with the key locked and no antenna, the closed circuit being in tune and the power and frequency normal. After this seasoning process, it is essential to take the unit out of the rack and tighten up the center bolt. The unit should then be perfect. If it is still impossible to obtain a clear note, the unit is beyond repair.

CHAPTER 12

COMMERCIAL RADIO RECEIVERS AND ASSOCIATED APPARATUS

Introduction—The idea in this chapter is to take up in detail the types of receivers most generally used for the reception of radio telegraph signals. No attempt is made at all to cover receivers employed in the reception of radio broadcasting for entertainment. The writer has found that the commercial operator requires an instruction book that he can carry from station to station and ship to ship and such a book should contain a brief description with circuits of receivers and associated apparatus as employed generally at these stations. Thus the operator may use the same for reference in order to quickly locate trouble and make repairs.

Model AR-1496-B Short Wave Radio Receiver

1a. Purpose—This receiver is designed for use in the reception of continuous short wave commercial telegraphic radio signals over a frequency range of 4,000 to 25,000 KC. It is also suited to the reception of short wave radio telephony. It is intended for installations where it is feasible to supply separate battery equipment for each set used. However, if desired, it can be operated on a common battery system if an external audio frequency filter system is used for each set.

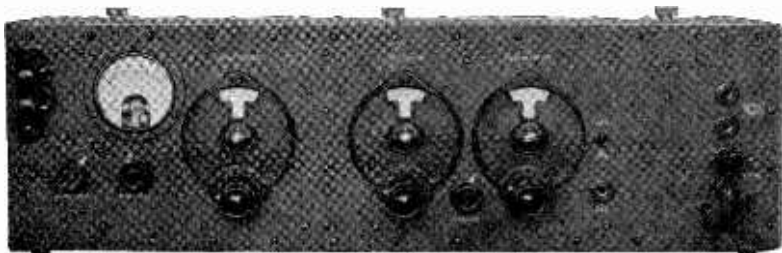

FIG. 234. RCA Model AR-1496-B Short Wave Radio Receiver.

1b. Source of Requirements—This set was designed to fill the need for a good commercial receiver at a moderate price.

Such a receiver must have good sensitivity, be easy of operation, be reasonably free from interaction between controls and be almost entirely free from effects due to body capacity or swinging.

The proposed receiver fully meets the above conditions. The sensitivity is sufficient to reach the noise level under average conditions in most locations. The circuits and controls are so arranged that operation is very smooth. Changes external to the set have practically no effect on the beat note frequency, the detector tuning or the regeneration setting. (Except of course for battery voltage fluctuations of considerable amplitude.)

ic. Source of Power—The power source required varies somewhat with the tube complement. The best tubes to use depend considerably on what arrangements can be made for power supply.

The following tubes may be used:

- 1 UX-222 Radiotron radio frequency amplifier.
- 1 UX-240 Radiotron detector tube.
- 2 UX-201-A Radiotron audio amplifier.

With the above tubes, the following voltages and currents are required for plate supply: 45 volts—1 ma; 90 volts—2 ma; 135 volts—8 ma. A 9-volt bias battery is to be used. A 6-volt filament heating battery is required to furnish 0.9 ampere.

If high plate voltages are available, the following tube complement is recommended.

- 1 UX-222 Radiotron radio frequency amplifier.
- 1 UX-841 Radiotron detector tube.
- 2 UX-210 Radiotron audio amplifier.

The above tubes will give longer life, greater reliability, slightly smoother operation and about 25% increase in signal strength over the smaller tubes.

With these tubes the following voltages and currents are required for plate supply: 45 volts—1 ma; 90 volts—2 ma; 135 volts—3 ma; 250 volts—25 ma. An 18-volt bias battery is to be used. An 8-volt filament heating battery is required to furnish 4 amperes.

id. Electrical Design—The circuit of this receiver is shown in figure 235. The set consists of a tuned radio frequency amplifier stage, a regenerative detector and a two stage audio frequency amplifier. A shield grid type four element tube (Radiotron UX-222) is used in the radio frequency amplifier. A shielded and

balanced input transformer is used on this tube. The arrangement used practically eliminates any effect on beat note frequency, detector tuning or regeneration setting due to changing antenna

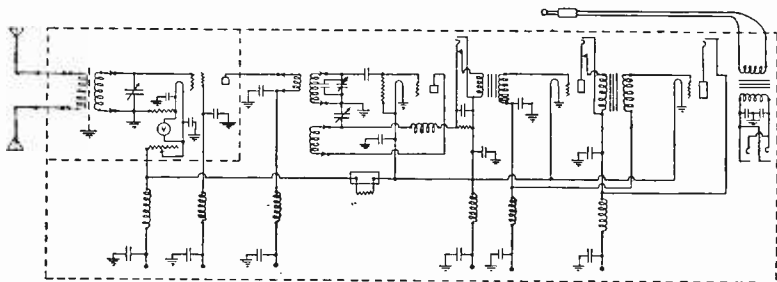

FIG. 235. Schematic Diagram, Modified Model AR-1496 Short Wave Receiver.

constants. Considerable radio frequency gain is secured due to the high amplification factor of the UX-222. The use of this tube also eliminates the need for neutralization. The balanced input transformer permits operation from a balanced radio frequency transmission line if desired. The detector functions on

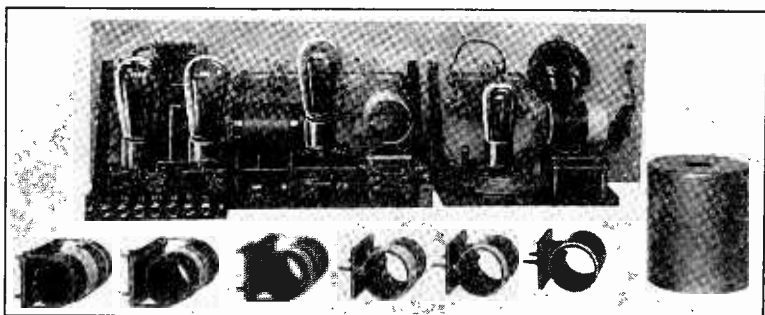

FIG. 236. RCA Model AR-1406-B Short Wave Receiver, Rear View with Case Removed.

the grid rectification principle. Regeneration is secured by use of a fixed tickler and controlled by a variable bypass condenser. The detector regeneration circuit is so adjusted that oscillations start and stop smoothly at all frequencies within the range. A two stage audio frequency amplifier completes the circuit.

Plug-in coils are used for changing frequency band. The antenna coupling coil is not changed over the entire range. The radio frequency plate coupling coil, the detector grid tuning coil and the tickler coil are constructed as a single unit.

Vernier drives are supplied on the three tuning controls. A fine adjustment of beat note is also supplied. The antenna coupling can be varied.

The output of the two stage audio amplifier can be taken directly from the plate circuit or an output transformer. The output transformer normally supplied in the set matches an output impedance of about 3000 ohms when used with a 201-A tube and 1200 ohms when used with a 210 tube (load impedance at 800 cycles). This load impedance matching is not critical. Jacks are provided so that two output circuits can be used in parallel on the output transformer. This transformer is arranged so that it can be plugged into the output of the detector. The first audio or the second audio amplifier.

A rheostat and voltmeter are provided to adjust the voltage on the UX-222 tube. The other tubes receive the correct voltage when connected directly to the filament battery recommended. A variable filament rheostat is neither necessary nor desirable for these tubes.

The set is inclosed in a shielding case and the coupling tube is further shielded from the rest of the set. All battery leads are provided with radio frequency filters to prevent radiation from the batteries or pick-up on them. Condensers are placed on the secondary of the output transformer for the same purpose. This arrangement gives entire freedom from body capacity effects. A master filament switch is provided.

re. Mechanical Design—The metal cabinet in which the receiver is enclosed has the following approximate dimensions:

Length—27 inches.

Height—8 inches.

Depth—8 inches.

The cabinet has two shields dividing it into three compartments. In the first compartment (on the left end) is the input coupling coil variable with respect to the R.F. grid coil and coupled to it through an electro-static shield. In the second compartment is the master rheostat, fixed resistor, variable condenser, R.F. grid coil and the tube with its associated bypass condenser. The tube

is further enclosed in a copper can. In the third compartment is the detector and audio stages.

All parts of the receiver are mounted either on the metal panel or the insulation sub-bases which are fastened together forming

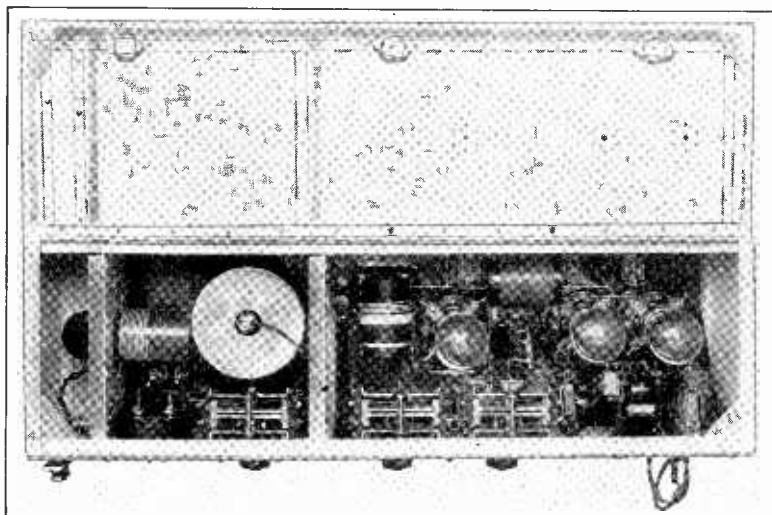

FIG. 237. RCA Model AR-1496-B Short Wave Receiver, Top View, Cover Open.

a complete assembly of all working parts. This unit fits into the cabinet from the front. The top of the cabinet is hinged so that the tubes and coils are readily accessible.

On the front of the panel appear the following:

- a. Antenna and ground binding posts.
- b. Filament voltage meter.
- c. Coupling control rheostat.
- d. Filament rheostat.
- e. Input tuning control.
- f. Detector tuning control.
- g. Fine tuning control.
- h. Regeneration control.
- i. Filament switch.
- j. Detector jack.
- k. First audio jack.

- l. Second audio jack.
- m. Two output jacks.

All power input binding posts are located on the back of the receiver.

Type 106-106-C-106-D R.C.A. Radio Receivers—Wavelength Range of These Receivers is from 200 to 3500 Meters.

The type 106 receiver is an inductively coupled oscillation transformer, consisting principally of a primary and secondary circuit. The period of the primary and secondary circuit and inductive relation between the two circuits can be varied. Provision is made for varying either the capacity or inductance in each circuit within certain limits. The inductance is tapped and the condenser is continuously variable.

2. Primary Circuit—The primary circuit consists of an inductance made variable by a switch and a variable capacity which may be inserted in the circuit if the capacity of the aerial circuit is too large for the desired wavelength. The “primary tens” switch varies the number of turns included in the primary in steps of 10 turns to each point, and, at the same time, disconnects

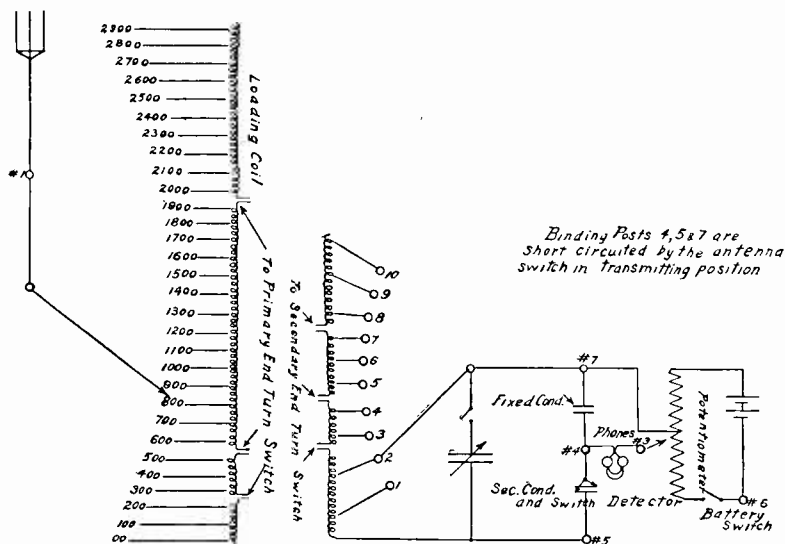

FIG. 238. Simplified Diagram of 106 Receiver Connected to Crystal Detector with Potentiometer.

"hanging on" end turns which are not in use. The "primary units" switch varies in steps of one turn to each point, so that with both switches any number of turns on the entire inductance may be used. When the primary condenser is not in use, it should be rotated to the position past 180 degrees marked "out." This automatically short-circuits the condenser.

3. Secondary Circuit—The secondary circuit consists of a variable inductance and a variable condenser. The transformer secondary switch varies the secondary inductance in appropriate steps and cuts off the unused portion of the coil. The secondary condenser is used for obtaining wavelength adjustments finer than those obtained by varying the inductance and for wavelengths above 2000 meters. When not in use, this condenser should be rotated past the zero point to the position marked "out." This automatically disconnects the condenser from the circuit. A crystal detector is mounted on the front of the receiver which can be used in an emergency. Battery binding posts are provided on the receiver, making it possible to use an external battery connected to a potentiometer. The potentiometer regulates the potential across the detector. The zero point of the potentiometer is in the middle so that the polarity of the voltage across the crystal may be easily reversed.

4. Coupling—The secondary coil is arranged so that it will slide inside of the primary coil and variation of distance between them is made by the coupling handle.

5. "Modifier Circuit"—The modifier or tickler system consists of a fixed winding or "stator" of the variometer in series with the grid of the secondary circuit. The variable or "rotor" winding is connected in series with the plate of the detector tube and primary of the audio frequency amplifying transformer. The modifier is mounted within a small box placed on top of the receiver. A bakelite dial controls the position of the rotating windings. By providing regeneration in the detector circuit the audibility of weak signals can be greatly intensified. Continuous wave signals can be received by increasing the feed-back in the detector circuit until the tube oscillates. A fixed condenser is connected across the primary windings of the first audio frequency transformer, to serve as a low impedance path for the radio frequency current in the detector plate circuit, and assists in the feed-back necessary for regeneration and oscillations. The stator windings of the tickler system are tapped, al-

lowing two different values of inductance. This is controlled by a snap switch on the modifier panel.

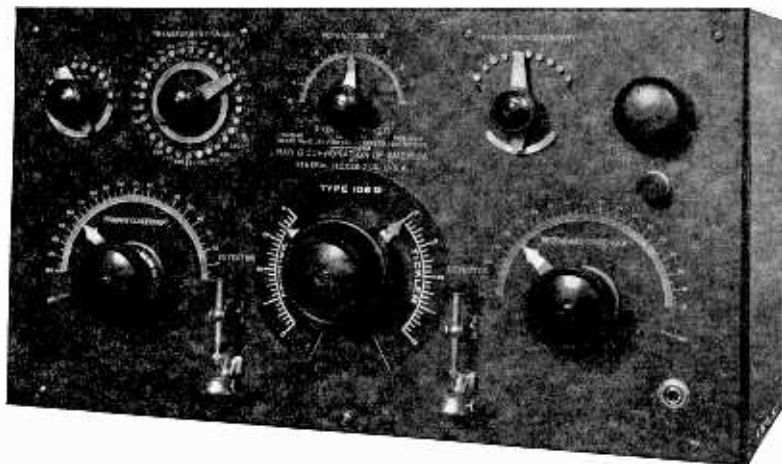

FIG. 239. Front View of 106-D Regenerative Receiver.

6. Adjustment of Receiver—Light the filaments of detector and amplifier tubes and adjust to normal brilliancy. Set the modifier dial at zero. Set the primary condenser at “out.” Adjust the coupling to about seven on the scale. Set the secondary condenser at “out.” If a test buzzer is connected, push test switch and make sure receiving circuits are functioning. Release the test switch and vary the primary and secondary inductances until the desired signal is heard with maximum response, then decrease the coupling by rotating the coupling handle to the left, until signal is just audible. Adjust primary and secondary condensers until signal is at a maximum. Generally the loudest signal is reached with a maximum secondary inductance and minimum secondary capacity. If the signal is too weak to read, increase regeneration by rotating dial of modifier. If the signal is from a spark transmitter it will be necessary to keep the tube from oscillating; otherwise the signal will be “mushed up,” making it difficult to read through interference. If the signal is from a self-rectifying continuous wave transmitter the signal may be heard

either with or without the detector tube oscillating. Continuous wave signals can only be heard with the detector tube oscillating.

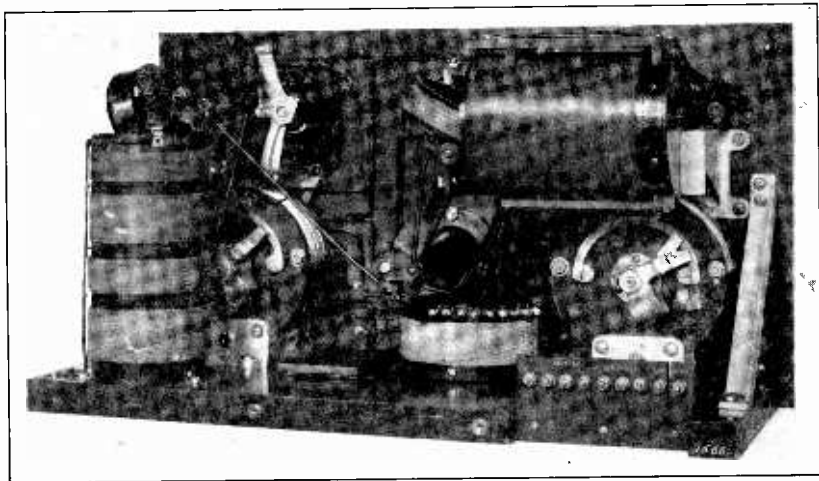

FIG. 240. Interior View of 106-D Regenerative Receiver.

To avoid interference, the operator should work with the loosest coupling possible. Greater selectivity may be had by using small secondary inductance and adjusting the secondary condenser until maximum response is obtained. If the wavelength of signal desired is shorter than can be obtained with the above adjustment, place the primary "tens" switch at zero, primary "units" switch at ten, rotate the primary condenser until signal is heard, using the lower points of secondary inductance. If a maximum signal is not obtained up to 180 degrees of primary condenser, more primary inductance will be needed. Follow the same method as with longer wavelengths. Selectivity may be still further increased, partly sacrificing intensity, by using a large amount of primary inductance, having the primary condenser in circuit.

7. Type 106-D Regenerative Receiver—The 106-D receiver is the 106-B receiver converted for operation with a vacuum tube detector. The secondary coil is placed in a fixed position. A small coupling coil placed within the primary inductance is

used to transfer energy from one circuit to the other. It can be rotated by the external coupling knob on the receiver, thereby increasing or decreasing the amount of coupling between the

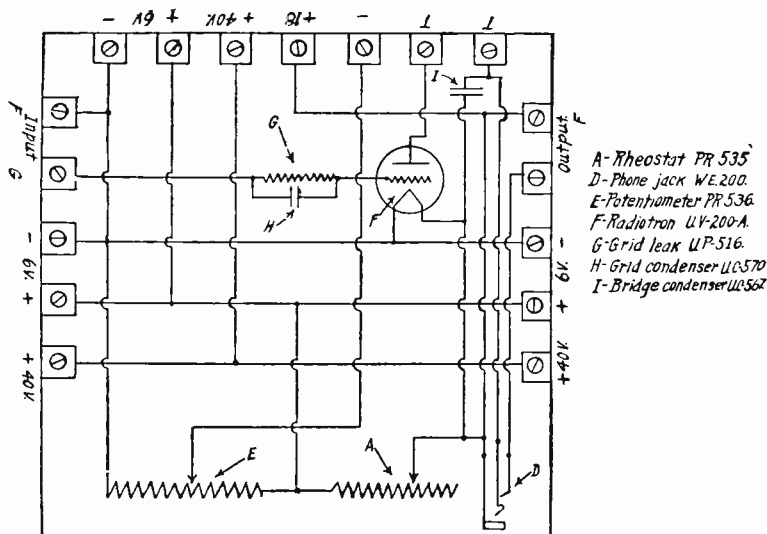

FIG. 241. Diagram of Model AD-1527 Detector Unit.

primary and secondary circuit. Regeneration is accomplished by a rotating tickler coil placed within one end of the secondary inductance. The position of the tickler coil is controlled by an external knob on the front of the receiver.

A phone jack extending through the front of the receiver panel makes it possible to plug the telephones in on the crystal detector.

8. Model AD-1527 Vacuum Tube Detector Unit—The AD-1527 vacuum tube detector unit is contained within a metal case and consists of the following: One rheostat, one potentiometer, one grid leak and condenser, one bridging condenser, a phone jack and tube socket. The potentiometer is connected in shunt to the 6-volt battery with the rotating arm connected to the negative "B" battery. This connection permits a variation of the plate potential applied to the detector tube. The detector box is provided with three terminal blocks as shown in figure 241. A wiring diagram of the detector unit is shown in figure 241.

9. **Model AA-1528 Amplifier Unit**—The AD-1528 amplifier is an individual audio frequency amplifier unit containing a filament rheostat, audio frequency amplifying transformer and telephone jack. The amplifier units are so constructed that plate and

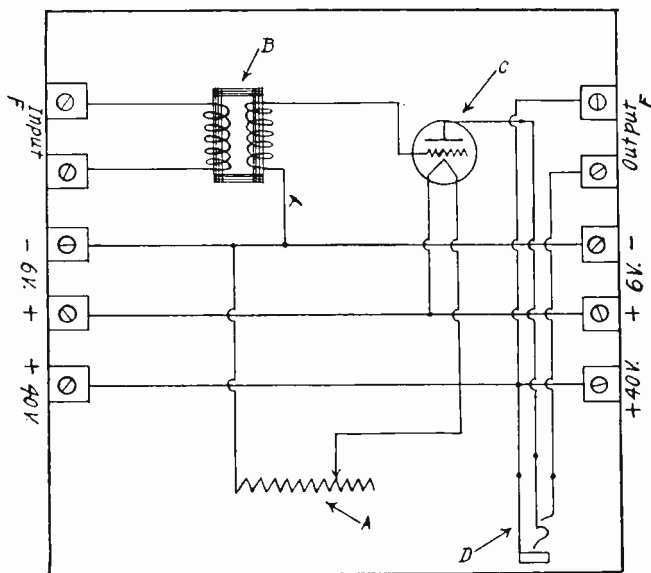

FIG. 242. Diagram of Model AA-1528 Audio Frequency Amplifier.

filament circuits are completed in each succeeding step when bus wires are in place. Plate and filament batteries are connected only to the detector box and these circuits are carried to the amplifiers through the bus wires. The terminals on the output side of the last step are always left disconnected. Figure 242 shows a wiring diagram of the AA-1528 amplifier unit.

10. **Model AA-1400 Detector-Amplifier Unit**—The detector-amplifier AA-1400 is a compact and easily operated detector-amplifier unit. It consists of a vacuum tube detector and two stages of audio frequency amplification enclosed in a neat metal case.

An important feature of model AA-1400 is the individual filament control system. A detector and two stages of amplification are furnished with separate rheostats, thus enabling the operator to obtain individual stage control of the received energy. The left

telephone jack is for plugging in on the detector tube only, the middle jack furnishes detection and one stage of audio frequency amplification, while the right hand jack gives maximum amplification output, i.e., detection with two stages of amplification. Re-

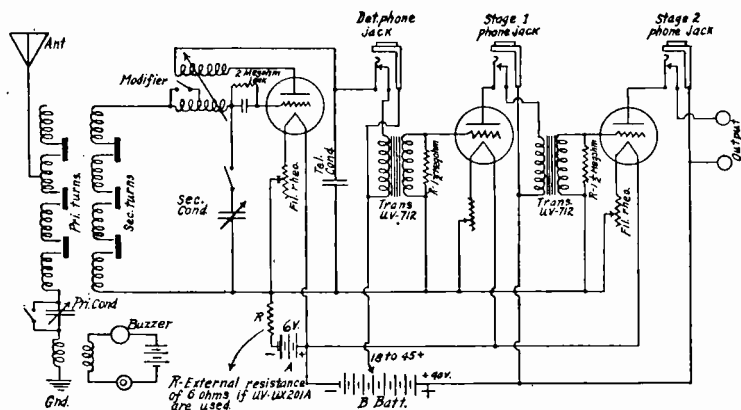

FIG. 243. Diagram of 106-C Regenerative Receiver Fitted with Model AA-1400 Detector-Amplifier Unit.

ception may be continued in emergency with the detector, or the detector and one stage of amplification, when the "A" battery has become discharged to such an extent that it will not properly operate the filaments of the three tubes, although this practice should not be generally followed.

The electrostatic shielding afforded by the metal case of this instrument eliminates all disturbances caused by the proximity of the hand or body to the instrument.

Originally designed for the UV-200 and UV-201 vacuum tubes, the filament rheostats in the model AD-1527 vacuum tube detector, model AA-1528 amplifier and model AA-1400 detector-amplifier are of low resistance and allow the passage of too much current for the new type of thorium or XL filament tubes. Therefore, it is advisable to connect an external resistance of 6 to 20 ohms in series with the negative side of the filament discharge line. A correct adjustment of this resistance will permit the operator to have the separate filaments under control by the individual rheostats. Not more than five volts should be impressed across the filament terminals of the UV or UX-201-A tubes; otherwise current in excess of $\frac{1}{4}$ ampere will pass, causing

a rapid exhaustion of the thorium drawn in the tungsten filament, thus decreasing the useful life of the tube.

11. Radiomarine Corp. of America Charging Panel UP-858—The charging panel UP-858 permits the use of two "A" batteries for heating the filaments of the vacuum tubes in the detector and amplifier units. It is so designed that by changing the position of the four-pole, double-throw switch on the charging panel, one battery may be placed on charge while the other is on discharge and vice versa. If it is desired to discharge one battery without charging the other at the same time, the double-pole switch of the ship's power switch should be opened.

If the ship is equipped with two engine room dynamos, care should be taken to ascertain that both machines are connected

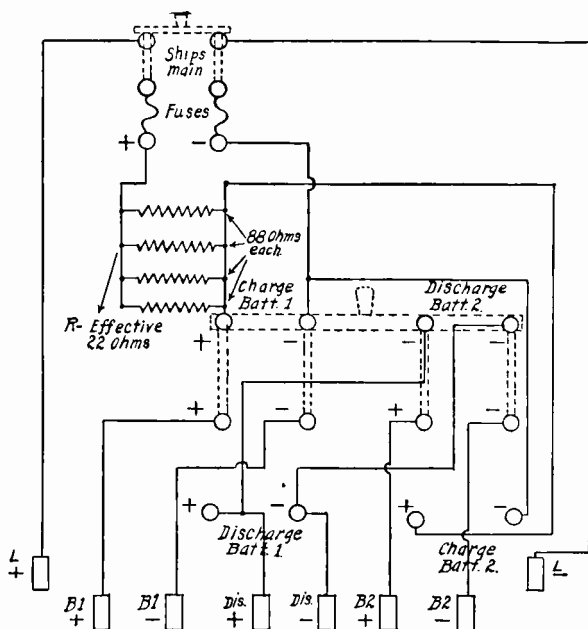

FIG. 244. Circuit of Charging Panel UP-858.

with the same polarity. Batteries should not be placed on charge unless it is definitely known that the engine room dynamo is running. Should engine room generator stop for any reason while batteries are on charge, the double-pole ship's power switch on the

charging panel must be pulled immediately. Both switches on the charging panel must be opened before leaving the radio room to go ashore.

Two 6-volt Exide batteries, type 3-LX-9-1, of 100 ampere hour capacity are furnished with the charging panel and vacuum tube equipment. The four resistances showing in figure 240 are connected in parallel. Each unit is of approximately 88 ohms resistance. The total effective resistance is therefore 22 ohms, permitting a charging rate of 5 amperes if the ship's generator has an output of 120 volts. If the charging voltage is lower the charging rate is reduced, making it necessary to charge the batteries longer. Under normal conditions a charge of from 5 to 7 hours should restore the battery to its rated capacity. Should any one of the resistance units burn out, the charging rate will be reduced depending upon the number of units inoperative and the charging voltage. If all the units were to burn out a bank of eight 50-watt lamps in parallel will permit the correct charging current to flow.

12. Installation of "C" Battery with Amplifier Units AA-1528 or AA-1400—

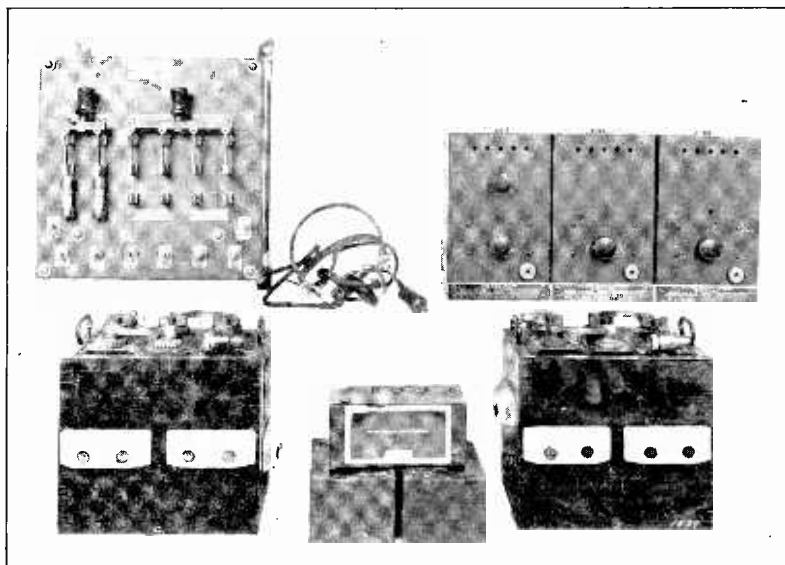

FIG. 245. Model UP-858 Charging Panel, Detector and Amplifier Units "A" and "B" Batteries.

1. Remove wires running from negative 6-volt terminal on unit to terminal "F" on audio frequency amplifying transformers. Connect both "F" terminals together and continue wire to 3 or 4½ negative terminal of "C" battery.

2. Connect positive terminal of "C" battery to negative terminal of 6-volt battery.

The "C" battery will reduce the milliampere drain on the "B" battery and thus prolong the life of the latter. When the tuner and amplifier are used for broadcast reception, a marked improvement in volume and quality will result.

Type IP-501 Regenerative Receiver. Wavelength Range 300 to 8,000 Meters, Which May Be Extended with IP-503

Long Wave Loading Unit, 300 to 19,000 Meters.

Made by The Wireless Specialty Apparatus Co.

The type IP-501 regenerative receiver is designed for the reception of either continuous wave or spark signals. The receiver is equipped with six binding posts, normally short-circuited for 300 to 6,800 meters, to which loading coils may be attached for the reception of wavelengths up to 23,000 meters. The proper loading coils are primary, 50; secondary, 50; tickler, 30 millihenries. This receiver possesses a high degree of selectivity, but it is also provided with an untuned or "standby" circuit.

A switching mechanism permits the use of either of two tuned circuits on an untuned or tuned secondary.

The coils used in the receiver are bankwound inductances of high-frequency cable, wound on threaded bakelite tubes. The assembled coils are impregnated in vacuum and baked. The individual sections are automatically connected, entirely disconnected and opened, or entirely disconnected and individually short-circuited by a mechanism operated by the inductance switch. By this means every coil in the receiver has a natural period when connected with its leads and switch points which is less than the shortest wavelength in the range of the receiver. This eliminates the reception of parasitic signals, reduces the absorption of the desired signal by the coils, forces the energy into the detector and minimizes interference on all wavelengths.

The condensers are of the self-balanced plate type. Insulating bushings are entirely absent in their construction. Their calibration is constant and their losses extremely low.

The receiver is mounted under a one-half inch bakelite-dilecto panel. The containing box is 5/8 inch oak. A switch is provided

for vacuum tube reception, and also to protect the detector during transmission.

The IP-501 receiver is similar in design and construction as the Navy SE-1420 receiver. The inductances and condensers are of the same values and arranged in the same network.

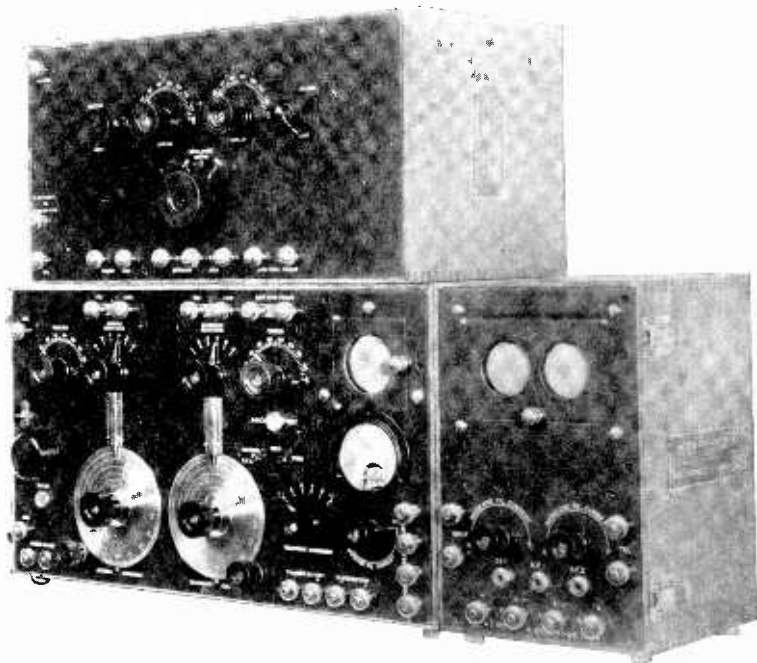

FIG. 246. Wireless Specialty Company IP-501 Radio Receiver and IP-503 Long Wave Loading Unit.

13. IP-503 Long Wave Loading Unit—The IP-503 long wave loading unit consists of three loading coils of sufficient inductance to load the primary, secondary and tickler circuits of the IP-501 receiver to extend the wavelength range up to 19,000 meters.

A wavelength control switch on the panel of the unit permits three ranges of wavelengths. In the position marked "Low" the coils are short-circuited, thus permitting the normal range of the receiver from 300 to 8,000 meters. Figure 247 shows the

schematic of the loading inductances for the three wavelength ranges.

14. Installation of IP-503 Long Wave Loading Unit—

1. Mount this unit on top of IP-501 receiver.
2. Remove short-circuiting straps from binding posts on IP-501 receiver marked "Pri. Load," "Sec. Load" and "Long Wave Tickler."
3. Connect these binding posts to posts directly above and similarly marked on long wave loading unit.
4. Connect antenna lead to post marked "Antenna" on long wave loading unit.

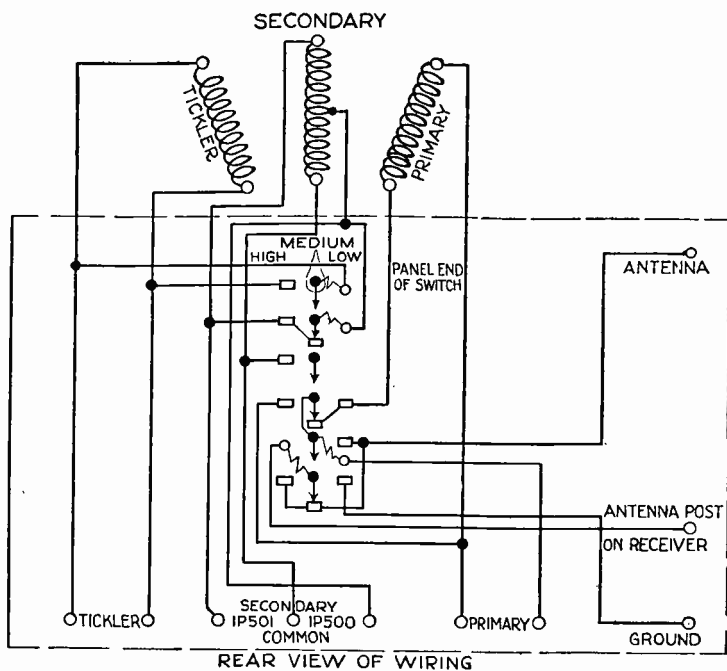

FIG. 247. Wiring Diagram of IP-503 Long Wave Loading Unit.
Rear View.

5. Connect binding post on IP-501 receiver marked "Ant." to binding post on long wave loading unit marked "To Antenna Post on IP-500 or IP-501."

6. Connect to ground the post marked "Gnd." on long wave loading unit and also the post marked "Gnd." on the IP-501 receiver.

15. Operation of Long Wave Loading Unit—

1. For wavelengths up to 8,000 meters, set wavelength switch at position marked "Low," thus entirely short-circuiting the long wave loading unit.

2. For wavelengths above 8,000 meters, set wavelength switch on long wave loading unit at position marked "Medium" or "High." Cut in all "antenna inductance" and "secondary inductance" of IP-501 receiver. Rotate "antenna condenser" and "secondary condenser" of IP-501 receiver until desired signal is heard. Vary coupling and tickler of long wave loading unit and make other adjustments in accordance with preceding instructions covering IP-501 receiver until maximum signal strength is obtained.

3. Lock coupling and tickler coils of long wave loading unit to prevent vibration or rolling of ship from throwing them out of adjustment.

16. IP-Triode "B" Amplifier—This two-step amplifier is a compact unit of the resonance low-frequency type. It provides a maximum of amplification due to the transformer design. The input impedance of each tube is automatically controlled by the filament rheostat.

The apparatus consists of two vacuum tube receptacles, two filament control rheostats, and two amplifying transformers. Shock-proof mountings protect the vacuum tubes from "noise" due to mechanical vibration.

The apparatus is mounted on the rear of a bakelite-dilecto panel and enclosed by an oak box. At the bottom of the panel are terminals for connecting the 6-volt filament and the 40-volt plate batteries. At the lower left of the panel are two input binding posts for connection to the receiver equipment. At the right of the panel are two binding posts for connecting telephones.

17. Installation of IP-Triode "B" Amplifier with IP-501 Receiver—

1. Connect two terminals marked "Input" to binding posts on IP-501 receiver marked "Telephones."

2. Connect "A," "B" and "C" batteries to four terminals at bottom of amplifier in accordance with markings on these terminals. Be sure that batteries are connected with correct polarity.

18. Operation—

1. Insert two UV-201-A radiotrons in tube sockets back of screened door. Before doing this be sure the filament rheostat is Off.

2. Set filament rheostats at point on scale corresponding to setting of detector tube rheostat when adjusted for five volts.

Plug telephones into jack marked "Det." if it is desired to use the detector tube only; jack marked "AF1" for one stage of audio frequency amplification or "AF2" for two stages of audio frequency amplification.

Two 6-volt Exide batteries, type 3 LX-9-1, and R.C.A. charging panel, UP-858, are used to complete the installation of the IP-501 receiver and IP-triode "B" amplifier. Any standard type of "B" battery may be used for plate supply.

**Navy Type SE-1420 Radio Receiver. Wavelength Range
250 to 8,000 Meters.**

The type SE-1420 receiver is designed for the reception of spark signals, using crystal detector, and for the reception of arc and other undamped signals, using a vacuum tube. The vacuum tube detector can also be used for the reception of spark signals. The receiver is a compact unit containing the radio frequency circuits and vacuum tube apparatus in a single case. Binding posts are provided for the connection of a crystal detector. This receiver possesses a high degree of selectivity coupled with maximum sensitivity.

19. Primary Circuit—The primary circuit consists of two primary cylindrical loading coils, a primary coupling coil and variable air condenser of .00008 mfd. to .0045 mfd. capacity, inductance switches, and automatic coil cut-outs. The inductance is variable in six steps by a rotary control switch. This switch automatically connects, entirely disconnects and opens or entirely disconnects and short-circuits the individual sections of inductance. This arrangement minimizes interference on all wavelengths within the range of the receiver.

The primary condenser is connected in series with the antenna circuit. It is of the self-balanced type with constant calibration and extremely low losses. Fine variation of the condenser is provided by a rotary control knob which is gear connected and gives a vernier motion to the condenser.

The condenser dial is engraved with degree graduations from 0 to 180° and with rows of concentric circles. A mechanism actuated by the inductance switch moves a pointer to the suc-

cessive circles on which may be marked the wavelength calibration of the receiver for the particular antenna with which it is used. This assists in identifying stations.

20. Secondary Circuit—The secondary circuit consists of a cylindrical inductance coil shunted by a variable air condenser. Both the secondary and primary coils are bank-wound inductances, wound of high frequency cable on threaded bakelite dielectric tubes impregnated and baked. The secondary inductance is variable in six steps by means of a rotary control switch. The condenser is of similar construction to the primary condenser, but with a capacity of about .00006 mfd. to .00032 mfd. This condenser like the primary condenser is also equipped with a fine control mechanism.

21. Coupling—The primary circuit is inductively coupled to the secondary by means of a movable primary coupling coil. The movement is governed by a rotary control switch provided with pointer and 180-degree scale mounted upon the receiver panel. The coupling between the primary and secondary is purely electromagnetic and continuously variable, passing from the maximum coupling value through zero to a small reverse coupling. It is thus possible to secure a point of minimum coupling between primary and secondary circuits on all wavelengths within the range of the receiver. The capacity coupling between primary and secondary circuits is entirely eliminated by heavy sheet copper boxes separately enclosing the two circuits. Interference is greatly reduced by this means.

22. Tickler System—The tickler system of this receiver consists of a coil coupled to the secondary at the short wave end of the secondary coil, and connected in series with the plate circuit of the vacuum tube. The coil is arranged in controllable inductive relation to the secondary coil, permitting control of the coupling between grid and plate circuits of the vacuum tube. This is accomplished by a rotary control on the panel with a scale graduated from 0 to 180 degrees. This allows reception of regenerative spark or undamped signals.

23. Buzzer Circuit—The buzzer circuit consists of a buzzer and push button mounted on the panel, on an external battery of about two volts connected to the binding posts on the panel marked "Buzzer Battery." The buzzer is capacitively connected to the antenna and is used for testing the adjustment of the crystal detector. It may also be used to indicate when the vacuum tube is oscillating, in which case a low hissing sound will be heard in the telephone receivers.

24. Telephone Condenser—Provision is made for variation of telephone capacity in this receiver by a rotary control switch mounted on the panel. This allows variations in six steps.

25. Vacuum Tube Apparatus—The vacuum tube is mounted inside the receiver case. A screened door in the upper right hand corner of the panel allows a view of the tube and permits easy removal or replacement. The vacuum tube and standard type socket connection are supported on a shock-proof mounting that reduces "noises" due to vibration. The tube is provided with a filament ammeter and a filament current control rheostat mounted on the panel directly below the tube. Binding posts are provided on the receiver panel for connecting the filament and plate batteries. A key switch allows the receiver circuits to be connected to either the vacuum tube or the crystal detector. A neutral position is also provided for protecting the detector circuits during transmission. In this type of receiver the vacuum tube is of the biased grid type which eliminates the grid condenser and grid leak ordinarily employed. (This method of detection has been explained in Chapter 4.) Extremely fine regeneration is provided.

26. Operation—If the crystal detector is to be used, throw the detector switch on the receiver panel to Crystal, and adjust the crystal to maximum sensitivity by means of the buzzer test. If the vacuum tube detector is to be used, throw the detector switch on the receiver panel to Audion. Before doing this, be sure the filament rheostat is Off. The rheostat handle should now be turned in the direction marked Increase Fil. Current until the filament ammeter reads the correct value of current at which the tube is operated. When it is desired to pick up a spark station the tickler should be set at about 120 degrees. Vary antenna, inductance and antenna condenser until maximum signal is heard. Then tune to resonance by means of the secondary inductance switch and secondary condenser. Adjust the telephone condenser until maximum signal is heard.

Maximum selectivity on spark signals is secured by using the loosest coupling consistent with an easily readable signal, and with antenna and secondary circuits tuned to resonance.

27. Continuous Wave Signals—For the selective reception of continuous wave signals loosen the tickler coupling as much as possible. Use loosest coupling between primary and secondary circuits. Adjust antenna circuit to resonance with the received wave, employing in general a similar process to that used for picking up spark signals. In this case, however, it will be found necessary to change the tune of the primary circuit very slowly,

swinging the secondary condenser through resonance at each slight change in the primary. When the secondary circuit is oscillating passage through the resonance point is marked by a slight click. The best note of the station will be heard at a setting slightly below or above the resonance point.

Summary—Procedure for Obtaining Oscillations.

1. Adjust coupling to about 45 degrees.
2. Raise filament current to correct value.
3. Set telephone condenser so that about one-half capacity is connected in.

28. Test for Oscillations—A clicking sound will be heard in the telephones if the bulb is oscillating:

1. When push button marked Osc'n Test is pressed in.
2. When primary circuit is brought into resonance with secondary circuit with medium inductance coupling.
3. When tickler coupling is tightened (periodic clicks).
4. If buzzer is operated and tube is oscillating, a soft hissing sound will be heard.

29. Failure to Obtain Oscillations—This may be due to:

1. Reversed plate battery.
2. Insufficient tickler coupling.
3. Reversed feed-back. (Reverse tickler connections.)

30. Care—

1. See that all connections are tight.
2. Clean the panel occasionally with a clean dry cloth.

**Western Electric Superheterodyne Radio Receiving Outfit,
Type 6004-C.**

31. General—This receiving outfit is designed to operate on an antenna tuned to 500 kilocycles (600 meters) while the radio transmitter is operating on a broadcasting frequency. It employs the 4-C receiver with the 2-A tuning unit for tuning the antenna and the 20-A filter for filtering out the transmitter frequency. Figure 248 shows the circuits of this receiver.

32. 4-C Radio Receiver—The 4-C receiver is a double-detection (superheterodyne) receiver employing six 215-A tubes. It is designed for operation with a loop antenna or with an outside antenna.

The first tube is an oscillator, which is adjusted to a frequency 45 kilocycles above or below the received frequency. The oscillator output and the received signal are applied together to the

grid of the second tube, which is a detector. The output of this detector is amplified by two 45-kilocycle amplifiers when it is again detected to produce the modulation frequency of the received signal. The last tube is used as an audio frequency ampli-

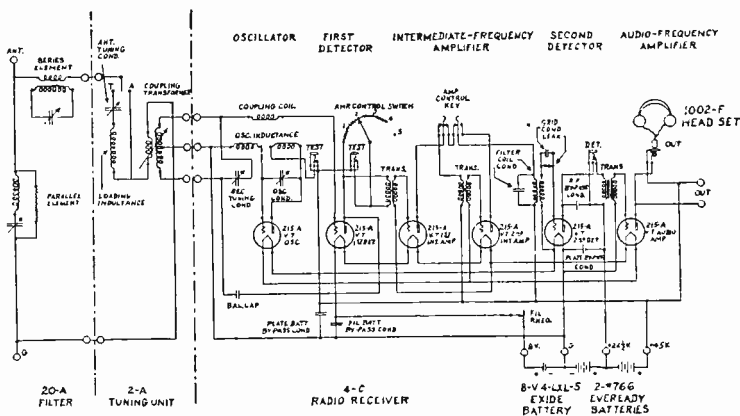

FIG. 248. Schematic Circuit of Western Electric Receiving Outfit, Type 6004-C.

fier. The output from the last tube is obtained directly from the plate of the tube through the jack on the front of the panel or terminals on the back. The output circuit must carry the d.c. plate current of the tube, which is about .001 ampere.

The filaments of all of the tubes are lighted in series by an 8-volt battery controlled by a filament rheostat on the panel. A 45-volt dry battery is used for the plate supply to the oscillator, the amplifier tubes and the first detector. A mid-tap of $22\frac{1}{2}$ volts is used to supply the second detector tube. Ammeter jacks marked "Test" are placed in the plate circuits of the oscillator and the first detector for testing purposes. The jack marked "Det." is connected to the plate circuit of the second detector so that the output circuit plug can be plugged in it to get the output from the detector directly. Plugging in this jack opens the interstage transformer at the plate of the detector. The amplifier control key short-circuits the second 45-kilocycle amplifier when it is thrown to the position marked "1," and puts it in the circuit at the position marked "2." The amplifier control switch controls

a shunt resistance across the primary of the input transformer to the first amplifier tube. The tuning condenser is used to tune the input circuit to the received radio frequencies and the oscillator condenser is used to tune the oscillator to a frequency about 45 kilocycles different from the received radio frequency.

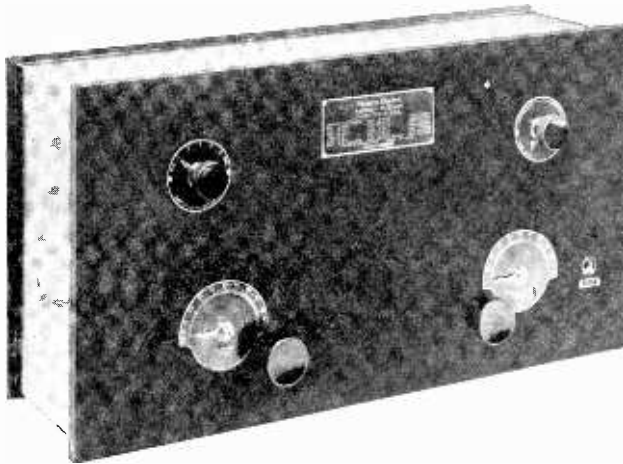

FIG. 249. Western Electric 4-D Radio Receiver (Superheterodyne).

33. 2-A Tuning Unit—The 2-A tuning unit is used for connecting an antenna to the 4-C receiver. It is a variable coupler with a secondary having a middle tap. The three secondary taps are connected to the loop terminals on the receiver. The primary is tuned with a loading coil and a variable condenser in the antenna circuit. Coupling to the secondary is controlled by a knob with an indicator on the front of the panel and an aperiodic-tuned switch is provided which connects the antenna to either the tuned circuit just described when on the point marked "T" or the primary coil alone when on the point marked "A." The aperiodic circuit is used for preliminary tuning of the receiving set after which more selectivity can be obtained by tuning the primary circuit.

34. 20-A Filter—The 20-A filter is provided for use with a receiving set under the transmitting antenna. It should be tuned to offer a high impedance to the transmitter frequency and a low impedance to the frequency it is desired to receive. With careful

adjustment of these circuits it should be possible to receive a frequency differing only 10 per cent from the transmitting frequency. The circuits are adjusted by first adjusting the receiver to the fre-

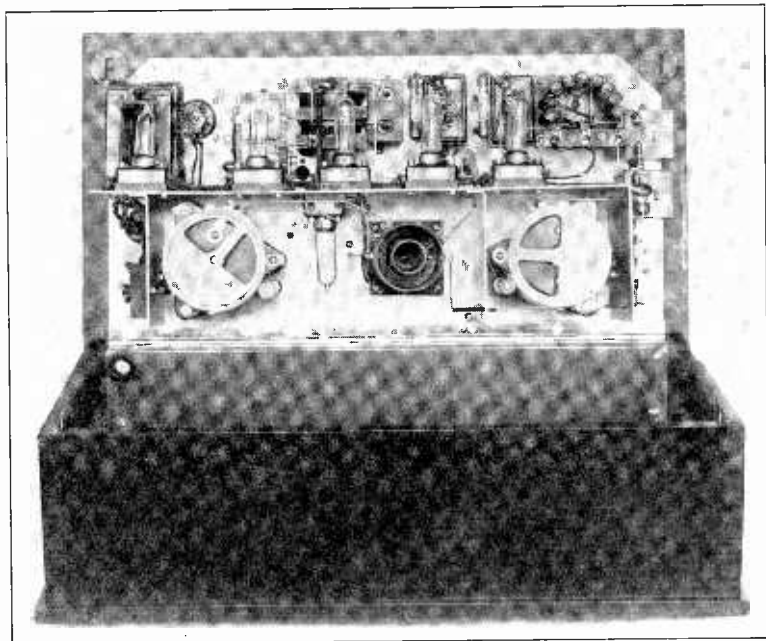

FIG. 250. Interior View of 4-D Receiver.

quency to be received. The filter circuits are then adjusted until the signal the transmitting frequency is reduced to a minimum. This will change the tuning of the primary circuit on the 2-A tuning unit which must again be tuned to the desired signal.

CHAPTER 13

THE AUTO-ALARM

1. **Introductory**—Article 21, Paragraph 21, of the International Radiotelegraph Convention provides for an automatic alarm signal to be transmitted solely to announce that the distress signal is about to follow. On certain vessels where a continuous watch is not employed by human operators, an automatic device called the auto-alarm is connected to a special receiver and when the operator goes off watch the receiver and auto-alarm are placed in operation. If the auto-alarm signal is transmitted accurately by an operator of a ship in trouble, prior to sending the SOS call, the signals will be picked up by the auto-alarm receiver; providing the distressed vessel is close enough and the signals sufficiently strong; thus closing a series of relays which finally causes a bell to ring in the operator's sleeping room, on the bridge and elsewhere on the ship. The operator immediately resumes watch and is prepared to copy the distress signal and messages that follow.

The Auto-Alarm made its first appearance in ports of the United States on vessels under the British Flag. On these vessels two particular types can be found: namely, that of the Marconi International Marine Communication Company, Ltd., and the Radio Communication Company, Ltd. These companies are now combined and are known as the British Wireless Marine Service.

Besides the British systems there are those of the French and German. Probably in time the engineers of the various communication companies of the United States will devise auto-alarms of their own design. However, at this time, there is no American system available for ship installation. American ships will likely be fitted at the start with the British Marconi System. Therefore it seems fitting to describe this system in order that students and operators may familiarize themselves with the diagrams and operation of the device. The instructions that follow are taken without alteration from the instruction book of the Marconi International Marine Communication Company, Ltd. Many phrases and terms unfamiliar to American operators appear in the text, so it has been thought best to list a few of the terms and then the American equivalent. The list is as follows:

| British. | American. |
|-------------------------|----------------------------|
| Valve. | Vacuum tube. |
| H. T. (high tension). | "B" power supply. |
| L. T. (low tension). | "A" power supply. |
| Reaction. | Regeneration. |
| Anode. | Plate. |
| Choke-capacity coupled. | Impedance-coupled. |
| A. T. I. | Antenna tuning inductance. |

The International Radio Telegraph Convention provides that the Auto-Alarm shall consist of a series of twelve dashes sent in one minute, the duration of each dash being four seconds, and the duration of the interval between two dashes, one second. Other particulars relative to the transmission of the Auto-Alarm signal can be found under the chapter entitled "Radio Laws and Regulations."

The description and operation instructions of the Marconi Auto-Alarm read as follows:

The Marconi Auto-Alarm

2. The Use of the Auto-Alarm—The auto-alarm is a mechanical device for attracting the attention of ships on board of which no wireless watch is being kept, should some other vessel in the neighborhood be in distress.

The most elaborate and searching tests have shown that no device simple enough to stand up to sea conditions can be produced which will record with certainty the SOS signal without also responding a large number of times a day to fortuitous combinations of "longs" and "shorts" which may happen to resemble the distress signal. Such an arrangement is also liable to miss calls, due to comparatively light interference. Therefore it was necessary to find some form of signal which could be identified by a simple and robust form of selector without risk of any material number of false calls, and in spite of considerable interference. It is also necessary that the form of signal chosen and the form of selector should be such that a reasonable amount of inaccuracy in the transmission of the signal should be permissible; that is to say, the selector must be devised so that it will accept the chosen signal, or something reasonably like it, without failure and without false calls, even in the presence of considerable interference.

Both practice and theory have shown that signal composed of

prolonged dashes, with brief periods of silence between, gives the best prospects of satisfying the above requirements, and thorough trials have shown that a signal composed of dashes of four seconds duration, separated by spaces of one second duration, gives the requisite degree of certainty of operation coupled with ease of sending, no more assistance being required than that of a watch with a second hand. This form of signal has the further

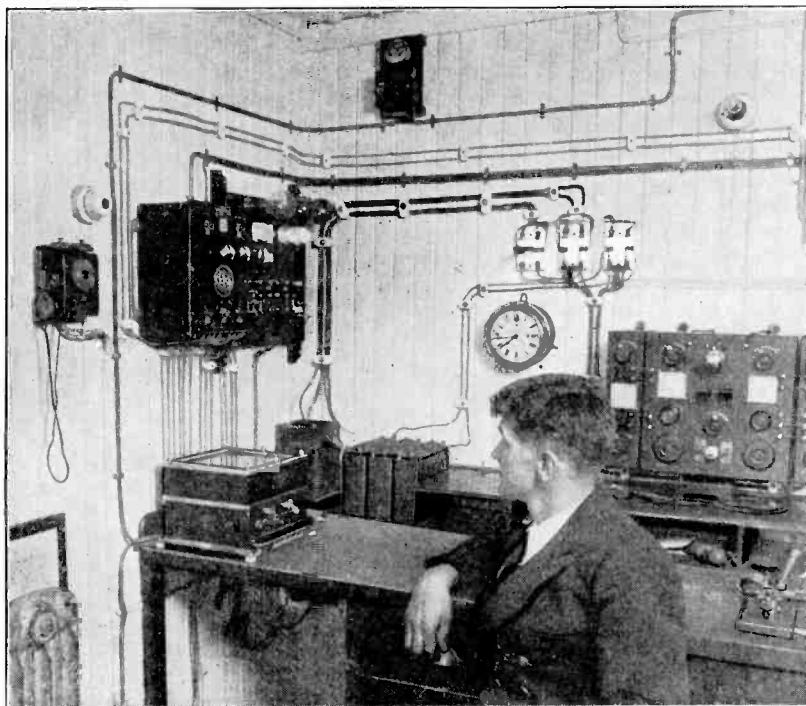

FIG. 251. Marconi Auto-Alarm Receiver and Selector as Installed on S.S. "Cedar Bank."

advantage of being fairly rapid in its action. Twelve such dashes with their spaces can be sent in one minute, and trials have shown that such a transmission is almost certain to operate the selector under any conditions in which it could be picked out by ear. Any longer dashes or spaces make the signal too slow in operation.

The group of twelve four-second dashes separated by spaces of one second is called the Alarm Signal, and ships in distress will send this signal as a preliminary to the existing SOS signal. The selector will then set alarm bells ringing in all ships in the vicinity which carry the apparatus and it has been found that should there be any ships within range in which watch is being kept the Alarm Signal is even more distinctive and arresting than the SOS.

3. Description of the Receiver and Selector—The Receiver Type 332 is a combined tuned receiver and amplifier, making use of three valves, the first two being three electrode valves type DER, and the third a four electrode valve type DE7. See figures.

This receiver, which may not be used for any other purpose, is connected directly to the ship's aerial when required by switch type 272, all other apparatus being disconnected. Its H.T. ("B" battery and L.T. ("A" battery) supply are switched on by the same movement of the switch. It is a coupled circuit receiver, the coupling and damping being arranged so that it shall be up to the standard of sensitiveness required on all waves between 585 and 615 meters, the sensitiveness on all waves between these limits being practically the same.

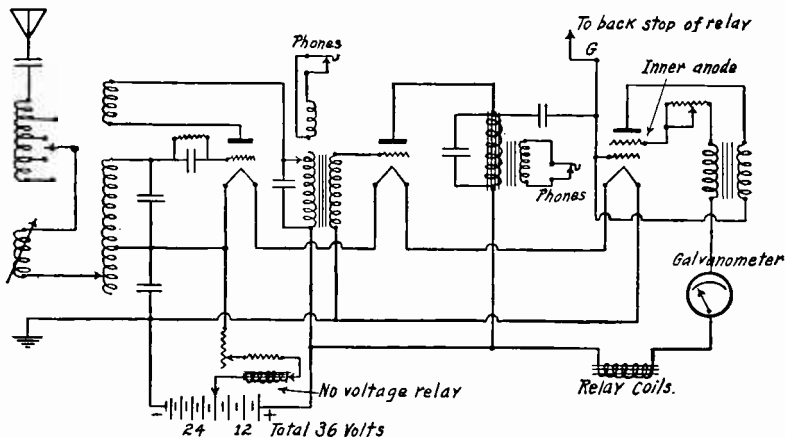

FIG. 251a. Simplified Diagram of Auto-Alarm Receiver, Marconi Type 332.

The first valve is used as a detector valve with reaction, the second as a simple note magnifier, and the third controls a special relay circuit. A diagram of the receiver is shown in figure 251a.

The aerial is connected through a small condenser (included so as to bring all probable ships' aerials within the tuning limits of the receiver) to an Aerial Tuning Inductance which has five stops for coarse adjustment and a variometer for fine adjustment. The aerial condenser is shunted by a resistance so as to prevent the accumulation of static charges. There is also a blocking condenser which is rendered necessary by the method of connecting the filament circuit.

The aerial circuit is direct coupled to a closed circuit which is permanently set to the proper wavelength. The condenser can be adjusted to correct small variations in manufacture. The closed circuit is connected through an ordinary grid leak and condenser to the grid of the first valve.

The anode of the first valve is connected through reaction coil to the medium resistance winding of the first intervalve transformer. This winding has a condenser across it. The low resistance winding is taken to two terminals to which telephones can be joined for testing purposes, and the high resistance winding is connected in the usual way between the grid of the second valve and the filament circuit.

The anode of the second valve is choke-capacity coupled to the grid of the third valve, the high resistance winding of the second intervalve transformer (with a condenser across it) being used as the choke. Another pair of testing telephone terminals are connected to the low resistance winding of this transformer.

The inner anode of the third valve is connected through a large variable resistance to the medium resistance winding of the last intervalve transformer, thence through a shunted galvanometer to no. 2 output terminal, thence through the coils of the relay (which is mounted in the selector) to no. 1 output terminal and so to the H.T. Supply.

The outer anode of the third valve is connected through the high resistance winding of the last intervalve transformer to its own grid.

It will be noted that the three filaments are in series with one another, and also with a fixed and a variable resistance and the "no-volts" relay in the selector. The supply is at 24 volts, which is the figure most suitable for the action of the selector.

4. The action of the receiver is as follows:

The coupling of the closed and aerial circuits makes the receiver responsive over a sufficient variety of wavelengths and the action of the first two valves is quite normal.

In the absence of any incoming signal a steady current of about 0.7 milliampere flows from filament to inner anode of the third valve, and thence via the last intervalve transformer through the main relay coils, thus holding its tongue in contact with the front stop against the bias of the relay.

The arrival of an incoming signal makes the grid of the third valve more negative and thus cuts down the current in the circuit described above, and if this takes place to a sufficient extent, the relay tongue will be released and will be pulled over by its bias. Any sudden reduction in the relay coil current will set up a momentary voltage across the ends of the high resistance winding of the last intervalve transformer, the connection of the windings being such that the change tends to make the grid still more negative, and thus sharpens and intensifies the action of the incoming signal.

It will be noticed that there is no grid leak to the third valve so its grid will remain negative once it is made so. The result of this would be that the relay would be operated by the beginning of an incoming signal and the valve would then remain paralysed by the accumulated charge on the grid. This trouble is cured by connecting the grid through the *G* terminal to the back contact of the relay, so that the grid is discharged when the tongue of the relay falls over. This connection is made to a selected point in the filament circuit which is at such a voltage with regard to the filament of the third valve that the grid will be restored to its original voltage, thus avoiding surging currents through the last intervalve transformer windings which might easily cause the relay to chatter.

As stated above, the filament circuit is supplied at 24 volts. The resistances are on the positive side of the filaments and the negative end of the filament of the third valve is earthed. The filament supply also passes through a no-volt relay in the selector, which acts as a telltale, should the filament current fall below the minimum value necessary to obtain a proper emission in each valve. All three valves are supplied with the same anode voltage, 36 above the negative point, 24 volts being derived from the 24-volt battery which supplies the filaments and actuates the selector mechanism, and the remaining 12 volts being provided by an extra H.T. battery.

A condenser is connected across the H.T. supply.

The selector, Type 333, is governed by the movement of the main relay, which is a polarized instrument so adjusted that the

bias pulls the tongue over to the back stop, which is connected as explained above via the *G* terminal to the grid of the third valve. See figures 252 and 253.

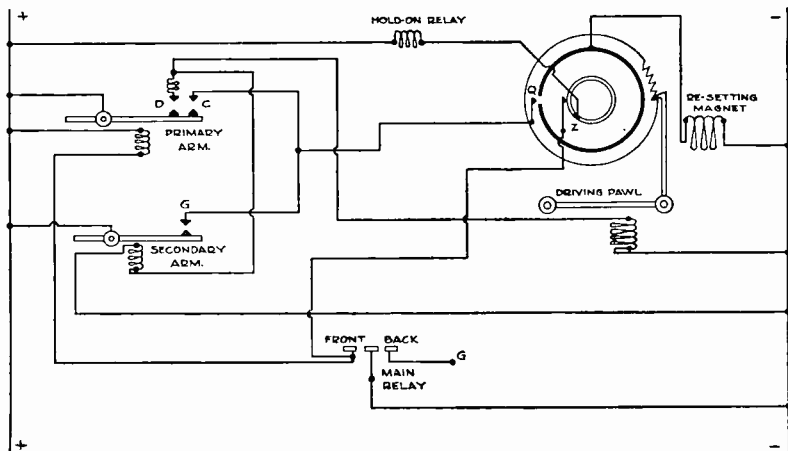

FIG. 252. Simplified Diagram of Selector Circuits. H and I Contacts, Shunt and Details Omitted.

The primary movement of the selector is governed by the movement of the relay tongue. In the state of rest the relay tongue is held against its front stop and a circuit is completed through the first magnet, thus holding the primary arm down against the action of its spring. When a signal of sufficient strength arrives the relay tongue falls away from the front stop, the current through the first magnet is broken and the selector begins to work. If the incoming signal is too feeble, the relay tongue will fall back to the front contact, the current through the first magnet will recommence and the selector action will be stopped.

All is now ready for another signal. If the signal is of proper working strength, the relay tongue will go right across to the back stop, the grid of the third valve will be discharged, the inner anode current will begin to increase through the relay coils, and the tongue of the relay will start its return journey to the front stop. If the signal continues, the main relay coil current will be again reduced and the tongue will be pulled back to the back stop. Therefore during the continuance of an incoming signal of sufficient strength the relay tongue chatters against its back stop, and

all the time the circuit through the first magnet is opened and the selector continues in operation.

The primary movement of the selector consists of an arm having a spring at one end and an air dash pot fitted for quick recovery at the other. The first magnet pulls this arm down against the action of the spring. When the current through the first magnet is stopped the spring pulls the arm up against the drag of the dash pot. If this movement continues for long enough, the arm will close the first working contact, known as the *D* contact. If the movement continues, the arm will also close the second working contact, known as the *C* contact. The dash pot adjustments are permanent and the position of the *D* contact cannot be adjusted, but the time the arm takes to close the *D* contact can be varied by altering the tension of the spring. This is set at three seconds. The *C* contact can be moved bodily so the time elapsing between the closing of the *D* and *C* contacts can be varied. This should be two seconds, or in other words, the *C* contact should be closed five seconds after the commencement of operation of the selector.

When the *D* contact is closed, a simple pawl and pawl wheel movement is operated, which rotates by one tooth of the pawl wheel a shaft carrying the ringing contacts.

If the primary arm closes the *C* contacts, both the holding and driving pawls are drawn back out of engagement with the pawl wheel by the re-setting magnets, and the shaft flies back to its starting position due to the action of a spring.

The circuit through the windings of these re-setting magnets also flows through a contact carried by the shaft, known as the *Q* contact which opens when the shaft is in its starting position, and is closed as soon as the shaft is turned. Were it not for this arrangement the circuit through the re-setting magnet would be completed through the *G* contact when the selector was in the ready position, and the pawls would be unable to start the rotation of the shaft.

Thus it is clear that since the movement of the primary arm is governed by the movement of the tongue of the main relay, which in turn is controlled by the incoming signal, the shaft will be advanced by one tooth of the pawl wheel if the signal consists of an unbroken dash lasting for three seconds, and if this dash continues to a total of five seconds the shaft will be returned to its starting position. Hence a four-second dash will cause the shaft to advance one tooth of the pawl wheel, and an allowance of practically one second each way is made to cover bad sending.

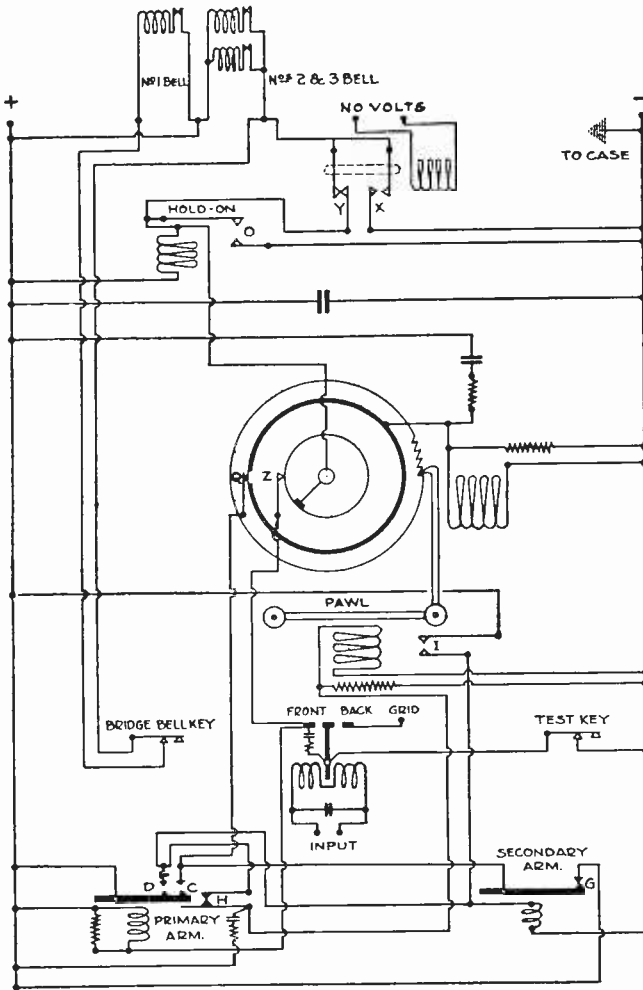

FIG. 253. Complete Arrangement of Selector, Type 333.

As soon as the *D* contact closes it also starts the secondary action of the selector by energising the magnet of a second arm, which is similar to the primary arm, and so pulling it down against the action of its spring. As soon as this circuit is opened the secondary arm will begin to rise again, its rate of movement being adjusted so that it closes its working contact, called the *G* contact, five seconds after the circuit is opened.

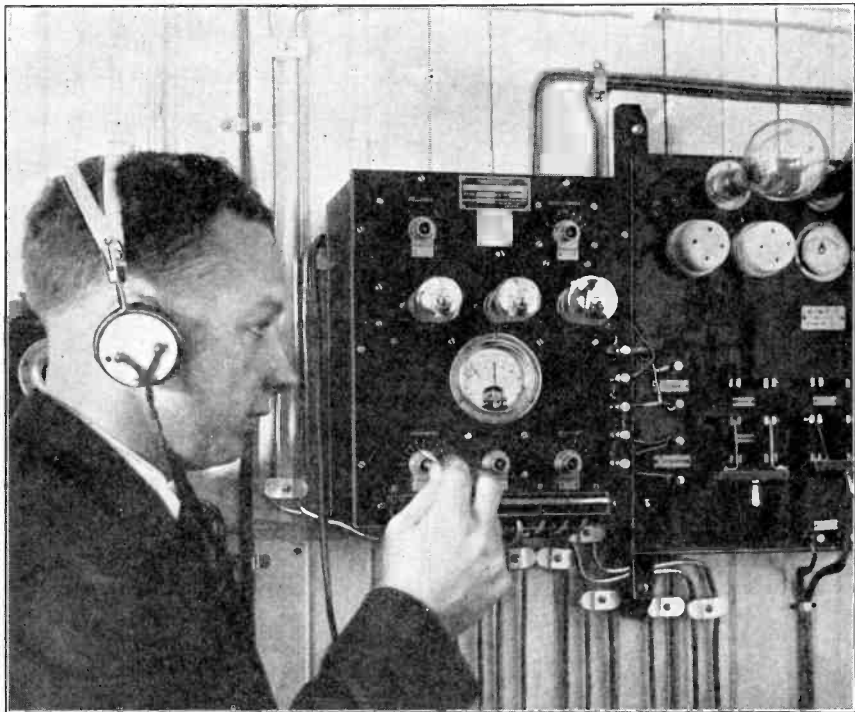

FIG. 253a. Close-up of Auto-Alarm Receiver.

Thus, suppose a correctly made four-second dash is received, the primary arm rises and at the end of the three seconds the *D* contact closes and the secondary arm comes down. At the end of the four-second dash the primary arm flies back to its starting position and the *D* contact is opened. The secondary arm now begins to rise and will close the *G* contact in five seconds if nothing intervenes to stop it.

But suppose that after a one-second space another four-second dash is started, when it has lasted three seconds the *D* contact will again be closed and the secondary arm will be pulled down again before it has reached the *G* contact. It takes five seconds to climb up to the *G* contact and when working as described it has only been allowed four seconds, one during the space and three seconds of number two four-second dash. Had the space lasted for two or more seconds time would have been allowed for the *G* contact to be closed, and as the *G* contact is in parallel with the *C* contact the pawls would have been pulled back and the shaft would have been released and would have returned to its starting position.

Thus we see that:

A dash of less than three seconds has no effect on the shaft.

A dash of three seconds or over allows the shaft to advance one tooth.

A dash of five seconds sends the shaft back to its starting position.

A second dash of not less than three seconds following the first at an interval of less than two seconds will allow the shaft to advance another tooth, but if the space exceeds two seconds, the shaft will fly back to its starting position, and if the space is too short to allow of the selector mechanism operating, the two dashes will be run into one and the shaft will fly back after a total of five seconds dash. Thus an allowance of nearly one second each way is made in the permissible length of the space, which can be anything less than two seconds and more than about one-fifth of a second.

A third dash of the correct length, separated by the proper space (both within the allowances mentioned above) will cause the shaft to advance by one more tooth, making three teeth in all, and at the termination of this dash the ringing circuits will be completed by the contact known as *Z*. If the last dash exceeds five seconds, the ringing circuit cannot be completed because the pawls will have been drawn back before the dash is finished.

The action of the ringing circuit is as follows:

When the shaft has advanced three teeth, the *Z* contact is closed.

The *Z* contact is in series with a hold-on relay and the connection made by the tongue of the main relay when it touches its front stop. When both the *Z* contact and the tongue front stop contact are closed, the hold-on relay is energized, and once it closes it will not open again.

The *Z* contact is closed as soon as the third dash has lasted

three seconds, but the tongue front stop contact does not close until the third dash ceases, and therefore the bells only ring on the completion of the third dash, provided that the third dash is of the proper length.

When the third dash has lasted three seconds the shaft is moved for the third time and the *Z* contact is closed. But the tongue of the relay is away from the front stop so no current will flow through the ringing circuit until the tongue of the main relay returns to its front stop, which will take place on the termination of the third dash. If the third dash carries on over the limit of five seconds, the shaft will have returned to its starting position by reason of the re-setting magnets having been energised on the closing of the *C* contact, and there will then be no continuity through the ringing circuit because, the shaft having returned to its starting position, the *Z* contacts will open.

The hold-on relay contact is in parallel with the combination of the *Z* contact and tongue of the relay front stop. Once it has been closed these two contacts are short circuited and the bells will go on ringing whether the contacts are open or not. Therefore, once the alarm bells have been started they will go on ringing until the whole apparatus is switched off.

Thus the straightforward action of the selector may be described as follows:

Provided that the nominal four-second dashes are in fact each of them over three seconds and under five seconds, and provided that the nominal one-second spaces are in fact over a fifth of a second and under two seconds, a series of three nominal four-second dashes, separated by nominal one-second spaces, will set the alarm bells ringing after the completion of the third dash.

From the above it becomes clear that the selector will respond to any reasonably close imitation of the correct ALARM SIGNAL—as the series of four-second dashes separated by one-second spaces is called. If interference exists at the same time, either from Morse signalling or from atmospherics, it is very unlikely to make any difference to the operation of the apparatus. It is obvious that nothing which may occur during one of the dashes can make any difference. The tongue of the relay will have left its front stop and will be chattering against the back stop, and that is everything it can do. So long as the signal is strong enough to work the relay no addition to the strength of signals can make any difference.

If interfering signals occur during the spaces, they can do no harm unless they bridge the space altogether. The design of the

whole instrument, both electrical and mechanical, makes it very quick to recover, and as stated before, a break between dashes as long as one-fifth of a second is enough to allow of the complete recovery of the primary arm, and the instrument will in that time be perfectly ready to commence the selection of the next dash.

Interfering signals may possibly just join on to the end of a dash and so prolong it. This will make no difference so long as the combination of unbroken dash due to signal plus interference does not amount to a total of five seconds. If the combination of unbroken dash does amount to five seconds, the re-setting magnets operate and the shaft returns to its starting position.

To allow for this possibility the full alarm signal consists of twelve dashes, each of four seconds, and the construction of the selector as described only demands that three consecutive dashes with their two separating spaces shall be within the limits stated above in order that the alarm bells may start ringing.

In actual practice it has been thoroughly established that the selector completely ignores the transmission of Morse at any hand speed from one station, and is almost certain to be able to find the three necessary consecutive dashes out of the full alarm signal if interference is experienced from two stations sending morse at hand speed at the same time.

The tuning of the receiver makes it independent of interference on waves other than 600 meters, except that 700 m. or 800 m. spark may break through if the interfering ship is fairly close by.

But there is another possible cause of practical failure—the recurrence of false calls. Were the selector left as has been so far described it would be possible to make it give false calls by the following combination. If Morse is being sent very fast, or if two transmitters are working at once, so that there is a large proportion of signal to space, the primary arm might creep up due to the spaces being so very short that it could not get right down during one of them. For this to happen the spaces must be less than one-tenth of a second.

If this went on, the primary arm would work up slowly, rising a little and falling a little, and would eventually begin to chatter against the *D* contact. If it strikes this contact three times in fairly quick succession, the driving pawl would pull the shaft round three teeth, and so effect a false call. This is prevented by the arrangements described in the next paragraph.

Two additional contacts are fitted. One known as the *H* contact, is fitted under the primary arm and is arranged so that it is

always closed unless the primary arm is right down, when it is opened. The other, known as the *I* contact, is fitted under the driving pawl and is closed as soon as the driving pawl moves down. See figure 253.

The connections of these two contacts are shown in figure 253. The *H* contact is between the driving pawl magnet and the *D* contact. The *I* contact is in parallel with the *D* contact. Their combined action is as follows:

As soon as the primary arm starts upwards the *H* contact closes. When the contact closes the driving pawl moves down and closes the *I* contact, which acts as a hold-on contact and keeps the driving pawl down and immovable whether the *D* contact opens or not. The *I* contact also keeps the circuit through the coils of the secondary arm magnet complete, so that the secondary arm cannot begin its upward journey against its dash pot until the primary arm has come right down and opened the *H* contact. Thus, both the driving pawl and the secondary arm are kept down once they have been pulled down. They are pulled down as soon as *D* closes and are not free to go on with their work until the *H* contact is opened by the primary arm getting right down to the bottom of its travel. Thus the chattering of the primary arm against the *D* contact cannot be followed by the driving pawl, and the form of false call mentioned above is rendered quite impossible.

When the primary arm gets right down it opens the *H* contact, which is between the *I* contact and the source of supply, and this breaks the circuit through the driving pawl magnet and allows the driving pawl to spring up and catch hold of the next tooth ready to rotate the shaft next time the *D* contact closes. It also frees the secondary arm.

The only form of false call which remains possible is due to the chance collection of Morse signals and interference which would show up on an inker tape as something near enough to the alarm signal to come within the limits for which the selector is designed.

In order that the selector shall work correctly a proper arrangement of resistances and condensers are fitted across the various contacts so as to absorb all sparking and prevent inductive action by one circuit on another.

The arrangement of the bell ringing circuits is as follows:

Three bells are fitted—one on the bridge, one in the wireless office, and one in the operator's cabin. Of these the bridge bell is known as no. 1.

As it is undesirable that no. 1 bell shall ring when the auto-alarm is being tested, a push is arranged on the selector which, while it

is held in, switches no. 1 bell off. This is called the Bridge Bell Key.

The no-volt relay holds open the bell ringing contacts. Should the filament current fall below the minimum useful value this contact will close and the bells will begin to ring. The hold-on relay does not come into this circuit so the bells will cease to ring as soon as the filament current is restored to its proper value.

A testing push, called the TEST KEY, is also fitted which has the same effect on the selector mechanism as the movement of the tongue of the relay.

Anti-sparking devices are fitted as follows:

There are kicking coils across the primary arm magnet, the driving pawl magnet, and the reset magnet. There is a condenser across the main relay coils. There is a combination of condenser and resistance across the relay tongue front stop contact, another similar combination is connected so as to be across any contact which opens the reset magnet circuit, and a third similar combination is connected so as to be across any contact which opens the secondary magnet circuit or driving pawl magnet circuit.

All the adjustments of the selector and receiver are made by means of sunk spindles which require a key to operate them. They are as follows:

Receiver Adjustments:

- A. T. I. for coarse tuning.
- Variometer for fine tuning.
- Reaction.
- Filament resistance.
- Third valve anode resistance.

Selector Adjustments:

- Relay adjustment.
- Primary arm tuning.
- Secondary arm tuning.

A simplified diagram of the connections of the receiver is given in figure 251a. Figure 252 is a simplified diagram of the selector circuits. Figure 253 shows the complete arrangement of the selector.

Figure 254 shows straight line diagrams of the bell circuits as follows:

- (a) Normal conditions.
- (b) Filament current failed—bells ringing.
- (c) Alarm signal received—bells ringing.

Figure 255 shows straight line diagrams of the selector circuits, as follows:

- (a) Dash in progress after three seconds.
- (b) Dash in progress over five seconds.
- (c) Result of too long a space.

a. NORMAL CONDITIONS

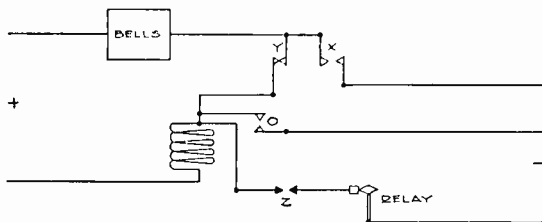

b. FAILURE OF FILAMENT CURRENT

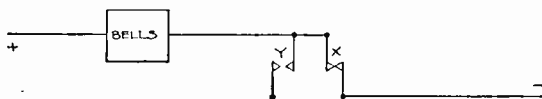

c. ALARM SIGNAL RECEIVED

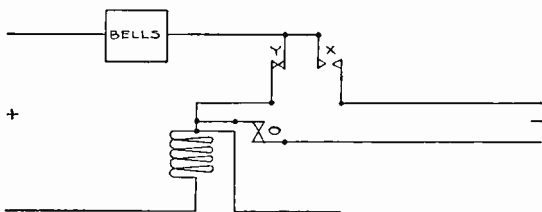

FIG. 254. Straight-Line Diagram of Bell Circuits.

5. Instructions for Fitting and Adjusting—The equipment consists of the selector, receiver, switch type 272, buzzer and key, charging board type 242, and batteries. As a general rule the selector should be placed on a small special shelf of its own, the receiver being placed against the bulkhead above it. The shelf should be not less than fifteen inches square.

The Switch Type 272 must be fitted in some position where it

can be reached and where the wiring is as simple as possible. The ordinary wireless installation is operative when the switch is in the *N* position, the auto-alarm is in use when the switch is in the *A* position, and the direction finder (if fitted) is in use when the switch is in the *D* position—see figure 8 and join up table.

a. AFTER THREE SECONDS DASH

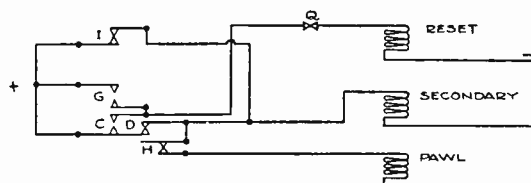

b. AFTER FIVE SECONDS DASH

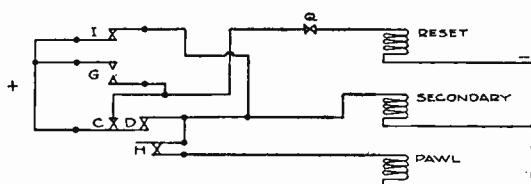

c. DURING A SPACE AFTER A CORRECT DASH

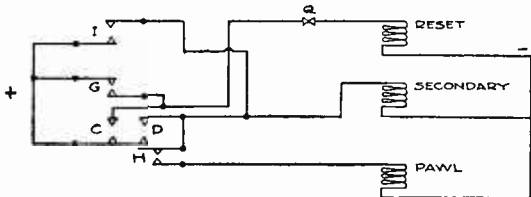

d. RESULT OF TOO LONG A SPACE

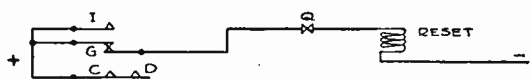

FIG. 255. Straight-Line Diagram of Selector Circuits.

One bell is fitted on the bridge, one in the wireless room, and one in the operator's cabin. Bells should be fitted vertical, with the magnets above the gong. If it is necessary to fit a bell horizontal, the clapper must not be above the gong.

The wiring between the selector and the bridge bell, and be-

tween the selector and the bell in the operator's cabin, is supplied and fitted by the shipowner, who is responsible for its maintenance in a satisfactory condition. These circuits must be two-wire (not earth return), and the insulation both between wires and from earth must be in good order.

The bell in the wireless room is to be joined up by means of no. 18 cab tyre carried on cleats.

The selector must be fitted with its base horizontal. The receiver may be either vertical or horizontal, but should if possible have its base vertical. It is most convenient to mount the selector on its bench with the receiver on the bulkhead immediately above it, sufficient room being left to allow of the removal of the selector cover. The selector should be mounted on one rubber buffer (as used for receivers) at each corner. This raises the selector from the bench, and the leads from its front terminal strip should be taken below the instrument to the back of the bench.

The lead from the *G* terminal of the receiver to the *G* terminal of the selector must be as short as possible and must be carried clear of all other leads and in its own cleats. This is very important.

Lead covered $3/22$ wire is to be used for the leads mains to switchboard and switchboard to accumulators. All other leads inside the wireless room are to be of no. 18 cab and are to be carried on cleats.

Having joined up, proceed to tune the receiver as follows:

Switch on the auto-alarm by setting the switch type 272 to its *A* position, put a pair of telephones on the "1st Mag." test terminals and tune for 600 meters, working first by the coarse A.T.I. and finally by the aerial variometer. This adjustment must be found when the reaction setting is one division of the scale back from the oscillation point.

Check by buzzer and wavemeter to see that signals are of approximately equal strength on all waves from 585 to 615 meters. It will usually be found that 585, 600 and 615 are of equal strength with slightly stronger signals at about 590 and 610, but rather accurate test apparatus is required to make these results obvious.

A check on the tuning of the aerial can be obtained as follows: The reaction should be adjusted to the very edge of oscillation when the aerial is in tune. A movement of the aerial variometer about one division (5 degrees) on each side of the "in tune" position should allow the receiver to commence oscillations. This is the extreme of sensitive and accurate adjustment. For seagoing

work the reaction should be reduced about half a division on the scale.

Next adjust the relay current by the filament resistance and anode resistance until the galvanometer on the receiver reads 20. This adjustment is almost permanent, and only requires alteration when the DE7 valve is changed. This adjustment should be made with the aerial disconnected, otherwise the readings may be disturbed by incoming signals. Make certain that a galvanometer reading of 20 can be obtained with all the spare DE7 valves on board. Any valve which cannot be made to give this reading by the adjustment of the filament and anode resistances must be replaced.

Next adjust the relay as follows:

Having set the galvanometer deflection to 20 with no signal coming in, turn the relay adjusting spindle left handed as far as it will go. Touch the buzzer key and the galvanometer needle will jump to zero and hang there. It will creep away very slowly due to leakage, and should it do so it can be returned to zero by another touch of the buzzer key.

Turn the relay adjusting spindle right handed until the galvanometer needle jumps from the zero position to about 20. The point at which the galvanometer needle just will not hang at the zero position after a touch of the buzzer is correct adjustment. The needle must jump to zero directly the buzzer key is pressed and immediately jump back to 20 when the buzzer key is released.

In this adjustment the relay tongue and primary arm will follow the fastest hand speed Morse that can be made by the buzzer and key. This is the correct and essential adjustment. The primary arm can be seen to tremble and if the ear is applied to the glass cover of the selector the relay tongue can be heard to buzz against its back stop.

Next check the timing, re-adjusting by the dash pot regulators on the front of the case if necessary. It should not be necessary to take the cover off the selector. Timing is best checked as follows:

Hold a watch to the ear so that the ticking can be heard clearly, and get into the habit of counting the ticks as follows: "GO—1-2-3-4—ONE—1-2-3-4—TWO—1-2-3-4—THREE—1-2-3-4—FOUR—1-2-3-4—FIVE—1-2-3-4—SIX, etc." Make sure that the word SIX corresponds with six seconds from the word GO. Practically all watches tick five times to the second as above.

Having got into the habit of counting the ticks, check the timing

of the primary arm. Take off the cover of the test key, place the thumb lightly upon it, pick up the rhythm of the ticking of the watch and start the count, pressing home the test key with the word go. At the THREE a distinct click should be heard due to the downward movement of the pawls when the *D* contact closes. This is called the first click. A second distinct click should be heard due to the operation of the re-setting magnets on the closing of the *C* contact at the FIVE. This is called the second click.

Until a great deal of practice has been obtained the clicks will appear to be one tick early, due to the human delay between intending to press the test key and actually getting it home. Thus the clicks may seem to be at the 4 before THREE and at the 4 before FIVE.

If the first click is early and the second click early (or if both are late), complete adjustment can be made by the primary arm adjusting spindle, but if when the first click is right, it is found that the second is early or late, the cover must be taken off the selector and the *C* contact moved up or down until both are right. This adjustment—the height of the *C* contact—is practically permanent and should last without alteration for at least a year.

Now check the timing of the secondary arm. Make preparations as before, press the test key and wait for the first click. As soon as possible after the first click release the test key and start the count with the word go as usual. A distinct click, called the third click, should be heard at the FIVE. This is caused by the action of the re-setting magnets on the closing of the *G* contact. Until some practice has been obtained this click will also appear early. It can be adjusted by the secondary arm adjusting spindle.

When all the above has been carried out, the auto-alarm is ready for service.

If it is required to examine the selector mechanism alone, switch on and work the set by making the alarm signal with the test key.

If it is required to examine the receiver and selector together, the alarm signal should be made by the buzzer key.

The bridge bell can be kept out of action by keeping the bridge bell key pressed.

To check the sensitiveness of the auto-alarm, put the test telephones on the "1st Mag." terminals and see that the primary arm is following strong signals. Never leave telephones connected to the test terminals unless they are actually in use.

Two special keys for working the controls are supplied. These two keys must be carefully guarded and must not be left lying

about or in position in the apparatus. Unless actually being used for adjustment they must be locked up in the deed box. It is particularly important that the special keys shall always be left locked in the deed box so that no unauthorized person can alter the adjustments of any part of the auto-alarm during the absence of the person responsible for its safety and operation.

The adjustments given in detail in Part III are practically permanent. When the apparatus is first installed all these adjustments must be verified, but they should none of them be disturbed again unless the auto-alarm fails to respond to the tests mentioned in Part III or otherwise shows signs of unsatisfactory working.

The cover of the selector is air-tight, and it must never be taken off unless careful tests have made it certain that some re-adjustment is necessary which cannot be made from outside the selector case.¹

6. Instructions for Maintenance and Operation—The auto-alarm is joined up by the switch type 272 directly to the aerial when it is closed to the *A* position. At the same time it completely disconnects the aerial from all other apparatus.

The auto-alarm batteries can be put on charge and discharge at their charging board, and as the battery leads are taken through the type 272 switch, it is impossible to switch on the batteries and forget the aerial, or vice versa.

Before leaving the auto-alarm to keep watch it must be tested as follows:

Having put the batteries to discharge, and the switch type 272 right over to *A*, work the buzzer key as for the alarm signal. The bells should ring at the end of the third dash, and go on ringing until the type 272 switch is put back to *N*. It must be left there for about 10 seconds to allow the auto-alarm to recover before it is replaced to *A*.

Connect a pair of telephones to the terminals marked "1st Mag.," and see that the primary arm is responding to all signals which are received of fair strength.

These two form the routine tests, and if the auto-alarm passes them satisfactorily it may be regarded as in working order.

Note: When testing it is advisable to press the bridge bell key,

¹ Most watches tick five times to the second, and with such a watch the timing can be checked to one-fifth of a second by the method laid down in the text.

If a watch is used which ticks four times to the second, the count must run GO—1-2-3—ONE—1-2-3, etc., and timing can then be checked to one quarter of a second.

or else warn the bridge that the auto-alarm is about to be tested. The bridge bell must be worked at least once a day.

As a general principle the auto-alarm batteries should be put on charge when human watch is being kept so as to make sure that they are ready when the device is required to keep watch. The 24-volt battery has a higher rate of discharge than the 12-volt battery, and separate charging arrangements are made for each. Free use should be made of the voltmeter type 243 to ensure that the batteries are kept in good condition.

If the filament current fails, due to batteries running down or to a filament breaking, the bells will ring and go on ringing until the filament current is restored (or the batteries become completely discharged).

If it becomes necessary to change one of the DER valves, it is unlikely that any re-adjustment will be necessary.

If the DE7 valve has to be changed, a re-adjustment of the galvanometer reading to 20 may be required. This can be done by means of the anode resistance at the top right hand corner of the receiver.

The galvanometer reading should not be above 20, nor below 18, or the auto-alarm will lose its sensitiveness. If less current is used than this figure, the relay may suffer from vibration.

CHAPTER 14

RADIO DIRECTION FINDERS

1. **Radio Direction Finders**—The radio compass or direction finder was developed in this country by F. A. Kolster and successfully introduced by him as an aid to navigation. Since its introduction and increasing use the United States Lighthouse Service has established automatic radio beacons on light vessels and at lighthouses in the vicinity of harbor entrances and places dangerous to navigation, the exact locations of which are clearly shown on all sailing charts. These stations send out characteristic radio signals similar to light flashes, thus enabling the master of a vessel fitted with a radio compass to take bearings as often as desired.

2. **Fundamental Principles**—It has long been known that an antenna consisting of a loop or closed coil has “directional” properties. Consider the coil of wire in figure 256 marked (a) as being supported vertically and its edge pointing in the direction of a radio transmitting station. A radio wave from the transmitter will pass through that portion of the loop marked *F* the merest fraction of time before it does that marked *R*. The result of this is that a difference of potential will exist between the two sides of the loop, thus producing a radio frequency current in the coil and condenser circuit. If this circuit is resonant to the

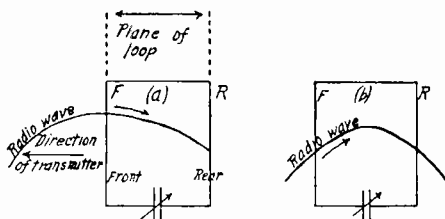

FIG. 256. Radio Wave Striking Loop Antenna.

frequency of the incoming wave a maximum e.m.f. will exist across the terminals of the condenser.

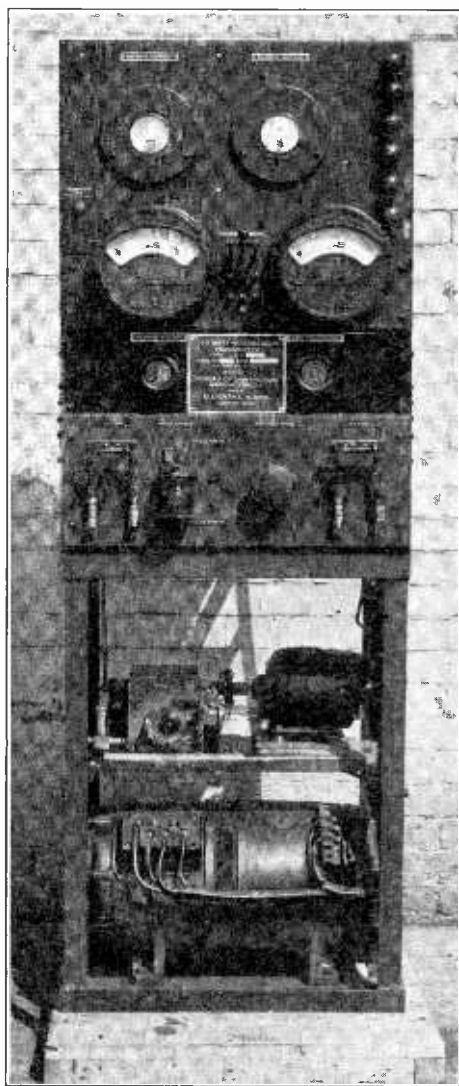

FIG. 257. U. S. Bureau of Lighthouse 100-Watt Radio Beacon Transmitter with Automatic Signalling Device.

As the wave advances there will be an instant when both F and R are subject to the same potential as the amplitude of the wave cutting both wires is the same. This is represented by b in figure 257.

As the wave continues to advance, the R wire will have a greater e.m.f. than that of F and again a current will flow in the loop circuit. As the end of the wave passes over the loop the current will fall to zero only to repeat the cycle of events just mentioned upon the arrival of the next wave.

Now consider the loop turned so as to be at right angles to the transmitting station. The wave arriving from the station will strike both the F and R wires at the same time. This results in e.m.f.s of equal potential but opposite in sign being induced in the loop, the result of which they cancel, and no current will flow.

If the terminals of the loop and condenser were connected to a vacuum tube detector and amplifier the signals from the transmitting station would have been heard

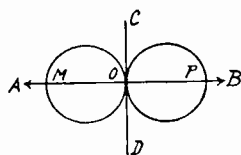

FIG. 258. Theoretical Directional Characteristic of Loop Antenna (Figure-of-Eight).

the loudest when the loop was pointing in the direction of the station, i.e., when the plane of the loop lay in the direction of the source of transmission. As the loop is turned from this position, through 180 degrees, the signal will gradually disappear, and when the plane of the loop is at right angles to the source of transmission the signal intensity will be zero. If the loop is continued in rotation the signal will gradually reappear, being at a maximum

when the plane of the loop again lies in the direction of the source of transmission. Referring to figure 257, the R turn has now become F and F become R . The signal intensity thus varies in accordance with the figure-of-eight characteristics as shown in figure 258, the direction A or B indicating maximum signal intensity.

3. Capacity of Loop Circuit to Ground—An important factor that has to be considered in the use of the loop antenna in its application as a direction finder is the effect produced in the coil by virtue of the coil structure having an appreciable capacity to earth. Also the detector and amplifier circuits are electrically unsymmetrical with respect to earth. This results in a distortion of the ideal figure-of-eight signal intensity characteristic obtained by rotation of the coil about its vertical axis. The critical position of "no signal" no longer exists and the directive qualities of the loop have been distorted.

An examination of figure 259 will show how this is brought about. The grid of the vacuum tube is actuated by an e.m.f. directly from the tuned input circuit consisting of the coil L and condenser C . The dotted lines C_g represent the capacity of the coil and apparatus to ground. Because of the electrically unsymmetrical relation of the coil system with respect to earth, an appreciable current will be set up in the loop circuit by the incoming wave acting through the earth capacities C_g . The potential produced by this current across the condenser C will likewise operate on the grid of the vacuum tube.

The ideal figure-of-eight signal intensity characteristic is therefore distorted by these additional effects, the degree of distortion depending upon their relative magnitudes. The signal variation characteristic which results from these effects is shown in figure 260. The position of minimum or zero signal intensity is no longer at right angles to the plane of the loop, nor does it coincide with the axis of the loop as in the ideal case.

The complete solution of the problem depends upon obtaining exact electrical symmetry of the loop system, including the vacuum tube apparatus with respect to earth. This is accomplished by balancing out this so-called "antenna effect" with a condenser connected as shown in figure 261. It can also be improved by inductively coupling the loop circuit to the vacuum tube.

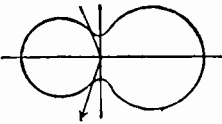

FIG. 260. Loop Characteristic Showing Effect of Current Set Up in Coil by "Antenna Effect."

thus giving the line of direction which is of course at right angles to the point of zero signal. However, the loop is subject to a possible 180 degree error, owing to the fact that there are two points at which the signal disappears, obtained by rotating the loop half a turn. When taking bearings from a coast station the general direction of which is known, the two points of zero signal do not matter, as the correct one is easily recognizable.

The occasion may arise wherein the location of the signalling

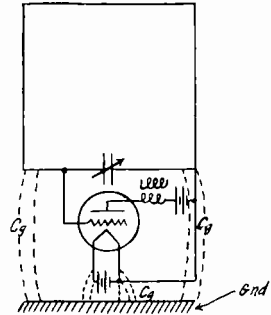

FIG. 259. Loop Circuit Showing Capacity to Ground.

4. Determination of Sense—As already explained, the loop system when properly balanced will give a critical zero signal,

station is necessary, such as locating and proceeding to the aid of a ship in distress. To obtain the true direction it is necessary to unbalance the loop by exaggerating the antenna effect. This is accomplished by connecting a small antenna to one side of the loop through a disconnecting or uni-directional switch. Normally the uni-directional switch is open when taking a bearing, but when

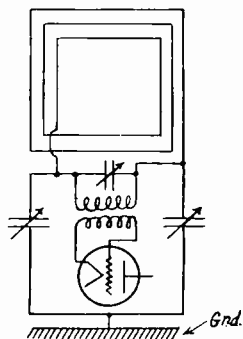

FIG. 261.
Method of Balancing Out "Antenna Effect" of Coil and Apparatus to Earth.

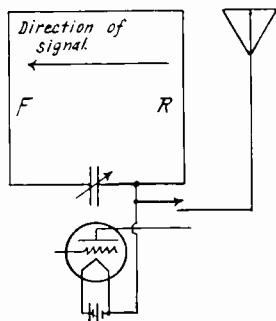

FIG. 262. Loop Unbalanced by "Sense Antenna."

the true direction is desired, the operator closes the switch and turns the loop to the position of maximum signal at which point the plane of the coil lies in the direction of the signalling station and points toward it as indicated by an index pointer provided for that purpose.

Referring to figure 262, the loop is turned so as to pick up the signal from the advancing wave as indicated by the arrow. Attached to one side of the loop is the small antenna previously mentioned. This antenna is connected to the rear side of the loop and picks up just enough energy to offset that picked by the front of the loop and the result is that no signal is heard.

Now, if the loop, with its small antenna attached, is rotated 180 degrees there will be communicated to the grid of the tube the combined energy of both loop and small antenna. The effect is that the combined e.m.f.s will greatly overbalance the feeble e.m.f. induced by the rear of the loop. Thus when the side of the loop with the antenna attached is turned so that a signal is heard at a maximum it establishes the direction of the transmitter. If the

loop is turned in any other direction the signal will be lost or considerably weakened.

5. **Wave Front Distortion**—When a direction finder is installed on shipboard there are certain distributing effects due to

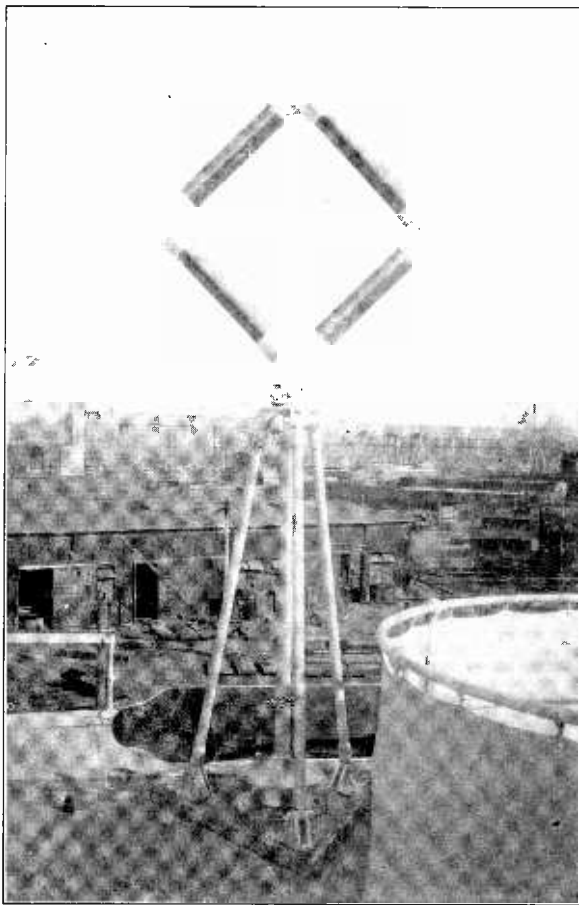

FIG. 263. Loop Employed with Radio Direction Finder of the Radiomarine Corporation of America.

the ship's equipment, the most serious of which are due to currents induced in the d.f. by wires, forming closed circuits, stays,

whistle cords and the like and which have a natural wavelength considerably less than the working wavelength. These currents are in phase opposition to the currents induced by the signal direct and therefore have the effect of decreasing the apparent sensitivity of the direction finder. Since the masts, stays, etc., are in various directions from the direction finder, they also have the effect of shifting the apparent direction of the arrival of the signal. This latter effect is more prominent when the wave is approaching from approximately 45 degrees from the ship's center line. In the fore-and-aft direction and directly abeam the error is at a minimum.

Currents induced in the direction finder by masts, grounded stays and any metal objects, which can act as a vertical antenna and which have a natural wavelength considerably less than the working wavelength, are 90 degrees out of phase with the current due to the signal. Therefore, no value of signal current can be obtained to cancel these antenna currents as the vectorial addition is always to make the resultant greater than either component. The effect apparent to the observer is the broadening of the minima, in two opposite quadrants, in taking of bearings in which the resultant mass effect causes currents to be induced in the direction finder. Usually these induced currents are not of sufficient magnitude to cause an appreciable shift in the apparent bearing of the signal.

In order to compensate for the apparent shift in direction of signal and adjustment to obtain a sharp minimum signal at all angles it becomes necessary to calibrate the direction finder. Calibration is done by taking simultaneous sight and radio bearings on a radio transmitter. This is accomplished by sailing completely around a radio beacon on a light vessel at a distance from one and a half to two miles while taking the sight and radio bearings. After calibration, a deviation or correction curve is plotted and applied to an automatic compensator which makes the instrument direct reading and eliminates the necessity of applying a correction to the bearings.

6. Proceeding with Calibration—Since the received wave is distorted or bent by the metal objects on the vessel it becomes necessary to place such objects in a permanent condition, i.e., either insulated or grounded. The latter method is most practical as it is easiest and cheapest. However, this cannot be done to the whistle cord, fore-and-aft stays or any such stays that form a closed loop around the d.f. loop. Therefore these are always broken up into small lengths by insulators so that each length has

a fundamental wavelength lower than that of the range of the direction finder receiver.

Usually a direction finder is equipped with two scale pointers. One is mounted under the compensating cover and is known as

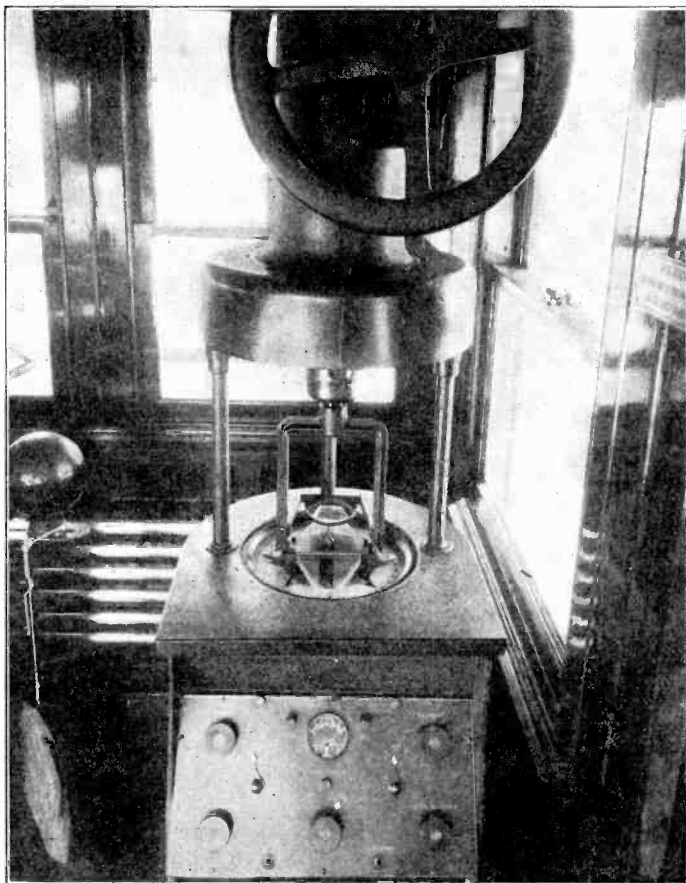

FIG. 264. R.C.A. Direction Finder Mounted in Chart House of Vessel.

the upper scale. This indicates the actual position of the loop. The other is at the bottom end of the extension shaft and indicates the true bearing after compensation is completed. During cali-

bration only the upper scale is used and it is adjusted so that scale reads zero when plane of loop is 90 degrees from the lubber line and the glass indicator reads on the lubber line.

Radio and sight bearings are taken as near to 10 degrees apart as possible and each bearing recorded and numbered as follows:

| Bearing Number. | Upper Scale. | Pelorus (Sight Bearing). | Correction. |
|-----------------|--------------|-----------------------------|-------------|
| 1 | 72 | 76½ | + 4½ |

where 72 is the position of the d.f. loop, 76½ is the correct bearing as per pelorus, + 4½ is the correction to be added to the d.f. bearing to give the true bearing.

When the d.f. loop is rotated by means of the hand wheel, the characteristic signals from a beacon station will be heard with a gradually varying degree of loudness until the plane of the coil is at right angles to the direction of the incoming waves at which point the signals should die out entirely. This position of silence is critical and sharp and therefore indicates with great accuracy the line of direction of the source.

After the ship has been swung and the required number of bearings taken they are recorded and a curve drawn. In practically all calibration curves there are four angles where no correction is necessary and the form of the curve resembles a sine wave. Theoretically, the curve is a sine wave for practically all cases with a given amplitude and phase angle for each installation. Considerable emphasis should be given this fact in drawing the curve from the data obtained, as it will help in judging what points are in error.

7. Compensation for Error—The compensator as employed with R.C.A. direction finder consists of an arm mounted at the top of the lower scale pointer shaft which has a roller fitted in the end. This roller bears on a circular band that is held semi-rigid by 24 screws spaced 15 degrees apart; by screwing or unscrewing as the occasion necessitates the shape of the cam is changed which causes the roller to move outward or inward at the appropriate points, thereby changing the position of the arm which in turn rotates the lower scale to read the true bearing.

These twenty-four screws are numbered from 1 to 24 inclusive and are mounted directly under the upper scale.

Record should be made of the numbers on the upper scale that are immediately over the screws. Consult the calibration curve at the point indicated by screw number 1 and note the correction. As in the table below, screw number 1 is under 6 on upper

| Screw Number. | Upper Scale. | Correction. | Lower Scale. |
|---------------|--------------|-------------|--------------|
| 1 | 6 | + 2 | 8 |
| 2 | 21 | | |
| 3 | 36 | | |
| 4 | 51 | | |

scale and 6 degrees shows a 2 degrees plus error, $6 + 2 = 8$, so that when the loop is at an angle of 6 degrees the pelorus indicates a plus two degrees error. It then becomes necessary to set the upper scale pointer on 6 and adjust screw number 1 until the lower pointer reads 8 which is the pelorus or true bearing at this particular angle. After this one is completed move upper scale to figures over screw 2 and adjust screw 2 until the lower scale pointer reads plus the error indicated by the chart and so on until the 24 screws have been adjusted. It should be noted that a minus as well as a plus error has to be compensated for, depending upon the angle of the loop for a particular reading.

While the d.f. is being operated the antenna employed for transmission and reception is placed in a neutral position, i.e., ungrounded.

The direction finder system as described in this chapter is employed on American vessels; however, there is another system known as the Bellini-Tosi, which is a development of the British Marconi Co. Equipment of this type is found on foreign vessels. Inasmuch as this book is primarily for American operators and descriptive of American apparatus, no details of the system will be given.

8. Radio Compass Stations on Shore—Radio compass stations on shore are direction finders established to furnish ships, upon request, radio bearings taken by one or more such stations. This system requires that the ship requesting the bearings become the signalling station, while the direction finder station or stations take the bearings and then communicate them to the ship. Such stations in the United States are established and controlled by the Navy Department. They are divided into two classes:

(a) Single stations, operating independently and furnishing a single bearing.

(b) Harbor entrance groups. All stations in harbor entrance groups are connected to and controlled by the master station; all stations of the group take bearings simultaneously and these bearings are transmitted to the ship requesting them by the master station.

Where only one radio compass station is available, the mariner may fix his position by two or more bearings from the station with

the distance run between, or may use the bearings as a line of position, or as a danger bearing, or the bearing may be crossed with a line of position obtained from an observation of an astronomical body to establish a "fix."

The maximum distance for which bearings from these stations are accurate is 150 miles, but accurate position cannot be plotted on a Mercator chart when the station is more than 50 miles distant without first correcting the bearing to allow for angular distortion due to the projection. This correction can be found by reference to tables or curves prepared for that purpose.

9. Wavelengths—Radio compass stations maintained by the U. S. Navy maintain a watch and transmit on a wavelength of 800 meters (375 kc.). Only this wave should be used to call and work these stations. Accuracy of bearings will probably be affected if the ship's transmitter is not adjusted to this wavelength. In order to obtain the best results, it is important that the ship should not transmit with too much power. Signals should, however, be fairly strong and clear; great care must be taken to keep the note and strength steady and to pay strict attention to spacing.

10. Obtaining a Bearing—The following procedure should be followed by a vessel desirous of obtaining a bearing from U. S. Navy radio compass stations.

To obtain a bearing from independent radio compass stations, call the station from which the bearing is desired in the usual manner and request bearings by means of the conventional signal given hereafter. Simultaneous bearings from two or more compass stations can be obtained by making the call include the other compass stations desired.

To obtain bearings from the harbor entrance group compass stations carry out the procedure previously given. The compass control station only will answer.

(a) A ship calling the radio compass or compass-control station should make the abbreviation QTE? (What is my bearing?). This request will be answered by the radio compass station or control station, and when ready to observe the radio bearing it will send the signal K (invitation to transmit), indicating to the ship that it is to commence testing, i.e., repeating its call letters for a period of 50 seconds. The signal should be made slowly with the dashes considerably prolonged. (See previous instructions regarding power, etc., to be used.)

(b) The testing should be made on 800 meters; upon the completion of the test the ship should await reply from the radio compass station.

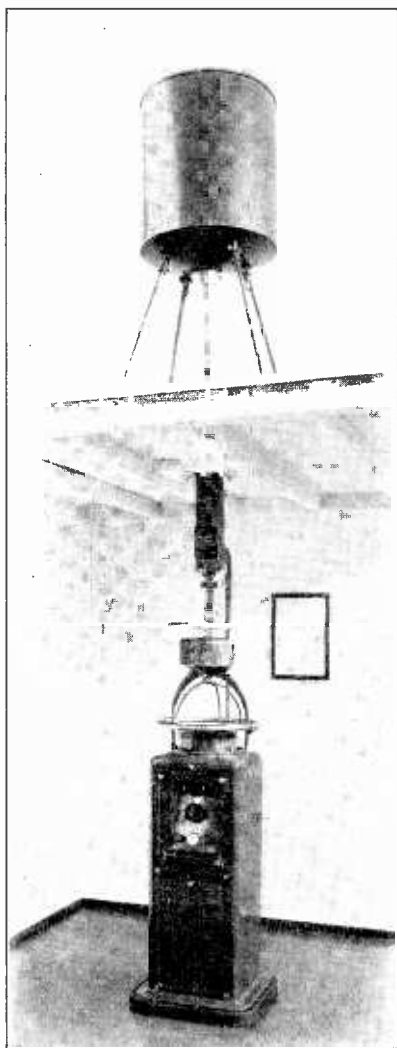

FIG. 265. Kolster Radio Compass, Type AM-4490.

(c) The radio compass station or control station will then reply, repeating the abbreviation QTE (Your bearing from — was — degrees) followed by the bearing in degrees of the ship station from the radio compass station, and then the time group giving the time of observation in local standard time. In the case of more than one radio compass connected by land line only, the station originally called will answer. This station will combine all the bearings taken by itself and associated stations into one message, which gives each bearing observed immediately after the name of the station making the observation. The ship then acknowledges receipt of the bearings and repeats the figures back to the compass station for verification.

11. Example—A ship (call letters KVA) desires to get bearings from the Delaware Bay entrance group (call letters NSD). The following procedure is used:

NSD NSD NSD de KVA KVA KVA — . . . — QTE
 . . . — — . . . ar.

KVA de NSD K.

NSD de KVA — . . . — QTE? KVA KVA KVA.

(Ship repeats call letters KVA for 50 seconds, prolonging the dashes.)

— . . . — KVA ar.

KVA de NSD — . . . — QTE.

Cape May 120 Cape Henlopen 110 Bethany Beach 085 at 0126

— . . . — NSD ar.

NSD de KVA — . . . — 120 110 085 at 0126 . . . — — . . . ar.

KVA de NSD R . . . — . — NSD.

This method is the only authorized procedure for calling, answering and testing, and should be followed exactly. Such signals as MO or V and other test signals are not authorized for radio compass traffic. The testing period of 50 seconds should not be exceeded.

12. Danger from Reciprocal Bearings—Attention is invited to the fact that when a single bearing is furnished there is a possibility of an error of approximately 180 degrees, as the operator at the compass station cannot always determine on which side of the station the vessel lies. Certain radio compass stations, particularly those on islands or extended capes, are equipped to furnish two corrected true bearings for any observation. Such

bearings when furnished vessels may differ by approximately 180 degrees, and whichever bearing is suitable should be used.

13. Caution—Mariners receiving bearings which are evidently the approximate reciprocal of the correct bearing should never attempt to correct these bearings by applying a correction of 180 degrees, as such correction would not include the correction necessary on account of deviation at the compass station. An error as large as 30 degrees may be introduced by mariners applying an arbitrary correction of 180 degrees to such bearings. Vessels receiving bearings manifestly requiring an approximate 180-degree correction should request the other bearing from the radio compass station if not previously furnished.¹

14. Bellini-Tosi Direction Finder—This type of direction finder, named after the inventor, is used extensively in European countries both on vessels and aircraft. It is rarely used in this country except on aircraft. In view of this last statement it has been thought best to omit an elaborate technical description of operation and simply give the reader a synopsis of the system.

A distinctive feature is the use of two fixed loops arranged to bisect each other at right angles and to make a 45-degree angle with the bow and stern of a vessel or aircraft. Each loop is tuned by a variable condenser and there is a coil in series with each loop arranged so as to be in an inductive relation to a rotating coil termed the exploring coil. This coil is fitted with a pointer and arranged to turn over a scale of 360 degrees and its energy fed into a vacuum tube detector and amplifier. In operation the effect produced in the exploring coil is such that its pointer will lie in the plane of the advancing wave. Bearings can then be taken in the same manner prescribed for a rotating loop direction finder, that is, by fading the signal out on each side of maximum audibility and taking the mean value in degrees from these readings as indication of the plane of transmission. To obtain the true direction it is necessary to unbalance one loop by coupling energy to it from a small antenna similar to that used with the rotating loop method which has already been described in the early part of the chapter.

RCA Model ER-1445-A Direction Finder

15. Determination of Ship's Position by Radio Bearings—The most general use of the radio direction finder is to ascertain the true bearing, or line of direction, of a radio beacon or radio station of known latitude and longitude. At the time the bearing is taken the ship will be somewhere on the line of direction, and if

the position of the vessel as determined by dead reckoning or observations is correct, or nearly so, it should fall on, or close to, the line.

The single bearing, or line of direction, can be utilized as a danger bearing, or, more properly, a safety bearing, for example: If two ships are approaching each other during thick weather, or if one ship is overtaking another, a radio bearing can be taken and the angle from the ship's head noted carefully. If then, other bearings are taken at intervals of ten or fifteen minutes (depending on speed and estimated distance) the angle from the ship's head will be either increasing or decreasing. If the angle is found to be decreasing, it should be taken as a danger signal and the ship's course altered one or two degrees, or until the angle is found to be increasing, and the ships will pass with safety. The distance between the vessels can be roughly estimated with experience in noting how quickly the angle between the vessels changes. If the distance is, say fifty miles or more, the angle will not show much change for some time, whereas if it changes quickly, it can be assumed that the other vessel is quite close.

The radio operator can be of much assistance to the Master in cases of this nature, as he can advise of any ships in the vicinity, and by listening in on the spare telephones of the direction finder can identify the ships on which bearings are desired. He can also judge approximately by the strength of the signals whether or not the other ship is within a short distance.

The line of direction can be used to good advantage when running for a lightship equipped with a radio beacon for if a bearing shows that the course being followed will carry the vessel either side of the lightship, it is only necessary to alter the course until the lightship is found to bear directly over the bow and, if this new course is followed, the lightship will be picked up dead-ahead.

16. Cross Bearings—If a single bearing taken to check the ship's position does not give satisfactory results, due to possible error in noting reading of the direction finder or figuring dead reckoning or observations, a good reliable fix can be obtained by taking bearings on two or three radio beacons. If unable to pick up more than one radio beacon, a radio telegraph station can be used. The ship's radio operator will again be of assistance in such instances to identify the station being used.

When the morning time sight is taken and a single line of position laid down, another line to cross it can be obtained by taking a radio bearing. The radio bearing should be taken simultane-

ously with the time sight. If there is any appreciable difference of time between them, due allowance should be made for the speed and course of the vessel. This will obviate the necessity of waiting until the sun changes its bearing sufficiently to obtain another position line which will cross the first at a good angle. This method can, of course, be used at any time of day or night when it is possible to obtain the altitude of a celestial body. Other similar uses of the radio direction finder can be devised by the master, for instance, in approaching a harbor where it is possible to obtain a bearing of a distant mountain peak, or lighthouse, another bearing to cross the first can be obtained by radio.

17. Precautions to be Observed—Whenever a radio bearing is about to be taken, the wheelsman should be told to stand-by and call out when the ship is right on the course, for if the ship has yawed off two or three degrees, the bearing will be in error by a similar amount. On ships equipped with direction finders having a live gyro repeater the observer can himself determine when the ship is on the course.

If any doubt exists in the mind of the observer as to the accuracy of the observed bearing, or if the ship is yawing badly due to heavy weather, several readings should be taken and the mean reading used as the correct one.

18. True and Relative Bearings—On vessels fitted with radio direction finders equipped with a movable dumb compass card, bearings can be taken either from the meridian or relative to the ship's head. On bearings taken to determine the ship's position, it is suggested that they be taken from the meridian, and if the dumb compass is adjusted to the true course (not compass course, unless gyro compass is used) of the vessel, the observed radio bearing is the true bearing. On bearings taken of lightships or other vessels to determine their position relative to the ship's head, the direction finder dumb compass should have its 0-360 mark to give the desired result.

On ships fitted with radio direction finders having the dumb compass set permanently with the 0-360 mark to the ship's head, all bearings taken are, of course, relative to the ship's head, and to obtain a meridian or true bearing it is necessary to add the true course of the vessel at the time bearing is taken.

On ships having live gyro repeaters installed in the radio direction finder all observed bearings are, of course, true bearings, and to obtain a relative bearing from the ship's head it is only necessary to take the difference in degrees between the reading of the gyro repeater and the direction finder pointer.

It is again suggested that occasional check bearings be taken when passing radio beacons under conditions of good visibility. Radio bearings should check with pelorus or azimuth compass bearings. Distance from the beacon should be at least two miles. Visual bearings in doubt due to rolling of vessel should be rejected. Such check bearings will serve to assure the master of the accuracy of the instrument. Whenever any large metal objects are added to or removed from the ship's deck structure the direction finder calibration should be checked, particularly through the arc in which the object is located, and if any unreasonable errors are detected, steps can be taken to have same corrected.

19. Convergency Correction Table for Radio Bearings Laid Down on Mercator Chart—As radio bearings are true great circle bearings, it is necessary that due allowance be made for chart distortion before they can be plotted by the navigator from the regular compass rose of a Mercator Chart. The following table will give the required corrections for each degree of latitude from 2 to 70 degrees,* and for each one-half degree of longitude from 1/2 to 16 degrees. For radio bearings taken at distances under seventy-five miles these corrections can be neglected, but should be used on all bearings taken at greater distances.

The arguments used in the table to find the correction are the middle latitude and difference of longitude between the vessel's dead reckoning position and the position of the radio beacon station used. Should the position by dead reckoning differ much from the true position as determined by a first plot, then a retrial, using the new position, is necessary to get the proper correction. The sign of the correction is as follows:

In north latitude when the vessel is $\frac{\text{eastward}}{\text{westward}}$ of the radio beacon the correction is $\frac{\text{subtractive}}{\text{additive}}$.

In south latitude when the vessel is $\frac{\text{eastward}}{\text{westward}}$ of the radio beacon the correction is $\frac{\text{additive}}{\text{subtractive}}$.

Example:

A vessel in lat. 38 degrees 45 minutes N., long. 63 degrees 45 minutes west, by dead reckoning, observes that Nantucket Lightship bears 282 degrees true.

To find the Mercator bearing:

Nantucket Lightship lat. 40 degrees 37 minutes N., long. 69 degrees 37 minutes west.

D. R. position lat. 38 degrees 45 minutes N., long. 63 degrees 30 minutes west.

Middle lat. 39 degrees 41 minutes N., diff. long. 6 degrees 07 minutes west.

Enter table with mid. lat. 40 degrees and diff. long. 6 degrees. The correction is found to be — 1 degree 56 minutes (since vessel is in north latitude and eastward of station).

Mercator bearing is then radio bearing minus correction, or 282 degrees — 1 degree 56 minutes = 280 degrees 04 minutes.

The table is computed from the formula:

$$\text{Tan. correction} = \frac{\text{Tan. Diff. Long.} \times \text{Sine Mid. Lat.}}{2}$$

When plotting the line from the radio beacon from a vessel's observed bearing of the beacon, the corrected bearing is, of course, increased 180 degrees. It may be noted again, as a measure of precaution, that the corrections given in the following table correct only for chart distortion due to angular error in construction of charts on Mercator projection, and has no relation for error of calibration of the direction finder. The Model ER-1445 and ER-1445-A RCA Direction Finders are provided with a compensator by which the error of calibration is permanently corrected at the time the instrument is installed and calibrated. The Model ER-1485 RCA Direction Finder does not automatically correct for error of calibration, however a table of correction is furnished with the instrument tabulated from 0 to 360 degrees to give the correct relative bearing for any observed reading of the indicator.

Elements of Apparatus

20. Loop—The signal from the radio station on which a bearing is to be taken is picked up on the look above deck. When the plane of the loop is in the direction from which the signal is coming, the signal is maximum. Conversely, the signal received is zero when the plane of the loop is at right angles to the direction of the signal. As the loop is turned through 180 degrees in the manner in which the signal changes intensity is shown in figure 266. Thus it is seen that a change of 30 degrees from position 1 to position 2 only changes the signal intensity from 100 per cent to 85 per cent, whereas the same movement of 30 degrees from position 3 to position 4, changes the signal intensity from 50 per

cent to zero. Consequently, to obtain accurate bearings the indicator is set to take readings on the minimum signal.

21. Indicator—Bearings are read by means of parallex lines engraved on a piece of plate glass, which revolves above a scale as the loop is turned. The scale consists of a standard pelorus card adjusted so that readings are referred to the ship's head. One

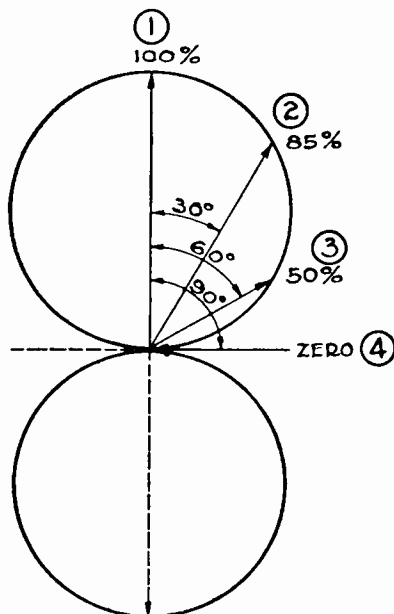

FIG. 266. Illustration of Change in Intensity of Signal.

side of the indicator is equipped with a reading glass and is also marked with an arrow head. This side should always be used for reading the bearings as it is the side used when the instrument is calibrated. The short pointers marked red and white are used only when the relative direction from which the signal is coming is not known.

On ships equipped with a Sperry compass, the pelorus card may be replaced by a gyro-repeater. In such cases, readings with the radio direction finder are referred to the true meridian.

22. Receiver-Amplifier—The receiver-amplifier must func-

tion to give a relatively loud signal in order that the minimum may be well defined, and to eliminate other signals or disturbances of whatever sort which otherwise would seriously interfere with obtaining an accurate reading. The superheterodyne receiver ranks highest in accomplishing this and, at the same time, with a simplicity of controls. There are two controls, one for tuning the loop and the other a secondary tuning. Each control scale is marked to show the approximate position of the tuning for given wavelengths.

Stations Available for Taking Bearings

In choosing a station on which to take a bearing, the following limitations should always be considered:

(a) A bearing should be avoided which involves a signal that has traveled any appreciable distance along the shore line. In such cases, the line of separation between the water and land acts as a partial reflection, bending the waves and possibly resulting in an erroneous bearing.

(b) A bearing taken on a station separated from the ship by intervening land should be considered as approximate.

(c) A bearing taken on a station more than 150 miles distant should be considered as approximate.

(d) On bearings taken shortly before or after sunrise or sunset errors due to so-called "night effect" may be observed. These errors are manifested by rapid swinging of the minimum so that the signal station seems to be changing its position while bearing is being taken. Bearings observed under such conditions cannot be relied upon. Errors due to "night effect" are usually negligible at distances of less than 100 miles.

There are four classes of stations which are available for taking bearings:

1. Special Radio Fog Signal Stations.
2. Radio Transmitters Associated with the U. S. Naval Radio Compass Stations.
3. Other Commercial and Government Radio Shore Stations.
4. Ships (under way).

To obtain bearings on stations in classes 2, 3 and 4, it will be necessary to call on the radio operator to identify the desired station by its radio call letters. When taking bearings on shore stations in class 3, it should be borne in mind that the published positions of such stations are, in many cases, only approximate. Also such stations are likely to be separated from the ship by

intervening land, which may cause swinging of the apparent direction of the station from the true reading. In general, bearings should not be taken on stations in class 3 unless the station used is known to be located directly on the shore.

Operation of Apparatus

1. Plug telephones in either jack. Another person may listen in with telephones plugged in the other jack.

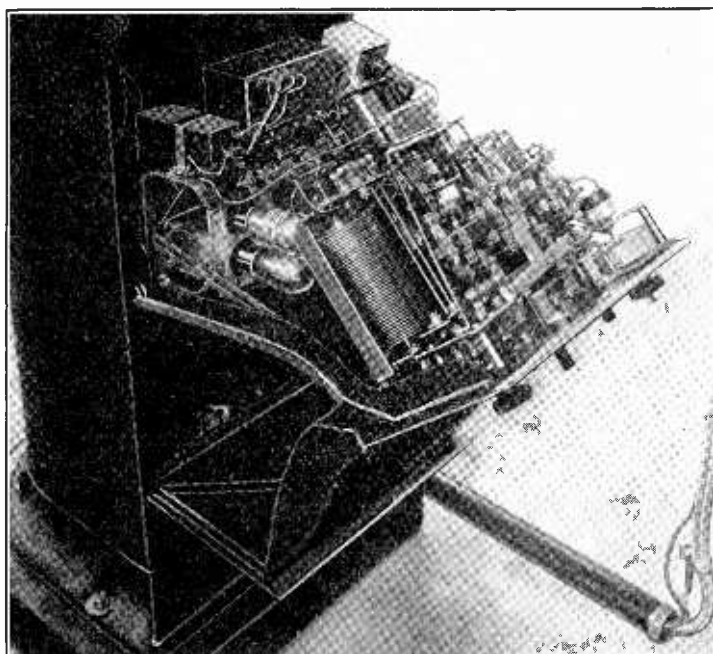

FIG. 267. Interior View of Model 1445 Direction Finder Receiver.

2. Press button on control panel marked "ON." This turns on a light in the radio room, which is a signal to the radio operator to open the antenna. When the antenna switch in the radio room is opened it automatically operates a relay in the battery compartment of the receiver to close the filament circuit. The direction finder cannot be operated until this has been done.

3. Turn filament rheostat to position where voltmeter reads five (5) volts on lower scale of meter.
4. Turn both tuning controls to approximate wavelength setting of station.
5. Carefully tune Station Selectors I and II, moving the pointers back and forth over the position for loudest signal about three times to determine the setting that gives the most intense signal. It is best to do this when the loop is turned so that the signal is not disagreeably loud. For good bearings accurate tuning of Selector I, or left hand control, is important.
6. Set BALANCE pointer at zero.
7. Rotate loop slowly until a dip in signal strength is noted. Leave loop in this position and set balance at position giving minimum signal. Re-adjust loop slightly to get zero signal strength. Read the bearings of the radio signal station from the end of the indicator that carries the reading glass. For best results both the BALANCE and the LOOP must be slowly and carefully adjusted. When taking bearings on stations within five miles it may be found desirable to reduce the signal strength. This can be done by reducing the filament voltage or by a slight re-adjustment of Station Selector II. By proper adjustment of the BALANCE bearings on beacons within a radius of 100 miles can be obtained which are definite as to sharpness, to one degree, and in some cases to 1/4 of a degree, or about as accurate as it is possible to adjust the loop.
8. If the sense of direction is not known, turn the loop to give maximum response. This is accomplished by turning loop 90 degrees after determining line of direction. Adjust filament control and Station Selector II to give signal of medium strength. Depress button on panel marked "SENSE"; noting strength of signal. Turn loop quickly through 180 degrees while holding down "SENSE" button and note strength of signal. If signal is stronger, the station is in the general direction indicated by the red pointer. If the signal is weaker, the general direction of the station is shown by the white pointer.

Maintenance

The following elements should be inspected at least once each week:

1. Turn on filaments and determine if voltage can be brought up to five (5) (to do this requires operation of the antenna switch in the radio room which in turn operates a relay in the battery

compartment of the direction finder receiver and is therefore a check on the relay).

2. Measure voltage of "B" battery, which should not be less than 60 volts. The "B" battery voltage may be read on the upper scale of the voltmeter on the control panel by depressing the push button mounted below the meter. If the "B" battery reads less than indicated above (60 volts), they should be replaced with new ones. The "C" battery should always be renewed whenever "B" batteries are renewed.

3. The storage battery used for the tube filaments is so arranged that when the "ON"-"OFF" switch is in the "OFF" position this battery is on trickle charge. Therefore the battery is being constantly charged at a slow rate while not in use. The rate of charge is normally adjusted to provide for average use of one hour per day. The charging resistance is tapped so that it may be adjusted to take care of greater use of the instrument if necessary.

Sufficient distilled water should be added to the "A" battery every three months to bring the level of the solution to within one inch of the top of the container. The storage "A" battery is of the low specific gravity type, about 1150 at full charge. The solution in the battery is covered by a layer of oil to prevent evaporation. No attempt should be made to test the state of charge with a hydrometer, as it would only draw off oil. The condition of the battery may be determined by the voltmeter on the control panel.

4. A service switch is provided in the top of the battery compartment which should always be open while the ship is in port. This switch disconnects the direction finder receiver from the ship's power and opens the battery charging circuit. It is imperative that this switch be opened if the ship's lighting circuits are connected to shore lines, which may be a.c. or of incorrect polarity for charging the battery.

Troubles and Remedies

1. If filament voltmeter does not read (when antenna switch is opened), see if relay in direction finder filament circuit closes. This relay is operated by the 6-volt "A" battery in the radio room. If it does not close, the batteries in the radio room are weak or the auxiliary contact on the antenna switch is dirty. If the relay closes but the filament voltmeter does not read, then the relay contacts are dirty or the filament battery in the direction finder is run down.

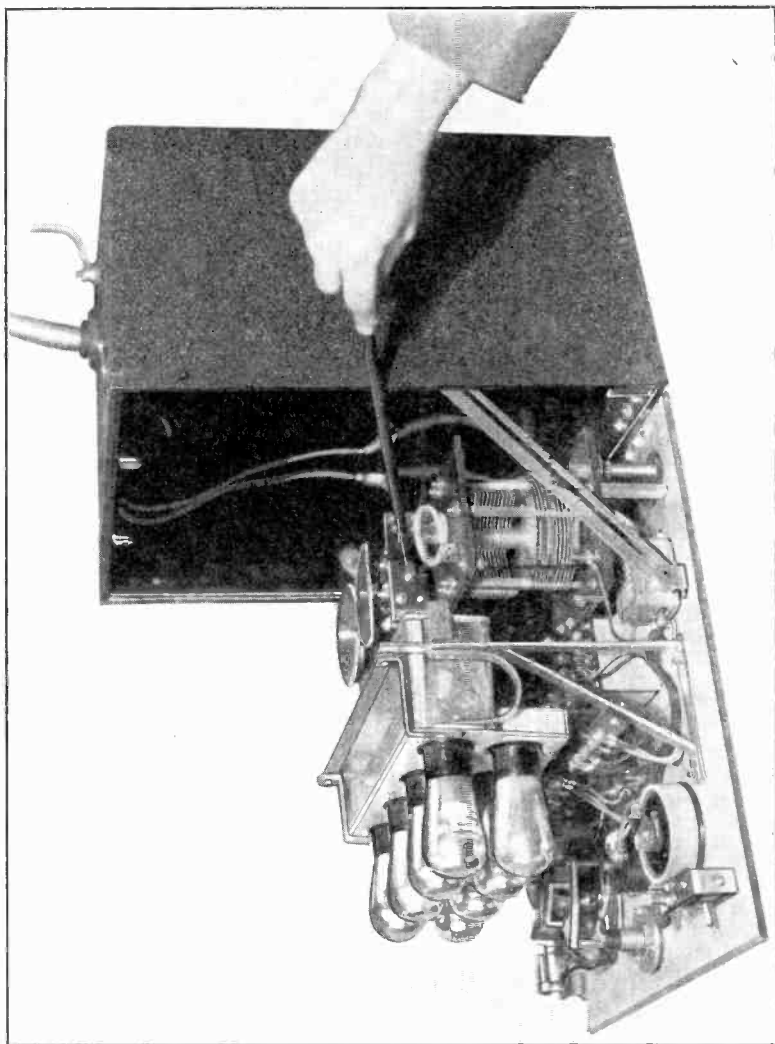

FIG. 268. "Superheterodyne" Assembly; Simplified D. F. Receiver.

2. If the filament voltmeter reads five (5) and the receiver sounds dead, inspect as follows:

(a) "B" battery voltage.

(b) Substitute a good tube in turn for each of the tubes in the receiver (these tubes use a thoriated filament which often does not burn out at the end of its useful life but has merely lost the capacity to supply emission and therefore the fact that the filament lights does not mean that the tube is good).

(c) See if connections to all batteries are in place and tight.

(d) See if brushes on the loop collector rings are making contact.

(e) Replace protective lamp in "B" battery circuit with one of spare lamps. This lamp protects tubes from damage should the filament and plate circuits become accidentally crossed. It acts as a fuse and, if burned out, the plate circuit will be opened and the receiver dead. The protective lamps consist of ordinary Eveready flash light bulbs no. 1193—3.6 volts which may be purchased in any electrical store or drug store. Persistent burning out of the protective lamp indicates a short circuit which must be cleared. It may be in a defective tube or in the wiring.

3. If the receiver is noisy, look for loose connections, particularly at battery connections and at collector rings. See if collector rings are clean and brushes making good contact. Noise may also be caused by a defective "B" battery.

RCA Model ER-1485-A Radio Direction Finder with Automatic Compensator

23. Operation of Apparatus—Adjust scale on loop shaft so that zero is under lubber line.

Unlock receiver. The receiver lock controls a switch in the filament circuit. Plug telephones in either jack. Another person may listen in with telephones plugged in the other jack.

If ship is equipped with radio telegraph equipment, instruct radio operator to open his antenna. The direction finder is calibrated with the ship's radio telegraph antenna open, and bearings taken with the antenna in any other condition are likely to be unreliable. An interlock is provided between the antenna opening switch and the direction finder receiver which causes the direction finder to be inoperative unless antenna switch is open. This automatically prevents taking of bearings with antenna closed. The interlock consists of a relay in the filament circuit which is actuated by auxiliary contacts on the antenna switch.

Turn filament rheostat to position where voltmeter reads five volts. If voltmeter does not read, make sure that receiver is unlocked and that auxiliary contacts on antenna switch in radio room are closed.

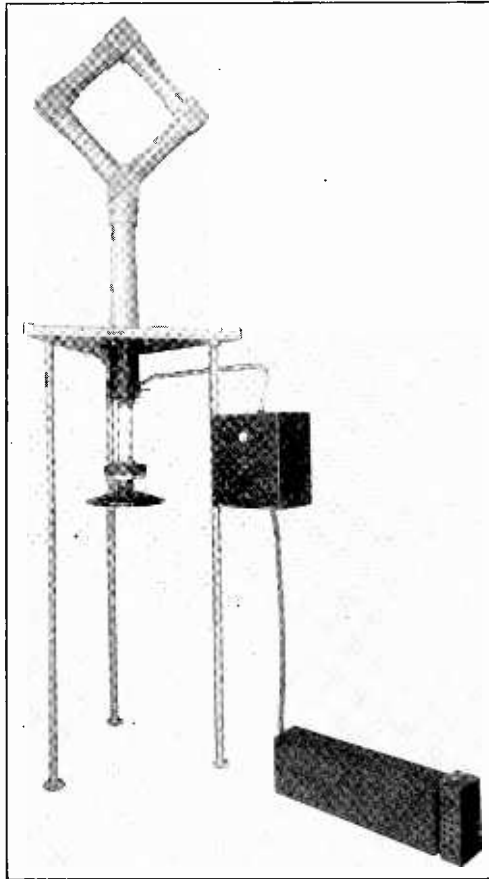

FIG. 269. Assembly of Model 1485 Direction Finder.

Turn wavelength band switch to right if it is desired to receive a signal between 550 and 1050 meters or to the left for signals between 300 and 550 meters.

Turn both tuning controls to approximate wavelength setting of station.

Carefully tune Station Selectors I and II, moving the pointers back and forth over the position for loudest signal about three times to determine the setting that gives the most intense signal. It is best to do this when the loop is turned so that the signal is not disagreeably loud. For good bearings accurate tuning of Selector I, or left hand control, is important. This control must be adjusted to exact resonance which is the setting giving the loudest signal.

Set BALANCE pointer at zero.

Rotate loop slowly until a dip in signal strength is noted. Leave loop in this position and set balance at position giving minimum signal. Re-adjust loop slightly to get zero signal strength. For best results, both the BALANCE and the LOOP must be slowly and carefully adjusted. When taking bearings on nearby stations, it may be found desirable to reduce the signal strength. This can be done by reducing the filament voltage. By proper adjustment of the BALANCE, bearings on beacons within a radius of 100 miles can be obtained which are definite as to sharpness, to one degree, and in some cases, to $1/4$ of a degree, or about as accurate as it is possible to adjust the loop.

If the general direction of the radio signal station is known, the reading should be taken on that part of the scale which will give the actual bearing in degrees relative to the ship's head and not the reciprocal of the bearing.

If the sense of direction is not known, proceed as follows:

- (a) Adjust loop and balance and read scale.
- (b) Rotate loop 90 degrees from the minimum position in the direction of the red dot on the indicator pointer. Turn balance knob to "sense" position. If signal increases slightly, the bearing just observed is correct. If there is a decided decrease, the bearing which was observed is the reciprocal of the correct bearing. The loop should be rotated 180 degrees and a new bearing taken. The sense of direction should again be checked as above and, if signal increases, the last bearing taken will indicate the correct angle of the signal station relative to the ship's head.

12. Bearings are read from the engraved scale attached to the loop shaft. This scale is divided into two parts. The upper part which is made fast to the loop shaft, carries only the lubber line. The lower part, engraved in degrees, is adjustable relative to the lubber line. It is suggested that all bearings be first observed

with the zero of the adjustable scale set on the lubber line. This will give the bearing relative to the ship's head. Lock the loop in the position at which bearing was read. To obtain a bearing relative to the meridian, it is necessary to know the course of the ship's head at the instant the radio bearing was taken. To avoid possible errors which might be caused by the ship being slightly off its course, it is advisable to have some one read the magnetic compass or gyro repeater simultaneously with the observation of the radio bearing. After ascertaining what was the true course of the ship's head at the instant bearing was observed, adjust the engraved scale relative to the lubber line until it agrees with the true course. The pointer will then indicate the true bearing of the radio signal station.

13. A light is provided on the receiver panel to illuminate the controls, also a spotlight which throws a confined beam of light on the pointer and scale. These lights are controlled by a switch on the receiver panel above the panel lamp.

14. To receive continuous wave signals pull out switch marked CW located between the telephone jacks.

24. **Maintenance**—The following elements should be inspected frequently:

1. Turn on filaments and determine if voltage can be brought up to five.

2. Measure voltage of "B" battery, which should not be less than 60 volts. If the "B" batteries read less than indicated above (60 volts), they should be replaced with new ones. The "C" battery should always be renewed whenever "B" batteries are renewed.

3. The storage battery used for the tube filaments is so arranged that when the filament rheostat is in the "OFF" position, this battery is on trickle charge. This is automatically controlled by a relay mounted in the metal switch box. Therefore, the battery is being constantly charged at a slow rate while not in use. The rate of charge may be adjusted to provide for average use of one, two, or three hours per day. The charging resistance is tapped so that adjustment may be made for the desired rate of use. Sufficient distilled water should be added to the "A" battery every three months to bring the level of the solution to within one inch of the top of the container. The storage "A" battery is of the low specific gravity type, about 1.125 at full charge. The condition of the battery may be determined by the voltmeter on the control panel.

4. A toggle switch is provided in the metal switch box which should always be off whenever the ship's dynamo is not running, or if the ship is laid up in port. This switch disconnects in the ship's power and opens the battery charging circuit. It is imperative that this switch be opened if the ship's lighting circuits are

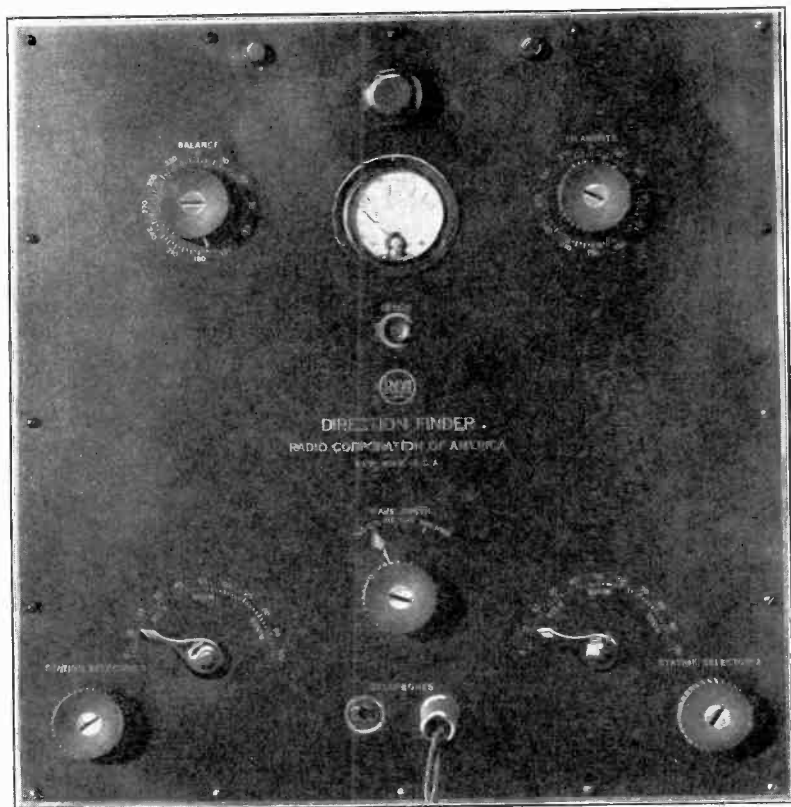

FIG. 270. Front View of Model 1485 Direction Finder Receiver.

connected to shore lines, which may be a.c. or of incorrect polarity for charging the battery.

25. Troubles and Remedies—

1. If filament voltmeter does not read (when filament control is

turned to right), see if relay in metal switch box is operating. Try operating relay by hand. Also check operation of filament relay in receiver. Try operating this relay by hand. Make sure that auxiliary contacts on antenna switch in radio room are closed.

2. If the filament voltmeter reads five (5) and the receiver sounds dead, inspect as follows:

(a) "B" battery voltage.

(b) Substitute a good UX 201-A tube in turn for each of the tubes in the receiver (these tubes use a thoriated filament which often does not burn out at the end of its useful life, but has merely lost the capacity to supply emission and therefore the fact that the filament lights does not mean that the tube is good).

(c) See if connections to all batteries are in place and tight.

(d) See if brushes on the loop collector rings are making contact.

(e) Replace protective lamp in "B" battery circuit with one of spare lamps. This lamp protects tubes and "B" battery from damage should the filament and plate circuits become accidentally crossed. It acts as a fuse and if burned out, the plate circuit will be opened and the receiver dead. The protective lamps consist of ordinary Eveready flash light bulbs no. 1193—3.6 volts which may be purchased in any electrical store or drug store. Persistent burning out of the protective lamp indicates a short circuit which must be cleared. It may be in a defective tube or in the wiring.

3. If receiver is noisy, look for loose connections, particularly at battery connections and at collector rings. See if collector rings are clean and brushes making good contact. Most cases of noise in the headphones may be traced to dirty collector rings. Remove cover from over collector rings and clean with fine sandpaper. Noise may also be caused by a defective "B" battery.

CHAPTER 15

AIRCRAFT RADIO EQUIPMENT

Aircraft Radio Beacon Development by the Bureau of Standards.²

A number of demonstrations have recently been given of the aircraft radio beacon system which has been under intensive development by the Bureau of Standards. The beacon system marks out an invisible but infallible course along which aviators can fly regardless of fog or other weather conditions. To make use of this system, an airplane need only be provided with a small receiving set carrying an indicator. An occasional glance at the indicator tells the pilot whether he is following the course, or how far off if he has deviated from it. The troublesome trailing wire antenna and headphones used in earlier stages of development have been eliminated. The experimental work is still in progress, but the system is sufficiently perfected that routine use of it on the regular airways is beginning.

With the radio beacon made practical and dependable, air route operations enter a new era of regularity and safety. Most of the trips which are now omitted or undertaken only at great risk can be confidently made. It has been the rule to undertake flights only when weather conditions were favorable enough so that the pilot could see points on the ground, and in the early days of our air mail service flying schedules were frequently interrupted on account of weather conditions.

A method of aerial navigation called "instrument flying" has been tried from time to time. When the pilot cannot see the earth below he forgets the outside world and, concentrating all his at-

²By courtesy of Geo. K. Burgess, Director Bureau of Standards, Department of Commerce.

tention on his instruments, navigates his craft from the information they convey. One instrument tells him his elevation, another his speed, another whether he is turning or flying straight away, and his compass indicates his general direction. But accurate as all these instruments may be, they do not tell him if he is drifting sidewise due to a cross wind, nor do they tell him exactly at what speed he is traveling because there may also be a head or tail wind to slow him down or to speed him up. Thus while instrument flying may enable a pilot to keep his craft at a safe altitude and in a generally correct direction, the hazard of getting far away from the course into strange, unfamiliar, and possibly dangerous areas is ever present.

What "instrument flying" has hitherto lacked is precisely supplied by the radio beacon system, because with its use the pilot can always know his location. The radio beacon system includes the double-beam directive beacon and smaller stations known as "marker beacons."

1. Early Work—The first work on the double-beam directive type of radio beacon was done by the Bureau of Standards in 1921 for the Army Air Service. The method consisted of transmitting radio waves alternately for two directive coil antennas placed at an angle with each other. Each antenna transmits a set of waves which is directive, i.e., it is stronger in its own plane than in other directions. When an airplane flies along the line exactly equidistant from the two beams of waves, i.e., on the bisector of the angle between the planes of the two antennas, the pilot hears the signals from the two with equal intensity. If the airplane deviates from this line the signals from one antenna are louder and the other weaker. Equality of received signals thus indicates a fixed line in space and provides a means to guide an observer on any kind of craft along that line. A different signal is used on each antenna, so as to distinguish between them.

In the early work a switch was used to throw the radio-frequency power from one antenna to the other. Tests made at Washington on the ground and on ships showed that a course was effectively marked out, permitting navigation without aid of landmarks, compass, or other navigational device. The apparatus was next set up at Dayton, Ohio, and tests made in the air. The method was successful in airplane flights, and had the important advantages that it required no special apparatus to be carried on the airplane, and that no error was introduced by wind drift.

2. Principle of Operation—If two loop antennas are arranged at an angle of 135 degrees and the energy from a trans-

mitting set impressed first on one and then the other once every second, there will be propagated intermittent waves directly from each coil. The intensity of the emitted waves with respect to the plane of each coil will vary in accordance with a figure-of-eight. (See previous paragraph on directive properties of a loop antenna.) Should an airplane or vessel fitted with an ordinary receiving set be located on any bisector of the angles formed between the two coils it will receive signals of equal intensity from both of them. Thus a definite course may be held in thick or foggy weather simply by navigation so that the signal strength from the two coils remains equal.

Referring to figure 271, the two loop antennas are arranged so as to be energized alternately by a radio transmitting set W . This is done by means of a special switch S , which is thrown rapidly from one loop to the other. Intermittent radio waves are thus propagated from each loop, the intensity with respect to the plane of the loop varying in accordance with a figure-of-eight as shown by the circles A' , A' and T' , T' . The loop aeriels are represented by the lines aa and tt . Thus a receiving set located anywhere along the line OY would receive a signal proportional to the length of the line OM from loop tt and another a few seconds later of intensity proportional to the length of the line OQ from loop aa . It is apparent, therefore, that along the line OY the signals from coil tt are more than twice as strong as those from coils aa . A receiving set located along the line OX will receive signals of equal intensity from both coils since (as it is the bisector of the angle formed by the two coils) the distance OP is the same for both coils. A similar condition exists along the lines OV , OK and OL . Therefore, if the receiving set is moved to any other points than those along these lines, signals of unequal intensity will be received from the two coils. Thus a ship or airplane fitted with an ordinary receiving set navigating so as to keep the signals received from aa and tt of equal intensity will be going toward or away from the point O or position where the two-loop antenna transmitting set is located.

In the following four years, the Army engineers at Dayton, Ohio, developed the beacon further; in particular, they devised a signal-switching arrangement such that the signals from the two antennas merged into a steady dash when on the course, giving an added criterion besides that of equal signal intensity to enable the observer to tell whether he was on or off the course. They also introduced a goniometer, or mutual inductance device, to permit orienting the course in any desired direction without moving

the antennas. The beacon as thus developed is described in "Stationary and Rotating Equisignal Beacons," by W. H. Murphy and L. M. Wolfe, *Journal Soc. Automotive Engineers*, 19, p. 209, Sept., 1926.

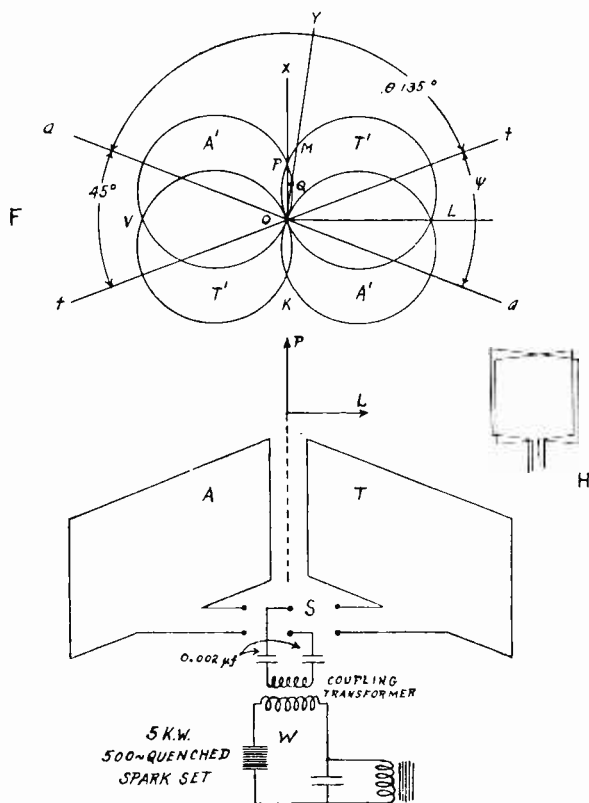

FIG. 271. Characteristic of Signal from Directive Radio Beacon Transmitter.

3. Development for the Department of Commerce— Shortly after its formation in July, 1926, the Aeronautics Branch of the Department of Commerce began a program of establishing aids to navigation on the nation's airways. The aids determined upon were: Upper air weather information, airways light-

ing for night flying, and radio aids. It was recognized that radio offered important advantages in the way of communication between the ground and air and also direct navigational assistance. As there had been little or no experience in the use of radio under the conditions of flight on the civil airways in the U. S. (the Air Mail Service did not employ radio on its airplanes), it was not immediately evident what form these radio aids should take.

The Aeronautics Branch assigned the necessary experimentation and development in this field to its research division, which was organized in the Bureau of Standards. As a first step, a conference was called, June 22, 1926, to secure information and advice from various organizations which had experience bearing upon this problem. The recommendations made have been of value to the Department in the developments since that time.

The development of radio aids for the airways was immediately begun, the principal features to be radio telephony from ground to aircraft, and a radio beacon system. One of the major considerations in narrowing the choice of radio aids to these two was the idea of minimizing the apparatus which would have to be carried aboard the airplanes. The system adopted requires only a simple receiving set to be carried by an airplane. With this set it receives radio telephone information on weather conditions, etc., and also the radio beacon signals to guide it along its course. All of the complicated and expensive apparatus is on the ground at the transmitting end, to be maintained by the Government. A description of the general system, and discussion of the considerations affecting it, are given in "Applications of Radio in Air Navigation," by J. H. Dellinger, *Engineers and Engineering*, 43, p. 301, Nov., 1926; *Mechanical Engineering*, 49, p. 29, Jan., 1927.

The experimental work done in 1927 made it apparent that this system is entirely practicable and that all technical requirements will be met by placing the radio telephone transmitting stations and the main beacon stations at the principal airports, something like two hundred miles apart. The Department of Commerce has begun the purchase of apparatus to make a number of the installations.

It has been demonstrated that the use of radio telephony to transmit weather and other important navigational information to the airplanes while in flight is thoroughly practicable. In public demonstrations in May, 1927, Hon. W. P. MacCracken, Assistant Secretary of Commerce for Aeronautics, and Dr. G. K. Burgess, Director of the Bureau of Standards, held conversations from their desks with other officials in airplanes. In one

case the whole two-way conversation was broadcasted to the radio public from station WRC.

This discussion is limited to the work on the radio beacon system. When the specific development of the beacon for the civil airways was begun in 1926, several improvements over the existing form of the beacon were sought. These included some matters of design detail (involving the goniometer, interlocking switch, etc.), an automatic device for setting the course successively on several courses (for use at airports where several courses intersect), and means of replacing the telephone receivers by a visual indicator. The work has been done at two field stations, one at College Park, Md., a suburb of Washington, and the other at Bellefonte, Pa., chosen because of its location on the New York-Cleveland airway in particularly hazardous mountain terrain. These two stations are equipped with radio beacon and also radio telephone and telegraph transmitting apparatus. They serve as development laboratories and as model and demonstration stations, and are in addition available to give radio service to the air routes on which they are located.

At College Park there is a directive radio beacon which is equipped to send signals of the aural interlocking variety, and also to send signals modulated at two low frequencies necessary for the visual indicator system that the Bureau has developed. The College Park stations are equipped with other special types of equipment for the sending of signals for experimental purposes. At Bellefonte the directive radio beacon is being remodeled so that it can send signals for use of the visual system in addition to the aural system.

The beacons operate in the frequency band 285 to 315 kc., and the telephone stations in the band 315 to 350 kc. These are allocated to air service by the 1927 International Radio Convention. For the present the beacons are adjusted to the frequency of 290 kc., and the telephone stations to 333 kc.

4. Visual Indicator Systems—The Bureau's work of the past year or so has been largely directed to the effort to replace the aural method by a practical visual method. The use of telephone receivers and determination of location by distinguishing certain aural signals requires skill and entails a certain strain upon the pilot. This would be eliminated if a method could be devised which required no listening but only an occasional glance at the instrument board.

The army engineers worked out a visual system in 1925, which superposed an arrangement of relays and lights on the interlock-

ing signal beacon. This was not found to be practical under flight conditions.

The Bureau of Standards has experimented with a number of possible visual indicator systems, most of them involving the use of two different modulating frequencies for the two crossed loop antennas. The modulated radio frequency is on the antennas continuously, instead of throwing from one to the other antenna as in the aural system. This permits the use of continuously indicating instruments on the airplane. If the airplane gets off to one side of the course, the intensity of one of the modulated waves will increase and the other decrease, owing to the directive nature of the two coil antennas.

It is required that a device be used in connection with the receiving set on the airplane which will give a visual indication of the relative amounts of the two modulated waves. This requires some form of tuning to these two modulation frequencies. In several devices tried, the tuning was secured by means of tuned circuits attached to the output of the receiving set. Modulation frequencies of 500 and 1000 cycles were used.

One form of indicator consisted of a pair of neon glow lamps. One of these was in each tuned circuit. They were so adjusted as to just light up when the airplane was on the course and they received equal voltage. Because of their critical response voltage, they gave a rather sharp indication when the voltage of either tuned circuit dropped. In another form of indicator the two tuned circuits were connected differentially to a rectifier and direct-current galvanometer. When the airplane was on the course and currents are the same in the two tuned circuits, the d.c. outputs balanced and the galvanometer needle remained in the center of the scale. For deviation to either side the galvanometer needle moved correspondingly. These forms of indicator were found too critical and too complicated for practical use.

The form most recently developed, which is likely to be adopted, consists of two vibrating steel reeds. Their vibration gives the visual indication and they themselves provide the necessary tuning to the two modulation frequencies. The indicator is very simple and practical, merely being connected to the receiving set in place of telephone receivers. When the beacon signal is received the two reeds vibrate. The tips of the reeds are white, with a dark background behind them, so that when vibrating they appear as a vertical white line. The reed on the pilot's left is tuned to a frequency of 85 cycles and the one on the right to 65 cycles. It is only necessary for the pilot to watch the two white lines produced

by the vibrating reeds. If they are equal in length, he is on his correct course. If the one on his right becomes longer than the other, the airplane has drifted off the course to the right (into the region where there is more of the 65 cycles). If he drifts off the course to the left, the white line on the left becomes longer.

5. Beacon Transmitting Apparatus—The directive radio beacon station is usually located at an airport, just off the landing field. It employs two loop antennas crossed at an angle of 90° with each other. Each of these emits a set of waves which is a maximum in its plane and a minimum at right angles thereto. Both antennas transmit 290-kilocycle waves but modulated at two dif-

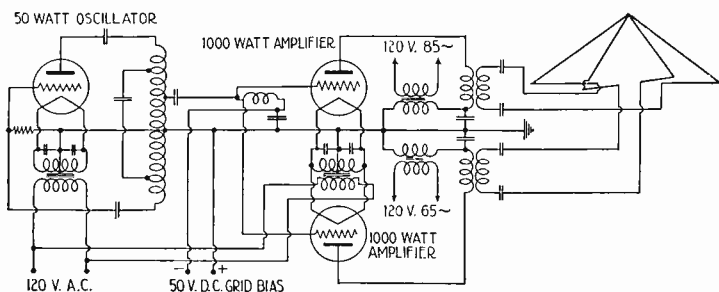

FIG 272. Diagram of Radio Beacon Transmitter Developed by Radio Section, Bureau of Standards.

ferent frequencies. A master oscillator producing 290-kilocycle current feeds two power amplifiers. These are modulated by two different low frequencies. Their outputs go separately to the two loop antennas.

Figure 272 is a circuit diagram of the transmitter in simplified form. The two loop antennas terminate in tuning condensers and coils as shown. They are both tuned to 290 kc., and so adjusted that there is no coupling between them. The coils are coupled to the plate circuits of the two 1000-watt amplifiers. The plate circuits are untuned, which reduces intercoupling between the two tuned loop antennas through the plate circuits of the power amplifiers. A radio-frequency voltage is supplied to the grids of the two amplifiers from the 50-watt oscillator operating at 290 kc. with direct voltage (not shown) applied to the plates.

The plates of the amplifier tubes are supplied with high-voltage alternating current through transformers, one being connected to a source of 85-cycle voltage and the other to a source of 65-cycle

voltage. These are the two modulation frequencies, to which the reeds of the visual indicator are tuned. Each power amplifier passes radio-frequency current every alternate half cycle, the frequency being 85 or 65 cycles. This occurs each time the plate is positive. The completely modulated output from one amplifier supplies power to one of the antennas only, and the other amplifier supplies only the other antenna.

The use of a common master oscillator prevents any shift in the indicated course due to tuning of the receiving set, which might occur if two master oscillators were used in case they differed slightly in frequency.

As mentioned, the description is illustrative only. In practice means must be provided to prevent the production of harmonics, which are not permissible.

A number of other methods for modulating the carrier frequency at the low frequencies required are possible and have been used. The method just described involves the supplying of plate power directly to the amplifier tubes at the low frequencies desired. This method was not found entirely practicable because the constancy of the low frequencies depends upon the steadiness of the frequency of the power source available, which in most cases varies somewhat. Even with a steady source available, alternators with synchronous motors of special design to drive them would be necessary.

Vacuum tube oscillators controlled by tuning forks which supply sufficient voltage to enable grid or plate modulation of intermediate amplifiers have been developed, and solve the difficulty of keeping the low frequencies steady. In the grid modulation method the modulating frequency is impressed upon the grid of one of the amplifier tubes. With the plate modulation method the low-frequency voltage is applied to the grids of modulating tubes, the plates of which are connected to the output of one of the amplifiers in a circuit arrangement analogous to that of the ordinary method of plate modulation employed in broadcasting stations. Both methods give satisfactory performance although the plate modulation scheme has some advantage in that less distortion of the wave form is introduced.

When the beacon is to be used for air routes in several directions, a goniometer, not shown in Fig. 272, must be introduced. This is a coupling arrangement connected between the antennas and the amplifiers, rotation of which is equivalent to rotating the antennas. It has two pairs of coils, each pair consisting of an 8-turn rotor and a 32-turn stator. The stator coils are fixed at

right angles to each other, and so are the rotors. Rotation of the rotor coils with respect to the stators orients the course marked out by the beacon in any desired direction. At airports where several courses intersect the beacon course can be set successively on the several courses for fixed time intervals.

6. Receiving Equipment—The beacon system can be used with any receiving set which operates at the frequencies used, merely replacing the telephone receivers by the simple reed indicator unit. There are, however, a number of special conditions involved in receiving on an airplane, and the bureau has developed special receiving sets in order to use the beacon system under the most advantageous conditions.

The use of a trailing wire as an antenna has long been recognized as a source of difficulty in airplane reception. Besides its obvious inconvenience and possible dangers, it is particularly unsuitable to radio beacon reception because it has a directional effect introducing apparent variation of the course and making it more difficult for a pilot to utilize the beacon signals. The trailing wire has been eliminated through the development of a receiving set having the necessary sensitivity and other characteristics necessary to receive on a short antenna through the ignition interference. The antenna now used is a metal pole extending vertically from the cockpit, having a total length of 10 feet. It has numerous advantages, not the least being that it practically eliminates direction errors in the beacon course which have been observed at night.

The receiving set weighs less than 15 pounds; its power supply is a 6-volt battery weighing 15 pounds. The receiving set operates in the frequency range from 285 to 350 kilocycles. A circuit

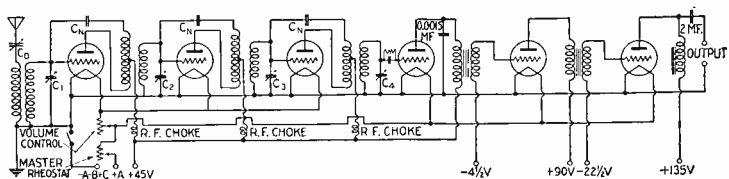

FIG. 273. Diagram of Radio Receiver Employed on Aircraft, to Receive Radio Beacon Signals and Weather Reports.

diagram is given in Fig. 273. It is used to receive either the beacon signals or radio telephone or telegraph messages at will.

It is highly selective as well as sensitive, and is provided with interstage shielding as well as shielding against extraneous inter-

ference. The selectivity of the set design is supplemented by the great selectivity of the reed vibrators, which help greatly in reducing interference. It uses 3-volt tubes, selected for freedom from microphonic noises. The set has remote control arrangements for tuning and volume, so that the set itself can be out of the way in the tail of the airplane.

The indicator for the beacon signals is mounted on the instrument board in front of the pilot. It functions essentially the same

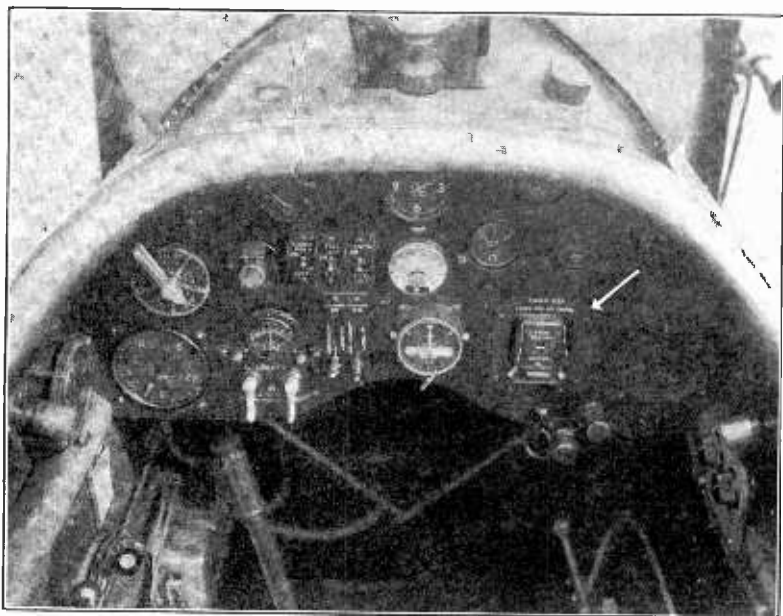

FIG. 274. Instrument Board on Aeroplane Showing Visual Indicator Which is Actuated by Radio Beacon Signals.

as a telephone receiver except that its vibrating portions are tuned while a telephone receiver responds almost equally to all frequencies. The indicator consists of a set of coils, through which passes the audio output current of the receiving set, acting on a pair of short steel strips or reeds. These two reeds are tuned to the two modulation frequencies of the beacon signals. When the two are received with equal intensity the two reeds vibrate with equal amplitude. Their vibration is made evident by the mo-

tion of white tabs on their ends. These tabs are all that the pilot sees of the instrument, apparently lengthening out into white lines against a dark background when the indicator is in operation. By piloting the airplane so that the two lines are always of equal length, he remains on the indicated course.

7. Supplementary Features—The directive beacons at College Park, Md., and Bellefonte, Pa., operate on 1 kilowatt. Such beacons, located about 200 miles apart, would give satisfactory beacon service when the course usually flown is practically a straight line between them. When the course varies in direction, lower power beacons at the turning points could be used. Where the course is straight for a considerable distance such as 200 miles, it is planned to utilize a supplementary feature called "marker beacons." The directive beacons successfully guide a pilot along the course but give him no information of the distance traversed along it. This lack is supplied through the installation of non-directive beacons, placed along the airway at short intervals (perhaps 25 miles). These marker beacons are of very low power (a few watts), and emit a characteristic signal which the airplane pilot will receive for one or two minutes. They tell the pilot when he is passing over a specified place, so that he can locate himself and always know his position. In fact, through keeping track of these marker beacons, the pilot will be able to gauge wind conditions and note any change in direction or velocity as he proceeds during flight. The marker beacons operate a 60-cycle reed vibrator mounted alongside the directive beacon indicator on the airplane's instrument board. Each marker beacon will send the characteristic signal assigned for its location, which will coincide where possible with the characteristic flash signal of the light beacon at the same location. Thus the marker beacon signals will come to the pilot in a logical and automatic manner.

The reed indicator can also be used to transmit messages to the pilot when necessary, merely by interrupting the transmitting current at a slow rate in accordance with a code understood by the pilot. Additional reeds, tuned to other frequencies, can be used if desired to send special information.

The audio-frequency tuning of the reed vibrators also helps to avoid interference between the directive beacons. When one beacon station uses modulating frequencies of 65 and 85, the next station could use 75 and 95, etc. Indicators consisting of several pairs of reeds are easily installed on the instrument board of an airplane.

8. Application of the System—Flights have been made under practical conditions up to 135 miles, in which the beacon signals actually determined the course. Parts of these flights

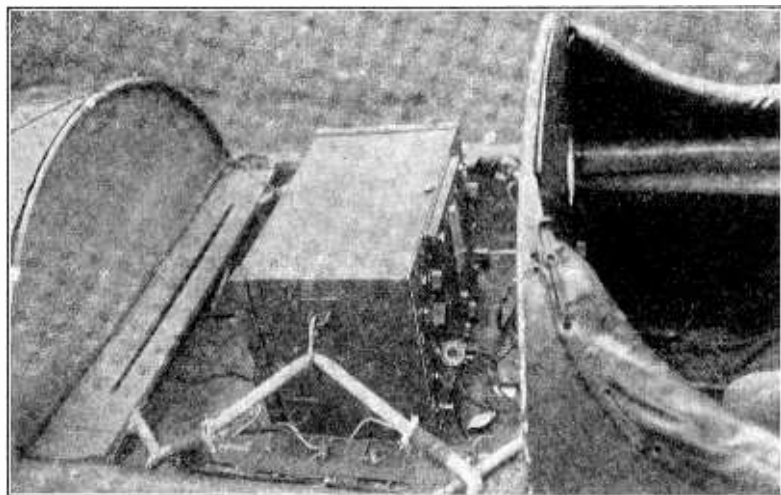

FIG. 275. Radio Receiver Installed on Aeroplane for Reception of Radio Beacon Signals and Weather Reports.

were made under conditions of low visibility, when the pilot had only the beacon indicator to determine his direction. To a large extent the device is unaffected by interference. It is affected little by airplane engine ignition interference. Such interference does not change the operating characteristic of the indicator signal, but merely reduces the distance range from the beacon station. The system was recently demonstrated to various prominent Government officials.

This development insures the full success of the Department of Commerce program of aids to air navigation. It is the intention of the department to establish radio telephone and radio beacon stations along the civil airways throughout the country, probably at the principal airports. To utilize both services, airplane operating companies will require only to provide a moderate amount of engine ignition shielding and to install a very simple radio receiving set on each of their airplanes.

Opinion recently expressed by the leading aviators converges on the necessity of a course indicator that will guide airplanes in conditions of low visibility. The radio beacon provides this and when the Department of Commerce has completed its development and established the system over the country, airplanes in flight will always have the beacon signals available to keep them constantly informed of their location. Indeed, when a pilot leaves his regular course either accidentally or to avoid a stormy area, the radio beacon will show him the way back.

9. Aircraft Radio Corporation Model B Aircraft Beacon and Telephone Receiver—The rapid growth in air transportation of freight, mail, and passengers, together with the development of radio aids to air navigation in the forms of beacon and weather service, has created an urgent need for suitable aircraft radio receiving equipment to operate over a limited band of frequencies. In the 1927 International Convention the 285–315-kc band was allocated for radio beacon services, and the 315–350-kc band for aircraft communication. It is the purpose of this article to describe the physical and electrical characteristics of an aircraft radio receiver designed for the above frequency ranges. This receiver is of practical commercial design, and has successfully withstood the severe conditions of regular operation on mail planes.

The design of the receiver was undertaken over a year ago at the request of the Bureau of Standards. The primary requirement of such a receiver was that it should be suitable for the reception of both visual and aural beacons with a consistent range of 150 miles on signals from a 2-kw ground transmitter, using a rigid pole as antenna not more than two meters in height and the bonded metal members of the airplane structure as a counterpoise. The design of a receiver to meet this unusual sensitivity requirement was undertaken as a progressive step in that program of aircraft receiver development so ably initiated in the work described elsewhere by Messrs. Pratt and Diamond.¹

The severe conditions of vibration and shock, and the great diversity of climatic conditions under which an airplane receiver is used, present certain novel problems of design. Above all else, an airplane receiver must be rugged, light, and compact. The receiver as a whole must be adequately shock-proofed from its mounting to prevent destruction of tubes and wiring by vibration; supplemental shock-proofing of the vacuum tubes within the receiver is also advantageous since the tube elements have natural

¹ By courtesy of Dr. L. M. Hull, Vice-President, Aircraft Radio Corporation, Boonton, N. J.

frequencies of mechanical vibration which may be excited at certain engine speeds. Lightness and compactness in the power supply are highly desirable. A further important requirement of present airplane receivers is that they be capable of installation wherever a vacant spot may be discovered in the plane. For simplicity of tuning and remote-controlling the receiver should have few controls and these should be of ample dimensions and shaped so that a pilot may easily operate them even though wearing heavy gloves. Further, it is highly important that all controls be equipped with some form of locking device to prevent creeping caused by vibration. The problem of rendering radio receiver performance sensibly independent of moisture is acute in designing a receiver for airplane use. A plane flying through fog encounters extremes of humidity seldom met indoors on the ground. The combination of receiver and associated antenna should have sufficient sensitivity to reach the average atmospheric noise level, assuming, of course, that ignition interference from the motor has been reduced to insignificance by shielding. A brief discussion of ignition shielding will be given later in this paper.

It was formerly considered necessary to employ a trailing wire as a receiving antenna. Mechanical objection to this arrangement are obvious, particularly in the case of mail or freight airplanes where the pilot must handle the antenna. Experience with reception of beacon signals has disclosed the further disadvantage of a trailing wire receiving antenna which results from the interception by the antenna of any horizontal components of electric force in the incoming wave. Two types of error are associated with these horizontal components, the "airplane effect" and the "night effect." "Airplane effect"² is produced by the inclination of the antenna when the airplane flies at an angle greater than zero with respect to the beacon course. It can occur irrespective of the presence of a downcoming or reflected wave, and thus may be troublesome in the daytime. It would be entirely eliminated by a wholly vertical antenna system. "Night effect" is produced by the downward wave reflected from the Heaviside-Kennelly layer and may be modified by the ground wave. In general it is increased by increasing length of the transmission path. It manifests itself, in the case of directional transmission to a non-directional receiver, as an apparent wandering of the transmitted beam. When the direction transmitter is a loop system, "night effect"

² By the Sommerfeld reciprocity theorem this situation is equivalent to a direction-finding loop on the ground and transmission from a partly horizontal antenna. The error so produced has been recognized for many years. See Ballantine: "Yearbook of Wireless Telegraphy" (London, 1921).

cannot be eliminated by the use of a vertical antenna, although it may be somewhat reduced thereby.

To summarize, the use of a rigid vertical antenna is justified by the elimination of physical hazards and burdens of maintenance on the pilot, as well as by a substantial reduction in the normal beacon errors. Accordingly, such an antenna was recommended by Radio Frequency Laboratories at the outset and the receiving equipment was designed with this in view. Subsequent experience has tended to justify this line of approach.

Owing to constantly changing conditions in the allocated frequency band it is difficult to specify just what minimum degree of selectivity the aircraft receiver should possess. At the present time, the problem of congestion in the 285-350-kc band is not acute, and for satisfactory discrimination the aircraft receiver requires somewhat less selectivity than is required in a modern broadcast receiver. Experience indicates that the order of selec-

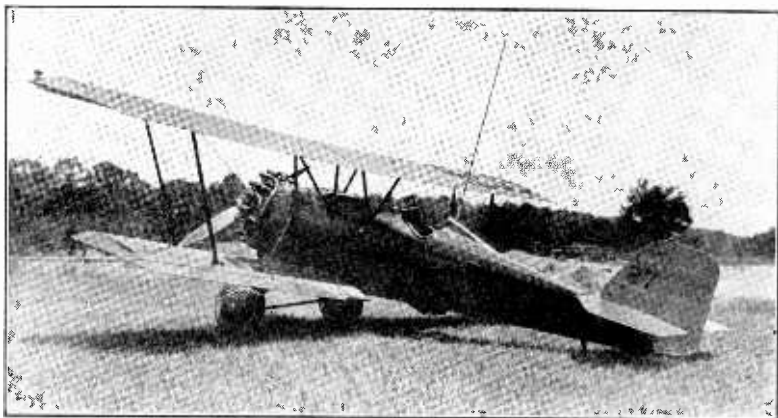

(Courtesy of Radio Frequency Laboratories, Inc.)

FIG. 276. Installation on Pitcairn PA-5 Mail Plane Showing Short Rigid Vertical Antenna.

tivity corresponding roughly to three tuned circuits in cascade, none of which has a power factor greater than one per cent, is sufficient for present requirements.

A severe demand on fidelity of the aircraft receiver is imposed by the visual type of beacon. In the visual beacon the radio-frequency excitations of the two crossed coils are modulated respectively with two different audio frequencies instead of with

dots and dashes as in the aural type beacon. These two audio frequencies differ by about 20 cycles and are usually both between 50 and 120 cycles per second. The aircraft receiver should therefore respond uniformly to modulation frequencies down to 50 cycles per second. For radio-telephonic reception of weather reports the aircraft receiver should maintain substantial fidelity up to frequencies of 3000 cycles per second and cut off rather sharply above this frequency in order to reduce noise.

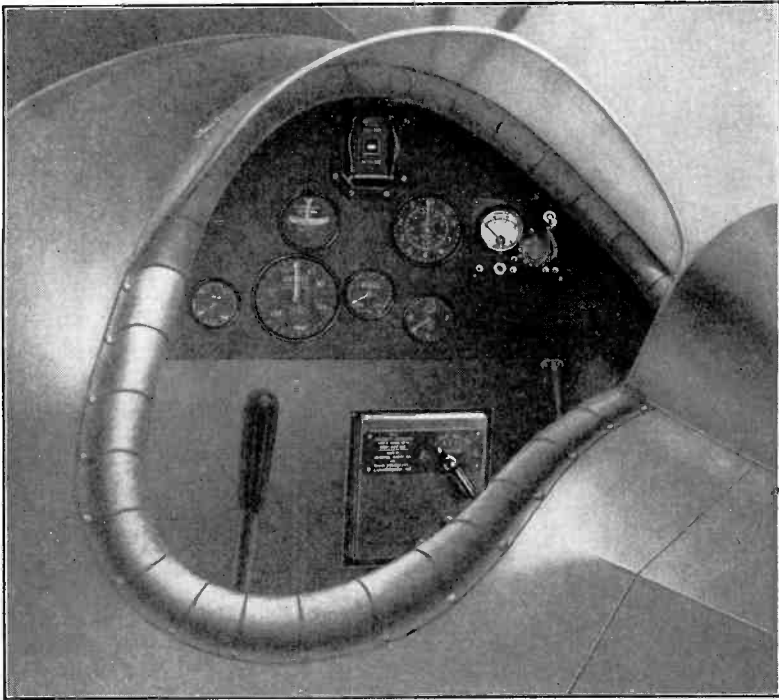

(Courtesy of Aircraft Corp. Radio Frequency Laboratories, Inc.)

FIG. 277. View of Control Cockpit in Pitcairn Plane and Receiver Installation; Reed Indicators on Instrument Panel, Upper Center. Receiver Control Panel at Right, Receiver Below.

Figure 276 is from a photograph of a mail plane equipped with the RFL receiver and vertical pole antenna. In this installation

the receiver was mounted in the front of the pilot's cockpit so that a remote tuning control was not required. The dash control panel (which will be described later) contains the volume control and is mounted on the instrument board. The front face of the receiver, dash control panel, and reed indicator are visible in figure 277, which is from a photograph taken looking forward into the pilot's cockpit. The antenna is a 7/8-in. diameter duralumin tube triangularly guyed to the upper wing and fuselage. In later installations the tube has been stream-lined to reduce wind resistance. The height of the tube above the fuselage is about two meters. With most planes, this will permit entrance to hangars having a clearance of 14 feet, so that the antenna need never be taken down.

The indicator reeds are held in a shock-proof mounting and are accurately tuned with temperature compensation to the two modulation frequencies of the beacon transmitter. They vibrate with equal amplitudes when the airplane is on its course. If the plane strays to the left of its course, the left reed develops a greater amplitude of vibration than the right, and vice versa. The dash control panel includes a volume control, which varies the filament current of the radio-frequency amplifier tubes, a double-range voltmeter for indicating the condition of plate and filament batteries, a switch for turning the receiver filaments "on" and "off," two cables, one making connection with the receiver and the other with the power supply, and a jack for the connection of telephones or reeds. The cable from the control panel to the receiver makes connection with the receiver through a multiple point plug. The mounting frame which supports the receiver is constructed to slide and lock in a track which is permanently fixed in the plane. These arrangements simplify the removal of the receiver from the plane. The front face of the receiver contains antenna and ground binding posts and the single tuning control, about which a direct calibration in kilocycles is engraved. The tuning control is the only control physically associated with the receiver itself, and is therefore the only control for which remote operation need ever be specially provided.

In almost all instances the airplane carries a storage battery for navigating or landing lights. This battery may be used for the filament supply of the radio receiver. Otherwise, a small 6-volt lead storage battery is provided. Such a battery, especially designed for airplane use, is now made by a number of manufacturers and weighs about ten pounds.

The left side of the receiver is hinged to permit access to the

tube compartment. In figure 278 this side has been opened to show the arrangement and method of shock-proofing the tubes. The tubes are all mounted on a rigid aluminum channel, which is

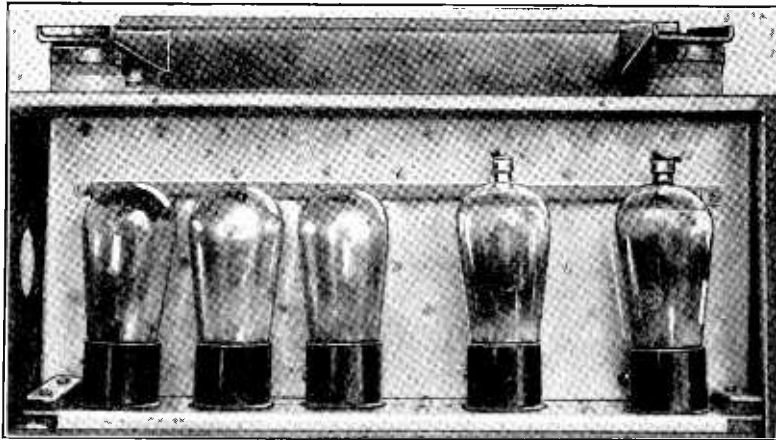

FIG. 278. Tube Compartment of Model B Receiver, Showing Shock-Proof Insulation of Tube Girder and Auxiliary Shock-Proof Support at Top of Tubes.

insulated from the receiver chassis by sponge rubber washers. Two horizontal sponge rubber strips, one fitted to the hinged side and the other to the receiver chassis, bear lightly against the tops of the tubes above the points of maximum diameter of the bulbs, and prevent the tubes from creeping out of their sockets or moving laterally in case appreciable vibration reaches them. Felt strips along the edges of the hinged side serve to protect the chassis from dust and moisture.

Five tubes are employed as follows: two shielded tetrodes as radio-frequency amplifiers; two high- μ triodes as detector and first audio amplifier; and a power triode as the second audio amplifier.

There are three tuned circuits operated by a single control. In place of the conventional gang condenser a gang variometer is used. This gang variometer is a rigid unitary assemblage of three approximately cubical cells, each of which houses a variometer. The design of the radio stage is simple and merely involves determining for a chosen size of shield the variometer

of required inductance range which has the lowest power factor. Two general types of construction have been successfully employed for the variometer gang: first, a welded construction using pure aluminum sheet; and second, a cast construction using an aluminum alloy coated with copper by the Schoop spray. Fixed condensers molded in bakelite are used in conjunction with the variometers in the tuned circuits.

Tuning by variable inductance is not desirable where a wide frequency range must be covered, but it possesses marked advantages when a frequency band defined by limits of two to one or less is required. It results in a very obvious saving of weight and space. Further, when used in conjunction with an antenna short in comparison with the wavelength, it permits exact single control with no trimming adjustments, when the antenna capacity is made equal to the fixed capacities employed in the other tuned circuits. Identical variometers may then be employed in the radio stages and antenna input circuit.

The use of tetrodes in the radio amplifier results in a radio gain of approximately 50 per stage instead of the gain of 10 or 15 per stage ordinarily obtainable with triodes. A high radio-frequency gain per stage is a more important consideration in an aircraft receiver than in ground sets where lightness and compactness are not vital. For the first audio amplifier, or at least for the detector, the tetrode is not so acceptable because of microphonic noises inherent in the structure of tubes now commercially available.

A detector capable of withstanding considerable overloading is provided in the receiver by the use of plate rectification with automatic grid bias.³ This feature is particularly important when using the receiver in conjunction with the visual type of beacon indicator. When closely approaching the beacon a pilot may neglect to keep his reed amplitude down to the proper level by adjustment of the volume control; if this condition persists, the detector may be so overloaded as to cause the reed amplitude to pass through a maximum and then fall to normal levels. Under such conditions the indicated course may be reversed, i.e., the reed of lesser amplitude will indicate the side to which the airplane is off course.

Plate detection with automatic grid bias has other advantages. It is commonly supposed that grid rectification results in greater sensitivity than plate rectification. As a matter of experimental fact the microvolt sensitivity of this tetrode receiver is twice as

³ This arrangement was devised by Stuart Ballantine.

great with plate detection as with grid detection, although the small-signal detection factor for the latter is about three times as great as for the former. Plate detection exceeds grid rectification in this case because it leaves unaffected the radio gain of the preceding stage, whereas due to electronic conductance grid detection reduces this gain by a factor greater than two to one. For the same reason the selectivity is considerably greater with plate rectification than with grid rectification. The higher output impedance resulting from plate detection does not impair the uniform transmission of low modulation frequencies essential for the visual beacon provided the coupling between detector and audio amplifier is properly designed.

A resistance coupled audio amplifier is employed in the receiver. In addition to mechanical advantages of compactness and light weight, such an amplifier has electrical characteristics desirable in the airplane receiver. Among these are low B battery drain and uniform transmission of the required modulation frequencies.

In addition to the standard laboratory measurements of performance represented by the sensitivity, selectivity, and fidelity curves, extensive tests of the receiver have been made under a wide variety of service conditions with the rigid antenna.

Tests were made early in 1928 with the receiver installed in an airplane belonging to the Bureau of Standards. With the receiver operating at less than full sensitivity, aural beacon signals from Bellefonte, Penna., were received at College Park, Md., a distance of about 140 miles. An installation on a Pitcairn Mailwing affords a satisfactory indication of the range on visual beacon service by producing at Hadley Field, N. J., normal amplitudes of the reed indicators from signals transmitted from College Park, Md., when the College Park transmitter is supplying a current of only 5 amperes to each loop. The two loops are triangular in shape, 70 feet high and 300 feet along the base. Repeated tests on an airplane belonging to the Radio Frequency Laboratories have demonstrated a reliable reception range of at least 150 miles for telephone weather broadcasts from Hadley Field, N. J. In the course of a number of flights, the Hadley beacon and weather services have been heard from Boonton, N. J., to Washington, D. C.

Similar ranges of reception of beacon and weather transmissions in different parts of the country have been observed in the course of a test flight from Boonton to Los Angeles and return.

Perhaps the most severe tests of the receiver by operators relatively unskilled in radio have been made on airplanes of the Na-

tional Air Transport, Inc., in flights over the New York-Chicago air mail route. In the course of tests under all sorts of night and day flying conditions a reliable range of 150 miles on weather and beacon service has been reported. In a number of cases satisfactory beacon service has been obtained at a distance of 250 miles over mountainous territory. The airplanes used in this service are powered by Liberty motors with battery ignition. In such planes the level of ignition noise cannot readily be reduced to the negligible amount attainable in magneto ignited air-cooled motors.

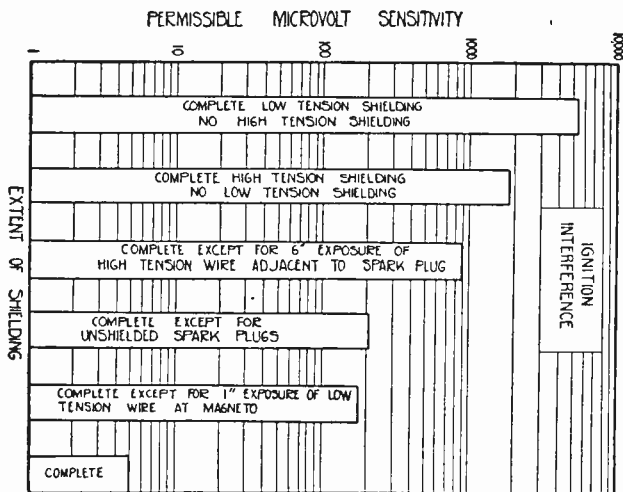
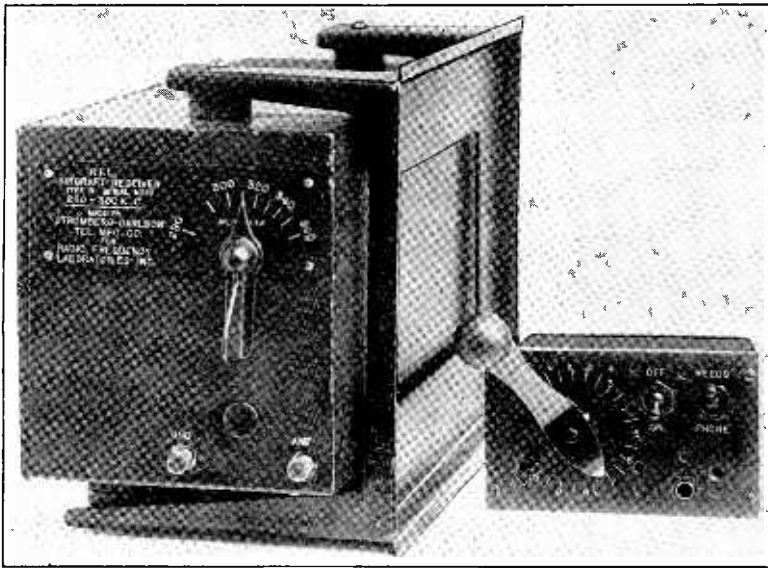

FIG. 278a. Analysis of Ignition Disturbance from Wright Whirlwind Motor; Relation between Permissible Receiver Sensitivity and Degree of Shielding.

Obviously any highly sensitive radio receiver imposes severe demands on the degree of ignition shielding. On planes equipped with battery ignition systems it is possible by careful shielding to reduce the disturbance for the receiver sensitivity herein described to a satisfactory low level. On planes using air-cooled motors with magneto ignition we have found that ignition disturbances may be completely eliminated by suitable shielding. Such shielding includes complete covering of magneto terminal blocks and all low-tension and high-tension wiring. Shielded spark plugs or their equivalent must be used.

In order to determine the relative contributions of the various parts of the ignition system to the general ignition disturbance a simple test has been devised. A receiver of the type described above is calibrated for sensitivity in microvolts against the position of the volume control rheostat. This receiver is then installed in a plane with a completely shielded ignition system. The test consists in removing various elements of the shielding and observing the points to which the receiver sensitivity must be reduced in order to make the interference just audible. Results of this test for a particular installation in an airplane equipped with a single Wright Whirlwind motor (Type J-5) are exhibited in figure 278a, which shows for various amounts of shielding the corresponding maximum receiver sensitivities permissible with negligible ignition interference. These data may be translated directly



(Courtesy of Aircraft Corp. Radio Frequency Laboratories, Inc.)

Fig. 279. Latest Model B Aircraft Receiver Showing Intensity Control Panel.

into attainable reception range if the law of attenuation is known for wave propagation between ground and plane. Of course, information of the sort given in figure 278a must be applied with

caution to other installations, where the various elements of the ignition system may be differently disposed with respect to the antenna; the only points of general interest are the relative magnitudes of the various factors contributing to the total disturbance. Of particular interest in figure 278a is the effect of shielded spark plugs in reducing ignition disturbance; they permit the use of a receiver forty times as sensitive as may be used with unshielded plugs.

Figure 279 shows a photograph of the latest Model B beacon and telephone receiver for rigid antenna developed by the Aircraft Radio Corporation. The principal difference between the old Model B described above and the new model, is the intensity control panel shown in the photograph. The logarithm of the receiver sensitivity is approximately proportional to the setting of

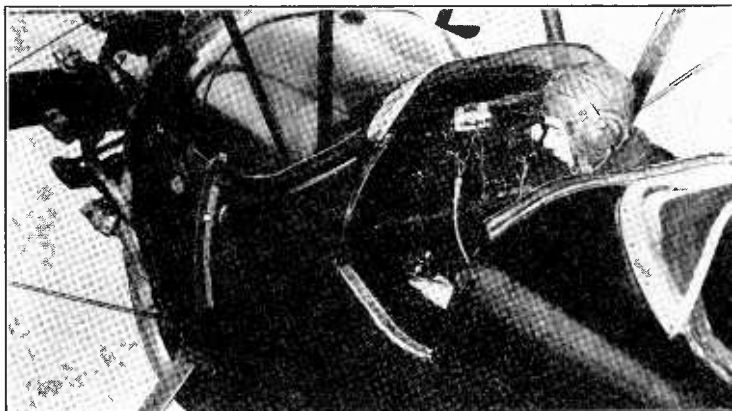

FIG. 280. Burgess Experimental High Frequency Transmitter and Receiver Mounted in Cockpit of Waco Airplane. Battery Operated.

the intensity-control lever, so that in flying on a given beacon the setting of this lever for constant signal strength serves as a rough indication of distance flown.

10. Experimental High Frequency Radio Transmitter and Receiver for Aircraft—By courtesy of the Burgess Battery Company the author has been permitted to describe an experimental short wave transmitter and receiver designed to be operated on an airplane using dry batteries for power supply, thereby permitting operation even though the airplane is on the ground.

The transmitter weighs 39 pounds including weight of its batteries and the receiver weighs 53 pounds, including microphone, key and antenna reel.

Laboratory tests indicate that the "A" batteries for the transmitter will last at least 50 hours and the "B" batteries more than 17 hours. Receiver "A" batteries will last more than 95 hours and the "B" batteries more than 200 hours.

Operating on a wavelength of 79 meters, communication was carried on by CW up to 500 miles. Employing voice modulation communication was established up to fifteen miles.

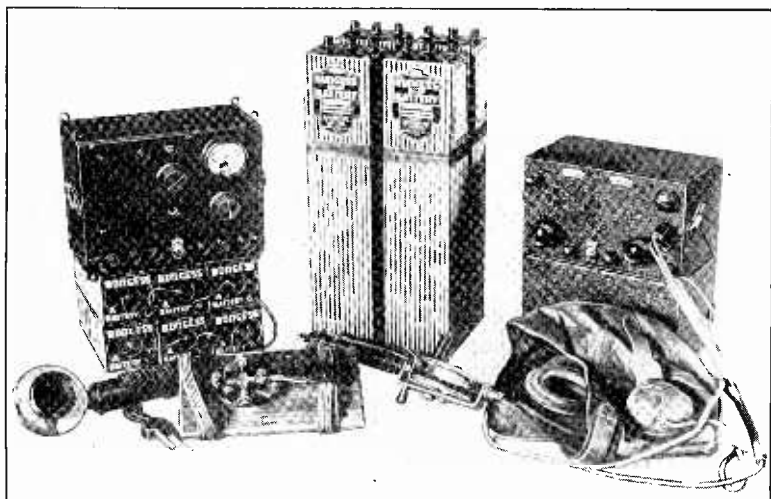

FIG. 281. Burgess Experimental Transmitter and Receiver Ready for Installation: Left to Right, Transmitter Setting on the "A" Batteries; "B" Batteries for Plate Supply and Self-Contained Receiver. In the foreground can be seen the Microphone, Key, Antenna Reel, Helmet and Ear Phones.

The photograph in figure 280 shows the complete radio apparatus installed in the forward cockpit of a Travel Air Airplane equipped with a Wright Whirlwind motor. The transmitter and receiver are suspended by rubber bands from a frame of brass angle. The clearance between frame and apparatus is one inch.

The description which follows is taken from the Burgess Battery Company's Engineering Circular No. 15.

11. Burgess Midget Transmitter Number "I"—Low power radio transmitters operated from dry cell batteries, at wavelengths

below 100 meters, have been proven reliable for communication over distances of a few hundred miles either day or night.

The midget transmitter was designed for short wave use where there is need for light and compact apparatus that will operate under severe conditions such as are found in airplanes, motor boats or automobiles, and where dry cell batteries are a most satisfactory form of power supply.

Two receiving type UX201A or CX-301A tubes with associated apparatus are enclosed in a stiff aluminum case, which measures 8 1/2 inches long, 6 1/2 inches high and 4 inches deep. This case is arranged in a manner that allows the top and back to fold back when two suit case snap catches are released, one at each side. From the lower back corners, where the two sections of the case are hinged together, the case opens diagonally upward to the front top corners and across the top. When the case is open all apparatus is readily accessible from the top, the back or the upper halves of the sides. The weight of the unit including tubes is 4 pounds and 12 ounces. A small eye bolt is provided in each corner of the case in order that the unit may be mounted by shock absorbing cord or springs.

Although two tubes are used, only one tube delivers its energy into the transmitting antenna system. The output tube which works as a radio frequency amplifier is connected in a balanced bridge circuit and carefully adjusted so that there cannot be any appreciable coupling from the antenna circuit to the other tube which is arranged to work as an oscillator or radio frequency generator.

This transmitter arrangement, commonly known as a Master-Oscillator Power-Amplifier, has long been recognized as a superior form of stable transmitter. When the oscillator is supplied with power from a constant d.c. source, such as can be obtained from dry cell batteries, and the amplifier is properly balanced, an arrangement is obtained that has remarkable stability.

The midget is primarily a telegraph transmitter and delivers about 4 watts when 350 volts are connected to the amplifier tube, and 180 volts supplied to the oscillator. Voice transmission is also provided for in a manner making it effective over short distances.

In the top middle portion of the front panel there is a small peep hole behind which a 2.3-volt flashlight lamp is mounted and connected in the antenna circuit for indicating resonance. Under this hole there is mounted a toggle switch for shorting the lamp out after tuning adjustments are made. Below this switch is a

knob for adjusting the series antenna condenser. The two binding posts at the upper left hand side are for antenna and counterpoise connections. Filament voltmeter and a knob for filament rheostat adjustment are provided at the right side of the panel. These are essential when receiving type tubes are operated with high values of potential in their plate circuits.

A jack, central in the panel, is arranged for plugging in a microphone when voice transmission is desired. Binding posts for battery and key connections together with a filament switch are arranged across the bottom.

Within the case, a sub-panel of hard rubber behind the front panel mounts the apparatus. The oscillator inductance and the amplifier plate to antenna transformer are mounted in vertical positions, over the tube sockets at either side of the unit in such a manner that the inductances surround the tubes when they are in place.

An aluminum sheet forming a shield is mounted between the coils of the two tube circuits.

The amplifier balancing condenser is mounted below the antenna tuning condenser and can only be adjusted by opening the case. Fixed tuning and by-pass condensers and grid leak resistances are mounted in positions best suited for convenience in connecting and for keeping connecting leads short.

By removing the nine screws from the edges of the front panel, the entire apparatus may be removed from the case as a unit.

Details of connections are shown in the circuit diagram. The antenna circuit runs from the antenna terminal to the antenna coil, which also is the secondary of the amplifier plate transformer, then to the antenna series capacity, which is made up of a fixed and a variable condenser in parallel. From the condensers the circuit continues through the indicating lamp which is shunted by a switch to the counterpoise or ground terminal.

The amplifier tube feeds its energy to the antenna circuit through the plate transformer which is untuned. Such a transformer will transfer energy efficiently over quite a band of wavelengths, if the secondary turns are made adjustable so that the impedances of the tube plate and the antenna circuits can be matched.

The oscillator tube is connected in a modified Colpitts circuit (described in patent No. 1,585,244, of May 18, 1926, by W. H. Hoffman) and the values of the capacities and inductances making up the tuned circuit are fixed.

Energy from the grid side of the oscillator circuit is fed through a fixed condenser to the grid of the amplifier tube. A grid leak

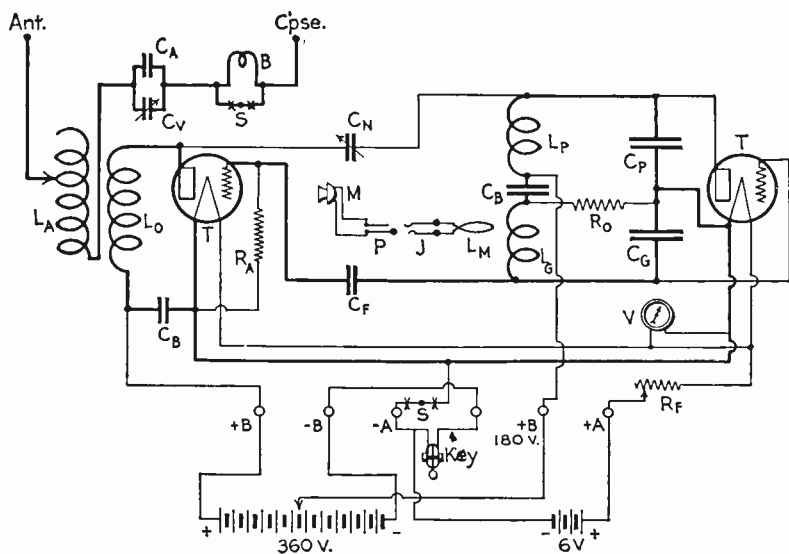

FIG. 282. Circuit Diagram of Burgess Transmitter (Hoffman Circuit).

- B* Flashlight lamp, 2.3 volts.
Ca and *Cf* Sangamo fixed mica condenser, 0.0001 mfd.
Cb Sangamo fixed mica condenser, 0.005 mfd.
Cv Precision microdenser, variable air, 135 mmf.
Cn General radio microdenser, variable air, 15 mmf.
Cg and *Cp* Sangamo fixed mica condensers.
 For 80 meters—0.0005 mfd. each.
 For 40 meters—0.00025 mfd. each.
J Frost single circuit jack.
Lg and *Lp* Oscillator inductance coils, No. 16 DCC wire wound on 2-inch tubing.
 For 80 meters—5 1/4 turns each.
 For 40 meters—3 1/4 turns each.
Lo Amplifier plate coil, wound on 2-inch tubing.
 For 80 meters—35 turns No. 22 DSC wire.
 For 40 meters—15 turns No. 28 DSC wire.
La Antenna inductance, 9 turns No. 12 bare copper wire, wound over *Lo* and spaced 1/16 inch from it. Turns spaced 3/16 inch.
Lm Voice modulation loop, 1 turn No. 28 DSC wire, wound 1/4 inch from grid end of oscillator inductance.
M Frost hand microphone.
P Weston phone plug.
Ra Allen-Bradley, Bradley unit, 10,000 ohms.
Ro Allen-Bradley, Bradley unit, 20,000 ohms.
S Cutler-Hammer toggle switch.
V Jewell 2-inch voltmeter, 0 to 8 volts.
T CX-301A or UX-201A tube.

from the amplifier grid to the filament circuit furnishes the required negative bias.

A connection from the plate side of the oscillator circuit through a small variable condenser to the plate of the amplifier makes it possible to balance or neutralize the amplifier preventing self oscillation and reducing coupling between the oscillator and antenna circuits to a very small value.

A single turn of wire, in close inductive relation to the oscillator inductance, is connected to the terminals of a jack. By plugging an ordinary telephone type microphone into the jack, short range voice transmission is made possible.

For plate power supply for operation from an airplane, 8 Burgess type 5308 "B" batteries inclosed in a wooden case $13 \frac{3}{4} \times 9 \frac{1}{4} \times 7$ inches have been used, furnishing a maximum of 360 volts. A 180-volt tap is brought out for the oscillator.

A similar case $11 \times 7 \frac{1}{2} \times 6$ inches houses 8 Burgess No. 6 Radio "A" batteries for filament supply.

12. Burgess Midget Receiver Improved Model Number X—

Inspired by the results of early tests with dry battery operated equipment in airplane communication, a new receiver of improved design was constructed. The changes in design were chiefly in refinement of controls, increased accessibility of interior apparatus, and facility of dry battery renewals. The new model is built up in two individual compartments, one containing the receiver itself and the other enclosing the dry battery "A" and "B" supplies.

By a system of plug and jacks and a pair of brass hasps, the two sections may be locked together as a single unit. External terminals permit the receiver to be used as a common table model with the usual isolated "A" and "B" batteries. The receiver case measures $4 \frac{5}{8} \times 4 \frac{7}{8} \times 8$ inches and is made of 0.040" aluminum. Its construction is similar to that of the transmitter. It is cut diagonally at the ends and hinged at the rear which makes the interior readily accessible. Adjustable coupling to the antenna is secured by means of a small three plate variable condenser in the antenna lead. A small variable "micro" type condenser of 50 micro-micro farads capacity and a system of four small plug-in coils are used to cover a wavelength range of 17 to 92 meters. Another small variable condenser identical with the one used in the tuned circuit is used as a "throttle" capacity to control oscillation. A pair of telephone jacks permit the use of one or two stages of audio frequency amplification as may be found desirable. A filament switch and rheostat mounted on the aluminum panel provides control of "A" battery supply.

The vernier system used in both controls is friction drive between two small pinching discs on the control knobs and a large disc on each of the condenser shafts. This provides a positive drive with a ratio of 16 to 1 and without "backlash" or slippage. These large discs carry the dial scale and are completely enclosed against possible damage. By overlapping these large discs, it has been possible to secure a most compact arrangement. The scale settings are observed through the celluloid covered windows.

All apparatus is mounted either on the aluminum panel or on the hard rubber sub-base which is fastened to the panel so that the entire receiver is released from the case when the panel screws are removed.

The front panel consists of two sheets of aluminum spaced $5/8$ " by heavy spacers. This secures an exceptionally rigid panel, double shielding against "body capacity effects," and protection for the large vernier discs. The two audio frequency amplifying transformers are completely enclosed in a metal case. The greater part of the wiring is laid beneath the hard rubber sub-base thoroughly protecting the former. All wiring which it is necessary to run above the sub-base is of heavy bus wire, with the additional protection of a varnished cambric covering.

Three type UX-199 tubes are used in this receiver. The filaments of these tubes draw 0.06 of an ampere, a total of 0.18 of an ampere, which permits the use of a very light "A" battery. The receiver is designed to use 45 volts of "B" battery as plate supply. The battery case measures $3\ 5/8$ " x $4\ 5/8$ " x 8" and is made of the same material as the receiver case. A hard rubber cover is removable to allow renewal of the batteries enclosed. The output plugs are mounted in this cover. By this arrangement one battery compartment may be replaced by a similar one containing renewals in a very few seconds. The space is sufficient to accommodate three Burgess No. 2370 4.5-volt "C" batteries and two Burgess No. 4156 22.5-volt "B" batteries. The three "C" batteries are connected in parallel and will operate the filaments of the three tubes for a continuous period of about ninety hours without renewal.

The entire assembly of battery case and receiver measures 8" x $4\ 5/8$ " x $8\ 1/2$ " and weighs eleven pounds including batteries.

This receiver has been tested under varying conditions and results have compared most favorably with those of larger construction and theoretically better design.

During a period of one hour and fifteen minutes in the early morning of December 18, 1927, amateur stations in all districts

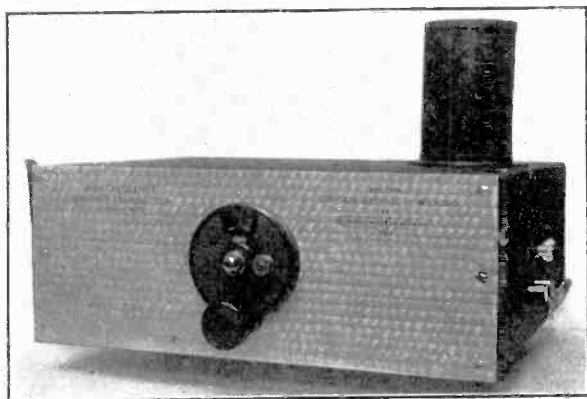

FIG. 283. 50-Watt Transmitter Used by Sir Geo. H. Williams in Flight across the North Pole.

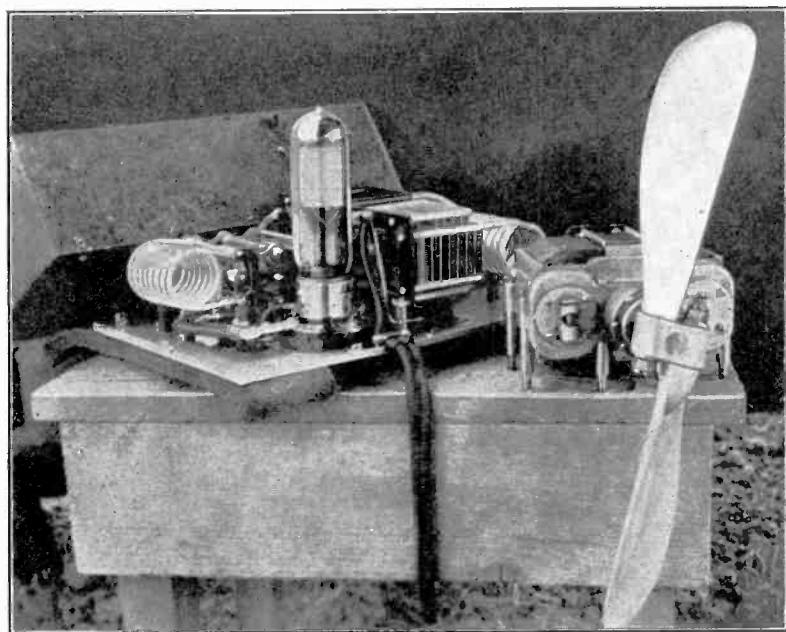

FIG. 284. Interior View of Transmitter Showing Wind Driven Generator.

of the United States were copied with good strength. Twenty-two of those logged were located on the Pacific Coast. In addition to this, five amateur stations in New Zealand were heard. The best of these was OZ-4AM, whose signals could be heard 20 to 25 feet from the head-phones.

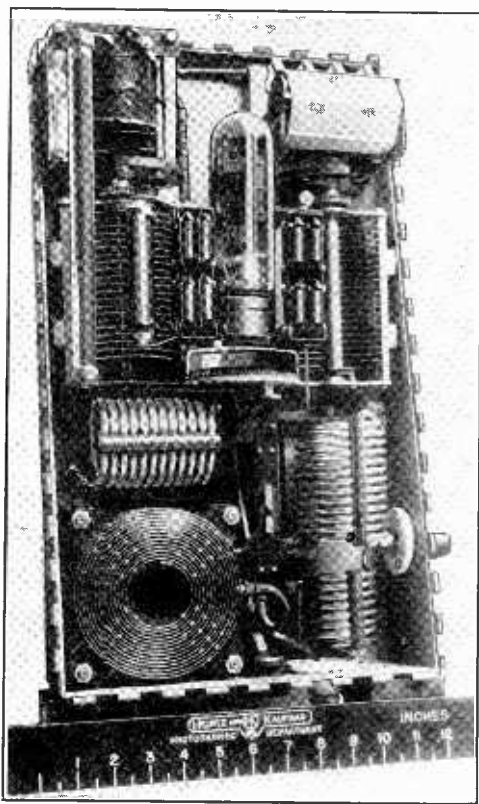

FIG. 285. Combination Medium and Short Wave Transmitter Used on All Planes of Byrd Expedition to South Pole.

Heintz and Kaufman Aircraft Transmitters—Aircraft transmitters of low power have played an important part in the success

of many expeditions and exploring parties. By providing communication between aircraft and base stations the flyers have been able to report the progress and conditions of the flight and in some instances have been the means of saving the lives of the crew of the plane by notifying the base of the necessity of a forced landing thus enabling rescue squads to proceed to the spot with food and supplies. Notable among such expeditions carrying radio equipment on planes are those of the Wilkins Expedition to the North Pole and the Byrd Expedition to the South Pole.

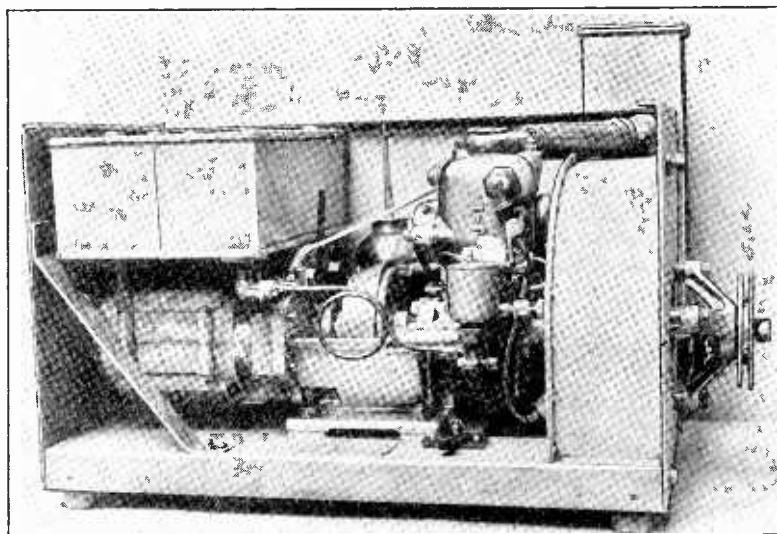

FIG. 286. Emergency Gas Engine Water-Cooled Unit of 1 HP Capable of Developing 250 Watts of Power for a V. T. Transmitter.

Radio transmitters for both these expeditions have been designed and built by Heintz and Kaufman of San Francisco. Figure 283 shows a photograph of a 50 watt transmitter built by this company for Sir Geo. H. Wilkins and used on his plane during a flight over the North Pole. Figure 284 shows an interior view of the set with wired driver generator.

Figure 285 shows a 50-watt combination transmitter built by the same company for the Byrd Expedition. This transmitter is capable of operating either on 31.5 meters or 600 to 800 meters.

The 600-meter wavelength can be used for transmitting a distress call on the normal wavelength used by all vessels thus giving some assurance that the call will be picked up and assistance rendered if necessary. The 800-meter wavelength permits compass bearings to be taken by shore compass stations and ships fitted with direction finders from the signals transmitted by the plane.

Figure 286 illustrates an emergency gas engine unit—air cooled of one H.P. capable of supplying power of 250 watts to a vacuum tube transmitter. With such a unit power is available for sending out distress calls and messages relating thereto even though the plane is not in flight.

RCA 100 Watt Aircraft Radio Communication Equipment Model ET-3653

24. General—The equipment covered by this specification consists of a medium weight combined radio telephone and radio telegraph transmitter, together with a suitable radio receiver. The receiving apparatus will contain everything necessary to receive radio frequency signals from the antenna and to convert them to audio frequency signals. The radio transmitter will include all apparatus necessary to take power from a suitable source and to furnish an output of 100 watts into a suitable antenna when used for radio telegraph signals, or 50 watts when used for radio telephony.

The equipment is designed to cover a range up to 300 miles or more under fair weather conditions when used for CW telegraph service, and up to 75 miles or more under fair weather conditions when used for telephone service. It should be noted that these range values in miles are approximate, yet conservative, ranges, and that a considerable increase in the values given may at times be secured. The apparatus has been divided into several small units which may be distributed about the fuselage of the plane in any convenient location. Only three of these units and an antenna ammeter need be within reach of the radio operator. This aircraft communication equipment has a total weight of approximately 133 pounds, and a typical installation includes the following apparatus:

| | Lbs. |
|---------------------------------------|------|
| 1 Transmitter (including tubes) | 18 |
| 1 Receiver (including tubes) | 11 |
| 1 Control box | 8 |
| 1 Potentiometer and filter box | 12 |
| 1 Fairlead | 1½ |
| 10 Antenna weights (8 spares) | 6 |

| | |
|--|-------------------|
| 1 Antenna reel with 300 ft. of wire | 5 |
| 1 Antenna ammeter | $\frac{1}{4}$ |
| 2 Helmets with head telephone receivers | 3 |
| 1 Jack box | $\frac{1}{2}$ |
| 2 Aircraft anti-noise microphones | 2 |
| 1 Deslauriers air propeller | $5\frac{1}{2}$ |
| 1 Wind driven, double-current generator | 46 |
| 2 Flame-proof keys, with cords and plugs | 2 |
| 1 Set inter-connecting cable (approx.) | 12 |
| Total | 132 $\frac{3}{4}$ |

Each of the above units will be described later on in this specification. They are all ruggedly built and well finished to withstand hard, continuous service. All the equipment is that which has been found most suitable for this type of service through the experience gained in building a great many equipments of this character.

The assumption has been made that the aircraft engine is adequately shielded so as to reduce interference from this source to a negligible quantity. It is further assumed that the plane on which the aircraft radio communication equipment is to be installed has been thoroughly bonded. By "bonding" is meant the connecting of all metal parts of the airplane by means of electrical conductors during the process of manufacture, which is a requirement of good airplane design since it eliminates the danger of sparks between metal parts.

A description of each of the above units, when used for aircraft service, follows:

25. Transmitter—The transmitter is that part of the equipment which converts the electric power output from the generator into a form which, when connected to a suitable antenna, will produce the radiation of radio waves. It is made of aluminum covered with a special imitation leather finish which is very durable, and is 16" long, 12" high and 8" deep (not including the external shock-absorbers) and weighs 18 pounds, including radiotrons. The plate and filament supply for the transmitting radiotrons is obtained from a wind driven generator, and the power for the receiver is obtained from the same generator through a suitable potentiometer and filter system.

The simplest possible form of circuit is employed. It consists of a Hartley type master oscillator using a UX-210 Radiotron and a neutralized power amplifier using a UV-211 Radiotron. This power amplifier is modulated by the Heising system, using another UV-211 Radiotron. A UX-210 Radiotron serves as a speech amplifier which is resistance coupled to the modulator.

When using the apparatus for telegraphy, the filament circuit of the latter two radiotrons is opened in the control box. In case of tube failure in flight, these two radiotrons may be interchanged with the other two and telegraph operation can then be continued, since the modulator and speech amplifier radiotrons are not necessary for telegraphy. The keying system used is of the type employing a change of grid bias sufficient to produce and stop oscillations alternately. No meters or other unnecessary weights are included in the transmitter unit. Jacks are used instead for plugging in meter cords when making adjustments to note that all of the essential parts of the transmitter are mounted on one panel and that all parts are easily accessible.

On the front panel is mounted the control dial for tuning the transmitter. This dial is graduated so that it can be checked for adjustment as indicated by a pointer on the panel. A locking device is provided to hold the dial in any desired position.

The frequency of the transmitter is continuously variable throughout its range from the front of the panel, and can be set to transmit on any one frequency (either CW telegraphy or telephony) in the band of from 2,250 to 2,750 kilocycles, or approximately 133 to 109 meters.

The construction of the box is such as to provide a very strong, rugged and light weight equipment, and also makes an excellent shield for the apparatus. This box is divided lengthwise by a duraluminum partition on the back of which are mounted the antenna coupling, neutralizing condenser, several fixed condensers, and the master oscillator tuning. In front of this partition are the four radiotrons together with a variable condenser, grid leak, resistors, choke coils and transformer used in the generation and modulation of high frequency currents.

The top half of the front panel and the front half of the top panel are of one piece of duraluminum and are hinged to the lower half of the front panel. When this section is open, the radiotrons, which are mounted on sponge rubber cushions, are easily removable.

26. Receiver—The receiver is mounted in an aluminum box, 10" high, 16" wide and only 2 3/4" thick (or 18" by 11" by 3" overall, including the shock-absorber mountings). The weight of the receiver will be approximately 11 pounds, including the tubes. It has a black leather finish with nickel trimmings and all parts are protected from atmospheric corrosion effects, the housing being made rain and splash proof. This unit may be placed in any position convenient to the radio operator or pilot. Clamps sus-

pended in sponge rubber provide a cushion support and permit the receiver to be quickly and easily mounted and dismantled. The top of the front panel of the receiver is hinged and opens downward, allowing access to the tubes, five of which are employed. The first two tubes constitute a tuned radio frequency amplifier, the third tube a regenerative detector, the fourth tube is the first stage of audio frequency amplification and the fifth tube is the second stage of audio frequency amplification. The receiver is uni-controlled and the tubes are mounted on sponge rubber cushions. A vernier control is provided for accurate tuning of weak signals as well as a "regenerative" control. No batteries are required for the receiver, and as previously mentioned, the power for this unit is obtained from the wind driven generator through the potentiometer and filter box. The receiver is designed to receive the entire band of from 3,750 to 2,200 kilocycles, or approximately 79.95 to 136.3 meters.

27. Control Box—This unit is used to control the operation of the transmitter and receiver, and contains switches for changing from "send" to "receive" and from CW telegraphy to telephony. It also includes telephone jacks, interphone transformer and all other equipment necessary for the control of the entire transmitter and receiver. This unit is contained in an aluminum box approximately 6" wide by 12" high by 8" deep, and weighs approximately 8 pounds complete. It has the same type of construction and finish as the main transmitter unit, and contains a switch for changing from radio telephone connections to those required for telegraphy and one for starting either the transmitter or receiver at will. Jacks are provided for connecting the key, microphone, and helmet phones.

This unit, the receiver and the antenna reel must be located within easy reach of the operator or the pilot. In some cases, it may be found desirable to locate one or two of these units near the pilot. Since the operator and the pilot are in constant telephonic communication, either may instruct the other as to what adjustments should be made.

28. Potentiometer and Filter Box—This unit is included in order to simplify the problem of power supply. Two voltages are supplied by the wind driven generator to this unit which includes a suitable combination of reactors, capacitors, resistors and a relay. All of the voltages necessary for the operation of the transmitter, receiver and interphones are obtained. Ordinarily, this unit requires no attention whatsoever after its original installation and adjustment. The relay in this box is used for keying.

29. Antenna Reel and Wire—The antenna wire is carried upon an insulated reel. The antenna wire itself is of copper-clad steel and is very light considering its strength and high conductivity. The reel is provided with a clamping device so that it may be locked against rotation when the desired length of antenna wire has been reeled out. A crank is provided to enable the operator to reel in the antenna when a landing is to be made.

30. Antenna Weights—In order that the antenna wire may float properly, it is necessary to have a small weight attached to the remote end. The type of weight furnished is such that if one originally attached to the wire should become detached in flight, another can be added from within the fuselage of the plane. Ten antenna weights are provided, two for normal use and eight as spares.

31. Fairlead—The antenna wire passes out through the fuselage by way of an insulating tube or fairlead. The fairlead is constructed of micarta tubing with moulded bakelite terminal block and metal end flange. This tube is so arranged that the connections from the antenna to the control box are made at both ends of the tube while the outside of the tube is insulated so as to prevent accidental contact to surrounding objects.

32. Power Supply—A double-current wind driven generator furnishes power at voltages of 1,000 and 10. The 1,000-volt commutator supplies the power for the plate and grid circuits of both the transmitter and receiver. The 10-volt commutator supplies the power for the filament circuits of both transmitter and receiver, and also for the interphones. This double-current generator is driven by a 500-watt Deslauriers constant speed self-regulating air-fan. The maximum output rating of the generator is 800 watts from both windings combined. At normal operation the generator furnishes 450 mils or 0.450 amperes at 1,000 volts for the plate supply of the transmitter radiotrons, and 9 amperes at 11 volts for the filament supply of the radiotrons and for excitation purposes. The high voltage commutator is at one end of the generator and the low voltage commutator is at the other end. The generator is made of streamline construction. This generator maintains a normal speed of 4,000 R.P.M. regardless of wind speeds or load as long as the plane is in the air. This regulating feature is due to the employment of a centrifugal governor which changes the pitch of the propeller blade as the speed of the plane changes.

33. Anti-Noise Microphones—This microphone is of the breast mounting type developed especially for aviation purposes. It is so constructed that motor and propeller noises have almost no effect on it while the operator's voice is transmitted clearly.

34. Helmets—Two standard aviators' leather helmets, complete with head telephone receivers, cords and plugs, are provided.

35. Telegraph Key—A special type of key is supplied which eliminates the danger from sparking at the contacts. This key is air-tight and cannot ignite fumes from gasoline. A clip is furnished so that the key may be attached to the operator's leg if desired.

36. Jack Box—The small jack box permits the pilot and operator to communicate with each other at all times, or it permits the pilot to communicate with the ground stations by telephone or telegraph while the operator listens in or vice versa. The box contains three telephone jacks which are for the microphone, key and helmet, and is usually located near the pilot.

37. Antenna Ammeter—In order to make it possible for the operator to adjust the antenna tuning, a small indicating ammeter is mounted conveniently within the range of vision of the radio operator or pilot. The dimensions are 2 1/2" in diameter by 1 7/8" deep with a weight of 1/4 pound. It is provided with a 0-5 ampere scale and is operated from a thermocouple mounted in the transmitter box. The meter tells at a glance whether or not the set is functioning properly.

RCA 300 Watt Aircraft Radio Communication Equipment Model ET-3654

This equipment is designed to cover a range up to 500 miles or more under fair weather conditions when used for (CW) telegraph service, or up to 200 or more under fair weather conditions when used for telephone service. It should be noted that these range values in miles are approximate, yet conservative, ranges, and that a considerable increase in the values given may at times be secured.

Each unit of the equipment will be designed for small size, light weight, and ruggedness, the major requirements for aircraft radio equipment. A complete equipment will consist of the following major units:

| | Lbs. |
|----------------------------------|------|
| 1 Transmitter (see note 1) | 30½ |
| 1 Main control unit | 4 |
| 1 Auxiliary control unit | 1 |

| | |
|--|-----|
| 1 Terminal box | 1 |
| 1 Receiver | 7½ |
| 1 Filter unit | 33¾ |
| 1 Antenna reel with wire (300 ft.) | 9 |
| 2 Antenna weights | 1½ |
| 1 Fairlead | 1¼ |
| 2 Aircraft anti-noise microphones | 2 |
| 1 Wind driven double-current generator | 79½ |
| 1 Deslauriers air propeller | 12 |
| 2 Flame-proof keys | 2 |
| 2 Helmets and phones, cords and plugs | 2 |
| 1 Set inter-connecting cable (approx.) | 15 |
| Total | 202 |

Note 1: Weight of 30½ pounds includes weight of transmitter plus weight of 3 UV-211 Radiotrons.

The assumption has been made that the aircraft engine is adequately shielded so as to reduce interference from this source to a negligible quantity. It is further assumed that the plane on which the aircraft radio communication equipment is to be installed has been thoroughly bonded. By "bonding" is meant the connecting of all metal parts of the airplane by means of electrical conductors during the process of manufacture, which is a requirement of good airplane design since it eliminates the danger of sparks between metal parts.

38. Rating—The normal rating of the transmitter will be 300 watts, and it will be designed to deliver this output when operating on any frequency within its frequency range.

39. Frequency Range—The transmitter circuit will be designed to operate on any fixed frequency between 2250 and 2750 kilocycles (133 to 109 meters approximately), with change of frequency possible when the aircraft is in flight providing units are so mounted as to be accessible.

40. Antenna Characteristics—A trailing wire antenna of 100 ft. approximate length will normally be used. Tuning of the antenna system will be accomplished by adjusting the length of the trailing wire, and the desirable feature of eliminating antenna loading equipment will thus be obtained.

41. Radiotrons—The transmitter will utilize eight radiotrons, as follows:

- 1 UV-211 as master-oscillator.
- 3 UV-211 as power-amplifiers.
- 1 UV-211 as speech-amplifier.
- 3 UV-211 as modulators.

The model UV-211 Radiotron requires 3.25 amperes at 10 volts for the filament and its normal plate potential is 1000 volts d.c.

42. Methods of Signalling—The equipment will provide continuous wave telegraphy (CW) and radio telephone communication. In addition to this, interphone communication will be provided between the two operators on board the aircraft.

43. Type of Circuit—The transmitter circuit is of the master-oscillator power-amplifier type. The master oscillator employs the Colpitts oscillator circuit with modification to allow for neutralization of the power amplifier. The power amplifier derives its excitation from the tank circuit of the master oscillator, and its plate circuit is coupled to the antenna system through a suitable antenna transformer. Part of the d.c. voltage which is built up across the power amplifier grid leak is used for bias on the speech-amplifier and modulator radiotrons as will be explained later. Keying of the transmitter is accomplished by a method which applies a cut-off bias voltage to the transmitter radiotrons when the transmitting key is open.

The constant current system of modulation is used. The microphone transformer has, in addition to the microphone and output winding, a side-tone winding which is connected across the headphones of the two operators and across the receiver output. The purpose of this is to allow the headphones to be used for interphone communication, for monitoring what is being transmitted over radiophone and for reception of incoming radio signals without the necessity of switching any headphone connections. Bias voltage for the modulator and speech-amplifier is obtained from the grid leak of the power amplifier after suitable filtering.

In order to permit send-receive operation which is controllable from two positions, a magnetically controlled send-receive relay is used.

44. Control Units—Two control units will be supplied. The main control unit will be installed near the operator who will have charge of the receiver and antenna-reel, and the auxiliary control unit will be mounted near the other operator. The main control unit will contain the necessary switches to provide phone or CW operation of the transmitter, and interphone operation, control over the send-receive relay, and means to transfer send-receive relay control to the auxiliary control unit.

The auxiliary control unit will provide control over this send-receive relay when control is transferred to it from the main unit.

Only one meter will be supplied. This will record antenna

current and will be of the external thermocouple type so that the recording element may be placed wherever convenient for the operator.

Adjustments of the transmitter to secure desired operation will be reduced to a minimum. After the frequency has been set on the master oscillator, it will then be necessary to resonate the antenna for maximum current by adjusting the length of the trailing wire. In extreme cases where antenna resistances vary considerably from normal value, it may be necessary to adjust the value of coupling between primary and secondary of the antenna transformer in order to get the proper power output. This coupling will be made easily accessible.

45. Power Supply—Power supply for the transmitter will be obtained from a wind-driven double-current generator. This generator will be driven by a Deslauriers constant speed, self-regulating propeller, and will supply power at 12 volts d.c. for filaments and control circuits, and 1000 volts d.c. for plate circuits of the radiotrons. The generator will be fitted with streamline covers and mounting feet. Approximate overall dimensions, including the propeller, will be as follows:

| | |
|--|-----------------------|
| Length | 32 " |
| Height, exclusive of propeller | 9 $\frac{3}{4}$ " |
| Maximum diameter of streamline section | 9 " |
| Radius of propeller | 18 " |
| Total weight, including Deslauriers air propeller | 91 $\frac{1}{2}$ lbs. |

46. Receiver and Filter Units—The receiver is designed for reception of telephone, ICW, or CW signals at any frequency between 2250 and 2750 kilocycles (133 to 109 meters). It will be separated physically from the transmitter for ease of installation. Power for the receiver filaments will be taken from the generator through a suitable filter. A potentiometer and filter will be used to obtain plate supply from the high voltage generator.

The receiver circuit consists of (a) a two-stage tuned neutralized radio frequency amplifier; (b) regenerative detector; (c) and (d) two stages of transformer coupled amplification. The stage of radio frequency amplification and the regenerative detector provide good sensitivity and selectivity. Jacks are provided so that either the first or both audio tubes may be used.

The potentiometer and filter contain all equipment necessary to supply plate filament and bias voltages to the receiver.

47. Western Electric 8A Aircraft Radio Transmitter—The set in question was developed by the Bell Laboratories for the

Western Electric Company and is now ready for commercial use. The Bell Telephone Laboratories was engaged in airplane radio developments during the war and has been actively at work in the radio field during the intervening years.

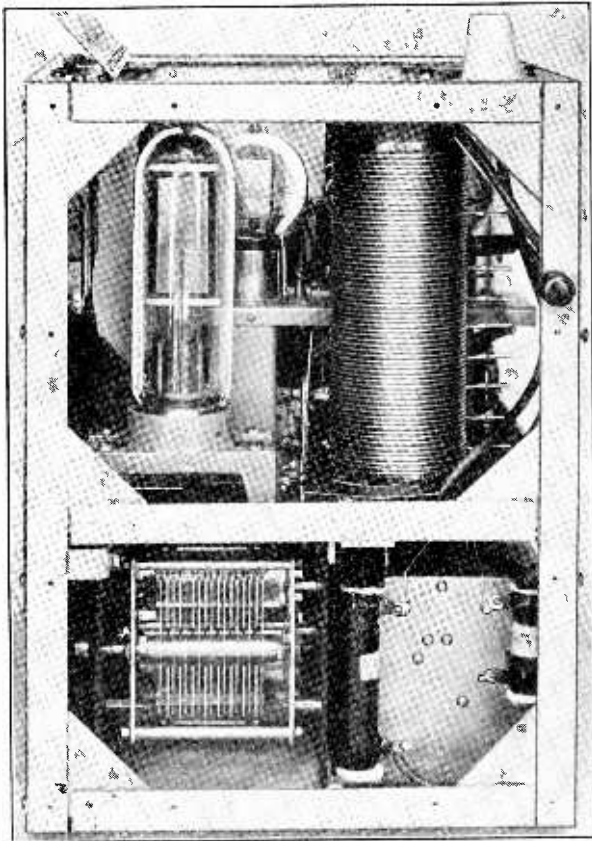

FIG. 287. Side View of Western Electric Type 8A Transmitter.

Over a year ago a Wasp motored Fairchild monoplane of the cabin type was purchased for the completion of the development work. The transmitter has been developed for the Western Electric Company for regular two-way telephone communication between plane and ground. It is housed in a case approximately

ten inches deep, fourteen inches high, and fifteen inches long. It combines simplicity of control with a minimum of weight, which is so essential for aircraft use.

Power for the transmitter is obtained from a double voltage direct-current generator geared to the airplane engine. Special control is provided to maintain constant voltage automatically at all engine speeds. Eleven hundred volts is taken off for the plate supply and is passed through filters in the transmitter to remove all objectionable noise. The regular airplane battery is floated across the low potential supply of fourteen volts and used for the tube filaments.

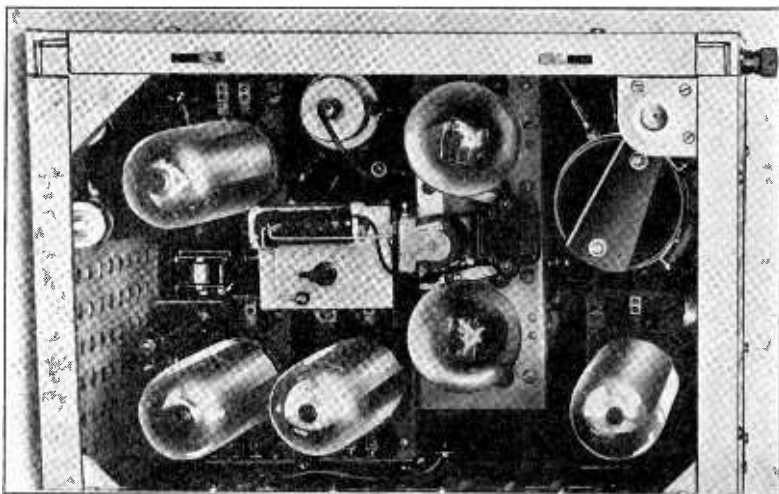

FIG. 288. Looking Down on 8A Transmitter Showing Arrangement of Tubes.

The transmitter has a carrier power of fifty watts but is arranged for 100 per cent modulation so that the peak power output at full modulation is 200 watts. A frequency range of from 1500 to 6000 kilocycles is provided (200 to 50 meters) and the operating frequency is maintained to within plus or minus .025 per cent under all conditions. To accomplish this a crystal oscillator of the Western Electric type is used which is thermostatically controlled to maintain a constant frequency over a temperature range of from forty degrees below zero Fahrenheit to one hundred and twenty degrees above. The complete frequency control equipment weighs less than nine ounces.

CHAPTER 16

AMATEUR SHORT WAVE APPARATUS

1. **Reflection of Short Waves**—When long distance communication was accomplished on wavelengths below 200 meters with small power, engineers began to consider that the atmosphere might have something to do with this phenomenon. This is indicated by remarks made by Dr. Hoyt Taylor in *QST* of May, 1924. Dr. Taylor says: "Perhaps the most outstanding thing about high-frequency or short wave work today is the amazing ranges obtained at frequencies in the neighborhood of 3000 kilocycles (100 meters). The intensity of signals received on these frequencies is so great that I am forced to conclude that these waves do not follow at all the ordinary laws of transmission. To me this would indicate that there is so complete a reflection of these waves at some upper and probably ionized layer of atmosphere, etc."

During these tests with amateurs in 1924, Dr. Taylor established the skip distance theory of short waves, the phenomena of which will be shown later.

John Reinartz had also made observations leaning towards a reflection of short waves from an ionized region. At the present time the height of this region as well as its activity is pretty well known. Experiments conducted by R. A. Heising of the Bell Telephone Laboratories fix this ionization of the atmosphere as beginning at an altitude of about 16 miles and extending upward, and experiencing diurnal and seasonal variations. This diurnal and seasonal variation of the reflecting area produces effects on radio waves according to their frequency. It has been found that the ratio of night to day signal decreases as the frequency is increased and that finally the day signal will be the stronger, depending upon the distance and frequency.

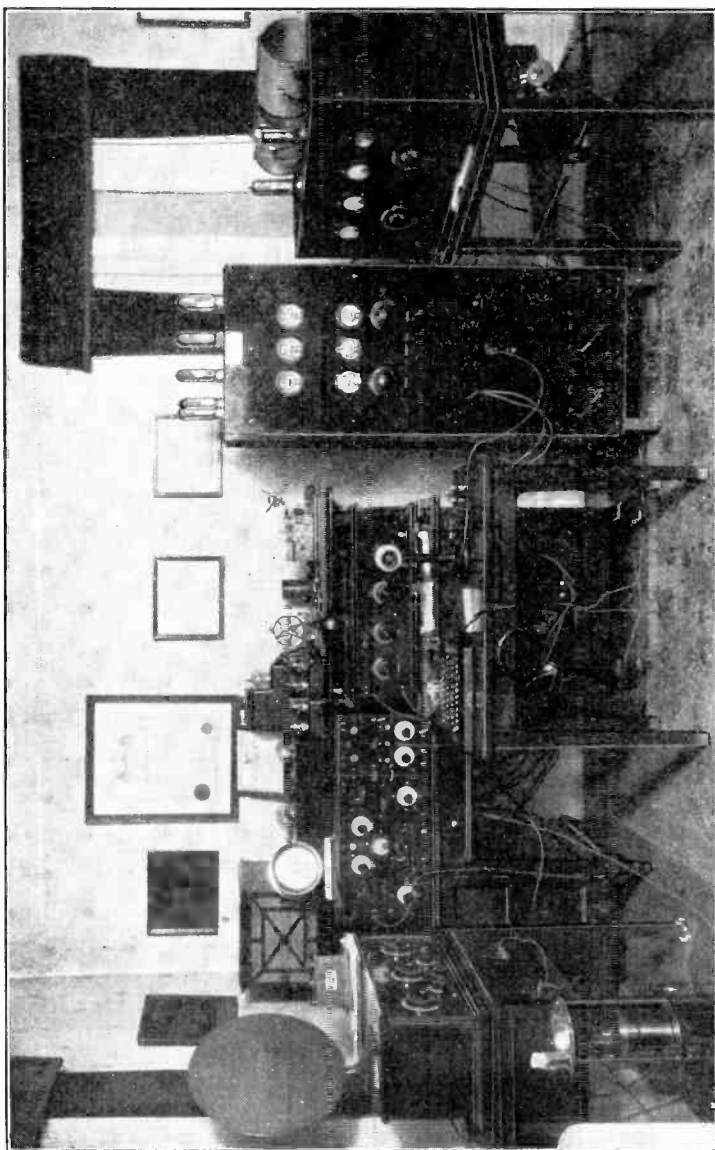

FIG. 289. Experimental and Amateur Station W₃XX—W₃ZO—W₃SD, Owned and Operated by Chas. Johnson of 5332 Gainer Road, Wynfield, Philadelphia, Penna.

It is not within the scope of this book to discuss at length the production of the ionized regions of the atmosphere; therefore, we will go on and show what happens to the short wavelengths after they leave the antenna of the transmitting station.

For an example, we will show what happened to a 20-meter wave that was transmitted from one of the General Electric Company's stations during the G.E.-A.R.R.L. tests.¹ As the wave leaves the transmitting antenna its signal intensity rapidly decreases due to spreading and energy absorption by the ground and other obstacles within its path. At 60 miles it showed a field strength of 10 microvolts per meter, its lowest useful level. As the distance is increased beyond 60 miles no signal can be heard; at a distance of approximately 850 miles the signal transmitted during the day becomes unexpectedly strong again. Continuing to greater distances the signal gradually falls off in intensity and reaches the useful limit of 10 microvolts per meter in the vicinity of 4000 miles by day. On a summer night the signal does not reappear after the 60-mile extinction until 4000 miles are reached, after which the signal falls off gradually to a very low value at 6500 miles.

4. Ground Wave and Reflected Wave—The signal which is heard up to 60 miles may be considered the ground wave limit of the transmitter. The day signal which reappears at 850 miles may be considered the sky wave. It is accounted for by a bending back to earth of a portion of the energy from the ionized regions of the atmosphere.

5. Skip Distance—The distance from the transmitter to the nearest point at which the refracted sky wave returns to earth is known as the skip distance. For a given wavelength the skip distance is at a minimum in the middle of the day and at a maximum on a winter night. As already stated, experiments show that the skip distance for a given time of day or night decreases with increasing wavelength. This may be explained by saying that the longer the wavelength the closer the sky wave returns to the transmitter and at a given wavelength a receiver may always be within range of both ground and sky wave.

It was also found that a radio wave starting out at a low angle will be only slightly bent or refracted and comes to earth at a great distance from the transmitter. On the other hand radio waves propagated at high angles will come to earth progressively nearer the transmitter until finally a critical angle is reached from

¹ A complete report of these tests was described by Chester W. Rice in QST of July and August, 1927.

which the refracted wave comes down at the nearest distance to the transmitter. For higher angles the points of return recede from the transmitter until eventually a second critical angle is reached at which the wave does not return to earth, but instead goes out into space and is lost. This effect is shown diagrammatically in figure 290.

6. Multiple Reflections—At a given wavelength there may be more than one reflection of the wave. A part of the refracted energy that strikes the ground will be reflected towards the sky and will return to earth again at twice the initial distance from the transmitter. Observations made at the Naval Laboratory at Bellevue, D. C., indicate that reflections of certain wavelengths at a certain time of day and year may occur such that a signal from a transmitter may be heard when the receiver is situated beyond the zone of ground wave reception and closer than the normal skip distance. In fact, several signals with time interval may be received from one impulse at the transmitter and the time interval shows that the waves travelled various distances other than the normal straight line distance between transmitter and receiver.

7. Echo Signals—Signals which have passed around the world in the reverse direction from transmitter to receiver or have passed more than once completely around the world are known in the art today as "echo" signals because they make themselves manifest in the receiver as echoes make themselves manifest in acoustic phenomena.

Signals from short wave transmitters have been photographically recorded after having passed approximately $2\frac{1}{2}$ times around the world. It has been noted that they are of sufficient intensity to cause serious interference and may prevent the receiving operator from making a perfect copy of the message.

Observations by the Naval Research Laboratory at Bellevue, D. C., indicate that echo signals manifest themselves first as direct signals over the great circle from transmitter to receiver and second as an echo going a long way around the world (probably in

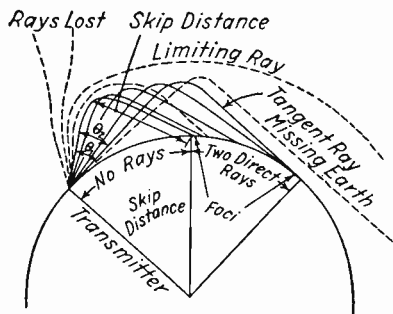

θ_1 Angle at transmitter corresponding to the first critical angle

θ_2 Angle at transmitter corresponding to the second critical angle

FIG. 290. Diagram Showing the Various Possible Paths of Radiation of Short Wavelengths.

the same great circle) but in the reverse direction (therefore arriving at an appreciable time interval later than a direct signal), have been observed on various frequencies between 28,000 kilocycles (10.7 meters) and 8,700 kilocycles (34.46 meters), but are usually restricted on the lower frequencies to a very limited time of day and time of year. The predominant period for observation of echo signals is in the spring or fall and the best periods of the day are in the morning or late afternoon hours. When the signal goes more than once around the world it is generally observed as coming from the same direction as the direct signal. Its time lag over the direct signal is the means of identifying it and this time lag is approximately .137 second, which corresponds to the time it would take an electro-magnetic wave to traverse the periphery of the world on the Heaviside layer at a distance of, roughly, 100 to 150 miles away from the surface of the earth. In other words, the time differences do not correspond to a ground wave but they correspond to the circumference of the Heaviside layer which is somewhat larger than the earth.

The time intervals are such as to throw the dots and dashes of a message into a complete jumble and in some cases have made it impossible to copy a message. The effect sounds as though two operators were sending the same message, one slightly behind the other.

In order to overcome the interference from echo signals the Bellevue Laboratory has employed long low single wire antennas erected so as to be directive in the direction of the transmitter it was desired to receive.

8. Choosing the Wavelength—From the foregoing discussion it can be seen that for long distance work on short waves low angle radiation is most effective, since the high angle radiation returns progressively near the transmitter or does not return to earth. High or low angle radiation depends upon whether the antenna is excited at its fundamental frequency or on a harmonic frequency. The method of feeding the antenna is a secondary consideration.

9. The Marconi Antenna—The form of antenna first made use of by Marconi in his early experiments used a ground and for that reason is known as the Marconi antenna. The distribution of current and voltage in a vertical Marconi antenna operating at its fundamental frequency is shown in *a*, figure 291. A grounded antenna can only be operated on its odd harmonics. *b* in figure 291 shows the distribution of current and voltage when such an antenna is operated on its third harmonic. The

frequency is three times the fundamental frequency and the wavelength is one-third of the fundamental wavelength. Other modes of oscillation have wavelengths $1/5$, $1/7$, $1/9$, etc., of the funda-

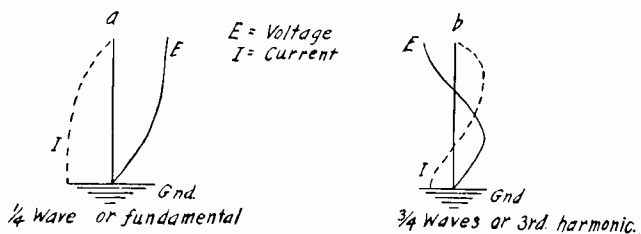

FIG. 291. Marconi Antenna Systems.

mental. Note from the figures that there is always a maximum voltage at the top of the antenna. A point of no voltage is spoken of as the nodal point. A point of maximum voltage would be a voltage loop or anti-nodal point. A point of maximum current is called the current loop and the point of no current, the current node.

10. Hertz Antenna—Antenna systems employing a counterpoise instead of a ground are known as Hertz antennas. Hertz in his early experiments employed an ungrounded antenna. A Hertz antenna can be made to oscillate at its fundamental frequency or at an even or odd harmonic of the fundamental. Figure 292 shows the distribution of current and voltage in a Hertz

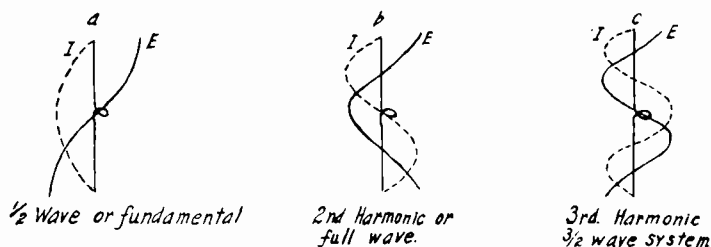

FIG. 292. Hertz Antenna Systems.

antenna when it is made to oscillate at its fundamental, second harmonic and third harmonic frequencies.

11. High and Low Angle Radiation—The Hertz antenna shown in figure 292 operating at its fundamental (half-wave an-

tenna) will radiate mainly at a low angle. As already shown, low angle radiation is desirable when it is desired to transmit over a considerable distance as the wave is only slightly bent or refracted and comes back to earth at a great distance from the transmitter.

If the antenna is made to oscillate at the second harmonic the angle of propagation will be increased, thus decreasing the range of the transmitter. The higher the harmonic at which the antenna is made to oscillate the higher will be the angle of radiation until finally at the seventh or eighth harmonic the wave projected upwards will be split up into several parts and there will be several maxima of radiation. This same is true of a grounded antenna when operated as $7/4$ or $9/4$ wave antenna corresponding to the seventh or ninth harmonic.

12. Horizontal and Vertical Antenna—Many tests have been conducted by various experimenters to determine the relative effectiveness of the horizontal and vertical antenna at short wavelengths. The results of these tests indicate that for DX (DX meaning long distance) purposes a vertical half-wave antenna with its lower end supported $1/4$ wavelength above the earth is superior.

13. Feeding the Antenna—There are two groups of methods generally employed by amateurs for feeding energy to the antenna system. They are known as the current feed and the voltage feed systems. The choice of a system depends upon the physical conditions existing at the station.

14. Current Feed—One system of current feed is shown in figure 293. Here the antenna has a gap cut at its center indi-

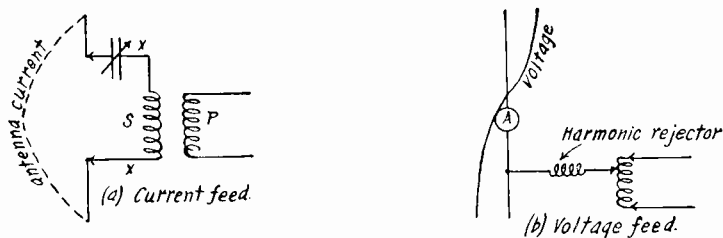

FIG. 293. Current and Voltage Feed Systems.

cated as X and to the two sides of this gap is connected the current-feeding device which consists of the secondary coil of the transmitter. A series condenser may be employed in either branch or both to keep the secondary from loading the antenna

to a wavelength higher than which it is desired to operate. Referring to figure 292 of the Hertz antenna system the secondary could be placed at any point in the system when there is a current loop. Figure 294 shows several different current-feed methods.

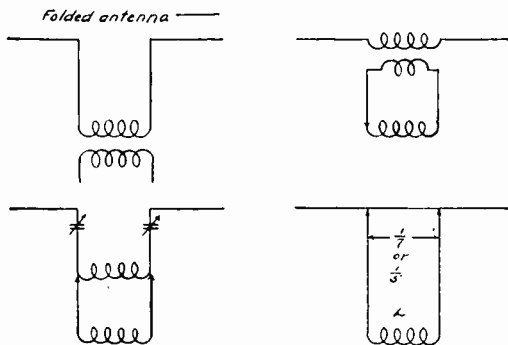

FIG. 294. A Group of Current Feed Systems.

15. Voltage Feed—One of the voltage feed systems is illustrated in *b* of figure 262. The single wire transmission line type of feeder requires that the feeder be connected to the antenna at a voltage loop. This method has several disadvantages, the main one being that the antenna is practically a fixed wavelength arrangement. Also any system of feeding an antenna through a 1-wire r.f. line is likely to make much the same troubles that are caused by direct coupled transmitter. To avoid this the feeder line should be inductively coupled to the driver with one end of the coupling coil grounded. This arrangement is shown in figure 295.

16. "Zeppelin" Antenna—The most popular of voltage feed systems employed by amateurs is the non-radiating two-wire transmission line feeding a straight wire antenna system known as a "Zeppelin" antenna. (See figure 296.) This system was mentioned by Dr. Greenleaf Pickard in *QST* of June, 1925, who at that time stated it was suggested by H. Begge-

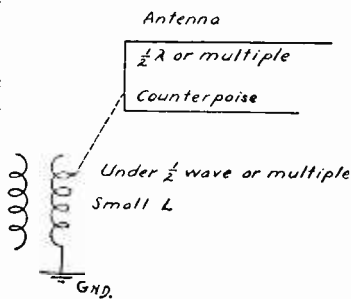

FIG. 295. One Wire Voltage Feed with Inductive Coupling.

row for Zeppelin airships. The antenna wire is cut to one-half of the desired wavelength in length and placed in any desirable location or position. (The wavelength in meters multiplied by 3.28 gives the wavelength in feet. For example, a 40-meter half-wave antenna would be $\frac{1}{2} \times 40 \times 3.28 = 65.6$ feet long.) The two-wire transmission line must be $\frac{1}{4}$ wavelength long or any odd number of quarter wavelengths, such as $\frac{3}{4}$ wavelength. The feeder wires should be spaced about $\frac{1}{200}$ wavelength. The system is so arranged that the currents in the feeders are exactly out of phase and radiation from the transmission line is zero.

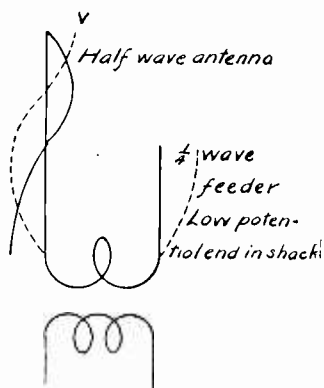

FIG. 296. Zeppelin Antenna System.

Note: In either case if feeders are a bit short use series inductance, or if too long use series capacity on both sides.

messages are accepted from the general public and transmitted free of charge. Sometimes such a message passes through several relay stations before reaching its destination.

Sometimes both groups of experimenters and traffic men unite in order to establish communication with some community which has been cut off from the outside world by an earthquake, flood or tornado. In the past both groups have been instrumental in keeping members of the Arctic and Antarctic exploring expeditions in touch with their families many thousands of miles away.

19. The Amateur in the World War—In all this has developed a trained corps of competent radio operators who can be

17. Getting on the Air—Amateurs are mainly divided into two groups. In one of these groups we find the amateur who desires to experiment and test out his own ideas and ideas suggested by those engineers more advanced in the art. Sometimes we find in this group one or more who develop ideas of their own which often prove of great benefit to the science. This group at times acts as a whole body in order to assist in making observations on transmission phenomena. A good example of this is the reports furnished by amateurs during the fading tests of 1923 and more recently the General Electric-A.R.R.L. tests on short waves.

18. Traffic Handlers—In the second group we find those who are engaged in the orderly transmission and reception of messages. These

of service to the Army and Navy when called upon in advent of war. No one can realize this any more than the writer who, while serving in the Radio Intelligence Section of the First Army in France during the World War, came in contact with many of such amateurs. Of the hundreds of operators received in France as graduates of war-time radio schools few were capable of being immediately placed in actual operation of intercept and goniometer (radio compass) stations. It was generally necessary to put these men through another schooling in order to increase their speed in reception and to train them in the enemy's method of procedure. This of course meant delay in expanding the work of the intelligence section and at the same time required the services of skilled men as instructors whose time could have been of much value in actual operation of field stations.

Each group of men received from the States were closely examined to determine if there were any former amateurs or commercial operators. If any were found they were received with much concealed joy by the C.O. and his staff because practice had shown that these men could be placed at once on field stations at the front and would produce results. With their previous experience in handling traffic they were quick to get on to methods employed by the German field stations in dispatching traffic and could make solid copies of code messages through all kinds of interference.

The value of this work and the skill of the operators engaged in it is attested to by General Russel, late Chief Signal Officer of the U. S. Signal Corps. In circular No. 129 issued in France, December 20, 1918, General Russel says in writing of the work of the Radio Section, Signal Corps: "The following incidents which have been reported to this office by the Assistant Chief of Staff, G-2, A.E.F., are recorded and copies furnished in order that the excellent work of the men of our radio section in the field may be known and duly appreciated.

"On a certain occasion, some remarkably clever interceptions of German code messages were made that enabled the Americans associated with the British and French code men to work out a solution of the new code. The cleverness of this work is apparent when it is known that a failure to get correctly any one of three code messages would have defeated the accomplishment of this end. When it is known that these code messages are the hardest kind of messages to copy, and that in order to be sure of getting the valuable messages it has been necessary to copy several hundred useless ones per day over long periods of time,

and that copying is done under difficult conditions and through interference which confuses all but the best operators, it is possible to appreciate the fine work which has been done. In this one case a few minutes' inattention, a single mistake in call letters or the missing of a few groups in one of the messages would have made the others useless. The American operators are the only ones who copied all three messages with sufficient accuracy to be useful."

20. Building the Receiver—In starting in the amateur game one usually begins by building a receiver designed to cover the wavelength bands authorized for amateur use. In this way he can listen in and see what is doing on the air and get practice in learning the code. After tuning around in the different bands he becomes accustomed to the methods of procedure in calling and transmitting messages.

With diligent practice one can within three or four months copy ten words per minute (five letters to the word), the speed required in order to secure an amateur operator's license which permits him to operate a licensed amateur station. After securing the operator's license he can proceed with the building of a transmitter and get it on the air and communicate with other amateurs in all parts of the globe.

Generally speaking, a short wave receiver designed for amateur use should be able to tune from 5 to 90 meters. This will cover all the short wave bands authorized for amateur use. Such a receiver will permit the broadcast listener to tune in on short wave broadcast stations both foreign and domestic. A short wave receiver may be a simple regenerative affair or elaborate one so as to include a stage of tuned r.f. amplification employing a shielded grid tube. Again the receiver may be of the double detection type better known as a super-heterodyne. In fact, any super-heterodyne may be revamped so as to cover a wide band of short wavelengths. This is easily done by employing a plug-in coil in both tuned input and oscillator.

The audio frequency end of the receiver should be designed to meet the pleasure of the operator. If it is desired to hear only code signals a peaked transformer may be used. On the other hand, if the operator desires to tune in the short wave broadcasting stations the audio end should be designed so as to have a flat frequency characteristic ranging from approximately 30 to 7,000 cycles. This can be satisfactorily done by choosing a good make of audio transformer such as a Silver-Marshall, Amertran, Thoradson, or General Radio.

21. Short Wave Regenerative Receiver—The simplest and most economical of all short wave receivers is the regenerative type employing plug-in coils, with the antenna inductively or capacitively coupled to the tuned circuit. There are various kits for sale on the market at reasonable prices which can be easily assembled by the amateur set builder.

The receiver about to be described is designed primarily for the amateur in order to cover the various wavelength bands authorized for amateur use.

The coils are wound on forms salvaged from the bases of burned-out UX tubes. A receiver of this type was described by

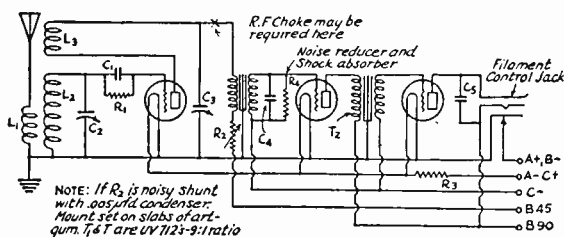

| REFERENCE TABLE | | | | |
|-----------------|-------------|-----------------------------------|-------|-----------|
| C ₁ | 500 μfd | Micro Fixed Condenser | | |
| L ₁ | 2 turns | bell wire around coil socket base | | |
| L ₂ | Grid rail | on plug-in tube base | | |
| L ₃ | Ticker | | | |
| C ₂ | 500 μfd | Micro Variable Grid plate | | |
| C ₃ | 500 μfd | Micro Variable Grid plate | | |
| C ₄ | 500 μfd | Micro Fixed Condenser | | |
| C ₅ | 500 μfd | Micro Fixed Condenser | | |
| R ₁ | 10 Megohm | Grid leak (Noiseless) | | |
| R ₂ | 500,000 Ohm | Resistor | | |
| R ₃ | 100,000 Ohm | Resistor | | |
| R ₄ | 100,000 Ohm | Resistor | | |
| L ₁ | 2 turns | bell wire around coil socket base | | |
| L ₂ | Grid rail | on plug-in tube base | | |
| L ₃ | Ticker | | | |
| WAVE BAND | Turns | # Strips | Noise | Impedance |
| 50 | 37 | 25 | 25 | 30 |
| 40 | 16 | 22 | 20 | 30 |
| 30 | 7 | 22 | 10 | 30 |
| 10 | 3 | 20 | 5 | 30 |
| 5 | 1 | 20 | 3 | 30 |

SHORT WAVE RECEIVER USING TUBE BASE COILS AND MIDGET CONDENSERS
BY
P. H. Quinby - 9DXY - St. Louis, Mo.

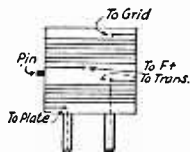

TUBE BASE COIL

NOTE: Remove old tube & leads from base. Drill small holes for leads. Wind both coils same direction. Run ends of coils thru prongs & solder.

ADVANTAGES: High L:C Ratio. No heavy end plates in condensers. High amplification with low noise level. Combined capacity and resistance control of regeneration. Good form factor in inductance. Economical efficient plug in system. Better signal spread over dial. Simplicity-Compactness.

FIG. 297. Circuit Diagram of Tube Base Short Wave Receiver with Reference Table.

P. H. Quinby in QST of March, 1928. The construction of this receiver as worked out by Mr. Quinby is as follows:

First of all it is necessary to secure five tube bases as five coils are required to cover all the amateur wavelength bands. The glass and old leads are removed from the inside of the base. Small holes are drilled for the leads which are soldered to the prongs.

22. **Removing Glass from Base**—In order to remove the glass from the tube put the whole tube in boiling water for about five minutes, then twist the glass part and it will come loose from the base. Hold the tube prongs downward and touch the ends of the prongs to the tip of a very hot soldering iron. After a moment, the solder can be flipped out with a snap of the wrist which will leave the leads running through the prongs free.

Figure 297 shows the circuit diagram of the receiver.

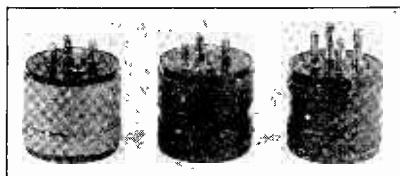

FIG. 298. Tube Base Coils.

Figure 298 shows three of the coils wound so as to cover the short wave bands.

REFERENCE TABLE.

- C_1 —100 micro-microfarad fixed condenser.
- C_2 —15 micro-microfarad midget variable condenser.
- C_3 —15 micro-microfarad midget variable condenser.
- R_1 —10 megohm grid leak (noiseless).
- R_2 —0-50,000 ohm Bradleyohm or Frost Resistance.
- R_3 —20 ohm rheostat.
- R_4 —100,000 ohm grid leak.
- L_1 —2 turns bell wire around socket base. Ant. coil.
- L_2 —Grid on plug-in tube base. Sec. coil.
- L_3 —Tickler on plug-in tube base.

COIL SPECIFICATIONS.

| Wave Band. | Secondary Coil. | | Tickler Coil. | |
|------------|-----------------|------------|---------------|------------|
| | No. of Turns. | Size Wire. | No. of Turns. | Size Wire. |
| 80 | 37 | 28 D.C.C. | 25 | 30 D.C.C. |
| 40 | 16 | 22 " | 20 | 30 " |
| 20 | 7 | 22 " | 10 | 30 " |
| 10 | 3 | 20 " | 5 | 30 " |
| 5 | 1 | 20 " | 3 | 30 " |

Both secondary and tickler coil are wound in the same direction with about $\frac{1}{4}$ -inch separation between the two windings. The outside winding of the secondary goes to the grid. The inner secondary terminal is soldered to the pin that engages in $F +$ on the socket. The outside of the tickler winding is soldered on to the pin that engages in P on the socket. The other terminal of the tickler winding is soldered to the pin that engages in the $F -$ of the socket. The $F -$ terminal of the socket connects to P of the 1st audio transformer.

The antenna is inductively coupled by winding two turns of bell wire on the socket base. This does for all wavelengths. The antenna may be capacitively coupled to the secondary by a midget condenser of one or two plates. If dead spots occur when the antenna is inductively coupled the antenna circuit should be detuned by loosening the coupling. This is accomplished by pulling the tube-base away from the socket. If the antenna is capacitively coupled dead spots can be eliminated by decreasing the value of the coupling condenser or cutting down the length of the receiving antenna.

23. The Detector Tube—A UX-112-A amplifier tube with a 9 or 10 megohm grid leak makes a good detector tube for short waves. It is non-microphonic and passes easily into oscillation with about 60 volts on the plate.

24. Fringe Howl—There is a tendency for some tubes to howl when regeneration is increased to the point of oscillation. This howl can be eliminated in most cases by connecting a fixed resistance across the secondary of each audio transformer. The value of this resistance lies between 25,000 and 100,000 ohms. In the receiver just described this resistance is indicated by R_4 .

25. Requirements of a Modern Amateur Transmitter—In order to meet the changes in amateur operating conditions occasioned by the enforcement of the new International Radio

Laws and Regulations, the Board of Directors of the American Radio Relay League authorized a program of investigation towards development and modification of amateur transmitting and receiving apparatus suitable to meet these new conditions.

In the August, 1928, issue of *QST*, Ross A. Hull, Associate Technical Editor of *QST* in charge of the A.R.R.L. Technical Development program, describes what the requirements are of a self-excited transmitter suitable for 1929 performance and tells how these requirements can be met.

Mr. Hull states briefly that the requirements of a self-excited

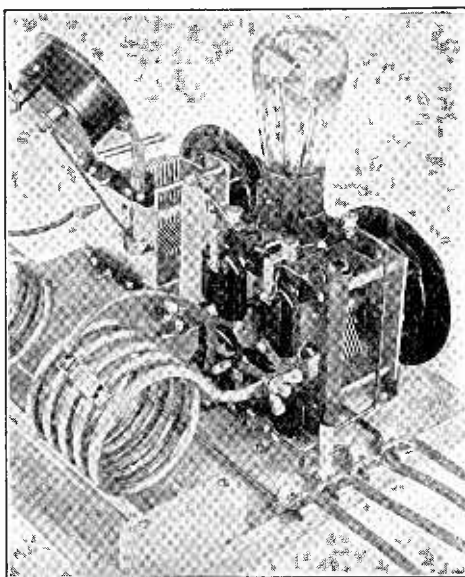

(Courtesy of *QST*.)

FIG. 299. A "Close-up" Showing the Heavy Tank Leads and Solid Construction.

The plate and grid fixed condensers are mounted immediately under the tube socket. Below them are the two filament by-pass condensers and the center-tapped filament resistor. On the far side of the tube socket is the plate choke supported from the plate terminal. On the near side is the grid leak pushed over a wooden peg in the base-board. Heavy flexible wire is used for the filament lead to the inductance, a clip being permissible in this case on account of the low current to be passed by it. Relatively enormous currents flow in the coil-condenser circuit and in this case connections between the two must be made with wing nuts, or some similar device, in order to avoid serious losses.

transmitter are as follows: "The frequency 'flutter' due to irregularities of plate supply must not exceed about 1/30 of 1 per cent (approximately 250 cycles at 40 meters). In addition, the frequency of the signal must be relatively constant. The signal must not 'shimmy' as the antenna vibrates, it should not 'chirp' as it is keyed, nor can it 'creep' appreciably as the line voltage fluctuates or the tube heats. In short, the frequency of the first dot transmitted should be within 1/10 of 1 per cent (about 750 cycles at 40 meters) of the hundredth dot, even if the plate has reddened or the line voltage drifted in the meantime. At the end of a few hours of operation the frequency should not have strayed much farther."

The problem of plate supply must be considered if one is to build a transmitter which will meet the requirements enumerated above. Raw a.c. is out of the question and one must decide on a d.c. generator or batteries or resort to rectification of a.c. with suitable choke coils and condensers.

Key clicks are also taboo. A key filter circuit is shown in figure 303 which effectively eliminates key clicks.

Another matter of great importance is the elimination of antenna swaying and the vibration of the set or any of its radio frequency wiring. The effect of coupling between tank circuit and antenna must also be studied. This will be discussed later when instructions are given for tuning the transmitter.

The investigation of the A.R.R.L. Technical Development program showed that a circuit having a low inductance-capacity ratio (termed a Hi-C circuit) has characteristics which make its use in the self-excited transmitter very desirable. In such a circuit the circulating currents increase rapidly as the inductance is reduced and the capacity increased. "A successful Hi-C plate circuit will require the use of 1/4-inch copper tubing (or strip of similar surface area) for the coils of the transmitter of 50 watts or less, and at least 3/8-inch tubing or its equivalent for the higher powers.

The voltages developed across a Hi-C circuit are much lower than in circuits of the usual constants. This will permit the use of good receiver type condensers with transmitters operating with plate voltages of 1000 or less, while nothing more than "double spacing" should be used for transmitters employing UX-852 or UV-204-A tubes.

26. Building the Transmitter—The Hartley circuit is used extensively by amateurs for short wave work and is easily adjusted and placed in operation. Figure 300 shows the connec-

tions of a Hartley circuit suitable for 1929 performance. The UX-210 7½-watt power tube adapts itself very well to a low-powered set for the beginner and will be used in this transmitter.

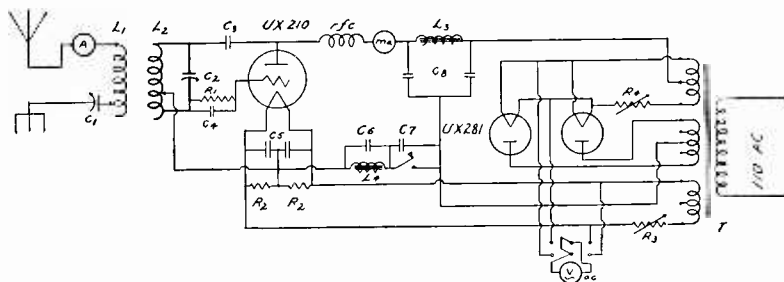

FIG. 300. Circuit Diagram of "High C" Hartley 7½-Watt Transmitter.

T—Acme 200-watt power transformer; *L*₁ and *L*₂ for various bands; *C*₁, *C*₂—500 micro-microfarad capacity receiver-type variable condenser of good quality; *C*₃—500 micro-microfarad fixed condenser (Sangamo); *C*₄—250 micro-microfarad fixed condenser (Sangamo); *C*₅—2000 micro-microfarad fixed condenser (Sangamo); *R*₁—10,000 ohm grid leak; *R*₂—50, 100 or 200 ohm fixed resistors or Christmas tree lamps; *r.f.c.*—radio frequency choke (see text); *C*₆—2 mfd. condenser—1000 volt test; *C*₇—1 mfd. condenser—1000 volt test; *C*₈—4 mfd. each (see list of parts); *R*₃—2 ohms—2 ampere capacity; *R*₄—2 ohms—4 ampere capacity; *L*₃—Acme 30 henry 300 m.a. choke; *L*₄—30 henry "B" eliminator choke.

Plate supply is obtained from rectified a.c. which is sufficiently filtered to give a pure C.W. note. Rectification is obtained by using two UX-281 tubes in a full wave rectifying circuit. Details of the filter circuit are shown in figure 300. The low-frequency power circuit can be wired up in the usual manner with No. 14 rubber-covered wire.

The inductances shown in figure 301 are designed to be tuned by a 500 micro-microfarad condenser (.0005 mfd.). Coils *A*, *B*, *C*, *D* and *E* are used for the 3500–4000 kc. (80 meter), 7000–7300 kc. (40 meter), 14,000–14,400 kc. (20 meter), 28,000–30,000 kc. (10 meter) and 56,000–60,000 kc. (5 meter) bands respectively. They have an inside diameter of 2⅝ inches and are made by winding ¼-inch soft copper tubing over a length of 2⅝ inches outside diameter water pipe by hand. To facilitate the winding process holes should first be drilled in the pipe and tubing, one end of the copper tubing being secured to the iron pipe with a machine screw before the winding is started. The ends of the coils are hammered flat and drilled to fit under

the wing nuts which hold them to the condenser leads. Two antenna coils—to be seen above the plate coils—serve for use with

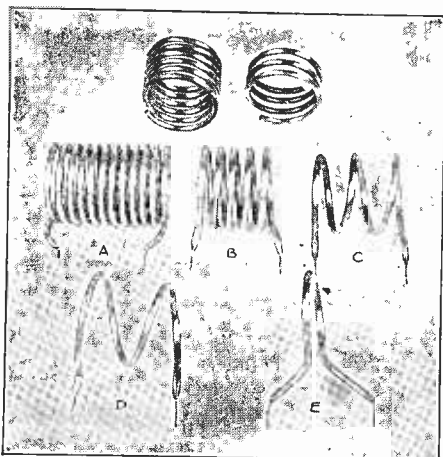

(Courtesy of QST.)

FIG. 301. Plate and Antenna Coils for Five Bands.

coils *A*, *B*, *C* and *D*. Their size will be determined to some extent by the type and constants of the antenna. Short stiff leads should be used between coils and condenser if the inductance is not connected directly to the condenser. In fact, the whole assembly should be made as compact and rigid as possible. A heavy flexible wire may be used for the filament lead to the inductance, a clip being permissible in this case on account of the low current to be passed by it.

The radio frequency choke coil can be made by winding 160 turns of No. 28 or 30 d.c.c. wire on a $\frac{3}{4}$ -inch diameter wooden rod. The size of the wire and tube is not extremely critical and smaller wires and other size tubes may be employed. A small choke of 25 turns should be connected in the grid lead to prevent generation of a frequency which is controlled by the grid-to-plate capacity as discussed in Chapter V.

27. **Tuning the Transmitter**—When the transmitter has been assembled and all leads tightened up and made stationary the plate supply can be turned on and the filaments adjusted to $7\frac{1}{2}$ volts. It is best to start at low power and with grid excitation giving half the rated plate current. The antenna coil should be disconnected during the preliminary adjustments for frequency

and power. The ratio of turns between grid and filament clip and the turns between the plate and filament clip should be somewhere between 1 to 4 or 5.

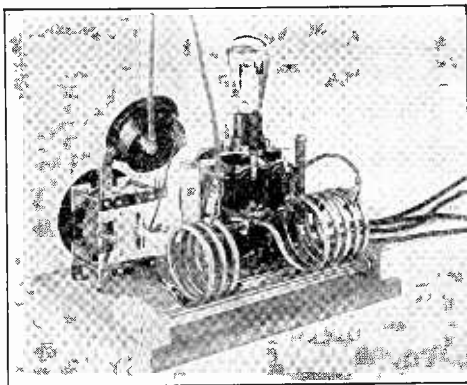

(Courtesy of QST.)

FIG. 302. A Rear View of the "1929 Type" Low Powered Hartley Transmitter.

The tube socket being mounted on top of the plate tuning condenser, its plate and grid terminals are particularly convenient to the leads between the condenser and the coil on to which they are connected through the plate and grid condensers. And the left is the antenna tuning unit, consisting of a coil—which is moved along the glass rods for variation of antenna coupling—a condenser, and a thermo-couple ammeter. The meter, though mounted on the condenser, must be insulated from it. The plate choke can be seen between the two variable condensers. Aside from their use in supporting the antenna coil, the glass rods also serve to prevent the plate coil from vibrating.

After the primary or tank circuit has been adjusted to the desired frequency the antenna coil can be connected and coupled loosely to the tank circuit coil. A coupling of 4 or 5 inches will do for low power. After resonance is secured in the antenna circuit as indicated by maximum deflection of the antenna current meter (or by maximum brilliancy of a flashlight bulb in the antenna lead) the power can be increased and adjustments made for normal plate current. The antenna coupling should then be reduced and the circuits resonated until the antenna current is about 75 to 85 per cent of the peak value. The operator should listen in on his receiver for a harmonic of the transmitter in order to determine on which side of resonance the best note is secured. In most every case the correct adjustment will be ob-

tained when the antenna is tuned to a lower frequency (a higher wavelength) than the tank circuit. Having determined this, the operator should make several test letters and note if the antenna meter follows the key and if it does not in all probability the antenna is too closely coupled to the tank circuit. Before calling a final check of the frequency should be made in order to insure that it is within the band authorized for amateur use.

28. Material and Parts Necessary to Build the Transmitter—

- 1 Acme 200 C.W. transformer 550-750 volts plate winding with oscillator and rectifier filament winding.
- 1 Acme 30 henry choke coil, 300 milliamperes capacity.
- 8 1 mfd. 1750-volt condensers.
- 1 Thermocouple ammeter, 0-1 amps.
- 1 Milliammeter, 0 to 200 milliamps.
- 1 0-15 a.c. voltmeter.
- 2 500 micro-microfarad receiver type variable condensers of good quality.
- 1 500 micro-microfarad fixed condenser.
- 1 250 micro-microfarad fixed condenser.
- 2 2000 micro-microfarad condensers.
- 3 UX sockets.
- 1 10,000 ohm grid leak tapped at 5000 ohms.
- 2 2 ohm rheostats each capable of handling 1.5 amperes without undue heating.
- 2 50, 100 or 200 ohm fixed resistors or Christmas tree lamps.
- 1 UX 210 power tube.
- 2 UX 281 half wave rectifier tubes.
- 1 Transmitting key.
- 25 feet of $\frac{1}{4}$ -inch soft copper tubing.

Key filter material:

- 1 30 henry "B" eliminator choke.
- 1 2 mfd. condenser, 1000 volts.
- 1 1 mfd. condenser, 1000 volts.
- 1 double-pole, double-throw switch for a.c. voltmeter connections.

29. **The Antenna System**—The simplest and most easily adjusted antenna for this set is a simple antenna-counterpoise system, the fundamental wavelength of which is a bit higher than the working wave. While it is probable that surrounding conditions will influence your particular antenna, it is also probable that if it is in a fairly open space a length of 35 feet, from the far end to where it connects to the set for the antenna and a

similar length for the counterpoise will be about correct. This should give a system having a (loaded) fundamental of approximately 45 meters which will be about right for operation in the 40-meter band with a series condenser in the antenna lead. For work in the 80-meter band the antenna and counterpoise should each have a length of approximately 62 feet from the insulator at the far end up to the transmitter.

30. Operating the Antenna on a Harmonic—With the transmitter just described it was shown how the antenna system was excited at just below its loaded fundamental wavelength by employing an antenna series condenser. If it was desired to operate in the 20-meter band it would be necessary to shorten both antenna and counterpoise and retune the primary circuit. However, one may desire to work in both 40- and 20-meter band on the same antenna. This can be accomplished by harmonic excitation of the antenna and was first suggested to amateurs by Boyd Phelps in QST of March, 1922, in an article entitled, "Radio Below 200 Meters."

Harmonic operation may be accomplished as follows: The antenna circuit of the transmitter is tuned to 40 meters as indicated by maximum glow of the flashlight bulb and remains as is. Adjustments are then made to the primary circuit until it is tuned to 20 meters, care being taken not to overload the tubes as indicated by excessive heating. When the primary circuit is tuned to approximately 20 meters the flashlight bulb will start to glow again and at a certain setting of the primary condenser may light nearly as bright as when the primary was operating at 40 meters. If the wavelength of the open circuit is measured it will indicate approximately 20 meters, showing that the antenna system is oscillating on its second harmonic frequency or one-half the wavelength of the fundamental. In a previous paragraph it was shown that it was undesirable to operate a Hertz system on an even harmonic as it was productive of a voltage loop at the center of the system which in most cases means at the coupling coil, thus producing losses. The logical thing then to do is to load the antenna circuit with inductance until it has a fundamental wavelength of 60 meters (the loading coil can be shortened out for 40-meter operation) and the primary tuned to 20 meters as before. When the flashlight bulb glows this time the system is operating on its third harmonic and should be very efficient in producing low angle radiation for long distance communication. One should not be deceived by the small antenna current when

operating on a harmonic. Sometimes with no visible current it is possible to do wonderful DX work.

31. Securing a License—It is unlawful for anyone in the United States (including Alaska, Porto Rico, Virgin Islands and Hawaii) to operate a radio transmitter for the purpose of amateur communication or experimentation without first securing an operator's and station license. The applicant for an amateur first grade operator's license is required to be able to receive and transmit in the International Morse Code at the rate of ten words per minute, five letters to the word. In addition, a knowledge of the radio communication laws of the United States and International Convention is required.

Before applying for an operator's license the applicant should get a copy of the "Radio Act of 1927," obtainable for five cents (not in stamps) from the Superintendent of Documents, Government Printing Office, Washington, D. C., and study especially the following sections: Section 1; Section 5, paragraphs C, D, E, F, G, and H; Section 11, paragraphs A and B; Section 12, paragraph 2; Section 20, Section 23, paragraph 2; Section 27, Section 28, Section 31, Section 32 and Section 33. The applicant is not required to quote word for word the text of these portions of the law, but should memorize the most important parts such as the requirements of a station operator upon hearing a distress call, penalty for transmission of a false distress call, secrecy of messages, the penalty for operating a station without an operator's or station license and penalty for violation of any regulation made by the licensing authority.

A copy of the International Radiotelegraph Convention should also be secured and those parts studied relative to procedure of calling and answering a station, and International regulations governing testing.

The United States and possessions are divided into nine radio districts, each district being presided over by a radio supervisor. A list of their addresses follows:

| District. | Addresses. |
|-----------|-------------------------------------|
| 1..... | Custom House, Boston, Mass. |
| 2..... | Sub-Treasury Bldg., New York, N. Y. |
| 3..... | Fort McHenry, Baltimore, Md. |
| 4..... | Post Office Bldg., Atlanta, Ga. |
| 5..... | Custom House, New Orleans, La. |
| 6..... | Custom House, San Francisco, Calif. |
| 7..... | L. C. Smith Bldg., Seattle, Wash. |
| 8..... | David Stott Bldg., Detroit, Mich. |
| 9..... | Engineering Bldg., Chicago, Ill. |

Alaska is under the jurisdiction of the 7th district, Hawaii under the 6th, and the Virgin Islands and Porto Rico under the 4th district.

To apply for an operator's license write the Supervisor of Radio for the district in which you live (this information can be generally obtained from some amateur or broadcasting station in your city or town; if in doubt write to Chief, Radio Division, Department of Commerce, Washington, D. C., who will forward your communication to the right supervisor), requesting application forms for operator's license and the date and place nearest your location at which you may appear for examination. If an applicant lives in some remote town or city from the place of examination the supervisor will issue a temporary operator's license which is valid for a period not exceeding one year, providing he can send and receive at the required rate and has a knowledge of the laws and regulations. The holder of a temporary license is expected to appear during the year for a regular amateur class examination.

After securing the operator's license application should then be made to the same supervisor's office for forms for a station license which should be properly filled out by the applicant and the notary's oath executed and then forwarded to the supervisor who will then issue the station license and call letters.

Revised U. S. Amateur Regulations

Superseding Those Dated September 1, 1928

An amateur station is a station operated by a person interested in radio technique solely with a personal aim and without pecuniary interest. Amateur licenses will not be issued to stations of other classes.

Amateur radio stations are authorized for communication only with similarly licensed stations, except as indicated below, and on wave lengths or frequencies within the following bands:

| Kilocycles | Meters |
|--------------------|------------------|
| 401,000 to 400,000 | 0.7481 to 0.7500 |
| 60,000 to 56,000 | 5.00 to 5.36 |
| 30,000 to 28,000 | 10.00 to 10.71 |
| 14,400 to 14,000 | 20.83 to 21.43 |
| 7,300. to 7,000 | 41.1 to 42.86 |
| 4,000 to 3,500 | 75.0 to 85.7 |
| 2,000 to 1,715 | 150.0 to 175.0 |

and at all times unless interference is caused with other radio services, in which event a silent period must be observed between

the hours of 8 p.m. and 10.30 p.m., local time, and on Sundays during local church services.

Amateur radio telephone operation will be permitted only in the following bands:

| Kilocycles | Meters |
|------------------|------------------|
| 60,000 to 56,000 | 5.00 to 5.36 |
| 3,550 to 3,500 | 84.50 to 85.70 |
| 2,000 to 1,715 | 150.00 to 175.00 |

Amateur television and operation of picture transmission apparatus will be permitted only in the following bands:

| Kilocycles | Meters |
|------------------|------------------|
| 60,000 to 56,000 | 5.00 to 5.36 |
| 2,000 to 1,715 | 150.00 to 175.00 |

Spark transmitters will not be authorized for amateur use.

Amateur stations must use circuits loosely coupled to the radiating system or devices that will produce equivalent effects to minimize key impacts, harmonics, and plate supply modulations. Conductive coupling, even though loose, will *not* be permitted, but this restriction shall not apply against the employment of transmission line feeder systems to Hertzian antennae.

Amateur stations are not permitted to communicate with commercial or Government stations unless authorized by the licensing authority except in an emergency or for testing purposes. This restriction does not apply to communication with small pleasure craft such as yachts and motor boats holding limited commercial station licenses which may have difficulty in establishing communication with commercial or Government stations.

Amateur stations are not authorized to broadcast news, music, lectures, sermons, or any form of entertainment, *or to conduct any form of commercial correspondence.*

No person shall operate an amateur station except under and in accordance with an operator's license issued to him by the Secretary of Commerce.

January 1, 1929.

W. D. TERRELL,
Chief, Radio Division.

32. Interference—One of the most serious difficulties that an amateur encounters upon his entrance into the transmitting game is the matter of interference to broadcast listeners, better known to the amateur fraternity as B.C.L.'s.

The revised amateur regulations of January 1, 1929, require that a silent period be observed on all WAVELENGTHS between the

hours of 8:00 p.m. and 10:30 p.m., local time, and on Sunday during local church services *if* interference is caused with other radio services. Therefore, if any amateur is informed by a B.C.L. or by a letter from the Supervisor of Radio that he is interfering with broadcast or other reception, he must immediately suspend operation of his transmitter during the hours from 8:00 p.m. to 10:30 p.m., local time, and on Sunday during local church services.

33. Key Thumps—Key thumps, sometimes called key clicks, are one of the most prevalent causes of interference to broadcast reception by amateur transmitters. The thump or click is due to the sudden shocking of the tube caused by an instantaneous rush of high voltage to the tube when the key is closed and the inductive kick with accompanying spark discharge when the key is opened.

34. Elimination—Various devices have been devised by members of the A.R.R.L. towards eliminating this source of interference. One of the simplest means of doing this is by connecting a choke coil, condenser and resistance in the keying circuit. The keying is done in the center tap connection of the filament winding. See figure 269.

Radio frequency chokes in the 110-volt a.c. supply will also prevent considerable interference by choking out induced currents which might travel all over the neighborhood by means of these conductors.

Cooperation with B.C.L.'s—In the past it has been shown that cooperation between B.C.L.'s and the amateur helps tre-

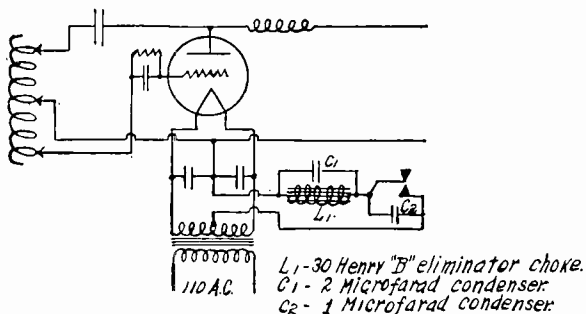

FIG. 303. Key Filter Circuit.

mendously towards solving the problem of interference. In most cases the Supervisor of Radio will furnish the amateur with the address of the complainant and request him to visit the latter at

his convenience to ascertain the kind of receiver the B.C.L. is using and note the character of the interference.

To make sure the interference is coming from the amateur transmitter he should arrange with another licensed amateur to come to his station and transmit a pre-arranged signal while he is at the home of the B.C.L., or tell the B.C.L. to listen for a certain character. If the interference is recognized as coming from the transmitter the owner of the same should recommend to the B.C.L. a means of making his receiver more selective, such as the employment of a wave trap, cutting down the length of the antenna or revamping the circuit in the receiver. On the other hand, if the interference is of the inductive type such as originates from street cars, motors, generators, faulty insulation of power

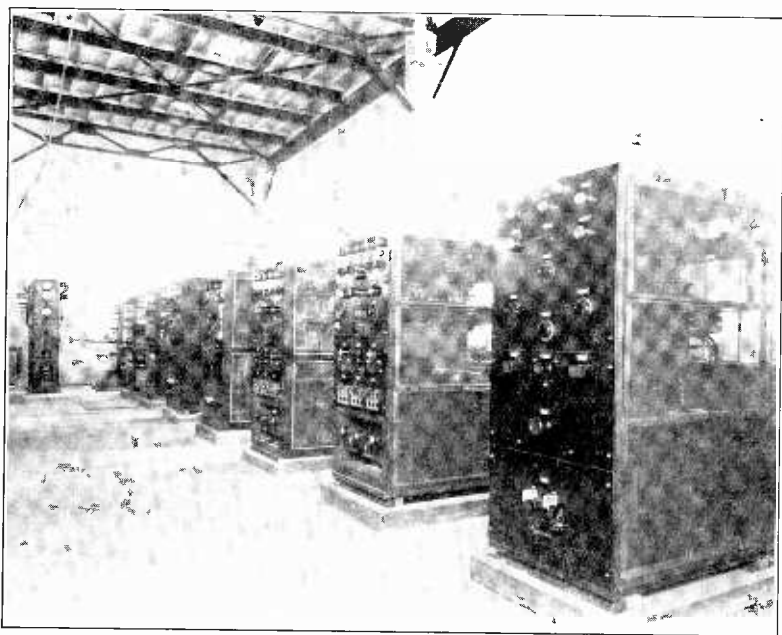

FIG. 304. A Group of High Frequency Transmitters Operated by the Radio Communications, Inc., at Rocky Point, L. I.

lines, heating pads, electric signs, violet ray, and X-ray machines, battery chargers of the vibrator type, precipitators and other in-

dustrial devices, the amateur should so inform the B.C.L. and explain to him how interference is generated by these devices and recommend a method of locating and remedying the same and offering to assist in this procedure if convenient. Of the hundreds of complaints made by broadcast listeners to the Federal Radio Commission or Supervisor of Radio in which amateurs are accused of creating certain disturbance to broadcast reception it has been found upon investigation that in the majority of cases the interference was caused by one or more of the devices of the type listed above and that interference caused by amateur transmission is a rare occurrence, especially so with the increased use of modern selective receivers employed for broadcast reception.

35. The American Radio Relay League—Every amateur should join the American Radio Relay League which is a non-commercial association of radio amateurs, bonded for the promotion of interest in amateur radio communication and experimentation, for the relaying of messages by radio, for the advancement of the radio art, and of the public welfare, for the representation of the radio amateur in legislative matters, and for the maintenance of fraternalism and a high standard of conduct.

Of, by and for the amateur, it numbers within its ranks practically every worth-while amateur in the world and it can be truly said that it has a history of glorious achievement as the standard-bearer in amateur affairs.

The only essential qualification for membership is a bona fide interest in amateur radio. Ownership of a transmitting station and knowledge of the code are not prerequisite. Membership in the league entitles one to a year's subscription to QST, a monthly publication describing the activities of amateur transmission, and technical articles dealing with the latest developments of the radio art. Correspondence should be addressed to the Secretary, Executive Headquarters, Hartford, Conn.

Article 5 Ter quoted below should be studied by all amateurs prior to taking examination for the first class or Extra first class amateur operator's license. The article follows:

ARTICLE 5 TER (INTERNATIONAL RADIOTELEGRAPHIC CONVENTION)

5. (1) The exchange of communications between private experimental stations of different countries shall be forbidden if the Administration of one of the interested countries has given notice of its opposition to this exchange.

(2) When this exchange is permitted the communications must, unless the interested countries have entered into other agreements among themselves, be carried on in plain language and be limited to messages bearing upon the experiments and to remarks of a private nature for which, by reason of their unimportance, recourse to the public telegraph service might not be warranted.

(3) In a private experimental station authorized to carry on transmission any person operating the apparatus, either on his own account or for another, must have proved his ability to transmit text in International Morse Code signals and to read by ear texts thus transmitted. He can be replaced only by authorized persons possessing the same qualifications.

(4) Administrations shall take such measures as they deem necessary to verify the qualifications, from a technical point of view, of all persons handling the apparatus.

CHAPTER 17

PRACTICAL TELEVISION AND RADIO MOVIES

1. Introduction—It is not the aim of the author to introduce in this chapter any large number of the problems met in the electrical transmission of images. Even in its present state television is too complex for such treatment since it involves nearly all the problems of ordinary entertainment broadcasting besides several complete families of new problems having to do with gaseous conduction, optics and synchronization.

It has been thought best therefore to give a brief outline of the most usual methods together with instructions for building inexpensive receiving equipment with which one may gain familiarity with the art by "looking in" on the experimental programs now being transmitted.

In the last two years many pages have been printed in which we are rather hysterically urged to leave television alone because it is not yet "ready for the public." Such talk is foolish since public interest in an art is the best assurance that it promptly will advance to a stage where it is fully "ready for the public." If one recalls the terrible things done by early broadcasting stations in the name of entertainment, it can be seen how far we have come in that field through the support and encouragement of public interest. A similar distance remains to be covered in the television art and the thing is therefore at this moment in a state where it is of interest to that part of the public which can be classified as scientists, engineers, experimenters or "fans." The apparatus discussed here is therefore obviously not final, indeed no art ever attains a final form until it stops growing. Furthermore, many believe that the methods now used base on incorrect fundamentals and will eventually be wholly superseded. They are not to be disregarded on this account; we have but to recall that spark radio transmitters were of the greatest service in their day although they are now completely obsolete.

At the present time it is possible to receive silhouettes and half-tone movies in the home, though not with the clearness and continuity of a moving picture show. At times the images are completely lost or unrecognizable. Nevertheless, there is fascination in the ability to tune in signals and see them weave a moving picture.

2. **Early Developments**—In June, 1925, Mr. C. Francis Jenkins gave the first public demonstration of the transmission of images of living subjects, and also of film records of persons and scenes. Mr. Jenkins effected his transmission by radio and in the latter case called his images of living subjects "radio-vision" and his transmission of films "radio movies." In April, 1927, the American Telephone and Telegraph Company transmitted images of living persons from Washington to New York over telephone circuits. The same sort of images were also transmitted by radio from the A. T. & T. experimental station at Whippany, N. J., to the laboratories in New York City. In the considerable publicity given to the A. T. & T. transmissions the term "television" was used, and has largely been adopted by the general public as applying to any form of visual broadcasting. One cannot well quarrel with established usage, even though incorrect, but a discrimination should be made between the radio transmission of living subjects and transmission of film records of such subjects. Therefore in this chapter we will call the first system "television" (meaning radio vision, although the term does not say so) and the second one "radio movies."

Now observe that in the A. T. & T. demonstrations wire and radio channels were used interchangeably. Thus the art of seeing at a distance is not essentially a radio one and the reason for introducing it into a radio book lies in the expectation that some form of it will see wide distribution as an auxiliary to the present (acoustic) radio broadcasting. Independent wire development for public entertainment can be expected.

3. **Radiomovies**—Radiomovies are made possible by first photographing the subject with an ordinary motion picture camera. The problem then becomes that of transforming the lights and shadows of this film into electrical impulses which may be transmitted and at the receiving point reconverted into lights and shadows properly distributed on the receiving screen. Since in the ordinary moving picture theatre a flickerless picture necessitates running the film through the projector at the rate of about 16 pictures per second, we must carry out our process of conversion at this same rate, which is to say, we must in $1/16$ of 1 second completely transform one "frame" or picture into electrical impulses and move it on so that the next "frame" may similarly be analyzed in the next $1/16$ of 1 second. The process of doing this is basically the same one of "scanning line-for-line" as is used in transmitting directly the image of a living person. However, the small size of the film permits some surprising simplifications and

economies in the apparatus and without doubt the greatest accomplishments have been made along the line of transmitting and receiving silhouette and half-tone radiomovies. As transmitted from

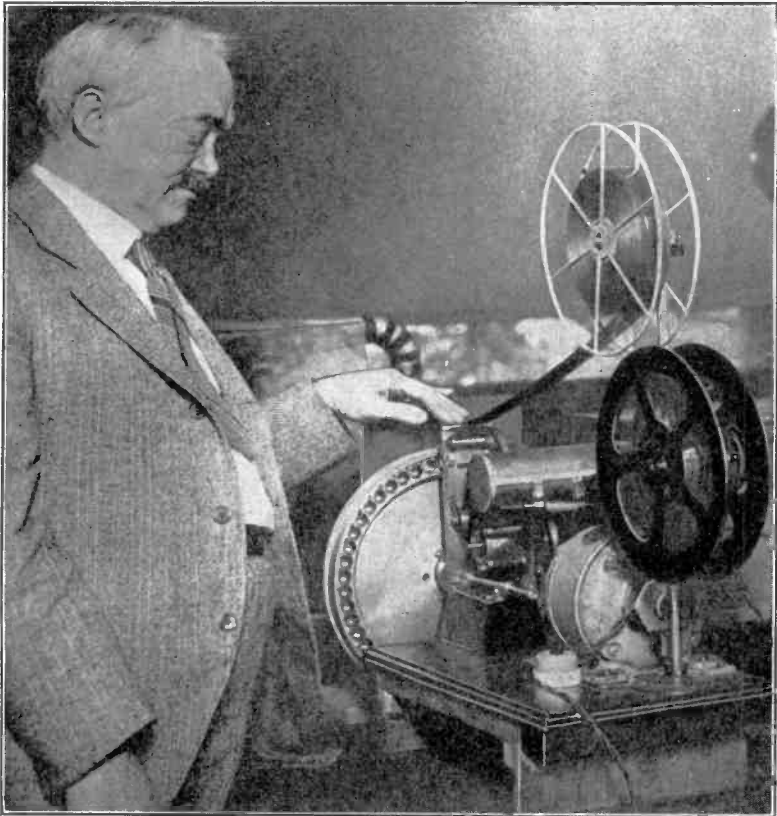

(Courtesy of Jenkins Laboratories, Inc.)

FIG. 305. Mr. C. Francis Jenkins and His Lens Disc Scanner for Broadcasting Radiomovies.

the Jenkins Station W₃XK these have been well received over a considerable portion of the United States.

The first radiomovies transmitted from the Jenkins Laboratories were only silhouettes in order to confine the frequency within a

ten-kc band. Some time later a wider band was granted and transmissions converted to the half-tone basis.

4. Transmitting Apparatus—Whether films or moving objects are to be transmitted, the radio transmitter employed may remain the same. It is much like that used for sound broadcasting, but must be able to amplify and radiate a carrier wave modulated by a wider band of frequencies, for instance 20,000 cycles on each side of the carrier instead of the more usual 5,000 or 6,000. The "pickup" is not a microphone but a species of electrical eye, namely, the photo-electric cell, which may be called the basis of the system.

5. The Photo-Electric Cell—The photo-electric cell is a glass tube or bulb containing gas and coated over most of its inner surface with a material like potassium bichloride, which liberates electrons when struck by light. The two terminals of the cell are this internal coating and a ring of photo-electrically inactive metal such as platinum or nickel. A battery is so connected as to keep the ring positive and the coating negative. When light enters the cell the electrons which are released (being negative particles) stream to the positive metal ring and an electric current accordingly flows through the battery. With proper cell design and circuit conditions this current is proportional to the light entering the cell. If therefore a resistor be connected in series with the battery and photo-electric cell, the voltage drop across the resistor will be proportional to the current and in turn to the light entering the cell. Although very feeble, this voltage may be amplified to any desired degree by a somewhat special vacuum tube amplifier such as shown in figure 314. The condenser between the resistor and the grid of the first amplifier tube serves to keep the steady battery voltage off this grid while permitting the variations to pass through.

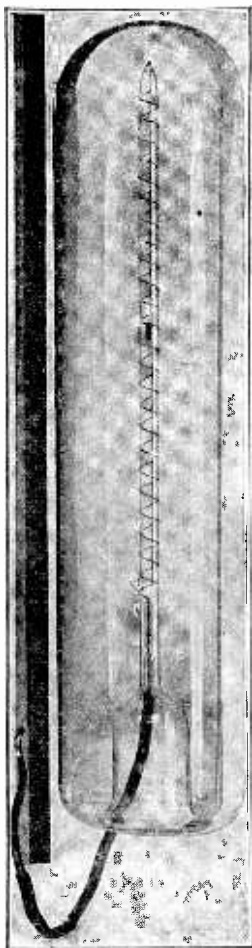

(Courtesy of Bell Telephone Laboratories, Inc.)

FIG. 306. Photo Electric Cell.

We now have a device able to perceive light intensities and to convert them into electrical effects of almost any desired intensity. Obviously this electrical output might be used to vary the output of a radio transmitter. This, however, is not all there is to the problem. We must not only be able to tell what the general brightness of the picture is but must be able to perceive how this brightness varies over different portions of the picture. The cell alone is not capable of doing this and it is therefore given the coöperation of a scanning device which in its most common form is a disc pierced by a spiral of small holes.

6. The Scanning Disc—The scanning disc is generally an aluminum plate with from 24 to 60 (usually 48 or 60) small holes arranged in a 1 turn spiral. There are several methods of using such a scanning disc in connection with a television transmitter, but only one will be described. In order to understand it we must first refer to a characteristic of the human eye called "persistence of vision."

7. Persistence of Vision—Persistence of vision makes possible the ordinary moving picture as well as the television picture. The moving picture screen appears to us as continuously illuminated by a moving picture. In reality, fifteen or so separate pictures are flashed on the screen which is entirely dark between-times. Our eyes, however, do not immediately stop seeing each picture when that picture is gone and thus retain the "remembered" picture long enough to blend it with the next picture, obtaining as a final result a smoothly moving image. The process is so perfect that the complete darknesses make on us no more impression than to make the picture seem to flicker very slightly.

8. Creating an Image by Linear Assembly of Individual Light Areas—The television transmitting and receiving system takes advantage of this convenient lag in the eye and brain. It does this by looking for (for instance) $1/20,000$ of a second at one portion of the image to be transmitted, causing the receiver to make a light of corresponding brightness at that point and then hurries on to inspect the rest of the image to be transmitted. One-fifteenth of a second later it has covered the rest of the picture and is looking at the original point once more, reporting to the receiver what changes in brightness have taken place in that time. Thus during the biggest part of each second this particular corner of the picture is receiving no attention and is quite as dark as the movie screen between pictures. However, the same convenient

persistence of vision carries on and causes us to see light where there is no light. Therefore, instead of needing hundreds or thousands of photo-electric cells, each looking at one part of the picture, we are able to use a single cell which looks over (or scans) the entire picture, one part at a time. There remains the problem of causing the photo-electric cell to see only one bit of the picture at a time and to look over the picture in an orderly manner, once for each fifteenth of a second. This is the business of the scanning disc. The arrangement is as shown in figure 307. The light

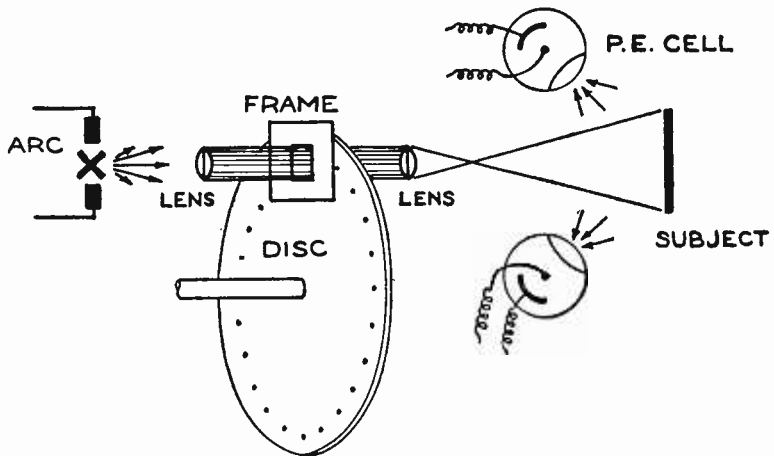

FIG. 307. Illustrative Transmitting Apparatus.

from a strong arc, or other lamp is thrown upon the subject to be transmitted. Two things are placed in the path of this light beam. One is a screen with a rectangular hole and the other is the scanning disc. The relative positions and size of these two is such that the innermost end of the spiral of holes in the scanning disc lies just within one edge of the square of light and the outermost end of the spiral is just at the other edge. The space between two successive holes in the spiral determines the other dimensions of the rectangular hole in the screen. Thus if the scanning disc were removed, the subject would be illuminated by a square of light. If the scanning disc is interposed, the subject is illuminated by

only a small patch of light whose position depends upon the location of the scanning hole which is at the moment before the square opening. If the disc is turned slowly, spots of light will wipe across the subject, each tracing a path slightly below the preceding one. The photo-electric cell (or cells) are arranged in front of the subject where they may stare at it and observe how much light is reflected. When the light spot strikes the subject's white hat the cells send out a strong impulse which we will presently convert into a flash of light at the receiver. When the light spot strikes the subject's black hair very little light is reflected to the cells and accordingly very little light is manufactured at the receiver. To *describe* a picture in this manner takes a great deal of time, but the photo-electric cell needs no such amount of time. Its response and report are instantaneous, so that we do not need to turn the disc a bit at a time but may drive it with a motor at 900 r.p.m. without fear that the cell will not have time to see. 900 r.p.m. corresponds to 15 revolutions per second, which is to say we now have a device which will 15 times per second report how bright or dark the various portions of the subject are. This report will appear at the receiver as a flickering light and the rest of the problem is to distribute that flickering light properly over a screen so that it will become reassembled into a picture as nearly as possible like the subject. This is done by another scanning device at the receiving end, though unfortunately not quite in the most obvious way.

9. Scanning at the Receiver—The simplest type of receiver would be possible if we could take the received signal and from its varying intensity manufacture a light of great strength, flickering exactly in time with the light and darkness reported by the photo-electric cell of the transmitter in its hurried inspection of the different portions of the subject. If we had such a light, we could set up an arrangement exactly like that of figure 308, drive the scanning disc in time with the one at the transmitter and simply shoot upon a screen the light which came from the lamp. The picture would be reassembled, for with the two discs in the same position our receiving lamp would illuminate the upper left corner of its screen at the moment when that corner was being inspected by the transmitting cell, likewise the intensity of that illumination would be correct since it depended upon the report then being made by the cell.

Unfortunately there is no such lamp as yet. Those lamps which are powerful enough for this use are 10,000 times too slow and those which are fast enough are pitifully weak. Since we ab-

solutely must have speed we therefore use the weak lamp and go to a different method. Figure 308 shows an illustrative arrangement of the parts in one system of television reception. The ob-

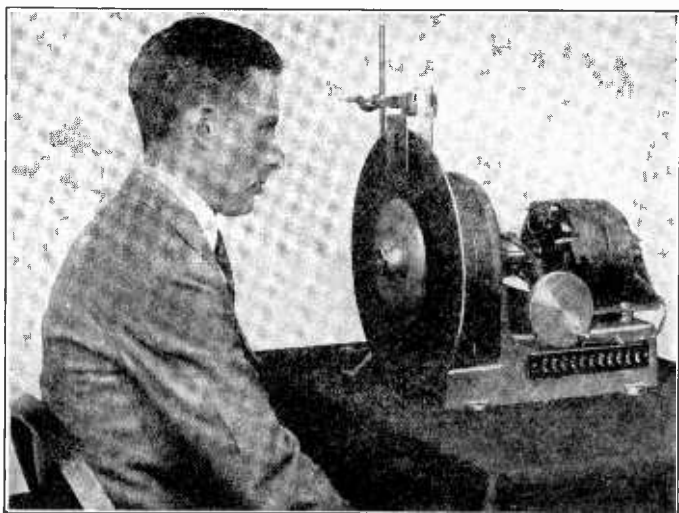

FIG. 308. Observer Sees Image Reproduced in Frame of Receiving Apparatus.

server is seated so as to look into a small opening or frame in front of the scanning disc. This frame, like the one at the transmitter is of such size that only one scanning hole is seen at a time. Behind the scanning disc is a neon lamp (figure 309) which creates a patch of light at least as large as the opening in the frame. This neon lamp is named for the gas which it contains. Neon under low pressure emits an orange red light when an electric current is passed through it, as we all know from observing advertising signs. If then the output of our transmitting photo-electric cell be used to vary the output of a radio transmitter (that is to say, modulate it), we may receive this resulting signal with a receiver not greatly different from an ordinary broadcast receiver and by feeding the output of the receiver to a pair of electrodes sealed into such a neon lamp we may derive a light which flickers in the necessary manner. The action has the requisite rapidity because the light does not depend upon heating or cooling something solid but only upon the ionization of a small quantity of gas. Of

course, the entire light area flickers, but at any instant the observer only sees that portion of it which is exposed by the scanning disc and this is exactly the portion which is even then being inspected by the transmitting photo-electric cell. It therefore follows that whatever portion of the receiving light may be visible is always of a brightness appropriate to that *part* of the picture at that *moment*.

We have now seen how it should be possible to cause a photo-electric cell and scanning disc to disassemble an image, converting it into a pulsating electric current. We have also seen how it should be possible from this pulsating electric current to create a pulsating light and with the aid of a scanning disc to reassemble these light pulsations into a picture. These are the barest fundamentals and have all been known for a long time. On the other hand, their reduction to practice involves many considerations of which only the most necessary will be touched on here, and these but very briefly. The optical problems, including the entire subject of color television, are regarded as wholly outside the province of this book. The problem of causing the receiving scanning disc to run in step with the transmitting scanning disc (synchronization) has received no very practical solution and is therefore not touched except to mention some of the simpler methods which, while requiring constant attention, are workable.

10. Scanning Disc Dimensions—To secure the necessary illumination one would like to make the holes in the scanning disc of both transmitter and receiver large. However, the paths of the holes must not overlap which means that larger holes necessitate a larger disc. In the case of a 60-hole disc producing a picture $1\frac{1}{2}$ " square, the holes may be only $.025$ " across. Since a $1\frac{1}{2}$ " square neon lamp is the practical limit of the moment the amount of light which may be seen at an instant becomes distressingly small and the image correspondingly dim. This is the illumination problem most im-

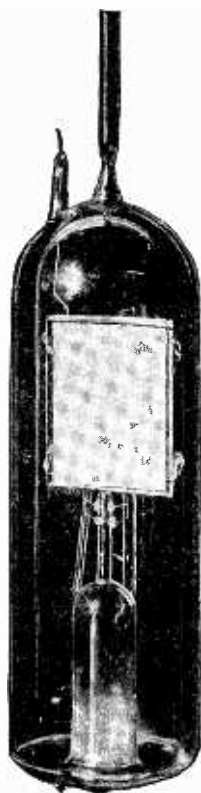

(Courtesy of Bell Laboratories, Telephone Inc.)

FIG. 309. Neon Lamp.

mediately apparent at the receiver. It will be seen also that the space between the holes, measured along the spiral, must be $1\frac{1}{2}$ " (nearly) and that therefore even this small picture requires a disc of a diameter in excess of $2\frac{1}{2}$ '. Here is encountered the difficulty of bulkiness in the receiver. The Jenkin's drum scanner, described later, materially alleviates the difficulties as to both bulk and intensity of illumination. Similar problems are encountered at the transmitter but it is fortunate that many receivers may be served by a single transmitter and thus the same limitations of cost do not

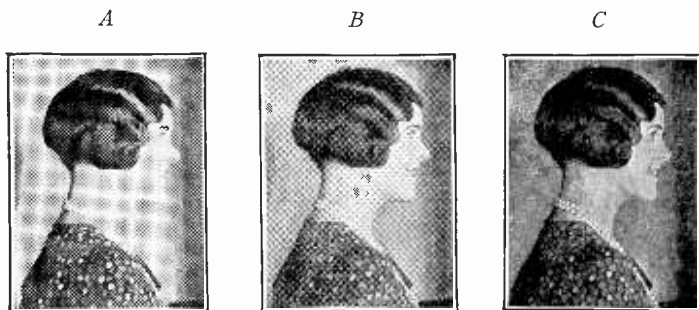

(Courtesy of Sheldon and Grisewood, "Television.")

FIG. 310. Increasing the Number of Picture Elements Results in Better Definition. (a) 60 Screen 3600 elements per square inch; (b) 100 Screen 10,000 elements per square inch; (c) 150 Screen 22,500 elements per square inch.

compel one to discard as impractical those things which would be quite impossible in a receiver. This is parallel to the case of ordinary broadcasting.

II. Frequency Considerations—Let us refer to the photograph in figure 310. Upon examination it will be seen that the pictures are composed of many black dots on a white background. The shading is the result of the grouping of these black dots. It will also be noted that picture *B* is clearer than *A* and that *C* is still more clearly defined. The reason for this is that there are many more dots in *B* than in *A*, while *C* has still more. These dots are the "picture elements" and the detail of reproduction depends upon the number of elements used per unit area. Picture *A* has 3600 elements per square inch. *B* has 10,000 elements per square inch and *C* has 22,500. It will then be wondered why tele-

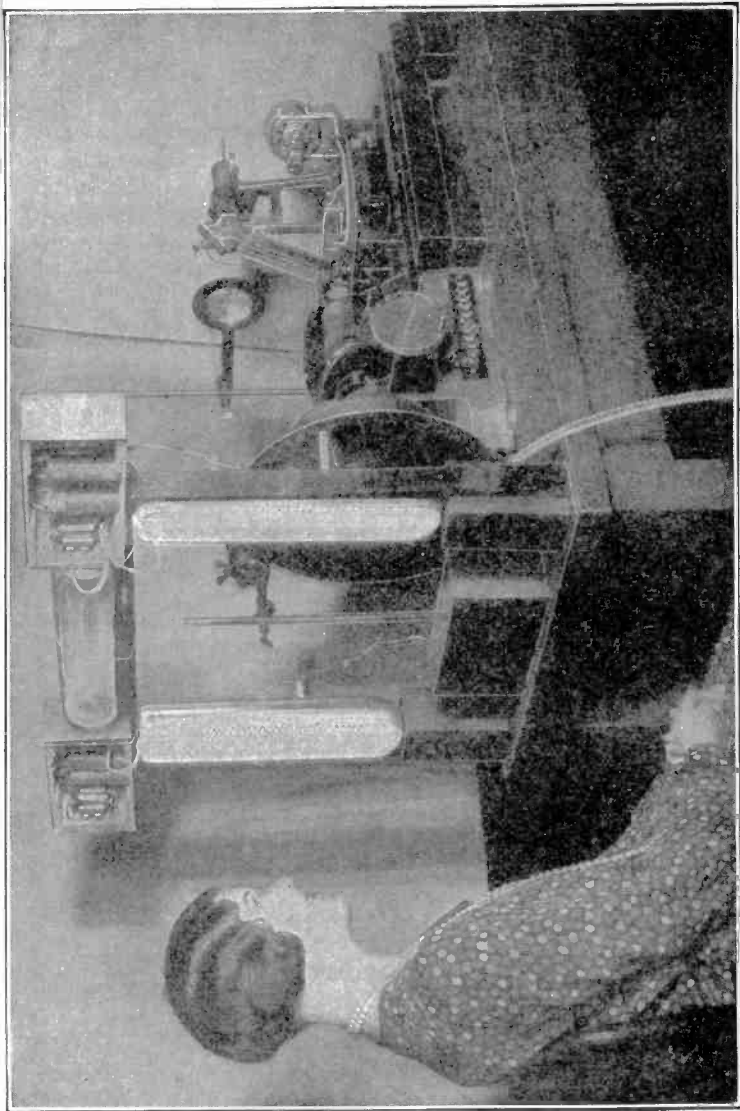

FIG. 310z. Arrangement for Scanning as Employed for Transmission in the Bell System. Light from the arc lamp is condensed on the disc which is driven by a high frequency synchronous motor. The disc carries a spiral of pin-hole apertures, each of which in turn projects a moving spot of light on the subject. Reflected light is collected by three large photo-electric cells.

(Courtesy of Bell Telephone Laboratories, Inc.)

vision transmitters should use but a 60-hole disc which gives a picture only corresponding to 3600 elements *for the entire picture*. The explanation lies in the fact that a consideration of the mathematics and the practice taken together shows that the television transmitter and receiver must be capable of handling a number of impulses equal to about $1/2$ of the number of picture elements which are inspected. For the case just mentioned this means about 1800 for each inspection of the subject and since these inspections are made at the rate of 15 per second (1 for each revolution of the scanning disc) we have $(3600/2)15 = 27,000$ per second. If the transmitter is modulated in the ordinary manner, this frequency band appears on both sides of the carrier and the station occupies 54,000 cycles or 54 kilocycles of valuable channel space for the transmission of one not especially good picture of small size. This is 5.4 times the territory required for very acceptable acoustic broadcasting and in view of the manner in which channels are fought for one may see readily why television broadcasts have been removed to the territory below 200 meters which, though no less valuable, is not used by such a large number of individuals. Furthermore, the very serious problem of amplifying such a wide band of frequencies has caused still further concessions to be made, as has also the illumination problem. Individual opinion has entered in here and one may find all manner of combinations of picture frequency (disc speed in r.p.s.) and hole frequency (number of holes times disc r.p.s.). A disc with as few holes as 48 will handle acceptable silhouettes, and reduce the top frequency by almost one-third of what was necessary with 60 holes. Picture frequencies as low as 7.5 and as high as 20 are in use while scanning discs are used with numbers of holes ranging from 24 to 60, with still other combinations in laboratory use. The disc diameter is (if the picture size remains unchanged) directly proportional to the number of holes since the distance between them must remain equal to the picture width.

12. The Jenkin's Drum Scanner—The Jenkin's drum scanner avoids certain limitations of the disc, as used at a receiver and is here described as in Jenkin's book "Radiomovies."

"To get a mental picture of the drum let us imagine a hollow cylinder about 7" in diameter, 3" long and having a $1/16$ " wall with a hub, hollow for the length of the drum and of about $1\ 1/2$ "

inside diameter. The hub has an extension outside the drum which slips on the $1/2''$ shaft of a small motor.

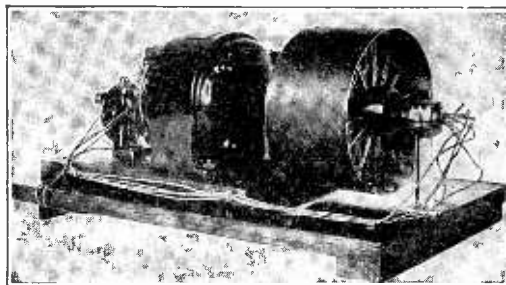

(Courtesy of Jenkins Laboratories, Inc.)

FIG. 311. Jenkins Drum Radiovisor Showing Quartz Rods to Conserve Light by Overcoming the Inverse Square Law.

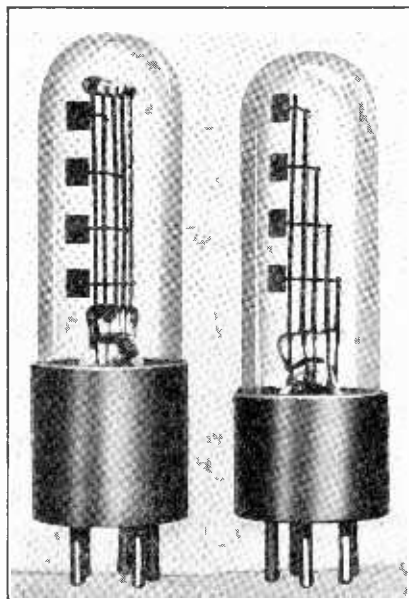

FIG. 312. Jenkins Multiple-Cathode Lamp Used in Drum Radiovisor.

“ There are 48 scanning apertures in the peripheral wall of the drum, each aperture being of elementary area, say $1/32$ inch diameter. The apertures are arranged in four helical turns and spaced 2 inches apart circumferentially, the turns being $1/2$ inch apart.

“ Inside the drum-hub a 4-target cathode-glow neon lamp, $1\ 1/8$ inches in diameter, is held by a clamp mounted on the motor platform, at the open end of the drum preferably.

“ Between the lamp and the periphery of the drum are quartz rods, each rod ending under its particular minute aperture in the drum surface.

“ A quartz rod has the peculiar property that light flows through it as water flows through a pipe; that is, the use of quartz rods avoids the light loss due to the inverse square law.

“ The cathode targets are located one each under each of the rows of quartz rods and are lighted in succession through a 4-segment commutator by current from the plate of the last tube of the radio receiver-amplifier.

“ Because the movement of the inner ends of the rods is so short, these cathode targets need be only about $1/8$ by $3/16$ inch size, or, for ample latitude in setting the lamp, say, $3/16$ by $1/4$ inch.

“ Such small targets obviously require only a very small amount of current compared with the current required for the $1\ 1/2$ inch square cathode plate of a disc-scanned picture; say, 3 to 5 milliamperes. The light modulation of these small cathode targets seems to be just as easily done, if not more easily than a large plate.

“ The quartz rods are employed to avoid the light loss due to the inverse square law. To discover how effective they are, one has but to remove the rods, for no picture can be seen without them, though every other condition remains the same.

“ The miniature cathode targets lie about $3/16$ ” from the inner end of the quartz rods, which at this point have relatively small movement. The size of the picture, however, is limited only by the arcuate distance from the outer end of one rod to the outer end of the next. But as the light at the outer end, that is, the picture end—of the rods is just as intense as it is within $3/16$ ” of the light source itself, we get an acceptably lighted picture, for there is no loss of light in its travel along the quartz rods. Neither does the drum scanner have another of the limitations of the disc; that is, the scanning apertures in the drum may be arranged

in a plurality of helical turns without in any way changing the spacing between any of the apertures.

"A 7" diameter with scanning apertures in four helical turns gives a 2" picture.

"The same drum with six helical turns gives a 3-inch picture, which is more than twice the area of any picture possible with a 36" disc.

"If the drum is increased to 10 1/2" diameter and turned six times per picture, the picture is 4" square.

"The light intensity is the intensity of the tiny cathode source, which (because it is so small) requires but little current for a definite light intensity and a given size picture, the picture generated by the outer ends of the quartz rods being a virtual magnification of the light source.

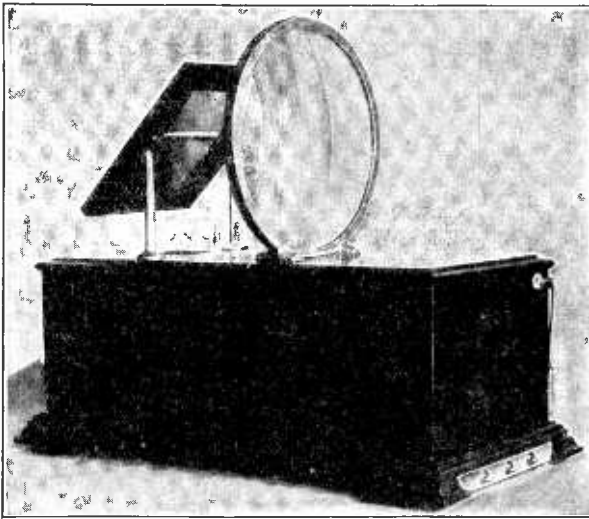

FIG. 313. Jenkins Radiovisor Showing Switches, Lens and Mirror. Shows a picture about 6 x 6 inches.

"The light source need be but little larger than the elementary area of the picture, for the arcuate movement of the outer end of each quartz rod through which the light is flowing is comparable to the movement over the picture area of this small light source itself.

“An increase in the size of the picture does not, therefore, require an increase in the light source, namely, the size of the cathode, but only a lengthening of the quartz rods; for the width of the picture is determined by the length of the arc of the angle subtended by radially adjacent quartz rods; and the height of the picture by the number of parallel lines, each the locus of the outer end of a quartz rod from which the light emerges undimmed by its distance from the source in the hub of the drum.”

13. Amplifiers—To handle the extremely wide range of frequencies lying between the picture rate and the scanning frequency a rather special amplifier is needed at both transmitter and receiver. Usually this amplifier depends to a considerable degree, or altogether upon resistance couplings, so called. As has been explained elsewhere, this is the term usually and inexactly applied to a coupling which consists of a plate resistor, a grid resistor and a capacitor connecting grid to plate. Since the capacitor is the only reactive element and this reactance may be made small by making the condenser large, one would expect such an amplifier to be al-

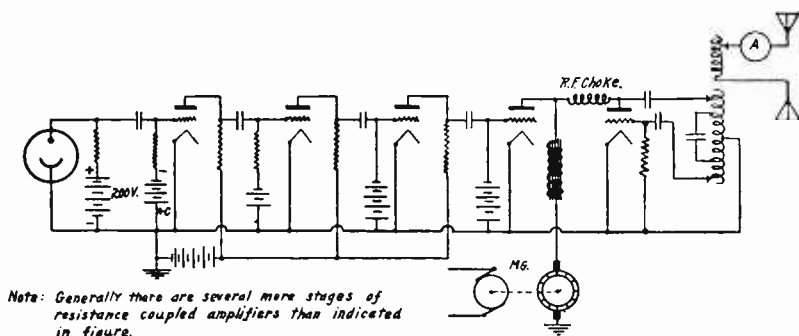

FIG. 314. Schematic Diagram of Television Transmitter.

most independent of frequency. In practice this is not true because of tube capacity, unavoidable couplings of other types and the fact that satisfactory resistances entirely without reactance are not available. Nevertheless, amplifiers of this general type are employed and at the transmitter become the source of difficulty because their wide admission band makes them peculiarly susceptible to oscillation. At the receiving end it is rarely necessary to use more than four stages. Figure 314 shows a schematic diagram of a television transmitter.

14. Synchronization—Synchronization of the transmitter and receiver of a television or radiomovie system requires that the transmitter and receiver scanning members run at exactly the same speed and, furthermore, that they be in step. Thus it is not enough that both operate at precisely 900 r.p.m.; the picture is spoiled if one is a part of a turn ahead of the other. The precision required is quite high since for a 48-hole disc the picture becomes badly deformed if one disc runs ahead or behind by as little as $1/200$ of a revolution. To secure this precision there have been suggested and used methods whereby there is sent from the transmitter over another channel (wire or radio) a "synchronizing frequency" in the order of several thousand cycles. This frequency is derived from a power source which drives a synchronous motor at the transmitter (driving motor for the scanning disc) while the portion of it sent to the receiver over the separate channel is amplified at the receiver and used to fix the exact speed of the receiving motor which must, of course, get most of its power from another source and must therefore be previously running at almost the right speed. Because of the extra channel required and the complexity of the receiver this scheme has been used largely in special demonstrations and the simpler methods mentioned hereafter, though requiring continual adjustment, used instead. (An exception must be made in the case of the simple and quite satisfactory case where transmitter and receiver may be driven by synchronous motors operated from a common power system. If the voltage is constant and the motors of good design, quite satisfactory results can be obtained.)

15. Variable Speed Motors—A universal or series motor changes speed when resistance is inserted in the line. If therefore a resistance is put in one side of the line and made of such value that the motor drives the scanning disc just a trifle slowly, one may "whip" the motor up to proper speed by occasionally depressing a telegraph key connected across a portion of this resistance. By practice and experience one may thus juggle the speed about the desired value. The work is less wearisome if the disc is rather heavy and the motor barely powerful enough to drive it above synchronism. A modification of the same scheme is possible with a shunt or compound motor, operating on the shunt field only.

The four types of motors just mentioned have the common disadvantage that both the brushes and the speed control spark and therefore produce interference which must be trapped out by a filter across the motor terminals.

16. Friction Drive—A simple and excellent way of obtaining synchronization has been described many times by Jenkins. This method makes use of a synchronous induction motor. In this motor, there is no commutator or brushes, thus no interference results from sparking period.

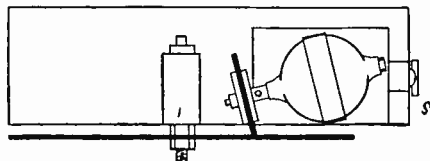

FIG. 315. Jenkins Method of Driving Scanning Disc in Order to Obtain Synchronization.

The scanning disc is not driven through its shaft but by means of a rubber driving wheel whose edge bears lightly against the back of the disc. This rubber wheel is clamped between flanges on the motor shaft. No rheostat is necessary; the motor is allowed to run at the speed for which it was designed and the speed of the scanning disc is controlled by moving the motor to and from the center of the scanning disc by means of a thumb screw which moves the wooden slide on which the motor is mounted. It is obvious that with constant motor speed the scanning disc will be driven faster as the rubber wheel is brought nearer the center of the disc. The ease of control is far greater than that of the other methods mentioned, and synchronous speed is easily obtained. There remains the problem of throwing the disc into step with the transmitting disc, that is, making it start around the spiral at the same instant. Though this sounds difficult, it can with practice be done by briefly touching the edge of the disc and thus producing momentary slip in the drive. Obviously it is no perfect method and in receivers built for ease of control there is accordingly introduced some method of rotating the entire assembly before the neon lamp or else there is introduced between the friction drive and the scanning disc a sort of differential gearing which permits changing the relative position while both are running. However, endless variations can be introduced in transmitter and receiving scanning, many of which employ no scanning disc, or even do away with moving parts altogether. Their practical value can at present only be conjectured.

17. Operation of the Neon Lamp—In the vacuum tubes we

have discussed any illumination given off is entirely incidental to the main process of propelling electrons from filament to plate whereas in the neon lamp electrons are sent through the gas for the sole purpose of producing light. This is accomplished through a process of ionization. Let us assume that we have two electrodes sealed into a glass bulb containing a small amount of an inert gas such as neon. The particles of gas are composed of many atoms, which in turn consist of electrons some of which are a constituent part of the atom while others are free. Now if a high electrical potential is applied to the electrodes, it will be noticed that the negative or cathode plate is covered by an orange red glow. This may be explained as follows. Suppose the voltage applied between the plates is 200. There will be a voltage drop of that value within the tube and this occurs mostly near the negative electrode or cathode. The positive charge on the anode attracts the free electrons mentioned before and they fly to it at accelerated velocity. If, while proceeding at high speed, it strikes an atom of gas, there is frequently knocked loose one of the constituent electrons, whereupon we speak of the atom of gas as having been "ionized." As was explained in an early chapter of the book, the ionized gas immediately seizes upon the nearest free electron, combines with it and in the process gives off a brief spurt of light. In this particular case the color of the light will be that corresponding to neon and therefore will be orange red, or salmon pink, depending upon the observer who is describing it. As long as the current through the lamp continues this process is going on in a tremendous number of places at once so that we see a solid glow whose intensity changes with the current. Because it is electronic the effect is exceedingly fast and the lamp may be caused to go on and off as high as 100,000 times per second. In addition to its speed, the neon lamp has the advantage of producing a usable light with the feeble current available. Furthermore, neon gas does not readily combine with any impurities in the electrodes and is only feebly absorbed by glass and other parts of the tube.

18. Commercial Neon Lamps Used in Television Reception
—Probably one of the most common types of neon lamp used by amateur experimenters is one in which the electrodes take the form of nickel plates mounted with their surfaces parallel, having a separation of one-eighth inch. The base of the tube is fitted with four prongs so as to fit a standard UX socket. The plate terminal of the socket connects with the anode and the filament terminal on the socket diametrically opposite the plate is the cathode connection. The tube may be mounted either in a vertical

or horizontal position. Some tubes are arranged so that either plate may be used as the cathode providing the correct polarity is maintained with the operating d.c. source so as to make the front plate glow.

19. Daven Television Lamp Type T-2080—This particular lamp has a cathode plate $1\ 1/2$ inches square, whereas the anode is rectangular in shape having the dimensions of $1\ 1/2$ inches long and $5/8$ inch wide. The socket should be mounted so as to keep the cathode plate to the front facing the scanning disc. This lamp requires a minimum starting voltage of 150 to 160 d.c. volts. It operates with a maximum current flow of 80 milliamperes. A photograph of this type of lamp is shown in figure 316.

20. Rathen Kino-Lamp—The plates in this lamp are each $1\ 1/2$ " square and either one may be used as the cathode. The plates are relatively close together so as to prevent the cathode plate from glowing on its inner surface as well as on the outer surface. The Kino-Lamp requires a starting voltage between 90 and 220 volts depending upon the lamp. This lamp also fits a UX type of socket and the same terminals are used to connect the plate supply to tube, namely, the plate terminal and filament terminal diametrically opposite. If the tube is mounted in such a position that the pin on its base points towards the scanning disc, the plate terminal must be made negative and the filament terminal positive. If the pin is pointed in an opposite direction, the polarity should be reversed. When this is done it assures that the plate facing the scanning disc will be made to glow by the direct current. (See figure 317.)

21. General Electric Lamp G-10AC—120-Volt Lamp—This is a smaller type of neon lamp having two semi-circular plates approximately $3/8$ " in diameter and $5/8$ " high.

Either plate can be used as the cathode by maintaining the correct polarity on the terminals of the tube. This tube has a screw base and is designed to fit a standard porcelain lamp socket. However, in order to mount it directly behind the scanning disc it may be convenient to make a lamp holder by winding a piece of no. 10 iron wire around the end of a broom handle with a separation that fits in the screw base of the lamp. The straight portion of the wire can be pushed into a hole in the shaft-bearing block of the scanning disc. The wire is bent so that the spiral holder stands up like a candle holder. Flexible leads can be run to the lamp while in this position.

The dynamic resistance of neon tubes such as those just described is very low, usually between 1200 and 1500 ohms. This

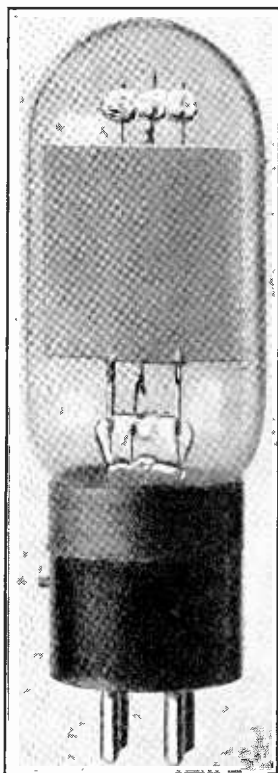

FIG. 316. Daven Neon Lamp, Type WT-2080.

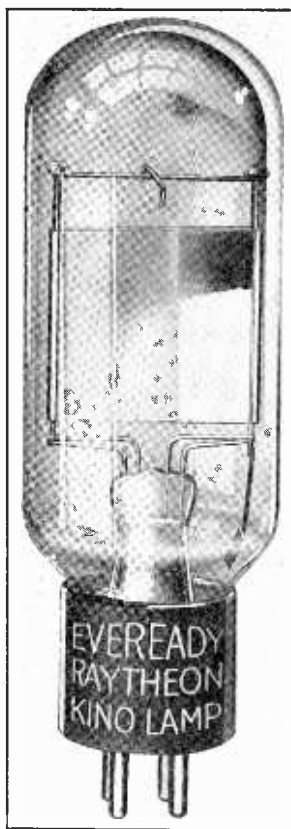

FIG. 317. Eveready Ratheon Kino Lamp.

makes them suitable for use with power tubes of low impedance such as the UX-171, UX-245 and UX-250.

It is necessary to employ a current limiting device such as a variable resistor in series with a tube operating on the gaseous conduction principle. The resistance is adjusted so that the cathode is just covered with a pink glow. The receiver output in the form of an alternating current is impressed upon the lamp whose luminosity then varies in accordance with the lights and shadows of the subject or person being scanned at the transmitter.

The experimenter is cautioned to regulate the d.c. through the

lamp so that it never draws more than its rated current. Where a good dark background is desired the d.c. voltage is adjusted just below the starting value. The additional a.c. voltage furnished by the signal operates the lamp.

22. **Connecting the Neon Lamp to the Output of the Amplifier**—There are several means by which the neon tube can be coupled to the output power tube of the amplifier. The simplest

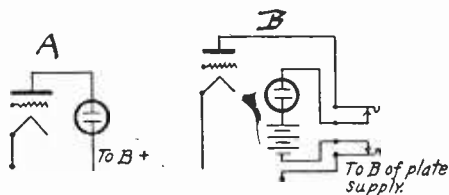
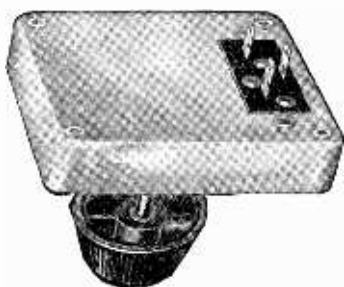

FIG. 318. A Simple Way of Coupling Neon Tube to Power Tube of Amplifier.



319



320

FIG. 319. Electrad Super-Tonatrol 5-Watt Resistor, Type No. 3. An Excellent Variable Resistor Suitable for Controlling Current through Neon Tube.

FIG. 320. Interior View of Electrad Super Tonatrol.

is to connect the lamp directly in series with the plate circuit of the tube as shown in figure 318. If the voltage drop through the neon tube is high, it may be necessary to connect several "B" batteries in series with lamp in order to provide sufficient current for operation. This is shown in figure 318-B. If the cathode of the neon tube is too bright, a resistor variable between the limits of 10,000 and 30,000 ohms should be connected in series with the battery and lamp.

A loud speaker jack is shown in figure 318. The connections to this jack are such that the speaker may be plugged in for announcements and occasional monitoring. When this is done the extra battery and lamp are cut out of the circuit.

If one is fortunate enough to have plenty of "B" batteries or an extra "B" eliminator, the arrangement shown in figure 321 should be used. The extra "B" supply is utilized by the neon lamp whereas the power tube receives its voltage from the common source of supply through the choke coil X^1 which acts as a reactance to the signal voltage. The charge in the 2 mfd. blocking condenser is then impressed across the plates of the neon tube which receives its d.c. supply through the 30 heavy choke marked X^2 . This choke also acts as a reactance to the current and consequently the full signal voltage is impressed upon the plates of the neon tube. By correct adjustment of the variable resistor the d.c.

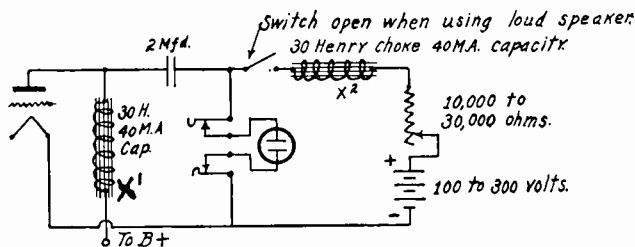

Fig. 321-A Method of Coupling Neon Lamp To Power Tube.

FIG. 321. A Method of Coupling Neon Lamp to Power Tube.

through the neon tube can be adjusted just below the starting value. The signal voltage supplies the added voltage to make the cathode glow. A dark background is assured by such adjustment. (Caution—If a loud speaker jack is used, it should be tested for insulation, otherwise there may be a voltage drop across it due to faulty insulation thus contributing a loss to the circuit and jeopardizing results. A well insulated double pole double throw switch should be substituted in place of the jack if d.c. voltages higher than 180 are employed with the lamp.)

Note that a switch is used to open the d.c. supply when listening for announcements. All these switching arrangements could be combined in a triple pole double throw switch.

23. **Television Receiver Design**—The signals from a television or radiomovie transmitter can be received with a vacuum tube receiver of the conventional types such as, tuned radio fre-

quency, double detection (superheterodynes) or regenerative receiver with or without r.f. amplification. However, careful consideration must be given to the radio frequency portion of the circuit in order that it may be designed to pass the exceedingly broad sidebands unimpaired. Furthermore, after detection we must deal with audio frequencies which may extend from 20 to 36,000 cycles. This makes the use of a transformer coupled audio system prohibitive. Therefore, it becomes necessary to use another type such as the resistance coupled amplifier. Even then special precautions must be observed in designing the system. Such an amplifier is described in a later paragraph.

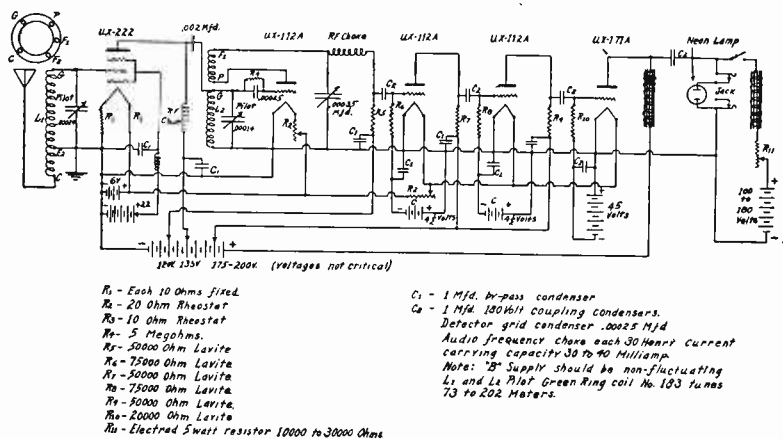

FIG. 322. Television Receiver with Resistance Coupled Amplifier.

24. The Radio Frequency Amplifier—Reference was made to the fact that a special band of frequencies is employed for visual broadcasting. This band of frequencies extends from 2,000 to 2,950 kilocycles—a wavelength band of from 150 down to 102 meters. Very little television transmission is done in the broadcast frequencies from 1,500 to 500 kilocycles. Nevertheless, the Federal Radio Commission may continue to issue experimental television or visual licenses in the regular broadcast band restricting operation to the hours from 1:00 a.m. to 6:00 a.m. only. The time may come when other frequencies may be used for television transmission. Therefore, it seems best to design the radio frequency amplifier so that it can be used over a wide band of frequencies. The most practical way the experimenter can do this is by the use of plug-in coils, using screen grid tubes as amplifiers.

The diagram shown in figure 322 shows the arrangement of the author's television receiver employing Pilot plug-in coils. These coils are not expensive and can be obtained at most all radio stores dealing in kits and supplies. For the benefit of those interested in building a receiver, the following list of materials is given.

- 1 Base board 7" x 24".
- 1 Rubber panel 7" x 24".
- 2 Pilot variable condensers no. 1608—.0014 mfd. cap.
- 1 Variable condenser—.00035 mfd. cap.
- 3 Vernier control dials.
- 2 Pilot green-ring coils no. 183 (tune 73-202 meters).
- 2 R.f. chokes.
- 5 UX sockets (cushioned or spring).
- 1 Stiff UX socket for neon lamp. (If small General Electric lamp is used, this socket is unnecessary.)
- 2 UX-227 sockets for coils.
- 1 Ten ohm rheostat.
- 1 Twenty ohm rheostat.
- 2 Ten ohm fixed resistors.
- 1 Five megohm grid leak.
- 2 75,000 ohm Lavite resistors.
- 3 50,000 ohm Lavite resistors.
- 1 20,000 ohm Lavite resistor.
- 1 Electrad 5 watt variable resistor, 10,000 to 30,000 ohms.
- 1 .002 mfd. Sangamo coupling condenser.
- 8 1 mfd. by-pass condensers.
- 3 1 mfd. (180 volt test) coupling condensers.
- 1 S.P.S.T. knife switch.
- 1 Daven or Ratheon neon lamp.
- 2 4 1/2-volt "C" batteries.
- 3 22 1/2-volt "C" batteries.
- 1 UX-222 V.T.
- 3 UX-112-A V.T.
- 1 UX-171-A V.T.
- 100 to 180 volts of "B" supply for neon lamp (separate supply from that used on receiver).
- 120 to 200 volt "B" supply for V.T. ("socket-power" or batteries).

It will be noted that the output of the r.f. amplifier is coupled through a condenser to the grid of the detector tube and the plate voltage to the UX-222 is fed through a r.f. choke coil. One may use a tuned plate circuit for the UX-222 tube. This will, of

course, require a blocking condenser to isolate the plate voltage from the grid of the detector tube. A diagram of such connection is shown in the chapter entitled "Theory of the Vacuum Tube." To assist in stabilizing the r.f. tube, the whole stage should be shielded from the detector circuit.

It will be noted that in the audio amplifier 1 mfd. condensers are specified as coupling condensers. Usually designers of resistance coupled amplifiers specify .01 to .1 mfd. By the use of 1 mfd. condensers phase displacement is prevented and better images produced. The audio amplifier may have a tendency to motor boat. This can sometimes be cured by experimenting with different values of grid resistors. If the motor-boating is confined to the last audio stage, it may be cured by using a 30 henry choke instead of a resistor in the grid of the 171 tube to the "C" battery. Extra resistances in series with the regular plate resistances may also be helpful. The value of the resistances must be determined by experimentation, but is usually from 1000 to 10,000 ohms. The by-pass condensers are connected at the high potential end of these resistors and the low potential end of the plate resistors. (See figure 323.)

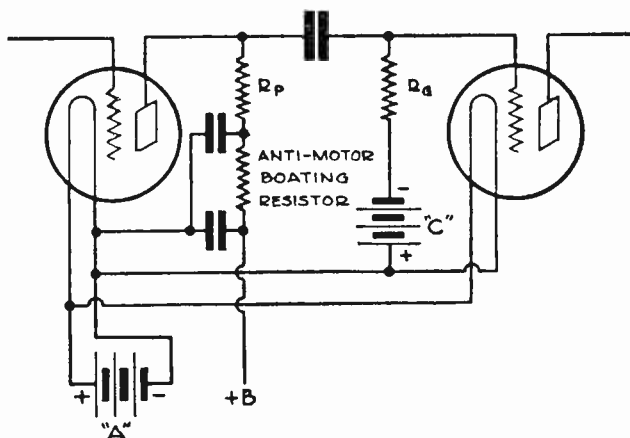

FIG. 323. A Method of Connecting an Extra Resistance in Plate Lead to Prevent Motorboating of Amplifier.

25. The Receiving Scanning Disc—It is most earnestly recommended that the experimenter buy a scanning disc rather than try to make one. The task of making one is extremely difficult and requires special tools which the average experimenter does not

have available. Before purchasing the disc the experimenter should decide which station or stations he desires to receive programs from and then secure a disc having the same number of holes as employed by the transmitting station. For instance, one station may be using a disc with 60 apertures whereas another may be employing one with only 48. In order to receive both stations it becomes necessary to have a 60 hole disc and a 48 hole disc.

The Standardization Committee of the Radio Manufacturers Association unanimously adopted for recommendation as standard practice the following particulars as regard to scanning:

1. 15 picture frames per second.
2. 48 lines per picture frame.
3. Scanning from left to right and top to bottom in consecutive sequence.



FIG. 324. Experimental Scanning Disc Arrangement and Driving Mechanism.

As a general rule, television transmitters are arranged to scan from left to right and top to bottom as specified above, or exactly in the order in which one reads a page of this book.

26. Instructions for Building and Mounting the Scanning Disc Driving Mechanism—The outfit about to be described is similar to that operated by the author. The particular arrangement of mounting and driving the discs is an elaboration of that first suggested by Jenkins. The outfit as shown in the photograph, figure 324, was built by Mr. R. Benser for the author. The photograph shows Mr. Benser adjusting the speed of the disc for synchronism. Referring to the photographs, the parts are as follows:

(a) A base board 18" x 7".

(b) Motor base board grooved to slide on bb and of such thickness as to bring center of motor shaft to same level as disc shaft.

(c) Blocks to support front bicycle wheel hub used as scanning disc mounting.

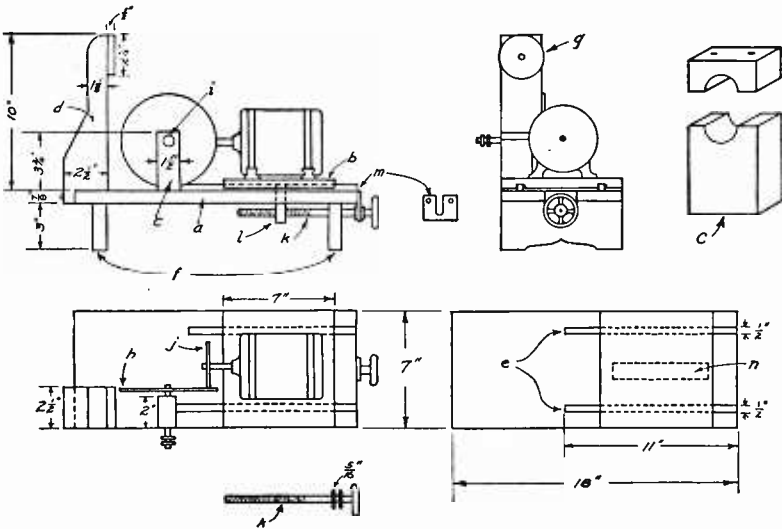

FIG. 324a. Detailed Drawing of Scanning Disc Mounting and Synchronizing Control.

(d) and (g) Mounting for neon tube socket. The height should be such that the top hole of the scanning disc just covers the upper edge of the tube plate.

(f) Base board battens.

(h) Aluminum driving disc 7" in diameter and 1/4" thick. This disc must be flat and run true.

- (i) Shaft, in this case the axle of a front wheel bicycle hub.
 (j) Rubber driving disc 3" in diameter made of two thicknesses of automobile inner tube vulcanized together.
 (k) $1/2$ " steel rod 8" long threaded for 5". Two collars, spaced by slightly more than the thickness of m are brazed or setscrewed about $1\ 1/2$ " from the unthreaded end which also carries a hand wheel.
 (l) Metal bracket $3/8$ " thick tapped to take the threaded part of k. This bracket is mounted on the motor base board b and extends through the slot n in the board a.

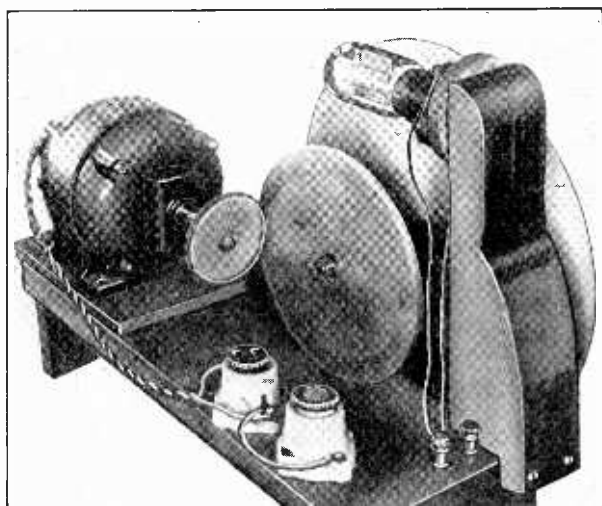

FIG. 325. Back View Showing Neon Lamp Mounting and Driving Mechanism.

(m) Slotted metal strip $2" \times 2" \times 1/4"$. This is mounted on a. The motor is a General Electric induction motor, type 5A— $1/20$ H.P., operated from the 110-volt, 60-cycle lines.

The disc speed is regulated by turning the hand wheel. Since the collars on the rod k prevent the rod from moving endwise, the bracket l, together with the motor, is pushed or drawn, thus changing the distance of the rubber driving disc from the center of the aluminum driven disc. When the rubber disc is approximately $1/4$ " from the edge of the aluminum disc the speed is 900 r.p.m. at which several stations operate. 1200 r.p.m. is obtained when the rubber disc is halfway in.

27. **The Jenkin's Amateur Receiver**—To reduce the matter of the first "looking-in" to the utmost simplicity and cheapness, Jenkins has, in his book "Radiomovies," described a scanning disc drive and mounting whose essential parts can be bought for about \$3. This device uses the small G-10 a.c. neon lamp, sold for about 50 cents. The small size of the lamp permits its operation from a rather ordinary amplifier, though the picture is, of course, correspondingly small. The scanning disc is only 12" in diameter and is equipped with 48 holes $1/32$ " in diameter. Theoretically these are too large but this helps the brightness of the picture

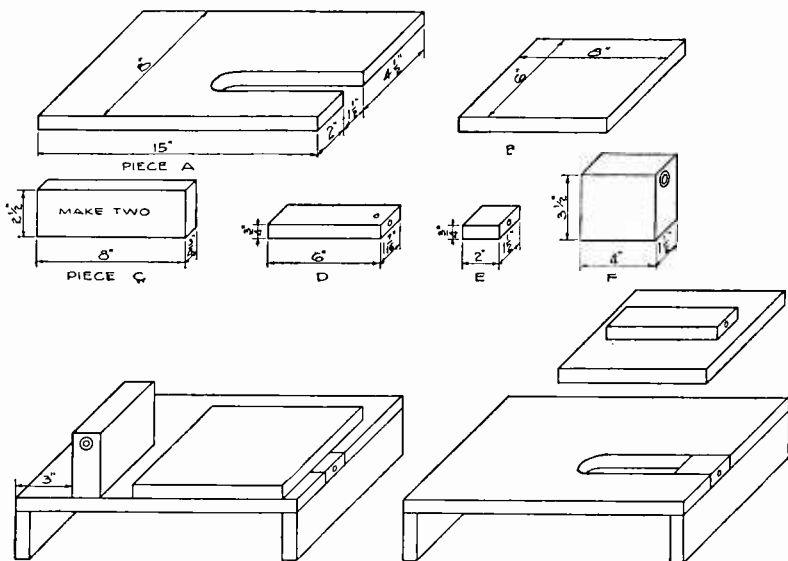

FIG. 326. The Woodwork Necessary for Constructing Jenkins' Scanning Disc Mounting.

much more than it damages its correctness. Such discs, together with some of the other parts not easily made by hand, have been sold by the Jenkins Laboratories but the practice will not necessarily continue until the appearance of this book. Jenkins, in his book "Radiomovies," suggests that where one must necessarily make the disc it can be done most easily by cutting out the 12" disc of black paper, cardboard, aluminum, brass, "tin," or sheet iron, mounting it on a $5/16$ " shaft and trueing up with a file or knife blade while it is being turned by hand. The disc should be

somewhat over 12" in diameter since the next move is to mark a 12" circle by holding a sharp pencil against the disc as it turns. The disc is then dismantled and the circle divided very carefully into 48 equal parts. This cannot be done with too great care. Radial lines are then drawn from the points marked to the center of the disc after which the disc is remounted. A piece of fish line or wire which is flexible, but does not stretch easily, is now secured to the shaft, given several turns around it, and its end secured

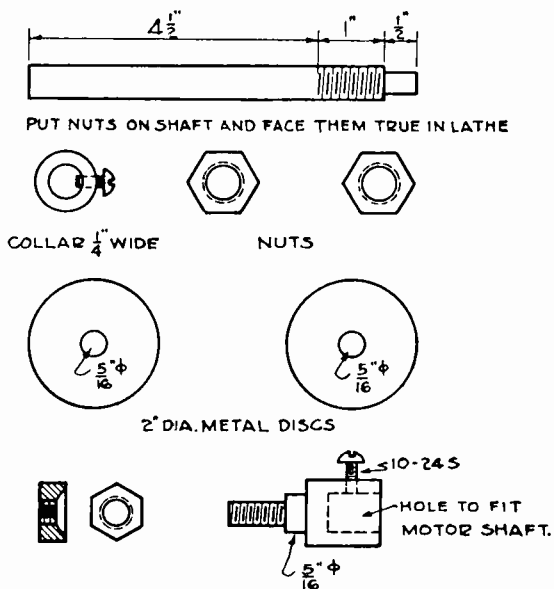

FIG. 327. Metal Parts Necessary for Constructing Jenkins' Scanning Disc and Mounting.

very close to the point of a carefully sharpened pencil. With the wire kept tight, the disc is turned slowly while the pencil point is held against it. If the thing is done carefully, the wire is fine enough, and the shaft is of the size indicated, there will result a spiral which is nearly enough correct for locating scanning holes. Beginning at a point where the spiral is about 1/4" from the 12" circle, it is followed through one complete turn and a scanning hole made at each intersection with a radial line. If a paper disc is used, clean holes may be punched with half of a broken sewing

needle, punching against the end grain of a smooth piece of hardwood. In metal they must be drilled and great care used to prevent the drill from wandering.

The mounting of so light a disc is comparatively simple and its drive may be from any small motor running about 1800 r.p.m. on the house supply. $1/20$ horse power is ample. The driving disc is cut from sheet rubber, such as an automobile inner tube, and may be mounted on a hub such as shown in figure 325 or else glued to a wooden hub pushed on the motor shaft. The wooden hub may be trued up with a chisel or rasp after mounting and also the rubber disc may be cut out roughly, marked to 3" diameter while running and then trued up with knife or scissors. The assembly is shown in figure 328 and is seen to be essentially the same as the device of figure 324. As in the other case, the motor is allowed to operate at constant speed and moved by means of the screw *S* (figure 328) to control the scanning disc speed. The

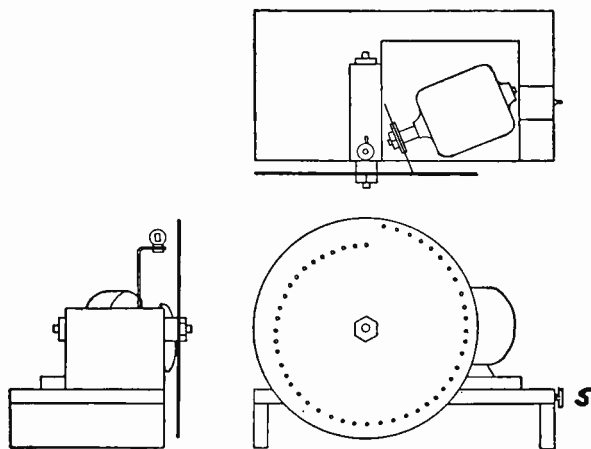

FIG. 328. General Arrangement of Parts.

rubber disc touches the scanning disc itself instead of an aluminum driving disc as in figure 324. If a paper disc is used, it is clamped between reinforcing discs such as phonograph discs. If not purchased with the disc, a $5/16$ " shaft must be turned up or improvised by threading one end of a 5" of $5/16$ " rod to permit clamping the scanning disc between nuts and washers. For so light a disc the bearing requirements are small and may be satisfied by as simple a thing as a pair of $5/16$ " brass bushings 1" long pushed

into a $1/2''$ hole drilled endwise through a hardwood block about 4" long.

The rest of the mounting seems rather obvious and is therefore only listed as follows: (See figure 326.)

(a) Base board $8'' \times 15'' \times 3/4''$ with slot $1\ 1/2''$ wide and 9" long 2" from one edge.

(b) Motor base $6'' \times 8'' \times 3/4''$.

(c) Two strips $2\ 1/2'' \times 8'' \times 3/4''$ to be secured crosswise underneath the baseboard as shown.

(d) Strip $1\ 7/16'' \times 6'' \times 3/4''$ to slide in slot of base. This is secured (centered) to the bottom of d. Bore $5/16''$ hole, centered, 2" into end of strip. $1''$ from end bore $5/8''$ hole as shown, intersecting the $5/16''$ hole.

(e) Block $1\ 1/2'' \times 2'' \times 3/4''$ with $1/4''$ hole bored through endwise, centered. This block is nailed or glued in the slot of the base board, flush with the end of the base board.

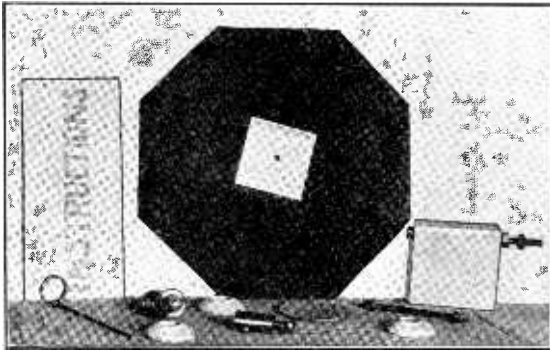

FIG. 329. Jenkins Kit for a 12-inch Disc Radiomovie Outfit.

(f) Bearing block $3\ 1/2'' \times 4'' \times 1\ 1/2''$ hardwood. Bore lengthwise to take brass bushings for scanning disc staff. Diameter of hole to fit bushings and height to agree with height of motor shaft.

(g) (Not shown.) $4'' \times 1/4''$ machine screw with nut. With motor base in place the nut is pushed up into the $5/8''$ hole in e. The screw is then put through the $1/4''$ hole in b, the $5/16''$ hole in e, and screwed into the nut, after which it may be turned to draw the motor toward the block b, increasing the disc speed.

It remains only to secure the motor to the motor board d at

such a position that the rubber disc bears lightly against the scanning disc about $2\frac{1}{2}$ " from the center when d is at about the center of its possible movement. The operation of synchronizing is effected by the screw s and can be done more easily if a washer or the like be soldered into the slot of the machine screw head as a sort of wing. Since the mechanism only operates to pull the motor outward, one must return it by hand and try again if synchronism is past.

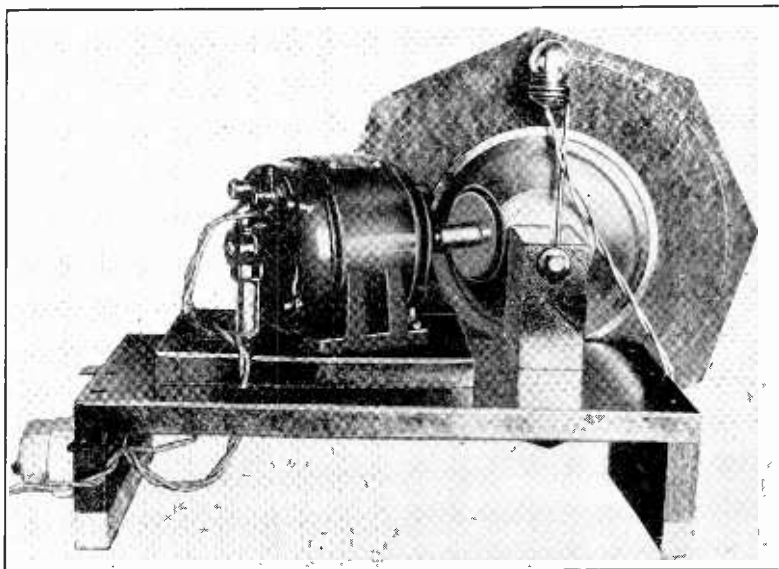

FIG. 330. The Jenkins Kit Assembled.

28. Comments on Adjustment—With any receiver of the scanning disc type one at first sees only confusion, but as the correct speed is approached red and black dots and dashes begin to appear which move more and more slowly until the picture appears rather suddenly, though perhaps still leaning to one side or drifting. Slight additional adjustment should then cause it to become stationary. If the image is upside down, the disc must be reversed on the shaft. If it is wrong right and left, the direction of rotation should be changed. The method of doing this depends on the type of motor used. For d.c. shunt motors or for

any type of series motor reverse *either* the field or the armature connections but *not both*. For induction or synchronous motors of single phase type reverse the starting coil connections. For polyphase induction motors exchange any two leads to the line. The "condenser" type of split phase induction motor is reversible by changing connections inside the machine or (in some types only) by removing the rotor and turning it end for end, the end plates being exchanged at the same time.

If the image appears with the upper half of the subject below and the lower half above, the disc is in synchronism but a portion of a turn behind or ahead of the transmitting disc. Framing may be accomplished by repeated light touches of the finger, slipping the scanning disc on the drive disc until the image is right. A less easy method is to adjust the speed slightly up or down and then to return it to synchronism.

Should the image have its lights and shadows exchanged (negative image), the voltage must be changed by a half cycle or 180 degrees. This can be done by adding or subtracting a stage of amplification or by using c bias detection instead of a grid leak and condenser.

If the signal fades, one may think that the disc is out of step but one should wait to see if the image will not return automatically. Surprisingly good average results can be obtained through fading and through static or interference.

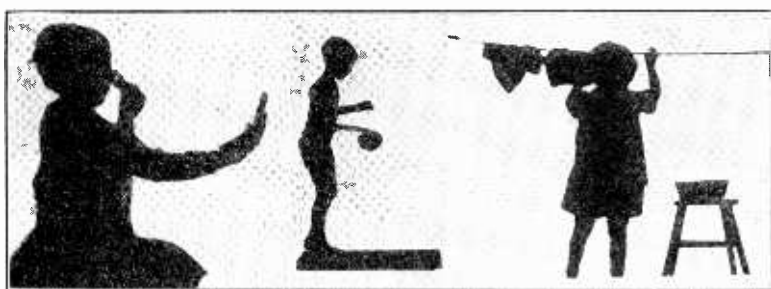

FIG. 331. Silhouettes as Broadcast by the Jenkins Laboratories.

Daven Television Kit—There may be some experimenters who would like to purchase a complete television kit. For this reason the author has chosen to give the details of one commercial type of kit which can be purchased at dealers or radio stores supplying parts and kits. The particular kit chosen for description

is that of the Daven Corporation. No radio receiver is furnished with this kit.

The parts of this kit are illustrated in figure 332. It consists of a scanning disc furnished with either 24, 36, or 48 apertures, a Universal motor, a motor speed control, 3 stages of resistance amplifier, a neon lamp, and instructions for assembling the kit. The retail price of this kit is \$60.00.

With this kit a receiver is necessary which will produce a clear audible signal at the detector output when tuned to the station broadcasting the television signals. The output from the detector tube is fed into three stages of amplification, the first two stages using high- μ tubes and the last stage a small power tube.



FIG. 332. Daven Television Kit.

The "Resisto-Couplers" furnished in such a kit simplify the assembly of a television receiver as they are manufactured with the proper condensers and resistors in each stage. If the builder will follow the layout given by the manufacturer, no difficulty should be encountered from feedbacks. The amplifier in the kit mentioned is designed for use with Daven high- μ tubes (MU-20)

and Daven power tube (MU-6 or AC-71) but will operate well with any standard tubes of similar type. It is recommended that the experimenter use at least three stages. If more illumination is desired, the last tube may be replaced by a 5-watt or 7 1/2-watt power tube with a.c. filament supply and 300 to 500-volt plate supply. Though screen grid tubes may be employed in a resistance amplifier, the beginner at least is advised to stick to the normal high-mu tube such as the MU-20 or UX240.

In any resistance amplifier the plate supply voltage must be higher than normal since an effective coupling resistance must be high enough so that a very considerable drop occurs through it. This drop, of course, applies not only to the signal voltage but also to the plate supply. The amplification per stage is not as high as for other methods of coupling and in fact one does not usually succeed in obtaining amplification above $2/3$ of the "mu" of the tube. This explains the use of the "mu-20" tubes in place

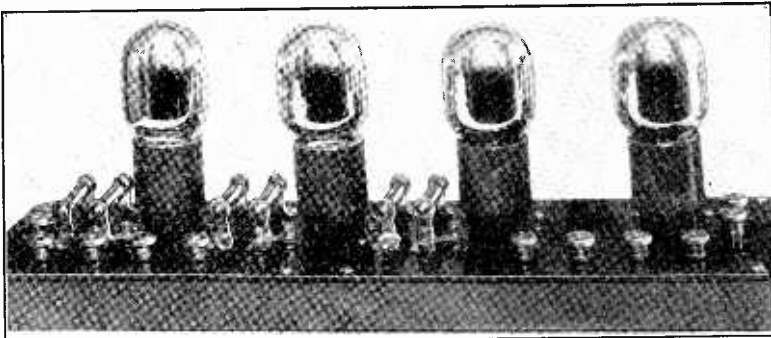

FIG. 333. Daven Television Resistance Coupled Amplifier.

of the more ordinary types with a mu of 9. These tubes, however, have a very small power handling ability and therefore the last stage must use some sort of a power tube. If something of the general class of the UX 171, AC 71, or the like is not sufficient, a pair of the same may be used in parallel or the 5-watt power tube previously suggested may be employed. In these combinations the rated plate current of the neon lamp is readily exceeded and therefore coupling methods are advisable which remove this plate current from the neon lamp. This may be done by means of another resistance coupling similar to those employed between the stages of the amplifier. To bring it up to the point of ignition,

the neon lamp is fed the necessary voltage from another battery just exactly as the C bias is supplied through the grid resistance in the previous couplings. Other manners of couplings are, of course, possible. A satisfactory one, however, will always provide a means of adjusting the steady current through the neon lamp.

29. Rules and Regulations of the Federal Radio Commission Governing the Operation of Visual Broadcasting—That visual broadcasting be designated to include both television broadcasting and picture broadcasting, or moving picture broadcasting and still picture broadcasting, and that all licenses issued be of an experimental nature for a period of six months only, the licensees to



FIG. 334. Daven Television Receiver.

report to the Commission the results of their experiments; the transmitters to be located outside of the city limits and sufficiently distant from important receiving centers to avoid interference.

LIST OF VISUAL BROADCASTING (TELEVISION) STATIONS

| Call signal | Location | Owner | Frequency in kilocycles, meters in parentheses | Power (watts) |
|-------------|---|---|--|---------------|
| W1XAE | 635 Page Boulevard, East Springfield, Mass. | Westinghouse Electric & Manufacturing Co. | 2,000-2,100 (150-142.9) | 20,000 |
| W1XAY | Adams Street, Lexington, Mass. | J. Smith Dodge | 4,800-4,900 (62.5-61.22) | 500 |
| W1XBB | 63 Gorham Street, Somerville, Mass. | General Industries | 2,100-2,200 (142.9-136.4) | 500 |
| W2XBA | Newark, N. J. | WAAM (Inc.) | 2,750-2,850 (109.1-103.3) | 50 |
| W2XBS | 70 Van Courtlandt Park, S., New York, N. Y. (portable) | Radio Corporation of America | 2,750-2,850 (109.1-103.3) | 5,000 |
| W2XBU | Beacon, N. Y. | Harold E. Smith | 4,800-4,900 (62.5-61.22) | 100 |
| W2XBV | New York, N. Y. (portable) | Radio Corporation of America | 2,000-2,100 (150-142.9) | 5,000 |
| W2XBW | Initial location: River Road, Bound Brook, N. J. (portable) | do. | 2,000-2,100 (150-142.9) | 5,000 |
| W2XCL | 323 Berry Street, Brooklyn, N. Y. | Pilot Electric Manufacturing Co. | 2,000-2,100 (150-142.9) | 250 |
| W2XCO | New York, N. Y. (near) | Radio Corporation of America | 2,100-2,200 (142.9-136.4) | 5,000 |
| W2XCR | 346-70 Claremont Street, Jersey City, N. J. | Jenkins Television Corporation | 2,100-2,200 (142.9-136.4) | 5,000 |
| W2XCW | 1 River Road, Schenectady, N. Y. | General Electric Co. | 2,100-2,200 (142.9-136.4) | 20,000 |
| W2XDR | 140 Nassau Street, New York, N. Y. | John V. L. Hogan | 2,000-2,100 (150-142.9) | 500 |
| W2XX | Overton Road, Ossining, N. Y. | Robert F. Cowen | 2,100-2,200 (142.9-136.4) | 100 |
| W2XK | 1519 Connecticut Avenue, Washington, D. C. | Jenkins Laboratories | 2,000-2,100 (150-142.9) | 5,000 |
| W2XL | River Road, Bound Brook, N. J. | Jenkins Television Corporation | 2,850-2,950 (105.3-101.7) | 30,000 |
| W2XE | Winter Park, Fla. | William J. Lee | 2,850-2,950 (105.3-101.7) | 2,000 |
| W2XAM | Washington and Oak Streets, Los Angeles, Calif. | Ben S. McClellan | 2,000-2,100 (150-142.9) | 500 |
| W2XC | 5135 South Grammercy Place, Los Angeles, Calif. | Robert B. Parrish | 4,500-4,600 (66.67-65.22) | 15,000 |
| W2XAO | Portland, Ore. | Wilbur Jerman | 2,750-2,850 (109.1-105.3) | 100 |
| W2XAV | East Pittsburgh, Pa. | Westinghouse Electric & Manufacturing Co. | 2,000-2,100 (150-142.9) | 20,000 |
| W2XAA | Foot of Grand Avenue, Chicago, Ill. | Chicago Federation of Labor | 2,750-2,850 (109.1-105.3) | 1,000 |
| W2XAG | 1768 Wilson Avenue, Chicago, Ill. | Aero Product (Inc.) | 2,000-2,100 (150-142.9) | 1,000 |
| W2XAO | 6312 Broadway, Chicago, Ill. | Nelson Bros. Bond & Mortgage Co. | 2,000-2,100 (150-142.9) | 500 |
| W2XAZ | Iowa City, Iowa | University of Iowa | 2,000-2,100 (150-142.9) | 500 |
| WRNY1 | Hudson Terrace, Coytesville, N. J. | Aviation Radio Station (Inc.) | 1,010 (#97) | 250 |

1 Operates between 1 and 6 a.m. only.

For joint use to visual broadcasting licensees, the Commission authorized the following bands of frequencies for experimental use only: 2000 to 2200 and 2750 to 2950 kilocycles. In addition, the Commission will authorize the operation of visual radio broadcasting transmitters in the band between 2200 and 2300 kilocycles, on the condition that they do not interfere in any way whatever with the services of any other nation on the North American Continent or in the West Indies, and that licenses be subject to revocation in case there are any complaints from any other nation of any such interference. The Commission may continue to issue experimental television or visual licenses in the broadcast band for operation between 1 and 6 a.m. only, in accordance with Central Order 50.

The Commission adopted the following rules of priority in the granting of applications:

1. Those engaged in experimentation to improve the technique of visual broadcasting.
2. Those who employ methods which give the maximum definition with the minimum radio frequency band widths.

CHAPTER 18

RADIO INTERFERENCE

1. Introduction—It is not the intent of the author to include in this chapter the procedure of servicing radio receivers. To do so would require a separate volume. It is the intent to describe various types of disturbances that tend to prevent clear reception of broadcast programs and to show how such disturbances originate, how they can be located and, finally, the treatment necessary to eliminate the disturbance after it has been traced to its source.

2. Trouble in the Receiver—Whenever a disturbance is heard in the loud speaker the first thing to do is to determine whether or not the interference originates in the receiver or its associated power apparatus. It is often quite difficult for the average broadcast listener to determine at the moment whether or not the disturbance is in the receiver or originates from the outside. Quite often the disturbance feeds through the power line and partly through the loop or antenna. Receivers operating directly from a.c. power lines usually have a higher noise level than those operated from batteries. In the case of the latter it is customary when tracing down interference to first disconnect the antenna and ground wires to see if the interference diminishes in intensity or disappears. If it does, it is a good indication that the source of disturbance is located outside. When the antenna and ground are disconnected from an AC set the noise frequently continues with the same intensity, indicating possibly that it is feeding through the power lines.

As a general rule, the average broadcast listener will not care to investigate very far into a receiver to see what is causing the noise. Usually a trained service man is called in on the case as he can by experience tell by listening to the tone characteristics of the noise whether or not it lies in the receiver or elsewhere. If the trouble is not first apparent, he will begin in an orderly manner to test the tubes, sockets, wiring, plugs, jacks, condensers and coils.

3. Defective Tubes—Tubes, as a rule, begin to cause disturbances when they are nearing the end of their filament life, especially high voltage rectifier tube which flash over and show a blue or purple glow within the bulb. Sometimes a defective condenser will cause a rectifier tube to act in this manner.

A microphonic tube has a tendency to produce a howl or tone in the loud speaker similar in nature to a steamboat whistle. The howl usually begins when the set is turned on or tuned to a loud signal and gradually builds up in amplitude and finally becomes so unbearable that the listener is forced to turn the set off. Such a howl is caused by "acoustic feed-back."

A microphonic tube is located by tapping on each tube individually with the set turned on and noting by the ear which one produces a bell-like ring or starts the howl in the speaker. It will be noted that the detector tube always produces a bell-like ring in the speaker whenever it is tapped, but if the sound seems exaggerated or increases in amplitude, another tube should be substituted.

Acoustic feed-backs are not always caused by defective tubes. The proper placement of the loud speaker plays an important part in the prevention of this form of interference. The speaker should never be placed so that it faces the radio receiver, neither should it be set directly over the detector tube. If one desires to set the speaker on top of the radio cabinet and an acoustic howl develops, it can be eliminated by placing a soft felt or rubber pad between speaker and cabinet. Oftentimes a lead cap placed over the detector tubes will prevent such disturbance. Such lead caps can be purchased at most every radio store. Howls are much less prevalent in sets having detectors of the indirectly heated type such as the 227 or the 224.

4. Inspection of Antenna—If it has been determined that the interference is not due to defects in the receiver, the next step is to connect the antenna and ground and then inspect the wires of each. All connections to the antenna should be tight and soldered and insulated from the ground. If a lightning arrester is in use, it is well to disconnect the ground side from it and listen in to note if there is any change in condition. The ground wire should be inspected closely to see if it is not rubbing or chaffing on pipes other than to which it is grounded. If the connection to the ground pipe is corroded, it should be removed and cleaned.

It is always best to connect the ground wire directly to the water pipes where it enters the earth.

Nine times out of ten, radio receivers are grounded on the nearest convenient piece of piping with the practical certainty that between this point and the actual earth there is connected on an electric light ground, a telephone ground and, very probably, the ground of some interference manufacturing device. The average radio installer will stare at the suggestion of running a separate

ground to the earth or at least to a point an inch from the entrance of the water pipe into the cellar wall, yet this change will frequently cut deafening radio interference down to a negligible murmur. If the noise is manufactured near the receiver, conditions are also favorable for great improvement by means of a longer antenna. In a particular case a sign flasher made local reception impossible with an indoor antenna while entirely satisfactory performance took place with an outdoor antenna 60 feet long and 35 feet high. The explanation is that the use of the large antenna enabled an increased pickup to be obtained in an area somewhat distant from the source of interference and at the same time the volume control on the set could be operated at a lower value.

5. "Static"—Before the advent of broadcasting a radio operator experienced interference at times from generally two causes. One of these was from signals transmitted on or close to the wavelength on which the operator was trying to receive, and the other was from atmospheric disturbances spoken of as "static" or "strays." Static was the most acceptable term in this country and has always been the commercial shipboard operator's, or "sparks" as he is familiarly known, main alibi when explaining to the skipper why he could not get any press the night before. The expression is inherited and today we find the broadcast listener, service man and layman terming every crash, rumble or sputter heard from a radio receiver as "static." Radio engineers recognize one form of static and that is natural static as created by atmospheric discharges. True enough, there are many forms of radio interference but scientific observation on the reception of broadcast signals in the northern section of the United States over a period of a year from August, 1922, to August, 1923, showed that interference from natural static atmospheric discharges constituted only 15 per cent of the interference to broadcast reception. Before proceeding with a discussion of the other forms of interference we will see what means are provided, if any, for the elimination or attenuation of this form of interference produced by nature.

Interference in the form of static caused by atmospheric disturbances is at a maximum during the summer months of the year. Such interference is experienced more frequently in the southern latitudes than in the northern latitudes. The Gulf of Mexico, for instance, is considered by radio operators as the worst place in the country for static. Static generally begins at sunset and continues throughout most of the night and sometimes during

the next day. It is easily identified by its intermittent crash and bang. It is always associated with a thunder shower and one can often see a lightning flash from an approaching shower simultaneously with hearing a crash in the loudspeaker. Incidentally, static unaccompanied by a local thunder shower does no more harm to the tubes or other parts of a receiver than would a strong local signal. However, a local lightning surge will, and besides is dangerous to one's life, and for that reason it is best to install an approved lightning arrester with one end grounded or, better still, a large lightning switch which entirely disconnects the antenna from the receiver and grounds it direct. Of course, these precautions need only be exercised on outdoor antennae.

There has not been invented any device which eliminates static in broadcast reception. In fact, despite advertising claims, there are no means of even seriously reducing the intensity of this type of interference. We are therefore compelled to resort to the method of reducing the sensitivity of the receiver to such a point that the noises produced are no longer unbearable, and then to receive whatever signals may be strong enough to make themselves noticed in the face of this low sensitivity. The reduction of sensitivity may be accomplished in a variety of ways. The most obvious is to operate the sensitivity control of the receiver, but the usefulness of this device is not great and with some types of sensitivity control reduces the signals more rapidly than the static. Another almost equally obvious method is to replace the normal antenna by a smaller one, less capable of supplying static impulses so powerful as to overload the receiver. This small collector may be either a low antenna of normal length, a short or even indoor antenna, or a long antenna buried a short distance under ground. Which, if any, of these expedients will prove useful in a certain case must be determined by trial. All of the types mentioned reduce both the signal strength and the strength of the interference. This is of advantage only where the initial difficulty was due to overloading by static or where the reduction of static noise is greater than the reduction of signal. The second effect (greater reduction of noise than signal) is accomplished in a very limited way by the small or low antenna, but some evidence has been obtained to show that certain types of *local* atmospherics are reduced in a greater ratio by a proper buried antenna. It is impossible to say what "proper" means for a given location. One must try it and see because everything depends on the soil conditions. In a very wet or very dry soil buried antennae are

almost invariably unsuccessful, while in a moderately moist soil they sometimes produce favorable results.¹ The concentrated buried antennae offered for sale usually produce results which can be exactly duplicated with 10 feet of wire and are therefore not considered in this discussion. The much longer buried antennae here referred to are distinctly directional and in fact owe some of their advantages to the ability of diminishing static from a given direction as compared to signals from another direction.

The growing tendency in the engineering profession has been to produce a signal of sufficient magnitude to override the static level.

Static produces very little interference on wavelengths below 30 meters. The author has often enjoyed programs direct from 5SW, England, during a local thunder storm. This station operates on a wavelength of approximately 25 meters.

6. "Man-made" Interference—There are hundreds of electrical devices that when in operation may seriously interfere with radio reception. Some electrical devices even when in perfect working order generate interference. Interference caused by electrical devices can be heard only at times in one particular receiver, while other forms may be of such magnitude as to paralyze reception for blocks or even several miles. At times this form of interference has a fairly well defined resonance peak, or in other words, the receiver has to be tuned to certain wavelengths in order to bring the interference in at a maximum. Interference originating from electrical devices is usually identified by sputters, crashes and crackles. Sometimes they are intermittent and at other times in the form of prolonged dashes. Not infrequently they almost take the form of dots and dashes used in radio telegraphy, and when such is the case it is usually blamed on some amateur with a transmitter when in all probability the amateur is not even on the air. In fact, whenever a spark or arc is produced by electricity it is capable of producing interference to radio reception.

7. Interference from Receivers—Man-made interference may be heard in the form of a squeal, "bloop," or prolonged whistle similar to that emitted by the peanut roaster. The squeal or "bloop" can be usually traced to a receiver operated with one of its tubes oscillating, thus producing in the antenna radio frequency current similar to those generated by a broadcast transmitter but of feebler intensity. Nevertheless, such oscillating receivers can be heard several blocks away.

¹ Proceedings Institute of Radio Engineers, Vol. 7, pp. 337 and 559, 1919.

8. Heterodyne Interference—The peanut whistle which usually persists steadily for a period of time is generally the result of two or more broadcasting stations operating on frequencies separated by less than 10 kilocycles. The science recognizes that transmitters whose carrier frequencies are separated by 10 kilocycles will produce no heterodyne interference. Broadcasting stations in the United States are assigned frequency channels on this basis. If a whistle is heard, it is the beat frequency resulting from the interaction of two stations operating on different frequencies less than 10 kilocycles apart. Nothing can be done in the receiving end to eliminate this form of interference.

Two, and possibly three, forms of interference might be alluded to here. The first is the aggravating business occasioned by a local signal strong enough to overload the first tube of the receiver, thus producing detection which is equivalent to frequency doubling and therefore creates a signal on the half wave. Thus, if one is near a broadcasting station which operates at 550 k.c., this tube may pass on to the rest of the set an 1100 k.c. signal. Should one tune to 1100 k.c., strong interference from the local station is therefore encountered. This thing is especially prevalent and aggravating with sets using the so-called "untuned" input which consists of a choke in the antenna (or a resistance for that matter) across which are connected the filament and grid of the first tube. The local station is thereupon accused of having a band harmonic but if a wave trap is put into the antenna, it will be found that the alleged harmonic disappears when the trap is tuned to the fundamental of the local station, showing positively that the difficulty originates in the first tube of the set. In some sets the couplings are such that this same thing can take place in a later stage when the interfering signal is not of a strength one would ordinarily regard as local.

Quite distinct from this is the interference created by true harmonics at the transmitter. These are easily distinguished from the receiver-generated harmonics by tests with a wave trap in the receiving antenna. Thus in the case just cited, if our 550 k.c. station had been guilty of a strong third harmonic, this would have appeared at 1650 k.c. and its elimination would require tuning the wave trap to that frequency. It will be observed that the frequency mentioned does not lie within the broadcast band, even though the 550 k.c. channel is the lowest one in the broadcast spectrum. From this it follows that third harmonic interference from broadcast stations will not fall within the range of a broadcast receiver. It is possible for the second harmonic (half wave)

to cause such interference and if the test just suggested shows that condition to exist to a serious degree, the attention of the station should be called to this fact since it is perfectly possible to reduce such interference to very low values.

In most cases a transmitter accused of "bad harmonics" is either entirely innocent or else the so-called harmonic is actually something entirely different, namely, re-radiation. By this is meant that the field of the transmitting antenna excites nearby metallic objects such as power lines, steel building frames and the like, which in turn re-radiate at a wavelength determined by their size. True harmonics occur almost exactly at one-half or one-third the wavelength (twice or three times the frequency) of the station while these re-radiated signals will only by accident occur at those particular points. Should the operating staff of a station be handicapped by a location in the center of a city they may not be altogether able to avoid this sort of thing, though a change of antennae will in some cases reduce the difficulty. The remedy lies in a new and more carefully chosen station location. The station management will always make such a change if there is sufficient public opinion to the effect that an unsatisfactory condition exists because of a mid-city location.

There is still another form of local-station interference, though opinion differs as to the manner in which it takes effect. This is the form of interference manifested by a strong local signal which appears *not* all over the tuning scale but only on the wavelength of certain other stations. If the microphone of the distant station is not being used for a moment, the signals of the local station will continue to come in on that wavelength quite as if they belonged there. This has been variously explained. One of the most credible theories is that the signals of the distant stations are modulated as they pass through the intense field of the antenna of the local stations. This, of course, requires that the two stations and the receiver all lie in a straight line which has in fact been the case in all of the comparatively few clear cut cases of this type of interference which have come under the observation of the author and editor.

9. Tuning the Antenna Circuit—The tuning of a non-selective receiver can be sharpened up by cutting down the size of antenna or, better still, by tuning it. The antenna circuit may be tuned by connecting in series with it a variometer or variable condenser. One may also use a tapped primary coil with the first radio frequency transformer. Figure 335 shows how these methods are accomplished.

10. Wave Traps—The best means of eliminating interference from a local station is by the use of a good wave trap. The construction and use of such devices are described in Chapter 7 and therefore will not be taken up here.

11. Code Interference—During the early days of broadcasting, code interference was a common occurrence. It originated mainly from radio transmitters on ships. At that time transmission from ship to shore and ship to ship was permitted on wavelengths in the broadcast band, namely, 450 (667 k/c) and 300 (1000 k/c) meters. At that time these transmitters were the

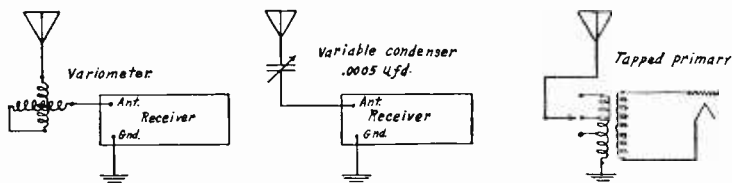

FIG. 335. Tuning the Antenna Circuit Increases the Selectivity of a Receiver.

spark discharge type which produced a very broad interfering wave. Today, one scarcely hears such interference as most of these transmitters have been replaced by the vacuum tube type and are being operated on wavelengths considerably above the broadcast band. The closest wave length to the broadcast band on which ship transmitters operate is that of 600 meters (500 k/c). This wavelength is reserved by International agreement for distress calls and messages relating thereto and to be used for a minimum of other traffic.

Occasionally a foreign ship may be heard on 450 or 300 meters talking to another ship of the same nationality. Usually, countries from which these ships hail are not bound by the terms of International Radio Laws of 1927. Nevertheless, the interference is most always noted by an inspector of the Radio Division, Department of Commerce, who copies the transmission and reports the same to Washington through the Supervisor of Radio of the district in which the interference was heard.

It is true that those living near the coast experience interference from ships, especially when the listener tunes to broadcasting stations operating on the higher wavelengths such as from 450 to 545 meters. Interference of this type can be eliminated by the use of a wave trap connected in the antenna circuit of the receiver and tuned to the interfering ship wavelength. Ships operate on wave-

lengths between 600 and 2400 meters. The wave trap should be adjusted first to the 600 meter (500 kilocycles) wavelength as this is the one most likely from which the interference originates.

12. Interference from Amateur Transmitters—Interference from amateur transmitters is usually experienced in the form of key thumps, code signals, or possibly in the form of radio telephone conversation. Amateur interference is generally heard on the lower end of the broadcast receiver dials or, in other words, in the high frequency portion of the broadcast spectrum. The majority of amateurs operate on high frequency channels corresponding to wavelengths of 80, 40, 20 and 10 meters. Amateur radio telephone transmitters are permitted on wavelengths from 150 to 175 meters, 84.5 to 85.7 meters and 5 to 5.35 meters. Modern shielded radio broadcast receivers seldom experience interference from amateurs. In fact, numerous amateurs operate their transmitters in their homes on short wavelengths while the other members of the family are listening to broadcast programs without interference.

The call letters of amateur stations are easily identified if one is fortunate to know the code. The United States and its territories are divided into 9 radio districts. Each district is in charge of a Supervisor of Radio to whom the amateur applies for a license. The license will indicate that the call signals consist of the letter W for stations in the continental limits of the United States and the letter K for those in detached territories and a single figure indicating the radio district in which the station is located, followed by a group of not more than three letters. For instance, a station operated in the third radio district might have the call W3ABE. The call letters are usually repeated several times during a transmission.

13. Hours of Operation—The United States regulations governing the operation of amateur stations state as follows: "Amateur radio stations are authorized for communication only with similarly licensed stations . . . and at all times unless interference is caused with other radio services, in which event a silent period must be observed between the hours of 8 p.m. and 10.30 p.m. Eastern Standard Time, and on Sunday during local church services.

14. Equal Right of Amateur and Broadcast Listener—These regulations do not intend that an amateur station may be operated at other times irrespective of the interference it may cause. During the period not covered by the regulations it is assumed that both transmitter and receiver have an equal right. If the trans-

mitter is operated in an inefficient manner or if some remedy can reasonably be applied which will prevent the interference, the amateur is expected to take the necessary action to correct such defects as there may be in his station. On the other hand, if the amateur transmitting station is operated efficiently and the operator has taken all reasonable precautions to avoid interference with his neighbors, he is not required to remain silent only during the periods mentioned above if the receiver is inefficient and the owner of the receiver is unwilling to take the same remedial steps.

15. Cooperation Between Amateurs and Broadcast Listeners—It is expected that both parties will do their part to relieve the interference. In most every case where this is done relief has been obtained. A broadcast listener desirous of obtaining the location of an amateur transmitter or filing a complaint of interference should write to the Supervisor of Radio of the district (see Chapter 14 for addresses of supervisors), stating the nature of the interference, the call letters of the interfering station, the time at which the interference is experienced and the type of receiver operated by the listener.

16. Interference from Electrical Apparatus and Devices—As already stated, it seems that every electrically operated device is capable of causing some form of radio interference. Instead of listing all these devices and treating the subject in a general way, it has been thought best to take up individually those cases which form the most prolific source and produce the greatest magnitude of interference. As the subject progresses the reader will note that the task of eliminating the interference once it has been found is a job for an experienced electrician and should not be trusted to the radio experimenter.

17. Locating Interference from Electrical Devices—Before tackling the job of suppressing the interference it must first be located. Various power companies and others have developed special radio receivers to trace down interference. In fact, most any of the loop-operated receivers can be used for this purpose. However, practice has shown that the more sensitive receivers make it difficult to localize the source as the disturbance may have the same apparent intensity over a considerable area. If the disturbance feeds over several power lines, as it usually does, the directive properties of the loop receiver will be useless. In most all cases it is best to use a simple, not too sensitive receiver, and depend upon tracing the interference by means of maximum audibility ("hot or cold method"), or if one care to, by combining audibility with a visual indicator in the form of a vacuum tube

voltmeter. The author had the occasion to design a radio receiver to be used for locating interference in connection with the work of the Radio Division, Department of Commerce. The diagram of connections with necessary parts is shown in figure 336.

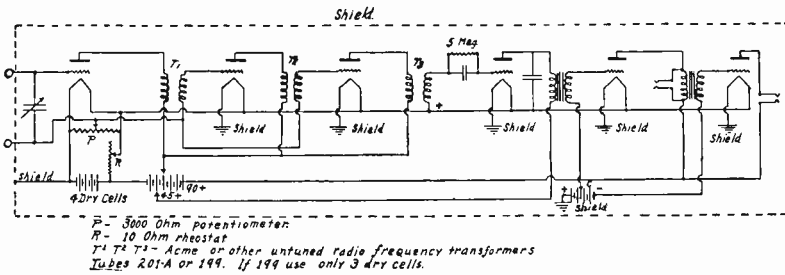
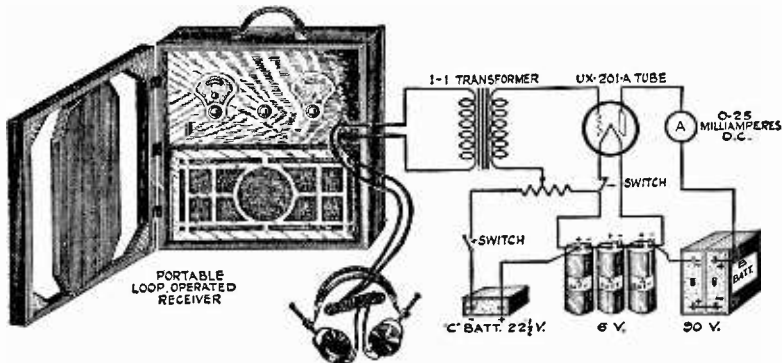

FIG. 336. Circuit of Loop Receiver for Locating Radio Interference. (Correction.) The Potentiometer shown in the diagram should be connected directly in shunt to "A" Battery instead of in shunt to one side of Rheostat and other side of "A" Battery.

Exceptionally good work has been done with this set within the third radio district. The idea of the visual indicator was suggested after reading a bulletin released by the Filterette Division,



(Courtesy of Deutschmann Corp.)

FIG. 337. Diagram of Visual Indicator.

Tobe Deutschmann Corporation, manufacturers of devices for suppressing radio interference. We shall hear more about the work of this company as the chapter progresses.

It will be noted that the cabinet for the receiver should be large enough to accommodate three or four 1 1/2-volt dry cells and 90 volts of "B" battery. The cabinet is shielded to prevent picking up signals by capacity of the wiring of the set.

18. Visual Indicator—The connections of the visual indicator are shown in figure 337. Its construction is relatively simple.

A transformer having one to one ratio should be connected at the output of portable receiver in place of the head telephones. The secondary of this transformer should be connected to a 201-A tube having some means of varying the grid bias. (A 5000-ohm potentiometer will do.) In the plate circuit of this tube a d.c. milliammeter having a full scale deflection of not over 25 milliamperes should be connected. The grid bias of the 201-A tube should be so adjusted that when a minimum of interference is being picked up there is no deflection of the plate current milliammeter. The indicator should not be operated from the batteries which are supplying current to the receiver.

The audibility of the interference may have the same apparent intensity over a considerable distance in any direction from the source. With the use of the visual indicator it will be found that the deflection of the milliammeter increases rapidly as the source of the interference is approached and decreases with equal rapidity when the source of interference is passed.

However, there is a bothersome exception in case of a noise which is fed for a long distance along a discontinuous line, that is, one with irregularities on it. Every irregularity reflects some of the noise wave and causes a portion of it to be radiated so that any one of these points will be the apparent source until one finds the next one. One does not always need a sub-station or even a transformer for a reflection point; sometimes the very insulators from the individual poles are sufficient. It is best to start out with the idea of finding a lot of bumps and then trying to puzzle out which is the worst and, having determined this, look around for the trouble. In order to obtain best results it is well to use the visual indicator in connection with the headset plugged in the receiver in order that the visual and aural indications may be compared.

A map of the area in which the investigation is being conducted is an essential portion of the proceedings. The different points of maximum audibility or intensity can be recorded on the map and will serve a useful purpose in checking over the results of the pro-

cedure from time to time. In the event that the interference shows up by the directional properties of the loop (see Chapter 14 on Directional Finders) various bearings can be taken and an intersection drawn on the map. These intersections are the places to look for the source of trouble.

It should not be assumed that all forms of radio interference feed out on power lines as it will be shown later that some electrical devices act exactly in the same manner as a spark system of radio telegraphy and radiate damped waves directly into the ether. Such forms of interference are more easily located by the use of cross bearings.

19. Interference Filters—Before considering the problem of eliminating interference originating from electrically operated devices with which the average radio fan is familiar, such as motors, vacuum cleaners, thermostats, oil burning furnaces, sign flashers, etc., it will be well to learn something of the nature of the filters used and how they work.

As a general rule, these filters are of three distinct types. The first depends for filtering upon capacity only; the second type depends upon inductance only; while the third type depends upon a combination of inductance and capacity.

20. Capacitive Type Filter—Referring to figure 338, the capacitive type of filter usually takes two forms. In *A* of figure 338 we see a condenser connected directly across the brush terminals of a motor, in *B* two condensers connected in series with the mid-point grounded. It is of extreme importance that the condensers used in a capacitive filter have a high safety factor.

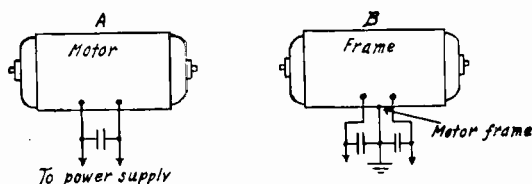

FIG. 338. Arrangement of Capacitive Type of Filter.

In other words, it is best to select a condenser whose flash voltage is five times higher than the maximum operating voltage of the device to which it is to be attached. For line voltages above 1000 this may be replaced by the rule of "2 times plus 1000," which means that the d.c. flash test should be double the line voltage plus another 1000.

If a condenser filter is connected directly across a commutator or a pair of contacts, there is usually trouble caused by burning or roughening of the contacts. On the break the electricity flows into the condenser charging it and at the next make it is explosively discharged through the contacts, either welding them slightly or outright vaporizing a bit of them. In either case rapid roughening results. The remedy is to decrease the time constant of the discharge. This can be done by resistance, inductance, or both. In the commercial filters manufactured by the Tobe Deutschmann Corporation this has been done and no damage to contact on commutators need be anticipated if the proper device is connected across them.

Whenever it becomes necessary to connect a capacitive filter across a 60 cycle a.c. line the capacity of the condenser should not exceed $1/4$ microfarad capacity or otherwise considerable a.c. will be by-passed to ground, thus increasing the cost of power for operation of the machine.

Generally the capacitive type of filter is applicable to all types of electrical apparatus which sets up radio disturbances. The capacitive filter should be placed as near as possible to the source of disturbance.

The diagram *A* of figure 338 shows the connections of a capacitive filter connected across the input terminals of a motor such as used in soda mixers, fans, hair dryers, vacuum cleaners, or any other device filtered with a small universal or d.c. motor. The capacity of the condenser being $1/4$ microfarad and tested to stand 200 or 300 volts. If the interference continues, it may become necessary to resort to the arrangement *B* of figure 338.

The arrangement in *B* of figure 338 may also be used across the output terminals of a d.c. generator.

21. Contact Noises—Contact noises originating from the operation of electric pads, furnace controls, refrigerator controls, sign flashers, elevator contactors, bell ringers, vibratory battery chargers, are most effectively eliminated by the use of a simple capacitive filter of the type *A* connected across the contact terminals. This condenser should be of 1 mfd. capacity and have a voltage safety factor. In installations where charge values of current are broken, such as elevator contactors, the capacity of the condenser should be much higher, say of 20 mfd. capacity.

22. Inductive or Choke Coil Filter—The inductive type of filter is generally employed when the interference is of a radio frequency nature. For instance, a step-up transformer may be used by an amateur for furnishing plate voltage to a vacuum tube

transmitter. Unless precautions are taken the radio frequency currents generated by the transmitter will feed back through the transformer and on to the power lines which act as "carriers" and broadcast reception in the neighborhood will be interfered with each time the amateur presses his key.

There are many electric devices the nature of operation of which generate highly damped radio frequency oscillations. The highly damped oscillations are capable of producing a widespread area of interference and will come in over a wide space on the dials of the receiver, this possibly preventing the reception of a desired station.

An inductive filter as shown in figure 339 installed at the source of interference will choke back these radio frequency currents and the interference will be eliminated. The choke coils used in the filter act as impedances to the radio frequency currents and they are prevented from flowing out on the power supply lines.

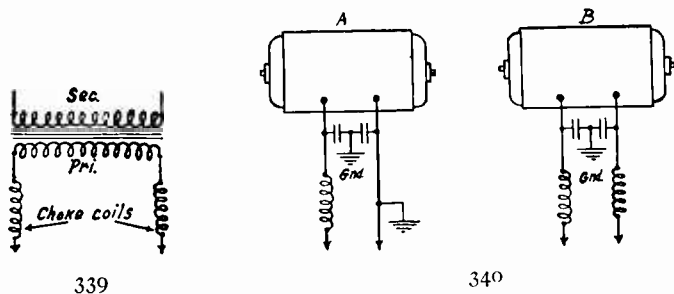

FIG. 339. Arrangement of Inductive or Choke Coil Filter.

FIG. 340. Arrangement of Combination of Capacitive and Inductive Filter.

In some cases of this nature it may become necessary to make use of a combination capacitive and inductive filter. In operation, the choke coils block the radio frequency currents and they are by-passed to earth by the condensers of the filter. (See figure 340.)

23. Sources of Interference—Before proceeding with the treatment of special cases of interference elimination, it will be well to list many of the electrical devices with which the average radio fan is familiar which is liable to be a potential source of disturbance. Nearly each one of those can be prevented from causing interference by the application of either a capacitive, inductive, or combination capacitive-inductive filter. In this list we find the following electrically operated household appliances:

| | |
|-----------------------|-----------------------------------|
| Vacuum cleaners | Small fans |
| Floor polishers | Some types of oil burner furnaces |
| Sewing machines | Small blowers |
| Hair dryers | Heating pads |
| Massage machines | Battery chargers |
| Drink mixers | Telephone dials |
| Egg beaters | |
| Kitchen help machines | |

OFFICE AND STORE APPLIANCES

| | |
|------------------|------------------------------|
| Cash registers | Billing machines |
| Adding machines | Drink mixers |
| Small fans | Electric typewriters |
| Printing presses | Electric addressing machines |

MACHINE SHOP AND GARAGE APPLIANCES

| | |
|--------------------------|----------------------------|
| Portable electric drills | Vibrating battery chargers |
| Small electric drills | Motor generators |
| Valve grinders | Mercury arc rectifiers |

BARBER SHOP AND BEAUTY PARLOR APPLIANCES

| | |
|--------------------|-------------|
| Hair clippers | Hair dryers |
| Massage machines | Small fans |
| Marcelling outfits | |

DENTAL OFFICE EQUIPMENT

| | |
|--------------|----------------|
| Small motors | X-Ray machines |
|--------------|----------------|

COMMERCIAL FIELD

| | |
|---------------------------|-------------------------|
| D.C. elevators | Annunciators |
| Moving picture theaters | Dough mixers |
| Plating works | Dishwashers |
| Printing presses | Precipitators |
| Sign flashers | Motors |
| Automatic railway signals | Generators |
| X-Ray machines | Electric cigar lighters |

24. Commercial Filters—Instead of trying to give the design of each particular type of filter applicable to the elimination of interference originating from the devices listed above, it has been thought best to list those manufactured and sold by the Tobe-Deutschmann Corporation of Canton, Mass.

Mr. W. K. Fleming, Chief Engineer of this Company, has made a detailed study of the interference problem and the Tobe Filterettes in the following list were designed as a result of this research

work. It will be noted that some models have various applications.¹

The list is as follows:

| Model | Applications for Filterette | Capacity |
|---------|---|---|
| Junior | Small motors, as on: barber clippers, cash registers, hair dryers, electric fans, vacuum cleaners, and similar devices. | 110 volts d.c. or a.c. 500 watts. |
| No. 10 | D.C. motors, generators, chargers, house lighting plants, etc. | 110 volts d.c. 5000 watts. |
| No. 11 | Motors, generators, chargers, transformers, house lighting plants, etc. | 110 volts a.c. 500 watts. |
| No. 20 | D.C. motors, generators, chargers, house lighting plants, etc. | 220 volts d.c. 10,000 watts. |
| No. 22 | Motors, generators, chargers, transformers, house lighting plants, etc. | 220 volts a.c. 10,000 Watts. |
| No. 23 | Same as No. 22, but where three wires are required instead of two. | 3 phase 220 volts a.c. Single phase 110-220 volts a.c. |
| No. 55 | Motors and any other apparatus, operating on 440 or 550 volts a.c. | 3 wire 110-220 volts d.c. 15,000 watts. |
| No. 56 | Same as No. 55, but where three wires are required instead of two. | 440-550 volts a.c. 25,000 watts. |
| No. 60 | Motors, generators, chargers, house lighting plants, etc. | 3 phase 440-550 volts a.c. |
| No. 110 | Refrigerators, oil burners, chargers, dental motors, electric heating pads, small electric signs or blinkers, and any type of apparatus within maximum potential named. Also properly shielded violet ray or diathermy apparatus. | 30,000 watts. 600 volts d.c. 25,000 watts. |
| No. 131 | Sign flashers (motor driven). | 110 volts a.c. or d.c. 500 watts |
| No. 132 | Sign flashers (motor driven). | Maximum current 5 amperes. |
| No. 133 | Sign flashers (motor driven). | 110 volts a.c. or d.c. 1000 watts—10 amperes. |
| No. 134 | Sign flashers (motor driven). | 110 volts a.c. or d.c. 2000 watts—20 amperes. |
| No. 135 | Sign flashers (motor driven). | 110 volts a.c. or d.c. 110 volts a.c. or d.c. 3000 watts—30 amperes. |
| No. 221 | Same as No. 110. | 110 volts a.c. or d.c. 4000 watts—40 amperes. 110 volts a.c. or d.c. 5000 Watts—50 amperes. 220 volts a.c. or d.c. 1000 watts—5 amperes. |

¹ Prices may be obtained by writing to the Tobe-Deutschmann Corporation at Canton, Mass.

25. Power Line Interference—While on the subject of power lines it will be well to consider some of the forms of interference for which they themselves are responsible.

26. Corona Discharge at Insulators—It has been found that on lines carrying high voltages in the neighborhood of 220,000

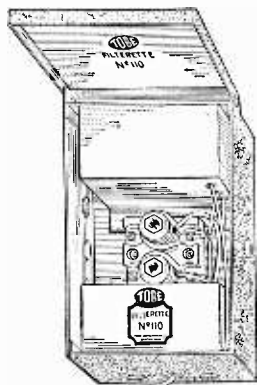

(Courtesy of
Tobe-Deutschmann Corp.)

FIG. 341. One of the Many Tobe Filterettes.

volts, a coronal discharge at the top of the insulators will cause considerable interference to reception. This has led to development of insulators built with a special aluminum shield at the top. When such type of insulators are used the corona discharge disappears and likewise the interference.

There are other causes of interference from insulators as, for instance, in the "alkali" regions insulators become coated with dust in dry seasons and this coating becomes conductive whenever sufficient moisture arrives in the form of dew, fog or rain. No particularly satisfactory protection against the dust seems evident. Another very common and very aggravating case is that of a line whose insulators were good at one time but have aged until their leakage is con-

siderable. This is the normal life history of a porcelain insulator and, unfortunately, bad noises result many months before the leakage is serious enough to cause such power loss or flash overs as to create actual necessity for insulator replacement. Fortunately, most public service companies go beyond the actual necessities in this matter to a degree which is both remarkable and unappreciated.

27. Swinging Grounds—Swinging grounds are usually caused by tree branches swinging against the lines and chaffing the insulation off thus producing an arc or spark each time the limb swings against the bare wire and registers in the speaker as a sputtering crash. Not infrequently a swinging ground may be caused by a guy wire of a pole of an electric lamp support coming in contact with a high voltage wire.

As an example of the latter case, let us quote from a report by Mr. Van Nostrand, Jr., Supervisor of Radio of the Fourth Radio District, Radio Division, Department of Commerce, as published in the Radio Service Bulletin, June 2, 1924. The investigation

was conducted in the city of Augusta, Georgia, and reads as follows:

"The investigation was continued that night about nine o'clock and the exceptionally loud interference was noticed in a large area in the vicinity of Central Avenue. The point of maximum intensity appeared to be at a certain residence on Central Avenue, where, with a radiofrequency receiver and a loudspeaker attached, the roar from this induction could be heard at a distance of two city blocks. Considerable signal strength was noticed on the specially constructed loop receiver mounted in an automobile parked in front of the residence, the loop pointing directly down the street. About four blocks from the residence one of the 13,000-volt transformers was located in the middle of the street on a pole between the street car tracks. The signal strength grew louder as we approached this transformer but by the time the transformer was reached it had decreased and the loop pointed back up the street. The transformers being under suspicion it was endeavored to train the loop toward them, but in each case the loop pointed up or down the middle of one side of the street and by turning it slightly toward the power-line poles in the middle of the street the signal strength decreased slightly. We therefore abandoned the idea of the interference coming from the transformers and when reaching the point of maximum interference, less than two blocks below the residence referred to above, the inspector got out of the automobile while the power company official was listening in and with a pole tapped a street light suspended directly in front of the automobile which resulted in the interference falling to nearly zero intensity and rising to maximum as the light swung from its support. The above is mentioned to show the exceptionally directional properties of the loop receiver being used which tended to point directly down the street rather than toward the transformer in the middle of the street. After moving two blocks below this light, the loop swung entirely around, the grid end pointing directly back toward this light. They then went to the right and to the left of this light and in each case the loop turned directly toward it.

"Shortly after this the services of a lineman were obtained to cut out the light, but the interference still prevailed. The lineman then climbed the pole in the middle of the street from which the light was suspended and connected to the main circuit and the outlet was entirely jumped and the light completely cut out of the circuit and the interference still prevailed. It was then decided to have the lineman shake the wires on the poles below the 13,000-volt

line and found that the interference was interrupted when he moved the guy wire holding the light. The guy wire was found to be lying across the primary of a 2,300-volt circuit and when it was removed the interference was entirely eliminated with the exception of a slight disturbance of less than one quarter the intensity, apparently coming from some other source. This is mentioned for the reason that a similar trouble experienced with a lighting circuit in Hartford, Conn., as reported in a recent periodical, resulted in eliminating interference by substituting new street lights, but a careful inspection of the lights and fixtures removed failed to show any reason why the fixtures removed should have caused the trouble. In the present case we had every reason to be suspicious of this particular light, but found that the light itself was causing no trouble and its support was touching a high-voltage line. This light, swinging at times in the wind and temporarily moving the guy wire from the high tension line, apparently accounted for the intermittent nature of the interference."

28. Transformers—It seems that whenever the broadcast listener cannot blame "static" on to an amateur that it must be caused by a transformer in the vicinity. This is one of the greatest "myths" of the interference problem. A power transformer itself is of such a nature that while in normal operation it produces no interference unless one approaches closely to it and listens in with an audio amplifier. Perhaps then there may be a hum produced by the magnetizing of the core.

If interference is traced directly to the transformer, it is well to notify the local power company who will send an electrician to look it over. In most every case in which the interference has been traced directly to the vicinity of the transformer it has been found that it was caused by one of the following defects:

1. Transformer insulating bushings broken down.
2. Loose contact at pole switches. (These are usually installed close to transformer.)
3. Loose ground connection on transformer cases.
4. Loose fuses on the high-tension side.

29. Lighting Circuits—Swinging grounds and bulbs loose in sockets probably constitute the greatest causes of interference from lighting circuits. It is always best to investigate swinging grounds when it is raining or when there is snow or ice on the wires, keeping on the lookout for small flashes or arcs, especially where the wiring system passes through tree limbs.

If one suspects a defective light or socket, he should notify the power company, requesting them to send a man to inspect it.

The same holds good if one discovers a swinging ground. It is dangerous to try and trim a tree in which power lines are passing through as quite often the primary line may have a voltage of 2200 volts and contact with such a line in most cases proves fatal. The trimming of the tree should be done by a representative of the power company. Power companies are, as a rule, usually willing to eliminate any form of defective wiring or apparatus as it means power lost to them.

30. Arc Light Circuits—It has been found that in general arc light circuits produce interference only under abnormal conditions although these abnormal conditions may not be sufficient to interfere with the operation of the arc light system. The report of Inductive Coordination Committee of the National Electric Light Association indicates that the source of interference may originate in the line, the arc light, or source of power supply which is usually either a mercury arc rectifier or direct current generator.¹ From this report we learn that "the most likely causes of interference from arc lights are grounds," loose connections, and lamp jumping. The first two of these are self-explanatory and in a well maintained circuit rarely occur."

Lamp jumping may be caused by any one of the following causes:

1. Broken, clipped or loose filtering globes.
2. Broken or loose flexible connection strip from upper electrode to upper electrode box.
3. Broken flexible construction cable to movable clutch rod.

These troubles are easily detected and repaired by an electrician of the power company. Whenever trouble is traced to an arc light the power company should be notified and under no circumstances should those in the trouble-shooting party attempt to climb the pole or in any other way come in contact with the system.

The reader is referred to the National Electric Light Association sub-committee's report of 1925 on Radio Interference for further details concerning interference from arc light systems.

31. Precipitators—A study of investigation and elimination of interference to broadcast reception caused by the operation of precipitators in the ore industry was begun as early as 1924 by the late Col. Dillon, who was then Supervisor of Radio of the Sixth Radio District, Radio Division, Department of Commerce, with

¹ Serial report of the Inductive Coordination Committee, edited from the report of its sub-committee on Radio Interference of the National Electric Light Association, Nela Park, Cleveland, Ohio.

headquarters at San Francisco, Calif. Col. Dillon was very successful in eliminating interference at one plant that before paralyzed reception in two towns. Before considering his work along these lines it will be well to consider the construction and operation of a precipitator. Such devices are not confined to the ore industry but are used for smoke and dust precipitation at cement mills, etc. They produce radio interference that can be heard at a distance of ten miles and are capable of making reception impossible over a wide area surrounding the installation.

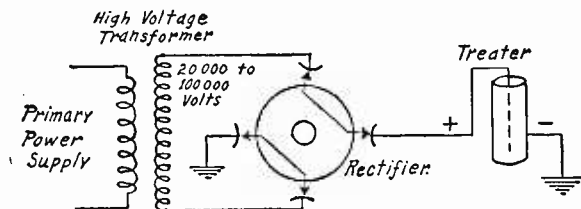

FIG. 342. Schematic Wiring of a Precipitator.

Referring to figure 342, it will be seen that the step-up transformer produces a secondary voltage varying in various installations from 20,000 to 100,000 volts. This voltage is rectified by a mechanical rectifier and then fed to the precipitator which consists of a rod or wire inside a pipe, or else several wires suspended between poles. In some types the high voltage for the rectifier is obtained directly from a self-contained motor generator. The precipitator operates by establishing a highly negatively charged field inside the pipe. The dust particles passing through become charged and driven against the walls where they stick and are removed in large masses.

The interference from such devices is similar to that radiated by a spark system of damped wave radio telegraphy. The treaters and insulator act as condensers while the leads from the rectifier furnish the inductance. During operation the sparks at the rectifier generate a highly damped wave which is somewhat resonant at the natural wavelength of the rectifier-treater circuit. However, this is not always the case as it will be seen from Col. Dillon's report. The report reads as follows:

"The inspector arrived in Globe and in Miami and listened to the interference being caused by a smelter which was operating a Cottrell electric precipitator. He found that the reports had not been exaggerated. As a matter of fact, reception was impossible

while the precipitator was working. On the following morning he visited the precipitator and found that the rectifier, which was operating on 60,000 volts, 3-phase, 47 1/2-cycle current, was supplying precipitators located approximately 214 meters distant from the rectifier, and as the interference was most serious on a wave length band of 300 to 500 meters, it seemed evident that these extension wires were not oscillating in their own period, because if they had been the resonance point would be approximately 449 meters, from which it would be deduced that forced oscillations were induced from the discharger and that these were communicated to the surrounding power lines by the wires leading to the precipitator. The resistances had been inserted close to the precipitator and upon inspection it seemed probable that the resistance was giving the effect of an open wire and that the oscillatory current was induced beyond them, causing the interference noted. In remedying the same he moved the resistance just outside the middle wall of the building and inserted an iron core impedance in the line. He next bridged the spark gap with an LC circuit to absorb the energy of the oscillatory current development. When these changes had been made and the auxiliary apparatus installed he cut off the other precipitator and called up both Globe and Miami and asked them to report on the interference. Happily, both cities reported that the interference had disappeared. It was then arranged to run all precipitators on the non interference circuit until additional devices could be procured for the other circuits. The result was most gratifying. Everyone in Globe and Miami appeared to rejoice in the elimination of the interference and for the first time in several months they made arrangements to 'listen in' on the evening concert."

The radio inspector of the Department of Commerce at Seattle was also successful in eliminating interference from a precipitator by inserting radio frequency choke coils in each of the precipitator leads. These choke coils were made by winding 500 turns no. 18 fixture wire, single layer, on a wooden form 4 1/2 inches in diameter. It was found that 400 turns were sufficient for current below 50 milliamperes and that 500 turns were required for 70 milliamperes or higher. Some interference was radiated by the transformer secondary wires but was eliminated by inserting chokes in each leg.

Particularly meritorious service in the investigation and elimination of interference from precipitators has been done by Mr. J. J. Jakosky for the Western Precipitation Company of Los Angeles,

Calif. Some of his work was described by Kruse in QST of March, 1927. Writing at that time, Kruse says: "It was found that choke coils at the rectifier terminals would to a certain extent stop the radio frequency currents from proceeding out on the line toward the precipitator but that the voltage across these chokes would use as high as 20,000 volts by reflection effects. This added to the line voltage was enough to cause discharges. There was therefore developed a choke that not only 'choked' but also absorbed the radio frequency energy and wasted it. The choke proper was made by winding a single layer of no. 26 double cotton covered wire on 2 5/8" diameter paraffined wood core, the winding being 13 1/2" long and the core 15 1/2" long. Bakelite strips are laid over this and 9 iron absorbing rings are slid over the bakelite."

Special treatment has been found necessary in several instances of precipitation interference. For instance, merely placing a grounded wire screen entirely around the wires of the rectifier and precipitator has eliminated the interference, while in other cases it has been necessary to bond and ground such things as metal fences near the precipitator before all the interference disappeared.

Where the electrical equipment is of the synchronous motor type, so that the oscillations can pass on to the primary power lines, these oscillations can be prevented from going on to this line by means of suitable condensers which are placed either in each of the three phases of the primary or else only in one phase, which supplies the transformer. These condensers may be ordinary power condensers of about 1 microfarad each, and about 800 volts, and two of these condensers may be placed in parallel and two in series, the middle being grounded. In this connection each one of the lines is connected with the ground through two 1 microfarad condensers. By this means it has been possible to practically eliminate all interference from precipitators where either the motor generator set or the synchronous motor set was used.

32. Oil Burning Furnaces—Once again we find it particularly fitting to consult the research work of Fleming along the lines of suppression of interference from oil burning furnaces. It is by special permission of the Töbe Deutschmann that the author has been permitted to use an article on this subject written by the above mentioned engineer and published in the Töbe Filterette Magazine, Vol. 1, No. 2.

"The radio interference set up by the oil burning furnaces is without doubt one of the most serious problems which is today confronting the radio engineer. Unfortunately, the correction of this type of interference is very difficult, especially with certain types of furnaces and in certain locations.

“ Before outlining the various methods of suppressing the interference, a brief summary will be given of the various types of furnaces and the way in which they cause radio difficulties.

“ To begin with, the interference set up by oil burning furnaces generally consists of two classes. First, that which is directly radiated from the furnace itself, and second that which is superimposed on the supply lines and radiated from these lines as well as from the house wiring. The first type of interference will generally affect only the house in which the furnace is located. The second type, however, may be the cause of a disturbance over a considerable distance; cases of interference set up by furnaces as far as a quarter of a mile away being not at all uncommon.

“ To suppress the first class of interference set by direct radiation, shielding is, of course, the logical solution.

Unfortunately however, proper shielding is not the easiest thing to do. In fact a great many cases of interference are aggravated by using improper methods of shielding or grounding shields, due to the fact that in some cases where shields are grounded they increase the intensity of the radiation.

“ The most satisfactory solution of both the direct radiation and the radiation from the supply lines is to employ a combination of shielding and filter. Where the correct type of filter is used, the direct radiation can generally be reduced or entirely eliminated by electrically connecting the shield to the return wire of the filter, while, of course, the radiation from the supply lines is suppressed by the proper application of the filter.”

33. “ **Three Classes of Furnaces**—As the intensity and character of the interference depends to a very great extent on the type of furnace used, these are divided into three general classes: first, furnaces in which the oil gas is ignited by a continuous elec-

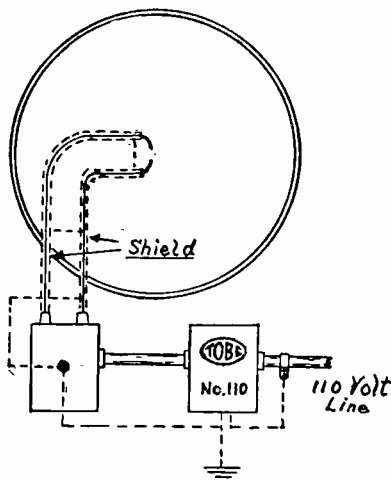

(Courtesy of Tobe-Deutschmann Corp.)

FIG. 343. If Interference is Caused by Ignition Only, Connect Filter to Primary Leads as Close to Transformer as Possible.

tric spark; second, furnaces in which the spark is intermittent in operation, the spark generally occurring at about two minute intervals and having a duration of between 10 and 30 seconds; third, furnaces which do not employ a spark for igniting the gas which, in this case, is ignited by a gas pilot."

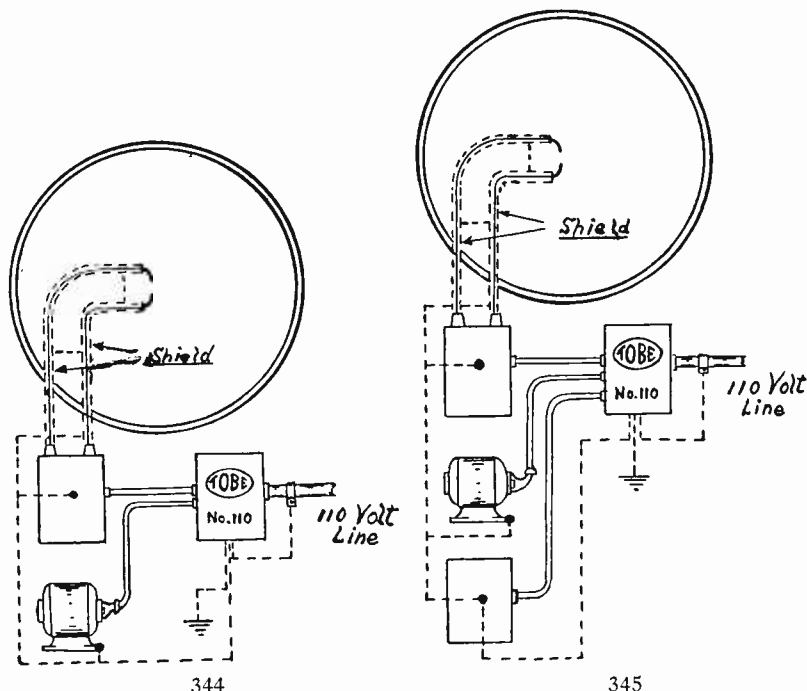

FIG. 344. If Interference is Caused by Motor as well as by the Ignition System, Connect Filter as Shown in Sketch.

FIG. 345. If Interference is set up by the Heat Regulator, the Filter should be installed so that the current passes through the Filter before going to the Control System.

"The first type of furnace is without doubt the greatest offender in setting up interference, although the second type is almost as bad; especially if several of them are located in the same neighborhood. The third type is the least offender as no interference whatsoever is set up by the ignition system. However, as all types of oil furnaces require electric motors for their operation, it quite frequently happens that interference is set up by the motor,

even though none is caused by the ignition. Heat, regulator controls and thermostat controls in general are also a cause of interference. All of these conditions must therefore be checked in order to suppress the disturbance."

"First of all, we will consider the interference set up by furnaces in class 1 and 2. The intensity of the disturbance will to a very great extent depend upon the construction of the ignition system and the manner of its installation. The least trouble is experienced from the ignition system when the leads from the secondary of the transformer are carried in conduit to within an inch or so of the actual point where the spark occurs. Some types of burners employ a metal sheath or tube which completely surrounds or encloses the ignition points, with the exception of a space through which the ignited gas passes. This construction tends to reduce to a very great extent the interference which would otherwise be set up. Other types of furnaces employ an open spark with no attempt whatsoever being made to shield the ignition points. This type of furnace is without doubt the worst offender."

34. How Cause Is Traced—"The first step in the suppression of oil burner interference is to determine what is causing the disturbance; that is, is it set up by the ignition, by the motor, or by the thermostatic motor or control? If the furnace employs continuous ignition, there will be a steady buzzing sound with a slight wavering in intensity if the interference is caused by the ignition. If the ignition employed is of the intermittent type, this can very easily be detected due to its intermittent character. If gas pilot ignition is used, any interference which is set up will, of course, be due to the motors or control. The interference set up by the motor may be in the form of a steady crackling or a grinding noise of varying intensity. When caused by the heat control motor, it will be rather high pitched and steady in character. Interference caused by the thermostat control will be in the form of clicks when the heat regulator begins to operate or when it stops. It is generally possible to determine which part of the apparatus is causing interference by noting the operation of the burner and comparing it with the noise picked up in the radio set. When this is not possible, the ignition system can be kept going with the rest of the furnace off. Then the ignition can be turned off and the furnace operated with the oil shut off. If a thermostat control motor is used, this can also be caused to operate with the rest of furnace off."

35. Methods of Correction—"Having once located the interference, the next step will be to determine the method of correction

which should be used. If it is caused by the ignition system, determine what type of points and shielding is used. If the secondary wires are unshielded, these should be run in flexible conduit as close to the points as is possible. A separate flexible conduit should be used for each wire and the conduits electrically connected together at both ends as well as in the center. A wire should then be run from the conduit to the transformer case so as to electrically connect the conduit and the case. Whenever it is found necessary to shield the secondary leads, they should be enclosed in rubber tubing before the shielding is applied. The shielding should, under all circumstances, be carefully insulated from the ignition points and transformer terminals. The next thing to do is to procure a suitable filter which, if the disturbance is caused by the ignition only, should be applied to the primary leads as close as possible to the transformer. The return wire from the filter should be run to the case of the transformer. If the primary wires to the transformer are carried in conduit, a wire should also be run from the conduit to the return wire of the filter, in some cases it will be found advisable to run a ground from the return wire of the filter to either the furnace or a water pipe or both. The way to determine which will give the best results can be found only by experiment. In some cases, no ground whatever is required. In fact, grounding the system sometimes brings back the disturbance.

If the trouble is caused by the motor as well as by the ignition system, then the filter should be applied to the apparatus as shown in figure 344. The same precautions should be observed in making the installation as shown in figure 343. If interference is set up by the heat regulator, the filter should be installed so that the current passes through the filter before going to the control system, as shown in figure 345. Of course, where no trouble is experienced from the ignition system, it is not necessary to enclose the secondary wires in conduit, but all other precautions as to connecting up the filter should be observed no matter what is causing the interference.

Although in the majority of installations satisfactory suppression of the interference can be secured by some one of the methods above outlined, there are some types of ignition systems which are almost impossible to correct. This is especially true of the type wherein one of the wires from the secondary to the transformer is made common to the burner. The only thing to do in this case is to shield the one wire which runs from the secondary of the transformer to the ignition points and to apply a filter in whatever manner is required to the particular installation. Before applying

shielding, the secondary wire should be enclosed in rubber tubing. The shielding should be carefully insulated from the ungrounded ignition point and transformer terminal, and should generally be electrically connected as close as possible to the grounded ignition point. However, the best place for this connection should be determined experimentally. This will probably help to such an extent that satisfactory results will be obtained. If the interference is still bad, however, the best thing to do is to change the ignition system to one wherein the interference can be suppressed by the addition of a filter.

36. Choice of Filter Type—The type of filter to use depends so much on the type of burner and the method of installation of the furnace that it is very difficult to use a simple capacitive type filter. In some installations, where the ignition system, though well shielded, is still the cause of some interference, or where interference is created by the operating motor, a simple capacitive filter is all that is required.

In the majority of installations, however, it has been found necessary to use a combined inductive capacitive filter.¹ This type of filter will generally prove more satisfactory for suppressing the simpler forms of interference created by oil burner installations, as well as the more complicated ones such as arise from unshielded ignition and a combination of ignition and motor disturbance. The combined inductive capacitive filter has also been found necessary with majority of furnaces which, although they employ gas ignition, still are the cause of interference due to the high speed motor which is employed for operating the furnace. It is therefore advisable, regardless of the type of furnace or ignition system that is used, to employ the inductive capacitive filter.

The filters used in this work should be constructed with high a.c. working voltage condensers. The filters should also be protected by proper fusing and, wherever possible, application of the filter should be made by a licensed electrician, as it is necessary to cut into the supply lines to install the inductive capacitive type filter.

37. Suppressing Interference from an Oil Burner Having Grounded Ignition System—One of the most difficult problems that the service man must meet is that of radio interference from an oil burner having an electrical ignition system with one side of the secondary grounded to the base of the burner.

The same rules that apply to oil burners having ungrounded ignition system secondaries must be followed in suppressing inter-

¹ Tobe Filterette 110 is the type of filter generally used.

ference from this type of burner. However, since one side of the secondary is common to all metal parts of the burner, it is obvious that the whole ignition system cannot be shielded. We usually find, however, that shielding applied to the ungrounded lead will sufficiently decrease the radiation from the ignition system, provided the connection from the shield to the grounded lead is sufficiently firm. It is usually advisable to make this connection to a brass or copper portion of the oil feed line as near as possible to the point where this line enters the base of the burner. It is essential that this ground connection be made to a carefully cleaned part of the installation, and that a good ground clamp be used.

In addition to careful application of shielding, it is also necessary to use a no. 110 Filterette in the power input leads to the installation. The return wire from the Filterette should be as short as possible and should be connected to the frame of the motor as well as to the case of the ignition transformer.

In all interference work it is necessary that leads be kept as short as possible and, if a long ground lead must be used, that this lead be shielded and the shield returned to a metal part of the oil burner installation.

38. Sign Flasher Interference—Again we are indebted to the Tobe Deutschmann Corporation for the use of Mr. Fleming's treatment of this subject.

“One of the most peculiar things about radio interference is the manner that seemingly simple phases of interference have of developing into really intricate problems. This is the case with sign flasher interference. To all intents and purposes, what could be easier than to remove the interference set up by opening a low tension circuit? Yet upon careful analysis, it is found to be one of the most difficult of radio interference problems to overcome.

“In most cases of interference, the disturbance picked up by the set is caused by oscillations or disturbing impulses set up in the *power supply line* to the set. These impulses may cause interference, due to their being conductively coupled to the set, as well as to the fact that the power line is radiating waves which are picked up by the antenna system. In either case, attaching a filter directly at the source of the interference is generally all that is necessary to reduce both effects to such an extent that they will not cause any objectionable interference. This type of interference may be designated as primary interference to distinguish it from other interference which may be set up by the apparatus and which we will term secondary interference.

“Primary interference set up by sign flashers can generally be

suppressed by an inductive capacitive type filter.¹ The secondary type of interference, however, is another story. Fortunately, not all sign flashers create objectionable secondary interference. In fact, in most cases, this interference is not of sufficient intensity to be objectionable unless the sign is operated in close proximity (under 100 feet) to the radio set or antenna system.

"The difficulty of overcoming what we have termed secondary interference is due to the fact that this interference is really very similar in character to that produced by standard transmitting apparatus. In some cases, the circuit is almost identical with unlawful types of transmitting circuits; that is, circuits wherein the antenna is conductively coupled to the transmitter rather than inductively coupled. The difficulty of overcoming this interference is due to the fact that the flasher radiates from the load circuit what might be considered highly damped waves.

39. "Types of Sign Flashers—The simplest type of sign flasher is that in which the mechanism is actuated by a thermostat. Interference caused by this type of mechanism is readily suppressed provided the mechanism, as is generally the case with small blinkers, is closely associated with the sign and enclosed in the sign housing. In this case the secondary interference set up is not of sufficient intensity to be objectionable.

"If the flasher mechanism is operated at a considerable distance from the sign, the secondary interference set up will probably be objectionable. In this case an additional filter will probably be required.

"The most universal type of sign flasher is that in which the mechanism is actuated by a motor. The primary interference set up by this type of flasher is generally suppressed by a standard inductive capacitive type filter, similar to that required for the simpler types of sign flashers.

"The secondary interference created by motor driven sign flashers is usually more severe than that created by the simpler flashers, due to the fact that the flasher mechanism is frequently operated at a considerable distance from the sign. An additional filter, as in the case of the simpler type of flasher mechanism, is therefore often necessary to suppress the secondary interference.

"The type of flasher mechanism employed for traffic lights and safety signs is generally of the solenoid or magnetic type. This type of mechanism is also employed for actuating larger types of signs. The primary type of interference is generally suppressed by installing a filter in a similar manner to that employed in the

¹Tobe Filterette No. 131-5.

case of a thermostat or motor driven type of sign flasher mechanism. The secondary interference, however, is extremely difficult to overcome provided the sign and the mechanism are not installed in the same housing. Where the sign is installed at a considerable distance from the flasher mechanism, the wiring between becomes the antenna system of a low potential transmitter, emitting highly damped waves which are capable of traveling over a considerable distance.

"It is fortunate that a great many of the smaller signs and blinkers which employ this type of mechanism are really self-contained units, wherein the mechanism and the light are in the same housing. In this case, the standard inductive capacitive type filter¹ is generally quite effective in suppressing the interference.

"When several of these lights are controlled from one central system, or when there is considerable distance between the flasher mechanism and the sign, we are, as before mentioned, confronted with one of the most difficult problems of secondary interference. A specially constructed type of filter must be used in order to secure satisfactory suppression of this interference.

40. "Character of Interference—To suppress satisfactorily the interference created by sign flashers, it is first necessary to determine whether the interference is primary or secondary in character. If it is primary in character, it is coming in over the power lines. If it is secondary in character, it is probably being picked up by the antenna system of the set. This classification of interference applies in the majority of cases. In some instances, however, secondary interference is picked up by the power lines and thus conveyed to the set, even though a filter is employed in the primary side of the flasher. In this case, as well as in the case of direct secondary radiation as picked up by the antenna system, it is necessary to use a filter which suppresses both primary and secondary radio interference; otherwise, complete elimination of the interference will not be secured.

"In some types of installation, the secondary interference may be reduced by carrying the wires from the flasher mechanism to the sign in metal conduit, which it is usually advisable to ground at two or three points; that is, at the sign flasher, in the middle of the conduit and at the end of the conduit. No hard and fast rule, however, can be laid down for this type of installation, as it quite frequently happens that grounding the conduit increases the interference rather than decreases it. This latter phenomenon is undoubtedly due to the fact that the conduit in this case is acting as

¹ Tobe Filterette No. 131-5.

a radiator, and the ground leads, therefore, really increase the length of the antenna effect and the consequent secondary interference, rather than decreasing it.

"The most satisfactory arrangement for a flashing sign is one in which the flasher mechanism and the lights are so placed that the leads to the lamps are extremely short. These leads should be carried in conduit or the back of the sign should be enclosed in metal. In fact, an ideal type of flashing sign would be one constructed entirely of metal. Where this construction is possible, secondary radiation is reduced to a negligible quantity, due to the large absorption effect of the metal sign.

"Smaller types of signs and blinkers frequently approach this ideal construction, as they are usually constructed of metal which is used to house the flasher mechanism as well as the lamps.

41. "To Determine Type of Interference—To determine whether the interference being picked up by the radio set is primary or secondary in character, the following procedure should be followed:

"Disconnect the antenna and ground from the set. If the interference is still audible, this indicates that it is due to the coupling of the set to the power lines. If no interference is audible, it would indicate that interference is being picked up by the antenna and ground system of the set. The ground wire should then be attached to the set. If the interference is then audible, it would indicate that this interference is being picked up by the ground system, and is due to either radiation or conductive coupling. If no interference is audible until the antenna as well as the ground is connected, it would indicate that the antenna system is picking up the disturbance.

"In the case of interference being audible in the set without the ground or antenna connected, it is necessary to install the proper type of filter¹ directly at the flasher mechanism before being able to determine whether the interference is primary or secondary in character. Installing the filter should entirely remove the interference which is audible without the ground and antenna being connected. With the interference thus cleared up, the ground should then be connected. If it again becomes audible, it would indicate that there is secondary interference present. Connecting the antenna system should increase this interference. It then becomes necessary to install an additional filter between the flasher mechanism and the sign, or to install a special filter designed to take care of both types of interference.

¹ Tobe Filterette No. 131-5.

“In general, the interference is primary in character with slight secondary power line characteristics when the flasher mechanism and the sign are enclosed in the same housing, or the mechanism and the sign are closely associated. Where a central control flasher system is used for actuating blinkers or signs, or where the leads from the flasher mechanism to the sign are over 10 feet long and are not carried in conduit, interference of both primary and secondary character will probably be present. Just how objectionable the secondary interference will be will depend upon the characteristics of the particular installation which is causing the trouble. The best practice to follow is to install a filter to take care of primary interference, and thus through experiment, determine whether additional filters are necessary in order to secure complete interference elimination.”

42. Authority of State to Regulate Interference Laws—

There have been many attempts by states and communities to enact laws prohibiting or limiting the operation of any device that interferes with broadcast reception. In some states and cities such laws are already in force. The legislature of the state of Maine, for instance, has enacted a law prohibiting the operation of any radio receiver between the wavelengths of 200 and 545 meters the operation of which as determined by a test is capable of causing interference to other receivers.

Generally such forms of legislature are aimed at the operation of electrical devices which cause interference by induction or by the generation of radio frequency currents. These disturbing effects usually come from non-radio sources such as motors, precipitators, and other devices mentioned throughout this chapter.

As shown by Stephen Davis, former Solicitor of the Department of Commerce, in Chapter 6, The Law of Radio Communication.¹

“The legislature power of the several states is absolute and extends to all persons and property within their respective boundaries. Being general, it includes both persons and property engaged in radio communication. An inquiry into state authority in radio matters is therefore not directed to the discovery of a source of power, but to a consideration of the extent to which the power is limited or confined. Limitations are to be found in the Constitution of each state and the Constitution of the United States the provisions most obviously applicable to possible legislation regulating or in aid of radio communication being the

¹ By courtesy of McGraw-Hill Book Co., Inc., 376 Seventh Ave., N. Y.

common clauses requiring due process of the law, prohibiting the taking of private property of private use and allowing a taking for public use only upon just compensation, requiring equal protection of the laws, and the clause of the Federal Constitution giving Congress authority to regulate interstate and foreign commerce.”

43. Power of City or Town—The question of the power of a city or town to enact an ordinance having to do with the prevention of radio interference is a local one dependent upon the constitution and statutes of the particular state.

44. Interstate Communications—It is unconstitutional for any state, city, town or community, to enact legislation aimed at the regulation of any radio station engaged in interstate communication. For example, several cities have tried to enact ordinances limiting the operation of amateur transmitting stations. The amateur stations are given a license by Federal Government and are engaged in interstate communication and in each case such ordinances have been held unconstitutional by the courts of the state.

CHAPTER 19

RADIO LAWS OF THE UNITED STATES AND INTERNATIONAL TELEGRAPHIC CONFERENCE

1. **Introduction**—In the United States we have two radio acts as enacted by Congress, one of which is designed to promote safety at sea through the employment of apparatus and operators to transmit and receive distress calls and other calls relating to perils and aids to navigation. It is known as the Ship Act and is quoted here exactly as enacted by Congress and approved July 23, 1912, to amend Section I of an act entitled, "An Act to Require Apparatus and Operators for Radio Communication on Certain Steamers," approved June 24, 1910. The amended act applies to vessels licensed to carry as well as those actually carrying 50 or more persons, etc.

Following the quotation of this Ship Act there will be found certain regulations which have been established by the Secretary of Commerce in order to secure the proper execution of this act by officers of the Radio Division, Department of Commerce.

Ship Act of July 23, 1912.

"Be it enacted by the Senate and House of Representatives of the United States of America in Congress assembled, . . .

"Section 1. That from and after October first, nineteen hundred and twelve, it shall be unlawful for any steamer of the United States or of any foreign country navigating the ocean or the Great Lakes and licensed to carry, or carrying, fifty or more persons, including passengers or crew or both, to leave or attempt to leave any port of the United States unless such steamer shall be equipped with an efficient apparatus for radio communication, in good working order, capable of transmitting and receiving messages over a distance of at least one hundred miles, day or night.

2. "**Auxiliary Power**—An auxiliary power supply, independent of the vessel's main electric power plant, must be provided which will enable the sending set for at least four hours to send messages over a distance of at least one hundred miles, day or night, and efficient communication between the operator in the radio room and the bridge shall be maintained at all times.



(Photo by courtesy of Commercial Radio Institute, Baltimore, Md.)
FIG. 346. Students learning radio by actual practice in building and assembling apparatus.

3. **“Operators and Penalty**—The radio equipment must be in charge of two or more persons skilled in the use of such apparatus, one or the other of whom shall be on duty at all times while the vessel is being navigated. Such equipment, operators, the regulation of their watches, and the transmission and receipt of messages, except as may be regulated by law or international agreement, shall be under the control of the master, in the case of a vessel of the United States; and every willful failure on the part of the master to enforce at sea the provisions of this paragraph as to equipment, operators, and watches shall subject him to a penalty of one hundred dollars.

“That the provisions of this section shall not apply to steamers plying between ports, or places, less than two hundred miles apart.

4. **“Cargo Operators**—Section 2. That this Act, so far as it relates to the Great Lakes, shall take effect on and after April first, nineteen hundred and thirteen, and so far as it relates to ocean cargo steamers shall take effect on and after July first, nineteen hundred and thirteen: Provided, That on cargo steamers, in lieu of the second operator provided for in this Act, there may be substituted a member of the crew or other person who shall be duly certified and entered in the ship's log as competent to receive and understand distress calls or other usual calls indicating danger, and to aid in maintaining a constant wireless watch so far as required for the safety of life.”

The remaining sections of the act of June 24, 1910, which are unchanged, read as follows:

5. **“Intercommunication**—Sec. 2. That for the purpose of this Act apparatus for radio communication shall not be deemed to be efficient unless the company installing it shall contract in writing to exchange, and shall, in fact, exchange, as far as may be physically practicable, to be determined by the master of the vessel, messages with shore or ship stations using other systems of radio communication.

6. **“Penalty**—Sec. 3. That the master or other person being in charge of any such vessel which leaves or attempts to leave any port of the United States in violation of any of the provisions of this Act shall, upon conviction, be fined in a sum not more than five thousand dollars, and any such fine shall be a lien upon such vessel, and such vessel may be libeled therefore in any district court of the United States within the jurisdiction of which such vessel shall arrive or depart, and the leaving or at-

tempting to leave each and every port of the United States shall constitute a separate offense.

“Sec. 4. That the Secretary of Commerce shall make such regulations as may be necessary to secure the proper execution of this Act by collectors of customs and other officers of the Government.”

7. Regulations Applied to Ship Stations Governed by the Ship Act of 1912—1. On vessels coming under the ship act, an emergency power supply, independent of the vessel's main electric power plant, must be provided which will enable radio messages to be sent for at least four hours over a distance of at least 100 miles day or night. The emergency power supply and equipment should be located and installed in such manner as to afford maximum protection against accident.

2. The radio transmitting apparatus, operated from the emergency power supply, should be capable of functioning within two minutes after unexpected notice to the operator.

3. The complete equipment must be maintained in an efficient condition at sea.

4. The complete emergency equipment should be tested before each sailing and daily at sea by the operator or an inspector and a note of its performance entered in the radio log.

5. Radio inspectors or other duly authorized officers of the Government will occasionally call for test messages, to be sent by means of the emergency apparatus, while the vessel is at sea.

6. An “induction coil” connected to “plain aerial” is not recommended as emergency apparatus, on account of the high voltages produced which frequently damage the antenna insulation and on account of “vibrator troubles.”

7. A motor generator or rotary converter operated by storage battery is probably the most satisfactory means available at present of energizing the transmitting apparatus.

8. Any auxiliary engine for wireless purposes must operate on a fuel which will fulfill the requirements of Rule XI, Section 5, of the General Rules and Regulations of the Steamboat-Inspection Service.

9. Every ship station shall carry a reasonable number of spares of such parts of both the main and emergency radiotelegraph equipments as are subject to undue wear, deterioration, or liability to accident.

10. One extra pair of head telephones, extra cords, and extra detectors must always be kept on hand.

11. A storage battery voltmeter, hydrometer, a supply of elec-

trolyte, and distilled water should be a part of the regular equipment, but are not prescribed in terms by statute. The absence of these and similar inexpensive emergency articles will be brought to the attention of the master and of the company installing the apparatus by the radio inspector, in writing, and if after a reasonable interval they have not been supplied, the inspector will communicate the fact to the Commissioner of Navigation.

12. The vessel's electric power for the operation of the main equipment shall, at all times while the steamer is under way, be available for the radio operator's use. On steamers where the dynamo is not run continuously there should be an efficient means of communication between the radio room and the dynamo room, in order that the radio operator may signal for power, as the law provides that he may not leave his post of duty.

13. Efficient communication between the radio room and the bridge must be maintained. A speaking tube or telephone will comply with this requirement. A bell and messenger service will not be acceptable unless there are special conditions justifying this equipment. The speaking tube or telephone must terminate in the radio room and on the bridge, or in the chart room if readily accessible from the bridge. If the radio room is adjacent to or accessible from the bridge so that orders may be transferred direct, no means of communication will be required. Any arrangement calling for the services of a third person to transmit the message will not be satisfactory. The radio inspectors will notify the ship authorities whether the means of communication provided is satisfactory at the time of inspection.

14. On vessels of the United States it is the statutory duty of the master to see that one operator is on duty at all times. The radio service of the ship is under the supreme authority of the master.

15. Masters should require operators on duty to communicate with the officer on the bridge every half hour.

16. Operators must make entries on the radio log *every* 15 minutes, as evidence that a continuous watch is being maintained. The entries must, if possible, consist of call letters of other stations communicating and a few words of the intercepted messages.

17. When vessels are in port the key to the radio room must at all times be on board in charge of the proper officer and the radio equipment shall be in such condition as to facilitate government inspection.

8. Reporting of Violations—The regulations established by law, or by the authority of law, or of the International Conven-

tion, will be enforced by the Secretary of Commerce through collectors of customs, radio inspectors, and other officers of the government.

The service regulations of the radiotelegraphic convention in force provide that "no station on shipboard shall be established or worked by private enterprise without authority from the government to which the vessel is subject." Such authority shall be in the nature of a license issued by said government. Stations on foreign ships will be licensed by their governments, respectively. Inspectors will report to the Commissioner of Navigation stations on foreign ships not so licensed.

A radio inspector is authorized in exceptional cases to act outside of his district for the convenience of commerce. In such cases he will communicate before or after acting with the inspector in whose district he has acted. Radio inspectors are authorized to communicate directly with collectors of customs and to cooperate with them in the enforcement of the law.

Violations of the laws and regulations will be reported to the chief customs officer of the district in which the offense occurs, who will report the case to the Secretary of Commerce (Bureau of Navigation), according to the procedure followed in violations of the navigation laws. Misdemeanors will be reported to the United States district attorney in the usual manner.

Collectors of customs and radio inspectors are enjoined that the reports required by paragraph 170 must be precise statements of the facts as the basis for possible proceedings by the United States attorney.

Violations by the master of a vessel of the United States of the provisions of the second paragraph of section 1 of the Ship Act will be reported to the collector of customs directly, and the usual procedure in cases of fines and penalties will be followed.

9. Inspection of Ship Stations—The radio inspectors and customs officers, as far as practicable, shall visit steamers subject to the act before they leave port and ascertain if they are equipped with the apparatus in charge of the operators prescribed by law and regulation.

When the radio apparatus is certified as complying with the requirements of law by the competent authorities of a foreign government, such certificate will be recognized by this department, but the radio inspector or customs officer may, if he deem it necessary or desirable, satisfy himself that the apparatus is in good working order.

Whenever practicable, the radio inspector shall satisfy himself

on his visit before the departure of a steamer subject to the act of June 24, 1910, as amended July 23, 1912, that the radio apparatus is efficient and in good working order within the meaning of the act. If the apparatus does not comply with the law, the radio inspector will furnish the master with the stub of Form 771, "Inspection Record," on which will be noted the particulars in which the apparatus does not comply with the law. Where apparatus is found to be in compliance with the law, the stub of Form 771 will not be detached.

Masters of vessels entering a port of the United States and expecting to leave under the act of June 24, 1910, as amended July 23, 1912, should file Form 753a, "Radio Declaration" (Appendix A) in duplicate with the customs officer at the time of entry. The customs officer will furnish one copy to the radio inspector in order that proper inspection of the radio equipment may be made before departure.

For each departure of a steamer under the act of June 24, 1910, as amended July 23, 1912, the master is required to furnish to the customs officer a certificate in the form of Appendix B (Form 753b), "Master's Certificate of Radio Apparatus." Such certificates shall be retained in the files of the collectors of customs. The collector of customs will arrange for the collection of these certificates at all times.

Where a steamer subject to the radio law is without the apparatus and the operators prescribed, or either of them, and is about to attempt to leave port, the radio inspector or customs officer visiting the vessel shall (a) furnish the master with a memorandum (stub of Form 771) of the particulars in respect of which the law has not been complied with and the penalty; (b) if convenient, notify the vessel's agents or the proper person in charge of the apparatus so that the necessary corrections may be made before sailing.

If a steamer clears in violation of the law, the radio inspector or customs officer shall submit to the collector of customs of the port a written report, stating the exact nature of the violation, the section of the act violated, and the penalties involved and all of the circumstances in connection therewith which will be of service to the collector and to the Secretary of Commerce in determining what action shall be taken. A copy of the report will be forwarded to the Commissioner of Navigation.

Statements should be obtained from operators, ships' officers, or other witnesses at the time the violation is discovered and should accompany the report to the collector of customs.

The collector of customs will report the case to the Secretary of Commerce in the usual manner as a navigation fine case.

Merchant vessels chartered by the United States Government are subject to the act of 1927, in every case, if the radio apparatus is owned and operated by a commercial company.

Merchant vessels chartered by the United States Government for the transportation of persons or supplies are subject to the requirements of the Ship Act (act of July 23, 1912), if the vessel is controlled and operated by the owners. Vessels commanded wholly or in part by government officers are not subject to the Ship Act.

Government vessels or vessels chartered by the government are subject to the act of 1927, if the radio equipment is owned and operated by private interests.

The Ship Act does not authorize the refusal of clearance in case of violation of its provisions, but specifically provides for the imposition of a fine in a sum not more than \$5,000.

The act does not apply to a vessel at the time of entering a port of the United States. Radio inspectors and customs officers may, however, accept as evidence of the efficiency of the apparatus and the skill of an operator messages shown to have been transmitted and received by him over a distance of at least 100 miles, by day, during the voyage to the United States.

10. Operators on Foreign Vessels—The act of July 23, 1912, amending the act of June 24, 1910, is designed to promote safety at sea through the employment of apparatus and operators to transmit and receive distress calls and other calls relating to perils and aids to navigation. It provides that in the case of American and foreign vessels subject to its provisions "the radio equipment must be in charge of two or more persons skilled in the use of such apparatus." This act does not require that the operators shall be licensed and the penalty prescribed in Section 3 of the act is not incurred by the master of a vessel whose operators are "skilled in the use of such apparatus," even though they may not be licensed.

The International Radiotelegraphic Convention (Service Regulations) provides that the service of the station on shipboard shall be carried on by a telegraph operator holding a certificate issued by the government to which the vessel is subject.

The act of July 23, 1912, as stated, requires that on foreign ships the operators must be "skilled in the use of such apparatus," but does not require that they must be licensed. To facilitate commerce and simplify administration, operators presenting Amer-

ican licenses or foreign certificates are accepted as "skilled in the use of such apparatus," except where there may be special reasons to doubt the operator's skill or reliability. Where operators on American or foreign ships do not have such licenses or foreign certificates, radio inspectors or customs officers under the act of July 23, 1912, may accept other competent evidence of skill or may examine such operators.

11. THE RADIO ACT OF 1927—The Radio Act of 1927 became effective February 23, 1927, and was enacted primarily for the regulation of "all forms of interstate and foreign radio transmissions and communications within the United States, territories and possessions; to maintain the control of the United States over all the channels of interstate and foreign radio transmission; and to provide for the use of such channels, but not the ownership thereof, by individuals, firms or corporations, for limited periods of time, under licenses granted by Federal authority, and no such license shall be construed to create any right, beyond the terms, conditions, and periods of the license.

It provided for the creation of a body of five members known as the Federal Radio Commission. Briefly, the duties of the Commission are to (a) classify radio stations; (b) prescribe the nature of the service to be rendered by each class of licensed stations; (c) assign bands of frequencies or wavelengths to the various classes of stations, and individual stations, and determine the power which each station shall use and the time during which it may operate; (d) determine the location of classes of stations or individual stations; (e) regulate the kind of apparatus to be used with respect to its external effects and the purity and sharpness of the emissions from each station and from the apparatus therein; (f) make such regulations not inconsistent with law as it may deem necessary to prevent interference between stations and to carry out the provisions of this act with certain provisions, etc. Authority is also granted for various other purposes which are of little interest to the commercial operator.

12. Duties of the Secretary of Commerce—Quoting from Section 5 of the act: From and after one year after the first meeting of the Commission created by this act, all the powers and authority vested in the Commission under the terms of this act, except as to the revocation of licenses, shall be vested in and exercised by the Secretary of Commerce; except that thereafter the Commission shall have power and jurisdiction to act upon and determine any and all matters brought before it under the terms of this section.

It shall also be the duty of the Secretary of Commerce:

(a) For and during a period of one year from the first meeting of the Commission created by this act, to immediately refer to the Commission all applications for station licenses or for the renewal or modification of existing station licenses.¹

(b) From and after one year from the first meeting of the Commission created by this act, to refer to the Commission for its action any application for a station license or for the renewal or modification of any existing station license as to the granting of which dispute, controversy, or conflict arises or against the granting of which protest is filed within ten days after the date of filing said application by any party in interest and any application as to which such reference is requested by the applicant at the time of filing said application.

(c) To prescribe the qualifications of station operators, to classify them according to the duties to be performed, to fix the forms of such licenses, and to issue them to such persons as he finds qualified.

(d) To suspend the license of any operator for a period not exceeding two years upon proof sufficient to satisfy him that the license (a) has violated any provision of any act or treaty binding on the United States which the Secretary of Commerce or the Commission is authorized by this act to administer or by any regulation made by the Commission or the Secretary of Commerce under any such act or treaty; or (b) has failed to carry out the lawful orders of the master of the vessel on which he is employed; or (c) has willfully damaged or permitted radio apparatus to be damaged; or (d) has transmitted superfluous radio communications or signals or radio communication containing profane or obscene words or language; or (e) has willfully or maliciously interfered with any other radio communications or signals.

(e) To inspect all transmitting apparatus to ascertain whether in construction and operation it conforms to the requirements of this act, the rules and regulations of the licensing authority, and the license under which it is constructed or operated.

(f) To report to the Commission from time to time any violations of this act, the rules, regulations, or orders of the Commission, or of the terms or conditions of any license.

(g) To designate call letters of all stations.

(h) To cause to be published such call letters and such other announcements and data as in his judgment may be required for

¹ Congress has since extended the life of the Commission until December 31, 1929.

the efficient operation of radio stations subject to the jurisdiction of the United States and for the proper enforcement of this act.

The Secretary may refer to the Commission at any time any matter the determination of which is vested in him by the terms of this act.

Any person, firm, company, or corporation, any State or political division thereof aggrieved or whose interests are adversely affected by any decision, determination, or regulation of the Secretary of Commerce may appeal therefrom to the Commission by filing with the Secretary of Commerce notice of such appeal within thirty days after such decision or determination or promulgation of such regulation. All papers, documents, and other records pertaining to such application on file with the Secretary shall thereupon be transferred by him to the Commission. The Commission shall hear such appeal *de novo* under such rules and regulations as it may determine.

Decisions by the Commission as to matters so appealed and as to all other matters over which it has jurisdiction shall be final, subject to the right of appeal herein given.

No station license shall be granted by the Commission or the Secretary of Commerce until the applicant therefor shall have signed a waiver of any claim to the use of any particular frequency or wavelength or of the ether as against the regulatory power of the United States because of the previous use of the same, whether by license or otherwise.

Section 1 of this act shall not apply to any person, firm, company, or corporation sending radio communications or signals on a foreign ship while the same is within the jurisdiction of the United States, but such communications or signals shall be transmitted only in accordance with such regulations designed to prevent interference as may be promulgated under the authority of this act.

Such station licenses as the licensing authority may grant shall be in such general form as it may prescribe, but each license shall contain, in addition to other provisions, a statement of the following conditions to which such license shall be subject:

(a) The station license shall not vest in the licensee any right to operate the station nor any right in the use of the frequencies or wavelength designated in the license beyond the term thereof nor in any other manner than authorized therein.

(b) Neither the license nor the right granted thereunder shall be assigned or otherwise transferred in violation of this act.

(c) Every license issued under this act shall be subject in terms to the right of use or control conferred by Section 6 hereof.

Section 12. The station license required hereby shall not be granted to, or after the granting thereof such license shall not be transferred in any manner, either voluntarily or involuntarily, to (a) any alien or the representative of any alien; (b) to any foreign government, or the representative thereof; (c) to any company, corporation, or association organized under the laws of any foreign government; (d) to any company, corporation, or association of which any officer or director is an alien, or of which more than one-fifth of the capital stock may be voted by aliens or their representatives or by a foreign government or representative thereof, or by any company, corporation, or association organized under the laws of a foreign country.

The station license required hereby, the frequencies or wavelength or lengths authorized to be used by the licensee, and the rights therein granted shall not be transferred, assigned, or in any manner, either voluntarily or involuntarily, disposed of to any person, firm, company, or corporation without the consent in writing of the licensing authority.

Section 18. If any licensee shall permit any person who is a legally qualified candidate for any public office to use a broadcasting station, he shall afford equal opportunities to all other such candidates for that office in the use of such broadcasting station, and the licensing authority shall make rules and regulations to carry this provision into effect: Provided, That such licensee shall have no power of censorship over the material broadcast under the provisions of this paragraph. No obligation is hereby imposed upon any licensee to allow the use of its station by any such candidate.

Section 19. All matter broadcast by any radio station for which service, money, or any other valuable consideration is directly or indirectly paid, or promised to or charged or accepted by, the station so broadcasting, from any person, firm, company, or corporation, shall, at the time the same is so broadcast, be announced as paid for or furnished, as the case may be, by such person, firm, company, or corporation.

Section 20. The actual operation of all transmitting apparatus in any radio station for which a station license is required by this act shall be carried on only by a person holding an operator's license issued hereunder. No person shall operate any such apparatus in such station except under and in accordance with an operator's license issued to him by the Secretary of Commerce.

Section 22. The licensing authority is authorized to designate from time to time radio stations the communications or signals of which, in its opinion, are liable to interfere with the transmission or reception of distress signals of ships. Such stations are required to keep a licensed radio operator listening in on the wavelengths designated for signals of distress and radio communications relating thereto during the entire period the transmitter of such station is in operation.

Section 23. Every radio station on shipboard shall be equipped to transmit radio communications or signals of distress on the frequency or wavelength specified by the licensing authority, with apparatus capable of transmitting and receiving messages over a distance of at least one hundred miles by day or night. When sending radio communications or signals of distress and radio communications relating thereto, the transmitting set may be adjusted in such a manner as to produce a maximum of radiation irrespective of the amount of interference which may thus be caused.

All radio stations, including government stations and stations on board foreign vessels when within the territorial waters of the United States, shall give absolute priority to radio communications or signals relating to ships in distress; shall cease all sending on frequencies or wavelengths which will interfere with hearing a radio communication or signal of distress, and, except when engaged in answering any radio communications or signals until there is assurance that no interference will be caused with the radio communications or signals relating thereto, shall assist the vessel in distress, so far as possible, by complying with its instructions.

Section 24. Every shore station open to general public service between the coast and vessels at sea shall be bound to exchange radio communications or signals with any ship station without distinction as to radio systems or instruments adopted by such stations, respectively, and each station on shipboard shall be bound to exchange radio communications or signals with any other station on shipboard without distinction as to radio systems or instruments adopted by each station.

Section 25. At all places where government and private or commercial radio stations on land operate in such close proximity that interference with the work of government stations cannot be avoided when they are operating simultaneously such private or commercial stations as do interfere with the transmission or reception of radio communications or signals by the government

stations concerned shall not use their transmitters during the first fifteen minutes of each hour, local standard time.

The government stations for which the above-mentioned division of time is established shall transmit radio communications or signals only during the first fifteen minutes of each hour, local standard time, except in case of signals or radio communications relating to vessels in distress and vessel requests for information as to course location, or compass direction.

Section 26. In all circumstances, except in case of radio communications or signals relating to vessels in distress, all radio stations, including those owned and operated by the United States, shall use the minimum amount of power necessary to carry out the communication desired.

Section 27. No person receiving or assisting in receiving any radio communication shall divulge or publish the contents, substance, purport, effect, or meaning thereof except through authorized channels of transmission or reception to any person other than the addressee, his agent, or attorney, or to a telephone, telegraph, cable, or radio station employed or authorized to forward such radio communication to its destination, or to proper accounting or distributing officers of the various communicating centers over which the radio communication may be passed, or to the master of a ship under whom he is serving, or in response to a subpoena issued by a court of competent jurisdiction, or on demand of other lawful authority; and no person not being authorized by the sender shall intercept any message and divulge or publish the contents, substance, purport, effect, or meaning of such intercepted message to any person; and no person not being entitled thereto shall receive or assist in receiving any radio communication and use the same or any information therein contained for his own benefit or for the benefit of another not entitled thereto; and no person having received such intercepted radio communication or having become acquainted with the contents, substance, purport, effect, or meaning of the same or any part thereof, knowing that such information was so obtained, shall divulge or publish the contents, substance, purport, effect, or meaning of the same or any part thereof, or use the same or any information therein contained for his own benefit or for the benefit of another not entitled thereto: Provided, That this section shall not apply to the receiving, divulging, publishing, or utilizing the contents of any radio communication broadcasted or transmitted by amateurs or others for the use of the general public or relating to ships in distress.

Section 28. No person, firm, company, or corporation within the jurisdiction of the United States shall knowingly utter or transmit, or cause to be uttered or transmitted, any false or fraudulent signal of distress, or communication relating thereto, nor shall any broadcasting station rebroadcast the program or any part thereof of another broadcasting station without the express authority of the originating station.

Section 29. Nothing in this act shall be understood or construed to give the licensing authority the power of censorship over the radio communications or signals transmitted by any radio station, and no regulation or condition shall be promulgated or fixed by the licensing authority which shall interfere with the right of free speech by means of radio communications. No person within the jurisdiction of the United States shall utter any obscene, indecent, or profane language by means of radio communication.

Section 31. The expression "radio communication" or "radio communications" wherever used in this act means any intelligence, message, signal, power, pictures, or communication of any nature transferred by electrical energy from one point to another without the aid of any wire connecting the points from and at which the electrical energy is sent or received and any system by means of which such transfer of energy is effected.

Section 32. Any person, firm, company, or corporation failing or refusing to observe or violating any rule, regulation, restriction, or condition made or imposed by the licensing authority under the authority of this act or of any international radio convention or treaty ratified or adhered to by the United States, in addition to any other penalties provided by law, upon conviction thereof by a court of competent jurisdiction, shall be punished by a fine of not more than \$500 for each and every offense.

Section 33. Any person, firm, company, or corporation who shall violate any provision of this act, or shall knowingly make any false oath or affirmation in any affidavit required or authorized by this act, or shall knowingly swear falsely to a material matter in any hearing authorized by this act, upon conviction thereof in any court of competent jurisdiction shall be punished by a fine of not more than \$5,000 or by imprisonment for a term of not more than five years or both for each and every such offense.

Section 34. The trial of any offense under this act shall be in the district in which it is committed; or if the offense is committed upon the high seas, or out of the jurisdiction of any par-

ticular State or district, the trial shall be in the district where the offender may be found or into which he shall be first brought.

13. General Orders of the Federal Radio Commission—As authorized by the Radio Act of 1927 the Federal Radio Commission has from time to time issued rules and regulations in the form of General Orders. Students who expect to take the Department of Commerce examination for radio operators' licenses of all grades are expected to have a knowledge of such regulations. Therefore several of the General Orders of which operators of stations are required to be familiar with are shown below. Those that are missing are of no particular interest to operators. New orders issued by the Commission are published in the Radio Service Bulletin, Radio Division, Department of Commerce.¹

14. General Order No. 7—The Federal Radio Commission hereby fixes a maximum of one-half kilocycle as the extreme deviation from authorized frequency which will be permitted to any broadcasting station operating under permit or license issued under the terms of the Radio Act of 1927. The Department of Commerce is hereby requested to notify its proper agents immediately of this order, and to direct them to report promptly any apparent violations thereof. Maintenance of the assigned frequency, within the limits herein prescribed, is the duty of each radio broadcasting station, and violation of this order will be deemed by the Federal Radio Commission cause for revocation of license under Section 14 of the Radio Act of 1927.

To facilitate the execution of this order, each radio broadcasting station is hereby directed, effective 12:01 a.m. local time, Monday, May 9, to announce twice each day, at the beginning and end of its program, that it is broadcasting on a frequency of — kilocycles by authority of the Federal Radio Commission.

15. General Order No. 16—The Federal Radio Commission finds that while the broadcasting of music performed through the agency of mechanical reproductions, such as records or perforated rolls, is not in itself objectionable, the failure clearly to announce the nature of such broadcasting is in some instances working what is in effect a fraud upon the listening public. The Commission, therefore, hereby orders that, effective August 21, 1927, all broadcasts of music performed through the agency of mechanical reproductions shall be clearly announced as such with the announcement of each and every number thus broadcast, and that proved

¹ Obtainable for 25 cents per year from the Supt. of Documents, Govt. Printing Office, Washington, D. C.

failure to make such announcement shall be deemed by the Commission cause for action under Section 32 of the Radio Act of 1927. (See G. O. 52.)

16. General Order No. 31—The Federal Radio Commission calls to the attention of all broadcasting stations Section 18 of the Radio Act of 1927 which reads as follows:

“Any licensee shall permit any person who is a legally qualified candidate for any public office to use a broadcasting station, he shall afford equal opportunities to all other such candidates for that office in the use of such broadcasting station, and the licensing authority shall make rules and regulations to carry this provision into effect: PROVIDED, That such licensee shall have no power of censorship over the material broadcast under the provisions of this paragraph. No obligation is hereby imposed upon any licensee to allow the use of its station by any such candidate.”

Any violation of this section of the Act will be considered as sufficient ground for the revocation or denial of a radio broadcasting license.

17. General Order No. 48—At a session of the Federal Radio Commission held at its offices in Washington, D. C., on October 22, 1928.

A limited time broadcasting station is hereby defined as a station which, under its license from this Commission, is permitted to operate during hours allowed daytime broadcasting stations as specified in General Order No. 41, and in addition during certain time temporarily not used by the unrestricted station or stations on the same frequency. An example is the use of late evening hours by a limited time broadcasting station in the West after the closing of an Eastern station on the same frequency.

A limited time broadcasting station desiring to operate after sunset shall so notify the Commission, which will ascertain what hours the use of which is not desired by the unrestricted station or stations on the same frequency, and will thereafter authorize the operation of the limited time station accordingly, subject, however, to the right of said unrestricted station or stations to reclaim the use of such hours upon reasonable notice to the Commission and to the limited time broadcasting station.

A limited time broadcasting station will not be permitted to operate at any time when its operation will cause heterodyne interference with other broadcasting stations assigned to the same frequency.

18. General Order No. 52—It is ordered that General Order

No. 49 heretofore issued by the Commission on October 26, 1928, be, and the same is hereby, to read as follows:

All broadcasting stations shall announce clearly and distinctly the character of all mechanical reproductions broadcast by them, the announcement to precede each such program item. In such announcements each photograph record used, whatever its character, shall be described as a "phonograph record"; each piano player selection used shall be described as played by "mechanical piano player"; every other mechanical reproduction shall be similarly described by the term generally used and understood by the public as meaning such mechanical reproduction:

Provided however, that where a recording or electrical transcript is made exclusively for broadcasting purposes and is neither offered nor intended to be offered for sale to the public, the words "phonograph record" may be replaced by any phrase which accurately describes such transcription and which is of such a nature as not to deceive or tend to deceive the public as to the character of the reproduction broadcast. Every station taking advantage of this proviso shall keep a record of the phrases actually used by such station and shall communicate such phrases to the Commission on request by the Commission.

19. General Order No. 53—At a session of the Federal Radio Commission held at its offices in Washington, D. C., on November 26, 1928.

Whenever a broadcasting station which, under its license from the Commission, is permitted to operate both during daytime hours and during evening hours, is, under said license or any modification thereof, permitted to use a greater amount of power during the daytime hours than during the evening hours, the station will not be permitted to use its daytime power after the average time for sunset at the station during any particular month. In no event will such a broadcasting station be permitted to use its authorized daytime power at any time or in such manner as to cause greater heterodyne interference during the daytime than exists during evening operation from the use of the amount of power permitted for such evening operation.

This Order supersedes General Order No. 10, which is hereby repealed.

20. General Order No. 55—At a session of the Federal Radio Commission held at its offices in Washington, D. C., on December 22, 1928.

The Commission, in order to carry out the provisions of the Radio Act of 1927, having determined that public interest, con-

venience, or necessity requires the allocation of certain frequencies, within the band of frequencies between 1500 and 6000 kilocycles, to those services and classes of stations hereinafter enumerated, hereby enters the following order.

It is ordered:

Paragraph I. That of those frequencies between 1500 and 6000 kilocycles, the following are hereby allocated to those services and classes of stations enumerated herein, for assignment to individual stations in conformity with this order.

(a) Mobile services:

1. Ship Stations and Coastal Stations: The frequencies 1504, 1508, 1512, 1516, 1520, 1524, 1528, 1532, 1536, 1540, 1544, 1548, 1552, 1556, 1560, 1564, 1568, 1572, 1576, 1580, 1584, 1588, 1592, 1596, 1660, 1672, 1684, 1708, 2320, 2332, 2350, 2368, 2380, 2416, 2428, 2446, 2452, 2476, 2482, 2554, 2566, 2584, 2596, 2614, 2626, 2632, 2638, 2644, 2668, 2692, 2728, 2740, 3076, 3106, 3118, 3130, 3142, 3420, 3428, 3436, 4116, 4148, 4172, 4188, 4196, 4755, 4775, 5525, 5555, 5585, 5615, 5645, 5675.

2. Aircraft and Aeronautical Stations: The frequencies 1608, 1612, 1616, 1620, 1624, 1628, 1632, 1636, 1640, 1644, 1648, 1656, 1668, 1676, 1688, 2302, 2326, 2344, 2362, 2374, 2392, 2506, 2518, 2524, 2530, 2536, 2542, 2560, 2578, 2590, 2608, 2620, 2650, 2662, 2680, 2698, 2722, 2734, 3070, 3082, 3100, 3112, 3124, 3136, 3148, 3452, 3460, 3468, 3484, 3492, 4108, 4124, 4140, 4164, 4180, 4765, 4785, 5510, 5540, 5570, 5600, 5630, 5660, 5690.

3. Portable stations: The frequencies 1600, 1652, 1604, 1608, 1704, 1712.

4. Railroad rolling stock stations and railroad harbor and tug stations: The frequencies 2410, 2422, 2440, 2458, 2470.

(b) Fixed Services:

1. Point to Point: The frequencies 3203, 3208, 3214, 3220, 3226, 3238, 3244, 3250, 4212, 4220, 4228, 4244, 4268, 4276, 4284, 4396, 4405, 4415, 4455, 4465, 4475, 4485, 4495, 4505, 4515, 4515, 4535, 4545, 4545, 4865, 4875, 4885, 4895, 4905, 5115, 5125, 5135, 5145, 5155, 5165, 5175, 5185, 5195, 5205, 5215, 5225, 5235, 5245, 5255, 5265, 5275, 5285, 5295, 5305, 5405, 5415, 5425, 5435, 5445, 5455, 5465, 5475, 5485, 5720, 5735, 5750, 5765, 5780, 5795, 5900, 5975, 5990.

2. Amateur: The band of frequencies between 1715 and 2000

kilocycles inclusive, and that band of frequencies between 3500 and 4000 kilocycles inclusive.

3. Experimental: The frequencies 1604, 2398, 3088, 4795.

4. Experimental visual broadcasting: The frequencies 2002 to 2300 inclusive, and 2750 to 2950 inclusive.

The following frequencies allocated to Fixed Services, Point to Point Stations, are to be assigned exclusively to stations devoted to promoting the interests of agriculture in addition to such assignments as may hereafter be made above 6000 kilocycles.

Frequencies 3202, 4244, 5485.

The following frequencies are reserved for assignment to stations rendering emergency services: Frequencies 3208, 3214, 3220, 3226, 3238, 3244, 3250.

Paragraph II. No license shall be granted to any applicant for a fixed station, coastal station, or aeronautical station who is unable to satisfy the Commission that he can maintain the assigned station frequency with an accuracy of .05 per cent or better at all times.

Paragraph III. Licensees of fixed, coastal, or aeronautical stations shall obtain and use for tuning and checking the tuning of their transmitters suitable frequency-measuring equipment which shall be accurate within .025 per cent on the frequencies on which the transmitter is licensed to operate. Furthermore, such licensees shall, at frequent intervals, take steps to have the frequency-measuring instruments calibrated or compared with the standards made available by the Department of Commerce.

Paragraph IV. Licensees must use radio transmitters, the emissions of which, by reason of actual decrement high-speed signalling modulation, spacing waves, harmonics, frequency modulation, key clicks, and mush, do not cause interference detrimental to traffic and programs being carried out on other authorized channels of communications.

21. **General Order No. 62**—At a session of the Federal Radio Commission held at its office in Washington, D. C., on April 5, 1929:

It is ordered:

That in the frequencies exceeding 1500 kc/s. per second, a channel of radio communication shall be regarded as a band of frequencies, the width of which varies according to its position in the

spectrum. The width of these channels increases with the frequency according to the following table:

| <i>Frequency (kc/s)</i> | <i>Channel Width (kc/s)</i> |
|-------------------------|-----------------------------|
| 1500- 2198 | 4 |
| 2200- 3313 | 6 |
| 3316- 4400 | 8 |
| 4405- 5490 | 10 |
| 5495- 8202.5 | 15 |
| 8210-10980 | 20 |
| 10990-16405 | 30 |
| 16420-21960 | 40 |
| 21980-32780 | 60 |

Note: A visual broadcasting channel shall not be more than 100 kc in width.

A commercial telephone channel below 3313 kcs shall be regarded as 6 kc in width.

A relay broadcasting channel between 6000 and 9600 kc shall be regarded as 20 kc in width.

In granting licenses, the Federal Radio Commission will specify the frequency in the center of the particular channel licensed to be used, but the licensee may occupy the center frequency and in addition such adjacent frequencies (within the limit indicated on the above table) as may be permitted by the frequency maintenance tolerance and required by the type of emission the station may be authorized to use, all of which will be specified in the instrument of authorization. Furthermore, the licensee, upon application to the Commission, may have the privilege of occupying the whole channel on condition that the emission from the station does not exceed the limits of the channel at any time, and provided that fixed stations shall maintain the constancy of any single emission of a carrier frequency to within 0.05 per cent or better at all times.

Fixed stations shall make full use of the channels that may be assigned them to the end that channels are occupied in the most effective and economical manner, and yet their limits not exceeded. The following uses are recognized and will receive encouragement: High-speed telegraphy, facsimile transmission, telephone, multiplex modulation, polyphase transmission, multiple emission on separate frequencies closely spaced.

In order that channels may be utilized to the fullest extent, licensees who have been granted two different channels for use at two or more stations will be granted the use of these same channels at any of the stations in their own system if such use will not create interference with stations of other systems.

Licenses of fixed stations who, at the expiration of the licenses, cannot demonstrate that they are using a channel to the fullest capacity consistent with the average state of the radio art, may be required to either occupy a channel of lesser width or to share the channel on a part-time basis with others.

Licenses of fixed stations who have been granted the use of a channel for communications with specified points, upon application to the Commission for license, may be granted the use of the same channel for communications with other points on the condition that the public interest, convenience, and necessity will be served by such a grant.

22. General Order No. 64—It is ordered:

All Licenses for experimental stations, including experimental relay broadcasting, experimental visual broadcasting, general experimental, and experimental aircraft stations, shall be issued for a period of one year.

It is further ordered:

(1) Experimental stations may be used only for experimental purposes. They are not licensed to conduct message traffic of any kind.

(2) All licensees of experimental stations shall file with the Commission reports as to each such station for each quarter of the year, ending March 31, June 30, September 30, and December 31, setting forth the nature of the experiments conducted and the results thereof during the preceding period of three months. These reports shall be mailed in time to reach the Commission within 15 days after the end of each quarter.

Each such report shall contain statements of:

(a) The specific hours of operation on each frequency during the period reported, together with a duly authenticated copy of the station log for that period.

(b) The general results accomplished in said period.

(c) The technical studies in progress at the time of filing thereof.

It is ordered also: That this general order be made a part of each experimental license hereafter to be issued by the Commission, and that failure to comply with this order or any provision contained herein shall be ground for the revocation of any such license.

23. General Order No. 66—It is ordered, for the purpose of carrying out the provisions of Section 22 of the Radio Act of 1927, that the following rules and regulations be and the same are hereby, adopted and promulgated by the Federal Radio Commission.

1. Each Broadcasting station shall give absolute priority to radio communications or signals relating to ships or aircraft in distress and shall cease broadcasting upon such frequencies and at such times when such broadcasting may, in any way, interfere with the reception of radio distress signals or traffic relating thereto.

2. Each broadcasting station, operating on any frequency in any location shall cease transmitting immediately upon notification by any Government or Commercial Marine Station, for the purpose of clearing the air of interference for distress signals or distress traffic.

3. Stations operating on 550 to 1000 kilocycles, inclusive, and of the following powers and within the following distances from the seacoast, Great Lakes or from any *Commercial or Government* radio receiving station engaged in marine communication, shall keep and maintain an effective continuous watch by a licensed operator, on the frequencies used for distress calls, during the entire period the transmitter of said station is in operation:

| <i>Transmitter Powers</i> | <i>Transmitter Distances</i> |
|-----------------------------------|------------------------------|
| To and including 5 KW | 30 miles |
| From 5 KW to and including 10 KW | 45 miles |
| From 10 KW to and including 25 KW | 70 miles |
| From 25 KW to and including 50 KW | 100 miles |

4. Each station covered by the above ruling shall cease transmitting immediately upon intercepting distress signals or distress traffic and shall remain silent until the distress traffic has been completed, or it is determined that the operation of the station will not interfere with the distress traffic.

5. No station shall resume operation until the need for distress traffic no longer exists, or it is determined that said station will not interfere with distress traffic as it is then being routed and said station shall again discontinue if the routing of distress traffic is so changed that said station will interfere. The status of distress traffic may be ascertained from time to time by oral or wire line communication with Government and Commercial stations.

6. No two or more broadcasting stations shall maintain a joint or common watch upon frequencies used for distress calls, without first having submitted their plans to and having obtained the express authorization of the Commission so to do.

7. No broadcasting station shall utilize the watch maintained upon the frequencies used for distress calls by a commercial marine station, without first having obtained the express authorization of the Commission so to do.

8. The Commission may hereafter require stations not included herein to keep an effective continuous watch.

9. The Commission may hereafter designate stations included herein to be excluded from these regulations.

24. General Order No. 68—It is ordered that all construction permits and licenses for relay broadcasting shall be issued on the following conditions:

1. No station engaged in relay broadcasting shall grant authority to any radio station within the United States to rebroadcast its programs without first obtaining written consent of the Commission:

2. Stations engaged in relay broadcasting shall report at least once each quarter, to wit: March 31, June 30, September 30, December 31, (said reports to be filed within 15 days after the close of such quarter),—(a) the stations located abroad which are regularly receiving and rebroadcasting the program originated by the licensee, (b) the times during which reception abroad is of sufficient intensity and quality to render rebroadcasting practicable, (c) the frequencies utilized abroad for reception of said programs, (d) the nature and extent of tests conducted abroad where relay broadcasting is carried on only for experimental purposes and not for rebroadcasting:

3. The conditions in General Order No. 64 relating to experimental service.

Important General Regulations Taken from the International Radio Telegraph Convention, Effective January 1, 1929.

25. Article 1—In the present regulations, supplementing the definitions given in Article Zero of the Convention:

The term "mobile station" means any mobile station.

The term "mobile stations" means all mobile stations, whatever their location.

The term "ship station" means a station on board a vessel not permanently moored.

The term "aircraft station" means a station on board an aircraft.

The term "coast station" means a land station used for communication with ship stations. It may be a fixed station used also for communication with ship stations; it is then considered as a coast station only for the duration of its service with ship stations.

The term "aeronautical station" means a land station used for communication with aircraft stations. It may be a fixed station used also for communication with aircraft stations; it is then considered as an aeronautical station only for the duration of its service with aircraft stations.

The term "station" means any station, without regard to its use.

The term "land station" has a general meaning; it is used when the intention is to cover at the same time communications with ship stations, with aircraft stations, and with any other mobile stations. The term then covers a coast station, in so far as concerns communication with ship stations, an aeronautical station in so far as concerns communication with aircraft stations and any station on land used for communications with any other mobile stations.

The term "broadcasting service" means a service carrying on the dissemination of radiotelephone communications intended to be received by the public, directly or by the intermediary of relay stations.

The term "fixed service" means a service carrying on radio communications of any kind between fixed points, exclusive of broadcasting and special services.

The term "mobile service" means a radio communication service carried on between mobile stations and land stations, and by mobile stations communicating with one another, exclusive of special services.

The term "special services" means the services of radio-beacons, radio compasses, transmission of time signals, notices to navigators, standard waves, transmissions having a scientific object, etc.

The term "radiobeacon" means a special station, the transmissions of which are intended to enable a receiving station to determine its bearing or a direction with respect to the radiobeacon.

The term "radio-compass station" means a station provided with special apparatus intended to determine the direction of the emissions of other stations.

The term "broadcasting station" means a station used for the dissemination of radiotelephone emissions intended to be received by the public.

The term "private experimental station" means:

1. A private station intended for experiments with a view to the development of radio technique or radio art;
2. A station used by an "amateur," i.e., by a duly authorized

person interested in radio technique solely with a personal aim and without pecuniary interest.

The term "administration" means a government administration.

26. Article 4: Classification and Use of Radio Emissions—

1. Radio emissions shall be divided into two classes:

A. Continuous waves,

B. Damped waves,

defined as follows:

Class A.—Waves the successive oscillations of which are identical under permanent conditions.

Class B.—Waves consisting of successive trains in which the amplitude of the oscillations, after having reached a maximum, decreases gradually.

Waves of Class A include the following types, which are defined below:

Type A1: Unmodulated continuous waves. Continuous waves, the amplitude or frequency of which is varied by means of telegraphic keying.

Type A2: Continuous waves modulated at audible frequency. Continuous waves, the amplitude or frequency of which is varied in a periodic manner at audible frequency, combined with telegraphic keying.

Type A3: Continuous waves modulated by speech or by music. Continuous waves, the amplitude or frequency of which is varied according to the characteristic vibrations of speech or music.

The above classification, into waves of Types A1, A2, and A3, shall not prevent the use, under conditions fixed by the Administrations concerned, of modulated and/or manipulated waves, by methods not falling within the definitions of Types A1, A2, and A3.

These definitions do not relate to systems of transmitting apparatus.

Waves will be designated in the first place by the frequency in kilocycles per second (kc/s). Following this designation there will be indicated, in parentheses, the approximate length in meters. In the present Regulations, the approximate value of the wavelength in meters is the quotient of the number 300,000 divided by the frequency expressed in kilocycles per second.

2. Waves emitted by a station must be maintained upon the authorized frequency, as exactly as the state of the art permits, and their radiation must also be as free as practicable from all emissions not essential to the type of communication carried on.

3. The interested administrations shall fix the tolerance allowed between the mean frequency of emissions and the recorded frequency; they shall endeavor to take advantage of technical improvements progressively to reduce this tolerance.

4bis. The width of a frequency band occupied by the emission of a station must be reasonably consistent with good current engineering practice for the type of communication involved.

4. In cases where frequency bands are assigned to a specified service, stations in that service must use frequencies sufficiently remote from the limits of these bands, so as not to produce serious interference with the work of stations belonging to services to which are allocated immediately neighboring frequency bands.

27. Article 6—The radio service of a mobile station shall be placed under the supreme authority of the master or of the person responsible for the vessel, aircraft, or other mobile station.

The master or person responsible, as well as all persons who may have knowledge of the text or simply of the existence of radio telegrams, or of any information whatever obtained by means of the radio service, shall be bound to maintain and ensure the secrecy of correspondence.

28. Article 9: General Procedure in the Mobile Service—

1. In the mobile service, the following detailed procedure shall be obligatory, except in the case of distress calls or of distress correspondence, to which the provisions of Article 21 are applicable.

2. (1) Before proceeding with a transmission, the sending station must make sure that no excessive interference will be caused to other communications in progress within its range on the frequency to be used; if there is probability of such interference occurring, it shall await the first break in the transmission with which it might interfere.

(2) If, in spite of this precaution, a radio transmission in progress is interrupted by the call, the latter must cease at the first request of a land station open to the international service of public correspondence or by any aeronautical station whatsoever. The station requesting this cessation must indicate the approximate duration of the suspension imposed upon the station whose call has been stopped.

3. In mobile service radiotelegraph correspondence the following procedure shall be used for calling a station:

(1) The calling station shall make the call by transmitting not more than three times the call signal of the station called and the word DE, followed not more than three times by its own call signal.

In making this call the calling station shall use the wave on which the station called keeps watch.

(2) The station called shall reply by transmitting not more than three times the call signal of the calling station, the word DE, its own call signal, and, if it is ready to receive traffic, the letter K (invitation to transmit), followed if deemed useful, by the appropriate abbreviation and by a number indicating the strength of the signals received.

(3) If the station called is unable to receive, it shall replace in the reply formula the letter K by the signal . — . . . (wait), followed by a number indicating in minutes the probable duration of the wait. If it is probable that this delay will exceed ten minutes, the delay must be explained.

(4) When there are several radiotelegrams to be transmitted in the same direction, they may be transmitted in series with the consent of the station which is to receive them.

(5) This latter station, in giving its consent, shall indicate the number of radiotelegrams which it is ready to receive in a series, and this indication shall be followed by the letter K.

(6) In principle, a radiotelegram containing more than 100 words shall be considered as forming a series, or shall terminate a series then under way.

(7) As a general rule, long radiotelegrams in plain language, code, or cipher, shall be transmitted in sections, each section containing 50 words in the case of plain language and 20 words or groups where code or cipher is used.

(8) At the end of each section the signal . . — — . . (?) meaning: "Have you received the radiotelegram correctly up to this point?" shall be transmitted. If the section has been correctly received, the receiving station shall send the letter K and the transmission of the radiotelegram shall be continued.

(9) The transmission of a radiotelegram shall be terminated by the signal . — . — . (end of transmission) followed by the call signal of the sending station and the letter K.

In case of transmission in series, the call signal of the sending station and the letter K shall be sent only at the end of the series.

(10) Acknowledgment of receipt of a radiotelegram shall be sent by means of the letter R followed by the number of the radiotelegram; this acknowledgement of receipt shall be preceded by the following formula: call signal of the sending station, word DE, call signal of the receiving station.

Acknowledgment of receipt of a series of radiotelegrams shall be sent by means of the letter R followed by the number of radio-

telegrams received as well as by the numbers of the first and of the last telegram composing the series. This acknowledgement of receipt shall be preceded by the formula given above.

(II) The conclusion of work between two stations shall be indicated by each of them, by means of the signal . . . — . — (end of work) followed by its own call signal.

4. (1) If the calling station intends to transmit its traffic with a type of wave and/or on a frequency other than those employed for the call, it shall send after its own call signal the service indications defining the type of wave and/or the frequency which it proposes to use for its transmission. The absence of these service indications shall signify that it does not intend to change the type of wave or frequency.

(2) If the station called wishes the calling station to send on a type of wave and/or frequency other than those used for the call, it shall add to the reply formula service indications defining the type of wave and/or the frequency which it desires to be used. The absence of these service indications shall signify that it does not desire that type of wave and/or the frequency used for the call be changed.

(3) If the calling station has indicated that it is going to use for transmission a type of wave and/or frequency other than those with which the call was made, the station called in the reply formula shall precede the letter K by abbreviations, indicating that from then on it would listen on the type of wave and/or the frequency announced and that it itself, will use the said type of wave and/or frequency for the entire period of communication.

(4) If the calling station is a land station which, according to the provisions of the present regulations, may employ a wave other than those which it is possible for the mobile station to transmit, it may, after having established contact, use this wave to transmit its traffic. In such case the procedure shall be as follows:

The land station shall call the mobile station by using the wave on which the latter is keeping watch; and after having obtained an answer shall inform it by means of the appropriate abbreviation that it must listen thereafter on the wave which it intends to use.

If the mobile station can receive the wave indicated, it shall send the letter K. If not, it shall inform the land station by means of the appropriate abbreviation that it is impossible to receive the proposed wave and the two stations shall agree to adopt another working wave.

(5) The land station shall continue to use the wave which it

has employed until after the transmission of the signal . . . — . — (end of work), followed by its call signal. This signal, followed by its call signal, shall be repeated by the mobile station on the international calling wave assigned to its service.

(6) When the land station which receives a request to change the type of wave and/or the frequency can not, or does not desire to comply with this request, it shall not transmit the signal K, but shall propose, by employing the appropriate abbreviations, the use of another type of wave and/or another frequency.

5. (1) On the wave of 500 kc/s (600 m.) (or on an authorized wave, in the case of communications with an aircraft station), the periods of continuous work between two stations must not exceed approximately ten minutes; after each of these periods a pause must be observed in order to permit, if necessary, another station to send a priority call or to transmit a priority message.

(2) On the other waves assigned to the maritime mobile service the length of the period of continuous work shall be controlled by the coast station. In the case of communications between two ship stations, the receiving station shall determine the length of the periods of continuous work.

(3) In communications between aircraft stations the length of the periods of continuous work shall be controlled by the receiving aircraft station, subject to the intervention, for that purpose, of the aeronautical station. In communications between aeronautical stations and aircraft stations, the aeronautical station shall control the length of the periods of continuous work.

6. When a station receives a call without being certain that such call is intended for it, it shall not reply until the call has been repeated and is understood. When, on the other hand, a station receives a call which is addressed to it, but is uncertain of the call signal of the calling station, it must answer immediately using the signal . . . — — . . . instead of the call signal of this latter station.

7. When it is necessary to make test signals in order to adjust the apparatus before proceeding with a call or a transmission, the signals must not be made for more than about ten seconds and they must be composed of a series of V's followed by the call signal of the sending station.

If a station sends test signals at the request of another station to permit the latter to adjust its receiving apparatus, these signals must likewise be composed of a series of V's in which the call signal of the transmitting station shall appear several times.

29. Article 9 bis—1. Stations desiring to enter into com-

munication with mobile stations, without, however, knowing the names of the mobile stations which are within their range of action, may use the signal of inquiry CQ, in place of the call signal of the station called in the calling formula, this formula being followed by the letter K (general call for all mobile stations with request for reply).

In regions where traffic is heavy, the use of the call CQ followed by the letter K shall be forbidden except in combination with urgent signals.

The call CQ not followed by the letter K (general call for all mobile stations without request for reply) shall be employed for radiotelegrams of general information, time signals, regular meteorological information, general safety notices, and information of all kinds intended to be read by anyone who can receive them.

30. Article 11: Interference—1. The exchange of unnecessary signals shall be forbidden to mobile stations. Tests and experiments shall be allowed in these stations only to the extent that they do not disturb the service of other stations.

Each Administration shall decide, with a view to their authorization, whether the proposed tests or experiments will be likely to interfere with the service of other stations.

8. Tests and adjustments in any station, must be conducted so as not to interfere with the service of other stations engaged in authorized correspondence. The test and adjustment signals must be chosen so that no confusion can be produced with a signal, abbreviation, etc., of special meaning defined by the Regulations.

2. Any station transmitting for tests, adjustments, or experiments must, during the course of these transmissions, send its call signals at frequent intervals.

9. An Administration or private operating company making a complaint regarding interference must, in order to support and justify this complaint, declare that it regularly uses receiving apparatus of a type equivalent to the best employed in the current practice of the service concerned.

31. Article 12: Reporting of Infractions—1. If an Administration has knowledge of a breach of the Convention or of these Regulations, committed in one of the stations of the mobile service which it has authorized, it shall determine the facts, fix the responsibility, and take the necessary measures.

2. Infractions of the mobile service rules must be reported by the stations detecting them to the Administration to which they

are subject by means of a form similar to that shown in Appendix 4.

3. In the case of repeated infractions on the part of the same station, representations must be made to the Administration of the country to which the station is subject.

32. Article 18: Conditions to be Observed by Mobile Stations—1. Mobile stations must be established in such a way as to conform, with reference to frequencies and types of waves, to the general provisions constituting the subject matter of Article 5. In accordance with these provisions, the use by mobile stations of damped waves (Type B) of a frequency below 375 kc/s (wavelength above 800 m.), shall be forbidden beginning January 1, 1930.

In addition, no new installations of transmitters of type B waves shall be made in mobile stations beginning January 1, 1930, except when these transmitters working on full power shall expend less than 300 watts measured at the input of the supply transformer at audible frequency.

Finally, the use of type B waves of all frequencies shall be forbidden beginning January 1, 1940, except for transmitters fulfilling the same conditions regarding power as above.

2. Every station installed on board a vessel or an aircraft following a maritime route, such vessel or aircraft being compulsorily equipped with radio apparatus in accordance with an international agreement, must be able to send and receive on a wave of 500 kc/s (600 m.) type A2 or B. Ship stations must, in addition, be able to use the wave of 375 kc/s (800 m.), type A2 (or B subject to the provisions of paragraph 1 above).

Aircraft stations must be able to send and receive the wave of 333 kc/s (900 m.) types A2 or A3 (or B subject to the provisions of paragraph 1 above).

3. In addition to the fixed waves stipulated above, mobile stations equipped to send waves of Types A1, A2 or A3 may use all the waves authorized in Article 5.

The use of waves of type B shall be authorized only for the following frequencies (wavelengths):

| Kc/s | Meters | Kc/s | Meter |
|----------|--------|------------|-------|
| 375..... | 800 | 500..... | 600 |
| 410..... | 730 | 665..... | 450 |
| 425..... | 705 | 1,000..... | 300 |
| 454..... | 660 | 1,364..... | 220 |

The use of the type B wave of 665 kc/s (450 m.) shall be for-

bidden henceforth in regions where this wave may interfere with broadcasting.

The use of the Type B wave of 1000 kc/s (300 m.) for traffic shall be forbidden, henceforth, between 6:00 p.m. and midnight, local time, and shall be absolutely forbidden, at all times, beginning January 1, 1930 at the latest. This same type B wave of 1000 kc/s (300 m.) may, however, continue in use indefinitely without restriction as to hours by stations on board fishing vessels, for radio-compass bearings among themselves, provided they do not interfere with broadcasting.

4. All apparatus in mobile stations established for the transmission of type A1 waves between 125 and 150 kc/s (2400-2000 m.) must permit the use of at least three frequencies chosen from this band, and must permit a rapid change from one to another of these frequencies.

5. All stations on ships compulsorily equipped with radio apparatus must be able to receive the wave of 500 kc/s (600 m.) and in addition all the waves necessary for the proper accomplishment of the service which they carry on.

Beginning January 1, 1932 they must be able to receive easily and efficiently on the same frequencies, waves of types A1 and A2.

6. Transmitting apparatus used in the mobile service must be provided with devices permitting reduction of power. This provision shall not apply to transmitters, the input power of which does not exceed 300 watts.

7. Receiving apparatus must be such, that the current which it produces in the antenna shall be as small as possible and shall not disturb neighboring stations.

The transmitting and receiving apparatus of all mobile stations must be such as to allow changing of frequency as rapidly as possible. All installations must be such that communications once being established the time necessary to change from transmission to reception and vice versa shall be as short as practicable.

33. Article 19: .Calling and Listening Waves—1. In the band between 360 and 515 kc/s (830-580m.) the only type B waves permitted shall be the following: 375, 410, 425, 454 and 500 kc/s (800, 730, 705, 660, and 600 m.).

The general calling wave, which must be used by all ships compulsorily equipped and by coast stations, shall be 500 kc/s (600 m.) (A1, A2 or B).

Besides the wave 500 kc/s (600 m.) the use of waves of all types between 485 and 515 kc/s (620-580 m.) shall be forbidden.

The wave of 500 kc/s (600 m.) shall be the international calling and distress wave. It may be used, but with discretion, for other purposes, if it does not interfere with distress, urgent, safety, or call signals.

Coast stations must be able to use at least one wave besides that of 500 kc/s (600 m.). This additional wave shall be underlined in the nomenclature to indicate that it is the normal working wave of the station. The additional waves thus chosen may be the same as those of ship stations or may be different. In any case, the working waves of the coast stations must be chosen in such a way as to avoid interference with neighboring stations.

Besides the normal working waves underlined in the nomenclature, coast and ship stations may use in the authorized band additional waves which they deem suitable. These waves shall be given in the nomenclature without being underlined.

4. (1) In order to increase safety of life at sea (ships) and over the sea (aircraft), all stations in the mobile *maritime* service must, during their hours of service, take the necessary measures to assure the watch on the distress wave (500 kc/s-600 m.) for three minutes twice per hour, beginning at the 15th minute and at the 45th minute after each hour Greenwich mean time.

(2) Stations carrying on a service of radiotelegraph correspondence, press news, etc., with ships at sea must observe silence during the intervals indicated above. Only the transmissions provided for in Article 21, paragraphs 25 to 27, may be made during these intervals.

(3) As an exception, however, land and ship stations equipped to correspond by means of continuous waves may continue to work during these periods; if they are in a position to maintain at the same time a satisfactory watch on the distress wave as provided for in subparagraph (1) of the present paragraph.

6. The following rules must be observed in the operations of stations in the mobile service using type A1 waves of the band 100 to 160 kc/s (3000-1875 m.) which is assigned to the mobile service.

(a) Every coast station carrying on communications on a long continuous wave must listen on the wave of 143 kc/s (2100 m.) unless it is otherwise indicated in the nomenclature. The coast station shall transmit all its traffic on the wave or waves especially assigned to it.

(b) When a mobile station desires to establish communication on a long continuous wave with another station of the mobile service it must employ the wave of 143 kc/s (2100 m.) unless it

is otherwise indicated in the nomenclature. This wave, designated as the general communication wave, must be employed:

1. For calls and answers thereto.

2. For sending signals preliminary to the transmission of traffic.

(c) A mobile station after having established communication on the general communication wave, with another station in the mobile service, may transmit its traffic on any wave in the authorized band on condition that it does not disturb the work of a coast station or work in progress on the calling wave.

(d) As a general rule, every mobile station, equipped for service on long continuous waves and not engaged in communication on another wave, must, in order to permit the exchange of traffic with other stations of the mobile service, return to the wave of 143 kc/s (2100 m.) for 10 minutes from the beginning of the 35th minute to the beginning of the 45th minute of each hour, Greenwich mean time, during the specified hours, according to the class to which the station in question belongs.

(e) Coast stations shall transmit their traffic lists at specified times, published in the nomenclature, on the wave or waves which are assigned to them.

Besides the times thus fixed for this transmission of their traffic lists, coast stations may call mobile stations individually, at any other time, according to circumstances or according to work which they have to carry on. These individual calls may be made on the wave of 143 kc/s (2100 m.) in regions where there is no congestion of traffic.

(f) The special provisions concerning the service carried on by land stations using long continuous waves shall be shown in detail in a special reference in the nomenclature.

34. Article 21: Distress, Alarm, Urgent and Safety Signals
—*Distress Signal*—1. The distress signal shall consist of the group . . . — — . . . which indicates that the ship, aircraft, or other mobile station sending it, is threatened by grave and imminent danger, and requests immediate assistance.

Distress Call—2. The distress call shall consist of the distress signal sent three times, followed by the word DE and the call signal of the mobile station in distress, sent three times. This call has absolute priority over all other transmissions. All mobile or land stations hearing it must immediately cease all transmissions capable of interfering with the distress calls or messages and must listen on the wave used for the distress call. This call must not be addressed to a particular station.

The same rules apply to the radiotelephone distress call which

consists of the spoken expression MAYDAY (corresponding to the French pronunciation of the expression "m'aider" [help me]).

Distress Message—3. The distress message shall include the distress call followed by the name of the ship, aircraft, or other mobile station in distress, and information concerning its position, the nature of the distress and the kind of assistance desired.

4. As a general rule and when a ship or aircraft on or over the sea is involved the position must be expressed in latitude and longitude (Greenwich) using figures for degrees and minutes, accompanied by one of the words NORTH or SOUTH, and by one of the words EAST or WEST. A period shall separate the degrees from the minutes. Where necessary, the true bearing and the distance in nautical miles from a known geographic point may be given.

5. The distress call and message shall be sent only by the authority of the master or person responsible for the ship, aircraft, or other mobile station.

6. A ship in distress shall transmit the distress call on the wave of 500 kc/s (600 m.) preferably of type A2 or B. This call must be followed as soon as possible by the distress message.

7. The distress call and message must be repeated at intervals until an answer has been received, especially during the periods of silence specified in Article 19, paragraph 4. The intervals must, however, be long enough for stations preparing to reply to the call to have time to start their sending apparatus. In the case where the ship in distress receives no answer to a distress call or message sent on the 500 kc/s (600 m.) wave, the call and the message may be repeated on any other available wave on which attention might be attracted.

8. Furthermore, a mobile station which is aware that another mobile station is in distress may transmit the distress message on condition that:

(a) The station in distress is not itself in a position to transmit it.

(b) The master (or his relief) of the vessel, aircraft, or other mobile station believes that further help is necessary.

9. Stations which receive a distress message from a mobile station which unquestionably is in their immediate vicinity, must at once acknowledge receipt thereof (see paragraphs 15 and 16 below), taking care not to interfere with the transmission of the acknowledgments of receipt of the said message sent by other stations.

Stations which receive a distress message from a mobile station which unquestionably is not in their immediate vicinity, must

listen for a short period before acknowledging receipt thereof in order to permit the stations nearer the mobile station in distress to answer and acknowledge receipt without interference.

Distress Traffic—10. Distress traffic shall include all messages relative to immediate relief of the mobile station in distress.

11. All distress traffic must include the distress signal, sent before the time of filing.

12. The control of distress communications devolves upon the mobile station in distress or upon the mobile station which by application of the provisions of paragraph 8, subparagraph (a), sent the distress call. These stations may delegate the control of the distress communications to another station.

13. All stations which are within the range of the distress communications but which do not take part in them must refrain from using the distress wave until the distress communications are finished. As soon as these communications are established on the distress wave, mobile stations not taking part in them may continue their normal service on other authorized waves of type A1, if by so doing they are still able effectively to receive the distress traffic.

14. When distress communications are ended and silence is no longer necessary, the station which has controlled these communications shall send a message on the distress wave addressed to CQ, indicating that the distress communications are ended. This message shall take the following form:

Call CQ (three times), word DE, call signal of the station transmitting the message, distress signal, time of filing the message, name and call signal of the mobile station which was in distress, words "distress traffic ended."

This message shall be repeated, where necessary, on the other waves on which the distress traffic has been sent.

Acknowledgment of Receipt—15. Acknowledgment of receipt of a distress message shall be made in the following form:

Call signal of the mobile station in distress (three times), word DE, call signal of the station acknowledging receipt (three times), group RRR, distress signal.

16. Every mobile station which acknowledges receipt of a distress message must make its name and position known as soon as possible (in the form shown in paragraph 4), taking care not to interfere with other stations more favorably situated to render immediate relief to the station in distress.

17. If a mobile station employing continuous waves not included in the band 485 to 515 kc/s (620-580 m.) hears a distress message sent on the waves of 500 kc/s (600 m.), during other than the obligatory silence periods on the wave of 500 kc/s (600 m.), and if the ship, aircraft or other mobile station is not in a position to render assistance, the said station must take all possible steps to attract the attention of other mobile stations in the vicinity, which are working on waves not included in the band mentioned above.

18. Repetition of the distress call or message, by mobile stations other than the one in distress, shall be permitted only on authorization from the master (or his relief) of said stations, taking care not to cause interference by useless repetition.

19. A station repeating a distress call or message shall add to the end thereof the word DE followed by its own call signal transmitted three times.

20. In a case where a station receives a distress call or message but is not in a position to render assistance and has reason to believe that there has been no acknowledgement of receipt of the distress message, it must repeat the message on full power on the distress wave and take all the necessary steps to advise the authorities who are capable of useful intervention.

Automatic Alarm Signal—21. The composition of the automatic alarm signal must comply with the following conditions:

(a) It must be possible to send this signal by hand or by an automatic apparatus, without difficulty and with a precision as to the measure of time, which must not be greater than that of a watch or a clock indicating seconds.

(b) Its composition must be clear, distinct, and easily recognized by a person ignorant of the Morse Code; and it must be adaptable to the easy and cheap manufacture of an automatic receiving apparatus which:

1. Shall respond to the alarm signal even when numerous stations are working as well as when there is atmospheric interference;

2. Shall not be started by powerful signals or by atmospherics when these are not accompanied by the alarm signal;

3. Shall possess a sensitiveness equal to that of a crystal receiver-detector connected with the same antenna;

4. Shall give warning when its operation ceases to be normal.

(c) The said composition must be different from the signal used for adjustment and functioning of the variometer.

(d) Before an automatic alarm receiver shall be approved for

use in ships under the jurisdiction of an Administration, the Administration must be satisfied by practical tests made under suitable conditions of interference, that the apparatus complies with the provisions of these Regulations.

(e) The following alarm signal shall hereafter be recognized:

A series of twelve dashes sent in one minute, the duration of each dash being four seconds and the duration of the interval between two dashes, one second.

(f) This special signal must have for its sole purpose, the operation of the apparatus used to give the alarm. It must be used solely to announce that the distress signal is about to follow.

(g) The adoption of the type of alarm signal mentioned in (e) shall not prevent an Administration from authorizing the use of an automatic apparatus which would comply with the conditions fixed above and would be operated by the regulation distress signal (. . . — — — . . .).

Urgent Signal—22. The urgent signal shall consist of several repetitions of the group XXX, sent by distinctly separating the letters of each group and the successive groups; it shall be sent before a call. This signal shall indicate that the calling station has a very urgent message to transmit concerning the safety of the ship, aircraft, or other vehicle in which it is located; of a ship, aircraft, or other vehicle in sight; or finally, of the safety of any person on board or in sight therefrom. In the aircraft radio service the indication of PAN shall be used as an urgent signal, by radiotelephony and by radiotelegraphy, when an aircraft station wishes to give notice of damage which compels the aircraft to land without requiring immediate assistance. In the case of radiotelegraphy, the three letters must be well separated in order that the signals AN be not transmitted as the signal P.

The urgent signal shall have priority over all other communications except those of distress, and all mobile or land stations which hear it must avoid interfering with the transmission of such urgent traffic.

As a general rule, the urgent signal may be employed only if the sending mobile station addresses it to a specific station.

23. Mobile stations which hear the urgent signal must continue to listen for a least three minutes. At the expiration of this period and if no urgent message has been heard, mobile stations may resume their normal service.

Land and ship stations nevertheless, which are in communica-

tion on authorized waves, other than that used for the transmission of the urgent signal and of the call which follows it, may continue their normal work without interruption.

24. The urgent signal shall be transmitted only with the authorization from the master or the person responsible for the ship, aircraft, or other mobile station.

Safety Signal—25. The safety signal shall consist of the transmission of the group TTT, with the letters well separated, followed by the word DE and by the call signal of the station sending it. It shall indicate that this station is about to transmit a message concerning the safety of navigation or giving important information relative to meteorological warning messages.

26. The safety signal and the safety message shall be sent on the wave of 500 kc/s (600 m.) and if necessary, on the normal listening wave of ship and aircraft stations.

27. The safety signal shall be sent once during the first silent period (Article 19, par. 4) and near the end of that period. All stations hearing it must continue to listen on the normal calling wave (ship stations) or on the authorized wave (aircraft station) until the message preceded by the safety signal shall have ended. The transmission of this message shall begin immediately after the end of the silent period.

35. Article 24 quater: Order of Priority in the Establishment of Communications in the Mobile Service—The order of priority in the establishment of communications in the mobile service shall be as follows:

1. Distress calls, distress messages, and distress traffic.
2. Communications preceded by an urgent signal.
3. Communications preceded by the safety signal.
4. Communications relative to radio-compass bearings.
5. All other communications.

36. Article 25: Calling—1. As a general rule, responsibility for establishing communication with the land station rests with the mobile station; the latter may call the land station, for this purpose, only after arriving within the range of action of said station.

In principle, a land station having traffic for a mobile station which has not indicated its presence, must call this station only if it has reason to believe that the said mobile station is within range and is keeping watch.

2. Land stations may, however, transmit their traffic list, consisting of the call signals of all mobile stations for which they have traffic on hand, at fixed intervals which have been established

by agreements between the governments concerned. Land stations which transmit their calls on the wave of 500 kc/s (600 m.) shall transmit the call signals of their traffic list in alphabetical order; land stations which use continuous waves shall transmit these call signals in the most convenient order.

In all cases, mobile stations which, during this transmission, hear their call signal must answer so soon as practicable, complying with provisions paragraph 1, and following so far as practicable the order in which they were called. The time at which land stations transmit their traffic lists as well as the frequencies and types of waves which they use for this purpose shall be indicated in the nomenclature.

The land station shall inform each mobile station concerned of the frequency and type of wave to be used for work with it, as well as of the approximate time at which the traffic may begin.

3. When a land station receives calls from several mobile stations at practically the same time, it shall decide the order in which these stations may transmit their traffic to it, its decision being based only on the requirement of permitting each calling station to exchange with it the greatest possible number of radiotelegrams.

4. When a land station answers a call from a mobile station it may, if deemed necessary, ask the mobile station, by means of appropriate abbreviations, to indicate the number of radiotelegrams on hand.

If information concerning the position, route, speed or ports of call of the ship, aircraft or other mobile station appears necessary to the land station, the latter asks for it by means of a free service advice, addressed to the master, or to the person in charge of the ship, aircraft or other mobile stations who furnishes it or not at his discretion. The mobile station must give such information to the land station only when it has been requested and furnished as stated above.

5. In communication between coast and mobile stations, the mobile stations shall follow the instructions of the coast station, in all questions relating to the order and time of transmission, as well as to the suspension of work. This provision shall not apply to cases of distress.

6. In communication between mobile stations, except in cases of distress, the station called shall control the work as indicated in paragraph 5 above.

7. When a station called does not answer to a call sent three times at intervals of two minutes, the call must cease and it may

be resumed only after an interval of fifteen minutes. The calling station, before resuming the call, must make certain that the station called is not at that moment in communication with another station.

The call may be repeated at shorter intervals if it is not likely to interfere with communications in progress.

8. When the name and address of the management of a mobile station are not shown in the nomenclature or are no longer in accord with the data given in the latter, it devolves upon the mobile station to furnish the land station to which it sends traffic all the necessary information, using for this purpose the appropriate abbreviations.

37. Article 26: Time of Filing Radiotelegrams—To indicate the time of filing radiotelegrams accepted in mobile stations, the person in charge shall employ Greenwich Mean Time, and shall use a notation according to the twenty-four hour system. This time shall always be expressed and sent by means of four figures (0000 to 2359).

The Administrations of countries located outside zone "A" (Appendix 17), however, may authorize ship stations following the coasts and their countries to use zone time to indicate, by a group of four figures, the time of filing, and in this case the group must be followed by the letter F.

38. Article 27—1. In principle, a mobile station using waves of types A₂, A₃ or B shall send its radiotelegrams to the nearest land station.

When, however, the mobile station may choose among several land stations, situated at approximately the same distance it shall give the preference to that located on the territory of the country of destination, or of the normal transit of the radiotelegrams to be sent. When the station chosen is not the nearest, the mobile station must cease work or change the type or frequency of the emission upon the first request made by the land station in the interested service which is actually the nearest, the request being based upon the interference which the work in question causes the latter.

2. A mobile station using Type A₁ waves included in the authorized band may transmit its radiotelegrams to a land station which is not the nearest. It is, however, recommended in this case that preference be given to the land station established on the territory of the country of destination or of the country which it appears could most reasonably effect the transit of the radiotelegrams to be sent.

3. A coast station, to which one or more waves included in the band 125-150 kc/s (2400-2000 m.) are allocated, shall have the right of preference on such wave or waves.

Any other station in the mobile service transmitting public traffic on such wave or waves and thereby causing interference to the said coast station must suspend its work at the request of the latter.

4. Except in the case of distress, communications between ship stations must not interfere with the work of coast stations. When this work is thus interfered with, the ship stations causing it must stop sending or change waves, upon the first request of the coast station with which they interfere.

5. If the sender of a radiotelegram filed in a mobile station has designated the land station to which he desires his radiotelegram sent, the mobile station must in order to effect this transmission to the designated land station, wait if necessary until the conditions specified in the preceding paragraphs shall have been fulfilled.

6. A mobile station which does not have fixed working hours must inform the land station with which it is in communication the time of closing and the time of reopening its service.

Every mobile station whose service is about to close by reason of arrival in port must notify the nearest land station.

39. Article 27 bis—In case of distress, the wave of 500 kc/s (600 m.) must be used preferably with type A2 or B. When it is not possible to use one of these types of waves, type A1 or A3 may be used. No provision of the present Regulations shall prevent the use by a mobile station in distress of any means at its disposal to attract attention, indicate its position, and obtain assistance.

40. Article 27 ter—I. In the case where waves other than the normal wave may be used, the ship station shall follow the instructions of the coast station with which it is in communication. In principle, the normal wave of 500 kc/s (600 m.) must not be used for the transmission of long radiotelegrams in regions where the radio work is heavy.

2. During their hours of service, stations using for their work waves of type A2, A3 or B, and open to the international service of public correspondence, must continue to listen on the wave of 500 kc/s (600 m.), except when they are exchanging traffic on other waves.

3. As a general rule, it is recommended that public correspond-

Q CODE:¹ LIST OF ABBREVIATIONS TO BE USED IN RADIO TRANSMISSIONS.

I. Abbreviations to be used in all services.

| Abbreviation. | Question. | Answer. |
|---------------|---|--|
| ORA..... | What is the name of your station?..... | The name of my station is |
| ORB..... | At what approximate distance are you from my station? | The approximate distance between our stations is nautical miles (or kilometers). |
| QRC..... | By what private company (or government administration) are the accounts for charges of your station liquidated? | The accounts for charges of my station are liquidated by the private company (or by the government administration of). |
| QRD..... | Where are you going?..... | I am going to |
| QRE..... | What is the nationality of your station?..... | The nationality of my station is |
| QRF..... | Where do you come from?..... | I come from |
| QRG..... | Will you indicate to me my exact wavelength in meters (or frequency in kilocycles)? | Your exact wavelength is meters (or kilocycles). |
| QRH..... | What is your exact wavelength in meters (frequency in kilocycles)? | My exact wavelength is meters (frequency kilocycles). |
| QRI..... | Is my tone bad?..... | Your tone is bad. |
| QRJ..... | Are you receiving me badly? Are my signals weak? | I can not receive you. Your signals are too weak. |
| QRK..... | Are you receiving me well? Are my signals good? | I receive you well. Your signals are good. |
| QRL..... | Are you busy?..... | I am busy. Or, (I am busy with). Please do not interfere. |
| QRM..... | Are you being interfered?..... | I am being interfered with. |
| QRN..... | Are you troubled by atmospherics?..... | I am troubled by atmospherics. |
| QRO..... | Must I increase power?..... | Increase power. |
| QRP..... | Must I decrease power?..... | Decrease power. |
| QRO..... | Must I send faster?..... | Send faster (..... words per minute). |
| QRS..... | Must I send more slowly?..... | Send more slowly (..... words per minute). |
| QRT..... | Must I stop sending?..... | Stop sending. |
| QRU..... | Have you anything for me?..... | I have nothing for you. |
| QRV..... | Must I send a series of V's?..... | Send a series of V's. |
| QRW..... | Must I advise that you are calling him? | Please advise that I am calling him. |
| QRX..... | Must I wait? When will you call me again? | Wait until I have finished communicating with I will call you immediately (or at o'clock). |
| QRY..... | Which is my turn?..... | Your turn is No. (or according to any other indication). |
| QRZ..... | By whom am I being called?..... | You are being called by |
| QSA..... | What is the strength of my signals (1 to 5)? | The strength of your signals is (1 to 5). |
| QSB..... | Does the strength of my signals vary?..... | The strength of your signals varies. |
| QSC..... | Do my signals disappear entirely at intervals? | Your signals disappear entirely at intervals. |
| QSD..... | Is my keying bad?..... | Your keying is bad. |
| QSE..... | Are my signals distinct?..... | Your signals are unreadable. |
| QSF..... | Is my automatic transmission good?..... | Your signals run together. |
| QSG..... | Must I transmit the telegrams by a series of 5, 10 (or according to any other indication)? | Your automatic transmission fades out. |
| QSH..... | Must I send one telegram at a time, repeating it twice? | Transmit the telegrams by a series of 5, 10 (or according to any other indication). |
| QSI..... | Must I send the telegrams in alternate order without repetition? | Transmit one telegram at a time, repeating it twice. |
| QSJ..... | What is the charge to be collected per word for including your internal telegraph charge? | Send the telegrams in alternate order without repetition. |
| | | The charge to be collected per word for is francs, including my internal telegraph charge. |

¹ The abbreviations take the form of questions when they are followed by question marks.

1. Abbreviations to be used in all services—Continued.

| Abbreviation. | Question. | Answer. |
|---------------|---|--|
| QSK..... | Must I suspend traffic? At what time will you call me again? | Suspend traffic. I will call you again at (o'clock). |
| QSL..... | Can you give me acknowledgment of receipt? | I give you acknowledgment of receipt. |
| QSM..... | Have you received my acknowledgment of receipt? | I have not received your acknowledgment of receipt. |
| QSN..... | Can you receive me now? Must I continue to listen? | I cannot receive you now. Continue to listen. |
| QSO..... | Can you communicate with directly (or through the intermediary of)? | I can communicate with directly (or through the intermediary of). |
| QSP..... | Will you relay to free of charge? | I will relay to free of charge. |
| QSQ..... | Must I send each word or group once only? | Send each word or group once only. |
| QSR..... | Has the distress call received from been attended to? | The distress call received from has been attended to by |
| QSU..... | Must I send on meters (or kilocycles) waves of Type A1, A2, A3 or B? | Send on meters (or on kilocycles) waves of Type A1, A2, A3 or B. I am listening for you. |
| QSV..... | Must I shift to the wave of meters (or of kilocycles) for the balance of our communications and continue after having sent several V's. | Shift to wave of meters (or of kilocycles) for the balance of our communications and continue after having sent several V's. |
| QSW..... | Will you send on meters (or on kilocycles) waves of Type A1, A2, A3 or B? | I will send on meters (or kilocycles) waves of Type A1, A2, A3 or B. Continue to listen. |
| QSX..... | Does my wavelength (frequency) vary? | Your wavelength (frequency) varies. |
| QSY..... | Must I send on the wave of meters (or kilocycles) without changing the type of wave? | Send on the wave of meters (or kilocycles) without changing the type of wave. |
| QSZ..... | Must I send each word or group twice? | Send each word or group twice. |
| QTA..... | Must I cancel telegram No. as if it had not been sent? | Cancel telegram No. as if it had not been sent. |
| QTB..... | Do you agree with my word count?... | I do not agree with your word count; I shall repeat the first letter of each word and the first figure of each number. |
| QTC..... | How many telegrams have you to send? | I have telegrams for you or for |
| QTD..... | Is the word count which I am confirming to you accepted? | The word count which you confirm to me is accepted. |
| QTE..... | What is my true bearing? (or) What is my true bearing relative to.....? | Your true bearing is degrees (or) Your true bearing relative to is degrees at (o'clock). |
| QTF..... | Will you give me the position of my station based on the bearings taken by the radiocompass stations which you control? | The position of your station based on the bearings taken by the radiocompass stations which I control is latitude longitude. |
| QTG..... | Will you transmit your call signal for one minute on a wavelength of meters (or kilocycles) in order that I may take your radiocompass bearing? | I am sending my call signal for one minute on the wavelength of meters (or kilocycles) in order that you may take my radiocompass bearing. |
| QTH..... | What is your position in latitude and longitude (or according to any other indication)? | My position is latitude longitude (or according to any other indication). |
| QTI..... | What is your true course?..... | My true course is degrees. |
| QTI..... | What is your speed?..... | My speed is knots, or kilometers per hour. |
| QTK..... | What is the true bearing of relative to you? | The true bearing of relative to me is degrees at (o'clock). |

I. *Abbreviations to be used in all services—Continued.*

| Abbreviation. | Question. | Answer. |
|---------------|--|---|
| QTL..... | Send radio signals to enable me to determine my bearing with respect to the radio beacon. | I am sending radio signals to permit you to determine your bearing with respect to the radio beacon. |
| QTM..... | Send radio signals and submarine sound signals to enable me to determine my bearing and my distance. | I am sending radio signals and submarine sound signals to permit you to determine your bearing and your distance. |
| QTN..... | Can you take the bearing of my station (or of) relative to you? | I cannot take the bearing of your station (or of) relative to my station. |
| QTP..... | Are you going to enter the dock (or the port)? | I am going to enter the dock (or the port). |
| QTR..... | What is the exact time?..... | The exact time is |
| QTS..... | What is the true bearing of your station relative to me? | The true bearing of my station relative to you is at (o'clock). |
| QTU..... | What are the hours during which your station is open? | My station is open from to |

II. *Abbreviations more especially used in the aircraft radio service.*

| Abbreviation. | Question. | Answer. |
|---------------|---|---|
| QAA..... | At what time do you expect to arrive at? | I expect to arrive at at (o'clock). |
| QAB..... | Are you en route to? | I am en route to or Go to |
| QAC..... | Are you returning to? | I am returning to or Return to |
| QAD..... | At what time did you leave? (place of departure). | I left (place of departure) at (o'clock). |
| QAE..... | Have you news of (call signal of the aircraft station)? | I have no news of (call signal of the aircraft station). |
| QAF..... | At what time did you pass? | I passed at (o'clock). |
| QAH..... | What is your height?..... | My height is meters (or according to any other indication). |
| QAI..... | Has any aircraft signaled in my neighborhood? | No aircraft has signaled in your neighborhood. |
| QAJ..... | Must I look for another aircraft in my neighborhood? | Look for another aircraft in your neighborhood (or) Look for (call signal of the aircraft station) which was flying near (or in the direction of) at (o'clock). |
| QAK..... | On what wave are you going to send the meteorological warning messages? | I am going to send the meteorological warning messages on wavelength of meters (or kilocycles). |
| QAL..... | Are you going to land at? | I am going to land at or Land |
| QAM..... | Can you give me the latest meteorological message concerning weather for (place of observation)? | Here is the latest meteorological message concerning weather for (place of observation). |
| QAN..... | Can you give me the latest meteorological message concerning surface wind for (place of observation)? | Here is the latest meteorological message concerning surface wind for (place of observation). |

II. *Abbreviations more especially used in the aircraft radio service.*

| Abbreviation. | Question. | Answer. |
|---------------|---|---|
| QAO..... | Can you give me the latest meteorological message concerning upper wind for (place of observation)? | Here is the latest meteorological message concerning upper wind for (place of observation). |
| QAP..... | Must I continue to listen for you (or for on meters (or kilocycles)? | Continue to listen for me (or for on meters (or kilocycles). |
| QAQ..... | Will you hasten the reply to message No (or in accordance with any other indication)? | I hasten the reply to message No. (or in accordance with any other indication). |
| QAR..... | Must I reply to for you? | Reply to for me. |
| QAS..... | Must I send message No. (or in accordance with any other indication) to? | Send message No. (or in accordance with any other indication) to |
| QAT..... | Must I continue to send? | Listen before sending; you are interfering; or Listen before sending; you are sending at the same time as |
| QAU..... | What is the last message received by you from? | The last message received by me from is |
| QAV..... | Are you calling me?..... or Are you calling (call signal of the aircraft station)? | I am calling you. or I am calling (call signal of the aircraft station). |
| QAW..... | Must I cease listening until (o'clock)? | Cease listening until (o'clock). |
| QAX..... | Have you received the urgent signal sent by (call signal of the aircraft station)? | I received the urgent signal sent by (call signal of the aircraft station) at (o'clock). |
| QAY..... | Have you received the distress signal sent by (call signal of the aircraft station)? | I received the distress signal sent by (call signal of the aircraft station) at (o'clock). |
| QAZ..... | Can you receive in spite of the storm?... | I can no longer receive. I am going off watch because of the storm. |

Scale Used to Express Strength of Signals:

1. Hardly perceptible; unreadable.
2. Weak; readable now and then.
3. Fairly good; readable, but with difficulty.
4. Good; readable.
5. Very good; perfectly readable.

ence traffic be transmitted on waves of type A1, rather than on waves of type A2 or B.

3 bis. All stations in the mobile service are bound to exchange traffic with the minimum of radiated energy necessary to insure good communication.

III. Miscellaneous Abbreviations.

| Abbreviation. | Meaning. |
|---------------|--|
| C..... | Yes. |
| N..... | No. |
| P..... | Announcement of private telegram in the mobile service (to be used as a prefix). |
| W..... | Word or words. |
| AA..... | "All after" (to be used after a question mark to request a repetition). |
| AB..... | "All before" (to be used after a question mark to request a repetition). |
| AL..... | "All that has just been sent" (to be used after a question mark to request a repetition). |
| BN..... | "All between" (to be used after a question mark to request a repetition). |
| BQ..... | Announcement of reply to a request for rectification. |
| CL..... | "I am closing my station." |
| CS..... | Call signal (to be used to ask repetition of a call signal). |
| DB..... | "I cannot give you a bearing, you are not in the calibrated sector of this station." |
| DC..... | "The minimum of your signal is suitable for the bearing." |
| DF..... | Your bearing at (o'clock) was degrees, in the doubtful sector of this station, with a possible error of two degrees. |
| DG..... | Please advise me if you note an error in the bearing given. |
| DI..... | Bearing doubtful in consequence of the bad quality of your signal. |
| DJ..... | Bearing doubtful because of interference. |
| DL..... | Your bearing at (o'clock) was degrees in the doubtful sector of this station. |
| DO..... | Bearing doubtful. Ask for another bearing later, or at (o'clock). |
| DP..... | Beyond 50 miles, possible error of bearing can attain two degrees. |
| DS..... | Adjust your transmitter; the minimum of your signal is too broad. |
| DT..... | I cannot furnish you with a bearing; the minimum of your signal is too broad. |
| DY..... | This station is bilateral; what is your approximate direction in degrees relative to this station? |
| DZ..... | Your bearing is reciprocal. (To be used only by the central station of a group of radiocompass stations when it is addressed to other stations of the same group). |
| ER..... | "Here" (to be used before the name of the mobile station in the sending of route indications). |
| GA..... | "Resume sending" (to be used more especially in the fixed service). |
| JM..... | "If I may send, make a series of dashes. To stop my transmission, make a series of dots" (not to be used on 600 meters (500 kilocycles)). |
| MN..... | Minute or minutes (to be used to indicate the duration of a wait). |
| NW..... | "I resume transmission" (to be used more especially in the fixed service). |
| OK..... | "We are in agreement." |
| RQ..... | Announcement of a request for rectification. |
| SA..... | Announcement of the name of an aircraft station (to be used in the sending of indications of passage). |
| SF..... | Announcement of the name of an aeronautic station. |
| SN..... | Announcement of the name of a coast station. |
| SS..... | Announcement of the name of a ship station (to be used in the transmission of indications of passage). |
| TR..... | Announcement of the request or of the sending of indications concerning a mobile station. |
| UA..... | "Are we in agreement?" |
| WA..... | "Word after" (to be used after a question mark to request a repetition). |
| WB..... | "Word before" (to be used after a question mark to request a repetition). |
| XS..... | Atmospherics. |
| YS..... | "See your service advice." |
| ABV..... | "Shorten the traffic by using the International Abbreviations" |
| | or |
| | "Repeat (or I repeat) the figures in abbreviation form." |
| ADR..... | Address (to be used after a question mark to request a repetition). |
| CFM..... | "Confirm" or "I confirm." |
| COL..... | "Collate" or "I collate." |
| ITP..... | "The punctuation counts." |
| MSG..... | Announcement of telegram concerning ship service only (to be used as a prefix). |
| PBL..... | Preamble (to be used after a question to request a repetition). |
| REF..... | "Referring to" or "Refer to" |
| RPT..... | "Repeat" or "I repeat" only (to be used to ask or to give repetition of all or part of the traffic by making the corresponding indication after the abbreviation). |
| SIG..... | Signature (to be used after a question mark to request a repetition). |
| SVC..... | Announcement of a service telegram concerning private traffic (to be used as a prefix). |
| TFC..... | Traffic. |
| TXT..... | Text (to be used after a question mark to request a repetition). |

41. Regulations Governing the Issuance of Radio Operators' Licenses

1. **Commercial Extra First Class**—To be eligible for examination, an applicant for this class of license must have held a commercial first-class license and must have been actually engaged as an operator at stations open to public correspondence for at least 18 months during the 2 years previous to his application. A speed in transmission and reception of at least 30 words per minute, in code groups, Continental Morse Code, and 25 words per minute, in plain language, American Morse Code, 5 characters to the word, must be attained. The questions in this examination will cover the same subjects required for a commercial second-class license but considerably wider in scope. A total percentage of at least 80 will constitute a passing mark. Holders of licenses of this class are authorized to act as chief operator at any licensed radio station.

2. **Commercial First Class**—To be eligible for examination, an applicant for this class of license must have been actually engaged as an operator at stations open to public correspondence for at least 12 months. Applicants for this class of license must pass code tests in transmission and reception at a speed of at least 20 words per minute in Continental Morse Code, in code groups, and 25 words per minute in Continental Morse Code, in plain language (5 characters to the word). The practical and theoretical examination will cover the same subjects as required for the commercial second-class license. A total percentage of 75 will constitute a passing mark. Holders of this class of license are authorized to act as chief operator at any licensed radio station.

3. **Commercial Second Class**—Applicants for this class of license must pass code tests in transmission and reception at a speed of at least 16 words per minute in Continental Morse Code, in code groups, and 20 words per minute in Continental Morse Code, in plain language (5 characters to the word). The practical and theoretical examination shall consist of comprehensive questions under the following headings:

(a) Diagram of radio installation: Applicants are required to draw a complete wiring diagram of a modern marine radio installation as used aboard American vessels. The applicant may be required to draw either a spark, arc, or vacuum tube transmitter (with radio telephone attachment).

(b) General principles of electricity, theory, adjustment, opera-

tion, and care of modern radiotelegraph and radiotelephone apparatus.

- (c) Receiving apparatus.
- (d) Operation and care of storage batteries.
- (e) Motors and generators.
- (f) International regulations governing radio communication and the United States Radio Laws and Regulations.

(g) Experience: An allowance for experience will be added as follows: Three months' or more satisfactory service at a station open to public correspondence under a commercial license, 10 per cent; two months' satisfactory service at a station open to public correspondence under a commercial license, 7.5 per cent; one month's satisfactory service at a station open to public correspondence under a commercial license, 5 per cent; service at United States Government stations open to public correspondence, same as above; service at other United States Government stations of three months or more duration, 5 per cent; less than three months, in proportion; graduates of residence radio schools, 5 per cent; amateur operators or graduates of correspondence radio schools, 2 per cent. Applicants must present satisfactory written evidence of their experience in order to obtain due allowance. A total percentage of 65 will constitute a passing mark for this class of license.

This license is valid for the operation of any licensed land or aircraft radio station or on any vessel except as indicated in the following. Holders of this class of license are not authorized to act as chief operator on a vessel in the first class. They will be authorized to act as chief operator on a vessel in the second class upon submission of written evidence at any time during the term of the license indicating six months or more satisfactory service as an operator at a station open to public correspondence.

| | <i>Credits</i> |
|----------------------------------|---|
| Experience—Maximum | 10 |
| Diagram | 10 |
| Transmitting Apparatus | 20 |
| Receiving Apparatus | 20 |
| Storage Batteries | 10 |
| Motor Generators | 10 |
| Radio Laws and Regulations | 20 |
| | <hr style="width: 10%; margin-left: auto; margin-right: 0;"/> |
| Total | 100 |

4. Broadcast Class—Unlimited—Applicants for this class of license must pass code tests in transmission and reception at a speed of at least 16 words per minute in Continental Morse Code, in code groups, and 20 words per minute in Continental Morse

Code, in plain language (5 characters to the word). The theoretical examination will cover the same subject as indicated for the commercial second-class license, except that under subject (a) the applicant is required to draw a diagram of a modern broadcast transmitter and under subject (b) the questions will relate strictly to broadcast apparatus. An allowance for service as an operator at a broadcast or other station will be made in accordance with the scale indicated under 3.—Commercial second class. Holders of this class of license are authorized to act as operator only at a licensed broadcast station. A percentage of 75 will constitute a passing mark.

Broadcast Class—Limited—This class of license will be valid only for the operation of those broadcast stations at which a listening watch on the marine distress frequency is *not* required as indicated in the Federal Radio Commission's General Order No. 66, copy of which has been included in this chapter.

The examination for the broadcast class—limited license will be the same as for the broadcast class (unlimited) license with the exception that no code test is required. When a license of this class is issued the wording on the face of the license following (c) should be stricken out by means of the typewriter. On the face of the license the following notation should be typed "Valid only for the operation of a broadcast station at which no listening watch on the marine distress frequency is required."

The scale of credits for the broadcast class and broadcast class—limited licenses are the same as for the commercial first class and commercial second class licenses.

5. **Radiotelephone Class**—No code test is required for this class of license. The practical and theoretical examination for this class of license shall consist of questions on adjustment and operation of radiotelephone apparatus and knowledge of international regulations governing radio communication and the United States Radio Laws and Regulations. The applicant must demonstrate his ability to transmit and receive clearly conversation by telephone apparatus. Whenever possible, a demonstration of the applicant's ability to operate radiotelephone apparatus will be required. A percentage of 75 will constitute a passing mark. Holders of this class of license are authorized to act as operators only at licensed radiotelephone stations, other than broadcast or amateur, of 300 watts or less input power.

6. **Amateur Extra First Class**—To be eligible for examination, an applicant for this class of license must have had at least two years' service as a licensed radio operator and must not have been penalized for violation of the radio laws. The applicant must

pass code tests in transmission and reception at a speed of at least 16 words per minute in Continental Morse Code, in code groups, and 20 words per minute in Continental Morse Code, in plain language (5 characters to the word). An applicant must pass a special examination relating to amateur apparatus and international regulations and acts of Congress affecting amateur stations and operators. A percentage of 75 will constitute a passing mark. This license is valid for the operation of licensed amateur radio stations only.

7. **Amateur Class**—Applicants for this class of license must pass a code test in transmission and reception at a speed of at least 10 words per minute, in Continental Morse Code (5 characters to the word). An applicant must pass an examination which will develop knowledge of the adjustment and operation of the apparatus which he desires to use and of the international regulations and acts of Congress in so far as they relate to interference with other radio communications and impose duties on all classes of operators. A percentage of 70 will constitute a passing mark. This license is valid for the operation of licensed amateur radio stations only.

8. **Temporary Amateur License**—Amateurs who can not present themselves for examination may be issued temporary licenses valid for the operation of a particular station until such time as they can be examined for a regular license but not to exceed a period of one year. The applicant must submit a sworn statement attesting to his ability to transmit and receive at a speed of not less than 10 words per minute in Continental Morse Code.

42. Renewal Regulations Radio Operator License

Basic requirement for renewal, without theoretical examination, of all class of licenses except Commercial Extra First Class..

3 months' satisfactory service during the last six months of the license term or 12 months' service out of two years of the license term may be accepted at the discretion of the examining officer.

COMMERCIAL EXTRA FIRST CLASS.

12 months' satisfactory service at land or ship station open to general public service, at least 6 months of which must have been during the last twelve months of license term.

Exceptions:

- (a) Holders of these licenses employed as radio inspectors, radio instructors or in similar occupations requiring exceptional qualifications where the duties require the testing, demonstrating or otherwise using commercial apparatus may be issued renewals provided such employment has covered a period of 18 months of the two year license term.
- (b) Where the applicant has not regularly used the telegraph codes or has used only one code he must pass the code test in the codes or code not used.

Requirements (in addition to basic requirement) for renewal of:

COMMERCIAL FIRST CLASS
(OLD FORM) FOR
COMMERCIAL FIRST CLASS.

To be eligible to hold this class of license applicant must have at some time during his operating experience been engaged as operator at stations open to public correspondence for a period of at least 12 months. Must pass code test (reception and transmission in Continental Morse Code) of 20 words per minute in code groups and 25 words per minute in plain language (five characters to the word). Must pass examination covering the theory, operation and care of modern radiotelephone equipment. The ex-

amination may be oral but applicant must satisfactorily answer at least seven out of ten of the transmitting questions contained in broadcast station operator examination sheets.

COMMERCIAL FIRST CLASS FOR
COMMERCIAL SECOND CLASS
(UNLIMITED).

To be eligible to hold this class of license applicant must have at some time during his operating experience been engaged as operator at stations open to public correspondence for a period of at least 6 months.

If renewal service has been at a station open to public correspondence, no code test necessary.

If renewal service has been at a limited commercial, broadcast, geophysical, experimental, or technical and training school station, applicant must pass code test of 16 words per minute in code groups and 20 words per minute in plain language.

Exceptions:

- (a) For all purposes service at land and/or ship stations of the Mississippi Warrior Service, Coast Guard and Marine Lighthouse Service shall be considered as public service.
- (b) For renewal purposes service at air mail, Signal Corps and certain limited commercial stations may, at the discretion of the examining officer, be accepted for license renewal without requiring code test.

- COMMERCIAL FIRST CLASS FOR
COMMERCIAL SECOND CLASS
(LIMITED). Same renewal requirements as
for Commercial Second Class
(Unlimited).
- COMMERCIAL FIRST CLASS FOR
BROADCAST. As Broadcast Class licenses are
only issued to those who have
passed the regular broadcast
examination this class of li-
cense may NOT be issued as
a renewal of a Commercial
First Class.
- COMMERCIAL SECOND CLASS
(EXCEPT BROADCAST).
(OLD FORM) Not renewable.
Exception:
(a) When the holder of this
class of license has the basic
renewal requirements on serv-
ice at a broadcast station, he
may be issued a Radiotele-
phone class license without
examination.
- COMMERCIAL SECOND CLASS
(BROADCAST GRADE) FOR
BROADCAST CLASS (UNLIM-
ITED). Must pass code test of 16 words
per minute in code groups
and 20 words per minute in
plain language.
- COMMERCIAL SECOND CLASS
(BROADCAST GRADE) FOR
BROADCAST CLASS—LIMITED. Basic renewal requirement only,
on service at a broadcast sta-
tion.
Exception:
(a) Service at certain experi-
mental stations wherein the
experimental work performed
is in connection with broad-
cast transmitting apparatus
may be accepted for renewal.
- COMMERCIAL FIRST CLASS,
COMMERCIAL SECOND CLASS,
COMMERCIAL SECOND CLASS,
BROADCAST GRADE, FOR AM-
ATEUR CLASS. When the holder of a Commer-
cial class license has not suffi-
cient service under that li-
cense for renewal but either
holds an amateur radio sta-

tion license or desires to act as operator at such a station he may, at the discretion of the examining officer, be issued an Amateur class license.

SPECIAL CASES

COMMERCIAL FIRST CLASS (RESTRICTED).

If the holder of this class of license is so situated that he can appear for examination, he should be obliged to pass the code test and radiotelephone examination. If he cannot meet the code requirements and/or pass the examination relative to radiotelephony, he may be issued a restricted commercial second class license without examination. Renewal service may be either at a limited commercial or broadcast station.

The licenses so issued should show in red the following restriction: "This license not valid for the operation of any general public station" if the renewal service has been at a limited public station or "This license not valid for the operation of any limited or general public station" if renewal service has been at a broadcast station.

COMMERCIAL FIRST CLASS

Where the applicant is eligible for a Commercial First Class but is unable to appear for the code tests and radiotelephone examination and

Will be issued a Commercial Second Class license without examination.

At any time during the first three months of the term of this license the holder may re-

renewal service has been at a station open to public correspondence.

place it with a Commercial First Class license by successfully passing the code tests and radiotelephone examination.

If the holder does not appear for examination during the three month period allowed, he can obtain a Commercial First Class license only by passing the entire examination for such a license.

COMMERCIAL FIRST CLASS
(RESTRICTED)

Where the applicant is eligible for a Commercial First Class but is unable to appear for the code tests and radiotelephone examination and renewal service has been at a limited commercial or broadcast station.

Same as above except that a restricted Commercial Second Class license will be issued, the wording of the restriction to be governed by the renewal service.

COMMERCIAL FIRST CLASS
(REGULAR OR RESTRICTED)

Where the applicant is not eligible for a Commercial First Class License at time of renewal.

If issued a Commercial Second Class License (unlimited or limited, but without restriction), the holder may at any time during the first year of the term of this license replace it with a Commercial First Class License by successfully passing the code tests and radiotelephone examination PROVIDED he becomes eligible for this class of license during that period. The eligibility requirement of one year's service at a station open to public correspondence may be partially or wholly under the second class license.

IN GENERAL

All Commercial Second Class licenses issued as renewals of Commercial First Class licenses should be so indicated on the face of the license showing the class, number and date of license of which it is a renewal.

When the holder of a Commercial Second Class license applies for permission to take the code tests and radiotelephone examination for a Commercial First Class license under the conditions and within the time periods specified under "SPECIAL CASES" he must present, to the examining officer, satisfactory proof of service at stations open to public correspondence for a period of at least one year.

An unlimited Commercial Second Class license is one that permits the holder to perform any or all of the duties authorized by that class of license as it bears the service endorsement (two signatures on license) whereas a limited Commercial Second Class License does not permit the holder to act as chief operator on vessels of the second class.

An unlimited Broadcast Class license permits the holder to serve as operator at any licensed broadcast station whereas a limited license of this class does not permit service at a broadcast station required to maintain a watch on marine distress frequencies.

Application for renewal must be made before date of expiration of the license, preferably within two or three weeks prior to the date of expiration. An operator employed on a ship whose license expires at sea is required to submit an affidavit attesting to that fact. This affidavit may be submitted to the Radio Division through the supervisor of radio or examining officer, attesting to the facts, which will be considered by the Radio Division, which will advise the supervisor of radio or examining officer in regard to the issue of a renewal of the license without examination. An operator who is about to leave on a trip, during which time his license will expire, should make application for renewal prior to sailing, providing the date of expiration is within one month from the date of sailing.

Service Records—Service records must be completed and signed only by masters, employers, or the duly authorized agents of either. Any improper alteration of the service record or the forgery of masters' or employers' signatures constitutes a violation of the regulations, and the operator may suffer suspension of license for a period not exceeding two years, at the discretion of the Secretary of Commerce.

Duplicate Licenses—Operators who have lost a valid operator's license may submit an affidavit to the radio division through the supervisor of radio or examining officer, attesting to the facts, which will be considered by the Radio Division which will advise the supervisor of radio or examining officer in regard to the issue of a duplicate of the lost license. Duplicate of licenses will bear the same date of issue and will expire on the same date as the original. If the original license is recovered, it must be forwarded to the Radio Division or one of its offices for cancellation and filing. Duplicates of amateur station licenses or of expired operator licenses will not be issued.

Reexamination—No applicant who fails to qualify will be reexamined within three months from date of the previous examination. However, when an applicant for the commercial first-class license fails in the code examination he will be reexamined the same day for any other one class of license desired. Those who pass the code test successfully but fail to attain a total percentage of at least 75 but do attain a total percentage of at least 65 will be issued a commercial second-class license, if desired. Those who fail in the code examination for the broadcast-class license will be examined the same day for either the radiotelephone or amateur class license, if desired. An applicant for the broadcast-class license who fails to attain a total percentage of at least 75 but does attain a percentage of at least 65 will be issued a radiotelephone-class license, if desired. All examination papers, except amateur, whether the applicant qualifies or not, will be forwarded to the Department of Commerce, radio division, for filing.

Amateur License—Applicants for this grade of license must pass a code test in transmission and reception at a speed of at least 10 words per minute in Continental Morse Code (five characters to the word).

An applicant must pass an examination which will develop knowledge of the adjustment and operation of the apparatus which he desires to use and of the International Regulations and Acts of Congress insofar as they relate to interference with other radio communications and impose duties on all classes of operators.

A percentage of 70 will constitute a passing mark.

This license is valid for the operation of licensed amateur radio stations only.

Temporary Amateur Licenses—Amateurs who cannot be examined at time of application may be given temporary licenses valid for the operation of a particular station until such time as

examination for a regular license can be held, but not to exceed a period of one year.

Amateur Extra First Grade—Licenses of this grade will be issued to persons passing the required special examination with percentage of at least seventy-five and code speed in sending and receiving at least twenty words a minute, five characters to the word; who have had at least two years' experience as licensed radio operators; and who have not been penalized for violation of the radio laws subsequent to the date of these regulations.

43. Preparation for Examination

Commercial Extra First Class, Commercial First Class, Commercial Second Class—Students expecting to take any one of the above examinations should first qualify in transmitting and receiving at the speed required for the particular class of license. (See regulations governing issuance of operators' licenses.) Many students in their anxiety to pass the receiving test neglect to practice transmitting and consequently fail the examination for this reason alone. The applicants are expected to be able to transmit clearly and distinctly the characters of the International Morse Code at speeds varying between 16 and 30 words per minute depending upon the class of license they are being examined for. The transmission registers on a tape recorder and it is essential that the dots and dashes be properly spaced. Applicants are not permitted to use mechanical devices such as "bugs" and "Cootie" keys. Neither are applicants allowed to take the receiving test on a typewriter; it must be in legible handwriting.

Diagram—After having passed the required code tests the applicant is required to draw a complete diagram of a modern shipboard radio installation including transmitter, regenerative receiver with V.T. detector and amplifier, "A" and "B" battery supply, the "A" batteries so arranged as to permit one to be charged while the other is on discharge; auxiliary power supply of sufficient capacity to operate the transmitter for four hours over a distance of one hundred nautical miles. If storage batteries are used for the auxiliary power supply, it is necessary to draw a diagram of the charging panel showing how the batteries are charged and discharged, together with the necessary protective devices.

The applicant may be required to draw any one of five different types of radio transmitters such as V.T. Master oscillator power

amplifier, V.T. master oscillator power amplifier with telephone attachment, V.T. full wave self-rectifying transmitter, arc transmitter with hand starter to control motor generator, or a quenched spark transmitter. The diagrams indicated as figures 185b, 186, 189 and 225 are acceptable for this part of the examination provided each is shown with batteries, charging circuit and receiver.

Transmitting Apparatus—In addition to the main diagram the applicant may be required to draw elementary diagrams of various types of transmitting circuits. In addition, questions are asked concerning the operation maintenance and repair of transmitting apparatus. A knowledge is required of such subjects as Piezo crystal oscillators, modulation systems, microphones, speech amplifiers, wavemeters, computing power input to tubes, effecting emergency repairs and substitutions for defective parts. The student will find sufficient material in Chapters 4, 5, 6, 8, 10 and 11 to study up on the subjects mentioned above.

Receiving Apparatus—On this subject the applicant is required to have a knowledge of direction finders, auto-alarms, theory and application of the vacuum tube as a detector and amplifier. The applicant is asked to describe various systems of radio and audio frequency amplification, use of screen grid tubes, power tubes, methods of connecting power tubes and calibration of receiving apparatus, methods of shooting trouble and making repairs together with maintenance and operating instructions. These subjects will be found in Chapters 1, 4, 5, 6, 7, 8, 12 and 13 where they are discussed and explained in detail.

Storage Batteries—Sufficient material is included in Chapter 3 to enable one to qualify in this subject. The care, maintenance and operation of both Edison and lead plate batteries are taken up in detail.

Motors and Generators—Chapter 2 covers this subject very well. The student is required to have a practical and theoretical knowledge of the construction and operating characteristics of shunt wound, series wound and compound wound machines. He is expected to tell how to treat a hot bearing, replace a motor field coil, armature coil and effect other repairs and adjustments. A knowledge of automatic starters, hand starters and water rheostats is essential. These subjects can be found in Chapters 2, 8, 10 and 11.

Radio Laws and Regulations—Commercial radio operators are required to have a thorough knowledge of U. S. Radio Laws and Regulations as well as that of the International Radiotelegraph Convention. (It is anticipated that operators will also be required

to have a knowledge of the radio requirements of the Safety at Sea Conference recently enacted in London.) Handling and abstracting traffic comes within the scope of this subject. Knowledge of computing charges on radiograms is required.

The prospective operator should study the Ship Act in order to understand its purpose and the penalties involved for violation of the terms of the Act.

The Radio Act of 1927 should be read through and various portions studied in detail. Paragraph (d) of section 5 should be memorized as well as sections 18, 19, 20, 22, 23, 24, 25, 26, 27, 28, 32 and 33 of the Act. The applicant is required to express in his own words the substance and intent of these sections.

Referring to the International Radiotelegraphic Convention the applicants should study Article 9, 9 bis, 11, 18, 19, 21, 24 quater, 25, 26, 27 and 27 ter. The important Q signals and their meaning such as those used extensively in commercial procedure should be memorized.

Broadcast Grade—Unlimited and Limited—The only difference between these two classes of licenses is the omission of the code test in the latter.

Diagram—A diagram of a modern broadcast transmitter is required. The diagram shown in Chapter 6 as figure 174 is acceptable. The diagram of the Western Electric Receiving outfit type 6004-C, shown in Chapter 12 as figure 248, is acceptable as the receiver. Any other modern type of receiver fitted with a wave-trap and capable of tuning to the 600 meter wavelength is also acceptable.

Transmitting and Receiving Apparatus—Questions are asked to ascertain the applicant's knowledge of vacuum tube transmitters, Piezo quartz oscillators, wave-traps, receivers, speech amplifiers, microphones, modulating systems, characteristics of power tubes, methods of determining power input to power tubes, elimination of harmonic frequencies and other subjects pertaining to the operation of radio telephone and broadcasting transmitters.

Storage Batteries and Motor Generators—The requirements of these subjects are the same as for the commercial first and commercial second class license.

Radio Laws and Regulations—In addition to a knowledge of the Radio Act of 1927 and International Telegraphic Convention the applicant is required to express in his own words the substance and intent of various General Orders issued by the Federal Radio Commission. These are General Orders number 7, 16, 31, 48, 52, 53 and 66.

Radiotelephone Class—No code test is required for this class of license. The practical and theoretical examination for this class of license shall consist of questions on adjustment and operation of radiotelephone apparatus and knowledge of international regulations governing radio communication and the United States Radio Laws and Regulations. The applicant must demonstrate his ability to transmit and receive clearly conversation by telephone apparatus. Whenever possible, a demonstration of the applicant's ability to operate radiotelephone apparatus will be required. A percentage of 75 will constitute a passing mark. Holders of this class of license are authorized to act as operators only at licensed radiotelephone stations, other than broadcast or amateur, of 300 watts or less input power.

This license is of particular interest to aviators whose planes are fitted with low power radiotelephone transmitters. In preparation for this examination the applicant should study Chapters 4, 5, 6, 15 and 19. The applicant is not required to draw a main diagram.

Amateur Class License—Applicants who are examined for this class of license are required to draw a diagram of the transmitting and receiving set they propose to operate. The transmitter should be connected in such a manner as to agree with the regulations governing the operation of amateur stations. An explanation is required telling how to tune the transmitter and place it on the air and in addition to describe how the V.T. generates radio frequency oscillations and how they are received and detected at the receiving end. The Radio Act of 1927 should be read and portions memorized as the applicant is required to tell in his own words the substance and intent of such sections as that pertaining to operating without an operator and station license, secrecy of messages, signals of distress, false signals and calls and the penalties involved for violation of such sections. These subjects are contained in section 5, paragraph b, sections 20, 23, 26, 27, 28, 32 and 33. Of the International Radio Telegraphic Convention Articles 5 ter, 11, 18 paragraph c; 19 paragraph 1; 21, paragraph 1 and 2; and several of the Q signals and their meanings such as QRM and QRT.

Extra First Class Amateur—Applicants having sufficient experience to qualify for this class of license should study Chapters 4, 5, and 16 extensively. A thorough knowledge of the Radio Act of 1927 and International Radiotelegraphic Convention is required, especially those sections enumerated above.

Radio Schools and Institutes—Throughout the United

States there are several radio schools and institutes equipped with modern radio apparatus for the practical instruction of students. Many of such schools are recognized by the Radio Division, Department of Commerce, and their graduates when presenting satis-



(Photo by courtesy of Commercial Radio Institute)

FIG. 347. A code class in a radio school.

factory letters of identification at the time of examination are credited with ten per cent for experience.

The layman or amateur who expects to enter the radio profession as a commercial or broadcast operator should give serious consideration to the idea of entering an accredited radio school or institute in order to prepare for the Government examination. Such schools usually have day and night classes. In addition to practical instruction, the student receives lectures on theory, also code practice one or two hours each day transmitting and receiving traffic similar to that encountered in commercial practice. The length of time required to complete the course depends upon the interest, efforts and adaptability of the student. Usually, from

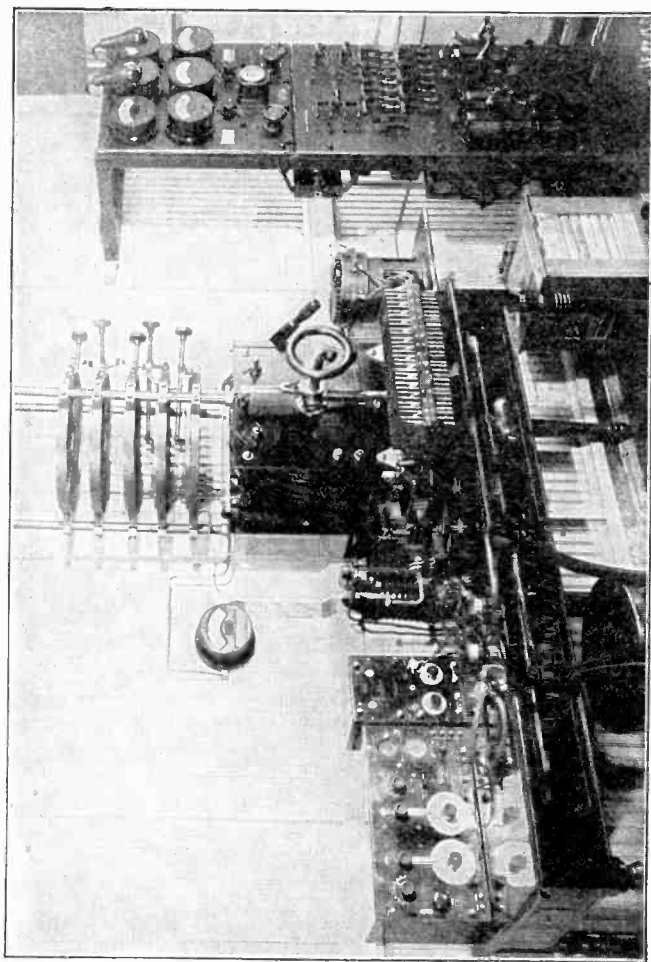

(Phot by courtesy of Commercial Radio Institute, Baltimore, Md.)

FIG. 348. A well-equipped radio school.

nine to twelve months are required of those having no previous knowledge of elementary electricity and magnetism. A licensed amateur with one or two years' experience might complete a commercial course in one or two months less than that stated above.

Radio stations on shipboard are maintained primarily for the protection of life and property at sea. The responsibility of the radio operator is quite apparent. One can never tell what may happen in an emergency. The radio apparatus may be rendered inoperative by a collision, fire, or by constant pounding of a vessel out of control at about the time the master orders the distress call transmitted. The practical operator can meet such an emergency by quickly locating the defects and making temporary repairs, thereby making it possible to summon aid to the stricken vessel. Ten or twelve months of practical instruction at a radio school is time well spent when the responsibility of the position is considered. It also means something to those interested in advancing themselves to a better position ashore after a period at sea.

A list of radio schools is printed below for the benefit of those interested. It is not known whether or not all the schools listed are accredited schools. This can be determined by writing to the Supervisor of Radio of the district in which the school is located. The address of Supervisors is given in Chapter 16.

44. List of Radio Schools in the United States

FIRST DISTRICT

| | | |
|--------------------------------|----------------------|-------------------|
| Mass. Radio & Telegraph | | |
| School | 18 Boylston St..... | Boston, Mass. |
| R. C. A. Institutes, Inc. | 899 Boylston St..... | Boston, Mass. |
| Rhode Island Radio School.... | 111 Empire St..... | Providence, R. I. |
| Essex County Radio School.... | 150 Essex St..... | Salem, Mass. |

SECOND DISTRICT

| | | |
|-------------------------------|-------------------------|---------------------|
| Y. M. C. A. Radio School.... | 66th St. & Broadway.... | New York, N. Y. |
| Radio Institute of America... | 326 Broadway | New York, N. Y. |
| U. S. Signal School..... | | Ft. Monmouth, N. J. |

THIRD DISTRICT

| | | |
|--------------------------------|-------------------------|-------------------|
| R. C. A. Institutes, Inc. | 1533 Pine St..... | Philadelphia, Pa. |
| Commercial Radio Institute .. | 38 W. Biddle St..... | Baltimore, Md. |
| Southern Radio Institute.... | 606 St. Paul..... | Baltimore, Md. |
| National Radio Institute | | |
| (correspondence school | | |
| only) | 16th & U Sts., N.W..... | Washington, D. C. |
| Loomis Radio College | 405 Ninth St., N.W..... | Washington, D. C. |
| R. C. A. Institutes, Inc..... | 1219 N. Charles St..... | Baltimore, Md. |

FOURTH DISTRICT

No radio schools in this district.

FIFTH DISTRICT

| | | |
|---|---------------------------|---------------------|
| Brantley-Draughon College | ..611½ Main St..... | Fort Worth, Texas. |
| Chenier Business College of Beaumont |571 Orleans St..... | Beaumont, Texas. |
| Gulf Radio School |844 Howard Ave..... | New Orleans, La. |
| Port Arthur Business College | ..1500 Proctor St..... | Port Arthur, Texas. |
| Tyler Commercial College | ...201 S. College St..... | Tyler, Texas. |

SIXTH DISTRICT

| | | |
|--|-------------------------------|---------------------|
| Pacific Radio School |433 Call Bldg..... | San Francisco, Cal. |
| Central High School | | Oakland, Cal. |
| W. A. Hammond |3020 Champion St..... | Oakland, Cal. |
| Y. M. C. A. Radio School | | Los Angeles, Cal. |
| National Automotive & Elec- trical School |4006 S. Figueroa St..... | Los Angeles, Cal. |
| Y. M. C. A. Radio School | | Santa Barbara, Cal. |

SEVENTH DISTRICT

| | | |
|---|--|----------------|
| Y. M. C. A. Radio School | ...Y. M. C. A. Bldg., 4th Ave. & Madison St.... | Seattle, Wash. |
| Oregon Institute of Technol- ogy (Y. M. C. A.) |Lownsdale & Taylor Sts. | Portland, Ore. |

EIGHTH DISTRICT

| | | |
|---|------------------------------|------------------|
| Radio Corporation of Penn- sylvania (Accredited) |1338 S. Michigan Blvd.. | Chicago, Ill. |
| Dodge's Telegraph & Radio Institute (Accredited) | | Valparaiso, Ind. |
| Federal Railway Institute | ...517 Wells St..... | Milwaukee, Wis. |
| Airways Technical School (Govt. school) |Chanute Field | Bantoul, Ill. |

Responsibility of Operator in Charge—Radio operators on ships have the status of an officer without executive authority and are usually furnished officers' quarters. The radio service of the ship is under the authority of the master of the vessel, and any instructions given by him must be carried out. However, in the event of such instructions conflicting with United States laws and regulations or International Laws, the operator shall advise the master of the circumstances for his further consideration. Failure to carry out the lawful orders of the master liables the operator to a suspension of his license for a period not to exceed two years.

Transmitting a Distress Call—The distress signal should never be transmitted by an operator unless ordered to do so by the master who at the time should furnish the operator with the position of the vessel, the nature of the disaster and kind of assistance required. The distress call should be transmitted at

a moderate speed with the name of the vessel spelled out and each word and group of figures repeated.

Answering a Distress Call—Upon hearing a distress call transmitted by another vessel the operator should copy all details and if he believes he is close to the vessel requiring aid he should answer the call, providing no interference is caused some other ship engaged in answering the call, acknowledging receipt of the distress message and giving his position. In all probability several vessels will answer the distress call and the operator who transmitted the distress call will designate the vessel or vessels he desires to communicate with relative to securing aid. In the meantime the operator receiving the call should communicate all details of the disaster to the master of his vessel and from then on work under his instructions.

Interference—Usually when a distress signal is transmitted considerable interference results from other vessels relaying such call or trying to tell some other ship who has not heard the call to "QRT SOS." Unless an operator is engaged in answering the distressed vessel he should not start up his transmitter for this purpose but leave it to the operator of the distressed vessel or those with whom he is communicating to silence those stations who are interfering.

As provided in the International Laws the operator will give the clear signal when he desires other stations to resume traffic.

Payment of Salary—Operators are paid directly by the steamship company and are required to sign on the ship's articles at the agreed rate of pay and receive payment of their salary in the same manner and at the same time as other members of the crew.

Key to Radio Room—Upon going ashore the operator must always leave the key to the radio room with the Chief Officer or next in authority.

Station License—When taking over a station the operator should ascertain if the apparatus is properly licensed. On vessels the radio station license is usually kept by the master with other documents of the ship. However, this is unnecessary as the ship's station license should be posted in the radio room where it can be seen by government inspectors and others in authority. If any doubt exists as to the license status of the station, information may be obtained directly from the service company or the office of the Supervisor of Radio or a sub-office.

A government tuning card should be posted in the radio station and the operator should check over the various wavelength set-

tings to see if the correct number of turns of the inductance are engaged as specified on the adjustment card.

Operator's License—The operator's license should also be posted in the station in plain view of radio inspectors and others concerned. This is necessary to facilitate government inspections as required by law.

Care of Apparatus—Under the Radio Act of 1927, the operator is held responsible for the condition of the apparatus and should he willfully allow the apparatus to become damaged, or deteriorated from lack of attention he is liable to suspension of his license for a period not to exceed two years.

Improper Endorsement of Service Record—Any improper alteration of the service record or the forgery of masters' or employers' signature constitutes a violation of the regulations, and the operator may suffer suspension of license for a period not exceeding one year, at the discretion of the Secretary of Commerce.

CHAPTER 20

HANDLING AND ABSTRACTING TRAFFIC

1. **Introduction**—The operator in charge of the station is responsible for all money collected from the public as tolls or messages transmitted. He is required to account for the same at the end of each voyage, or, on ships making short voyages, at the end of each monthly period. When the money is turned in at the office of a service company controlling the radio service of the vessel he will be furnished with a receipt.

Usually the operator collects the money due for messages filed by the captain at the end of the voyage. Messages filed by the public or members of the crew should be collected for at the time of filing the message.

By arrangement with the Radiomarine Corporation of America the author has been permitted to quote directly from their general orders relative to abstracting of traffic. The forms thus referred to in the text apply only to those forms used by this company although the methods employed by other companies are very much the same. By careful study of the following the student should secure an excellent idea of how to make up an abstract sheet at the end of a voyage.

2. **Acceptance of Radiograms**—(19) Radiograms and the money due thereon shall be accepted from passengers by the radio operators in accordance with the following instructions.

(20) Inquiries from the public should at all times be courteously and promptly answered, giving any particulars regarding stations, rates, etc., which may lead to the service being made use of. The number of messages handled on board ship is very largely dependent on the attention given by the operators to such matters, and to the proper advertising of the facilities offered. Operators should be on the alert to stimulate traffic, but should be careful not to resort to advertising methods which might not be approved by the steamship company or captain of the vessel.

(21) All messages accepted from the public or from the bridge must be written on the proper form provided by the corporation or attached thereto in such a manner as not to cover the space reserved for service entries. Messages accepted from the bridge

must be signed or initialed by the captain or his responsible officer before transmission.

(22) Care must be taken to obtain, for reference, the sender's full name, permanent postal address and cabin number on the back of the form; otherwise difficulty and delay may arise should it become necessary at any time to refer to the sender.

(23) The address of a message handed in for acceptance should be as clear and complete as possible to insure correct delivery.

(24) All radiograms accepted for transmission must be written legibly. Should the accepting operator be unable to read the message, he shall request the sender to rewrite or explain whatever is doubtful. If the sender refuses to comply with this request, the operator shall transmit the message as he understands it, and shall note on the back of the form that the sender has refused to rewrite or explain. Any correction, amendment or erasure made in a radiogram handed in for acceptance must be initialed by the sender.

3. Censoring of Radiograms—(25) Any message filed on board pertaining to the business of the steamship company (the ship's health, accidents at sea, service on board, etc.) must be submitted to the captain of the vessel for censoring before being transmitted, and the sender of the message concerned is to be advised of this procedure when the radiogram is handed in. Should the sender refuse to allow the message to be censored by the captain, the operator shall not accept it. All messages filed on board may be censored by the captain if he so desires.

(26) No message containing profane or obscene language may be accepted for transmission.

4. Routing of Radiograms—(27) Should the sender of the message specify the route by which it is required to be sent, the operator shall insert the necessary particulars in the preamble which shall not be counted or charged for. Messages not specifically routed otherwise by the sender shall in all cases be routed by the operator over the corporation's system when available.

5. Receipt to be Given—(28) An official receipt on the Corporation's form No. 10, showing the total amount paid must be given to the sender of each message on which cash is collected. These receipts shall be made out in duplicate, the carbon copy to be pasted on the back of the message concerned. This carbon copy must be an exact duplicate of the original held by the sender, and no change shall be made in the amounts as originally written. Should it be later found that an overcharge has inadvertently been made, the full amount collected must nevertheless be turned in to

the corporation with suitable explanation on the abstract in order that refund may be made to the sender.

(29) The charges collected on each message must be clearly shown in American money in the spaces provided for the purpose on the form on which the message is written. Ship charges, coast station charges and other charges must be entered separately.

6. Numbering of Messages—(30) All messages accepted shall be numbered progressively for the day of acceptance. This is the accepted number which is not to be transmitted. All messages transmitted shall be numbered progressively for the day of transmission and with regard to the station to which transmitted, a separate series of numbers being used for each station.

7. Timing of Messages—(31) The time and date of acceptance of all messages must be written on the message copy and transmitted in the preamble of the message, but shall not be counted or charged for.

8. Language to be Used in Radiograms—(32) Radiograms may be accepted when written in plain language, code, or cipher, except in the case of certain countries which do not admit code or cipher radiograms or only admit them under certain restrictions.

(a) *Plain Language*—Radiograms in plain language are those composed of words, figures, and letters which offer an intelligible meaning. They may be expressed in any of the European languages and certain others, such as Annamite, Arabic, Armenian, Japanese, Malay, Persian and Siamese. The words and letters must be written in Roman characters.

(b) *Code Language*—Radiograms in code language are composed of real words not forming intelligible phrases, or of artificial words consisting of pronounceable groups of letters. The real words may be drawn from any of the following languages: English, French, German, Italian, Spanish, Portuguese, Dutch and Latin. The artificial words must be formed of syllables which are pronounceable according to the current usage of one of these languages.

(c) *Cipher*—Radiograms in cipher are composed of Arabic figures or groups or series of Arabic figures having a secret meaning, or combinations of letters not fulfilling the conditions applicable to plain language or code.

9. Counting and Charging—(33) The number of words in a plain language message is computed on the basis of fifteen letters to each word. Where a word regularly used exceeds fifteen letters it will be charged for as two words. Subject to this limit ordinary compound words, names of towns, countries, provinces,

places, family names and names of ships are counted as single words, provided they are written without a break or hyphen. If joined by a hyphen or separated by an apostrophe, they are counted as so many separate words, and the hyphen or apostrophe, if transmitted, will be chargeable as an additional word. The same mode of counting applies to the names of streets, squares, etc., but the words "street," "square" or their equivalent in other languages cannot be combined contrary to the usage of the language with such names so as to form a single chargeable word. Compound numbers written in words and without a break are also counted as single words, subject to the same limit as to the number of letters.

(34) Words incorrectly spelled, so as to reduce the number of letters below the maximum, or incorrectly joined together contrary to the usage of the language, are inadmissible. Such words as "safternoon," "allright" or "alright," "midocean" and "good-bye" must in all cases be counted and charged for as two words.

(35) In all radiograms every isolated letter or figure is charged for as one word. Groups of figures are counted at the rate of five figures to a word, and at the same rate for any excess. The same method of counting is applicable to groups of letters forming a commercial expression, such as "cod," "fob," or commercial marks. Letters added to figures to form a number of an address or a commercial mark or quotation are considered as figures and charged for accordingly. Bars of division, decimal points and stops used in the formation of numbers are counted as figures. Otherwise signs of punctuation are not transmitted, except at the special request of the sender, and they are then charged for as separate words. The dollar mark (\$) or pound mark (£) is always counted as a separate word.

(36) Code messages are counted at the rate of ten letters to a word. The presence of a code word in an otherwise plain language message converts the entire message into a code message and therefore subjects each word in the text of the message to a ten letter count.

(37) The combination "ch" which is counted as one letter in plain language, must always be counted as two letters when used in code.

(38) Cipher messages must be counted and charged for on the basis of five letters to a word. The letters or figures in each uninterrupted series shall be counted at the rate of five or a fraction of five as one word. The mixture in one group of figures and letters having a secret meaning is permitted, but such groups sub-

ject the count to one word for each letter or numeral, thus R2C counts as three words. This prohibition does not extend to trade terms, such as 106B which are not considered as having a secret meaning.

(39) Groups of letters and figures shall be transmitted in groups, as written by the sender of the message, and must not be divided in transmission, even when counted and charged for as more than one word.

(40) The cable system of counting is used for all radiograms, all words in the address, text and signature being counted and charged for. The message may contain any number of words and no text or signature is required. The address must consist of at least two words, the first indicating the name of the addressee and the second the destination. The name of the office of destination of a radiogram is counted and charged for as one word, without regard to the number of letters required to spell it. The name of the state, province or country in which the office of destination is located may be placed and transmitted in brackets without being counted or charged for. The number of a street written, for example, as 146th is counted as one word, provided the total number of characters, including figures and letters in the group does not exceed five. Telephone numbers appearing in the address must always be followed by the name of the office of destination. Letters following telephone numbers are counted in the same group subject to the limit of five characters.

(41) The following examples will serve to illustrate the rules to be followed in counting radiograms:

| | In Address | Number of Words | |
|--|------------|---|-----------------------------|
| | | In Text Plain Language Message | Code Language Message |
| New York..... | 1 | 2 | 2 |
| Newyork..... | 1 | 1 | 1 |
| Frankfurt Main..... | 1 | 2 | 2 |
| Frankfurtmain..... | 1 | 1 | 2 |
| Newsouthwales..... | 1 | 1 | 2 |
| Dubois (name of a person)..... | 1 | 1 | 1 |
| Vandebrande (name of a person)..... | 1 | 1 | 2 |
| Saint James Street..... | 3 | 3 | 3 |
| Saintjames Street..... | 2 | 2 | 2 |
| Alright) contrary to the usage | | | |
| Allright) of the language..... | | 2 | 2 |
| Times Square..... | 2 | 2 | 2 |
| Timesquare..... | 2 | 2 | 2 |
| Responsibility (14 characters)..... | | 1 | 2 |
| Unconstitutionality (19 characters)..... | | 2 | 2 |
| 44 1/2 (5 characters)..... | | 1 | 1 |

| | In Address | Number of Words | |
|---|------------|------------------------------|-----------------------------|
| | | In Text | |
| | | Plain Language Message | Code Language Message |
| 444 1/2 (6 characters) | | 2 | 2 |
| 444.5 (5 characters) | | 1 | 1 |
| 444.55 (6 characters) | | 2 | 2 |
| E | 1 | 1 | 1 |
| E M (isolated letters) | 2 | 2 | 2 |
| Ch23 (commercial sign or trade mark) | | 1 | 1 |
| GHF456 (Commercial sign or trade mark) | | 2 | 2 |
| Emythf (6 characters, unpronounceable, secret meaning) | | 2 | 2 |
| Twohundredandthirtyfour (23 characters, numbers written out and joined) | | 2 | 3 |
| The affair is <u>urgent</u> leave at <u>once</u> (two underlines) | | 9 | 9 |
| Starokonstantinow (Town in Russia) | 1 | 2 | 2 |
| \$100 | | 2 | 2 |
| Onehundred dollars | | 2 | 2 |
| £100 | | 2 | 2 |
| 10 fr. 50 | | 3 | 3 |
| 11 h 30 | | 3 | 3 |
| 4 1/2 | | 1 | 1 |
| City of Savannah (name of ship) | 1 | 3 | 3 |
| Cityofsavannah (name of ship) | 1 | 1 | 2 |
| USS | 1 | 1 | 1 |
| 949893 (cipher) | | 2 | 2 |
| 106 A (number of house) | 1 | 1 | 1 |
| (no doubt) | | 3 | 3 |
| <u>Totally</u> (underlined) | | 2 | 2 |
| <u>Incontrovertibly</u> (underlined) | | 3 | 3 |

10. **Code Addresses**—(42) Radiograms bearing code addresses may be accepted but the operator should in such cases ascertain from the sender whether the address is registered with the telegraph service required to make delivery of the message at the office of destination. For example, a code address which is only registered with the Western Union Telegraph Company cannot be accepted in a message to be delivered in London by the British Post Office. The corporation will not be responsible for non-delivery of messages carrying code addresses not properly registered.

11. **Prefixes**—(43) The following prefixes shall be used with respect to the different classes of traffic, which must be transmitted in the proper order of priority. These prefixes are only to be used when communicating with RCA ships or coast stations and ships controlled by associated companies. The letter "X" should be dropped from the prefix of relayed messages by

the operator transmitting the message to the station of destination.

| PRIORITY | PREFIX | | CLASSIFICATION |
|--------------|--------------------------|--------------------------------|-------------------------------|
| | <i>When for delivery</i> | <i>When for retransmission</i> | |
| First..... | S O S | S O S | Distress messages |
| Second..... | S | X S | Government messages |
| Third..... | A | X A | Telegraphic service messages |
| Fourth..... | M S G | M X G | "Masters Service" messages |
| Fifth..... | P | X | Ordinary paid messages |
| Sixth..... | P D H | X D H | Franked or dead head messages |
| Seventh..... | PRESSE | XPRESSE | Press messages |
| Eighth..... | O L | | Ocean letters |

(44) Messages within the same class shall be transmitted in the order in which accepted.

12. Government Messages—(48) Messages may be accepted under this classification pertaining to official business of the United States Government. They may be filed by the captain of the ship or by an accredited official or representative of the government on board. Such messages shall be forwarded through U. S. Government costal stations whenever possible.

(49) Government messages may further be of the nature of one or other of the following:

(a) *Govt. S. B.*—Official messages having relation to the navigation or operation of vessels owned or controlled by the U. S. Shipping Board, passing between the master or other accredited official aboard said vessels and officials of the U. S. Shipping Board or accredited agents of the person, firm or corporation assigned as manager, or operator of said vessels.

(b) *Govt. W. B.*—Weather Bureau messages addressed to "Observer." Such messages are not to be transmitted more than twelve hours after the time at which the observation was taken.

(c) *Govt. Hydro.*—Messages containing hydrographic information.

(50) The expression "Govt.," "Govt. S. B.," "Govt. W. B.," or "Govt. Hydro." whichever is applicable, must be transmitted in the preamble and "Govt." as the first item in the address of all government messages, and is counted and charged for as one word. Such messages shall contain no personal matter whatsoever.

13. Telegraphic Service Messages—(51) A service message shall only be sent when it pertains to traffic previously handled.

Every service message must be pasted on the back of the message to which it refers, in the order in which it was transmitted or received, but in such manner that all messages can be easily read.

(52) Whenever it is impossible to deliver a message that has been received, a service must be forwarded immediately to the office of origin of the message which cannot be delivered, stating the reason for non-delivery.

(53) Service message received pertaining to non-delivery due to improper address of a message previously transmitted should be compared with the original message, and if there is any discrepancy, the office reporting non-delivery shall be immediately notified by service of the correct address as appearing on the original message. In such cases it is not necessary to notify the sender.

(54) Should, however, the address as repeated in the service be found to correspond with the address on the original message, a copy of the service message shall be delivered to the sender and a receipt obtained. In such cases the sender can only rectify or complete the address by means of a paid service message.

(55) All service messages are addressed directly to the station or office concerned and signed by the office or origin, followed by the date filed. Such messages must contain the full address and signature of the message to which it refers, and must be transmitted with a number but no check or preamble.

14. Masters Service Messages—(59) Master service messages are those having relation to the navigation or other business in connection with the operation of a ship exchanged between the captain and his owners or duly accredited agents or between the respective captains of two or more ships. Such messages must always be signed or initialed by the captain or his responsible officer before transmission. They shall contain no personal matter whatsoever.

15. Ordinary Paid Messages—(60) These are messages fully prepaid accepted from the public for transmission or received for delivery to the public.

16. Franked or Dead Head Messages—(61) See section of this book pertaining to Franked or Dead Head Messages.

17. Press Messages—(62) These are messages accepted from duly accredited press representatives addressed to newspapers or press agencies for publication. News matter originating on board a vessel shall not be transmitted until the message has been censored and initialed by the captain. Press messages are subject to full tolls over the corporation's system, but will be handled at reduced rates on the landlines.

18. Ocean Letters—(63) This is a class of traffic at special rates accepted under certain conditions fully explained in the section of this book pertaining to Ocean Letters.

19. Special Classes of Traffic—(64) Certain classes of radiograms are indicated by conventional signs transmitted in the preamble and again as the first item of the address. Such signs are counted and charged for in the address as one word. These signs are as follows:

| | |
|---|--|
| Radiograms with prepaid reply.. | RP, and the amount prepaid |
| Collated Radiograms..... | TC. |
| Radiograms to be delivered by mail | The word "Post" |
| Radiograms to be posted as registered letters | PR. |
| Radiograms for special delivery when the cost of delivery is to be collected from the addressee | The word "EXPRESS" |
| Radiograms for special delivery in the country of the coast station through which the message is sent, when the cost of the special delivery is prepaid | XP. |
| Radiograms not to be delivered during the night time | The word "JOUR" |
| Radiograms to be delivered at night time if received then ... | The word "NUIT" |
| Radiograms to be called for at a Telegraph Office | TR. |
| Radiograms to be called for at a Post Office | GP. |
| Radiograms with multiple addresses | TM, and the figure representing the number of addresses. |
| Radiograms with acknowledgment of receipt: | |
| By Telegraph | PC. |
| By Post | PCP. |
| Radiograms to be given priority over the land telegraph system, i.e., urgent messages | D. |
| Paid service advices | ST. |

20. Radiograms with Prepaid Reply—(65) Radiograms may be accepted with an answer prepaid. Full transmission charges for such messages must be collected and in addition the full charges for the reply based on the number of words the sender expects the reply to contain. "Reply Paid" messages are transmitted with the letters "RP" in the preamble and again as the first item in the address, followed by the amount prepaid, as for example "RP two dollars ten cents" or "RP francs 10.50," the entire expression "RP two dollars ten cents" or "RP francs 10.50" being counted and charged for as one word.

(66) When an "RP" message is received at its office of destination the receiving operator will deliver to the addressee with the message a Reply Paid Voucher (Form No. 11-A) covering the amount prepaid for a reply. Such a voucher will be accepted to the extent of its face value in lieu of cash in whole or part payment for any reply or other telegram which the holder may wish to send from the vessel on which the voucher was issued. Vouchers so accepted must be pasted on the back of the message for which it was taken in payment. A frank held by the sender of an "RP" message does not cover any of the charges due for the reply.

21. Collated Radiograms—(67) The sender of a radiogram may request that the message be repeated back to the sending station for the purpose of verification. Such messages may be accepted upon payment by the sender of an additional charge equal to one-half the regular tolls. The expression "TC" must be transmitted in the preamble and again as the first item of the address. A message carrying the expression "TC" must always be repeated back by each station immediately upon its being received.

22. Radiograms to be Delivered by Mail—(68) The address of this class of message must be drawn up in the following manner:

(a) The paid indication "Post" followed by the name of the port at which the radiogram is to be posted.

(b) Full name and address of the addressee.

(c) Name of the ship station from which the radiogram is to be posted. For example, the SS Philadelphia, wishing to send a radiogram to be posted from the SS Caracas at New York would address the message as follows:

Post New York John Smith
75 N. Charles St.,
Baltimore, Md.
Caracas.

(69) When a radiogram is handed in at an inland telegraph office for transmission through a land station to a ship station, to be posted from the latter at a port of call, the name of the land station must be included in the address. For example, a person wishing to transmit a message from Boston to be posted from the SS Huron on arrival at Buenos-Aires would address it as follows:

Post Buenos-Aires Jose Lopez
560 Calle Lavalle
Huron Cape May.

(70) Five cents for postage will be collected on such messages in addition to the radio charges. If message is to be forwarded by registered mail the expression "PR" is used instead of "Post" and fifteen cents collected for postage instead of five.

23. Radiograms for Special Delivery—(71) These are messages which involve delivery beyond the ordinary limits of the telegraph service. Such delivery is accomplished by special messenger or telephone. Charge for special delivery will be collected from the addressee so that only the usual rates are to be collected from the sender. Such messages are transmitted with the expression "Express" in the preamble and again as the first item of the address.

(72) Pre-payment of the special delivery charge may be allowed where the message is destined for the country in whose territory the receiving coast station is situated. Such messages are transmitted with the expression "XP" in the preamble and again as the first item of the address.

It should be noted, however, that in the United States the land-line rates for radio messages cover delivery to any point in a given state.

24. Radiograms to be Called for at a Telegraph or Post Office—(73) Radiograms from ships when intended to be left until called for at a telegraph office or post office should bear the words "Telegraphe Restante" or "Poste Restante" as required, as the first item of the address (counted as two words in each case), or the abbreviation "TR" and "GP" respectively may be used to represent these expressions, in which case the abbreviated sign will be counted and charged for as one word.

25. Radiograms with Multiple Addresses—(74) Radio-

grams may be accepted addressed either to several persons in the **same town**, or to the same person at several addresses in the **same town**; but to be transmitted by radio as a single message. In computing radio charges each word in all the addresses and the text is counted but once, but the landline tolls must be computed for so many different complete messages (cable count), as the landline telegraph companies in the United States do not recognize multiple messages. The expression "TM" followed by the number of addresses must be transmitted in the preamble and again as the first item of the address. Thus a multiple message with five addresses would carry the expression "TM5."

26. Radiograms Calling for Acknowledgement of Receipt—(75) Such messages must originate on shore and cannot be accepted on board ship. Acknowledgment of receipt is limited to notification to the office of origin of the date and hour at which the coastal station shall have transmitted to the station on ship-board a radiogram addressed to the latter. These messages are transmitted with the expression "PC" or "PCP" in the preamble and again as the first item of the address. "PC" calls for telegraphic acknowledgments and "PCP" for acknowledgment by mail. Mail acknowledgments are sent free. If telegraphic acknowledgment is requested the sender will be required to pay, in addition to the usual charges, the landline telegraph charges on a five word telegram by the same route.

27. Urgent Radiograms—(76) Certain foreign countries permit an urgent classification. Such messages are given no preference in the radio transmission but have priority on the inland telegraph systems of the countries permitting them. Extra landline charges must be collected, usually about double the ordinary rate. The letter "D" must be transmitted in the preamble, and again as the first item of the address.

28. Paid Service Messages—(77) Such messages may be accepted from the sender of and pertaining to a previous message for various reasons, as, to rectify or complete an address, rectify or complete the text, or to cancel a message. Paid service notices requesting a repetition or information are prohibited. The expression "ST" must be transmitted in the preamble and again as the first item of the address.

29. Order of Transmission—(78) All messages shall be transmitted in the following order:

- Prefix
- Number of message

Letter "M" (indicating vessel controlled by Radio Corp. of America).

Number of words (check)
 The word "radio" (required by law)
 Office of origin
 Time filed
 Date filed (only if different from date sent)
 Service instructions (if any)
 Address
 Text
 Signature

30. Received Traffic—(79) All messages received for delivery on board must be copied on Form No. 4 and Ocean Letters received for mailing on Form No. 275. Messages received for relay must be copied on Form No. 2, and service messages on Form No. 106A.

31. Delivery—(80) Messages delivered to the public (including the captain, passengers and crew) must be enclosed in a delivery envelope (Form No. 128) and handed to the addressee, from whom a delivery receipt must be obtained. This receipt is to be pasted on the back of the office copy of the message.

(81) Operators should bear in mind the importance of such receipt in the event that refund of tolls should be claimed for alleged non-delivery. In such cases, if the corporation is unable to prove delivery through negligence of an operator to obtain the signature of the addressee on a delivery receipt, the operator responsible will be held liable for the amount refunded by the corporation.

32. Non-Delivery—(82) In the event that for any reason delivery cannot be effected of any message received on board, a service message must be sent advising the office of origin of non-delivery. See paragraphs covering telegraphic service messages.

(83) Messages undelivered or not transmitted shall never be destroyed by the operator. A notation covering the circumstances should be made on such messages which must be abstracted and handed in with other traffic returns.

Franked or Dead Head Messages.

33. Free Transmission—(86) Franked messages are entitled to free transmission throughout the marine service of the corporation (with the exception of the ship tax of vessels operated under contract with the U. S. Shipping Board) but are sub-

ject to all "Other Line" charges, including charges of associated companies' ships and coast stations.

34. Classification of Franked Messages—(87) Franked or "Dead Head" messages may be of any one of the following classes:

(a) Messages filed by holders of the corporation's complimentary frank cards, properly countersigned, which must be exhibited at the time message is handed in.

(b) Messages pertaining to the corporation's business filed by duly authorized representatives of the corporation.

(c) Personal messages of the operators, limited to thirty words per ship per calendar month, which must be signed with the sender's full name. This privilege is not cumulative, only thirty free words per ship being allowed during each calendar month, regardless of the number of words used during the preceding months.

(88) Franked messages filed by the holders of the corporation's frank cards are only to be accepted when they are of a personal or social nature. Business or political messages cannot be franked.

(89) It must be particularly noted that the ship tax must be collected on all franked messages to or from U. S. Shipping Board vessels operated and controlled by the corporation.

(90) "Other Line" charges may also be franked upon presentation by the sender of a bonafide frank of the telegraph company concerned.

(91) Franked numbers must be inserted in the service instructions on the message copy and transmitted in the preamble of the message, except that an RCA frank number need not be transmitted if the message is sent to other than an RCA station. For example, if the holder of an RCA frank files a message on board an RCA ship to be forwarded through a naval coast station, the frank covers only the ship tax, and therefore is of no interest to the coast station and should not be transmitted.

Ocean Letters.

(92) The Ocean Letter is a class of radiogram which may be sent from one ship to another ship going in a different direction, for delivery by registered mail from the first suitable port of call of the latter vessel. Conditions covering the acceptance and transmission of Ocean Letters are as follows:

(a) The maximum length of such messages shall be 100 words, cable count.

(b) They shall only be exchanged between ships proceeding in different directions.

(c) Only one ship to ship transmission is permitted.

(d) They must be written in plain language only and the sender may not choose the ship via which the message is to be sent or the port from which it is to be mailed.

(e) No abbreviated addresses are allowed and the given name or the designation "Mr.," "Mrs.," "Miss," etc. should always be included in the address of this class of message. Ocean Letters may not contain multiple addresses.

(f) Under no condition whatever may such messages be sent to a coast station for delivery by mail.

(g) Transmission of Ocean Letters is not to interfere with the prompt despatch of ordinary traffic and such messages shall not be transmitted when either of the ships concerned is within the normal daylight working range of a shore station open for commercial traffic and no interference with the ordinary working of other stations in the neighborhood is to be caused by the transmission of Ocean Letters.

(h) Ocean Letters are to be transmitted only to ship stations of the corporation or associated companies, with the exception of the Italian Company, which company only admits this class of traffic when the handling is performed exclusively between ships of Italian registry. Ocean Letters can be handled between Shipping Board vessels, regardless of Radio Company control. Modification applies only to U. S. Shipping Board vessels and Ocean Letters handled must be in strict accordance with paragraphs 82 to 78, inclusive, of General Orders.

(93) As the sender of an Ocean Letter may not specify or select any particular route by which it is to be forwarded, and as this duty falls upon the operator, it is obvious that discretion should be exercised when clearing Ocean Letters. The receiving vessel shall be selected carefully from among such ships as are available. If the operator has a choice of several ships through which to forward Ocean Letters, preference should be given, if possible, to passenger ships bound for the country to which the message is destined. Speed of the vessel and her next port of call should also be taken into account. Operators should in all cases select from among ships within range the vessel which, in their opinion, is likely to effect the speediest delivery to office of destination.

(94) The prefix "O. L." and the service instruction "Ocean Letter" must be signalled to the receiving ship.

(95) When an operator is in receipt of Ocean Letters for mailing, he must exercise his best judgment as to the most suitable port from which to forward them and should always be guided by the nature of the postal facilities offered, with a view to there being as little delay as possible between the time of mailing and actual delivery to the addressee. For this reason Ocean Letters should be registered and mailed at the earliest possible moment after arrival at a suitable port. Registry receipts in respect to such messages will be accepted from the operator in lieu of cash when he turns in his traffic. In case registration cannot be effected, the message shall be forwarded by ordinary letter mail and a note of explanation made on the back of the office copy.

(96) Ocean Letters accepted on board shall be written on Form No. 274 and Ocean Letters received for mailing shall be written on Form No. 275. Form No. 128 with delivery receipt attached shall be used for mailing Ocean Letters.

(97) The rate for Ocean Letters is \$1.20 for twenty words plus 4 cents per word for each word after twenty (maximum of one hundred words) inclusive of postage and registration.

Relay Traffic.

35. Form to be Used—(98) All messages received for relay shall be received on Form No. 2.

36. Abstracting—(99) All relayed messages must be entered on the abstract and copies handed in with the traffic returns. Under no circumstances, shall a message be relayed without a copy being kept by the relaying station. This is imperative.

37. Free Relay Service—(100) Ships operated and controlled by the corporation will relay free of retransmission charge messages for other ships operated by the corporation, or by one of the associated companies listed in this book; also for any ship of the United States Navy or other United States Government Department. Relay service performed by or for ships other than the above will be subject to a relay charge of 8 cents per word, except that traffic shall be relayed to or from any of the corporation's ship or shore stations free of charge regardless of the control of the ship for which such service is performed.

(101) Care should be taken to collect relay charges on messages accepted on board for relay via a ship not included in the reciprocal arrangements referred to above and to show on the

abstract relay charges due from the steamship company and from other wireless telegraph systems.

"This Line" Privileges.

38. **"This Line" Stations**—(102) All vessels on which the radio stations are operated and controlled by the corporation under rental or service contracts and all marine coastal stations operated by the corporation, together with vessels operated and controlled by associated companies, are known as "This Line" stations and are entitled to "This Line" privileges. All other vessels equipped with radio are known as "Other Line" stations and are not entitled to "This Line" privileges.

(103) "This Line" privileges comprise:

- (a) Transmission of "Master's Service" messages (MSG's) free of ship tax.
- (b) Participation in "Ocean Letter" service.
- (c) Free Re-transmission.

39. **"Other Line" Stations**—(104) Messages of class (a) transmitted to or received from any "Other Line" ship direct are subject to one receiving ship tax; for example, a "Master's Service" message transmitted from a "This Line" station to an "Other Line" ship station, should be charged as follows:

"This Line"—ship tax free.

"Other Line"—ship tax to be collected from sender.

Similarly, in cases of "Master's Service" messages received from an "Other Line" ship station, the "This Line" charge is to be entered on the abstract as due from the "Other Line" transmitting station.

40. **Free Relay Service**—(105) Free re-transmission or relay service will be performed for or by all "This Line" stations free of charge. However, all relayed messages must be abstracted by the relaying ship and under no circumstances should such messages be treated as having been handled direct.

(106) All relay service performed for and by "Other Line" stations shall be subject to the ship tax of the relaying ship and must be so abstracted. However, this will not apply to vessels of the United States Navy and other United States Government Departments with which the corporation has reciprocal relay arrangements.

(107) It must be particularly noted that Ocean Letters may not be forwarded to or received from "Other Line" stations.

(108) Operators may determine the names of "This Line" stations by reference to the International List of Radiotelegraph Stations and the list of associated companies given in this book.

Log Sheets.

(128) Form No. 6 is to be used for keeping a record of all important routine matters during the voyage, and of all communications with other stations.

(129) In compiling logs the following points shall be observed:

(a) On vessels where continuous watch is maintained an entry must be made at least every fifteen minutes of the voyage; on vessels having one operator similar entries shall be made during the times he is on duty.

(b) Each sheet of the log must be numbered and dated.

(130) The following shall be recorded:

(a) All communications established and reason.

(b) Call letters of other stations communicating and a few words of intercepted messages.

(c) Distress calls, unusual and special incidents. Such entries shall be the subject of a special report to be compiled by the operator-in-charge and handed in or forwarded promptly to the Division Superintendent.

(d) Delays in disposing of traffic or gaining attention of coastal or other stations and reason, break down of apparatus, failure of engine-room current supply, noises or disturbances tending to delay traffic.

(e) Arrival at and departure from ports.

(f) Position report of vessel in miles from some given point once each day. (Noon position preferred.)

(131) Logs must be signed as follows:

(a) On vessels carrying two or more operators, at change of each watch, both the relieved and relieving men shall sign. At end of voyage, senior operator shall sign completed log, as operator-in-charge.

(b) On vessels carrying one operator, completed log shall be signed at end of voyage.

(132) Upon completion of voyage the log sheets must be fastened together in numerical order and handed in with the trip's reports.

(133) All information entered on log must be regarded as strictly confidential.

(134) The time used for making entries in the log must be stated at the top of the sheet, i.e., Greenwich mean time, 75th meridian time, or whatever time is used, depending on the trade in which the vessel is engaged. It should be noted that for radio purposes 0000 G. M. T. represents midnight at the meridian of Greenwich which is equivalent to 7 p.m. 75th meridian time or 4 p.m., 120th meridian time, the time changing one hour for each fifteen degrees longitude.

(135) Below is given an extract from a well-kept log and operators should model their logs accordingly, paying particular attention to neatness, legibility of writing and accuracy of the time entries:

S. S. "HURON"

January 1st, 1922.

| <i>Date</i> | <i>Time</i> | <i>Remarks</i> |
|-------------|-------------|--|
| Jan. 1 | 9.00 a.m. | 75th meridian time. Senior Operator J. Smith and Junior Operator E. Ward reported for duty. |
| | 11.00 | Left Pier 1, North River, New York, enroute Havana, Cuba. On watch, J. Smith |
| | .15 | WNY de KUSD—Tr Huron left NY 11 a.m. enroute Havana, QRU—QTC? |
| | .25 | KUSD de WNY—R QRU |
| | .40 | KUSD de KDOW—R No. 1 "MSG". WNY de KUSD—S No. 1 "P" KUSD de WNY—R QRU |
| | .50 | NQF de NAH—No answer. |
| 12.00 | Noon | QST de NAA—Time tick and weather report. (Record weather report.) |
| | .30 p.m. | Off watch—J. Smith On watch—E. Ward. |
| | .35 | Engine room advise dynamo temporarily out of commission. Power not available for short period. |
| | .50 | Nil.—X's bad. |
| | 1.00 | Engine room advise power now O.K. |
| ETC. | | |

Rates.

41. Computing Rates—(160) Tolls chargeable on a radiogram to or from a ship at sea are computed by adding together the charges of the various stations or systems handling the message during its transmission from the office of origin to the office of destination. The factors entering into the total rate consist of the charge of the ship station referred to as the ship tax; the charge of the relaying ship, if any, referred to as the relay charge; the charge of the coast station through which message was routed referred to as the coast tax; and landline, cable, or trans-oceanic radio charges referred to as forwarding charges.

(161) Therefore the total rate per word to be charged on a message originating on a ship at sea destined to some point on shore is arrived at by adding together the following separate rates:

Ship tax of ship of origin.

Relay charge (if any).

Coast tax of station through which message is routed.

Forwarding charges from coast station to destination.

(162) The total rate per word to be charged on a message originating on a ship destined to some other ship is arrived at by adding together the following separate rates:

Ship tax of ship of origin.

Relay charge (if any).

Ship tax of ship of destination.

(163) The total rate per word thus computed multiplied by the number of chargeable words in the message (to which must be added war tax on messages filed within the three mile limit) gives the total charge on the message.

42. R. C. A. Rates—(164) The ship tax of all vessels controlled by the Radio Corporation (except ships plying the Great Lakes) is 8 cents per word, no minimum. The coast tax of all coastal stations controlled by the Radiomarine Corporation is 10 cents per word, no minimum.

43. Relay Charges—(165) The same charge of 8 cents per word is made for relay service performed for vessels controlled by radio systems with which the corporation has no reciprocal relay arrangement. In general, the relay charge of all ships is the same as their rate of ship tax and the relay charge of coast stations is the same as their rate of coast tax.

44. Rate Sheets—(166) All ships controlled by the corporation will be furnished with a Berne List and rate sheets from which coast station and forwarding charges may be ascertained.

45. Obtaining Rates by "QSJ"—(167) Whenever there is

any doubt regarding the proper rate to be charged, the ship operator must obtain the rate by means of the abbreviation "QSJ" from the coast station or ship to which message was sent. Operators obtaining rates by "QSJ" must definitely ascertain the currency in which the rate is expressed and whether the amount given covers both coast tax and forwarding charges. An explanatory notation regarding rates so obtained must be made in the "Remarks" column of the abstract. In addition to this an exact copy of the information requested and also the reply obtained must be written on service blanks (Form 106-A) which shall be attached to the message to which they apply. This is required as a permanent record in the event of any question arising at a later date regarding the rates quoted.

46. Ocean Letter Rates—(168) The rate for Ocean Letters filed on board a vessel controlled by the corporation is \$1.20 for twenty words, plus 4 cents per word for each word after twenty (maximum of 100 words) inclusive of postage and registration. It shall be noted, however, that Ocean Letters at this rate can only be accepted for forwarding via a ship controlled by the corporation or an associated company.

47. Government Rates—(169) Messages on United States Government business, carrying the abbreviation "Govt." as the first word of the address, are entitled to government rates on the landlines within the United States. The government landline rate is computed by deducting one cent from the regular landline rate per word for commercial messages, and dividing the remainder by two. For example, if the commercial rate is 6 cents per word the government rate will be $2\frac{1}{2}$ cents per word.

(170) Government messages may be forwarded through United States Naval stations free of coast tax, but if sent through commercial coast stations, regular coast tax must be charged. No ship tax will be charged on such messages by United States Naval vessels or other United States Government vessels, including vessels operated by the United States Shipping Board.

(171) The rate for "Observer" (Govt. WB) messages, when forwarded through coastal stations other than those of the United States Navy, is 8 cents per word ship tax, plus the actual coastal station rate and landline charge. When forwarded through a U. S. Naval coastal station the only charge is 4 cents per word ship tax, no coast tax or landline charge being applied. If the message originates on a vessel of the United States Shipping Board, no ship tax is charged. Observer messages will be relayed by RCA

ships free of charge, regardless of the control of the ship on which they originate.

(172) No ship tax is charged on "Hydrographic" (Govt. Hydro) messages, and if sent to a U. S. Naval station no coast tax or landline forwarding charges are applied.

48. Undercharges—(173) Operators will be required to personally make good any undercharges due to the use of incorrect rates or other mistakes in the calculation of the charges due on a message.

Shipping Board Vessels.

49. Special Instructions—(195) The instructions in this section apply only to operators assigned to Shipping Board vessels. Should any part thereof conflict with other sections of this book, Shipping Board operators will comply with instructions given in this section.

50. Contract with Shipping Board—(196) The corporation operates and maintains under contract the radio service on a number of ships owned by the U. S. Shipping Board. Under the terms of this contract the Shipping Board has engaged the corporation to act as its radio service agent. The corporation inspects repairs and maintains the radio apparatus and storage batteries on board these ships in efficient working condition, assigns operators, attends to accounting for traffic and generally performs all service work in connection with the Shipping Board's radiotelegraph business.

51. Status of Shipping Board Operators—(197) The operators on these vessels are paid by the Shipping Board, through its agents, and are responsible to the Shipping Board and to the Master of the ship. However, the corporation is responsible for the proper care of the apparatus and conduct of the radio service, and under its contract has full jurisdiction over radio operators, and all operators will be expected to adhere strictly to instructions issued by the corporation. Our contract provides that radio operators on Shipping Board vessels shall be treated as officers but without executive authority, and shall be provided accommodations suitable for an officer.

52. Official U. S. S. B. Messages—(202) Official messages having relation to the navigation or operation of vessels owned or controlled by the Shipping Board, passing between Master or other accredited officials aboard said vessels, and officials of the Shipping Board, or accredited agents of the person, firm or corporation assigned as manager or operator shall be handled without ship charges. On these messages all other line charges and coast station charges must be collected by the radio operator from the

master or official of the Shipping Board sending said message when message is filed; however, until further notice, no coast station charge shall apply if the message is sent through a station of the United States Navy, provided message is transmitted with the special prefix "Govt. S. B." and carries the abbreviation "Govt." as the first word of the address. No message shall be deemed an official message if it contains any matter whatsoever of a personal nature; any such message must be prepaid at commercial rates by the sender. Operators will be held personally responsible for failure to collect proper charges.

(203) "Govt. S. B." messages should, whenever possible, be forwarded through U. S. Naval coastal stations. If sent through a commercial shore station full coast station tolls must be collected. Shipping Board vessels on bare-boat charter or sold on deferred payment plan are not entitled to "Govt. S. B." privileges.

53. Government Rates—(204) "Govt. S. B." messages are entitled to government rate on landlines (Western Union and Postal) within the United States regardless of whether they are forwarded through U. S. Naval or commercial stations. However, in both cases the prefix "Govt. S. B." and the abbreviation "Govt." as the first word of the address must be transmitted.

54. Personal Messages—(205) Full tolls at commercial rates including ship charge, must be collected from the captain or members of the crew on personal messages. Such messages shall be approved by the captain before transmission. This also applies to personal messages of the radio operator.

55. U. S. S. B. Time and Date Code—(209) When an official message is filed for transmission on a Shipping Board vessel the operator shall insert as the last word of the message immediately preceding the signature a five figure code which shall designate the time and date the message was filed. The first two figures shall designate the hour from 0 (midnight) to 23 (11 p.m.) the middle figure the nearest ten minute period and the last two the date (inserting 0 if less than 10). For example, a message filed at 2:40 a.m. on the 3d day of the month would be numbered 02403; a message filed at 4:27 p.m. on the 25th day of the month would be 16325; 8:08 p.m. on the 30th day of the month would be written 20130. The local standard time of the radio station through which message is transmitted shall be used.

Hours of Watch.

(189) On ships carrying two or more operators continuous watch must be maintained throughout the voyage. The operator

on watch must wear the head 'phones at all times and under no circumstances shall he leave the radio room, unless relieved.

(190) On vessels carrying but one operator, the hours of watch shall be arranged to conform to the wishes of the master, except on Shipping Board vessels, where the following schedule of watches must be maintained.

| Zones. | Western Limit. | Eastern Limit. | Times of Watch for One Operator, Greenwich Mean Time. |
|---|--|---|--|
| A. Eastern Atlantic, Mediterranean, North Sea, Baltic, Western Arctic Sea. | Meridian of 30° W., Coast of Greenland. | Meridian of 30° E. to the South of the Coast of Africa. Eastern limit of Mediterranean, Black Sea, and of the Baltic, 30° E. to the North of Coast of Norway. | from 8 h. to 10 h. 12 h. to 14 h. 16 h. to 18 h. 20 h. to 22 h. |
| B. Indian Ocean, Eastern Arctic Sea. | Eastern Limit of Zone A. | Meridian of 90° E. | from 0 h. to 2 h. 12 h. to 14 h. 16 h. to 18 h. 20 h. to 22 h. |
| C. China Sea, Western Pacific Ocean, | Eastern Limit of Zone B. | Meridian of 160° E. | from 0 h. to 2 h. 4 h. to 6 h. 12 h. to 14 h. 20 h. to 22 h. |
| D. Central Pacific Ocean. | Eastern Limit of Zone C. | Meridian of 140° W. | from 0 h. to 2 h. 4 h. to 6 h. 8 h. to 10 h. 20 h. to 22 h. |
| E. Eastern Pacific Ocean. | Eastern Limit of Zone D. | Meridian of 70° W. South of the Coast of America, West Coast of America. | from 0 h. to 2 h. 4 h. to 6 h. 16 h. to 18 h. 20 h. to 22 h. |
| F. Western Atlantic Ocean and Gulf of Mexico. | Meridian of 70° W. South of the Coast of America, East Coast of America. | Meridian of 30° W. Coast of Greenland. | from 0 h. to 2 h. 12 h. to 14 h. 16 h. to 18 h. 20 h. to 22 h. |

HANDLING AND ABSTRACTING TRAFFIC 765

R. C. A. RATE SHEET

| Via | | WCC | WIM | WSA | WNY | WSH | WSC | WPA | KPH | KSE | Via | | WCC | WIM | WSA | WNY | WSH | WSC | WPA | KPH | KSE | |
|----------------|---------------|-----|-----|-----|-----|-----|-----|-----|-----|-----|-----------------|----|-----|-----|-----|-----|-----|-----|-----|-----|-----|----|
| To | | 07 | 17 | 14 | 14 | 07 | 06 | 06 | 11 | 11 | To | | 03 | 03 | 03 | 03 | 03 | 03 | 07 | 09 | 09 | 07 |
| Alabama | Alaska | 11 | 15 | 13 | 13 | 13 | 13 | 06 | 11 | 15 | New Jersey | 03 | 03 | 03 | 03 | 03 | 03 | 03 | 07 | 09 | 09 | 07 |
| Arizona | Arkansas | 11 | 11 | 11 | 07 | 06 | 06 | 06 | 11 | 11 | New Mexico | 03 | 03 | 03 | 03 | 03 | 03 | 03 | 07 | 09 | 09 | 07 |
| Bris. Columbia | California | 11 | 11 | 09 | 07 | 07 | 04 | 04 | 11 | 11 | New York City | 03 | 03 | 03 | 03 | 03 | 03 | 03 | 07 | 09 | 09 | 07 |
| Colorado | Connecticut | 03 | 07 | 09 | 11 | 11 | 11 | 11 | 11 | 15 | Other Offices | 04 | 06 | 06 | 06 | 06 | 06 | 06 | 06 | 06 | 06 | 06 |
| Dist. Columbia | Florida | 04 | 07 | 09 | 11 | 11 | 11 | 09 | 11 | 11 | North Carolina | 05 | 05 | 05 | 05 | 05 | 05 | 05 | 06 | 06 | 06 | 06 |
| Key West | Other Offices | 11 | 05 | 11 | 15 | 15 | 15 | 09 | 11 | 15 | North Dakota | 05 | 05 | 05 | 05 | 05 | 05 | 05 | 06 | 06 | 06 | 06 |
| Georgia | Illino. | 07 | 06 | 07 | 07 | 07 | 07 | 07 | 11 | 11 | Nova Scotia | 05 | 05 | 05 | 05 | 05 | 05 | 05 | 06 | 06 | 06 | 06 |
| Illinois | Indiana | 06 | 07 | 07 | 09 | 09 | 09 | 09 | 11 | 11 | Ohio | 05 | 05 | 05 | 05 | 05 | 05 | 05 | 06 | 06 | 06 | 06 |
| Indiana | Iowa | 06 | 07 | 07 | 07 | 07 | 07 | 07 | 11 | 11 | Oklahoma | 05 | 05 | 05 | 05 | 05 | 05 | 05 | 06 | 06 | 06 | 06 |
| Iowa | Kansas | 07 | 07 | 07 | 07 | 07 | 07 | 07 | 11 | 11 | Oregon | 05 | 05 | 05 | 05 | 05 | 05 | 05 | 06 | 06 | 06 | 06 |
| Kansas | Kentucky | 06 | 06 | 07 | 11 | 11 | 11 | 11 | 11 | 11 | Pennsylvania | 03 | 03 | 03 | 03 | 03 | 03 | 03 | 06 | 06 | 06 | 06 |
| Kentucky | Laborator. | 16 | 10 | 19 | 21 | 21 | 21 | 21 | 11 | 11 | Philadelphia | 03 | 03 | 03 | 03 | 03 | 03 | 03 | 06 | 06 | 06 | 06 |
| Laborator. | Louisiana | 07 | 06 | 06 | 11 | 11 | 11 | 11 | 11 | 11 | Other Offices | 03 | 03 | 03 | 03 | 03 | 03 | 03 | 06 | 06 | 06 | 06 |
| Louisiana | Maine | 04 | 07 | 09 | 11 | 11 | 11 | 11 | 11 | 11 | Prince Edw. Is. | 08 | 08 | 08 | 08 | 08 | 08 | 08 | 06 | 06 | 06 | 06 |
| Maine | Manitoba | 09 | 09 | 09 | 11 | 11 | 11 | 11 | 11 | 11 | Quebec | 06 | 06 | 06 | 06 | 06 | 06 | 06 | 06 | 06 | 06 | 06 |
| Manitoba | Maryland | 04 | 07 | 09 | 11 | 11 | 11 | 11 | 11 | 11 | Rhode Island | 03 | 03 | 03 | 03 | 03 | 03 | 03 | 06 | 06 | 06 | 06 |
| Maryland | Massachusetts | 03 | 07 | 09 | 11 | 11 | 11 | 11 | 11 | 11 | Saskatchewan | 14 | 14 | 14 | 14 | 14 | 14 | 14 | 06 | 06 | 06 | 06 |
| Massachusetts | Mexico | 20 | 20 | 20 | 20 | 20 | 20 | 20 | 11 | 11 | South Carolina | 09 | 09 | 09 | 09 | 09 | 09 | 09 | 06 | 06 | 06 | 06 |
| Mexico | Michigan | 06 | 07 | 09 | 11 | 11 | 11 | 11 | 11 | 11 | Tennessee | 06 | 06 | 06 | 06 | 06 | 06 | 06 | 06 | 06 | 06 | 06 |
| Michigan | Minnesota | 07 | 09 | 09 | 11 | 11 | 11 | 11 | 11 | 11 | Texas | 06 | 06 | 06 | 06 | 06 | 06 | 06 | 06 | 06 | 06 | 06 |
| Minnesota | Missouri | 12 | 15 | 15 | 18 | 18 | 18 | 18 | 11 | 11 | Utah | 04 | 04 | 04 | 04 | 04 | 04 | 04 | 06 | 06 | 06 | 06 |
| Missouri | Mississippi | 07 | 07 | 07 | 09 | 09 | 09 | 09 | 11 | 11 | Vermont | 04 | 04 | 04 | 04 | 04 | 04 | 04 | 06 | 06 | 06 | 06 |
| Mississippi | Montana | 09 | 09 | 09 | 09 | 09 | 09 | 09 | 11 | 11 | Virginia | 05 | 05 | 05 | 05 | 05 | 05 | 05 | 06 | 06 | 06 | 06 |
| Montana | Nebraska | 07 | 11 | 11 | 11 | 11 | 11 | 11 | 11 | 11 | Washington | 05 | 05 | 05 | 05 | 05 | 05 | 05 | 06 | 06 | 06 | 06 |
| Nebraska | Nevada | 11 | 11 | 11 | 09 | 06 | 06 | 06 | 11 | 11 | West Virginia | 05 | 05 | 05 | 05 | 05 | 05 | 05 | 06 | 06 | 06 | 06 |
| Nevada | New Brunswick | 06 | 09 | 09 | 11 | 11 | 11 | 11 | 11 | 11 | Wyoming | 05 | 05 | 05 | 05 | 05 | 05 | 05 | 06 | 06 | 06 | 06 |
| New Brunswick | Newfoundland | 12 | 15 | 15 | 17 | 17 | 17 | 17 | 11 | 11 | Yukon | 04 | 04 | 04 | 04 | 04 | 04 | 04 | 06 | 06 | 06 | 06 |
| Newfoundland | New Hampshire | 04 | 07 | 07 | 09 | 09 | 09 | 09 | 11 | 11 | | | | | | | | | | | | |

INTERNATIONAL FORWARDING CHARGES

| | | | | |
|-------------|----|----|----|----|
| Argentina | 42 | 53 | 53 | 56 |
| Australia | 30 | 41 | 41 | 44 |
| Austria | 26 | 37 | 37 | 40 |
| Azores | 23 | 34 | 34 | 37 |
| Belgium | 36 | 42 | 42 | 46 |
| Bermuda | 41 | 41 | 41 | 46 |
| Porto Rico | 40 | 51 | 51 | 54 |
| Spain | 33 | 44 | 44 | 47 |
| Sweden | 25 | 36 | 36 | 39 |
| Switzerland | 27 | 38 | 38 | 41 |
| Turkey | 36 | 47 | 47 | 50 |
| Venezuela | 60 | 71 | 71 | 74 |

Coastal station charge 10 cents (52 centimes) per word. There is a local land line rate (not published above) of \$0.03 per word on all radiograms from ships at sea, when such messages are addressed to the same city where the radio station, via which the message is routed, is located. This rate should be applied in all such instances.

APPENDIX I

SCHEDULES OF NAVAL STATIONS TRANSMITTING TIME, WEATHER, HYDROGRAPHIC, ICE, AND PRESS BULLETINS.

| Time (Greenwich civil). | Station. | Call signal. | Frequency (kilocycles) and type of emission. | Wave-length (meters). | Material broadcast. |
|-------------------------|--------------------------------|--------------|--|-----------------------|--|
| 0000 | Brownsville, Tex... | NAY | 132 i. c. w..... | 2,273 | Weather, hydrographic. |
| 0045 | San Juan, P. R.... | NAU | 48 c. w..... | 6,250 | Weather (July 1 to Nov. 15). |
| 0100 | { Norfolk, Va. | NAM | 122 i. c. w..... | 2,459 | Weather. |
| | { Puget Sound, Wash. | NPC | 118 c. w..... | 2,542 | Do. |
| 0115 | Arlington, Va..... | NAA | 4,015 a. c. w..... | 74.72 | Aviation weather and upper-air reports. |
| | { Eureka, Calif. | NPW | 104 i. c. w..... | 2,885 | Weather, hydrographic. |
| 0130 | { Norfolk, Va. | NAM | 122 i. c. w..... | 2,459 | Weather. |
| | { Cavite, P. I. | NPO | { 56 c. w..... | 5,357 | { Press (for naval vessels only). |
| | | | { 112 a. c. w..... | 2,679 | |
| | { Guantanamo Bay, Cuba..... | NAW | 113 c. w..... | 2,655 | Weather (June 1 to Nov. 15). |
| 0200 | { San Juan, P. R.... | NAU | 108 i. c. w..... | 2,778 | Weather (July 1 to Nov. 15). |
| 0215 | San Francisco, Calif. | NPG | { 4,175 c. w..... | 71.85 | { Aviation weather. |
| | | | { 8,350 c. w..... | 35.9 | |
| | | | { 112 a. c. w..... | 2,679 | |
| | | | { 690 r. t. | 435 | |
| | { Arlington, Va..... | NAA | { 4,015 a. c. w..... | 74.72 | { Time signals. |
| 0255 to 0300 | | | { 8,030 a. c. w..... | 37.36 | |
| | { Annapolis, Md..... | NSS | { 12,045 a. c. w..... | 24.9 | |
| | | | { 17.6 c. w..... | 17,045 | |
| | { Cavite, P. I. | NPO | { 56 c. w..... | 5,357 | { Do. |
| | | | { 112 a. c. w..... | 2,679 | { Do. |
| | { Arlington, Va..... | NAA | { 68 c. w. l. | 4,412 | { Marine weather, hydrographic, ice reports (in season). |
| | | | { 112 a. c. w..... | 2,679 | { Weather, hydrographic. |
| 0300 | { Cavite, P. I. | NPO | { 56 c. w..... | 5,357 | { Do. |
| | { Key West, Fla..... | NAR | { 112 a. c. w..... | 2,679 | { Do. |
| | { Puget Sound, Wash. | NPC | 102 i. c. w..... | 2,941 | Hydrographic. |
| 0305 | { Navy Yard, Wash., D. C. | NAA | 118 c. w..... | 2,542 | Weather. |
| | | | 690 r. t. | 435 | Weather, hydrographic. |
| | { San Francisco, Calif. | NPG | { 42.8 c. w..... | 7,009 | { Aviation weather. |
| 0330 | | | { 108 i. c. w..... | 2,778 | { Hydrographic. |
| | { Tutuila, Samoa.... | NPU | { 8,350..... | 35.9 | |
| | | | { 66 c. w..... | 4,545 | |
| 0355 to 0400 | { Balboa, Canal Zone. | NBA | 46 c. w..... | 6,522 | Time signals. |
| | { Colon, Canal Zone. | NAX | 132 i. c. w..... | 2,273 | Do. |
| | Arlington, Va..... | NAA | 4,015 a. c. w..... | 74.72 | Weather broadcast to Europe. |
| 0400 | Great Lakes, Ill.... | NAJ | 132 i. c. w..... | 2,273 | Weather, hydrographic. |
| | { Puget Sound, Wash. | NPC | 118 c. w..... | 2,542 | Weather. |
| | { San Juan, P. R.... | NAU | 48 c. w..... | 6,250 | Do. |
| 0430 | { Astoria, Oreg..... | NPE | 112 a. c. w..... | 2,679 | Hydrographic. |
| | { San Diego, Calif. . . | NPL | 102 a. c. w..... | 2,941 | Weather. |
| 0500 | Brownsville, Tex... | NAY | 132 i. c. w..... | 2,273 | Weather, hydrographic. |
| 0555 to 0600 | { San Francisco, Calif. | NPG | { 62 c. w..... | 4,839 | { Time signals. |
| 0600 | { Do..... | NPG | { 108 i. c. w..... | 2,778 | { Do. |
| 0600 | Do..... | NPG | 108 i. c. w..... | 2,778 | Weather, hydrographic. |
| 0630 | Honolulu, Hawaii.. | NPM | 54 a. c. w..... | 5,555 | Do. |

SCHEDULES OF NAVAL STATIONS TRANSMITTING TIME, WEATHER, HYDROGRAPHIC, ICE, AND PRESS BULLETINS—Continued.

| Time (Greenwich civil). | Station. | Call signal. | Frequency (kilocycles) and type of emission. | Wave-length (meters). | Material broadcast. |
|-------------------------|-----------------------|--------------|--|-----------------------|---|
| 0700 | Annapolis, Md..... | NSS | 17.6 c. w..... | 17,045 | Press (for naval vessels only). |
| 0730 | Arlington, Va..... | NAA | 112 a. c. w..... | 2,679 | Do. |
| | Tutuila, Samoa..... | NPU | 66 c. w..... | 4,545 | Hydrographic. |
| | Balboa, Canal Zone. | NBA | 46 c. w..... | 6,522 | Hydrographic Press (for naval vessels only). |
| 1000 | Do..... | NBA | 118 c. w..... | 2,542 | Press (for naval vessels only). |
| | Colon, Canal Zone. | NAX | 132 i. c. w..... | 2,273 | Hydrographic. |
| 1300 | San Diego, Calif. . . | NPL | 30.6 c. w..... | 9,804 | Press (for naval vessels only). |
| | Puget Sound, Wash. | NPC | 118 c. w..... | 2,542 | Weather. |
| 1315 | Arlington, Va..... | NAA | 4,015 a. c. w..... | 74.72 | Aviation weather and upper-air reports. |
| | | | 8,030 a. c. w..... | 37.36 | |
| 1330 | Norfolk, Va..... | NAM | 12,045 a. c. w..... | 24.9 | Weather. |
| | | | 122 i. c. w..... | 2,459 | |
| 1355 to 1400 | Cavite, P. I . . . | NPO | 56 c. w..... | 5,357 | Time signals. |
| 1400 | Do..... | NPO | 112 a. c. w..... | 2,679 | Weather, hydrographic. |
| | | | 36 c. w..... | 8,333 | |
| 1415 | San Francisco, Calif. | NPG | 112 a. c. w..... | 2,679 | Aviation weather. |
| | | | 4,175 c. w..... | 71.85 | |
| 1500 | Arlington, Va..... | NAA | 8,350 c. w..... | 35.9 | Marine weather, ice reports (in season). |
| | | | 112 a. c. w..... | 2,679 | |
| 1505 | New Orleans, La. . . | NAT | 16,060 a. c. w..... | 18.68 | Weather. |
| | | | 106 c. w..... | 2,830 | |
| 1505 | Arlington, Va..... | NAA | 690 r. t..... | 435 | Do. |
| | | | New York, N. Y. . . | NAH | |
| 1530 | Charleston, S. C. . . | NAO | 122 i. c. w..... | 2,459 | Weather, hydrographic. |
| | | | San Francisco, Calif. | NPG | |
| 1545 | Philadelphia, Pa. . . | NAI | 108 c. w..... | 2,778 | Weather. |
| | | | 8,350 c. w..... | 35.9 | |
| 1545 | Great Lakes, Ill. . . | NAJ | 104 i. c. w..... | 2,885 | Aviation weather. |
| | | | Norfolk, Va..... | NAM | |
| 1600 | Boston, Mass..... | NAD | 122 i. c. w..... | 2,459 | Weather, hydrographic, ice reports (in season). |
| | | | Newport, R. I. . . . | NAF | |
| 1600 | Arlington, Va..... | NAA | 118 i. c. w..... | 2,542 | Do. |
| | | | 12,045 a. c. w..... | 24.9 | |
| 1600 | New Orleans, La. . . | NAT | 12,045 a. c. w..... | 24.9 | Weather broadcast to Europe. |
| | | | 106 c. w..... | 2,830 | |
| 1630 | San Juan, P. R. . . . | NAU | 106 c. w..... | 2,830 | Weather, hydrographic. |
| | | | Savannah, Ga. . . . | NEV | |
| 1630 | Jupiter, Fla. | NAQ | 132 i. c. w..... | 2,273 | Do. |
| | | | Do..... | NAP | |
| 1645 | San Diego, Calif. . . | NPL | 128 spark..... | 2,344 | Do. |
| | | | St. Augustine, Fla. . | NAP | |
| 1645 | Pensacola, Fla. . . . | NAS | 112 i. c. w..... | 2,679 | Do. |

SCHEDULES OF NAVAL STATIONS TRANSMITTING TIME, WEATHER, HYDROGRAPHIC, ICE, AND PRESS BULLETINS—Continued.

| Time (Greenwich civil). | Station. | Call signal. | Frequency (kilocycles) and type of emission. | Wave-length (meters). | Material broadcast. | | | | | | | | | | | | | | |
|-------------------------|---------------------------|-------------------------|--|-----------------------|------------------------|-------------------|----------------------|------------------------|-----------------------|----------------------------------|-----------------------|-------------------|-------------------|--------------------------|--------------------------|--------------------|-------|---|--------------------------|
| 1655 to 1700 | Arlington, Va..... | NAA | 112 a. c. w. | 2,679 | } Time signals. | | | | | | | | | | | | | | |
| | | | 690 r. t. | 435 | | | | | | | | | | | | | | | |
| | | | 4015 a. c. w. | 74.72 | | | | | | | | | | | | | | | |
| | | | 8030 a. c. w. | 37.36 | | | | | | | | | | | | | | | |
| | | | 12,045 a. c. w. | 24.9 | | | | | | | | | | | | | | | |
| | | | 17.6 c. w. | 17,945 | | | | | | | | | | | | | | | |
| 1700 | Annapolis, Md..... | NSS | 132 i. c. w. | 2,273 | Do. | | | | | | | | | | | | | | |
| | | | Great Lakes, Ill..... | NAJ | 102 i. c. w. | 2,941 | Do. | | | | | | | | | | | | |
| | | | | | Key West, Fla..... | NAR | 106 c. w. | 2,830 | Do. | | | | | | | | | | |
| | | | | | | | New Orleans, La..... | NAT | 30.6 c. w. | 9,804 | } Do. | | | | | | | | |
| | | | | | | | | | 102 a. c. w. | 2,941 | | | | | | | | | |
| | | | | | | | | | 112 a. c. w. | 2,679 | | | | | | | | | |
| 132 i. c. w. | 2,273 | | | | | | | | | | | | | | | | | | |
| 1755 to 1800 | Eureka, Calif..... | NPW | 104 i. c. w. | 2,885 | | | | | Do. | | | | | | | | | | |
| | | | Key West, Fla..... | NAR | 102 i. c. w. | 2,941 | | | Do. | | | | | | | | | | |
| | | | | | Puget Sound, Wash..... | NPC | 118 c. w. | 2,542 | Do. | | | | | | | | | | |
| | | | | | | | San Francisco..... | NPG | 42.8 c. w. | 7,009 | Do. | | | | | | | | |
| | | | | | | | | | 1800 to 1830 | Balboa, Canal Zone..... | NBA | 46 c. w. | 6,522 | } Time signals. | | | | | |
| | | | | | | | | | | | | 132 i. c. w. | 2,273 | | | | | | |
| Colon, Canal Zone..... | NAX | 46 c. w. | | | | | | | | | | 6,522 | } Hydrographic. | | | | | | |
| | | Balboa, Canal Zone..... | NBA | 54 a. c. w. | | | | | | | | 5,555 | | | } Weather, hydrographic. | | | | |
| | | | | Honolulu, T. H..... | NPM | 66 c. w. | | | | | | 4,545 | | | | } Hydrographic. | | | |
| | | | | | | 1930 | Tutuila, Samoa..... | NPU | | | | 112 a. c. w. | | | | | 2,679 | } Time signals. | |
| | | | | | | | | | Astoria, Oreg..... | NPE | 104 i. c. w. | 2,885 | | | | | | | |
| | | | | | | | | | | | Eureka, Calif..... | NPW | | 42.8 c. w. | | | 7,009 | | |
| 1955 to 2000 | San Francisco, Calif..... | | | | | | | | | | | | NPG | 62 c. w. | | | 4,839 | | } Do. |
| | | 108 c. w. | 2,778 | | | | | | | | | | | | | | | | |
| | | 2045 | Arlington, Va..... | NAA | 690 r. t. | | | | | | | | | 435 | } Weather. | | | | |
| | | | | | Norfolk, Va..... | NAM | 122 i. c. w. | 2,459 | | | | | | } Weather, hydrographic. | | | | | |
| | | | | | | | 2100 | Puget Sound, Wash..... | NPC | 118 c. w. | | | | | | 2,542 | } Do. | | |
| | | | | | | | | | | 2130 | Astoria, Oreg..... | NPE | | | | 112 a. c. w. | | 2,679 | |
| Boston, Mass..... | NAD | | | | | | | | | | | | 102 i. c. w. | | | 2,941 | | } Weather, hydrographic, ice reports (in season). | |
| | | | | | | | | | | | | | 2200 | | | Newport, R. I..... | | | NAF |
| | | New York, N. Y..... | NAH | 108 i. c. w. | | | | | | | | | | | 2,778 | | | | |
| | | | | Philadelphia, Pa..... | NAI | 104 i. c. w. | | | | | | | | 2,885 | } Weather, hydrographic. | | | | |
| | | | | | | 2230 | Eureka, Calif..... | NPW | 104 i. c. w. | | | | | 2,885 | | | } Do. | | |
| | | | | | | | | | Great Lakes, Ill..... | NAJ | 132 i. c. w. | 2,273 | | } Hydrographic. | | | | | |
| New Orleans, La..... | NAT | | | | | | | | | | 106 c. w. | 2,830 | | | | | | } Weather, hydrographic. | |
| | | | | | | | | | | | San Diego, Calif..... | NPL | 102 a. c. w. | | | 2,941 | | | } Weather, hydrographic. |
| | | Honolulu, T. H..... | NPM | | | | | | | | | | 54 a. c. w. | | | 5,555 | | | |
| | | | | 2300 | Charleston, S. C..... | | | | | | | | NAO | | 122 i. c. w. | 2,459 | | | |
| | | | | | | Jupiter, Fla..... | NAQ | 132 i. c. w. | | | | | | | 2,273 | } Weather. | | | |
| | | | | | | | | Pensacola, Fla..... | NAS | 112 i. c. w. | | | | 2,679 | } Do. | | | | |
| Savannah, Ga..... | NEV | | | | | | | | | 132 i. c. w. | | | | 2,273 | | | } Do. | | |
| | | | | | | | | | | 2330 to 2355 to 2400 | Tutuila, Samoa..... | NPU | | 66 c. w. | | | | 4,545 | } Hydrographic. |
| | | Honolulu, T. H..... | NPM | | | | | | | | | | | 26.1 c. w. | | | | 11,494 | |
| | | | | 106 i. c. w. | 2,830 | | | | | | | | | | | | | | |

¹ This frequency is discontinued at 0.400 G. C. T.

APPENDIX 2

SHORT WAVE SCHEDULES

| | | |
|--------------------|-----------------------|----------------------------|
| TX = Time Signals. | WX = Weather Reports. | PX = Press. |
| Washington ...NAA | 74.7-37.4-24.9 | TX 02.55-16.55 G. M. T. |
| Mexico City...XDA | 40 | TX 00.55-18.55 " |
| Rio de Janeiro.POT | 34.4 | TX 00.01 " |
| ParisFL | 32.5 | TX 07.56-19.56 " |
| Mogadiscio ...ISG | 55 | TX 05.56-18.56 " |
| SaigonFZA | 25 | TX 19.00-19.05" (Rhythmic) |
| TsingtaoXRT | 44 | TX 00.25-10.25 " |
| TokyoJJC | 53 | TX 12.00 " |
| ManilaWUAJ | 43 | TX 14.00 " |

WEATHER

| | | | |
|--------------------|-----------|-------------------|-------------------------|
| Washington ...NAA | 18.6 | 15.00 GMT | |
| San Francisco .NPG | 35.9 | 15.30-03.30 | |
| GuamNPN | 36 | 10.00 | (not reliable) |
| LondonGFA | 40.43 | 09.00 | (see insert aids * 925) |
| IssyOCDJ | 32.5 | 09.40 | (see aids 1060) |
| ParisFL | 73.5 | 04.20-08.40 | (see aids 1060) |
| TunisOCTU | 50 | 21.00 | (see aids 1127) |
| RomeIDO | 32 | 19.35 | (see aids 1168) |
| BeirutOCBY | 26 | 21.00-21.30 | (see aids 1225) |
| BeirutFUL | 25 | 08.00-15.00 | (see aids 1225) |
| RabatOCRB | 36 | 07.50-16.10-22.10 | (see aids 1236) |
| BordjaAIN | 51 | 08.30-19.30 | (see aids 1245) |
| BordjaAIN | 50 | 22.00 | (see aids 1245) |
| BaghdadGHB | 22.2-42.0 | 15.00 | (see aids 1288) |
| Pratas Is.XPI | 35.5 | 06.20-11.20 | (see aids 1319) |
| ShanghaiFFZ | 34 | 11.30 | (see aids 1320) |
| TsingtaoXRT | 42 | 03.40 | (see aids 1322A) |

PRESS

| | | | |
|--------------------|---------|----------|-----------------------------------|
| New YorkWHD | 36.45 | 06.00 | (never misses) (N. Y. "Times") |
| Washington ...NAA | 37.4 | 07.00 | (Naval press) |
| San Francisco .KUP | 47.35 | 09.00 | (Frisco "Examiner") |
| CaviteNPO | 17-23 | 02.00 | (either wave—not reliable) |
| RugbyGBR | 37-22.6 | 02-12-20 | (British Official except 02.00) |
| SydneyVIS | 51 | 12.30 | (probably changed sked. recently) |
| LouisburgVAS | 52 | 12.30 | (scheduled, but never heard) |
| HonoluluNPM | 35 | 09.00 | (seldom heard) |
| Mexico City ..XDA | | | (see July Wireless Age RCA) |

* Aids to Navigation, U. S. H. O. No. 205.

INTERNATIONAL MORSE CODE AND CONVENTIONAL SIGNALS

TO BE USED FOR ALL GENERAL PUBLIC SERVICE RADIO COMMUNICATION

1. A dash is equal to three dots.
2. The space between parts of the same letter is equal to one dot.
3. The space between two letters is equal to three dots.
4. The space between two words is equal to five dots.

| | |
|-----------------------------------|---|
| A . - - | Period |
| B - - - - | Semicolon |
| C - - - - | Comma |
| D - - - | Colon |
| E . | Interrogation |
| F - - - | Exclamation point |
| G - - - | Apostrophe |
| H . . . | Hyphen |
| I . . | Bar indicating fraction |
| J - - - - | Parenthesis |
| K - - - - | Inverted commas |
| L | Underline |
| M - - - | Double dash |
| N - - | Distress call |
| O - - - - | Attention call to precede every transmission |
| P - - - - | General inquiry call |
| Q - - - - | From (de) |
| R - - - | Invitation to transmit (go ahead) |
| S . . . | Warning—high power |
| T - | Question (please repeat after)— interrupting long messages |
| U . . . | Wait |
| V . . . - | Break (Bk.) (double dash) |
| W . - - - | Understand |
| X - - - - | Error |
| Y - - - - | Received (O. K.) |
| Z - - - - | Position report (to precede all position messages) |
| <hr/> | |
| Ä (German) | End of each message (cross) |
| Á or Å (Spanish- Scandinavian) | Transmission finished (end of work) (conclusion of correspondence) |
| CH (German-Spanish) | |
| É (French) | |
| Ñ (Spanish) | |
| Ö (German) | |
| Ü (German) | |
| <hr/> | |
| 1 - - - - | |
| 2 - - - - | |
| 3 . . . - | |
| 4 . . . - | |
| 5 | |
| 6 - - - . | |
| 7 - - - . | |
| 8 - - - . | |
| 9 - - - . | |
| 0 - - - - | |

APPENDIX 3

KILOCYCLE-METER CONVERSION TABLE

The provisions of the International Radiotelegraph Convention effective January 1, 1929, require that the assignment of waves to transmitting stations be designated in the first place by their frequency in kilocycles per second (kc/s). Following this designation there will be indicated, in parenthesis, the approximate length in meters. In the present Regulations, the approximate value of the wavelength in meters is the quotient of the number 300,000 divided by the frequency expressed in kilocycles per second. The Radio Division, Department of Commerce, has devised the following conversion table which gives values for every 10 kilocycles or meters between the limits of 10 and 30,000. The table is entirely reversible; that is, for example, 80 kilocycles equals 3,750 meters and also 3,750 meters equals 80 kilocycles. The range of the table is easily extended by shifting the decimal point; the shift is in opposite direction for each pair of values. For example, one cannot find 567 in the first column, but its equivalent is obtained by finding later in the table that 5,670 kilocycles or meters equals 52.91 meters or kilocycles, from which 567 kilocycles or meters equals 529.1 meters or kilocycles.

KILOCYCLES (kc) TO METERS (m), OR METERS TO KILOCYCLES

Columns Are Interchangeable

| kc or m | m or kc | kc or m | m or kc | kc or m | m or kc | kc or m | m or kc | kc or m | m or kc | kc or m | m or kc | kc or m | m or kc |
|---------|---------|---------|---------|---------|---------|---------|---------|---------|---------|---------|---------|---------|---------|
| 10 | 30,000 | 560 | 536 | 1,110 | 270.3 | 1,660 | 180.7 | 2,210 | 135.7 | 2,760 | 108.7 | | |
| 20 | 15,000 | 570 | 526 | 1,120 | 267.9 | 1,670 | 179.6 | 2,220 | 135.1 | 2,770 | 108.3 | | |
| 30 | 10,000 | 580 | 517 | 1,130 | 265.5 | 1,680 | 178.6 | 2,230 | 134.5 | 2,780 | 107.9 | | |
| 40 | 7,500 | 590 | 509 | 1,140 | 263.2 | 1,690 | 177.5 | 2,240 | 133.9 | 2,790 | 107.5 | | |
| 50 | 6,000 | 600 | 500 | 1,150 | 260.9 | 1,700 | 176.5 | 2,250 | 133.3 | 2,800 | 107.1 | | |
| 60 | 5,000 | 610 | 492 | 1,160 | 258.6 | 1,710 | 175.4 | 2,260 | 132.7 | 2,810 | 106.7 | | |
| 70 | 4,286 | 620 | 484 | 1,170 | 256.4 | 1,720 | 174.4 | 2,270 | 132.2 | 2,820 | 106.4 | | |
| 80 | 3,750 | 630 | 476 | 1,180 | 254.2 | 1,730 | 173.4 | 2,280 | 131.6 | 2,830 | 106.0 | | |
| 90 | 3,333 | 640 | 469 | 1,190 | 252.1 | 1,740 | 172.4 | 2,290 | 131.0 | 2,840 | 105.6 | | |
| 100 | 3,000 | 650 | 462 | 1,200 | 250.0 | 1,750 | 171.4 | 2,300 | 130.4 | 2,850 | 105.3 | | |
| 110 | 2,727 | 660 | 455 | 1,210 | 247.9 | 1,760 | 170.5 | 2,310 | 129.9 | 2,860 | 104.9 | | |
| 120 | 2,500 | 670 | 448 | 1,220 | 245.9 | 1,770 | 169.5 | 2,320 | 129.3 | 2,870 | 104.5 | | |
| 130 | 2,308 | 680 | 441 | 1,230 | 243.9 | 1,780 | 168.5 | 2,330 | 128.8 | 2,880 | 104.2 | | |
| 140 | 2,143 | 690 | 435 | 1,240 | 241.9 | 1,790 | 167.6 | 2,340 | 128.2 | 2,890 | 103.8 | | |
| 150 | 2,000 | 700 | 429 | 1,250 | 240.0 | 1,800 | 166.7 | 2,350 | 127.7 | 2,900 | 103.4 | | |
| 160 | 1,875 | 710 | 423 | 1,260 | 238.1 | 1,810 | 165.7 | 2,360 | 127.1 | 2,910 | 103.1 | | |
| 170 | 1,765 | 720 | 417 | 1,270 | 236.2 | 1,820 | 164.8 | 2,370 | 126.6 | 2,920 | 102.7 | | |
| 180 | 1,667 | 730 | 411 | 1,280 | 234.4 | 1,830 | 163.9 | 2,380 | 126.1 | 2,930 | 102.4 | | |
| 190 | 1,579 | 740 | 405 | 1,290 | 232.6 | 1,840 | 163.0 | 2,390 | 125.5 | 2,940 | 102.0 | | |
| 200 | 1,500 | 750 | 400 | 1,300 | 230.8 | 1,850 | 162.2 | 2,400 | 125.0 | 2,950 | 101.7 | | |
| 210 | 1,429 | 760 | 395 | 1,310 | 229.0 | 1,860 | 161.3 | 2,410 | 124.5 | 2,960 | 101.4 | | |
| 220 | 1,364 | 770 | 390 | 1,320 | 227.3 | 1,870 | 160.4 | 2,420 | 124.0 | 2,970 | 101.0 | | |
| 230 | 1,304 | 780 | 385 | 1,330 | 225.6 | 1,880 | 159.6 | 2,430 | 123.5 | 2,980 | 100.7 | | |
| 240 | 1,250 | 790 | 380 | 1,340 | 223.9 | 1,890 | 158.7 | 2,440 | 123.0 | 2,990 | 100.3 | | |
| 250 | 1,200 | 800 | 375 | 1,350 | 222.2 | 1,900 | 157.9 | 2,450 | 122.4 | 3,000 | 100.0 | | |
| 260 | 1,154 | 810 | 370 | 1,360 | 220.6 | 1,910 | 157.1 | 2,460 | 122.0 | 3,010 | 99.7 | | |
| 270 | 1,111 | 820 | 366 | 1,370 | 219.0 | 1,920 | 156.3 | 2,470 | 121.5 | 3,020 | 99.3 | | |
| 280 | 1,071 | 830 | 361 | 1,380 | 217.4 | 1,930 | 155.4 | 2,480 | 121.0 | 3,030 | 99.0 | | |
| 290 | 1,034 | 840 | 357 | 1,390 | 215.8 | 1,940 | 154.6 | 2,490 | 120.5 | 3,040 | 98.7 | | |
| 300 | 1,000 | 850 | 353 | 1,400 | 214.3 | 1,950 | 153.8 | 2,500 | 120.0 | 3,050 | 98.4 | | |
| 310 | 968 | 860 | 349 | 1,410 | 212.8 | 1,960 | 153.1 | 2,510 | 119.5 | 3,060 | 98.0 | | |
| 320 | 938 | 870 | 345 | 1,420 | 211.3 | 1,970 | 152.3 | 2,520 | 119.0 | 3,070 | 97.7 | | |
| 330 | 909 | 880 | 341 | 1,430 | 209.8 | 1,980 | 151.5 | 2,530 | 118.6 | 3,080 | 97.4 | | |
| 340 | 882 | 890 | 337 | 1,440 | 208.3 | 1,990 | 150.8 | 2,540 | 118.1 | 3,090 | 97.1 | | |
| 350 | 857 | 900 | 333 | 1,450 | 206.9 | 2,000 | 150.0 | 2,550 | 117.6 | 3,100 | 96.8 | | |
| 360 | 833 | 910 | 330 | 1,460 | 205.5 | 2,010 | 149.3 | 2,560 | 117.2 | 3,110 | 96.5 | | |
| 370 | 811 | 920 | 326 | 1,470 | 204.1 | 2,020 | 148.5 | 2,570 | 116.7 | 3,120 | 96.2 | | |
| 380 | 789 | 930 | 323 | 1,480 | 202.7 | 2,030 | 147.8 | 2,580 | 116.3 | 3,130 | 95.8 | | |
| 390 | 769 | 940 | 319 | 1,490 | 201.3 | 2,040 | 147.1 | 2,590 | 115.8 | 3,140 | 95.5 | | |
| 400 | 750 | 950 | 316 | 1,500 | 200.0 | 2,050 | 146.3 | 2,600 | 115.4 | 3,150 | 95.2 | | |
| 410 | 732 | 960 | 313 | 1,510 | 198.7 | 2,060 | 145.6 | 2,610 | 114.9 | 3,160 | 94.9 | | |
| 420 | 714 | 970 | 309 | 1,520 | 197.4 | 2,070 | 144.9 | 2,620 | 114.5 | 3,170 | 94.6 | | |
| 430 | 698 | 980 | 306 | 1,530 | 196.1 | 2,080 | 144.2 | 2,630 | 114.1 | 3,180 | 94.3 | | |
| 440 | 682 | 990 | 303 | 1,540 | 194.8 | 2,090 | 143.5 | 2,640 | 113.6 | 3,190 | 94.0 | | |
| 450 | 667 | 1,000 | 300.0 | 1,550 | 193.5 | 2,100 | 142.9 | 2,650 | 113.2 | 3,200 | 93.8 | | |
| 460 | 652 | 1,010 | 297.0 | 1,560 | 192.3 | 2,110 | 142.2 | 2,660 | 112.8 | 3,210 | 93.5 | | |
| 470 | 638 | 1,020 | 294.1 | 1,570 | 191.1 | 2,120 | 141.5 | 2,670 | 112.4 | 3,220 | 93.2 | | |
| 480 | 625 | 1,030 | 291.3 | 1,580 | 189.9 | 2,130 | 140.8 | 2,680 | 111.9 | 3,230 | 92.9 | | |
| 490 | 612 | 1,040 | 288.5 | 1,590 | 188.7 | 2,140 | 140.2 | 2,690 | 111.5 | 3,240 | 92.6 | | |
| 500 | 600 | 1,050 | 285.7 | 1,600 | 187.5 | 2,150 | 139.5 | 2,700 | 111.1 | 3,250 | 92.3 | | |
| 510 | 588 | 1,060 | 283.0 | 1,610 | 186.3 | 2,160 | 138.9 | 2,710 | 110.7 | 3,260 | 92.0 | | |
| 520 | 577 | 1,070 | 280.4 | 1,620 | 185.2 | 2,170 | 138.2 | 2,720 | 110.3 | 3,270 | 91.7 | | |
| 530 | 566 | 1,080 | 277.8 | 1,630 | 184.0 | 2,180 | 137.6 | 2,730 | 109.9 | 3,280 | 91.5 | | |
| 540 | 556 | 1,090 | 275.2 | 1,640 | 182.9 | 2,190 | 137.0 | 2,740 | 109.5 | 3,290 | 91.2 | | |
| 550 | 545 | 1,100 | 272.7 | 1,650 | 181.8 | 2,200 | 136.4 | 2,750 | 109.1 | 3,300 | 90.9 | | |

KILOCYCLE-METER CONVERSION TABLE 773

KILOCYCLE-METER CONVERSION TABLE—Continued

| kc or m | m or kc | kc or m | m or kc | kc or m | m or kc | kc or m | m or kc | kc or m | m or kc | kc or m | m or kc | kc or m | m or kc |
|---------|---------|---------|---------|---------|---------|---------|---------|---------|---------|---------|---------|---------|---------|
| 3,310 | 90.6 | 3,860 | 77.7 | 4,410 | 68.03 | 4,960 | 60.48 | 5,510 | 54.45 | 6,060 | 49.50 | | |
| 3,320 | 90.4 | 3,870 | 77.5 | 4,420 | 67.87 | 4,970 | 60.36 | 5,520 | 54.35 | 6,070 | 49.42 | | |
| 3,330 | 90.1 | 3,880 | 77.3 | 4,430 | 67.72 | 4,980 | 60.24 | 5,530 | 54.25 | 6,080 | 49.34 | | |
| 3,340 | 89.8 | 3,890 | 77.1 | 4,440 | 67.57 | 4,990 | 60.12 | 5,540 | 54.15 | 6,090 | 49.26 | | |
| 3,350 | 89.6 | 3,900 | 76.9 | 4,450 | 67.42 | 5,000 | 60.00 | 5,550 | 54.05 | 6,100 | 49.18 | | |
| 3,360 | 89.3 | 3,910 | 76.7 | 4,460 | 67.26 | 5,010 | 59.88 | 5,560 | 53.96 | 6,110 | 49.10 | | |
| 3,370 | 89.0 | 3,920 | 76.5 | 4,470 | 67.11 | 5,020 | 59.76 | 5,570 | 53.86 | 6,120 | 49.02 | | |
| 3,380 | 88.8 | 3,930 | 76.3 | 4,480 | 66.96 | 5,030 | 59.64 | 5,580 | 53.76 | 6,130 | 48.94 | | |
| 3,390 | 88.5 | 3,940 | 76.1 | 4,490 | 66.82 | 5,040 | 59.52 | 5,590 | 53.67 | 6,140 | 48.86 | | |
| 3,400 | 88.2 | 3,950 | 75.9 | 4,500 | 66.67 | 5,050 | 59.41 | 5,600 | 53.57 | 6,150 | 48.78 | | |
| 3,410 | 88.0 | 3,960 | 75.8 | 4,510 | 66.52 | 5,060 | 59.29 | 5,610 | 53.48 | 6,160 | 48.70 | | |
| 3,420 | 87.7 | 3,970 | 75.6 | 4,520 | 66.37 | 5,070 | 59.17 | 5,620 | 53.38 | 6,170 | 48.62 | | |
| 3,430 | 87.5 | 3,980 | 75.4 | 4,530 | 66.23 | 5,080 | 59.06 | 5,630 | 53.29 | 6,180 | 48.54 | | |
| 3,440 | 87.2 | 3,990 | 75.2 | 4,540 | 66.08 | 5,090 | 58.94 | 5,640 | 53.19 | 6,190 | 48.47 | | |
| 3,450 | 87.0 | 4,000 | 75.00 | 4,550 | 65.93 | 5,100 | 58.82 | 5,650 | 53.10 | 6,200 | 48.39 | | |
| 3,460 | 86.7 | 4,010 | 74.81 | 4,560 | 65.79 | 5,110 | 58.71 | 5,660 | 53.00 | 6,210 | 48.31 | | |
| 3,470 | 86.5 | 4,020 | 74.63 | 4,570 | 65.65 | 5,120 | 58.59 | 5,670 | 52.91 | 6,220 | 48.23 | | |
| 3,480 | 86.2 | 4,030 | 74.44 | 4,580 | 65.50 | 5,130 | 58.48 | 5,680 | 52.82 | 6,230 | 48.15 | | |
| 3,490 | 86.0 | 4,040 | 74.26 | 4,590 | 65.36 | 5,140 | 58.37 | 5,690 | 52.72 | 6,240 | 48.08 | | |
| 3,500 | 85.7 | 4,050 | 74.07 | 4,600 | 65.22 | 5,150 | 58.25 | 5,700 | 52.63 | 6,250 | 48.00 | | |
| 3,510 | 85.5 | 4,060 | 73.89 | 4,610 | 65.08 | 5,160 | 58.14 | 5,710 | 52.54 | 6,260 | 47.92 | | |
| 3,520 | 85.2 | 4,070 | 73.71 | 4,620 | 64.94 | 5,170 | 58.03 | 5,720 | 52.45 | 6,270 | 47.85 | | |
| 3,530 | 85.0 | 4,080 | 73.53 | 4,630 | 64.79 | 5,180 | 57.92 | 5,730 | 52.36 | 6,280 | 47.77 | | |
| 3,540 | 84.7 | 4,090 | 73.35 | 4,640 | 64.66 | 5,190 | 57.80 | 5,740 | 52.26 | 6,290 | 47.69 | | |
| 3,550 | 84.5 | 4,100 | 73.17 | 4,650 | 64.52 | 5,200 | 57.69 | 5,750 | 52.17 | 6,300 | 47.62 | | |
| 3,560 | 84.3 | 4,110 | 72.99 | 4,660 | 64.38 | 5,210 | 57.58 | 5,760 | 52.08 | 6,310 | 47.54 | | |
| 3,570 | 84.0 | 4,120 | 72.82 | 4,670 | 64.24 | 5,220 | 57.47 | 5,770 | 51.99 | 6,320 | 47.47 | | |
| 3,580 | 83.8 | 4,130 | 72.64 | 4,680 | 64.10 | 5,230 | 57.36 | 5,780 | 51.90 | 6,330 | 47.39 | | |
| 3,590 | 83.6 | 4,140 | 72.46 | 4,690 | 63.97 | 5,240 | 57.25 | 5,790 | 51.81 | 6,340 | 47.32 | | |
| 3,600 | 83.3 | 4,150 | 72.29 | 4,700 | 63.83 | 5,250 | 57.14 | 5,800 | 51.72 | 6,350 | 47.24 | | |
| 3,610 | 83.1 | 4,160 | 72.12 | 4,710 | 63.69 | 5,260 | 57.03 | 5,810 | 51.64 | 6,360 | 47.17 | | |
| 3,620 | 82.9 | 4,170 | 71.94 | 4,720 | 63.56 | 5,270 | 56.93 | 5,820 | 51.55 | 6,370 | 47.10 | | |
| 3,630 | 82.6 | 4,180 | 71.77 | 4,730 | 63.42 | 5,280 | 56.82 | 5,830 | 51.46 | 6,380 | 47.02 | | |
| 3,640 | 82.4 | 4,190 | 71.60 | 4,740 | 63.29 | 5,290 | 56.71 | 5,840 | 51.37 | 6,390 | 46.95 | | |
| 3,650 | 82.2 | 4,200 | 71.43 | 4,750 | 63.16 | 5,300 | 56.60 | 5,850 | 51.28 | 6,400 | 46.88 | | |
| 3,660 | 82.0 | 4,210 | 71.26 | 4,760 | 63.03 | 5,310 | 56.50 | 5,860 | 51.19 | 6,410 | 46.80 | | |
| 3,670 | 81.7 | 4,220 | 71.09 | 4,770 | 62.89 | 5,320 | 56.39 | 5,870 | 51.11 | 6,420 | 46.73 | | |
| 3,680 | 81.5 | 4,230 | 70.92 | 4,780 | 62.76 | 5,330 | 56.29 | 5,880 | 51.02 | 6,430 | 46.66 | | |
| 3,690 | 81.3 | 4,240 | 70.75 | 4,790 | 62.63 | 5,340 | 56.18 | 5,890 | 50.93 | 6,440 | 46.58 | | |
| 3,700 | 81.1 | 4,250 | 70.59 | 4,800 | 62.50 | 5,350 | 56.07 | 5,900 | 50.85 | 6,450 | 46.51 | | |
| 3,710 | 80.9 | 4,260 | 70.42 | 4,810 | 62.37 | 5,360 | 55.97 | 5,910 | 50.76 | 6,460 | 46.44 | | |
| 3,720 | 80.6 | 4,270 | 70.26 | 4,820 | 62.24 | 5,370 | 55.87 | 5,920 | 50.68 | 6,470 | 46.37 | | |
| 3,730 | 80.4 | 4,280 | 70.09 | 4,830 | 62.11 | 5,380 | 55.76 | 5,930 | 50.59 | 6,480 | 46.30 | | |
| 3,740 | 80.2 | 4,290 | 69.93 | 4,840 | 61.98 | 5,390 | 55.66 | 5,940 | 50.51 | 6,490 | 46.22 | | |
| 3,750 | 80.0 | 4,300 | 69.77 | 4,850 | 61.86 | 5,400 | 55.56 | 5,950 | 50.42 | 6,500 | 46.15 | | |
| 3,760 | 79.8 | 4,310 | 69.61 | 4,860 | 61.73 | 5,410 | 55.45 | 5,960 | 50.34 | 6,510 | 46.08 | | |
| 3,770 | 79.6 | 4,320 | 69.44 | 4,870 | 61.60 | 5,420 | 55.35 | 5,970 | 50.25 | 6,520 | 46.01 | | |
| 3,780 | 79.4 | 4,330 | 69.28 | 4,880 | 61.48 | 5,430 | 55.25 | 5,980 | 50.17 | 6,530 | 45.94 | | |
| 3,790 | 79.2 | 4,340 | 69.12 | 4,890 | 61.35 | 5,440 | 55.15 | 5,990 | 50.08 | 6,540 | 45.87 | | |
| 3,800 | 78.9 | 4,350 | 68.97 | 4,900 | 61.22 | 5,450 | 55.05 | 6,000 | 50.00 | 6,550 | 45.80 | | |
| 3,810 | 78.7 | 4,360 | 68.81 | 4,910 | 61.10 | 5,460 | 54.95 | 6,010 | 49.92 | 6,560 | 45.73 | | |
| 3,820 | 78.5 | 4,370 | 68.65 | 4,920 | 60.98 | 5,470 | 54.84 | 6,020 | 49.83 | 6,570 | 45.66 | | |
| 3,830 | 78.3 | 4,380 | 68.49 | 4,930 | 60.85 | 5,480 | 54.74 | 6,030 | 49.75 | 6,580 | 45.59 | | |
| 3,840 | 78.1 | 4,390 | 68.34 | 4,940 | 60.73 | 5,490 | 54.64 | 6,040 | 49.67 | 6,590 | 45.52 | | |
| 3,850 | 77.9 | 4,400 | 68.18 | 4,950 | 60.61 | 5,500 | 54.55 | 6,050 | 49.59 | 6,600 | 45.45 | | |

KILOCYCLE-METER CONVERSION TABLE—Continued

| kc or m | m or kc | kc or m | m or kc | kc or m | m or kc | kc or m | m or kc | kc or m | m or kc | kc or m | m or kc | kc or m | m or kc |
|---------|---------|---------|---------|---------|---------|---------|---------|---------|---------|---------|---------|---------|---------|
| 6,610 | 45.39 | 7,160 | 41.90 | 7,710 | 38.91 | 8,260 | 36.32 | 8,810 | 34.05 | 9,360 | 32.05 | | |
| 6,620 | 45.32 | 7,170 | 41.84 | 7,720 | 38.86 | 8,270 | 36.28 | 8,820 | 34.01 | 9,370 | 32.02 | | |
| 6,630 | 45.25 | 7,180 | 41.78 | 7,730 | 38.81 | 8,280 | 36.23 | 8,830 | 33.98 | 9,380 | 31.98 | | |
| 6,640 | 45.18 | 7,190 | 41.72 | 7,740 | 38.76 | 8,290 | 36.19 | 8,840 | 33.94 | 9,390 | 31.95 | | |
| 6,650 | 45.11 | 7,200 | 41.67 | 7,750 | 38.71 | 8,300 | 36.14 | 8,850 | 33.90 | 9,400 | 31.91 | | |
| 6,660 | 45.05 | 7,210 | 41.61 | 7,760 | 38.66 | 8,310 | 36.10 | 8,860 | 33.86 | 9,410 | 31.88 | | |
| 6,670 | 44.98 | 7,220 | 41.55 | 7,770 | 38.61 | 8,320 | 36.06 | 8,870 | 33.82 | 9,420 | 31.85 | | |
| 6,680 | 44.91 | 7,230 | 41.49 | 7,780 | 38.56 | 8,330 | 36.01 | 8,880 | 33.78 | 9,430 | 31.81 | | |
| 6,690 | 44.84 | 7,240 | 41.44 | 7,790 | 38.51 | 8,340 | 35.97 | 8,890 | 33.75 | 9,440 | 31.78 | | |
| 6,700 | 44.78 | 7,250 | 41.38 | 7,800 | 38.46 | 8,350 | 35.93 | 8,900 | 33.71 | 9,450 | 31.75 | | |
| 6,710 | 44.71 | 7,260 | 41.32 | 7,810 | 38.41 | 8,360 | 35.89 | 8,910 | 33.67 | 9,460 | 31.71 | | |
| 6,720 | 44.64 | 7,270 | 41.27 | 7,820 | 38.36 | 8,370 | 35.84 | 8,920 | 33.63 | 9,470 | 31.68 | | |
| 6,730 | 44.58 | 7,280 | 41.21 | 7,830 | 38.31 | 8,380 | 35.80 | 8,930 | 33.59 | 9,480 | 31.65 | | |
| 6,740 | 44.51 | 7,290 | 41.15 | 7,840 | 38.27 | 8,390 | 35.76 | 8,940 | 33.56 | 9,490 | 31.61 | | |
| 6,750 | 44.44 | 7,300 | 41.10 | 7,850 | 38.22 | 8,400 | 35.71 | 8,950 | 33.52 | 9,500 | 31.58 | | |
| 6,760 | 44.38 | 7,310 | 41.04 | 7,860 | 38.17 | 8,410 | 35.67 | 8,960 | 33.48 | 9,510 | 31.55 | | |
| 6,770 | 44.31 | 7,320 | 40.98 | 7,870 | 38.12 | 8,420 | 35.63 | 8,970 | 33.44 | 9,520 | 31.51 | | |
| 6,780 | 44.25 | 7,330 | 40.93 | 7,880 | 38.07 | 8,430 | 35.59 | 8,980 | 33.41 | 9,530 | 31.48 | | |
| 6,790 | 44.18 | 7,340 | 40.87 | 7,890 | 38.02 | 8,440 | 35.55 | 8,990 | 33.37 | 9,540 | 31.45 | | |
| 6,800 | 44.12 | 7,350 | 40.82 | 7,900 | 37.97 | 8,450 | 35.50 | 9,000 | 33.33 | 9,550 | 31.41 | | |
| 6,810 | 44.05 | 7,360 | 40.76 | 7,910 | 37.93 | 8,460 | 35.46 | 9,010 | 33.30 | 9,560 | 31.38 | | |
| 6,820 | 43.99 | 7,370 | 40.71 | 7,920 | 37.88 | 8,470 | 35.42 | 9,020 | 33.26 | 9,570 | 31.35 | | |
| 6,830 | 43.92 | 7,380 | 40.65 | 7,930 | 37.83 | 8,480 | 35.38 | 9,030 | 33.22 | 9,580 | 31.32 | | |
| 6,840 | 43.86 | 7,390 | 40.60 | 7,940 | 37.78 | 8,490 | 35.34 | 9,040 | 33.19 | 9,590 | 31.28 | | |
| 6,850 | 43.80 | 7,400 | 40.54 | 7,950 | 37.74 | 8,500 | 35.29 | 9,050 | 33.15 | 9,600 | 31.25 | | |
| 6,860 | 43.73 | 7,410 | 40.49 | 7,960 | 37.69 | 8,510 | 35.25 | 9,060 | 33.11 | 9,610 | 31.22 | | |
| 6,870 | 43.67 | 7,420 | 40.43 | 7,970 | 37.64 | 8,520 | 35.21 | 9,070 | 33.08 | 9,620 | 31.19 | | |
| 6,880 | 43.60 | 7,430 | 40.38 | 7,980 | 37.59 | 8,530 | 35.17 | 9,080 | 33.04 | 9,630 | 31.15 | | |
| 6,890 | 43.54 | 7,440 | 40.32 | 7,990 | 37.55 | 8,540 | 35.13 | 9,090 | 33.00 | 9,640 | 31.12 | | |
| 6,900 | 43.48 | 7,450 | 40.27 | 8,000 | 37.50 | 8,550 | 35.09 | 9,100 | 32.97 | 9,650 | 31.09 | | |
| 6,910 | 43.42 | 7,460 | 40.21 | 8,010 | 37.45 | 8,560 | 35.05 | 9,110 | 32.93 | 9,660 | 31.06 | | |
| 6,920 | 43.35 | 7,470 | 40.16 | 8,020 | 37.41 | 8,570 | 35.01 | 9,120 | 32.89 | 9,670 | 31.02 | | |
| 6,930 | 43.29 | 7,480 | 40.11 | 8,030 | 37.36 | 8,580 | 34.97 | 9,130 | 32.86 | 9,680 | 30.99 | | |
| 6,940 | 43.23 | 7,490 | 40.05 | 8,040 | 37.31 | 8,590 | 34.92 | 9,140 | 32.82 | 9,690 | 30.96 | | |
| 6,950 | 43.17 | 7,500 | 40.00 | 8,050 | 37.27 | 8,600 | 34.88 | 9,150 | 32.79 | 9,700 | 30.93 | | |
| 6,960 | 43.10 | 7,510 | 39.95 | 8,060 | 37.22 | 8,610 | 34.84 | 9,160 | 32.75 | 9,710 | 30.90 | | |
| 6,970 | 43.04 | 7,520 | 39.89 | 8,070 | 37.17 | 8,620 | 34.80 | 9,170 | 32.72 | 9,720 | 30.86 | | |
| 6,980 | 42.98 | 7,530 | 39.84 | 8,080 | 37.13 | 8,630 | 34.76 | 9,180 | 32.68 | 9,730 | 30.83 | | |
| 6,990 | 42.92 | 7,540 | 39.79 | 8,090 | 37.08 | 8,640 | 34.72 | 9,190 | 32.64 | 9,740 | 30.80 | | |
| 7,000 | 42.86 | 7,550 | 39.74 | 8,100 | 37.04 | 8,650 | 34.68 | 9,200 | 32.61 | 9,750 | 30.77 | | |
| 7,010 | 42.80 | 7,560 | 39.68 | 8,110 | 36.99 | 8,660 | 34.64 | 9,210 | 32.57 | 9,760 | 30.74 | | |
| 7,020 | 42.74 | 7,570 | 39.63 | 8,120 | 36.95 | 8,670 | 34.60 | 9,220 | 32.54 | 9,770 | 30.71 | | |
| 7,030 | 42.67 | 7,580 | 39.58 | 8,130 | 36.90 | 8,680 | 34.56 | 9,230 | 32.50 | 9,780 | 30.67 | | |
| 7,040 | 42.61 | 7,590 | 39.53 | 8,140 | 36.86 | 8,690 | 34.52 | 9,240 | 32.47 | 9,790 | 30.64 | | |
| 7,050 | 42.55 | 7,600 | 39.47 | 8,150 | 36.81 | 8,700 | 34.48 | 9,250 | 32.43 | 9,800 | 30.61 | | |
| 7,060 | 42.49 | 7,610 | 39.42 | 8,160 | 36.76 | 8,710 | 34.44 | 9,260 | 32.40 | 9,810 | 30.58 | | |
| 7,070 | 42.43 | 7,620 | 39.37 | 8,170 | 36.72 | 8,720 | 34.40 | 9,270 | 32.36 | 9,820 | 30.55 | | |
| 7,080 | 42.37 | 7,630 | 39.32 | 8,180 | 36.67 | 8,730 | 34.36 | 9,280 | 32.33 | 9,830 | 30.52 | | |
| 7,090 | 42.31 | 7,640 | 39.27 | 8,190 | 36.63 | 8,740 | 34.32 | 9,290 | 32.29 | 9,840 | 30.49 | | |
| 7,100 | 42.25 | 7,650 | 39.22 | 8,200 | 36.59 | 8,750 | 34.29 | 9,300 | 32.26 | 9,850 | 30.46 | | |
| 7,110 | 42.19 | 7,660 | 39.16 | 8,210 | 36.54 | 8,760 | 34.25 | 9,310 | 32.22 | 9,860 | 30.43 | | |
| 7,120 | 42.13 | 7,670 | 39.11 | 8,220 | 36.50 | 8,770 | 34.21 | 9,320 | 32.19 | 9,870 | 30.40 | | |
| 7,130 | 42.08 | 7,680 | 39.06 | 8,230 | 36.45 | 8,780 | 34.17 | 9,330 | 32.15 | 9,880 | 30.36 | | |
| 7,140 | 42.02 | 7,690 | 39.01 | 8,240 | 36.41 | 8,790 | 34.13 | 9,340 | 32.12 | 9,890 | 30.33 | | |
| 7,150 | 41.96 | 7,700 | 38.96 | 8,250 | 36.36 | 8,800 | 34.09 | 9,350 | 32.09 | 9,900 | 30.30 | | |

KILOCYCLE-METER CONVERSION TABLE 775

KILOCYCLE-METER CONVERSION TABLE—Continued

| kc or m | m or kc | kc or m | m or kc | kc or m | m or kc | kc or m | m or kc | kc or m | m or kc | kc or m | m or kc | kc or m | m or kc |
|---------|---------|---------|---------|---------|---------|---------|---------|---------|---------|---------|---------|---------|---------|
| 9,910 | 30.27 | 10,460 | 28.68 | 11,010 | 27.25 | 11,560 | 25.95 | 12,110 | 24.77 | 12,660 | 23.70 | 9,920 | 30.24 |
| 9,920 | 30.24 | 10,470 | 28.65 | 11,020 | 27.22 | 11,570 | 25.93 | 12,120 | 24.75 | 12,670 | 23.68 | 9,930 | 30.21 |
| 9,930 | 30.21 | 10,480 | 28.63 | 11,030 | 27.20 | 11,580 | 25.91 | 12,130 | 24.73 | 12,680 | 23.66 | 9,940 | 30.18 |
| 9,940 | 30.18 | 10,490 | 28.60 | 11,040 | 27.17 | 11,590 | 25.88 | 12,140 | 24.71 | 12,690 | 23.64 | 9,950 | 30.15 |
| 9,950 | 30.15 | 10,500 | 28.57 | 11,050 | 27.15 | 11,600 | 25.86 | 12,150 | 24.69 | 12,700 | 23.62 | 9,960 | 30.12 |
| 9,960 | 30.12 | 10,510 | 28.54 | 11,060 | 27.12 | 11,610 | 25.84 | 12,160 | 24.67 | 12,710 | 23.60 | 9,970 | 30.09 |
| 9,970 | 30.09 | 10,520 | 28.52 | 11,070 | 27.10 | 11,620 | 25.82 | 12,170 | 24.65 | 12,720 | 23.58 | 9,980 | 30.06 |
| 9,980 | 30.06 | 10,530 | 28.49 | 11,080 | 27.08 | 11,630 | 25.80 | 12,180 | 24.63 | 12,730 | 23.57 | 9,990 | 30.03 |
| 9,990 | 30.03 | 10,540 | 28.46 | 11,090 | 27.05 | 11,640 | 25.77 | 12,190 | 24.61 | 12,740 | 23.55 | 10,000 | 30.00 |
| 10,000 | 30.00 | 10,550 | 28.44 | 11,100 | 27.03 | 11,650 | 25.75 | 12,200 | 24.59 | 12,750 | 23.53 | 10,010 | 29.97 |
| 10,010 | 29.97 | 10,560 | 28.41 | 11,110 | 27.00 | 11,660 | 25.73 | 12,210 | 24.57 | 12,760 | 23.51 | 10,020 | 29.94 |
| 10,020 | 29.94 | 10,570 | 28.38 | 11,120 | 26.98 | 11,670 | 25.71 | 12,220 | 24.55 | 12,770 | 23.49 | 10,030 | 29.91 |
| 10,030 | 29.91 | 10,580 | 28.36 | 11,130 | 26.95 | 11,680 | 25.68 | 12,230 | 24.53 | 12,780 | 23.47 | 10,040 | 29.88 |
| 10,040 | 29.88 | 10,590 | 28.33 | 11,140 | 26.93 | 11,690 | 25.66 | 12,240 | 24.51 | 12,790 | 23.46 | 10,050 | 29.85 |
| 10,050 | 29.85 | 10,600 | 28.30 | 11,150 | 26.91 | 11,700 | 25.64 | 12,250 | 24.49 | 12,800 | 23.44 | 10,060 | 29.82 |
| 10,060 | 29.82 | 10,610 | 28.28 | 11,160 | 26.88 | 11,710 | 25.62 | 12,260 | 24.47 | 12,810 | 23.42 | 10,070 | 29.79 |
| 10,070 | 29.79 | 10,620 | 28.25 | 11,170 | 26.86 | 11,720 | 25.60 | 12,270 | 24.45 | 12,820 | 23.40 | 10,080 | 29.76 |
| 10,080 | 29.76 | 10,630 | 28.22 | 11,180 | 26.83 | 11,730 | 25.58 | 12,280 | 24.43 | 12,830 | 23.38 | 10,090 | 29.73 |
| 10,090 | 29.73 | 10,640 | 28.20 | 11,190 | 26.81 | 11,740 | 25.55 | 12,290 | 24.41 | 12,840 | 23.36 | 10,100 | 29.70 |
| 10,100 | 29.70 | 10,650 | 28.17 | 11,200 | 26.79 | 11,750 | 25.53 | 12,300 | 24.39 | 12,850 | 23.35 | 10,110 | 29.67 |
| 10,110 | 29.67 | 10,660 | 28.14 | 11,210 | 26.76 | 11,760 | 25.51 | 12,310 | 24.37 | 12,860 | 23.33 | 10,120 | 29.64 |
| 10,120 | 29.64 | 10,670 | 28.12 | 11,220 | 26.74 | 11,770 | 25.49 | 12,320 | 24.35 | 12,870 | 23.31 | 10,130 | 29.62 |
| 10,130 | 29.62 | 10,680 | 28.09 | 11,230 | 26.71 | 11,780 | 25.47 | 12,330 | 24.33 | 12,880 | 23.29 | 10,140 | 29.59 |
| 10,140 | 29.59 | 10,690 | 28.06 | 11,240 | 26.69 | 11,790 | 25.45 | 12,340 | 24.31 | 12,890 | 23.27 | 10,150 | 29.56 |
| 10,150 | 29.56 | 10,700 | 28.04 | 11,250 | 26.67 | 11,800 | 25.42 | 12,350 | 24.29 | 12,900 | 23.26 | 10,160 | 29.53 |
| 10,160 | 29.53 | 10,710 | 28.01 | 11,260 | 26.64 | 11,810 | 25.40 | 12,360 | 24.27 | 12,910 | 23.24 | 10,170 | 29.50 |
| 10,170 | 29.50 | 10,720 | 27.99 | 11,270 | 26.62 | 11,820 | 25.38 | 12,370 | 24.25 | 12,920 | 23.22 | 10,180 | 29.47 |
| 10,180 | 29.47 | 10,730 | 27.96 | 11,280 | 26.60 | 11,830 | 25.36 | 12,380 | 24.23 | 12,930 | 23.20 | 10,190 | 29.44 |
| 10,190 | 29.44 | 10,740 | 27.93 | 11,290 | 26.57 | 11,840 | 25.34 | 12,390 | 24.21 | 12,940 | 23.18 | 10,200 | 29.41 |
| 10,200 | 29.41 | 10,750 | 27.91 | 11,300 | 26.55 | 11,850 | 25.32 | 12,400 | 24.19 | 12,950 | 23.17 | 10,210 | 29.38 |
| 10,210 | 29.38 | 10,760 | 27.88 | 11,310 | 26.53 | 11,860 | 25.30 | 12,410 | 24.17 | 12,960 | 23.15 | 10,220 | 29.35 |
| 10,220 | 29.35 | 10,770 | 27.86 | 11,320 | 26.50 | 11,870 | 25.27 | 12,420 | 24.15 | 12,970 | 23.13 | 10,230 | 29.33 |
| 10,230 | 29.33 | 10,780 | 27.83 | 11,330 | 26.48 | 11,880 | 25.25 | 12,430 | 24.14 | 12,980 | 23.11 | 10,240 | 29.30 |
| 10,240 | 29.30 | 10,790 | 27.80 | 11,340 | 26.46 | 11,890 | 25.23 | 12,440 | 24.12 | 12,990 | 23.09 | 10,250 | 29.27 |
| 10,250 | 29.27 | 10,800 | 27.78 | 11,350 | 26.43 | 11,900 | 25.21 | 12,450 | 24.10 | 13,000 | 23.08 | 10,260 | 29.24 |
| 10,260 | 29.24 | 10,810 | 27.75 | 11,360 | 26.41 | 11,910 | 25.19 | 12,460 | 24.08 | 13,010 | 23.06 | 10,270 | 29.21 |
| 10,270 | 29.21 | 10,820 | 27.73 | 11,370 | 26.39 | 11,920 | 25.17 | 12,470 | 24.06 | 13,020 | 23.04 | 10,280 | 29.18 |
| 10,280 | 29.18 | 10,830 | 27.70 | 11,380 | 26.36 | 11,930 | 25.15 | 12,480 | 24.04 | 13,030 | 23.02 | 10,290 | 29.15 |
| 10,290 | 29.15 | 10,840 | 27.68 | 11,390 | 26.34 | 11,940 | 25.13 | 12,490 | 24.02 | 13,040 | 23.01 | 10,300 | 29.13 |
| 10,300 | 29.13 | 10,850 | 27.65 | 11,400 | 26.32 | 11,950 | 25.10 | 12,500 | 24.00 | 13,050 | 22.99 | 10,310 | 29.10 |
| 10,310 | 29.10 | 10,860 | 27.62 | 11,410 | 26.29 | 11,960 | 25.08 | 12,510 | 23.98 | 13,060 | 22.97 | 10,320 | 29.07 |
| 10,320 | 29.07 | 10,870 | 27.60 | 11,420 | 26.27 | 11,970 | 25.06 | 12,520 | 23.96 | 13,070 | 22.95 | 10,330 | 29.04 |
| 10,330 | 29.04 | 10,880 | 27.57 | 11,430 | 26.25 | 11,980 | 25.04 | 12,530 | 23.94 | 13,080 | 22.94 | 10,340 | 29.01 |
| 10,340 | 29.01 | 10,890 | 27.55 | 11,440 | 26.22 | 11,990 | 25.02 | 12,540 | 23.92 | 13,090 | 22.92 | 10,350 | 28.99 |
| 10,350 | 28.99 | 10,900 | 27.52 | 11,450 | 26.20 | 12,000 | 25.00 | 12,550 | 23.90 | 13,100 | 22.90 | 10,360 | 28.96 |
| 10,360 | 28.96 | 10,910 | 27.50 | 11,460 | 26.18 | 12,010 | 24.98 | 12,560 | 23.88 | 13,110 | 22.88 | 10,370 | 28.93 |
| 10,370 | 28.93 | 10,920 | 27.47 | 11,470 | 26.16 | 12,020 | 24.96 | 12,570 | 23.87 | 13,120 | 22.87 | 10,380 | 28.90 |
| 10,380 | 28.90 | 10,930 | 27.45 | 11,480 | 26.13 | 12,030 | 24.94 | 12,580 | 23.85 | 13,130 | 22.85 | 10,390 | 28.87 |
| 10,390 | 28.87 | 10,940 | 27.42 | 11,490 | 26.11 | 12,040 | 24.92 | 12,590 | 23.83 | 13,140 | 22.83 | 10,400 | 28.85 |
| 10,400 | 28.85 | 10,950 | 27.40 | 11,500 | 26.09 | 12,050 | 24.90 | 12,600 | 23.81 | 13,150 | 22.81 | 10,410 | 28.82 |
| 10,410 | 28.82 | 10,960 | 27.37 | 11,510 | 26.06 | 12,060 | 24.88 | 12,610 | 23.79 | 13,160 | 22.80 | 10,420 | 28.79 |
| 10,420 | 28.79 | 10,970 | 27.35 | 11,520 | 26.04 | 12,070 | 24.86 | 12,620 | 23.77 | 13,170 | 22.78 | 10,430 | 28.76 |
| 10,430 | 28.76 | 10,980 | 27.32 | 11,530 | 26.02 | 12,080 | 24.83 | 12,630 | 23.75 | 13,180 | 22.76 | 10,440 | 28.74 |
| 10,440 | 28.74 | 10,990 | 27.30 | 11,540 | 26.00 | 12,090 | 24.81 | 12,640 | 23.73 | 13,190 | 22.74 | 10,450 | 28.71 |
| 10,450 | 28.71 | 11,000 | 27.27 | 11,550 | 25.97 | 12,100 | 24.79 | 12,650 | 23.72 | 13,200 | 22.73 | | |

KILOCYCLE-METER CONVERSION TABLE—Continued

| kc or m | m or kc | kc or m | m or kc | kc or m | m or kc | kc or m | m or kc | kc or m | m or kc | kc or m | m or kc | kc or m | m or kc |
|---------|---------|---------|---------|---------|---------|---------|---------|---------|---------|---------|---------|---------|---------|
| 13,210 | 22.71 | 13,760 | 21.80 | 14,310 | 20.96 | 14,860 | 20.19 | 15,410 | 19.468 | 15,960 | 18.797 | 16,510 | 18.178 |
| 13,220 | 22.69 | 13,770 | 21.79 | 14,320 | 20.95 | 14,870 | 20.17 | 15,420 | 19.455 | 15,970 | 18.785 | 16,520 | 18.773 |
| 13,230 | 22.68 | 13,780 | 21.77 | 14,330 | 20.94 | 14,880 | 20.16 | 15,430 | 19.443 | 15,980 | 18.773 | 16,530 | 18.762 |
| 13,240 | 22.66 | 13,790 | 21.75 | 14,340 | 20.92 | 14,890 | 20.15 | 15,440 | 19.430 | 15,990 | 18.762 | 16,540 | 18.750 |
| 13,250 | 22.64 | 13,800 | 21.74 | 14,350 | 20.91 | 14,900 | 20.13 | 15,450 | 19.417 | 16,000 | 18.750 | | |
| 13,260 | 22.62 | 13,810 | 21.72 | 14,360 | 20.89 | 14,910 | 20.12 | 15,460 | 19.405 | 16,010 | 18.738 | | |
| 13,270 | 22.61 | 13,820 | 21.71 | 14,370 | 20.88 | 14,920 | 20.11 | 15,470 | 19.392 | 16,020 | 18.727 | | |
| 13,280 | 22.59 | 13,830 | 21.69 | 14,380 | 20.86 | 14,930 | 20.09 | 15,480 | 19.380 | 16,030 | 18.715 | | |
| 13,290 | 22.57 | 13,840 | 21.68 | 14,390 | 20.85 | 14,940 | 20.08 | 15,490 | 19.367 | 16,040 | 18.703 | | |
| 13,300 | 22.56 | 13,850 | 21.66 | 14,400 | 20.83 | 14,950 | 20.07 | 15,500 | 19.355 | 16,050 | 18.692 | | |
| 13,310 | 22.54 | 13,860 | 21.65 | 14,410 | 20.82 | 14,960 | 20.05 | 15,510 | 19.342 | 16,060 | 18.680 | | |
| 13,320 | 22.52 | 13,870 | 21.63 | 14,420 | 20.80 | 14,970 | 20.04 | 15,520 | 19.330 | 16,070 | 18.668 | | |
| 13,330 | 22.51 | 13,880 | 21.61 | 14,430 | 20.79 | 14,980 | 20.03 | 15,530 | 19.317 | 16,080 | 18.657 | | |
| 13,340 | 22.49 | 13,890 | 21.60 | 14,440 | 20.78 | 14,990 | 20.01 | 15,540 | 19.305 | 16,090 | 18.645 | | |
| 13,350 | 22.47 | 13,900 | 21.58 | 14,450 | 20.76 | 15,000 | 20.00 | 15,550 | 19.293 | 16,100 | 18.634 | | |
| 13,360 | 22.46 | 13,910 | 21.57 | 14,460 | 20.75 | 15,010 | 19.987 | 15,560 | 19.280 | 16,110 | 18.622 | | |
| 13,370 | 22.44 | 13,920 | 21.55 | 14,470 | 20.73 | 15,020 | 19.973 | 15,570 | 19.268 | 16,120 | 18.610 | | |
| 13,380 | 22.42 | 13,930 | 21.54 | 14,480 | 20.72 | 15,030 | 19.960 | 15,580 | 19.255 | 16,130 | 18.599 | | |
| 13,390 | 22.40 | 13,940 | 21.52 | 14,490 | 20.70 | 15,040 | 19.947 | 15,590 | 19.243 | 16,140 | 18.587 | | |
| 13,400 | 22.39 | 13,950 | 21.51 | 14,500 | 20.69 | 15,050 | 19.934 | 15,600 | 19.231 | 16,150 | 18.576 | | |
| 13,410 | 22.37 | 13,960 | 21.49 | 14,510 | 20.68 | 15,060 | 19.919 | 15,610 | 19.218 | 16,160 | 18.564 | | |
| 13,420 | 22.35 | 13,970 | 21.47 | 14,520 | 20.66 | 15,070 | 19.907 | 15,620 | 19.206 | 16,170 | 18.553 | | |
| 13,430 | 22.34 | 13,980 | 21.46 | 14,530 | 20.65 | 15,080 | 19.894 | 15,630 | 19.194 | 16,180 | 18.541 | | |
| 13,440 | 22.32 | 13,990 | 21.44 | 14,540 | 20.63 | 15,090 | 19.881 | 15,640 | 19.182 | 16,190 | 18.530 | | |
| 13,450 | 22.30 | 14,000 | 21.43 | 14,550 | 20.62 | 15,100 | 19.868 | 15,650 | 19.169 | 16,200 | 18.519 | | |
| 13,460 | 22.29 | 14,010 | 21.41 | 14,560 | 20.60 | 15,110 | 19.854 | 15,660 | 19.157 | 16,210 | 18.507 | | |
| 13,470 | 22.27 | 14,020 | 21.40 | 14,570 | 20.59 | 15,120 | 19.841 | 15,670 | 19.145 | 16,220 | 18.496 | | |
| 13,480 | 22.26 | 14,030 | 21.38 | 14,580 | 20.58 | 15,130 | 19.828 | 15,680 | 19.133 | 16,230 | 18.484 | | |
| 13,490 | 22.24 | 14,040 | 21.37 | 14,590 | 20.56 | 15,140 | 19.815 | 15,690 | 19.120 | 16,240 | 18.473 | | |
| 13,500 | 22.22 | 14,050 | 21.35 | 14,600 | 20.55 | 15,150 | 19.802 | 15,700 | 19.108 | 16,250 | 18.462 | | |
| 13,510 | 22.21 | 14,060 | 21.34 | 14,610 | 20.53 | 15,160 | 19.789 | 15,710 | 19.096 | 16,260 | 18.450 | | |
| 13,520 | 22.19 | 14,070 | 21.32 | 14,620 | 20.52 | 15,170 | 19.776 | 15,720 | 19.084 | 16,270 | 18.439 | | |
| 13,530 | 22.17 | 14,080 | 21.31 | 14,630 | 20.51 | 15,180 | 19.763 | 15,730 | 19.072 | 16,280 | 18.428 | | |
| 13,540 | 22.16 | 14,090 | 21.29 | 14,640 | 20.49 | 15,190 | 19.750 | 15,740 | 19.060 | 16,290 | 18.416 | | |
| 13,550 | 22.14 | 14,100 | 21.28 | 14,650 | 20.48 | 15,200 | 19.737 | 15,750 | 19.048 | 16,300 | 18.405 | | |
| 13,560 | 22.12 | 14,110 | 21.26 | 14,660 | 20.46 | 15,210 | 19.724 | 15,760 | 19.036 | 16,310 | 18.394 | | |
| 13,570 | 22.11 | 14,120 | 21.25 | 14,670 | 20.45 | 15,220 | 19.711 | 15,770 | 19.023 | 16,320 | 18.382 | | |
| 13,580 | 22.09 | 14,130 | 21.23 | 14,680 | 20.44 | 15,230 | 19.698 | 15,780 | 19.011 | 16,330 | 18.371 | | |
| 13,590 | 22.08 | 14,140 | 21.22 | 14,690 | 20.42 | 15,240 | 19.685 | 15,790 | 18.999 | 16,340 | 18.360 | | |
| 13,600 | 22.06 | 14,150 | 21.20 | 14,700 | 20.41 | 15,250 | 19.672 | 15,800 | 18.987 | 16,350 | 18.349 | | |
| 13,610 | 22.04 | 14,160 | 21.19 | 14,710 | 20.39 | 15,260 | 19.659 | 15,810 | 18.975 | 16,360 | 18.337 | | |
| 13,620 | 22.03 | 14,170 | 21.17 | 14,720 | 20.38 | 15,270 | 19.646 | 15,820 | 18.963 | 16,370 | 18.326 | | |
| 13,630 | 22.01 | 14,180 | 21.16 | 14,730 | 20.37 | 15,280 | 19.634 | 15,830 | 18.951 | 16,380 | 18.315 | | |
| 13,640 | 21.99 | 14,190 | 21.14 | 14,740 | 20.35 | 15,290 | 19.621 | 15,840 | 18.939 | 16,390 | 18.304 | | |
| 13,650 | 21.98 | 14,200 | 21.13 | 14,750 | 20.34 | 15,300 | 19.608 | 15,850 | 18.927 | 16,400 | 18.293 | | |
| 13,660 | 21.96 | 14,210 | 21.11 | 14,760 | 20.33 | 15,310 | 19.595 | 15,860 | 18.912 | 16,410 | 18.282 | | |
| 13,670 | 21.95 | 14,220 | 21.10 | 14,770 | 20.31 | 15,320 | 19.582 | 15,870 | 18.900 | 16,420 | 18.270 | | |
| 13,680 | 21.93 | 14,230 | 21.08 | 14,780 | 20.30 | 15,330 | 19.569 | 15,880 | 18.892 | 16,430 | 18.259 | | |
| 13,690 | 21.91 | 14,240 | 21.07 | 14,790 | 20.28 | 15,340 | 19.557 | 15,890 | 18.880 | 16,440 | 18.248 | | |
| 13,700 | 21.90 | 14,250 | 21.05 | 14,800 | 20.27 | 15,350 | 19.544 | 15,900 | 18.868 | 16,450 | 18.237 | | |
| 13,710 | 21.88 | 14,260 | 21.04 | 14,810 | 20.26 | 15,360 | 19.531 | 15,910 | 18.856 | 16,460 | 18.226 | | |
| 13,720 | 21.87 | 14,270 | 21.02 | 14,820 | 20.24 | 15,370 | 19.519 | 15,920 | 18.844 | 16,470 | 18.215 | | |
| 13,730 | 21.85 | 14,280 | 21.01 | 14,830 | 20.23 | 15,380 | 19.506 | 15,930 | 18.832 | 16,480 | 18.204 | | |
| 13,740 | 21.83 | 14,290 | 20.99 | 14,840 | 20.22 | 15,390 | 19.493 | 15,940 | 18.821 | 16,490 | 18.193 | | |
| 13,750 | 21.82 | 14,300 | 20.98 | 14,850 | 20.20 | 15,400 | 19.481 | 15,950 | 18.809 | 16,500 | 18.182 | | |

KILOCYCLE-METER CONVERSION TABLE 777

KILOCYCLE-METER CONVERSION TABLE—Continued

| kc or m | m or kc | kc or m | m or kc | kc or m | m or kc | kc or m | m or kc | kc or m | m or kc | kc or m | m or kc |
|---------|---------|---------|---------|---------|---------|---------|---------|---------|---------|---------|---------|
| 16,510 | 18.171 | 17,060 | 17.585 | 17,610 | 17.036 | 18,160 | 16.520 | 18,710 | 16.034 | 19,260 | 15.576 |
| 16,520 | 18.160 | 17,070 | 17.575 | 17,620 | 17.026 | 18,170 | 16.511 | 18,720 | 16.026 | 19,270 | 15.568 |
| 16,530 | 18.149 | 17,080 | 17.561 | 17,630 | 17.016 | 18,180 | 16.502 | 18,730 | 16.017 | 19,280 | 15.560 |
| 16,540 | 18.138 | 17,090 | 17.544 | 17,640 | 17.007 | 18,190 | 16.493 | 18,740 | 16.009 | 19,290 | 15.552 |
| 16,550 | 18.127 | 17,100 | 17.544 | 17,650 | 16.997 | 18,200 | 16.484 | 18,750 | 16.000 | 19,300 | 15.544 |
| 16,560 | 18.116 | 17,110 | 17.534 | 17,660 | 16.988 | 18,210 | 16.474 | 18,760 | 15.991 | 19,310 | 15.536 |
| 16,570 | 18.105 | 17,120 | 17.523 | 17,670 | 16.978 | 18,220 | 16.465 | 18,770 | 15.983 | 19,320 | 15.528 |
| 16,580 | 18.094 | 17,130 | 17.513 | 17,680 | 16.968 | 18,230 | 16.456 | 18,780 | 15.974 | 19,330 | 15.520 |
| 16,590 | 18.083 | 17,140 | 17.503 | 17,690 | 16.959 | 18,240 | 16.447 | 18,790 | 15.966 | 19,340 | 15.512 |
| 16,600 | 18.072 | 17,150 | 17.493 | 17,700 | 16.949 | 18,250 | 16.438 | 18,800 | 15.957 | 19,350 | 15.504 |
| 16,610 | 18.061 | 17,160 | 17.483 | 17,710 | 16.940 | 18,260 | 16.429 | 18,810 | 15.949 | 19,360 | 15.496 |
| 16,620 | 18.051 | 17,170 | 17.472 | 17,720 | 16.930 | 18,270 | 16.420 | 18,820 | 15.940 | 19,370 | 15.488 |
| 16,630 | 18.040 | 17,180 | 17.462 | 17,730 | 16.920 | 18,280 | 16.411 | 18,830 | 15.932 | 19,380 | 15.480 |
| 16,640 | 18.029 | 17,190 | 17.452 | 17,740 | 16.911 | 18,290 | 16.402 | 18,840 | 15.924 | 19,390 | 15.472 |
| 16,650 | 18.018 | 17,200 | 17.443 | 17,750 | 16.901 | 18,300 | 16.393 | 18,850 | 15.915 | 19,400 | 15.464 |
| 16,660 | 18.007 | 17,210 | 17.432 | 17,760 | 16.892 | 18,310 | 16.384 | 18,860 | 15.907 | 19,410 | 15.456 |
| 16,670 | 17.996 | 17,220 | 17.422 | 17,770 | 16.882 | 18,320 | 16.376 | 18,870 | 15.898 | 19,420 | 15.448 |
| 16,680 | 17.986 | 17,230 | 17.411 | 17,780 | 16.873 | 18,330 | 16.367 | 18,880 | 15.890 | 19,430 | 15.440 |
| 16,690 | 17.975 | 17,240 | 17.401 | 17,790 | 16.863 | 18,340 | 16.358 | 18,890 | 15.881 | 19,440 | 15.432 |
| 16,700 | 17.964 | 17,250 | 17.391 | 17,800 | 16.854 | 18,350 | 16.349 | 18,900 | 15.873 | 19,450 | 15.424 |
| 16,710 | 17.953 | 17,260 | 17.381 | 17,810 | 16.844 | 18,360 | 16.340 | 18,910 | 15.865 | 19,460 | 15.416 |
| 16,720 | 17.943 | 17,270 | 17.371 | 17,820 | 16.835 | 18,370 | 16.331 | 18,920 | 15.856 | 19,470 | 15.408 |
| 16,730 | 17.932 | 17,280 | 17.361 | 17,830 | 16.826 | 18,380 | 16.322 | 18,930 | 15.848 | 19,480 | 15.400 |
| 16,740 | 17.921 | 17,290 | 17.351 | 17,840 | 16.816 | 18,390 | 16.313 | 18,940 | 15.839 | 19,490 | 15.393 |
| 16,750 | 17.910 | 17,300 | 17.341 | 17,850 | 16.807 | 18,400 | 16.304 | 18,950 | 15.831 | 19,500 | 15.385 |
| 16,760 | 17.899 | 17,310 | 17.331 | 17,860 | 16.797 | 18,410 | 16.295 | 18,960 | 15.823 | 19,510 | 15.377 |
| 16,770 | 17.889 | 17,320 | 17.321 | 17,870 | 16.788 | 18,420 | 16.287 | 18,970 | 15.814 | 19,520 | 15.369 |
| 16,780 | 17.878 | 17,330 | 17.311 | 17,880 | 16.779 | 18,430 | 16.278 | 18,980 | 15.806 | 19,530 | 15.361 |
| 16,790 | 17.868 | 17,340 | 17.301 | 17,890 | 16.769 | 18,440 | 16.269 | 18,990 | 15.798 | 19,540 | 15.353 |
| 16,800 | 17.857 | 17,350 | 17.291 | 17,900 | 16.760 | 18,450 | 16.260 | 19,000 | 15.789 | 19,550 | 15.345 |
| 16,810 | 17.847 | 17,360 | 17.281 | 17,910 | 16.750 | 18,460 | 16.251 | 19,010 | 15.781 | 19,560 | 15.337 |
| 16,820 | 17.836 | 17,370 | 17.271 | 17,920 | 16.741 | 18,470 | 16.243 | 19,020 | 15.773 | 19,570 | 15.330 |
| 16,830 | 17.826 | 17,380 | 17.261 | 17,930 | 16.732 | 18,480 | 16.234 | 19,030 | 15.765 | 19,580 | 15.322 |
| 16,840 | 17.815 | 17,390 | 17.251 | 17,940 | 16.722 | 18,490 | 16.225 | 19,040 | 15.756 | 19,590 | 15.314 |
| 16,850 | 17.804 | 17,400 | 17.241 | 17,950 | 16.713 | 18,500 | 16.216 | 19,050 | 15.748 | 19,600 | 15.306 |
| 16,860 | 17.794 | 17,410 | 17.231 | 17,960 | 16.704 | 18,510 | 16.207 | 19,060 | 15.740 | 19,610 | 15.298 |
| 16,870 | 17.783 | 17,420 | 17.222 | 17,970 | 16.694 | 18,520 | 16.199 | 19,070 | 15.732 | 19,620 | 15.291 |
| 16,880 | 17.773 | 17,430 | 17.212 | 17,980 | 16.685 | 18,530 | 16.190 | 19,080 | 15.723 | 19,630 | 15.283 |
| 16,890 | 17.762 | 17,440 | 17.202 | 17,990 | 16.676 | 18,540 | 16.181 | 19,090 | 15.715 | 19,640 | 15.275 |
| 16,900 | 17.751 | 17,450 | 17.192 | 18,000 | 16.667 | 18,550 | 16.173 | 19,100 | 15.707 | 19,650 | 15.267 |
| 16,910 | 17.741 | 17,460 | 17.182 | 18,010 | 16.657 | 18,560 | 16.164 | 19,110 | 15.699 | 19,660 | 15.259 |
| 16,920 | 17.730 | 17,470 | 17.172 | 18,020 | 16.648 | 18,570 | 16.155 | 19,120 | 15.690 | 19,670 | 15.252 |
| 16,930 | 17.720 | 17,480 | 17.162 | 18,030 | 16.639 | 18,580 | 16.146 | 19,130 | 15.682 | 19,680 | 15.244 |
| 16,940 | 17.710 | 17,490 | 17.153 | 18,040 | 16.630 | 18,590 | 16.138 | 19,140 | 15.674 | 19,690 | 15.236 |
| 16,950 | 17.700 | 17,500 | 17.143 | 18,050 | 16.620 | 18,600 | 16.129 | 19,150 | 15.666 | 19,700 | 15.228 |
| 16,960 | 17.689 | 17,510 | 17.133 | 18,060 | 16.611 | 18,610 | 16.120 | 19,160 | 15.658 | 19,710 | 15.221 |
| 16,970 | 17.678 | 17,520 | 17.123 | 18,070 | 16.602 | 18,620 | 16.112 | 19,170 | 15.649 | 19,720 | 15.213 |
| 16,980 | 17.668 | 17,530 | 17.114 | 18,080 | 16.593 | 18,630 | 16.103 | 19,180 | 15.641 | 19,730 | 15.205 |
| 16,990 | 17.657 | 17,540 | 17.104 | 18,090 | 16.584 | 18,640 | 16.094 | 19,190 | 15.633 | 19,740 | 15.198 |
| 17,000 | 17.647 | 17,550 | 17.094 | 18,100 | 16.575 | 18,650 | 16.086 | 19,200 | 15.625 | 19,750 | 15.190 |
| 17,010 | 17.637 | 17,560 | 17.084 | 18,110 | 16.565 | 18,660 | 16.077 | 19,210 | 15.617 | 19,760 | 15.182 |
| 17,020 | 17.626 | 17,570 | 17.075 | 18,120 | 16.556 | 18,670 | 16.069 | 19,220 | 15.609 | 19,770 | 15.175 |
| 17,030 | 17.616 | 17,580 | 17.065 | 18,130 | 16.547 | 18,680 | 16.060 | 19,230 | 15.601 | 19,780 | 15.167 |
| 17,040 | 17.606 | 17,590 | 17.055 | 18,140 | 16.538 | 18,690 | 16.051 | 19,240 | 15.593 | 19,790 | 15.159 |
| 17,050 | 17.595 | 17,600 | 17.045 | 18,150 | 16.529 | 18,700 | 16.043 | 19,250 | 15.584 | 19,800 | 15.151 |

KILOCYCLE-METER CONVERSION TABLE—Continued

| kc or m | m or kc | kc or m | m or kc | kc or m | m or kc | kc or m | m or kc | kc or m | m or kc | kc or m | m or kc | kc or m | m or kc |
|---------|---------|---------|---------|---------|---------|---------|---------|---------|---------|---------|---------|---------|---------|
| 19,810 | 15.144 | 20,360 | 14.735 | 20,910 | 14.347 | 21,460 | 13.979 | 22,010 | 13.630 | 22,560 | 13.298 | 23,110 | 12.966 |
| 19,820 | 15.136 | 20,370 | 14.728 | 20,920 | 14.340 | 21,470 | 13.973 | 22,020 | 13.624 | 22,570 | 13.292 | 23,120 | 12.960 |
| 19,830 | 15.129 | 20,380 | 14.720 | 20,930 | 14.333 | 21,480 | 13.966 | 22,030 | 13.618 | 22,580 | 13.286 | 23,130 | 12.954 |
| 19,840 | 15.121 | 20,390 | 14.713 | 20,940 | 14.327 | 21,490 | 13.960 | 22,040 | 13.612 | 22,590 | 13.280 | 23,140 | 12.948 |
| 19,850 | 15.113 | 20,400 | 14.706 | 20,950 | 14.320 | 21,500 | 13.953 | 22,050 | 13.605 | 22,600 | 13.274 | 23,150 | 12.942 |
| 19,860 | 15.106 | 20,410 | 14.699 | 20,960 | 14.313 | 21,510 | 13.947 | 22,060 | 13.599 | 22,610 | 13.268 | 23,160 | 12.936 |
| 19,870 | 15.098 | 20,420 | 14.691 | 20,970 | 14.306 | 21,520 | 13.941 | 22,070 | 13.593 | 22,620 | 13.263 | 23,170 | 12.930 |
| 19,880 | 15.091 | 20,430 | 14.684 | 20,980 | 14.299 | 21,530 | 13.934 | 22,080 | 13.587 | 22,630 | 13.257 | 23,180 | 12.924 |
| 19,890 | 15.083 | 20,440 | 14.677 | 20,990 | 14.293 | 21,540 | 13.928 | 22,090 | 13.581 | 22,640 | 13.251 | 23,190 | 12.918 |
| 19,900 | 15.075 | 20,450 | 14.670 | 21,000 | 14.286 | 21,550 | 13.921 | 22,100 | 13.575 | 22,650 | 13.245 | 23,200 | 12.912 |
| 19,910 | 15.068 | 20,460 | 14.663 | 21,010 | 14.279 | 21,560 | 13.915 | 22,110 | 13.569 | 22,660 | 13.239 | 23,210 | 12.906 |
| 19,920 | 15.060 | 20,470 | 14.656 | 21,020 | 14.272 | 21,570 | 13.908 | 22,120 | 13.562 | 22,670 | 13.233 | 23,220 | 12.900 |
| 19,930 | 15.053 | 20,480 | 14.648 | 21,030 | 14.265 | 21,580 | 13.902 | 22,130 | 13.556 | 22,680 | 13.228 | 23,230 | 12.894 |
| 19,940 | 15.045 | 20,490 | 14.641 | 21,040 | 14.259 | 21,590 | 13.895 | 22,140 | 13.550 | 22,690 | 13.222 | 23,240 | 12.888 |
| 19,950 | 15.038 | 20,500 | 14.634 | 21,050 | 14.252 | 21,600 | 13.889 | 22,150 | 13.544 | 22,700 | 13.216 | 23,250 | 12.882 |
| 19,960 | 15.030 | 20,510 | 14.627 | 21,060 | 14.245 | 21,610 | 13.882 | 22,160 | 13.538 | 22,710 | 13.210 | 23,260 | 12.876 |
| 19,970 | 15.023 | 20,520 | 14.620 | 21,070 | 14.238 | 21,620 | 13.876 | 22,170 | 13.532 | 22,720 | 13.204 | 23,270 | 12.870 |
| 19,980 | 15.015 | 20,530 | 14.613 | 21,080 | 14.231 | 21,630 | 13.870 | 22,180 | 13.526 | 22,730 | 13.198 | 23,280 | 12.864 |
| 19,990 | 15.008 | 20,540 | 14.606 | 21,090 | 14.225 | 21,640 | 13.863 | 22,190 | 13.520 | 22,740 | 13.192 | 23,290 | 12.858 |
| 20,000 | 15.000 | 20,550 | 14.599 | 21,100 | 14.218 | 21,650 | 13.857 | 22,200 | 13.514 | 22,750 | 13.187 | 23,300 | 12.852 |
| 20,010 | 14.993 | 20,560 | 14.591 | 21,110 | 14.211 | 21,660 | 13.850 | 22,210 | 13.507 | 22,760 | 13.181 | 23,310 | 12.846 |
| 20,020 | 14.985 | 20,570 | 14.584 | 21,120 | 14.205 | 21,670 | 13.844 | 22,220 | 13.501 | 22,770 | 13.175 | 23,320 | 12.840 |
| 20,030 | 14.978 | 20,580 | 14.577 | 21,130 | 14.198 | 21,680 | 13.838 | 22,230 | 13.495 | 22,780 | 13.169 | 23,330 | 12.834 |
| 20,040 | 14.970 | 20,590 | 14.570 | 21,140 | 14.191 | 21,690 | 13.831 | 22,240 | 13.489 | 22,790 | 13.164 | 23,340 | 12.828 |
| 20,050 | 14.963 | 20,600 | 14.563 | 21,150 | 14.184 | 21,700 | 13.825 | 22,250 | 13.483 | 22,800 | 13.158 | 23,350 | 12.822 |
| 20,060 | 14.955 | 20,610 | 14.556 | 21,160 | 14.178 | 21,710 | 13.819 | 22,260 | 13.477 | 22,810 | 13.152 | 23,360 | 12.816 |
| 20,070 | 14.948 | 20,620 | 14.549 | 21,170 | 14.171 | 21,720 | 13.812 | 22,270 | 13.471 | 22,820 | 13.146 | 23,370 | 12.810 |
| 20,080 | 14.940 | 20,630 | 14.542 | 21,180 | 14.164 | 21,730 | 13.806 | 22,280 | 13.465 | 22,830 | 13.141 | 23,380 | 12.804 |
| 20,090 | 14.933 | 20,640 | 14.535 | 21,190 | 14.158 | 21,740 | 13.799 | 22,290 | 13.459 | 22,840 | 13.135 | 23,390 | 12.798 |
| 20,100 | 14.925 | 20,650 | 14.528 | 21,200 | 14.151 | 21,750 | 13.793 | 22,300 | 13.453 | 22,850 | 13.129 | 23,400 | 12.792 |
| 20,110 | 14.918 | 20,660 | 14.521 | 21,210 | 14.144 | 21,760 | 13.787 | 22,310 | 13.447 | 22,860 | 13.123 | 23,410 | 12.786 |
| 20,120 | 14.911 | 20,670 | 14.514 | 21,220 | 14.138 | 21,770 | 13.780 | 22,320 | 13.441 | 22,870 | 13.118 | 23,420 | 12.780 |
| 20,130 | 14.903 | 20,680 | 14.507 | 21,230 | 14.131 | 21,780 | 13.774 | 22,330 | 13.435 | 22,880 | 13.112 | 23,430 | 12.774 |
| 20,140 | 14.896 | 20,690 | 14.500 | 21,240 | 14.124 | 21,790 | 13.768 | 22,340 | 13.429 | 22,890 | 13.106 | 23,440 | 12.768 |
| 20,150 | 14.888 | 20,700 | 14.493 | 21,250 | 14.118 | 21,800 | 13.761 | 22,350 | 13.423 | 22,900 | 13.100 | 23,450 | 12.762 |
| 20,160 | 14.881 | 20,710 | 14.486 | 21,260 | 14.111 | 21,810 | 13.755 | 22,360 | 13.417 | 22,910 | 13.095 | 23,460 | 12.756 |
| 20,170 | 14.874 | 20,720 | 14.479 | 21,270 | 14.104 | 21,820 | 13.749 | 22,370 | 13.411 | 22,920 | 13.089 | 23,470 | 12.750 |
| 20,180 | 14.866 | 20,730 | 14.472 | 21,280 | 14.098 | 21,830 | 13.743 | 22,380 | 13.405 | 22,930 | 13.083 | 23,480 | 12.744 |
| 20,190 | 14.859 | 20,740 | 14.465 | 21,290 | 14.091 | 21,840 | 13.736 | 22,390 | 13.399 | 22,940 | 13.078 | 23,490 | 12.738 |
| 20,200 | 14.851 | 20,750 | 14.458 | 21,300 | 14.085 | 21,850 | 13.730 | 22,400 | 13.393 | 22,950 | 13.072 | 23,500 | 12.732 |
| 20,210 | 14.844 | 20,760 | 14.451 | 21,310 | 14.078 | 21,860 | 13.724 | 22,410 | 13.387 | 22,960 | 13.066 | 23,510 | 12.726 |
| 20,220 | 14.837 | 20,770 | 14.444 | 21,320 | 14.071 | 21,870 | 13.717 | 22,420 | 13.381 | 22,970 | 13.060 | 23,520 | 12.720 |
| 20,230 | 14.829 | 20,780 | 14.437 | 21,330 | 14.065 | 21,880 | 13.711 | 22,430 | 13.375 | 22,980 | 13.055 | 23,530 | 12.714 |
| 20,240 | 14.822 | 20,790 | 14.430 | 21,340 | 14.058 | 21,890 | 13.705 | 22,440 | 13.369 | 22,990 | 13.049 | 23,540 | 12.708 |
| 20,250 | 14.815 | 20,800 | 14.423 | 21,350 | 14.052 | 21,900 | 13.699 | 22,450 | 13.363 | 23,000 | 13.043 | 23,550 | 12.702 |
| 20,260 | 14.808 | 20,810 | 14.416 | 21,360 | 14.045 | 21,910 | 13.692 | 22,460 | 13.357 | 23,010 | 13.038 | 23,560 | 12.696 |
| 20,270 | 14.800 | 20,820 | 14.409 | 21,370 | 14.038 | 21,920 | 13.686 | 22,470 | 13.351 | 23,020 | 13.032 | 23,570 | 12.690 |
| 20,280 | 14.793 | 20,830 | 14.402 | 21,380 | 14.032 | 21,930 | 13.680 | 22,480 | 13.345 | 23,030 | 13.026 | 23,580 | 12.684 |
| 20,290 | 14.786 | 20,840 | 14.395 | 21,390 | 14.025 | 21,940 | 13.674 | 22,490 | 13.339 | 23,040 | 13.020 | 23,590 | 12.678 |
| 20,300 | 14.778 | 20,850 | 14.388 | 21,400 | 14.019 | 21,950 | 13.667 | 22,500 | 13.333 | 23,050 | 13.015 | 23,600 | 12.672 |
| 20,310 | 14.771 | 20,860 | 14.382 | 21,410 | 14.012 | 21,960 | 13.661 | 22,510 | 13.327 | 23,060 | 13.010 | 23,610 | 12.666 |
| 20,320 | 14.764 | 20,870 | 14.375 | 21,420 | 14.006 | 21,970 | 13.655 | 22,520 | 13.321 | 23,070 | 13.004 | 23,620 | 12.660 |
| 20,330 | 14.757 | 20,880 | 14.368 | 21,430 | 13.999 | 21,980 | 13.649 | 22,530 | 13.315 | 23,080 | 12.998 | 23,630 | 12.654 |
| 20,340 | 14.749 | 20,890 | 14.361 | 21,440 | 13.993 | 21,990 | 13.643 | 22,540 | 13.310 | 23,090 | 12.993 | 23,640 | 12.648 |
| 20,350 | 14.742 | 20,900 | 14.354 | 21,450 | 13.986 | 22,000 | 13.636 | 22,550 | 13.304 | 23,100 | 12.987 | 23,650 | 12.642 |

KILOCYCLE-METER CONVERSION TABLE 779

KILOCYCLE-METER CONVERSION TABLE—Continued

| kc or m | m or kc | kc or m | m or kc | kc or m | m or kc | kc or m | m or kc | kc or m | m or kc | kc or m | m or kc | kc or m | m or kc |
|---------|---------|---------|---------|---------|---------|---------|---------|---------|---------|---------|---------|---------|---------|
| 23,110 | 12.981 | 23,660 | 12.680 | 24,210 | 12.392 | 24,760 | 12.116 | 25,310 | 11.853 | 25,860 | 11.601 | | |
| 23,120 | 12.976 | 23,670 | 12.674 | 24,220 | 12.387 | 24,770 | 12.111 | 25,320 | 11.848 | 25,870 | 11.596 | | |
| 23,130 | 12.970 | 23,680 | 12.669 | 24,230 | 12.381 | 24,780 | 12.107 | 25,330 | 11.844 | 25,880 | 11.592 | | |
| 23,140 | 12.965 | 23,690 | 12.664 | 24,240 | 12.376 | 24,790 | 12.102 | 25,340 | 11.839 | 25,890 | 11.587 | | |
| 23,150 | 12.959 | 23,700 | 12.658 | 24,250 | 12.371 | 24,800 | 12.097 | 25,350 | 11.834 | 25,900 | 11.583 | | |
| 23,160 | 12.953 | 23,710 | 12.653 | 24,260 | 12.366 | 24,810 | 12.092 | 25,360 | 11.830 | 25,910 | 11.579 | | |
| 23,170 | 12.948 | 23,720 | 12.648 | 24,270 | 12.361 | 24,820 | 12.087 | 25,370 | 11.825 | 25,920 | 11.574 | | |
| 23,180 | 12.942 | 23,730 | 12.642 | 24,280 | 12.356 | 24,830 | 12.082 | 25,380 | 11.820 | 25,930 | 11.570 | | |
| 23,190 | 12.937 | 23,740 | 12.637 | 24,290 | 12.351 | 24,840 | 12.077 | 25,390 | 11.816 | 25,940 | 11.565 | | |
| 23,200 | 12.931 | 23,750 | 12.632 | 24,300 | 12.346 | 24,850 | 12.072 | 25,400 | 11.811 | 25,950 | 11.561 | | |
| 23,210 | 12.925 | 23,760 | 12.626 | 24,310 | 12.341 | 24,860 | 12.068 | 25,410 | 11.806 | 25,960 | 11.556 | | |
| 23,220 | 12.920 | 23,770 | 12.621 | 24,320 | 12.336 | 24,870 | 12.063 | 25,420 | 11.802 | 25,970 | 11.552 | | |
| 23,230 | 12.914 | 23,780 | 12.616 | 24,330 | 12.330 | 24,880 | 12.058 | 25,430 | 11.797 | 25,980 | 11.547 | | |
| 23,240 | 12.909 | 23,790 | 12.610 | 24,340 | 12.325 | 24,890 | 12.053 | 25,440 | 11.792 | 25,990 | 11.543 | | |
| 23,250 | 12.903 | 23,800 | 12.605 | 24,350 | 12.320 | 24,900 | 12.048 | 25,450 | 11.788 | 26,000 | 11.538 | | |
| 23,260 | 12.898 | 23,810 | 12.600 | 24,360 | 12.315 | 24,910 | 12.043 | 25,460 | 11.783 | 26,010 | 11.534 | | |
| 23,270 | 12.892 | 23,820 | 12.594 | 24,370 | 12.310 | 24,920 | 12.039 | 25,470 | 11.779 | 26,020 | 11.530 | | |
| 23,280 | 12.887 | 23,830 | 12.589 | 24,380 | 12.305 | 24,930 | 12.034 | 25,480 | 11.774 | 26,030 | 11.525 | | |
| 23,290 | 12.881 | 23,840 | 12.584 | 24,390 | 12.300 | 24,940 | 12.029 | 25,490 | 11.769 | 26,040 | 11.521 | | |
| 23,300 | 12.876 | 23,850 | 12.579 | 24,400 | 12.295 | 24,950 | 12.024 | 25,500 | 11.765 | 26,050 | 11.516 | | |
| 23,310 | 12.870 | 23,860 | 12.573 | 24,410 | 12.290 | 24,960 | 12.019 | 25,510 | 11.760 | 26,060 | 11.512 | | |
| 23,320 | 12.864 | 23,870 | 12.568 | 24,420 | 12.285 | 24,970 | 12.014 | 25,520 | 11.755 | 26,070 | 11.507 | | |
| 23,330 | 12.859 | 23,880 | 12.563 | 24,430 | 12.280 | 24,980 | 12.010 | 25,530 | 11.751 | 26,080 | 11.503 | | |
| 23,340 | 12.853 | 23,890 | 12.558 | 24,440 | 12.275 | 24,990 | 12.005 | 25,540 | 11.746 | 26,090 | 11.499 | | |
| 23,350 | 12.848 | 23,900 | 12.552 | 24,450 | 12.270 | 25,000 | 12.000 | 25,550 | 11.742 | 26,100 | 11.494 | | |
| 23,360 | 12.842 | 23,910 | 12.547 | 24,460 | 12.265 | 25,010 | 11.995 | 25,560 | 11.737 | 26,110 | 11.490 | | |
| 23,370 | 12.837 | 23,920 | 12.542 | 24,470 | 12.260 | 25,020 | 11.990 | 25,570 | 11.732 | 26,120 | 11.485 | | |
| 23,380 | 12.831 | 23,930 | 12.537 | 24,480 | 12.255 | 25,030 | 11.986 | 25,580 | 11.728 | 26,130 | 11.481 | | |
| 23,390 | 12.826 | 23,940 | 12.531 | 24,490 | 12.250 | 25,040 | 11.981 | 25,590 | 11.723 | 26,140 | 11.477 | | |
| 23,400 | 12.821 | 23,950 | 12.526 | 24,500 | 12.245 | 25,050 | 11.976 | 25,600 | 11.719 | 26,150 | 11.472 | | |
| 23,410 | 12.815 | 23,960 | 12.521 | 24,510 | 12.240 | 25,060 | 11.971 | 25,610 | 11.714 | 26,160 | 11.468 | | |
| 23,420 | 12.810 | 23,970 | 12.516 | 24,520 | 12.235 | 25,070 | 11.966 | 25,620 | 11.710 | 26,170 | 11.464 | | |
| 23,430 | 12.804 | 23,980 | 12.510 | 24,530 | 12.230 | 25,080 | 11.962 | 25,630 | 11.705 | 26,180 | 11.459 | | |
| 23,440 | 12.799 | 23,990 | 12.505 | 24,540 | 12.225 | 25,090 | 11.957 | 25,640 | 11.700 | 26,190 | 11.455 | | |
| 23,450 | 12.793 | 24,000 | 12.500 | 24,550 | 12.220 | 25,100 | 11.952 | 25,650 | 11.696 | 26,200 | 11.450 | | |
| 23,460 | 12.788 | 24,010 | 12.495 | 24,560 | 12.215 | 25,110 | 11.947 | 25,660 | 11.691 | 26,210 | 11.446 | | |
| 23,470 | 12.782 | 24,020 | 12.490 | 24,570 | 12.210 | 25,120 | 11.943 | 25,670 | 11.687 | 26,220 | 11.442 | | |
| 23,480 | 12.777 | 24,030 | 12.484 | 24,580 | 12.205 | 25,130 | 11.938 | 25,680 | 11.682 | 26,230 | 11.437 | | |
| 23,490 | 12.771 | 24,040 | 12.479 | 24,590 | 12.200 | 25,140 | 11.933 | 25,690 | 11.678 | 26,240 | 11.433 | | |
| 23,500 | 12.766 | 24,050 | 12.474 | 24,600 | 12.195 | 25,150 | 11.928 | 25,700 | 11.673 | 26,250 | 11.429 | | |
| 23,510 | 12.761 | 24,060 | 12.469 | 24,610 | 12.190 | 25,160 | 11.924 | 25,710 | 11.669 | 26,260 | 11.424 | | |
| 23,520 | 12.755 | 24,070 | 12.464 | 24,620 | 12.185 | 25,170 | 11.919 | 25,720 | 11.664 | 26,270 | 11.420 | | |
| 23,530 | 12.750 | 24,080 | 12.458 | 24,630 | 12.180 | 25,180 | 11.914 | 25,730 | 11.660 | 26,280 | 11.416 | | |
| 23,540 | 12.744 | 24,090 | 12.453 | 24,640 | 12.175 | 25,190 | 11.909 | 25,740 | 11.655 | 26,290 | 11.411 | | |
| 23,550 | 12.739 | 24,100 | 12.448 | 24,650 | 12.170 | 25,200 | 11.905 | 25,750 | 11.650 | 26,300 | 11.407 | | |
| 23,560 | 12.733 | 24,110 | 12.443 | 24,660 | 12.165 | 25,210 | 11.900 | 25,760 | 11.646 | 26,310 | 11.403 | | |
| 23,570 | 12.728 | 24,120 | 12.438 | 24,670 | 12.161 | 25,220 | 11.895 | 25,770 | 11.641 | 26,320 | 11.398 | | |
| 23,580 | 12.723 | 24,130 | 12.433 | 24,680 | 12.156 | 25,230 | 11.891 | 25,780 | 11.637 | 26,330 | 11.394 | | |
| 23,590 | 12.717 | 24,140 | 12.428 | 24,690 | 12.151 | 25,240 | 11.886 | 25,790 | 11.632 | 26,340 | 11.390 | | |
| 23,600 | 12.712 | 24,150 | 12.422 | 24,700 | 12.146 | 25,250 | 11.881 | 25,800 | 11.628 | 26,350 | 11.385 | | |
| 23,610 | 12.706 | 24,160 | 12.417 | 24,710 | 12.141 | 25,260 | 11.876 | 25,810 | 11.623 | 26,360 | 11.381 | | |
| 23,620 | 12.701 | 24,170 | 12.412 | 24,720 | 12.136 | 25,270 | 11.872 | 25,820 | 11.619 | 26,370 | 11.377 | | |
| 23,630 | 12.696 | 24,180 | 12.407 | 24,730 | 12.131 | 25,280 | 11.867 | 25,830 | 11.614 | 26,380 | 11.372 | | |
| 23,640 | 12.690 | 24,190 | 12.402 | 24,740 | 12.126 | 25,290 | 11.862 | 25,840 | 11.610 | 26,390 | 11.368 | | |
| 23,650 | 12.685 | 24,200 | 12.397 | 24,750 | 12.121 | 25,300 | 11.858 | 25,850 | 11.605 | 26,400 | 11.364 | | |

KILOCYCLE-METER CONVERSION TABLE—Continued

| kc or m | m or kc | kc or m | m or kc | kc or m | m or kc | kc or m | m or kc | kc or m | m or kc | kc or m | m or kc | kc or m | m or kc |
|---------|---------|---------|---------|---------|---------|---------|---------|---------|---------|---------|---------|---------|---------|
| 26,410 | 11.359 | 27,010 | 11.107 | 27,610 | 10.866 | 28,210 | 10.635 | 28,810 | 10.413 | 29,410 | 10.201 | | |
| 26,420 | 11.355 | 27,020 | 11.103 | 27,620 | 10.862 | 28,220 | 10.631 | 28,820 | 10.409 | 29,420 | 10.197 | | |
| 26,430 | 11.351 | 27,030 | 11.099 | 27,630 | 10.858 | 28,230 | 10.627 | 28,830 | 10.406 | 29,430 | 10.194 | | |
| 26,440 | 11.346 | 27,040 | 11.095 | 27,640 | 10.854 | 28,240 | 10.623 | 28,840 | 10.402 | 29,440 | 10.190 | | |
| 26,450 | 11.342 | 27,050 | 11.091 | 27,650 | 10.850 | 28,250 | 10.619 | 28,850 | 10.399 | 29,450 | 10.187 | | |
| 26,460 | 11.338 | 27,060 | 11.086 | 27,660 | 10.846 | 28,260 | 10.616 | 28,860 | 10.395 | 29,460 | 10.183 | | |
| 26,470 | 11.334 | 27,070 | 11.082 | 27,670 | 10.842 | 28,270 | 10.612 | 28,870 | 10.391 | 29,470 | 10.180 | | |
| 26,480 | 11.329 | 27,080 | 11.078 | 27,680 | 10.838 | 28,280 | 10.608 | 28,880 | 10.388 | 29,480 | 10.176 | | |
| 26,490 | 11.325 | 27,090 | 11.074 | 27,690 | 10.834 | 28,290 | 10.604 | 28,890 | 10.384 | 29,490 | 10.173 | | |
| 26,500 | 11.321 | 27,100 | 11.070 | 27,700 | 10.830 | 28,300 | 10.601 | 28,900 | 10.381 | 29,500 | 10.169 | | |
| 26,510 | 11.316 | 27,110 | 11.066 | 27,710 | 10.826 | 28,310 | 10.597 | 28,910 | 10.377 | 29,510 | 10.166 | | |
| 26,520 | 11.312 | 27,120 | 11.062 | 27,720 | 10.823 | 28,320 | 10.593 | 28,920 | 10.373 | 29,520 | 10.163 | | |
| 26,530 | 11.308 | 27,130 | 11.058 | 27,730 | 10.819 | 28,330 | 10.589 | 28,930 | 10.370 | 29,530 | 10.159 | | |
| 26,540 | 11.304 | 27,140 | 11.054 | 27,740 | 10.815 | 28,340 | 10.586 | 28,940 | 10.366 | 29,540 | 10.156 | | |
| 26,550 | 11.299 | 27,150 | 11.050 | 27,750 | 10.811 | 28,350 | 10.582 | 28,950 | 10.363 | 29,550 | 10.152 | | |
| 26,560 | 11.295 | 27,160 | 11.046 | 27,760 | 10.807 | 28,360 | 10.578 | 28,960 | 10.359 | 29,560 | 10.149 | | |
| 26,570 | 11.291 | 27,170 | 11.042 | 27,770 | 10.803 | 28,370 | 10.575 | 28,970 | 10.356 | 29,570 | 10.145 | | |
| 26,580 | 11.287 | 27,180 | 11.038 | 27,780 | 10.799 | 28,380 | 10.571 | 28,980 | 10.352 | 29,580 | 10.141 | | |
| 26,590 | 11.282 | 27,190 | 11.033 | 27,790 | 10.795 | 28,390 | 10.567 | 28,990 | 10.348 | 29,590 | 10.139 | | |
| 26,600 | 11.278 | 27,200 | 11.029 | 27,800 | 10.791 | 28,400 | 10.563 | 29,000 | 10.345 | 29,600 | 10.135 | | |
| 26,610 | 11.274 | 27,210 | 11.025 | 27,810 | 10.787 | 28,410 | 10.560 | 29,010 | 10.341 | 29,610 | 10.132 | | |
| 26,620 | 11.270 | 27,220 | 11.021 | 27,820 | 10.784 | 28,420 | 10.556 | 29,020 | 10.338 | 29,620 | 10.128 | | |
| 26,630 | 11.265 | 27,230 | 11.017 | 27,830 | 10.780 | 28,430 | 10.552 | 29,030 | 10.334 | 29,630 | 10.125 | | |
| 26,640 | 11.261 | 27,240 | 11.013 | 27,840 | 10.776 | 28,440 | 10.549 | 29,040 | 10.331 | 29,640 | 10.121 | | |
| 26,650 | 11.257 | 27,250 | 11.009 | 27,850 | 10.772 | 28,450 | 10.545 | 29,050 | 10.327 | 29,650 | 10.118 | | |
| 26,660 | 11.253 | 27,260 | 11.005 | 27,860 | 10.768 | 28,460 | 10.541 | 29,060 | 10.323 | 29,660 | 10.115 | | |
| 26,670 | 11.249 | 27,270 | 11.001 | 27,870 | 10.764 | 28,470 | 10.537 | 29,070 | 10.320 | 29,670 | 10.111 | | |
| 26,680 | 11.244 | 27,280 | 10.997 | 27,880 | 10.760 | 28,480 | 10.534 | 29,080 | 10.316 | 29,680 | 10.108 | | |
| 26,690 | 11.240 | 27,290 | 10.993 | 27,890 | 10.757 | 28,490 | 10.530 | 29,090 | 10.313 | 29,690 | 10.104 | | |
| 26,700 | 11.236 | 27,300 | 10.989 | 27,900 | 10.753 | 28,500 | 10.526 | 29,100 | 10.309 | 29,700 | 10.101 | | |
| 26,710 | 11.232 | 27,310 | 10.985 | 27,910 | 10.749 | 28,510 | 10.523 | 29,110 | 10.306 | 29,710 | 10.098 | | |
| 26,720 | 11.228 | 27,320 | 10.981 | 27,920 | 10.745 | 28,520 | 10.519 | 29,120 | 10.302 | 29,720 | 10.094 | | |
| 26,730 | 11.223 | 27,330 | 10.977 | 27,930 | 10.741 | 28,530 | 10.515 | 29,130 | 10.299 | 29,730 | 10.091 | | |
| 26,740 | 11.219 | 27,340 | 10.973 | 27,940 | 10.737 | 28,540 | 10.512 | 29,140 | 10.295 | 29,740 | 10.087 | | |
| 26,750 | 11.215 | 27,350 | 10.969 | 27,950 | 10.733 | 28,550 | 10.508 | 29,150 | 10.292 | 29,750 | 10.084 | | |
| 26,760 | 11.211 | 27,360 | 10.965 | 27,960 | 10.730 | 28,560 | 10.504 | 29,160 | 10.288 | 29,760 | 10.081 | | |
| 26,770 | 11.207 | 27,370 | 10.961 | 27,970 | 10.726 | 28,570 | 10.501 | 29,170 | 10.285 | 29,770 | 10.077 | | |
| 26,780 | 11.203 | 27,380 | 10.957 | 27,980 | 10.722 | 28,580 | 10.497 | 29,180 | 10.281 | 29,780 | 10.074 | | |
| 26,790 | 11.198 | 27,390 | 10.953 | 27,990 | 10.718 | 28,590 | 10.493 | 29,190 | 10.277 | 29,790 | 10.070 | | |
| 26,800 | 11.194 | 27,400 | 10.949 | 28,000 | 10.714 | 28,600 | 10.490 | 29,200 | 10.274 | 29,800 | 10.067 | | |
| 26,810 | 11.190 | 27,410 | 10.945 | 28,010 | 10.710 | 28,610 | 10.486 | 29,210 | 10.270 | 29,810 | 10.064 | | |
| 26,820 | 11.186 | 27,420 | 10.941 | 28,020 | 10.707 | 28,620 | 10.482 | 29,220 | 10.267 | 29,820 | 10.060 | | |
| 26,830 | 11.182 | 27,430 | 10.937 | 28,030 | 10.703 | 28,630 | 10.479 | 29,230 | 10.263 | 29,830 | 10.057 | | |
| 26,840 | 11.177 | 27,440 | 10.933 | 28,040 | 10.699 | 28,640 | 10.475 | 29,240 | 10.260 | 29,840 | 10.054 | | |
| 26,850 | 11.173 | 27,450 | 10.929 | 28,050 | 10.695 | 28,650 | 10.471 | 29,250 | 10.256 | 29,850 | 10.050 | | |
| 26,860 | 11.169 | 27,460 | 10.925 | 28,060 | 10.691 | 28,660 | 10.468 | 29,260 | 10.253 | 29,860 | 10.047 | | |
| 26,870 | 11.165 | 27,470 | 10.921 | 28,070 | 10.688 | 28,670 | 10.464 | 29,270 | 10.249 | 29,870 | 10.044 | | |
| 26,880 | 11.161 | 27,480 | 10.917 | 28,080 | 10.684 | 28,680 | 10.460 | 29,280 | 10.246 | 29,880 | 10.040 | | |
| 26,890 | 11.157 | 27,490 | 10.913 | 28,090 | 10.680 | 28,690 | 10.457 | 29,290 | 10.242 | 29,890 | 10.037 | | |
| 26,900 | 11.152 | 27,500 | 10.909 | 28,100 | 10.676 | 28,700 | 10.453 | 29,300 | 10.239 | 29,900 | 10.033 | | |
| 26,910 | 11.148 | 27,510 | 10.905 | 28,110 | 10.672 | 28,710 | 10.449 | 29,310 | 10.235 | 29,910 | 10.030 | | |
| 26,920 | 11.144 | 27,520 | 10.901 | 28,120 | 10.669 | 28,720 | 10.446 | 29,320 | 10.232 | 29,920 | 10.027 | | |
| 26,930 | 11.140 | 27,530 | 10.897 | 28,130 | 10.665 | 28,730 | 10.442 | 29,330 | 10.228 | 29,930 | 10.023 | | |
| 26,940 | 11.136 | 27,540 | 10.893 | 28,140 | 10.661 | 28,740 | 10.438 | 29,340 | 10.225 | 29,940 | 10.020 | | |
| 26,950 | 11.132 | 27,550 | 10.889 | 28,150 | 10.657 | 28,750 | 10.435 | 29,350 | 10.221 | 29,950 | 10.017 | | |
| 26,960 | 11.128 | 27,560 | 10.885 | 28,160 | 10.653 | 28,760 | 10.431 | 29,360 | 10.218 | 29,960 | 10.013 | | |
| 26,970 | 11.123 | 27,570 | 10.881 | 28,170 | 10.650 | 28,770 | 10.428 | 29,370 | 10.215 | 29,970 | 10.010 | | |
| 26,980 | 11.119 | 27,580 | 10.877 | 28,180 | 10.646 | 28,780 | 10.424 | 29,380 | 10.211 | 29,980 | 10.007 | | |
| 26,990 | 11.115 | 27,590 | 10.874 | 28,190 | 10.642 | 28,790 | 10.420 | 29,390 | 10.208 | 29,990 | 10.003 | | |
| 27,000 | 11.111 | 27,600 | 10.870 | 28,200 | 10.638 | 28,800 | 10.417 | 29,400 | 10.204 | | | | |

APPENDIX 4

IMPORTANT ARTICLES TAKEN FROM THE INTERNATIONAL CONFERENCE OF SAFETY OF LIFE AT SEA, 1929

CHAPTER IV—RADIOTELEGRAPHY

Article 27. Fitting of Radio Installations—I. All ships to which this chapter applies shall, unless exempted under Art. 28, be fitted with a radiotelegraph installation complying with the provisions of Art. 31, as follows: (a) all passenger ships, irrespective of size; (b) all cargo ships of 1,600 tons gross tonnage and upwards.

2. Each administration may delay the application of the provisions of paragraph 1(b) to cargo ships belonging to its country of less than 2,000 tons gross tonnage for a period not exceeding five years from the date of the coming into force of the present Convention.

Article 28. Exemptions from the requirements of Article 27—
I. Each Administration may, if it considers that the route and the conditions of the voyage are such as to render a radiotelegraph installation unreasonable or unnecessary, exempt ships belonging to its country from the requirements of Article 27 as follows:

I. Passenger Ships. (a) Individual passenger ships or classes of passenger ships which, in the course of their voyage do not go more than (i) 20 miles from the nearest land; or (ii) 200 miles in the open sea between two consecutive ports. (b) Passenger ships which make voyages entirely within restricted areas specified in Annex of this Article.

II. Cargo Ships. Individual cargo ships or classes of cargo ships which, in the course of their voyage, do not go more than 150 miles from the nearest land.

Article 29. Watches—

I. Passenger Ships. Each passenger ship which, in accordance with Article 27, is required to be fitted with a radiotelegraph installation, shall, for safety purposes, carry a qualified operator, and, if not fitted with an auto-alarm, shall, whilst at sea, keep watches by means of a qualified operator or a certified watcher,

as under: (a) All passenger ships under 3,000 tons gross tonnage as determined by the Administration concerned; (b) All passenger ships of 3,000 tons gross tonnage and over, continuous watch.

Each Administration is authorized to exempt passenger ships belonging to its country from 3,000 tons to 5,500 tons gross tonnage, both included, from the requirement of a continuous watch for a period not exceeding one year from the date of the coming into force of the present Convention, provided that during the period of such exemption they shall maintain a watch of at least 8 hours per day.

2. Cargo Ships. Each cargo ship which, in accordance with Article 27, is required to be fitted with a radiotelegraph installation, shall, for safety purposes, carry a qualified operator and, if not fitted with an auto-alarm, shall, whilst at sea, keep watches by means of a qualified operator or a certified watcher, as under: (a) All cargo ships under 3,000 tons gross tonnage, as determined by the Administration concerned; (b) cargo ships from 3,000 to 5,500 tons gross tonnage, both included, at least 8 hours watch per pay; (c) cargo ships over 5,500 tons gross tonnage, continuous watch.

Each Administration is authorized to exempt ships belonging to its country included in (c) above from the requirements of a continuous watch for a period not exceeding one year from the date of the coming into force of the present Convention, provided that during the period of such exemption they shall maintain a watch of at least eight hours per day.

Each Administration is also authorized to exempt ships belonging to its country from 5,500 to 8,000 tons gross tonnage from the requirement of a continuous watch for a further period of one year, provided that during this further period of exemption they shall maintain a watch of at least 16 hours per day.

Article 30. Watchers—1. A watcher's certificate shall not be granted by a Contracting Government unless the applicant proves that he is capable: (a) of receiving and understanding the alarm, distress, safety and urgency signals when these signals occur among a series of other signals; (b) of correct reception by ear of code groups (mixed letters, figures and punctuation marks) at a speed of sixteen groups per minute, each group being composed of five characters and each figure or punctuation mark counting as two characters; (c) of regulating the receivers used in the ship's radiotelegraph installation.

Article 31. Technical Requirements—The radiotelegraph installations required by Article 27 above and the direction finding

apparatus required by Article 47 shall comply with the following requirements:

1. The ship's station must be placed in accordance with the detailed Regulations of the Government of the country to which the ship belongs, in the upper part of the ship in a position of the greatest possible safety, as high as practicable above the deepest load water line.

2. There shall be provided, between the bridge of the ship and the wireless telegraph room, means of communication either by voice pipe or by telephone or in some other manner equally efficient.

3. A reliable clock with a seconds hand must be provided in the wireless telegraph room.

4. A reliable emergency light must be provided in the wireless telegraph room.

5. The installation shall comprise a main installation and an emergency (reserve) installation. If, however, the main installation complies with all the requirements of an emergency (reserve) installation, the latter is not then obligatory.

6. The main and emergency (reserve) installations must be capable of transmitting and receiving on the frequencies (wave lengths) and types of waves assigned by the International Radiotelegraph Convention in force for the purpose of distress and safety of navigation to ships compulsorily fitted with radiotelegraph installations in accordance with the present Convention.

7. The main and emergency (reserve) transmitters shall have a note frequency of at least 100.

8. The main transmitter shall have a NORMAL RANGE of 100 nautical miles, that is to say, it must be capable of transmitting clearly perceptible signals from ship to ship over a range of at least 100 nautical miles by day under normal conditions and circumstances, the receiver being assumed to be one employing a rectifier of the crystal type without amplification.

9. Sufficient power must be available in a ship station at all times to operate the main radiotelegraph installation efficiently under normal conditions over the above range.

10. All parts of the emergency (reserve) installation shall be placed in the upper part of the ship in a position of the greatest possible safety, as high above the deepest load water line as practicable. The emergency (reserve) installation must be provided with a source of energy independent of the propelling power of the ship and of the main electricity system and must be capable of being put into operation rapidly and of working for at least six continuous hours.

For the emergency (reserve) installation, the normal range as defined in paragraph 8 above must be at least eighty nautical miles for ships required to maintain a continuous watch and at least fifty nautical miles for all other ships.

11. The receiving installation must permit of the reception of such of the waves used for the transmission of time signals and meteorological messages as may be considered necessary by the Administration.

12. The receiver must be so arranged as to be capable of maintaining reception by means of a rectifier of the crystal type.

13. In ships in which watch is kept by means of an automatic alarm receiver a means of giving audible warning shall be provided in the wireless telegraph room, in the wireless operator's cabin, and on the bridge, which shall operate continuously after the receiver has been operated by the alarm signal or distress call until stopped. Only one switch for stopping the warning shall be provided and this shall be situated in the wireless telegraph room.

14. In such ships the wireless operator, when going off watch, shall connect the automatic alarm receiver to the aerial and test its efficiency. He shall report to the master or the officer on watch on the bridge whether it is in working order.

15. Whilst the ship is at sea the emergency source of power shall be maintained at its full efficiency and the automatic alarm receiver shall be tested at least once every twenty-four hours. A statement that both these requirements have been fulfilled must be inserted in the ship's official log daily.

16. A wireless log shall be carried by every ship compulsorily equipped with wireless transmitting apparatus. This document shall be kept in the wireless telegraph room, and in it shall be inserted the names of the operators and watchers as well as all incidents and occurrences connected with the wireless service which may appear to be of importance to safety of life at sea, and in particular all distress messages and distress traffic in full.

17. The direction-finding apparatus required by Article 47 shall be efficient and capable of receiving clearly perceptible signals and of taking bearings from which the true bearings and direction may be determined. It shall be capable of receiving signals on the frequencies prescribed for distress, direction finding and wireless telegraph beacons by the International Radiotelegraph Convention in force.

Efficient communication shall be provided between the apparatus and the bridge.

Unless a more precise and practical method is available to de-

termine the range of transmitter, it is recommended that, as a guide, the following relations between the range in nautical miles (from ship to ship under normal conditions in daytime) and the power of the ship transmitter in metre-amperes for 500 kilocycles per second (600 m) to be used:

| | |
|--------------------|-------|
| 100 nautical miles | 60 MA |
| 80 nautical miles | 45 MA |
| 50 nautical miles | 25 MA |

M being the actual height in meters of the aerial from its highest point to the load line.

A being the current in amperes measured at the base of the aerial in case of B, or fully modulated A₂, transmitter.

Article 42. Misuse of Distress Signals—The use of an international distress signals, except for the purpose of indicating that a vessel is in distress, and the use of any signals which may be confused with an international distress signal, are prohibited on every ship.

Article 44. Speed of Distress Messages—The speed of transmission of messages in connection with cases of distress, urgency or safety, shall not exceed 16 groups per minute, as such groups are defined in Article 30 (1) (b) of the present Convention.

Article 46. Signalling Lamp—All ships of over 150 tons gross tonnage, which are engaged on international voyages, shall have on board an efficient signalling Lamp.

Article 47. Direction-Finding Apparatus—Every passenger ship of 5,000 tons gross tonnage and upwards shall within two years from the date on which the present Convention comes in force, be provided with an approved direction-finding apparatus (radio compass), complying with the provisions of Article 31 (17) of the present Convention.

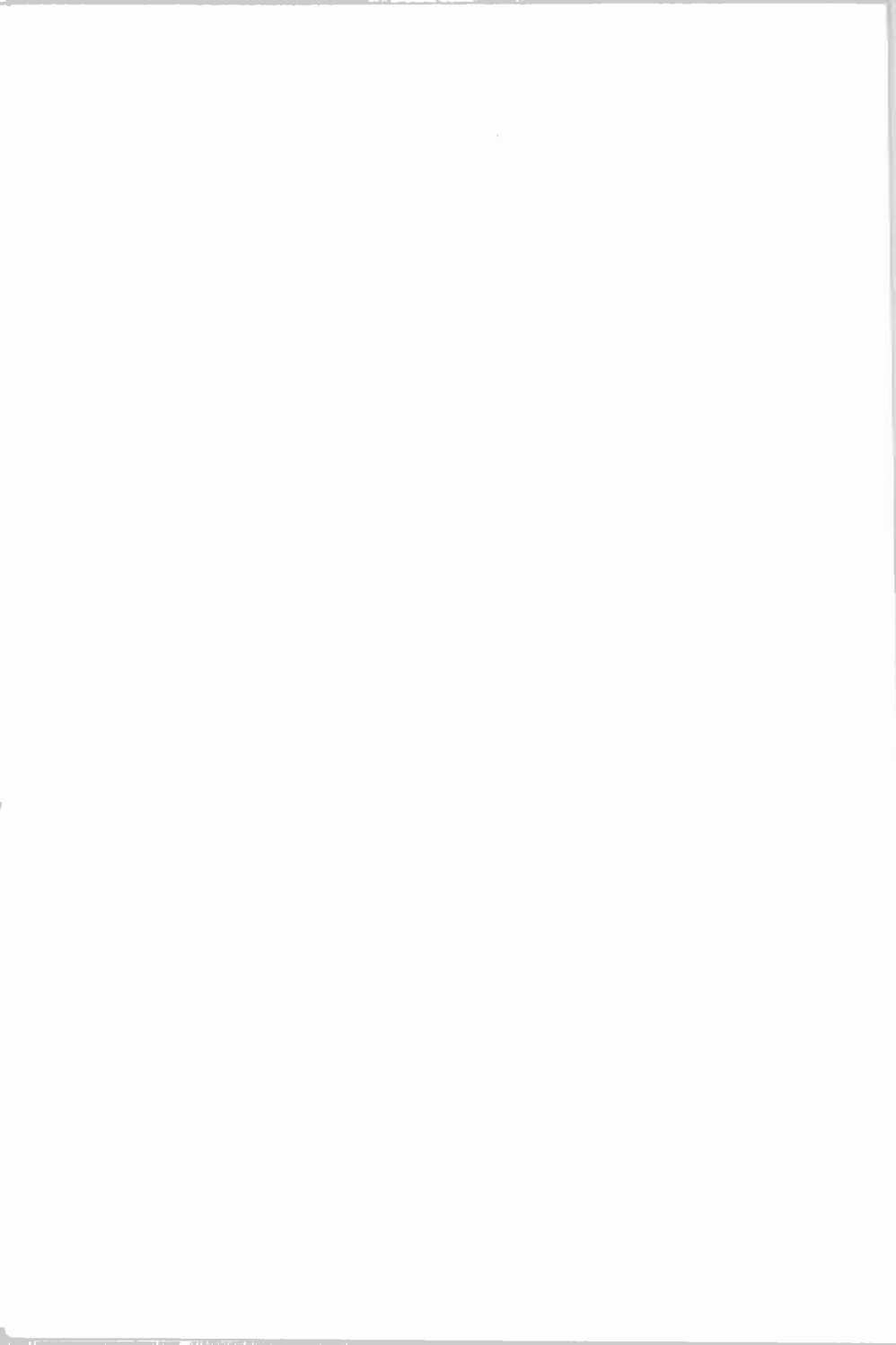

apparatus required by Article 47 shall comply with the following requirements:

1. The ship's station must be placed in accordance with the detailed Regulations of the Government of the country to which the ship belongs, in the upper part of the ship in a position of the greatest possible safety, as high as practicable above the deepest load water line.

2. There shall be provided, between the bridge of the ship and the wireless telegraph room, means of communication either by voice pipe or by telephone or in some other manner equally efficient.

3. A reliable clock with a seconds hand must be provided in the wireless telegraph room.

4. A reliable emergency light must be provided in the wireless telegraph room.

5. The installation shall comprise a main installation and an emergency (reserve) installation. If, however, the main installation complies with all the requirements of an emergency (reserve) installation, the latter is not then obligatory.

6. The main and emergency (reserve) installations must be capable of transmitting and receiving on the frequencies (wave lengths) and types of waves assigned by the International Radiotelegraph Convention in force for the purpose of distress and safety of navigation to ships compulsorily fitted with radiotelegraph installations in accordance with the present Convention.

7. The main and emergency (reserve) transmitters shall have a note frequency of at least 100.

8. The main transmitter shall have a NORMAL RANGE of 100 nautical miles, that is to say, it must be capable of transmitting clearly perceptible signals from ship to ship over a range of at least 100 nautical miles by day under normal conditions and circumstances, the receiver being assumed to be one employing a rectifier of the crystal type without amplification.

9. Sufficient power must be available in a ship station at all times to operate the main radiotelegraph installation efficiently under normal conditions over the above range.

10. All parts of the emergency (reserve) installation shall be placed in the upper part of the ship in a position of the greatest possible safety, as high above the deepest load water line as practicable. The emergency (reserve) installation must be provided with a source of energy independent of the propelling power of the ship and of the main electricity system and must be capable of being put into operation rapidly and of working for at least six continuous hours.

For the emergency (reserve) installation, the normal range as defined in paragraph 8 above must be at least eighty nautical miles for ships required to maintain a continuous watch and at least fifty nautical miles for all other ships.

11. The receiving installation must permit of the reception of such of the waves used for the transmission of time signals and meteorological messages as may be considered necessary by the Administration.

12. The receiver must be so arranged as to be capable of maintaining reception by means of a rectifier of the crystal type.

13. In ships in which watch is kept by means of an automatic alarm receiver a means of giving audible warning shall be provided in the wireless telegraph room, in the wireless operator's cabin, and on the bridge, which shall operate continuously after the receiver has been operated by the alarm signal or distress call until stopped. Only one switch for stopping the warning shall be provided and this shall be situated in the wireless telegraph room.

14. In such ships the wireless operator, when going off watch, shall connect the automatic alarm receiver to the aerial and test its efficiency. He shall report to the master or the officer on watch on the bridge whether it is in working order.

15. Whilst the ship is at sea the emergency source of power shall be maintained at its full efficiency and the automatic alarm receiver shall be tested at least once every twenty-four hours. A statement that both these requirements have been fulfilled must be inserted in the ship's official log daily.

16. A wireless log shall be carried by every ship compulsorily equipped with wireless transmitting apparatus. This document shall be kept in the wireless telegraph room, and in it shall be inserted the names of the operators and watchers as well as all incidents and occurrences connected with the wireless service which may appear to be of importance to safety of life at sea, and in particular all distress messages and distress traffic in full.

17. The direction-finding apparatus required by Article 47 shall be efficient and capable of receiving clearly perceptible signals and of taking bearings from which the true bearings and direction may be determined. It shall be capable of receiving signals on the frequencies prescribed for distress, direction finding and wireless telegraph beacons by the International Radiotelegraph Convention in force.

Efficient communication shall be provided between the apparatus and the bridge.

Unless a more precise and practical method is available to de-

termine the range of transmitter, it is recommended that, as a guide, the following relations between the range in nautical miles (from ship to ship under normal conditions in daytime) and the power of the ship transmitter in metre-amperes for 500 kilocycles per second (600 m) to be used:

| | |
|--------------------|-------|
| 100 nautical miles | 60 MA |
| 80 nautical miles | 45 MA |
| 50 nautical miles | 25 MA |

M being the actual height in meters of the aerial from its highest point to the load line.

A being the current in amperes measured at the base of the aerial in case of B, or fully modulated A₂, transmitter.

Article 42. Misuse of Distress Signals—The use of an international distress signals, except for the purpose of indicating that a vessel is in distress, and the use of any signals which may be confused with an international distress signal; are prohibited on every ship.

Article 44. Speed of Distress Messages—The speed of transmission of messages in connection with cases of distress, urgency or safety, shall not exceed 16 groups per minute, as such groups are defined in Article 30 (1) (b) of the present Convention.

Article 46. Signalling Lamp—All ships of over 150 tons gross tonnage, which are engaged on international voyages, shall have on board an efficient signalling Lamp.

Article 47. Direction-Finding Apparatus—Every passenger ship of 5,000 tons gross tonnage and upwards shall within two years from the date on which the present Convention comes in force, be provided with an approved direction-finding apparatus (radio compass), complying with the provisions of Article 31 (17) of the present Convention.

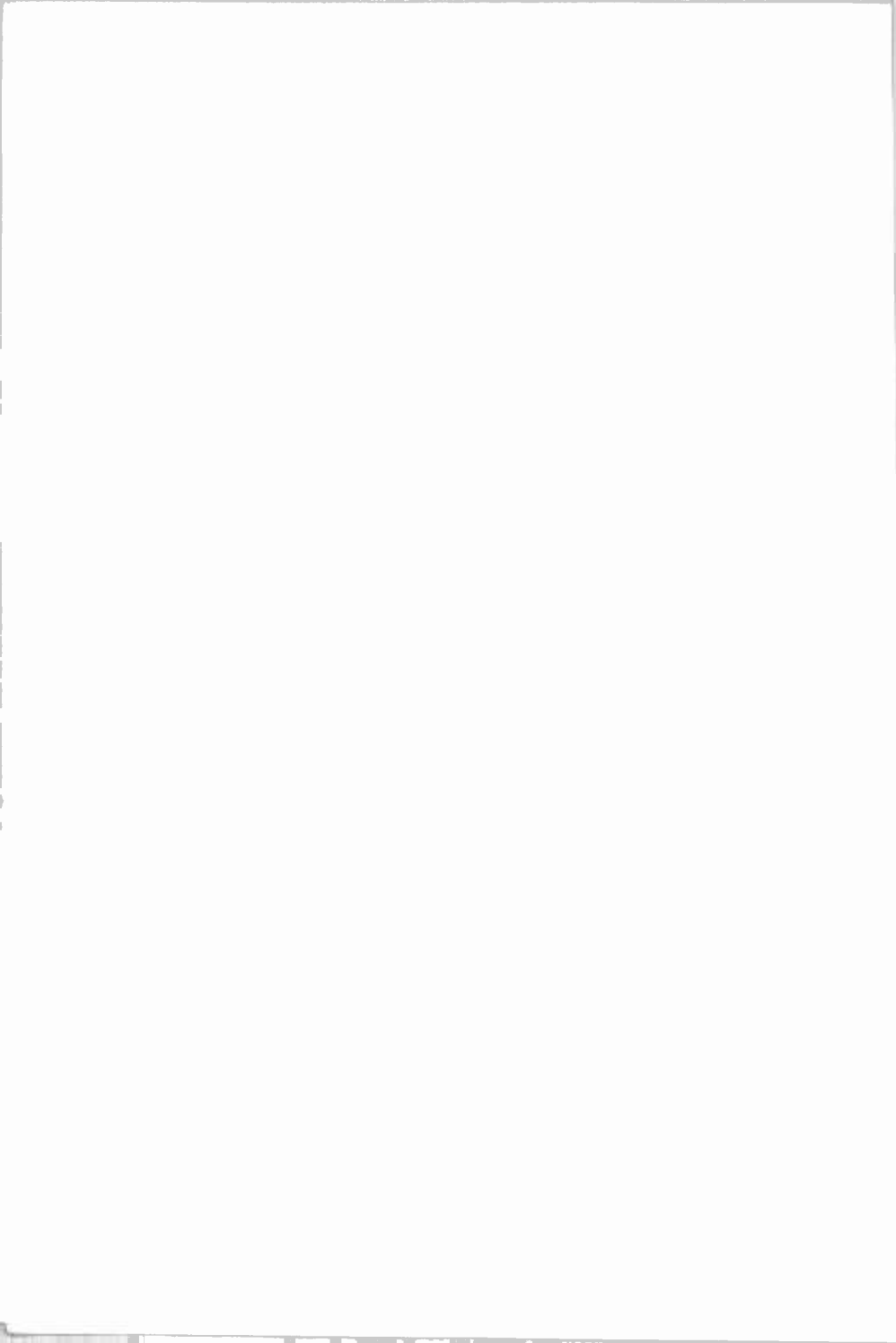

INDEX

A

Absorption Modulation, 215
Abstracting Traffic, 741
Acceptor Circuit, 253-254
Adjusting Master Oscillator—Power Amplifier, 185
Adjustment of One Wire Voltage Feed Line, 183
Aircraft Radio Equipment, 525
 Receivers, 534
Aircraft Radio Corp., 538
 Model B Receiver, 538
Alternating Current, 34
 Induction Motor, 74
 Transformers, 45-46
 Vacuum Tubes, 112
 Screen Grid Tubes, 173
 Generator, 55
Alternator, Inductor Type, 57
Amateur, Operators License, 590
 Interference, 592-645
 Hours of Operation, 645
 Key Thumps, 593
 Short Wave Receivers, 579-580
 Short Wave Apparatus, 569
 Regulations, 591
Ammeter, 18
 Hot Wire, 35
 Thermo-Coupler, 35
Amplifier, V. T., 117
 Audio Frequency, 118-119
 Circuit of Audio Frequency, 123
 Daven Resistance Coupled, 612
 Television, 612
Amplification Audio Frequency, 118
 Radio Frequency, 131
Amplification Constant, 120
Amperes, 10
Ampere Hour Meter, 97
Ampere Turns, 16
American Radio Relay League, 595
Angle of Declination, 16
Angle of Radiation, 515
Anode, Arc, 417
Antenna, Artificial, 202
 Care of, 370

 Calculations, 273
 Choosing the Amateur, 588
 Current Feed System, 265, 268, 575
 Effective Height, 256
 Hertzian, 264, 574
 Doublet, 264
 Loading Coils, 441
 Loop, 495
 Marconi, 573
 Horizontal, 575
 Vertical, 575
 Feeding the, 515
 Voltage Feed System, 576
 Zeppelin, 576
 Power Calculations, 203
 Resistance Curves, 200
 Resistance Measurements, 199
 Systems, 51
 Tuning, 643
Artificial Telephone line, 243
Atoms, 3
Atmospherics, 639

B

Back Shunt, Method of Signalling, 44, 419
Battery Rating, Edison, 97
Baume Hydrometer, 95
Beat Frequency Reception, 152-153
Beacon Transmitter, 532
Bellini-Tosi Direction Finder, 508
Binocular Coil, 25
Break-in Relay, 285
Broadcast, duty of Control Operator, 243
Burgess Aircraft Radio Equipment, 248

C

Cable Count, 745
Cathode, Arc, 408
Capacitive Coupling, 184
Capacity Effects, 26
Capacity Reactance, 33-40
Calling a station, 711

- Calibration of Direction Finder, 54
 Carrier Current, 212-213
 Carrier Frequency, Instability of, 231
 Carbon Microphone, 232-233
 Operation of, 237
 Cell, Primary, 11
 Censoring Messages, 742
 Charging a battery, 89-92
 Charging Panel, 465, 858
 Charged bodies, 5
 Characteristic Curve of V. T., 114
 Chopper, 285, 401, 420, 428
 Choke Coil, 409
 Circuit—Western Electric 5C Transmitter, 322
 Western Electric Superheterodyne, 470
 Circuit of "A" Battery Charging Panel, 460
 Auto Alarm, 408-409
 Coupling, Inductive, 180, 439
 Impedance, 120-128
 Resistance, 125-126
 Transformer, 119-122
 Condenser, 7
 Capacity of a, 7
 Electrolytic, 331-371
 Condensers in Series, 29
 Condensers in Parallel, 29
 Condenser Microphone, 235-236, 392-394
 Circuit of a, 397
 Condenser, Oscillatory discharge of a, 432
 Coils, Loading, 441
 Spider Web, 25
 Honey Comb, 25
 Colpitts Circuit, 177-178, 291, 297
 Counter E. M. F., 66
 Constant Current Modulation, 220-221
 Conductor, 10
 Cooling System for Power Tubes, 351
 Coupled Circuits, Reaction of, 438
 Compass, 15-16
 Compound Wound Generator, 61
 Commutator, 58
 Ripple, 192
 Continuous Wave, 53, 194
 Continuous Waves, Generation of by the arc, 397
 Critical Coupling, 182
 Crystal Detector, 453
 Current, Alterating, 31
 Carrier, 212-213
 Dielectric, 26
 Displacement, 26
 Direct, 10
 Direction of, 10
 Effects of, 14
 Eddy, 44
 Feed Systems, 265-268, 575-576
 Radio Frequency, 31
- D**
- D'Arsonval Movement, 18
 Daven Television Kit, 631
 Damping, 435
 D.C. Motors, 65
 D.C. Generator, 58
 Detector V. T., 114
 Crystal, 453
 Grid Leak and Condenser, 116
 C. Bias, 115
 Determination of Frequency, 58, 433
 Polarity, 92
 Decrement of Circuit, 434
 Decibel, 401
 Dielectric, 29
 Current, 32, 26
 Constant, 27
 Strength of a Condenser, 28
 Difference of Potential, 11
 Differential Field Winding, 73
 Direction Finder, Calibration of, 501
 Obtaining a bearing, 505-514
 Reciprocal Bearing, 508-509
 Bellini Tosi, 508
 R. C. A. Model E. R.—1445-A, 508
 E. R.—1485-A, 519
 Correction Table for Bearings laid down on Mercator Chart, 511
 Operation of Apparatus, 515
 Maintenance of, 516
 Troubles and Remedies, 517
 Direction of Rotation, 66
 Direction of Current, 10
 Directive effect of loop Antenna, 495
 Distress Messages, 706-708
 Priority of, 684
 Call, 694
 Transmitting, 738
 Answering, 739
 Displacement, Phase, 33

Distributed Capacity, 52
 Distortion in A. F. Transformers,
 124
 Double Detection Receiver, 154
 Duties of a Broadcast Control Oper-
 ator, 243
 Dynamotor, 78-79, 193

E

Echo Signals, 572
 Eddy Current, 44, 419
 Edison Battery, 83
 Electrolyte, 83
 Plate Construction, 83
 Chemical Action, 83
 Sectional View, 84
 Container, 85
 Voltage Characteristics, 85
 Height of Solution, 86
 Testing Height of Solution, 86
 Refilling Battery, 87
 Maintenance, 87
 Cell Data and Tray Dimensions,
 88
 Charging, 89
 Characteristic Curve of Charge
 and Discharge, 90
 Electricity, 3
 Electrons, 3
 Movement of, 9-10
 Freq, 4
 Electromagnet, 14
 Electrodes of arc, 408
 Electromotive Force, 10, 39
 Electrostatic Field, 6
 Electric Field, 6
 Elimination of Harmonics, 148
 Electrolyte of Edison battery, 83
 Lead plate battery, 94
 Equalization of Telephone Lines, 240
 Equalizer Circuit, 240
 Equalizing Charge, 101
 Examination, Preparation for opera-
 tor licenses, 731-734
 Exide Storage Battery Switchboard,
 102
 Operating Switchboard, 104

F

False Signal, 686
 Farad, 28
 Failure of Generator to Build Up,
 63

Federal Arc, Model of, 415
 Federal Radio Commission, 680
 General Orders of the, 687
 Feeding the Antenna, 575-576
 Feed-back Prevention and Compens-
 ation in R. F. Amplifiers, 135-
 136
 Filter Circuit, Key thump, 593
 Filters Circuit for M. G., 192
 Filters, Commercial Interference,
 652
 Filters, Interference, 649
 Capacitive type, 649
 Radio Frequency, 651
 Field Strength Measurements, 255
 Unit of Measurements, 255
 Apparatus and Procedure, 256-
 258
 Field Rheostat, 67
 Field Electrostatic, 6
 Filament Supply for V. T. of
 Transmitter, 191
 Filament Construction of Power
 Tubes, 150
 Floating Charge, 101
 Force, Residual Lines of, 15
 Frequency, Assignments, 690
 Check by Piezo Oscillator, 250
 Determination of Alternation, 58
 Doubling Amplifier, 190
 Harmonic, 146
 Side Band, 232
 Modulation, 228
 Meter, 37, 248
 Theory, 249
 Use of, 260
 Distortion, 125
 Fringe Howl, 582
 Fundamental Oscillator Circuit, 174
 Fundamental Wavelength, 52-53
 Full Wave-Self Rectifying Circuit,
 312

G

Generation of R. F. Current by a
 V. T. 132
 By a Spark Transmitter, 432
 Generation of Continuous Waves,
 397
 Generation of A.C., 56
 Generator, D.C., 58
 Shunt Wound, 60
 Series Wound, 61
 Compound Wound, 61

Failure to Build up, 63
 Reversal of Polarity, 63-64
 General Radio Piezo Electric Oscillator, 251
 Care of, 252
 General Orders of the Federal Radio Commission, 687
 Grid Excitation, 174
 Grid Bias, 149
 Ground Wave, 571
 Ground Indicators, 64
 Grounds, 207

H

Harmonic Operation of Antenna, 589
 Harmonics, 31, 146, 148, 184, 642
 Harmonic Distortion, 125
 Hartley Circuit, 174, 180, 183
 Hazeltines Neutrodyne, 136
 Hand Starter, Motor, 68
 Heising Modulation, 220-221
 Heaviside Layer, 573
 Heating Effect of A.C., 14, 35
 Henry, 24
 Heterodyne Reception, 153
 Hertz Antenna, 573
 High Angle Radiation, 573
 High Frequency Communication, 57, 569
 High Power Modulation, 222-224
 Hoffman Transmitting Circuit, 552
 Hydrogen Gas, 409
 Hydrometer, 99
 Baume, 95
 Hydrographic Reports, 766, 769
 Hysteresis Loss, 44, 419

I

Impedance, 32-33
 Matching, 451
 Coupling, 28
 Inductive Reactance, 33, 39
 Inductive Coupling, 180
 Adjustment of, 181
 Critical Coupling, 182
 Inductance, 24
 Iron Core, 25
 Induction, 21
 Induction—Electromagnetic, 22
 Self, 23
 Mutual, 23
 Coil, 48

Inductors, Forms of, 25
 Inductive Coupler, 439
 Interference, 637
 Power Line, 654
 Corona Discharge, 654
 Swinging Grounds, 654-655
 Procedure in Locating, 648, 655
 From Transformers, 656
 Arc Light, 657
 Precipitators, 657
 Eliminating Interference, Amateur, 592
 Key Thumps, 593
 Interference from Oil Burning Furnaces
 Cause of, 660
 Treatment for eliminating, 662-666
 Choice of Filter, 665
 From Sign Flashers, 666
 From Ignition Aircraft, 546
 Shielding, 547
 From Strong Local Signals, 643
 Wavetraps, 644-645
 Code, 644
 Amateur Transmitters, 645
 From Electrical Devices, 646
 Locating Interference, 646
 Receiver for Locating, 647
 Filters, 649
 Capacitive Type,
 Contact Noises,
 Inductive or Choke Coil Filter, 650
 Sources of, 651
 Commercial Filters for Eliminating, 652
 Authority of States to Regulate interference laws, 670
 Power of City or town, 671
 Interference to Distress Calls, 739
 International Radio Laws, 695
 International Radio Telegraph Convention, 695
 International Morse Code, 770
 Intercommunication, 684
 Independent Arc, Type R. H., 425
 Operation, 429
 Interrupted C. W., 195
 Induced Charges, 6
 Inspections Ship Stations, 677
 Operators on Foreign Vessels, 679
 Ionization of the Atmosphere, 569
 by Collision, 9

Ionization, 615
 Ion, 9
 Iron Core Inductance, 25

J

Jenkins Television Kit, 626
 Jenkins Drum Scanner, 608
 Joule, 14

K

Keying Methods, 198
 Keying, Back Shunt, 411, 419, 428
 Ignition Method, 411-412, 429
 Compensation Wave, 413
 Copper, 415, 420
 Key Thumps, Interference from, 593
 Kilocycle, 50
 Kilocycle Meter Conversion Table,
 771-780

L

Laws, Radio, 672
 Interference, 670
 Governing Visual Broadcasting,
 634
 Language to be used in Radiograms,
 Lagging Phase, 33
 Lamp Bank, 91
 Leakage, 28
 Lead Plate Sulphuric Acid Battery,
 93
 Voltage Discharge Limits, 98
 Chemical Action, 98
 Charging, 99
 Cell Construction, 93
 Separators, 94
 Electrolytic, 94
 Use of Pure Water, 95
 Containers, 95
 Voltage Characteristics, 96
 Local Action, 100
 Removing Sulphation, 100
 Leading Phase, 321
 License, Operators:
 Commercial Extra First Class,
 720-723
 Commercial First Class, 720, 724-
 725
 Commercial Second Class, 720,
 725-726
 Broadcast Class Unlimited, 721,
 726

Broadcast Class Limited, 722
 Radio-Telephone Class, 722
 Amateur Extra First Class, 722
 Amateur First Class, 723
 Temporary Amateur Class, 723
 Renewal Requirements, 723, 729
 License Operators, 723, 729
 Service Record, 729, 740
 Duplicate, 730
 Re-examination, 730
 Posting Operator licenses, 740
 License, Station, 739
 Lightning Flash, what it is, 9
 Line Pad, 243
 Local Action, 100
 Logarithmic Decrement of Oscilla-
 tions, 434
 Low Angle Radiation, 574
 Low Power Modulation, 222-224
 Log Stations, 758
 Locating Interference, 646
 Long Wave Loading Unit for 1P
 501 Receiver, 462
 Losser Methods of Stabilizing R. F.
 Amplifiers, 134

M

Magnetism, 15
 Residual, 15
 Theory of, 17
 Field, 15-16
 Pole, 15-16
 Effect of Current, 14
 Magnetic Microphone, 236
 Magneto, 55
 Matter, 3
 Master Oscillator,—Power Amplifier
 Circuit with Telephone Attach-
 ment, 290
 Power Amplifier Circuit, 266, 269,
 280-281
 Power Amplifier, 185
 Masters Responsibility, 644
 Maintenance and Care of Edison
 Battery, 87
 Maintaining Frequency of Trans-
 mitter, 188
 Marconi Antenna, 51, 573
 Marine Short Wave Transmitters,
 259
 Messages,
 Acceptance of, 741
 Censoring of, 742

- Numbering, 743
 - Timing,
 - Plain Language, 743
 - Code Language, 743
 - Cipher, 743
 - Counting and Charging, 743-744
 - Cable Count, 745
 - SVC., 747-748
 - Master SVC., 748
 - Dead Head, 748
 - Press, 748
 - Ocean letter, 749
 - Special Class, 749
 - Order of Transmission, 752
 - Received Traffic, 753
 - Log Sheets, 758
 - Computing Rates, 760
 - Shipboard Messages, 762
 - R. C. A. Rate Sheet, 765
 - Measuring the wave length of a Transmitter, 250
 - Meter, Amper Hour, 97
 - Amperes, 255
 - Frequency, 37
 - Meissner Circuit, 176, 184
 - Megacycle, 50
 - Microvolt per meter, 255
 - Microphone, 392
 - Microphone, Single Button
 - Carbon, 232
 - Double Button, 233
 - Condenser Type, 235
 - Western Electric 394-W Transmitter, 235
 - Magnetic, 236
 - Speech Amplifier, 237
 - Motors, 64
 - D.C. Shunt, 65
 - Series Wound, 73
 - Differential Field Winding, 73
 - Induction, 74
 - Motor Starters, 67-69
 - Hand, 416
 - Motors, Variable Speed for Television, 613
 - Universal, 613
 - Motor Generators, 75
 - Motor Generators Care of, 369
 - Maintenance, 273-274, 287
 - to replace armature, 301
 - Modulation, 191
 - Systems, 210
 - Classification of, 216
 - Low Power, 222-224
 - High Power, 222-224
 - 100% Modulation, 213, 225
 - Circuit Showing 100%, 226
 - Modulation, Process of, 212
 - Absorption, 214-216
 - Grid Bias, 217
 - Plate, 218
 - Heising, 220-221
 - Constant Current, 220-221
 - Modulation Frequency, 228
 - Modulating Tubes, 224-225
 - Molecule, 9, 17
 - Monitoring Broadcast Transmission, 349, 367
 - Morse Code, 770
 - Mutual Conduction, 122
 - Mutual Induction, 23-24
 - Multiplier, 19
- N**
- Navy Standard Spark Transmitter, 439
 - Tuning, 443
 - Receivers, 466
 - Negative Electricity, 3
 - Charge, 4-5
 - Potential, 8
 - Neutralizing Power Amp, 186, 360-361
 - Neutrodyne Hazeltine, 136
 - History of, 138
 - Neon Lamp, 604
 - Operation, 614-615
 - Commercial Lamp for Television Reception, 615
 - Daven Type T20-80, 616
 - Ratheon Kino Lamp, 616
 - General Electric Lamp G10 A.C., 616
 - Neon Lamp Connections, 618
 - Non-Synchronous Rotary Spark Gap, 435
 - Non-Conductors, 10
- O**
- Ohms Law, 12, 19
 - Examples of, 12
 - Ohm, Standard, 10
 - Oil Burning Furnaces,
 - Cause of interference from, 660
 - Treatment for eliminating Interference, 663
 - Operators License, Cause for suspension, 681

- Operation of V. T. Transmitter, 270, 281, 313
- Operators on Foreign Vessels, 679
- Operating the Antenna on a harmonic, 589
- Oscillations, 132
- Parasitic, 205
- Oscillator V. T., 144
- Oscillatory Discharge of a Condenser, 432
- Oscillograph use of, 367
- Over Modulation, Cause of, 367
- Overcharge, 99
- Oxide filaments, 158
- P**
- Parallel Connections, 11
- Parallel Connection of Condensers, 29
- Penalty for Violation of Radio Act of 1927, 686
- Permanent Magnet, 15
- Permeability, 16
- Photo-Electric Cell, 600
- Phase, Displacement, 33
- Leading, 34
- Piezo Crystal Control of Frequency, 187, 318
- Crystal Oscillators, 337, 341, 318
- Care of, 373
- Piezo Oscillator, 250
- Use of to check frequency, 250-251
- Plate Modulation, 197, 218
- Plate Supply for V. T. of Transmitter, 191
- Plate Impedance, 121
- Plate Blocking Condenser, 293
- Plate Dissipation, 149
- Plain Aerial Connections, 307
- Power, 14
- Regulation of, 685
- In Antenna, 203
- Tube Data, 209
- Factor, 34
- Rating of V. T., 148
- Power Tubes, Reactivation, 168
- Power Line Interference, 654
- Corona Discharge at Insulators, 654
- Swinging Grounds, 654
- Transformers, 656
- Polarity, Determination of, 692
- Potential, 8
- Negative, 9
- Positive, 9
- Positive Charge, 4-5
- Potentiometer Capacity, 350
- Press Schedules, 766-769
- Precipitators, Interference from, 650, 657
- Protective Devices, 81
- Protons, 3
- Push-Pull Amplifier, 125
- Q**
- Q Signals, 715-717
- Quenched Spark Transmitter, 297
- Quartz Crystal Oscillator, 187
- Quenched Spark Gap, 437
- Care of, 446
- Seasoning, 447
- R**
- Radio Direction Finders, 495
- Fundamental Principles, 495
- Determination of Sense, 498
- Wave Front Distortion, 500
- Radio Compass, Stations on Shore, 504
- Radio Beacon, 525
- Principle of Transmitter Operation, 526
- Visual Indicator System, 530
- Transmitting Apparatus, 533
- Radiotelephone Attachment, R. C. A. Model A. T. 829 Circuit, 290
- Radio Frequency Waves, 49-50
- Length of, 50
- Frequency of, 50
- Amplification, 131
- Tuned, 132
- Feed Lines, 183
- Radiomovies, 598
- Early Development of, 598
- Radio Receivers, Aircraft, 553
- Radio Laws and Regulations Governing Visual Broadcast, 634
- Radio Laws, 672
- Ship Act, 672-673
- Act of 1927, 680
- Auxiliary Power Requirements, 672
- Operation and penalty, 674

- Intercommunication, 674
 - Penalty, 674
 - Reporting Violations, 676
 - Operators on Foreign Vessels, 679
- Radio Act of 1927, 680
- Operators Penalty, 681
- Radio Interference, 637
 - Receiver trouble, 637
 - Microphonic Tube, 638
 - Acoustic Feed Back, 638
 - Static, 639
 - Atmospherics, 639
 - Man-made Interference, 641
 - Interference from receivers, 641
 - Heterodyne Interference, 642
 - Harmonic Interference, 642
- Radio Schools, 734
- Rate Sheet, R. C. A., 765
- Ratio of Transformation, 43
- R. C. A. V. T. Transmitters, 259
 - Model E. T. 3628 A. C. W. Transmitter, 291
 - Model E. T. 3627A, 278
 - Model E. T. 3650 Emergency Transmitter, 308
 - Model A. T. 829 Telephone Attachment, 290
- R. C. A. Aircraft Radio Equipment, 558
 - Model E. T. 3653, 538
 - Model E. T. 36-54, 563
- R. C. A. Radio Receivers, 448
 - Model 1496-B, 448
 - 106 B and C, 453, 456
 - A. D. 1527 Det. Unit, 457
 - A. A. 1528 Audio Frequency Amplifier, 458
 - Charging Panel, 460
- R. C. A. Direction Finder Model
 - E. R. 1445A, 508
 - Model E. R. 1885A, 519
- Reception of Undamped (C. W.) Waves, 151
- Receiver, Short Wave, 448, 579
 - R. C. A. 106, 453
 - R. C. A. AR 1496B, 448
 - W. S. A. 1 P 501, 462
 - Navy Standard S. E. 1420, 466
 - Western Electric Type 6004C, 469
- Receiver, Television, 619
- Receiver, Trouble, 637
 - Microphonic Tube, 638
 - Acoustic feed back, 638
- Receiver, for locating interference
 - Circuit of, 674
- Receivers, Double Detection, 151
 - Regenerative, 143
 - Superheterodyne, 154
 - Aircraft, 534
 - Aircraft Radio Corp. Model B., 538
 - Burgess Short Wave, 553
- Receiver A. Battery Charging Panel, 460
- Reactance Coils, 39
- Reactance, 32-33
 - Coil, 32
 - Inductive, 33
 - Capacity, 33
- Reactance, Capacitive, 40
- Reactance, Regulator, 45
- Reactivation of V. T., 162
 - Equipment, 164
 - Operation, 165
- Rectifiers V. T., 193, 335
 - Chemical, 194
- Reflected Waves, 571
 - Multiple Reflections, 572
- Relay—Time Delay, 354
 - Maintenance, 372
- Resistance, 10
 - Starting, 67
 - Measuring of Antenna, 199
 - Coupling, 126
- Resistance Coupled A. F. Amplifier, 127
 - Circuit of, 127
 - Remedy of Motor Boating, 128
- Regulations U. S. Amateur, 591
- Regulation, 62-63
- Regenerative Amplification, 142
- Regeneration, 133, 142
- Regulations Governing the issuance of operator license, 720
- Retentivity, 13
- Resonance, 39
- Resonance Frequency, 39
 - In A.C. Sets, 39
 - How Obtained, 40
- Re-radiation, 643
- Reversal of Polarity of Generator, 63
- Requirements of Examination for operator licenses, 720
- Rejector Circuit, 252
- Shunt rejector, 253
- Series, 253

R. F. Feed Line, 174
 R. F. Choke Coils, 206
 R. F. Current, Generation of by a
 spark transmitter, 432
 Rice Circuit, 135, 140
 Rotary Converter, 78

S

Safe Plate Dissipation, 149
 Safety at Sea Conference, 781
 Safety Signal, 711
 Scanning Disc for Television, 626
 Schedules of Government Press,
 Weather and Time Transmis-
 sions, 766
 Schools, Radio, 734
 Address of, 737-738
 Screen Grid Vacuum Tubes, 142,
 169, 173
 Screen Grid V. T. Spmitter, 260
 Seasoning Quenched Spark Gap, 447
 Secrecy of Messages, 685
 Self Induction, 23
 Self Rectifying Transmitter, 196
 Series Feed to Plate, 179
 Series Connection of Batteries, 11-
 12
 of Condensers, 29
 Series Motor, 73
 Generator, 61
 Service Range of Broadcasting Sta-
 tion, 318
 Shielding, 457, 546
 Short Wave Apparatus, 448, 584
 Receiver, 448
 Schedules, 769
 Stations, 769
 Short Waves, Reflection of, 569
 Ground Wave, 571
 Skip Distance, 571
 Reflected Wave, 571
 Multiple Reflections, 572
 Echo Signals, 572
 Ship Act, 672
 Auxiliary Power Requirements,
 672
 Operators required Under, 674
 Master's Responsibility, 674
 Intercommunication, 674
 Penalty, 674
 Regulations, 674
 Reporting Violations, 676
 Inspection of Ship Stations, 677
 Ship Stations, 677
 Shipping Board Messages, 762
 Sine Wave, 31
 Side Band Frequencies, 232
 Signalling Systems, 411, 419, 428-
 429
 Sign Flashers, Interference from,
 666-668
 Skin Effect, 36
 Skip Distance, 571
 Shunt Feed, 179
 Shunt Wound Generator, 60
 Slot Ripple, 192
 Soft Tube, 207
 Solenoid, 16, 25
 Spark Transmitter, 432-433
 Commercial, 439
 Spark Gap, 435-437
 Spark Discharge, 432-433
 Speech Amplifier, 237
 Speech Input Equipment W. E., 379
 Specific Gravity of Electrolyte, 95-
 106
 Step-up Transformer, 41
 Step-down Transformer, 41
 Stabilizing R. F. Amplifiers, 134
 Losser Methods, 134
 Bridge, 135
 Reversed Tickler, 135
 Neutrodyne, 136
 Rice Circuit, 140
 Static Interference, 639
 Starting Resistance, 67
 Storage Batteries, 82
 Edison, 83
 Charging, 89
 Lead Plate, 93
 Buckled Plates, 101
 Height of Solution, 101
 Maximum Gravity and Equalizing
 Charge, 101
 Trickle Charge, 101
 Impurities in Electrolyte, 107
 Broken Jar, 107
 Indications and Trouble, 107
 Stress, 6
 Studio Arrangement, 224
 Superhetrodyne Receivers, 154
 Frequency Changer, 155
 Oscillators, 155-157
 Intermediate Frequency Amplifier,
 159
 Switch, Wave Change, 441
 Swinging Signals, 304

Synchronization of Television Scanning Disc, 613
Synchronous Rotary Gap, 436

T

Tank Circuit, 180
Television, 567
 Early Developments, 598
 Transmitting Apparatus, 600
 Photo Electric Cell, 600
 Scanning Disc, 601
 Persistence of Vision, 601
 Illustrative Transmitting Apparatus, 602
 Negative Image, 631
 Daven Kit, 631
 Rules and Regulations Governing Visual Broadcasting stations, 636
 Receiving Scanning Disc, 622
 Making Receiver Disc Instructions for,
 Building Mounting Scanning Disc Driving Mechanism, 624
 Jenkins Amateur Kit, 626
 Amplifier, 612
 Obtaining Synchronization, 613, 638
 Variable Speed Motor, 613-614
 Jenkins Friction Driving Method, 614
 Connecting Neon Lamp in Receiver Output, 618
 Receiver Design, 619
 Silhouettes Broadcast from Jenkins Laboratories, 631
 Scanning at the Receiver, 603
 Neon Lamp use of, 604-605
 Scanning Disc Dimensions, 605
 Frequency Consideration, 606-608
 Picture Elements, 606-608
 Arrangement for Scanning at Transmitter, 607
 Jenkins Drum Scanner, 608
Telephone Receivers, 30
Temperature Control of Quartz Crystal, 337
Temperature Control Circuit for Piezo Oscillator, 318, 338
Theory of V. T., 111
Thoriated Filament, 111
Thermionic Electronic Emission, 110
Thermo-Couple Ammeter, 35
Time Schedules, 766-769
Toroid Coil, 25
Tone Modulation, 197
Transmitters, Spark, 432
 Arc, 408
 Radio Beacon, 530
 Burgess Aircraft, 548
 Transmitters C. W., 194
 Transmitter Condenser, 372
 Transmitters, Interference from amateur, 645
 Quiet Hours, 645
 Transmitters, Amateur Short Wave, 583
 Broadcasting, 319
 Tuning, 586
 Aircraft, 558
 Television, 600
 Illustrative Apparatus, 602
 Frequency Characteristics, 608
 Diagram of Transmitter, 612
 Synchronization, 612
 Transmitter V. T. Adjustment, 313
 V. T. Half Wave Self-Rectifying, 196
 Full Wave Self-Rectifying, 197
 Transmitter, W. E. 5C, 319
 Transmitting, Tubes, 267
 Transmission Unit, 238
Transformers, Interference from Power Transformer, 656
Transformer Coupling, 122
 Diagram, 123
 Transformers, 40-41
Transformers, A.C. Step-up, 41
 Step Down, 41
 Construction of A.C., 41
Traffic, Handling, 74
Troubles and Remedies for Direction Finders, 517
Troubles and Remedies, 205, 208, 275, 303
 In Arc Transmitters, 424
 Transmission Line, 264-265, 268
 Tuning a Spark Transmitter, 443
 Sparking of Loading Coils, 444
 Tuning Chart, Government, 445
 Tuning a Receiver to Incoming Signals, 468
 Tuning a V. T. Transmitter, 267, 281
 Tuning the Transmitter, 586
 Tubes Fail to Oscillate, 304
 Tuned Plate Coupling, 142

Tuned Grid, Tuned Plate Circuit,
178
Tube Base Receiver, 580
T. U., 401

U

Ultradyn, 159
Unit of Capacity, 96
Undamped Oscillations, 132, 151
Urgent Signal, 710
Undamped Waves, 53

V

Vacuum Tube, Construction of, 110
Voltmeter, 647
Water Cooled, 347
Rectifiers, 335
Screen Grid, 142
Filaments, 111
Action of the Grid, 112
Characteristic Curve, 113
Detector Action, 114-115
As Amplifier, 117
Plate Impedance, 121
Mutual Conductance, 122
Variometer, 142, 420
Visual Indicator, Aircraft, 530
Receiving Equipment, 534
Application of System, 537
Visual Indicator, 542, 647
Volt, 10-11
Voltmeter, 18
Shunt, 19
Voltage Characteristics of Edison
Battery, 85
Voltage Characteristics of D.C.
Generator, 61-62
Voltage Feed Line, 183
Systems, 576
Volume Indicator, 239, 404
V. T. Transmitters, Troubles, Remedies, 275
Emergency Measures for Apparatus Failure, 275

Locating Trouble, 303-376
Adjustments, 313
Operation, 270, 281
Substituting Defective Parts, 208
Operating Instructions, 204
V. T. Water Cooled, 150
Data on Power, 209
V. T. Rectifiers, 193
A. C., 173
V. T. Reactivation, 162
V. T. Oscillators, 144, 157, 198

W

Wave Traps, 252, 472, 481, 644
Rejector Circuits, 253
Acceptor Circuit, 254
Bypass, 254
Wavemeter, 248
Wavelength of Radio Compass Station, 505
Wavelength, Choosing the, 573
Amateur, 591
Wavelength, 49-51, 704
Water Cooled V. T., 150
Water Cooling System for Arc, 419, 427
Water Cooled V. T., 347
Wattmeter, 34
Watt, 14
Watch, Hours of, 763-764
Wave Change, Switch, 441
W. E. 8B. Speech Input Equipment, 379
Western Electric Broadcasting Equipment, 319
Western Electric Superheterodyne, 469
Western Electric 100% Modulation System, 163, 319
Weather Report Schedules, 766-768
Wheatstone Bridge, 135
Circuit, 139
W. S. A. Co. 1 P-501 Radio Receiver, 462

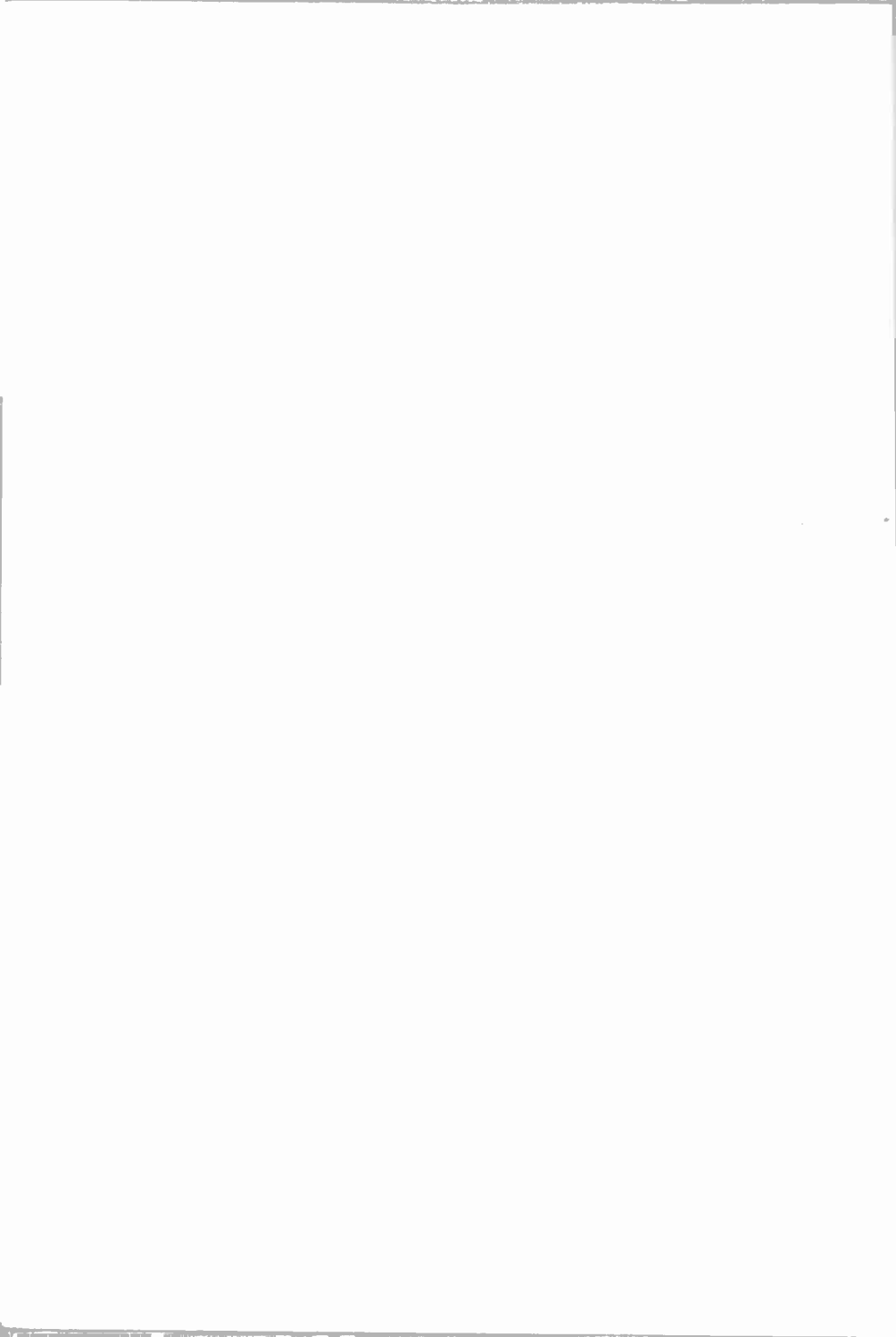

A Selection of Van Nostrand Books on Radio and Elementary Electricity.

Radio: A Textbook of First Principles, By ELMER E. BURNS, *Instructor in Physics, Austin High School, Chicago.* About 280 pp. 225 illus. $5\frac{1}{2} \times 8\frac{1}{4}$. Buckram. \$2.50

Elements of Radio Communication, By ELLERY W. STONE, *Lieut.-Comm. U. S. N. R., Fellow, Institute of Radio Engineers, U. S. Naval Institute.* Third Edition—Revised and Enlarged. 442 pp. 220 illus. 56 full page plates. $5\frac{1}{2} \times 7\frac{3}{4}$. Cloth. \$3.00

Fundamentals of Radio, By JAMES L. THOMAS. This book covers fully and simply the fundamentals of radio, furnishing a text that gives the elementary principles on which all radio sets operate. 211 pp. Illus. $5 \times 7\frac{1}{2}$. Cloth. \$1.50

Radio: Beam and Broadcast, By A. H. MORSE. Its Story and Patents. Full-page plates, diagrams, tables. 192 pp. $5\frac{1}{2} \times 8\frac{3}{4}$. \$4.00

Practical Tests for the Electrical Laboratory, By CHESLEY H. JOHNSON, *North East High School, Philadelphia,* and RALPH P. EARLE, *Central High School, Philadelphia; Associate Members, American Institute Electrical Engineers.* 354 pp. Illus. $5\frac{1}{2} \times 8\frac{1}{2}$. Cloth. \$2.50

Lessons in Practical Electricity, By C. W. SWOPE. An Elementary Textbook. *Rewritten by ERICH HAUSMANN, E.E., Sc.D., Professor of Physics, Polytechnic Institute of Brooklyn, N. Y., Fellow, American Institute of Electrical Engineers.* Seventeenth Edition—Third Printing. 710 pp. 543 illus. $5\frac{3}{4} \times 8$. Cloth. \$2.50

Electricity and Its Application to Automotive Vehicles, By PAUL MCD. STONE, *Assistant Principal, Michigan State Automobile School.* Second Printing. 860 pp. 395 illus. 6×9 . Flexible Fabrikoid. \$4.00

Storage Batteries: Theory, Manufacture, Care and Application, By MORTON ARENDT, *E.E., Fellow, American Institute of Electrical Engineers; Assistant Professor of Electrical Engineering, Columbia University.* About 350 pp. 156 illus. $6\frac{1}{4} \times 9\frac{1}{4}$. Full Buckram. \$4.50

Industrial Mathematics Practically Applied, By P. V. FARNSWORTH. Third Printing. 250 illus. and over 1,000 problems and answers. $5 \times 7\frac{1}{2}$. Cloth. 285 pp. \$2.50

Mathematics for the Practical Man, By GEORGE HOWE. Third Edition, Corrected with a Supplement, Giving the Answers to Problems. 42 illus. $5\frac{1}{4} \times 7\frac{3}{4}$. Cloth. 143 pp. \$1.50

Full Description, or Examination Copies, Sent on Request.