

STORAGE TUBES
and Their Basic Principles

STORAGE TUBES

and Their Basic Principles,

M. KNOLL

*Professor of Electrical Engineering
Princeton University
Member of the Technical Staff
RCA Laboratories Division*

B. KAZAN

*Member of the Technical Staff
RCA Laboratories Division*

**JOHN WILEY & SONS, INC., NEW YORK
CHAPMAN & HALL, LIMITED, LONDON**

Copyright, 1952

By

John Wiley & Sons, Inc.

All Rights Reserved

This book or any part thereof must not
be reproduced in any form without the
written permission of the publisher.

Library of Congress Catalog Card Number: 52-9368

Printed in the United States of America

PREFACE

Although the importance of electronic storage for television, computer, and signal-converter applications is generally recognized, and a number of books exist which treat this subject, no previous textbook has been primarily concerned with storage tubes. It is the purpose of this book to explain in concise form the fundamental operation of the different types of storage tubes and to provide this information in an easily accessible manner.

During the evolution of the manuscript it became more and more apparent that the operation of charge-controlled storage tubes could in general be explained on a common basis of relatively few fundamental processes of writing and reading. It is believed that this approach facilitates the understanding of the mechanism of such devices and should make the book useful both to electronic engineers and to teachers or students interested in this general subject.

In the text the different storage tubes have been described with many minor details omitted. This has been done for the sake of emphasizing the fundamental storage principles. It is hoped that the reader will refer to the bibliography (Part VIII) for additional details.

Many of the storage tubes described are still in the development stages. Since their uses and applications have not yet been fully explored and they are still subject to modifications, no attempt has been made to compare the properties of similar types of tubes quantitatively.

A substantial portion of this book was initially prepared for the U. S. Army Signal Corps in the form of a report. The authors wish to express their appreciation for the support of Dr. J. E. Gorham of the Evans Signal Laboratory and are indebted to Miss Ruth Pearl of the same laboratory for her cooperation and diligence in typing the material for the manuscript.

In addition, the authors wish to acknowledge many stimulating discussions with members of the staff of the RCA Laboratories, especially with Mr. L. Pensak.

M. KNOLL
B. KAZAN

Princeton, New Jersey
August, 1952

INTRODUCTION

Charge-controlled storage tubes have been employed as television-camera tubes since the early days of television. Since about 1940 they have also become increasingly important as devices for signal conversion, direct viewing, and computing applications. Since the storage of information in such tubes depends neither on mechanical movements nor on physicochemical changes in a material, but on the establishing or removing of minute electrical charges on an insulating surface (or array of insulated elements), the speed of operation is very high. In practical tubes the amount of electrical charge stored per target element is in the order of 10^{-11} coulombs or less, thus permitting time-varying electrical information to be stored on (or removed from) successive elements at rates as high as a few megacycles per second.

Because of the fact that a pattern of electric charges corresponding to the light and dark areas of a visual picture can be established on the storage surface, the storage tube has found its most extensive use in television applications, especially in the field of pickup tubes which convert visual to electrical signals. For these types of applications storage tubes such as the Iconoscope and Image Orthicon have been furthest developed.

In the transmission of picture information it is frequently necessary to change from one type of scanning to another such as radial scanning (P.P.I.) to rectangular scanning (raster), or to change the frame frequency of transmitted electrical information in coordinating, for example, one television system with another. For these purposes the frequency-converter type of storage tube is very useful. It is also important in applications involving integration for increasing the signal-to-noise ratio, and the recording of single transients from which it is desired to produce a number of copies. Considerable developmental work has already been accomplished on several of these devices, with many new applications expected.

Where the direct viewing of visual patterns or pictures is

concerned, charge-controlled viewing storage tubes, although not as fully developed as the other types above, are expected to play an important part in applications where, for example, it is desired to view a short electrical transient signal for a long period with little decay, where it is desired to control the decay of a stored signal, where higher light output is desired than can conveniently be obtained with ordinary scanning types of cathode-ray tubes, or where low frame repetition rates are desired without flicker.

Charge-controlled storage tubes have also become important as essential components in computing devices. Because of the rapidity with which electrical information can be stored at an arbitrary target element (time durations as short as a few microseconds) storage tubes are finding one of their most important uses where complex operations require rapid storage of intermediary information and rapid access to this information. For computing applications several successful types of tubes have already been designed, with additional development work continuing.

The operating mechanism of storage tubes is largely dependent on the control of secondary-emission currents from an insulating target and bombardment-conductivity currents through the target material. In Part I the equilibrium potentials acquired by insulated elements under steady electron bombardment are discussed. On the basis of this discussion and the definitions of Part II the various methods of establishing a charge pattern by dynamically controlling the secondary emission and bombardment conductivity are then described in Part III. A more complete understanding of secondary emission itself may be obtained from the literature indicated in Part A of the bibliography. In particular, the works of Bruining (Ref. 2) and McKay (Ref. 9) provide relatively complete surveys of the secondary emission of both insulators and metals.

In addition to secondary emission and bombardment conductivity, the processes of photoemission and photoconductivity play an important role in the charging action of television camera tubes. These charging actions are therefore also discussed in the above-mentioned parts from the static and dynamic viewpoints.

The following Parts, IV, V, VI, and VII, are devoted to a

discussion of the various types of storage tubes. Although these tubes have been grouped into parts on the basis of their general application, such as signal conversion or computing, it is also believed desirable to classify the tubes (a) by the method of applying the input signal (cathode modulation or backplate modulation, for example), since it most clearly differentiates the tubes on the basis of their circuit operation, and (b) by the basic writing and reading mechanisms which take place within the tubes.

It should be noted that in a number of cases the physical construction of a tube permits it either to be employed for a different application or to operate with a different writing and reading mechanism than indicated in the following text. However, individual storage tubes have usually been designed with a particular application and type of operation in mind so that numerous design considerations incorporated in their structure, such as target thickness, target leakage, secondary-emission properties of the target, collector geometry, and beam current and voltage as required by electron-optical considerations, frequently limit the practical employment of individual tubes differently than intended by the original design.

In the following sections simplified diagrams which indicate only the essential components of each tube are employed, so that the mechanism of operation can be most clearly explained. For the purpose of discussing the operation of the tubes on a common basis related to Parts I, II, and III each tube is described with the collector electrode connected to ground directly or through an output resistor. Although in the reference literature the electrode which is grounded may vary from tube to tube, the assumption of a grounded collector does not change the basic operation.

CONTENTS

	Page
Introduction	vii
Part I. Equilibrium Potentials Acquired by an Insulating Surface under Electron Bombardment and the Action of Light	
A. Equilibrium States of an Electron-Bombarded "Floating" Surface (Figs 1, 2, and 3)	1
B. Target Potential-Shifting Diagram (Fig. 4)	5
C. Equilibrium of the Branch b-c' of the V_{eq} Curves of Figs 3 and 4	7
D. Influence of the Velocity Distribution of the Secondary Electrons on the Shape of Branch c-d of Figs. 3 and 4 (Fig. 5)	8
E. Variation of Instantaneous Collector Current as a Function of the Floating Target Potential (Fig. 6)	11
F. Slope of the Branch d-e of the V_{eq} Curve of Figs. 3 and 4	12
G. Photoemission Levels Above the V_k Axis of Fig. 3	13
H. Photoconductivity Levels Above and Below the V_k Axis of Fig. 3	14
I. Bombardment-Induced Conductivity Levels Above and Below the V_k Axis of Fig. 3 (Fig. 7)	15
J. Redistribution Levels Below the Line c-d of the Equilibrium Curve of Fig. 3 (Fig. 8)	16
Part II. Definitions	19
Part III. Methods of Writing and Reading	
A. Writing Methods	22
1. Equilibrium Writing	22
2. Bistable Writing with the Aid of a Holding Beam	24
3. Nonequilibrium Writing	25
4. Redistribution Writing	27
5. Induced-Conductivity Writing (Electron Bombardment or Light)	28
a. Bombardment-Conductivity Writing	28
b. Photoconductivity Writing	29
6. Methods of Applying the Input Signals During Writing (Fig. 9)	29
B. Reading Methods	30
1. Capacity-Discharge Reading (Fig. 10)	31
2. Redistribution Reading (Fig. 11)	33
3. Grid-Control Reading	34
a. Transmission Modulation (Fig. 12a)	36
b. Emission Modulation (Fig. 12b)	36
c. Reflection Modulation (Fig. 12c)	38

	Page
C. Erasing and Decay	38
D. Halftones	39
1. Halftone Writing	40
a. Equilibrium Writing	40
b. Bistable Writing	40
c. Nonequilibrium Writing	40
d. Redistribution Writing	41
e. Induced-Conductivity Writing	41
2. Reading Halftones	42
a. Capacity-Discharge Reading	42
b. Redistribution Reading	43
c. Grid-Control Reading	43
d. Combination of Writing and Reading Methods	43
 Part IV. Signal-Converter Storage Tubes (Electrical-Electrical)	
A. Primary-Current-Modulation Types	44
1. Nonequilibrium Writing—Capacity-Discharge Reading (Krawinkel, Kronjäger, and Salow) (Fig. 13)	44
2. Nonequilibrium Writing—Grid-Control Reading (Hergenrother and Gardner) (Fig. 14)	47
3. Induced-Conductivity Writing—Capacity-Discharge Reading (Graphechon) (Pensak) (Fig. 15)	50
4. Bistable Writing—Capacity-Discharge Reading (Memory Tube) (Haeff) (Fig. 16)	53
B. Cathode-Voltage-Modulation Types	58
Equilibrium Writing—Grid-Control Reading (Knoll and Randmer) (Fig. 17)	58
C. Backplate-Modulation Types	61
Equilibrium Writing—Capacity-Discharge Reading (Radechon) (Jensen, Smith, Mesner, and Flory) (Fig. 18)	61
 Part V. Viewing Storage Tubes (Electrical-Visual)	
A. Primary-Current-Modulation Types	66
1. Nonequilibrium Writing—Grid-Control Reading	66
a. Photoelectric Viewing Cathode—Single-Sided Target (Krawinkel) (Fig. 19)	66
b. Secondary-Emission Viewing Cathode—Two-Sided Target (Knoll and Randmer) (Fig. 20)	69
c. Reflection Target (Hergenrother and Gardner)	72
2. Nonequilibrium Writing—Light-Valve Reading (Donal and Langmuir) (Fig. 21)	73
3. Bistable Writing—Luminescent Target (Haeff)	77
B. Cathode-Modulation Types	78
Equilibrium Writing—Grid-Control Reading (Knoll) (Fig. 22)	78
C. Collector-Modulation Types	81
Equilibrium Writing—Grid-Control Reading	81
Photoelectric Viewing Cathode—Double-Sided Target (Schroeter) (Fig. 23)	81

CONTENTS

xiii

	Page
Part VI. Computer Storage Tubes (Electrical-Electrical)	
A. Primary-Current-Modulation Types	85
Redistribution Writing—Capacity-Discharge Reading (Williams and Kilburn (Fig. 24)	85
B. Collector-Modulation Types	89
Equilibrium Writing—Capacity-Discharge Reading (Forrester) (Fig. 25)	89
C. Backplate-Modulation Types	92
1. Bistable Writing—Grid-Control Reading (Rajchman) (Fig. 26)	92
2. Bistable Writing—Capacity-Discharge Reading (Dodd, Klemperer, and Youtz) (Fig. 27)	97
Part VII. Television-Camera Storage Tubes (Visual-Electrical)	
A. Light-Intensity-Modulation Types	102
1. Redistribution Writing—Redistribution Reading (Iconoscope) (Zworykin, Morton, and Flory) (Fig. 28)	102
2. Nonequilibrium Writing—Capacity-Discharge Reading (Orthicon) (Rose and Iams) (Fig. 29)	107
3. Nonequilibrium Writing—Capacity-Discharge Reading (Storage Orthicon) (Forgue)	111
4. Photoconductivity Writing—Capacity-Discharge Reading (Vidicon) (Weimer, Forgue, and Goodrich) (Fig. 30)	112
B. Primary-Current-Modulation Types	
1. Redistribution Writing—Redistribution Reading (Image Iconoscope) (For authors, see text) (Fig. 31)	114
2. Nonequilibrium Writing—Capacity-Discharge Reading (Image Orthicon) (Rose, Weimer, and Law) (Fig. 32)	118
3. Nonequilibrium Writing—Capacity-Discharge Reading (Image Isocon) (Weimer) (Fig. 33)	122
4. Nonequilibrium Writing—Grid-Control Reading (Knoll and Randmer) (Fig. 34)	125
Part VIII. Bibliography	131
Index	141

PART I

EQUILIBRIUM POTENTIALS ACQUIRED
 BY AN INSULATING SURFACE
 UNDER ELECTRON BOMBARDMENT
 AND THE ACTION OF LIGHT

A. EQUILIBRIUM STATES OF AN ELECTRON-
 BOMBARDED "FLOATING" SURFACE

The establishing of a charge pattern in a storage tube is frequently accomplished by means of secondary emission. For an understanding of this process a knowledge of the potential acquired by an insulated element under steady bombardment is essential.

In Fig. 1 an electrode arrangement typical of a storage tube is indicated. Under steady bombardment by primary electrons in a high vacuum, an insulated (metallic or non-metallic) element of the target at an arbitrary initial potential, V_{ft} , will be charged to an equilibrium potential, V_{eq} . For a given material the value of this equilibrium potential (measured with respect to the secondary-current collector anode G) depends, to a first approximation (within several volts), on the energy V_{pr} of the primary electrons striking the target, and the effective resistance R_i of the material between the target element and the backplate P.

Figure 2 indicates the well-known curve, characteristic of all materials (including metals) of secondary-emission ratio δ_e as a function of primary electron energy V_{pr} , expressed in electron volts (Refs. 2, 9). (δ_e is defined as the ratio of the secondary current i_s to the primary current i_{pr} .) The lower and higher values of V_{pr} corresponding to $\delta_e = 1$ are designated as first and second crossover potentials V_{cr1} and V_{cr2} respectively.¹ This curve always exhibits a maximum value² of δ_e between V_{cr1} and V_{cr2} . At primary energies

¹ V_{cr1} is usually of the order of 100 volts or less and V_{cr2} of the order of 1000 volts or greater.

²For some pure metals, and carbon in the form of soot, the maximum value of δ_e is less than unity. In such cases no crossover potentials exist.

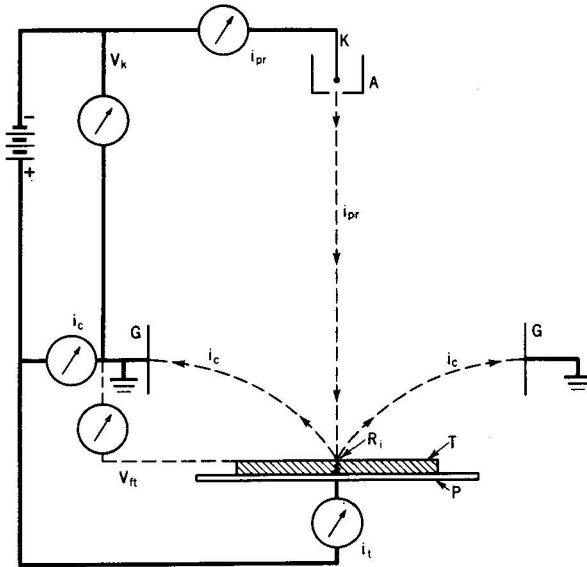

Fig. 1. Typical electrode arrangement for an electron-bombarded storage target.

A, accelerating anode; G, collector cylinder; i_c , collected current; i_{pr} , primary current; i_t , current reaching backplate from target (leakage target current); K, cathode; P, metal backplate; R_i , resistance between surface of target element and backplate, due to leakage, conductivity induced by bombardment or light, or both; T, target (insulator sheet or coating); V_{ft} , instantaneous potential of target surface with respect to collector; V_k , potential of cathode with respect to collector.

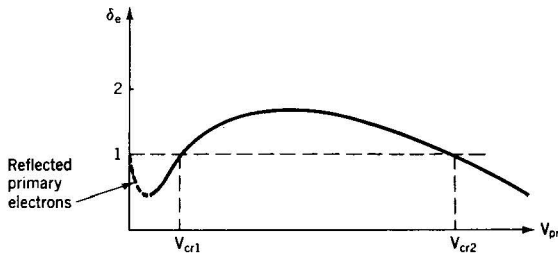

Fig. 2. Typical secondary emission curve: secondary-emission ratio δ_e as a function of bombarding primary-electron energy V_{pr} at the target.

V_{cr1} , first crossover potential; V_{cr2} , second crossover potential.

below the maximum, δ_e increases with increasing V_{pr} because of the increasing primary energy available. At primary energies above the maximum, δ_e decreases as a function of V_{pr} because the secondary electrons are generated in progressively deeper layers of the material and therefore are absorbed to a greater degree with increasing V_{pr} . At very low energies, a large fraction of the primary electrons is reflected by collision with the target atoms. If these reflected electrons are collected together with the secondary electrons, the apparent secondary-emission ratio (shown by the dotted portion of the curve) approaches unity as V_{pr} approaches zero.

If the conductivity of the target is sufficiently high, such as for metals, the secondary-emission curve of Fig. 2 can be obtained by direct-current measurements. For an insulating target film, the portion of the curve corresponding to higher primary electron velocities may also be obtained by direct-current measurements, using the effect of bombardment-induced conductivity of a penetrating beam (see Part I-I and Refs. 16, 32); otherwise, the curve must be obtained by pulse techniques (Refs. 9, 24, 40). In obtaining this curve it is assumed that the accelerating field between the collector and target is sufficient to remove all secondary electrons emitted from the surface of the target.

In operation of storage tubes, such an accelerating field does not always exist, and some of the emitted secondary electrons return to the target. To differentiate clearly between the secondary-electron current i_s emitted by a certain target material under bombardment and the portion i_c of this electron current (consisting of either secondary or reflected primary electrons, or both, from the target) which lands at the collector, the following notations are used:

$$\frac{i_s}{i_{pr}} = \delta_e \text{ (secondary-emission ratio as commonly used in the literature) and}$$

$$\frac{i_s}{i_{pr}} = \delta_c \text{ (collected-current ratio)}$$

For a given material and a given primary electron velocity at the target, δ_c will always be equal to or smaller than δ_e except for very low primary energies where the collected electrons include the reflected electrons. The condition $\delta_c \leq \delta_e$ is caused by a decelerating field between the target and col-

lector which results when the target is positive with respect to the collector (see Part I-D), or from a space-charge-potential minimum near the target, due to the low velocity of the emitted secondary electrons.

V_{eq} , the equilibrium potential of a target element bombarded by the primary electrons, is experimentally known to be a function of the cathode potential V_k with respect to the collector (Ref. 28). This relationship is indicated by the curve of Fig. 3. For values of V_k which correspond to values of V_{pr} below V_{cr1} , V_{eq} decreases linearly with increasing magnitude of V_k and usually jumps to a slightly positive value for a value of V_k equal to or greater than V_{cr1} . Under some conditions, however, the target may be caused to assume potentials along the dashed line b-c' as V_k is increased beyond the value V_{cr1} (see Part I-C). For values of V_k corresponding to V_{pr} greater than V_{cr2} , V_{eq} again decreases linearly³ with increasing value of V_k . A more detailed discussion of the equilibrium curve is given below.

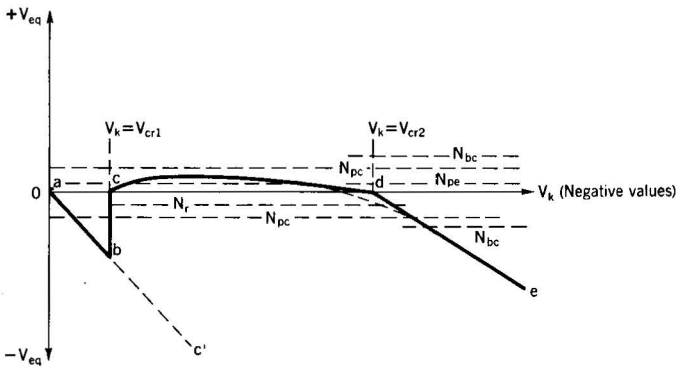

Fig. 3. Curve of secondary-emission equilibrium potential V_{eq} as a function of cathode voltage V_k .

N_{bc} , typical potential levels resulting from bombardment-induced conductivity; N_{pe} , typical potential level resulting from photoemission; N_{pc} , typical potential levels resulting from photoconductivity; N_r , typical potential level resulting from redistribution.

³Although, as indicated in Fig. 3 (and also Fig. 4) the portion d-e of the equilibrium curve is a straight line intersecting the line c-d at the point d, actually, in the case of insulators the line d-e becomes curved as it joins the portion c-d. This is indicated by the dotted line near point d of Fig. 3.

B. TARGET POTENTIAL-SHIFTING DIAGRAM

The origin of the experimental equilibrium curve (Fig. 3) of a "floating" insulated target element may be understood with the help of Fig. 4. This figure indicates by means of arrows the direction of potential shift of an insulated target element with any initial potential V_{ft} , when bombarded with primaries from a cathode at any potential V_k with respect to the collector. Since the values of V_k along the x axis) and V_{ft} (along the y axis) are plotted on the same scale, lines of 45-degree slope represent lines of constant potential difference, $V_{ft} - V_k$. (Note that while V_k is always a negative number, it is indicated along the positive x axis.) This potential difference, $V_{ft} - V_k$, is actually the potential V_{pr} , and thus these sloping lines represent values of constant electron energy V_{pr} at the target.

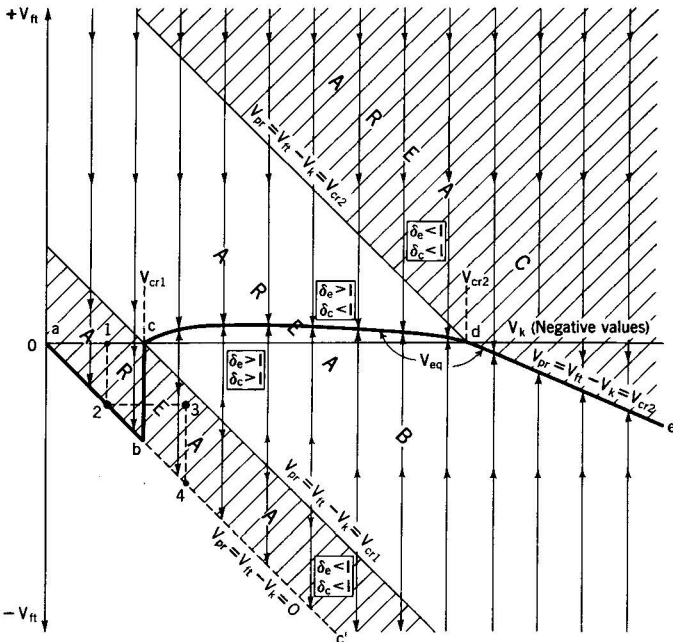

Fig. 4. Potential shift of a floating target under electron bombardment as a function of its initial potential V_{ft} and the cathode voltage V_k .

V_{ft} , instantaneous potential of target surface; V_{eq} , particular value of V_{ft} at equilibrium potential of target surface; V_k , cathode potential of bombarding primary beam.

In Fig. 4, three 45-degree lines are drawn for the particular electron energies zero, V_{cr1} , and V_{cr2} . The entire area between the lines $V_{pr} = 0$ and $V_{pr} = V_{cr1}$ (area A) includes only points where $\delta_e < 1$ and therefore also $\delta_c < 1$ since for all these points (as indicated by Fig. 2) the target will be bombarded with an energy less than the first crossover potential.

The area between the lines $V_{pr} = V_{cr1}$ and $V_{pr} = V_{cr2}$, in a similar manner, includes only points where $\delta_e > 1$. However, since the second crossover potential does not remain constant, but increases with increasing accelerating field at the target (see Part I-F), the region of $\delta_e > 1$ is extended (for negative values of V_{ft}) to the line d-e which has a slope of less than 45 degrees. This line is indicated as $V_{pr} = \bar{V}_{cr2}$ and represents the condition $\delta_c = 1$, since along the line the secondary emission ratio, δ_e , is by definition equal to unity, and all the secondaries are attracted to the collector.

The entire region of $\delta_e > 1$ of Fig. 4 (area B) is divided into two portions by the slightly curved line c-d which represents the condition $\delta_c = 1$. (The reasons for the shape and position of this line are discussed in Part I-D.) Above the line, δ_c is less than unity since some or all of the secondary electrons are returned to the target by the decelerating field between the target and collector. Below the line, δ_c is greater than unity since there is less decelerating field or an increasing accelerating field.

To the right of the line $V_{pr} = V_{cr2}$ (above the V_k axis) and to the right of the line $V_{pr} = V_{cr2}$ (below the V_k axis), the energy of the primary electrons at the target is greater than the second crossover potential. All points in this region (area C), therefore, correspond to $\delta_e < 1$ and thus to $\delta_c < 1$ as well.

Since a floating target element, when bombarded with primaries under the condition $\delta_c > 1$, becomes more positive and, when bombarded under the condition $\delta_c < 1$, becomes more negative, the direction of these potential shifts can be indicated by the arrows of Fig. 4 in the corresponding regions. These arrows converge on the line c-d-e from above and below, thus indicating it to be a line of stable equilibrium since along it $\delta_c = 1$ and any small potential deviations from it will be compensated by such change in δ_c as will shift the target back toward the line. Since arrows end on only one side of the line a-b-c', points on this line are quasi-stable in the

sense that, although the condition $\delta_c = 1$ exists, only positive potential deviations will be compensated by a change in δ_c . Negative potential deviations, however, will not be compensated since, for points below the line $V_{pr} = 0$, primary electrons will no longer have sufficient energy to reach the target. Only by removal of the charge by leakage or other means, such as positive ions or the use of an auxiliary electron beam with a more negative cathode potential, can the target charge positively toward the line a-b-c'. (Although δ_c is also equal to unity along the line $V_{pr} = V_{cr1}$ below the V_k axis, stable equilibrium cannot be achieved in this case since slight potential deviations from the line will cause the target to shift away from the line, as indicated by the arrows, instead of toward the line.)

As mentioned above, the portion d-e of the equilibrium curve corresponds to the condition $V_{pr} = \bar{V}_{cr2}$ and since $V_{pr} = V_{ft} - V_k$, the resulting relationship $V_{ft} - V_k = \bar{V}_{cr2}$ exists along this line. Because of this relationship, indicating that at equilibrium the target potential cannot exceed the cathode potential by more than the amount \bar{V}_{cr2} as the cathode potential is increased, \bar{V}_{cr2} is frequently referred to as the "sticking potential."

C. EQUILIBRIUM OF THE BRANCH b-c' OF THE V_{eq} CURVES OF FIGS. 3 AND 4

Target elements can only be shifted to the line b-c' if the target and cathode potentials correspond to points which fall in the area A to the right of the line b-c'. If the target element is assumed to be initially at zero potential, one means of shifting its potential to a point on the line b-c' is as follows: The target element is first bombarded with primary electrons from a cathode whose potential, V_k , is between 0 and V_{cr1} as indicated by point 1 of Fig. 4. If the cathode potential is maintained at V_k , the target element will shift its potential by secondary emission action to point 2, the time required being determined by the primary beam current and the capacity of the target element to all the other target elements and electrodes in the tube. If the cathode potential is now increased by an additional quantity less than V_{cr1} , but such that the total cathode potential V'_k is greater than V_{cr1} ,

the target will be at point 3 and will again be shifted by secondary emission action to the point 4 on the line $b-c'$. In similar manner, other points corresponding to $V_{pr} = 0$ can be reached along the dashed equilibrium line $b-c'$.

D. INFLUENCE OF THE VELOCITY DISTRIBUTION OF THE SECONDARY ELECTRONS ON THE SHAPE OF BRANCH $c-d$ OF FIGS. 3 AND 4

The position and slightly curved shape of the line $c-d$ of Figs. 3 and 4 can be qualitatively understood from Fig. 5 where the relative number of secondary electrons is plotted as a function of their emission energy, V_e , expressed in volts. Two curves, 1 and 2, are shown, corresponding to the bombardment of a given target with primary electrons of energy V_{pr1} and V_{pr2} respectively.

As indicated in Fig. 5, a maximum occurs in each curve at a relatively low emission energy⁴ and another more narrow peak at a higher energy. The latter peak occurs at an emission energy equal to the particular energy V_{pr} of the primary electrons striking the target. In general, the majority of the secondary electrons are emitted with not more than a few volts energy and are in the vicinity of the low-voltage maximum. From the physical standpoint these electrons constitute the "true" secondaries.

Although the transition is not sharp, electrons emitted with higher energies consist of primary electrons which have given up a part of their energy to the target atoms by collision and are inelastically reflected. The sharp peak at the emission energy V_{pr} is produced by the elastic reflection of a fraction of the primary electrons which undergo no loss of energy in striking the target. In the discussions which follow, the expression "secondary electrons" will be taken to mean the total of all of the emitted electrons unless otherwise specified.

If the vertical coordinate of Fig. 5, indicating the relative number of secondary electrons, is assumed to be more ex-

⁴For insulators, this peak in the curve occurs at about 1 volt of emission energy or less. For metals, the peak is somewhat higher but generally less than 5 volts.

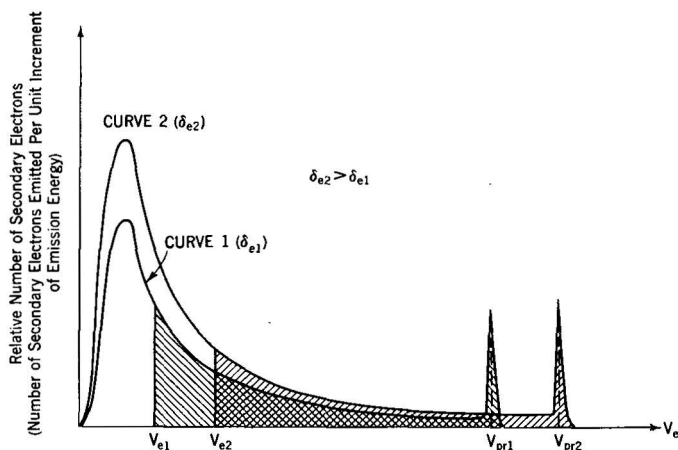

Fig. 5. Velocity distribution curves of secondary electrons for a given material showing minimum energy of secondary electrons which can reach the collector for different primary energies. V_e , emission energy of secondary electrons in volts.

Explicitly defined as the number of secondary electrons emitted per unit interval of emission energy, the entire integrated area under each curve will represent the total number of secondary electrons. The ratio of the total number of secondaries represented by each curve to the number of primary electrons corresponds, therefore, to the secondary emission ratios δ_{e1} and δ_{e2} respectively.

Referring to curve 1 of Fig. 5, if the target has a small positive potential V_{ft} equal to V_{e1} , only the electrons represented by the corresponding hatched area will have sufficient energy to reach the collector against the decelerating field.⁵ For any positive target potential V_{ft} , it is therefore possible to determine the number of electrons able to reach the collector by setting the value of V_e equal to V_{ft} and measuring the area under the curve to the right of the ordinate V_e . The ratio of the number of electrons reaching the collector to the number of primary electrons is, by definition, the value of δ_c . Of special interest is V_{eq} , the particular value of V_{ft} which corresponds to the condition $\delta_c = 1$. This is determined from

⁵For simplicity, it is assumed here that the secondary electrons are emitted only in the direction of the electric field between target and collector.

the particular value of V_{e1} ($= V_{ft}$) such that the hatched area represents a number of secondary electrons equal to the number of primary electrons.

Since, by definition, the total area under the velocity distribution curve will be increased with increases in δ_e , because of changes in primary electron velocity V_{pr} , the value of V_{eq} will also be increased to some extent by increases in δ_e (assuming approximately the same shape of velocity distribution curve). This is indicated in Fig. 5 where curve 2, having the same shape but a higher value of δ_e than curve 1, causes the potential V_{e2} to be higher than the potential V_{e1} of curve 1 for the condition $\delta_c = 1$. The line c-d, in Fig. 4, which is a plot of target potential V_{eq} for the equilibrium condition $\delta_c = 1$, is therefore slightly above the horizontal axis, representing the small positive values of V_{eq} , and rises and falls in height as δ_e varies with V_{pr} , as shown in Fig. 2.

Assuming that the shapes of the velocity distribution curves for different materials are geometrically similar, materials having greater values of δ_e will have higher values of V_{eq} for $\delta_c = 1$. The line c-d will thus be somewhat higher for such materials but of the same general shape.

Actually, the emitted secondaries will cause a space-charge cloud to form between the bombarded target element and the collector. This space charge, if sufficiently great, will produce a potential minimum in its neighborhood, preventing additional low-velocity secondaries from reaching the collector. The resulting net increase in electrons at the target will thus cause it to assume a new equilibrium potential, somewhat less positive than the ideal value, V_{eq} , discussed above, or a few volts negative with respect to the collector. The shift to a more negative equilibrium potential enables the number of secondaries leaving to equal the primary electrons (because of the reduction in decelerating field or the creation of an accelerating field), reestablishing the condition $\delta_c = 1$. Since the current density of the secondaries leaving the target determines the amount of space charge created, the equilibrium potential assumed by the target during bombardment will depend on the current density of the primary beam.

E. VARIATION OF INSTANTANEOUS COLLECTOR CURRENT AS A FUNCTION OF THE FLOATING TARGET POTENTIAL

For values of V_k whose magnitudes lie between V_{cr1} and V_{cr2} , the typical variation of the collected-current ratio δ_c with respect to V_{ft} is indicated by the solid curve of Fig. 6. In this figure, the dotted line, which is partially superimposed on the solid line, indicates the curve of secondary-emission ratio δ_e as a function of V_{pr} , the primary electron energy at the target. The solid curve is drawn with the assumption that the cathode potential V_k is held at some particular value V_{k0} , and the target potential V_{ft} is varied.

Since, by definition, V_{ft} is the target potential with respect to the collector, the abscissa $V_{ft} = 0$ corresponds to a primary energy V_{pr} at the target which is equal in magnitude to V_{k0} , the cathode potential with respect to the collector (Refs. 51, 54). For values of $V_{ft} < 0$ where an accelerating field exists between the target and collector, essentially all the emitted secondary electrons will be collected and the curves of δ_e and δ_c will therefore be superimposed.

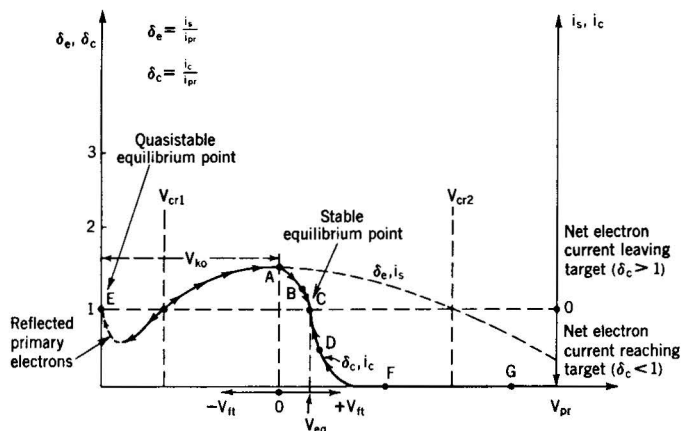

Fig. 6. Curve of instantaneous collected current as a function of floating target potential V_{ft} showing equilibrium points C and E.

V_{ft} , floating-target potential with respect to collector. $V_{ft} = 0$ represents target potential equal to collector potential.

For $V_{ft} > 0$ a decelerating field will exist at the target. If V_{ft} has a small positive value, the emission energies of the secondary electrons will enable a fraction of them to reach the collector as indicated in Part I-D. However, as V_{ft} is increased, the number of secondaries reaching the collector will decrease until essentially none of them will be capable of reaching the collector for large values of V_{ft} . This decrease in the collected current i_c is indicated by the solid line⁶ in Fig. 6 which includes points B, C, and D. The particular positive value of V_{ft} where the δ_c curve crosses the line $\delta_c = 1$ (point C) corresponds to the stable equilibrium potential V_{eq} . The exact value of δ_c for a particular positive value of V_{ft} can be obtained by determining the area under the energy-distribution curve of Fig. 5 to the right of abscissa V_{ft} as discussed in Part I-D. Since a target with a potential V_{ft} tends to shift positively or negatively, depending on whether $\delta_c > 1$ or $\delta_c < 1$, respectively, these potentials are indicated by the arrows on the δ_c curve of Fig. 6. Point C on the curve where the arrows converge from both sides is a point of stable equilibrium ($V_{ft} = V_{eq}$) and point E where the arrows arrive from one side only ($V_{pr} = 0$) is a quasi-stable point (as mentioned in Part I-B).

It should be noted that the point E (where $V_{pr} = 0$) requires a target potential V_{ft} which is negative with respect to the cathode by a fraction of a volt, since the primary electrons are emitted from the cathode with a small amount of thermal energy. Although not indicated in Fig. 6, the point $V_{ft} = 0$ thus corresponds to a primary energy $V_{pr} = V_{ko}$, plus a fraction of a volt.

F. SLOPE OF THE BRANCH d-e OF THE V_{eq} CURVE OF FIGS. 3 AND 4

It is experimentally observed that the slope of the branch d-e is less than 45 degrees (Refs. 21, 22). This may be accounted for by assuming that, as the accelerating field between the target and collector is increased, the value of δ_e becomes greater for a given material, with an accompanying

⁶In practice, the slope of this line will be influenced by the geometry of the target and collector system. For closer spacing of the collector to the target surface, the slope tends to increase.

increase in the value of V_{cr2} . Physically, the change in δ_e may be explained by assuming that more of the secondary electrons emitted in random directions inside the material can escape, since they are drawn toward the surface by the internal accelerating field.

Referring to Fig. 4, it is assumed that near the point d, where the accelerating field is approximately zero, the value of the second crossover is V_{cr2} . It is also assumed, for the purpose of illustration, that along the line d-e the value of V_{cr2} increases by an increment which is linearly proportional to V_{ft} so that $\bar{V}_{cr2} = V_{cr2} - \alpha V_{ft}$. (Note that α is a positive quantity and V_{ft} is always a negative quantity along the line d-e.) Since, by definition, the relationship $V_{pr} = V_{ft} - V_k$ exists, it is possible to write for the conditions along the line d-e, where $V_{pr} = \bar{V}_{cr2}$ holds true:

$$\bar{V}_{cr2} = V_{ft} - V_k.$$

Substituting

$$V_{cr2} - \alpha V_{ft} \text{ for } \bar{V}_{cr2}$$

gives

$$V_{cr2} - \alpha V_{ft} = V_{ft} - V_k,$$

or

$$V_{ft} = \frac{V_{cr2} + V_k}{1 + \alpha} = \frac{V_k}{1 + \alpha} + \text{constant}.$$

This is the equation of a line whose slope, as indicated in Fig. 4, is less than 45 degrees in magnitude.

G. PHOTOEMISSION LEVELS ABOVE THE V_k AXIS OF FIG. 3

In some cases the storage target may be covered with a mosaic of photoemissive elements insulated from each other. These elements can be charged by the action of incident light as well as by the action of secondary emission (Refs. 4b, 25, 26, 94, 95, 96, 97). Since by photoemission such target elements can only lose electrons, they always tend to charge in the positive direction. However, in charging by photoemission, the elements cannot shift more positive than the potential corresponding to the maximum energy of the emitted photo-

elections for a particular color or frequency of light. If the potential V_{ft} of a photoemissive element is shifted (by the capacitive action of a voltage applied to the backplate, for example) to a value greater than this potential, none of the emitted photoelectrons will be able to reach the collector, due to the decelerating field, and will be returned to the target surface. Since the number of photoelectrons emitted is proportional to the light energy incident on the surface, the charge lost is a linear function of the light energy, assuming sufficient accelerating field between target and collector. In Fig. 3, a typical potential level established by photoemission is indicated by the dashed line N_{pe} . This potential is of the order of several volts for visible light.

H. PHOTOCONDUCTIVITY LEVELS ABOVE AND BELOW THE V_k AXIS OF FIG. 3

If a potential difference has been established between the front surface and backplate of a thin insulating target, and the target material is photoconductive, the effect of incident light at a particular element will be to reduce this potential difference by increasing the conductivity of the target material (Refs. 4a, 4b, 18a, 20a, 77, 96).

The initial potential difference may be established by secondary-emission action. If, for example, the target surface is bombarded with primary electrons from a cathode whose potential is between V_{cr1} and V_{cr2} so that the surface is charged to approximately the collector potential, and at the same time the backplate is maintained at a different potential (either negative or positive) with respect to the collector, a corresponding potential difference will result between the target surface and backplate.

In general, the conduction current from the target surface to the backplate will decrease with time of illumination because of the reduced gradient as the surface approaches the backplate potential. Unlike the process of photoemission, the process of photoconduction does not cease at the instant of cutting off the incident light but persists, decaying rapidly at first, followed by an extended tail. The decay time varies considerably for different materials, the time required for the initial rapid drop in conductivity being in the order of a few milliseconds or less to reach $1/e$ of its initial value and

the tail extending in some cases for as long as several minutes.

I. BOMBARDMENT-INDUCED CONDUCTIVITY LEVELS ABOVE AND BELOW THE V_k AXIS OF FIG. 3

If a potential difference exists between the target surface and backplate (established by secondary emission, for example, as described in Part I-H) the target surface may be caused to shift to the backplate potential by means of bombardment-induced conductivity. This effect occurs when the target is thin (1 micron, for example) and the primary beam has sufficient energy to penetrate through the target material (Refs. 1, 4, 10, 15, 17, 18). Such induced conductivity may exceed by several orders of magnitude the conductivity of the unbombarded insulating target.

In Fig. 7, typical curves (taken from Pensak, Ref. 17) are shown for a target of silica, 0.25 micron thick, indicating the ratio of bombardment-induced current to primary current as a function of primary beam energy V_{pr} . It should be noted that these curves do not continue to rise with increasing primary beam energy but go through a maximum. For a given target this maximum occurs at approximately the primary beam voltage at which the greatest fraction of beam energy is absorbed in the target. As also shown by the curves, the bombardment-induced conductivity depends somewhat on the polarity of the initial potential difference established between target surface and backplate, being greater for most materials when the target surface is negative with respect to the backplate. (For exceptions see Ref. 18.)

Since secondary electrons will be emitted simultaneously from the surface of the target during bombardment, the tendency of the surface to assume the backplate potential by induced conductivity will be either aided or opposed by the secondary-emission action of the primary beam depending on the equilibrium potential associated with the primary-beam cathode potential (see Fig. 4). Neglecting secondary emission effects, the potential shift which an element of the target surface undergoes depends on the energy of the primary beam and the potential difference initially established between the target surface and backplate as well as the time of bombard-

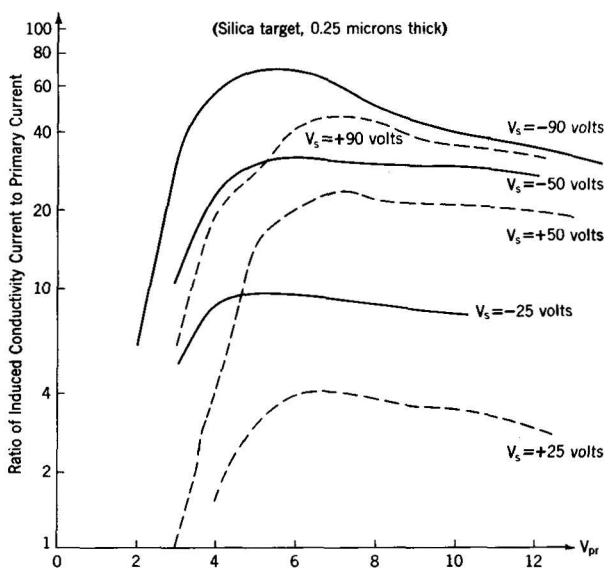

Fig. 7. Typical curves showing change in bombardment-induced conductivity with primary beam energy V_{pr} .

V_{pr} , primary beam energy in kilovolts; V_s , potential of target surface with respect to backplate (Pensak, Ref. 17).

ment. In Fig. 3, typical potential levels established by bombardment-induced conductivity are indicated by the dashed lines N_{bc} . These lines may be either above or below the V_k axis, depending on the backplate potential, and are drawn in the region where the cathode potential V_k assumes relatively large values (producing high bombarding energies).

J. REDISTRIBUTION LEVELS BELOW THE LINE c-d OF THE EQUILIBRIUM CURVE OF FIG. 3

In the preceding discussion relating to the potential shifting of a floating target under electron bombardment, no account was taken of secondary electrons emitted from a particular bombarded target element returning to other target elements (case of a scanned target). This "redistribution effect" is important since a target element, after having reached the equilibrium potential V_{eq} during bombardment, will become more negative as the primary electron beam later scans other elements. Redistribution usually occurs

when a weak decelerating field exists at the target such as at points along the branch c-d of the equilibrium curve of Fig. 3, or when a weak accelerating field exists such as at points slightly below the V_k axis.

In Fig. 8a, a bombarded target element is shown at a positive equilibrium potential, V_{eq} , of +5 volts with respect to the collector. Also indicated are the equipotential lines in the space between the target and collector. Since, as mentioned in Part I-D, a large fraction of the secondary electrons are emitted with energies of 5 volts or less, these electrons will be reflected back to other elements of the target surface

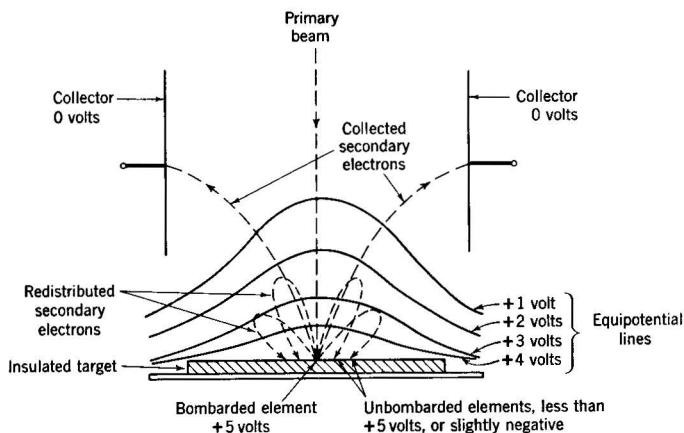

Fig. 8a. Typical target potentials due to electron distribution.

as well as to the bombarded element by the decelerating field above the target. Included in the secondaries which are reflected is a fraction of the electrons with greater than 5 volts energy but whose energy in the direction of the decelerating field is less than 5 volts because of their emission angle. The reflected electrons thus tend to charge negative other elements of the target surface⁷ at a rate depending on their

⁷In general, a large fraction of the redistributed electrons will return to the target surface in the neighborhood of the bombarded spot within a distance of a spot diameter. (See Footnote 21, page 86.)

distance from the bombarded spot (Ref. 67).

The redistribution effect can be substantially reduced or entirely eliminated if a fine-mesh barrier grid is placed very close to the target surface, as indicated in Fig. 8b, and the collector cylinder is maintained at a positive potential with respect to the grid. In this case, secondary electrons escaping through the holes of the mesh will be unable to return to the target surface because of the accelerating field existing between the mesh and the collector. However, secondary electrons with insufficient energy to escape through the mesh holes will return to the target surface very close to the point from which they were emitted. It is important to note that, although a large fraction of the collected secondary electrons may reach the collector cylinder through the holes of the

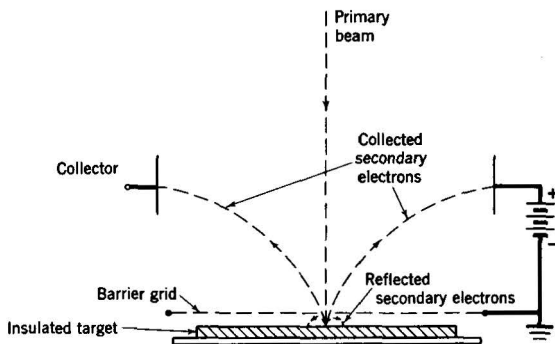

Fig. 8b. Barrier grid for reducing electron redistribution.

mesh, the barrier grid acts as the effective collector in determining the equilibrium potential of the target elements since it tends to prevent secondary electrons from leaving the target if the surface becomes positive with respect to the grid.

In addition to preventing redistribution, the barrier grid serves to prevent coplanar grid effects at the target surface, i.e., the tendency of a target element which has acquired a large negative charge to prevent the leaving of secondary electrons from or landing of primary electrons on adjacent elements during scanning.

PART II DEFINITIONS

The discussion in Part III covering the dynamic processes in storage tubes is based on the following definitions.⁸ These definitions are primarily concerned with charge-controlled storage tubes. Definitions relating to other storage processes in computers are given in the IRE Standards on Electron Computers; Definition of Terms, 1950 (Proc. IRE 39, March, 1951, 271-277).

1. Storage Tube (General). An electron tube into which information can be introduced and then extracted at a later time.
2. Storage Tube (Charge-Controlled). A storage tube in which information is retained by means of static electric charges. Such charges are generally retained on a homogeneous insulating surface or on an array of discrete insulated (metallic or nonmetallic) areas.
3. Storage Element. The smallest portion of the target which can be distinguished in the output signal from other differently charged portions under specified writing and reading conditions.
4. Writing. The action of establishing a charge pattern corresponding to the input signal. This may also be referred to as storing.
5. Maximum Writing Speed (Storage Elements per Second). The maximum rate at which successive storage elements can be charged to establish the desired charge pattern (determined by the output requirements).
 - a. Where halftones are required in reading, the maximum writing speed will be determined by the specified level of output variations, the resolution, and the amount of signal deterioration (see Definition 17a) introduced in the writing and reading processes.

⁸In the formulation of these definitions the suggestions of A. S. Jensen, F. H. Nicoll, J. A. Rajchman, A. Rose, P. Rudnick, R. Serrell, and especially those of L. Pensak are gratefully acknowledged.

- b. In bistable writing, the maximum speed is defined as the maximum rate at which successive storage elements can be shifted from one equilibrium potential to another.
- c. In viewing storage tubes employed for oscilloscope purposes, the maximum speed is defined analogously to nonstoring oscilloscope tubes as the maximum rate at which successive storage elements can be charged to produce a useful visual output.
6. Reading. The generation of an electrical or visual output signal corresponding to the stored charge pattern.
7. Maximum Reading Duration (Seconds). The maximum uninterrupted time of signal generation under specified scanning or viewing conditions. This period may depend on such factors as the required degree of contrast, constancy of halftones, number of distinguishable halftone levels, resolution, magnitude of output signal, and output signal-to-noise ratio.
8. Erasing. The removing of a previously stored charge pattern with the aid of a controllable process such as secondary emission, photoconductivity, etc.
9. Erasing Speed (Storage Elements per Second). The maximum rate at which storage elements charged in writing can be discharged to a specified low value.
10. Retention. The retention of a stored charge pattern for a period of time, such as by means of target insulation or holding action, but without writing, reading, or external circuit regeneration.
11. Retention Time (Seconds). The maximum time after writing that may elapse without reading which will permit a satisfactory electrical or visual signal to be produced.
12. Holding. The maintaining of the storage elements at their equilibrium potentials by electron bombardment against the action of leakage, or the loss or gain of charge due to the landing of undesired electrons or ions.
13. Decay. The reduction in magnitude of a stored charge pattern without writing, reading, erasing, or holding action.
14. Decay Time Constant (Seconds). The decay time for the stored charge to fall to $1/e$ of its initial value without holding action. This time constant is usually a function of the target insulation.

15. Charge Factor (Per Cent). The fraction of the desired potential shift which is produced at a particular target element during a single scan with a given writing beam current.
16. Discharge Factor (Per Cent). The fraction of potential shift of a particular target element from the potential established in writing toward equilibrium potential by a single scan during erasing.
17. Useful Number of Storage Elements. The maximum number of storage elements which can be employed for storing equally spaced "black" and "white" (or on-off) input signals with a specified deterioration in the output signal.
 - a. The deterioration of the output signal may manifest itself by, first, the addition of thermal noise, noise caused by scattering, or from target irregularities; or second, changes in the signal shape, due to the spot sizes and their density distributions, redistribution, and target leakage.
 - b. In general, the useful number of elements will be dependent on the required number of distinguishable output levels of each element.
18. Resolvable Number of Storage Elements. The maximum number of storage elements which can be employed for storing equally spaced "black" and "white" (or on-off) input signals which will produce a resolvable⁹ visual or electrical output. This number is equal to the product of the number of resolvable scanning lines and the number of resolvable elements per line.

⁹A detailed description and evaluation of the effect of spot size on resolution in television systems is given by O. H. Schade, "Electro-Optical Characteristics of Television Systems," RCA Rev., IX, 1948.

PART III

METHODS OF WRITING AND READING

A. WRITING METHODS

The purpose of writing is to establish a desired charge pattern on the storage surface. This process usually consists of two steps: (a) charging the entire target surface, usually by secondary emission, to a uniform potential equal or close to the equilibrium potential V_{eq} (frequently accomplished in the process of erasing or as a result of continuous reading); and (b) adding or subtracting charges from the target surface in a pattern corresponding to the input signal. Since each insulated target element comprises a miniature condenser between its front surface and the backplate, the process of establishing a charge pattern can be considered as a capacity-charging action.

The first step, charging the target to a uniform potential, may be accomplished either by flooding the entire target surface with primary electrons or by scanning the target elements with an unmodulated beam. The second step, the writing as such, can be accomplished in a number of ways as described below.

1. Equilibrium Writing

In one form of equilibrium writing (described below as cathode modulation) the direct-current potential of the electron-gun cathode is set at a value below V_{cr1} or above V_{cr2} so that the target elements when bombarded assume an equilibrium potential on either the sloping portion a-b or d-e of the equilibrium curve of Fig. 3. The target is then scanned by the primary beam, and voltage variations are applied to the cathode, which cause the corresponding target elements to assume new equilibrium potentials along one of these lines in accordance with the input signal.

In another form of equilibrium writing (backplate or collector modulation) the cathode potential of the electron gun is

set at a value above V_{cr1} and voltage variations are applied to the backplate¹⁰ or collector¹¹ so that the potential V_{ft} between the target surface and collector will vary as the target is scanned by the unmodulated primary beam.¹² At the moment of bombardment, the surface of each target element will then be maintained at the equilibrium potential by the charging action of the beam against the action of the instantaneous backplate or collector voltage. As a result, each element will acquire a net charge such that after scanning it will have a potential (with respect to V_{eq}) equal¹³ and opposite to the instantaneous potential variations V_{ft} applied to the target surface during scanning.

In practice, when the cathode potential V_k is between V_{cr1} and V_{cr2} , this form of equilibrium writing requires a barrier grid spaced close to the target surface, as indicated in Fig. 8b, to prevent the landing of redistribution electrons on the target surface (see Part I-J). If a barrier grid is not employed, the redistribution charges acquired by the elements may com-

¹⁰When the input signal is applied to the backplate, a large fraction of the voltage will usually appear at the target surface by capacitive action, since the capacity between the backplate and front surface of the target is generally large compared with the capacity of the front surface to the other tube electrodes.

¹¹Actually, in this type of writing, a barrier grid (which is the effective collector) is usually provided near the storage surface, in addition to a collector cylinder such as electrode G as shown in Fig. 1. The signal is then applied either to the backplate or barrier grid (see, for example, Part IV-C). Since modulation of the effective collector (barrier grid) causes corresponding shifts in the potential difference V_k between the cathode and effective collector, shifting of the equilibrium potential must be taken into account when V_k exceeds V_{cr2} .

¹²If the target surface is composed of photoemissive elements, writing may be accomplished by scanning the target with a light beam instead of an electron beam while modulating the backplate (or barrier grid collector). In this case, as discussed in Part I-G, the target elements will tend to shift to a photoemission equilibrium level a few volts positive with respect to the collector. The target potential V_{ft} with respect to the collector may then be varied only in the negative direction by the input signal, since the photoemission process can shift the target elements only in the positive direction.

¹³In operation it may not always be possible or practical to provide sufficient beam current to shift each target element completely to the equilibrium potential. This difficulty is increased by the fact that, as the target elements approach the equilibrium potential, δ_c approaches unity (see Fig. 6), and the rate of potential shift of the target elements is slowed. In practice, however, the target elements can acquire potentials which are a substantial fraction of the input signals.

pletely mask the charge pattern intended to be stored (Ref. 37). As indicated in Part III-A-4, the redistribution effect, although undesirable for equilibrium writing, can be employed as the basis for a different type of writing, namely, redistribution writing.

2. Bistable Writing with the Aid of a Holding Beam

When the individual target elements are not required to assume more than two possible potentials (yes-and-no or black-and-white operation) and the reading duration and retention time are required to be very long, writing may be accomplished by means of a writing beam and an auxiliary holding beam. The holding-beam action is based on the fact that, if the cathode of this beam is operated at a potential greater than V_{cr1} with respect to collector (see Fig. 4), a target element bombarded by this beam will shift to an equilibrium potential either on the portion of the equilibrium curve c-d-e, or to a point on the dashed line b-c'. The particular potential which a target element assumes will depend on the potential it first acquires as a result of bombardment by the writing beam.

If, as a result of the writing-beam action alone, the target element acquires a potential with respect to the holding beam such that it falls on a point above the line $V_{pr} = V_{cr1}$ of Fig. 4, subsequent bombardment by the holding beam will shift it to the line c-d-e, whereas, if the target element acquires a potential such that it falls below the line $V_{pr} = V_{cr1}$, the holding beam will shift it to the dashed line¹⁴ b-c'. Bistable writing may also be accomplished if a particular element is simultaneously bombarded by the writing beam and the holding beam. In this case, the writing-beam current must be sufficiently large compared to the holding-beam current so that the potential shift produced by the writing beam predominates.

If, as a result of the writing-beam and holding-beam action, all the target elements have been shifted to one or the other of the two equilibrium potentials, subsequent shifts in the potentials of the elements, due to leakage or removal of a

¹⁴In practice, the holding beam may either scan the target elements sequentially or flood them simultaneously. It may also bombard the target either during the time of scanning by the writing beam or after.

fraction of the charge by reading, may be restored. This is accomplished by the secondary-emission action of the holding beam, which tends to shift the target elements to the initial equilibrium potentials existing before the leakage or reading action. The ability of the holding beam to provide indefinitely long reading time under proper conditions is of considerable practical value, making this type of writing desirable in many cases despite the lack of resolution and the absence of half-tones (Part III-D).

Since the holding beam tends to maintain all the elements of the target at either of two potentials that may differ by approximately 50 volts or more, the gradient across the boundary between elements of different potential will be correspondingly high and leakage will occur through the target. In general, for such high gradients the potential boundaries will tend to shift under the action of the holding beam, especially if the target surface is homogeneous. These boundary shifts will manifest themselves by a continuous growth of the areas at holding-gun cathode potential at the expense of the areas at approximately collector potential, or vice versa.

The shifting of the potential boundaries can be reduced or prevented by employing a target whose surface is covered with a mosaic of conducting particles or islands which are sufficiently small so that each storage element includes a number of these particles. In this case, the potentials assumed by the individual particles in writing will tend to remain unchanged by leakage to the surrounding areas, since the leakage currents to the edge of a particle will be replenished by the secondary-emission action of the holding beam over the entire area of the conducting particle. In the case of a homogeneous target without a mosaic, however, any leakage current across a potential boundary can only be compensated for by the action of the holding beam at the actual boundary itself, since the target insulation prevents the flow of currents to the boundary from adjacent areas which are also under the holding beam.

3. Nonequilibrium Writing

This type of writing, accomplished either by secondary-emission or photoemission action, involves two steps: (a) adjusting the electrode potentials so that the point of operation on Fig. 4 is shifted off the secondary-emission equilibrium

curve or a photoemission equilibrium level (depending on which of these processes is employed for writing); and (b) allowing each element to shift a controlled amount by secondary emission or photoemission toward the equilibrium level in accordance with the input signal.

If secondary-emission action is employed, step (a), shifting off the equilibrium curve, is achieved by either changing V_{ft} , i.e., shifting the backplate or collector potential, or shifting the potential of the cathode V_k , making use of either of the sloping portions of the equilibrium curve. For step (b), the primary current striking each target element is modulated by the input signal so that each element is allowed to shift toward the equilibrium potential by a controlled amount. In practice, modulation of the primary current may be accomplished in several ways. If the target is scanned by the writing beam, the primary current striking the individual elements may be modulated by applying signal voltage variations to the primary-current control grid, assuming the scanning velocity to be constant; or the input signal may be applied to the deflection circuits so that the instantaneous rate of scanning of the target elements varies in accordance with the signal, thus causing variations in the time of bombardment of the successive elements by the constant-current beam (Refs. 50, 95). For the nonscanning case, step (b) may be accomplished by allowing an extended pattern of primary currents to fall on the target surface, such as from an image photosurface (e.g., as in the Image Orthicon, Part VII-B-2).

If photoemission action is employed for writing, shifting off the equilibrium level, step (a), is similarly accomplished by changing the potential V_{ft} of the target surface with respect to the collector, i.e., shifting either the backplate or collector potential. Since, as mentioned in Part I-G, the elements can only charge positive by photoemission, the potential shift of step (a) must be in the direction such that the target surface is made negative with respect to the collector. Step (b) is then achieved by allowing a controlled amount of light to strike each target element so that its potential shifts by a corresponding amount toward the equilibrium level. The light striking the elements may be in the form of a pattern or picture focused on the surface of the target (e.g., as in the Orthicon, Part VII-A-2), or it may be in the form of a modulated beam which scans the element sequentially.

Although not usual, nonequilibrium writing may also be accomplished by scanning the target with an unmodulated electron beam of low current under the condition $\delta_e > 1$ and applying the input signals to the backplate (Ref. 46). In this case the input signal voltages, assumed to be small, cause the potential of the target surface to acquire instantaneous values along the sloping portion B-C-D of the δ_c curve of Fig. 6. Because of the very low primary current, each element will not be shifted to the equilibrium potential V_{eq} when bombarded, but will acquire or lose a net amount of electrons proportional to the variations in δ_c from its equilibrium value of unity.

4. Redistribution Writing

For targets which do not have a barrier grid, redistribution generally interferes with the writing process (see Part I-J). However, redistribution can also be usefully employed for writing. If the target surface is approximately at collector potential, such writing can be accomplished by (1) bombarding the target elements with primary electrons from a cathode whose potential is between V_{cr1} and V_{cr2} or (2) illuminating them with light if the elements are photoemissive.

In case 1, the bombarded elements tend to lose electrons by secondary emission, since the bombardment is under the condition $\delta_e > 1$. However, because of the lack of accelerating field between target and collector, a large fraction of the secondary electrons will return to other target elements by redistribution (see Part I-J). If a controlled amount of primary current is allowed to strike each element (as, for example, when the writing beam consists of a pattern of currents from an extended photocathode), the net effects of the secondary emission and redistribution will be to cause the elements bombarded with the greatest amount of current to charge most positive and the elements bombarded with less current to be shifted less positive or possibly negative (see, e.g., Refs. 72, 77).

In case 2, where the target elements are photoemissive (Ref. 94), redistribution writing may be accomplished by focusing a pattern of light on the target surface. Although the illuminated elements tend to lose electrons by photoemission, a large fraction of the photoelectrons will be returned to other target elements by redistribution, as in the case of secondary

emission because of the lack of an accelerating field. In similar manner the net effect of photoemission and redistribution will cause those elements receiving the most light to charge most positive and those elements receiving less light to charge less positive or possibly negative.

In general the magnitude of the potential variations established on the target surface by redistribution writing is relatively small, not exceeding a few volts. On the one hand the maximum positive potential of the elements is set by either the secondary-emission equilibrium potential or the photoemission equilibrium potential, both of which are only a few volts positive with respect to the collector; on the other hand, the minimum potential is set by the redistribution level which is only a few volts negative.

Redistribution writing may also be accomplished by scanning the target elements sequentially with a modulated primary beam or light beam. In one form of such writing (Part VI-A), writing is performed by modulating the primary current with a dot and dash signal, thus producing a corresponding redistribution charge pattern.

5. Induced-Conductivity Writing

(Electron Bombardment or Light)

Before writing by this method, it is assumed that the target surface is shifted to a common equilibrium potential (usually collector potential), while the backplate is maintained at a voltage different from the equilibrium potential. As a result, a uniform potential difference will exist between the front and back surfaces of the insulating target and each of the elementary target condensers will be equally charged.

Writing may now be accomplished by causing the conductivity of each target element to increase by a controlled amount so that the front surface of the target will shift to varying degrees toward the backplate potential. The conductivity of the target elements can be controlled by either of the two methods that follow.

- a. Bombardment-Conductivity Writing. If the target is thin (approximately 0.5 micron) and a high-velocity writing beam is used (10,000 volts, for example), primary electrons will penetrate the insulating target, causing bombardment conductivity at the corresponding elements (see

Part I-I). By controlling the number of primary electrons striking each element (either by scanning the target with a current-modulated primary beam or by focusing an extended pattern of primary currents on the target from an auxiliary photoemitting surface), a pattern of charges or potential variations can be established on the target surface.

- b. Photoconductivity Writing. If the target is composed of a thin layer of photoconductive material, incident light on the surface will cause the conductivity to increase at the elements which are illuminated (see Part I-H). By controlling the amount of incident light at each element (such as by focusing an optical image on the surface), a pattern of charges or potential variations can also be established on the target surface.

6. Methods of Applying the Input Signals During Writing

In practice, writing is accomplished by modulation of the control-grid voltage, deflection voltage or current, cathode voltage, collector voltage, backplate voltage, or modulation of the light falling on the target if it is photoemissive or photoconductive. These types of modulation are illustrated in Fig. 9 where a single-beam charge-controlled storage tube with its basic elements is shown.

The following types of modulation are thus possible for writing:

- a. Primary-current modulation
- b. Scanning-velocity modulation
- c. Cathode-voltage modulation¹⁵
- d. Collector-voltage modulation
- e. Backplate-voltage modulation
- f. Light-intensity modulation

It should be noted that, whereas the modulations of a, b, and f regulate charging of the target elements by control of the number of incident primary electrons or photons, the

¹⁵Since by definition, cathode-voltage modulation is meant to exclude simultaneous primary-current control-grid modulation, a coupling condenser, indicated in dashed lines between the cathode and control grid of Fig. 9, may be employed when cathode modulation is used.

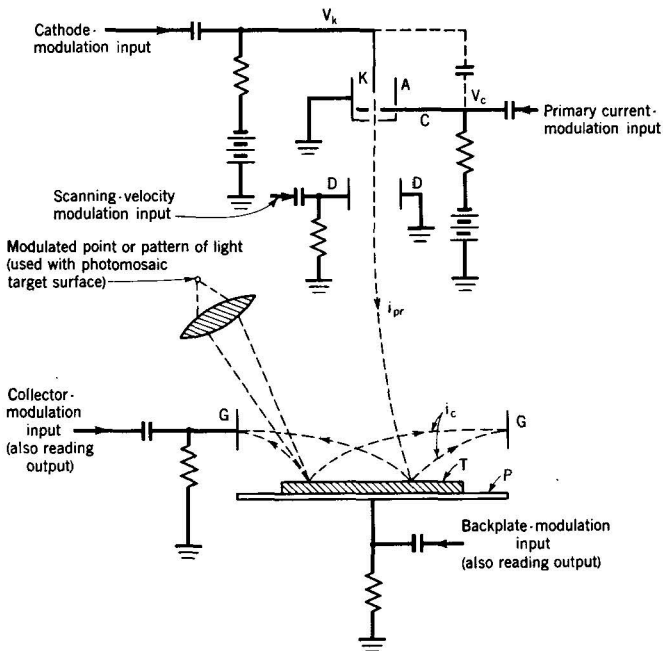

Fig. 9. Methods of applying input signals to a storage tube.

A, accelerating anode; C, control grid; D, deflection plates; G, collector; i_c , collected current; i_{pr} , primary current; K, cathode; P, backplate; T, target; V_c , control-grid bias voltage; V_k , cathode bias voltage.

modulations of d and e regulate charging of the target elements by control of the number of secondary electrons leaving the target as a result of controlling the field between target surface and collector. The modulation of c regulates charging by changing the secondary-emission ratio δ_e (operation above the second crossover potential V_{cr2}), or the reflection of primary electrons (operation below the first crossover potential V_{cr1}).

B. READING METHODS

The process of reading is basically one of obtaining output currents corresponding to the charge stored in writing on each of the target elements. In general, three methods may be employed for reading as described below.

1. Capacity-Discharge Reading

This method of reading is based on the fact that each target element, between its front and back surface, is a miniature condenser. As indicated in Fig. 10, the target is shown divided by the dashed lines into its effective capacitive elements (each of which is approximately equal in area to the cross section of the primary beam).

If, in the writing process, a charge pattern was established on the front surface of the target elements, the corresponding elementary condensers will be charged to varying degrees. In reading, these elements are scanned by an unmodulated pri-

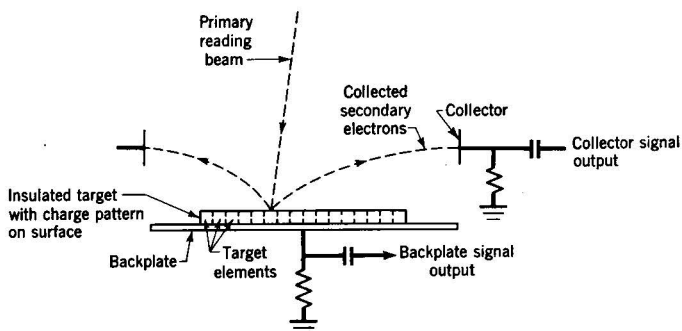

Fig. 10. Capacity-discharge reading system.

mary beam so that they tend to shift toward the equilibrium potential V_{eq} when bombarded. The amount of potential shift each element undergoes will depend on the beam current and the value of δ_C for each element. As a result of scanning by the reading beam, capacity-discharge currents corresponding to the potential shifts of the target elements will be produced in the backplate¹⁶ circuit. At the same time, current variations of opposite polarity will result in the collector circuit, since the instantaneous collected current i_C is equal to the difference between the primary current (which is unmodu-

¹⁶ Capacity-discharge reading systems sometimes do not employ a backplate (such as indicated in Fig. 9). An example of this is the Image Orthicon, where the writing beam establishes the charge pattern on one side of the insulating target and the reading beam capacitively "neutralizes" these charges from the opposite side. In such an arrangement the reading signal is obtained from the collector-current variations.

lated) and the instantaneous capacitive target current. By inserting a resistor either between the backplate or collector and ground, output voltage variations may be obtained corresponding to the initial input writing signal.

In capacity-discharge reading, the beam current may be sufficient to shift each of the target elements to the equilibrium potential in a single scan, or it may be set at a smaller value so that the elements are shifted only a portion of the way toward equilibrium in one scan. In the latter case an output signal can be obtained for a number of scans (copies) before all the elements are shifted to the equilibrium potential. (The choice of reading-beam current will also affect the generation of halftones, as discussed in Part III-D. For example, sufficient beam current to discharge the target elements in one scan will produce linear halftones, whereas lower beam currents will produce nonlinear or no halftones.)

In general, the beam current needed in reading to shift the target elements the required amount toward the equilibrium potential depends on the capacity of the individual target elements. This capacity will similarly determine the amount of beam current required in writing. For a given insulating material, the target thickness is usually in the range of 0.5 to 100 microns, depending on the required target capacity. The choice of target capacity is based on a number of factors. If, for example, large output currents are required in reading, it is necessary to have a high-capacity target for storing large quantities of charge. If the charge pattern is established by equilibrium writing with backplate-voltage modulation, it is desirable that the loading of the target on the input amplifier be small, necessitating a small capacity between backplate and barrier grid, i.e., a thick target. If bombardment-induced conductivity is used for writing, the target must be sufficiently thin (approximately 1 micron or less) to allow penetration by the primary beam, resulting in a relatively high target capacity.

In capacity-discharge reading as described above it is assumed that no redistribution effects are present (see Part I-J).¹⁷ If redistribution exists, it will reduce the magnitude

¹⁷Although undesirable in capacity-discharge reading, the redistribution effect plays a definite role in producing the output signal as described below under redistribution reading.

as well as cause distortion of the output signal. Redistribution effects may be prevented by employing a barrier grid such as indicated in Fig. 8b. If a barrier grid is not used, redistribution may also be prevented by applying a potential shift to the backplate or collector so that the target element potentials are all substantially negative with respect to the collector and by not allowing the elements to shift positive to a point close to the collector potential in reading. By such means the accelerating field at each target element can be made sufficiently strong to prevent redistribution.

2. Redistribution Reading

This type of reading is usually carried out while the input signals are applied simultaneously to the target by redistribution writing, as, for example, in the Iconoscope. The target-potential variations established in writing are small and are in the neighborhood of the collector potential. As in capacity-discharge reading, the target is scanned by the unmodulated reading beam under the condition $\delta_e > 1$, and the output signal is obtained from the backplate or collector electrode.

In order to explain the generation of the output signal, it is convenient to consider first the target during scanning by the reading beam before writing signals have been applied. During this scanning, each target element will periodically undergo a positive shift at the moment of bombardment and gradually shift negative by an equal and opposite amount as it acquires redistribution electrons between successive times of bombardment. A typical curve of the potential of a target element with time is indicated by the solid line a-b-c-d in Fig. 11a. Since the reading-beam current is usually low in such writing (a fraction of a microampere, for example) the target elements will generally not be shifted sufficiently positive to reach the equilibrium potential V_{eq} when bombarded.

If now, during scanning by the reading beam, potential variations caused by redistribution writing (involving photoemission, for example, as in the Iconoscope) are superimposed on the target potentials, the individual elements will have new potentials such as indicated by the dotted lines a'-b'-c'-d' and a''-b''-c''-d'' of Fig. 11a, depending on whether they lost or gained electrons respectively in the writing process. Nevertheless, despite the loss or gain of electrons by an ele-

ment in writing, its positive potential shift when bombarded will be approximately the same, i.e., the lines $b-c$, $b'-c'$, and $b''-c''$ are approximately equal in Fig. 11a (Ref. 37).

During bombardment of each element by the reading beam, a large fraction of the secondary electrons will return to the target surface as a whole by redistribution. However, the number of electrons which escape to the collector will depend on the potential of the element under bombardment (Ref. 37). For example, if the element had acquired a slightly positive charge in writing, such as indicated by the line $a'-b'-c'-d'$ of Fig. 11a, fewer secondaries would reach the collector and more redistribution electrons return to the target as a whole when the element was bombarded. The opposite would be the case if the element had acquired a negative charge such as indicated by the line $a''-b''-c''-d''$. (Since the potential variations of the target are assumed to be very small, each element can be considered to have the same value of δ_e .) As a result of scanning by the reading beam, collector current and capacitive current variations through the target will arise because of potential variations such as $b-b'$ (Fig. 11a) on successive target elements, thus producing an output signal at either of the two electrodes.

The curves of Fig. 11a assume that the writing signal (light pattern) is maintained continuously during reading and that the primary current is low. If the writing signal is not maintained, the continuous landing of redistribution electrons on all the elements will gradually reduce the potential differences. In practice, a reading signal may be obtained for several scans after the writing signal has been cut off.

If higher beam currents are employed in reading, each element will be shifted to the equilibrium potential V_{eq} when bombarded, as in capacity-discharge reading, regardless of the potential variations acquired in writing. This condition is indicated in Fig. 11b, where the solid line $a-b-c-d$ indicates the potential with respect to time of an element before writing, and the dotted lines $a-b'-c'-d'$ and $a-b''-c''-d''$ represent the potentials of elements which acquire positive and negative charges respectively under continuous writing action.

3. Grid-Control Reading

In this type of reading the local electrostatic fields at the target, produced by the charges established in writing, control

(a) the amount of reading-beam current passing through target holes, (b) the currents emitted from the target surface, or (c) the deflection of primary electrons as they are being reflected at the target surface. In all these cases the modulation of the reading beam is not dependent on the landing of reading electrons on the insulated target elements as in capacity-discharge or redistribution reading. Although limited by target

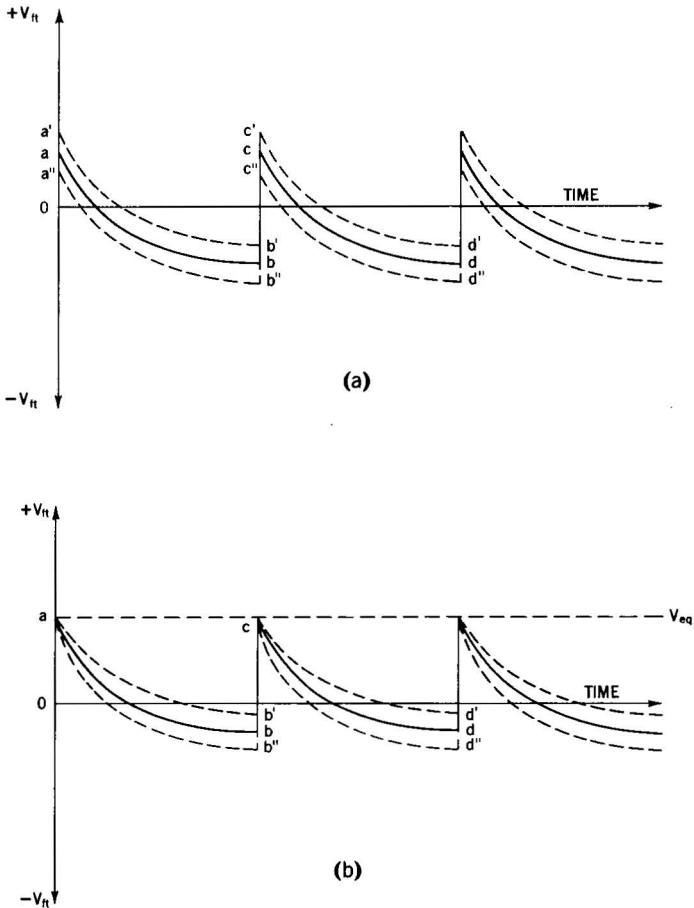

Fig. 11. Instantaneous target-element potentials, V_{ft} , as a result of redistribution reading.

- (a). Scanning with low-beam current.
- (b). Scanning with high-beam current.

leakage and the landing of ions, grid-control reading is thus suitable for reading where output signals are required for relatively long periods of time.

Grid-control reading can be accomplished either by scanning the target with a focused beam or by flooding all the elements with electrons or light. For the production of time-varying output signals the target elements are scanned, whereas for the production of a visual picture the target is either scanned or flooded with the reading beam and the resulting pattern of reading currents made visible on a phosphor surface.

The three different methods of grid-control reading are described below.

a. Transmission Modulation. In this reading method the target is constructed of a metal mesh or perforated conducting plate with insulating material surrounding the holes on either the reading gun side (Fig. 12a and Ref. 52a) or the opposite surface (Ref. 49). From previous writing, a pattern of charges is assumed to have been established on the insulating elements, producing corresponding electrostatic fields in the neighborhood of the target holes. In the reading operation, the potential of the reading-gun cathode is adjusted so that the reading-beam electrons have low velocity as they approach the target surface. The electrostatic fields produced by the stored charges are thus able to control, by coplanar grid action, the number of electrons penetrating each target hole and the corresponding number reflected. The resulting variations in the reading-beam currents which emerge from the target holes constitute the output signal. This form of reading is generally accomplished with the insulating elements sufficiently negative so that none of the reading-beam electrons are able to land on them. (See Parts IV-A-2 and V-B for examples of this type of reading.)

b. Emission Modulation. In this method (Refs. 42, 52, 57), the reading-beam currents originate at conducting elements on the target surface as a result of photoemission (see Fig. 12b), thermal emission, or secondary emission. Between the conducting elements on the target surface are insulated elements assumed to be charged from previous writing. As in transmission modulation, the stored charges produce local electrostatic fields at the target surface which, in this case, control the number of electrons leaving the individual con-

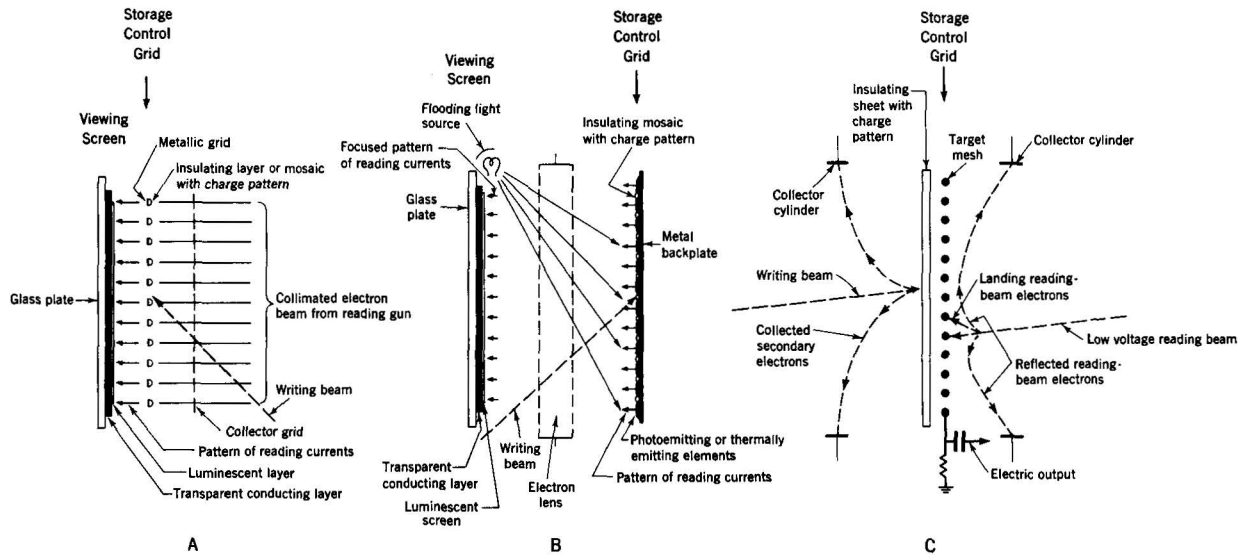

Fig. 12. Grid-control reading systems.

A, transmission modulation (visual output). B, emission modulation (visual output). C, reflection modulation (electrical output).

ducting elements of the target. The insulated elements here also are charged to potentials negative with respect to the conducting area of the target so that none of the emitted electrons are able to land on them. (See Parts V-A-1-a, V-A-1-b, and VII-B-4.)

c. Reflection Modulation. In one form of such reading (see Fig. 12c) a thin insulating target is provided with a close-spaced metallic mesh on one side, and a charge pattern is established by the writing gun on the opposite side. The cathode potential of the reading gun is adjusted so that primary electrons approach a given element on the mesh side of the target with very low velocity. The insulating elements are sufficiently negative, with respect to the target mesh, that the reading-beam electrons are unable to land on them. The reading electrons are thus either deflected to the target mesh, or partially or wholly reflected back to the collector, depending on the amount of negative charge stored on the back side of the corresponding target element. By scanning the target with the reading beam, time-varying output currents to the target mesh are produced (and also opposite polarity current variations to the collector mesh) in accordance with the stored charge pattern (Ref. 90).

In another form of reflection modulation, without a target mesh (Part VII-B-3), all the reading-beam electrons are reflected at the target surface and directed back to the reading gun, where a special collector is provided. Because of the variations in the deflection of the reading beam at the target as it undergoes reflection, the trajectories of the returning electrons are correspondingly modulated. These variations in the trajectories in turn cause variations in the number of electrons landing on the special collector as successive target elements are scanned.

C. ERASING AND DECAY

The removal of a stored charge pattern may be accomplished in two ways: either allowing the charges to decay as a result of leakage of the insulated target elements; or by erasing them as, for example, by secondary-emission action. When capacity-discharge reading systems are employed, erasing by secondary-emission action is always involved during reading, since the output signals are obtained from the

discharge of the target elements themselves. At the same time, decay of the stored charges may also be a factor assisting in the charge removal.

When grid-control reading systems are employed, the reading process, as such, generally does not erase the stored charges by secondary-emission action. In this case, the decay of the charges by leakage and gas ions are the only erasing actions during the reading process. If the decay in this case is not sufficiently rapid or uniform, it is necessary to resort to secondary-emission action to assist in removing the charges. It is also frequently possible to erase a charge pattern by writing over it if equilibrium writing is employed, since in such writing the target elements will shift to the new potentials regardless of their previous charge.¹⁸ It is understood, of course, that all the previously charged elements must be rescanned if erasure of the entire pattern is to be accomplished.

The decay time is determined in general by the leakage of the target material and the number of gas ions in the tube. Except insofar as these two conditions can be varied by factors such as the temperature of the insulating target or the residual pressure of the storage tube respectively, the decay time is fixed. The erasing time, however, may be varied within limits, by adjusting the current of the erasing beam or its cathode voltage. In a capacity-discharge reading system where reading and erasing are carried on simultaneously, such current adjustment will control the reading time as well (since the reading time is approximately equal to the erasing time) and also the magnitude of the output signal.

D. HALFTONES

In general, if the output signal or reading current corresponding to a particular element is continuously variable as a function of the input voltage or writing signal over a substan-

¹⁸This is generally true except for the case of equilibrium writing by cathode modulation where the direct-current potential of the writing beam cathode is less than V_{cr1} . Here, since the target elements assume potentials equal to the writing-beam cathode, rewriting can only be accomplished if an element is to be shifted to a new potential which is more negative. If the instantaneous potential of the writing-beam cathode is made more positive than the existing potential on an element, primary electrons will be unable to land on that element.

tial range, it is possible to employ a storage tube for halftone signals. Whether or not the halftones in the output are linear with respect to those in the input will depend on (a) the linearity with respect to the input signal of the charge stored during writing on each element, and (b) the linearity of the output current from a particular element with respect to the charge stored on that element. These two factors will be discussed below as "Halftone Writing" and "Halftone Reading" for the various writing and reading methods.

1. Halftone Writing

a. Equilibrium Writing. In this type of writing, the target element potentials can be varied over a continuous range by potentials applied to either the cathode, backplate, or collector, thus resulting in a halftone charge pattern. When the input signals are applied to the backplate or collector the target elements will acquire potentials approximately equal in magnitude to the input signals, so that the halftones will be linear. When the input signals are applied to the cathode, the target elements will be shifted along either the sloping portion a-b or d-e of the equilibrium curve of Fig. 3. Since the line a-b is straight, as is the line d-e with the exception of the curved part near d (see Footnote 3, page 4), the target elements will, in this case, generally acquire linear halftones.

Equilibrium writing is in some respects to be preferred for the production of linear halftones in that it is to a considerable degree independent of parameters which in other types of writing must be more carefully controlled, such as the linearity of beam current as a function of input voltage or the uniformity of scanning speed when nonequilibrium writing is employed.

b. Bistable Writing. This type of writing, by its mechanism, is intended to give the individual target elements one of two equilibrium potentials. However, methods for retaining halftone information by means of bistable writing have not been published.

c. Nonequilibrium Writing. Since in this type of writing the degree of potential shift of a target element is controlled over a continuous range by the magnitude of the input signal, a halftone charge pattern can be established. The degree of halftone linearity, however, will depend (assuming that the number of primary electrons or light quanta striking each

target element is proportional to the input signal voltage) on whether the charging of the target element is proportional to the number of primary electrons or light quanta.

In particular, if writing is accomplished with a modulated electron beam, the production of linear halftones requires that the collected current ratio δ_c from each element remain relatively unchanged during the charging of each element in writing. This can be accomplished if, first, the target surface has a potential before writing which falls on a flat portion of the δ_c curve of Fig. 6 such as to the left of point A or on part F-G; and, second, the potential shifts of the elements do not carry them to sloping portions of the curve such as near points B and D where δ_c varies rapidly with target potential. For producing linear halftones when V_{ft} is positive, it is assumed that redistribution is avoided by the use of a barrier grid at the target surface.

If modulated light is employed for writing, linearity of halftones requires that the storage elements always be maintained sufficiently negative with respect to the collector so that all the emitted photoelectrons reach the collector.

If the writing is accomplished by backplate modulation, a linear halftone charge pattern can be established provided, first, a very low beam current is used so that none of the elements are shifted to the equilibrium potential V_{eq} when bombarded; and, second, the input signals are maintained sufficiently small so that the target surface potential variations occur on the relatively linear portion of the δ_c curve of Fig. 6 near point C.

d. Redistribution Writing. This type of writing is capable of producing halftones, but, because of the relatively small potential variations possible in such writing (see Part III-A-4), the halftone range is correspondingly small. In practice, if small writing signals are applied, halftone picture signals can be produced which are relatively linear (see Part VII-A-1).

e. Induced-Conductivity Writing. Since the degree of induced conductivity can be controlled by the amount of primary current or incident light, a halftone charge pattern can be established in this type of writing. Although the induced conductivity is a more or less linear function of primary current or light, assuming small values, the discharge of the target elements is an exponential function, $e^{-k\sigma}$, of the induced conduc-

tivity σ (the bombarding time and capacity of all elements being equal). The degree of halftone linearity will therefore depend on how small a portion of the exponential curve is used; i.e., the variations in the induced conductivity σ should be small, restricting the writing to small signals.

2. Reading Halftones

a. Capacity-Discharge Reading. This type of reading may be accomplished either with the reading-beam current (1) sufficiently large so that all the stored-potential variations are removed in a single scan, or (2) the reading-beam current sufficiently small so that output signals are obtained for a number of successive scans.

If reading is accomplished under the first condition, the current variations in the collector or backplate circuits will be linearly related to the magnitude of the stored charge, since variations in the rate of removal of the charges constitute the output-current variations.

If reading is accomplished under the second condition, the production of halftones will depend on which portion of the δ_c curve of Fig. 6 the target potentials fall. If the target elements are charged to potentials which fall near the upper portion of the curve, such as near point A, the collected current i_c will be essentially constant over a considerable range of variations of V_{ft} and, as a result, the output will be largely a black-and-white signal with relatively small amounts of halftones. Similarly, potential variations which fall on the curve near point F, where δ_c is also relatively constant, will produce almost entirely black-and-white output signals.

If, however, the target-potential variations fall on the sloping portion B-C-D of the δ_c curve, variations in the target-element potentials will cause corresponding variations in the output current so that halftones will appear in reading. For potential variations close to point C, where the values of V_{ft} are small, an essentially linear halftone output can be obtained, since the δ_c curve is most linear at this point.

For example, in the Graphechon (Ref. 54), halftones can be produced if the potential V_{ft} is less than 10 volts with respect to V_{eq} . For more negative potentials of V_{ft} , black-and-white output signals are produced.

Because of the gradually changing slope of the curve as it approaches the point $V_{ft} = 0$, target elements initially on the

flat portions (to the left of point A and to the right of point D) will, after partial discharge in reading with a low-beam current, shift to the more sloping portion B-C-D, thus producing halftones during later scans toward the end of their discharge.

b. Redistribution Reading. This type of reading is capable of producing halftone output signals which are linear. If very low beam currents are used so that the elements when bombarded do not reach the equilibrium potential V_{eq} , the output will be linear, since the amount of current i_c escaping to the collector from a particular element is essentially linear as a function of the target potential (Ref. 37). If higher beam currents are employed, so that each target element is shifted to the equilibrium potential V_{eq} in a single scan, the output will also be linear, since it will be proportional to the amount of charge gained or lost by each element.

c. Grid-Control Reading. This type of reading, depending on a negative grid control by means of the charged elements, is generally capable of providing halftones, since the output-signal current is continuously variable as a function of the potential of the control elements. The actual shape of the curve of output current versus potential on the storage elements will be a function of the geometry of the target and collector system so that the degree of linearity of halftones in reading and the range of target element potentials for such operation will be determined by these factors.

d. Combination of Writing and Reading Methods. Summarizing the above discussion of halftones, under proper operating conditions any one of the writing methods, with the exception of bistable writing, may be employed for establishing a halftone charge pattern. Similarly, any one of the reading methods may be employed for obtaining a halftone output signal, with the exception of the capacity-discharge method, when the target element potentials fall on the flat portions of the δ_c curve and each element is not completely discharged in a single scan. If long reading time with halftones is required, a grid-control reading method must be employed.

PART IV

SIGNAL-CONVERTER STORAGE TUBES (ELECTRICAL-ELECTRICAL)

A. PRIMARY-CURRENT-MODULATION TYPES

1. Nonequilibrium Writing—Capacity-Discharge Reading (Krawinkel, Kronjäger, and Salow, Ref. 53)

Description (Fig. 13). This tube employs one electron gun, a target constructed of a metal backplate covered with a thin insulating layer and a collector cylinder. The input signal is applied to the control grid of the electron gun. The output signal is obtained from the backplate as a voltage variation across the output resistor R_0 .

Writing. As a result of the scanning process during previous reading, the surface of the insulating target is assumed to be at approximately the collector potential. For writing, the backplate potential is switched from -50 volts (maintained during reading) to the writing potential of -300 volts. Since the insulating target is very thin, almost all of this -250 -volt change in potential will appear on the front surface of the insulating target because of the high capacity between its front and back surfaces compared with the capacity between the target surface and the collector. The target is now scanned by the writing beam whose current is modulated by the input signal.

As indicated in Fig. 13, the cathode potential is maintained at -1000 volts. Primary electrons will thus strike the target under the condition $\delta_e > 1$. The front surfaces of the bombarded elements will thus shift their potential positive toward that of the grounded collector since an accelerating field exists between target and collector ($\delta_c > 1$). The target surface will thus acquire a positive charge pattern corresponding to the input signal, since the writing signals modulate the primary current striking the individual target elements.

In the above writing process the bombarded storage elements are allowed to charge positively by only a small fraction of the -250 volts potential difference existing between the

front of the storage surface and the collector. This condition prevents loss of resolution by providing an adequate accelerating field at the storage surface for the secondary electrons so that redistribution effects (secondary electrons from a bombarded storage element landing at another storage element instead of at the collector) are reduced.

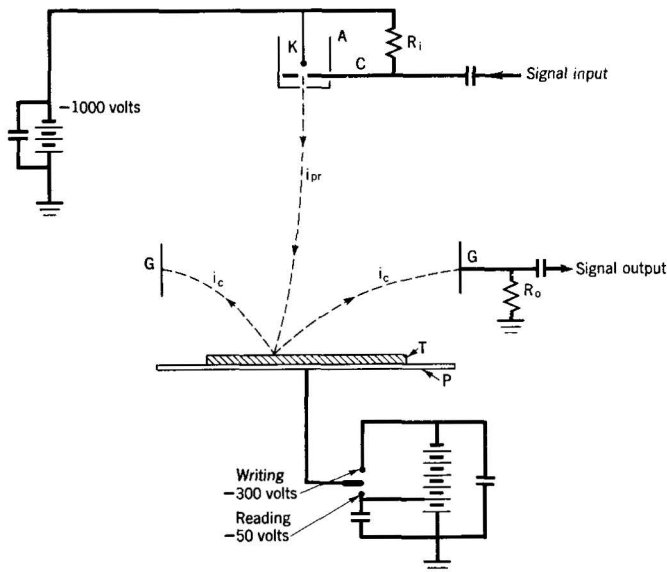

Fig. 13. Signal-converter storage tube (Krawinkel, Kronjäger, and Salow).

A, accelerating anode; C, primary current control grid; G, collector; i_c , collected current; i_{pr} , primary current; K, cathode; P, backplate; R_i , input resistor; R_o , output resistor; T, insulating target.

Reading. For reading, the backplate potential is switched back to -50 volts and the surface is scanned by the unmodulated beam. As a result of writing, the target elements will now have small varying positive potentials with respect to the collector. Although the cathode potential is still maintained at -1000 volts, thus maintaining $\delta_e > 1$, the elements, because of their positive potentials with respect to the collector, will have values of $\delta_c < 1$ so that the action of the primary electrons during reading will be to shift the target-element potentials toward that of the collector. As the target elements

are scanned in the reading process, the variations in δ_c will cause variations in the current reaching the collector and corresponding voltage variations across the output resistor R_o . Since more than one scanning frame (copy) of the storage pattern is usually desired, the primary current is chosen so that the target elements are only partially discharged in a single scan.

Erasing. Since the process of reading as described above acts to remove the stored charge pattern and at the same time shift the target surface toward the equilibrium potential necessary for writing, no erasing procedure is required other than normal reading of several frames.

Polarity and Halftones. The output polarity of this device is positive in the sense that an increasing positive input voltage will cause an increasing positive output voltage from the corresponding storage element. This can be seen from the fact that a positive signal applied to the control grid will increase the primary current, causing a particular target element to undergo a positive shift in potential. During the reading process this target element will acquire a net increase in electrons, thus shifting negative and causing a reduction in the number of secondaries reaching the collector with a consequent positive output.

Since writing is accomplished with the target surface always substantially negative with respect to the collector (points to the left of A, Fig. 6), δ_c is relatively constant and a halftone pattern can be established which is linear with respect to the writing-beam current (see Part III-D-1-c). During reading, the output signals may not be linear since the target potential variations must be of sufficient magnitude to provide a signal of more than one output scan, which in turn requires that the potential variations fall on the nonlinear portion of the δ_c curve of Fig. 6 near point D, for example.

Additional Considerations. As described in Ref. 53, this tube was operated with the potential switching applied to the collector. Also, in actual construction, the storage target was made of a conducting glass with a relatively short decay time to reduce the erasing time for the purpose of frequency conversion in television systems.

2. Nonequilibrium Writing — Grid-Control Reading (Hergenrother and Gardner, Ref. 49)

Description (Fig. 14). This tube employs a storage target, an electron gun mounted at one end of the tube, and a collector-reflector electrode adjacent to the target on the opposite side. The storage target consists of a sheet of fine conducting mesh, S, coated on the side facing the collector-reflector with an insulating material but with the perforations of the mesh kept open. Input signals are applied to the control grid of the electron gun. Output signals are obtained from the collector-reflector electrode as voltage variations across the output resistor R_O . (The output may also be viewed directly as a visual picture, as described in Part V-A-1-c.)

Writing. As a result of scanning during previous erasing, it is assumed that the insulating surface of the target is uniformly charged to -70 volts with respect to the storage mesh. For writing, the cathode is maintained at -1500 volts and the storage mesh S is switched to -1200 volts. Because of the high capacity between the mesh and the surface of the insulating material, the potential of the surface will be -1270 volts, i.e., -70 volts with respect to the mesh. Input signals are now applied to the control grid of the electron gun as the target is scanned by the primary beam. Primary electrons incident at the holes of the storage mesh will pass through them but will be reflected in the space between the collector-reflector electrode and the storage target, since the potential of the collector-reflector, -1800 volts, is more negative than that of the electron-gun cathode. Because of the relatively short distance of travel, the reflected electrons will strike the insulating elements at points very close to the target holes from which they initially emerged. Since the reflected electrons striking the insulating surface will have 230 volts energy, they will bombard the surface under the condition $\delta_e > 1$. The insulated elements will thus tend to charge positive toward the potential of the storage mesh, which in this case acts as the collector. Since the primary current is modulated by the input signal, the amount of positive potential shift of each target element will be controlled as the storage surface is scanned and a pattern of potential variations will be established on the insulator.

Reading. For reading, the collector-reflector electrode

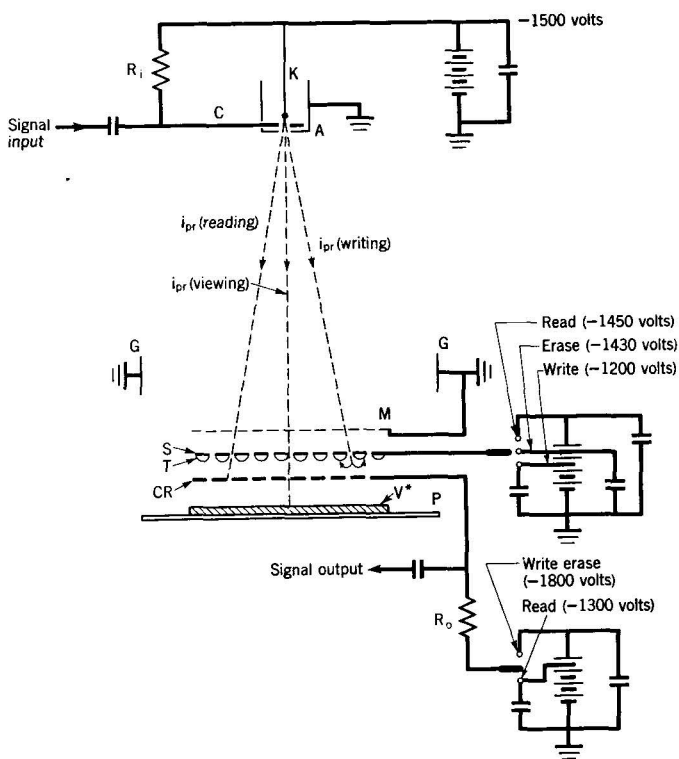

*Used only for visual output (see Part V-A-1-c).

Fig. 14. Signal-converter storage tube (Hergenrother and Gardner).

A, accelerating anode; C, primary current control grid; CR, collector-reflector (open mesh if phosphor V is used); G, collector anode; i_{pr} , primary current; K, cathode; M, anode screen; P, transparent supporting insulator; R_i , input resistor; R_o , output resistor; S, target mesh; T, insulating target coating; V, viewing phosphor.

is switched to -1300 volts, the storage mesh switched to -1450 volts, for example, and the target scanned with the unmodulated primary beam. Under these conditions, the insulating elements will have potentials in the region between -1520 and -1450 volts (those elements uncharged in writing being still -70 volts with respect to the target mesh S and thus below gun-cathode potential, and the charged elements being less negative or above gun-cathode potential). Because of the negative charges on the insulating elements, decelerating fields of varying magnitudes will exist in the space adjacent to the

target on the insulating side. As a result, the number of primary electrons (whose energy at the target mesh is 50 volts), which will penetrate the target holes will depend on the amount of negative charge stored on the corresponding insulating elements. Those electrons which penetrate the target holes will be accelerated to the collector-reflector, producing current variations at this electrode and corresponding voltage variations across the output resistor R_0 as the target is scanned.

Erasing. For erasing, the collector-reflector is switched to -1800 volts, the storage mesh switched to -1430 volts, for example, and the target scanned with the unmodulated primary beam. Under these conditions, it is assumed that the primary electrons (whose energy at the target mesh S is now 70 volts) will have sufficient energy to pass through the holes of the mesh, but, because of the decelerating field in the space between the reflector-collector and the storage surface, they will be reflected, striking the insulating elements. Since it is also assumed that the primary electrons strike the insulating elements under the condition $\delta_e < 1$ because of the low bombarding energy, all the elements will be shifted to the potential of the electron-gun cathode.

Polarity and Halftones. The output polarity of this device is negative in the sense that a more positive input signal voltage causes a more negative output signal voltage from the corresponding storage element. Since the more positive input signals increase the primary current in writing, the corresponding target elements will be charged more positive. As a result, more primary electrons will be capable of passing through the corresponding target holes to the collector-reflector in reading, producing a more negative output across R_0 .

By means of the nonequilibrium writing employed, a half-tone charge pattern can be established in writing. This pattern, in turn, is capable of producing a half-tone output signal because of the grid-control reading method.

Additional Considerations. The decay time of the charge pattern established in writing (reading beam cutoff) may be many hours, controlled by the resistivity of the insulating material used. Although during continuous reading the positive ions generated by the reading beam will gradually diminish the potential of the more negative insulating elements, as

many as 25,000 readings can be made before any substantial reduction in the charge pattern is noted.

In order to obtain a small spot size, the primary beam is accelerated to 1500 volts energy and maintained at this potential in the anode region. To minimize defocusing when the beam is decelerated to the potential of the storage mesh, an anode screen, M, is provided close to the storage mesh so that the decelerating space is very short.

Because of the necessity for switching the potential of the reflector-collector between writing and reading, these two processes cannot be accomplished simultaneously regardless of the fact that only one gun is employed.

In addition to the writing process described above where the conducting storage mesh is maintained above the cathode potential by a value greater than the first crossover potential V_{cr1} of the storage material, writing can also be accomplished by maintaining the storage mesh below V_{cr1} so that the bombarded elements are shifted negative. In this case the output polarity will be positive.

3. Induced-Conductivity Writing

Capacity-Discharge Reading (Graphechon)

(Pensak, Refs. 17, 54, 55)

Description (Fig. 15). This tube employs a writing gun mounted at one end of the tube, a reading gun mounted at the opposite end, a thin insulating target between them, and a collector cylinder surrounding the target. The target consists of a sheet of thin insulating material, such as magnesium fluoride, approximately 0.5 micron thick, evaporated onto one side of a thin aluminum foil which is supported on a fine metallic mesh having a high electron transmission. The writing gun, facing the aluminum-covered side of the target, is operated with a high negative potential so that electrons from it have sufficient energy to pass through the foil, causing induced conductivity in the insulator. The input signal is applied to the control grid of the writing gun. The output signal is obtained from the backplate as a voltage variation across the output resistor R_o . Simultaneous writing and reading can be accomplished by means of the two guns.

Writing. As a result of the scanning process during previous reading, the insulating surface of the target is assumed

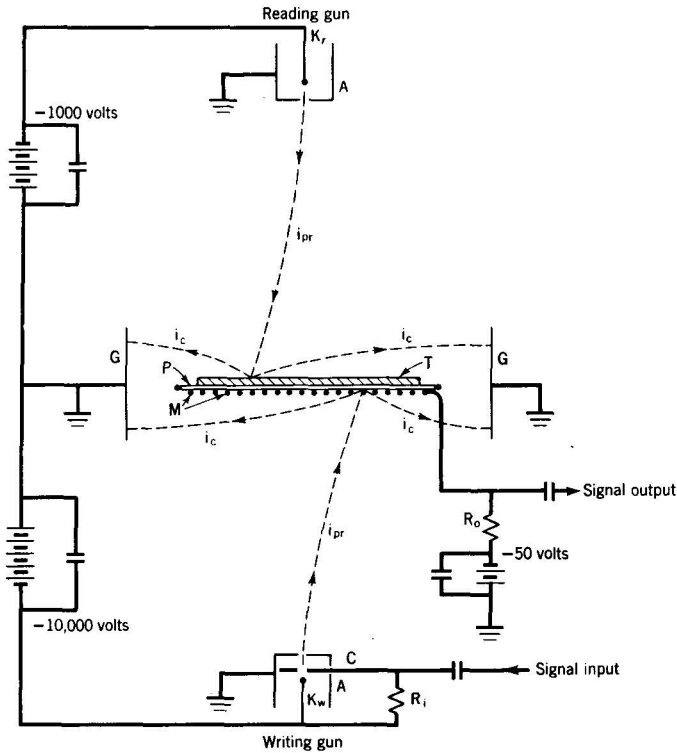

Fig. 15. Signal-converter storage tube (Graphechon).

A, accelerating anodes; C, writing-gun control grid; G, collector; i_c , collected current; i_{pr} , primary current; K_r , reading-gun cathode; K_w , writing-gun cathode; M, target-supporting mesh; P, backplate (aluminum foil); R_i , input resistor; R_o , output resistor; T, insulating target.

to be approximately at collector potential. Since the aluminum foil on the opposite side of the target is always maintained at about -50 volts, a potential difference of 50 volts will have been established between the front surface of the insulating target and the back. Writing is accomplished by scanning the target with the writing beam whose current is modulated by the input signal. Since the cathode potential of the writing gun is sufficiently negative, $-10,000$ volts, for example, primary electrons from the writing beam will penetrate the aluminum foil and the insulating layer. The resulting bombardment-induced conductivity in the insulating target elements will

lower the potential of their front surfaces by varying degrees to that of the -50 -volt aluminum backplate. The front surface of the insulating target will thus acquire a pattern of potential variations between 0 and -50 volts.

Reading. Reading is accomplished by scanning the target surface with the unmodulated reading beam. Since the cathode of the reading gun is operated at approximately -1000 volts, there will be little effects from bombardment-induced conductivity, and all the target elements, by secondary-emission action ($\delta_e > 1$), will shift their potentials acquired during writing toward that of the collector. As the elements are sequentially charged positive during this process, a corresponding capacity current to the backplate will arise, producing a signal voltage across the output resistor R_O . By adjusting the current in the reading beam, the reading time can be varied from a few seconds to about a minute.

Erasing. Since the process of reading as described above acts to remove the stored charge pattern and at the same time bring the target surface to the equilibrium potential necessary for writing, no erasing procedure is required other than normal reading.

Polarity and Halftones. The output polarity of this device is positive in the sense that a more positive input signal voltage will cause a more positive voltage in the output from the corresponding storage element. This follows from the fact that a positive signal applied to the writing-gun control grid will increase the primary current, thus lowering the potential of the target elements by increasing the bombardment-induced conductivity. During reading, the potential of these elements will be shifted positive, thus capacitively producing a positive voltage across the output resistor.

The output signal will contain halftones (assuming that they have been established during writing), only if the target elements have potentials V_{ft} such that the potential difference $V_{ft} - V_{eq}$ is small, for example, between 0 and -10 volts. In this voltage range the target elements will have potentials falling on the sloping portion of the δ_c curve in the range B-C of Fig. 6. As a result, the collected current i_c and also the capacitive current to the output resistor will be more or less proportional to the potential of the target elements. If the elements are more negative with respect to V_{eq} than about -10 volts, they will fall on the relatively flat portion of the

δ_c curve, near point A, so that poor or no halftones will be observed in the output unless the reading-beam current is sufficiently large to bring each element to equilibrium in a single scan.

Additional Considerations. When the tube is employed for simultaneous writing and reading, it is necessary to prevent the writing-beam current modulations from generating a signal directly in the output. This may be accomplished by intensity-modulating the reading beam at a frequency such as 30 megacycles, well above the maximum frequency contained in the input writing signal. As a result, the desired output will be an amplitude-modulated 30-megacycle signal, which can be separated from the lower-frequency components produced by the writing beam and rectified to produce the desired reading signal.

The maximum number of scanning frames (copies) obtainable during reading depends on the magnitude of the voltage variations established on the target during writing and the minimum reading-beam current which may be employed without the amplifier noise becoming appreciable with respect to the output signal. In practice, if the target is scanned in a typical television manner, approximately 1000 copies can be obtained.

4. Bistable Writing—Capacity-Discharge Reading

(“Memory Tube”)
(Haeff, Ref. 48)

Description (Fig. 16). This tube employs a thin insulating target, a writing gun, a reading gun, a holding gun, and a fine-mesh collector grid near the target surface. The input signal is applied to the control grid of the writing gun. The output signal is obtained from the collector grid as a voltage variation across the output resistor R_0 . (The output may also be obtained as a visual picture, as described in Part V-A-3.) With the aid of the holding beam, a pattern of stored charges, once established on the target surface, will be maintained indefinitely despite the removal of a portion of them by reading or leakage. By means of the separate writing and reading guns, simultaneous writing and reading can be accomplished.

Writing. In this device, the writing signal shifts the desired elements from one equilibrium potential to the other,

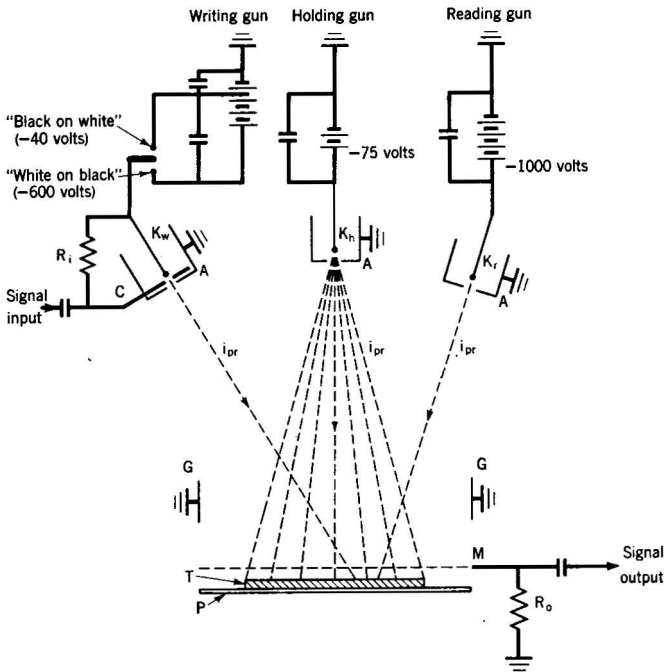

Fig. 16. Signal-converter storage tube (Memory Tube).

A, accelerating anodes; C, writing-gun control grid; G, collector cylinder; i_{pr} , primary current; K_h , holding-gun cathode; K_r , reading-gun cathode; K_w , writing-gun cathode; M, collector grid; P, transparent supporting insulator; R_i , input resistor; R_o , output resistor; T, insulating target (phosphor if used for visual output).

as discussed in Part III-A-2 under Bistable Writing. The charge pattern established in writing may have either one or two polarities. In one form of this writing called "white-on-black" writing, all the elements are initially at the cathode potential of the holding gun, -75 volts, for example, with respect to the collector, and the action of the writing beam together with that of the holding beam is to shift the potential of the desired elements positive to approximately the collector potential. In the other form of this writing, called "black-on-white" writing, all the elements are initially at approximately the collector potential, and the action of the writing beam together with that of the holding beam is to shift the potential of the desired elements negative to the holding-beam cathode potential. In either case the cathode voltage of the holding

beam must be greater than the first crossover potential V_{cr1} (assumed here to be 50 volts) of the target material.

Although, as indicated in Fig. 16, the holding beam is shown as flooding all the target elements simultaneously, the holding action may also be accomplished by scanning the elements during or after writing. However, if the holding and writing beams bombard the target elements simultaneously, it is necessary that the writing-beam current be sufficiently high with respect to the holding-beam current so that in shifting the target-element potentials it can overcome the secondary-emission action of the holding beam.

1. White-on-Black Writing. In this case the writing beam must shift the target elements positive. This is accomplished by operating the writing-gun cathode at a potential such as -600 volts, as indicated in Fig. 16. The target elements, initially at -75 volts, will thus be bombarded by primary electrons with 525 volts energy and charge toward the collector potential, since $\delta_e > 1$. The writing-beam current, however, must be sufficiently large so that, in the scanning time allowed, it will shift the elements positive by an amount greater than V_{cr1} with respect to the holding-gun cathode. If this condition exists, the holding beam will assist the writing beam in shifting the corresponding target elements positive and will maintain them at collector potential after writing (see Part III-A-2). By applying the input signal to the control grid of the electron gun, the desired elements will be shifted positive and a potential pattern will be established on the target surface.
2. Black-on-White Writing. In this case the writing beam must shift the target elements negative. This is accomplished by operating with the writing-gun cathode at a potential of -40 volts, as indicated in Fig. 16. The target elements, initially at approximately collector potential, will thus be bombarded by primary electrons with 40 volts energy and charge toward the cathode potential of the writing gun, since $\delta_e < 1$. The writing-beam current must also in this case be sufficiently high so that in the scanning time allowed it will shift the desired elements negative to a potential less than the amount V_{cr1} above that of the holding-gun cathode. The holding beam will thus assist the writing beam in shifting the corresponding target elements and maintaining them at the holding-gun cathode

potential. By applying the input signal to the control grid of the writing gun as the target is scanned by the writing beam, the desired elements can be shifted negative and a potential pattern can be established on the target surface.

Reading. Since as a result of previous writing the target elements are neither at the cathode potential of the holding gun (-75 volts) or at approximately the collector potential (0 volts), an output reading signal can be obtained by scanning the target with a reading beam whose cathode is sufficiently negative, -1000 volts, for example, so that all the elements will be bombarded by primary electrons with a secondary-emission ratio of $\delta_e > 1$. Under this condition, those target elements at approximately collector potential will have a value of $\delta_c = 1$, whereas those elements at -75 volts will have a value of $\delta_c > 1$. As a result, a signal will be produced across the output resistor R_0 by the current variations to the collector grid. Since the capacity-discharge action of this reading process causes the negatively charged elements to discharge, it is necessary that the reading-beam current be sufficiently small so that none of the negative elements will be shifted positive beyond the point where they have potentials greater than V_{cr1} with respect to the holding-gun cathode. If this occurs, the holding beam will shift the negative elements to collector potential, thus erasing the stored charge pattern.

Erasing. For erasing, all the target elements must be shifted to the common potential assumed before writing, i.e., cathode potential of the holding gun (-75 volts) if "white-on-black" writing is used, or approximately collector potential (0 volts) if "black-on-white" writing is used. For "white-on-black" writing, erasing can be accomplished by flooding or scanning all the target elements with the holding beam but with the cathode potential of the holding gun reduced from its value of -75 volts to a value below V_{cr1} , such as -40 volts. All the target elements at collector potential will now be bombarded with primary electrons such that $\delta_e < 1$ and will shift their potentials to the -40 -volt cathode potential. Shifting the holding-gun cathode once again to -75 volts will now bring the -40 -volt target elements to -75 volts, since they will again be bombarded with primaries under the condition $\delta_e < 1$. Erasing may also be accomplished for "white-on-black" writing by scanning all the target elements with the writing beam but switching the potential of the writing gun to

that employed during writing "black-on-white," since in this condition the elements will be shifted to the cathode potential of the holding gun as desired.

For "black-on-white" writing, erasing can be accomplished by scanning the target elements with the reading beam but with the holding gun cut off. In this case the negative target elements will be shifted to the collector potential by the capacity-discharge action of the reading beam if the reading process is allowed to continue. If desired, erasing can also be accomplished by shifting the potential of the writing-gun cathode to that employed in writing "white-on-black" and scanning the target elements, since this will shift the potential of all the target elements to the collector potential.

Polarity and Halftones. For "white-on-black" writing the output polarity is positive in the sense that a positive signal input voltage causes a positive output voltage from the corresponding storage element. This results from the fact that a positive input signal shifts the corresponding target elements in the positive direction to the collector potential. During reading, these elements have a value of $\delta_c = 1$ while the negative areas have a value of $\delta_c > 1$, so that fewer secondary electrons reach the collector from these elements, producing a corresponding positive output voltage across R_0 . For "black-on-white" writing the output polarity is negative, since the same relationships apply in reading except that a positive signal input voltage shifts the corresponding target elements negative instead of positive.

As discussed in Part III-D-1, a halftone charge pattern cannot be established by the type of writing employed in this tube, and consequently no halftone output signals can be obtained.

Additional Considerations. Since separate writing and reading guns are employed, both the writing and reading operations may be accomplished simultaneously, provided that the secondary currents in the output from the writing action are separated from those generated by the reading action. This can be achieved by the same method employed in the case of the Graphechon tube (Part IV-A-3), by modulating the reading-beam current at a high frequency and separating the signals in the output.

Since the potential of the "black" elements in a stored charge pattern is relatively large (-75 volts as described

above) these target elements may be shifted in potential by substantial amounts during each reading scan and thus produce a large output signal as compared to other signal-converter storage tubes where the potential shift in reading may be only several volts. Since the holding gun beam acts to restore the writing pattern, a relatively large output signal can be obtained continuously.

In operation, the cathode potential of the holding gun must not be made too negative since a correspondingly large potential difference will exist between the "black" elements (at holding-gun-cathode potential) and the "white" elements (at collector potential). If this potential difference is too large, the resulting potential gradients between elements will cause the more positive ("white") areas to spread over the entire target surface.

In general, from the standpoint of resolution, it is desirable to employ "white-on-black" writing, since in this form of writing a higher writing-beam electron velocity is employed, which enables better focusing of the writing beam.

B. CATHODE-VOLTAGE-MODULATION TYPES

Equilibrium Writing—Grid-Control Reading (Knoll and Randmer, Ref. 52)

Description (Fig. 17). This tube employs a two-sided target, a collector cylinder, and a writing gun on one side of the target and a reading gun on the opposite side. The target is constructed of a thin aluminum foil which may be supported by a fine-mesh grid and whose side facing the writing gun is covered with a mosaic of tiny insulating particles such as magnesium oxide. Input signals are applied to the cathode of the writing gun. Output signals are obtained from the aluminum foil (backplate) as voltage variations across the output resistor R_0 . With the aid of separate writing and reading guns, simultaneous writing and reading can be accomplished.

Writing. As a result of the scanning process during previous erasing, the mosaic of insulated particles is assumed to be at approximately the potential of the target foil which is maintained at -100 volts. For writing, the target is scanned by the writing beam while the input signals are applied to the

cathode of the writing gun. Since the direct-current bias of the writing-gun cathode is maintained at -4020 volts and the second crossover potential V_{cr2} of the insulating particles is assumed to be 4000 volts, the bombarded element will shift to an equilibrium potential, V_{eq} , on the sloping portion d-e of the equilibrium curve of Fig. 3 (assuming sufficient beam current). Because of the modulation of the writing-gun-cathode voltage by the input signal, the bombarded target element will

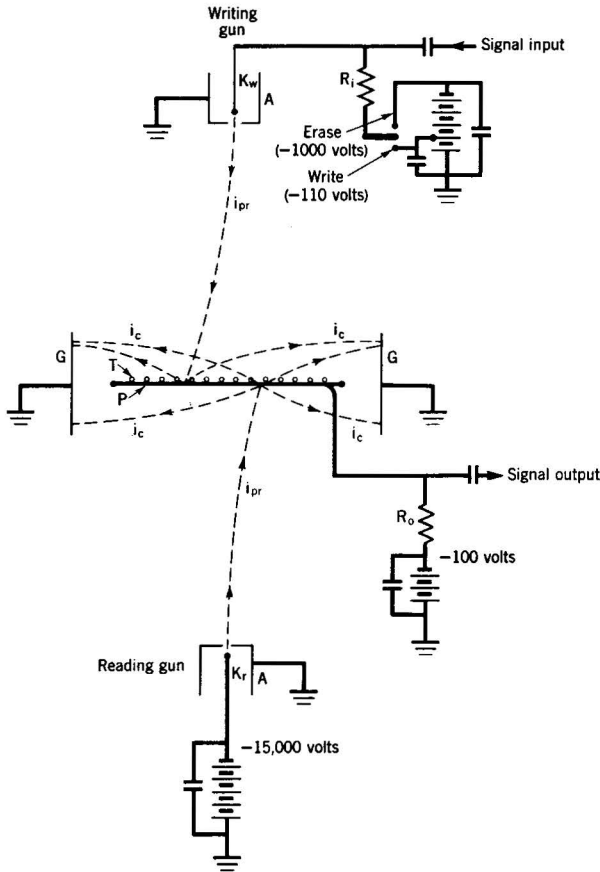

Fig. 17. Signal-converter storage tube (Knoll and Randmer).

A, accelerating anodes; G, collector; i_{pr} , primary current; i_c , collected current; K_r , reading-gun cathode; K_w , writing-gun cathode; P, backplate (aluminum foil); R_i , input resistor; R_o , output resistor; T, insulating mosaic.

thus acquire corresponding variations in potential along the line d-e. These variations, however, will be superimposed on the negative potential which the target element would acquire when scanned in the absence of an input signal. If, for example, the slope of the d-e of Fig. 3 were 45 degrees and it were entirely linear, the pattern of potential variations established in the target in writing would be superimposed on a -20-volt level.

Reading. Reading is accomplished by scanning the target with the unmodulated reading beam. The potential of the reading-gun cathode (-15,000 volts, for example) is assumed to be such that the primary electrons striking the target will have sufficient energy to penetrate almost the entire thickness of the thin aluminum foil. As a result, secondary electrons will be emitted not only from the side of the foil facing the reading gun but also from the opposite side which is covered with the insulating mosaic. The secondary electrons emitted from the mosaic side of the target foil (a large fraction of which have energies less than several volts) must pass between the insulated particles in order to reach the collector. Since the insulated particles are charged to varying degrees negative with respect to the backplate, they act as control grids, creating a decelerating field which varies from element to element over the mosaic side of the target surface. As a result, the value of δ_c of the aluminum-foil secondary-emitting cathode will correspondingly vary as the target is scanned, and voltage variations will be produced across the output resistor R_0 . Since the insulated particles are assumed to be charged negative with respect to the target foil, secondary electrons will, in general, be unable to reach them in the reading process, so that, neglecting leakage and discharge due to positive ions, reading can be continued for an extended period.

Erasing. For erasing, all the insulated elements must be returned to the potential of the target foil. This may be accomplished by scanning the target with the writing beam but with the cathode of the writing gun switched to -1000 volts, for example, so that primary electrons will now bombard the storage elements under the condition $\delta_e > 1$, thus tending to charge them positive. Although in general a homogeneous insulating target would charge to the collector potential, in this case the exposed backplate acts as a collector and maintains

the mosaic particles at the backplate potential. This is due to the fact that any tendency of the insulated elements to become positive with respect to the target foil will be counteracted by secondary electrons from the foil being attracted to the particles and charging them negatively, and the suppression of coplanar grid effect of secondaries leaving the particles.

Polarity and Halftones. The output polarity of this device is positive in the sense that an increasing input voltage will cause an increase in the output voltage from the corresponding storage element. This is explained by the fact that a positive input signal applied to the writing gun will cause the corresponding storage element to shift more positive, allowing more secondary current i_c to leave the target element during reading. As a result, there will be a corresponding increase in the electron current through R_0 to the target foil from ground and the output-signal voltage will be more positive.

Since equilibrium writing is employed, a linear halftone charge pattern can be established during writing, assuming operation is on a linear portion of the line d-e of the equilibrium curve of Fig. 3. In the reading process, the output currents can provide halftones because of the grid-control action. The linearity in this case will depend on the scale of potential variations of the insulated storage elements falling in the proper range of the grid-control system. This can be achieved by adjusting the direct-current cathode potential of the writing gun so that in the absence of an input signal the target will assume a suitable negative equilibrium potential, V_{eq} .

C. BACKPLATE-MODULATION TYPES

Equilibrium Writing—Capacity-Discharge Reading

(Radechon)

(Jensen, Smith, Mesner, and Flory, Ref. 51)

Description (Fig. 18). This tube employs one electron gun, a collector cylinder, a target constructed of a metal backplate covered with a thin insulating sheet (0.5—5.0 mils thick), and a fine-mesh barrier grid spaced several mils from the insulating surface. The input signal is applied to the backplate. The output signal is obtained from the collector as voltage variations across the output resistor R_0 . This tube as frequently

employed differs from the other signal converter tubes in that the output signal does not correspond to the input signal but to the difference between the input signals applied during successive scans. Writing and reading are thus accomplished simultaneously.

Writing. Because of the 110-volt potential difference between the target and the cathode of the electron gun, the insulating surface is assumed to be bombarded by primary electrons under the condition $\delta_e > 1$. As a result, the insulating surface, during scanning in the absence of an input signal, will assume an equilibrium potential, V_{eq} , slightly positive with respect to the barrier grid (see Part I-J) since the bar-

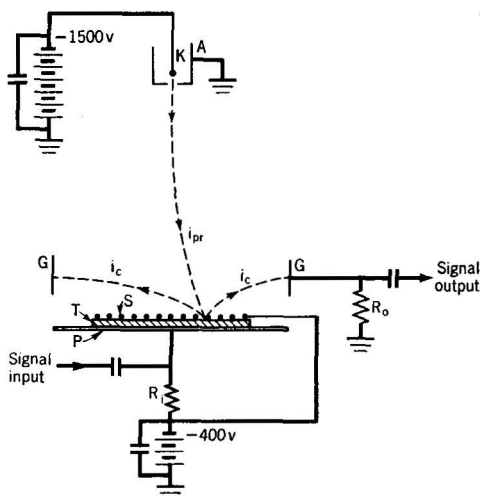

Fig. 18. Signal-converter storage tube (Radechon).

A, accelerating anode; G, collector; i_c , collected current; i_{pr} , primary current; K, cathode; P, backplate; R_i , input resistor; R_o , output resistor; S, barrier grid; T, insulated target.

rier grid acts as the effective collector. When an input signal is applied to the backplate, the entire front surface of the insulating layer will capacitively undergo corresponding potential variations. If the target is simultaneously scanned by the primary beam, (assuming sufficient primary current) each particular element when bombarded will be maintained by secondary-emission action at the equilibrium potential against

the action of the instantaneous backplate voltage. Because of this action, at the end of a single scan, a pattern of potential variations will be left on the target surface equal and opposite to the signal applied to the insulating surface during writing.

Reading. If the writing process described above is repeated with a new input signal which differs from the original signal, the resultant pattern of potential variations on the target surface will correspond to the second signal regardless of the previous target potentials since each element while being scanned during the second signal will again shift to the equilibrium potential V_{eq} as was the case during the first signal. However, the net charge added or subtracted from each element as it is scanned the second time will depend directly on the amount of potential shift the element must undergo in changing from its original potential to the new potential. As the successive elements are scanned, the target current i_t (the time rate of addition or subtraction of charges to the target surface) will cause corresponding variations in the collected current i_c , since the relationship $i_{pr} = i_t + i_c$ exists and the primary current i_{pr} is constant. In other words, during the second scan the collected reading current i_c will be a direct measure of the difference in signal voltage applied to the respective target elements during this scan as compared to the signal voltage applied during the first scan.

By the same process, new input signals applied during successive scans will produce voltages across the output resistor corresponding to the difference between the signal being applied and the last previous stored signal. In particular, if identical time-varying input signals are applied to the backplate during successive scans, no variations will result in the collected current i_c . If, during successive scans, the applied input signals are not identical, variations will be observed in i_c corresponding only to those particular elements where the input signal is being changed.

Erasing. As described above, the writing of a new signal automatically erases the previous signal. Erasing as a separate action is therefore not required.

Polarity and Halftones. The polarity of this tube is positive in the sense that, if, for a particular element, the input signal is more positive than the previous input signal, a positive output signal will be produced. This polarity exists because a positive increase in voltage applied to the backplate

on successive scans for a particular element requires an increase of negative charge or an increase of electron current i_t to the target to maintain the surface at the equilibrium potential V_{eq} . The resulting decrease in collected current i_c causes a positive voltage variation across the output resistor R_o .

Since the writing method employed is of the equilibrium type, relatively linear halftone charge patterns with respect to the input voltage can be stored. The output also contains corresponding linear halftone differences between successive stored charge patterns, since the target elements are charged essentially to the new potentials during each scan.

Additional Considerations. As discussed above, the tube is constructed with a barrier grid closely spaced to the insulating surface. One function of this grid, as mentioned in Part I-J, is to avoid redistribution effects by preventing those secondary electrons which penetrate its plane from returning to the target surface because of the accelerating field between the collector cylinder and the barrier grid. Since those secondary electrons with insufficient energy to penetrate the barrier grid are returned to a point on the target surface very close to the point from which they were emitted, little loss of resolution is caused. Another function of this grid is to reduce coplanar grid effects, i.e., the tendency of an element which has acquired a large negative charge to prevent landing of primary electrons or leaving of secondary electrons from adjacent elements during scanning.

Although in the above discussion it has been assumed that the target elements reach the equilibrium potential V_{eq} during scanning, in practice this ideal condition may not be entirely possible. In other words, if an input signal V_S is applied capacitively to the surface of a target element during bombardment, the resulting element potential after scanning will be $-fV_S$ where the "discharge factor" f is usually somewhat less than unity and is a function of the primary beam current, target capacitance, spot size, scanning speed, and input signal.

This tube may also be employed for storing a charge pattern by applying input signals to the backplate in equilibrium writing and then obtaining an output signal from the collector by subsequent scanning of the target with the writing signals cut off. Nonequilibrium writing may also be accomplished with this tube by modulation of the primary current, as in the

case of the tube described in Part IV-A-1 (Krawinkel, Kronjäger, and Salow), or by applying the input signals to the backplate. An example of the latter case is given in Ref. 46 (Harrington and Rogers), where input signals are applied in a number of successive scans before reading, for the purpose of integration. In this case, the primary-beam current is made sufficiently small so that the target elements do not reach equilibrium in a single writing scan. For linear integration, however, such a writing method is restricted to operation on the linear sloping portion B-C-D of the δ_c curve of Fig. 6.

PART V

VIEWING STORAGE TUBES (ELECTRICAL—VISUAL)

A. PRIMARY-CURRENT-MODULATION TYPES

1. Nonequilibrium Writing—Grid-Control Reading

a. Photoelectric Viewing Cathode—Single-Sided Target (Krawinkel, Ref. 42)

Description (Fig. 19). This tube employs one electron gun, a collector cylinder, a storage target, and a viewing phosphor. The target is constructed of a metal backplate covered with a continuous photoelectric layer upon which is a mosaic of insulating particles. The input signal is applied to the control grid of the electron gun. The output is obtained as a visual picture on the phosphor surface.

Writing. As a result of the scanning process during previous erasing, the insulating mosaic elements are assumed to be at approximately zero potential, equal to the target photo-surface and collector. For writing, the target is scanned by the primary beam with the electron-gun cathode set at -7000 volts, for example, and the target backplate is maintained at zero potential (collector potential). Under these conditions the input signals are applied to the control grid of the electron gun. Since the second crossover potential V_{cr2} of the insulating elements is, in this case, assumed to be below 7000 volts, primary electrons will strike them under the condition $\delta_e < 1$ and tend to charge them negatively toward the equilibrium potential. (Under these conditions the equilibrium potential will fall on the line d-e of the equilibrium curve of Fig. 3.) Because of the current modulation of the primary beam, however, each target element is allowed to shift by only a controlled amount toward this equilibrium potential so that as a result of a single scan a pattern of negative stored charges will be established on the target surface corresponding to the input signal.

Reading. For reading, the primary beam is cut off (for

example, by switching the cathode to zero potential), the target backplate (and its associated photocathode) is switched negative to -5000 volts, and light from an external source is allowed to flood the storage surface. Although photoelectrons will be generated over the entire target surface, the charged insulating elements will prevent photoelectrons from leaving the adjacent photoelectric elements of the target by coplanar

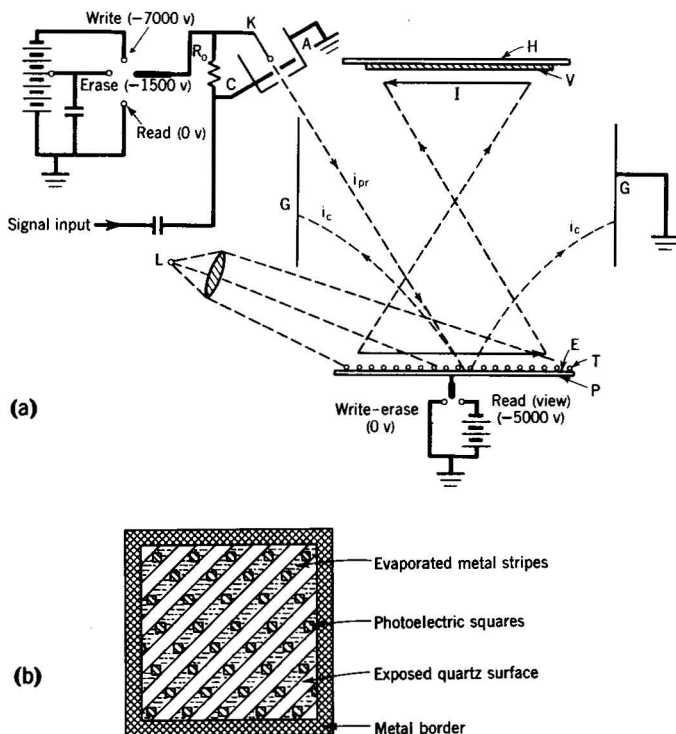

Fig. 19. Photoelectric viewing storage tube (Krawinkel). (a), tube with metallic viewing-cathode support and mosaic storage elements on it. (b), homogeneous insulating plate for the viewing-cathode support.

A, accelerating anode of writing gun; C, control grid of writing gun; E, photosurface (viewing-beam cathode); G, collector; H, transparent supporting insulator; I, electron-optical image from photosurface; i_c , collected secondary current of writing beam; i_{pr} , primary current of writing beam; K, cathode of writing gun; L, auxiliary light source for reading; P, backplate with photosurface E; R_o , output resistor; T, mosaic of insulating particles; V, viewing phosphor.

grid action to a degree controlled by the amount of charge at each element. Because of the potential difference between the collector cylinder and the target surface, those photoelectrons able to leave the photosurface will be accelerated and focused to an image on the phosphor surface, producing a visible picture which corresponds to the stored charge pattern. Since the mosaic of insulating particles is charged negatively to varying degrees with respect to the photosurface, photoelectrons in general are unable to reach the insulating elements, thus permitting the viewing process to continue for an extended period.

Erasing. Erasing is accomplished by returning the target backplate (and photocathode) to zero potential, switching the cathode of the electron gun to a potential of -1500 volts, for example, which is below the second crossover potential V_{cr2} , and scanning the surface with the unmodulated primary beam. Under these conditions the secondary emission ratio δ_e of the insulated particles will be greater than 1, and, assuming sufficient beam current and bombarding time, they will all charge to approximately the collector (zero) potential.

Polarity and Halftones. The output polarity of this device is negative in the sense that a more positive input signal will cause less light output from the corresponding phosphor element. This relationship is caused by the fact that the more positive input signals establish greater negative charges on the corresponding elements of the storage surface, which in turn reduce the number of photoelectrons that can reach the phosphor from these elements in reading.

By means of the nonequilibrium writing method employed, a halftone charge pattern can be stored. This pattern in turn can produce a halftone visual picture because of the grid-control reading method employed.

Additional Considerations. Because of the high insulating quality of the particles (either quartz or magnesium oxide which make up the mosaic, the memory time is very long. In practice a stored charged pattern may remain on the target surface for as much as several weeks if the writing and viewing beams are cut off. However, the reading time is much shorter. If the tube is maintained in operation, i.e., continuous reading is employed, the stored charge pattern will be gradually diminished by the action of positive ions reaching the target as indicated in Part III-C. In order to reduce the

number of positive ions formed, therefore, a special getter device with a heated cathode is placed inside the envelope to maintain the gas pressure at a minimum. With a pressure of 5×10^{-7} millimeters so obtained, a continuous reading time of 10 to 15 minutes, for example, has been observed.

In order to prevent the auxiliary light source from masking the output picture, it is desirable that the auxiliary light be confined to the ultraviolet and infrared regions of the spectrum where it cannot be seen directly. For this purpose, the photoelectric surface of the target is correspondingly sensitized.¹⁹

Because of difficulties in constructing uniform target surfaces of the type described above, a modified form of target has also been used which operates on the same principle. The modified target, as indicated in Fig. 19b, consists of a homogeneous quartz plate upon which are evaporated diagonal metal stripes of silver or aluminum, all of which are connected to a common metal stripe bordering the edge of the plate. Evaporated in turn on the diagonal metal stripes are tiny photoelectric squares. The exposed quartz areas thus serve as the insulating control elements for the storage of charges, and the photoelectric squares connected to the external circuit through the diagonal stripes serve as the source of viewing electrons for reading.

Although the tube has separate writing and viewing cathodes, simultaneous writing and viewing is not possible because of the necessity for switching the potential of the viewing-beam photocathode between writing and viewing. If simultaneous writing and viewing were attempted, the required accelerating field between the collector and photocathode for viewing would cause serious distortion of the writing-beam trace and focus.

b. Secondary-Emission Viewing Cathode — Two-Sided Target (Knoll and Randmer, Ref. 52)

Description (Fig. 20). This tube consists of a two-sided storage target with a viewing phosphor mounted at one end of

¹⁹Although not employed in this tube, another method for preventing the auxiliary light source from interfering with the viewing of the output picture is to coat the viewing phosphor with an electron-transparent aluminum layer. In this case the auxiliary light need not be restricted to the ultraviolet or infrared regions.

the tube, and, at the other end, a writing gun and a reading gun. The target consists of a thin aluminum foil, approximately 1 micron thick, covered on the side facing the phosphor with a mosaic of fine insulating particles. If necessary, the aluminum foil is supported by a fine-mesh metal grid. Input signals are applied to the control grid of the writing gun. The output is obtained as a visual picture on the phosphor surface. By means of the separate writing and reading guns, writing (integration type) and reading can be accomplished simultaneously.

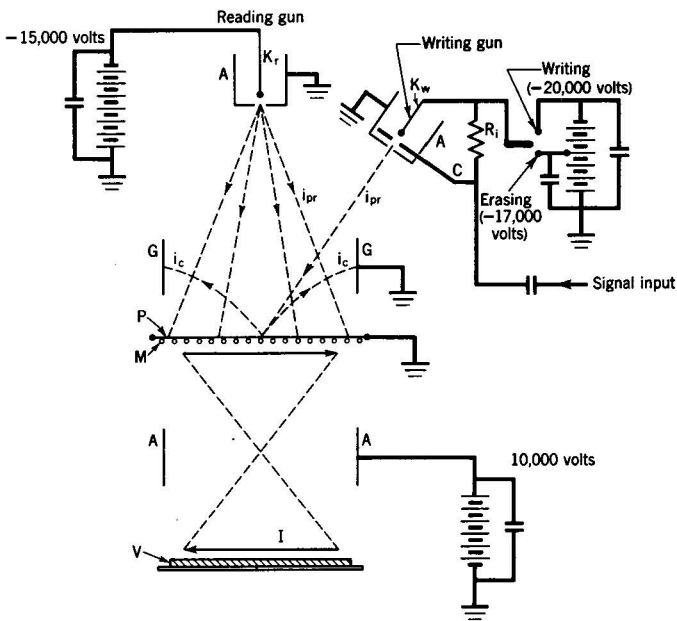

Fig. 20. Viewing storage tube (Knoll and Randmer).

A, accelerating anodes; C, control grid; G, collector cylinder; I, image of secondary currents; i_c , secondary current; i_{pr} , primary current; K_r , reading-gun cathode; K_w , writing-gun cathode; M, insulating mosaic; P, target foil; R_i , input resistor; V, viewing phosphor.

Writing. As a result of scanning during previous erasing, the insulated elements are all assumed to be at approximately the potential of the aluminum foil. For writing, the input signals are applied to the control grid of the writing gun while

the target is scanned with the writing beam. Since the writing gun cathode is at a potential of $-20,000$ volts, for example, primary electrons reaching the target are assumed to have sufficient energy not only to penetrate the aluminum but also to strike the insulating elements with an energy corresponding to a potential greater than V_{cr2} ($\delta_e < 1$). As a result, the particles will tend to charge negative, in this case toward a potential which falls on the line d-e of the equilibrium curve of Fig. 3. Because of the modulation of the writing-beam current by the input signal as the target is scanned, the insulating elements will be charged negative by amounts controlled by the signal voltage, thus establishing a charge pattern on the insulating mosaic.

Reading. For reading, the entire target is flooded with primary electrons from the reading gun whose cathode is at $-15,000$ volts. The energy of the primary electrons is assumed to be such that, although the electrons do not completely penetrate the aluminum foil, they cause secondary electrons to be emitted from the foil on the mosaic side as well as from the side facing the reading gun. Since the insulating particles are charged negative to varying degrees with respect to the target foil, they will cause corresponding decelerating fields at the unbombarded surface (mosaic side) of the target. As a result, because of their relatively low velocities, the number of secondary electrons which are able to leave this side of the target will vary from element to element depending on the negative charge established on the mosaic in writing. By means of an accelerating and focusing system, an image of the pattern of secondary currents leaving the target can be formed on the phosphor surface, providing a visual picture of the stored charge distribution. Since the mosaic particles are charged negative to varying degrees with respect to the target foil, the viewing secondary electrons are prevented from landing on the mosaic, thus permitting the viewing process to continue for an extended time.

Erasing. Because of the nonequilibrium type of writing employed, a separate erasing action is required. Since an additional erasing gun is not used, erasing is accomplished by switching the writing-gun cathode to $-17,000$ volts, for example, so that primary electrons will penetrate the thin aluminum foil and strike the insulating elements with an energy corresponding to a potential between V_{cr1} and V_{cr2} ($\delta_e > 1$).

Scanning the target will thus shift all the insulating elements to the potential of the target foil, which in this case acts as the collector.

Polarity and Halftones. The polarity of this device is negative in the sense that a more positive signal will cause less light output from the corresponding phosphor element. Since the more positive input signals permit more beam current in writing, the corresponding insulating elements will be charged more negative, resulting in fewer secondary electrons arriving at the phosphor from the secondary-emission-cathode elements.

By means of the nonequilibrium writing employed, a half-tone charge pattern can be established on the target surface. This pattern in turn can provide a halftone visual picture because of the grid-control reading method used.

Additional Considerations. At the bombarded side of the target foil, secondary electrons are emitted with a range of energies considerably greater than that of thermally or photoemitted electrons (although a large fraction has less than several volts energy). However, this range is much smaller and confined to lower energies for secondaries emitted from the mosaic side of the target foil. The resolution of the resulting viewing-beam pattern at the phosphor surface will thus be sufficiently high for many purposes (although not as high as for a thermionic or photoelectric viewing cathode). Despite the disadvantage in resolution this type of viewing cathode offers the advantage of simplicity.

Although the tube has separate writing and reading guns, writing and erasing must follow each other in sequence. If simultaneous writing, erasing, and reading are desired, equilibrium writing (with, for example, cathode modulation of the writing beam) must be employed instead of primary-current modulation.

c. Reflection Target

(Hergenrother and Gardner, Ref. 49)

This device is identical to the storage tube described in Part IV-A-2 except that the collector-reflector is in this case an open-meshed metallic screen, followed by a thin layer of phosphor (see Fig. 14). The major portion of the reading-beam electrons reaching the collector-reflector will, instead of being collected, pass through it and strike the phosphor,

producing a visible picture of the stored charge pattern. Although electrical and visual output signals can be obtained simultaneously, if only a visual output is required the entire target may be flooded with electrons by defocusing the primary beam during reading. This eliminates the need for scanning the target with a focused reading beam as required when the tube is used as a signal converter.

Simultaneous reading and writing is not possible because a single gun is employed and the potential of the collector-reflector electrode must be switched between writing and reading. The output polarity of the device for viewing (if operated as described in Part IV-A-2) is positive in the sense that a more positive input signal causes an increasing amount of light from the corresponding phosphor element.

2. Nonequilibrium Writing—Light-Valve Reading (Donal, Ref. 44; Donal and Langmuir, Ref. 45)

Description (Fig. 21). This tube employs one electron gun, a collector cylinder, and a storage target which serves as part of a two-dimensional multi-element light valve. The light valve consists of two thin sheets of mica spaced approximately 1 millimeter apart, between which is a fluid containing tiny platelike particles held in the form of a suspension. One mica sheet faces the electron gun and acts as the storage target. The surface of the other mica sheet is covered with a semi-transparent conducting coating on the side adjacent to the suspension.

During writing, input signals are applied to the control grid of the electron gun, establishing a charge pattern on the target surface. These stored charges produce electric fields across the elements of the suspension valve which control the orientation of the particles and hence the transmission of light through the valve. The output is obtained as a visual picture, directly viewed or projected, when light from an external source is directed through the suspension.

Writing. As a result of the scanning process during previous erasing, the target surface is assumed to be at approximately the collector potential. For writing, the target is scanned by the primary beam with the cathode set at -5000 volts while the input signals are applied to the control grid of the electron gun. Since the second crossover potential V_{cr2}

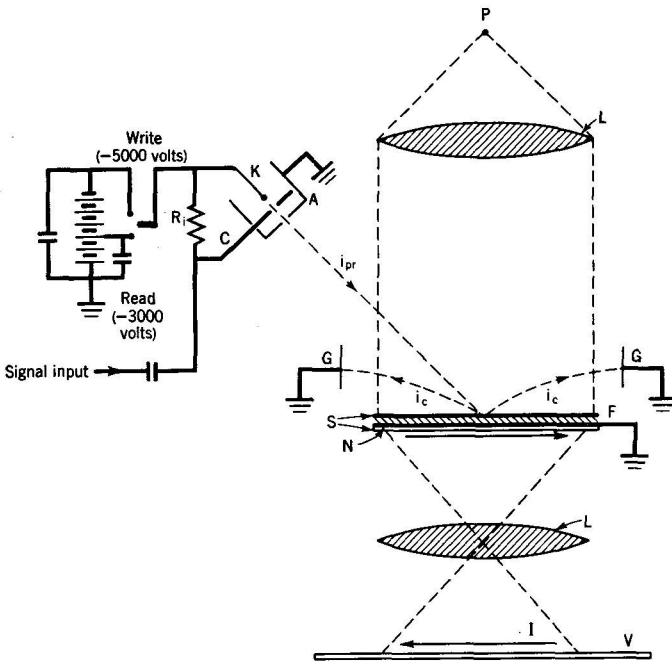

Fig. 21. Light-valve viewing storage tube (Donal and Langmuir).

A, electron-gun anode; C, primary current control grid; F, light-valve suspension; G, collector; I, optical image from suspension valve; i_c , collected secondary current; i_{pr} , primary writing current; K, electron-gun cathode; L, glass lenses; N, transparent conductive coating; P, auxiliary light source; R_i , input resistor; S, transparent insulating sheets; V, projection screen for viewing.

of the mica storage surface is assumed to be 3000 volts, primary electrons will strike the target elements under the condition $\delta_e < 1$ and tend to charge them negative toward the equilibrium potential, which, in this case, falls on the line d - e of the equilibrium curve of Fig. 3. Each target element shifts by a controlled amount, however, toward the equilibrium potential because of the current modulation of the primary beam, so that as a result of a single scan a pattern of stored charges will be established on the target surface.

Reading. Since the conductive coating on the outer mica sheet is maintained at collector (zero) potential, the negative

charges stored on the other wall of the valve will cause an electrostatic field across the suspension whose magnitude will vary from element to element in accordance with the amount of stored charge. Because of the platelike shape of the suspension particles, they will tend to orient themselves like dipoles so that their flat surfaces are parallel to the electric field. (It is assumed that the particles are either conducting or have a dielectric constant greater than that of the liquid.) As a result, the transmission of light through the suspension will vary from element to element, depending on the degree of orientation of the particles. This orientation is proportional over a considerable range, to the time duration of the applied field and the square of the field strength. (It is interesting to note that the rate of orientation of the particles is almost wholly controlled by the viscosity of the fluid, the effects of their inertia being negligible in comparison.)

However, because of the conductivity of the suspension, the charges established in writing will be neutralized on the opposite side of the storage target, and the electric field established across the suspension will generally fall to zero in a few hundredths of a second. This will occur despite the fact that the charge pattern stored during writing may be intact on the mica surface outside the suspension. Immediately after a storage element is scanned in the writing process, therefore, the light transmission of the corresponding suspension valve element will begin to increase as the particles start to orient themselves under the influence of the electric field, but, because of the polarization of the light valve due to leakage, the light transmission of the valve element will, after initially rising, fall again to its original value. If an external source of light is directed through the element, a flash of light will be observed through it immediately following the charging process. Thus, the establishing of a charge pattern by scanning the entire storage surface will cause a similar flash of light from each valve element corresponding to the charge pattern, so that a resultant short-duration visible picture will be produced.

Erasing. Because of the polarization of the mica sheet and the consequent removal of the pattern of electric fields across the suspension, the picture decays rapidly, although the stored charge pattern outside the suspension may still be present. Before establishing a new charge pattern it is de-

sirable to unpolarize the target mica sheet. This process, constituting the erasing action, is accomplished by scanning the target with the unmodulated primary beam, but with the cathode of the electron gun switched to the "erase" position of -3000 volts. Under this condition all the target elements will be bombarded with primary electrons whose energy corresponds to a potential equal to or less than the second crossover potential V_{cr2} of the target, and, since sufficient beam current is assumed, all the elements will be shifted to approximately the collector potential. However, this action will set up new fields across the suspension, opposite in polarity from the original fields. Since the orientation of the particles is independent of the polarity of the field, the original picture will be again flashed before the polarizing currents reduce the field to zero. A more detailed consideration shows that, after the target is scanned during "erasing," a pattern of potential variations on the target surface corresponding to the original pattern established during "writing" will still be left on the target surface after the polarizing currents flow, but it will be considerably less in magnitude. Although this remaining pattern can be reduced by successive "erasing" scans, for practical purposes, scanning the target once with a defocused beam will generally suffice before the cathode is switched to the "write" position and new input signals applied.

Polarity and Halftones. The output polarity of this device is positive in the sense that a more positive input signal causes an increase in the brightness of the corresponding target element. This relationship exists because a positive signal input to the control grid will establish a correspondingly greater amount of negative charge on a particular storage element, which in turn will create a greater electrostatic field across the suspension valve with consequent increase in light transmission.

Although the nonequilibrium type of writing employed permits an essentially linear halftone charge pattern to be stored, this charge pattern in reading produces a visual picture the brightness of whose elements is proportional to the square of the stored charges (or their potentials).

Additional Considerations. This device has been designed primarily for television applications, where best results have generally been obtained when the cathode is switched from the "writing" potential to the "erasing" potential during alternate

scans. Since during the "erasing" scan the primary beam is unmodulated, however, new signal information can be stored only every second scan when the tube is operated in this manner. This requirement limits the usefulness of the tube.

Because of polarization effects, several alternate writing and reading scans with the same input signal may be required before the visual response of the valve is in equilibrium with the stored charge pattern.

3. Bistable Writing — Luminescent Target (Haefl, Ref. 48)

This device is identical to the storage tube described in Part IV-A-4 except that the insulated storage target is in this case a thin sheet of phosphor on a transparent surface such as glass (see Fig. 16). All the storage operations previously described will be, however, unchanged except that, in addition to electrical reading of the stored information as the target is scanned, the output will also be obtained as a visual picture. Since the holding beam bombards only the "white" areas of the storage target, these areas will fluoresce, leaving the remaining areas dark and thus producing a visual pattern corresponding to the stored information.

As discussed in Part IV-A-4, the primary electrons from the holding gun will have a relatively low energy at the "white" target elements (75 volts), so that the light output from the phosphor will be limited. This energy can be made somewhat higher by changing the operating potentials, but difficulties, as previously mentioned, may arise in that the increased potential gradients on the target surface between the "white" and "black" areas will cause a spreading of the "white" areas. The limitation in light output, however, is partially compensated by the fact that the holding beam may be operated so that it floods all the target elements continuously, in contrast to the scanning action required in a conventional kinescope.

The output polarity of this device depends on whether "white-on-black" or "black-on-white" writing is employed, as mentioned in Part IV-A-4. For "white-on-black" writing the output polarity is positive, whereas for "black-on-white" writing the output polarity is negative. As also discussed previously, no halftones can be produced with this device since it employs bistable writing.

B. CATHODE-MODULATION TYPES

Equilibrium Writing—Grid-Control Reading
(Knoll, Ref. 52a; Knoll and Rudnick, Ref. 52b)

Description (Fig. 22). This tube employs a writing gun, a reading gun, and a collector grid mounted on one side of a storage grid, and a viewing phosphor mounted on the opposite side. The storage grid consists of a fine-mesh metal screen (100—500-mesh per linear inch) covered on the side facing the electron guns with a thin insulating layer of a material such as vitreous silica. The viewing phosphor, spaced a few millimeters from the target, is mounted on a glass sheet with a transparent conducting coating between the phosphor and the glass.

Input signals are applied to the cathode of the writing gun, and output signals are obtained as visual pictures on the phosphor surface. Writing and reading can be accomplished simultaneously by means of the separate writing and reading guns.

Writing. Writing may be accomplished by applying the input signals to the cathode of the writing gun while the storage grid is simultaneously scanned with the writing beam. Since the cathode of the writing gun is maintained at a direct-current potential of -4000 volts, for example, and since the second crossover potential \bar{V}_{cr2} of the insulating storage elements is assumed to be 3900 volts, each insulating element when scanned will be shifted to a negative potential which falls on the line d-e of the equilibrium curve of Fig. 3, assuming sufficient beam current. In the absence of input signals, the target elements will be charged to a potential of -100 volts with respect to the collector G, i.e., to a potential positive with respect to the writing-gun cathode by an amount equal to \bar{V}_{cr2} , 3900 volts (see Part I-B). However, because of the slope of the line d-e, variations of the writing-gun-cathode potential due to input signals will cause the target elements to acquire potential variations which are slightly above and below -100 volts, (between -95 and -105 volts, for example). As a result of scanning, therefore, the storage target will acquire a pattern of potential variations corresponding to the input signal.

Reading. Reading may be accomplished simultaneously with writing by flooding the entire storage grid with a collimated beam of primary electrons from the reading gun whose

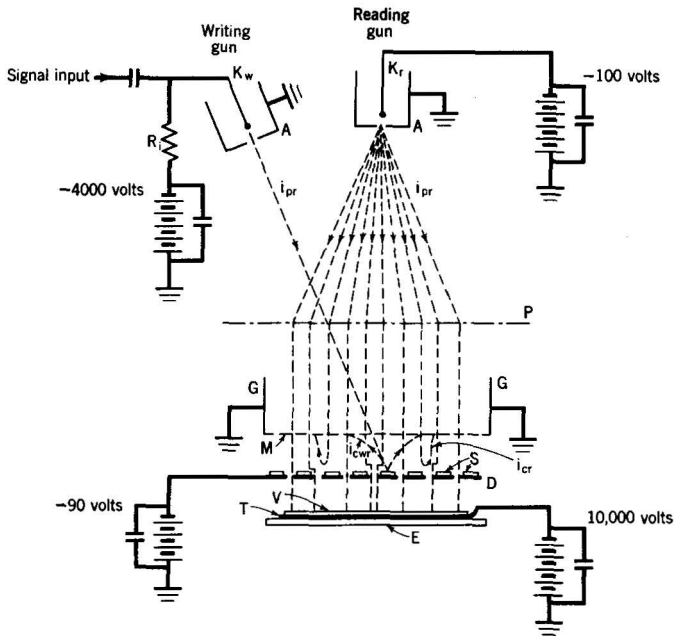

Fig. 22. Viewing storage tube with electron lens raster (Knoll).

A, accelerating anodes; D, storage mesh; E, transparent sheet; G, collector cylinder; i_{cwr} , collected writing current; i_{cr} , collected viewing (reading) current; i_{pr} , primary current; K_r , reading-gun cathode; K_w , writing-gun cathode; M, collector screen (fine mesh); P, principal plane of electron-optical lens of primary viewing beam; R_i , input resistor; S, insulating target elements; T, transparent conducting layer; V, viewing phosphor.

cathode is maintained at a potential of -100 volts. Since the metal grid of the storage target is maintained at a potential close to that of the reading-gun cathode, -90 volts, for example, and the target elements are charged to potentials between -95 and -105 volts by the writing-beam primary electrons, viewing-beam electrons will reach the neighborhood of the target surface with very low velocities. Because of the high potential maintained on the conductive coating adjacent to the phosphor ($10,000$ volts), a portion of the electrostatic field created between the phosphor and the target screen will penetrate the holes of the storage mesh, tending to draw electrons

through the openings.²⁰ However, since as a result of writing, the insulating elements of the storage target have potentials close to the reading- (viewing-) gun cathode and the storage mesh, they will act as control grids determining the proportion of primary current which is allowed to pass through each target hole as compared to the primary current reflected to the collector. In this manner a pattern of current variations corresponding to the input signal will flow through the openings of the target, producing a visible picture on the phosphor surface which is mounted close to the storage grid.

Erasing. With cathode modulation in writing, this device requires no separate erasing action before the application of new input signals. Since operation is accomplished along the line d-e of the equilibrium curve of Fig. 3, each target element will shift to a new equilibrium potential when bombarded, corresponding to a new input signal regardless of the potential established by the previous signal (assuming sufficient writing-beam current).

Polarity and Halftones. The output polarity of this device is positive in the sense that an increasing positive signal applied to the cathode of the writing gun will cause an increase in the output brightness of the corresponding element of the viewing phosphor. This is due to the fact that the more positive input signals applied to the writing-gun cathode cause the target elements to be shifted to less negative equilibrium potentials, with the result that more reading (viewing) electrons can pass through corresponding openings of the target to the phosphor.

This device is capable of relatively linear halftone operation. Since equilibrium writing along the portion d-e of the equilibrium curve of Fig. 3 is employed, the linearity of potential variations established on the storage grid in writing will depend on the linearity of the line d-e at the point of operation. In reading, because of the grid-control action of the target, a halftone visual picture may also be obtained.

Additional Considerations. Although, as described above, the writing process is accomplished with the writing-gun

²⁰Because of the high ratio of field strengths on both sides of the storage target, each target opening constitutes a tiny electron lens which focuses the viewing-beam electrons into tiny elementary beams. These lenses maintain good resolution of the viewed pattern by preventing overlapping of the elementary beams from adjacent holes.

cathode at a potential greater in magnitude than the second crossover potential V_{cr2} , writing may also be accomplished with the writing-gun cathode below V_{cr1} , in which case the target elements will be charged to the cathode potential of the writing gun. This type of operation, however, requires a separate erasing action, since the writing beam is able only to charge the target elements negative. Such operation also causes difficulty because of resolution problems resulting from the low-beam velocity near the target surface.

In addition to producing a bright single picture for several minutes, this tube (as compared to standard television or radar viewing tubes) offers the advantages of lower anode voltage for the same brightness, and of a smaller signal band width where reduction is desired in frame repetition frequency without flicker effect.

Other versions of this tube have been operated with induced-conductivity writing and nonequilibrium writing. Such types of writing involve primary-current modulation and are not capable of erasing while writing with a common beam, as in the case of equilibrium writing. In the case of tubes employing bombardment-induced conductivity writing the insulating target layer must, of course, be sufficiently thin to be penetrated by the writing beam.

C. COLLECTOR-MODULATION TYPES

Equilibrium Writing — Grid-Control Reading

Photoelectric Viewing Cathode — Double-Sided Target
(Schroeter, Refs. 57, 58)

Description (Fig. 23). This tube consists of a double-sided storage target, a writing gun and collector grid on one side, and a viewing phosphor on the opposite side. The storage target consists of an insulating sheet, approximately 1 micron thick, which is coated on the side facing the viewing phosphor with a photoelectric layer perforated with closely spaced fine holes. The input signal is applied to the collector grid, and the output signal is obtained as a visual picture on the phosphor surface. By means of the double-sided target, writing and reading can be accomplished simultaneously.

Writing. Writing is accomplished by scanning the insulating target with the writing beam and simultaneously apply-

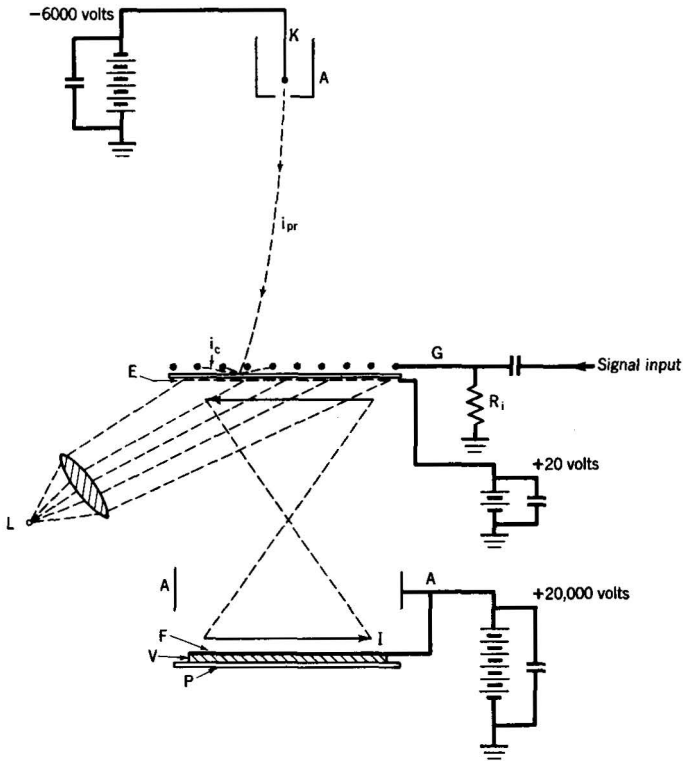

Fig. 23. Photoelectric viewing storage tube (Schroeter).

A, accelerating anodes; E, perforated photosurface; F, metal foil; G, collector grid; I, electron-optical image from photosurface; i_c , collected current; i_{pr} , primary current; K, cathode; L, auxiliary light source; P, transparent sheet; R_i , input resistor; V, viewing phosphor.

ing the input signals to the collector grid. The cathode potential of the writing gun (-6000 volts) is assumed to be such that the primary electrons will strike the target elements under the condition $\delta_e > 1$, tending to shift them to approximately the collector potential. Assuming sufficient primary current, therefore, each target element, as a result of scanning, will acquire a potential equal to the instantaneous signal voltage applied to the collector grid. (As mentioned in Part III-A-1, the collector grid must be spaced close to the target to prevent redistribution effects from interfering with the writing process.)

Reading. For reading, the entire photosurface of the target which is maintained at 20 volts is uniformly flooded with light from an external source. However, because of the perforations in the photosurface, the charges stored on the opposite side of the target during writing will cause decelerating electric fields so that photoelectrons released by the external light at each element will be prevented from leaving the surface to a degree depending on the amount of negative charge stored on the corresponding insulating element behind it. The resultant pattern of currents leaving the photosurface is accelerated and focused to form a visible image on the viewing phosphor, corresponding to the input signal. This image can be viewed for an extended period limited only by the removal of the stored charges by leakage or discharge due to positive ions.

Erasing. Because of the equilibrium writing employed, each insulating element when bombarded will shift to the instantaneous potential of the collector grid regardless of its previous potential. Rescanning of the target with a new input signal will, therefore, leave a pattern of potential variations on the target surface corresponding to the new signal, thus requiring no separate erasing action.

Polarity and Halftones. The output polarity of this device is positive in the sense that a more positive input signal causes an increase in the light output from the corresponding element of the viewing phosphor. This is caused by the fact that the more positive input signals shift the corresponding storage elements more positive in writing. These elements in turn produce less decelerating field, so that more photoelectrons from them can arrive at the phosphor.

Because of the equilibrium writing employed, a relatively linear halftone charge pattern can be stored in writing. By means of the grid-control reading method used, a corresponding halftone picture can be produced from this pattern.

Additional Considerations. In order to prevent the auxiliary light source from interfering with viewing the output picture, the phosphor is coated with a thin film of aluminum, opaque to light, but through which the accelerated image electrons can readily pass because of their 20,000-volt energy. As a means of minimizing disturbance effects due to the interception of primary electrons from the writing beam, the collector is constructed of thin wires 10 microns in diameter,

arranged parallel to the direction of the scan.

Since this tube permits continuous viewing of the output picture at the same time that the new input signals are being applied, it is particularly applicable for television purposes where reduction in frame-repetition frequency without flicker is desired.

PART VI
COMPUTER STORAGE TUBES
(ELECTRICAL-ELECTRICAL)

A. PRIMARY-CURRENT-MODULATION TYPES

Redistribution Writing — Capacity-Discharge Reading
(Williams and Kilburn, Ref. 66)

Description (Fig. 24). This device consists essentially of a conventional single-beam kinescope or oscilloscope tube whose phosphor surface serves as the storage screen. The front face is covered with an external electrode capacitively coupled to the phosphor. Input signals (yes-no information) are applied as either short- or long-duration pulses to the control grid of the gun during scanning. Output signals are obtained across R_0 from the external electrode as voltage pulses whose polarity is determined during subsequent scanning by the type of input signal stored at a particular element.

Writing. Writing is accomplished by scanning the target at a uniform speed and applying positive pulses to the electron gun control grid which is biased to cutoff. The positive pulses initiated at regular intervals (approximately 10 microseconds) have one of two time durations: either 2 microseconds or 5 microseconds, for example, depending upon the information to be stored at a particular element. Since the scanning time per line is approximately 300 microseconds and the line width about 1/200 of its length, the beam trace produced by the shorter pulse will be a slightly elongated spot, whereas the trace produced by the longer pulse will be in the form of a dash. Because of the cathode potential (-1500 volts, for example), primary electrons are assumed to strike the target under the condition $\delta_e > 1$, and, since sufficient beam current is used, the bombarded areas will be shifted to the equilibrium potential V_{eq} several volts positive with respect to the collector. When a dot or dash is traced by the primary beam, some of the secondary electrons, by redistribution, will land on the areas immediately surrounding the spot. In the case of a dot, the area bombarded by the writing beam will be shifted

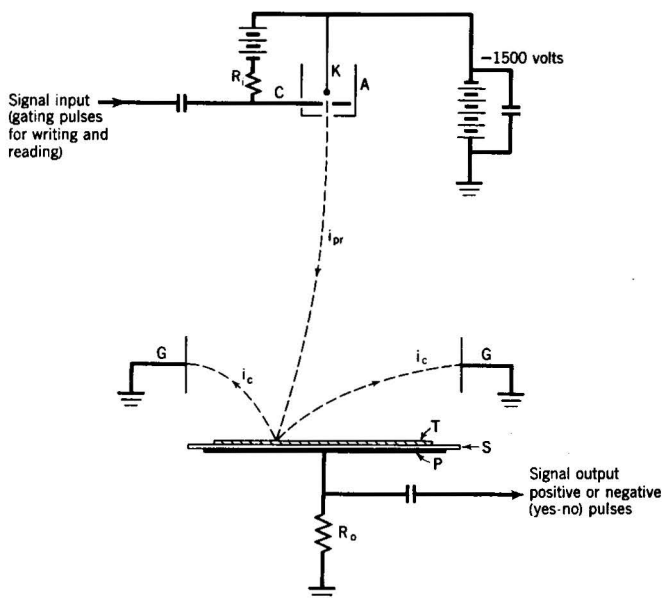

Fig. 24. Computer storage tube (Williams and Kilburn).

A, accelerating anode; C, control grid; G, collector; i_c , collected current; i_{pr} , primary current; K, cathode; P, metal backplate; R_i , input resistor; R_o , output resistor; S, glass sheet; T, insulating target (phosphor).

to the equilibrium potential V_{eq} although redistribution electrons will land on the surrounding areas.²¹ In the case of a dash, however, although the primary beam will first shift the portion initially bombarded to the equilibrium potential, as the beam moves to the subsequent portions of the dash, some of the redistributed secondary electrons from these portions will land on the first part of the dash as well as on the surrounding areas, thus shifting the initial portion of the dash to a potential somewhat negative with respect to V_{eq} . As a re-

²¹Most of the redistributed secondary electrons will land on the areas very close to a bombarded spot. In practice it was found that if two spots are spaced such that the distance between their centers is twice their diameter, bombardment of one spot for as long as 400 microseconds will not substantially affect the potential of the unbombarded spot. Because of this, the distance between dots and dashes along a single line and the distance between lines was chosen in operation to be approximately equal to the spot width.

sult of the above writing process, each element will have stored on it a dot whose potential is V_{eq} or a dash whose potential at the initial portion is less than V_{eq} .

Reading. Reading is based on the fact that if the beam is positioned to (a) a dot or (b) the beginning of a dash and suddenly switched on, pulses of different polarity will be observed across the output resistor R_O . The polarity of the pulse immediately after the beam is switched on will be determined by whether a dot or a dash was previously established at that point in writing.

If a dot was established at a particular element, switching the beam on will not cause any net potential change, since the spot under the beam had already been shifted to the equilibrium potential V_{eq} in writing and had not been shifted by the landing of redistribution electrons between scans. The only effect observed immediately after the beam is switched on will be a negative pulse, capacitively produced across R_O , because of the sudden arrival of the primary electrons and the growth of a cloud of secondary electrons near the bombarded spot.²²

If a dash was previously established, bombardment of its initial portion will cause its potential to shift positively since it was left at a potential below V_{eq} in previous writing and is now shifted to V_{eq} . The net effect immediately after the beam is switched on (due to the sudden appearance of the primary and secondary electrons at the target as in the case of a dot and the shifting of the spot positive by secondary-emission action) will be the production, by capacitive action, of a positive pulse across R_O .

In practice the reading process is accomplished by scanning the elements as in writing with the beam cut off and applying a positive pulse to the control grid as the beam passes each element. All these pulses may be of 2 microseconds duration, for example, so that the beam traces a dot which coincides with either a dot or the beginning of a dash already established at each element in writing. At the same time, the output pulses across R_O are sampled by the output circuit immediately after the initiation of each reading pulse as to

²²A corresponding positive pulse will also be produced immediately after the beam is switched off due to the sudden disappearance of the space charge cloud in front of the target element. This positive pulse is generally not employed in reading.

their polarity. Because of sampling at the beginning of each reading pulse, only the negative portion of the output which occurs in the reading of a dot will be accepted by the output circuit while the positive portion will be rejected.

Erasing. Because each element is shifted to the equilibrium potential V_{eq} when bombarded, it is not necessary to erase the old pattern before writing again. In particular, if a dot is written on a dot, or a dash on a dash, the target elements will be left with the same potentials as before. If a dash is written on a dot, the resulting potentials will be that of a dash, since the production of a dash involves essentially a continuation of the process of forming a dot. If a dot is written on a dash, the initial portion of the dash will be shifted to the equilibrium potential, so that on subsequent reading a negative pulse will be produced in the output, indicating a dot. Since the remaining portion of the dash is not scanned, no signal is produced from this part.

Polarity and Halftones. As indicated above, the operation of this device is such that a short pulse input signal produces a negative output signal, and a long pulse input signal produces a positive output signal.

Since the writing process involves only the production of dots and dashes (yes-no operation), no halftones are produced in the output.

Additional Considerations. As described above, reading can only be accomplished once, since the initial portion of each dash will be shifted to the equilibrium potential in this process. In order to allow reading of the stored information as many times as desired, a regeneration process is combined with the reading process. In this case the reading is accomplished as described above, except that a feedback circuit arrangement is provided which samples the polarity of the output pulse before the reading pulse has ended and which controls the reading pulse in such a manner that, if a positive pulse is observed in the output, indicating the existence of a dash, the reading pulse is lengthened from its 2-microsecond duration to 5 microseconds, as in writing a dash. However, if a negative pulse is observed in the output, the reading pulse is not lengthened. As a result, if a dash was previously written, the regeneration action would rewrite it, and if a dot was written it would remain unchanged.

Regardless of the need for regenerating the dots and

dashes when more than one reading is required, it is also necessary, because of target leakage, to regenerate the stored information periodically (in some cases at least once every few tenths of a second.²³). Furthermore, if only one particular line of the target is read and regenerated many times, it is necessary to regenerate the neighboring lines more frequently since they will be gradually affected by the landing of re-distributed secondary electrons on them from the scanned line.

Instead of using dots and dashes for the storage of yes-no information, other patterns may also be employed, such as superimposed focused and defocused spots or concentric dots and circles. In the first method the focused beam may be defocused by the application of a pulse to the focusing anode, and in the second method (Eckert, Lukoff, and Smoliar, Ref. 61) the circles are generated when desired by switching to the deflection plates two small, high-frequency sinusoidal voltages, 90 degrees out of phase. In this case the target is not scanned at a uniform speed, but the cutoff beam is positioned to each element by a steplike deflection voltage, then pulsed on, either with or without the sinusoidal voltages for the circle applied to the deflecting plates as desired.

B. COLLECTOR-MODULATION TYPES

Equilibrium Writing—Capacity-Discharge Reading (Forrester, Ref. 62)

Description (Fig. 25). This device employs one electron gun, and a target consisting of a thin insulating sheet mounted on a metal backplate. Input signals are applied as either positive or negative potentials to the collector grid (yes-no operation). Output signals are obtained as voltage pulses across R_0 , whose polarity is determined by the input signal previously stored at a particular element.

Writing. Writing is accomplished by positioning the cutoff beam to a particular target element, applying either a positive or a negative potential of 100 volts, for example, to the col-

²³Although it is convenient to employ a conventional cathode-ray tube which automatically produces a visual output, and thus does not require a separate monitor tube, the necessity for rapid regeneration due to leakage may be avoided by employing a target of suitably high insulation, not necessarily luminescent, e.g., silica.

lector grid and pulsing the beam on for a short time. Since the cathode is maintained at a potential of -2000 volts, for example, primary electrons are assumed to strike the target under the condition $\delta_e > 1$, and, since sufficient bombarding time is assumed, the element will be charged to an equilibrium potential slightly positive with respect to the collector potential. In this manner, by positioning the beam to successive target elements, they can be charged to a potential either

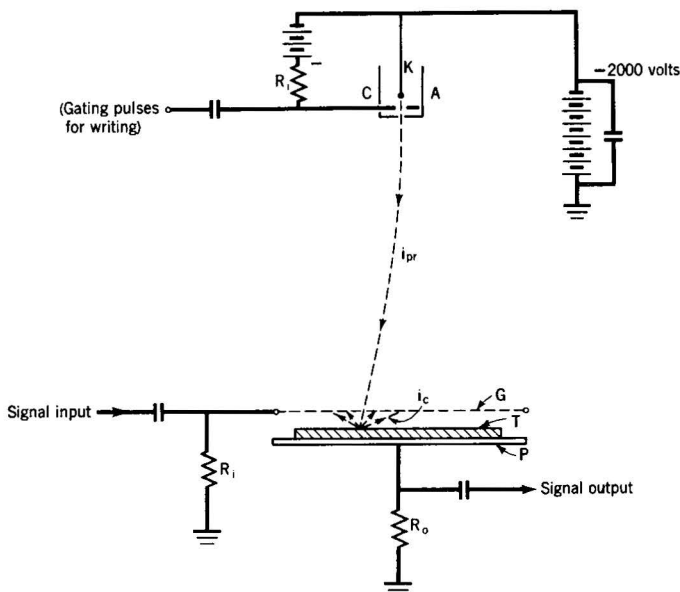

Fig. 25. Computer storage tube (Forrester).

A, accelerating anode; C, control grid; G, collector; i_c , collected current; i_{pr} , primary current; K, cathode; P, metal back-plate; R_i , input resistor; R_o , output resistor; T, insulated target.

approximately 100 volts positive or 100 volts negative with respect to the collector, corresponding to the yes-no information, respectively.

Reading. Reading is accomplished by positioning the cut-off beam to a particular target element and pulsing the beam on with the collector at zero potential. In this case the element will again be shifted to approximately the collector potential since sufficient bombarding time is assumed. If the element was shifted to a positive potential in writing, a nega-

tive pulse would be produced capacitively across R_0 as the element now is shifted to approximately zero potential. Similarly, if the element was shifted to a negative potential in writing, a positive pulse would be produced across R_0 . In this manner, the yes-no information stored at each element can be determined by the polarity of the output pulse produced when the beam is positioned to that element.

Erasing. Since an equilibrium type of writing is employed the target elements can be shifted to new potentials without regard to their previous potentials, thus eliminating the need for a separate erasing action.

Polarity and Halftones. The output polarity of this device is negative in the sense that a positive input signal will cause a negative output signal from the corresponding storage element. Since, as previously indicated, a positive input signal in writing will shift the target element positive in reading, a negative pulse will be produced as the element is discharged.

Since only two potentials are employed in the writing process (yes-no operation), no halftones are produced in the output.

Additional Considerations. Since the reading operation completely discharges the target elements, it is necessary to regenerate the stored information after reading at each element if the information is to be retained. This can be accomplished by a circuit connected to the output such that if a negative pulse is produced in reading (indicating a positive input signal in writing), it will shift the collector to a 100-volt positive potential before the beam is switched off. Similarly, if a positive pulse is produced, the circuit will shift the collector to 100 volts negative before the beam is switched off. In this manner the target potentials are restored to the potentials they acquired in writing, thus allowing repeated reading.²⁴

Although, as described above, the input information is applied to the collector grid, similar operation can be obtained if the positive and negative writing potentials are applied to

²⁴In the regeneration process a pulse of opposite polarity will be obtained in the output following the reading pulse at each element as the element is shifted back to its original potential. It is therefore necessary for the regeneration circuit to respond at each element only to the first pulse, i.e., the reading pulse; otherwise there will be more than one reversal of polarity of each element before the beam is removed.

the backplate instead. In this case the output signal, also obtained from the backplate, will be of positive polarity.

It should be noted that, in general, collector or backplate modulation may cause spurious charging of the target elements due to redistribution of secondaries (see Part III-A-1). However, in this particular tube these effects are not serious because of the large input-signal voltages employed and the yes-no type of operation.

C. BACKPLATE-MODULATION TYPES

1. Bistable Writing—Grid-Control Reading (Rajchman, Refs. 63, 64, 65)

Description (Fig. 26). This device employs a large number of short parallel beams of electrons emitted from elongated flat cathodes which lie side by side in a single plane. Between the cathodes and parallel to them in the same plane are selecting bars. In an adjacent plane is another set of selecting bars perpendicular to the first set so that a series of windows is formed with an element of the cathode inside each window through which an electron beam may flow. By means of a series of external leads the potentials of the individual selecting bars can be controlled. Parallel to the planes of the cathode and the selecting bars are three successive perforated metal plates: a collector plate, a writing plate, and a reading plate. The holes of each plate coincide with the windows formed by the selecting bars. In each hole of the writing plate is an insulated metal eyelet which serves as a storage element. Beyond the reading plate is a Faraday cage formed by two additional perforated plates whose holes coincide with those of the other plates. Between the plates of the Faraday cage are reading output wires parallel to the plates but spaced between the holes. External to the Faraday cage, placed against its outer plate, is a glass sheet coated with phosphor on the side facing the cathode.

The input signal (yes-no information) is applied by allowing primary current to flow through a particular window, applying a voltage pulse to the writing plate, and then cutting off the current through the window either during or at the end of the pulse, depending on the information to be stored by the primary current at the eyelet. The output signal is obtained by determining the presence or absence of a voltage pulse

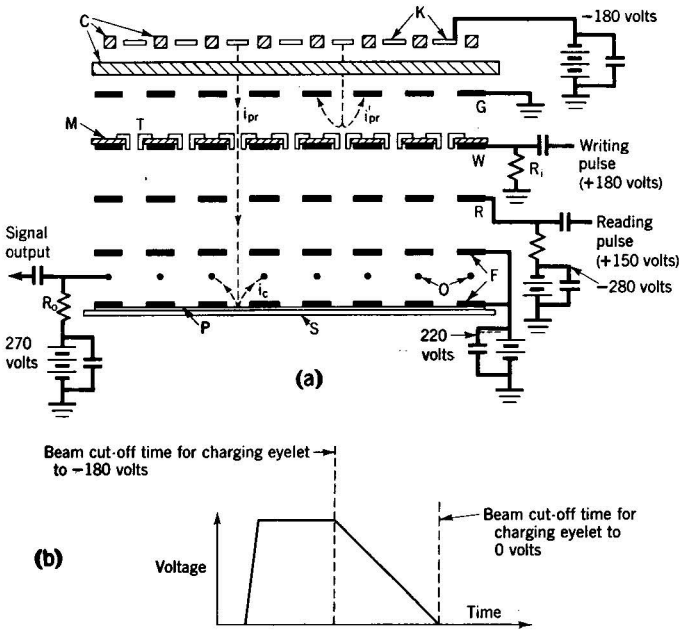

Fig. 26. Computer storage tube (Rajchman). (a), electrode system; (b), pulse applied to writing plate.

C, selecting bars; F, Faraday cage; G, collector plate; i_c , collected secondary current from phosphor; i_{pr} , unreflected primary current (eyelet at 0 volts); i'_{pr} , reflected primary current (eyelet at -180 volts); K, cathode; M, insulating sheet; T, metal storage eyelets; W, writing plate. P, phosphor surface; R, reading-pulse plate; R_1 , input resistor; R_0 , output resistor; S, glass plate; O, reading (output) wires.

across the output resistor R_0 connected to the reading-output wires when a particular window is allowed to pass electrons and a voltage pulse is applied to the reading plate. Output signals are also obtained visually as light spots on the phosphor elements external to the Faraday cage.

Writing. The process of writing consists of charging each insulated writing-plate eyelet either to the potential of the cathode (-180 volts) or approximately the potential of the collector (0 volts). Since the first crossover potential V_{CR1} of the metal eyelets is assumed to be less than 180 volts, the eyelets will tend to acquire either the cathode potential or approximately the collector potential at equilibrium (see Figs. 3 and 4). Although writing can be accomplished in several

ways, a typical method is described below.

The primary current passing through all the windows except one is first cut off by pulsing all the selecting bars to a potential of -250 volts with respect to the cathode except the four bars associated with the particular window, which are allowed to remain at cathode potential. (Current will only flow through a window when all four bars associated with it are at cathode potential, thus preventing the flow of current through windows adjacent to the desired one.)

While current is flowing through the window a positive pulse is next applied to the writing plate, capacitively raising the potential of the eyelets approximately 180 volts. The shape of this pulse is such that it has a rapid rise time, a flat portion of constant amplitude, and a long decay time (see Fig. 26b). If the insulated eyelet was at cathode potential initially, it will suddenly be shifted to a value close to the collector potential. During the flat portion of the pulse, primary electrons striking the eyelet will tend to shift it to the equilibrium potential V_{eq} , slightly positive with respect to the collector (or maintain it at V_{eq} if it has already reached that potential), since the eyelet will be bombarded under the condition $\delta_e > 1$. If the eyelet was at collector potential initially, the pulse will shift it approximately 180 volts positive with respect to the collector. The eyelet will now shift negative during the flat portion of the pulse until it reaches the equilibrium potential V_{eq} . In either case, at the end of the flat portion of the pulse the eyelet will be at approximately the collector potential.

Depending on the desired final potential of the eyelet after writing, the primary current passing through the window is either (a) suddenly cut off at the end of the flat portion of the writing-plate pulse, or (b) allowed to remain on during the time of the slow decay of the pulse. If the primary current is suddenly cut off, the eyelet will merely be lowered from approximately collector potential to the cathode potential (-180 volts) by capacitive action as the pulse decays. If, however, the primary current is allowed to remain on, the eyelet will be maintained continuously at approximately collector potential by secondary-emission action as the pulse decays (assuming sufficient primary current), so that, at the end of the pulse, the eyelet will be at approximately collector potential. In a similar manner, by successively opening the other windows, each storage eyelet can be charged to either cathode or collector potential.

In order to prevent an output signal from appearing during writing, the reading plate is maintained at a potential of -280 volts, 100 volts negative with respect to the cathode, so that no electrons can reach the output circuit.

The writing access time, i.e., the time required for circuit switching and charging a particular element, is about 7 microseconds for the above type of writing. By means of another form of writing (see Ref. 65) the writing-access time can be reduced to 5 microseconds.

Reading. Reading is accomplished by allowing the primary current to flow through a particular window and observing whether a pulse is produced in the output across R_O when a 150 -volt positive pulse is applied to the reading plate. If the eyelet corresponding to this window was left at cathode potential as a result of previous writing, primary electrons would reach it with essentially zero energy and no current would pass through the holes. If the eyelet was left at collector potential, primary electrons would reach it with an energy corresponding to approximately 180 volts and a portion of the electrons reaching it would pass through the hole. The eyelet thus acts as a control grid whose potential determines whether or not electrons pass through it.

Since the pulse applied to the reading plate carries it to a potential 50 volts positive with respect to the cathode, primary current, if it passes through the eyelet, will also pass through the reading plate and continue through the Faraday cage whose potential is 220 volts. These primary electrons will finally strike the phosphor surface outside the cage, producing secondary electrons which will be attracted to the reading output wires whose potential, 270 volts, is 50 volts greater than that of the Faraday cage. As a result, a negative pulse will be produced across the common output resistor R_O , and a visual spot will be produced at the phosphor surface where it is bombarded.

In the same manner, the potential of each eyelet can be individually determined by allowing primary current to flow through the corresponding window and applying a positive pulse to the reading plate. Since the action of the primary current tends to maintain the eyelets at the equilibrium potentials established in writing, any shift in the eyelet potentials due to leakage or gas ions will be compensated by the reading action.

In practical operation the minimum access time for read-

ing, i.e., the time required for switching and obtaining the output signals, is about 3 microseconds.

Erasing. Since, as indicated in the writing process, the potentials of the individual eyelets can be shifted either to the cathode or the collector potential regardless of their previous potentials, no separate erasing action is required before the writing of new information.

Polarity and Halftones. The output of this device is such that if the current through a window is cut off in writing after the decay of the writing-plate pulse, a negative output pulse will be produced in reading. If the current through a window is cut off before the decay of the writing-plate pulse, no output pulse will be observed in reading.

Since the process of writing involves shifting the eyelet potentials to only two possible values (yes-no operation) no halftones can be produced in the output.

Additional Considerations. For monitoring purposes, the potentials of all the storage eyelets can be determined by biasing the reading plate positive with respect to the cathode and allowing current to flow through all the windows simultaneously. In this case, a pattern of bright dots will be observed on the phosphor surface, corresponding to the eyelets which are at collector potential.

In typical tubes the decay time for the insulated eyelets is about 20 milliseconds. In operation, therefore, after each writing and reading action, all the windows are maintained open, since the primary current tends to maintain by a "holding" action of each of the eyelets at the equilibrium potential established in writing. This technique provides an indefinite number of readings regardless of leakage or ion discharge.

Since all the four selecting bars associated with a particular window must be at cathode potential for current to flow through the window, it is possible to connect the selecting bars internally in groups, thus reducing the number of external leads required, although still allowing control of one window at a time. In this device, which employs 256 windows, only 18 external leads are required for separate control of each window. In general, by such a method of grouping the selecting bars, the number of windows individually controlled can be made proportionate to the fourth power of the number of external leads.

2. Bistable Writing—Capacity-Discharge Reading (Dodd, Klemperer, and Youtz, Ref. 60)

Description (Fig. 27). This device employs a write-read gun and a holding gun mounted at one end of the tube, and an insulating storage target at the other end with a fine-mesh collector screen (100 mesh per linear inch) spaced close to the target surface (approximately 0.015 inch). The storage target consists of a mica sheet, approximately 0.005 inch thick, mounted on a metal backplate and having evaporated onto its front surface a mosaic of tiny conducting squares of beryllium (40-100 per linear inch) insulated from each other.

Input signals (yes-no information) are applied to the backplate as either the presence or absence of a positive pulse, while a short-duration positive pulse is simultaneously applied to the control grid of the write-read gun. Output signals are obtained in one of two alternate ways, depending on the method of reading. In one method a pulse of positive or negative polarity is obtained from the backplate across the output resistor R_0 when the reading beam is switched on at a particular element. In the other method a pulse of radio frequency is obtained from the backplate, the relative phase of which (with respect to the radio-frequency intensity-modulated reading beam) determines the information stored at a particular element.

By means of the holding beam, charges lost by the individual elements in reading or through leakage can be replenished so that the elements can be maintained indefinitely at the potentials established in writing.

Writing. As a result of previous writing, each of the target elements (consisting of approximately 10 to 25 mosaic squares) is assumed to be at either approximately zero (collector) potential, or at -100 volts (holding-gun cathode potential). Writing of new information is accomplished with the output resistor R_0 switched to ground and the cutoff beam from the write-read gun deflected to a particular target element. This element can now be shifted to, or maintained at, either zero potential (positive writing) or -100 volts (negative writing), as described below, irrespective of which potential it had previously.

1. Positive Writing. In this case a positive pulse is applied to the control grid of the cutoff write-read gun so that the

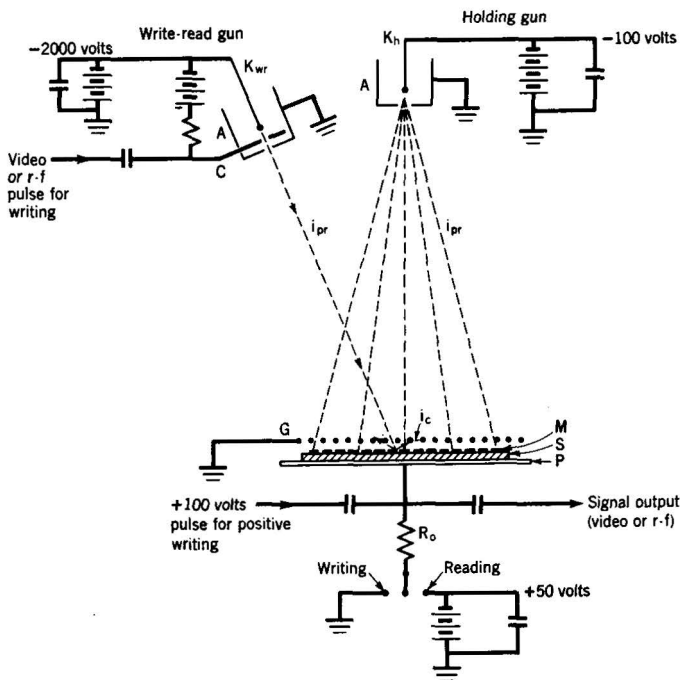

Fig. 27. Computer storage tube (Dodd, Klemperer, and Youtz).

A, accelerating anodes; C, control grid of write-read gun; G, collector grid; i_c , collected current; i_{pr} , primary currents; K_h , cathode of holding gun; K_{wr} , cathode of write-read gun; M, mosaic of conducting squares; P, metal backplate; R_o , output resistor; S, insulating target.

storage element is bombarded for a short time by the primary beam. Since the cathode of the write-read gun is maintained at -2000 volts, the element will be bombarded under the condition $\delta_e > 1$, and, assuming sufficient beam current, it will be shifted to approximately the collector potential if it was initially at -100 volts, or maintained at approximately collector potential if it was already at this potential.

2. Negative Writing. In this case a 100 -volt positive pulse is first applied to the backplate, capacitively raising the potential of all the storage elements by almost the full 100 volts. If the particular element was initially at zero poten-

tial it will be capacitively shifted to approximately +100 volts, whereas if it was at -100 volts it will be shifted to approximately zero potential. While this backplate pulse is still on, a positive pulse is also applied to the control grid of the cutoff write-read gun as in the case of positive writing above. Because of bombardment of the element under the condition $\delta_e > 1$ it will be shifted to, or maintained at, zero (collector) potential. After the control-grid pulse has ended, the backplate pulse is terminated, thus lowering the potential of the bombarded element to approximately -100 volts.

Following establishment of the desired potential at each element, the holding beam is switched on, flooding all the elements simultaneously. Since the cathode of the holding gun is maintained at -100 volts, and the first crossover potential V_{cr1} of the beryllium mosaic is assumed to be about 50 volts, the holding beam tends to maintain the elements either at its cathode potential (-100 volts) or at approximately collector potential, replenishing charges lost by leakage (see Part III-A-2).

Reading. Reading is accomplished by first switching the output resistor R_0 to +50 volts so that the surface of each of the target elements is shifted to approximately +50 or -50 volts, depending on the potentials established in writing. Two types of reading may be employed: video reading or radio-frequency reading, as follows:

1. Video Pulse Reading. In this case the reading beam is deflected to a particular element and a positive pulse is applied to the control grid of the write-read gun. Since primary electrons will bombard the element under the condition $\delta_e > 1$, it will tend to shift toward the collector potential. As a result a video pulse will be capacitively produced across the output resistor R_0 . This pulse will be positive if the element was initially at -50 volts, and negative if the element was at +50 volts.
2. Radio-Frequency Reading. In this case the reading beam is deflected to a particular element and a pulse of 10 megacycles radio frequency is applied to the control grid of the write-read gun. As in video reading, the element will tend to shift toward the collector potential, except that the instantaneous net current leaving or arriving at the target will be modulated by the 10-megacycle varia-

tions in the primary-beam current. If the element is at +50 volts, the 10-megacycle variations in the net electron current leaving the target will be in phase with the variations in the primary current arriving at the target (since $\delta_c > 1$). If the element is at -50 volts, the 10-megacycle variations in the net electron current arriving at the target will be in phase with the primary current at the target (since $\delta_c < 1$). The resulting radio-frequency currents which capacitively arise in the output resistor R_o will correspondingly differ in phase with respect to the primary-current radio frequency, thus indicating whether a particular element is at +50 or -50 volts. This type of reading is employed as a means of separating the output signal from the 50-volt pulse which is applied to the backplate in reading. Since the output signal is at 10 megacycles, it can easily be separated from the backplate pulse which contains lower frequencies.

In order that the information stored at each of the elements may be retained for reading more than once, the reading-beam current must be relatively small, so that the elements are only partly shifted to the collector potential each time they are bombarded by the reading beam. By switching on the holding beam after each reading process the charges lost during reading can be restored and reading may be repeated indefinitely.

Erasing. Since, as discussed above, an element can be shifted to either one of the two desired potentials in writing, irrespective of its previous potential, no separate erasing action is required other than normal writing.

Polarity and Halftones. The output polarity of this device is negative in the sense that a target element charged negative in writing will produce a positive output pulse in video reading. Since bistable writing is employed, no halftone output signals can be obtained in reading.

Additional Considerations. Although a homogeneous or uniform target may also be employed for bistable writing (see Part IV-A-4), the potential gradients between the elements which are at the holding-gun cathode potential and those at collector potential frequently cause migration of the potential boundaries because of leakage. Such effects are considerably reduced by constructing the target with a mosaic of conducting elements as employed in this device. In this case, leakage

currents across the potential boundary at the edge of a mosaic square are replenished by the gain or loss of charge to the entire area of the conducting square through the secondary-emission action of the holding beam. In the case of a homogeneous target, however, these leakage currents can only be replenished by the secondary-emission action in the immediate neighborhood of the boundary itself, since charge migration to the boundary from adjacent parts of the target is prevented by the relatively high insulation of the target material (see Part III-A-2).

With the mosaic target employed, approximately 400 storage elements can be conveniently obtained on a target 4 inches in diameter although as many as about 1000 elements can be obtained under some conditions.

PART VII

TELEVISION-CAMERA STORAGE TUBES (VISUAL-ELECTRICAL)

A. LIGHT-INTENSITY-MODULATION TYPES

1. Redistribution Writing — Redistribution Reading

(Iconoscope)

(Zworykin, Morton, and Flory, Ref. 94)

Description (Fig. 28). This device employs an electron gun, a collector cylinder, and an insulating target. The target consists of a mica sheet approximately 100 microns thick covered with a mosaic of silver-cesium (sometimes antimony-cesium) photoemitting elements on the side facing the electron gun and a conducting film on the opposite side which acts as the backplate.

Input signals are applied as patterns of light focused on the target mosaic. Output signals are obtained as voltage variations from the backplate across the output resistor R_O . Writing and reading can be accomplished simultaneously by means of the combined photoemission and secondary-emission processes at the target.

Writing.

1. Scanning In Darkness (before writing). As a result of scanning the target with the unmodulated electron beam under the condition $\delta_e > 1$ (with $V_k = 1000$ volts, for example) the target surface is assumed to be at approximately collector potential. Actually there will be a potential variation of several volts over the target surface, as mentioned in Part III-A-4, and (periodically during scanning) each element will undergo a positive potential shift of a few volts at the instant of bombardment and gradually shift negative again by the landing of redistribution electrons between successive times of bombardment. (The secondary-emission ratio δ_e may be as high as 5 for this type of photoemitting surface bombarded under the conditions described above. Because of the absence of an

accelerating field most of the secondary electrons emitted from each element will return to the target surface by redistribution.) Because of the low-beam currents employed, however, (approximately 0.1 microampere) for obtaining high resolution, the target elements will not shift sufficiently positive (see Ref. 28) to reach the equilibrium potential V_{eq} , which is 4 or 5 volts positive with respect to the collector for this type of surface.

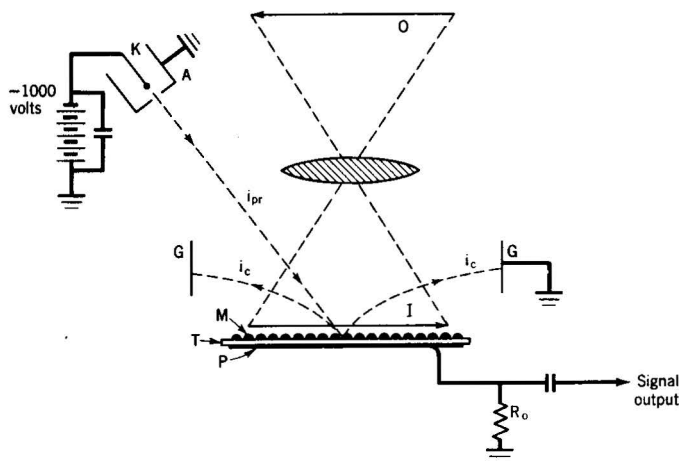

Fig. 28. Television-camera storage tube (Iconoscope).

A, accelerating anode; G, collector; I, light image; i_c , collected current; i_{pr} , primary current; K, cathode; M, photoemissive mosaic; O, visual object; P, backplate; R_o , output resistor; T, insulating target.

2. Actual Writing. Writing is accomplished during the above scanning process by focusing an optical image on the target so that photoelectrons are released from the mosaic in a pattern corresponding to the incident light. Because of the lack of accelerating field between the target surface and the collector, however, the bulk of the photoelectrons, as in the case of the secondary electrons mentioned above, will return to the target by redistribution with relatively few photoelectrons reaching the collector. These redistributed photoelectrons will establish a negative potential pattern related to the pattern of photoemitted electrons.

Neglecting for a moment the time-varying potential shift of each target element due to the scanning action of the primary beam and redistribution of secondary electrons, the result of the photoemission and the redistribution of photoelectrons alone will be such that those target elements receiving the most light will undergo the greatest net loss of electrons, whereas those elements receiving less light will undergo a correspondingly smaller net loss or possible gain of electrons by the combined emission and redistribution of photoelectrons. As a result of this emission and redistribution of photoelectrons, the target surface will acquire a pattern of potential variations determined by the input light pattern. These potential variations are superimposed on the time-varying potentials due to the secondary-emission and redistribution action of the primary beam.

Although, in general, as mentioned above, photoelectrons return to the target surface by redistribution throughout the scanning cycle, photoelectron emitted from target elements which are a short distance in front of the scanning beam are strongly attracted to target elements under bombardment and those just bombarded. Since the bombarded elements are relatively positive they serve as the effective collector for photoelectrons emitted from the elements immediately in front of the beam, which are more negative. As a result, the photoemission of the target elements in front of the beam becomes saturated and these elements become increasingly sensitive during a small fraction of the scanning cycle. This increased sensitivity is called "line sensitivity" (see Refs. 79 and 94).

Reading. The output signal, obtained during the writing process, consists of voltage variations across R_0 caused by capacity currents to the backplate as the target is scanned by the primary beam. If no input signal was applied during writing, i.e., the entire mosaic was maintained in darkness, no current variations will be produced across R_0 during the scanning, since a constant flow of secondary electrons equal to the primary current will reach the collector and a constant flow of secondary electrons will return to the target as a whole by redistribution.²⁵

²⁵ Actually, the flow of secondary electrons to the collector (and redis-

If an input light signal is applied so that a pattern of potential variations is superimposed on the time-varying potentials at the target due to secondary emission and redistribution during scanning, the potential of each element just before bombardment will be, to a varying degree, greater (due to photoemission) or less (due to landing of redistributed photoelectrons) than if the mosaic were in darkness (see Part III-B-2). Under these conditions, as each element is scanned, the number of redistributed electrons returning to the target as a whole as well as to the bombarded spot will vary in accordance with the potential just before bombardment of the element: those elements slightly more positive just before bombardment will cause an increase in the number of secondary electrons returning to the target, whereas those slightly more negative will cause a decrease in the number of secondary electrons returning to the target. (These conditions apply for very low-beam currents of the order of 10^{-6} — 10^{-7} amperes, as used in the Iconoscope where the elements are not fully shifted to the equilibrium potential of the mosaic surface in scanning; see Ref. 37.) Because of this effect, variations will be caused in the net current to the target surface as a whole (and also to the collector) as the elements are scanned. The resulting capacity currents through R_0 constitute the output-voltage variations corresponding to the input light image.

Erasing. In the operation of this device no separate erasing action is necessary before the application of new input light images. This is due to the fact that scanning action of the primary beam tends to gradually remove by means of secondary emission and redistribution effects the potential variations established in writing and also the fact that the application of a new light pattern to the mosaic tends to remove the previous potential variation by the emission of photoelectrons in a new pattern and the associated redistribution of photoelectrons.

Polarity and Halftones. The output polarity of this device

tributed electrons to the target) is not entirely constant, largely because of the variations in the weak accelerating field over the target surface, caused by the geometry of the target-collector system. Such variations produce a "spurious signal" in the output, which appears as a large-area irregular shadow ("shading signal") superimposed on the desired picture when viewed on a cathode-ray tube (see Ref. 30). (This "shading signal" can be reduced by special circuits which generate equal and opposite signals in the output.)

is negative in the sense that those target elements receiving the greatest amount of incident light during writing will produce the most negative voltage variation across R_0 when they are scanned. This relationship is caused by the fact that those elements receiving the greatest amount of incident light are charged most positive by photoemission, so that when scanned they cause the greatest return of redistributed secondary electrons to the target as compared to the collector, thus capacitively producing a negative output voltage across R_0 .

This device is capable of halftone operation. By means of the photoemission processes involved a halftone charge pattern can be stored on the target surface. The resulting pattern in turn causes capacity-current variations to the target backplate which are sufficiently linear as a function of the variations in target potential for a halftone picture output.

Additional Considerations. Since both the photoemission and secondary-emission processes involved in this device are unsaturated, i.e., a large fraction of the photoelectrons and secondary electrons return to the target by redistribution, both the potential variations established in writing and the output voltages generated in reading are substantially reduced from the values which would exist under saturated conditions with a strong accelerating field at the target. Because of these factors the overall efficiency in practical tubes is reduced to about 5 per cent of the efficiency which would exist under saturated conditions (see Ref. 95). However, because of the redistribution writing employed, this device is capable of reproducing halftones over a relatively large range of light levels and also has the advantage of being stable at very high light levels.

In earlier discussions of the Iconoscope (Ref. 95) it was assumed that the output signal, although also understood to be reduced in magnitude by redistribution effects, was caused by the variations in capacity current due to shifting the target elements from their individual potentials to the common equilibrium potential V_{eq} during bombardment. The operation of the Iconoscope as described above is not based on this assumption but rather on the results of later investigations which indicate that at low-beam currents the target elements do not reach the common equilibrium potential V_{eq} and that the output signal is derived from the redistribution currents (see Ref. 37).

Although not discussed above, the target may be constructed with a transparent conducting coating employed for the backplate. In this case (RCA tube type 5527, for example) the optical image can be focused on the mosaic from the back side of the target, permitting the electron gun and the optical system to be on the same axis.

Although the insulating target is usually mica, Iconoscope tubes have also been constructed with thin insulating coatings on a metal backplate, for example, aluminum oxide on an aluminum backplate. Such insulators frequently have a rougher surface, so that the surface insulation is higher, especially in cases where evaporation of barium from the gun cathode occurs. For the same purpose sandblasted instead of smooth mica is used. In this case it is observed that higher contrast output signals are obtained. This may be due either to the prevention of multiple reflections inside the tube or to the increased light absorption by the photoelements of the mosaic.

In practice it is advisable to cut off the scanning beam completely during the flyback time between successive frames, to prevent the appearance of the flyback lines in the output viewing picture. These lines are due to redistribution writing of the scanning beam as it crosses the target surface during the flyback time.

2. Nonequilibrium Writing—Capacity-Discharge Reading (Orthicon) (Rose and Iams, Ref. 84)

Description (Fig. 29). This device employs an electron gun, a collector anode, a decelerating ring, and a storage target. The target consists of a sheet of thin insulating material, approximately 12 microns thick, covered on the side facing the electron gun with a mosaic of photoemitting elements and on the opposite side with a transparent conducting coating which acts as the backplate.

Input signals are applied as light images focused on the mosaic from the rear of the target through the backplate and mica sheet. Output signals are obtained as voltage variations from the backplate across R_0 . Writing and reading can be accomplished simultaneously by means of the combined photoemission and secondary-emission processes at the target surface.

Writing. As a result of previous scanning by the electron beam during reading, the mosaic surface is assumed to be at an equilibrium potential corresponding to that of the electron-gun cathode, -100 volts. Input signals are applied by focusing a pattern of light on the mosaic surface so that photoelectrons

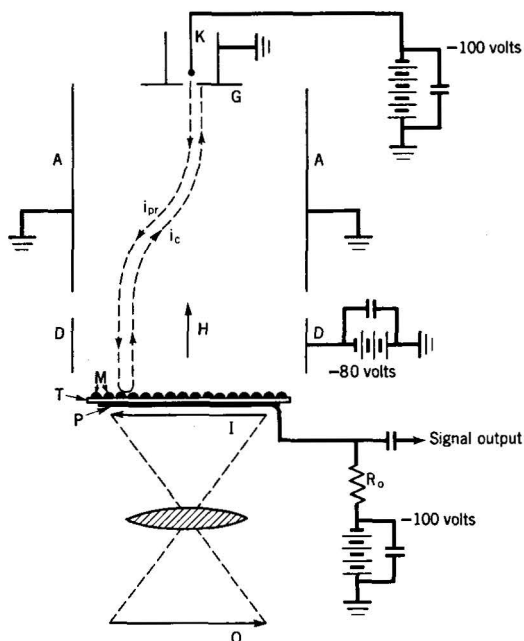

Fig. 29. Television-camera storage tube (Orthicon).

A, accelerating anode; D, decelerating anode; G, collector anode; H, direction of magnetic focusing field; I, light image; i_c , collected current; i_{pr} , primary current; K, cathode; M, photo-emissive mosaic; O, visual object; P, backplate; R_o , output resistor; T, insulating target.

are emitted from the elements in amounts corresponding to the incident light. Since the decelerating ring is maintained at a potential of only -80 volts an accelerating field will be provided for the photoelectrons at the target. (These electrons will be collected on the electron-gun anode [which is at zero potential] at a point close to the gun aperture because of

the magnetic focusing field usually employed.²⁶) As a result of the incident light signal the target surface will acquire a corresponding pattern of positive potential variations. This pattern will be superimposed on the -100-volt initial potential of the storage mosaic.

Reading. Reading is accomplished simultaneously with writing by scanning the target with the primary beam. Those target elements not shifted positive in the writing process since the time of last scanning will be at the cathode potential of the electron gun, -100 volts, and will thus cause the primary electrons to be completely reflected. Those elements which acquired a positive potential shift in writing, however, will permit primary electrons to land, but, since the potential shifts are of the order of a few volts, primary electrons will land under the condition $\delta_e < 1$. These last elements, therefore, will be charged negative and, since sufficient beam current is employed, they will be shifted to the cathode potential of the electron gun during bombardment. In this process each element will receive an amount of negative charge proportional to the positive potential shift acquired in writing. Capacity currents will thus flow to the backplate, and voltage variations will be observed across R_0 corresponding to the potential shift of each element in writing.

Erasing. In the operation of this device no separate erasing action is necessary before the application of new input light signals, since the action of the scanning beam in reading is to automatically shift all the target elements to the cathode potential of the electron gun as required initially for writing.

Polarity and Halftones. The output polarity of this device is negative in the sense that those elements receiving an increasing amount of incident light during writing cause a more negative potential variation to appear in the output during scanning. This results from the fact that the illuminated target elements are charged positive by photoemission during writing, so that, in discharging, a negative potential variation is generated capacitively in the output.

This device is capable of linear halftone operation. Since the photoemission is saturated, i.e., all emitted photoelec-

²⁶Since the velocity of the electrons is very low, they will follow closely the direction of the field lines of the combined magnetic focusing and deflecting fields.

trons are attracted to the anode, the charging of the elements is proportional to the incident light, and, since each element is completely discharged in reading, the output capacity current is proportional to the amount of charge stored at each element.

Additional Considerations. In operation it is necessary to prevent the incident light from reaching high intensities such that the positive potential shift of an element by photoemission is greater than the discharge action of the primary beam per scan. If this occurs, and the storage element becomes charged to a potential above the first crossover potential V_{cr1} , it will be shifted to and maintained at approximately the collector potential by the secondary-emission action of the primary beam. This effect appears in the output picture of a viewing tube as a bright cloud on the picture. Since it tends to spread over the target surface it is frequently referred to as "blooming."

In practice it is necessary to operate the tube with a beam current sufficient to prevent "blooming" of the brightest picture area. However, for input signals having a large range of light levels the apparent detail of the low-light-level picture areas is lost as viewed on a cathode-ray tube. This is due to the strictly linear response of the Orthicon. It is not so, for example, in the Iconoscope, where a saturating effect occurs at high light levels, enabling detail to be seen more readily in the shadow areas when other parts of the input picture are relatively bright.

As a means of producing a sharply focused primary beam with the low electron velocities employed, the tube is immersed in a uniform axial magnetic field. To insure that all the target elements are fully shifted to the cathode potential of the electron gun in scanning, it is essential that the primary electrons strike all the target elements perpendicularly. This is accomplished by employing magnetic fields for deflection as well as for focusing.

Because of the accelerating field at the target surface, redistribution effects,²⁷ as in the case of the Iconoscope, (Part VII-A-1) are avoided. The Orthicon as compared to the Iconoscope thus converts with relative efficiency both the emitted

²⁷Since the primary energy at the target is so low, most of the electrons leaving the target are reflected primaries, not secondaries.

photoelectrons into target-potential variations and the target-potential variations into electrical output signals.

3. Nonequilibrium Writing—Capacity-Discharge Reading

(Storage Orthicon)
(Forgue, Ref. 69)

This device, except for the addition of a secondary-emission amplifier in the output, employs the same basic elements as the Orthicon (Part VII-A-2) and operates on the same principles. It differs from the Orthicon in operation, however, in that the potential variations established in writing are not erased by a single scan of the primary beam in reading but are gradually erased in successive scans. This is accomplished by employing a target whose capacity between the mosaic surface and the backplate is considerably higher than that of the Orthicon and is operated with a low beam current so that the target elements are discharged only a small amount during each scan. (Each of these factors serves individually to lengthen the reading time.) As a result, an output signal may be obtained continuously for as many as several hundred scans after the input-light signal is cut off.

In general, the output of this device does not contain halftones. Although a linear halftone charge pattern can be established in writing as in the case of the Orthicon, because of the high-capacity target the potential variations are relatively small and are in the neighborhood of the low voltage minimum at the left of the δ_c curve of Fig. 6. In reading, the differences in δ_c of differently charged elements will thus be similarly small, producing correspondingly small halftone output signals.²⁸

As in the case of the Orthicon, the Storage Orthicon is subject to "blooming" if insufficient reading-beam current is employed to discharge a target element which is strongly il-

²⁸Actually, because of thermal energy the primary electrons will tend to shift the target elements to a potential a fraction of a volt below that of the electron-gun cathode. In the limited range between this potential and the cathode potential halftones may be produced, since the amount of primary current landing on a target element will continuously decrease (due to the distribution in thermal velocities) as the element is charged negative below cathode potential, thus lowering the rate of discharge. The limited potential range for halftone production, however, is a small fraction of the potential variations normally established in writing.

luminated. Unlike the Orthicon, however, this device does not obtain its output voltage from a resistor in the backplate circuit, but instead employs a secondary-emission amplifier at the gun end of the tube, which amplifies the variations in the collected current returning from the target in the same manner as described for the Image Orthicon (see Part VII-B-2).

4. Photoconductivity Writing—Capacity-Discharge Reading (Vidicon)

(Weimer, Forgue, and Goodrich, Ref. 92)

Description (Fig. 30). This device employs an electron gun, a collector, a photoconductive target, and a fine-mesh screen adjacent to the target on the electron gun side. The target is coated on the back side with a transparent conducting coating which acts as the backplate.

Input signals are applied as a pattern of light focused on the photoconductive target from the rear, and output signals are obtained as voltage variations from the backplate circuit across the output resistor R_o . By means of the combined target photoconductivity and secondary-emission action of the scanning beam, simultaneous writing and reading can be accomplished.

Writing. As a result of previous scanning the target surface is assumed to be at the potential of the cathode, -300 volts. At the same time, because of the -280-volt direct-current bias maintained on the backplate, a 20-volt potential difference will exist between the front and back surfaces of the target. Writing is accomplished by focusing a pattern of light on the target whose conductivity increases at the areas which are illuminated. Since the target conductivity varies with the intensity of the incident light, the elements will shift their potentials positive by varying amounts because of leakage currents to the backplate. In this manner a pattern of potential variations is established on the target surface corresponding to the input-light signal.

Reading. Reading is accomplished simultaneously with writing by scanning the target with the primary beam. As in the case of the Orthicon (Part VII-A-2) those elements which were not shifted positive in writing (remaining at cathode potential) will cause complete reflection of the primary beam, whereas those elements shifted positive in writing will allow

primary electrons to land. These primary electrons will strike the target under the condition $\delta_e < 1$, since the positive potential shifts of the elements are assumed to be less than the first crossover potential V_{cr1} of the target material. Since a relatively high beam current is employed each target element will be shifted to substantially the cathode potential when scanned during reading. In this process an amount of

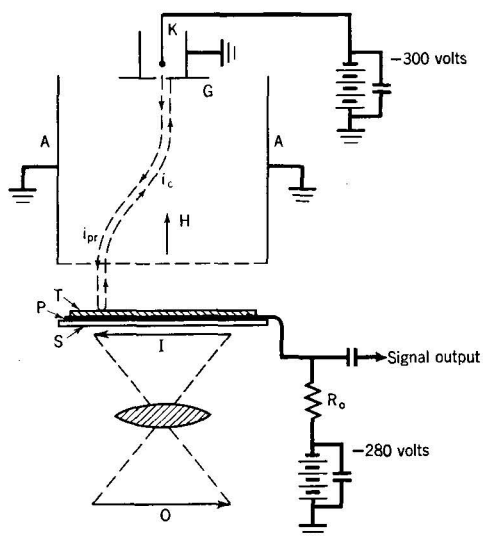

Fig. 30. Television-camera storage tube (Vidicon).

A, accelerating anode; G, collector anode; H, direction of magnetic focusing field; I, light image; i_c , collected current; i_{pr} , primary current; K, cathode; O, visual object; P, transparent conducting backplate; R_o , output resistor; S, glass plate; T, photoconductive target.

negative charge will be deposited on each target element proportional to the amount of potential shift which occurred in writing. As a result, capacity-current variations will flow to the backplate and voltage variations corresponding to the input light signal will be produced across the output resistor R_o .

Erasing. In this device a separate erasing action is not required before the application of new input signals since the action of the scanning beam in reading is to automatically

shift the potentials of the target elements to the cathode potential of the electron gun, as required before writing a new pattern.

Polarity and Halftones. The output polarity of this device is negative in the sense that an increasing amount of incident light on a target element causes a greater negative variation in voltage across R_0 when the corresponding element is scanned in reading. This relationship is caused by the fact that an illuminated element is shifted positive in potential in writing and shifted negative by the scanning beam in reading with a consequent negative potential variation produced capacitively in the output.

This device is capable of halftone operation. The photoconductive process permits a relatively linear charge pattern to be established in writing at the lower light levels. Since each target element is charged to essentially the cathode potential in reading this process also produces a linear output.

Additional Considerations. As in the cases of the Orthicon (Part VII-A-2) and the Image Orthicon (Part VII-B-2), the low-velocity primary electrons are focused and deflected magnetically to maintain good focusing and to cause them to arrive perpendicularly at all points of the target. In order to provide a uniform decelerating electric field for the primary electrons approaching the target, a fine-mesh screen at anode potential is placed at the end of the anode near the target.

Because of the relatively large photoconduction currents which exist in this tube compared to the photoemission currents obtained for the same amount of light in devices such as the Image Orthicon (Part VII-B-2), the sensitivity of the Vidicon to light signals is approximately as great as that of the Image Orthicon, although it does not employ a secondary-emission amplifier.

B. PRIMARY-CURRENT-MODULATION TYPES

1. Redistribution Writing—Redistribution Reading

(Image Iconoscope)

(For Authors, See Refs. 29, 67, 76, 77, 79, 81, 95)

Description (Fig. 31). This device employs an electron gun, a collector, an insulating target, and a separate semi-transparent photocathode arranged so that electrons from the gun and photocathode can strike the same side of the target.

The target consists of a thin, homogeneous sheet of dielectric, such as mica, approximately 100 microns thick, covered on one side with a conducting film which acts as the backplate. On the opposite side facing the electron gun and photocathode the dielectric sheet may be covered with a mosaic material such as Ag-Cs, to increase the secondary-emission ratio of the target surface.

Input signals are applied as light images focused on the photocathode surface, and output signals are obtained as voltage variations from the backplate circuit across the output resistor R_O . Writing and reading can be accomplished simultaneously by means of the combined secondary-emission action at the target of primary electrons from the photocathode and the electron gun.

Writing. Writing is accomplished by focusing an optical

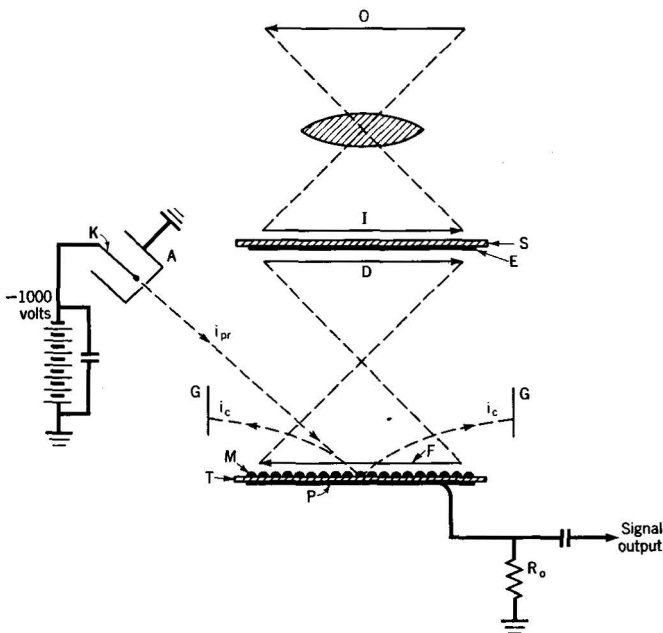

Fig. 31. Television-camera storage tube (Image Iconoscope).

A, accelerating anode of reading gun; D, photoemission pattern; E, photocathode; F, image of photocathode; G, collector; I, light image; i_c , collected current; i_{pr} , primary reading current; K, electron-gun cathode; M, secondary-emission mosaic; O, visual object; P, backplate; R_O , output resistor; S, transparent sheet; T, insulating target.

image on the photocathode while the target is scanned continuously by the unmodulated reading beam from the electron gun. Since the cathode of this gun is at approximately -1000 volts, primary electrons will strike the target surface under the condition $\delta_e > 1$, thus maintaining it at approximately collector potential. At the same time, photocurrents emitted from the semitransparent photocathode are accelerated and focused to form an electron image at the target surface. These electrons, constituting the writing beam, also strike the target surface under the condition $\delta_e > 1$, assuming the photocathode to be maintained at a potential of -2000 volts. As a result of the combined action of the writing and reading beams, potential variations will be established on the target surface corresponding to the pattern of the electron-current image originating at the photocathode.

The mechanism of formation of the potential variations on the target surface is explained in the same manner as the writing mechanism of the Iconoscope described in Part VII-A-1, the only difference being that in the Image Iconoscope the target elements tend to lose electrons as a result of the secondary-emission action of the writing-beam electrons, whereas in the Iconoscope the target elements tend to lose electrons directly by photoemission as a result of the incident light. In both cases, however, the emitted electrons have relatively low velocities and a large fraction return to other parts of the target by redistribution.

Reading. The output signal, obtained during the writing process, consists of voltage variations across R_0 caused by capacity currents to the backplate as the target is scanned by the primary beam. The method of generating the output voltages is identical to that described for the Iconoscope in Part VII-A-1.

Erasing. In the operation of this device no separate erasing action is necessary before the application of new input light images. The reasons for this are basically those stated for the Iconoscope in Part VII-A-1.

Polarity and Halftones. The output polarity of this device is negative in the sense that those elements of the photocathode receiving the greatest amount of light during writing will produce the most negative voltage variations across R_0 when the corresponding storage elements are scanned. Since those elements of the photocathode which receive the greatest

amount of incident light will emit the most electrons, the corresponding target elements when bombarded by these photoelectrons will tend to lose more electrons by secondary emission. When these target elements are scanned, as mentioned in Part III-B-2, there will be an increase in the number of redistribution electrons which return to the target as a whole, thus capacitively producing a negative output voltage across R_0 .

This device is capable of halftone operation. Since the electron currents generated at the photocathode are proportional to the amount of incident light, corresponding halftone-potential variations will be established on the target, as indicated in Part III-D-1. These potential variations will cause relatively linear capacity-current variations to the target backplate during scanning, as indicated in Part III-D-2.

Additional Considerations. Although, as described above, the photocathode is maintained at a potential of -2000 volts, operation is also possible at a potential of -3000 volts, for example, so that primary electrons from the photocathode bombard the target under the condition $\delta_e < 1$ (assuming a target material such as mica) (Ref. 79). In this case, the secondary-emission action of the primary electrons will tend to charge the corresponding target elements negative instead of positive, and the resultant polarity of the output signal will be reversed, i.e., positive.

As mentioned above, the writing and reading mechanisms at the storage target of the Image Iconoscope are similar to those of the Iconoscope. The Image Iconoscope, however, produces signal outputs which may be as much as six to ten times greater than those of the Iconoscope because of (a) an increase in photoemission resulting from a separate continuous photocathode surface which allows an accelerating field at the surface; (b) multiplication of the writing photoelectrons at the target surface by secondary emission; and (c) an increase in the potential variations established on the target because of the higher emission velocities of the secondary electrons as compared to photoelectrons.

As in the case of the Iconoscope, shading signals appear in the output because of the nonuniform field at the target due to the geometry of the collector and target, which results in a nonuniform escape of secondary electrons. In practice, compensating voltages are applied in the output amplifier for the purpose of eliminating these spurious signals.

2. Nonequilibrium Writing—Capacity-Discharge Reading

(Image Orthicon)

(Rose, Weimer, and Law, Ref. 86)

Description (Fig. 32). This device employs an electron gun and accelerating anode mounted at one end of the tube, a semitransparent photocathode mounted at the other end, and a two-sided thin glass storage target having a limited conductivity, approximately 3 microns thick, mounted between them. Adjacent to the target is a fine-mesh collector screen, C, on the photocathode side and a decelerating anode ring, D, on the gun side. At the gun end of the tube is a secondary-emission amplifier whose first dynode, G, is also the aperture-forming anode of the gun.

Input signals are applied as patterns of light focused on the photocathode surface. Output signals are obtained as voltage variations from the multiplier anode N across the output resistor R_O . Writing and reading are accomplished simultaneously by means of the combined secondary-emission action of the writing and reading beams (from the photocathode and electron gun respectively) which bombard the target at the same time.

Writing. As a result of previous scanning, the target surface on the gun side is assumed to be at an equilibrium potential corresponding to that of the cathode of the electron gun, i.e., -100 volts. Due to leakage, the opposite side of the gun is assumed to be at the same potential. Writing is accomplished by focusing a pattern of light on the semitransparent photocathode, maintained at -400 volts, which emits a corresponding pattern of photocurrents from the back side. These currents, constituting the writing beam, strike the target surface with an energy of about 300 volts, bombarding it under the condition $\delta_e > 1$. Since the collector screen adjacent to the target is maintained at a potential of approximately -99 volts, i.e., 1 or 2 volts positive with respect to the target, secondary electrons will be attracted to the collector. As a result the bombarded elements will be shifted positive in varying degrees depending on the amount of photocurrent striking them, and a pattern of potential variations will thus be established on the target corresponding to the input-light signal. (Since the target elements cannot shift positive more than a slight amount above that of the collector

screen, the total potential shift possible in writing is about 1 volt.)

Reading. Reading is accomplished during the writing process by scanning the target with the reading beam. Since the target is very thin, it has a high capacity between both sides so that potential variations established on the photo-

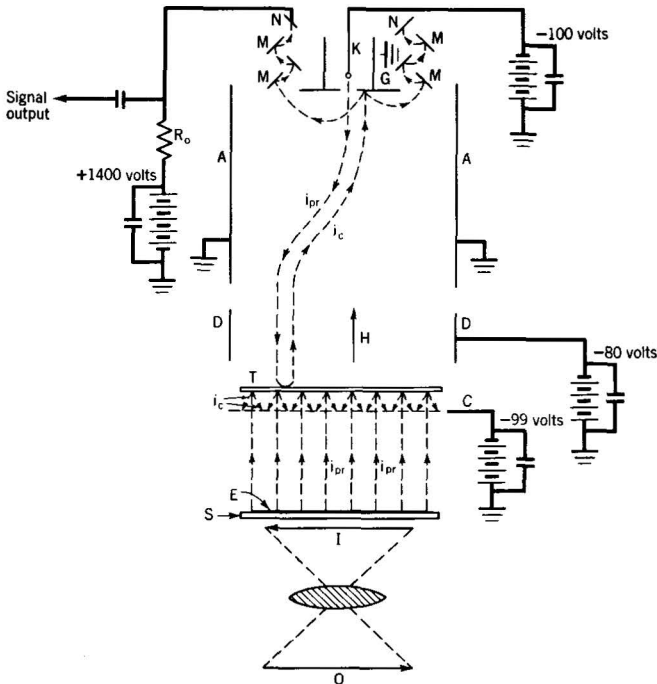

Fig. 32. Television-camera storage tube (Image Orthicon).

A, accelerating anode; C, collector screen; D, decelerating anode; E, photocathode; G, collector anode and first dynode; H, direction of magnetic focusing field; I, optical image; i_c , collected currents; i_{pr} , primary currents; K, reading-gun cathode; M, multiplier dynodes; N, multiplier anode; O, visual object; R_o , output resistor; S, transparent sheet; T, insulating target.

cathode side in writing will appear on the reading-beam side with almost the same magnitude. As in the case of the Orthicon (Part VII-A-2), the electron beam scans the target with very low-energy primary electrons (approximately 1 volt or less), which are either entirely reflected from those elements whose potential was not shifted in writing or which land under

the condition $\delta_e < 1$ on those elements shifted slightly positive in writing. Since sufficient beam current is employed, each target element on the reading-beam side of the target will be shifted to the cathode potential of the reading gun each time it is bombarded (once per scan). In the scanning process varying amounts of negative charge will be deposited on the target elements, depending on their initial potentials, and at the same time corresponding variations will arise in the collected current i_c , which consists of secondary and reflected electrons returning from the target. These current variations are amplified by a factor of approximately 1000 by the secondary-emission electron multiplier and generate signal voltage variations across the output resistor R_0 .

Immediately after each element is scanned by the reading beam, however, it will still have the positive charge established on the photocathode side acquired during writing, although it acquired an essentially equal negative charge on the scanning-beam side during reading. In order to eliminate these charges, the target glass is made sufficiently conducting so that in the time between successive scans these charges neutralize each other by leakage. If the target does not have sufficient conductivity, "picture sticking" will occur. This causes the previous picture to appear in the output, but reversed in polarity, when the photocathode is flooded with light or illuminated with a new picture. The "sticking" effect is due to the fact that failure of the charges to neutralize each other leaves a residual pattern of potential variations on the photocathode side of the target after reading. When new writing-beam electrons from the photocathode arrive at the target, the collected current ratio δ_c from the more positive elements is less than from the other elements, since a reduced accelerating field exists between them and the collector mesh. A new pattern of charges is thus established on the target such that the elements previously charged most positive acquire the least amount of additional positive charge, producing a reversed picture in reading. If the resistivity of the target is high by only a small amount, the "sticking" effect will appear when the tube is first turned on but will disappear as the tube warms up.

Erasing. In this device separate erasing action is not required before the application of new input signals since the combined action of the reading beam and the target leakage is

to remove the potential variations established in writing and leave both sides of the target surface at the reading-beam cathode potential.

Polarity and Halftones. The output polarity of this device is positive in the sense that those elements of the photocathode receiving an increasing amount of incident light during writing cause a more positive voltage variation in the output when the corresponding element of the storage target is scanned. This results from the fact that those photocathode elements receiving the most light cause the corresponding storage elements to shift most positive in potential, so that these elements acquire the most electrons during discharge in scanning. This in turn causes a reduction in the amount of collected current returning from the target, so that a decrease results in the electron current through the output resistor, and therefore a more positive output-voltage variation.

This device is capable of establishing a halftone charge pattern on the storage target in writing and generating a corresponding halftone electrical output. For low-intensity picture signals the charging of the target is strictly proportional to the amount of light incident on the photocathode. However, for higher light intensities, as the target elements become more positive, the accelerating field to the collector becomes correspondingly small and a saturating effect occurs. When the light levels are very high, the lack of accelerating field between the target and collector allows redistribution to take place. This results in bright areas being surrounded by black borders in the output picture, since the secondary electrons emitted from the bright areas land on the surrounding elements and drive them negative. Since, in reading, each target element is completely discharged to the reading-gun cathode potential, the current variations in the output are linear with respect to the target-potential variations established in writing.

Additional Considerations. As in the case of the Orthicon (Part VII-A-2) the entire tube is immersed in a uniform axial magnetic field. This field serves simultaneously to maintain the low-velocity primary beam in focus and to maintain the writing-beam electrons from the photocathode in a focused pattern at the target. Together with magnetic deflection fields, the magnetic focusing field also serves to maintain the primary beam perpendicular to the target as it scans the surface.

In general, the Image Orthicon has a greater sensitivity than the Orthicon because of its separate photocathode and the use of a secondary-emission current multiplier. It has the advantage also, compared to the Orthicon, of being stable over a large range of input-light levels (approximately several hundred to one) and is superior for reproducing scenes containing both highlights and shadows because of the saturating effect at the higher light levels. Compared to the Iconoscope the Image Orthicon is about one hundred times more sensitive and, like the Orthicon, is free from shading signals.

3. Nonequilibrium Writing—Capacity-Discharge Reading

(Image Isocon)
(Weimer, Ref. 89)

This device (Fig. 33) employs an electrode and target structure similar to that of the Image Orthicon (see Part VII-B-2) and operates with approximately the same potentials. Input signals are similarly applied as patterns of light, and output signals are obtained from the secondary-emission multiplier. The Image Isocon differs from the Image Orthicon, however, in the method by which the output signal is produced. As described below, this method reduces the noise components in the output which arise from the shot noise of the reading beam.

The noise reduction in the Image Isocon depends on the separation into two parts of the reading-beam electrons returning from the target. These returning electrons consist of (a) those specularly reflected, i.e., reflected in front of target elements which are fully discharged from previous scanning, and (b) electrons which are scattered, i.e., electrons which strike the more positive target elements and are then reflected. (Since the electrons striking the target have energies of about 1 volt or less they do not produce secondaries but, as mentioned in Part I-D, a fraction are reflected with no loss in energy after elastic collision with the target atoms.)

Due to collision with the target atoms the scattered electrons returning to the electron multiplier have trajectories slightly displaced from the trajectories of the specularly reflected electrons. By proper positioning of the edge of the first dynode of the multiplier, only the scattered electrons are intercepted. These intercepted electrons produce second-

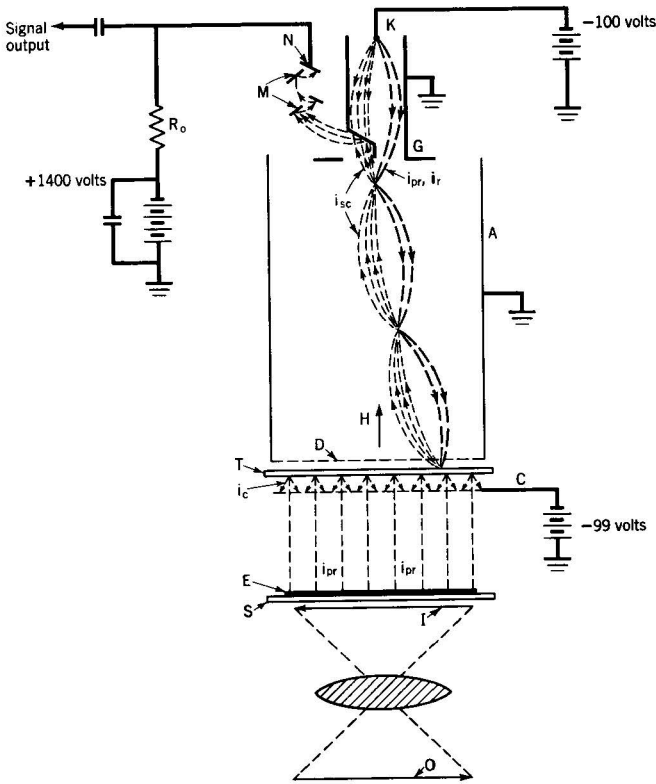

Fig. 33. Television-camera storage tube (Image Isocon).

A, anode; C, collector screen; D, anode screen; E, photocathode; G, first dynode and primary-beam accelerating anode; H, direction of magnetic focusing field; I, optical image; i_c , collected electrons; i_{pr} , primary electrons; i_r , reflected electrons; i_{sc} , scattered electrons; K, reading-gun cathode; M, multiplier dynodes; N, multiplier anode; O, visual object; R_o , output resistor; S, transparent sheet; T, insulating target.

aries at the dynode, which in turn enter the multiplier.

Since the more positive target elements (charged previously in writing) allow more reading-beam electrons to land on them, more scattered electrons are produced as these elements are discharged by the reading beam. As a result the electron currents obtained from the multiplier output vary in accordance with the amount of positive charge on the individual elements. In other words, the target areas corresponding to the brighter picture areas of the photocathode cause greater electron currents in the output.

Since the shot-noise energy in the output is proportional to the instantaneous current reaching the first dynode, the Image Isocon produces a relatively small amount of noise in the output for low-light-level signals and correspondingly higher noise levels for the brighter signals. By comparison, in the Image Orthicon the greatest number of electrons return to the multiplier from target elements least positive, i.e., from elements corresponding to signals of low light level. The shot noise in the output is thus greatest for low-level input signals. As a result, for low light levels the signal-to-noise ratio of the Image Isocon is approximately four times greater than for the Image Orthicon, whereas for high light levels it is approximately equal to that of the Image Orthicon.

The Image Isocon, like the Image Orthicon, is capable of halftone operation. The halftone pattern established in writing is linear at the low input levels and saturated at the higher levels. In reading, the scattered electrons entering the multiplier are proportional to the target-element potentials, so that this process is linear.

The output polarity of the Image Isocon is negative, i.e., reversed from that of the Image Orthicon, since the more positive target elements cause an increase in the number of scattered electrons returning to the multiplier dynode, and consequently a more negative potential across the output resistor because of the greater electron current in the output.

Since the Image Isocon produces output-current variations due to the changes in the trajectories of the electrons returning from the target, it is also capable of producing output signals without the reading-beam electrons landing on any of the target elements. It thus can be operated with grid-control reading as well as capacity-discharge reading (see Part III-B). If, for example, the cathode potential of the reading beam is set at -98 volts, all the reading-beam electrons will be reflected a short distance before the target surface, which is assumed, for instance, to have potential variations between -99 and -100 volts. Since the charge pattern established in writing produces local electrostatic fields with components parallel to the target surface, the reflected electrons will acquire slightly varying trajectories as a result of deflection by the local electrostatic fields at the target. In a similar manner, as described above, the output signal can be derived from the variations in the number of electrons strik-

ing the specially positioned first dynode. However, since output signals produced in this manner correspond to the potential gradients at the target surface, not to the potential variations themselves, the signal appears differentiated with respect to the input and is thus of limited usefulness except for applications involving, for example, maps or other line pictures.

4. Nonequilibrium Writing—Grid-Control Reading (Knoll and Randmer, Refs. 52, 56)

Description (Fig. 34). This tube employs an electron gun, a semitransparent photosurface, a collector cylinder, and a storage target. The target consists of a metal backplate covered on the side facing the gun and photosurface with a mosaic of insulating particles such as vitreous silica.

Input signals are applied as patterns of light focused on the surface of the photocathode. Output signals are obtained as voltage variations from the backplate across the output resistor.

Writing. As a result of scanning the target with the primary beam during previous erasing, the mosaic of insulated particles is assumed initially to be at approximately the potential of the metal backplate, i.e., -100 volts. For writing, a pattern of light is focused on the photosurface so that a corresponding pattern of photocurrents is emitted from the opposite side. Since the photocathode is maintained at a potential of -110 volts, the photoelectrons will reach the target elements with an energy corresponding to 10 volts, tending to charge them negative toward the potential of the photocathode. The target elements will thus be bombarded under the condition $\delta_e < 1$. However, since the currents emitted from the photocathode are small, the mosaic elements will not be completely shifted to the potential of the photocathode, but will be shifted negative by varying smaller amounts determined by the amount of primary current striking each element. As a result, a pattern of potential variations, negative with respect to the backplate, will be established on the mosaic surface, corresponding to the input-light signal.

Reading. Reading is accomplished by scanning the target with the unmodulated primary beam from the electron gun whose cathode is maintained at -5000 volts, so that primary

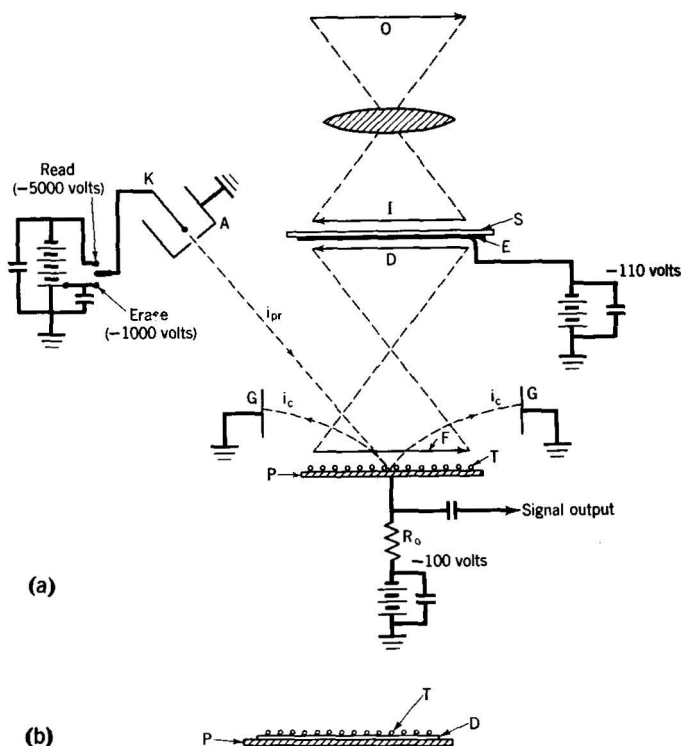

Fig. 34. Television-camera storage tube (Knoll and Randmer).

(a), tube with insulating-particle mosaic.

A, accelerating anode; D, photoemission pattern; E, photoemitting surface; F, image of photocathode; G, collector; I, optical image; i_c , collected current; i_{pr} , primary reading current; K, cathode; O, visual object; P, metal backplate; R_o , output resistor; S, transparent insulating layer; T, mosaic of insulating particles.

(b), target with metal-particle mosaic.

D, insulating sheet; P, metal backplate; T, mosaic of metal particles.

electrons strike the target with an energy corresponding closely to the second crossover potential V_{cr2} of the insulating mosaic. Since the potential variations established on the mosaic in writing are assumed to be relatively small, the secondary-emission ratio δ_e of each insulating element will be close to unity, and the elements will shift their potentials relatively slowly during scanning.

In the scanning process, however, secondary electrons will also be generated at the exposed surface of the metal

backplate. These secondary electrons, which for the most part have energies less than several volts, must pass between the insulated particles in order to reach the collector. Since the insulated particles are charged negative to varying degrees with respect to the backplate, they act as control grids, creating decelerating fields which vary from element to element over the target surface. During scanning, therefore, the value of δ_c will vary and current variations will be produced in the backplate circuit. These current variations will, in turn, produce voltage variations across the output resistor R_o , corresponding to the input signal.

In the above process, the reading time is determined by the rate of removal or addition of charges on the insulated elements. Ideally, if each insulated element were bombarded with primaries exactly under the condition $V_{pr} = V_{cr2}$, the reading time would be indefinite (neglecting leakage and discharge due to positive ions), but since the insulated elements have potential variations as a result of writing this condition is not possible and the elements will of necessity have secondary-emission ratios, δ_e , which may be slightly greater or less than unity. In reading, the individual elements will thus shift their potential at a rate determined by the degree of variation in δ_e from unity. For long reading times, it is necessary that the variations in δ_e be small for the given potential variations on the target surface. This means essentially that the insulating material employed should have a δ_e/V_{pr} curve whose slope is small at the point V_{cr2} (see Fig. 6).

Erasing. Erasing is accomplished by scanning the target with the primary beam from the electron gun, whose cathode is now maintained at -1000 volts, so that all the mosaic elements are bombarded under the condition $\delta_e > 1$. Since sufficient beam current is assumed, each insulating element will be shifted during bombardment to approximately the potential of the backplate. Although, in the case of a homogeneous insulating target, bombardment of the surface under the condition $\delta_e > 1$ would shift it to approximately the collector potential, in the case of an insulating mosaic the elements will not be shifted positive by more than a small amount above the backplate potential. If this did occur, secondary electrons emitted from the adjacent exposed areas of the metallic blackplate would be attracted to the insulating elements, thus counteracting the positive potential shift. Also, any tendency of the

insulating particles to become positive would cause coplanar grid effects (the exposed areas of the backplate acting as the control grid) in reverse of the actual reading process, thus preventing secondary electrons from leaving the insulating particles. Therefore, as a result of scanning under the condition $\delta_e > 1$, the mosaic elements will be shifted to the -100 -volt backplate potential initially assumed before writing.

Polarity and Halftones. The output polarity of this device is positive in the sense that an increasing amount of light on an element of the photocathode will cause a more positive voltage variation in the output when the corresponding element of the storage target is scanned in reading. This results from the fact that an increase in the amount of incident light causes an increase in the amount of photoemitted current, which in turn shifts the corresponding mosaic element more negative. In reading, this mosaic element reduces by grid action the number of secondary electrons escaping to the collector, thus causing a reduction in the electron current flow through the output resistor and consequently a more positive output-voltage variation.

This device is capable of halftone operation. Since non-equilibrium writing is employed, a halftone charge pattern can be established on the insulating mosaic. In reading, a halftone output signal can also be produced because of the grid-control action of the mosaic. The linearity in reading will depend largely on the insulating elements having potentials in the proper operating range with respect to the backplate potential.

Additional Considerations. As described above, the target elements are bombarded during reading with primary electrons whose energy at the target corresponds closely to the second crossover potential V_{cr2} of the insulating material. In practice, however, the value of V_{cr2} may vary locally from element to element of the mosaic because of differences in the surface states of the material. These more or less fixed variations in V_{cr2} over the target surface may cause variations in the value of δ_e during reading which are relatively large as compared with the deviations from unity caused by the potential pattern established in writing. As a result the potentials of some of the insulated elements may be shifted more rapidly, and the reading time for the various parts of the target will not be constant. If this is to be avoided,

insulating particles with highly uniform secondary-emission characteristics must be employed.

Since the value V_{cr2} of metals is relatively uniform and stable, this problem can also be solved by constructing the target as indicated in Fig. 34b with a mosaic of metallic control elements instead of insulating particles. In this case, the metallic elements are insulated from each other by means of a thin insulating sheet between them and the backplate. Operation is essentially the same as before except that, in writing, both the metallic elements and the exposed surface of the insulator are charged, instead of only the insulating elements as before. In reading, the target is bombarded with electrons whose energy corresponds approximately to the value V_{cr2} of the metal particles, so that the potential shift of the particles is relatively small. As in the previous case secondary electrons emitted from the areas between the particles are controlled by the coplanar grid action of the particles. The primary beam is assumed to have sufficient energy, however, so that, instead of charging the surface of the insulated areas between the particles positive by secondary emission, it causes bombardment-induced conductivity within the thin insulating sheet, thus maintaining the surface at approximately the potential of the backplate. The insulating material covered or shielded by the metal particles, however, is not directly bombarded and thus retains its insulating quality, so that the metal particles above it hold their negative charges and can control the emission of secondary electrons from the adjacent areas.

PART VIII
BIBLIOGRAPHY

A. SECONDARY EMISSION, PHOTOEMISSION, PHOTO-
CONDUCTIVITY, AND BOMBARDMENT CONDUCTIVITY

1. F. Ansbacher and W. Ehrenberg, "Electron Bombardment Conductivity," Nature, 164, p. 144, 1949. (Experiments made with dielectric films sandwiched between conducting layers one of which is evaporated onto the surface.)
- 1a. F. Ansbacher and W. Ehrenberg, "Electron Bombardment Conductivity of Dielectric Films," Proc. Phys. Soc. (London), Series A, 36, p. 362, 1951.
2. H. Bruining, "Die Sekundärelektronen-Emission fester Körper" (The secondary emission of solids), Springer, Berlin, 1942. (Relatively complete text on subject.)
3. H. Daene and G. Schmerwitz, "Prüfung der theoretischen Erklärungen der Sekundärelektronen-Emission von Isolatoren" (Proof of theories of secondary emission of insulators), Zeit. Phys., 53, p. 404, 1929.
4. M. F. Distad, "Equilibrium Currents Induced in Zincblende by Electron Bombardment of Negative Electrode," Phys. Rev., 80, pp. 879-886, 1950.
- 4a. W. Ehrenberg, Chi-Shi Lang, and R. West, "The Electron Voltaic Effect," Proc. Phys. Soc. (London), Series A, 36, p. 424, 1951.
- 4b. S. V. Forgue, R. R. Goodrich, and A. D. Cope (RCA), "Properties of Some Photoconductors, Principally Antimony Trisulfide," RCA Rev., XII, pp. 335-349, 1951.
- 4c. A. L. Hughes and L. A. Dubridge, Photoelectric Phenomena, McGraw-Hill Book Co., New York, 1932. (Extensive survey of experimental and theoretical aspects of photoemission and photoconductivity.)
5. G. Kalckhoff, "Über die Geschwindigkeitsverteilung der an Isolatoren ausgelösten Sekundärelektronen (Velocity distribution of secondary electrons from insulating materials), Zeit. Phys., 80, pp. 3-5-323, 1933.
6. M. Knoll and B. Kuehnreich, "Sekundäre Elektronenemission von Kristallphosphoren und MgO bei hohen Elektronengeschwindigkeiten" (Secondary electron emission of phosphors and MgO at high electron energies), Reichsberichte Phys., pp. 108-110, 1944.
7. E. Krautz, "Zur Aufladung u. Aufladungserniedrigung elektronenbestrahlter Leuchtstoffe und Halbleiter" (Charging and discharging of electron-bombarded luminescent materials and semiconductors), Zeit. Phys., 114, pp. 459-464, 1939. [Decelerating field at a luminescent screen bombarded with fast electrons ($\delta_e < 1$) decreased by additional bombardment with slower ($\delta_e > 1$) electrons.]
8. H. B. Law, "Formation of Insulating Layers by the Thermal Decomposition of Ethyl Silicate," Rev. Sci. Instr., 20, p. 958, 1949.

9. K. G. McKay, "Secondary Electron Emission," Advances in Electronics, I, Academic Press, New York, 1948, pp. 65-130. (Exhaustive survey, insulators.)
10. K. G. McKay, "Electron Bombardment Conductivity in Diamond," Phys. Rev., 74, pp. 1606-1621, 1948, and 77, pp. 816-825, 1950.
11. K. G. McKay, "A Pulse Method of Determining the Energy Distribution of Secondary Electrons from Insulators," Jour. Appl. Phys., 22, pp. 89-94, 1951.
12. H. Mahl, "Feldemission aus geschichteten Kathoden bei Elektronenbestrahlung" (Field emission from striated cathodes under electron bombardment), Zeit. Tech. Phys., 18, pp. 559-563, 1937. ("Malter effect" on 0.2-micron cesiated Al_2O_3 target, observed in electron microscope. Positive potential on the surface determined as 10-40 volts; measurement of velocity distribution of "field electrons.")
13. S. T. Martin and L. B. Headrick, "Light Output and Secondary Emission Characteristics of Luminescent Materials," Jour. Appl. Phys., 10, pp. 116-127, 1939.
14. C. W. Mueller, "The Secondary Emission of Pyrex Glass," Jour. Appl. Phys., 16, pp. 453-458, 1945. [50 to 10,000 volts; sharp max. at 400 volts ($\delta_e \cong 2.4$); upper crossover at -2300 volts.]
15. R. R. Newton, "Space-Charge Effects in Bombardment Induced Conductivity through Diamond," Phys. Rev., 75, pp. 234-246, 1949.
16. W. B. Nottingham, "Electrical and Luminescent Properties of Willemite under Electron Bombardment," Jour. Appl. Phys., 8, pp. 762-778, 1937, and 10, pp. 73-83, 1939. (Floating target potential as a function of final anode potential.)
17. L. Pensak, "Conductivity Induced by Electron Bombardment in Thin Insulating Films," Phys. Rev., 75, pp. 472-478, 1949. (Two-beam scanning technique, steady-state currents observed.)
18. L. Pensak, "Electron Bombardment Induced Conductivity in Selenium," Phys. Rev., 79, pp. 171-172, 1950.
- 18a. A. Rose, "An Outline of Some Photoconductive Processes," RCA Rev., XII, pp. 362-414, September, 1951.
19. H. Salow, "Über die Winkelabhängigkeit der S. E. von Isolatoren" (Secondary emission of insulators as a function of angle of incidence), Phys. Zeit., 41, pp. 434-442, 1940. (Pulse method as described in Zeit. Tech. Phys., 21, p. 8, 1940; δ_e varies for glass at 3500 volts from 1.2 to 3, at 500 volts from 3.2 to 4 between 0 and 70°; similar for mica; slope is smaller for ZnS; discussion of former measurements.)
20. P. K. Weimer, "Measurement of Secondary Emission of Insulators at Low Primary Energies," Phys. Rev., 74, p. 1219, 1948.
- 20a. P. K. Weimer and A. D. Cope, "Photoconductivity in Amorphous Selenium," RCA Rev., XII, pp. 314-334, September, 1951. (Study of photoconductivity by television scanning techniques.)

B. CHARGING PROCESSES OF AN ELECTRON-BOMBARDED INSULATING SURFACE AND THEIR MEASUREMENT

21. H. Bey, "Aufladepotentiale elektronenbestrahlter Leuchtmassen," (Potentials of electron-bombarded luminescent materials), Phys. Zeit., 39, pp. 605-611, 1938. (Influence of charge potentials on brightness of luminescence and electron spot size; slope of equilibrium curve above

- second crossover for glass and luminescent materials $< 45^\circ$, which is explained by a loss of charge of the screen due to the electric field in its volume. Under bombardment with $2 \times 10^{-6} \text{A/cm}^2$ and 8 kilovolts, second crossover shifts for Willemite from 6.5 to 4 kilovolts in 50 minutes, similar in CaWO_4 , CdWO_4 and CdS:Cu .)
22. C. Hagen, "Aufladepotentiale, Sekundäremission u. Ermüdungserscheinungen elektronenbestrahlter Metalle u. Leuchtsubstanzen" (Equilibrium potentials, secondary emission and fatigue of electron bombarded metals and luminescent materials), *Phys. Zeit.*, 40, pp. 621-640, 1939. (Slope of equilibrium potential versus collector potential above second crossover, which is 45 degrees for floating metals, decreases for zinc silicate from 34 to 27 degrees if field strength at the target is increased from 1500 to 3000 volts per centimeter. Reason: Increase of secondary emission factor by the electric field in the interior of the insulator. Smooth glass surface shows second crossover at 2.3 kilovolts and 39-degree slope, powder surface from the same glass shows second crossover at 3.7 kilovolts and 26-degree slope. Reason for higher crossover is a greater angle of incidence, reason for smaller slope is higher field strength at the top of glass particles. Measurement of target potential with electrometer between target and collector.)
 23. C. Hagen and H. Bey, "Aufladepotentiale elektronenbestrahlter Isolatoren" (Charge potentials of electron bombarded insulators), *Zeit. Phys.*, 104, pp. 681-684, 1937. (Measurement of screen potential by electrometer filament within the collector-target field; second crossover of secondary-emission curve 1900 volts for glass, 4300 volts for willemite, 3100 volts for zinc silicate, 6000 volts for CaWO_4 .)
 24. W. Heimann and K. Geyer, "Ein Verfahren zur direkten Messung der Sekundärelektronen-Ausbeute an Isolatoren" (A method for direct measurement of the secondary emission of insulators), *El. Nachr. Technik.*, 17, pp. 1-5, 1940. (Pulse method employing oscilloscope; secondary-emission characteristics of mica, alkali-glass, and electrolytically prepared Al_2O_3 between 100 and 2500 volts; second crossover for mica and Al_2O_3 1700 volts; for glass, 450 volts.)
 25. W. Heimann and K. Wemheuer, "Über die Ursache des Störsignals bei Bildfängerröhren" (On the cause of the shading signal in picture pickup tubes), *Zeit. Tech. Phys.*, 19, pp. 451-454, 1938. (Model of mosaic potential during scanning; oscillograms from an insulated element within the mosaic plate.)
 26. W. Heimann and K. Wemheuer, "Beitrag zur Wirkungsweise des Elektronenstrahl-Bildabtasters" (Mechanism of the Iconoscope), *El. Nachr. Technik.*, 15, pp. 1-9, 1938. (Measuring of mosaic surface potential by coplanar probe observed by television picture and oscillogram.)
 27. H. Hintenberger, "Über Sekundärelektronen-Emission u. Aufladungserscheinungen an Isolatoren" (Secondary-electron emission and charge effects on insulators), *Zeit. Phys.*, 114, pp. 98-109, 1939. (Mica, NaCl , Al_2O_3 in 4-micron layer; for bombarding energies above first crossover of secondary-emission curve; negative space charge below the surface of insulator is produced which draws an electron current from the interior to the surface. δ_e may suddenly change from $\delta_e > 1$ to $\delta_e < 1$ after the development of this space charge.)
 28. M. Knoll, "Aufladepotential und Sekundäremission elektronenbestrahlter Körper" (Equilibrium potential and secondary emission of electron-

- bombarded bodies), *Zeit. Tech. Phys.*, 16, pp. 467-475, 1935. (Equilibrium potential curve of floating targets, monoscope; scanning microscope.)
29. M. Knoll, "Änderung der sekundären Elektronenemission von Isolatoren und Halbleitern durch Elektronenbestrahlung" (Change of secondary emission of insulators and semiconductors by electron bombardment, *Naturwissenschaften*, 24, p. 345, 1936. (Image Iconoscope effect with writing-beam spot; positive or negative picture as a function of backplate-voltage; storage time on Al_2O_3 , several minutes.)
 30. M. Knoll, "Die Bedeutung des 'Streuelektronen-Effekts' für die Wirkungsweise der Bildabströhren" (The significance of the "redistribution-effect" for the operation of television pickup tubes), *Zeit. Tech. Phys.*, 19, pp. 307-313, 1938. [Redistributed secondary electrons produce negative equilibrium potential on the insulating surface of pickup tubes. Discussion of signal production in the Iconoscope (including shading and "return line effect") and in the Image Iconoscope.]
 31. M. Knoll, "Steuerwirkung eines geladenen Teilchens im Felde einer Sekundäremission-Kathode" (Control effect of a charged particle in the field of a secondary-emission target), *Naturwissenschaften*, 29, p. 335, 1941. (Coplanar grid effect as a function of potential, height, and diameter of the charged particle.)
 32. M. Knoll, O. Hachenberg, and J. Randmer, "Zum Mechanismus der Sekundäremission im Inneren von Ionenkristallen" (On the mechanism of secondary emission in the interior of ionic crystals), *Zeit. Phys.*, 122, pp. 137-162, 1944. [Secondary-emission characteristics of KCl from 500 to 10,000 volts; δ_e decreases with increasing temperature; radiated areas (F—centers) exhibit smaller secondary emission which may be restored by heating. Transient suppression of secondary electrons by photoelectrons or secondary electrons from writing beam; image of secondary-electron distribution in a KCl layer 1 micron below the surface.]
 33. M. Knoll and R. Theile, "Kapazitätsgesteuerte Bildabströhren" (Capacitance-controlled scanning tubes), *Tel-, Fernsprech-, Funk-, und Fernseh-Tech.*, 27, pp. 538-540, 1938. (The capacity distribution between backplate and surface of an insulated target can be observed if the elementary capacities are charged by redistributed or additional low-velocity electrons and then discharged periodically by a reading beam.)
 34. M. Knoll and R. Theile, "Elektronenabtaster zur Strukturabbildung von Oberflächen u. dünnen Schichten" (Imaging the structure of surfaces and thin layers by electron scanning), *Zeit. Phys.*, 113, pp. 260-280, 1939. (Secondary-emission picture of the surface of insulators and metals on which may be superimposed a picture of the resistance and capacity distribution of the target.)
 35. H. B. Law, "A Technique for the Making and Mounting of Fine Mesh Screens," *Rev. Sci. Instr.*, 19, pp. 879-881, 1948. (200 to 1500 meshes per inch, up to 50 per cent transmission.)
 36. I. G. Maloff, "Electron Bombardment in Television Tubes," *Electronics*, 17, pp. 108-111 and 327-331, January, 1944. (Discussion of redistribution effect of secondaries on the target of Iconoscopes.)
 37. R. A. McConnell, "Video Storage by Secondary Emission from Simple Mosaics," *Proc. I.R.E.*, 35, pp. 1258-1264, 1947. [Discussion of the

- secondary electron redistribution process in the case of homogeneous insulating targets, such as employed in the Iconoscope, and on the storage of signals by modulation of the writing-beam current (grid modulation).]
38. H. Nelson, "Method of Measuring Luminescent-Screen Potential," *Jour. Appl. Phys.*, 9, pp. 592-599, 1938. (Target potential of a kinescope is measured by heating a graphite-covered spot of the glass bulb from outside with hot air and connecting it to an electrostatic tube voltmeter.)
 39. C. V. Parker, "Charge Storage in Cathode-Ray Tubes," *Proc. I.R.E.*, 39, pp. 900-907, 1951. (Analysis of charging and surface potentials, including effects of redistribution, in a conventional cathode-ray tube.)
 40. H. Salow, "Über den Sekundäremissionsfaktor elektronenbestrahlter Isolatoren" (Secondary emission factor of insulators), *Zeit. Tech. Phys.*, 21, pp. 8-15, 1940. (Pulse method with alternating current of 50,000 cycles; secondary-electron characteristics of mica, silica, and glasses between 100 and 4000 volts; change of secondary-electron curves with time for mica.)
 41. H. Strübig, "Das Potential eines im Hochvakuum isolierten Auffangschirmes bei Beschiessung mit Elektronen" (Potential in a high vacuum of an insulated electron-bombarded target), *Phys. Zeit.*, 37, pp. 402-409, 1936. (Second crossover of secondary-emission curve for Aquadag, 900 volts.)

C. SIGNAL CONVERTER AND VIEWING STORAGE TUBES

(Retention Time \cong Reading Time \cong 1 second to several hours)

42. J. F. Adams, "The Krawinkel Image-Storing CR Tube." *Fiat final report 1027, PB-78273*, April, 1947. [Recording kinescope with coplanar grid-controlled photocathode. Cathode consists of quartz plate upon which a metallic line grid (60 lines per cm) is evaporated which contacts photomosaic elements (3600/cm²). Photoemission is controlled by coplanar grid action of free quartz surface, charged by the writing beam.]
43. P. R. Bell, G. D. Forbes, and E. F. MacNichol, Jr., "Storage Tubes," Chapter 21, *Wave Forms*, Radiation Laboratory Series, No. 19, McGraw-Hill Book Company, New York, N. Y., p. 707. (Storage by means of a conventional cathode-ray tube with capacitively coupled signal plate.)
- 43a. A. H. Benner and L. M. Seeberger, "Graphechon Writing Characteristics," *RCA Rev.*, XII, pp. 230-250, June, 1951.
44. J. S. Donal, "Cathode-Ray Control of Television Light Valves," *Proc. I.R.E.*, 31, pp. 195-208, 1943. [Mica tube face (0.25-0.5 mm) is charged by high-velocity electron beam ($\delta_e < 1$) and controls a suspension light valve mounted on it. Charges are removed by rescanning (erasing) with the same beam at reduced velocity ($\delta_e > 1$).]
45. J. S. Donal and D. B. Langmuir, "A Type of Light Valve for Television Reproduction," *Proc. I.R.E.*, 31, pp. 208-213, 1943.
- 45a. L. E. Flory, J. E. Dilley, W. S. Pike, and R. W. Smith, "A Storage Oscilloscope," *RCA Rev.*, XII, pp. 220-229, June, 1951.
46. J. V. Harrington and T. F. Rogers, "Signal-to-Noise Improvement Through Integration in a Storage Tube," *Proc. I.R.E.*, 38, pp. 1197-1203, 1950.

47. J. V. Harrington, "Storage of Small Signals on a Dielectric Surface," Jour. Appl. Phys., 21, pp. 1048-1053, 1950. (Analysis of charge storage in a barrier-grid type of storage tube.)
48. A. V. Haeff, "A Memory Tube," Electronics, 20, pp. 80-83, September, 1947. (Recording kinescope and signal-converter tube; uses in addition to writing and reading beam a "holding" beam which bombards or is reflected respectively from the "white" or "black" areas of a floating luminescent screen.)
49. R. C. Hergenrother and B. C. Gardner, "The Reading Storage Tube," Proc. I.R.E., 38, pp. 740-747, 1950. (Storage of charges by reflection on the back side of a storage grid; reading by electrical output or by means of an internal fluorescent screen.)
50. M. A. Honnell and M. D. Prince, "Television Image Reproduction by Use of Velocity Modulation Principles," Proc. I.R.E., 39, pp. 265-268, 1951. (Intensity modulation of nonstoring cathode-ray tube produced by modulation of scanning velocity.)
51. A. S. Jensen, J. P. Smith, M. H. Mesner, and L. E. Flory, "Barrier Grid Storage Tube and its Operation," RCA Rev., IX, pp. 112-135, March, 1948. (One unmodulated electron beam scans insulating target. Writing is accomplished by backplate-voltage modulation; the local charges thereby produced on the target surface cause variations in collector current during reading.)
52. M. Knoll and J. Randmer, "Ladungs-Bildspeicherröhren mit Speichergitter" (Control-grid reading type of storage tubes), Archiv El. Übertragung, 4, p. 238, 1950.
- 52a. M. Knoll, "Electron Lens Raster Systems," Report of the National Bureau of Standards Symposium on Electron Physics, November 5-7, 1951.
- 52b. M. Knoll and P. Rudnick, "Electron Lens Raster Viewing Storage Tube," Report of the National Bureau of Standards Symposium on Electron Physics, November 5-7, 1951.
53. G. Krawinkel, W. Kronjäger, and H. Salow, "Zur Frage der el. Bildspeicherung" (Electrical picture storage), Tel.-, Fernsprech-, Funk-, und Fernseh-Tech., 27, pp. 527-533, 1938. [Properties of a one-beam, homogeneous (slightly conducting) glass target signal converter storage tube; writing and reading voltage \cong 700 volts.]
54. L. Pensak, "The Graphechon—A Picture Storage Tube," RCA Rev., X, pp. 59-73, March, 1949. (Potential control of the surface of a thin insulating film, penetrated by the writing beam and locally charged by a negative backplate. Reading is accomplished by scanning the film surface with an unmodulated beam.)
55. L. Pensak, "Picture Storage Tube," Electronics, 22, pp. 84-88, July, 1949.
56. J. Randmer, "Über eine gitterartige Steuerung der Sekundäremission für Bildübertragungszwecke" (Gridlike control of secondary emission for picture transmission purposes), Diss. Techn. Hochschule München, 1948.
57. F. Schroeter, "Bildspeicherung im Fernsehempfang" (Image storage in television reception), Optik, 1, pp. 406-409, 1946. (Two-sided photocathode target in storage kinescope for reducing the frame number to 16 per second. Advantage: narrow frequency band and brighter picture.)
58. F. Schroeter, "Image Storage Problems," Bull. Schweiz. Elektrot. Verein, 40, pp. 564-566, 1949.

59. M. Von Ardenne, "Methoden u. Anordnungen zur Speicherung beim Fernsehempfang" (Methods and devices for storing in television reception), *Tel.-, Fernsprech-, Funk-, und Fernseh-Tech.*, 27, pp. 518-524, 1938. (Charge-controlled light valve screen for storage kinescopes; discussion of equilibrium potential curves; writing- and erasing-beam operation and different light-valve principles.)

D. COMPUTER STORAGE TUBES

60. S. H. Dodd, H. Klemperer, and P. Youtz, "Electrostatic Storage Tube," *Elec. Eng.*, 69, pp. 990-995, 1950. (Storage of 400 binary digits on a mica sheet on which is evaporated a beryllium mosaic. By means of a writing beam electrostatically positioned, each element is shifted to one of two stable potentials and maintained at equilibrium by a holding gun.)
61. J. P. Eckert, Jr., H. Lukoff, and G. Smoliar, "A Dynamically Regenerated Memory Tube," *Proc. I.R.E.*, 38, pp. 498-510, 1950. (Uses standard cathode-ray tube; signal obtained from redistribution effect; dot and circle pattern.)
62. J. W. Forrester, "High-Speed Electrostatic Storage," *Symposium of Large Scale Calculating Machinery*, Harvard University Press, Cambridge, 1948, pp. 125-129. (One gun, insulating target storage cathode-ray tube for computers; 32×32 storage locations on the target; writing with positive or negative collector grid, reading with neutral grid, output from backplate.)
63. J. A. Rajchman, "The Selectron," *Symposium of Large Scale Calculating Machinery*, Harvard University Press, Cambridge, 1948, pp. 133-145. [Figure 3: Storage mechanism. A great number of storage elements are pulsed separately by a common backplate into a negative or positive equilibrium position. Reading by luminescence (if insulated storage elements are covered with luminescent material) or by checking the displacement current to the backplate.]
64. J. A. Rajchman, "The Selectron, A Tube for Selective Electrostatic Storage," *Mathematical Tables and Other Aids to Computation*, II, No. 20, pp. 359-561, October, 1947. (Brief discussion of the basic storage principles.)
65. J. A. Rajchman, "The Selective Electrostatic Storage Tube," *RCA Rev.*, XII, pp. 53-97, March, 1951.
66. F. C. Williams and T. Kilburn, "A Storage System for Use with Binary-Digital Computing Machines," *Proc. Inst. Elec. Eng. (London)*, 96, Part II, pp. 183-202, and Part III, pp. 77-100, 1949; and 97, Part IV, pp. 453-454, 1950. (Uses normal cathode-ray tube with external pickup plate at the screen. Writing and reading by redistribution effect of secondary electrons; spot raster with 32×32 elements; mechanism corresponds to "return-line effect" in Iconoscope.)

E. TELEVISION CAMERA STORAGE TUBES

[Reading Time (In General) \cong Writing Time \cong 0.01 - 0.1 second]

- 66a. R. Barthelemy, "Les Analyseurs Electroniques" (Electronic analyzers), Paris, 1947. (Television camera tubes.)
- 66b. R. Barthelemy, "Contribution à l'Etude des Emissions Secondaires" (Contribution to the study of secondary emission), *L'Onde Electrique*,

- 30, pp. 499-509, 1950. (Velocity distribution of secondary electrons and its effect on target potential.)
- 66c. R. Barthelemy, "Analyseurs de Television" (Television analyzers), *L'Onde Electrique*, 31, pp. 415-419, 1951. (Operation of Image Iconoscope with auxiliary flooding beam.)
67. M. Berthillier, "L'Eriscope," *Le Vide*, 2, pp. 355-359, November, 1947. (Image Iconoscope with homogeneous insulator target.)
68. D. G. Fink, "The Orthicon," *Electronics*, 12, pp. 11-14, 58-59, July 1939. (Mechanism is explained, partly in pictures.)
69. S. V. Forgue, "The Storage Orthicon and its Application to Teleran," *RCA Rev.*, VIII, pp. 633-650, December, 1947. [High-capacity target (an order of magnitude thinner than in the usual Orthicon) with higher resistivity than that of the Image Orthicon; low reading current; storage and continuous reproduction of the signal for several hundred scanning frames.]
70. W. Heimann, "Über die Wirkungsweise u. Steigerung der Empfindlichkeit von Bildfängerröhren" (Mechanism and improvement of sensitivity of picture pickup tubes), *Tel.-, Fernsprech-, Funk-, und Fernseh-Techn.*, 27, pp. 541-544, 1938. (Discussion of double-sided targets, slightly conducting target layers and Image Iconoscope.)
71. H. Iams and A. Rose, "Television Pickup Tubes with Cathode-Ray-Beam Scanning," *Proc. I.R.E.*, 25, pp. 1048-1070, 1937. (Use of Cu-, Al-, and Zr-oxide, activated with Cs, Se; Ge was used as a target sensitive to heat radiation; Image Iconoscopes with one-sided and two-sided targets.)
72. H. Iams, G. A. Morton, and V. K. Zworykin, "The Image Iconoscope," *Proc. I.R.E.*, 27, pp. 541-547, 1939. [Discussion of three different targets: (a) Cesium silver mosaic on mica sheet, 40 microns thick; (b) homogeneous mica sheet, glowed in O₂ and cesiated; (c) metallic signal plate covered by finely divided insulating powder (China clay).]
73. R. B. Janes and W. H. Hickok, "Recent Improvements in the Design and Characteristics of the Iconoscope," *Proc. I.R.E.*, 27, pp. 543-540, 1939. (Spectral response adapted to the eye; diminishing of "spurious signals"; cylindrical envelope; sandblasting of mosaic; measuring methods.)
74. R. B. Janes, R. E. Johnson, and R. R. Handel, "A New Image Orthicon," *RCA Rev.*, X, pp. 586-592, December, 1949. (Panchromatic photosurface.)
75. R. B. Janes, R. E. Johnson, and R. S. Moore, "Development and Performance of Television Camera Tubes," *RCA Rev.*, X, pp. 191-223, June, 1949.
76. R. B. Janes and A. A. Rotow, "Light-Transfer Characteristics of Image Orthicons," *RCA Rev.*, XI, pp. 364-376, September, 1950. (Discussion of redistribution effects on the target at high lights and possible changes in tube design for minimizing effects.)
77. M. Knoll and F. Schroeter, "Elektronische Bild u. Zeichenübertragung mit Isolator — bzw. Halbleiterschichten" (Picture transmission by insulating or semiconducting layers), *Phys. Zeit.*, 38, pp. 330-333, 1937. (Mechanism for obtaining an electrical signal from a photoconductive homogeneous insulating target, and Image Iconoscope.)
78. G. Krawinkel, W. Kronjäger, and H. Salow, "Über einen speichernden Bildfänger mit halbleitendem Dielektrikum" (Storage television pickup

- tube with semiconducting dielectric), *Zeit. Techn. Physik*, 19, pp. 63-73, 1938. [Possible improvement of efficiency of Iconoscopes by replacement of the nonconducting target layer (mica) by a semiconducting one (e.g., slightly conducting glass). Higher field strength at the target surface will increase charges of photomosaic and reduce redistribution of electrons at the surface.]
79. J. D. McGee, and H. G. Lubszynski, "EMI Cathode Ray Television Transmission Tubes," *Jour. Inst. Elec. Eng.*, 84, pp. 468-482, 1939. (Description of an Iconoscope and an Image Iconoscope with mosaic targets; mosaic potential diagram; discussion of operation of writing or reading beam above second crossover of secondary-emission curve.)
80. J. D. McGee, "Distant Electric Vision," *Proc. I.R.E.* 38, pp. 596-608, June, 1950. (Survey and description of the various types of television camera tubes.)
81. M. Nagashima, K. Shinozaki, Y. Udagawa, and K. Kizuka, "The Tecoscope Cathode-Ray Television Transmitter," *Rep. Rad. Res. (Japan)*, 7, pp. 12-13, June, 1937. (Image Iconoscope. No difference between cesiated and clean silver mosaic target observed.)
82. A. Rose, "The Relative Sensitivity of Television Pickup Tubes, Photographic Film, and the Human Eye," *Proc. I.R.E.*, 30, pp. 293-300, 1942. (Influence of storage on sensitivity of pickup tubes.)
83. A. Rose, "Television Pickup Tubes and the Problem of Vision," *Advances in Electronics*, I, pp. 131-166, 1948.
84. A. Rose and H. Iams, "The Orthicon, a Television Pickup Tube," *RCA Rev.*, IV, pp. 186-199, October, 1939. (Uses low-velocity scanning with target at cathode potential.)
85. A. Rose and H. Iams, "Television Pickup Tubes using Low-Velocity Beam Scanning," *Proc. I.R.E.*, 27, pp. 547-555, 1939. [Advantages: low level of spurious signals; high maximum signal output; high efficiency of conversion of light into signal; discussion of the mechanism compared with high velocity ($\delta_e > 1$) scanning.]
86. A. Rose, P. K. Weimer, and H. B. Law, "The Image Orthicon, a Sensitive Television Pickup Tube," *Proc. I.R.E.*, 34, pp. 424-432, 1946. [Low-velocity scanning, two-sided target, image converter; target consists of a thin (several microns thick) sheet of low-resistivity glass which neutralizes charges on opposite sides during a frame time = 1/30 second; mesh screen collector on the image side of the glass target has 500-1000 meshes per linear inch and an open area of 50-75 per cent.]
87. P. Schagen, "On the Mechanism of High-Velocity Target Stabilization and the Mode of Operation of Television Camera Tubes of the Image-Iconoscope Type," *Philips Res. Rept.*, 6, pp. 135-153, 1951.
88. R. Urtel, "Die Wirkungsweise der Kathodenstrahlbilderleger mit Speicherwirkung," *Hochfrequenztechnik u. Elektroakustik*, 48, p. 150, 1936. (Mechanism of storage-camera tubes.)
89. P. K. Weimer, "The Image Isocon," *RCA Rev.*, X, pp. 366-386, September, 1949. (Reduction of beam noise in an Image-Orthicon device by separation of scattered electrons from reflected electrons and obtaining the output signal from the scattered electrons only.)
90. P. K. Weimer, U. S. Patent No. 2,537,250, January 9, 1951. (Discussion of a method of grid-control reading.)
91. P. K. Weimer, H. B. Law, and S. V. Fargue, "Mimo—Miniature Image Orthicon," *RCA Rev.*, VII, pp. 358-366, September, 1946. (Same mechanism employed as in standard Image Orthicon.)

92. P. K. Weimer, S. V. Fergue, and R. R. Goodrich, "The Vidicon—Photoconductive Camera Tube," Electronics, 23, pp. 70-73, May, 1950; also RCA Rev., XII, pp. 306-313, September, 1951. (Use of a photoconducting target for establishing a charge pattern instead of photocathode as in the Orthicon.)
93. V. K. Zworykin, "Industrial Television and the Vidicon," Elec. Eng., 69, pp. 624-627, 1950.
94. V. K. Zworykin, G. A. Morton, and L. E. Flory, "Theory and Performance of the Iconoscope," Proc. I.R.E., 25, pp. 1071-1092, 1937. (Discussion of limits and improvements of sensitivity; range of operation: 2.5 to 6 millilumens cm^2 on the target; curve of instantaneous potential at the mosaic surface.)
95. V. K. Zworykin and G. A. Morton, Television, John Wiley & Sons, Inc., New York, 1940. (Includes material on theory and construction of Iconoscope and Image Iconoscope.)
96. V. K. Zworykin and E. G. Ramberg, Photoelectricity and Its Applications, John Wiley & Sons, Inc., New York, 1949. (Basic processes and their application to television camera tubes.)
97. V. K. Zworykin, "The Iconoscope—A Modern Version of the Electric Eye," Proc. I.R.E., 22, pp. 16-32, 1934. (Description of the Iconoscope, its construction and operating principles.)
98. V. K. Zworykin, "New Television Camera Tubes and Some Applications Outside the Broadcasting Field," Jour. Soc. Motion Picture Engs., 55, pp. 227-242, 1950. (Camera tubes as applied to industrial television and astronomy.)
99. V. K. Zworykin and E. G. Ramberg, "Standards Conversion of Television Signals," Electronics, 25, pp. 86-91, January, 1952.

SUBJECT AND AUTHOR INDEX

- Applications of storage tubes, V, 66
 Auxiliary light source, 67, 69, 75, 83
- Backplate modulation, 22, 29
 Barrier grid, 18, 23, 33, 64
 Bistable writing, 24, 53, 77
 Black-on-white writing, 54
 Blooming, 110, 111
 Bombardment-induced conductivity,
 curves, 15
 levels, 15
 writing, 28, 51
- Capacity-discharge reading, 31
 for halftones, 42
 Cathode modulation, 22, 29
 Charge factor, definition, 21
 Charge migration, see Leakage
 between target elements
 Collected-current ratio, 3, 6
 Collector current characteristic, 11
 Collector modulation, 22, 29
 Collector-reflector electrode, 47
 Computer storage tubes, VI, 85
 Coplanar grid action, 18, 61, 128, 129
 Crossover potentials, 1, 4, 6, 22, 24
- Decay, 38, 49
 definitions, 20
 Decelerating ring, 107, 118
 Definitions, 19
 Difference signals, 62
 Direct viewing storage tubes, 66
 Discharge factor, 64
 definition, 21
 Dodd, 97
 Donal, 73
 Dot and circle writing, 89
 Dot and dash writing, 85
- Electron lens raster, 80
 Emission modulation in reading, 36
 Equilibrium curves, 4
 slope of, 12
- Equilibrium states, of an electron-
 bombarded "floating" surface,
 1, 12
 Equilibrium writing, 22
 for halftones, 40
 Erasing, 38
 definitions, 20
- Faraday cage, 92
 Feedback, 88, 91
 Flicker, 81, 84
 Flooding electrons 55, 78
 Flory, 61, 102
 Flyback signal, 107
 Forgue, 111, 112
 Forrester, 89
 Frequency conversion, 46
- Gardner, 47
 Goodrich, 112
 Graphechon, 42, 50
 Grid-control reading, 35
 for halftones, 43
- Haeff, 53, 77
 Halftone reading, 42
 Halftone writing, 40
 Halftones, 39
 due to thermal energy, 111
 grid-control reading for, 43
 Hergenrother, 47
 Holding, definition, 20
 Holding beam, 24, 53
- Iams, 107
 Iconoscope, 33, 102
 Image Iconoscope, 114
 Image Isocon, 122
 Image Orthicon, 118
 Induce-conductivity writing, see
 Bombardment-induced conduc-
 tivity
 Input signals, application methods,
 29

- Instantaneous collector current, 11
 Integration, 65
- Jensen, 61
- Kilburn, 85
 Klemperer, 97
 Knoll, 58, 69, 78, 125
 Krawinkel, 44, 66
 Kronjäger, 44
- Langmuir, 73
 Law, 118
 Leakage between target elements, 25,
 58, 77, 89, 100
 Light-intensity modulation, 25, 27,
 29
 Light-valve reading, 73
 Luminescent target, 77, 85
- Maximum reading duration, definition,
 20
 Maximum writing speed, definition, 19
 Memory tube, 53
 Mesner, 61
 Metal eyelet, 92
 Morton, 102
 Mosaic squares, 97
- Noise reduction, 122
 Nonequilibrium writing, 25
 for halftones, 40
- Orthicon, 107
- Pensak, 50
 Photoconductivity, 14, 29, 112
 Photoemission, 13, 26, 27
 Photosurface, 26, 102, 107, 114, 118,
 122
 Picture sticking, 120
 Polarization effects, 77
 Potential levels of a floating surface,
 4
 Primary-current modulation, 26, 29,
 44
 Pulse techniques, for measurement
 of secondary emission, 3
- Radechon, 61
 Rajchman, 92
 Randmer, 58, 69, 125
- Reading, access time, 95
 definitions, 20
 methods, 30
 with R-F pulse, 99
 with video pulse, 99
 Reading plate, 92
 Reading pulse, 95
 Redistribution, 16, 18, 23, 34, 86
 Redistribution reading, 33
 Redistribution writing, 29, 85
 for halftones, 41
 Reflection modulation in reading, 37
 Reflection of electrons, 17, 112, 119,
 122
 Regeneration, 88, 91
 Resolution, 19, 21, 25
 Retention, definition, 20
 Retention time, definition, 20
 R-F reading, 99
 Rose, 107, 118
 Rudnick, 78
- Salow, 44
 Saturation of signal, 122
 Scanning-velocity modulation, 29
 Scattered electrons, 122
 Schroeter, 81
 Secondary electrons, velocity dis-
 tribution, 8, 72
 Secondary emission, amplifier, 112,
 118, 122
 curve, 1
 ratio, 3
 Selecting bars, 92
 Selective electrostatic storage tube,
 92
 Shading signal, 105, 117
 Shot noise energy, 124
 Signal converter storage tubes, 44
 Signal-to-noise ratio, 124
 Simultaneous writing and reading,
 53, 57
- Smith, 61
 Space-charge, 4, 10
 Sticking potential, 7
 Storage elements, 19
 resolvable number of, 21
 useful number of, 21
 Storage eyelet, 92
 Storage Orthicon, 111
 Storage tubes, classification, VII
 computer, 85

- Storage tubes,
 definitions, 19
 signal converter, 44
 television camera, 102
 viewing, 66
- Target, capacity, 32, 44
 conductivity, 120
 roughness, 107
- Target potential-shifting diagram, 5
- Television, V, 66
- Transmission modulation in reading,
 36
- Video-pulse reading, 99
- Vidicon, 112
- Viewing storage tubes, V, 66
- Weimer, 112, 118, 122
- White-on-black writing, 54
- Williams, 85
- Window, electron, 92
- Writing, access time, 95
 definitions, 19
 methods, 22
 plate, 92
 pulse, 94
 speed, 19
- Yes-no information, 85, 89, 92
- Youtz, 97
- Zworykin, 102, 114