

catalogue  
**84R**

# Electronic Transformers *and* Cabinetry

*a trusted name...*

# HAMMOND

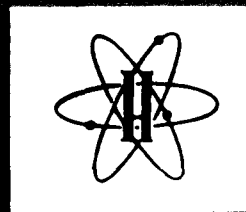

# ELECTRICAL TRANSFORMERS CUSTOM PRODUCTION FACILITIES

# HAMMOND

## CONTROL, POTENTIAL, CURRENT AND DISTRIBUTION TRANSFORMERS

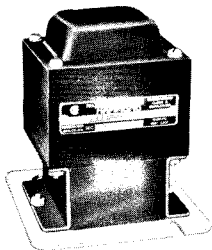

Type D — Control Trans.  
25 to 100 VA

In addition to the industrial electronic group of transformers listed in this Catalogue, HAMMOND produces a popular companion line of electrical transformers which are displayed in the electrical catalogue. Ask for Catalogue Series 70 and Engineering Bulletins. These two standard lines, available from stocking distributors coast to coast, and stocked in depth at the factory are designed to satisfy a majority of applications confronting design and construction people. Where a standard product cannot be used, our custom facilities, which are described below, are at your service.

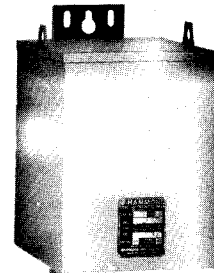

Type Q — Single Phase  
0.5 KVA to 25.0 KVA  
Outdoor Dry Type  
Control & Distribution  
600 & 480 V Tapped Primaries  
120/240 Volt Secondaries

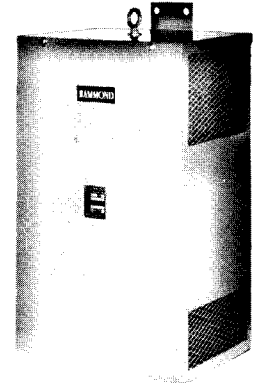

Type F — Single Phase 3 to 75 KVA  
Indoor Dry Type Distribution Transformer  
Class B & H insulation.

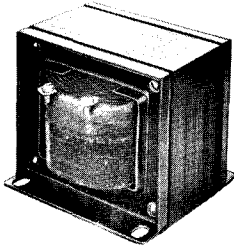

Type H — Open Indoor Dry Type  
Control Trans. 25 to 5,000 VA

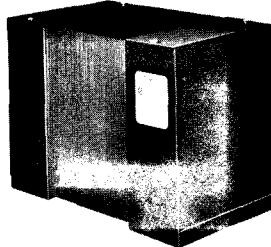

Type E — Enclosed Indoor Dry Type  
Control Trans. 50 to 5000 VA  
Autotransformers  
240/120 Volts 150 to 3000 VA  
208/230 Volts 0.50 to 10 KVA

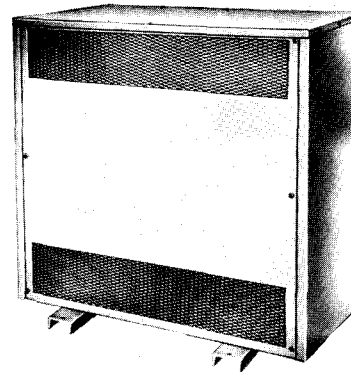

Type K — 2 to 225 KVA  
Indoor Dry Type Distribution Transformer  
240 or 120/208 Secondaries  
Class B, F & H Insulation

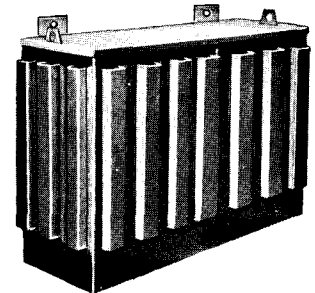

Type QT — 3 Phase 9, 15, 30, & 45 KVA  
Outdoor Dry Type Distribution Transformer  
208/120 Volt Secondaries

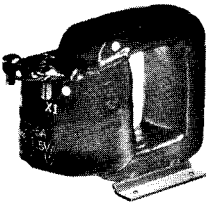

Type CW — Current Trans.  
with Rectangular Window  
100:5 to 1200:5 AMP.

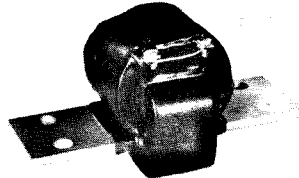

Type CP — Current Transformer  
with Primary Bus. 200:5 to 1200:5 AMP.

## CUSTOM TRANSFORMER FACILITIES

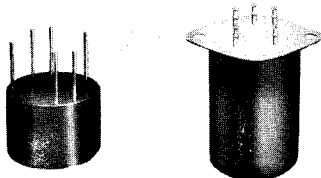

Military — Aerospace High Reliability for  
severe environments.  
Hermetically Sealed, Encapsulated  
or epoxy vacuum cast.  
In Plant QA. to MIL-T-27

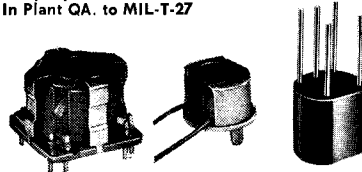

Pot Cores & Ferrites.  
For high frequency use.  
Compact open, encapsulated  
or cast with p.c. pins.

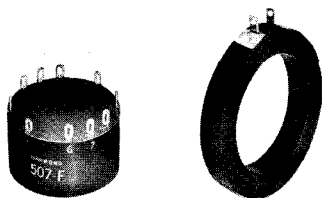

Toroidal Products.  
From 0.4" O.D. up to 17" O.D.  
Open or encapsulated.

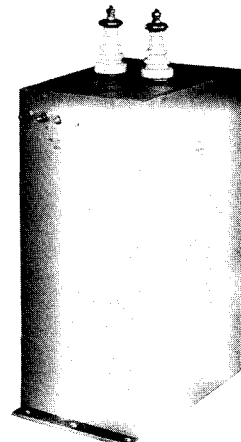

High Voltage Trans.  
Testing, Isolation, X-Ray, Filament  
Open Dry Type to 20 KV rms.  
Oil Filled up to 100 KV rms.  
Bulletins 5110 and 5309.

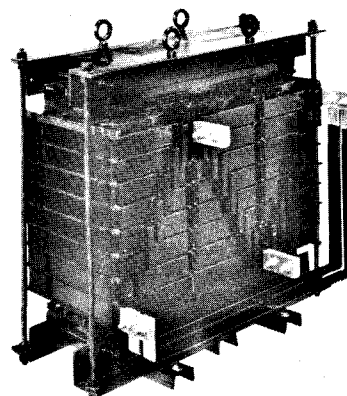

Heavy Rectifier and Plate Trans.  
Open core & coil designs.  
Single Phase up to 150 KVA  
Bulletin 5277.  
Three Phase up to 500 KVA  
Bulletin 4650.

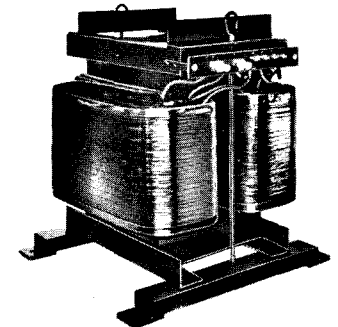

Saturable Reactors — Open or Enclosed  
Single Phase to 150 KVA  
Three Phase to 300 KVA  
Open Type — Bulletins 5245, 5264, 5274  
Enclosed Type — Bulletins 5020, 5275  
For regulated power supplies, electric  
heat control. Technical Bulletin 5245  
describes principles.  
Magnetic Amplifiers also available  
Bulletin #5185.

Hammond Products are continually being revised and improved, to use the best materials available. For this reason, Hammond Manufacturing Company Limited reserves the right to modify existing electrical or mechanical characteristics of any catalogue item without notice. Dimensions shown in this catalogue are nominal, subject to normal manufacturing tolerances. Transformers and chokes require some clearance for adequate ventilation.

## TRANSFORMER SECTION

Type—Description	Page
Auto, audio matching	6, 13
line adjusting	33, 34
Audio, bridging	14
broadcast	14, 15
input	7, 9, 10, 11, 12, 14, 15
interstage/driver	7, 9, 10, 11, 12, 14, 15
hybrid	10, 14, 15
line isolating	15
line matching	13, 15
to speaker	7, 13
low profile	14
miniature	8, 9, 11
output	6, 7, 9, 10, 11, 12, 14, 15, 16
sound distribution	7
ultra linear	16
blocking oscillator	24
Chokes, filter	27, 28
heavy current	27, 28
high voltage	28
radio frequency	25
shielded, swinging	27, 28
Control & Current	2
Converter	30
Demagnetizer, Tool	33
Demonstration	32
Distribution	2
Educational	32
Encapsulated	2
Epoxy Vacuum Cast	2, 4, 9, 14, 23
Ferrite core products	2
Filament, low voltage	18, 19, 20
high voltage	21, 23
High Voltage, special; hermetically sealed	2
Inactive	17
Intercom	7
Inductors, miniature; inverter	29, 30
Isolating	2, 34
Line Isolating and Adjusting	33, 34, 35

Type—Description	Page
Line Voltage adjuster	33, 35
Mag Amps, Special	2
Main	30
Microscope Illuminator	33
Military—special designs	2
Mountings	4, 5
Multiple Secondary, multi-tap secondary	21
Oscilloscope, high voltage	24
Plate	2, 26
Pot Core Devices, potential	2
Power, 60 cycle	17, 22, 23, 24, 25
400 cycle	20
low profile	23
Printed Circuit, open and cast	4, 8, 9, 10
Pulse	2, 31
Reactors, filter	27, 28
saturable	2
Rectifier, low voltage	18, 19, 20, 22
high voltage	2, 21
heavy current special	2
Research	32
Shielded & Mumetal	4, 11, 14
Types CW, CP, D, E, F, H, K, Q, QT	2
<b>SPECIAL TRANSFORMERS</b>	2, 29
Switching	30
System matching	13
Tape eraser	33
Technical Data	5, 13, 23, 30, 32
Testing	2
Toroidal Products	2, 4, 29, 30
miniature	8, 11
Transistor, general purpose	10, 12
high power	12
Trigger	31
Tube Checker	21
Ultralinear	16
Vertical Output, blocking oscillator	24
X-Ray	2

Series	Page
20, 1	33
25, 6	32
91	24
101, 2, 4, 6	8, 9
119	7, 13
120	6
140, 1, 2	8, 11
143, 4	11
145, 6	12
147, 8, 9	10, 12
153, 4, 5, 6, 7, 8, 9	27
165	18
166	18, 19
167	19, 20
168	33
169, 170	34
171, 2, 3, 4	35
193	27
195, 6	28
210	22
214, 5, 6	24
220, 222	20
226, 7, 8	23
262	22
263 to 282	21, 24, 25
300	13
507, 9, 11, 13	30
560	14
585	14
610, 11, 12	31
621, 2	29
710 to 795	26
800, 850	4, 15
900	13
1100	21
1500	26
1600, 50	16
1700	13, 16

## CABINET SECTION

Accessories, cabinet and console	40, 41, 48
Baffles, ceiling	56
Blowers, intake, exhaust	47
Boxes, Panel, Type 1, 4, 12	59
push button type 12	59
wiring type 12	59
Cabinets, component	56
dust tight	59
equipment	55
floor rack, enclosed	40, 42
floor rack, modular	41
general purpose	57
low silhouette	53, 54
oil tight	59
sloping front and ventilated	53
speaker, table and wall	56
storage, industrial	43
table rack	42, 55
type 1, 4, 12	59
universal parts	55
wall and swingout	43, 55
water tight	59
Carrier, equipment parts	36, 37
Cases, component ventilated	59
handy	52
instrument and miniature	54
meter	53
sloping front	53
utility	52, 53
Casters	36
Chassis, aluminum and steel	51, 52
bottom plates	51
covers, ventilated	51
depressed	50
heavy-duty trays	50
miniature	52
Consoles, enclosed	38, 59
modular	44
pedestal, half & full desks	38

Covers, chassis ventilated	51
Custom Production facilities	59
Dolly, cabinet	36
equipment	37
oscilloscope	36, 37
Drawers, turntable, utility	48
Filter Coat	47
General Purpose, type I	59
Hardware, miscellaneous	58
Industrial	59
Inactive	57
Laboratory Bench Cabinet	39
Modular racks	41, 44
Panel adapters	49
Panels, aluminum and steel	49, 50
access door	50
depressed chassis	50
enclosures	59
formed	49
speaker	50
switch	49
utility	50
ventilated and baffle	47
Plates, bottom	51
Printed Circuit Card Rack	46
Project Stand, mobile	37
Racks, p.c. card	46
cover, dust	45
modular cubicle	59
relay, floor	45
relay, table	45
Shelves, draw out writing	48
equipment	48
Tables, equipment	39
Tool stand, mobile	37
Tote truck, warehouse	37
Turrets	39

1401, 4	54, 53
1405	55
1406, 7, 8	56
1409	48
1411, 2	52, 53
1413, 4	58, 59
1415	52
1416, 8	59
1419	52
1420	59
1421	58
1422, MD	59
1423	58
1424, 5	36
1426	54
1427	58
1428	55
1429	53
1431, 2, 3, 4	51
1440	50
1441, 2, 3, 4	51
1445, 51	52, 51
1454, 5	53, 54
1459	55
1460, 1	42
1463	40
1464	44
1465, 6, 7, 8	45
1469	41
1470	36, 37
1472	59
1475	47
1476	45
1479	59
1483, 4	43
1491	55
1499	46
5000	38, 9

# TRANSFORMER MOUNTINGS

# HAMMOND

The following two pages describe popular mounting systems which are used in HAMMOND transformers and developed during 44 years experience in production of transformers and reactors for industry. They are used when producing special devices to your specifications. (Many others are also available.)

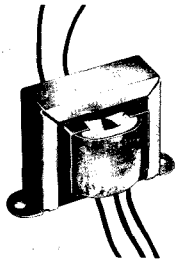

HORIZONTAL

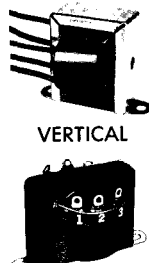

VERTICAL

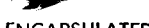

ENCAPSULATED

## OPEN HORIZONTAL and VERTICAL BRACKET

- Used for small audio and filament transformers and reactors where shielding is not important.
- Economical open core and coil construction.
- Formed bright zinc finished steel bracket with two-hole mounting.
- Flexible leads or lugs for connections.
- Horizontal, vertical or miniature versions used depending on space available.
- May be encapsulated or supplied less mounting feet on special order.
- Bulletins 5043 and 5044 give dimension data of available sizes.

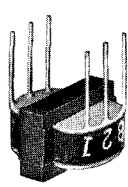

PIN MOUNT

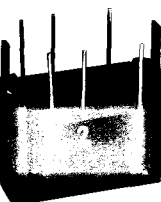
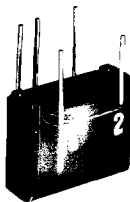

LUG MOUNT

## OPEN PRINTED CIRCUIT

- A miniature EI or EE lamination mounting for printed circuits.
- Economical open core and coil construction.
- Solid tinned copper leads  $\frac{1}{2}$ " long on 0.1" grid.
- Seven core sizes available with p.c. leads.
- $\frac{1}{4}$ " lamination and over are mounted by means of two clinching lugs.
- Encapsulated versions available on special order.
- Bulletin 5272 gives dimension data of available sizes.

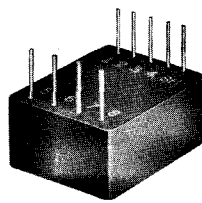
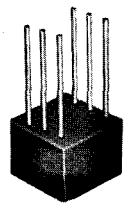

## VACUUM EPOXY RESIN CAST

- Vacuum epoxy-cast construction produces a completely sealed transformer, withstanding severe environmental conditions.
- Epoxy materials improve heat dissipation and allow more compact sizes.
- Pin terminals  $\frac{1}{2}$ " long on standard 0.1" grid for printed circuit construction or subminiature devices.
- Available on special order to meet MIL-T-27.
- Bulletins 5361 and 5372 give dimension data of available sizes.



## MUMETAL CASE

- Heavy drawn Mumetal case for maximum shielding of low level audio input or bridging transformers.
- Hermetically sealed for consistent characteristics and long life.
- Smooth grey enamel finish.
- Two convenient 6-32 mounting studs 0.38" long on 0.94 centres, 1.41" O.D., 1.94" high.
- Modern, turret head, solder terminals 0.22" long.

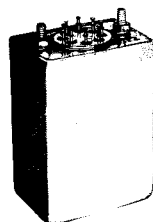
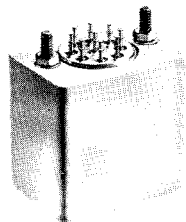

## 800 & 850 SERIES

- Hermetically sealed for consistent characteristics and protection of broadcast quality transformers.
- Modern, rigid deep drawn steel case with smooth grey enamel finish, 1.75" wide, 1.25" deep and 1.65 or 2.56" high.
- Two convenient 6-32 mounting studs on 1.31" mounting centres.
- Multi-terminal header for convenient solder connections — 0.22" long.

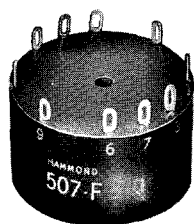

EPOXY CAST

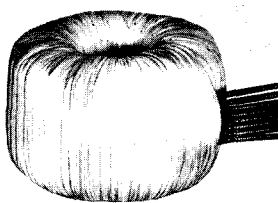

VARNISH IMPREGNATED

## TOROIDAL DEVICES

- For transistor power supplies, current transformers, and high Q filter inductors up to 200 KHz.
- Available in open varnish impregnated designs with flexible leads, p.c. pins or epoxy cast styles with solder lugs.
- May be conveniently mounted with a single bolt.
- Standard powdered or strip wound core materials are used.
- Toroid minimum inside diameter is 0.10", maximum outside diameter 17.0" maximum coil height 7.0".
- Bulletins 5364 and 5365 give dimension data on standard sizes.

Refer to the table on Page 29 for the data required when ordering or specifying special transformers.

## OPEN TYPE H

- Heavy current choke, reactor, filament, control or power transformer mounting.
- For OEM or replacement use inside other housings — occupying minimum space.
- Economical 4 slot mounting, open core and coil construction.
- Rigid, steel end frames with 4 through bolts.
- Dull black enamel finish.
- Lugs or flexible leads.
- Bulletin 4651 gives dimensions of standard sizes. Vertical mounting 4652 using less panel or chassis space, available on special order.

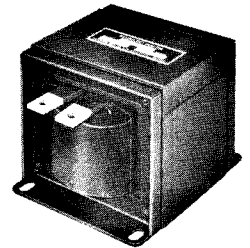

## TYPE X CASE

- Used for medium sized power, filament, line and output transformers, chokes, and reactors built on 1" to 2" EI cores.
- Drawn and formed steel end covers with black, baked, smooth semi-gloss enamel finish.
- May be produced with knockouts for surface mounting applications.
- Convenient four slot above chassis mounting — laminations vertical.
- Flexible leads only supplied.
- Bulletin 4654 gives dimensions of available sizes.

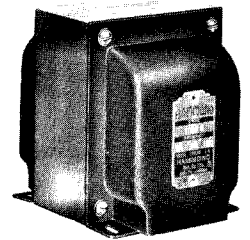

## TYPE Z CASE

- For medium sized power transformer built on 1" to 2" EI cores.
- Drawn and formed steel case with black, baked, semi-gloss enamel.
- Convenient four hole above or through chassis mounting.
- Allows an alternate leakage flux orientation compared to "X" mounting, laminations horizontal.
- Flexible leads only supplied.
- Bulletin 4653 gives dimensions of available sizes.

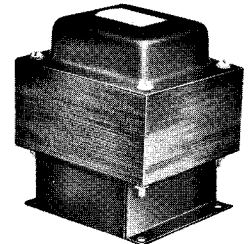

## TYPE R CASE

- For larger designs of plate transformers and reactors.
- Rugged cast end frames used with 2" to 3" EI laminations.
- Bakelite end panel with bolt and nut terminals and ceramic HV bushings.
- Baked enamel finish.
- Bulletin 4649 gives dimensions of available sizes.

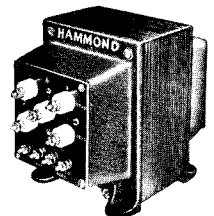

## DEFINITION – INSERTION LOSS

When measured at mid-band, insertion loss is a method of expressing the efficiency of a device. When measured at other frequencies, it includes the droop of the frequency response characteristic. It is the logarithmic ratio of power input to power output and is expressed in dB.

$$\text{Insertion loss dB} = 10 \log \frac{P_i}{P_o}$$

For measurement purposes in correctly terminated circuitry this becomes:

$$\text{Insertion loss dB} = 10 \log \frac{V_g^2 R_s}{4V_s^2 R_p}$$

Where  $R_p$  and  $R_s$  are the mid-band impedances of the pri. and sec.,  $V_g$  is the generator voltage and  $V_s$  is the sec. voltage.

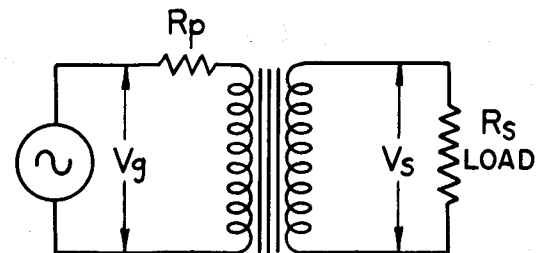

## DEFINITION – TURNS RATIO – REFLECTED IMPEDANCE

In a transformer the ratio of secondary turns ( $N_s$ ) to primary turns ( $N_p$ ) is called the turns ratio ( $n$ ) i.e.  $n = \frac{N_s}{N_p}$

If  $n$  is greater than 1, we have a step up transformer or if less than 1, a step down transformer, or

$$\frac{V_s}{V_p} = n \quad \text{and} \quad \frac{I_p}{I_s} = n$$

Combining these relations, the turns ratio  $n = \sqrt{\frac{Z_s}{Z_p}}$ , Also,  $Z_p = \frac{Z_s}{n^2}$  or, the impedance we see reflected at the primary terminals, when the secondary is terminated with  $Z_s$ , is the secondary impedance divided by the square of the turns ratio.

Refer to the table on Page 29 for the data required when ordering or specifying special Transformers.

# AUDIO TRANSFORMERS OUTPUT & MATCHING

# HAMMOND

- Economical open bracket mounting (see p. 4 details).
- For general replacement service or OEM use.
- Primary and secondary leads 5 to 6" long.

Cat. No.	† Primary Impedance	Max. Pri. ma dc	Max. Watts	Core Size	Dimensions				Wt. Lb.
					A	B	C	D	

### SINGLE PLATE TO 3.2 OHM VOICE COIL. 3 to 10 watts

41	25000	15	3	3/8 x 3/8	2 1/16	1 1/8	1 3/16	1 3/4	.25
43	2000	45	3	3/8 x 3/8	2 1/16	1 1/8	1 3/16	1 3/4	.25
45	5000	35	3	3/8 x 3/8	2 1/16	1 1/8	1 3/16	1 3/4	.25
48	8000	27	3	3/8 x 3/8	2 1/16	1 1/8	1 3/16	1 3/4	.25
49	10000	25	3	3/8 x 3/8	2 1/16	1 1/8	1 3/16	1 3/4	.25
53	2500	60	5	1/2 x 1/2	2 3/8	1 1/4	1 3/8	2	.3
54	4500	45	5	1/2 x 1/2	2 3/8	1 1/4	1 3/8	2	.3
55	5000	45	5	1/2 x 1/2	2 3/8	1 1/4	1 3/8	2	.3
57	7000	27	5	1/2 x 1/2	2 3/8	1 1/4	1 3/8	2	.3
59	10000	25	5	1/2 x 1/2	2 3/8	1 1/4	1 3/8	2	.3
63	2500	70	8	5/8 x 5/8	2 13/16	1 5/8	1 5/8	2 3/8	.5
64	4500	60	8	5/8 x 5/8	2 13/16	1 5/8	1 5/8	2 3/8	.5
67	7000	35	8	5/8 x 5/8	2 13/16	1 5/8	1 5/8	2 3/8	.5
69	18000	20	8	5/8 x 5/8	2 13/16	1 5/8	1 5/8	2 3/8	.5
74	4500	90	10	3/4 x 3/4	3 1/4	1 5/8	1 15/16	2 13/16	1

### SINGLE PLATE TO 45 OHM LOAD. 7 watts

61A	5000	60	7	5/8 x 5/8	2 13/16	1 5/8	1 5/8	2 3/8	.5
-----	------	----	---	-----------	---------	-------	-------	-------	----

### SINGLE PLATE TO 3.2 OHM VOICE COIL. Primary has 3% Humucking Tap. 5 watts

52	2500	45	5	1/2 x 1/2	2 3/8	1 1/4	1 3/8	2	.3
----	------	----	---	-----------	-------	-------	-------	---	----

### PUSH-PULL PLATES TO 3.2 OHM VOICE COIL. 3 to 12 watts

47	50000 ct	15	3	3/8 x 3/8	2 1/16	1 1/8	1 3/16	1 3/4	.25
58	14000 ct	20	5	1/2 x 1/2	2 3/8	1 1/4	1 3/8	2	.3
65	5000 ct	60	8	5/8 x 5/8	2 13/16	1 5/8	1 5/8	2 3/8	.5
66	10000 ct	27	8	5/8 x 5/8	2 13/16	1 5/8	1 5/8	2 3/8	.5
79	10000 ct	60	10	3/4 x 3/4	3 1/4	1 5/8	1 15/16	2 13/16	1
85	5000 ct	70	12	3/4 x 1	3 1/4	1 7/8	1 15/16	2 13/16	1.25
88	8000 ct	60	12	3/4 x 1	3 1/4	1 7/8	1 15/16	2 13/16	1.25
89	10000 ct	60	12	3/4 x 1	3 1/4	1 7/8	1 15/16	2 13/16	1.25

### PUSH-PULL or SINGLE PLATE UNIVERSAL OUTPUT TRANSFORMERS. 5 to 10 watts

- Only 3 sizes yield primary impedances from 1,200 to 27,000 ohms, and secondary impedances from 1.5 to 15 ohms.
- Primary leads 5 to 6" long, secondary solder lugs.
- Convenient complete application tables listing 90 precalculated ratios with each transformer.

125 B	1200 to 25000	45	5	1/2 x 1/2	2 3/8	1 1/4	1 3/8	2	.3
125 C	1200 to 25000	60	8	5/8 x 5/8	2 13/16	1 5/8	1 5/8	2 3/8	.5
125 D	1200 to 25000	70	10	3/4 x 3/4	3 1/4	1 5/8	1 15/16	2 13/16	1.0

### AUTO MATCHING TRANSFORMERS — Wide Range Frequency Response

Cat. No.	† Impedance Taps	Watts	Core Size	Mtg. Type	Mtg. Cts.	Wt. Lb.
120 C	0-3.2-45 ohms	5	1/2 x 1/2	Horiz. Brkt.	2	.4
120 D	0-3.2-8-16 ohms	5	1/2 x 1/2	Horiz. Brkt.	2	.5
120 E	0-3.2-8-16 ohms	15	3/4 x 3/4	Horiz. Brkt.	2 13/16	1
120 G	0-3.2-8-16 ohms	40	1 x 1	Horiz. Brkt.	3 3/16	2.3
◆120 H	0-3.2-8-16 ohms	60	1 x 1 1/2	Horiz. Brkt.	3 3/16	2.8
◆120 J	0-3.2-8-16 ohms	100	1 1/4 x 1 1/4	Type X	2 1/2 x 2 1/4	4.5

† When operating at impedances below nominal, power capability and the frequency spectrum are proportionately lower; conversely, at higher impedances power capability and frequency spectrum will be proportionately higher.

#### ◆ New Product.

Special designs of these series produced quickly to your specifications.

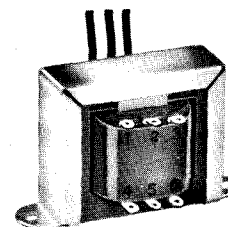
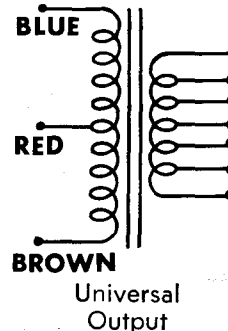
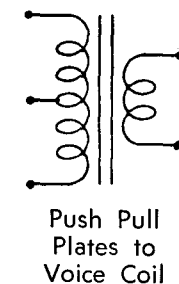
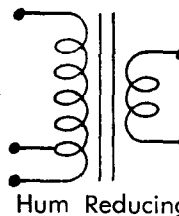
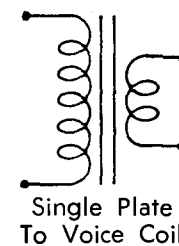
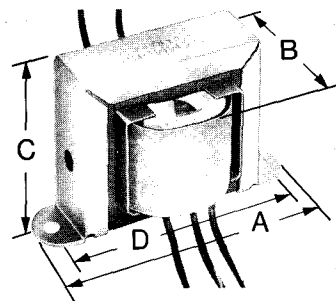

Typical  
120 & 125 Series

## INPUT AND INTERSTAGE REPLACEMENT AND GENERAL PURPOSE

- Economical open horizontal bracket mounting (see p. 4 details).
- For general replacement or OEM use.
- Primary and secondary leads 5 to 6" long.

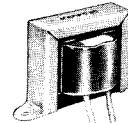

Cat. No.	Application	Nominal Impedance		Overall Turns Ratio Pri. to Sec.	Max. Pri. mA DC	Core Size	Mtg. Cts.	Wt. Lb.
		Primary	Secondary					
111	Plate to Single Grid	10000	90000	1:3	10	3/4 x 3/4	2 13/16	1.0
112	Plate to P.P. Grids	10000	120000 ct	1:3 1/2	10	3/4 x 3/4	2 3/8	1.0
113	Plate to P.P. Grids	10000	120000 ct	1:3 1/2	10	3/4 x 3/4	2 13/16	1.0
130 A	Voice Coil to Grid	4	80000	1:140	250	3/8 x 3/8	1 3/4	.25
132	Line to Grid	500 ct	50000	1:10	40	5/8 x 5/8	2 3/8	.5
133	Line to Line	500 ct	500 ct	1:1	90	5/8 x 5/8	2 3/8	.5

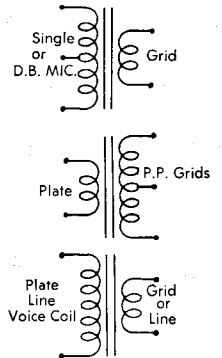

## SOUND DISTRIBUTION

- Couples 3.2, 8 or 16 ohm speakers to the 25 or 70 volt outputs of modern amplifiers at different power levels without the use of artificial attenuation devices (pots or pads).
- 8 power output levels available with each transformer.
- Low insertion loss over the 100 to 9000 Hz frequency range.
- Liberally designed for long life and trouble free service.
- Economical open horizontal bracket mounting (see p. 4 details) solder lug terminals.
- May be used to couple speakers to 500 ohm or other lines providing peak voltages do not exceed approximately 200V.
- Complete, convenient application tables included with each transformer.
- Autotransformers or two winding transformers available.

Cat. No.	Watt Rating	Type	Audio Power Taps	Voice Coil Impedance	Core Size	Mtg. Cts.	Wt. Lb.
<b>70 VOLT</b>							
119 E	4	Auto	4, 3, 2, 1 1/2, 1, 3/4, 1/2, 1/4	3.2	1/2 x 1/2	2	1/2
119 F	4	Auto	4, 3, 2, 1 1/2, 1, 3/4, 1/2, 1/4	8	1/2 x 1/2	2	1/2
119 G	8	Auto	8, 6, 4, 3, 2, 1 1/2, 1, 1/2	3.2	3/4 x 3/4	2 3/4	1
119 H	8	Auto	8, 6, 4, 3, 2, 1 1/2, 1, 1/2	8	3/4 x 3/4	2 3/4	1
119 J	16	Auto	16, 12, 8, 6, 4, 3, 2, 1	3.2	1 x 1	3 5/8	2 1/4
119 K16	16	Auto	16, 12, 8, 6, 4, 3, 2, 1	8	1 x 1	3 5/8	2 1/4
◆ 119 K32	32	Auto	32, 24, 16, 12, 8, 6, 4, 2	8	1 x 1	3 5/8	2 1/4
119 L	16	Auto	16, 12, 8, 6, 4, 3, 2, 1	16	1 x 1	3 5/8	2 1/4
119 M	4	2 Wdg	4, 3, 2, 1 1/2, 1, 3/4, 1/2, 1/4	3.2	1/2 x 1/2	2	1/2
119 N	4	2 Wdg	4, 3, 2, 1 1/2, 1, 3/4, 1/2, 1/4	8	1/2 x 1/2	2	1/2
119 O	8	2 Wdg	8, 6, 4, 3, 2, 1 1/2, 1, 1/2	3.2	3/4 x 3/4	2 3/4	1
119 P	8	2 Wdg	8, 6, 4, 3, 2, 1 1/2, 1, 1/2	8	3/4 x 3/4	2 3/4	1
<b>25 VOLT</b>							
119 Q	4	Auto	4, 3, 2, 1 1/2, 1, 3/4, 1/2, 1/4	3.2	1/2 x 1/2	2	1/2
119 R	4	Auto	4, 3, 2, 1 1/2, 1, 3/4, 1/2, 1/4	8	1/2 x 1/2	2	1/2
119 S	8	Auto	8, 6, 4, 3, 2, 1 1/2, 1, 1/2	3.2	3/4 x 3/4	2 3/4	1
119 T	8	Auto	8, 6, 4, 3, 2, 1 1/2, 1, 1/2	8	3/4 x 3/4	2 3/4	1
◆ 119 V16	16	Auto	16, 12, 8, 6, 4, 3, 2, 1	8	3/4 x 3/4	2 3/4	1
◆ 119 V32	32	Auto	32, 24, 16, 12, 8, 6, 4, 2	8	3/4 x 1	2 3/4	1 1/4

## 119 SERIES

### 25 and 70 VOLT SYSTEMS

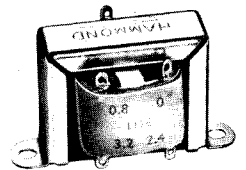

Bracket mtg.

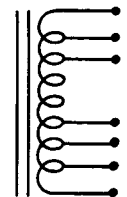

Auto

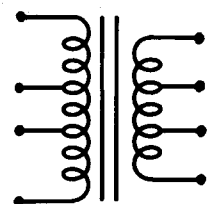

2 Winding

## 8 or 16 OHM - OUTPUT TO 70V OR 25V LINE

- Autotransformers for use with 1650 series high power output transformers on P.16 to provide a 25V or 70V line and also suitable for reverse operation at speaker location.
- Available with 8 or 16 ohm taps at maximum wattage output.
- Frequency response 50 Hz to 10 K Hz.

Cat. No.	Max. Watts Output	Line Output	Mtg. Type	Core Size	Mtg. Centres	Wt. Lb.
◆ 119 Y30	30	70 & 25v	Bracket	1 x 1	3 1/16	2.4
◆ 119 Y60	60	70 & 25v	X Mtg.	1 x 1 1/2	2 1/8 x 2 1/4	3.3
◆ 119 Y100	100	70v only	X Mtg.	1 1/4 x 1 1/4	2 1/2 x 2 1/4	4.7
◆ 119 Y250	250	70v only	X Mtg.	1 1/4 x 2	2 1/2 x 3	6.7

## 119 Y SERIES

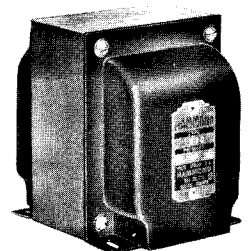

### ◆ New Product

Special designs of these series produced quickly to your specifications.

# AUDIO TRANSFORMERS MINIATURE TRANSISTOR

# HAMMOND

## 101 SERIES

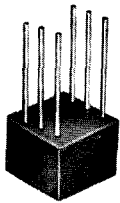

- For use in miniature transistor circuitry.
- Pin type printed circuit mounting.
- Rugged black epoxy cast construction produces a completely sealed unit withstanding severe environmental conditions. (See p. 4 details.)
- Available on special order to MIL-T-27. (Grade 5, Class S).
- Bifilar winding technique used on centre tapped units for balanced resistive and capacitive characteristics.
- For open printed circuit mounting types, refer to the factory.

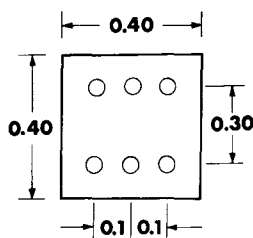

Height 0.29"  
Pin Dia. 0.02"  
Pin Length 0.50"  
Net Wt. 0.1 oz.

Cat. No.	*Nominal Impedance		Nominal Resistance		Useful Impedance Range	
	Primary	Secondary	Primary	Secondary	Pri./Sec.	to Pri./Sec.
◆101 D	300 ct	600 ct	42	96	150/300	600/1200
◆101 F	600 ct	600 ct	78	96	300/300	1200/1200
◆101 H	1200 ct	600 ct	140	93	600/300	2400/1200
◆101 J	2500 ct	600 ct	300	92	1250/300	5000/1200
◆101 P	300 ct	50 ct	42	7.5	150/25	600/100
◆101 R	600 ct	50 ct	78	7.5	300/25	1200/100
◆101 T	1200 ct	50 ct	140	7.5	600/25	2400/100
◆101 V	2500 ct	50 ct	300	7.5	1250/25	5000/100

### NOTES

- \* Secondary may be used as primary and primary as secondary
- Power level: 30 mW @ 400 Hz, 60 mW @ 1 KHz
- Frequency range at + 3 dbm is 300 to 100 KHz  $\pm$  0.5 db
- Frequency range at + 10 dbm is 400 to 100 KHz  $\pm$  0.5 db
- Frequency range at + 15 dbm is 500 to 100 KHz  $\pm$  0.5 db
- All frequency measurements with no D.C. saturation

## 141 SERIES

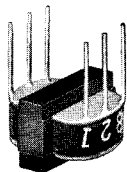

- Economical version of the 142 series with pins for P.C. mounting.
- Special miniature light weight core.
- Low height to facilitate high card densities.
- Frequency response 200 to 50 KHz at the 2 db point.
- Insulation test 250 v rms.

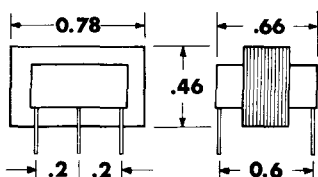

Pin Dia. 0.02" Pin Length 0.50"  
Net Weight 0.6 oz.

Cat. No.	Nominal Impedance		Max. Pri. D.C. mA	D.C. Resistance ohms		Output Milli-watts
	Primary	Secondary		Pri.	Sec.	
◆141 B	200 K	1000	0	3775	85	4
◆141 D	3000 ct	1000 ct	1	120	51	150
◆141 F	25 K	50	2	1645	65	100
◆141 H	600 ct	600 ct	2	32	45	150
◆141 M	30 K	1200 ct	2	1100	47	100
◆141 P	1200 ct	8	2	50	0.45	150

## 142 SERIES

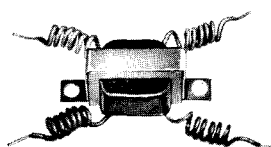

- Economical open, 2 hole, horizontal special strap bracket mounting.
- Insulated flexible leads, 3" long — colour coded.
- Special, miniature, light weight core.
- Frequency response 200 to 50 KHz at the 2 db point.
- Insulation Test 250 v rms.

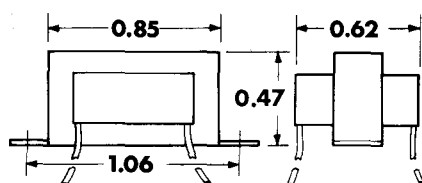

Mounting Centres 1.06  
Net Wt. 0.6 oz.

Cat. No.	Nominal Impedance		Max. Pri. DC MA	DC Resistance in Ohms		Output Milli-watts
	Primary	Secondary		Primary	Secondary	
◆142 B	200000	1000	0	3775	85	4
◆142 F	25000	50	2	1645	6.5	100
◆142 K	25000	1000	2	1075	45	100
◆142 M	30000	1200 ct	2	1100	47	100
◆142 Q	1200	3.2	5	84	0.5	250
◆142 R	1200	50	5	84	7.5	250
◆142 T	1200 ct	3.2	10 per side	84	0.5	250

### ◆ New Products

Special designs of these series produced quickly to your specifications.



# HAMMOND

# AUDIO TRANSFORMERS EPOXY CAST – PRINTED CIRCUIT

## 102 104 106 SERIES

- For use in miniature (solid state) circuitry.
- Pin type printed circuit mounting. • Insulation test 250 V rms.
- Bifilar winding technique used on centre tapped units for balanced resistive and capacitive characteristics.
- Rugged black epoxy cast construction produces a completely sealed unit withstanding severe environmental conditions including those of MIL-T-27. (See p. 4 details.)
- For open printed circuit mounting types, refer to 148 or 149 Series p. 10.
- For smaller cast units refer to 101 Series p. 8.

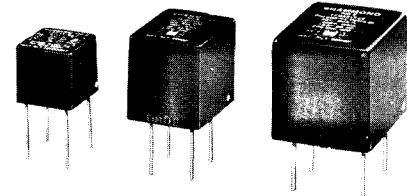

Cat. No.	Application	Nominal Impedance		Pri. D.C. M.A. ✓	D.C. Res. *		Output † Milliwatts	Freq. □ — 1 db
		Primary	Secondary		Primary	Secondary		
102 B	Input	50	1500	0	4	95	20	310
102 D	Input	600	1500	0	48	95	20	310
102 H	Interstage	2000	500 ct	5.6	341	62	20	310
102 J	Interstage	6000	2000 ct	2.8	900	260	20	310
102 K	Interstage	10000	2000 ct	2.5	1585	260	20	310

† For 1.5 db or less Insertion loss at 1000 Hz.

104 B	Input	150	80000	0	6.6	3730	5	60
104 F	Interstage	1500	500 ct	8.0	111	24	35	200
104 G	Interstage	3000	1000 ct	5.6	265	53	35	200
104 H	Interstage	10000	2000 ct	3.2	675	89	35	200
104 K	Interstage	20000	1000 ct	2.2	790	125	35	200
104 L	Interstage	25000	600 ct	2.0	1890	25	35	200
104 Q	Output	500 ct	3.2	6	27	0.4	500	200
104 R	Output	500 ct	8	6	27	0.9	500	200
104 S	Output	600 ct	150 ct	6	47	10.6	500	200

† Insertion Loss is 1 db approx.

106 C	Input	50000	1500 ct	0	2400	52	10	60
106 D	Input	200 K	1000	0	1970	33	5	50
106 E	Input	600 ct	600	9	65	83	500	150
106 F	Interstage	2000	500 ct	14	148	17	150	215
106 G	Interstage	4000	600 ct	10	340	24	150	215
106 H	Interstage	4000	2600 ct	10	340	100	150	215
106 J	Interstage	10000	2000 ct	6.5	700	89	150	215
106 K	Interstage	15000	200 ct	5.0	850	10	150	215
106 L	Interstage	20000	1000 ct	4.5	1180	50	150	215
106 M	Interstage	20000	2000 ct	4.5	1180	89	150	215
106 Q	Output	48 ct	3.2	32	2.4	0.3	1500	170
106 R	Output	48 ct	8	32	2.4	0.7	1500	170
106 S	Output	100 ct	3.2	22	4.4	0.3	1500	170
106 T	Output	100 ct	8	22	4.4	0.7	1500	170
106 U	Output	250 ct	3.2	14	11	0.3	1500	170
106 V	Output	250 ct	8	14	11	0.7	1500	170
106 W	Output	500 ct	3.2	10	26	0.3	1500	170
106 X	Output	500 ct	8	10	26	0.7	1500	170
106 Y	Output	4000 ct	3.2	3.5	220	0.3	1500	170

† Insertion Loss is 1 db approx.

### NOTES

□ Approximate frequency in hertz at which the output, at rated load and D.C. unbalance, is 1 db below the 1000 hertz rating. The High Frequency roll-off point exceeds 20 KHz (Above 35 KHz in most types).

\* Resistance tolerance  $\pm 15\%$ .

✓ Where primary is centre-tapped, this figure is the maximum unbalance.

— Overall dimensions are maximum; pin spacings are  $\pm .010''$ .

† When operating at impedances below nominal, power capability and the frequency spectrum are proportionately lower; conversely, at higher impedances power capability and frequency spectrum will be proportionately higher.

Special designs of this series produced quickly to your specifications.

### 102 SERIES

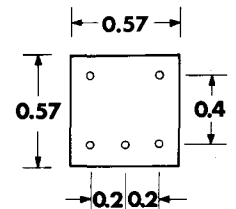

Height 0.50"  
Pin Dia. .025", Length 0.5"  
Net Wt. 0.32 oz.

### 104 SERIES

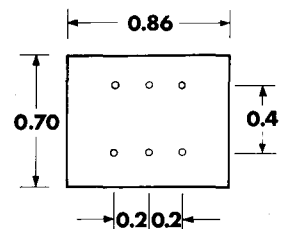

Height 0.72"  
Pin Dia. .025", Length 0.5"  
Net Weight 0.8 oz.

### 106 SERIES

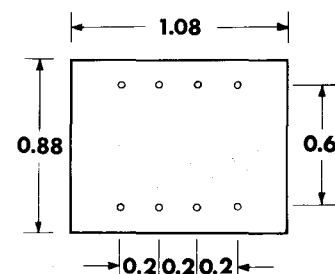

Height 0.85"  
Pin Dia. .032", Length 0.5"  
Net Wt. 1.45 oz.

# AUDIO TRANSFORMERS OPEN PRINTED CIRCUIT

# HAMMOND

## TRANSISTOR TRANSFORMERS

- Designed for printed circuit mounting by means of pins (148 series) or by clinching lugs (149 series).
- Economical, light weight, horizontal bracket designs. (See p. 4 details.)
- Solid tinned copper leads .032 dia., 0.5" long on 0.2" grid.
- Bifilar wound centre tapped and split wound units for balanced capacitive and resistance characteristics.
- Frequency response 200 to 15,000 Hz (-1 db reference 1000 Hz).
- Insertion loss less than 1½ db. • Insulation test 250 V rms.
- Total distortion approximately 2% for drivers and 1% for outputs at 200 Hz decreasing at higher frequencies.
- For rugged epoxy cast type of printed circuit mounting refer to 102, 104 or 106 Series p. 9.
- Approx. Weight - 148 series 0.6 oz. - 149 series 1.0 oz.

### PIN MOUNTED

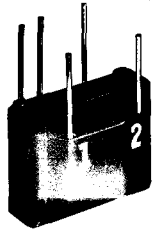

ACTUAL SIZE

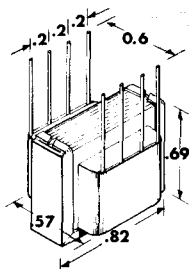

Cat. No.	Application	Nominal Impedance		DC Resistance *		Pri. DC ma †	Output Milliwatts	Supply Volts § For Rated Output
		Pri.	Sec.	Pri.	Sec.			
148 A	Input	150/600	600/2400	45	300	1.9	300	—
148 B	Input	150	400/1600	11.3	200	3.8	300	—
148 C	Input	50,000	250/1000	1760	25.4	0	12	—
148 D	Input	200 K	1000	1760	6.2	0	3	—
148 E	Driver	500	125/500	79	60	18.0	75	10
148 F	Driver	1500	125/500	220	58	11.6	75	17
148 G	Driver	2000	250/1000	313	107	9.3	75	20
148 H	Driver	3000	250/1000	480	107	7.5	75	25
148 J	Driver	4000	250/1000	520	102	6.5	75	28
148 K	Driver	4000	500/2000	540	230	6.5	75	28
148 M	Driver	6000	500/2000	850	230	5.3	75	35
148 Q	Driver	10,000	500/2000	1700	238	4.1	75	45
148 R	Driver	20,000	250/1000	2230	123	2.4	50	52
148 T	Output	500 ct	3.2	41	0.34	2.1	300	10
148 V	Output	600 ct	150 ct	45	14	1.9	300	11
148 W	Output	1200 ct	3.2	137	0.34	1.4	300	16
148 X	Output	4000 ct	3.2	380	0.34	0.8	300	28
148 Y	Output	5000 ct	500 ct	410	52	0.7	300	32
148 Z	Output	8000 ct	3.2	840	0.34	0.5	300	40

### LUG MOUNTED

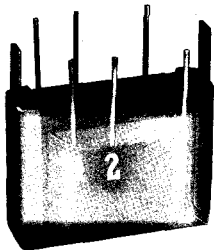

ACTUAL SIZE

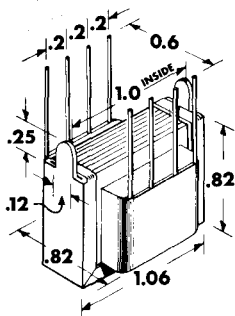

Cat. No.	Application	Nominal Impedance		DC Resistance *		Pri. DC ma †	Output Milliwatts	Supply Volts § For Rated Output
		Pri.	Sec.	Pri.	Sec.			
149 C	Driver	160	20/80	24	6.5	56	200	9
149 E	Driver	300	30/120	41	9.7	42	200	12
149 F	Driver	450	40/160	52	19	33	200	15
149 G	Driver	600	150/600	92	58	29	200	18
149 H	Driver	1000	60/240	155	24	22	200	22
149 J	Driver	1600	100/400	248	37	18	200	28
149 K	Driver	3000	200/800	445	85	12	200	39
149 M	Driver	6000	250/1000	760	114	9	100	39
149 Q	Output	200 ct	3.2	19	0.4	7	1,000	11
149 R	Output	400 ct	3.2	34	0.4	5	1,000	16
149 S	Output	600 ct	150 ct	53	17	4	1,000	20
149 T	Output	600 ct	600 ct	53	70	4	1,000	20
◆149 U	Output	150/600	8	53	85	4	1,000	20
◆149 V	Hybrid	600 ct	300/1200	53	63	4	1,000	20
	(2 req'd) for use in hybrid circuit							
149 W	Output	1600 ct	3.2	135	0.4	2.5	1,000	32

### NOTES

- \* Resistance values are for total windings and tolerance is ± 15%.
- On four terminal transformers, centre pins are omitted.
- † Output transformers - this figure is the maximum unbalance.
- § Supply volts based on 75% efficiency for 148 series and 80% for the 149 series.

### ◆ New Product.

When operating at impedances below nominal, power capability and the frequency spectrum are proportionately lower conversely, at higher impedances power capability and frequency spectrum will be proportionately higher.

Special designs of these series produced quickly to your specifications.

## MINIATURE SHIELDED INPUT TRANSFORMERS

- OEM and replacement use in intercoms and small amplifiers. • Insulated leads 5 to 6".
- Heavy drawn steel case for proper shielding — low hum pickup.
- Frequency response 70 to 11,000 Hz (-1 db).

Cat. No.	Application	Nominal Impedance		Overall Turns Ratio Pri. to Sec.
		Primary	Secondary	
<b>140 SERIES</b>				
140 A	Voice Coil to Single Grid	4	60000	1:122
140 B	Dyn. MIC. to Single Grid	30	60000	1:45
140 C	MIC. to Single Grid	50	60000	1:34.5
140 H	Bridging Line to P.P. Grids	10000	40000 ct	1:2
140 K	MIC. to Single Grid	150	60000	1:20
140 M	CRYS. MIC. to Base	100K	1500	8:1
140 N	Dyn. MIC. to Base	50	1500	1:5.5
140 P	Line to Base	150/600	600/2400	1:2
◆140 Q	Line to Line	600 ct	600 ct	1:1

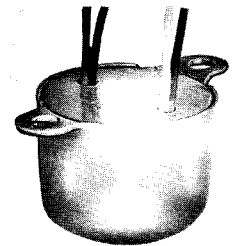

Weight 2 oz.

Dimensions  
Diameter  $1\frac{3}{16}$ ", Height 1"  
Mtg. Cts.  $1\frac{1}{2}$ "  
Tolerance  $\pm \frac{1}{16}$ "

Insulation Test 250 V. rms

## MINIATURE TRANSISTOR TRANSFORMERS

- Light weight, open, 2 hole horizontal bracket mounting. (See p. 4 details.)
- Insulated colour coded flexible leads 4" long.
- For experimental, OEM or replacement applications.
- For similar printed circuit devices refer to 148 Series p. 10.
- Frequency response 150 to 15,000 Hz (-1 db reference 1000 Hz.)

Cat. No.	Application	Nominal Impedance		D.C. Resistance *		Primary† D.C. MA.	Output Milliwatts
		Pri.	Sec.	Pri.	Sec.		
<b>143 SERIES</b>							
143 B	Input	3.2	4000	0.4	245	0	15
143 D	Input	200K	1000	5700	34	0	25
143 H	Driver	1500	500 ct	111	24	4	30
143 J	Driver	3000	1000 ct	265	53	2.6	30
143 L	Driver	10000	200 ct	720	9	1.5	30
143 N	Driver	10000	2000 ct	720	89	1.5	30
143 P	Driver	20000	1000 ct	830	125	1.1	30
143 R	Driver	25000	600 ct	1890	25	1	30

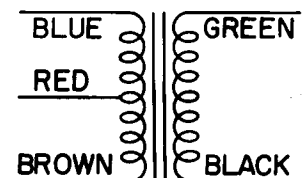
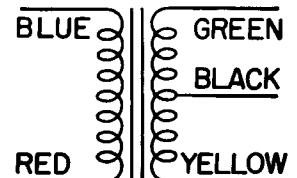
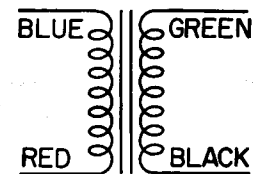
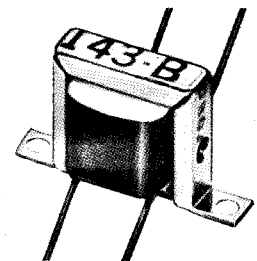

## 144 SERIES

144 B	Output	200 ct	3.2	10	0.4	10	150
144 D	Output	300 ct	3.2	15	0.4	9	150
144 F	Output	500 ct	3.2	27	0.4	6	150
144 G	Output	500 ct	8	27	0.9	6	150
144 H	Output	500 ct	50	28	7.3	6	150
144 i	Output	600 ct	150 ct	45	8.2	6	150
144 J	Output	1000 ct	3.2	56	0.4	4	150
144 K	Output	2500 ct	3.2	144	0.4	3	150
144 P	Output	10000	3.2	575	0.5	5	50
144 Q	Output	10000	8	575	0.9	5	50
144 R	Output	20000	3.2	1240	0.5	3.5	50
144 S	Output	20000	8	1240	0.9	3.5	50

Weight 0.5 oz.  
Core Size  $\frac{3}{16} \times \frac{3}{16}$   
Mtg. Cts.  $1\frac{1}{16} \pm \frac{1}{16}$ "

Overall dimensions  
 $1\frac{1}{16} \times \frac{9}{16} \times \frac{1}{16}$  high  $\pm \frac{1}{16}$ "  
Insulation Test 250 V. rms

### ◆ New Product.

† For output transformers this figure is maximum unbalance.

\* Total winding resistance  $\pm 15\%$ .

When operating at impedances below nominal, power capability and the frequency spectrum are proportionately lower; conversely, at higher impedances power capability and frequency spectrum will be proportionately higher.

Special designs of these series produced quickly to your specifications.

# AUDIO TRANSFORMERS TRANSISTOR

# HAMMOND

## MINIATURE TRANSISTOR TRANSFORMERS

- Economical open, 2 hole, horizontal bracket mounting. (See p. 4 details.)
- Insulated flexible color coded leads 3" long.
- Frequency response 150-15,000 Hz minimum (-1 db, ref. 1000 Hz).
- For OEM, experimental or replacement applications.

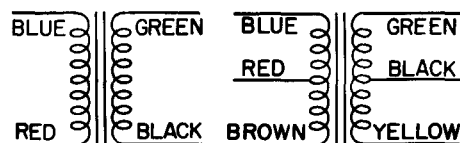
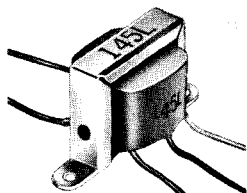

Core Size  $\frac{1}{4} \times \frac{1}{4}$   
Mtg. Cts.  $1\frac{3}{8}'' \pm \frac{1}{16}''$   
Insulation Test 250 V. R.M.S.  
\*Total Winding Resistance  $\pm 15\%$

Overall Dimensions  
 $1\frac{5}{8} \times \frac{3}{4} \times \frac{1}{16}$  high  $\pm \frac{1}{16}$   
Weight 1.4 oz.

For printed circuit applications  
refer to 149 series P. 10.

Cat. No.	Application	Nominal Impedance		D.C. Resistance*		Max. mA Pri. or Unbal.	Output Milli-Watt
		Primary	Secondary	Pri.	Sec.		
145 A	Driver	100	200 ct	14	19	45	100
145 B	Driver-Output	600	600	52	67	18	100
145 C	Input	50000	1500 ct	2400	52	1	50
145 D	Input	200K	1000	3600	33	0.5	10
145 E	Input-Output	600 ct	600 ct	65	83	5	200
145 F	Driver	600	200 ct	45	9	20	135
145 G	Driver	2000	200 ct	140	9	12	135
145 H	Driver	2000	500 ct	148	17	12	135
145 J	Driver	4000	600 ct	340	24	8	135
145 K	Driver	4500	1500 ct	360	60	7.5	135
145 L	Driver	4000	2600 ct	340	100	8	135
145 N	Driver	10000	2000 ct	700	89	5	135
145 O	Driver	15000	200 ct	850	10	4	135
145 P	Driver	20000	1000 ct	1180	50	3.5	135
145 R	Driver	20000	2000 ct	1180	89	3.5	135
146 B	Output	48 ct	3.2	2.4	0.3	20	700
146 C	Output	48 ct	8	2.4	0.7	20	700
146 D	Output	100 ct	3.2	4.4	0.3	14	700
146 E	Output	100 ct	8	4.4	0.7	14	700
146 F	Output	250 ct	3.2	11	0.3	8	700
146 G	Output	250 ct	8	11	0.7	8	700
146 H	Output	500 ct	3.2	26	0.3	6	700
146 i	Output	500 ct	8	26	0.7	6	700
146 J	Output	1000 ct	3.2	56	0.3	4	700
146 K	Output	1000 ct	8	56	0.7	4	700
146 M	Output	2000 ct	3.2	97	0.3	3	700
146 N	Output	2000 ct	8	97	0.7	3	700
146 R	Output	4000 ct	3.2	220	0.3	2	700
146 S	Output	4000 ct	8	220	0.7	2	700

## HIGHER POWER TRANSISTOR AUDIO TRANSFORMERS

- Economical open bracket, enclosed "type X", or open "type H" mounting. (p. 4 & 5 details.)
- Insulated flexible leads, 6 to 8" long, or solder lugs.
- For OEM, experimental or replacement use in larger amplifiers and transmitters.
- Silicon steel cores.

Cat. No.	Application	Nominal Impedance		D.C. Resistance $\pm 15\%$		Max. mA Pri. or Unbal.	Freq. Resp. -2 db	Max. Watts Output	Mtg. Type	Core Size	Wt. Lb.
		Primary	Secondary	Pri.	Sec. ✓						
147 B	Input	200	200	19	22	80	100-10KHz	0.5	BRKT	$\frac{3}{8} \times \frac{3}{8}$	$\frac{1}{4}$
147 D	Driver	12	100 ct	.33	2.4	500	170-15KHz	1.0	BRKT	$\frac{3}{8} \times \frac{1}{2}$	$\frac{1}{4}$
147 E	Driver	100	100 ct	10	8	100	100-12KHz	5.0	BRKT	$\frac{5}{8} \times \frac{5}{8}$	$\frac{1}{2}$
147 G	Driver	5000	3000 ct	80	75	2	50-20KHz	0.015	BRKT	$\frac{1}{2} \times \frac{1}{2}$	$\frac{1}{3}$
147 J	Output	26	3.2	2.5	0.6	600	100-20KHz	3.0	BRKT	$\frac{1}{2} \times \frac{1}{2}$	$\frac{1}{3}$
147 K	Output	48 ct	3.2	3.0	0.35	12	100-20KHz	3.0	BRKT	$\frac{1}{2} \times \frac{1}{2}$	$\frac{1}{3}$
147 L	Output	125 ct	8	1.84	0.48	9	50-12KHz	1.0	BRKT	$\frac{1}{2} \times \frac{1}{2}$	$\frac{1}{3}$
147 N	Output	8 ct	8 ct	0.14	0.14	55	70-10KHz	5.0	BRKT	$\frac{5}{8} \times \frac{5}{8}$	$\frac{1}{2}$
147 P	Output	20 ct	4/8/16	0.8	0.8	25	60-15KHz	10	BRKT	$\frac{3}{4} \times \frac{3}{4}$	1
147 Q	Output	32 ct	4/8/16	1.2	0.8	27	60-15KHz	10	BRKT	$\frac{3}{4} \times \frac{3}{4}$	1
147 R	Output	48 ct	4/8/16	1.8	0.8	22	60-15KHz	10	BRKT	$\frac{3}{4} \times \frac{3}{4}$	1
147 RD	Output (Auto)	60	8	2.8	—	—	120-20KHz	5.0	BRKT	$\frac{3}{4} \times \frac{3}{4}$	1
147 RF	Output	830	8	83	1.0	110	50-30KHz	4.0	BRKT	$\frac{3}{4} \times \frac{3}{4}$	1
147 RH	Driver	1600	100/100	50	12.6	35	35-20KHz	1.0	BRKT	$\frac{3}{4} \times \frac{3}{4}$	1
147 RK	Driver	750	80/80	24	6.4	52	35-20KHz	1.0	BRKT	$\frac{3}{4} \times \frac{3}{4}$	1
147 RL	Driver	1800	50/50	65	7.0	34	30-20KHz	1.0	BRKT	$\frac{3}{4} \times \frac{3}{4}$	1
147 RM	Driver	24	6 ct	3.1	0.8	500	35-30KHz	1.0	BRKT	$\frac{3}{4} \times \frac{3}{4}$	1
147 S	Output	18 ct	4/8	0.5	0.2	60	50-20KHz	20	X	$1 \times 1\frac{1}{4}$	3
147 SG	Output	600 ct	8/16	30	0.8	7	45-20KHz	25	H	$1 \times 1\frac{1}{4}$	3
147 TJ	Output	600 ct	8/16	26	0.68	8	55-20KHz	35	H	$1\frac{1}{8} \times 1\frac{1}{4}$	3
147 U	Output	16 ct	4/8/16	0.2	0.27	85	50-20KHz	35	X	$1\frac{1}{4} \times 1\frac{1}{4}$	4 $\frac{1}{2}$
147 UB	Output	5 ct	8/16	0.17	0.64	96	50-20KHz	50	H	$1\frac{1}{4} \times 1\frac{1}{2}$	5

NOTE — Output audio transformers having CT pri. and CT sec. may be used to couple PP DRIVER to PP OUTPUT.

✓ Total secondary resistance of the split windings connected in series.

# HAMMOND

# AUDIO TRANSFORMERS LINE MATCHING

These unique line matching transformers have been assembled functionally for emphasis and ease of selection. Special designs of these series can be produced quickly to your specifications.

## LINE TO SPEAKER (VOICE COIL) TRANSFORMERS

Cat. No.	Watt Rating	Primary Impedance	Primary Termination	Secondary Impedance	Secondary Termination	Core Size	Mtg. Cts.	Wt. Lb.
119 A	4	500	6" Leads	3.2 ohms	6" Leads	1/2x1/2	2	.3
119 B	3	500, 1000, 1500	Solder lugs	3.2 ohms	6" Leads	1/2x1/2	2	.3
119 C	5	500, 1000, 1500	Solder lugs	3.2 ohms	6" Leads	5/8x5/8	2 3/8	.5
119 D	12	500 (600)	6" Leads	4-8-16 ohms	Solder Lugs	3/4x1	2 13/16	1.25

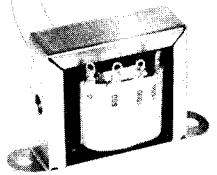

## 300 AND 400 SERIES

- Rugged drawn steel case with smooth black semi-gloss enamel finish — 2 hole mounting.
- Compound filled for long trouble free service.
- Suitable for above or below chassis wiring.

**300 SERIES** — 3/4 x 3/4 Core Mounting Centres 2 3/4 ± 1/16 Wt. 1.25 lb. Length 2 1/2" Height 2 7/8" Width 2".

Cat. No.	Application	Primary Nominal Impedance	Secondary Nominal Impedance	Overall Turns Ratio	Max. Primary DC per Leg
307	Line to Line	500/125 (600/150)	500 ct (600 ct)	1:1	100
322	Isolating, Matching	500 ct	50/250/500	1:1	60
324	Line to Grid	500 ct	50000	1:10	40
326	Line to P.P. Grids	500 ct	65000 ct	1:11.4	40
332	Single Plate to P.P. Grids	20000	80000 ct	1:2	10
346	P.P. Plates to Line	8000 ct	500 ct	4:1	35
382	Line to Voice Coil	500/1000	0—3.2—8	8 watts output	

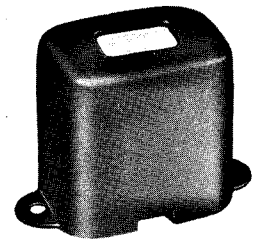

**400 SERIES** — 1 x 1 Core mounting Centres 3 5/16 ± 1/16" Weight 2.9 lb. Length 3 1/8" Height 3 1/4" Width 3 5/8".

**481** Multiple Line to Voice Coil Pri. Imp. 50/125/200/250/500 Sec. Imp. 1 1/2, 3 3/4, 6, 7 1/2, 10, 15 ohms 15 watts  
The 481 transformer is one with many uses in matching line to voice coil. 49 different impedance combinations possible. Complete details enclosed with each transformer.

**482** Line to Voice Coil Pri. Imp. 500/1000 Sec. Imp. 4, 8, 15 ohms 15 watts

**900 SERIES** Dim. 2 5/16 x 2 13/16 x 3 1/2" High; Mounting Centres 1 11/16 x 2 1/16; Weight 1 3/4 lb.

**903** Isolating and Matching M-Line/M-Line + 20 dbm Max. Pri. D.C. 125 mA

M-Line matches 50, 125, 200, 250, 333, 500 ohm lines.

Exact balance on 125, 200 and 500 ohm taps.

Max. level for 50-15000 Hz ± 1/2 db.

Electrostatic shield between primary and secondary.

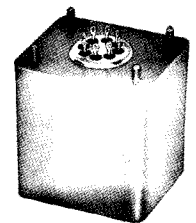

## 1700 SERIES — LINE TO SPEAKER

- Frequency response 40-12,000 Hz.
- Sturdy flange mounted steel case with black semi-gloss enamel finish.
- Solderless terminals (8-32 studs).

Cat. No.	Watt Rating	Primary Impedance Taps	Secondary Impedance Taps	Core Size	Mtg. Cts.	Wt. Lb.
1782	30	500, 1000, 1500	4, 8, 15, 30 ohms	1 1/4 x 1 1/4	3 5/16 x 4 3/16	8
1786	60	500, 1000, 1500	4, 8, 15, 30 ohms	1 1/2 x 2	3 11/16 x 4 13/16	16

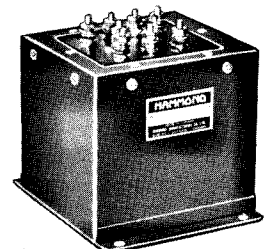

## LINE-TO-DISTRIBUTION SYSTEM MATCHING AUTOTRANSFORMER

**1789** — To match 500 ohm output of 30, 60, 100 or 120 watt amplifier to 70 volt distribution system.

Compound-filled case. Wt. 11 lb.

## AUDIO TRANSFORMER LEAD COLOR CODE



**NOTE** — These lead colors are used on HAMMOND Audio Transformers although other colors may be added or substituted when necessary.

# BROADCAST SERIES TRANSFORMERS



## LOW PROFILE AUDIOS — 560 SERIES

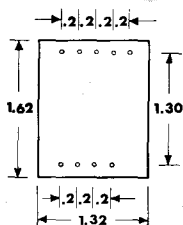
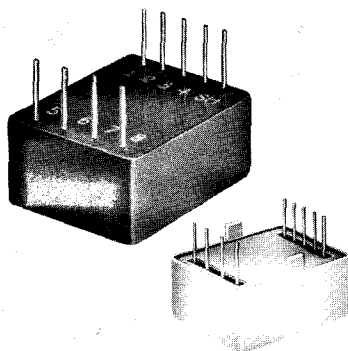

Base Outline

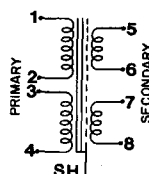

Schematic

- Epoxy cast broadcast quality for P.C. Boards.
- Frequency response at 0 dBm 30 Hz to 30KHz(over 50 KHz in low impedance units, 600 ohm or less).
- Electrostatic shield between pri. and sec. connected to core and pin "SH".
- Humbucking construction.
- Balanced split windings on primary and secondary for circuit versatility — primary and secondaries can be reversed for impedance matching.
- Overall dimensions 1.62" x 1.32" x .76" high.
- Nine P.C. pins .04" diameter by 0.5" long.
- Magnetic shielding: optional mumetal slip-on case available as **560-Z** which mounts with two tinned .12" x .18" tabs. Overall dimensions of shield assembly 1.68" long x 1.46" wide x 0.82" high.
- Shipping weight 4 oz.; Shield assembly 1.5 oz.

Cat. No.	Application	Nominal Impedance	
		Primary	Secondary
◆560 C	Emitter or mic to Line	12/48	150/600
◆560 E	Emitter or mic to Line	50/200	150/600
◆560 G	Isolating or Hybrid	150/600	150/600
◆560 J	Collector to Line or Line to Base	150/600	1200/4800
◆560 L	Collector to Line, or Matching	150/600	5k/20k
◆560 N	Collector to Line	150/600	10k/40k
◆560 Q	Matching or Bridging	10k/40k	10k/40k
◆560 Z	Shield Assembly — dimensions	1.68" W x 1.46" D x .82 high	

## INPUT TRANSFORMERS — MUMETAL-SHIELDED — 585 SERIES

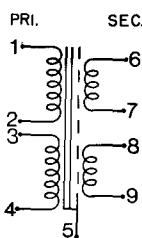
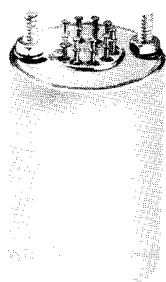

Schematic

- Heavy drawn mumetal case for maximum shielding—grey enamel finish. (See p. 4 details.)
- Hermetically sealed for long life and stable characteristics.
- Humbucking construction with electrostatic shield between pri. and sec. connected to core and terminal provides excellent noise and hum attenuation.
- For radio and TV broadcast applications — transistor and tube circuits.
- Two convenient 6-32 x .38" mounting studs.
- Modern, turret head, solder terminals .22" long.
- Frequency response 50 to 15,000 Hz (−1 db reference 1 KHz).
- Level + 5 dBm.
- Overall dimensions (max.) 2.38" high x 1.41" dia.; case height 1.94".
- Each transformer carton contains instruction bulletin #585 which provides a drilling template and terminal connection data.

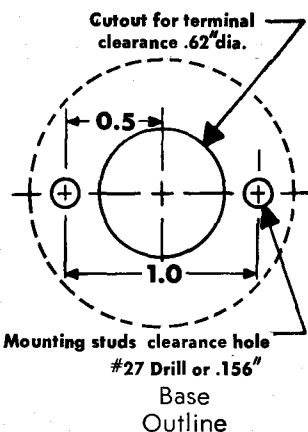

Cat. No.	Application	Nominal Impedance		Overall Ratio
		Primary	Secondary	
585 D	MIC to Grids	37.5/150	25K/100K	1:25.4
585 E	MIC to Base	37.5/150	600/2400	1:8
585 F	Line to Grids	150/600	25K/100K	1:12.7
585 G	Line to Base	150/600	600/2400	1:2
585 H	Bridging	5K/20K	20K/80K	1:2
585 J	Bridging	5K/20K	600/2400	2.9:1

### ◆ New Product

When operating at impedances below nominal, power capability and the frequency spectrum are proportionately lower; conversely, at higher impedances power capability and frequency spectrum will be proportionately higher.

Special designs of these series produced quickly to your specifications.

# HAMMOND

# BROADCAST SERIES TRANSFORMERS

## AUDIO TRANSFORMERS — 850 SERIES

- New broadcast quality designs have extended frequency range. Frequency response is within 0.5 dB from 20 Hz to 20 KHz, units over 5Kohms impedance may be 1 dB down at 20 KHz.
- Capable of higher power levels: up to + 15 dBm with the specified characteristics, or higher levels with reduced low frequency performance.
- Insertion loss is approximately 1 dB.
- Distortion is approximately 1.5% at 20 Hz under full power.
- Lower profile than the 800 series, only 1.7" x 1.2" x 1.65" high.
- Hermetically sealed for stable characteristics and long life. Header has nine 0.22" long solder terminals.
- Deep-drawn steel case with pleasing smooth semi-gloss grey enamel finish and two convenient 6-32 mounting studs with hardware.
- Humbucking construction and electrostatic shield between primary and secondary provides excellent noise attenuation.
- Split balanced windings on primary and secondary for circuit versatility. Primary may be used as a secondary and vice versa for impedance matching.

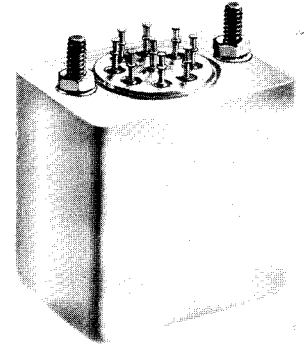

Rdc is full winding D.C. resistance in ohms  $\pm$  20%  
Shipping Wt. 0.4 lb.

Cat. No.	Application	Primary Nominal Imp.	RDC	Secondary Nominal Imp.	RDC
◆850 C	Emitter or mic to line	12/48	6	150/600	70
◆850 E	Emitter or mic to line	50/200	27	150/600	68
◆850 G	Line Isolation or Hybrid	150/600	71	150/600	71
◆850 H	Line Isolation or Hybrid	150/600	70	300/1200	140
◆850 J	Output to Line, or Line to Base	150/600	69	1200/4800	570
◆850 L	Output to Line, Matching, or Bridging	5k/20k	2240	150/600	69
◆850 N	Output to Line, Matching or Interstage	150/600	65	10k/40k	4980
◆850 Q	Interstage or Isolating	10k/40k	4890	10k/40k	4980

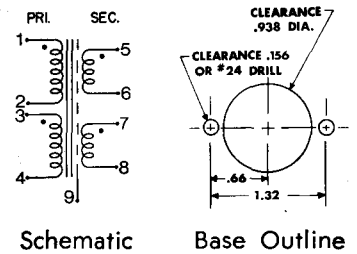

## AUDIO TRANSFORMERS — 800 SERIES

- Compact efficient units for broadcast applications.
- Balanced core and coil construction with effective low hum pickup.
- Split primary and secondary windings for versatility.
- Hermetically sealed for long life and consistent characteristics.
- Frequency response 50 - 15 KHz at 15 dBm except 841, 2, 3, & 4, which are 20 dBm ( $-1/2$  dB reference 1 KHz) Max. level for 50-15000 Hz  $\pm$   $1/2$  dB.
- Modern rigid drawn steel case with smooth grey enamel finish and two convenient 6-32 mounting studs. (See p. 4 details.)
- Multi terminal header with  $7/32$ " long solder pins.
- Each transformer carton contains instruction bulletin #800 which provides a drilling template and terminal connection data.
- 1.75" Wide, 1.25" Deep, 2.56" High • 1.3" Mtg. Cts. • Two 6-32 studs. • Net Wt. 0.5 lb.

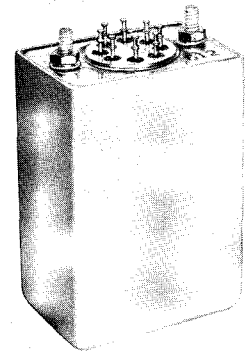

Cat. No.	Application	Primary Nominal Impedances	Secondary	Max. Pri. DC mA Unbalance
801	Isolating, Matching	*50/200	50/200	0.8
802	Isolating, Matching	*50/200 (60/240)	125/500 (150/600)	0.8
804	Isolating, Matching, Hybrid	*125/500 (150/600)	125/500 (150/600)	0.5
806	Dynamic MIC or Voice Coil to Grid	*7.5/30	10K/40K	1.6
807	Dynamic MIC or Voice Coil to Base	*7.5/30	600/2400	1.6
808	MIC or Mixer to Single or P.P. Grid	*50/200	10000/40000	0.6
809	MIC or Mixer to Base	*50/200	600/2400	0.6
812	Line or 150 ohm MIC to 1 or 2 Grids	*125/500 (150/600)	10K/40K (12K/48K)	0.4
813	Line or 150 ohm MIC to Base	*125/500 (150/600)	600/2400 (720/2880)	0.4
818	Crystal Pickup, etc., to Line	*20K/80K	50/200	0
832	Interstage 1:2	5K/20K	20K/80K	0
834	Interstage 1:1.4	5K/20K	10K/40K	0
835	Interstage 1:1	10K/40K	10K/40K	0
841	P.P. Plates† to Line	5K/20K	50/200	0
842	P.P. Plates† to Line	5K/20K (6K/24K)	125/500 (150/600)	0
843	P.P. Plates† to Line	10K/40K	50/200	0
844	P.P. Plates† to Line	10K/40K (12K/48K)	125/500 (150/600)	0

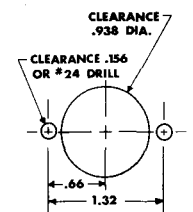

Base Outline

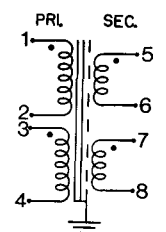

Schematic

\* Electrostatic shield between primary and secondary. † Single plate requires parallel feed.  
When operating at impedances below nominal, power capability is lower and the frequency spectrum is shifted downward; conversely, at higher impedances power capability and frequency spectrum will be shifted upward.

Special designs of these series produced quickly to your specifications.

# AUDIO OUTPUT TRANSFORMERS

# HAMMOND

## 1600 SERIES — 10 Watt to 75 Watt

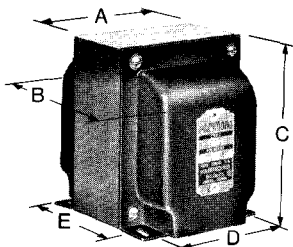

- Designed for Hi-Fi, Stereo or P.A. system applications (Tube circuits).
- Sturdy, convenient, 4 hole above chassis "X Mtg." (See p. 5 details) in semi-gloss black enamel.
- Screen taps on 1620 (21% of pri. turns) and 1626 (41% of pri. turns); for ultra-linear operation if required.
- Frequency response 50 to 15 kHz (−1 dB ref 1000 Hz minimum) Type 1626 is from 30 to 30 kHz.
- Insulated flexible leads 10-12" long.

Cat. No.	Audio Watts	Primary Impedance	Max. DC mA Per Side	Secondary Impedance	Core Size	Dimensions					Wt. Lb.
						A	B	C	D	E	
1605	10	5000 ct	80	4-8-16	1 x 1	2½	2½	3	2⅛	1¾	2.5
1608	10	8000 ct	60	4-8-16	1 x 1	2½	2½	3	2⅛	1¾	2.5
1609	10	10000 ct	45	4-8-16	1 x 1	2½	2½	3	2⅛	1¾	2.5
1615	15	5000 ct	45	4-8-16	1 x 1½	2½	3	3	2⅛	2¼	3.25
1618	20	10000 ct	40	4-8-16	1 x 1½	2½	3	3	2⅛	2¼	3.25
1620	20	6600 ct	80	4-8-16	1 x 1¾	2½	3¼	3	2⅛	2½	3.5
1626	20	6600 ct	80	4/16	1¼ x 1¼	3⅛	3½	3¾	2½	2¼	4.5
1635	30	5000 ct	100	4-8-15-250-500	1¼ x 1¼	3⅛	3½	3¾	2½	2¼	4.5
1637	30	6600 ct	60	4-8-15-250-500	1¼ x 1¼	3⅛	3½	3¾	2½	2¼	4.5
1664	60	3800 ct	100	4-8-15-250-500	1¼ x 2¼	3⅛	4½	3¾	2½	3¼	8.0
1668	75	4500 ct	125	4-8-15-30-250-500	1½ x 1¾	3¾	4½	4½	3	2¾	8.8
<b>TYPES FOR 4, 8, 15 OHMS AND 70 VOLT LINE</b>											
1645	30	5000 ct	100	4-8-15 ohms, 70 v	1¼ x 1¼	3⅛	3½	3¾	2½	2¼	4.5
1647	30	6600 ct	80	4-8-15 ohms, 70 v	1¼ x 1¼	3⅛	3½	3¾	2½	2¼	4.5
1649	30	10000 ct	60	4-8-15 ohms, 70 v	1¼ x 1¼	3⅛	3½	3¾	2½	2¼	4.5
1656	50	6000 ct	100	4-8-15 ohms, 70 v	1¼ x 2	3⅛	4¼	3¾	2½	3	6.5

## 1650 SERIES — 25 to 280 watts

- Designed for push-pull tube output circuits.
- Suitable for Hi-Fi, Stereo, Guitar amplifiers and P.A. applications.
- Sturdy, 4-hole above chassis type "X" mounting finished in semi-gloss black enamel (See p. 5).
- Insulated flexible leads 10-12" long.
- Frequency response 30 to 30 kHz (−1 db max. ref. 1000 Hz minimum).
- For added versatility, the 119 Y series on Page 7 may be used to feed 25V or 70V lines.

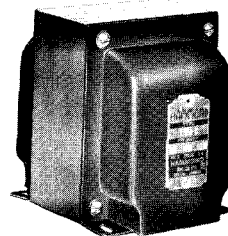

Cat. No.	Watts Output	Primary Impedance	Ultra-Linear Taps †	Secondary Impedance	Core Size	Dimensions					Wt. Lb.
						A	B	C	D	E	
◆1650 F	25	7600 ct	21%	4-8-16	1 x 2	2½	3⅝	3	2⅛	2¾	4.0
◆1650 H	40	6600 ct	nil	4-8-16	1¼ x 1¾	3⅛	4⅛	3⅜	2½	2¾	6.5
◆1650 K	50	3400 ct	40%	4-8-16	1¼ x 2¼	3⅛	4⅝	3⅜	2½	3¼	7.0
◆1650 N	60	4300 ct	21%	4-8-16	1¼ x 2½	3⅛	4⅞	3⅜	2½	3½	8.0
◆1650 R	100	5000 ct	21%	4-8-16	1½ x 2½	3¾	5¼	4⅞	3	3⅞	12.0
◆1650 T	120	1900 ct	nil	4-8-16	1½ x 3	3¾	5¾	4⅞	3	3⅞	14.0
◆1650 W	280	1900 ct	nil	4-8-16	2 x 3½	5	7	6½	4⅞	5⅞	28.0

**NOTE** — † Primary winding has screen taps for ultra-linear operation of output stage of models indicated if required.  
 — Available on special order in through chassis mounting — type Z or top plate models (see page 5 for details). e.g. Order as "1650 N except Z case".

## 1700 SERIES — 20 watts

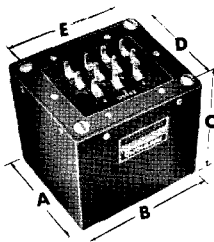

- Sturdy, steel cases with black semi-gloss baked enamel.
- Primary has 40.5% screen taps for ultra-linear operation of output stage.
- Frequency response 20 to 50,000 Hz.
- Negligible wave form distortion.
- Low leakage reactance.

Cat. No.	Audio Watts	Primary Impedance	Secondary Impedance	Leakage Inductance	Primary Inductance	Dimensions					Wt. Lb.
						A	B	C	D	E	
1726	20	6600 ct	4-8-16	20 mH	50 H	3⅞	4⅞	4	3	3⅝	6½

◆ New Product

Special designs of these series produced quickly to your specifications.



# HAMMOND

# INACTIVE TRANSFORMERS

The transformers listed below are types that have been made for several years. With the present demand showing a downward trend, we list them separately and when necessary can still be ordered. Further details on each series will be found on other pages of this catalogue, or previous catalogues in the "80" Series.

## AUDIO

Cat. No.	Application	Nominal Impedance		Max. Watts	Overall Turns Ratio Pri. to Sec.	Max. Pri. mA DC	Mtg. Type	Mtg. Cts.	Wt. Lb.
		Primary	Secondary						
51	Plate to P.P. Grids	10000	40000 ct	—	1:2	8	H. Brkt. 2		0.4
68	P.P. Plate to Voice Coil	14000 ct	3.2	8	—	27	H. Brkt. 2 <sup>3</sup> / <sub>8</sub>		0.5
77	Single Plate to Voice Coil	7000	3.2	10	—	60	H. Brkt. 2 <sup>13</sup> / <sub>16</sub>		1.0
78	P.P. Plate to Voice Coil	8000 ct	3.2	10	—	60	H. Brkt. 2 <sup>13</sup> / <sub>16</sub>		1.0
80	P.P. Plate to Voice Coil	14000 ct	3.2	10	—	45	H. Brkt. 2 <sup>13</sup> / <sub>16</sub>		1.0
102 F	Input	100 K	1500	(2 mW)	—	0	Cast	—	0.32 oz.
104 J	Interstage	10000	90000	(35 mW)	—	3.2	Cast	—	0.7 oz.
104 T	Output	1000 ct	3.2	0.5	—	4.0	Cast	—	0.7 oz.
104 U	Output	2500 ct	3.2	0.5	—	2.5	Cast	—	0.7 oz.
130 B	Voice Coil to Grid	4	80000	—	1:140	350	H. Brkt. 2		0.4
131	Single or DB MIC to Grid	200 ct	50000	—	1:22.4	60	H. Brkt. 2 <sup>3</sup> / <sub>8</sub>		0.5
134	Plate to P.P. Grids	10000	40000 ct	—	1:2	10	H. Brkt. 2 <sup>3</sup> / <sub>8</sub>		0.5
139	Plate to Line	7000	500 ct	—	3.7:1	40	H. Brkt. 2 <sup>3</sup> / <sub>8</sub>		0.5
148 N	Mod. (300-5000 Hz) (12.6 v)	8 ct	5K - 7K	30	—	110/92 (Sec)	X	2 <sup>1</sup> / <sub>8</sub> x 1 <sup>3</sup> / <sub>4</sub>	2.5
148 P	Mod. (250-5000 Hz) (12.6 v)	32 ct	3K - 4K - 6K	10	—	80/70/58 (Sec)	H. Brkt. 2 <sup>3</sup> / <sub>8</sub>		1.25
1610	Output	10000 ct	4/16	15	—	45	X	2 <sup>1</sup> / <sub>8</sub> x 2 <sup>1</sup> / <sub>4</sub>	3.25
1639	Output	10000 ct	4-8-15-250-500	30	—	45	X	2 <sup>1</sup> / <sub>2</sub> x 2 <sup>1</sup> / <sub>4</sub>	4.50
1724	Output—U.L. (40.5% Sc. taps)	3500 ct	4-8-16	20	—	—	Steel Case	3 x 3 <sup>5</sup> / <sub>8</sub>	6.50

## VIBRATOR

Cat. No.	Pri. Volts	DC Volts	DC mA	Mounting Centres		Wt. Lb.	Cat. No.	Pri. Volts	DC Volts	DC mA	Base Size	Height	Wt. Lb.
164 6	6	150	40	2 <sup>3</sup> / <sub>8</sub>	—	1.0	164 L6	6	150	40	1 <sup>7</sup> / <sub>8</sub> x 2 <sup>1</sup> / <sub>4</sub>	1 <sup>1</sup> / <sub>4</sub>	1.0
164 12	12	150	40	2 <sup>3</sup> / <sub>8</sub>	—	1.0	164 L12	12	150	40	1 <sup>7</sup> / <sub>8</sub> x 2 <sup>1</sup> / <sub>4</sub>	1 <sup>1</sup> / <sub>4</sub>	1.0
164 A6	6	180	45	2 <sup>3</sup> / <sub>8</sub>	—	1.3	164 N6	6	180	45	1 <sup>7</sup> / <sub>8</sub> x 2 <sup>1</sup> / <sub>4</sub>	1 <sup>1</sup> / <sub>2</sub>	1.3
164 A12	12	180	45	2 <sup>3</sup> / <sub>8</sub>	—	1.3	164 N12	12	180	45	1 <sup>7</sup> / <sub>8</sub> x 2 <sup>1</sup> / <sub>4</sub>	1 <sup>1</sup> / <sub>2</sub>	1.3
164 B6	6	200	45	2 <sup>13</sup> / <sub>16</sub>	—	1.5	164 P6	6	200	45	2 <sup>3</sup> / <sub>16</sub> x 2 <sup>5</sup> / <sub>8</sub>	1 <sup>3</sup> / <sub>8</sub>	1.5
164 B12	12	200	45	2 <sup>13</sup> / <sub>16</sub>	—	1.5	164 P12	12	200	45	2 <sup>3</sup> / <sub>16</sub> x 2 <sup>5</sup> / <sub>8</sub>	1 <sup>3</sup> / <sub>8</sub>	1.5
164 C6	6	250	50	2 <sup>1</sup> / <sub>8</sub>	1 <sup>11</sup> / <sub>16</sub>	2.3	164 R6	6	225	50	2 <sup>3</sup> / <sub>16</sub> x 2 <sup>5</sup> / <sub>8</sub>	1 <sup>5</sup> / <sub>8</sub>	1.8
164 C12	12	250	50	2 <sup>1</sup> / <sub>8</sub>	1 <sup>11</sup> / <sub>16</sub>	2.3	164 R12	12	225	50	2 <sup>3</sup> / <sub>16</sub> x 2 <sup>5</sup> / <sub>8</sub>	1 <sup>5</sup> / <sub>8</sub>	1.8
164 J6	6	275	60	2 <sup>1</sup> / <sub>8</sub>	1 <sup>15</sup> / <sub>16</sub>	2.8	164 T6	6	250	50	2 <sup>1</sup> / <sub>2</sub> x 3	1 <sup>1</sup> / <sub>2</sub>	2.3
164 J12	12	275	60	2 <sup>1</sup> / <sub>8</sub>	1 <sup>15</sup> / <sub>16</sub>	2.8	164 T12	12	250	50	2 <sup>1</sup> / <sub>2</sub> x 3	1 <sup>1</sup> / <sub>2</sub>	2.3

## AUDIO

Cat. No.	Description	Nominal Impedance		Overall Turns Ratio	Max. Pri. DC	Cat. No.	Description	Nominal Impedance		Overall Turns Ratio	Max. Pri. DC
		Pri.	Sec.					Pri.	Sec.		
306	Matching, Isolating	50/200	200 ct	1:1	100	340	Single Plate to Line	15 K	500 ct	5.75:1	10
330	Single Plate to Grid	10 K	90 K	1:3	10	342	P.P. Plate to Line	20 K ct	500 ct	6.3:1	10
331	Single Plate to P.P. Grids	10 K	120 K ct	1:3.5	10	344	Single Plate to Line	4 K	500 ct	2.8:1	35
333	P.P. Plates to P.P. Grids	20 K ct	20 K/5 K	1:1	10	347	Single Plate to Line	7 K	500 ct	3.75:1	35
334	S. Plate to Class "AB" Grids	20 K	10.5 K ct	1.37:1	10	348	P.P. Plates to Line	14 K ct	500 ct	5.3:1	35

## POWER/FILAMENT

Cat. No.	Description	Mtg.	Secondary		KV Test	Fil. No. 1		Fil. No. 2		Fil. No. 3		Core Size	Mtg. Cts.	Wt. Lb.
			RMS Volts	mA		V	A	V	A	V	A			
287	Power	X	300-0-300	270	—	5.0	4	6.3	10	6.3	1.5	1 <sup>1</sup> / <sub>2</sub> x 2 <sup>1</sup> / <sub>4</sub>	3 x 3 <sup>1</sup> / <sub>4</sub>	12.0
288	Power	X	300-0-300	270	—	5.0	4	6.3	10	—	—	1 <sup>1</sup> / <sub>2</sub> x 2	3 x 3	11.0
289 C	Power	X	300-0-300	225	—	5.0	4	6.3	10	6.3	1.5	1 <sup>1</sup> / <sub>2</sub> x 2 <sup>1</sup> / <sub>4</sub>	3 x 3 <sup>1</sup> / <sub>4</sub>	12.0
1125 R	Filament	R	—	—	3	5.0 ct	13	5.0 ct	13	5.0 ct	3	1 <sup>1</sup> / <sub>2</sub> x 1 <sup>1</sup> / <sub>2</sub>	2 <sup>7</sup> / <sub>8</sub> x 5 <sup>1</sup> / <sub>2</sub>	8.0
1136 R	Filament	R	—	—	2.5	6.3 ct	5	6.3 ct	5	—	—	1 <sup>1</sup> / <sub>4</sub> x 1 <sup>3</sup> / <sub>4</sub>	2 <sup>1</sup> / <sub>4</sub> x 5 <sup>1</sup> / <sub>4</sub>	6.25
1143 R	Filament	R	—	—	3	10.0 ct	8	10.0 ct	8	—	—	1 <sup>1</sup> / <sub>2</sub> x 1 <sup>3</sup> / <sub>4</sub>	2 <sup>7</sup> / <sub>8</sub> x 5 <sup>3</sup> / <sub>4</sub>	9.75
1165 T	Filament (HV)	T (Max DC	4 KV)	10	2.5 ct	5	—	—	—	—	—	1 <sup>1</sup> / <sub>4</sub> x 3 <sup>4</sup> / <sub>4</sub>	2 <sup>1</sup> / <sub>4</sub> x 4 <sup>1</sup> / <sub>8</sub>	4.0
1165 X	Filament(HV)	X (Max DC	3 KV)	8	2.5 ct	5	—	—	—	—	—	1 <sup>1</sup> / <sub>4</sub> x 3 <sup>4</sup> / <sub>4</sub>	2 <sup>1</sup> / <sub>2</sub> x 1 <sup>5</sup> / <sub>8</sub>	3.0
1171 T	Filament (HV)	T (Max DC	4.5 KV)	10	5.0 ct	7.5	—	—	—	—	—	1 <sup>1</sup> / <sub>2</sub> x 1	2 <sup>7</sup> / <sub>8</sub> x 5	6.0
1171 X	Filament(HV)	X (Max DC	4 KV)	10	5.0 ct	7.5	—	—	—	—	—	1 <sup>1</sup> / <sub>2</sub> x 1	3 x 2	6.0

## PLATE

Cat. No.	Description	Secondary A.C. Volts (Max.)		Max. D.C. mA		D.C. Volts Output				Pri. Amps. Max.	Core Size	Mtg. Cts.	Wt. Lb.
				CCS	ICAS	Choke Input							
774	Plate Trans	1740-0-1740	200	300	1500, 1350, 1200, 1050, 945, 840	3.6	2 x 2 <sup>3</sup> / <sub>4</sub>	4 <sup>1</sup> / <sub>4</sub> x 4 <sup>1</sup> / <sub>4</sub>	27				
776	Plate Trans	1740-0-1740	300	450	1500, 1350, 1200, 1050, 945, 840	5.7	2 x 4 <sup>1</sup> / <sub>2</sub>	4 <sup>1</sup> / <sub>2</sub> x 7	38				
783	Plate Trans	2320-0-2320	300	450	2000, 1800, 1600, 1400, 1260, 1120	7.7	2 <sup>1</sup> / <sub>2</sub> x 3	5 <sup>3</sup> / <sub>4</sub> x 4 <sup>3</sup> / <sub>4</sub>	48				
787	Plate Trans	2880-0-2880	300	450	2500, 2250, 2000, 1750, 1570, 1400	8.0	2 <sup>1</sup> / <sub>2</sub> x 4	5 <sup>3</sup> / <sub>4</sub> x 5 <sup>3</sup> / <sub>4</sub>	56				

All inactive transformers are listed on this page only. (See page 57 for inactive S/M items)

# FILAMENT — L.V. RECTIFIER TRANSFORMERS

# HAMMOND

## 165 SERIES — Open horizontal frames

- Dual purpose — filament or LV rectifier, continuous service.
- Convenient, economical, 4 slot, open horizontal frame mounting. (See p. 5 details.)
- Conservative designs; are CSA approved "LR 3902".
- Insulated flexible leads — 8-10" long or tabs with holes.
- Primary 115 volts, 60 Hz.
- Secondary 3 to 14 volts, 4 to 50 amps, R.M.S.
- Insulation Test 2000 volts.
- Mounting slots .22" x .44" except 165 V12 which has .28" x .56" slots.

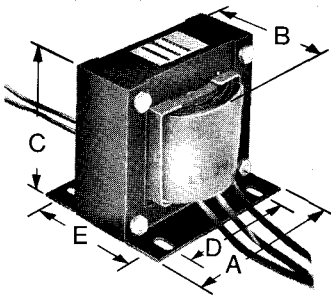

Cat. No.	Full Load Secondary		No Load Secondary	Core Size	Dimensions					Wt. Lb.
	Volts	Amps	Volts		A	B	C	D	E	
165 Z3	3.0 ct	50	3.12	1 1/4 x 2 1/4	3.75	4.63	3.13	3.13	3.50	7.5
165 R5	5.0 ct	8	5.36	1 x 1	3.00	2.25	2.56	2.50	2.50	2.4
165 S5	5.0 ct	10	5.35	1 x 1 1/4	3.00	2.50	2.56	2.50	2.50	2.85
165 U5	5.0 ct	15	5.3	1 x 1 3/4	3.00	3.00	2.56	2.50	2.75	3.75
165 V5	5.0 ct	20	5.3	1 x 2	3.00	3.25	2.56	2.50	3.00	4.1
165 X5	5.0 ct	30	5.3	1 1/4 x 2	3.75	4.38	3.13	3.13	3.25	6.7
◆165 Q6	6.3 ct	6	6.7	1 x 1	3.00	2.25	2.56	2.50	2.50	2.4
165 S6	6.3 ct	10	6.7	1 x 1 1/2	3.00	2.25	2.56	2.50	2.75	3.25
165 U7	7.5 ct	15	8.1	1 1/4 x 1 1/4	3.75	3.63	3.13	3.13	2.50	4.7
165 V7	7.5 ct	21	8.0	1 1/4 x 2	3.75	4.38	3.13	3.13	3.25	6.7
165 N10	10.0 ct	4	10.7	1 x 1	3.00	2.25	2.56	2.50	2.50	2.4
165 P10	10.0 ct	5	10.7	1 x 1 1/4	3.00	2.50	2.56	2.50	2.50	2.85
165 R10	10.0 ct	8	10.6	1 x 1 3/4	3.00	3.00	2.56	2.50	2.75	3.75
165 S10	10.0 ct	10	10.65	1 x 2	3.00	3.25	2.56	2.50	3.00	4.1
165 P11	11.0 ct	5	11.8	1 x 1 1/4	3.00	3.63	2.56	2.50	2.50	2.85
165 S11	11.0 ct	10	11.75	1 1/4 x 1 1/4	3.75	3.63	3.13	3.13	2.50	4.7
165 U11	11.0 ct	15	11.65	1 1/4 x 2	3.75	4.38	3.13	3.13	3.25	6.7
165 N12	12.6 ct	4	13.4	1 x 1 1/4	3.00	3.63	2.56	2.50	2.50	2.85
165 Q12	12.6 ct	6	13.6	1 x 1 3/4	3.00	3.75	2.56	2.50	2.75	3.75
165 R12	12.6 ct	8	13.3	1 x 2	3.00	3.25	2.56	2.50	3.00	4.1
◆165 S12	12.6 ct	10	13.2	1 1/4 x 1 1/2	3.75	3.50	3.13	3.13	2.75	5.5
◆165 V12	12.6 ct	20	13.0	1 1/2 x 2	4.50	4.63	3.75	3.75	3.25	10.0
165 Q14	14.0 ct	6	15.1	1 x 2	3.00	3.25	2.56	2.50	3.00	4.1
◆165 M25	25.0 ct	3	26.6	1 x 1 3/4	3.00	3.50	2.56	2.50	2.75	3.75
◆165 P25	25.0 ct	5	27.2	1 1/4 x 1 1/2	3.75	3.50	3.13	3.13	2.75	5.5
◆165 L50	50.0 ct	2	53.2	1 x 2	3.00	3.25	2.56	2.50	3.00	4.1

## 166 SERIES — Channel bracket mounting

- Dual purpose—filament or LV rectifier, continuous service.
- Convenient, economical, open 2 hole horizontal and vertical bracket mounting.
- Conservative designs; are CSA approved "LR 3902".
- Insulated flexible leads 6"-7" long.
- Insulation test 2000 volts.
- Primary 115 volts, 60 Hz
- Secondary 2.5 to 100 volts, 0.025 to 4 amps. R.M.S.

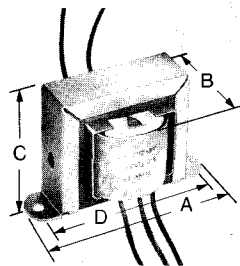

Horizontal Channel Bracket  
FIG. A

Cat. No.	Full Load Secondary		No Load Secondary	Core Size	Dimensions				Wt. Lb.
	Volts	Amps	Volts		A	B	C	D	
166 L2	2.5	2.5	2.85	5/8 x 5/8	2.80	1.88	1.69	2.38	0.5
§166 L5	5.0	2.0	5.5	3/4 x 3/4	2.88	2.00	2.38	2.38	1.25
166 E6	6.3	0.15	7.45	3/8 x 3/8	2.06	1.25	1.19	1.75	0.25
166 F6	6.3	0.3	7.1	1/2 x 1/2	2.38	1.38	1.38	2.00	0.3
◆166 G6	6.3 ct	0.6	7.8	1/2 x 1/2	2.38	1.38	1.38	2.00	0.3
166 J6	6.3	1.0	7.1	5/8 x 5/8	2.81	1.88	1.69	2.38	0.5
†166 K6	6.3 ct	1.2	7.25	3/4 x 3/4	3.25	2.00	2.00	2.81	1.0
§166 L6	6.3 ct	2.0	7.14	3/4 x 3/4	2.88	2.00	2.38	2.38	1.0
166 N6	6.3 ct	4.0	6.9	7/8 x 7/8	3.69	2.13	2.31	3.13	1.5
166 G10	10.0 ct	0.5	11.0	5/8 x 5/8	2.81	1.88	1.69	2.38	0.5
◆166 C12	6.3/12.6	.1/.05	7/14	1/4 x 1/2	1.63	1.13	0.81	1.38	0.2
166 F12	12.6 ct	0.3	15.7	1/2 x 1/2	2.38	1.38	1.38	2.00	0.3
§166 J12	12.6 ct	1.0	14.3	3/4 x 3/4	2.88	2.00	2.38	2.38	1.0
166 L12	12.6 ct	2.0	13.8	7/8 x 7/8	3.69	2.13	2.31	3.13	1.5
◆166 N12	12.6 ct	4.0	13.4	1 x 1 1/4	4.00	3.25	2.63	3.56	2.85
166 E14	14.0 ct	0.15	17.5	3/8 x 1/2	2.06	1.38	1.19	1.75	0.3
◆166 G14	14.0 ct	0.5	16.1	5/8 x 5/8	2.81	1.88	1.69	2.38	0.5
◆166 J14	14.0 ct	1.0	16.0	3/4 x 3/4	3.25	2.00	2.00	2.81	1.0
◆166 M16	16.0 ct	3.0	17.4	1 x 1	4.00	2.50	2.63	3.56	2.25
◆166 B18	9.0/18.0	.06/.03	10/20	1/4 x 1/2	1.63	1.13	0.81	1.38	0.2
166 D20	20.0 ct	0.1	24.6	3/8 x 1/2	2.06	1.38	1.19	1.75	0.3
◆166 E20	20.0 ct	0.15	23.5	1/2 x 1/2	2.38	1.38	1.38	2.00	0.3
◆166 F20	20.0 ct	0.3	22.8	5/8 x 5/8	2.81	1.88	1.69	2.38	0.5
166 G20	20.0 ct	0.5	22.0	3/4 x 3/4	3.25	2.00	2.00	2.81	1.0
◆166 J20	20.0 ct	1.0	22.0	7/8 x 7/8	3.69	2.13	2.31	3.13	1.5

§ Vertical Bracket Mounting Fig. B. All others Fig. A.

† High voltage insulation (7000 volt rms test) for damper tube heater, etc.

◆ New Product

166 SERIES CONTINUED NEXT PAGE

## 166 SERIES — Channel bracket mounting Continued

Cat. No.	Full Load Secondary		No Load Secondary Volts	Core Size	Dimensions				Wt. Lb.
	Volts	Amps			A	B	C	D	
◆166 A24	12.6/25.2	.05/.025	14/28	1/4 x 1/2	1.63	1.13	0.81	1.38	0.20
◆166 D25	25.0 ct	0.1	28.8	1/2 x 1/2	2.38	1.38	1.38	2.00	0.3
◆166 E25	25.0 ct	0.15	30.8	1/2 x 1/2	2.38	1.38	1.38	2.00	0.3
◆166 F25	25.0 ct	0.3	29.0	5/8 x 5/8	2.81	1.88	1.69	2.38	0.5
◆166 G25	25.0 ct	0.5	28.0	3/4 x 3/4	2.88	2.00	2.38	2.38	1.0
◆166 J25	25.0 ct	1.0	27.5	7/8 x 7/8	3.69	2.13	2.31	3.13	1.5
◆166 K25	25.0 ct	1.5	26.8	1 x 1	4.00	2.50	2.63	3.56	2.25
◆166 G28	28.0 ct	0.5	32.0	3/4 x 3/4	3.25	2.00	2.00	2.81	1.0
◆166 J28	28.0 ct	1.0	30.8	7/8 x 7/8	3.69	2.13	2.31	3.13	1.5
◆166 J33	33.0 ct	1.0	35.0	1 x 1	4.00	2.50	2.63	3.56	2.25
◆166 E36	36.0 ct	0.15	40.7	5/8 x 5/8	2.81	1.88	1.69	2.38	0.5
◆166 F36	36.0 ct	0.3	39.4	3/4 x 3/4	3.25	2.00	2.00	2.81	1.0
◆166 G36	36.0 ct	0.5	40.0	3/4 x 1	3.25	2.25	2.00	2.81	1.25
◆166 J36	36.0 ct	1.0	38.7	1 x 1	4.00	2.50	2.63	3.56	2.25
◆166 C50	50.0 ct	0.075	62.0	1/2 x 1/2	2.38	1.38	1.38	2.00	0.3
◆166 F50	50.0 ct	0.3	57.0	3/4 x 3/4	3.25	2.00	2.00	2.81	1.0
◆166 G50	50.0 ct	0.5	55.0	7/8 x 7/8	3.69	2.13	2.31	3.13	1.5
◆166 J50	50.0 ct	1.0	54.5	1 x 1	4.00	2.50	2.63	3.56	2.25
◆166 G60	60.0 ct	0.5	65.2	1 x 1	4.00	2.50	2.63	3.56	2.25
◆166 G80	80.0 ct	0.5	85.5	1 x 1	4.00	2.50	2.63	3.56	2.25
◆166 G100	100.0 ct	0.5	107.0	1 x 1	4.00	2.50	2.63	3.56	2.25

For the descriptive features of this line refer to the 166 data on p. 18.

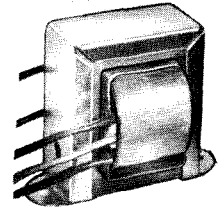

Vertical Channel Bracket § Fig. B

## 167 SERIES — "X" Mounting

Cat. No.	Full Load Secondary		No Load Secondary Volts	Core Size	Dimensions					Wt. Lb.
	Volts	Amps			A	B	C	D	E	
167 M5	5.0 ct	3	5.4	1 x 1/2	2.50	2.13	3.00	2.13	1.25	1.8
167 Q5	5.0 ct	6	5.43	1 x 3/4	2.50	2.38	3.00	2.13	1.50	1.9
167 R5	5.0 ct	8	5.36	1 x 1	2.50	2.63	3.00	2.13	1.75	2.4
167 S5	5.0 ct	10	5.35	1 x 1 1/4	2.50	2.88	3.00	2.13	2.00	2.85
167 U5	5.0 ct	15	5.3	1 x 1 3/4	2.50	3.38	3.00	2.13	2.50	3.75
167 V5	5.0 ct	20	5.3	1 x 2	2.50	3.63	3.00	2.13	2.75	4.1
167 X5	5.0 ct	30	5.3	1 1/4 x 2	3.13	4.38	3.81	2.50	2.25	6.7
167 N6	6.3 ct	4	7.0	1 x 3/4	2.50	2.38	3.00	2.13	1.50	1.9
167 Q6	6.3 ct	6	6.7	1 x 1	2.50	2.63	3.00	2.13	1.75	2.4
167 R6	6.3 ct	8	6.74	1 x 1 1/4	2.50	2.88	3.00	2.13	2.00	2.85
167 S6	6.3 ct	10	6.7	1 x 1 1/2	2.50	3.13	3.00	2.13	2.25	3.25
167 T6	6.3 ct	12	6.8	1 x 1 3/4	2.50	3.38	3.00	2.13	2.50	3.75
167 U6	6.3 ct	16	6.75	1 1/4 x 1 1/4	3.13	3.63	3.81	2.50	2.25	4.7
167 U7	7.5 ct	15	8.1	1 1/4 x 1 1/4	3.13	3.63	3.81	2.50	2.25	4.7
167 V7	7.5 ct	21	8.0	1 1/4 x 2	3.13	4.38	3.81	2.50	3.00	6.7
167 N10	10.0 ct	4	10.7	1 x 1	2.50	2.63	3.00	2.13	1.75	2.4
167 P10	10.0 ct	5	10.7	1 x 1 1/4	2.50	2.88	3.00	2.13	2.00	2.85
167 R10	10.0 ct	8	10.6	1 x 1 3/4	2.50	3.38	3.00	2.13	2.50	3.75
167 S10	10.0 ct	10	10.65	1 x 2	2.50	3.63	3.00	2.13	2.75	4.1
167 P11	11.0 ct	5	11.8	1 x 1 1/4	2.50	2.88	3.00	2.13	2.00	2.85
167 S11	11.0 ct	10	11.75	1 1/4 x 1 1/4	3.13	3.63	3.81	2.50	2.25	4.7
167 U11	11.0 ct	15	11.65	1 1/4 x 2	3.13	4.38	3.81	2.50	3.00	6.7
167 L12	12.6 ct	2	13.7	1 x 3/4	2.50	2.38	3.00	2.13	1.50	1.9
167 N12	12.6 ct	4	13.4	1 x 1 1/4	2.50	2.88	3.00	2.13	2.00	2.85
167 Q12	12.6 ct	6	13.6	1 x 1 3/4	2.50	3.38	3.00	2.13	2.50	3.75

- Dual purpose—filament or LV rectifier, continuous service.
- Convenient, economical enclosed 4 hole "Type X" mounting, (See p. 5 details)
- Conservative designs are CSA approved "LR 3902".
- Insulated flexible leads—6"-8" long.
- Primary 115 volts 60 Hz
- Secondary 5 to 100 volts 0.5 to 30 amps R.M.S.
- Insulation Test 2500 V

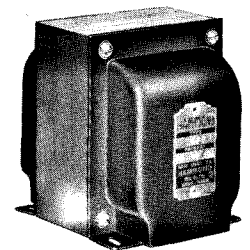

"X" Mounting

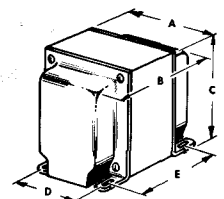

◆ New Product.

Special designs of these series produced quickly to your specifications.

167 Series continued on p. 20.

# FILAMENT — L.V. RECTIFIER & 400 Hz TRANSFORMERS

# HAMMOND

## 167 SERIES "X" Mounting — Continued . . .

For the descriptive features of this line refer to 167 data on p. 19

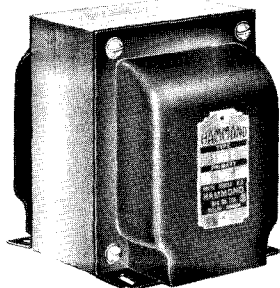

"X" Mounting

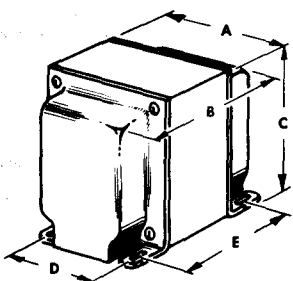

Cat. No.	Full Load Secondary		No Load Secondary Volts	Core Size	Dimensions					Wt. Lb.
	Volts	Amps			A	B	C	D	E	
167 R12	12.6 ct	8	13.3	1 x 2	2.50	3.63	3.00	2.13	2.75	4.1
167 S12	12.6 ct	10	13.2	1 1/4 x 1 1/2	3.13	3.88	3.81	2.50	2.50	5.5
◆167 V12	12.6 ct	20	13.0	1 1/2 x 2	3.75	4.75	4.56	3.00	2.94	10.0
167 Q14	14.0 ct	6	15.1	1 x 2	2.50	3.63	3.00	2.13	2.75	4.1
◆167 P16	16.0 ct	5	17.4	1 x 2	2.50	3.63	3.00	2.13	2.75	4.1
◆167 M16	16.0 ct	3	16.9	1 x 1	2.50	2.63	3.00	2.13	1.75	2.4
167 J25	25.0 ct	1	27.0	1 x 3/4	2.50	2.38	3.00	2.13	1.50	1.9
167 K25	25.0 ct	1.5	26.8	1 x 1	2.50	2.63	3.00	2.13	1.75	2.4
167 M25	25.0 ct	3	26.6	1 x 1 3/4	2.50	3.38	3.00	2.13	2.50	3.75
167 N25	25.0 ct	4	26.6	1 x 2	2.50	3.63	3.00	2.13	2.75	4.1
167 P25	25.0 ct	5	27.2	1 1/4 x 1 1/2	3.13	3.88	3.81	2.50	2.50	5.5
167 S25	25.0 ct	10	25.1	1 1/2 x 2	3.75	4.75	4.56	3.00	2.94	10.0
◆167 J28	28.0 ct	1	30.5	1 x 3/4	2.50	2.38	3.00	2.13	1.50	1.9
◆167 K30	30.0 ct	1.5	31.6	1 x 1 1/4	2.50	2.88	3.00	2.13	2.00	2.85
◆167 M30	30.0 ct	3	32.0	1 x 2	2.50	3.63	3.00	2.13	2.75	4.1
167 J33	33.0 ct	1	35.0	1 x 3/4	2.50	2.38	3.00	2.13	1.50	1.9
167 J36	36.0 ct	1	39.5	1 x 3/4	2.50	2.38	3.00	2.13	1.50	1.9
167 L36	36.0 ct	2	38.3	1 x 1 1/2	2.50	3.13	3.00	2.13	2.25	3.25
◆167 M36	36.0 ct	3	37.9	1 1/4 x 1 1/4	3.13	3.63	3.81	2.50	2.25	4.7
167 P36	36.0 ct	5	38.2	1 1/4 x 2	3.13	4.38	3.81	2.50	3.00	6.7
◆167 R36	36.0 ct	8	37.4	1 1/2 x 2 1/4	3.75	5.00	4.56	3.00	3.19	11.0
◆167 L44	44.0 ct	2	46.0	1 x 2	2.50	3.63	3.00	2.13	2.75	4.1
167 J50	50.0 ct	1	54.5	1 x 1	2.50	2.63	3.00	2.13	1.75	2.4
167 L50	50.0 ct	2	53.2	1 x 2	2.50	3.63	3.00	2.13	2.75	4.1
167 G55	55.0 ct	0.5	59.7	1 x 3/4	2.50	2.38	3.00	2.13	1.50	1.9
167 J55	55.0 ct	1	58.7	1 x 1 1/4	2.50	2.88	3.00	2.13	2.00	2.85
167 L55	55.0 ct	2	58.5	1 1/4 x 1 1/4	3.13	3.63	3.81	2.50	2.25	4.7
167 G60	60.0 ct	0.5	65.2	1 x 3/4	2.50	2.38	3.00	2.13	1.50	1.9
167 J60	60.0 ct	1	63.5	1 x 1 1/2	2.50	3.13	3.00	2.13	2.25	3.25
167 L60	60.0 ct	2	64.0	1 1/4 x 1 1/4	3.13	3.63	3.81	2.50	2.25	4.7
◆167 L70	70.0 ct	2	73.0	1 1/4 x 2	3.13	4.38	3.81	2.50	3.00	6.7
◆167 N70	70.0 ct	4	72.0	1 1/2 x 2 1/4	3.75	5.00	4.56	3.00	3.19	11.0
167 G80	80.0 ct	0.5	85.5	1 x 1	2.50	2.63	3.00	2.13	1.75	2.4
167 J80	80.0 ct	1	84.5	1 x 2	2.50	3.63	3.00	2.13	2.75	4.1
167 L80	80.0 ct	2	82.7	1 1/4 x 2	3.13	4.38	3.81	2.50	3.00	6.7
167 G100	100.0 ct	0.5	107.0	1 x 1	2.50	2.63	3.00	2.13	1.75	2.4
167 J100	100.0 ct	1	106.5	1 x 2	2.50	3.63	3.00	2.13	2.75	4.1

## 400 HERTZ TRANSFORMERS

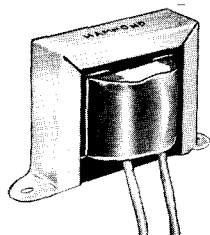

220 Series

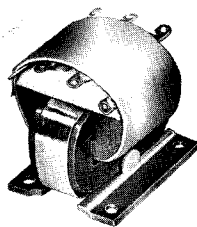

222 Series

- For experimental & OEM applications in 380 to 1000 Hz circuits.
- May be used in rectifier, signal reference and filament heating circuits, etc.
- 220 series supplied in open horizontal bracket mounting (See p. 4 details) with 6" leads.
- 222 series supplied in open "C-core" mountings with solder lugs.
- Rated from 1 to 45 VA, higher VA ratings available up to approx. 15 KVA.

### ON SPECIAL ORDER

- May be supplied in printed circuit mounting, epoxy encapsulated or to MIL-T-27 specifications on special order.

Cat. No.	VA Rating	Pri. Volts	Sec. Volts	Sec. Amps	Overall Dimensions	Mtg. Cts.	Wt. Lb.
220 C	1	115	26	.038	1 1/16 x 5/8 x 1 1/16 H	1 1/16	0.03
220 G	4	115	6.3 ct	.64	1 5/8 x 1 1/16 x 1 1/16 H	1 3/8	0.07
220 K	4	115	26 ct	.15	1 5/8 x 1 1/16 x 1 1/16 H	1 3/8	0.07
220 M	15	115	50 ct	.30	2 1/16 x 1 1/8 x 1 3/16 H	1 3/4	0.25
222 D	20	* 115	26 ct	.70	1 1/2 x 1 1/8 x 1 1/4 H	1 1/8 x 7/8	0.27
222 H	45	115	12.6 ct	1.79	1 1/16 x 1 5/8 x 1 7/8 H	1 3/8 x 1 1/8	0.38
			12.6 ct	1.79			

\* Tapped at 57.5 & 99.7 V. May be used for a Scott 3 phase to 2 phase connection.

### ◆ New Product

Special designs of these series produced quickly to your specifications.

## H. V. RECTIFIER — Filament Transformers

- For 866 A, 872 A and similar tubes.
- Insulated for high voltage OEM broadcast and amateur applications in transmitters, induction heating equipment, etc.
- Convenient "X or T Mtg." available. (See p. 5 for details.)
- Conservative, rugged designs are CSA approved "LR 3902" for operation on 115 V, 60 Hz.
- Special units to operate at up to 50,000 volt levels supplied to specifications.
- Special 230 V primaries are available, e.g., order similar to Cat. 1166 X except primary 230 V.

Cat. No.	Secondary Volts Amps.	Sec. rms. Ins. Test	Maximum DC Volts	Core Size	Overall Dimensions	Mounting Centres	Wt. Lb.
1166 T	2.5 ct 10	10000	4000	1 1/4 x 3/4	3 1/8 x 6 x 4 1/8 H	2 1/4 x 4 1/8	4
1166 X	2.5 ct 10	8000	3000	1 1/4 x 3/4	3 1/8 x 3 x 3 3/4 H	2 1/2 x 1 3/4	3
1172 T	5 ct 15	10000	4500	1 1/2 x 1 3/4	3 3/4 x 7 1/4 x 5 H	2 7/8 x 5 3/4	9
1172 X	5 ct 15	8000	3000	1 1/2 x 1 3/4	3 3/4 x 4 1/2 x 4 1/2 H	3 x 2 3/4	9

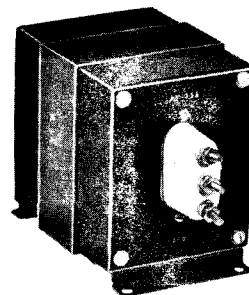

"T" Mounting

## MULTIPLE SECONDARY

- Convenient "X Mtg." available. (See p. 5 for details.)
- Conservative designs are CSA approved "LR 3902" for 115 V, 60 Hz operation.

Cat. No.	Secondary Volts	Amps.	Sec. rms. Ins. Test	Core Size	Overall Dimensions	Mounting Centres	Wt. Lb.
266 X	5.0	2.0	2500	1 x 1 1/2	2 5/8 x 3 1/8 x 3 H	2 1/8 x 2 1/4	3.3
	6.3	4.0	2500				
267 X	5.0 ct	3.0	3000	1 1/4 x 1 1/4	3 1/8 x 3 3/4 x 3 3/4 H	2 1/2 x 2 1/4	4.75
	6.3 ct	6.0	2500				
*267 C	6.3	10.0	2500	1 1/4 x 2	3 1/8 x 4 1/2 x 3 3/4 H	2 1/2 x 3	6.5
	6.3	10.0	2500				
1125 X	5.0 ct	13.0	3000	1 1/2 x 1 1/2	3 3/4 x 4 3/8 x 4 1/2	3 x 2 1/2	8.0
	5.0 ct	13.0	3000				
1136 X	5.0 ct	3.0	2500	1 1/4 x 1 3/4	3 1/8 x 4 1/8 x 3 3/4 H	2 1/2 x 2 3/4	6.25
	6.3 ct	5.0	2500				
	6.3 ct	5.0	2500				
1143 X	10 ct	8.0	3000	1 1/2 x 1 3/4	3 3/4 x 4 5/8 x 4 1/2 H	3 x 2 3/4	9.75
	10 ct	8.0	3000				

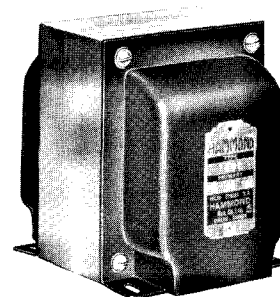

"X" Mounting

\*NOTE — This transformer is "X Mtd." and suitable for sealed beam lights, boat lighting, etc. Secondary windings in parallel 6.3 v. 20 amps. or secondary windings in series 12.6 v. 10 amps.

## MULTI-TAP SECONDARY

- Economical open bracket mounting (see p. 4 details).
- For laboratory supplies, test equipment, or experimental power supplies.
- Primary tapped at 105 and 120 V, 60 Hz.
- Leads 8" long.

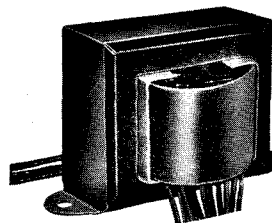

Cat. No. **163 B** Core 1 x 1 Mtg. Cts. 3 3/8 Weight 2.5 lb.

- Secondary tapped at 1.4, 2.0, 2.5, 3.3, 5.0, 6.3, 7.5, 12.6 volts at 2.0 amps., and 25, 30, 35, 50, 70, 117 volts at 0.25 amps.

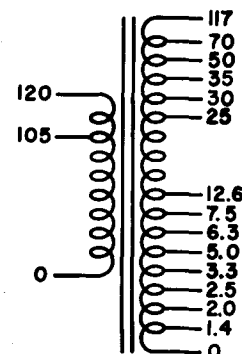

◆ Cat. No. **163 D** Core 1 x 1 Mtg. Cts. 3 3/8 Weight 2.5 lb.

- Secondary tapped at 5, 6.3, 7.5, 10, 12.6, and 14 volts at 2.0 amps., and 20, 25 and 30 volts at 1.0 amps.

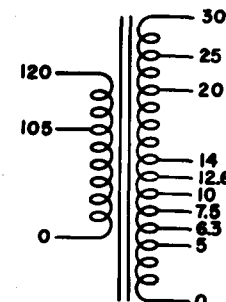

Note — For intermittent service — 2 min. on, 6 min. off, increase above ratings 100%.

◆ New Product

# L.V. RECTIFIER TRANSFORMERS



## RECTIFIER TRANSFORMERS — LOW VOLTAGE — 60 Hertz.

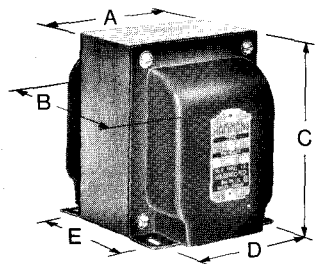

- Designed for use with selenium, silicon, germanium or copper oxide rectifiers in capacitor or choke input circuits.
- Ideal for OEM or replacement applications in battery chargers, low voltage high current power supplies, etc.
- May be used in single phase, full wave centre tapped or bridge circuits.
- Primary or secondary tapped for output voltage adjustment.
- Convenient 4 hole "type X" mounting with knockout (p. 5 details).

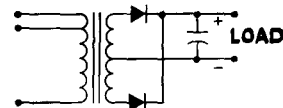

FULL WAVE CENTER TAP

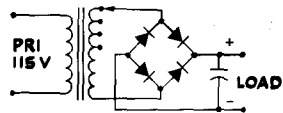

FULL WAVE BRIDGE

Cat. No.	Primary Taps	Secondary Volts	Amps	Core Size	Dimensions					Wt. Lb.
					A	B	C	D	E	
210 A	110-120	7-0-7	2	1 x 1	2 5/8	2 5/8	3 1/8	2 1/8	1 3/4	2 1/2
210 B	110-120	7-0-7	5	1 1/4 x 1	3 1/8	3 3/8	3 3/4	2 1/2	2	4 1/4
210 E	110-120	13-0-13	2	1 1/4 x 1	3 1/8	3 3/8	3 3/4	2 1/2	2	4 1/4
210 H	110-120	13-0-13	5	1 1/2 x 1 1/2	3 3/4	4 1/4	4 1/2	3	2 1/2	8
210 J	110-120	25-0-25	3	1 1/2 x 1 1/2	3 3/4	4 1/4	4 1/2	3	2 1/2	8
210 K-5	115	0-14-16-18-20	5	1 1/4 x 2	3 1/8	4 3/8	3 3/4	2 1/2	3	6
210 K-10	115	0-14-16-18-20	10	1 1/2 x 2 1/4	3 3/4	5	4 1/2	3	3 1/4	11
210 L	115	0-20-22-24-26	5	1 1/4 x 2 1/4	3 1/8	4 5/8	3 3/4	2 1/2	3 1/4	7
210 M	115	0-28-31-34-37	3	1 1/4 x 2 1/4	3 1/8	4 5/8	3 3/4	2 1/2	3 1/4	7
210 P	115	0-28-31-34-37	5	1 1/2 x 2 1/4	3 3/4	5	4 1/2	3	3 1/4	11
210 S	115	0-28-31-34-37	10	2 x 2	5	5 1/2	6 1/2	4 1/8	3 1/2	22

## POWER TRANSFORMERS — LOW VOLTAGE — Primary 115 V — 60 Hertz

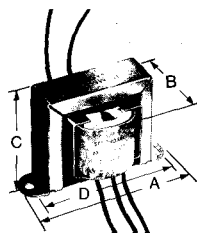

- Designed for use with selenium, silicon, germanium, or copper oxide rectifiers in capacitor or choke input circuits.
- For OEM or replacement applications in small power or bias supplies, test equipment, pre-amps, etc.
- Suitable for single phase half wave, full wave centre tapped (261 series only), full wave bridge or voltage doubler circuits.
- Economical "bracket" or "Type X" mounting. (See p. 4 and 5 details.)
- Convenient 6.3 or 12.6 volt filament/auxiliary winding.

Cat. No.	Va.	Secondary		Filament		Core Size	Mtg. Type	Dimensions					Wt. Lb.
		Volts	DC mA/V	Volts	Amps			A	B	C	D	E	
261 C6	13.5	250 CT	25	6.3	1.0	3/4 x 3/4	BRKT	3 1/4	1 3/4	2	2 13/16	—	1
♦ 261 E6	21	250 CT	50	6.3	1.0	7/8 x 7/8	BRKT	3 3/4	2 1/4	2 5/16	3 1/8	—	1 1/2
♦ 261 G6	42	250 CT	100	6.3	2.0	1 x 1	BRKT	4	2 1/2	2 5/8	3 9/16	—	2
♦ 261 M6*	70	215	125	6.3	4.0	1 1/8 x 1 1/4	Open Vert.	2 13/16	2 5/8	3 3/8	2	2	4
262 B6	4	120	15	6.3	0.3	5/8 x 5/8	BRKT	2 13/16	1 7/8	1 5/8	2 3/8	—	5/8
262 B12	6	120	15	12.6	0.3	5/8 x 5/8	BRKT	2 13/16	1 7/8	1 5/8	2 3/8	—	5/8
262 D6	9	120	30	6.3	0.9	3/4 x 3/4	BRKT	3 1/4	2	2	2 13/16	—	1
262 D12	9	120	30	12.6	0.45	3/4 x 3/4	BRKT	3 1/4	2	2	2 13/16	—	1
262 E6	14	120	50	6.3	1.2	3/4 x 1	BRKT	3 1/4	2	2	2 13/16	—	1 1/4
262 E12	14	120	50	12.6	0.6	3/4 x 1	BRKT	3 1/4	2	2	2 13/16	—	1 1/4
262 F6	19	120	75	6.3	1.5	7/8 x 7/8	BRKT	3 3/4	2 1/4	2 5/16	3 1/8	—	1 1/2
262 F12	19	120	75	12.6	0.75	7/8 x 7/8	BRKT	3 3/4	2 1/4	2 5/16	3 1/8	—	1 1/2
262 G6	25	120	100	6.3	2.1	1 x 1	"X"	2 5/8	2 5/8	3 1/8	2 1/8	1 3/4	2 1/2
262 G12	25	120	100	12.6	1.0	1 x 1	"X"	2 5/8	2 5/8	3 1/8	2 1/8	1 3/4	2 1/2
262 J6	34	120	150	6.3	2.5	1 x 1 1/2	"X"	2 5/8	3 1/8	3 1/8	2 1/8	2 1/4	3 1/4
262 L6	43	120	200	6.3	3.0	1 x 2	"X"	2 5/8	3 5/8	3 1/8	2 1/8	2 3/4	3 1/2
262 L12	43	120	200	12.6	1.5	1 x 2	"X"	2 5/8	3 5/8	3 1/8	2 1/8	2 3/4	3 1/2
262 P6	68	120	300	6.3	5.0	1 1/4 x 1 1/4	"X"	3 1/8	3 5/8	3 3/4	2 1/2	2 1/4	4 1/2
262 R6	110	120	500	6.3	8.0	1 1/4 x 2	"X"	3 1/8	4 3/8	3 3/4	2 1/2	3	6 1/2

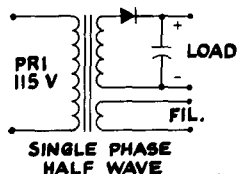

SINGLE PHASE HALF WAVE

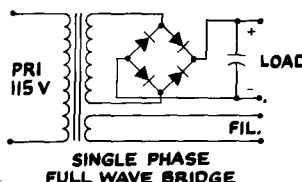

SINGLE PHASE FULL WAVE BRIDGE

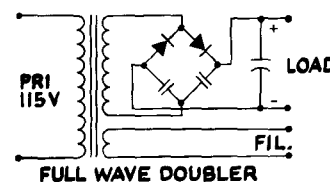

FULL WAVE DOUBLER

\* For replacement of power transformers in European radios. (Supersedes previous number 89662). ♦ New Products  
 ✓ Current measured at output of full wave bridge circuit (half wave and full wave doubler rectifier circuits yield only half this secondary current).

# HAMMOND

# LOW PROFILE POWER TRANSFORMERS

## LOW PROFILE EPOXY CAST POWER TRANSFORMERS

- Low profile and light weight for printed circuit mounting with minimum card spacing.
- Primaries designed for 115 volt operation.
- Epoxy cast to withstand shock and severe environments.
- 226 & 227 pin mounted on 0.1 standard grid, 228 is insert mounted with p.c. pins, also on 0.1 grid.
- Laminations in the horizontal plane parallel to p.c. board.
- Low magnetic radiation.

### ON SPECIAL ORDER

- Other voltage combinations or physical configurations available.
- Open versions with leads or pins.

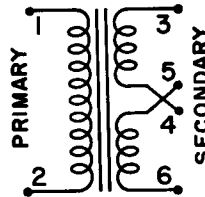
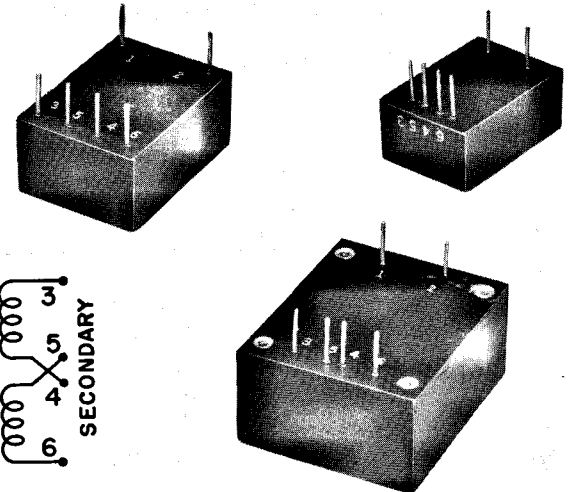

Cat. No.	VA	Hz	Secondary Volts	RMS Amps	Temp. Rise °C	Reg. %
<b>226 SERIES</b>						
◆226 D	1	60	10/20	0.1/0.05	25	20
◆226 F	1	60	15/30	0.067/0.034	25	20
◆226 H	1	60	20/40	0.05/0.025	25	20
◆226 N	20	400	10/20	2.0/1.0	35	7.5
◆226 P	20	400	13/26	1.54/0.77	35	7.5
◆226 R	20	400	15/30	1.33/0.67	35	7.5
◆226 T	20	400	20/40	1.0/0.5	35	7.5

### DIMENSIONS and WEIGHTS

Type 226  
3.5 oz  
0.78" High

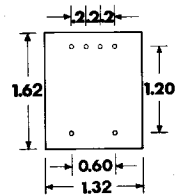

## 227 SERIES

◆227 D	5	60	10/20	0.5/0.25	25	20
◆227 F	5	60	15/30	0.34/0.17	25	20
◆227 H	5	60	20/40	0.25/0.125	25	20
◆227 N	40	400	10/20	4.0/2.0	45	6
◆227 P	40	400	13/26	3.08/1.54	45	6
◆227 R	40	400	15/30	2.66/1.33	45	6
◆227 T	40	400	20/40	2.0/1.0	45	6

Type 227  
6.0 oz  
0.95" High

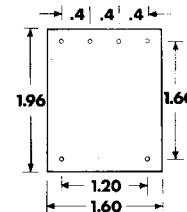

## 228 SERIES

◆228 D	10	60	10/20	1.0/0.5	20	10
◆228 F	10	60	15/30	0.67/0.34	20	10
◆228 H	10	60	20/40	0.5/0.25	20	10

Type 228  
14.5 oz  
1.20" High

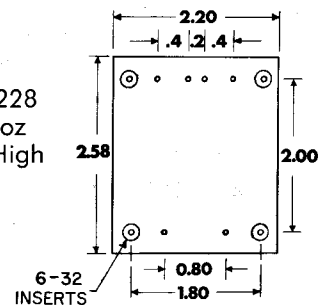

## POWER-FILAMENT TRANSFORMER LEAD COLOR CODE — EIA of Canada Standard CRS-31

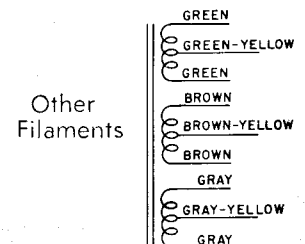
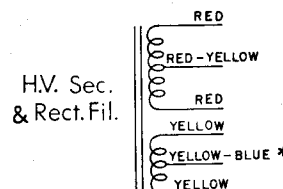
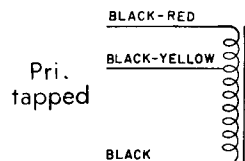
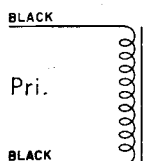

**NOTE** — These lead colors are used on HAMMOND Power and Filament Transformers although other colors may be added or substituted when necessary.

\* This appears yellow-black after impregnation.

### ◆ New Product

Special designs of these series produced quickly to your specifications.

# POWER TRANSFORMERS

# HAMMOND

## "X MOUNTED" SERIES — 115 Volt, 60 Hertz operation

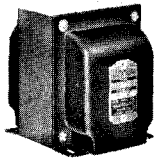

- Convenient 4 hole, above chassis "X Mtg." (See p. 5 details.)
- Conservative designs are C.S.A. approved. "LR 3902"
- Flexible leads 6" to 8" long. • Variety of adaptable ratings.
- Alternate Z mounting available — see next page.
- Dimension tolerance  $\pm \frac{1}{16}$ ".
- Other voltage & current combinations on special order.

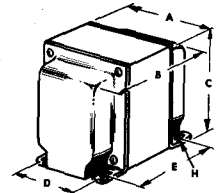

Cat. No.	Pri. VA	Secondary R.M.S. Volts	DC mA†	Fil. No. 1 Rectifier	Fil. No. 2 Heater	Core Size	Dimensions					Wt. Lb.
							A	B	C	D	E	
263 AX	25	100-0-100	100	5.0 v., 2 a.	—	1 x 1	2 1/2	2 5/8	3	2 1/8	1 3/4	2 1/2
263 CX	78	180-0-180	250	5.0 v., 3 a. ct	—	1 1/4 x 1 1/2	3 1/8	3 7/8	3 3/4	2 1/2	2 1/2	5 1/2
269 AX	35	125-0-125	100	—	6.3 v., 2.0 a.	1 x 1	2 1/2	2 5/8	3	2 1/8	1 3/4	2 1/2
269 BX	40	150-0-150	75	—	6.3 v., 2.0 a.	1 x 1	2 1/2	2 5/8	3	2 1/8	1 3/4	2 1/2
269 EX	38	190-0-190	65	—	6.3 v., 2.5 a.	1 x 1	2 1/2	2 5/8	3	2 1/8	1 3/4	2 1/2
269 GX	37	225-0-225	65	—	6.3 v., 2.5 a.	1 x 1	2 1/2	2 5/8	3	2 1/8	1 3/4	2 1/2
269 JX	41	250-0-250	60	—	6.3 v., 2.5 a.	1 x 1	2 1/2	2 5/8	3	2 1/8	1 3/4	2 1/2
270 X	42	240-0-240	40	5.0 v., 2 a.	6.3 v., 1.5 a.	1 x 1	2 1/2	2 5/8	3	2 1/8	1 3/4	2 1/2
270 AX	42	240-0-240	50	—	6.3 v., 2.5 a.	1 x 1	2 1/2	2 5/8	3	2 1/8	1 3/4	2 1/2
270 BX	51	275-0-275	50	5.0 v., 2 a.	6.3 v., 2.0 a.	1 x 1 1/2	2 1/2	3 1/8	3	2 1/8	2 1/4	3 1/4
270 CX	50	275-0-275	65	6.3 v., 0.6 a.	6.3 v., 2.5 a.	1 x 1 1/2	2 1/2	3 1/8	3	2 1/8	2 1/4	3 1/4
270 DX	71	275-0-275	90	5.0 v., 2 a.	6.3 v., 3.0 a.	1 1/4 x 1 1/4	3 1/8	3 5/8	3 13/16	2 1/2	2 1/4	4 1/2
270 EX	88	275-0-275	125	5.0 v., 3 a.	6.3 v., 4.0 a.	1 1/4 x 1 1/2	3 1/8	3 7/8	3 13/16	2 1/2	2 1/2	5 1/2
270 FX	101	275-0-275	150	5.0 v., 3 a.	6.3 v., 5.0 a. ct	1 1/4 x 1 3/4	3 1/8	4 1/8	3 13/16	2 1/2	2 3/4	6
270 HX	130	275-0-275	200	5.0 v., 3 a. ct	6.3 v., 6.0 a. ct	1 1/4 x 2 1/2	3 1/8	4 7/8	3 13/16	2 1/2	3 1/2	8
271 X	55	280-0-280	60	5.0 v., 2 a.	6.3 v., 2.0 a. ct	1 1/8 x 1 1/8	2 13/16	3 1/8	3 1/16	2 1/4	2 1/16	3 1/2
272 X	70	310-0-310	70	5.0 v., 2 a.	6.3 v., 2.4 a.	1 1/4 x 1 1/4	3 1/8	3 5/8	3 13/16	2 1/2	2 1/4	4 1/2
272 BX	86	300-0-300	100	5.0 v., 2 a.	6.3 v., 3.0 a.	1 1/4 x 1 1/2	3 1/8	3 7/8	3 13/16	2 1/2	2 1/2	5 1/2
272 DX	103	300-0-300	125	5.0 v., 3 a.	6.3 v., 4.0 a.	1 1/4 x 1 3/4	3 1/8	4 1/8	3 13/16	2 1/2	2 3/4	6
272 FX	120	300-0-300	150	5.0 v., 3 a. ct	6.3 v., 5.0 a. ct	1 1/4 x 2 1/2	3 1/8	4 7/8	3 13/16	2 1/2	3 1/2	8
272 HX	152	300-0-300	200	5.0 v., 3 a. ct	6.3 v., 6.0 a. ct	1 1/2 x 1 1/2	3 3/4	4 1/4	4 1/16	3	2 1/16	8
272 JX	195	300-0-300	250	5.0 v., 4 a. ct	6.3 v., 8.0 a. ct	1 1/2 x 2	3 3/4	4 3/4	4 1/16	3	2 15/16	10 1/2
273 X	95	350-0-350	110	5.0 v., 2 a.	6.3 v., 4.0 a. ct	1 1/4 x 2	3 1/8	4 3/8	3 13/16	2 1/2	3	7
273 BX	133	350-0-350	175	5.0 v., 3 a.	6.3 v., 5.0 a. ct	1 1/4 x 2 5/8	3 1/8	5	3 13/16	2 1/2	3 5/8	8 3/4
274 X	115	375-0-375	110	5.0 v., 3 a.	6.3 v., 5.0 a. ct	1 1/2 x 1 1/4	3 3/4	4	4 1/16	3	2 3/16	7
274 BX	160	375-0-375	175	5.0 v., 3 a. ct	6.3 v., 6.0 a. ct	1 1/2 x 1 3/4	3 3/4	4 1/2	4 1/16	3	2 11/16	8 3/4
275 X	135	400-0-400	135	5.0 v., 3 a. ct	6.3 v., 5.0 a. ct	1 1/2 x 1 3/4	3 3/4	4 1/2	4 1/16	3	2 11/16	8 3/4
276 X	120	300-0-300	150	5.0 v., 3 a. ct	6.3 v., 5.0 a. ct	1 1/2 x 1 1/4	3 3/4	4	4 1/16	3	2 3/16	7
278 X	185	400-0-400	200	5.0 v., 3 a. ct	6.3 v., 6.0 a. ct	1 1/2 x 2	3 3/4	4 3/4	4 1/16	3	2 15/16	10 1/2
♦278 CX	341	400-0-400	465	—	6.3 v., 6.0 a. ct	1 1/2 x 3 1/4	3 3/4	6 1/4	4 1/16	3	4 1/16	16
279 X	137	425-0-425	150	5.0 v., 3 a.	6.3 v., 5.0 a. ct	1 1/2 x 1 1/4	3 3/4	4	4 1/16	3	2 3/16	7
282 X	195	500-0-500	200	5.0 v., 3 a. ct	6.3 v., 6.0 a. ct	1 1/2 x 2 1/2	3 3/4	5 1/4	4 1/16	3	3 1/16	12

† D.C. mA measured with capacitor input filter.

## H. V. OSCILLOSCOPE TRANSFORMERS — 115 v. 60 Hertz operation

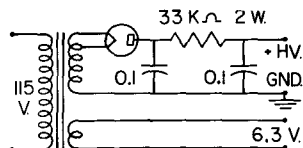
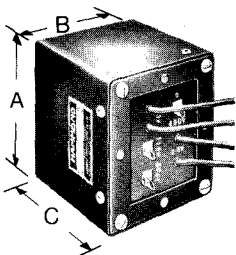

- H.V. secondary supplies up to 10 ma D.C. after rectifier.
- 2.5 V filament and separate 6.3 volt CRT filament windings.
- High voltage and filament end of secondary and 6.3 V winding have insulated leads or porcelain insulated terminal.
- Primary, ground end of H.V. secondary have solder lug terminals.

Cat. No.	Sec. R.M.S. Volts	Fil. No. 1 Volts - Amps	Fil. No. 2 Volts - Amps	Dimensions			Wt. Lb.
				A	B	C	
214	800	2.5 — 1.75	6.3 — 0.6	3 5/8	3 1/8	3 1/4	3 3/4
215	1500	2.5 — 1.75	6.3 — 0.6	3 5/8	3 1/8	3 1/4	4 1/4
216	3000	2.5 — 1.75	6.3 — 0.6	4 5/16	3 11/16	4	10 1/2

## VERTICAL OUTPUT TRANSFORMERS — Vertical Bracket Mounting — See page 4 for details.

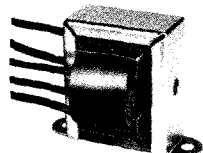

Cat. No.	Application	Turns Ratio	Pri. Z or Ind.	Pri. DC ohms	Sec. DC ohms	Mtg. Cts.	Wt. Lb.
91 F	Vert. Blocking Osc.	1:4.2	1.5H	215	1100	2	0.3
91 K	Gen. Purpose Vertical Output	11:1	17,000 ohms	975	11.4	2 13/16	1
91 R	Universal Vertical Output	18 different ratios	4.5:1 to 40.7:1			3 1/8	1.5

(Sheets with each unit give ratio data to duplicate performance of original part in most Canadian TV sets.)

Special designs of these series produced quickly to your specifications.



# HAMMOND

# POWER TRANSFORMERS

## "Z MOUNTED" SERIES — 115 Volt, 60 Hertz operation

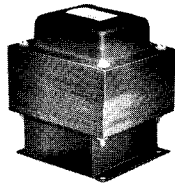

- Convenient 4 hole above chassis Z Mtg., see p. 5 for details.
- Conservative designs are CSA approved "LR 3902".
- Flexible leads 8 to 10 inches long.
- Drawn and formed steel case — baked black semi-gloss finish.

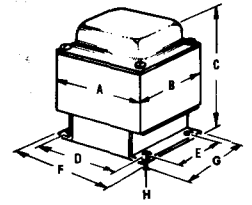

Cat. No.	Pri. VA	Secondary R.M.S. Volts	DC mA†	Fil. No. 1 Rectifier	Fil. No. 2 Heater	Core Size	Dimensions					Wt. Lb.
							A	B	C	D	E	
268 Z	25	200-0-200	35	—	6.3 v., 2.0 a.	7/8 x 7/8	2 5/8	2 3/16	2 5/8	*	1 7/8	1 3/4
269 AZ	35	125-0-125	100	—	6.3 v., 2.0 a.	1 x 1	3	2 1/2	2 5/8	*	2 3/16	2 1/2
269 BZ	40	150-0-150	75	—	6.3 v., 2.0 a.	1 x 1	3	2 1/2	2 5/8	*	2 3/16	2 1/2
269 EZ	38	190-0-190	65	—	6.3 v., 2.5 a.	1 x 1	3	2 1/2	2 5/8	*	2 3/16	2 1/2
269 GZ	37	225-0-225	65	—	6.3 v., 2.5 a.	1 x 1	3	2 1/2	2 5/8	*	2 3/16	2 1/2
269 JZ	41	250-0-250	60	—	6.3 v., 2.5 a.	1 x 1	3	2 1/2	2 5/8	*	2 3/16	2 1/2
270 Z	42	240-0-240	50	5.0 v., 2 a.	6.3 v., 1.5 a.	1 x 1	3	2 1/2	2 5/8	*	2 3/16	2 1/2
270 AZ	42	240-0-240	50	—	6.3 v., 2.5 a.	1 x 1	3	2 1/2	2 5/8	*	2 3/16	2 1/2
270 BZ	51	275-0-275	50	5.0 v., 2 a.	6.3 v., 2.0 a.	1 x 1 1/2	3	2 1/2	3 1/8	*	2 3/16	3 1/4
270 CZ	50	275-0-275	65	6.3 v., 0.6 a.	6.3 v., 2.5 a.	1 x 1 1/2	3	2 1/2	3 1/8	*	2 3/16	3 1/4
270 DZ	71	275-0-275	90	5.0 v., 2 a.	6.3 v., 3.0 a.	1 1/4 x 1 1/4	3 3/4	3 1/8	3 1/16	3 1/8	2 1/2	4 1/2
270 EZ	88	275-0-275	125	5.0 v., 3 a.	6.3 v., 4.0 a.	1 1/4 x 1 1/2	3 3/4	3 1/8	3 11/16	3 1/8	2 1/2	5 1/2
270 FZ	101	275-0-275	150	5.0 v., 3 a.	6.3 v., 5.0 a. ct	1 1/4 x 1 3/4	3 3/4	3 1/8	3 15/16	3 1/8	2 1/2	6
270 HZ	130	275-0-275	200	5.0 v., 3 a. ct	6.3 v., 6.0 a. ct	1 1/4 x 2 1/2	3 3/4	3 1/8	4 7/16	3 1/8	2 1/2	8
271 Z	55	280-0-280	60	5.0 v., 2 a.	6.3 v., 2.0 a.	1 1/8 x 1 1/8	3 3/8	2 13/16	3 1/8	2 13/16	2 1/4	3 1/2
272 Z	70	310-0-310	70	5.0 v., 2 a.	6.3 v., 2.4 a.	1 1/4 x 1 1/4	3 3/4	3 1/8	3 7/16	3 1/8	2 1/2	4 1/2
272 BZ	86	300-0-300	100	5.0 v., 2 a.	6.3 v., 3.0 a.	1 1/4 x 1 1/2	3 3/4	3 1/8	3 11/16	3 1/8	2 1/2	5 1/2
272 DZ	103	300-0-300	125	5.0 v., 3 a.	6.3 v., 4.0 a.	1 1/4 x 1 3/4	3 3/4	3 1/8	3 15/16	3 1/8	2 1/2	6
272 FZ	120	300-0-300	150	5.0 v., 3 a. ct	6.3 v., 5.0 a. ct	1 1/4 x 2 1/2	3 3/4	3 1/8	4 7/16	3 1/8	2 1/2	8
272 HZ	152	300-0-300	200	5.0 v., 3 a. ct	6.3 v., 6.0 a. ct	1 1/2 x 1 1/2	4 1/2	3 3/4	4 1/4	3 3/4	3	8
272 JZ	195	300-0-300	250	5.0 v., 4 a. ct	6.3 v., 8.0 a. ct	1 1/2 x 2	4 1/2	3 3/4	4 3/4	3 3/4	3	10 1/2
273 Z	95	350-0-350	110	5.0 v., 2 a.	6.3 v., 4.0 a. ct	1 1/4 x 2	3 3/4	3 1/8	4 3/16	3 1/8	2 1/2	7
273 BZ	133	350-0-350	175	5.0 v., 3 a.	6.3 v., 5.0 a. ct	1 1/4 x 2 5/8	3 3/4	3 1/8	4 13/16	3 1/8	2 1/2	8 3/4
274 Z	115	375-0-375	110	5.0 v., 3 a.	6.3 v., 5.0 a. ct	1 1/2 x 1 1/4	4 1/2	3 3/4	4	3 3/4	3	7
274 BZ	160	375-0-375	175	5.0 v., 3 a. ct	6.3 v., 6.0 a. ct	1 1/2 x 1 3/4	4 1/2	3 3/4	4 1/2	3 3/4	3	8 3/4
275 Z	135	400-0-400	135	5.0 v., 3 a. ct	6.3 v., 5.0 a. ct	1 1/2 x 1 3/4	4 1/2	3 3/4	4 1/2	3 3/4	3	8 3/4
276 Z	120	300-0-300	150	5.0 v., 3 a. ct	6.3 v., 5.0 a. ct	1 1/2 x 1 1/4	4 1/2	3 3/4	4	3 3/4	3	7
278 Z	185	400-0-400	200	5.0 v., 3 a. ct	6.3 v., 6.0 a. ct	1 1/2 x 2	4 1/2	3 3/4	4 3/4	3 3/4	3	10 1/2
279 Z	137	425-0-425	150	5.0 v., 3 a.	6.3 v., 5.0 a. ct	1 1/2 x 1 1/4	4 1/2	3 3/4	4	3 3/4	3	7

\* Two hole mounting. The E dimension is midway along side A.

† D.C. mA measured with capacitor input filter.

## R. F. CHOKES • Low loss ceramic or powdered iron forms • Tolerance ± 10% on inductance and resistance.

Cat. No.	D.C. MA	Induct MH	D.C. Res. ohms	No. Pies	Form		Wt. Oz.
					Type	Length	
1500	125	1.0	12.0	1	Powdered	5/8	1/4
1501	75	10	47.0	2	Powdered	7/8	1/2
1502	500	.007	1.3	Layer	Ceramic	1 1/2	1/4
1503	50	2.5	22.0	2	Powdered	5/8	1/4
1504	125	2.5	44.0	4	Ceramic	1 1/2	1/2
1505	250	2.5	12.0	4	Ceramic	1 1/2	3/4
1506	250	1.6	12.0	4	Ceramic	1 1/2	1/2
1508	500	.035	3.1	Layer	Ceramic	3	1.3
1509	600	1.0	6.0	5	Ceramic	3	2
1510	400	4.4	12.0	5	Ceramic	3	3
1511	600	4.0	11.0	5	Ceramic	3	2 1/2
1512	1000	3.2	4.5	5	Ceramic	3	5
◆1515	500	0.25	3.8	Layer	Ceramic	4	8
◆1518	750	0.1	1.2	Layer	Ceramic	4	8
◆1521	1000	0.09	0.68	Layer	Ceramic	4	8

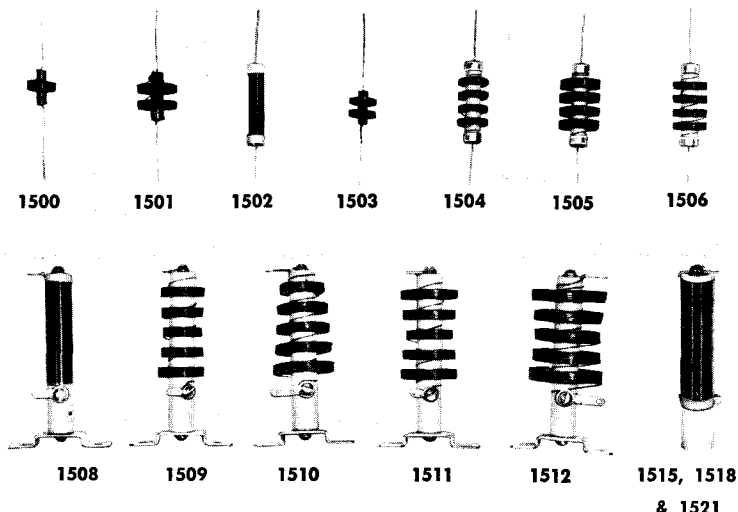

◆ **New Product.** These new heavy duty type R.F. chokes are suitable for use in linear amplifiers or other transmitter applications. Wound on 1" dia. ceramic forms with stand-off insulators and 1/4-20 mounting bolt.

# PLATE TRANSFORMERS

# HAMMOND

## PLATE TRANSFORMERS — Primary 115 Volts, 50/60 Hz

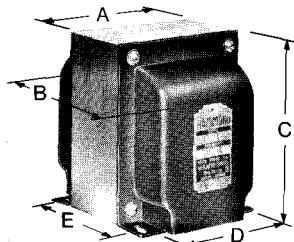

Fig. A

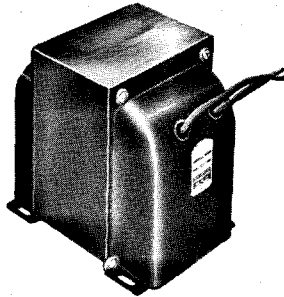
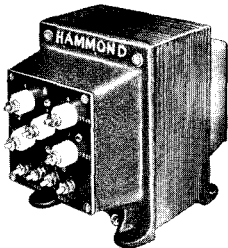

Fig. B

- For OEM or Amateur power supply applications.
- Type X 4-hole mounting, black semi-gloss baked enamel, mtg. A (See p. 5 details).
- Above 1000 v, secondary leads through rubber bushings, mtg. B.
- Conservative designs are CSA approved "LR 3902".

Cat. No.	Secondary A.C. Volts	D.C. Volts Choke Input	D.C. CCS	mA ICAS	Core Size	Mtg. Type	Dimensions					Wt. Lb
							A	B	C	D	E	
710	375-0-375	300	300	450	1½ x 1¼	A	3¾	4⅛	4½	3	2¼	7.2
712	425-0-425	350	300	450	1½ x 1¾	A	3¾	4⅝	4½	3	2¾	8.8
714	510-0-510	400	170	250	1½ x 1½	A	3¾	4¾	4½	3	2½	7.7
715	510-0-510	400	300	450	1½ x 1¾	A	3¾	4⅝	4½	3	2¾	9
717	510-0-510	400	500	750	2 x 1¾	A	5	5¼	6½	4⅞	3¼	17.7
718	625-0-625	500	200	300	1½ x 1½	A	3¾	4¾	4½	3	2½	8
720	625-0-625	500	300	450	1½ x 2¾	A	3¾	5⅝	4½	3	3¾	13
722	625-0-625	500	500	750	2 x 1¾	A	5	5¼	6½	4⅞	3¼	17.7
724	750-0-750	625	200	300	1½ x 2¾	A	3¾	5¼	4½	3	3⅝	12
726	890-0-890	750	175	260	1½ x 2¾	A	3¾	5¼	4½	3	3⅝	12
728	1000-0-1000	850	150	225	1½ x 2¾	B	3¾	5¼	4½	3	3⅝	12
732	1250-0-1250	1000	200	300	2 x 1¾	B	5	5¼	6½	4⅞	3¼	17.7
733	1250-0-1250	1000	300	450	2 x 2½	B	5	6	6½	4⅞	4	24
735	1500-0-1500	1250	250	375	2 x 2½	B	5	6	6½	4⅞	4	24
737	1500-0-1500	1250	400	600	2 x 3½	B	5	7	6½	4⅞	5	28.5
738	1750-0-1750	1500	250	375	2 x 3	B	5	6⅝	6½	4⅞	4½	27
739	1750-0-1750	1500	400	600	2 x 4	B	5	7⅝	6½	4⅞	5½	34.7

## PLATE TRANSFORMERS



- Rugged 4 hole, "Type R" mounting — ceramic HV Terminals (See p. 5 details).
- Conservative CSA approved designs "LR 3902".
- OEM or Amateur application.
- Each secondary tapped at 70% and with the tapped primary, 6 output voltages are possible.
- Two pie construction for close voltage, resistance and capacity balance (except 768).

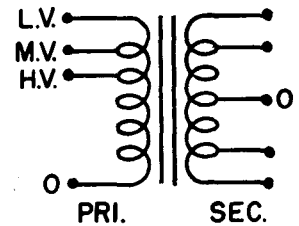

Cat. No.	Secondary A.C. Volts (Max.)	Max. D.C. mA		D.C. Volts Output Choke Input	Pri. Amps Max.	Core Size	Dimensions					Wt. Lb
		CCS	ICAS				A	B	C	D	E	
<b>Primary 115 Volts, 50/60 Hz</b>												
777	1740-0-1740	500	750	1500, 1350, 1200, 1050, 945, 840	8.7	2½ x 4	6¼	10¼	8	5¾	5¾	57
779	1740-0-1740	1000	1500	1500, 1350, 1200, 1050, 945, 840	16.0	3 x 4½	7½	12	9½	6½	6½	87
784	2320-0-2320	500	750	2000, 1800, 1600, 1400, 1260, 1120	12.0	3 x 3	7½	10½	9½	6½	5	65
788	2880-0-2880	500	750	2500, 2250, 2000, 1750, 1570, 1400	15.0	3 x 3½	7½	11	9½	6½	5½	72
793	3450-0-3450	300	450	3000, 2700, 2400, 2100, 1880, 1680	10.8	3 x 2¾	7½	10¼	9½	6½	4¾	61
795	3450-0-3450	500	750	3000, 2700, 2400, 2100, 1880, 1680	18.0	3 x 4	7½	11½	9½	6½	6	80

### Primary 230 Volts, 50/60 Hz

◆789	2880-0-2880	500	750	2500, 2250, 2000, 1750, 1570, 1400	7.5	3 x 3½	7½	11	9½	6½	5½	72
◆796	3450-0-3450	500	750	3000, 2700, 2400, 2100, 1880, 1680	9.0	3 x 4	7½	11½	9½	6½	6	80

### Primary 230 Volts, 50/60 Hz — For solid state full-wave bridge rectifier circuits.

◆768	2550-3400	750	1000	3000, 2750, 2500, 2250, 2000, 1750	15.0	4 x 3	10	9½	14	9	5	140
------	-----------	-----	------	------------------------------------	------	-------	----	----	----	---	---	-----

Plate transformers for full wave voltage doubler rectifier circuits, for use in single sideband transmitters or linear amplifiers are available on special order.

If we do not list a suitable stock plate transformer, send us yours specifications.

# HAMMOND

# REACTORS or FILTER CHOKES

## OPEN BRACKET

No. Cat.	Induc. Henrys	Current Ma. D.C.	Resist. Ohms	Max. Op. Volts D.C.	Dimensions					Wt. Lb.
					A	B	C	D	E	
153 E	7.0	25	770	300	1 5/8	3/4	1 3/16	1 3/8	—	.1
153 H	2.2	50	305	300	1 5/8	3/4	1 3/16	1 3/8	—	.1
153 L	0.9	75	125	300	1 5/8	3/4	1 3/16	1 3/8	—	.1
153 M	0.6	100	86	300	1 5/8	3/4	1 3/16	1 3/8	—	.1
154 E	20	20	1666	300	2 1/16	1 1/8	1 3/16	1 3/4	—	.25
154 G	9	40	700	300	2 1/16	1 1/8	1 3/16	1 3/4	—	.25
154 H	4	50	300	300	2 1/16	1 1/8	1 3/16	1 3/4	—	.25
154 M	2	100	175	300	2 1/16	1 1/8	1 3/16	1 3/4	—	.25
155 C	60	8	2750	400	2 3/8	1 1/4	1 3/8	2	—	.3
155 G	7	40	340	400	2 3/8	1 1/4	1 3/8	2	—	.3
155 H	5	50	270	400	2 3/8	1 1/4	1 3/8	2	—	.3
155 J	15	30	1026	400	2 3/8	1 1/4	1 3/8	2	—	.3
156 C	150	8	3700	400	2 13/16	1 1/16	1 5/8	2 3/8	—	.5
156 G	9	40	300	400	2 13/16	1 1/16	1 5/8	2 3/8	—	.5
156 L	5	75	135	400	2 13/16	1 1/16	1 5/8	2 3/8	—	.5
156 M	3	100	86	400	2 13/16	1 1/16	1 5/8	2 3/8	—	.5
156 R	1.5	200	56	400	2 13/16	1 1/16	1 5/8	2 3/8	—	.5
157 G	30	40	595	400	3 1/4	1 5/8	1 15/16	2 13/16	—	1
157 J	10	65	205	400	3 1/4	1 5/8	1 15/16	2 13/16	—	1
157 L	14	75	429	400	3 1/4	1 5/8	1 15/16	2 13/16	—	1
157 M	8	100	259	400	3 1/4	1 5/8	1 15/16	2 13/16	—	1
157 Q	3.5	150	98	400	3 1/4	1 5/8	1 15/16	2 13/16	—	1
157 R	2	200	64	400	3 1/4	1 5/8	1 15/16	2 13/16	—	1
158 L	15	75	411	400	3 1/4	1 7/8	1 15/16	2 13/16	—	1.25
158 M	10	100	262	400	3 1/4	1 7/8	1 15/16	2 13/16	—	1.25
158 Q	5	150	105	400	3 1/4	1 7/8	1 15/16	2 13/16	—	1.25
158 R	2	200	63	400	3 1/4	1 7/8	1 15/16	2 13/16	—	1.25
◆158 S	1.5	250	60	400	3 1/4	1 7/8	1 15/16	2 13/16	—	1.50
◆158 T	1.0	300	40	400	3 1/4	1 7/8	1 15/16	2 13/16	—	1.50
159 M	15	100	256	500	4	2 1/4	2 5/8	3 3/16	—	2.25
159 P	10	125	155	500	4	2 1/4	2 5/8	3 3/16	—	2.25
159 Q	7	150	100	500	4	2 1/4	2 5/8	3 3/16	—	2.25
159 S	4	225	65	500	4	2 1/4	2 5/8	3 3/16	—	2.25
159 T	2.5	300	43	500	4	2 1/4	2 5/8	3 3/16	—	2.25
159 V	1.5	500	27	500	4	2 1/4	2 5/8	3 3/16	—	2.25
159 Y	0.6	750	11	500	4	2 1/4	2 5/8	3 3/16	—	2.25

## HIGH CURRENT BRACKET MOUNTED CHOKES — See page 28 for higher ratings.

155 B	6 mH	2000	0.3	400	2 3/8	1 1/4	1 3/8	2	—	.3
156 B	1.5 mH	5000	0.07	400	2 13/16	1 1/16	1 5/8	2 3/8	—	.5
157 D	1 mH	10000	0.038	400	3 1/4	1 5/8	1 15/16	2 13/16	—	1
159 ZA	300 mH	1000	6.0	500	4	2 1/8	2 5/8	3 3/16	—	2.50
159 ZC	60 mH	2000	0.7	500	4	2 1/8	2 5/8	3 3/16	—	2.50
◆159 ZE	28 mH	3000	0.43	500	4	2 3/8	2 5/8	3 3/16	—	2.75
◆159 ZG	15 mH	4000	0.25	500	4	2 1/4	2 5/8	3 3/16	—	2.75
◆159 ZJ	10 mH	5000	0.16	500	4	2 1/4	2 5/8	3 3/16	—	2.75
◆159 ZL	2.5 mH	10000	0.044	500	4	2 1/2	2 5/8	3 3/16	—	2.75

## SHIELDED TYPE X

193 B	12	100	155	600	2 5/8	2 5/8	3 1/8	2 1/8	1 3/4	2.5
193 C	20	100	181	600	2 5/8	3 1/8	3 1/8	2 1/8	2 1/4	3.25
193 D	8	150	75	600	2 5/8	3 1/8	3 1/8	2 1/8	2 1/4	3.25
193 G	10	150	102	800	3 1/8	3 3/8	3 13/16	2 1/2	2	4.25
193 H	5	200	65	600	2 5/8	2 5/8	3 1/8	2 1/8	1 3/4	2.5
193 J	10	200	82	800	3 1/8	3 7/8	3 13/16	2 1/2	2 1/2	5.5
193 K	2.6	300	21	800	2 5/8	3 1/8	3 1/8	2 1/8	2 1/4	3.25
193 L	5	300	57	800	3 1/8	3 7/8	3 13/16	2 1/2	2 1/2	5.5
193 M	10	300	63	800	3 3/4	4 3/4	4 1/16	3	3	10.5
193 P	5	500	26	800	3 3/4	5	4 1/16	3	3 1/4	10.75
193 Q	10	500	53	1000	5	5 1/2	6 1/16	4 1/16	3 1/2	21
193 R	.3	1000	3.5	1000	3 1/8	3 5/8	3 13/16	2 1/2	2 1/4	4.5
193 S	1.0	1000	5.75	1000	3 3/4	4 1/4	4 1/16	3	2 1/2	8
193 T	.05	2000	0.7	300	2 5/8	2 5/8	3 1/8	2 1/8	1 3/4	2.5
193 U	.2	2000	1.7	300	3 1/8	4 3/8	3 13/16	2 1/2	3	6
193 V	.15	3000	1.0	300	3 3/4	4 3/4	4 1/16	3	3	9

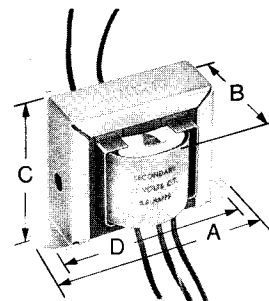

Open Bracket Mounting

- CORE SIZES  
153 Series—1/4 x 1/4  
154 Series—3/8 x 3/8  
155 Series—1/2 x 1/2  
156 Series—5/8 x 5/8  
157 Series—3/4 x 3/4  
158 Series—3/4 x 1  
159 Series—1 x 1
- Economical "open bracket" or "Type X" mounting. (See p. 4 & 5 details.)
- Coils are vacuum varnish impregnated for long life.
- Leads 4" to 10" long.
- Tolerance ± 15% on inductance and resistance.
- Units will exhibit less inductance at slightly higher currents or more at lower currents.
- Inductances are measured with rated DC current flowing.
- Series 153, 154 and 155 available with pin leads for printed circuit mounting, refer to the factory.
- All dimensions in inches ± 1/16", except "B" which is maximum.

## ◆ New Product

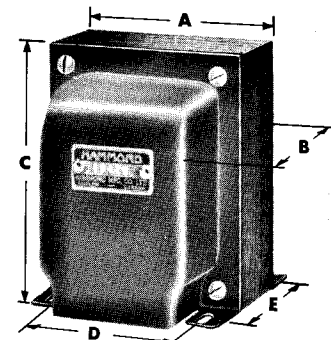

Type X Mounting

# FILTER CHOKES REACTORS

# HAMMOND

## REACTORS — HEAVY CURRENT — 0.5 to 100 Millihenry — 5 to 100 Amps.

- For OEM or replacement use in D.C. power supplies, battery chargers, etc.
- Economical open core & coil, 4 slot mounting, for inside other enclosures (see p. 5 details).
- Connections made to leads or copper tabs with holes. • Test voltage 2500 V.
- See bracket mounted high current chokes p. 27.

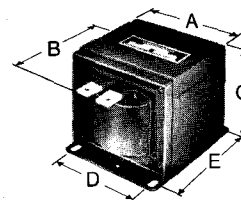

Cat. No.	Inductance Millihenries	Current D.C. Amps.	Resis. Ohms	INS CL	Dimensions					Slot	Wt. Lb.
					A	B+	C	D	E		
195 B150	0.5	150	.0018	B	7 1/2	5 3/4	6 1/4	6	4 1/2	3/8 x 5/8	38
195 C20	1.0	20	.013	A	3	2 1/4	2 1/2	2 3/8	2	3/16 x 3/16	2.5
195 C30	1.0	30	.009	A	3 3/4	3	3 1/8	2 7/8	2 1/2	7/32 x 7/16	5
195 C50	1.0	50	.005	A	4 1/2	5 3/4	3 3/4	3 3/4	4 1/4	5/16 x 1/2	13
195 C75	1.0	75	.0045	A	6	6 1/2	5	5	4 1/8	5/16 x 1/2	21
195 C100	1.0	100	.0036	B	6	5 3/4	5	5	5 3/8	5/16 x 1/2	26
195 E20	2.5	20	.025	A	3 3/4	2 1/4	3 1/8	2 7/8	2 3/4	7/32 x 7/16	5.7
195 E30	2.5	30	.01	A	4 1/2	4 1/2	3 3/4	3 3/4	3 1/2	5/16 x 1/2	11
195 E50	2.5	50	.008	A	6	5 3/4	5	5	4 7/8	5/16 x 1/2	26
195 E75	2.5	75	.008	B	7 1/2	6	6 1/4	6	4 3/4	3/8 x 5/8	40
195 E100	2.5	100	.006	B	9	8	7 1/2	7	6	7/16 x 3/4	75
195 G10	5	10	.042	A	3 3/4	2 3/4	3 1/8	2 7/8	2 1/4	7/32 x 7/16	4.2
195 G20	5	20	.03	A	4 1/2	4	3 3/4	3 3/4	3 1/4	5/16 x 1/2	9.3
195 G30	5	30	.023	A	6	4 3/4	5	5	3 7/8	5/16 x 1/2	19
195 G50	5	50	.021	B	7 1/2	5 3/4	6 1/4	6	4 1/2	3/8 x 5/8	38
195 G75	5	75	.01	B	9	8 3/4	7 1/2	7	6 3/4	7/16 x 3/4	87
195 J10	10	10	.07	A	3 3/4	3 1/2	3 1/8	2 7/8	3	7/32 x 7/16	6.7
195 J20	10	20	.053	A	6	4 1/2	5	5	3 5/8	5/16 x 1/2	17
195 J30	10	30	.037	A	6	7	5	5	5 7/8	5/16 x 1/2	36
195 J50	10	50	.023	B	9	8 1/4	7 1/2	7	6 1/4	7/16 x 3/4	79
195 M10	20	10	.13	A	4 1/2	4 1/4	3 3/4	3 3/4	3 1/2	5/16 x 1/2	10
195 M20	20	20	.075	A	6	6 3/4	5	5	5 7/8	5/16 x 1/2	34
195 M30	20	30	.045	B	7 1/2	7 1/2	6 1/4	6	6 1/4	3/8 x 5/8	55
195 P5	30	5	.23	A	3 3/4	2 1/4	3 1/8	2 7/8	2 3/4	7/32 x 7/16	5.7
195 P10	30	10	.16	A	4 1/2	5 1/2	3 3/4	3 3/4	4 3/4	5/16 x 1/2	15
195 P20	30	20	.13	B	7 1/2	5 1/2	6 1/4	6	4 1/4	3/8 x 5/8	35
195 R10	50	10	.185	A	6	5 1/4	5	5	4 3/8	5/16 x 1/2	23
195 R20	50	20	.13	B	9	7 3/4	7 1/2	7	5 3/4	7/16 x 3/4	72
195 T5	100	5	.52	A	4 1/2	5	3 3/4	3 3/4	4 1/4	5/16 x 1/2	13
195 T10	100	10	.42	B	7 1/2	5 1/2	6 1/4	6	4 1/4	3/8 x 5/8	35

+B dimension is approximate maximum over coil or copper tabs.

## CHOKES — HIGH VOLTAGE FILTER AND SWINGING

- Sturdy formed steel case with black semi-gloss enamel finish.
- Four convenient 1/4 x 20 mounting screws top and bottom on B, C, H, T & V; 5/16 x 18 mounting screws on D, F, G, J, W & Y.
- Terminals are 1" diameter, 1 1/2" high porcelain insulators on 1 1/2" centres.
- Tolerances are ± 15% on inductance and ± 10% on resistance measured at 23° C.

Cat. No.	Henrys at Rated MA	Henrys at 10% Rated MA	Current DC MA	Res. Ohms	Max. Optg. Peak Volts	Case Dimensions	Mounting Dimensions	Wt. Lb.
196 B	10	—	200	82	4000	3 11/16 x 4 5/16 x 4 H	3 x 3 5/8	7 3/4
196 C	8.7	—	300	63	4000	4 3/16 x 5 3/16 x 4 1/2 H	3 5/8 x 4 1/2	13 1/2
196 D	9.1	—	500	54	4000	5 3/4 x 6 3/4 x 5 1/2 H	4 7/8 x 5 7/8	24
196 F	9.6	—	750	29	5000	5 3/4 x 6 3/4 x 8 1/2 H	4 7/8 x 5 7/8	35
196 G	9.4	—	1000	26	5000	7 x 8 1/4 x 7 1/2 H	6 1/8 x 7 3/8	54
196 H	5.0	—	500	26	4000	4 5/16 x 5 3/16 x 5 1/4 H	3 5/8 x 4 1/2	15
196 J	5.0	—	1000	16	5000	5 3/4 x 6 3/4 x 7 1/2 H	4 7/8 x 5 7/8	36
196 T	4.6	21.4	200	82	5000	3 11/16 x 4 3/16 x 4 H	3 x 3 5/8	7 3/4
196 V	4.15	23.4	300	63	5000	4 5/16 x 5 3/16 x 4 1/2 H	3 5/8 x 4 1/2	13 1/2
196 W	3.4	27.0	500	54	5000	5 3/4 x 6 3/4 x 5 1/2 H	4 7/8 x 5 7/8	24
196 Y	3.5	24.0	750	29	6000	5 3/4 x 6 3/4 x 8 1/2 H	4 7/8 x 5 7/8	35

NOTE — Inductances are measured with rated DC current flowing.

Special designs of this series produced quickly to your specifications.

### MINIATURE INDUCTORS

- Vacuum epoxy cast for stability.
- Constructed to pass MIL environmental specifications.
- Low profile and pin mounted for P.C. applications.
- Pin diameter 0.032".

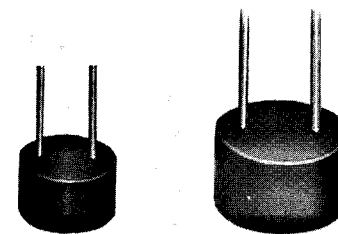

### 621 SERIES

Cat. No.	Inductance ± 2% mH	Nominal Q	Freq. kHz	D.C. Resistance ± 20%
◆621 G	1.0	40	50	2.0
◆621 J	2.2	40	45	4.5
◆621 L	4.7	38	40	8.2
◆621 N	10.0	38	30	20.0
◆621 Q	22.0	36	35	45.0

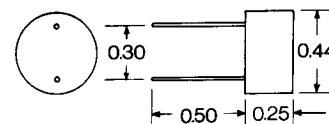

### 622 SERIES

Cat. No.	Inductance ± 2% mH	Nominal Q	Freq. kHz	D.C. Resistance ± 10%
◆622 S	47	65	16	27
◆622 U	100	64	15	49
◆622 W	220	60	13	122
◆622 Y	470	54	10	218
◆622 ZA	1000	45	8	400

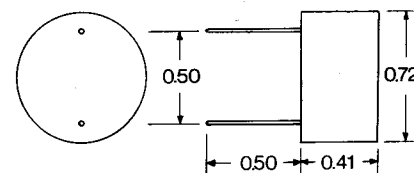

Units produced on larger cores are available vacuum varnished with leads. Intermediate higher and lower values can be produced on special order.

### SPECIAL TRANSFORMER & INDUCTOR DATA

If your requirements call for special voltages, extra taps, unusual mounting methods or a non-standard frequency, ask your authorized distributor or send us your specifications. Our sales, engineering and manufacturing facilities are geared to give you fast service.

### TO ASSURE PROMPT SERVICE ON YOUR SPECIAL DEVICES

#### PLEASE SPECIFY THE FOLLOWING DATA

	Power Trans	Chokes	Audio Trans	Inductor
1. Quantity to be ordered .....	X	X	X	X
2. Description or function — rectifier, filament, input, output, etc. ....	X	X	X	X
3. Power capacity — total volt amperes or watts (audio) .....	X	—	X	—
4. Primary Parameters —				
a. Voltage and taps if required .....	X	—	X	—
b. Frequency — 25, 50, 60, 400 Hz etc. ....	X	—	X	X
c. Impedance or inductance .....	—	henrys	ohms	henrys
d. Current — total or max. unbalance .....	—	mA	mA	mA
5. Secondary parameters —				
a. Voltage and taps if required .....	X	—	—	—
b. Current rms amps. ....	X	—	—	—
c. DC if rectified — See note .....	X	—	—	—
d. Impedance .....	—	—	ohms	—
6. Specify the frequency range over which response is to be within 1 db of the mid-band level .....	—	—	X	—
7. Q (Quality factor) minimum, specify frequency .....	—	—	—	X
8. Duty cycle — Continuous or minutes ON and minutes OFF .....	X	X	—	—
9. Mounting style — See p. 4 and 5 .....	X	X	X	X

NOTES — For rectifier transformers, specify type of circuit (Bridge, Full Wave, C.T., Half Wave, Doubler, etc.) and whether capacitor or choke input filter.

◆ New Product

# CONVERTER-INVERTER TRANSFORMERS

# HAMMOND

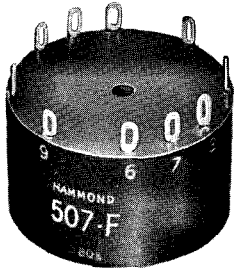

Vacuum  
Epoxy  
Cast  
Toroid

### Typical Circuits

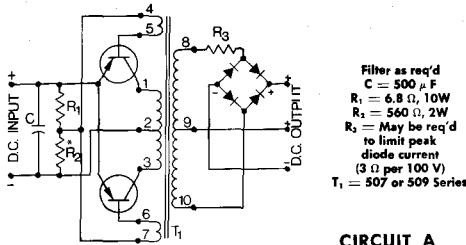

CIRCUIT A

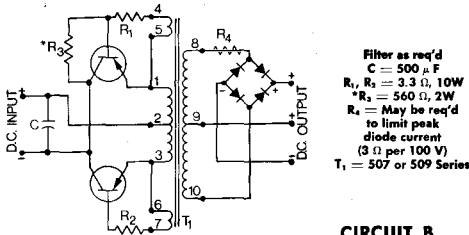

CIRCUIT B

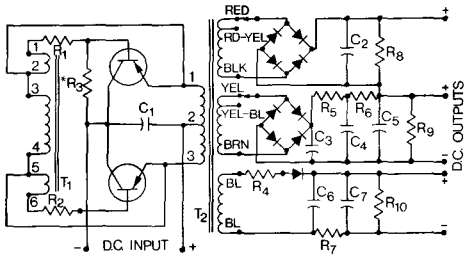

T<sub>1</sub> = 511 E or 511 G  
T<sub>2</sub> = 511 F or 511 H  
R<sub>1</sub>, R<sub>2</sub> = 1.6  $\Omega$ , 10W  
R<sub>3</sub> = 330  $\Omega$ , 2W  
R<sub>4</sub> = 1 K  $\Omega$ , 1W  
R<sub>5</sub>, R<sub>6</sub> = 100  $\Omega$ , 5W  
R<sub>7</sub> = 560  $\Omega$ , 1W  
R<sub>8</sub>, R<sub>9</sub> = 560 K  $\Omega$ , 2W  
R<sub>10</sub> = 100 K  $\Omega$ , 0.5 W  
C<sub>1</sub> = 500  $\mu$ F  
C<sub>2</sub> = 20  $\mu$ F, 600V  
C<sub>3</sub> = 20  $\mu$ F, 400V  
C<sub>4</sub>, C<sub>5</sub> = 40  $\mu$ F, 400V  
C<sub>6</sub>, C<sub>7</sub> = 10  $\mu$ F, 150V

CIRCUIT H

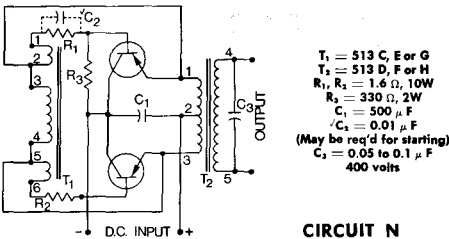

CIRCUIT N

\*Value of resistor may vary between 200 and 560 ohms for reliable starting under inductive load or low temperature. Choose transistors with VCE minimum of twice DC input voltage  $\pm$  10% and I<sub>c</sub> sufficient for input current.

Switching and Main  
"Power Pair"

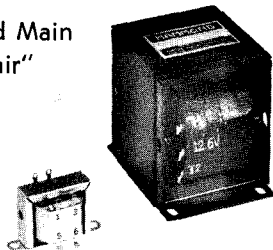

## DC TO DC CONVERTER – TOROIDAL TRANSFORMERS

- Epoxy cast toroidal transformer (See p. 5 details).
- One hole mounting.
- Square loop alloy cores with bifilar windings deliver clean square wave output.
- Produce highly efficient DC to DC converter units.
- The outputs of similar power supplies may be series or parallel connected.
- Typical Circuits **A & B**.

Cat. No.	DC Input		DC Output ‡		Approx. Oper. Freq. Hz	Dia.	Ht.	Wt. Lb.
	Volts	Amps	Volts	mA				
507 F	12.6	7.0	250/125	210	1500	2 1/16"	1 3/8"	0.4
507 K	12.6	7.0	300/150	170	1500	2 1/16"	1 3/8"	0.4
507 M	12.6	7.0	350/175	150	1500	2 1/16"	1 3/8"	0.4
509 F	12.6	11.0	250/125	400	850	2 3/16"	1 15/16"	1.0
509 K	12.6	11.0	300/150	335	850	2 3/16"	1 15/16"	1.0
509 N	12.6	11.0	375/187	270	850	2 3/16"	1 15/16"	1.0
509 P	12.6	11.0	450/225	220	850	2 3/16"	1 15/16"	1.0
509 R	12.6	11.0	500/250	200	850	2 3/16"	1 15/16"	1.0
509 T	12.6	11.0	600/300	165	850	2 3/16"	1 15/16"	1.0

NOTES – Special units designed for 25.2 or 28V are available, order similar to 509 P except for a D.C. input of 28 volts.

‡ This is the total mA output from a typical power supply.

## DC TO DC CONVERTER – SWITCHING AND MAIN TRANSFORMERS

- For efficient, quiet, high power DC to DC conversion.
- Epoxy cast toroid switching transformer (See p. 5 details).
- Square loop alloy core – bifilar wound – delivers clean square wave switching signal, at approximately 200 Hz.
- Main transformer is open vertical mounting (See p. 5 details).
- Typical Circuit **H**.

511 E "Switching" Toroid 12.6 V. D.C. Dia. 2 1/16", Ht. 1 3/8", used with 511 F, Wt. 0.4 lb.

511 F "Main" Trans 380 VA., Dim. 3 3/4 x 4 3/4 x 4 1/2" H, Wt. 10.5 lb. Bias Wdg. 100 V @ 50 mA.

Power Wdg. #1 280 V Tapped at 250 V @ 400 mA D.C.

Power Wdg. #2 425 V Tapped at 375 V @ 400 mA D.C.

Wdgs. #1 & #2 in series will deliver 625, 655, 675, or 705 V @ 400 mA.

◆511 G "Switching" Toroid 12.6 V. D.C., Dia. 2 1/16", Ht. 1 3/8" used with 511 H, Wt. 0.4 lb.

◆511 H "Main" Trans. 275 VA. Dim. 3 3/4 x 4 3/4 x 4 1/2" H, Wt. 10.5 lb. Bias Wdg. 100 V @ 60 mA.

Power Wdg. #1 300 V Tapped at 250 V @ 500 mA D.C.

Power Wdg. #2 475 V Tapped at 450 V @ 300 mA D.C.

Wdgs. #1 & #2 in series will deliver 700, 725, 750 or 775 V @ 300 mA D.C. and will simultaneously supply 300 or 250 volts at 200 mA D.C.

## DC TO AC INVERTER – SWITCHING AND MAIN – POWER PAIRS

- For inverter power supplies with 12 V DC input and 115 V 60 hertz AC square wave output. Regulation approx. 10%.
- Compact open vertical bracket (See p. 4 details) for the switching transformer, and vertical H mounting (See p. 5 details) for the "Main" transformer.
- Typical Circuit **N**.

Cat. No.	Function	Input DC Amps	Output VA	Overall Dimensions	Mtg. Cts.	Wt. Lb.
513 C	Switching	—	—	2 1/16 x 1 1/4 x 1 3/16 H	1 3/4	0.25
513 D	Main	6.5	60	2 1/2 x 3 x 3 H	2 x 2 1/2	3.5
513 E	Switching	—	—	2 1/16 x 1 1/4 x 1 3/16 H	1 3/4	0.25
513 F	Main	11.0	100	3 1/8 x 3 1/2 x 3 3/4 H	2 1/4 x 2 3/4	6.0
513 G	Switching	—	—	2 3/8 x 1 3/8 x 1 3/8 H	2	0.30
513 H	Main	20.0	200	2 3/4 x 5 x 4 1/2 H	2 3/4 x 4	13.0

NOTE – Tolerance on output voltage and frequency  $\pm$  7% at rated input voltage and load.

To minimize switching harmonic radiation, a suitable hash filter should be used between the D.C. source and the converter or inverter (See transistor manufacturer's manual).

◆ New Product

Ask for bulletin 507.

# HAMMOND

# PULSE & TRIGGER TRANSFORMERS

## PULSE TRANSFORMERS

- Available in 3 different mounting types.
- Rise times and insulation suitable for use in SCR firing circuits.
- Special types up to 100KV and high powers available on special order.



610 SERIES

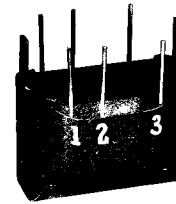

611 SERIES

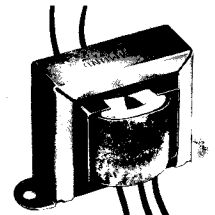

612 SERIES

- Weighs only 0.5 oz.
- These may be produced to MIL-T-27 on request.

Cat No.	Ratio	Circuit Volts (max.)	$L_p$	D.C. Res ( $\Omega$ )			Insulation test (rms volts)
				$R_p$	$R_{s1}$	$R_{s2}$	
◆610 A	1:1	250	5.2 mH	3.4	3.9	—	1000
◆610 B	1:1:1	250	4.8 mH	2.1	1.85	2.3	1000

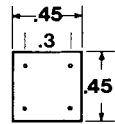

610 A

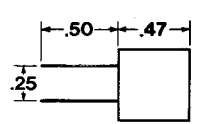
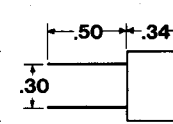

610 B

- Weighs only 0.7 oz.

Cat. No.	Ratio	Circuit Volts (max.)	$L_p$ mH	D.C. Res. ( $\Omega$ )			Insulation test (rms volts)	Wt. oz.
				$R_p$	$R_{s1}$	$R_{s2}$		
◆611 A	1:1	125	8.6	0.45	0.55	—	1000	0.7
◆611 B	1:1:1	125	17.2	1.26	1.0	1.53	1000	0.7
◆611 C	1:1	250	56	3.31	4.46	—	1500	1.2
◆611 D	1:1:1	250	17	1.73	1.31	2.12	1500	1.2

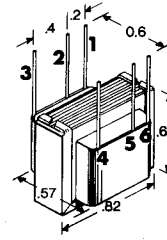

611 A & B

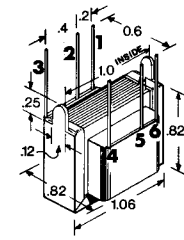

611 C & D

- Weighs only 8.0 oz.

Cat. No.	Ratio	Circuit Volts (max.)	$L_p$ mH	D.C. Res. ( $\Omega$ )			Insulation test (rms volts)	Wt. oz.
				$R_p$	$R_{s1}$	$R_{s2}$		
◆612 G	1:1	600	6.6	0.87	0.87	—	4000	8.0
◆612 H	1:1:1	600	1.5	0.45	0.42	0.49	4000	8.0

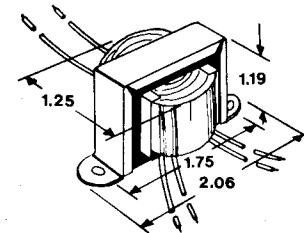

612 G & H

NOTE — 610 A is replacement for old part #84287 and 610 B for #70303.

## TRIGGER TRANSFORMERS

- Open cylindrical construction with bare leads.
- Requires switching circuit to trigger primary.
- Used to trigger a capacitive discharge in an electronic photo flash or strobe tube.
- For further application details, ask for Bulletin 616.
- Weighs only 1.0 oz.

Cat No.	Output Kv	Step Up Turns Ratio	Typical Pri. Capacitor $\mu$ F	Min. D.C. Charge Voltage	Input Energy to Coil Millijoules
◆616 B	4	1:35	0.5	120	3.2
◆616 E	10	1:50	1.0	200	20.0
◆616 G	15	1:60	1.0	250	30.0

## SPECIAL PULSE TRANSFORMERS — how to specify \*

1. Primary voltage (peak) and source impedance (if known).
2. Secondary voltage (peak) and load impedance.
3. Duration of pulse and allowable droop percentage.
4. Rise time, if important (when the ratio of duration to rise time specified exceeds approx. 10:1 cost may increase.)
5. Repetition rate.
6. Type of mounting — epoxy cast with P.C. pins, open with P.C. pins, leads or terminals.

$T_d$  = pulse duration  
 $T_r$  = rise time  
 $T_f$  = fall time

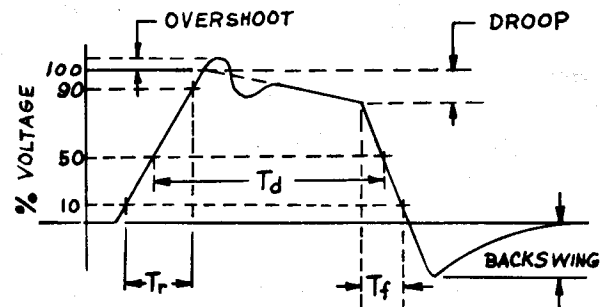

Pulse transformer dynamic parameters

\* Blocking oscillator transformer characteristics depend greatly on circuitry, and it may be necessary to test a prototype unit in the actual circuit before a final design can be obtained.

# EDUCATION-DEMONSTRATION TRANSFORMERS

# HAMMOND

## 25 SERIES

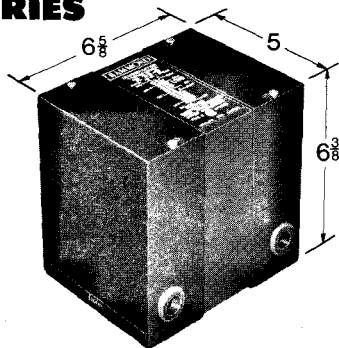

TYPE 25 B

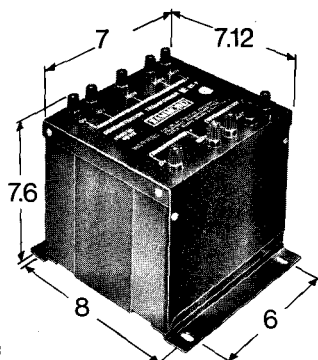

TYPE 25 C & F

- For electrical experiments in Technical High Schools.
- Conservative 300 and 1000VA, 240 volt, 60 hertz designs with split secondary.
- Schematic diagram displayed on top of transformer.
- Type 25 C and 25 F are open core and coil models with protective top terminal panels and convenient plastic binding posts for fast experimental connections.
- Type 25 B is supplied in a Type E metal enclosure in which access to screw terminals is through a primary and secondary side cover. Leads may be brought out through side knock-outs.
- Students may demonstrate series, parallel or autotransformer (buck-boost) connections.
- By using two or three units, classes may experiment with three phase combinations including star, delta, open delta and scott-T connections.

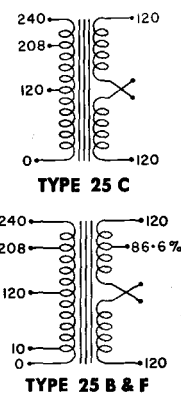

Cat. No.	Primary		Secondary		Ship. Wt. Lb.
	Volts	Taps	Volts	Taps	
◆25 B	240	10, 120, 208	120/240	86.6%	20
25 C	240	120, 208	120/240	nil	50
25 F	240	10, 120, 208	120/240	86.6%	50

NOTE — The 86.6% tap is 86.6% of the two 120V secondary windings in series (208V) or 88 volts of one 120V winding.

## RESEARCH AND EDUCATIONAL APPARATUS

HAMMOND supplies various types of transformers for educational demonstration and experimentation in trade and high schools. Both multiple tap devices as illustrated or transformers that can be completely dismantled can be supplied. Special coils and transformers for research projects are also produced to university specifications. Specific inquiries are invited.

## 26 SERIES



- Compact designs of core and coils may be assembled in classes by students to demonstrate transformer principles.
- Various coil combinations are possible—may be quickly changed in class.
- Primary coil may be placed inside any of the secondary coils and then on opposite leg of core to demonstrate leakage inductance, phase angle, etc.
- Clamping of core with thumb screws allows variations in core gap hence exciting current.
- Rugged 8-32 screw terminals on all coils.
- Each coil is plainly marked for turns, voltage and current.

Cat. No.	Description	Turns	Voltage	Current	Ship Wt. Lb.
◆26 B	Core Assembly	—	—	—	3.5
◆26 D	Secondary	1200T	240V	0.5A	1.5
◆26 F	Primary	600T	120V	1.0A	1.5
◆26 G	Secondary	300T	60V	2.0A	1.5
◆26 K	Secondary	150T	30V	4.0A	1.5
◆26 M	Secondary	75T	15V	8.0A	1.5

## WHAT IS A TRANSFORMER ?

Fundamental principles of transformers — how they work — how they're made — how they're used — are explained in an eight page introductory brochure entitled "WHAT IS A TRANSFORMER?". It is available free from your HAMMOND distributor or the HAMMOND factory.

◆ New Product



# HAMMOND

# TAPE ERASERS, MICROSCOPE & AUTOTRANSFORMERS

## UNIVERSAL TAPE ERASER & TOOL DEMAGNETIZER— 115 volt, 60 Hertz

- Magnetic eraser for clearing up to 10½" diameter audio, video and data recording tapes; also suitable for bulk erasing cassette or cartridge tapes.
- For use with plastic, aluminum, or other non-magnetic reels with ¾" diameter holes (for larger inside diameters see adaptors listed below).
- High flux density assures minimum signal residue and unusually simple operation. Complete operating instructions on the back.
- May be used to demagnetize tools or components having some residual magnetism.
- Cat. 21 B has on-off toggle switch on the side; Cat. 21 F is supplied with foot switch.
- Capable of erasing tape widths up to ¾" or 1½" by turning tape over for a second pass.
- Heavy 'U ground' plug and 6 foot cord.
- Sturdy formed steel case with durable leather-like greytex finish.
- Non slip rubber feet on bottom and rear surface.
- Ask for Bulletin 5269.
- CSA approved.

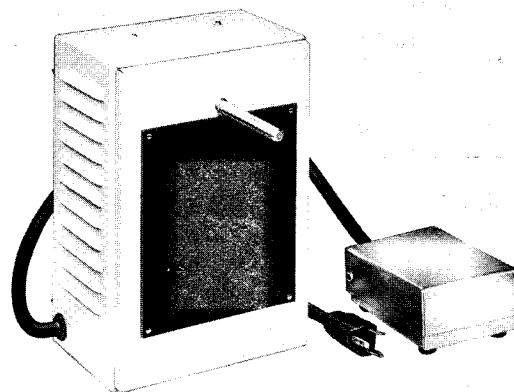

Cat. No.	Reel Diameter	Operating Voltage	Current Required	Overall Dimensions			Ship. Wt. Lb.
				L	D	H	
21 B	3, 4, or 5"	115	6 Amps	6¼	5¾	6¼	8
21 F	3, 4, 5, 7, or 10½"	115	14 Amps	6¼	5¾	9	25

21 W Adapter for EIA Standard Type "A" Hub. Nominal 3" dia. for 10" reels  
 21 X Adapter Bushing for ¾" inside diameter Reels.

## MICROSCOPE TRANSFORMERS

— 115 volt, 60 Hertz, CSA approved

- Safe, foolproof, 2 prong outlet receptacle complete with 6' adapter cord & plug for illuminator (other outlet types available on special order).
- On-Off switch and pilot light on all models.
- Supplied with 6 foot 115 volt line cord & U-ground plug.
- Smooth variable voltage control.
- Black semi-gloss finish on formed steel case.
- Model 20 K includes A.C. ammeter for accurate adjustment & recording of lamp current.

- Clearly marked control scale for recording experiment results.
- Economical to operate — Model 20 D draws 30 VA and Model H & K draws 55 VA at rated load.

Cat. No.	Dimensions			Output Volts	Output Amp.	Ship. Wt. Lb.
	H	W	D			
20 D	3⅝	3⅜	4¼	3 to 7	3	3.5
20 H	4⅝	3⅝	4½	3.5 to 7.5	5.5	5
20 K	6¼	3⅝	4½	3.5 to 7.5	5.5	8



Model 20 D

Model 20 H

Model 20 K

## LINE ADJUSTING AUTOTRANSFORMERS — 200 VA to 2000 VA — 50 OR 60 Hertz operation.

- Input 115 V • Output taps at 85-95-105-110-115-125 V.
- Good regulation from a single correctly proportioned winding.
- Ideal for line voltage adjustment for electronic equipment or small appliance operation (manually adjusted).
- Supplied with 9" to 12" flexible leads. • C.S.A. approved.

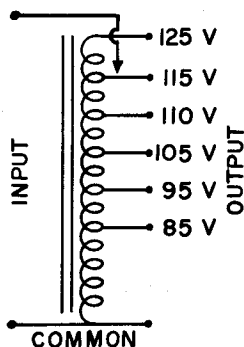

Cat. No.	Volt-Amp. Capacity	Core Size	Dimensions					Wt. Lb.
			A	B	C	D	E	
168 B	200	1¼ x 1	3⅞	3⅞	3¾	2½	2	4¼
168 C	350	1¼ x 1¾	3⅞	4⅞	3¾	2½	2¾	6½
168 D	500	1½ x 1½	3¾	4¼	4½	3	2½	8
168 E	750	1½ x 2¼	3¾	5	4½	3	3⅞	11
168 F	1000	2 x 1¾	5	5¼	6½	4⅞	3¼	18
168 H	1500	2 x 2¼	5	5¾	6½	4⅞	3¾	23
168 J	2000	2 x 3	5	6½	6½	4⅞	4½	31

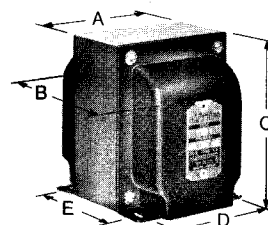

Special designs of these series produced quickly to your specifications.

# ISOLATING AND AUTOTRANSFORMERS

# HAMMOND

## LINE ISOLATING AND ADJUSTING TRANSFORMERS— 100 VA to 750 VA — 60 Hz.

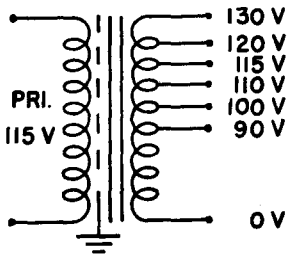

- Primary 115 V
- Secondary taps at 90-100-110-115-120-130 V.
- Type X mounting (p. 5 details) with knockouts.
- Electrostatic shield between pri. and sec. for true circuit isolation and minimum leakage.
- Flexible leads 9" - 12" long.

Cat. No.	Volt-Amp. Capacity	Core Size	Dimensions					Wt. Lb.
			A	B	C	D	E	
169 C	100	1¼ x 1¾	3⅞	4⅞	3¾	2½	2¾	6
169 E	250	1½ x 3	3¾	5¾	4½	3	4	12
169 G	500	2 x 2	5	5½	6½	4⅞	3½	22
◆169 J	750	2 x 3½	5	7	6½	4⅞	5⅞	28

## LINE ISOLATION TRANSFORMERS — 15 VA to 200 VA — 60 Hz operation.

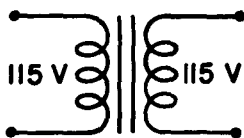

- Type X mounting (see p. 5 details) with knockouts.
- Flexible leads 9" to 12" long.
- Primary 115 V.
- Secondary 115 V.
- Circuit isolation or bias power supply.

Cat. No.	Volt-Amp. Capacity	Secondary Volts	mA	Core Size	Dimensions					Wt. Lb.
					A	B	C	D	E	
169 P	15	115	130	¾ x 1	Horizontal Brkt. Mtg. with Side Shields. Mtg. Cts. 2⅞					1¼
169 Q	30	115	260	1 x 1	2⅞	2⅞	3	2⅞	1¾	2½
169 R	50	115	435	1 x 1½	2⅞	3⅞	3	2⅞	2¼	3¼
169 S	75	115	650	1¼ x 1¼	3⅞	3⅞	3¾	2½	2¼	4½
169 T	100	115	870	1¼ x 2	3⅞	4⅞	3¾	2½	3	6½
169 V	150	115	1300	1¼ x 2½	3⅞	4⅞	3¾	2½	3½	11
169 W	200	115	1700	1½ x 2½	3¾	5⅞	4½	3	3½	12

## LINE AUTOTRANSFORMERS — 50 VA to 2000 VA — 50 OR 60 Hz operation.

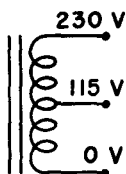

- Type X mounting (see p. 5 details) with knockouts.
- Flexible leads 9" to 12" long.
- 230 V to 115 V step down or 115 V to 230 V step up.
- Operation of European electronic equipment in America or American equipment in Europe.

Cat. No.	Volt-Amp. Capacity	Core Size	Figure	Dimensions					Wt. Lb.
				A	B	C	D	E	
170	50	1.00 x 1.00	A	2.63	2.50	3.00	2.13	1.75	2.5
170 A	100	1.00 x 1.50	A	2.63	3.13	3.00	2.13	2.25	3.25
170 B	200	1.25 x 1.25	A	3.13	3.63	3.75	2.50	2.25	4.7
170 C	300	1.25 x 1.75	A	3.13	4.13	3.75	2.50	2.75	6.1
170 D	500	1.50 x 2.00	A	3.75	4.75	4.50	3.00	3.00	10.0
170 E	750	1.50 x 3.25	A	3.75	6.00	4.50	3.00	4.19	13.0
170 F	1000	2.00 x 1.75	A	5.00	5.25	6.50	4.56	3.31	18.0
170 G	1500	2.00 x 2.75	A	5.00	6.25	6.50	4.56	4.31	24.0
◆170 J	2000	2.00 x 3.00	A	5.00	6.50	6.50	4.56	4.56	27.0

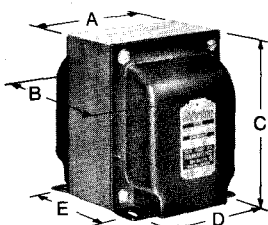

Type X  
Fig. A

- Totally enclosed case with convenient knockouts facilitates connections and mounting.
- Extra vacuum varnish for use in high humidity atmospheres, domestically or around the world.
- Supplied with three connectors and bushings for two knockouts.
- Connections details included for 230V to 115V step down or 115V to 230V step up operation.

Cat. No.	Volt-Amp. Capacity	Core Size	Figure	Dimensions					Wt. Lb.
				A	B	C	D	E	
◆170 BE	200	1.25 x 1.25	B	3.13	4.19	4.13	2.25	3.25	5.0
◆170 CE	300	1.25 x 1.75	B	3.13	4.70	4.13	2.25	3.75	6.5
◆170 DE	500	1.50 x 2.00	B	3.75	4.94	4.88	2.75	4.00	10.5
◆170 EE	750	1.50 x 3.25	B	3.75	6.19	4.88	2.75	5.25	13.5
◆170 FE	1000	2.00 x 1.75	C	5.00	6.38	6.38	4.00	4.88	19.0
◆170 GE	1500	2.00 x 2.75	C	5.00	7.38	6.38	4.00	5.88	25.0
◆170 JE	2000	2.00 x 3.00	C	5.00	7.63	6.38	4.00	6.13	28.0

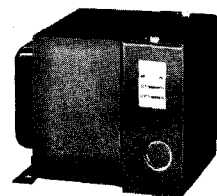

Fig. B

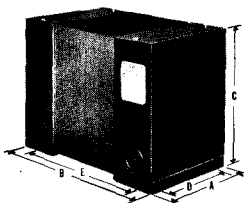

Fig. C

Totally Enclosed "E Case"

Special designs of these series produced quickly to your specifications.

◆ New Product

# HAMMOND

## LINE ADJUSTING AND ISOLATING TRANSFORMERS

### LINE ISOLATING TRANSFORMERS – CSA Approved "LR 3902"

100 VA to 900 VA – 50/60 Hz.

- 115 V Primary • Secondary 115 V • Circuit isolation.
- Electrostatic shield between primary and secondary.
- 5 foot "U ground" cord and plug • Single outlet receptacle up to 300 VA; 500 & 900 VA have duplex receptacle.

Cat. No.	Input Voltage	Output Voltage	Volt-Amp. Capacity	Core Size	Dimensions					Wt. Lb.
					A	B	C	D	E	
171 A	115	115	100	1½ x 1¼	3¾	4¾	5	3	2⅝	7½
171 B	115	115	200	1½ x 2¾	3¾	5½	5	3	4⅛	12
171 C	115	115	300	1½ x 3¼	3¾	6	5	3	4⅝	16
171 E	115	115	500	2 x 2¼	5	5¾	6½	4⅞	3¾	24
171 F	115	115	900	2 x 4½	5	8½	6½	4⅞	6	39

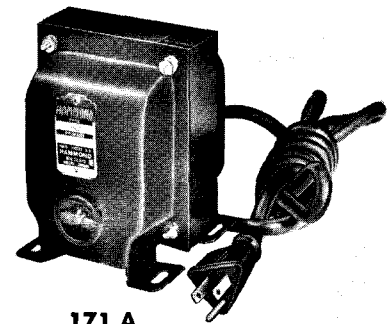

171 A

### LINE ISOLATING TRANSFORMERS – CSA Approved "LR 3902"

100 VA to 500 VA – 50/60 Hz.

- 230 V Primary • Secondary Fused 115 V • Circuit isolation.
- Electrostatic shield between primary and secondary.
- 5 foot "U Ground" cord and plug. • Single outlet receptacle.

Cat. No.	Input Voltage	Output Voltage	Volt-Amp. Capacity	Core Size	Dimensions					Wt. Lb.
					A	B	C	D	E	
172 A	230	115	100	1½ x 1¼	3¾	4	4½	3	2⅝	7½
172 B	230	115	200	1½ x 2¾	3¾	5½	4½	3	4⅛	12
172 D	230	115	500	2 x 2¼	5	5¾	6½	4⅞	3¾	24

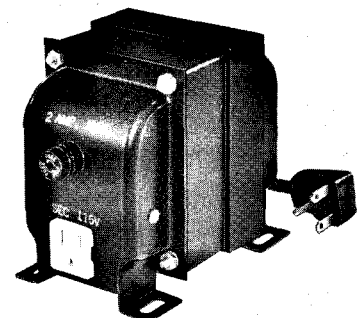

172 A

### LINE VOLTAGE ADJUSTERS - MANUAL OPERATION

#### 173 SERIES – 300 VA & 500 VA – 60 Hz operation – CSA Approved "LR 28732"

- Two-tone (grey and blue Hammerlin) sturdy steel case.
- Efficient autotransformers allow output to be held at 115 volts with an input voltage varying from 88 to 124 volts.
- Ten point tap switch for accurate voltage adjustment.
- 0-150 V voltmeter for monitoring output voltage.
- 6 foot "U Ground" cord, plug and duplex outlet receptacle.
- Front operated ON-OFF switch. • Dimensions 7⅝" W x 6¼" D x 5⅞" H.



Cat. No.	Max. Output VA	Wt. Lb.
173 C	300	9.5
◆173 D	500	12

#### 174 SERIES – 1000 VA & 1500 VA – 60 Hz. – CSA Approved "LR 28732"

- Sturdy formed steel case with attractive two-tone baked enamel finish (light blue base and dark blue hammerlin cover).
- Efficient autotransformers allow output to be held at 115 V with an input variation of 88 to 124 V.
- Heavy duty 10 point tap switch with silver contacts.
- Wide view 0-150 V voltmeter for monitoring output voltage.
- Six foot "U Ground" cord, plug and duplex outlet receptacle.
- Front operated ON-OFF switch.
- Overall dimensions 9½" W x 7" D x 7" H.

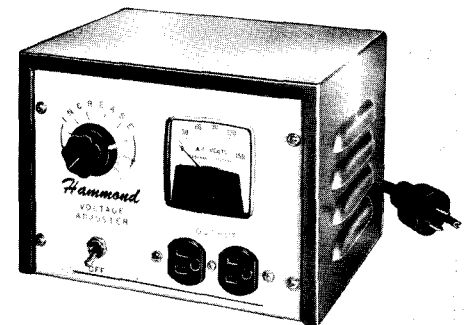

Cat. No.	Max. Output VA	Wt. Lb.
174 F	1000	22
174 H	1500	25.

**NOTE** – Cat. No. 173 D replaces Cat. No. 174 D, Cat. No. 173 C replaces Cat. No. 173.

◆ **New Product**

Special designs of these series produced quickly to your specifications.

# EQUIPMENT CARRIERS

# HAMMOND

## SCOPE DOLLY — 1470 C

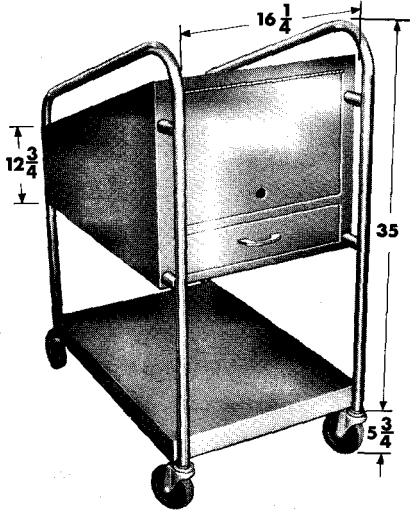

- Designed to carry popular types of laboratory oscilloscopes.
- A 16 ga. top deck has a 20 degree slope with adjustable brackets for scope width and depth.
- One-inch chrome plated tubular steel frame.
- Bottom deck 28 x 18 1/2 x 2" complete with non slip rubber mat for carrying VTVM, signal generators, etc.
- Top section has a 3 1/2 x 15 7/8 x 14" deep felt lined 18 ga. probe drawer with 1427 H Handle (Page 58).
- Top hinged 14 ga. 15 7/8 x 10 5/8" front panel provides a convenient writing surface and access to an equipment storage compartment for scope pre-amplifiers, etc.
- Rear of top section has a 16 x 5" removable auxiliary mounting panel covering an opening of 4 1/8 x 15 1/8".
- Punching for a duplex receptacle each side of top section with a hole and 5/8" grommet at rear for a line cord.
- 5" rubber casters provide 300 lb. load capacity — two at rear are fixed — two at front are swivel casters with braking devices.
- Finished in standard ASA 61 grey baked enamel.

1470-C—Approximate overall dimensions 32 1/4 L x 18 1/2 W x 40 H. Ship. wt. 85 lb.

## EQUIPMENT/PARTS CARRIER — 1470 P

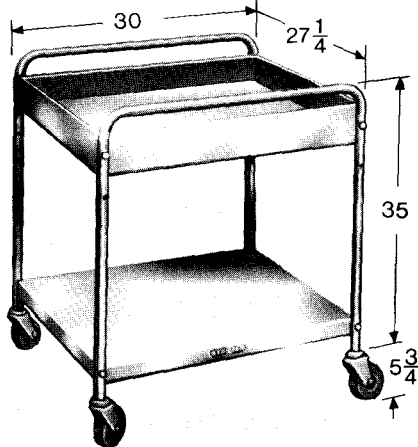

- Designed to carry auxiliary test equipment, components or lab materials.
- One-inch chrome plated tubular steel frame with two 14 ga. steel decks.
- Reversible top deck 30" x 24" x 6" adjustable 4" down on pre-drilled holes.
- Bottom deck 30" x 24" x 2" has punchings on both sides for duplex receptacles and a hole with 5/8" rubber grommet at rear for a line cord.
- Rubber 5" dia. casters — two at rear are fixed — two at front are swivel casters with braking devices.
- Finished in standard ASA 61 grey baked enamel.

1470 P—Approx. overall dimensions 31 1/2 L x 27 1/4 W x 40 3/4 H. Ship wt. 65 lb.

### ON SPECIAL ORDER

- 4 swivel casters — special paint finishes.
- models with stainless steel decks — order as 1470 PS.

## CABINET DOLLIES — 1424 SERIES

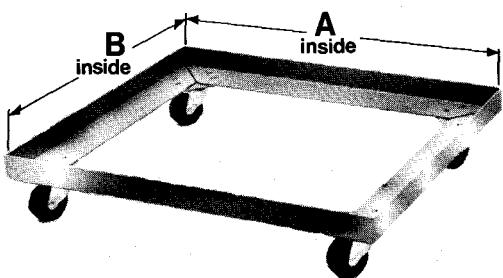

- Designed to give mobility to equipment housed in table or floor racks.
- Constructed of 1/8" steel angles. • Load capacity approx. 600 lb.
- Four stock ball bearing type swivel hard rubber casters (1425 A).
- Standard ASA 61 grey baked enamel finish.
- Model 1424 T has solid platform with suitable holes to mount relay racks.

Cat. No.	A	B	For Cabinet	Ship Wt. Lb.
1424 B	21 1/2	16 3/4	1460, 1, 2	15
1424 G	22 3/4	17 3/4	1463-1, 1469-1	16
1424 J	22 3/4	24 1/4	1463-2, 1469-2	20
1424 K	27 3/4	24 1/4	1463-4, 1469-4	25
◆1424 T	28	21 1/2	1466, 1467	35

## CASTERS — 1425 SERIES

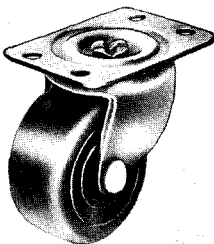

- For use on stock consoles, cabinets or racks.
- Ball bearing swivel type hard rubber wheels.
- Supplied in sets of 4 with mounting hardware.

Cat. No.	Size of Wheel	Overall Height	Capacity Per Set (4)	Ship Wt. Lb. Per Set (4)
1425 A (sets of 4)	2"	2 1/2	600 lb.	4
1425 B (sets of 4)	3"	3 3/4	360 lb.	6
1425 C (sets of 4)	4"	5	640 lb.	6
1425 D (sets of 4)	4" (with brake)	5	800 lb.	15

Special designs of these series produced quickly to your specifications.

## GENERAL FEATURES

- Sold completely assembled
- All models have 2-fixed and 2-swivel 4" wheels except 1470 E which has 4 swivel wheels, providing a total capacity of 640 lbs.
- Finished in ASA 61 grey baked enamel
- Welded steel construction uses 16 ga. frame and bottom with 18 ga. shelves, except the 1470 T

## SCOPE DOLLY — ♦1470 E

- More economical than the 1470 C
- Suitable for most laboratory oscilloscopes
- Clearance of 11" between bottom and second shelf
- Top has 20° slope with back stop and width guides to strap scope in position
- Rear of dolly is punched for standard duplex receptacle
- Standard 1427 L Pull Handle installed on front
- Overall dim. 37" H x 18" W x 26¼" L (less handle)
- Ship wt. 52 lb.

## ECONOMICAL LAB EQUIPMENT DOLLY — ♦1470 Q

- Companion to the 1470 E Scope Dolly
- Flat top design suitable as mobile work surface
- Punched to accept standard duplex receptacle
- Overall dim. 33" H x 18" W x 28½" L
- Ship wt. 60 lb.

## 3-SHELF MOBILE TOOL STAND — ♦1470 R

- Useful in work shops, maintenance departments, tool rooms, stock rooms and service departments
- Clearance of 12" between middle and bottom shelves and 10½" between top and middle shelves
- Overall dim. 33" H x 18" W x 28½" L
- Ship wt. 42 lb.

## 4-SHELF MOBILE TOOL OR PROJECTOR STAND — ♦1470 S

- Similar to 1470 R except height 42" with additional shelf
- Extra height makes it a useful projector dolly with ample space for film storage
- Clearance between shelves from top to bottom is 8", 10" and 12" respectively
- Overall dim. 42" H x 18" W x 28½" L
- Ship wt. 54 lb.

## WAREHOUSE TOTE TRUCK — ♦1470 T

- Ideally suited for picking and placing orders in stock rooms and storage areas
- 18" clearance between top tray and formed sides of bottom tray with a 21¾" clearance at front opening of bottom tray
- Top tray has 14" sides, open at front for easy loading
- Welded steel construction uses 12 gauge frame and 14 gauge top tray
- Overall dim. 42" H x 21¼" W x 26¼" L
- Ship wt. 78 lb.

### ♦ New Products

Special designs of this series produced quickly to your specifications.

1470 E ↘

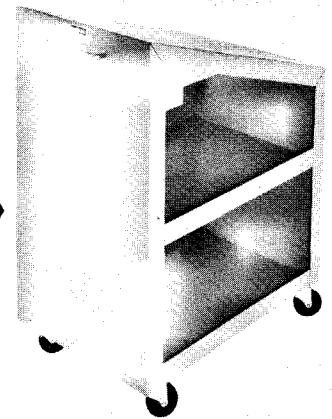

↙ 1470 Q

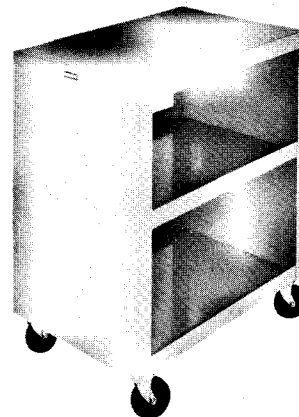

1470 R ↘

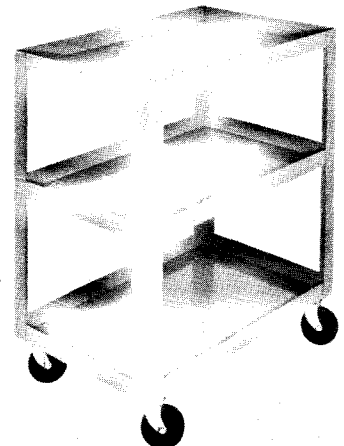

↙ 1470 S

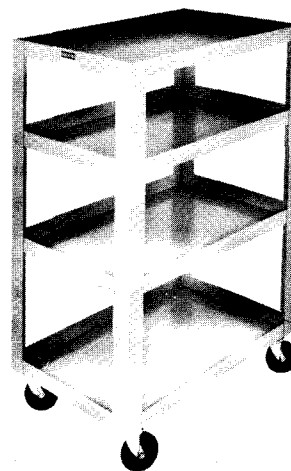

1470 T ↘

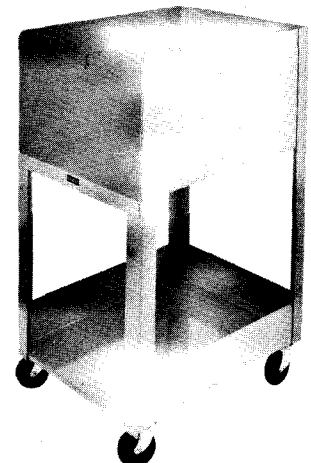

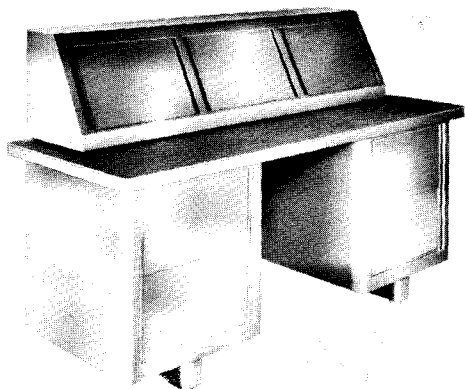

Rear Panels  
in Place

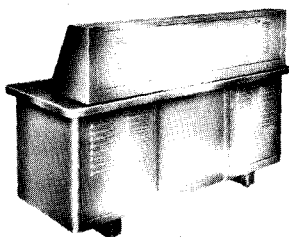

Rear Panels  
Removed

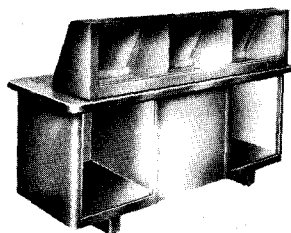

5034 B

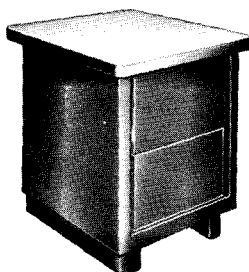

## GENERAL DESCRIPTION — 5000 SERIES

- For supervisory control and instrumentation systems — electrical, pneumatic, or hydraulic — in the communication, entertainment, automation, machine tool, and broadcast fields.
- Modern, versatile, flexible, basic consoles, tables and turrets can be readily designed into modern systems.
- Will stand the rugged environment of industry, research or education facilities.
- Many adaptations and combinations are possible using other accessories from this catalogue.
- Manufactured from cold rolled steel with particular attention to providing a high quality metal finish — standard baked ASA 61 grey enamel.
- Working surfaces are supplied with grey linoleum and attractive anodized aluminum trim mold.
- Units have four levelling feet.
- Ask for Bulletin 5060.

## COMMON FEATURES — 5034 SERIES

Each pedestal on all consoles is equipped with the following

- Two standard 10½" steel panels (5-1050 p. 49).
- Removable, rear panel complete with a keyed lock (1427B p. 58).
- Two sets of panel rails, drilled and tapped for 10-32 screws on standard EIA/RETMA rack spacings of ½" - 1¼" facilitating the mounting of panel equipment both front and rear.
- Two vertical stainless steel dress trims to cover panel screws.
- One 4" high leg bolted to each pedestal except the 5034 B.

## SMALL CONSOLE — 5034 B

- Top dimensions 26" x 30".
- Body dimensions 22½" W x 26" D x 30" H.
- Suitable for use with a single turret, Cat. No. 5036 B or 5036 L.
- Ship wt. 125 lb.

## MEDIUM CONSOLE — 5034 D

- Top dimensions 53" x 30".
- Body dimensions 49" W x 26" D x 30" H.
- Adds knee hole comfort and larger work surface to the smaller 5034 console.
- Baffle (modesty) panel joins rear of pedestal to large support leg.
- Suitable for use with double turret 5036 D or 5036 N.
- Pedestal may be assembled on either left or right side by means of repositioned weld nuts.
- Ship wt. 190 lb.

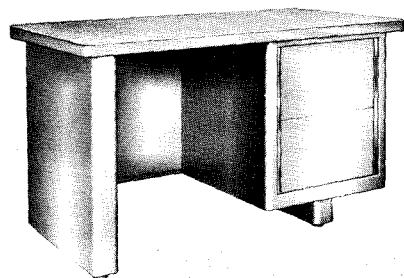

5034 D

## LARGE CONSOLE — 5034 F

- Top dimensions 70" x 30".
- Body dimensions 66" W x 26" D x 30" H.
- Provides larger work surface and additional panel space of two pedestals joined by a rear baffle (modesty) panel.
- Will accommodate a triple turret 5036 F or 5036 Q.
- Ship wt. 250 lb.

5034 F

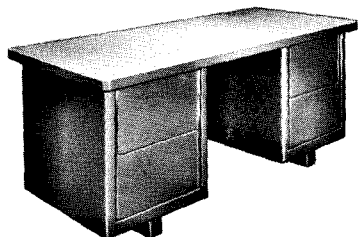

# HAMMOND

## LAB BENCHES TABLES AND TURRETS

### LAB BENCH CABINET — 5034 Y

- Top Dim. 70 x 30; Body Dim. 66 x 26 x 37½ H.
- Provides both extra equipment storage facilities, and additional working surface for industrial, educational, or research laboratories.
- Top and body dimensions same as 5034 F except 37½" high.
- Unit sits on two 4" legs as do all 5034 consoles.
- Three right hand piano hinged doors 28½" high.
- Doors have flush lock (1427 B p. 58) providing access to a 19¼" deep full length interior shelf.

### EQUIPMENT TABLES — 5035 SERIES

- Designed to support heavy equipment loads in research, educational or industrial laboratories, or for use wherever a rugged work table is required.
- Assembled from the same basic components as the consoles, except equipped with two support legs and reinforcing tie rail.
- Pedestals may be added by using pre-positioned weld nuts.
- Three convenient sizes match the 5034 console and 5036 turret series.

Cat. No.	Overall Height	TABLE TOP		Ship. Wt. Lb.
		Length	Width	
5035 B	30	26	30	80
5035 D	30	53	30	120
5035 F	30	70	30	150

NOTE: Baffle (modesty) panel between legs available on specified order.

### TURRETS — 5036 SERIES

- For control systems designed with operator comfort and efficiency in mind.
- Two panel angles available — 30 and 10 degrees to the vertical — 10° units designed for housing panel supported chassis.
- Each turret supplied with removable ventilated rear panel with keyed lock (1427 B p. 58).
- Double and triple units have removable interior partitions.
- Flange below rear panel punched with knock outs for cable or conduit entrance.
- Each turret section is supplied with standard 19" steel panel.
- Stainless steel dress trim supplied to cover panel screws.
- Ask for bulletin 5036.

Cat. No.	DIMENSIONS			Number of Panels	Ship. Wt. Lb.
	A	B	C		
<b>12¼" PANEL HEIGHT — 30° SLOPE</b>					
5036 B12	21⅝	7½	15	1	50
5036 D12	42	7½	15	2	82
5036 F12	62½	7½	15	3	120
<b>12¼" PANEL HEIGHT — 10° SLOPE</b>					
5036 L12	21⅝	12¾	15	1	50
5036 N12	42	12¾	15	2	82
5036 Q12	62½	12¾	15	3	120
<b>14" PANEL HEIGHT — 10° SLOPE</b>					
5036 L14	21⅝	12¾	16¾	1	62
5036 N14	42	12¾	16¾	2	87
5036 Q14	62½	12¾	16¾	3	132
<b>17½" PANEL HEIGHT — 10° SLOPE</b>					
5036 L17	21⅝	11¾	20¼	1	73
5036 N17	42	11¾	20¼	2	100
5036 Q17	62½	11¾	20¼	3	140

### ON SPECIAL ORDER

- Consoles, tables, turrets or benches to your specifications.
- Special paint finishes.
- Other working surface materials, e.g., vinyl, formica, etc.
- Oversize table tops for 5034 and 5035 series 6" deeper and 6" longer — add L to part number e.g., 5035 FL or 5034 FL.

### ◆ New Product

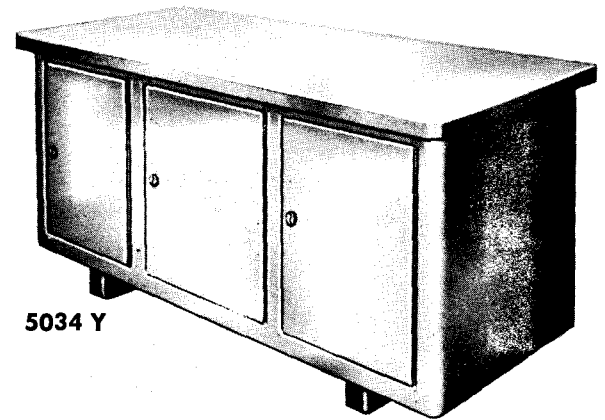

5034 Y

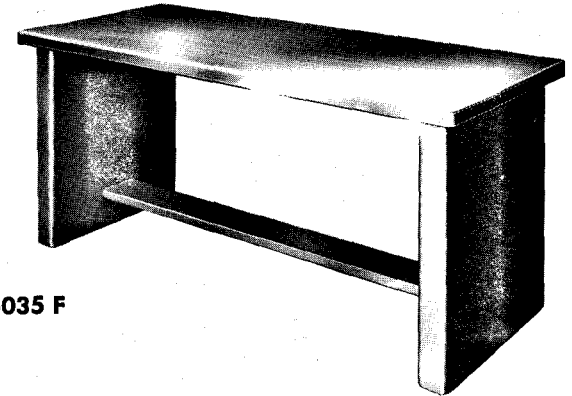

5035 F

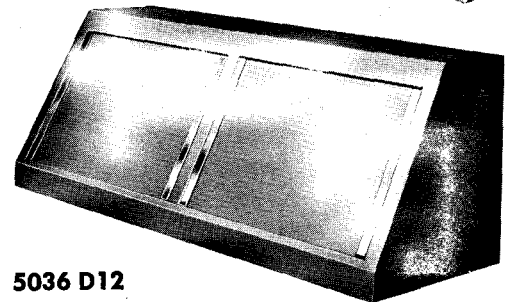

5036 D12

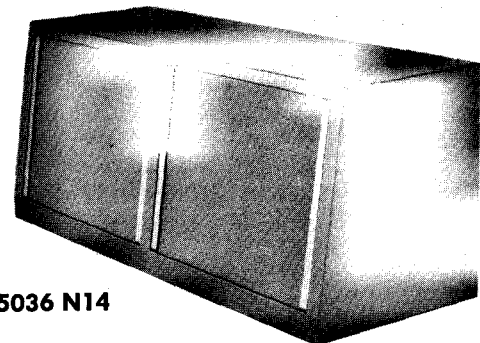

5036 N14

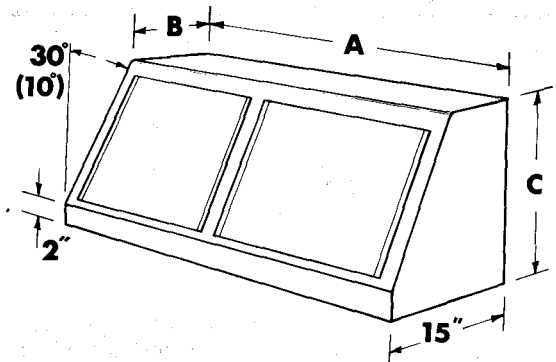

# CABINET RACKS

# HAMMOND

## 1463 SERIES

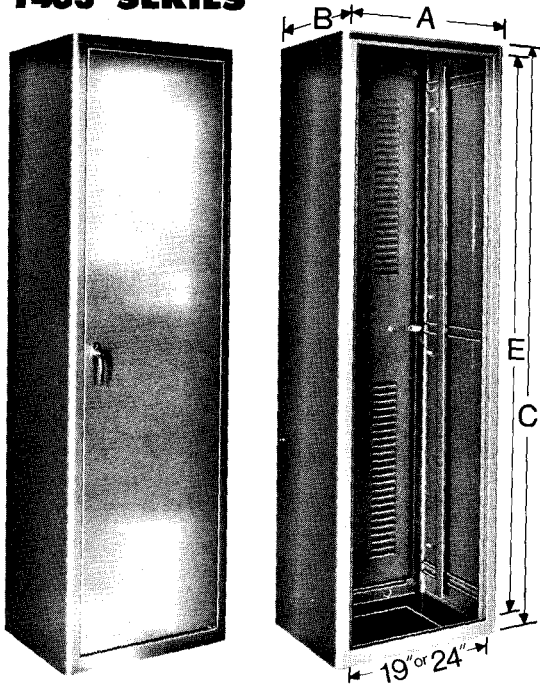

Front View with  
Optional Solid Door

Front View

### FEATURES

- Flexible, versatile, modern cabinets for 19 or 24" panel mounting equipment, standard ASA 61 gray baked enamel finish.
- All-welded 16 ga. formed steel body on heavy 14 ga. steel base.
- All vertical edges rounded with 3/4" radius.
- One pair vertical 10 ga. panel rails, drilled and tapped for 10-32 screws, on standard EIA rack spacing of 1/2-1 1/4" are fully adjustable front to back on 6 horizontal Amhal struts.
- Readily removable louvred rear door on steel pin hinges with flush type keyed lock. (1427 B see p. 58).
- Bottom 9 1/2"x9 1/2" cut out with removable cover plate for cable or conduit entrance.
- Two 1/2 x 3/4" conduit knock out provided in flange below rear door.
- One pair vertical 12 ga. Z rails for rear support of panel mounted equipment are fully adjustable front to back.
- Four cable clips welded at the rear on the right hand side.
- Stainless steel dress trim strips for top front of cabinet and to cover vertical panel rail screws. (See p. 58—1421 Q Series for replacements.)
- For complete details refer to Bulletin #1463.

### CABINETS

Cat. No.	For Standard Panels	Panel Space	A	Dimensions B	C	Ship. Wt. Lb.
1463 A1	19"	49	22 1/2	17 1/2	52 1/2	140
1463 B1	19"	61 1/4	22 1/2	17 1/2	64 3/4	160
1463 C1	19"	70	22 1/2	17 1/2	73 1/2	180
1463 E1	19"	80 1/2	22 1/2	17 1/2	84	200
1463 A2	19"	49	22 1/2	24	52 1/2	160
1463 B2	19"	61 1/4	22 1/2	24	64 3/4	185
1463 C2	19"	70	22 1/2	24	73 1/2	210
1463 E2	19"	80 1/2	22 1/2	24	84	235
1463 A4	24"	49	27 1/2	24	52 1/2	170
1463 B4	24"	61 1/4	27 1/2	24	64 3/4	195
1463 C4	24"	70	27 1/2	24	73 1/2	220
1463 E4	24"	80 1/2	27 1/2	24	84	245

### ON SPECIAL ORDER — Refer to the Factory

- Non standard sizes.
- Special paint or enamel finishes.
- Solid rear door, identify by adding R to solid front door part number, e.g. 1463 C1SR.
- Panels, side sheets or doors drilled to customer specifications.
- Special panel rails drilled and tapped to accept 10-24 or 12-24 screws.

### OPTIONAL ACCESSORIES — SEE TABLE BELOW (order separately)

- For general accessories such as chassis, panels, brackets, etc., refer to the following pages of this catalogue.
- Louvred or solid front door with 1427 A automotive handle (cabinet door frame pre-drilled for hinges and door stops).
- Extra pairs of vertical panel rails or Z rails complete with mounting hardware.
- Three spring loaded nuts, washers and bolts for attaching devices to horizontal Amhal struts — order **1463 S**.
- Convenience duplex receptacle box with mounting hardware for attaching to horizontal struts — order **1463 R**.
- CSA approved 120 volt U-ground A.C. distribution strip with receptacle spacings of 6 inches available in 4 lengths, fully adjustable on horizontal Amhal struts.
- Copper ground bus strip 1/8" x 5/8" drilled to suit standard Amhal struts complete with hardware.

For Use With Cabinet	FRONT DOORS			EXTRA PAIRS RAILS			GROUND BUS STRIP		DISTRIBUTION STRIP		
	Louvred Cat. No.	Solid Cat. No.	Ship. Wt. Lb.	Panel rails Cat. No.	Z rails Cat. No.	Ship. Wt. Lb.	Cat. No.	Ship. Wt. Lb.	Cat. No.	Number of receptacles	Ship. Wt. Lb.
1463 A1,2	1463 A1L	1463 A1S	25	1463 AP	1463 AZ	11	◆1463 AGB	3	◆1463 AW	6	6
1463 B1,2	1463 B1L	1463 B1S	31	1463 BP	1463 BZ	14	◆1463 BGB	4	◆1463 BW	10	7
1463 C1,2	1463 C1L	1463 C1S	36	1463 CP	1463 CZ	16	◆1463 CGB	5	◆1463 CW	11	8
1463 E1,2	1463 E1L	1463 E1S	40	1463 EP	1463 EZ	19	◆1463 EGB	6	◆1463 EW	12	9
1463 A4	1463 A4L	1463 A4S	33	1463 AP	1463 AZ	11	◆1463 AGB	3	◆1463 AW	6	6
1463 B4	1463 B4L	1463 B4S	40	1463 BP	1463 BZ	14	◆1463 BGB	4	◆1463 BW	10	7
1463 C4	1463 C4L	1463 C4S	46	1463-CP	1463 CZ	16	◆1463 CGB	5	◆1463 CW	11	8
1463 E4	1463 E4L	1463 E4S	52	1463 EP	1463 EZ	19	◆1463 EGB	6	◆1463 EW	12	9

### ◆ New Product

Special designs of this series produced quickly to your specifications.



# HAMMOND

# MODULAR RACKS

## 1469 SERIES

- Modular all welded 14 ga. formed steel frame with open sides.
- Removable louvered rear door, with square corners on concealed pin hinges with flush keyed lock (1427 B p. 58).
- Rack and dress panels have a modern angular appearance.
- May be joined to companion units with six conveniently supplied bolts to form sturdy equipment housings.
- One pair of vertical 10 ga. panel rails drilled and tapped for 10-32 screws on standard EIA rack spacing of 1/2-1 1/4" are fully adjustable on horizontal Amhal struts.
- One pair adjustable 12 ga. Z rails mounted on Amhal struts.
- Two 1/2 x 3/4" conduit knockouts provided in flange below rear door.
- Cut out in bottom 9 1/2"x9 1/2" for cable or conduit entrance with bolted coverplate.
- Standard ASA 61 grey baked enamel finish.
- Two stainless steel vertical dress trims covering panel screws (replacement strips available, see p. 58).
- One set of 8 wiring clips — 4 each front and rear.
- For complete details refer to bulletin 1469.

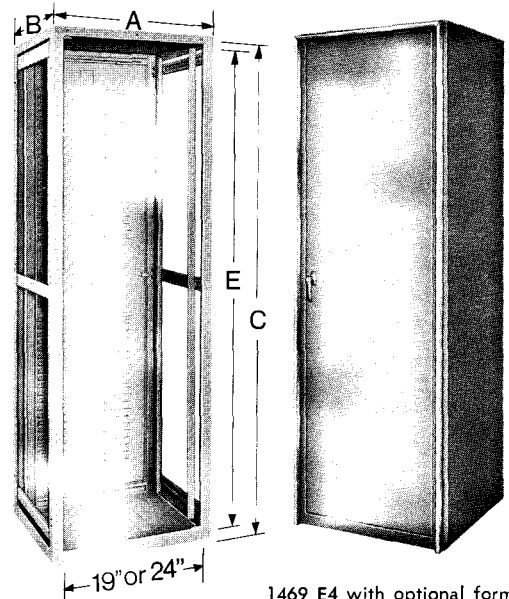

1469 E4  
(less accessories)

1469 E4 with optional formed dress panels, front door and extruded aluminum dress trim.

## CABINETS

Cat. No.	Panel Size	Vertical (E) Panel Space	Dimensions			Ship. Wt. Lb.
			A	B	C	
◆1469 A1	19	49	22 1/2	17 1/2	52 1/2	100
◆1469 B1	19	61 1/4	22 1/2	17 1/2	64 3/4	120
◆1469 A2	19	49	22 1/2	24	52 1/2	120
◆1469 B2	19	61 1/4	22 1/2	24	64 3/4	135
1469 C2	19	70	22 1/2	24	73 1/2	160
1469 E2	19	80 1/2	22 1/2	24	84	180
1469 C4	24	70	27 1/2	24	73 1/2	195
1469 E4	24	80 1/2	27 1/2	24	84	220
◆1469 F2	19	85 3/4	22 1/2	24	90	195
◆1469 F4	24	85 3/4	27 1/2	24	90	235

## OPTIONAL DRESS PANELS AND TRIM

Formed Dress Panels (Pair) Cat. No.	Ship. Wt. Lb.	Flat Dress Panel (Pair) Cat. No.	Ship. Wt. Lb.	Extruded Dress Trim Cat. No.	Ship. Wt. Lb.
◆1469 A1P	40	◆1469 A1Q	23	◆1469 A1T	3
◆1469 B1P	50	◆1469 B1Q	33	◆1469 B1T	4
◆1469 A2P	50	◆1469 A2Q	33	◆1469 A1T	3
◆1469 B2P	65	◆1469 B2Q	43	◆1469 B1T	4
◆1469 C2P	75	◆1469 C2Q	50	◆1469 C1T	5
◆1469 E2P	85	◆1469 E2Q	55	◆1469 E1T	6
◆1469 C2P	75	◆1469 C2Q	50	◆1469 C4T	5
◆1469 E2P	85	◆1469 E2Q	55	◆1469 E4T	6
◆1469 F2P	90	◆1469 F2Q	60	◆1469 F1T	7
◆1469 F2P	90	◆1469 F2Q	60	◆1469 F4T	7

## OPTIONAL ACCESSORIES — SEE TABLE BELOW AND ABOVE (order separately).

- For general accessories such as chassis, panels, brackets, etc., refer to the following pages of this catalogue.
- Attractive brushed aluminum extruded dress trim attaches to cabinet face by means of concealed screws (see above table).
- Louvred or solid front door with 1427 A automotive handle (cabinet door frame pre-drilled for hinges and door stops).
- Extra pairs of vertical panel rails or Z rails complete with mounting hardware.
- Three spring loaded nuts, washers and bolts for attaching devices to horizontal Amhal struts — order **1469 S**.
- Convenience duplex receptacle box with mounting hardware for attaching to horizontal struts — order **1469 R**.
- Copper ground bus strip 1/8" x 3/8" drilled to suit standard Amhal struts complete with hardware.
- 45° corner units available with removable rear cover plates, identify by adding suffix "K" e.g. 1469 C2K, 1469 E2K.
- CSA approved 120 volt U-ground A.C. distribution strip with receptacle spacings of 6 inches available in 4 lengths, fully adjustable on horizontal Amhal struts.

For Use With Cabinet	FRONT DOORS			EXTRA PAIRS RAILS			GROUND BUS STRIPS		DISTRIBUTION STRIPS		
	Louvred Cat. No.	Solid Cat. No.	Ship. Wt. Lb.	Panel Rail Cat. No.	Z Rail Cat. No.	Ship. Wt. Lb.	Cat. No.	Ship. Wt. Lb.	Cat. No.	Number of receptacles	Ship. Wt. Lb.
1469 A1,2	1469 A1L	1469 A1S	25	1469 AP	1469 AZ	11	◆1469 AGB	3	◆1469 AW	6	6
1469 B1,2	1469 B1L	1469 B1S	31	1469 BP	1469 BZ	14	◆1469 BGB	4	◆1469 BW	10	7
1469 C2	1469 C1L	1469 C1S	36	1469 CP	1469 CZ	16	◆1469 CGB	5	◆1469 CW	11	8
1469 E2	1469 E1L	1469 E1S	40	1469 EP	1469 EZ	19	◆1469 EGB	6	◆1469 EW	12	9
1469 C4	1469 C4L	1469 C4S	46	1469 CP	1469 CZ	16	◆1469 CGB	5	◆1469 CW	11	8
1469 E4	1469 E4L	1469 E4S	52	1469 EP	1469 EZ	19	◆1469 EGB	6	◆1469 EW	12	9
1469 F2	◆1469 F1L	◆1469 F1S	43	◆1469 FP	◆1469 FZ	20	◆1469 FGB	7	◆1469 FW	13	10
1469 F4	◆1469 F4L	◆1469 F4S	56	◆1469 FP	◆1469 FZ	20	◆1469 FGB	7	◆1469 FW	13	10

## ON SPECIAL ORDER — Refer to the factory

- Non standard sizes.
- Special paint or enamel finishes.
- Solid rear door only, identify by adding R to solid front door part number, e.g. 1469 A1SR.
- Special panel rails drilled and tapped to accept 10-24 or 12-24 screws.
- Special corner wedge units.
- Dress panels or doors punched as specified.

## ◆New Products

# TABLE & FLOOR CABINET RACKS

# HAMMOND

## TABLE & FLOOR CABINET RACKS — 1460 SERIES

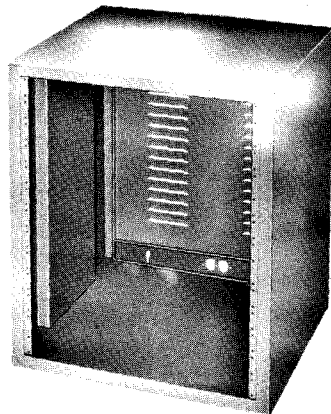

1460 D

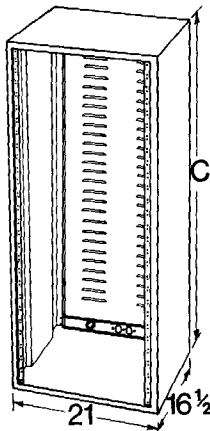

1460 R

- Modern economical design with angular appearance with solid top, from 18 ga. steel, suitable for 19" panel equipment.
- May be used as table or floor mounted cabinets in a modular arrangement or as individual housings.
- Two fixed vertical panel rails recessed ( $\frac{5}{16}$ " ) tapped 10-32 on standard EIA  $\frac{1}{2}$ - $1\frac{1}{4}$ " spacings.
- Louvred rear door with flush keyed lock on all models except 1460 B, C & D which have removable rear panels attached with self-tapping screws.
- Removable  $1\frac{3}{4}$ " bottom rear connection panel with one  $\frac{1}{2}$ - $\frac{3}{4}$ " knockout for conduit or cable installation, punched to accept one duplex receptacle and one strain relief bushing.
- Standard ASA 61 grey baked enamel finish.
- Refer to the following pages for general accessories.
- Ask for bulletin 1460.

### ON SPECIAL ORDER

- Cabinets to accept 24" panels — specify 1460 C24 etc.
- Mounting rails tapped for 10-24 or 12-24 screws.
- Custom finishes as specified.

Cat. No.	Height C	Panel Space	Ship Wt. Lb.	Cat. No.	Height C	Panel Space	Ship Wt. Lb.
◆1460 B†	10 $\frac{3}{4}$	8 $\frac{3}{4}$	25	◆1460 K	42 $\frac{1}{4}$	40 $\frac{1}{4}$	67
◆1460 C†	12 $\frac{1}{2}$	10 $\frac{1}{2}$	28	◆1460 M	49 $\frac{1}{4}$	47 $\frac{1}{4}$	75
◆1460 D	16	14	35	◆1460 P	56 $\frac{1}{4}$	54 $\frac{1}{4}$	85
◆1460 F	24 $\frac{3}{4}$	22 $\frac{3}{4}$	47	◆1460 R*	63 $\frac{1}{4}$	61 $\frac{1}{4}$	130
◆1460 H	30	28	54	◆1460 T*	72	70	146
◆1460 J	35 $\frac{1}{4}$	33 $\frac{1}{4}$	58	◆1460 V*	82 $\frac{1}{2}$	80 $\frac{1}{2}$	160

\* Same vertical panel space as the inactive 1462 series.

† These models do not have side stiffeners.

## TABLE CABINET RACKS — 1461 SERIES

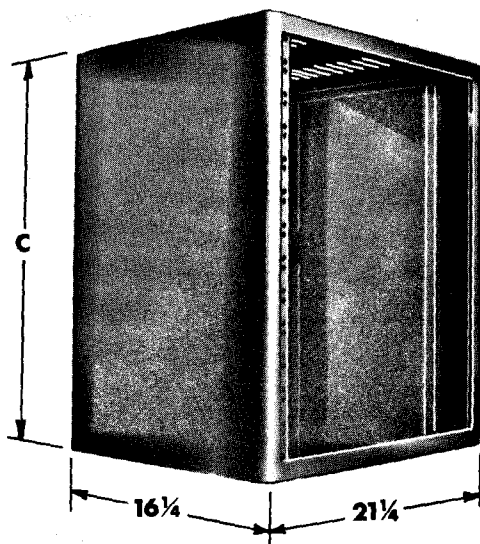

- Versatile, sturdily constructed cabinets with radius corners on front from 18 ga. steel for mounting 19" panels.
- Recessed panel rails punched and tapped for 10-32 screws on standard EIA  $\frac{1}{2}$ - $1\frac{1}{4}$ " spacings.
- Louvered top on all models.
- Louvered rear door on all models except B, C, & D which have removable rear panels, attached with self tapping screws.
- Removable  $1\frac{3}{4}$ " bottom rear connection panel with one  $\frac{1}{2}$ - $\frac{3}{4}$ " knockout for conduit or cable installation, punched to accept one duplex receptacle and one strain relief bushing.
- Standard ASA 61 grey baked enamel finish.
- For general accessories refer to the following pages of this catalogue.

Cat. No.	C	Panel Space	Chassis Brackets (Pairs)	Ship. Wt. Lb.	Cat. No.	C	Panel Space	Chassis Brackets (Pairs)	Ship. Wt. Lb.
1461 B†	10 $\frac{3}{4}$	8 $\frac{3}{4}$	Nil	25	1461 J	35 $\frac{1}{4}$	33 $\frac{1}{4}$	3	58
1461 C†	12 $\frac{1}{2}$	10 $\frac{1}{2}$	Nil	28	1461 K	42 $\frac{1}{4}$	40 $\frac{1}{4}$	4	67
1461 D	16	14	1	35	1461 M	49 $\frac{1}{4}$	47 $\frac{1}{4}$	4	75
1461 F	24 $\frac{3}{4}$	22 $\frac{3}{4}$	2	47	1461 P	56 $\frac{1}{4}$	54 $\frac{1}{4}$	4	85
1461 H	30	28	2	54					

† These models do not have side stiffeners.

### ON SPECIAL ORDER

- Cabinets to accept 24" panels — specify 1461 C24 etc.
- Mounting rails tapped for 10-24 or 12-24 screws.
- Custom finishes as specified.

### ◆ New Products

Special designs of these series produced quickly to your specifications.

# HAMMOND

# STORAGE CABINETS 'SWING-OUT' WALL CABINETS

## INDUSTRIAL STORAGE CABINETS — 1483 SERIES

- General purpose industrial storage cabinets available in single or double door models.
- Rugged construction ideally suited for industrial tool and instrument storage.
- Locking doors protect industrial and educational papers or laboratory standards.
- Suitable for storing valuable electronic components.
- May be used as an economical Type 1 electronic or electrical cubicle.
- Provides a convenient enclosure for loosely integrated subsystems in prototypes or production applications.
- Standard ASA 61 grey baked enamel finish.
- Modern 1427 W locking handle supplied on single door models, 1427 W and 1427 X on two door models.
- Adjustable shelves within full height of the cabinet.
- Concealed pin hinge top and bottom allows doors to be removed.
- Doors swing approximately 90°.
- Basic cabinet is all welded construction from 16 gauge steel.
- Additional formed shelves available as an optional supply item—see table.
- Ask for Bulletin 1483.

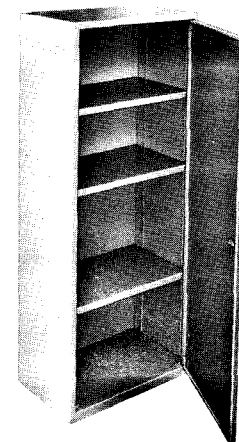

Single Door

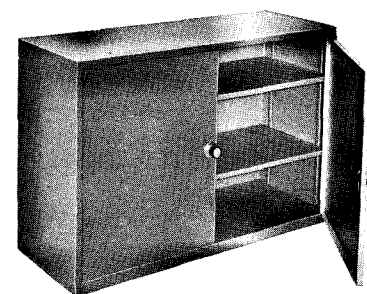

Double Door

### CABINETS

Cat. No.	Dimensions			No. of Shelves Included	No. of Doors	Ship. Wt. Lb.	OPTIONAL ADDITIONAL SHELVES	
	H	W	D				Cat. No.	Ship. Wt. Lb.
◆1483 C5	30	42	15	2	2	115	◆1483 S5	12
◆1483 C6	30	48	15	2	2	130	◆1483 S6	13
◆1483 F2	48	24	15	2	1	100	◆1483 S2	7
◆1483 H2	60	24	15	3	1	130	◆1483 S2	7
◆1483 K3	72	30	15	4	1	170	◆1483 S3	9

## 'SWING-OUT' WALL CABINETS — 1484 SERIES

- Totally enclosed wall mounting rack cabinet suitable for industrial electronics, telecommunication, closed circuit TV and sound systems, and similar applications.
- Hinged 1½" deep, 14 gauge steel, rear door-panel allows cabinet to be wall hung yet provide access to rear wiring or equipment area. (Mounting holes within width and height of cabinet.)
- Rear panel has two 4" x 10" cutouts with cover plates near the top and bottom as a convenience for electrical or other wiring installations.
- All welded 16 gauge steel cabinet finished in standard ASA 61 grey baked enamel.
- Swinging front door (optional) with automotive locking handle (1427 A) covers captive slotted screws preventing access to rear compartment unless front door is opened.
- Ventilating louvres top and bottom for convection cooling.
- One pair of vertical panel rails, drilled and tapped for 10-32 screws, on standard EIA rack spacing of ½-1¼" are fully adjustable front to back on 2 horizontal amhal struts.
- Ask for Bulletin 1484.

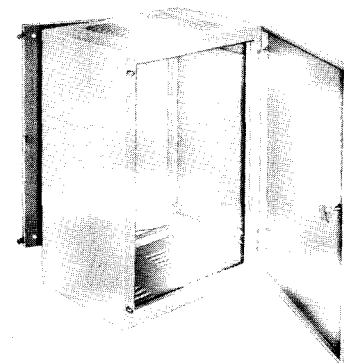

1484 G with 1484 GS optional front door.

### OPTIONAL ACCESSORIES

- Solid front or rear door with hinges and bright chrome locking handle (1427 A).
- Kickbase 3" high with mounting hardware has open back to allow complete ventilation through the bottom. Order as 1484 MF3 — suitable for all models.

### CABINETS

### OPTIONAL ACCESSORIES

Cat. No.	Height C	Panel Space E	Max. Load Limit	Ship. Wt. Lb.	Hinged Front (rear) door	Ship. Wt. Lb.	EXTRA ADJUSTABLE RAILS			
							Panel	Ship. Wt. Lb.	Z	Ship. Wt. Lb.
◆1484 D	26¼	22¾	120 lb.	70	◆1484 DS	16	◆1484 DP	6	◆1484 DZ	6
◆1484 G	31½	28	130 lb.	80	◆1484 GS	20	◆1484 GP	7	◆1484 GZ	7
◆1484 L	40¼	36¾	140 lb.	100	◆1484 LS	26	◆1484 LP	8	◆1484 LZ	8

Overall Cabinet Dimensions: 22½" wide, 18" deep (not including front door), cabinet depth only — 16".

Special designs of these series produced quickly to your specifications.

◆ New Product



# HAMMOND

# RELAY RACKS

## RELAY RACKS - GENERAL FEATURES

- Light or heavy weight racks for floor or table use allowing maximum access to panel mounted equipment or instruments.
- Designed for use with light electronic or electrical equipment or for heavy duty industrial or commercial applications such as installations of radio, television, sound or test equipment.
- Standard finish ASA 61 grey enamel.
- Mounting rails drilled and tapped 10-32 to standard EIA 1/2-1 1/4 spacings for 19" panels (front of rail only).
- Front or rear mounted dust covers available for most 1466, 1467 series. See 1468 series.
- For general accessories refer to the following pages of this catalogue.

### FLOOR RELAY RACK - 1467 SERIES

- This is a lighter weight version of the heavy duty 1466 series.
- Welded, formed, 12 gauge steel construction.
- Two 3/16" diameter holes on 16 3/4" centres located midway between front and rear.
- Ask for bulletin 1467 for further design data.

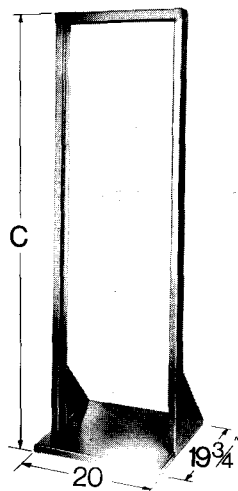

Cat. No.	Overall Height C	Panel Space	Ship. Wt. Lb.
1467 A	49 7/8	47 5/8	35
1467 B	58 5/8	56 1/8	38
1467 D	65 5/8	63 1/8	41
1467 F	72 5/8	70 1/8	42
1467 H	79 5/8	77 1/8	45

### ON SPECIAL ORDER - All rack series.

- 1466 or 1467 racks designed to accept 24" panels, specify as 1466 H24 or 1467 H24, etc.
- Special height and paint finishes to specifications.
- Mounting rails drilled and tapped for 10-24 or 12-24 screws.
- Rails drilled and tapped front and back to EIA-RETMA standards.

### FLOOR RELAY RACKS

#### - 1466 and 1476 SERIES

- 3" heavy duty channel and angle iron arc welded construction.
- Two 4 x 6 x 3/8" angle base drilled for 3/4" diameter deck bolts or lag screws
- Ask for bulletin 1466 for further design data.

Cat. No.	Overall Height C	Panel Space	Ship. Wt. Lb.
----------	------------------	-------------	---------------

#### 19" Panels

1466 D	69 1/8"	63"	95
1466 F	76 1/8"	70"	100
1466 H	83 1/8"	77"	105
◆1466 K	90 1/8"	84"	110
◆1466 M	107 5/8"	101 1/2"	120
◆1466 P	137 3/8"	131 1/4"	140

#### 23" Panels - Telephone Standard

◆1476 F	76 1/8"	70"	110
◆1476 H	83 1/8"	77"	115
◆1476 K	90 1/8"	84"	120
◆1476 M	107 5/8"	101 1/2"	130
◆1476 P	137 3/8"	131 1/4"	150

#### NOTE-

23" racks drilled and tapped 10-32 to standard EIA 1/2-1 1/4 spacings (front of rail only).

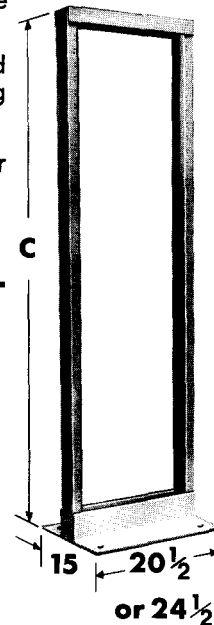

### TABLE RELAY RACKS - 1465 SERIES

- Welded formed 18 gauge light weight steel construction for desk or table mounting.
- Deep bases with four rubber feet provide maximum stability and freedom from slippage.
- Ask for bulletin 1465.

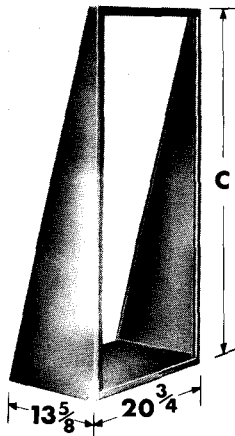

Cat. No.	Overall Height C	Panel Space	Ship. Wt. Lb.
1465 B	23	21	13
1465 C	30	28	17
1465 E	37	35	23
1465 G	44	42	30

### RACK DUST COVER - 1468 SERIES

- To protect rack mounted electronic or electrical apparatus.
- For use with 1466 or 1467 racks.
- Two convenient lifting handles.
- Front or rear mounting.
- Lift off design is readily removed.
- Formed 18 gauge steel—standard ASA 61 grey baked enamel finish.
- Open bottom and top louvres for ventilation.

Cat. No.	Rack Space Covered "C"	Use with these racks or larger	Ship. Wt. Lb.
1468 Q	57 5/8	1467 B	35
1468 S	64 5/8	1466 D or 1467 D	40
1468 V	71 5/8	1466 F or 1467 F	45
1468 X	78 5/8	1466 H or 1467 H	50

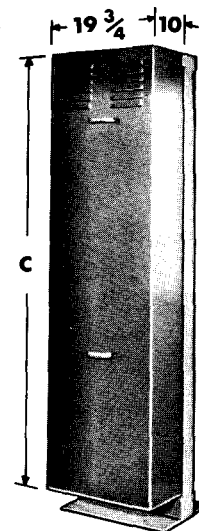

#### ◆ New Products

Special designs of these series produced quickly to your specifications.

# PRINTED CIRCUIT CARD RACK

# HAMMOND

## 1499 SERIES

The 1499 system is designed for heavy duty p.c. card service in the industrial and communication field. When installed in companion racks or cabinets such as the 1428, 1459, 1460, 1463 or 1469 from other sections of this catalogue, p.c. designs emerge with a professional and neat appearance.

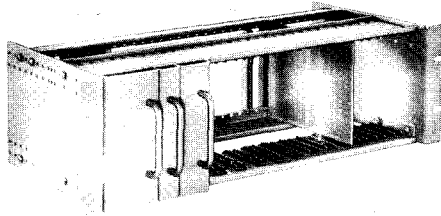

- From formed 16 & 14 ga. steel, ASA 61 grey baked enamel finish for industrial service in 19" racks to EIA/RETMA panel standards.
- Each model is assembled and ready to accept most popular p.c. connectors and cards with minimum of effort.
- Front guide accepts p.c. cards from 1/2" to 3/2" without modification—32 supplied.
- Card spacing minimum of 1/2" — 32 usable positions.
- Attractive card and chassis panels with handles are available.
- Front p.c. card guides are easily snapped in place and provide some side grip for positive card insertion.

- Connector mounting and guide rails adjustable so that system can be totally enclosed.
- Front upper and lower guide plates form a base for card identification strips and panel stop.

## CAGE (STEEL) — 19" RACK MOUNTING — 5 1/4" panel space — two standard depths

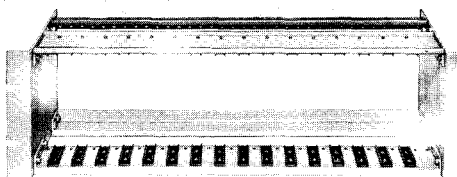

Cat. No.	Nominal P.C. card		P.C. Card Range		Panel Height	Cage Depth	Wt. Ship.
	H	D	H	D*			
◆1499 C5	4 1/2	6 1/2	3 1/2 & 4 1/2	4 1/2 - 7 1/2	5 1/4	8	5.5
◆1499 E5	4 1/2	10 1/2	3 1/2 & 4 1/2	7 1/2 - 11 1/2	5 1/4	12	7.5

— Aluminum side plates available; order as ◆1499 C5AL.

\* 1/2" increments.

## OPTIONAL ACCESSORIES — Suitable for cages using 5 1/4" panel space

### FORMED FRONT DRESS PANEL



- From 20 ga. steel
- For use with chassis (e.g. 1499 W56) or as a "card puller"
- Supplied with 1427 P chrome plated pull handles
- For p.c. card height from 3 1/2 to 4 1/2"

Cat. No.	Nominal Width	Actual Width	Track Pos. Used	Ship. Wt.
◆1499 P52	1	1 5/16	2	3 oz.
◆1499 P53	1 1/2	1 7/16	3	3.5 oz.
◆1499 P55	2 1/2	2 3/16	5	5 oz.
◆1499 P57	3 1/2	3 3/16	7	6.5 oz.
◆1499 P59	4 1/2	4 1/4	9	8 oz.

### CHASSIS



- Formed .051" Aluminum, drilled to accept p.c. male plug.
- For use with formed front dress panel 1499 P series.

Cat. No.	Nominal Depth	Usable Depth	Card Height	Nominal Width	Actual Width	Track Pos.	Ship. Wt. Lb.
◆1499 W56	6 1/2	5 1/4	4 1/2	1 1/2	1 1/8	3	.5
◆1499 W57	7 1/2	6 1/4	4 1/2	1 1/2	1 1/8	3	.75
◆1499 W510	10 1/2	9 1/4	4 1/2	1 1/2	1 1/8	3	1.00

**FRONT UNITRACK — ◆1499 T2 — 36 per pkg.** • From moulded Polycarbonate plastic.  
(Ambient temperature range from -60°F to + 280°F)

**TOP AND BOTTOM SHIELD/DUST COVER — (20 ga. Steel) — ◆1499 S8 — Pair for 8" Deep Cage** Ship Wt. 3.25  
◆1499 S12 — Pair for 12" Deep Cage Ship Wt. 4.75

### NOTES

- These stock cages are suitable for many popular card sizes. However, if your requirements are beyond the scope of our present models, we would be pleased to quote to your specifications.
- Designs suitable for 24" rack mounting are available on special order basis.
- "Piggy Back" arrangements with common side frames available on special order.
- Stacking plates are also possible.

◆ New Product

# HAMMOND

# VENTILATING BLOWERS & PANELS

## INTAKE AND EXHAUST BLOWERS — 1475 series

- Uses a tangential fan noted for its unusual **low noise** level and minimum vibration.
- Both motor and impeller bearings can withstand ambient temperature up to 100°C and are adequately oiled for up to 5000 hours.
- Under normal operating conditions, with regular maintenance, a motor and impeller bearing life in excess of 30,000 hours can be expected.
- The blower housing is constructed of 14 gauge steel sides and 18 gauge steel top and bottom.
- For standard EIA 19" rack mounting requiring 5¼" panel space.
- Steel bar grill with piano hinge to provide easy access to the filter and fan for regular maintenance.
- Finished in ASA 61 grey baked enamel.
- Appearance is compatible with **9-175 G** and **9-350 G** baffle panels.
- Operates on 120 volts AC, 60 Hertz at 0.63 amperes (free air).
- Three-wire line cord and SPST toggle switch supplied loose.
- Ask for bulletin 1475.

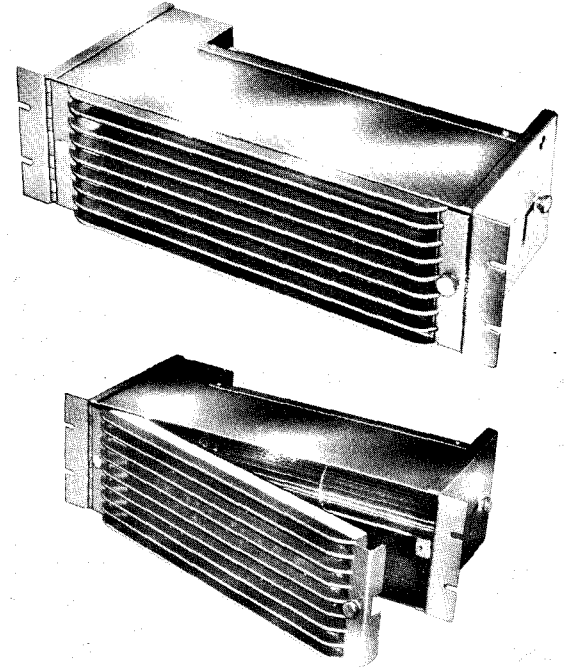

## INTAKE BLOWER — ♦ 1475 C

- Supplied with a completely washable aluminum filter.
- May be adjusted to one of seven different positions by means of three thumb screws and repositioning the deflector plate.
- Provides up to 120 cfm.
- Ship Wt. 14.6 lb.

## EXHAUST BLOWER — ♦ 1475 H

- No filter supplied.
- Motor and impeller mounted in one fixed position.
- Provides up to 190 cfm.
- Ship Wt. 14.0 lb.

## FILTER — ♦ 1475 R

- Aluminum filter completely washable.
- Replacement filter for 1475 C blower only.

## FILTER COAT — ♦ 1475 Q

- 1 pint, pressurized container.
- Provides an adhesive with grease-like consistency, which absorbs and traps dust particles.
- Shipping weight — 1.2 lb.

## ECONOMICAL VENTILATING PANELS

- 14 gauge 19" steel panel notched to EIA ½"-1¼" standard.
- Punched with 39 1 x ¼" slots per row.
- Finished in standard ASA 61 grey baked enamel.

STEEL	ALUMINUM			
Cat. No.	Cat. No.	Panel Height	Rows of Slots	Ship. Wt. Lb.
♦5-175 VS	♦7-175 VA	1¾	1	1.0
♦5-350 VS	♦7-350 VA	3½	2	1.5

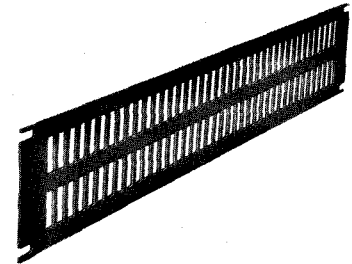

## FUNCTIONAL VENTILATING PANELS

- An economical yet efficient method of ventilating equipment cabinets.
- Formed 16 gauge steel panels notched to standard EIA ½"-1¼" spacings to mount in any 19" Hammond cabinet.
- Punched with three rows of standard 4" louvers.
- Two models — with louvers punched inwards.
- — with louvers protruding outwards..
- Standard ASA 61 grey baked enamel finish.

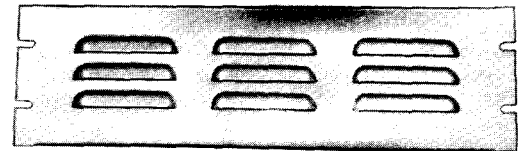

Cat. No. **5-525 VT** For louvers inwards. Ship. Wt. 2¼ lb.  
 Cat. No. **5-525 VB** For louvers outwards. Ship. Wt. 2¼ lb.

## VENTILATED BAFFLE PANELS

- A modern distinctive method of ventilating equipment cabinets.
- Steel bar grills is finished in either bright chrome or ASA 61 grey baked enamel finish.
- Rear sloping aluminum baffle for directing air flow has a bright natural finish on bottom for reflecting heat and dull black on top for absorbing heat.
- Unit has an overall depth of 13⅞" with flanges notched to standard EIA ½"-1¼" spacings.

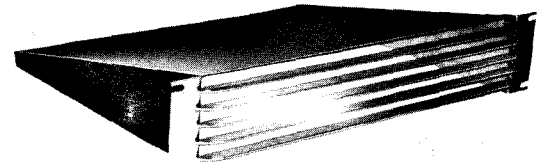

Chrome	ASA 61 Grey	Height	Ship. Wt.
Cat. No.	Cat. No.		Lb.
<b>9-175 C</b>	<b>9-175 G</b>	1¾	2½
<b>9-350 C</b>	<b>9-350 G</b>	3½	4

## ON SPECIAL ORDER

— Grey Hammerlin finish for matching purposes or special paint finishes to your specifications.

# CABINET & CONSOLE ACCESSORIES

# HAMMOND

## TURN-TABLE DRAWER

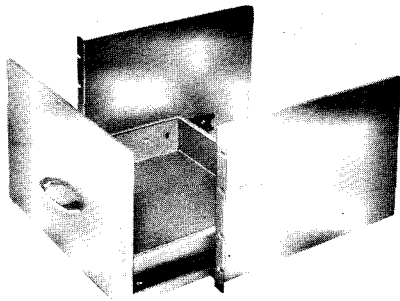

- Requires 10½" panel space for use in modular or self contained racks or consoles with standard 19" or 24" mounting rails.
- Mounted in sturdy support cradle and supplied with plywood platform for mounting record changer, or electronic components.
- Formed steel drawer slides with 11" of travel; handle (1427 H page 58).
- Standard ASA 61 grey baked enamel finish.
- Ask for bulletin 1409 A.

Cat. No.	Overall Dimensions			Drawer Dimensions			Ship. Wt. Lb.
	W	D	H	W	D	H	
<b>1409 A19</b>	19	15½	10½	15¾	14	3	30
◆ <b>1409 A24</b>	24	15½	10½	20¾	14	3	40

**ON SPECIAL ORDER** — Dust cover for 1409 A19 or 1409 A24 — order with suffix D (e.g. 1409 A19D).  
 — Drawer with flush keyed lock (1427 B) — order with suffix L (e.g. 1409 A19L).

## UTILITY DRAWER

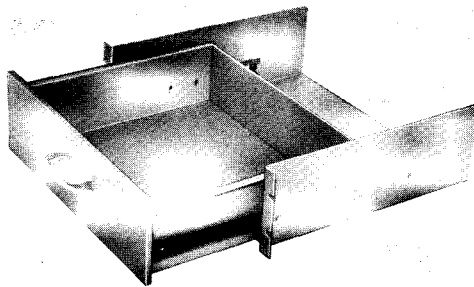

- Requires either 5¼ or 10½" panel space for use in modular or self contained racks or consoles with standard 19" mounting rails.
- Mounted in sturdy support cradle.
- Formed steel drawer slides.
- Attractive brushed chrome handle (1427 H page 58).
- Standard ASA 61 grey baked enamel finish.
- Ask for bulletin 1409 B.

Cat. No.	Overall Dimensions			Drawer Dimensions			Drawer Travel	Ship. Wt. Lb.
	W	D	H	W	D	H		
<b>1409 B19</b>	19	15½	5¼	15⅙	14	3⅝	11	23
◆ <b>1409 B24</b>	24	15½	5¼	20⅙	14	3⅝	11	27
◆ <b>1409 C19</b>	19	22½	5¼	15⅙	22½	3⅝	21	31
◆ <b>1409 C24</b>	24	22½	5¼	20⅙	22½	3⅝	21	35
<b>1409 F19</b>	19	15½	10½	15⅙	14½	9	13	32
◆ <b>1409 F24</b>	24	15½	10½	20⅙	14½	9	13	43
<b>1409 G19</b>	19	22½	10½	15⅙	22½	9	21	50
◆ <b>1409 G24</b>	24	22½	10½	20⅙	22½	9	21	53

## WRITING SHELF AND UTILITY DRAWER

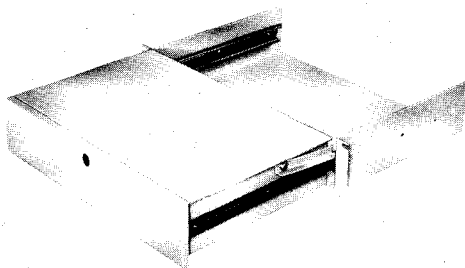

- Versatile writing shelf and utility drawer for use with modular or self-contained consoles, relay and cabinet racks with 19" or 24" panel rails.
- Writing surface hinged to provide access to drawer while acting as a dust cover.
- Centrally located finger hole.
- Formed steel spot welded construction.
- 14 gauge cradle requires 3½" panel space.
- Drawer slides lock firmly in position when fully extended providing a working area of 10¼" x 16¾" (1409 S19) and 10¼" x 21¾" (1409 S24).
- Standard ASA 61 grey baked enamel finish.

Cat. No. ◆**1409 S19** Overall Dim. 19 x 15½ x 3½ H, Ship. wt. 19 lb.

Cat. No. ◆**1409 S24** Overall Dim. 24 x 15½ x 3½ H, Ship. wt. 21 lb.

## EQUIPMENT SHELF

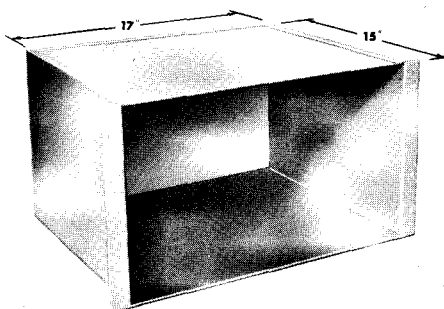

- Designed as equipment shelves to support electronic or electrical test equipment such as voltmeters, signal generators, etc.
- Formed from 18 gauge spot welded steel for standard 19" rails.
- Two 1½" diameter holes at rear, ¾" from bottom, 2½" from each side for power line cords or other wiring.
- Standard ASA 61 grey baked enamel finish.

Cat. No. 19" Models	Panel Height	Ship. Wt. Lb.	Cat. No. 24" Models	Panel Height	Ship. Wt. Lb.
<b>1409 T19</b>	8¾	17	◆ <b>1409 T24</b>	8¾	23
<b>1409 V19</b>	10½	18	◆ <b>1409 V24</b>	10½	24
<b>1409 X19</b>	12¼	21	◆ <b>1409 X24</b>	12¼	26

### ◆ New Products

Special designs of this series produced quickly to your specifications.



# HAMMOND

# RACK PANELS

## STEEL AND ALUMINUM PANELS 19" and 24" wide.

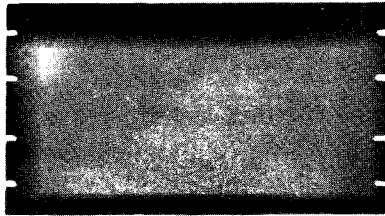

- 14 gauge (.0747) steel or 1/8" 65S-T6 aluminum alloy (except paper covered panels).
- Suitable for electronic or electrical equipment functions.
- All panels slotted to standard EIA 1/2 - 1 1/4 spacings for 19 or 24" mounting rails in racks, cabinets, and consoles.
- Standard ASA 61 grey baked enamel finish.
- Paper covered aluminum panels are natural mill finish.

### STEEL PANELS

### ALUMINUM PANELS

Panel Height	19" width		24" width		19" width		24" width	
	Cat. No.	Ship. Wt. Lb.	Cat. No.	Ship. Wt. Lb.	Cat. No.	◆Paper Covered Ship. Wt. Lb.	Cat. No.	Ship. Wt. Lb.
1 3/4	5-175	1	2-175	1 1/4	7-175	◆7P 175 1/2	3-175	1
3 1/2	5-350	1 1/2	2-350	2	7-350	◆7P 350 1	3-350	1 1/4
5 1/4	5-525	2 1/4	2-525	3	7-525	◆7P 525 1 1/2	3-525	1 3/4
7	5-700	2 3/4	2-700	3 1/2	7-700	◆7P 700 1 3/4	3-700	2 1/4
8 3/4	5-875	3 3/4	2-875	4 3/4	7-875	◆7P 875 2 1/4	3-875	2 3/4
10 1/2	5-1050	4 1/4	2-1050	5 1/4	7-1050	◆7P 1050 2 3/4	3-1050	3 1/4
12 1/4	5-1225	5	2-1225	6 1/4	7-1225	◆7P 1225 3	3-1225	3 3/4
14	5-1400	5 3/4	2-1400	7 1/4	7-1400	◆7P 1400 3 1/2	3-1400	4 1/2
15 3/4	5-1575	6 1/2	2-1575	8 1/4	7-1575	◆7P 1575 4	3-1575	5
17 1/2	5-1750	7 1/4	2-1750	9 1/4	7-1750	◆7P 1750 4 1/2	3-1750	5 3/4
19 1/4	5-1925	8	2-1925	10	7-1925	◆7P 1925 5	3-1925	6 1/2
21	5-2100	8 3/4	2-2100	11	7-2100	◆7P 2100 5 1/4	3-2100	7 1/4
22 3/4	5-2275	9 1/2	2-2275	12	7-2275	◆7P 2275 5 1/2	3-2275	8
24 1/2	◆5-2450	10	◆2-2450	13				
26 1/4	◆5-2625	11	◆2-2625	14				

Note — Paper covered panels are not painted.

## FORMED STEEL PANELS

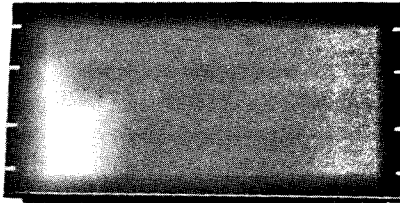

- Complements the series of flat panels by providing a line with 1/2" folded flange top and bottom edges for additional rigidity.
- Slotted to standard EIA 1/2 - 1 1/4 spacing for 19" mounting rails.
- Made of 16 gauge (.060) steel. • Standard ASA 61 grey baked enamel finish.

Panel Height	Cat. No.	Ship. Wt. Lb.	Panel Height	Cat. No.	Ship. Wt. Lb.	Panel Height	Cat. No.	Ship. Wt. Lb.
1 3/4	5-175 F	3/4	8 3/4	5-875 F	3	15 3/4	5-1575 F	5 1/4
3 1/2	5-350 F	1 1/4	10 1/2	5-1050 F	3 1/2	17 1/2	5-1750 F	5 3/4
5 1/4	5-525 F	1 3/4	12 1/4	5-1225 F	4	19 1/4	5-1925 F	6 1/2
7	5-700 F	2 1/2	14	5-1400 F	4 3/4	21	5-2100 F	7

### ON SPECIAL ORDER

- Panels with alternate oval holes in place of slots.
- Formed panels available for 24" mounting rails — order with prefix 2 (e.g. 2-350 F).
- Panels modified with punching and brackets to accept tape recorders, meters and other recording instruments.
- Panels for 23" rack mounting available — specify by description.
- Grey hammerlin finish for matching purposes or special paint finishes to your specifications.

## PANEL ADAPTORS

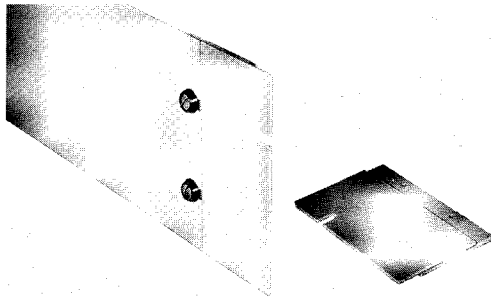

- Suitable for adapting 14 ga. steel or 1/8" aluminum 19" panel equipment to 24" rack mounting.
- Panel mounting holes drilled and tapped for 10-32 screws on standard EIA spacings.
- Finished in ASA 61 grey baked enamel.

Panel Height	For Steel Panels		For Alum. Panels		Panel Height	For Steel Panels		For Alum. Panels	
	Cat. No.	Ship. Wt. Lb.	Cat. No.	Ship. Wt. Lb.		Cat. No.	Ship. Wt. Lb.	Cat. No.	Ship. Wt. Lb.
1 3/4	◆2-175 A	3/4	◆3-175 A	1/2	8 3/4	◆2-875 A	2 1/2	◆3-875 A	1 3/4
3 1/2	◆2-350 A	1 1/4	◆3-350 A	3/4	10 1/2	◆2-1050 A	3	◆3-150 A	2
5 1/4	◆2-525 A	1 1/2	◆3-525 A	1	12 1/4	◆2-1225 A	3 1/2	◆3-1225 A	2 1/4
7	◆2-700 A	2	◆3-700 A	1 1/4	14	◆2-1400 A	4	◆3-1400 A	2 3/4

## SWITCH PANELS

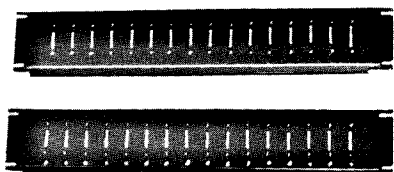

- Two models with 16 slots (1 x 5/32") at 1" centres for roller switches or for switches and pilot lights. Mounting holes 5/32" dia. 1 5/8" cts.
  - Made of 16 gauge steel, 3 1/2" high, with folded top and bottom edges.
  - Slotted to standard EIA 1/2 - 1 1/4 spacing for 19" mounting rails.
  - Standard ASA 61 grey baked enamel finish.
- Cat. No. **5-350 SW** — for switches only. Ship. Wt. 1.25 lb.  
 Cat. No. **5-350 SWL** — with 5/16" pilot light holes. Ship. Wt. 1.25 lb.

◆ New Product

# SPECIAL RACK & CHASSIS PANELS

# HAMMOND

## ACCESS DOOR RACK PANEL

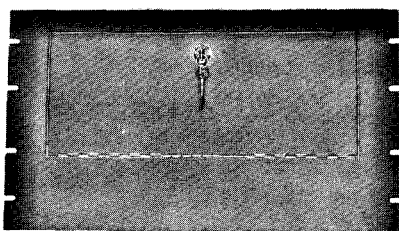

- Designed to allow immediate access to controls, tubes, transistors, relays, or to make minor adjustments, yet prevent unauthorized entry.
  - Supplied with sufficient space below door to mount a standard chassis to the panel.
  - Made from 14 gauge steel on standard 19" widths and 10½" high with standard EIA ½"-1¼" notchings.
  - Continuous hinged 15" x 6" door is spaced 3½" from bottom.
  - Supplied with flush keyed lock and two keys.
  - Standard ASA 61 grey baked enamel finish.
- Cat. No. **5-1050 DS** Ship. Wt. 5 Lb.

## SPEAKER PANELS

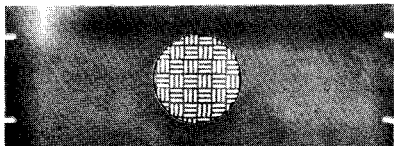

- 14 gauge 19" steel panel notched to standard EIA ½"-1¼" spacings.
- Openings for 5" and 8" speakers covered with steel grille.
- Standard ASA 61 grey baked enamel finish.

Cat. No.	Height	Speaker Size	Ship. Wt. Lb.
<b>5-700 S</b>	7"	5"	2½
<b>5-1050 S</b>	10½"	8"	3½

## DEPRESSED CHASSIS PANELS

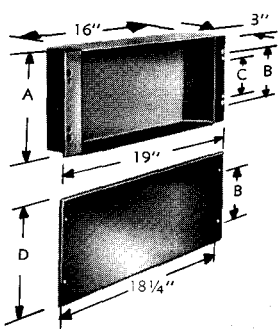

- Chassis unit and panel made from 14 gauge steel.
- A convenient method of mounting key equipment or rack mounted amplifiers, etc.
- Screws supplied for mounting chassis unit to panel rails.
- Standard ASA 61 grey baked enamel finish.

Cat. No.	A	B	C	D	Ship. Wt. Lb.
<b>5-350 D</b>	3 <sup>3</sup> / <sub>16</sub>	*	*	3 <sup>15</sup> / <sub>32</sub>	5
<b>5-525 D</b>	4 <sup>15</sup> / <sub>16</sub>	2¼	1¼	5 <sup>7</sup> / <sub>32</sub>	6½
<b>5-700 D</b>	6 <sup>11</sup> / <sub>16</sub>	4	3	6 <sup>31</sup> / <sub>32</sub>	8
<b>5-875 D</b>	8 <sup>7</sup> / <sub>16</sub>	5¾	4¾	8 <sup>23</sup> / <sub>32</sub>	9
<b>5-1050 D</b>	10 <sup>3</sup> / <sub>16</sub>	7½	6½	10 <sup>15</sup> / <sub>32</sub>	11
<b>5-1225 D</b>	11 <sup>15</sup> / <sub>16</sub>	9¼	8¼	12 <sup>7</sup> / <sub>32</sub>	13
<b>5-1400 D</b>	13 <sup>11</sup> / <sub>16</sub>	11	10	13 <sup>31</sup> / <sub>32</sub>	14

## ALUMINUM CHASSIS PANELS

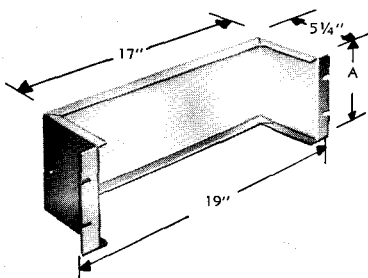

- Designed to complement the depressed chassis panels.
- Formed from .064 half hard aluminum.
- Front flanges are notched on standard EIA ½ - 1¼ spacings for cabinet or rack mounting.
- Supplied in natural finish.

Cat. No.	A (Height)	Ship. Wt. Lb.	Cat. No.	A (Height)	Ship. Wt. Lb.
<b>7-350 D</b>	3½	1¼	<b>7-1050 D</b>	10½	2¾
<b>7-525 D</b>	5¼	1½	<b>7-1225 D</b>	12¼	3
<b>7-700 D</b>	7	2	<b>7-1400 D</b>	14	3¼
<b>7-875 D</b>	8¾	2¼			

## UTILITY ALUMINUM PANELS

- From ¼" aluminum — for other than rack mounting.
- For use as baffles, plates, sub panels, etc.
- Not punched and have natural finish.

Cat. No.	Height	Length	Ship. Wt. Lb.
<b>8-690</b>	6"	9"	½
<b>8-710</b>	7"	10"	½
<b>8-812</b>	8"	12"	¾
<b>8-1017</b>	10"	17"	1¼

## HEAVY DUTY CHASSIS TRAYS

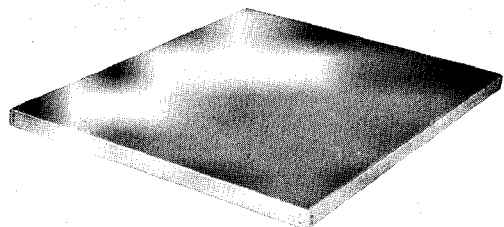

- Ideally suited for surface mounting and wiring applications.
- Shallow 1" height reduces overall height of equipment when under-chassis wiring is not required.
- Formed 14 or 16 ga. steel finished in ASA 61 grey baked enamel and .064" or .080" aluminum in natural finish.

STEEL CHASSIS			ALUMINUM CHASSIS			Dimensions		
Cat. No.	Ga.	Ship. Wt. Lb.	Cat. No.	Ga.	Ship. Wt. Lb.	L	W	H
<b>◆1440-15 S</b>	16	2.0	<b>◆1440-15 A</b>	.064	1.0	10	6	1
<b>◆1440-22 S</b>	16	2.5	<b>◆1440-22 A</b>	.064	1.5	12	8	1
<b>◆1440-30 S</b>	14	5.0	<b>◆1440-30 A</b>	.080	2.5	17	10	1
<b>◆1440-34 S</b>	14	6.0	<b>◆1440-34 A</b>	.080	3.0	17	12	1
<b>◆1440-38 S</b>	14	7.0	<b>◆1440-38 A</b>	.080	3.5	17	14	1

# HAMMOND

# CHASSIS & PLATES

## STEEL AND ALUMINUM CHASSIS

- Spotwelded construction for heavy duty service.
- Bottom edges flanged inwards providing added strength and a fastening surface for bottom.
- Steel chassis finished in ASA 61 grey baked enamel or bright zinc.
- Aluminum chassis available in natural or ASA 61 grey baked enamel finish.

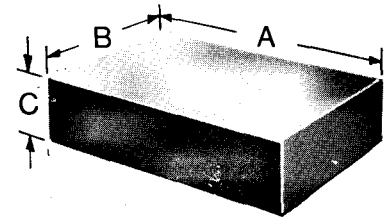
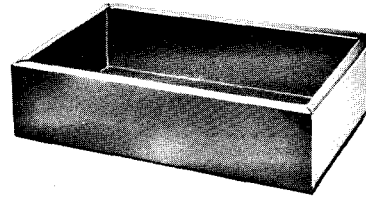

STEEL CHASSIS				ALUMINUM CHASSIS				DIMENSIONS		
ASA 61 Grey	Bright Zinc	Steel Gauge	Ship. Wt. Lb.	ASA 61 Grey	Natural	Alum. Gauge	Ship. Wt. Lb.	A	B	C
1441-6	1442-6	20	3/4	1443-6	1444-6	18	1/2	4	4	2
1441-8	1442-8	20	3/4	1443-8	1444-8	18	1/2	6	4	2
1441-9	1442-9	20	3/4	1443-9	1444-9	18	1/2	8	4	1
1441-10	1442-10	20	1	1443-10	1444-10	18	1/2	8	4	2
1441-12	1442-12	20	1 1/4	1443-12	1444-12	18	1/2	7	5	2
1441-14	1442-14	20	1 1/2	1443-14	1444-14	18	1/2	9	5	2
1441-15	1442-15	20	1 1/2	1443-15	1444-15	18	1/2	10	6	1
1441-16	1442-16	20	1 3/4	1443-16	1444-16	18	3/4	10	6	2
1441-18	1442-18	20	1 3/4	1443-18	1444-18	18	3/4	13 1/2	5	2
1441-20	1442-20	20	2 1/2	1443-20	1444-20	18	1	17	4	3
1441-22	1442-22	20	2 1/2	1443-22	1444-22	16	1	12	8	2
1441-24	1442-24	20	3	1443-24	1444-24	16	1 1/2	12	8	3
1441-26	1442-26	20	3 1/4	1443-26	1444-26	16	1 1/2	16	8	2
1441-28	1442-28	20	3 1/2	1443-28	1444-28	16	1 3/4	16	8	3
1441-29	1442-29	20	3	1443-29	1444-29	16	1 1/2	12	10	2
1441-30	1442-30	20	3	1443-30	1444-30	16	1 3/4	17	10	2
1441-32	1442-32	20	4	1443-32	1444-32	16	2 1/4	17	10	3
◆1441-33	◆1442-33	20	4 1/4	◆1443-33	◆1444-33	16	2 1/2	17	10	4
1441-34	1442-34	18	4 1/2					17	12	2
1441-36	1442-36	18	5					17	12	3
1441-38	1442-38	18	6					17	14	3
1441-40	1442-40	18	7					17	14	4
1441-42	1442-42	16	8 1/2					17	14	5

## BOTTOM PLATES

STEEL				ALUMINUM			
ASA 61 Grey	Zinc	Size	Ship. Wt. Lb.	ASA 61 Grey	Natural	Size	Ship. Wt. Lb.
1431-6	1432-6	4 x 4	1/4	1433-6	1434-6	4 x 4	1/4
1431-8	1432-8	4 x 6	1/2	1433-8	1434-8	4 x 6	1/4
1431-10	1432-10	4 x 8	1/2	1433-10	1434-10	4 x 8	1/2
1431-12	1432-12	5 x 7	1/2	1433-12	1434-12	5 x 7	1/2
1431-14	1432-14	5 x 9	1/2	1433-14	1434-14	5 x 9	1/2
1431-16	1432-16	6 x 10	3/4	1433-16	1434-16	6 x 10	1/2
1431-18	1432-18	5 x 13 1/2	3/4	1433-18	1434-18	5 x 13 1/2	1/2
1431-20	1432-20	4 x 17	3/4	1433-20	1434-20	4 x 17	3/4
1431-22	1432-22	8 x 12	1	1433-22	1434-22	8 x 12	3/4
1431-26	1432-26	8 x 16	1 1/2	1433-26	1434-26	8 x 16	3/4
1431-29	1432-29	10 x 12	1 1/4	1433-29	1434-29	10 x 12	3/4
1431-30	1432-30	10 x 17	1	1433-30	1434-30	10 x 17	3/4
1431-34	1432-34	12 x 17	2				
1431-38	1432-38	14 x 17	2 1/2				

- To protect users from electrical shock.
- To provide shielding and prevent damage to component parts.
- Finishes supplied the same as on above chassis.

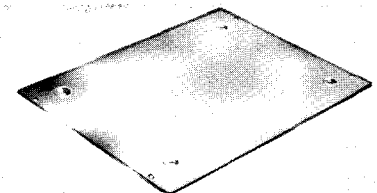

## VENTILATED CHASSIS COVERS

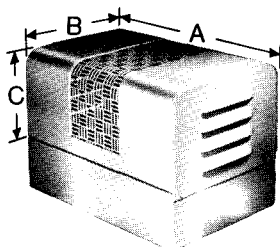

- Attractive, modern chassis covers provide good ventilation and protection to electronic assemblies.
- Spotwelded steel construction.
- For use with 1441 and 1443 series chassis.
- Standard ASA 61 grey baked enamel finish.

Cat. No.	A	B	C	For Chassis	Ship. Wt. Lb.
1451-10	8	4	5 1/4	4 x 8	2
1451-14	9	5	5 1/4	5 x 9	2 1/2
1451-16	10	6	5 1/4	6 x 10	3
1451-22	12	8	5 1/4	8 x 12	3 1/2
1451-26	16	8	5 1/4	8 x 16	5
1451-30	17	10	5 1/4	10 x 17	5

◆ New Product.

Special designs of these series produced quickly to your specifications.

# MINIATURE CHASSIS & UTILITY CASES

# HAMMOND

## OPEN END ALUMINUM CHASSIS — 1419 SERIES

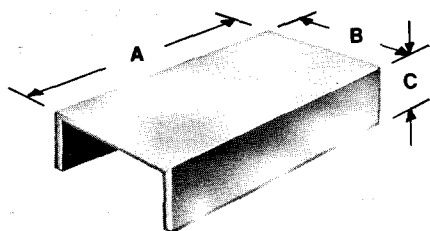

- Made of half-hard aluminum.
- Ends formed for additional strength.
- Supplied in natural finish.

Cat. No.	A	B	C	Ship. Wt. Lb.	Cat. No.	A	B	C	Ship. Wt. Lb.
1419 D	7	5	2	1	◆1419 O	8½	5¾	1	1
1419 F	13½	5	2	1½	◆1419 Q	9½	10¾	1½	1¼
1419 H	12	8	2	2	◆1419 S	10½	4¾	1	1¾
1419 J	16	8	3	2½	◆1419 V	10½	6¾	1	2
◆1419 K	4½	3¾	1	⅓	◆1419 W	10½	8¾	1	2¼
◆1419 M	6½	4¾	1	½	◆1419 Y	10½	4¾	1½	2¼

## MINIATURE OPEN END ALUMINUM CHASSIS — 1445 SERIES

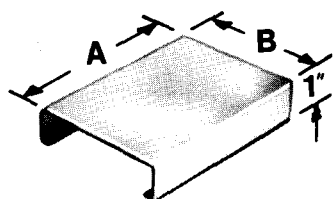

- Light gauge aluminum, easily worked with hand tools.
- For use with transistorized circuitry, prototypes, sub-chassis.
- Supplied in natural finish.
- Cat. No. 1445 G, N, W and X are suitable for 1455 series instrument cases.

Cat. No.	A	B	Ship. Wt. Lb.	Cat. No.	A	B	Ship. Wt. Lb.
1445 C	2¾	2	0.1	1445 L	4½	3½	0.2
1445 D	3	1¾	0.1	1445 M	4	4	0.2
1445 E	3	2¼	0.1	◆1445 N	5	3	0.3
1445 F	3½	2½	0.15	1445 P	5	3½	0.2
◆1445 G	3	3	0.15	1445 Q	6	3	0.25
1445 H	4	2	0.15	1445 R	6	4	0.3
1445 J	4	3	0.15	◆1445 W	4	5	0.35
				◆1445 X	6½	5	0.35

NOTE: \*Models "W" and "X" are 1½" high.

## UTILITY CASES — 1415 SERIES

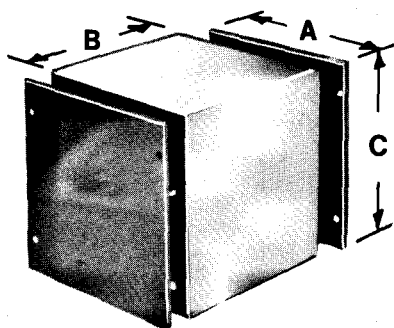

- Interchangeable front and rear panel provides easy accessibility making it very useful for housing a variety of electronic components.
- Spotwelded cold rolled steel construction.
- Self-tapping screws supplied.
- Standard ASA 61 grey baked enamel finish.

Cat. No.	A	B	C	Ship. Wt. Lb.	Cat. No.	A	B	C	Ship. Wt. Lb.
1415 A	4	2	4	1	1415 F	8	7	10	5
1415 B	5	3	4	2	1415 G	7	6	12	5
1415 C	5	4	6	2½	1415 H	10	8	10	7
1415 D	6	6	6	3	1415 I	11	8	12	8
1415 E	6	5	9	3½	1415 J	9	7	15	9

1415 C case can be supplied with meter hole in front panel.

Type 1415 C2 — 2¼" Dia. hole for 2½" meter.

Type 1415 C3 — 2⅞" Dia. hole for 3" meter.

## HANDY CASES — 1411 SERIES

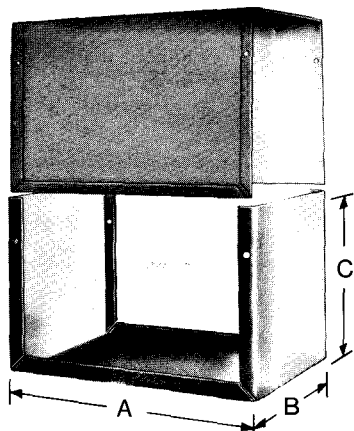

- All sizes are made of 18 gauge half hard aluminum.
- Four self-tapping screws supplied.
- Economical two piece construction permits installation of more components than possible in more conventional designs.
- ASA 61 grey enamel finish.

Cat. No.	A	B	C	Ship. Wt. Lb.	Cat. No.	A	B	C	Ship. Wt. Lb.
1411 B	2¾	2⅛	1⅝	¼	1411 N	5¼	3	2⅛	¼
1411 C	3¼	2⅛	1⅛	¼	1411 P	6	5	4	¾
1411 D	3¼	2⅛	1⅝	¼	1411 Q	7	5	3	¾
1411 F	4	2	2¾	¼	1411 R	8	6	3½	1
1411 G	4	2⅛	1⅝	¼	◆1411 S	8	3½	3	¾
1411 H	4	2¼	2¼	¼	1411 T	10	2	1⅝	½
1411 J	4¼	2¼	1½	¼	1411 U	10	6	3½	1¼
1411 K	5	2¼	2¼	¼	1411 W	12	2½	2¼	¾
1411 L	5	4	3	½	1411 X	12	7	4	1¾
◆1411 M	6	2½	3	½	1411 Z	17	5	4	2¼

◆ New Product.

Special designs of these series produced quickly to your specifications.

# HAMMOND

# CABINETS and CASES

## SLOPING FRONT CABINETS — 1404 SERIES

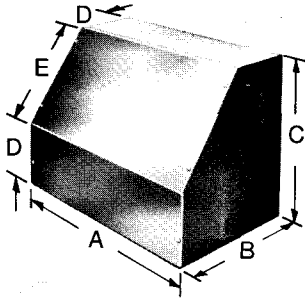

- Easily adapted as instrument cases or for other equipment.
- Front is removable with an access opening in rear for chassis connections.
- Supplied with panel mounting screws and four rubber feet.
- Standard ASA 61 grey baked enamel finish.

Cat. No.	A	B	C	D	E	For Chassis	Ship. Wt. Lb.
1404 A	6	4	5	2	3	-----	2
1404 B	10	5 1/8	6 1/4	3	3 7/8	1441-14	3
1404 D	11	6 1/8	7 1/4	3 1/2	4 1/2	1441-16	3
1404 F	13	8 1/8	9 1/4	3 7/8	6 7/8	1441-22	4
1404 H	17	8 1/8	9 1/4	4 1/2	6	1441-28	6 1/2

## VENTILATED CABINETS — 1429 SERIES

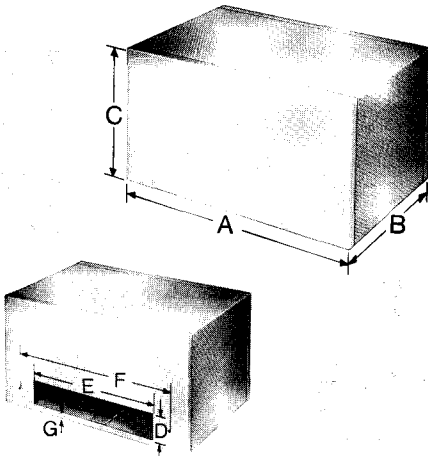

- Modern, economical instrument or component case with neat appearance.
- Readily removable aluminum front panel (requires no screws) is fastened to various standard chassis by controls or switches.
- Non-removable rear panel with a cutout for easy access to terminals or cable connections.
- A sturdy 18 gauge perforated steel shell on four rubber feet.
- Durable leather-like Greytex enamel finish.

Cat. No.	A	B	C	D	E	F	G	Chassis Size	Ship. Wt. Lb.
1429 C	7 1/4	5 3/16	5	1	4	5 1/8	1/4	7 x 5 x 2	2.5
1429 E	9 1/4	5 3/16	5 1/2	1 1/2	5	7 1/8	1/4	9 x 5 x 2	2.5
1429 G	10 1/4	6 3/16	6	1 1/2	6	8 1/8	1/4	10 x 6 x 2	3.25
1429 J	12 1/4	8 3/16	6 1/2	1 1/2	8	10 1/8	1/4	12 x 8 x 2	4.5
1429 L	16 1/4	8 3/16	6 1/2	1 1/2	12	14 1/8	1/4	16 x 8 x 2	5.0
1429 N	6 1/4	10 3/16	6	1 1/2	4	4 3/4	1/4	6 x 10 x 2	3.25
1429 P	8 1/4	12 3/16	6 1/2	1 1/2	4 1/4	6 1/8	1/4	8 x 12 x 2	4.5
1429 R	12 1/4	10 3/16	8	1 1/2	8	10 1/8	1/4	12 x 10 x 2	5.33

## METER CASES — 1412 SERIES

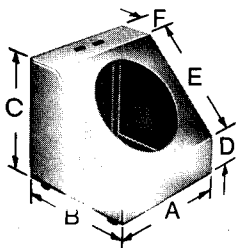

- Modern sloping front cases designed to accept standard meter sizes.
- Spotwelded steel construction, finished in ASA 61 grey baked enamel.
- Back and bottom panel removable for easy accessibility.
- Supplied with four rubber feet and self tapping screws.

Cat. No.	A	B	C	D	E	F	Meter Size	Hole Size	Ship. Wt. Lb.
1412 AA	4	3 3/4	3 3/4	1 1/4	3 5/8	1 1/4	2	2 1/16	1.0
1412 A	4	3 3/4	3 3/4	1 1/4	3 5/8	1 1/4	2 1/2	2 1/4	1.0
1412 B	4	3 3/4	3 3/4	1 1/4	3 5/8	1 1/4	3	2 7/8	1.0
1412 D	5 1/2	5 1/2	5 1/2	1 13/16	5 1/4	1 13/16	4	2 7/8	1.7

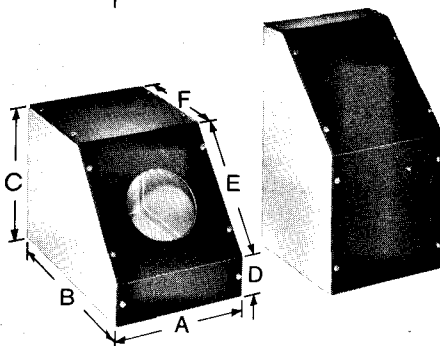

- Spotwelded 16 ga steel construction with removable .081 aluminum front panel (blank or with meter hole).
- Case painted ASA 61 grey; bright blue front panel with philips 6-32 screws.
- Four self-adhesive rubber feet.

Cat. No.	A	B	C	D	E	F	Hole Size	Ship. Wt. Lb.
◆1412 J	4	6 5/8	4 1/8	1 1/2	3 3/4	4	No hole	2.0
◆1412 K	4	6 5/8	4 1/8	1 1/2	3 3/4	4	2 1/4	2.0
◆1412 L	5 1/2	9 3/8	5 5/8	2	5 3/8	5 1/2	No hole	3.5
◆1412 M	5 1/2	9 3/8	5 5/8	2	5 3/8	5 1/2	2 7/8	3.5

## SLOPING FRONT UTILITY CASE — 1454 SERIES

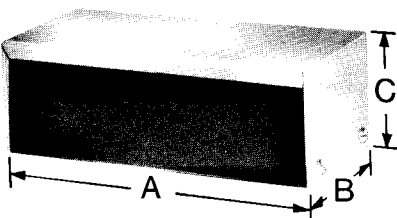

- Attractive low profile sloping front utility case.
- Suitable housing for solid state power supplies, preamplifiers, microphone mixers, crossover networks, etc.
- Formed two-piece construction from 20 gauge steel.
- Two-tone finish, black front and back with vista green sides and top.
- Four self-adhesive rubber feet.

Cat. No.	A	B	C	Wt. Lb.	Cat. No.	A	B	C	Wt. Lb.
◆1454 C	4	2 1/2	2	.50	◆1454 K	8	3 1/2	2 1/2	1.5
◆1454 G	6	2 1/2	2	.75	◆1454 P	10	5	3 1/2	3.0

◆ New Product

# INSTRUMENT CASES

# HAMMOND

## LOW SILHOUETTE CABINET — 1426 SERIES

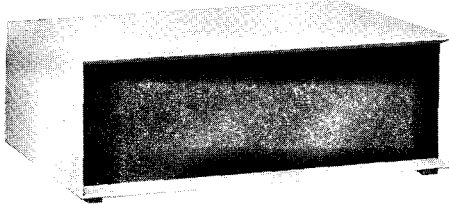

Improved 1426 J

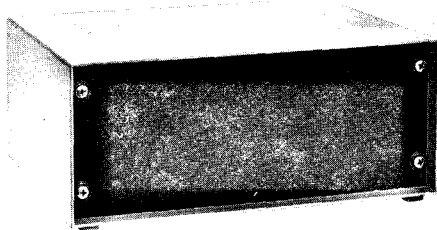

1426 S — Front View

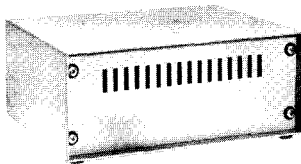

1426 S — Rear View  
Showing Ventilated Panel

- Modern cabinet for miniature tube or transistor assemblies.
- Now available in new shorter depths.
- Four self-adhesive rubber feet supplied (1421 T3).
- Case and rear ventilating panel finished in Greytex or Bluetex enamel with compatible aluminum front panel.

Greytex Cat. No.	Bluetex Cat. No.	W	D	H	Chassis Size (Incl.)	Use Chassis	Ship. Wt. Lb.
---------------------	---------------------	---	---	---	-------------------------	----------------	------------------

- Formed 20 ga. steel with perforated bottom and open rear for ventilation.
- A recessed removable aluminum front panel (no screws required) is joined to 1" high chassis by switches and controls (chassis included).

1426 C	◆1426 C-B	6	5	4	5 x 4 x 1	— — —	1.75
1426 E	◆1426 E-B	8	6	4	7 x 5 x 1	— — —	2.5
1426 G	◆1426 G-B	10	7	4	9 x 6 x 1	— — —	3.0
1426 J	◆1426 J-B	12	8	4	11 x 7 x 1	— — —	4.0

- Recessed removable aluminum front panel and ventilating steel rear panel mounted with 8-32 philip head screws and nylon cup washer (supplied assembled).

- Chassis not included (See 1419 series chassis page 52).

◆1426 K	◆1426 K-B	6	5	4	— — —	1419 K	1.5
◆1426 M	◆1426 M-B	8	6	4	— — —	1419 M	2.5
◆1426 O	◆1426 O-B	10	7	4	— — —	1419 O	3.5
◆1426 Q	◆1426 Q-B	11	11 <sup>3</sup> / <sub>4</sub>	5 <sup>1</sup> / <sub>2</sub>	— — —	1419 Q	7.5
◆1426 S	◆1426 S-B	12	6	4	— — —	1419 S	3.5
◆1426 V	◆1426 V-B	12	8	4	— — —	1419 V	4.5
◆1426 W	◆1426 W-B	12	10	4	— — —	1419 W	6
◆1426 Y	◆1426 Y-B	12	6	5 <sup>1</sup> / <sub>2</sub>	— — —	1419 Y	5

## INSTRUMENT CASES — 1401 SERIES

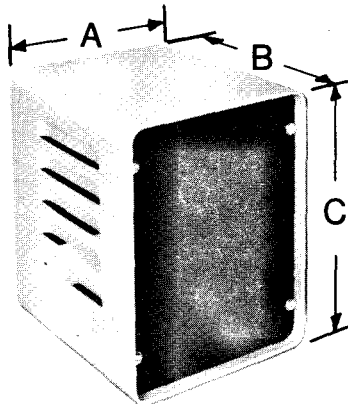

- Versatile, attractive cases for instrument or electronic assemblies.
- Formed of .051 half hard aluminum with a .064 aluminum panel.
- Front panel is recessed <sup>3</sup>/<sub>8</sub>" and finished flat black.
- Inward type louvres assure adequate ventilation and smooth lines.
- All models have opening in bottom rear for wire connections.
- Four screw-on rubber feet supplied.
- Durable leather-like Greytex enamel finish.

Cat. No.	A	B	C	For Chassis	Ship. Wt. Lb.
1401 B	6 <sup>1</sup> / <sub>8</sub>	7 <sup>5</sup> / <sub>8</sub>	8	5 x 7 x 2	2 <sup>1</sup> / <sub>2</sub>
1401 D	7 <sup>1</sup> / <sub>8</sub>	10 <sup>5</sup> / <sub>8</sub>	9	6 x 10 x 2	3 <sup>1</sup> / <sub>2</sub>
1401 F	9 <sup>1</sup> / <sub>8</sub>	12 <sup>5</sup> / <sub>8</sub>	9	8 x 12 x 2	4 <sup>1</sup> / <sub>2</sub>
1401 H	8 <sup>1</sup> / <sub>8</sub>	5 <sup>5</sup> / <sub>8</sub>	8	5 x 7 x 2	2 <sup>1</sup> / <sub>2</sub>
1401 J	11 <sup>1</sup> / <sub>8</sub>	6 <sup>5</sup> / <sub>8</sub>	9	6 x 10 x 2	3 <sup>1</sup> / <sub>2</sub>
1401 L	13 <sup>1</sup> / <sub>8</sub>	8 <sup>5</sup> / <sub>8</sub>	9	8 x 12 x 2	4 <sup>1</sup> / <sub>2</sub>

## MINIATURE INSTRUMENT CASE — 1455 SERIES

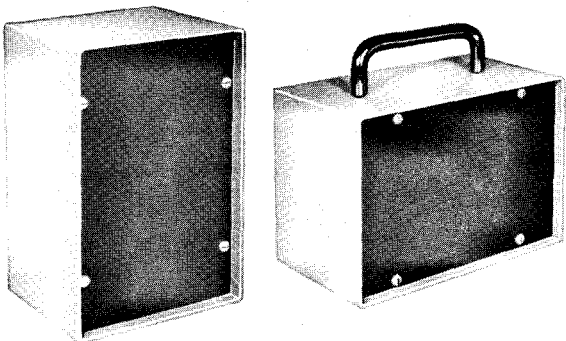

- Versatile instrument case — modern angular appearance.
- Formed of 20 gauge steel with .060 aluminum front panel.
- Removable front panel is recessed <sup>1</sup>/<sub>4</sub>".
- Ventilation is provided through slots in rear panel.
- Screws and four rubber feet supplied.
- Handles (1427 N) supplied on horizontal models.
- Aluminum chassis available (see 1445 series page 52).
- Durable Greytex or Bluetex enamel with compatible aluminum front panel.

Greytex Cat. No.	Bluetex Cat. No.	Width	Depth	Height	Use Chassis	Ship. Wt. Lb.
1455 B	◆1455 B-B	4 <sup>3</sup> / <sub>16</sub>	3 <sup>1</sup> / <sub>2</sub>	6 <sup>3</sup> / <sub>16</sub>	1445 G	1.3
1455 C	◆1455 C-B	6 <sup>3</sup> / <sub>16</sub>	3 <sup>1</sup> / <sub>2</sub>	4 <sup>3</sup> / <sub>16</sub>	1445 N	1.3
1455 F	◆1455 F-B	5 <sup>3</sup> / <sub>16</sub>	5 <sup>1</sup> / <sub>2</sub>	7 <sup>1</sup> / <sub>16</sub>	1445 W	2.0
1455 G	◆1455 G-B	7 <sup>1</sup> / <sub>16</sub>	5 <sup>1</sup> / <sub>2</sub>	5 <sup>3</sup> / <sub>16</sub>	1445 X	2.0

◆ New Product

# HAMMOND

# EQUIPMENT CABINETS & WALL RACKS

## CABINETS — 1428 SERIES

- Modern, square cornered 18 gauge steel, spotwelded construction.
- Ventilated by a perforated top and removable rear panel, front accepts standard 19" panels (not supplied) (See p. 49).
- Accommodates 14" x 17" chassis (See p. 51)
- Standard ASA 61 grey baked enamel finish.
- Four rubber feet supplied.

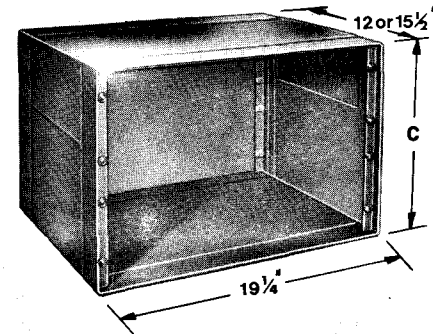

15 1/2" DEEP CABINET				12" DEEP CABINET			
Cat. No.	(C) Overall Height	Panel Height	Ship. Wt. Lb.	Cat. No.	(C) Overall Height	Panel Height	Ship. Wt. Lb.
1428 AA	5 1/2	5 1/4	14	◆1428 J	5 1/2	5 1/4	12
1428 A	7 1/4	7	17	◆1428 K	7 1/4	7	15
1428 B	9	8 3/4	20	◆1428 L	9	8 3/4	18
1428 D	10 3/4	10 1/2	23	◆1428 M	10 3/4	10 1/2	21
1428 F	12 1/2	12 1/4	27	◆1428 N	12 1/2	12 1/4	25
◆1428 G	14 1/4	14	32	◆1428 R	14 1/4	14	29

## CABINETS — 1405 SERIES

- Welded 18 gauge steel construction with ventilating louvers on both ends.
- Panel rails front and rear drilled and tapped 10-32 on standard EIA rack spacings for 19" steel or aluminum panels (See p. 49).
- Equipped with four rubber feet • Bulletin 1405.
- Standard ASA 61 grey baked enamel finish.
- Overall dimensions: Length 22 1/8", Depth 11 1/4".

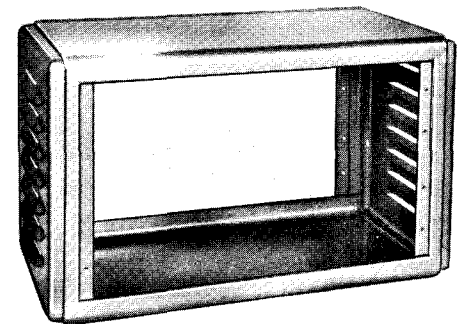

Cat. No.	Overall Height	Panel Height	Ship. Wt. Lb.
1405 H	13	10 1/2	14
1405 J	14 3/4	12 1/4	15
1405 L	16 1/2	14	16

## UNIVERSAL CABINET PARTS — 1491 SERIES

- A complete formed 18 gauge steel cabinet consists of top assembly, bottom plate, and end pairs.
- Accepts standard 19" panels both front and rear (See p. 49).
- Cabinet height is altered by selecting end pairs.
- Accommodates 10" x 17" chassis (See p. 51).
- Standard ASA 61 grey baked enamel finish.

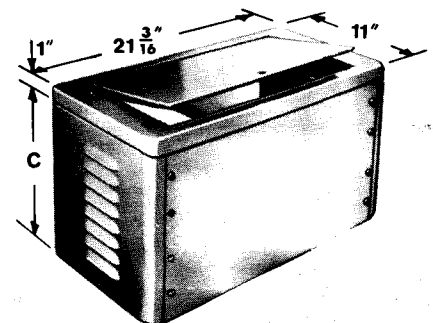

Cat. No.	Description	C (Height)	Ship. Wt. Lb.
1491 A	Bottom Plate		4
1491 E	Hinged Top Assembly		6
1491 L	Cabinet End Pairs	5 1/4	3
1491 P	Cabinet End Pairs	8 3/4	4 1/2
1491 S	Cabinet End Pairs	14	6 1/2

## OPEN WALL OR TABLE RACK — 1459 SERIES

- Economical open modular rack for 19" panels, suitable for wall or table mounting where dust is not a problem.
- Suitable for audio visual telecommunication sound distribution and paging systems.
- Three 1/2-3/4 conduit knockouts top and bottom rear for cable entrance.
- Rear has key holes for ease of wall mounting.
- Open top, bottom, sides and rear to facilitate equipment mounting.
- All welded 16 gauge formed steel, finished in standard ASA 61 baked grey enamel.
- Sold with top & bottom cover panels installed.
- Ask for bulletin #1459.
- Four screw on rubber feet for table mounting when required.

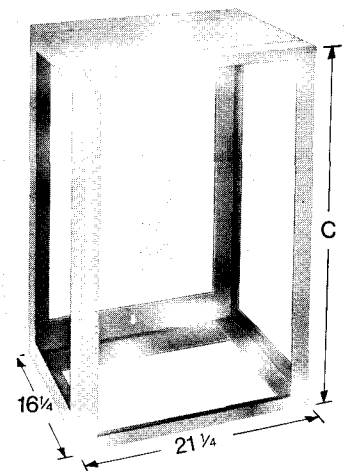

RACK CABINET				OPTIONAL ACCESSORIES (sold in pairs)	
Cat. No.	Height C	Panel Space	Ship. Wt. Lb.	Flat Side Panels	Ship. Wt. Lb.
◆1459 F	24 3/4	22 3/4	25	◆1459 FQ	15
◆1459 J	35 1/4	33 1/4	30	◆1459 JQ	20
◆1459 M	49 1/4	47 1/4	35	◆1459 MQ	30

NOTE: — Height does not include rubber feet.  
Special designs of these series produced quickly to your specifications.

◆ New Product.

1459 J WITH TOP COVER PANEL INSTALLED

# SPEAKER CABINETS

# HAMMOND

## TABLE SPEAKER CABINETS — 1408 SERIES

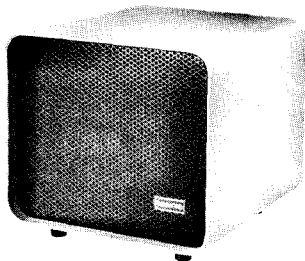

- Attractively styled to match current designs of receivers and transceivers.
- Includes a high quality 8 ohm PM speaker mounted on a 3/4" recessed baffle board for best reproduction.
- Sturdy 18 gauge formed steel case with perforated grille front.
- Convenient rear mounted screw terminals. • Four rubber feet included.
- A durable, leatherlike Greytex enamel with a flat black grille.

Cat. No.	Height	Width	Depth	Speaker Size	Magnet Weight	Output (Watts)	Ship. Wt. Lb.
1408 J	6 5/8	8	8	5" x 7" oval	2.4 oz.	3 - 4	6
1408 L	8	8	8	8" dia.	6 oz.	6 - 8	9

Both models have 8 Ω voice coil

## COMPONENT CABINET — 1408 SERIES

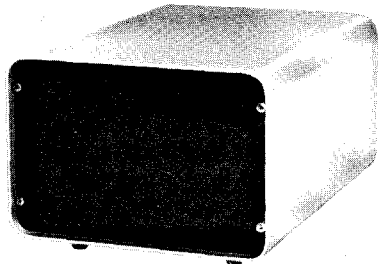

- Styling matches the 1408 speaker cabinets and current designs of receivers and transceivers.
- Suitable for power supplies or speaker assemblies.
- Formed 18 ga. steel cabinets and perforated steel rear panel (removable) finished in Greytex enamel.
- Removable solid aluminum front panel finished in semi-gloss black enamel.
- Four 1/2" high screw-on rubber feet.
- Overall dimensions 13" D x 10" W x 6.5" H.

Cat. No. ♦1408 P Shipping Weight 8.0 lb.

## CEILING BAFFLE — 1408 SERIES

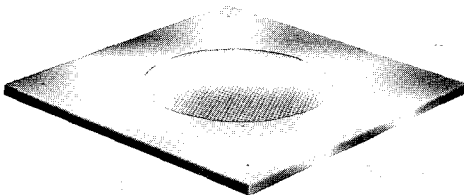

- Mounting holes accept standard 8" round speaker.
- Formed 20 ga. steel with perforated steel grille with punched holes for quick installation.
- Overall dimensions 12" x 12" x 3/8".
- Finished in white baking enamel.

Cat. No. ♦1408 C Shipping Weight 2.0 lb.

## TABLE SPEAKER CABINETS — 1406 SERIES

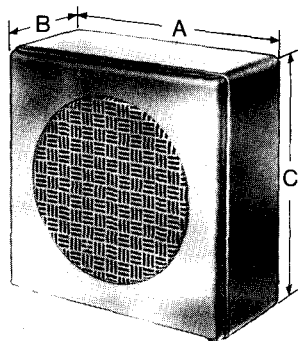

- A modern, attractive speaker cabinet.
- Formed 20 gauge cold rolled steel construction with removable rear cover.
- A special felt strip installed on the inside walls dampens metallic resonance.
- Standard ASA 61 grey baked enamel finish.
- Four rubber feet included.

Cat. No.	A	B	C	Speaker Size	Ship. Wt. Lb.
1406 C	6 3/8	3 3/8	6 3/8	4"	1 1/2
1406 D	7 7/8	3 7/8	7 7/8	5"	2 1/4
1406 E	8 3/8	4 3/8	8 3/8	6"	2 3/4
1406 F	10 3/8	5 3/8	10 3/8	8"	4
1406 H	14 3/8	8 3/8	14 3/8	12"	8

## WALL MOUNTED SPEAKER CABINETS — 1407 SERIES

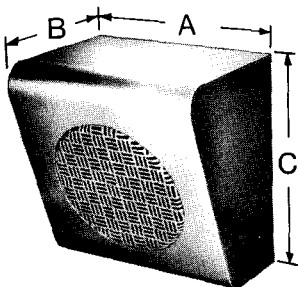

- A distinctive line of speaker cabinets for wall mounting.
- Formed spotwelded 20 gauge cold rolled steel construction.
- Key slots at rear for easy wall mounting.
- A special felt strip installed on the inside walls dampens metallic resonance.
- Standard ASA 61 grey baked enamel finish.

Cat. No.	A	B	C	Speaker Size	Ship. Wt. Lb.
1407 E	8	6 1/4	8	6"	2 1/4
1407 F	10	7 3/8	10	8"	3 1/2
1407 H	14	10 3/8	14	12"	7 1/2

♦ New Product.

Special designs of these series produced quickly to your specifications.



The following metal products are types that have been made for several years. (In many cases, new products may be substituted.) Since demand for these indicates a downward trend we list them separately and when necessary can still be ordered. Further details on each series will be found on other pages of this catalogue, or previous catalogues.

## TWO-WAY SPEAKER ENCLOSURE — 1408 SERIES

- Two tone baked enamel finish. • Four rubber feet supplied.
- Mounts to wall with wire concealing 'L' bracket supplied.
- Mounts direct to 4" junction box on walls or ceiling.
- Knockout for 1/2" conduit for pedestal mounting and cable entrance.
- Supplied with a 6", 3.2 ohm P.M. speaker mounted on a minimal steel baffle.

Cat. No. **1408 ET** — Blue hammerlin body and light grey grille. Ship. Wt. 4 1/2 lb.

Cat. No. **1408 EG** — Beige body and ivory grille. Ship. Wt. 4 1/2 lb.

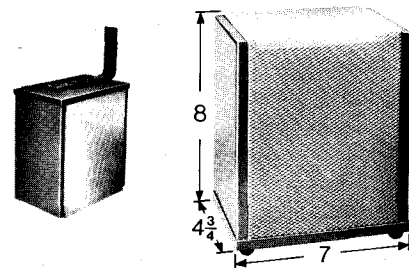

## MULTI-USE CABINETS — 1402 AND 1403 SERIES

- All purpose steel cabinet with smooth rounded corners.
- Front panel is removable for easy drilling and assembly.
- Ventilating louvers on sides and fixed rear panel.
- Rear openings provide cable or lead entrance.
- Hinged access lid supplied on 1403 models only.
- Equipped with four rubber feet.
- Standard ASA 61 grey baked enamel finish.

**OBSOLETE**

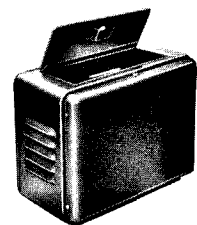
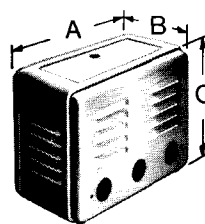

Cat. No.	Cat. No.	L	D	H	For Chassis	Ship. Wt. Lb.	Cat. No.	Cat. No.	L	D	H	For Chassis	Ship. Wt. Lb.
<b>1402 B</b>	-----	9 1/8	4 3/8	6 3/8	4 x 8	4	<b>1402 G</b>	<b>1403 G</b>	17 1/8	8 3/8	8 3/8	8 x 16	12
<b>1402 C</b>	<b>1403 C</b>	10 1/8	5 3/8	7 3/8	5 x 9	5 1/2	<b>1402 H</b>	<b>1403 H</b>	18 1/8	10 3/8	8 3/8	10 x 17	16
<b>1402 D</b>	<b>1403 D</b>	11 1/8	6 3/8	7 3/8	6 x 10	7	<b>1402 I</b>	<b>1403 I</b>	18 1/8	12 3/8	8 3/8	12 x 17	18
<b>1402 E</b>	<b>1403 E</b>	13 1/8	8 3/8	8 3/8	8 x 12	10	<b>1402 J</b>	<b>1403 J</b>	18 1/8	14 3/8	10 3/8	14 x 17	22

## MISC. CABINETS

- For complete description of Hammond speaker cabinets 1406 and 1407 Series, refer to page 56.
- Cabinet parts are described in the complete 1491 series on page 55.

Cat. No.	Description	H	W	D	Speaker Diam.	Ship. Wt. Lb.
<b>1491 M</b>	Cabinet End Pairs	7	21 3/8	11	—	3 1/2
<b>1491 Q</b>	Cabinet End Pairs	10 1/2	21 3/8	11	—	5
<b>1491 R</b>	Cabinet End Pairs	12 1/4	21 3/8	11	—	6
<b>1406 G</b>	Table Speaker Cabinet	12 3/8	12 3/8	6 3/8	10	6
<b>1407 G</b>	Wall Speaker Cabinet	12	12	8 1/2	10	5

## MISC. PANELS

- 14 gauge steel panels notched to standard EIA 1/2 - 1 1/4 spacings. • Meter Panels punched for standard meters.
- All panels are 19". • Standard ASA 61 grey baked enamel finish.

Cat. No.	Description	Panel Height	Ship. Wt. Lb.	Cat. No.	Description	Panel Height	Ship. Wt. Lb.
<b>5-525 G</b>	Meter panel 4 holes 2 1/4" dia.	5 1/4	2	<b>5-525 M</b>	Meter panel 4 holes 2 7/8" dia.	5 1/4	2
<b>5-525 H</b>	Meter panel 5 holes 2 1/4" dia.	5 1/4	2	<b>5-1050 DV</b>	Ventilating door panel	10 1/2	5
<b>5-525 K</b>	Meter panel 3 holes 2 7/8" dia.	5 1/4	2	<b>5-1225 S</b>	Speaker panel for 10" speaker	12 1/4	4 1/2

## CABINET RACKS — 1462 SERIES

- Functional, welded, formed 16 ga. steel cabinet with angular corners, 20" wide x 16" deep.
- Louvred rear door on steel slip hinges with flush keyed lock.
- 9 x 11" bottom cutout with cover plate.
- Two 3/4-1" conduit knockouts and one duplex receptacle opening under rear door.
- Two fixed vertical panel rails drilled and tapped 10-32 at EIA 1/2 - 1 1/4" spacing for 19" panels.
- Four cable clips welded on the rear of the right hand side.
- Standard ASA 61 grey baked enamel. • Refer to page 42 for new 1460 series cabinet racks.

Cat. No.	Overall Height	Panel Space	Ship. Wt. Lb.
<b>1462 B</b>	64	61 1/4	130
<b>1462 C</b>	72 3/4	70	145
<b>1462 E</b>	83 3/8	80 1/2	160

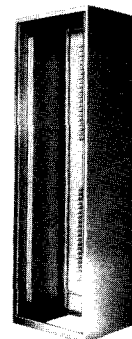

All inactive sheet metal items are listed on this page only. (See page 17 for inactive transformers)

# MISCELLANEOUS HARDWARE

# HAMMOND

## HANDLES & LOCKS — IN KIT FORM

### ATTRACTIVE LOCKING & PULL KNOB



- Die cast knob and plate with satin chrome finish.
- Knob sleeve is matt black high strength polystyrene
- Lock has brass tumbler, phosphor bronze springs and die cast barrel.
- Two nickel plated keys.

Cat. No.	Description	Wt. Lb.
◆1427 W	Knob (locking)	0.5
◆1427 X	Knob (pull)	0.3

### AUTOMOTIVE LOCKING HANDLE



- High quality chrome plated die-cast handle and flange.
  - Extended 3" threaded latch shaft.
  - Keyed lock in handle.
  - Used on 1463, 1469, 1484, or similar cabinets.
- Cat. No. **1427 AK\*** or **1427 AF\*\*** Wt. 1 lb.

### FLUSH LOCK



- Inconspicuous flush mounting in single 3/4" dia. hole.
  - Chrome plated brass housing and reversible latch.
  - For use on type 1463, 1464 or similar cabinets.
- Cat. No. **1427 BK\*** or **1427 BF\*\*** Wt. 0.25 lb.

### RING CATCH



- Neat semi-flush ring pull catch.
  - Chrome plated die-cast.
  - For use on flat plate cabinet doors.
- Cat. No. **1427 EK\*** or **1427 EF\*\*** Wt. 0.25 lb.

- ### FOLDING HANDLE
- Black, modern, shock & scratch resist ant light weight polystyrene plastic.
  - Nickel plated steel support posts.
  - Steady load 60 lb. max. • Length 5".
- Cat. No. **1427 F.** Wt. 0.25 lb.

### DRAWER PULL



- Brushed-chrome plated die-cast.
  - Length 5". • Mounting centres 3 1/2".
  - Supplied with 8-32 screws.
- Cat. No. **1427 H.** Wt. 0.25 lb.

### LIFTING or PULL HANDLES — chrome plated steel

Cat No.	1427 L	1427 M	1427 N	1427 P	1427 Q
Mtg. Centres	7	5 1/4	3 1/2	2 3/8	2 1/4
Mtg. Screws	10-32	10-32	10-32	6-32	6-32
Diameter	3/8	3/8	3/8	1/4	1/4
Projection	1 1/4	1 1/4	1 1/4	1	1
Clearance	7/8	7/8	7/8	3/4	3/4

### STAINLESS STEEL DRESS TRIM STRIPS WITH MTG. CLIPS (pairs)

Cat. No.	Length (Panel Space)	Cat. No.	Length (Panel Space)
◆1421 Q12	12 1/4	◆1421 Q49	49
◆1421 Q14	14	◆1421 Q61	61 1/4
◆1421 Q21	21	◆1421 Q70	70
◆1421 Q26	26 1/4	◆1421 Q80	80 1/2
◆1421 Q33	33 1/4	◆1421 Q85	85 3/4
◆1421 Q40	40 1/4		

- ### TOUCH-UP PAINT 1/4-PINT TINS
- WT. 1/2 LB.
- 1413 A** — Grey hammerlin enamel.
  - 1413 B** — Beige hammerlin enamel.
  - 1413 D** — Black semi-gloss enamel.
  - ◆**1413 E** — Touch-up Greytex.
  - ◆**1413 L** — ASA 61 grey enamel.

### ◆NEW PRODUCT

\*K—Kit Form \*\* F—Factory Installed

## CHASSIS SUPPORTS

### TRIANGULAR BRACKETS



- For extra support and reinforcing.
- Finished in ASA 61 grey baked enamel.
- Mounting holes punched at EIA rack mounting centres.

Cat. No.		Dimensions	Gauge	Wt. Lb.
<b>1423 B</b>	(pr.)	5 1/4 x 4	20	.25
<b>1423 C</b>	(pr.)	7 x 5	20	.5
<b>1423 D</b>	(pr.)	9 1/2 x 7 1/2	20	1.25
<b>1423 F</b>	(pr.)	12 x 10	18	2.00

### CHASSIS BRACKETS



- Supports chassis from cabinet side walls (1461, 1462, 1464).
  - Formed 14 ga. steel, with mounting holes and screws supplied.
  - Finished in ASA 61 grey baked enamel.
  - Overall Dim. 1 7/8 x 2 1/8 x 8" L.
- Cat. No. **1423 J** (pair). Wt. 1.25 lb.

### CHASSIS SUPPORT PLATE

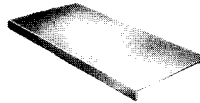

- Use to bridge 1423 J brackets.
- Formed 16 gauge steel.
- Finished in ASA 61 grey baked enamel.

Cat. No.	L	D	H	Wt. Lb.
<b>1423 L19</b>	17 3/4	8 1/4	3/4	4.5
<b>1423 L24</b>	22 3/4	8 1/4	3/4	5.0

### CABINET CROSS CHANNEL



- For use with 1463 or 1469 cabinets between Z rails.
- Formed 16 gauge steel, 3/4" fold.
- Finished in ASA 61 grey baked enamel.

Cat. No.	L	D	H	Wt. Lb.
<b>1423 P19</b>	17 5/8	2	3 1/2	1.75
<b>1423 P24</b>	22 5/8	2	3 1/2	2.0

## PANEL HARDWARE AND FEET

### SCREWS AND CUPWASHERS

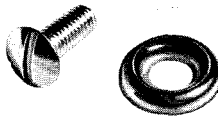

Cat. No. **1421**—Four nickel plated 10-32 screws 1/2" long and cup washers (2 sets required for 10 1/2" high panels and larger).



Cat. No. **1421 A** — Four 3/4" long 10-32 screws with Philips head and black nylon washers.

◆Cat. No. **1421 C** — Four 1/2" long 8-32 screws with Philips head and black nylon washers.



### THUMB SCREW WITH CAPTIVE WASHER

Cat. No. **1421 B** — Four nickel plated 10-32 x 3/8" thumb screw and captive washers.

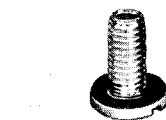

### PANEL SCREW — Suitable for use with dress trim strips.

◆Cat. No. **1421 D** — Package of 25 zinc plated 3/8" long 10-32 pan head slotted panel screws.

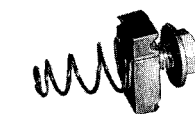

### AMHAL STRUT HARDWARE

- Spring loaded nut. • Three per pkg.
  - Washer and 3/8-16 x 3/4 bolt.
- Cat. No. **1463 S.** Wt. 0.25 lb.

### SELF-ADHESIVE RUBBER FEET

- 1/2" square, package of 24.
- ◆Cat. No. **1421 T3**

## TYPE 1, 4 & 12 PANEL ENCLOSURES FOR ELECTRICAL/INDUSTRIAL APPLICATIONS

In addition to the industrial electronic group of enclosures listed in this Catalogue, HAMMOND produces a popular companion line of electrical cabinets, boxes and enclosures displayed in the electrical catalogue. Ask for **Catalogue Series 70** and **Engineering Bulletins**. These two standard lines, available from stocking distributors coast to coast, and stocked in depth at the factory, are designed to satisfy a majority of applications confronting design and construction people. Where a standard product cannot be used, our custom facilities, which are described below, are at your service.

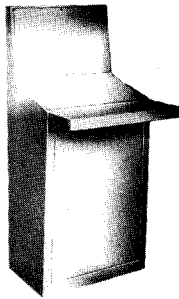

Series 1472  
Oil/Dust Tight  
Control Console

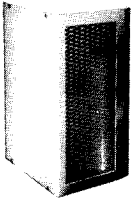

Series 1416  
Ventilated  
Component Case

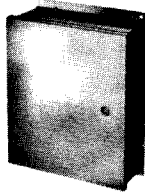

Series 1439  
Flush or Surface Mount Panel  
Type 1 - 3 Piece Assembly

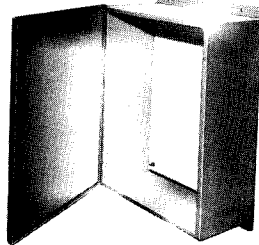

Series 1420  
Type 1 General Purpose  
Enclosure

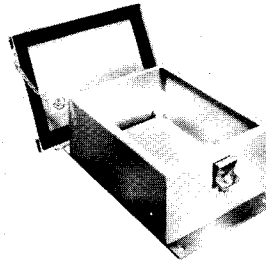

Series 1414  
Oil/Dust & Watertight  
Panel Boxes

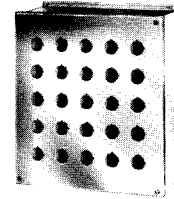

Series 1435  
1 to 42 Hole  
Push Button / Wiring Boxes

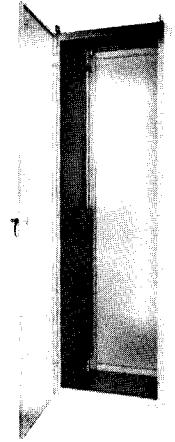

Series 1479  
72'' & 90'' High - Type 1  
Modular Cubicle Rack

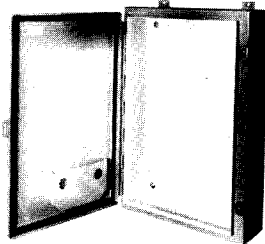

Series 1418  
Oil/Dust & Watertight  
Single Door Panel Enclosure

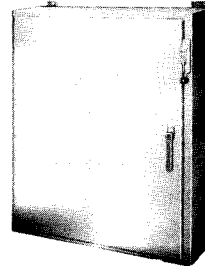

Series 1447  
Oil/Dust Tight Enclosure  
For Square-D Safety Switches

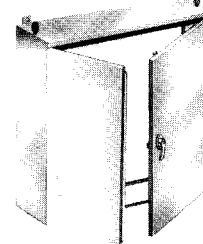

Series 1422  
Type 12, Two-Door  
Panel Enclosure

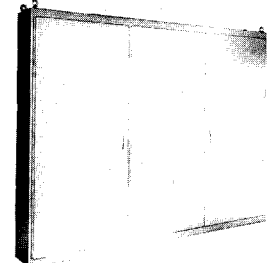

Series 1422 MD  
Type 12 Multi-Door  
Enclosure

## CUSTOM METAL FABRICATION FACILITIES

For industrial customers and OEM's, the HAMMOND factory produces custom cabinets and cubicles for electronic, pneumatic and hydraulic controls. We handle metal fabrication projects of varying complexity in stainless, light structural steel and aluminum as well as sheet and plate materials up to 1/4" thick. The fully integrated factory puts 'in plant' shearing, N/C punching, folding, welding and high quality paint finishing at your disposal. Our Engineering group prepares functional, attractive and economical designs and our factory staff is highly trained and specially selected to insure emphasis on quality. We welcome your inquiries during the initial design stages. Send your sketches, drawings or specifications for a prompt quotation.

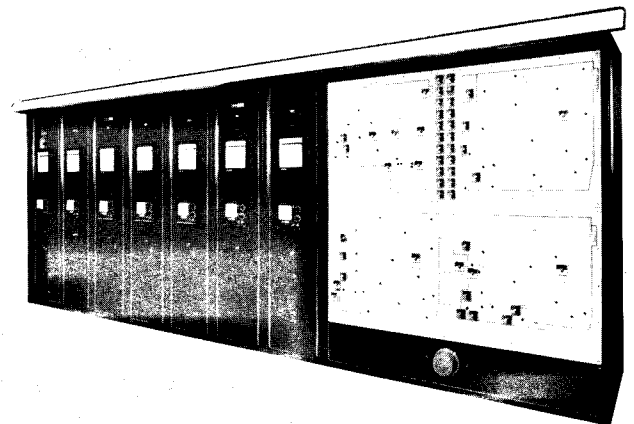
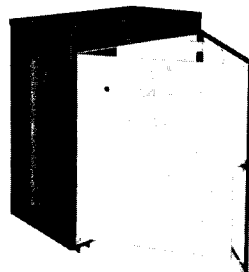
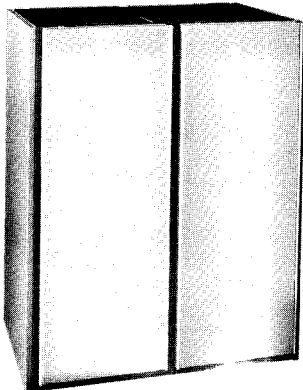

## GUARANTEE

We guarantee Hammond products to be free from defects in workmanship or material, and will, without charge, replace or repair within one year from date of shipment from our factory any products that may be found defective upon inspection at our factory. This guarantee does not obligate us where products have been subjected to careless handling, improper application or faulty installation, and we expressly disclaim any obligation, guarantee or liability whatsoever except as above stated.

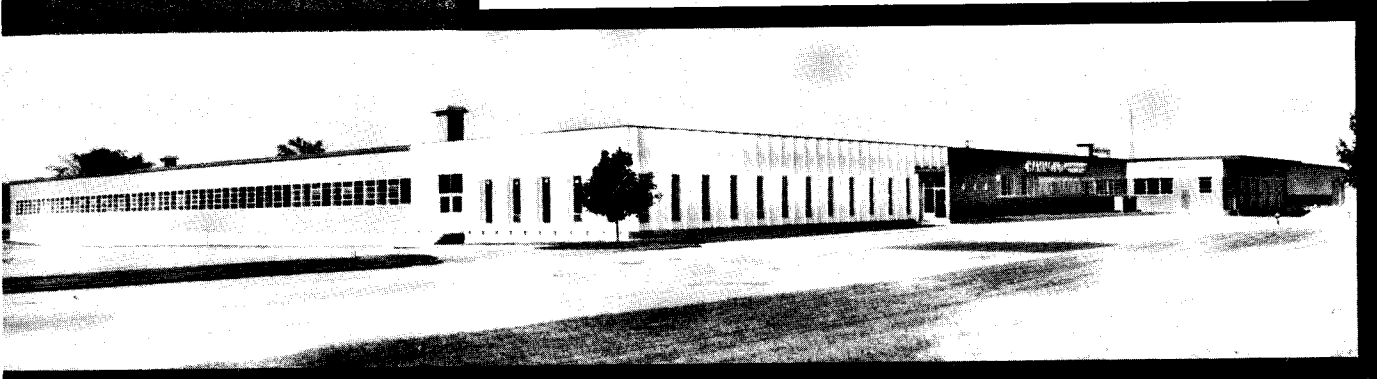

### Head Office and Plant.

Hammond Manufacturing Company is devoted to the design and production of high quality iron core components and fabricated metal products for the electrical and electronic industries in North America. In the modern 185,122 square foot plant, emphasis is on quality, service, and flexibility.

Since 1927 this Company has continually earned and retained the respect and confidence of its customers. Hammond and its technical staff are proud to act as component headquarters for the demands of a changing industry.

Popular sizes of HAMMOND products are stocked in leading distributor warehouses.

SUPERSEDES ISSUE JUNE 1973

EFFECTIVE SEPT. 1974

**HAMMOND MANUFACTURING COMPANY LIMITED**

394 Edinburgh Rd. N. .... Guelph, Ontario, Canada, N1H 1E5

**HAMMOND MANUFACTURING COMPANY (U.S.) INC.**

1051 Clinton St. .... Buffalo, New York, U.S.A. 14206

W50M1070RAK  
W13M0971RNM  
W10M0872RNM  
W10M0673RNM  
W10M0974RNM