

WIRELESS TELEGRAPHY

A HANDBOOK FOR THE USE OF OPERATORS
AND STUDENTS

BY

W. H. MARCHANT

Author of "Radio-Telegraphist's Guide"

154 ILLUSTRATIONS

WHITTAKER & CO.

2 WHITE HART STREET, PATERNOSTER SQUARE, LONDON,
E.C. AND 64-66 FIFTH AVENUE, NEW YORK

1914

WHITTAKER'S PRACTICAL HANDBOOKS

- BARR, J. R. . . . Direct Current Electrical Engineering. 10s. net.
- BARR & ARCHIBALD. Design of Alternating-Current Machinery. 12s. 6d. net.
- GRAY, J. . . . Electrical Influence Machines (Wimshurst Machines). 5s. net.
- HAWKINS & WALLIS. The Dynamo: Its Theory, Design and Manufacture. Two Vols. Vol. I., 10s. 6d. net; Vol. II., 10s. 6d. net.
- HERBERT, T. E. . Telegraphy. 7s. 6d. net.
- HIBBERT, W. . . Magneto and Electric Ignition. 2s. net.
- HOBART, H. M. . Electric Motors — Continuous, Polyphase and Single-Phase Motors. 18s. net.
- MARCHANT, W. H. Radio-Telegraphists' Guide and Log-Book. 4s. 6d. net.
" Wireless Telegraphy.
- MAYCOCK, W. P. Electric Lighting and Power Distribution. Vol. I., 6s. net; Vol. II., 6s. 6d. net.
" . Alternating-Current Circuit and Motor. 4s. 6d. net.
" . Electric Wiring Tables. 3s. 6d. net.
" . Electric Wiring, Fittings, Switches, and Lamps. 6s. net.
" . Electric Wiring Diagrams. 2s. 6d. net.
" . Electric Circuit Theory and Calculations. 3s. 6d. net.
- OULTON & WILSON. Practical Testing of Electrical Machines. 4s. 6d. net.
- PENDRY, H. W. . Elementary Telegraphy. 2s. 6d. net.
" . Baudôt Printing Telegraph System. 2s. 6d. net.
- POOLE, J. . . . Practical Telephone Handbook. 6s. net.
- SALOMONS, Sir D. Management of Accumulators. 6s. net.
- STILL, A. . . . Polyphase Currents. 6s. net.
- WALKER, S. F. . Electricity in Homes and Workshops. 5s. net.
" . Electric Lighting for Marine Engineers. 4s. 6d.
- WHITTAKER'S Arithmetic of Electrical Engineering. 1s. net.
" Electrical Engineer's Pocket-Book. 5s. net.
" Mechanical Engineer's Pocket-Book. 3s. 6d. net
- WHITE, W. J. . . Wireless Telegraphy and Telephony. 2s. 6d. net.

WHITTAKER & CO.

2 White Hart Street, Paternoster Square, London, E.C.

207981

JAN 11 1917

TQ.W

M33

6462734

PREFACE

THIS book is intended primarily for the use of those engaged in the practical operation of Radio-Telegraph installations and for students who already possess some knowledge of electrical science.

The first portion of the book (Chapters I.-V.) deals with the production and radiation of electric oscillations and waves, followed by a description of the various pieces of apparatus which go to make up a Radio-Telegraph installation and the principles which govern their construction and erection.

Following this will be found descriptions of the principal systems. Chapter VI. is devoted to the Marconi system, which is the principal system employing the spark method of generating electrical oscillations. In this chapter will be found a full description of the Marconi $1\frac{1}{2}$ kw. ship set. This type of installation is in such very general use that hardly any students sitting for the P.M.G.'s certificate pass their examination on any other apparatus. For this reason considerable space has been devoted to it and the various pieces of apparatus fully illustrated.

Chapter VII. deals with the Poulsen system, which is representative of the arc method of generating electrical oscillations. In it will be found a full description of Poulsen apparatus, both for hand and automatic work-

ing. The quenched-spark method of generating electrical oscillations is represented by a description of a Telefunken I.T.K. set and of the Lepel system.

Following this will be found a description of the Goldschmidt high-frequency alternator, a machine which in the future may play a leading part in long-distance wireless telegraphy. A special chapter is devoted to portable installations, and sets suitable for airships, military purposes, yachts and small craft generally are described therein.

In Chapter XII. the apparatus necessary and methods of carrying out all the more important measurements will be found described.

Following this is a short chapter on the interpretation of diagrams, which it is thought will prove useful to students approaching the subject for the first time. Such students are recommended to read through this chapter first and so become acquainted with the meaning of the symbols used to represent the various pieces of apparatus.

Chapters XIV. and XV. contain the principal regulations and instructions for Radio-Telegraph stations licensed by H.M. Postmaster-General and the various abbreviations, codes, etc., used in working.

In conclusion the author desires to tender his sincere thanks to the following gentlemen and companies for assistance rendered :—Sidney Brown, Esq., for information relating to his telephone relay ; Messrs the Marconi Press Agency Limited for illustrations of the Marconi system ; Messrs Siemens Bros. & Coy. for illustra-

PREFACE

vii

tions and information relating to the Telefunken system; the Topical Press Agency for illustrations of Poulsen and Marconi apparatus; Baron Egbert von Lepel, the Anglo-German wireless Syndicate, and Basil Binyon, Esq., for some of the illustrations used in description of the Lepel system; the Universal Radio Syndicate for illustrations of the Poulsen system; the Board of Editors *P.O. Electrical Engineers' Journal* for permission to reproduce description of Poulsen high-speed transmitter; Dr Goldschmidt, A. S. M. Sorenson, Esq., and B. Binyon, Esq., for information relating to the Goldschmidt alternator; Finlay M'Culloch, Esq., and N. G. Smith, Esq., for assistance in preparation of drawings; to the Editor of *The Indian Telegraphist* for information relating to Log Chart for calculation of wave-length and frequency of oscillating circuits; to Robert Humfrey, Esq., for assistance with photographs, and to N. B. Holmes, Esq., for checking chapter on Regulation Abbreviations, etc.

W. H. M.

WITHINGTON, 1914.

CONTENTS

CHAPTER I

	PAGE
ELECTRIC OSCILLATIONS AND WAVES	I
Introductory — Condensers — Electric Oscillations — Inductance — Electric Waves — Resonance	

CHAPTER II

THE TRANSMITTER	18
Evolution of Transmitter from Hertz Oscillator — Direct and Inductive Coupling — Condensers for transmitting Circuits — Inductances and Oscilla- tion Transformers — Spark-Gaps — The Antennæ — Directive Antennæ — Earth Connection — The In- duction Coil — Accumulators — Morse Keys — Alter- nating-Current Transformers — Alternating Cur- rents — Power in A.C. Circuits — Rotary Converters and Motor Generators — Choking Coils — Motor Starting Switch	

CHAPTER III

THE RECEIVER	53
Arrangement of Receiving Circuits — Practical Construction of Tuners	

CHAPTER IV

DETECTORS OF ELECTRICAL OSCILLATIONS	59
Marconi Coherer Receiver — Lodge Muirhead Coherer — Electrolytic Detector — Carborundum Detector — Fleming Valve — Thermo-Electric De- tectors — Magnetic Detector — The Telephone Receiver	

CHAPTER V

THE TESTING BUZZER	76
The Testing Buzzer — Telephone Relay — The Variometer — Blocking Switches	

CONTENTS

CHAPTER VI

	PAGE
THE MARCONI SYSTEM	85
The Transmitter $1\frac{1}{2}$ Kw. Set—The Emergency Transmitter—Charging Switchboard—Multiple Tuner—Magnetic Detector—Fleming Valve Tuner —Telephone Condenser	

CHAPTER VII

POULSEN SYSTEM	109
The Poulsen Arc—The Tikker Receiver—Photo- graphic Recorder—High-Speed Transmitter—Tone Sender	

CHAPTER VIII

TELEFUNKEN QUENCHED-SPARK SYSTEM	122
The Transmitter—The Receiver—Calling-up Apparatus—Sound Intensifier	

CHAPTER IX

LEPEL SYSTEM	136
The Transmitter—Musical Note Device—The Receiver—Modification for Receiving Undamped Waves	

CHAPTER X

GOLDSCHMIDT HIGH-FREQUENCY ALTERNATOR	145
---	-----

CHAPTER XI

PORTABLE INSTALLATIONS AND SMALL POWER-SETS	149
Marconi $\frac{1}{2}$ Kw. Set—Marconi Military Set— Telefunken Small-Power Ship Set—Telefunken Simplified Receiver—Telefunken Airship Station —Lepel Military Set	

CONTENTS

xi

CHAPTER XII

	PAGE
MEASUREMENTS	172
Capacity—Dielectric Losses in Condensers— Capacity of Antennæ—Insulation Resistance of Antennæ—H.F. Resistance—H.F. Currents— Wave Meters—Measurement of Wave-Length— Resonance Curves and Damping Decrements— The Marconi Decremeter—Logarithmic Chart— Inductance—Coefficient of Coupling—Calibration of Receiving Circuits—Earth Plate Resistance— Strength of Received Signals—Energy in Antennæ	

CHAPTER XIII

DIAGRAMS	210
Their Interpretation and Preparation	

CHAPTER XIV

REGULATIONS AND INSTRUCTIONS	213
Speed of Transmission—Power—Wave-Lengths— Obligation to Communicate—Priority of Messages —Calling—Preliminary Correspondence—Distress Signals—Admiralty Signalling—Controlling Station	

CHAPTER XV

ABBREVIATIONS, CODES, ETC.	219
List of Abbreviations—International Morse Code —American Morse Code—Time Signals—Table to convert Course and Bearing into Degrees	

CHAPTER XVI

LOCALISATION OF FAULTS	230
INDEX	239

Wireless Telegraphy

CHAPTER I

ELECTRIC OSCILLATIONS AND WAVES

Introductory—Condensers—Electric Oscillations—Inductance—
Electric Waves—Resonance

IN Hertzian-wave or Radio-Telegraphy we are concerned with operations carried on in an infinitely tenuous medium termed the æther, which fills all space and permeates all matter. In order that a wave-motion may be set up in any medium it is necessary that it should be endowed with elasticity—that is to say, with the ability to restore itself to its former condition after any force which causes a strain or distortion in it is withdrawn. Also it should possess inertia. As is well known, sound is due to a disturbance in the air, and if, say, a tuning-fork is caused to vibrate, the air in its neighbourhood will be carved into waves of alternate compression and rarefaction which will travel outward from the source at a rate depending on the ratio of the square root of the elasticity of the medium to its density; in the case of air at atmospheric pressure the waves travel at a speed of about 1090 feet per second.

The distance between one place of maximum compression and the next is termed the wave-length of the sound, and is determined by the rate at which the source of the sound vibrates and on the velocity with which the disturbance is transmitted through the medium.

Suppose that we had two tuning-forks, one emitting a high note, the other a low note, if the forks are kept in vibration for the same length of time, say one second, the sound-waves from each source will have travelled the same distance, but the fork emitting the high note vibrates much quicker than the fork emitting the low note, therefore it must generate more waves and the length of each wave must be shorter. The length of the waves can be found by dividing the

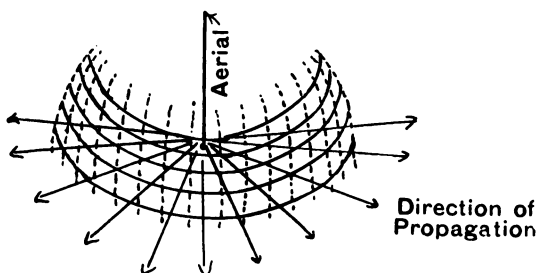

FIG. 1

Dotted lines = electric component
 Continuous lines = magnetic component

velocity of propagation by the frequency with which the source of the sound vibrates. Just as a vibrating mechanical body, such as a tuning-fork, sets up sound-waves in the air, so will electrical vibrations in a circuit set up waves in the æther. The vibration of particles producing sound-waves consists of a to-and-fro movement in the direction of propagation, but the æther is not competent to sustain a wave-motion of this kind. In the case of æther-waves the medium is displaced in a direction at right angles to the direction of propagation, and the electric and magnetic components of which they are made up are also at right angles to each other

ELECTRIC OSCILLATIONS AND WAVES 3

and to the direction of propagation (Fig. 1). The æther-waves used in wireless telegraphy are produced by the charging and discharging of a condenser, and we shall now consider the means adopted for their production.

CONDENSERS

A condenser consists essentially of two conducting surfaces separated by an insulating material. The conducting surfaces are known as the plates of the condenser and the insulating material as the dielectric of the condenser. If such an arrangement be connected to a source of current, for example a battery of cells, an electro-static strain will be set up in the dielectric medium between the

plates, and, if the plates are free to do so, they will attract each other and come together just as if they were connected by stretched india-rubber bands. Fig. 2 shows the closely adjacent plates of a



FIG. 2

Showing direction of lines of strain in charged condenser

condenser with the lines of force between them. These lines of force will continue to exist after the withdrawal of the charging battery, and the condenser is then said to be charged. If the plates of the condenser are connected by a conductor, a momentary current will flow through it and the lines of force will collapse, and the condenser is then discharged.

The capacity of a condenser is equal to the quantity of electricity required to raise its potential to unity, thus, if \mathbf{x} unit of electricity raises its potential to \mathbf{x} , its capacity is \mathbf{x} .

A glance at Fig. 3 will perhaps make the matter plain. Suppose we have two glass vessels, the diameter

of one large compared with the diameter of the other, and of infinite height, and suppose the vessels have a graduated scale engraved on them, as, for instance, a medicine-glass. As the height of the jars is infinite we cannot measure their capacity by the quantity of liquid which they will hold, because we can never fill them, but if we now pour liquid into both vessels and

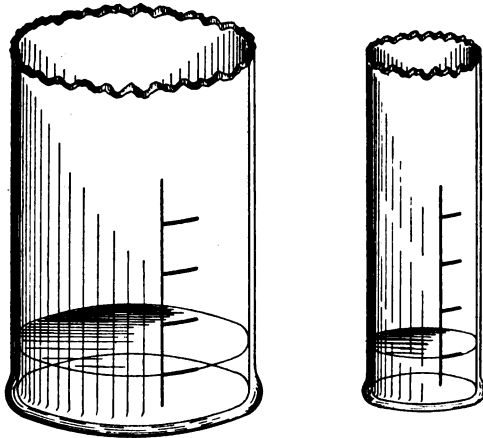

FIG. 3

note the quantity required to raise the level one scale division, in each case we can say that in the first case the vessel has a capacity of 1, because unit quantity of liquid has raised the water level to 1, and in the second case we could, if it required 2 units of liquid to raise the level to 1, say that it had a capacity of 2.

The capacity of a condenser depends on the size of the opposing surfaces, on the distance between them, and on the nature of the dielectric. The capacity of a condenser with air as dielectric, providing the distance

ELECTRIC OSCILLATIONS AND WAVES 5

between the plates is very small compared with their area, can be found from the following formula:—

$$C = \frac{S}{4 \pi t} k$$

where S = surface of plates, $\pi = 3.1416$, t = thickness of dielectric, and k = dielectric constant.

From this it will be seen that the capacity varies directly as the area of the plates, and inversely as the thickness of the dielectric or distance between the plates.

Suppose now we had two condensers, the size of the plates and the distance between them being the same in both cases. If the space between the plates of one of them were filled by the insertion of a sheet of glass, we should find, if we measured the capacity in both cases, that the condenser with the glass dielectric had a much greater capacity than the condenser whose dielectric was air. This is due to the fact that the various insulating substances, such as glass, hard rubber, paraffin wax, etc., permit electro-static action to take place across them in varying degree. The ratio between the capacity of a condenser with a dielectric other than air and one which has an air dielectric, is known as the specific inductive capacity of the material, and to make use of the above formula to calculate the capacity of a condenser, we must first know the specific inductive capacity of the material used as dielectric. The dielectric constant of air is 1, and in the chapter on measurements will be found a table giving the dielectric constants for materials most frequently used in the manufacture of condensers. It should be noted, however, that the dielectric constant varies enormously for different specimens of the same material, and there-

fore the use of the formula is practically restricted to air condensers.

ARRANGEMENT OF CONDENSERS

Condensers may be arranged in two ways—in parallel or in series. Fig. 4 shows a number of condensers arranged in parallel. The total capacity when they are so connected is the sum of the separate capacities: for instance, supposing each of the condensers to have a capacity of 5 microfarads, the total capacity will be 15 mfd.

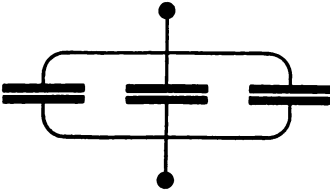

FIG. 4

Condensers connected in parallel

Fig. 5 shows a number of condensers arranged in series. The total capacity in this case will be equal to the reciprocal of the sum of the reciprocals of the capacities, and will always be smaller than the smallest in the series. The capacity can be found from the formula

$$C = \frac{1}{\frac{1}{C_1} + \frac{1}{C_2} + \frac{1}{C_3} + \dots}$$

when C = total capacity, and $C_1, C_2, C_3,$ etc., equal capacity of condensers in the series.

As an example, suppose each of the condensers to have a capacity of 10 mfd., the sum of the reciprocals will be $\frac{1}{10} + \frac{1}{10} + \frac{1}{10} = \frac{3}{10}$ and the reciprocal of this is $\frac{10}{3} = 3\frac{1}{3}$, therefore the total capacity of the three condensers in series is $3\frac{1}{3}$ mfd. It

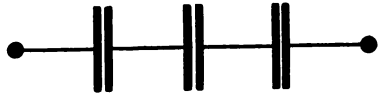

FIG. 5

Condensers connected in series

ELECTRIC OSCILLATIONS AND WAVES 7

is quite a simple matter to see why the capacity should be smaller when condensers are connected in this way, as what we are in effect doing is to increase the thickness of the dielectric. In the above example the thickness of the dielectric has been increased three times and the capacity therefore reduced to one-third. If all the condensers in the series have the same capacity, the total capacity can be found by dividing the capacity of one by the number in series.

CONSTRUCTION OF CONDENSERS

The earliest form of condenser, the well-known Leyden jar—so named from the town in which it was discovered—consists of a glass jar coated for a certain distance both inside and outside with tinfoil. The foils form the plates of the condenser and the glass of the jar the dielectric; connection to the inner foil is made by means of a chain (Fig. 6).

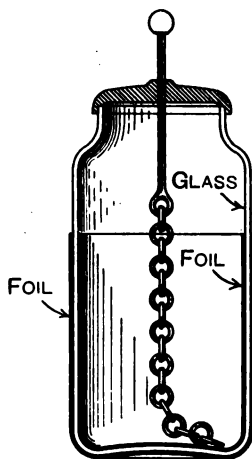

FIG. 6
Leyden jar



FIG. 7

In the modern type, instead of tinfoil, the jar is coated electrolytically with copper. This is a great improvement, as the tinfoil frequently blisters and

peels off. Fig. 7 shows the method in which condensers are usually built ; the size and number of plates and the nature and thickness of the dielectric will depend upon the capacity required and the voltage to which it will be subjected.

ELECTRIC OSCILLATIONS

If a condenser be discharged through a conductor having a high resistance, the current will be in one direction only and the discharge is said to be dead beat or non-oscillatory. If we plot the current in the circuit against the time the curve will assume the form

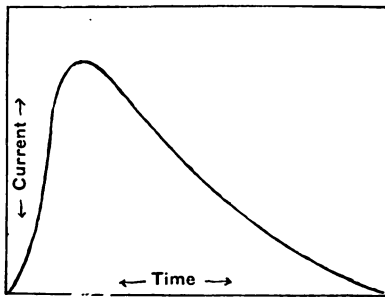

FIG. 8

Curve showing dead-beat nature of condenser discharge through high resistance

shown in Fig. 8. It will be seen that it rises quickly to a maximum and then dies down more slowly. If, however, the condenser be discharged through an inductive conductor of low resistance, say a coil consisting of a few turns of stout copper wire, the effect will be

entirely different ; the current in the circuit will be an alternating current—that is, a current which varies periodically in magnitude and direction. If there were no source of energy absorption in the circuit, the amplitude of each half-cycle would remain constant and the oscillations would be said to be undamped, but owing to the resistance of the conductor which forms

ELECTRIC OSCILLATIONS AND WAVES 9

the discharger, and the resistance of the spark-gap which is included in the circuit, the amplitude does not remain constant, but decays, as shown in Fig. 9, and the oscillations are said to be damped. The rate at which the oscillations in the circuit decay depends upon the resistance of the circuit, and in some cases the dielectric of the condenser is also a source of energy absorption and will therefore increase

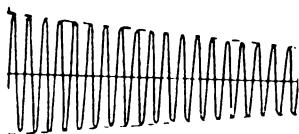

FIG. 9

Showing oscillatory nature of discharge when resistance is small

the damping. If the amplitude of the oscillations decays rapidly they are said to be strongly damped, and if the decay of the amplitude is not great they are said to be feebly damped oscillations. The amplitude of each half-swing bears a constant ratio to the one preceding it, and if the naperian logarithms of each amplitude are written down, it will be seen that they exhibit a constant difference: this difference is termed the logarithmic decrement of the oscillations. The number of complete alternations of current per second in the circuit is called the frequency of the oscillations. The frequency depends upon the capacity and inductance of the circuit and can, if the capacity and inductance are known, be found from the formula $n = \frac{5.033 \times 10^8}{\sqrt{CL}}$ where n equals the frequency, C the capacity of the circuit and L the inductance.

Fig. 10 shows in a modified form a hydraulic model of a Leyden jar or condenser, devised by Sir Oliver Lodge, and serves admirably to illustrate the fact that under certain conditions the discharge is oscillatory.

The model consists of two glass jars, representing the two plates of a condenser ; the jars are connected on their under side by means of a U-shaped tube provided with a stop-cock, the tube representing the discharger. Now suppose the stop-cock to be closed and one jar to be filled with water, also suppose that the U-shaped tube be partially filled with sand : if now the cock is opened the water will rise in the second jar quickly at first and, as the difference in level decreases, more slowly, until the water is at the same level in both jars.

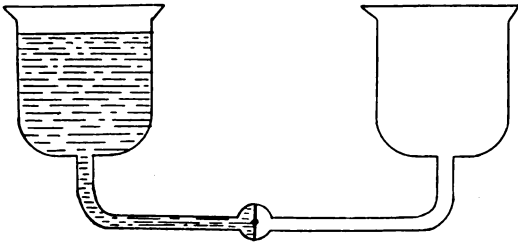

FIG. 10

This illustrates the case of a condenser discharged through a conductor of considerable resistance, the discharge in the electrical case being accompanied by a current in one direction only till the plates of the condenser are both at zero potential, and in the case of the hydraulic analogue by a flow of water in one direction only till the water-level is the same in both jars. Now suppose the sand-choked tube to be removed and replaced by another of fairly large internal diameter and, the cock being closed as before, one jar to be again filled with water. On the stop-cock being opened the water in the first jar will rush through the tube

ELECTRIC OSCILLATIONS AND WAVES 11

into the second jar, but, owing to its inertia, it will not stop when the pressure in the two jars is equalised, but will continue to flow till the water in the second jar is at a higher level than that in the first ; it will then flow through the tube in the reverse direction and again will not stop on the water obtaining equal level in the jars, but will continue to flow till the first jar is at a slightly higher level than the second. The operation will then be repeated till, by the viscosity of the water and the friction on the sides of the jars and tube, it is finally brought to rest and the water-level is the same in both jars. This serves to illustrate the oscillatory character of a condenser discharge through a conductor of low resistance. In the electrical case the discharge is accompanied by a current in the conductor which periodically reverses its direction and by the periodic reversal of the sign of the potential difference at its terminals. In the case of the hydraulic model we have seen that on the stop-cock being opened—which represents the passing of the spark in the electrical case—there was a current of water set up in the tube which periodically reversed its direction of flow, also the difference in water-level in the two vessels periodically reversed, which is the analogue of the alternating potential differences of the condenser.

INDUCTANCE

A current of electricity cannot be started in a circuit at once ; it takes time to reach its full value. This is due to a property of the conductors forming the circuit termed inductance.

Consider for a moment a circuit consisting of a coil

12 WIRELESS TELEGRAPHY

of wire, a battery and a switch. When the switch is closed a current of electricity will flow in the circuit and a magnetic field will be built up round the conductors. As the current is increasing in strength, the lines of magnetic force will cut across neighbouring portions of the circuit, and as a result an electro-motive force will be set up which will tend to send a current round the circuit in the reverse direction to the current from the battery. The magnitude of this opposing electro-motive force will depend on the inductance. It will thus be seen that if the inductance of a circuit is great, the time taken for the current to reach its full strength will be proportionally great.

In the same way, if the switch in the circuit is opened, the current will not cease immediately, because, as the lines of magnetic force collapse, they again cut across the circuit and set up an electro-motive force which acts in the same direction as the battery and tends to prolong the current in the circuit, the continuity of the circuit being preserved for a short time by the spark which takes place at the contacts of the switch as it is being opened.

Inductance may be defined as the inertia quality of a conductor, or the quality which resists changes being made in the strength of current flowing in it.

The inductance, when magnetic material is absent, depends upon the length of the conductor. Coiling the conductor increases the inductance, and the insertion of an iron core will still further and very largely increase it. The inductance of a coil (from which magnetic material is absent) will, provided all the lines of magnetic force are linked with all the turns, vary as the square of the number of turns.

ELECTRIC OSCILLATIONS AND WAVES 13

The unit of inductance is the henry, equal to 10^9 absolute units, and a conductor is said to possess unit inductance when the current through it, varying at the rate of 1 ampere per second, induces in it an electro-motive force of 1 volt. For the purposes of wireless telegraphy, the henry is far too large a unit for the inductances employed ; it is therefore customary to use a sub-unit, the millihenry or the microhenry, which equal one-thousandth and one-millionth of a henry respectively ; the inductance is also frequently expressed in absolute units or centimetres : one microhenry equals 1000 centimetres.

If the inductance is in a circuit conveying an alternating current, it may prevent the current from attaining any considerable value before the direction of the current is reversed, and will act just as a resistance would do in a direct current circuit. Coils of wire wound upon iron cores so as to have great inductance are, as a matter of fact, used to regulate the current in alternating-current circuits. If the reversals of the current are very high (as electrical oscillations), even a coil of comparatively small inductance will operate to choke them altogether, and will, in fact, behave to them as an insulator. This fact is made use of in wireless telegraphy installations to prevent high-frequency currents from flowing back and possibly damaging certain parts of the apparatus, as, for instance, the secondary winding of the transformer used to charge the condenser, although the inductance is not great enough to appreciably diminish the low-frequency current from the transformer.

ELECTRIC WAVES

We have already seen that if a condenser is discharged through a conductor having inductance and small-resistance oscillations are set up in the circuit. Suppose now that the condenser, instead of consisting of two sets of closely adjacent plates, consists of two plates widely separated and connected to the inductance and

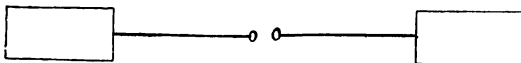

FIG. 11

spark-gap, as in Fig. 11; also suppose that the inductance capacity and resistance are equal in both cases. If oscillations are set up in such a circuit we shall find that the decay in their amplitude is much more rapid (Fig. 12). This shows that some other source of energy



FIG. 12

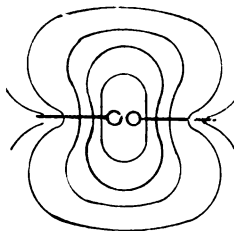

FIG. 13

dissipation has been introduced. The increased damping of the oscillations is due to the fact that a portion of the energy is radiated into space and does not return to the conductors of the circuit.

The first stage in the production of a wave (before the passing of a spark) is shown in Fig. 13. It will be seen that lines of electric strain stretch from one

ELECTRIC OSCILLATIONS AND WAVES 15

conductor to the other. Upon the passing of the spark the ends of the lines of strain move along the conductor toward the spark-gap, the result being that some of them become completely closed and detached curves, by reason of the uniting together of their ends. The motion of the lines of strain along the conductors constitutes a current in them; therefore, during the formation of the closed loops of electric strain, a magnetic field is built up around them. The collapse of these lines of magnetic force will result in the condenser being again charged, but in opposite sense. At this stage the radiation of the wave commences and the closed loops of electric strain, together with the magnetic field, which takes the form of expanding circles having the conductors of the circuit as their centre, are radiated into space. The speed with which the wave travels outward from the source depends upon the elasticity and density of the medium and is the same as the velocity of light—that is, 186,000 miles per second. This fact has led to the assumption that both light and electric waves are identical in nature, and that both are undulations in the same medium (the æther), differing only in wave-length. Like light, the electric waves can be refracted and reflected, as was demonstrated by Hertz.

RESONANCE

The means adopted by Hertz to detect the electric waves at a distance consisted of an open oscillatory circuit similar to Fig. 11, but the spark-gap was very finely adjustable by means of a micrometer screw. If such a circuit be set up at a distance from and parallel to the generating circuit, a stream of sparks will be

observed to pass the micrometer spark-gap during the time the generating circuit is in action, the maximum effect being produced in the detecting circuit when the product of its capacity and inductance equals that of the generating circuit. When the product of the capacity and inductance of one circuit is equal to that of another, the two circuits are said to be in tune, or in resonance, and will oscillate to the same frequency.

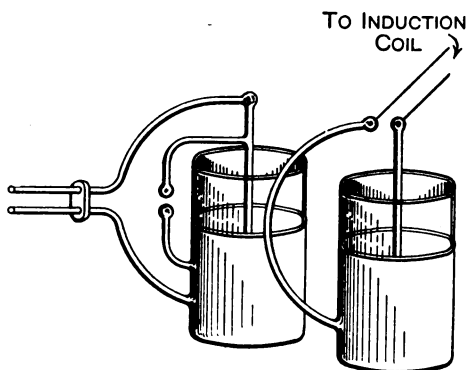

FIG. 14
Lodge syntonic jars

The reason why the maximum effect is produced in the detecting circuit when it has the same frequency as the generating circuit is, that the effect of the waves is cumulative and each impulse is received at the exact time when it will help to increase the amplitude of the oscillations already set up in the circuit. An example of how a large number of feeble impulses can, if they are administered at the right times, produce a great effect is furnished by a heavy weight suspended by a cord or rope. If the weight is lightly pushed it will

ELECTRIC OSCILLATIONS AND WAVES 17

swing to one side, but the amplitude of the swing will be small ; if a second impulse be administered at the moment it attains its maximum amplitude to one side or the other, the effect will be cumulative ; and if a number of such impulses are administered, the weight will eventually attain a very great amplitude.

Sir Oliver Lodge has devised an apparatus for the demonstration of resonance effects, the construction of which is as follows :—a condenser, usually a Leyden jar, and a conductor having inductance were joined across the spark balls of a Rhumkorff coil ; another circuit, consisting of a capacity and variable inductance and having a small spark-gap shunted across the terminals of the condenser, was set up at a short distance from it. When the Rhumkorff coil was set going minute sparks were observed to jump across the small gap in the detecting circuit, but only when, by adjusting its capacity or inductance, it had been brought into resonance with the generating circuit.

CHAPTER II

THE TRANSMITTER

Evolution of Transmitter from Hertz Oscillator—Direct and Inductive Coupling—Condensers for Transmitting Circuits—Inductances and Oscillation Transformer—Spark-Gaps—The Antennæ—Directive Antennæ—Earth Connection—The Induction Coil—Accumulators—Morse Keys—Alternating-Current Transformers—Alternating Currents—Power in A.C. Circuits—Rotary Converters and Motor Generators—Choking Coils—Motor Starting Switch.

WITH the means already described it would not be possible to carry on practical communication over any

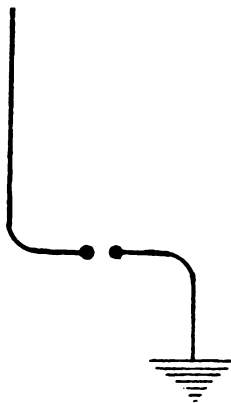

FIG. 15
Marconi plain aerial

considerable distance, and it was not until Marconi brought out his first apparatus that a system suitable for the transmission of messages came into being. Marconi's first transmitter consisted of an induction coil, one side of the spark-gap being connected to an insulated vertical wire termed an aerial, the other side being connected to earth (Fig. 15). In the primary circuit of the induction coil was a morse key, by means of which signalling was effected. It will be seen that this arrangement is a modification of the Hertzian oscillating circuit (Fig. 11): one arm being in a vertical instead of

a horizontal position and the other arm replaced by the earth. The waves radiated from this type of transmitter will not be completely closed loops of electric strain, as was the case with the Hertzian oscillator, but semi-loops having their extremities on the earth, as shown in Fig. 16. The magnetic component will consist of expanding concentric circles having the aerial wire as their centre.

With such an arrangement, used in conjunction with the coherer receiver, it was found possible to carry on communication over a distance of about 100

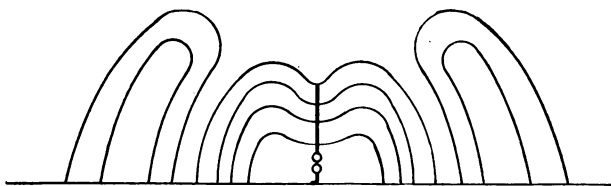

FIG. 16

miles. With a transmitter of this kind it will be seen that the oscillations are generated in and radiated from one and the same circuit. This circuit is an open or good radiating circuit: therefore the decay in the amplitude of the oscillations will be rapid and the energy is practically concentrated in two or three swings. Now suppose a number of receiving stations to be within range: they will all respond to the signals sent out, because the amplitude of the first oscillation is great enough to actuate the detecting device. If we wish to confine the effect to one particular receiver, we must find means to spread the energy over a large number of comparatively feeble impulses, any one of which by itself would be insufficient to actuate the

detector ; in other words, we must find means to generate and radiate feebly damped oscillations. Also we must adjust the receiver so that it has the same frequency as the transmitter. When this is done, the effect of the oscillations being cumulative, their amplitude will eventually be great enough to set the detector in action. A receiver having a different frequency will not be actuated, because the impulses, being administered at the wrong times, will be mutually destructive.

Another disadvantage of the plain aerial transmitter is that no considerable energy can be stored in it. The energy stored in a condenser is equal to half the product of its capacity and the square of the voltage to which it is charged, $E = \frac{CV^2}{2}$. The capacity of a vertical wire with respect to the earth is very small, therefore to impart large energy it must be charged to a very high voltage. The voltage to which the aerial is charged will be determined by the length of the spark-gap. The spark-gap cannot be indefinitely lengthened because as its length is increased its resistance increases also, which results in increasing the damping of the oscillations. The length of the spark-gap cannot advantageously much exceed one centimetre. The problem of selective wireless telegraphy resolves itself into this : That means must be found to generate and radiate feebly damped oscillations ; also, if considerable distances are to be covered, the capacity of the generating circuit must be large in order that considerable energy may be imparted to it.

Sir Oliver Lodge's solution of the problem is a compromise between an open or good radiative circuit and

a closed circuit which is a persistent oscillator and has large energy storage, owing to the large capacity which may be given to it.

Fig. 17 shows the form which his antennæ takes. A and B are capacity areas connected one to each side of the spark-gap; included in the leads are variable

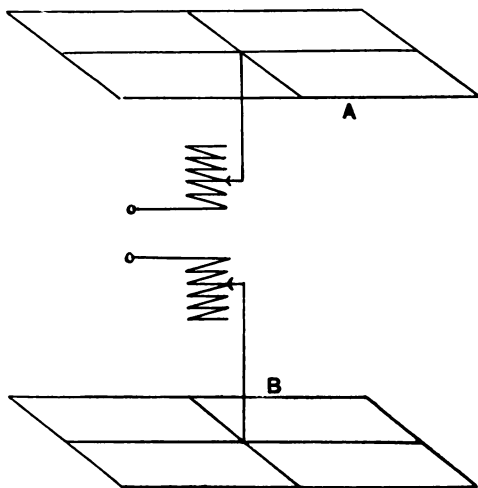

FIG. 17
Lodge antennæ

inductances for tuning. Such an arrangement, by increasing the capacity, enables a much larger amount of energy to be put into the antennæ, also, as it is a partially closed circuit, the oscillations in it will be more persistent, although the radiative properties it possesses are less than those of the vertical wire before mentioned.

The practical disadvantages of the arrangement are

that four masts are required, also considerable ground-space, for its erection. For ship working it would, of course, be impossible or, at the best, very inconvenient

to put up such an arrangement. Other investigators tackled the problem in a different way, by using a closed or non-radiating circuit in which to generate feebly damped oscillations and inductively transferring them to an open circuit from which they are radiated. The capacity of the

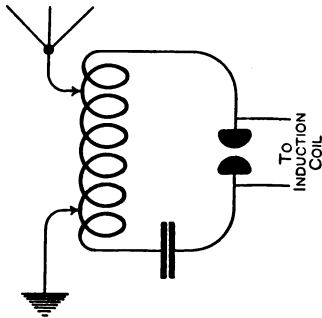

FIG. 18.—Oscillatory circuits of directly coupled transmitter

condenser in the closed circuit can be made large, and therefore the energy storage will be great.

There are several methods of coupling the open and closed circuits together. Fig. 18 shows what is known as the direct method of coupling, the closed circuit consists of a capacity joined in series with a spark-gap and an inductance. The antennæ and earth are connected to two points on the inductance, as shown in the diagram. If a large number of the turns of the inductance are common to both circuits the coupling is said to be close, and if few turns are common to both

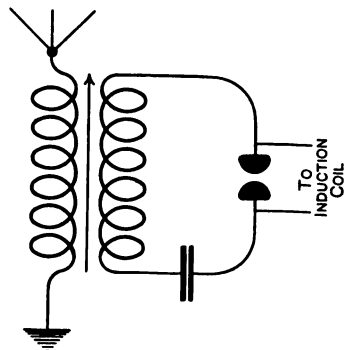

FIG. 19.—Oscillatory circuits of inductively coupled transmitter

is said to be close, and if few turns are common to both

circuits the coupling is said to be loose. The second or inductively coupled method is shown in Fig. 19. In this case the closed circuit is constituted as before, but the antennæ and earth wires are connected to a second coil. If this second coil be placed in such a position, with respect to the first, that all the lines of magnetic force which come into being when oscillations are set up in the closed circuit cut across all the turns in the second coil, the coupling is said to be close, and if it is placed in such a position that only a few of them cut across it, the coupling is said to be loose. When the coupling between the circuits is close, the energy passes from the closed to the open circuit rapidly, and close coupling therefore increases the damping of the oscillations. If the coupling between the circuits is loose, the energy passes slowly from the generating to the radiating circuit, and the damping of the oscillations will be small. There is no essential difference between direct and inductive coupling and in both cases it is necessary that the open and closed circuits should be adjusted to the same frequency. If this is not done, the oscillations in the primary or generating circuit will not be effectively transferred to the open circuit. A convenient method of ascertaining when the two circuits are in tune is to insert a hot wire amperemeter in the earth wire and adjust the circuits till it gives the largest reading.

When two circuits are coupled together there will be mutual reaction between them, which results in two waves of different frequencies and therefore different wave-lengths being emitted. One of the wave-lengths will be greater and one less than the natural wave-length of the circuit. If the coupling between the

circuits is close, the difference between the wave-lengths will be great, but as the coupling is made looser they approach till, when a certain degree of coupling is reached, they are so close together as to practically merge into one. The radiation of waves of two lengths by the transmitter is a disadvantage, because as well as actuating receivers tuned to either wave-length, and thereby producing interference, part of the energy radiated is wasted, as the receiver can only make use of the energy of the wave-length to which it is tuned. The coupling of the transmitter circuits, therefore, should be loose in order to concentrate the whole of the energy radiated into one wave-length and so keep interference at a minimum. The coupling, however, cannot be loosened beyond a certain point without reducing the intensity of the radiated waves and therefore reducing the working distance.

The measurement of the coupling co-efficient is dealt with in the chapter on measurements.

CONDENSERS FOR TRANSMITTING CIRCUITS

In the construction of a condenser for use in the transmitting circuit we have to consider what material used as a dielectric will absorb least energy ; also we must so construct it as to withstand the high voltage to which it will be subjected.

The losses in a condenser may be classed under three heads : first, the dielectric losses due to hysteresis ; secondly, those due to brushing from the edges and corners of the plates ; and, also, as a current is flowing in and out of the condenser during the time it is charging and discharging there will be some energy absorption

due to the resistance of the plates, but if these are made of good conducting material, and are fairly stout, the loss will be so small as to be negligible.

The hysteresis losses vary considerably with the material of the dielectric, and also with the frequency being greater for high frequencies; the measurement of condenser losses is dealt with in a later chapter.

In respect of internal losses an air condenser would be ideal, as the internal losses when air is the dielectric are nil. We are, as a general rule, however, faced with a practical difficulty—namely, the space required for the housing of such a condenser, as, owing to the fact that the dielectric strength of air is small, the plates would have to be a considerable distance apart to withstand the pressure. In practice, therefore, the types of condenser most frequently met with are those consisting of metal plates arranged in a containing vessel and immersed in oil—the oil forming the dielectric—and those in which the dielectric is glass. These also are frequently immersed in oil: the object being to prevent brushing from the edges of the plates. On small-power installations the well-known Leyden jar is by far the most generally used.

The specific inductive capacity of glass is very high, being about nine times as great as air. This, together with the fact that it has great dielectric strength, enables the condenser to be kept within reasonable dimensions. The jars are built up in groups, sufficient being put in series to safely withstand the tension, and then in parallel till the required capacity is obtained.

If the jars show considerable brushing while in use, an improvement may be effected by putting more jars in series and so lessening the tension across each jar;

but if this is done it will, of course, be necessary to add more in parallel to bring the condenser back to its original capacity. The measurement of the capacity of condenser will be dealt with in the chapter on measurements.

INDUCTANCES

In the chapter on high-frequency resistance we shall see that the resistance of a solid metallic conductor of large section is not the same for currents of high and low frequency, but may be much greater for the former by an amount which depends partly on the frequency and partly on the thickness of the wire, the reason being that high-frequency currents, or oscillations, confine themselves to the surface of the conductor and penetrate to no appreciable depth. We shall also see how this increase in resistance may be avoided by using conductors built up of a large number of small wires insulated from each other and joined in parallel.

If an auto-transformer is used it is not practical to construct it in this way, the reason being that connection must be made by clips and to any part of the coil. It is therefore made of flat copper strips, or from copper tubing, which, having a large surface, tends to keep the high-frequency resistance low. The practical shapes taken by the inductances can be seen by reference to the photographs of the various systems.

If magnetic or inductive coupling is used, the coils of the transformer are made from conductors built up of a large number of insulated wires laid together. The methods adopted for adjusting the coupling between the coils vary. In some cases the coils are cylindrical, one coil having a smaller diameter than

the other and being stood within it; the coupling in this case is varied by withdrawing the inner coil more or less. In other cases the coils are made to slide over each other; this type is greatly used by the Marconi Company, and examples of its construction can be seen by referring to the description of their $1\frac{1}{2}$ and $\frac{1}{2}$ kilowatt sets.

SPARK-GAPS

The spark-gap takes various forms: in some systems the spark is taken between blunt rods, in others between balls. Plates and rings are also used, but never sharp points, as these cause premature discharge. The chief point to be considered in a spark-gap is its resistance, which should be kept as low as possible.

It has been found that the resistance of a spark-gap decreases with its length till a certain point is reached, after which it increases with the length of the spark-gap, rapidly if the condenser discharging across it is small, and less rapidly as the condenser is made larger. The length of the spark to give best results for any given transmitter is best found experimentally. A hot wire ammeter should be included in the antennæ and, assuming that the circuits have already been tuned to each other, the spark-length should be varied until the greatest reading is shown on the meter. The resistance of the spark-gap, however, varies not only with its length, but with the amount of energy discharged across it. Thus for a given length of spark the larger the energy the less will its resistance be. For this reason the condensers in the circuit are given as large a capacity as possible.

The voltage required to break down the insulation of the spark-gap depends on the length of the gap, and the size and shape of the discharger. If the latter consists of balls, the greater the radius of the balls the larger will be the voltage required to break down the insulation of the air-gap ; and as it is very important that there should be no brushing or premature discharge, the balls should be of fair size and kept quite smooth.

The disruptive voltage when the spark is taken between points is approximately 30,000 volts per centimetre for spark-lengths up to 2 or 3 centimetres, after this it is somewhat less, as the dielectric strength of air is relatively greater for small thicknesses.

The spark-gap is sometimes placed in a compressed-air chamber, as the voltage required to break down a given spark-length is much greater in compressed air than in air at ordinary pressure : consequently the condenser can be charged to a much higher voltage. The noise from the spark is very great, and it is therefore the practice to enclose it in a muffled chamber, or else to place it in a room by itself, away from the operator. The ozone which is given out by the spark is also very objectionable, and means are therefore taken to conduct it to the outer atmosphere.

The Marconi Company have brought forward of recent years a spark-gap which consists of two discs rapidly rotated, the spark taking place between their peripheries. This form of spark-gap can be used either with direct or alternating current. The advantages claimed are : that although a true oscillatory discharge may take place across the gap the rapid relative motion of the discs effectually prevents the formation of an

arc. When used with direct current the oscillations generated are practically continuous and undamped. This discharger when used with an alternating current supply consists of a metallic disc carried on the shaft of the alternator and fitted with transverse studs equal in number to the poles of the alternator. Two fixed insulated studs, mounted on a carrier of some insulating material, and capable of being rotated through a certain number of degrees about the axis of the discs are connected in the primary oscillatory circuit. The spark takes place at the moment the moving studs approach the fixed studs, and during the greater part of the time the condenser is discharging the spark-gap is practically short-circuited and the resistance of the circuit and consequent damping of the oscillations reduced. By adjusting the position of the fixed studs the condenser discharge can be made to take place at the moment the alternator is giving maximum voltage, and as the number of studs is equal to the number of poles on the machine, one discharge takes place for each half-cycle of current. The advantages claimed for this form of spark-gap are: reduction of damping of the oscillations in the closed circuit by reducing resistance of the gap; no reflux of energy back to the primary, because the spark-gap is opened immediately after the condenser has discharged; and greater regularity in the spark frequency. An example of this type of spark-gap is given in the description of the Marconi $\frac{1}{2}$ kilowatt set in a later chapter.

THE ANTENNÆ

The antennæ is that portion of a Radio-Telegraph installation which radiates or absorbs energy. It

consists in its simplest form of a single vertical wire, but the modern practice is to have a number of wires in parallel. This has the effect of increasing the capacity, and therefore the amount of energy that can be put into it. It also diminishes the resistance of the antennæ and thereby reduces the damping. The wires should not be too close together, but well spaced, if the full benefit in increase of capacity is to be obtained ; this is owing to the fact that if they are close together the distribution of the lines of force is unsymmetrical for each wire. The best material for an antennæ is copper or bronze wire, preferably

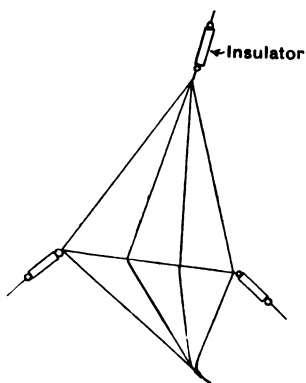

FIG. 20

Inverted fan antennæ

stranded, 7/20 is a very convenient size. The form the antennæ will take depends upon circumstances—such as amount of ground available, number of masts, etc.

Fig. 20 shows a very convenient type : it consists of four wires connected together at the masthead and spread out by means of a rope like an inverted fan. The wires are then bunched together at their lower ends and led into the station. If two masts are

available an excellent antennæ can be constructed, as in Fig. 21, the vertical wires being connected to a horizontal one at their upper ends. A favourite type of antennæ is that shown in Fig. 22 and known as an umbrella antennæ. It consists of a vertical portion from the top of which radiate a number of wires like

the spokes of a wheel; these wires should be connected at their lower ends to another wire which encircles the mast; the horizontal wires, while they

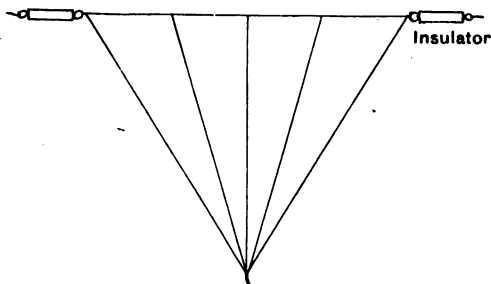

FIG. 21

do not increase the radiation, add largely to the capacity of the antennæ.

As regards antennæ for ships, there is not much

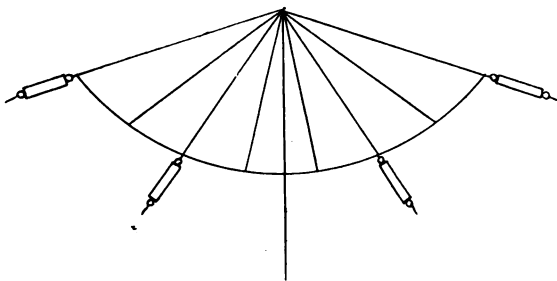

FIG. 22

Umbrella antennæ

choice as to shape, and they usually consist of a number of wires stretched horizontally between the masts, the perpendicular portion being connected about the middle, as shown in Fig. 23.

32 WIRELESS TELEGRAPHY

Care should be taken in the construction of an antennæ to keep it free from points and sharp edges, as brushing is likely to take place from these and the efficiency of the transmitter thereby impaired.

To sum up, the qualities it is desirable that the antennæ should possess are: good radiation, low

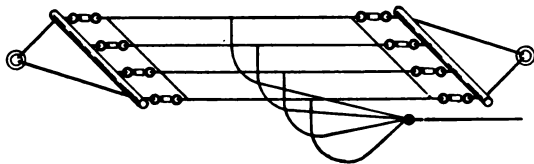

FIG. 23
Ship's antennæ

resistance to high-frequency currents and good insulation, which in the case of conductors carrying high-frequency currents means that not only should they be well insulated for conduction currents, but that they should be kept away from all earthed metal-work, as if they are near to it, and especially if they are parallel to it for any distance, a dielectric current passes.

DIRECTIVE ANTENNÆ

The energy from an ordinary vertical antennæ is radiated equally in all directions. This, in the case of ship stations, is an advantage, because it is not till communication has been established that the position of the ship can be known. In the case of communication between two fixed points it would be advantageous if the energy could be concentrated in the direction of the receiving station, as not only would less interference result, but also the effect produced on the

receiver would be greater by reason of the concentration.

The Marconi Company for their Transatlantic stations use a type of antennæ which, while it does not concentrate wholly in one direction, confines the action of the transmitter mainly in the direction of the receiving-station. This type of antennæ is shown in Fig. 24: it consists of a vertical portion and a horizontal portion, the length of the latter being great compared with the vertical portion.

With an antennæ of this kind the lines of electric strain will stretch much farther out into space in the direction A than in any other direction, because the horizontal portion concentrates them between itself and earth.

The field of action of such a trans-

mitter is roughly like the figure 8, the maximum effect being produced in the direction A, a second but smaller maximum being produced in the opposite direction, whilst in directions approximately at right angles very little effect is produced.

The point at which the detachment of the wave occurs is not at the antennæ itself, but at a distance equal approximately to one quarter of a wave-length from it. Between this point and the antennæ the movement of the lines of strain is sometimes inward, as part of the lines reconnect with the antennæ, but from the point outward from the antennæ the movement of the strain lines is uniformly outward or away from the antennæ. The intensity of the field pro-

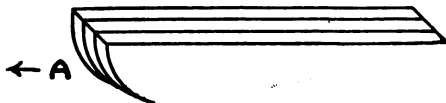

FIG. 24

Marconi directive antennæ

duced about the antennæ diminishes approximately as the cube of the distance from it. The result of the concentration of the lines of force by the horizontal part of the antennæ is that in certain directions the field produced at the point where the wave is radiated is very weak, whilst in the direction A, where the lines stretch far out into space, the strength of the field is great.

INSULATION OF ANTENNÆ

It is very important that the insulation of the antennæ should be of the most perfect description possible. The potential is greatest at the upper part, and it is therefore of the first importance that the masthead insulators should be efficient. A form of insulator commonly used consists of an ebonite rod

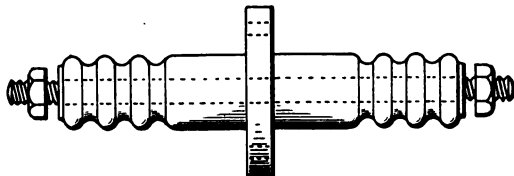

FIG. 25

Leading-in insulator

one or two feet in length and about one and a half inches in diameter, the rod having a screw-eye at each end. They are connected to the antennæ wires and to the spreader, as shown in Fig. 23.

The second point at which special attention must be paid to the insulation is the point at which the antennæ is led into the operating-room.

Fig. 25 shows a type of insulator much used. It

consists of a porcelain tube corrugated on the outside to increase the effective surface and having a metallic rod passing through it which has a terminal at each end: the antennæ is connected to the outer terminal and the lead to the instruments to the inner terminal.

A type of leading-in insulator, almost exclusively used by the Marconi Company and called by them a Bradfield insulator, consists of an ebonite tube three or four feet in length and having, as in the former case, a metallic core passing through it. At the outer end, in addition to the terminal by means of which electrical connection between the antennæ wires and the instruments is effected, is a shackle, the purpose of which is to remove all mechanical strain from it. Instead of being corrugated, a number of ebonite discs are threaded over the tube and serve the same purpose. At the upper end is a metal hood to keep the upper part of the insulator dry.

EARTH CONNECTION

Great difference of opinion exists as to the advisability of earthing the antennæ, Sir Oliver Lodge maintaining that the earthing of an antennæ is inimical to very sharp tuning. The general opinion, however, is that the antennæ should be earthed, and that if the system of earth wires is properly constructed it is beneficial and increases the distance over which signalling can be carried on. In the early days of Radio-Telegraphy it was a common practice to use a copper plate buried in the ground as an earth, but by experiment it was found that the best earth connection

was formed of a large number of wires laid in the ground radially from the station and stretching out from it as far as possible. It is not necessary that the wire should be deeply buried: if the station stands on grass-land it is sufficient to turn up the turf, insert the wires and replace it. At the point where the wires meet they are connected together and led into the station. Fessenden, in America, devised what he called a wave chute, which consists of an arrangement of wires identical with that above described, the wires, however, being laid on the surface of the ground and not buried. In a ship station the earthing is effected by connecting to the side of the vessel.

The lead from the instruments to the point at which it is connected to earth should in all cases be as short as possible.

THE INDUCTION COIL

In a small-power installation the condenser is charged from the secondary terminals of an induction coil. For the benefit of readers not already acquainted with this piece of apparatus we append the following description:—

The coil consists of a soft iron core C (Fig. 26), which is built up of a large number of soft iron wires insulated from each other by varnish. The object of thus subdividing the core is to prevent eddy currents from being set up in it and the consequent loss of energy. Over the core is a winding of thick insulated copper wire P (Fig. 26); this is known as the primary winding. Over the primary winding is wound a large number of turns of fine insulated copper wire S (Fig. 26), which is the secondary winding. The ends of this winding are

brought out to terminals, which are also connected to the spark-gap.

The secondary is not usually wound on in layers extending the whole length of the coil, but in small sections, the object being to prevent high differences of potential from existing between neighbouring turns, which might break down the insulation. One end of the primary is connected to a terminal, the other end being connected to one side of the contact-breaker B (Fig. 26), the other side of which is connected to a second terminal. The contact-breaker consists of a small disc of soft iron carried at the end of a metal strip.

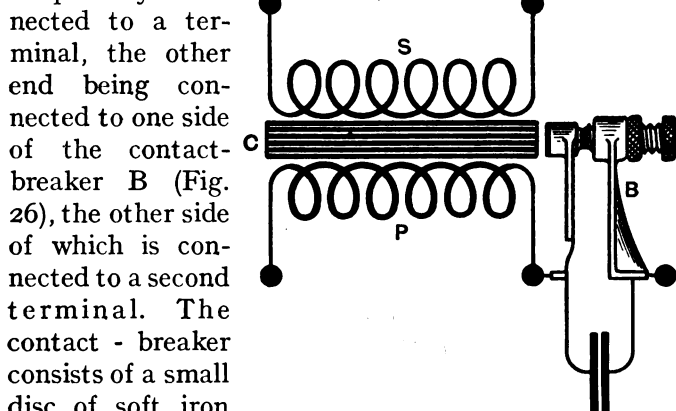

FIG. 26
Induction coil

The iron disc is termed the armature and as mounted is exactly opposite and close to one end of the core. Behind the spring carrying the armature is a brass pillar which has a platinum-tipped adjusting screw, by means of which the play of the armature and the tension on the spring can be adjusted; across the contact-breaker a condenser of large capacity (about 1 mf. for a 10-inch coil) is connected. The action of the coil is as follows:—When a battery is connected to the primary terminals a current will flow

through the primary winding and the core will be magnetised; as the magnetism of the core is increasing the lines of force will cut across the secondary winding and, as is well known, an induced current in the secondary will result. The core being magnetised will attract the armature which, by pulling the platinum contacts apart, will break the circuit, and the lines of magnetic force brought into being by the current in the primary will collapse and again cut the secondary winding, and an induced current will be again set up in the secondary, but in the reverse direction to the first. It will be seen that as soon as the core loses its magnetism the armature will be released and the platinum contacts will again come together, and the cycle of operations will be repeated as long as current is supplied to the coil.

At the moment the armature is attracted by the core a bright spark, due to the self-induction of the primary winding, will be seen at the contacts of the contact-breaker. This spark tends to prolong the current in the primary, and therefore the collapse of the lines of force will not be very sudden. The voltage produced at the secondary terminals will depend upon the number of turns of wire on the secondary winding, upon the number of lines of force cutting it, and upon the speed at which they cut it. If now means can be found to prevent the sparking at the contacts of the coil a much greater effect will be produced in the secondary. The condenser connected across the contact-breaker does this, as the current due to the self-induction of the primary flows into and charges it every time the circuit is broken, instead of forming the spark at the contact-breaker. It will thus be seen that the induced current in the secondary at break is

much greater than at make, and the discharge will therefore be uni-directional, as the effect produced at make is too small to cause a spark at the discharger.

ACCUMULATORS

Accumulators, or secondary cells, are of two types—the pasted type and the formed type. In the case of the pasted type the plates are prepared by pressing oxide of lead into a leaden grid so formed that the paste shall make intimate contact with it and be firmly held in position. The plates are immersed in dilute sulphuric acid and held apart by glass rods or by corrugated celluloid separators. If now they are connected to the poles of a direct-current dynamo or other source of direct current, electrolytic action takes place, which still further oxidises one of the plates, whilst on the other plate the oxide is reduced and the lead rendered spongy or porous: the spongy plate is termed the negative plate, the other plate being the positive.

The plates may be distinguished by their colour—the positive plates being a dark chocolate colour and the negative plates grey. The terminals of a secondary cell are marked + and —, that marked + being the positive terminal and that marked — being the negative terminal.

In the formed type of cell the active material is produced by electro-chemical means. An accumulator cell, when fully charged, has a voltage of about 2·3 volts. To charge such a cell or group of cells the following procedure should be adopted:—

The positive plate of the accumulator should be

connected to the positive pole of the charging dynamo and the negative plate to the negative pole of the dynamo ; included in the circuits should be a variable resistance to regulate the charging current which should not exceed 20 per cent. of the capacity of the cell ; thus, supposing the cell to have a capacity of 50 ampere hours, the charging current should not

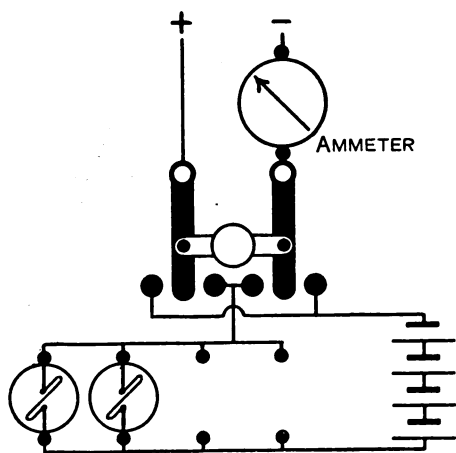

FIG. 27
Accumulator charging

exceed 10 amperes, and preferably should be less. During charging the vent pegs should be removed. The safe discharging rate is about 25 per cent. of the capacity, and the voltage per cell should never be allowed to fall lower than 1.85 volts.

A convenient form of resistance to use when charging accumulators is the ordinary carbon filament incandescent lamp. A board should be obtained and on it should be mounted a number of lamp-sockets connected in parallel ; now obtain a double-pole double-throw switch and connect the accumulators, the switch and the charging dynamo, as shown in Fig. 27. A lamp should now be inserted in one of the sockets and the switch put first in one position and then in the other

and the brightness of the lamp noted. The correct charging position will be that in which the lamp is least bright, because the voltage of the accumulator is then in opposition to the voltage of the dynamo, or, in other words, the positive pole of the dynamo is connected to the positive pole of the accumulator. The correct charging current is obtained by inserting more lamps in the sockets until ampere meter shows the right reading. The lamps must, of course, be of the same voltage as the charging dynamo.

The faults most likely to occur are the following:—
Buckling of the plates, due in most cases to excessive rate of discharging; the same cause is also frequently responsible for the disintegration of the plates which sometimes occurs. Another fault to be guarded against is the sulphating of the plates, an insoluble substance termed sulphate of lead forming on the plates, the cause may be any of the following:—too strong a solution of acid, discharging the cell too low, by undercharging or by leaving the cell partially discharged for long periods without removing the acid. The remedy is to give the cells a prolonged charging at a low charging rate. The acid solution is made up of 9 parts water and 1 part commercial sulphuric acid, the specific gravity of the acid solution being about 1.2.

Most makers of storage batteries send out full instructions with them, as to charging and discharging rates and general treatment—and it will conduce to the long life and satisfactory working of the cells if these instructions are faithfully followed.

MORSE KEYS

For small-power installations the Morse keys used are not very different from those employed in ordinary land-line telegraphy, the only difference being that the platinum contacts are larger; when, however, it is desired to interrupt large currents precautions must be taken to eliminate the heavy sparking which occurs when the key is opened.

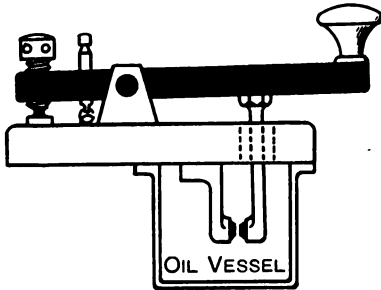

FIG. 28.—Oil break key

Fig. 28 shows a form of Morse key much used in the larger installations; it will be seen that the contacts of the key are immersed in oil, which, when the circuit is broken by the opening of the key, flows into the gap and effectually prevents the formation of an arc. In some installations sparking at the key is eliminated by shunting a condenser of large capacity across the contacts. For use on an alternating current circuit a key shown diagrammatically in Fig. 29 is sometimes used.

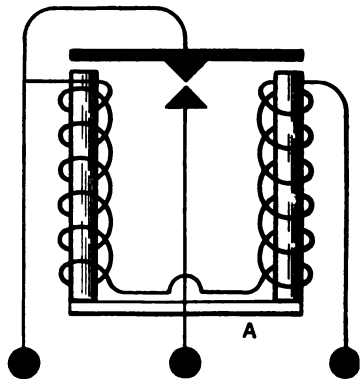

FIG. 29.—Magneti key

It is known as a minimum break key, and its action is as

follows :—when the circuit is closed by the depression of the Morse key the current flows through the coils of the magnet A, which forms part of the circuit. The magnet, being thus excited, attracts the armature and closes a second pair of contacts which are in shunt with the contacts of the Morse key. If now the Morse key is opened the auxiliary contacts will not immediately follow but will remain closed until the alternating current is at or near zero. It will thus be seen that there is no danger of an arc forming, as the circuit is not broken until the current is practically nil. The key is provided with two adjusting screws : one to regulate the play and the other to regulate the tension of the spring which pulls the contacts apart when the excitation of the magnet is too feeble to hold the armature. Fig. 30 shows the way in which the minimum break key is connected in circuit and with the signalling key.

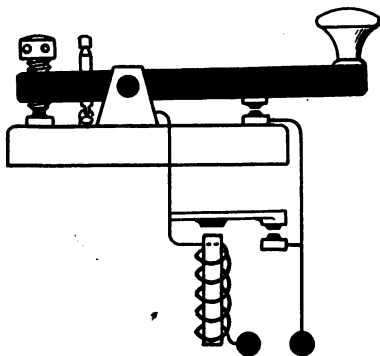

FIG. 30

two adjusting screws : one to regulate the play and the other to regulate the tension of the spring which pulls the contacts apart when the excitation of the magnet is too feeble to hold the armature. Fig. 30 shows the way in which the minimum break key is connected in circuit and with the signalling key.

ALTERNATING-CURRENT TRANSFORMERS

In stations intended for long-distance working it is necessary to use much larger energies than an induction coil is capable of dealing with ; recourse is therefore had to an alternating-current transformer which can be built for practically any power required. The

purpose served is exactly the same as that served by the induction coil that is to step up or increase the voltage of the current used to charge the condenser. In construction it is somewhat similar to the induction coil. It consists of a laminated soft iron core on which is the primary winding of large gauge copper wire. Over the primary winding is the secondary winding, which consists of many more turns of wire but of smaller gauge. The ratio of the voltages at the terminals of the primary

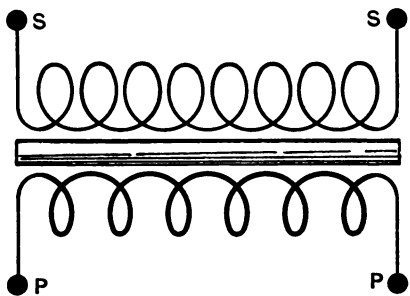

FIG. 31

Alternating-current transformer

and secondary windings will be equal to the ratio of the number of turns on the two windings. As an example, suppose there are 100 times as many turns on the secondary as there are on the primary, then the voltage at

the secondary terminals will be 100 times as great as the voltage at the primary. There is no need for an interrupter on the primary circuit, because the current supplied being alternating the lines of force will cut across the secondary coil as it rises and falls and a current will be thereby induced in it. Owing to the high voltage on the secondary, great care must be taken to secure perfect insulation, and to this end the transformer is usually immersed in oil of high insulating properties. For the purposes of wireless telegraphy it is usual to supply current at from 100 to 500 volts and to transform it up to 20,000 or 30,000 volts.

ALTERNATING CURRENTS

If a current of electricity periodically passes through a series of changes, both in direction and strength, it is termed an alternating current. The time taken by one complete cycle of changes is termed the period and the number of cycles per second is the frequency of the alternating current. Fig. 32 illustrates the cycle of changes. The divisions along the line X, Y represent intervals of time, and the strength of the current at

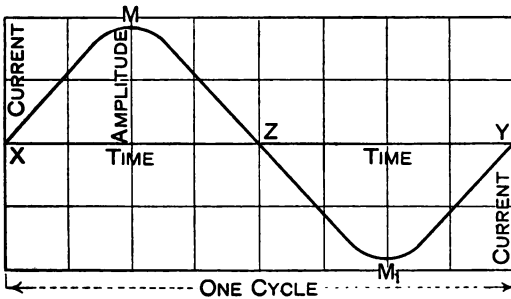

FIG. 32

any instant is represented by the length of the ordinal above or below the line X; Y, according to whether it is positive or negative. Starting at the point X the current value is zero, as we continue along the line X; Y it increases in value till at the point M it is at a maximum. It then diminishes till at the point Z it is again zero; then changing its direction of flow round the circuit it reaches a negative maximum at M₁; after which it again falls to zero. A fresh cycle of changes is then commenced. If an ampere meter be included in an alternating-current circuit its reading, since the current is constantly varying, will be some intermediate value

between the limits of the variations. It might perhaps be thought that this reading would be the mean or average value of the current, but this is not the case: the reading shown by the meter is the square root of the mean of the squares of the current. This value is termed the "virtual" value of the current. In the case of the volt meter the reading shown will be the square root of the mean of the squares of the volts and the reading will therefore show the "virtual" volts.

Suppose the ampere meter to be first calibrated by means of a direct current; then if the meter is used on an alternating-current circuit and gives a reading of, say, 100 amperes that really indicates that the current in the circuit rises to a maximum value of 141.4 amps. and then attains a negative maximum of the same value. The term virtual volts or virtual amperes really means the value of the direct and continuous voltage or current required to produce an equal effect.

POWER IN ALTERNATING-CURRENT CIRCUITS

In a direct-current circuit the power in watts can, since it is the product of volts and amperes, be obtained by multiplying together the readings on the volt and ampere meters. In an alternating-current circuit containing resistance only the power in watts can be obtained in like manner. If, however, the circuit has inductance or capacity we can no longer rely on the meters to give us the power in the circuit. This is owing to the fact that the alternating currents in the circuit will not attain their maximum at the same time as the alternating volts impressed on the circuit. If inductance is present in the circuit the current will

lag behind the volts, and if capacity is present in the circuit the current will be in advance of the volts. The curve (Fig. 33) shows the lagging effect when inductance is present in the circuit.

To find the power in such a case we should have to

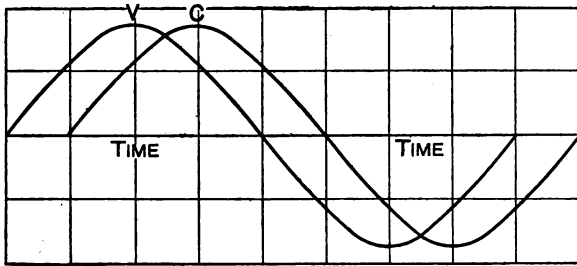

FIG. 33

multiply the product of the meter readings by the power factor of the circuit, which is equal to the cosine of the angle of lag.

The power may, however, be measured directly if we are in possession of a suitable watt meter which will take account of any phase difference which may exist.

ROTARY CONVERTERS AND MOTOR GENERATORS (SINGLE PHASE)

The purpose for which a rotary converter is used on a wireless telegraph transmitter is to convert a direct current into an alternating current. The machine is similar in construction to a shunt-wound direct-current motor, but in addition to the commutator it is furnished with slip rings and brushes which are carried on the opposite end of the shaft. Two tapping points are made on the armature winding (which, in the case

of a single-phase machine, are 180 degrees apart) and are connected to the slip rings. There are usually two or more pairs of poles on the field magnets, this being necessary if we are to obtain the required frequency without revolving the armature at an excessive speed. The direct-current side of the machine is connected up to the starter and field-regulating resistance exactly as an ordinary shunt-wound motor.

The relation between the direct voltage and current and the alternating current and voltage will be if the D.C. voltage and current are each 100—70·7 volts 141 amps. alternating.

Another type of machine called motor generators are also frequently met with on wireless installations and serve the same purpose as the rotary converter. These machines consist of a direct-current shunt-wound motor coupled on the same shaft as an alternating-current dynamo, the field magnets of the alternator being excited from the same source as that which drives the motor.

CHOKING COILS OR REACTANCE REGULATORS

When inductance is present in an alternating-current circuit it will have another effect besides the retardation of phase already mentioned. The current in an alternating-current circuit, as we have already seen, rises and falls, and the lines of magnetic force which are set up round the conductor will therefore cut across it and an induced current will result. These self-induced currents must be taken into account, as they react on the electro-motive force and tend to prevent the

current from rising. The self-induced electro-motive force will be a maximum when the rate of change of the current is greatest, and zero when the rate of change of current is zero, therefore the reactive impulses of electro-motive force will be exactly ninety degrees behind the current.

If in an alternating-current circuit the resistance is small and the inductance great it is the inductance which will determine the current in the circuit. The quantity $\sqrt{R^2 + (2\pi nL)^2}$ is termed the impedance of the circuit, and it will readily be seen that if R , which equals the ohmic resistance of the circuit, is small, L , which equals the inductance, will be the controlling factor in determining the current in the circuit. In the above formula n equals the frequency of the current $\pi = 3.1416$; if the circuit contains capacity as well as inductance the impedance will be $\sqrt{\left[R^2 + \left(2\pi nL - \frac{I}{2\pi nK} \right)^2 \right]}$ when K equals the capacity of the circuit.

In the alternating-current circuit of a wireless transmitter the resistance is usually small and the current is therefore regulated by means of a variable inductance usually termed a reactance regulator. Fig. 34 shows such a piece of apparatus. Tapping points are made at intervals

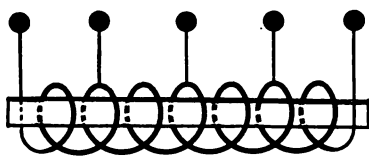

FIG. 34
Reactance regulator

along the coil and brought out to terminals to which the circuit leads are brought and a greater or less amount of inductance included. The reactance regulator therefore serves the same purpose in an

D

alternating-current circuit as a variable resistance does in a direct-current circuit.

MOTOR STARTING SWITCH

The resistance of the armature winding of a motor is low, and if the full voltage of the supply mains were applied to it while at rest the result would be that

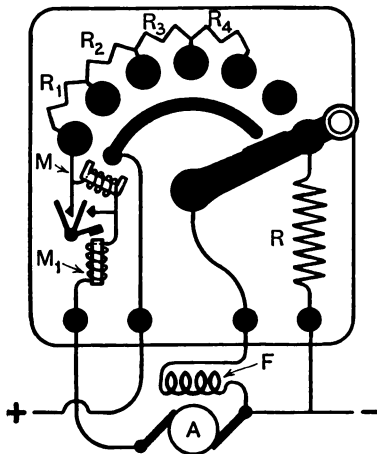

FIG. 35

Motor starting switch

the insulation would be destroyed, owing to the heating of the conductor by the very large current which would pass. When the motor is running an E.M.F. is set up due to the fact that the armature coils are revolving in a magnetic field; the E.M.F. so generated is in opposition to that of the supply mains and the total electro-motive force acting on the armature is therefore the

difference between the two. It is therefore necessary during the time the motor is starting to place a resistance in series with the armature winding to keep the current through it low. This is done by means of a piece of apparatus known as a starting switch.

The starting switch (Fig. 35) performs the following operations and in the order named. When moved from its position of rest it first makes contact with a

segment which completes the circuit through the field coils, which are then fully excited, it next closes the circuit through the armature of the motor, the starting resistances being in series with it. As the motor gathers speed the switch arm is moved further round, and the resistance diminished step by step until, when the motor has attained its maximum speed, they are finally cut out altogether. In starting the motor, the switch should only be kept on each segment long enough for the motor to attain its top speed for that segment and then moved on to the next. If this is not done, and the arm is kept too long on one segment, it may result in the heating up of the starting resistances. Referring to the diagram, M is an electro-magnet whose coil is included in the main circuit, the function of this magnet is to hold over the arm of the switch while the motor is running, and if from any cause the supply current is cut off from the mains the arm will be released, and by the action of a spring will be carried to the off position. The motor will thus be protected from the damage that would occur if it had come to rest and the supply current was switched right on the armature without the starting resistance being in series with it. M_1 is also an electro-magnet whose coil is included in the main circuit. The function of this coil, which is termed an overload release, is to automatically cut off the supply current should it from any cause rise to dangerous proportions; it does this in the following way. The coil is furnished with an armature so arranged that the normal current flowing through the coil is insufficient to attract it, but if the current is increased beyond a certain value the armature will be pulled down and when in this

position will short-circuit the coil of the magnet M , and the switch arm being thus released will move over to the off position.

Referring again to the diagram, F is the field-magnet coil, A the armature of the motor, R_1 , R_2 , R_3 , and R_4 the starting resistances, and R is a resistance about equal to the field-magnet coils. It will be seen that when the motor is stopped the arm of the switch in moving back to its position of rest will put this resistance in parallel with the field coils before their circuit is broken, the function of the resistance being to take up the current induced by the opening of such a highly inductive circuit as the field magnets ; if this precaution were not taken it is probable that the insulation of the field-magnet coils would be damaged.

CHAPTER III

THE RECEIVER

Arrangement of Receiving Circuits—Practical Construction of Tuners

IN the earlier forms of receiver the detector was inserted directly in the base of the antennæ. With such an arrangement, owing to the damping of the oscillations by the detector, little use could be made of resonance and the detector would be actuated by oscillations of any frequency which were in the antennæ.

The present-day practice is to place the detector in a subsidiary circuit which is either directly or inductively coupled to the antennæ circuit. The arrangement of the circuits when direct coupling is used is shown in Fig. 36.

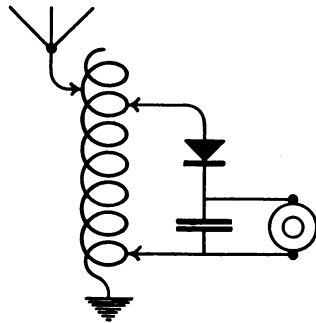

FIG. 36
Circuits of directly coupled receiver

The tuner consists of a former of some insulating material wound with insulated copper wire, the insulation of the wire being removed for a small space on each turn to enable metallic connection to be made by a sliding contact. The tuning is effected by varying the amount of inductance in the antennæ

circuit and the coupling of the detector circuit is also varied by means of the sliding contacts the position of which determine how much of the inductance is common to both circuits.

Such an arrangement has the merit of simplicity inasmuch as there is only one variable and if the coil is of fair size a large range of wave-lengths can be covered. In actual use it has been found that the sliding contact is apt to become dirty and make indifferent contact with the coil which by introducing resistance increased the damping and thereby weakens the signals.

When using a tuner of this kind it is not possible to get very fine tuning, but as a call-seeking device, or where by reason of inability to secure highly skilled operators extreme simplicity is necessary, it has its advantages.

The method of inductive coupling is the one most generally used, the tuners usually consist of three circuits, a primary or antennæ circuit, a secondary circuit which is tuned to the primary and coupled to it and a tertiary circuit which is untuned and contains the detector.

The coils for such a tuner should preferably be laminated—that is to say, instead of using a solid copper wire it should be built up of a large number of very small insulated wires laid side by side. The reason for this is that when a conductor is traversed by high-frequency currents, the current tends to confine itself to the surface and penetrates to no appreciable depth ; the resistance of the wire is therefore many times higher for currents of high frequency than for steady currents. As, however, a conductor built up of many insulated

strands has a very large surface, the difference between its resistance to high-frequency currents and its resistance for steady currents will not be great, as would be the case with a solid conductor whose surface is small compared with its cross-section. It is also advisable that the coils should not be too closely wound, as close winding tends to confine a high-frequency current to a

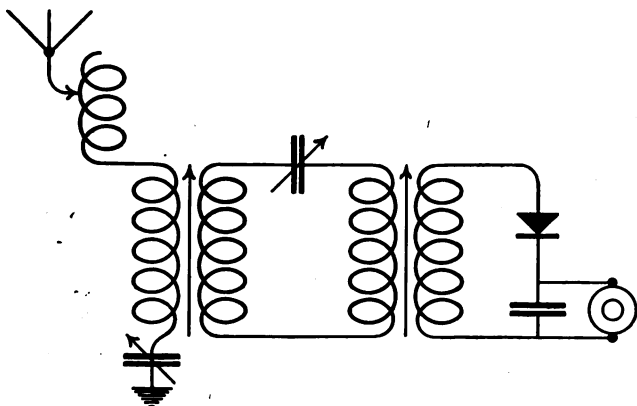

FIG. 37

Circuits of inductively coupled tuner with intermediate circuit

certain part of the surface of the wire, and this also, it will be seen, would still further increase the resistance. Fig. 37 shows diagrammatically the arrangement of an inductively coupled tuner. As will be seen, the tuning of the primary circuit is effected by means of the variable inductance and the variable condenser which is in series with the antennæ. The object of providing both a variable inductance and a variable condenser in this circuit is to enable the operator by means of the inductance to tune in wave-lengths

greater than the natural wave-length of the antennæ, and by means of the condenser to tune in wave-lengths shorter than the natural wave-length of the antennæ.

The secondary or intermediate circuit is a closed and feebly damped circuit. It consists of inductance and capacity in series, the condenser being variable. (In the diagram the inductance is shown as consisting of two coils ; this need not be and in fact very often is not the case, but is so shown simply to make the diagram clearer.)

The tertiary circuit consists of the coil fixed capacity and the detector. The function of the condenser in this circuit is to act as a shunt to the telephone, which by reason of its high self-inductance would act as a choking coil and prevent oscillations from being set up in the circuit. The capacity of this condenser to produce the best results will depend upon the resistance and inductance of the telephones and also on the spark frequency of the transmitter. Generally speaking, if high-resistance telephones are used the capacity of the condenser is small, and if low-resistance telephones are in use the capacity will be greater. In some installations the capacity of this condenser is variable in steps, but the optimum value is not very sharply marked.

The action of the tuner is as follows. On the primary circuit being tuned to the transmitter from which it is desired to receive signals oscillations are set up in it and the primary, acting inductively on the secondary, which is loosely coupled to it, passes the oscillations on, the secondary circuit in turn acting inductively on the detector circuit. It will be seen

that owing to the looseness of the coupling no considerable effect can be produced in the secondary circuit except by resonance and it must therefore be exactly in tune with the primary. Any oscillations of different period that may exist in the antennæ circuit will not be passed on to the secondary and so are prevented from actuating the detector. The rejection of signals not absolutely in tune is one of the chief advantages of the inductively coupled tuner, as considerable inter-

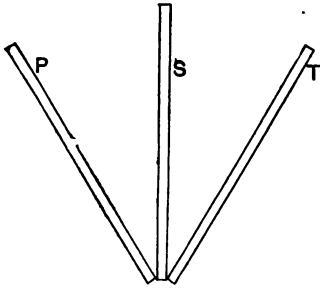

FIG. 38

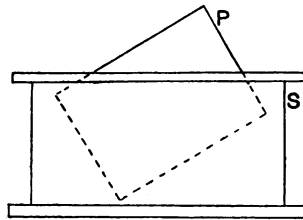

FIG. 39

ference from neighbouring stations working on only slightly different wave-lengths is avoided. In actual practice the tuners take various shapes, in some the coils are mounted on a rod on which they can slide and the coupling varied by bringing them nearer or farther apart. In others the coils take the form of flat spirals mounted on sheets of ebonite which are hinged together like the leaves of a book and the coupling varied by opening or closing the leaves (Fig. 38). In the most practical form the tuner consists of two coils placed one within the other, the inner one being so arranged that its plane can be turned

58 WIRELESS TELEGRAPHY

through an angle of 90 degrees and the coupling thus varied (Fig. 39). The tertiary in this case is not a

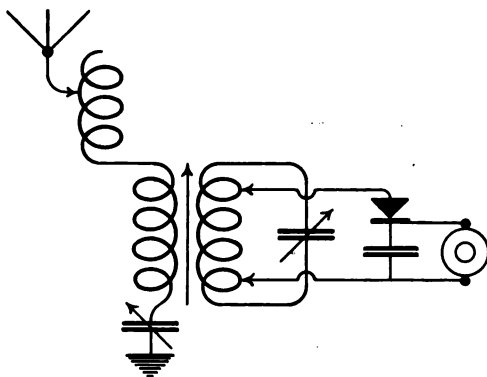

FIG. 40

separate coil, but is formed by tapping off a few turns of the secondary (Fig. 40).

CHAPTER IV

DETECTORS OF ELECTRICAL OSCILLATIONS

Marconi Coherer Receiver—Lodge Muirhead Coherer—
Electrolytic Detector—Carborundum Detector—Fleming
Valve—Thermo-Electric Detectors—Magnetic Detector—
The Telephone Receiver

THE detectors used in Radio-Telegraphy may be broadly divided into two classes: those that are potential actuated and those that are current actuated: the former are always joined across the terminals of the condenser, as the potential differences are largest there, and the latter or current-actuated variety are connected in series with the condenser. Detectors may also be further subdivided into classes—namely, imperfect contact devices, such as the Marconi coherer; rectifying devices, such as the Fleming valve and the carborundum detector; electrolytic detectors, as those of Fessenden and Schломilch; the thermo-electric type, formed of galena against graphite, and various other combinations, and those that depend for their action on the alteration of their magnetic properties: in this class is the Marconi magnetic detector.

THE COHERER

The coherer, which is the result of the work of many men—Hughes, Lodge, Branley and Popoff among

others—consists essentially of a small quantity of metal filings lying loosely between metallic electrodes. The first practical form of the device for telegraphic purposes was brought out by Marconi, and consisted of a very small quantity of nickel filings, to which were added a small percentage of silver filings, lying between silver electrodes having bevelled ends so that the space between them, in which were the filings, was wedge-shaped.

The purpose of thus bevelling the plugs is to enable the sensitiveness of the coherer to be adjusted. The most sensitive position is when the nose of the wedge



FIG. 41
Marconi coherer

is pointing downward and the reverse position is that of least sensitiveness.

The plugs and filings are enclosed in a glass tube, which is exhausted to a partial vacuum, and the wires connected to the plugs pass out through the ends of the tube (Fig. 41).

The coherer depends for its action on the fact that, if its terminals are subjected to a potential difference above a certain value, the resistance due to the loose contact between the filings and plugs suddenly falls to a much lower value ; some investigators think that ordinary electro-static attraction is a sufficient explanation of its behaviour, others hold that microscopic sparks pass between the filings and slightly weld them together ; however this may be, the fact

remains that, after being subjected to the potential differences set up by the oscillations, the resistance falls enormously, and if the coherer is joined up with a relay and cell, and the relay contacts joined up with a Morse writer and battery, the passage of electrical oscillations will be made evident by the closing of the relay circuit and consequent recording of signals. As, however, the coherer will not of itself resume its

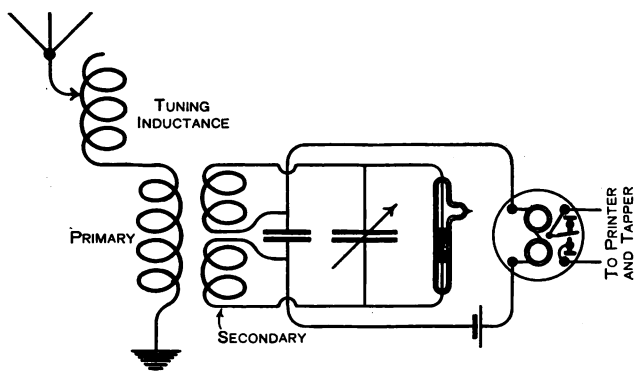

FIG. 42

Circuits of Marconi coherer receiver

former high resistance a small electro-magnetic hammer is provided to tap gently on its under side, and by shaking the filings loose it restores the coherer to its high resistance and again renders it sensitive to oscillations.

Fig. 42 shows the circuits of the Marconi coherer receiver. The antennæ circuit consists of tuning inductance and primary of oscillation transformer joined in series and connected to antennæ and earth. The secondary winding of the oscillation transformer

is cut in the middle but its continuity for electrical oscillations is preserved by the insertion of a condenser. To the ends of the secondary winding is connected a variable condenser for tuning it to the primary and across this latter is the coherer.

The relay with a single dry cell in series is connected across the condenser inserted in the break of the secondary winding. To the contact terminals of the relay are joined a battery of cells in series with the Morse printer, and in parallel with the printer is

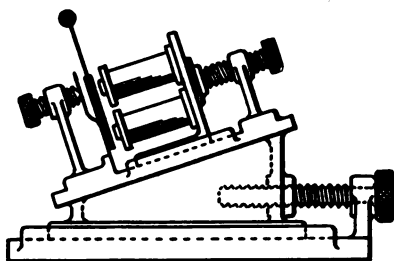

FIG. 43
Marconi decoherer

the tapper, the function of which is to shake loose the filings in the coherer after it has been actuated by the oscillations.

Owing to the high self-induction of the relay, printer, and tapper coils, it is essential that they

and also the contacts of the relay and tapper should be shunted by high non-inductive resistances to eliminate the sparking which would otherwise occur and which, though small, would be sufficient to actuate the coherer.

The adjustment of the various circuits and pieces of apparatus comprised in the above-described set is usually thought to be a difficult matter, but if it is systematically done it will be found fairly simple. The operator should proceed as follows:—first, by means of the adjusting screw set the magnet of the tapper as far away from its armature as is possible, then adjust the knob of the tapper so that it is at the distance of

about one millimetre from the coherer. The next step is to turn the adjusting screw of the relay till the local circuit closes and then to slowly turn it in the reverse direction till it just opens. Test letters should now be sent on the buzzer (the buzzer is a small trembler movement worked by a dry cell and constitutes a generator of feeble electrical oscillations), and at the same time the magnet of the tapper made to gradually approach its armature till the strength of the beat is sufficient to give good sharp signals on the Morse pointer.

If the beat is too weak the signals will tend to run together, and if it is too strong they will be cut up—that is to say, the dashes will appear as a series of dots. The whole of the apparatus above described, with the exception of the printer, is enclosed in a metallic box to prevent damage to the coherer from the powerful oscillations which would be set up in the circuits when the transmitter was in use.

LODGE MUIRHEAD COHERER

This coherer, which may be used either with a telephone or with a syphon recorder, is constructed as follows:—a small metallic cup A (Fig. 44) contains a globule of mercury on which is placed a small drop of oil, which forms an infinitely thin insulating film over it; above the globule of mercury is a small iron disc with a sharp edge and which is slowly rotated. By means of an adjusting screw the lower

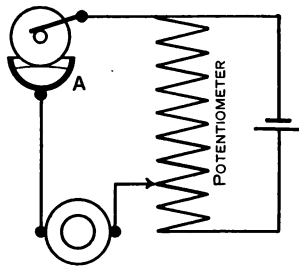

FIG. 44
Lodge Muirhead coherer

edge of the disc is made to touch the oil-covered mercury, but the pressure is not so great as to puncture the film of oil. In series with the coherer is joined a dry cell and telephone receiver, or syphon recorder, as the case may be, and the passage of electrical oscillations, by breaking down the insulating film of oil, allows the cell to operate the receiving instrument. This form of coherer is self-restoring and needs no tapping arrangement.

ELECTROLYTIC DETECTOR

This detector consists of a platinum cup containing a solution of dilute acid. The cup forms one electrode and the other consists of a wollaston wire sealed into a glass tube, which is drawn out very fine and then broken off, leaving only the cross-section of the wollaston wire exposed. Connection is made to the wire by means of the metal tube in which the electrode is mounted. The detector with high-resistance phones in series with it is tapped across two points of a potentiometer which has a battery across its terminals. The small current which passes through the detector polarises it—that is to say, gas is formed at the electrodes and the resistance thereby materially increased. If now the arrangement be subjected to the small alternations of potential and current set up in a receiving circuit by the impact of electrical oscillations it will be depolarised, and the resistance of the electrolytic cell falling, a small current will pass through the phones and will be audible to the operator ; after the arrival of each wave train the battery again polarises the cell, the device being thus self-restoring.

To adjust the cell, the small electrode having been inserted in the holder and its point dipping into the electrolyte, the arm of the potentiometer is moved round till a hissing noise is heard in the phones, it is then moved back until the noise just ceases. The detector is then in its most sensitive condition. This form of detector is in extensive use, and is very sensitive and reliable ; it has been found, however, that

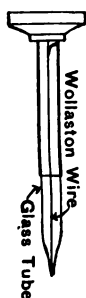

FIG. 45

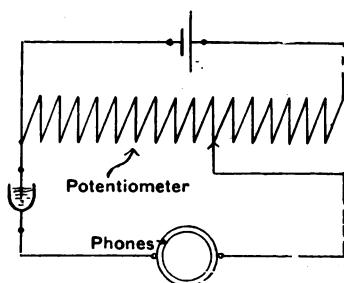

FIG. 46
Electrolytic detector

atmospheric disturbances, if at all strong, render the device insensitive, but not permanently so, as it restores itself in the course of a few seconds. The restoration may be accelerated by momentarily increasing the voltage across its terminals by moving the arm of the potentiometer round a little. Fig. 45 shows the wollaston wire electrode and Fig. 46 the method of connecting the detector with battery and potentiometer.

CARBORUNDUM DETECTOR

The carborundum detector is very simple in construction, and may consist simply of a small car-

borundum crystal held between two brass springs. It works by virtue of the fact that carborundum has what is termed an unilateral conductivity. Supposing a crystal of carborundum be joined in series with a battery and galvanometer, and the current noted, and the poles of the battery reversed and the current again noted, it will be found that the two currents differ greatly although the electro-motive force of the battery has remained unaltered. This shows that for currents in one direction carborundum has a very high resistance and is practically an insulator, but for currents in the reverse direction it is comparatively a good conductor. It will thus be seen that a crystal of carborundum can act as a rectifier and change an oscillatory or alternating current into a direct current. Many crystals beside carborundum possess an unilateral conductivity, but not in such a marked degree.

It has also been found that for certain voltages the unilateral conductivity of the crystal is greater than for others, and in practice therefore it is usual to tap the crystal across two points of a potentiometer to the terminals of which a battery is joined. The detector is fairly sensitive and reliable, and is greatly used in the United States.

FLEMING VALVE

The Fleming valve detector consists of a carbon or tungsten filament lamp, in the bulb of which is also included a metal plate insulated from the filament, and the connecting wire of which is brought through the glass wall of the bulb to a third terminal outside. If the filament be rendered incandescent by the applica-

tion of a suitable battery to its terminals the space between the filament and the insulated plate will be found to possess an unilateral conductivity, and if it be now included in a circuit in which oscillations are taking place it will by its rectifying action convert them into an unidirectional current

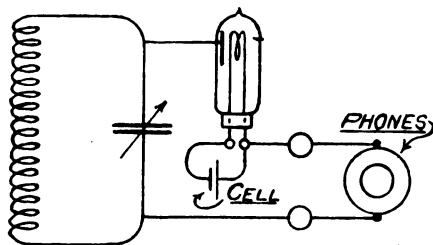

FIG. 47
Fleming valve

capable of actuating a telephone receiver. The valve is shown in Fig. 47, which also shows the method of connecting it to the circuit.

THERMO-ELECTRIC DETECTORS

If the junction between two dissimilar metals forming part of a closed circuit be heated a current will be produced in the circuit. For instance, suppose we take a piece of the metal bismuth and a piece of antimony, place them in contact and connect their free ends to a suitable galvanometer we shall find that if the junction be heated to a higher temperature than the rest of the circuit that a current will flow in the direction bismuth to antimony, the current being proportional to the excess of temperature. In any good text-book on electricity will be found a table showing the thermo-electric series of metals with their thermo-electric power or electro-motive force per degree centigrade when used in conjunction with lead. For instance,

suppose we formed a couple of tellurium and lead and heated it 1 degree centigrade above the rest of the circuit, the E.M.F. produced would be about 500 microvolts.

It has been found that some of the metallic sulphides, for instance, galena, exhibit very marked thermoelectric power and therefore galena usually forms one of the elements in a thermo-couple when used as a detector for wireless telegraphy.

Two very efficient combinations for the purpose are

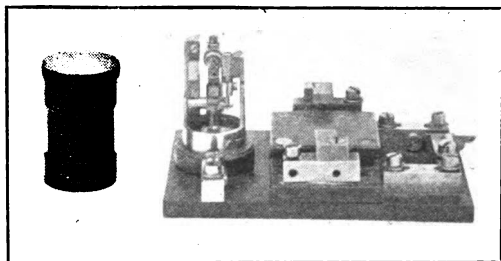

FIG. 48

galena graphite or galena tellurium, both being extremely sensitive. The construction of such a detector can be seen from Fig. 48. The galena crystal is soldered in the holder by woods metal (this metal will melt in boiling water) and the graphite may be any fairly hard pencil, the refills sold for use with propelling pencils being very convenient.

A small screw is provided for adjusting the pressure. Being a current-actuated device, the thermo-junction is connected in series with the condenser, and on the passing of oscillations it is heated and a small potential difference thereby is created at its terminals and

charges the condenser which discharges through the telephone receiver.

With a good galena crystal the detector requires very little attention, but the passage of strong atmospherics sometimes throw it out of order, due no doubt to its behaving like a coherer and the surfaces of the electrodes becoming slightly welded together. If the graphite and galena are just pulled apart and then allowed to come together again it will be found that its sensitiveness is fully restored.

MAGNETIC DETECTOR

The Marconi magnetic detector consists of an endless band built up of 70 strands of number 40 silk-covered iron wire. The band passes over two grooved pulleys which are kept in rotation by a clockwork motor and at a certain point in its journey passes through a small glass tube wound for a length of about two centimetres with a layer of number 36 silk-covered copper wire the ends of this wire which form the primary winding being brought out to terminals. Over this winding is a small bobbin wound with wire of the same gauge to a resistance of about 140 ohms, this forms the secondary winding and the ends are taken to terminals to which the telephone receivers are also connected. Above the coils are arranged two permanent horseshoe magnets, with like poles together as shown in diagram. The detector depends for its action on the fact that electrical oscillations have the ability to annul the magnetic hysteresis of iron. Reference to Fig. 49 will perhaps help to make this plain. Suppose a certain piece of soft iron, say the core of an alternating-current

transformer, to be subjected to a magnetising force H which rises to a maximum, descends to zero, then attains a maximum in the reverse direction and again descends to zero, it will be found that if the magnetising force H is plotted against the density of the lines of force B the curve will assume the shape shown in Fig. 49. Starting from zero, if the magnetising force is gradually increased to the maximum and the value of the flux density for each increment of the magnetising force noted, we get the curve to

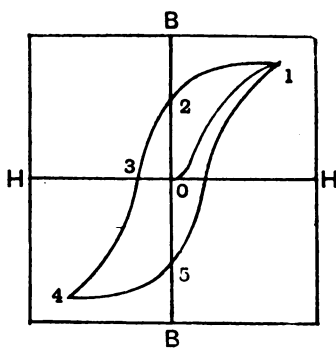

FIG. 49

1. If now the force is decreased to zero the curve will not return on itself, but will follow the direction 1, 2, and if the iron be now subjected to a magnetising force in the reverse direction the curve will take the position 2, 3, 4, 5. It will thus be seen that the magnetic effect produced on the iron owing

to its hysteresis lags behind the magnetising force operating to produce it, and that after it has been magnetised it will retain its magnetism for some time after the withdrawal of the magnetising force. It is this lagging that the electrical oscillations passing through the primary annul. Consider now the magnetic detector itself. We have here a soft iron band passing before the poles of two permanent magnets, as each portion of the band passes the poles it becomes magnetised and by the action of the clock-work motor this magnetised portion is carried forward.

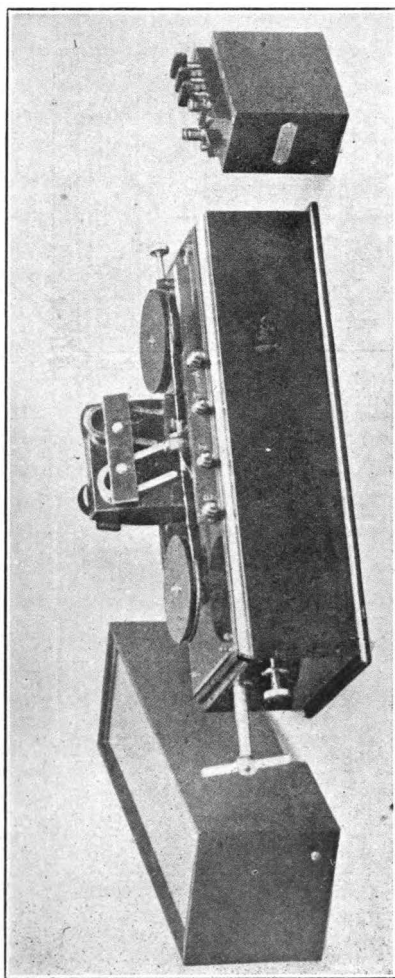

FIG. 50
Marconi magnetic detector (cover removed) and telephone condenser

If now electrical oscillations pass through the primary windings the hysteresis of the band is annulled and the magnetised portion which has moved out of the

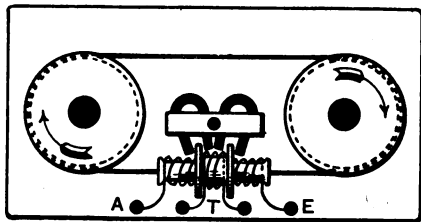

FIG. 51
Magnetic detector

field of the magnet has its magnetism destroyed and a redistribution of the lines of force through the secondary winding takes place, which sets up a current in it and the telephone re-

ceivers which are connected to it and a sound is thus produced.

Fig. 50 shows the instrument as manufactured by the Marconi Company; it will be seen that there are two sets of coils and magnets, the clockwork and moving iron band being common to both. In the event of one side breaking down all that is necessary is to change over to the other side. On the left hand of the instrument is the winding key and the key to start or stop the clockwork, the adjusting screw at the top of the instrument to the right is to regulate the tension of the moving iron band.

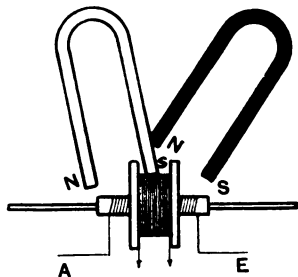

FIG. 52

Fig. 51 is a diagram of the detector and shows the magnets in the most sensitive position—*i.e.* with like poles together. In this position, although very sensitive,

a breathing noise is sometimes produced in the telephone which is very disturbing when reading weak signals. This can be overcome by placing the magnets, as in Fig. 52, with unlike poles together, the pole of one being some little distance up the limb of the other, or by moving the magnets away from the band, the best position being found by experiment. The magnets used on this detector have one face brightly polished and the other blackened. When both bright faces or both black faces are to the front like poles will be together, when one bright and one dull face are to the front unlike poles will be together. In practical use this detector has proved itself to possess the great merit of reliability. It is also sensitive and needs practically no attention beyond occasional winding of the clockwork.

TELEPHONE RECEIVERS

The telephone receivers used for the reception of wireless messages are not essentially different from those in ordinary commercial use; they, however, differ somewhat in the minor details of construction. As is well known, the telephone receiver consists essentially of a permanent magnet of the horseshoe type, having at its poles soft iron extensions on which are wound a quantity of insulated copper wire, the two coils being joined in series and the free ends brought out to terminals; immediately in front of the pole pieces, and close to them, is a flexible soft iron disc or diaphragm clamped firmly about its periphery. Fig. 53 shows clearly the construction. Two such receivers are joined in series and attached to a leather-

covered metal band, which passes over the head of the operator so that the telephones fit over the ears. As the telephones are usually in circuit with a high-resistance detector, and the effect depends on the ampere turns, it is customary to wind them to a much higher resistance than the ordinary commercial type, the resistance being from 500 to 5000 ohms according to the nature of the circuit on which they are to be used. As it would be impossible to get the requisite

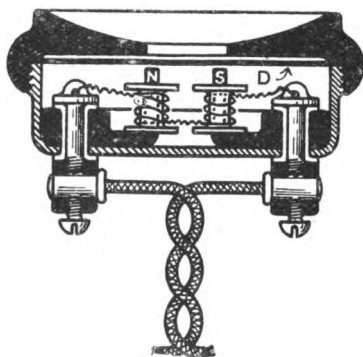

FIG. 53
Telephone receiver

number of turns into the small space of the bobbin, if ordinary silk or cotton insulated wire were used, the bobbins are wound with an enamel insulated wire which occupies much less space.

The telephone receiver is acknowledged to be one of the most sensitive appliances for detecting the presence of an electric current ever invented, its sensitiveness can be judged from the fact that an intermittent current of only a few microamps produces an easily audible sound in it. The loudness of

the sound, however, depends not only on the value of the current but on its frequency ; it has been ascertained that the telephone receiver has a maximum sensitiveness to frequencies lying between 600 and 1000 per second. This is no doubt due to the fact that the natural frequency of the diaphragm is something of this order, and also perhaps to the fact that the human ear is affected more strongly by these frequencies.

CHAPTER V

THE TESTING BUZZER

The Testing Buzzer—Telephone Relay—The Variometer—
Blocking Switches

THIS piece of apparatus, the purpose of which is to test the receiver, consists of an electro-magnetic vibrator and in construction is exactly similar to a trembler bell, but without the gong. Two extra terminals are provided and are connected one to each side of the contact-breaker. If we connect to one of these terminals a yard or so of wire supported in a vertical position and connect the other terminal to earth we are in possession of a miniature plain aerial transmitter, capable of generating and radiating electrical oscillations of such a strength as to produce signals of about the same intensity as those emanating from a more powerful but distant station. The action is as follows :—when the switch is closed current flows through the coils of the magnet and a magnetic field is built up round them, the magnets being now excited the armature is attracted and the circuit being thus broken the lines of force collapse and cut across the winding of the coils. This cutting of the coils by the lines of force sets up a difference of potential at the point at which the circuit is broken—viz. the contact-breaker, to which, as we have already seen, is attached a miniature antennæ and an earth connection. The

potential difference produced at the break owing to the great self-inductance of the coils is sufficiently high to jump the small gap formed and the antennæ is therefore charged to this potential, and on the passing of the spark electrical oscillations are set up and radiated from it. Fig. 54 shows the buzzer. The battery and

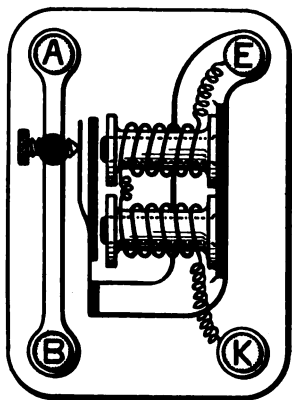

FIG. 54
Testing buzzer

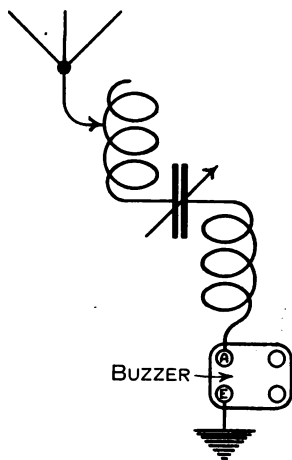

FIG. 55

key are connected to terminals marked B, K, and the small antennæ and earth wire to terminals A and E.

It should be noted that the production of a sound in the telephone receiver does not necessarily indicate that the whole of the receiver is in order and that signals could be received from a distant station ; all that the test proves is that the detector and telephones are in order. The most satisfactory evidence that the receiver is in working order is to tune in signals from a distant station, but these are not always available

when required ; the operator should therefore proceed as follows :—

First, supposing the tuner to be of the three circuit type, set the condenser of the intermediate circuit at some convenient value then detach the earth lead from the tuner and connect in circuit the terminals of the buzzer marked A, E, as in Fig. 55, set the buzzer going and adjust the primary circuit till resonance is attained which will be indicated by maximum sound being produced in the telephones ; the coupling between the circuits should be very loose. If this test is made when the station is known to be in working order and the adjustment of the condenser and variable inductance in the primary circuit noted, it can be repeated at any subsequent time ; and if resonance is attained with the same adjustments, it is proof that the receiver is still in working order. What we are in effect doing is to produce in the antennæ circuit by local means comparatively feeble oscillations and then by means of the calibrated intermediate circuit ascertaining that the capacity and inductance of the primary circuit have not altered.

THE TELEPHONE RELAY

This instrument, the invention of Mr S. G. Brown, has for its object the stepping up or magnification of feeble telephone currents, thus rendering them more audible.

It consists of a novel kind of microphone formed of two pieces of hard osmium iridium alloy, separated to an infinitesimal degree by the adjoining screw W (Fig. 56) and by the action of the local current which flows through it and the winding K (Fig. 56). The

local current assists in forming the microphone by rendering the small space between the contacts conductive and after the relay has been actuated by the passage of current through the winding H it restores it to its original adjustment by means of the regulating winding K.

Fig. 56 shows clearly the construction of the relay.

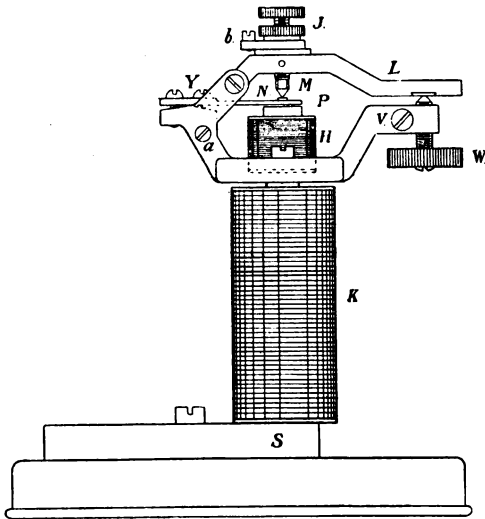

FIG. 56

Fig. 57 gives an enlarged view of the microphone contacts and shows the position the reed should occupy with regard to the magnet H. Fig. 58 shows the connections of the relay: the terminals A should be connected to the receiving circuit in place of the ordinary telephones. The local circuit consists of the microphonic contacts, the regulating winding K, a

dry cell, milliampere meter and telephone receiver all in series. The working of the relay appears to be as follows:—supposing the telephone current to be

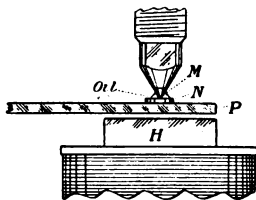

FIG. 57

magnified circulates through the winding H in such a direction as to increase its magnetism the reed P will be pulled toward the magnet, and, the resistance of the microphone being thus altered, a sound will be heard in the telephones, and as the local current is

taken through the winding K, in such a direction as to assist the magnetism of the permanent magnet, any opening of the microphonic contact and thereby increase of its

resistance causes the current to fall, and the magnet thereby being weakened the reed P resumes its normal position. Also it will be seen that should the current in the winding H be in

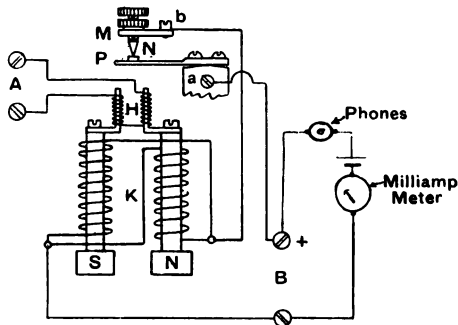

FIG. 58

such a direction as to oppose the permanent magnet, the microphone will lower its resistance owing to the removal of part of the force which is acting against the stiffness of the reed P and tending to hold the contacts apart and then, owing to the decrease in

resistance of the microphone and consequent rise in local current strength, the power of the magnet will be increased and the reed pulled back to the normal position. The inventor is of opinion that the resistance of the local circuit should not much exceed

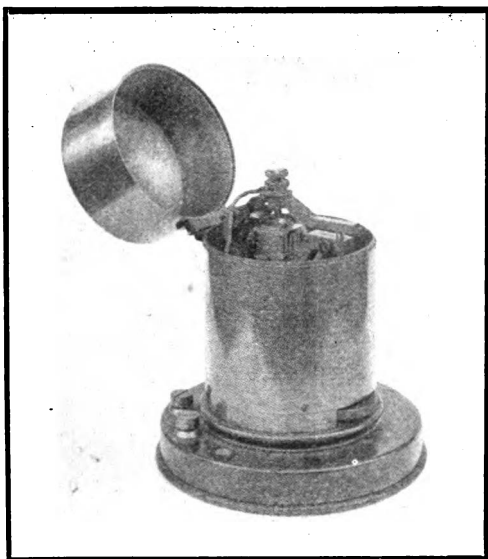

FIG. 59
Brown telephone relay

6 ohms and that the voltage of the local battery should be .5 of a volt. This voltage he obtained by putting in opposition to each other a dry cell whose voltage was 1.5 and a 2-volt accumulator cell.

The writer, however, has obtained excellent results using phones whose resistance was about 60 ohms and a single dry cell. It was found that signals which

F

were quite inaudible when the ordinary means of reception were in use could by the interposition of the relay be distinctly heard, and when the signals were of average strength the use of the relay made them so loud as to be easily read at distances varying from 10 feet upwards from the phones.

A small drop of thin oil placed on the lower contact increases the reliability of the arrangement. It is also necessary to support the relay on a felt or rubber pad to protect it from outside vibration. For the same reason all connecting wires should be flexible, as if they are solid and stiff the slightest touch causes them to vibrate and the vibration being transmitted to the relay is heard in the phone magnified many times. Using a voltage of 1.5 and phones whose resistance was about 60 the milliamperemeter read from 10 to 15 milliamperes when the relay was in the most sensitive adjustment.

THE VARIOMETER

The variometer is a form of variable inductance in which, however, the usual sliding contact is absent. It consists of two ebonite frames on which are wound the coils of wire. One end of each coil is connected by a flexible wire and the remaining ends are brought out to terminals; the inner coil is pivoted and is free to move about its vertical axis. It will be seen from Fig. 60 that when the inner coil is in the position shown the wire on the frames forms a continuous coil of two layers, the winding being all in one direction; this is the position of maximum inductance.

If, however, the inner coil be turned through 180

degrees it will be observed that the wire doubles back on itself and forms a bifilar or non-inductive winding :

th variometer is usually provided with a pointer moving over a scale divided into 180 degrees. The advantages of this form of inductance are that sliding or rubbing contacts which often become dirty and thereby introduce a high resistance into the circuit are avoided, the inductance also is continuously variable practically from zero to a value determined

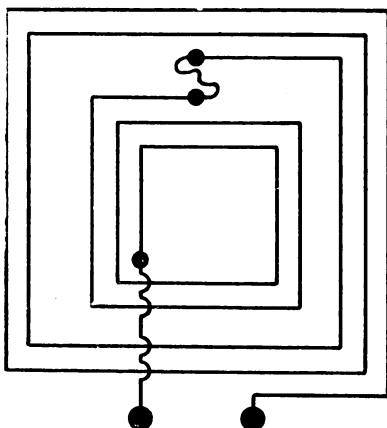

FIG. 60
Variometer.

by the dimensions of the coils, and occupies less space than the older types.

BLOCKING SWITCHES

When the transmitter is in use it is necessary that the detector should be protected from the comparatively heavy currents set up in the circuits of the receiver by reason of their proximity to the transmitter. There are a number of methods of doing this. In the case of the Marconi coherer set a long arm switch is arranged at the side of the Morse key, which, when down or in the send position, completes the power circuit by connecting to contacts which otherwise form

a break in the circuit and at the same time by means of a cord passing over a pulley fixed in the ceiling above it lifts the antennæ rod from its socket and so isolates the coherer. It will thus be seen that the connection of the antennæ to the receiver necessitates the opening of the power circuit, and should the Morse key be accidentally depressed the coherer will be uninjured, as no current is supplied to the transmitter ; also it will be seen that before the transmitter can be brought into use the arm of the switch must be lowered to shoot the break in the power circuit and that this cannot be done without at the same time disconnecting the antennæ from the receiver.

In other systems protection is afforded to the detector either by providing it with a low-resistance non-inductive shunt or else by breaking the circuit in which it is situated. The usual method of doing this is by means of auxiliary contacts on the switch used to charge the antennæ from the transmitter to the receiver so arranged that when the antennæ switch is over to send the detector is either short-circuited or its circuit broken, and when it is in the receive position the short circuit removed or the circuit completed while the power circuit is broken. The method of breaking the detector circuit is the more usual and also the more satisfactory of the two, as it is difficult to provide an efficient shunt for the detector owing to the practical impossibility of getting the antennæ switch near enough to the detector to avoid the use of long wires.

CHAPTER VI

THE MARCONI SYSTEM

The Transmitter $1\frac{1}{2}$ Kw. Set—The Emergency Transmitter—
Charging Switchboard — Multiple Tuner — Magnetic
Detector—Fleming Valve Tuner—Telephone Condenser

As an example of the Marconi system we have chosen the $1\frac{1}{2}$ Kw. installation as it is perhaps in more general use than any other set manufactured by that company. The general principles of the transmitter and the receiver have already been dealt with and this chapter will therefore be mainly descriptive of the apparatus. A rotary converter is used to convert the direct current from the ship's dynamo into an alternating current. The machine has four poles and runs at a speed of 1500 revolutions per minute, the frequency of the alternating current will therefore be 50. Across the brushes on both the alternating and direct-current side, a special form of lamp resistance is connected. These are known as the guard lamps and provide a path of low self-inductance to shunt out any high-frequency currents which might be set up in the circuit by induction from the oscillatory circuits of the transmitter and cause damage to the machine.¹ The

¹ High-frequency currents will if two paths are open to them divide in inverse proportion to the inductances of the paths. The inductance of the guard lamps is very small compared with that of the coils of the converter, therefore practically the whole of any high-frequency current set up in the circuit would pass through it.

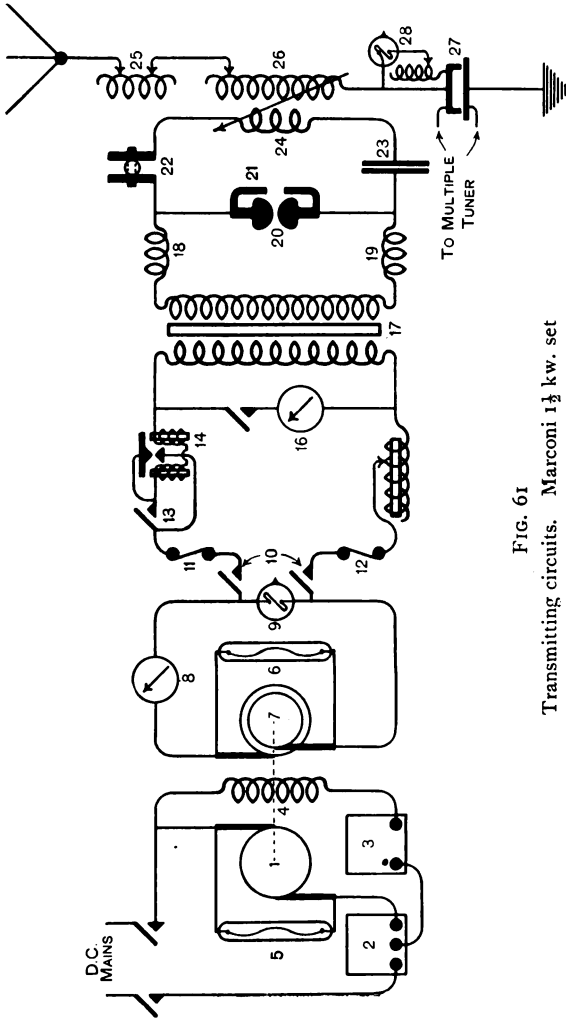

FIG. 61

Transmitting circuits, Marconi 1 1/2 kw. set

- | | |
|--------------------------------|--|
| 1. D.C. side rotary converter | 22. Sliding inductance |
| 2. Motor starting switch | 23. Condenser |
| 3. Field regulating resistance | 24. Primary oscillation transformer |
| 4. Field winding | 25. Aerial tuning inductance |
| 5 and 6. Guard lamps | 26. Secondary of oscillation transformer |
| 7. Slip rings rotary converter | 27. Earth arrester |
| 8. Ampere meter | 28. Tuning lamp and choke |
| 9. Pilot lamp | |
| 10. Double-pole switch | |

transmitter of this set consists of five circuits—namely, the direct-current circuit, the low-tension alternating - current circuit, the high-tension alternating-current circuit and the primary and secondary high-frequency circuits. The direct-current circuit consists of the motor starting switch, the field regulating resistance and the D.C. side of the rotary converter connected together and to the direct-current supply of the ship

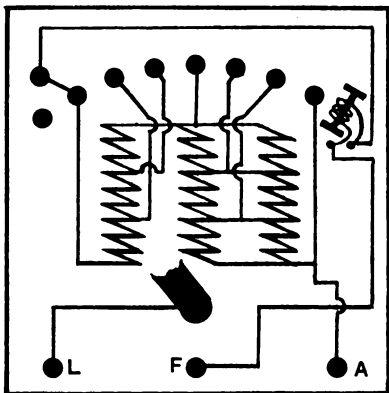

FIG. 62

Motor starting switch

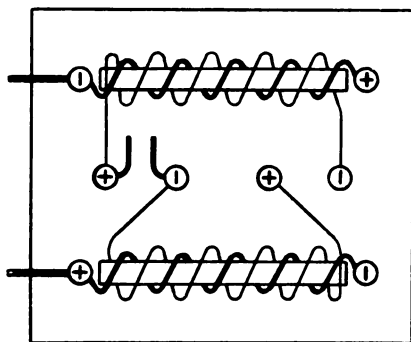

FIG. 63

Internal connections. A.C. transformer

as shown in Fig. 61. The internal connections of the starter are shown in Fig. 62, and it will be seen that it differs somewhat from the ordinary pattern. As the arm of the switch is moved over the contacts, the resistance which at the start was in series with the armature coils is transferred to the field circuit, as this weakens the field it enables the motor to start

quickly. The small electro-magnet on the face of the

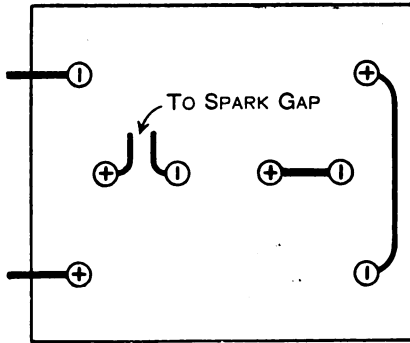

FIG. 64

A.C. transformer. Primaries and secondaries connected in series

alternating-current circuit consists of the primary of the transformer, Morse key, magnetic key, and impedance coil which together with the ampere meter and fuses are connected in series and to the slip rings of the alternating-current side of the rotary converter, as in Fig. 61.

Fig. 63 shows the internal connections

of the alternating-current transformer. It will be seen that it really consists of two open core transformers

starter is termed a no volt release and serves while the machine is running to hold over the arm of the switch and should the power-supply fail or the field circuit be broken the arm will be released and move over to the off position, and cut the motor out of circuit.

The low-tension

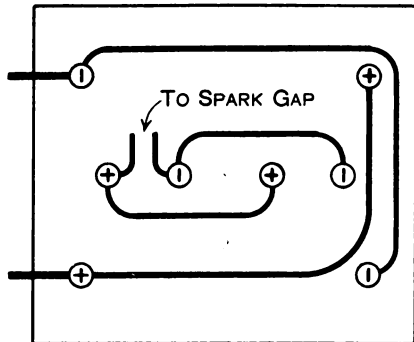
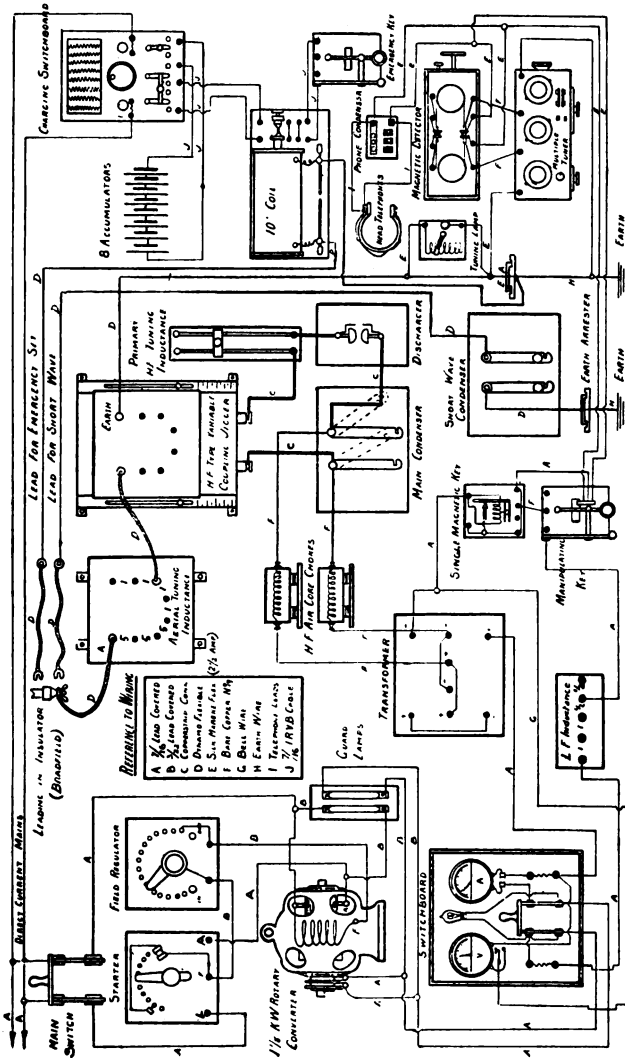

FIG. 65

A.C. transformer. Primaries and secondaries connected in parallel



From "P.O. Electrical Engineers' Journal." By permission of Board of Editors
 FIG. 66

Wiring diagram. Marconi 1 1/2 kw. set

placed side by side in the same case and that the primaries and secondaries can be connected in series

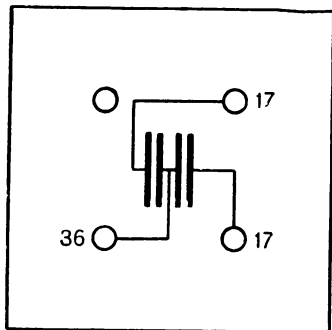

FIG. 67

Internal connections of condenser

or in parallel as necessity requires. The case is filled with oil to improve insulation. The construction of the magnetic key and its action has already been described in an earlier chapter. The Morse key is of the ordinary heavy contact type, but connection between the lower contact and its terminal is made through a side lever which provides a means of breaking the alternating-current circuit ready to the hand of the operator in case of emergency. The lever of the Morse key also carries a small ebonite arm which closes a pair of contacts so arranged and connected as to short-circuit the telephone receiver before the main contacts of the key close.

The volt and ampere meters, the fuses, the double-pole quick-break switch, and the pilot lamp are mounted together on a slate panel (Fig. 66). The high-tension alternating-current circuit consists of the secondary of the

which provides a means of breaking the alternating-current circuit ready to the hand of the operator in case of emergency. The lever of the Morse key also carries a small ebonite arm which closes a pair of contacts so arranged and connected as to short-circuit the telephone receiver before the main contacts of the key close.

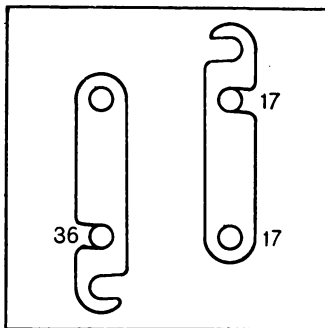

FIG. 68

Condenser. Position of connecting strips for 600 metre wave

transformer connected through two air core chokes to the spark-gap and so to the condenser. The purpose of the chokes is to prevent the high-frequency currents in the closed oscillatory circuit from flowing back into the secondary of the transformer. The primary or closed oscillatory circuit consists of the condenser, spark-gap, primary of oscillation transformer and a variable inductance all connected in series. The condenser, the plates of which are zinc and the dielectric of which is glass, is so constructed that by changing the positions of the connecting strips between its terminals its capacity can be reduced to one-fourth of its maximum capacity. This provides a means of changing from the 600 to the 300 metre wave. Figs.

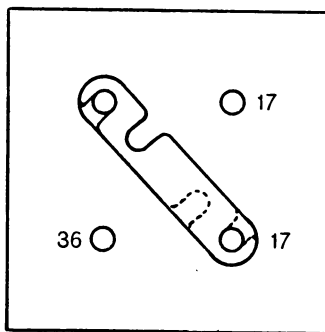

FIG. 69

Condenser. Position of connecting strips for 300 metre wave

67, 68 and 69 show the internal connections of the condenser and the positions of the connecting strips for the two wave-lengths. The numbers on the terminals indicate the number of plates connected to each terminal. When working on a 600 metre wave the secondaries of the transformer should be connected in parallel and when working on the 300 metre wave they should be in series and the spark-gap doubled in length. The purpose of making these changes is to keep the spark frequency and the energy stored in the condenser before discharge constant. The energy stored in a condenser is proportional to the

product of its capacity and the square of the voltage to which it is charged and therefore as the capacity of the condenser has been reduced to one-fourth in order to get the 300 metre wave, we must charge it to double the voltage, if we wish to keep the energy constant.

The variable inductance consists of two brass rods

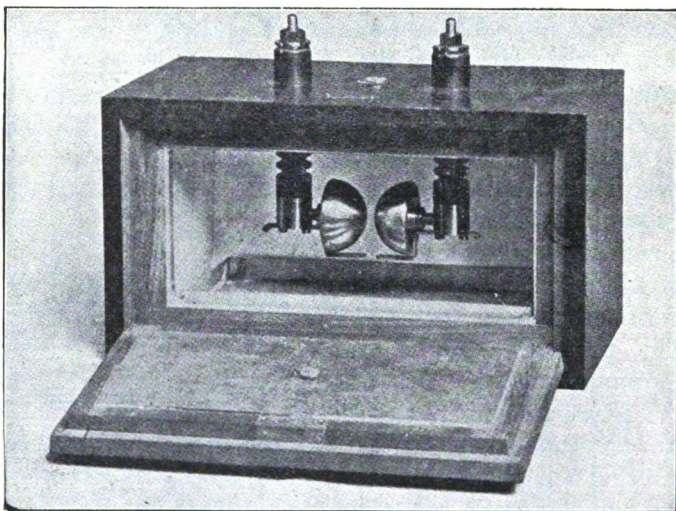

FIG. 70
Spark-gap

with a metallic bridge, the position of which determines the amount of inductance included in the circuit: the purpose of this inductance is to secure the exact adjustment of the circuit to a given wave-length after the main adjustment has been made on the condenser. The spark-gap which is enclosed in a muffling chamber is shown in Fig. 70. It consists of two steel hemispheres,

the length of the gap can be adjusted by turning either of them.

In parallel with the main spark-gap is another formed of two pointed brass rods ; the length of this gap, which is kept constant, is determined by the safe voltage to which the condenser can be charged and its purpose is to protect the condenser from excessive voltages, which might puncture the dielectric. Connection between the various pieces of apparatus in this circuit is made by means of flat copper strips and not ordinary round sectioned conductors. These copper strips have large surface and therefore their resistance to high-frequency currents is low, also they are placed parallel and near together (about $\frac{1}{8}$ " apart) and the space between them filled with strips of hard rubber. It will thus be seen that they are in effect a condenser and form part of the capacity of the circuit. The inductance of the circuit therefore consists almost entirely of the primary of the oscillation transformer and practically the whole of the inductance can therefore be utilised for coupling purposes. The secondary or open oscillatory circuit is made up of variable tuning inductance, secondary of oscillation transformer, the inductance of which is also variable, and a special form of spark-gap called by the Marconi Company an earth arrester terminal all connected together in series and to antennæ and earth. The tuning of the circuit is effected by varying the inductance and the coupling can be varied by sliding the secondary over the primary. The earth arrester terminal (Fig. 71) consists of two brass plates separated except for a small space round the edge by a mica washer. The receiving apparatus is connected across

the spark-gap so formed and its purpose is to obviate the necessity for a change-over switch and so permit the receiving operator to interrupt the sending operator during the course of transmission if necessity requires. Its action is as follows :—during the time the Morse key is closed the receiver is shorted out by the sparks which pass between the plates, but the moment the

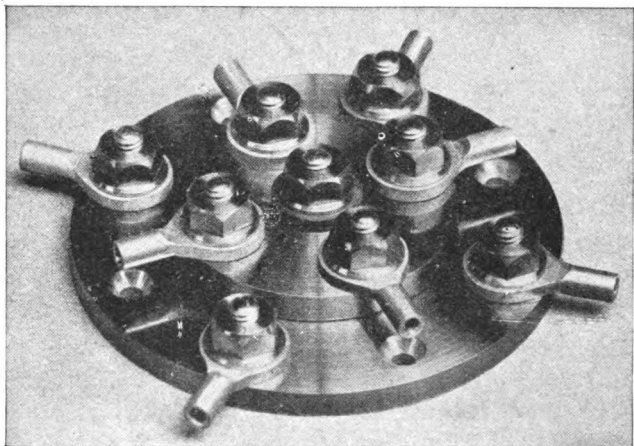

FIG. 71
Earth arrester terminal

key is opened the path of incoming oscillations will be through the primary circuit of the tuner as the received oscillations are not of sufficient intensity to jump the gap. Shunted across about a yard of the earth lead is a small incandescent lamp in series with a variable choking coil ; the purpose of the lamp is to indicate when the primary and secondary circuit of the transmitter are in tune. The brilliancy of the lamp will of course be a maximum when resonance is obtained.

The function of the variable choke is to regulate the current through the lamp and thus to protect it from excessive currents which might burn out its filament.

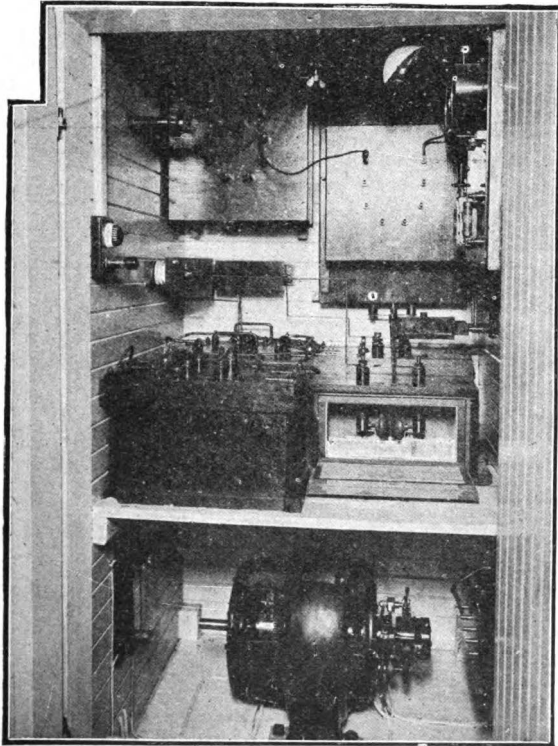

FIG. 72

Transmitting apparatus mounted in silence cabinet

If a high-frequency current has two paths open to it, it splits up in inverse proportion to the inductance of the paths and therefore if we insert inductance in the

branch in which is the tuning lamp we shall diminish the current through it.

EMERGENCY TRANSMITTER

In addition to the above-described transmitter it is the practice of the Marconi Company to provide an emergency set which is quite independent of the ship's machinery. The advantage of this provision will be apparent and has justified the extra cost involved on

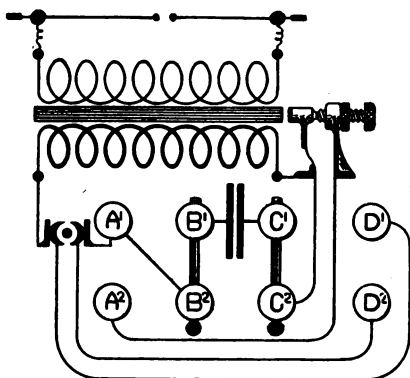

FIG. 73

Connections. Marconi 10-inch induction coil

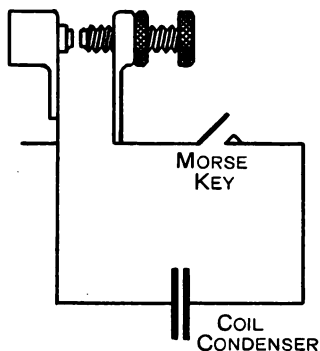

FIG. 74

Showing position of coil condenser with respect to Morse key and contact-breaker

many occasions. The set consists of a 10-inch induction coil, a battery of 8 accumulator cells and a special type of switchboard designed to facilitate the charging of the cells and to provide a ready means of changing the coil to or from the cells to the current-supply of the ship. Fig. 73 is a diagram of the coil connections; it will be seen that the condenser in the base of the

coil, being across the contact-breaker and the Morse

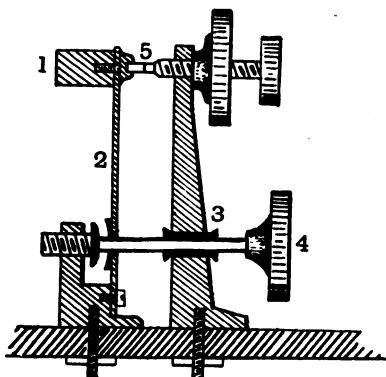

FIG. 75.—Showing construction of contact-breaker

- 1. Hammer-head. 2. Spring. 3. Insulating collar. 4. Screw to adjust tension on spring. 5. Platinum contacts

key in series as well as serving its usual purpose of

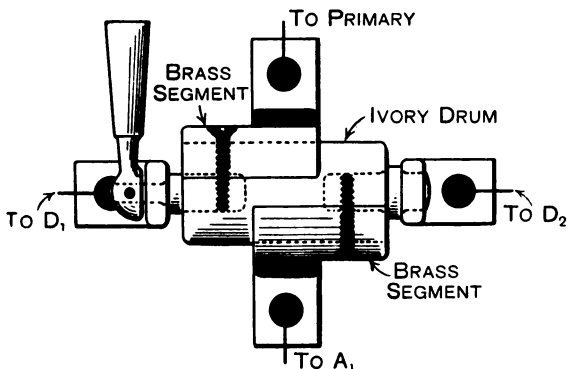

FIG. 76.—Commutator

accelerating the rate at which the lines of force cut

G

the secondary winding when the circuit is broken, also serves to eliminate the sparking at the key contacts. Copper pins form outside connections between the terminals B^1 and B^2 , C^1 and C^2 , and their removal will isolate the condenser for testing purposes. Fig. 78 is the charging switchboard. To charge the accumulators the double-pole switch is placed first in one position, then in the other: the correct position for

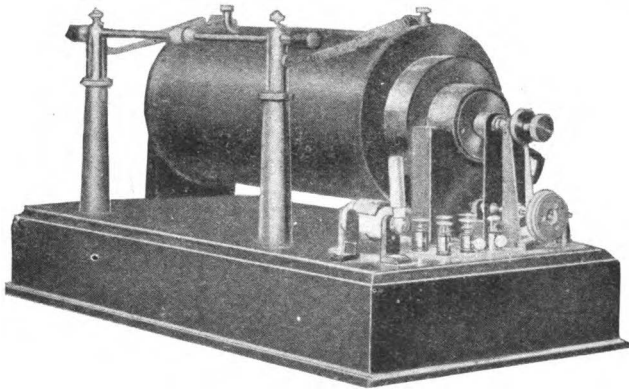

FIG. 77.—Marconi 10-inch induction coil

charging being that in which the lamp resistances are dim. In this position the voltage of the cells is opposing that of the charging dynamo and the positive pole of the dynamo is therefore connected to the positive pole of the accumulators and the negative pole to the negative pole of the accumulators.

The voltage of the lamps used as resistances is chosen to suit the voltage of the ship's supply and the candle power to permit the correct charging current being supplied to the accumulators. The single-pole switch

in one position enables the coil to be worked from the cells and in the other position from the ship's dynamo, the coil resistances at the top of the board being in series in order to cut down the current to the correct

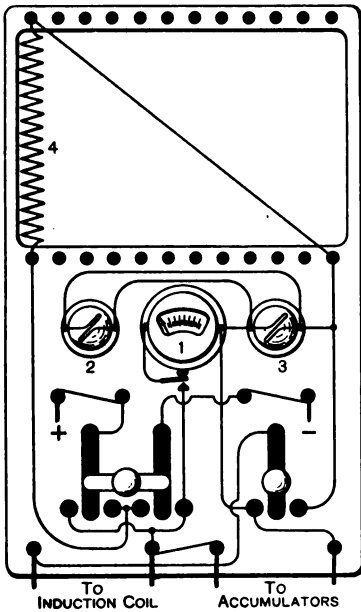

FIG. 78.—Marconi marine type charging switchboard
 1. Voltmeter
 2 and 3. Lamp resistances
 4. Coil resistances

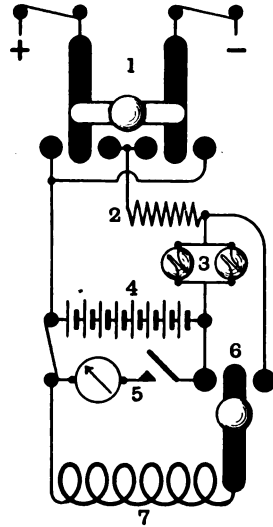

FIG. 79

- 1. Double-pole switch
- 2. Coil resistances
- 3. Lamp resistances
- 4. Accumulators
- 5. Voltmeter
- 6. Single-pole switch
- 7. Primary of coil

value. Fig. 79 will enable the composition of the circuits for different positions of the switch to be seen. It should be noted that when working off the dynamo the lamp resistance must be removed and the double-pole switch may then be placed in either position.

THE MULTIPLE TUNER

The Marconi multiple tuner, which is of the three circuit type described in the chapter on receiving

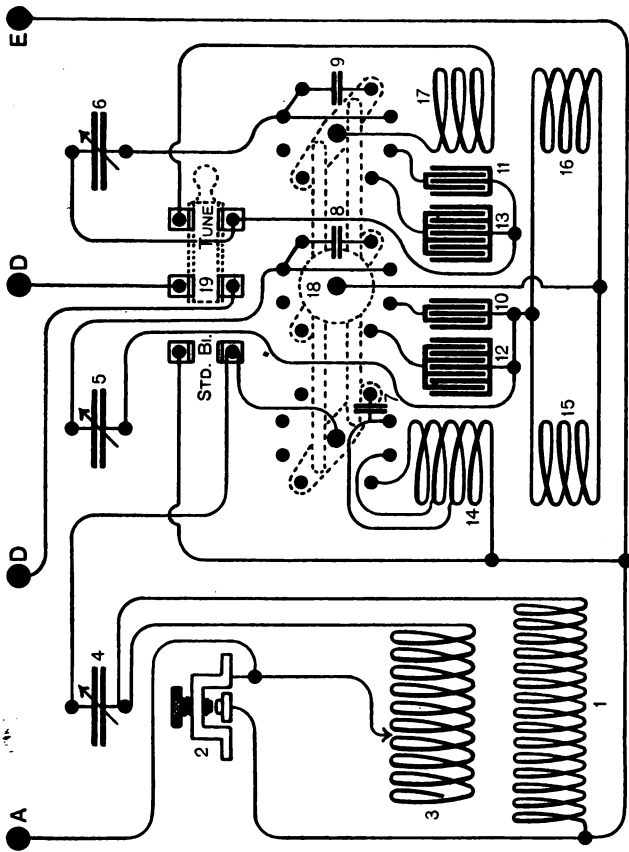
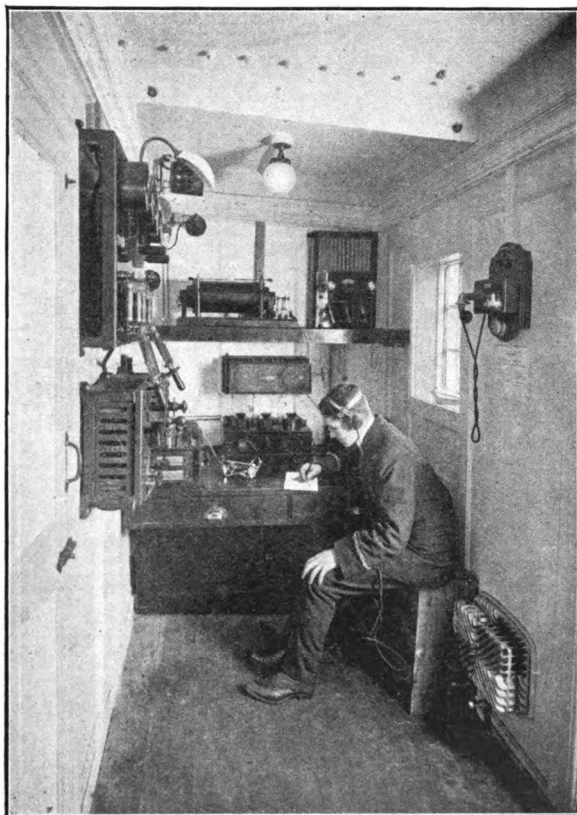

FIG. 80.—Circuits of Marconi multiple tuner

- 1. High self-inductive shunt
- 2. Micrometer spark-gap
- 3. Aerial tuning inductance
- 4, 5 and 6. Variable capacitors
- 7, 8 and 9. Small fixed capacity condensers
- 10, 11, 12 and 13. Fixed capacity condensers
- 14. Primary coupling coil
- 15 and 16. Coils of intermediate circuit
- 17. Coil of detector circuit
- 18. Multiple tuning switch
- 19. Change-over switch

apparatus, and the magnetic detector are usually used as the receiving apparatus with the $1\frac{1}{2}$ kw. set,

although on some stations the Fleming valve and the special tuner with which it is incorporated are in use.



Photo

FIG. 81

Topical

Operating cabin s.s. *Franconia*

Fig. 80 shows the internal connections of the multiple tuner. It will be seen that as the three coupled switches are moved round the effect is to add capacity

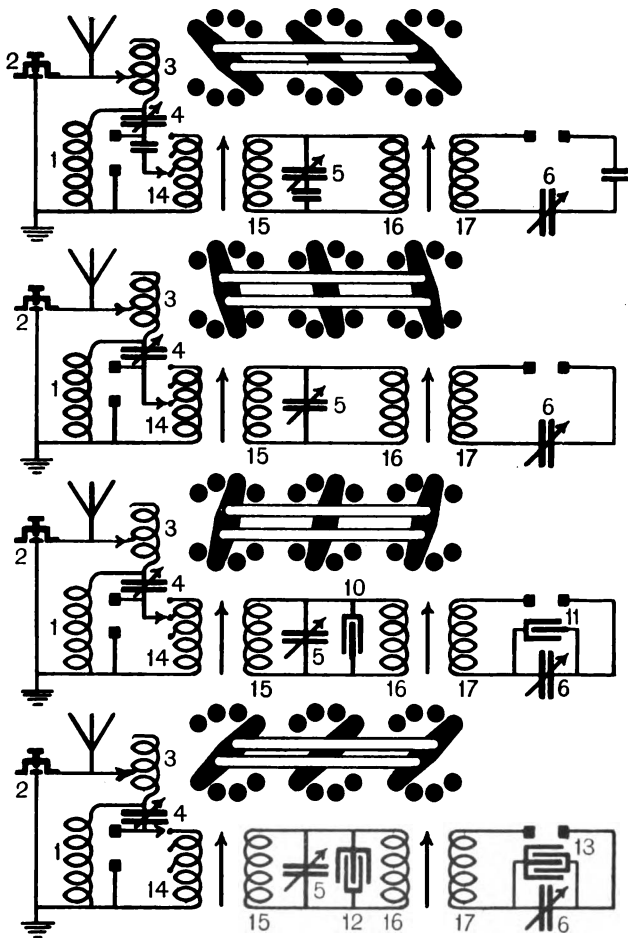

FIG. 82

Reference numbers as in Fig. 80

(and in the case of the primary circuit inductance) to the three circuits and so to increase the wave-length range. For instance, when the switch is in position one a small condenser of fixed capacity is put in series with the variable condenser in each of the three circuits and only half the turns on the primary coupling coil are in circuit, when the switch is in position two the small condensers are cut out of circuit. Position three increases the inductance of primary coil and puts condensers of fixed capacity in parallel with the variable condensers in the intermediate and detector circuits. Position four puts still larger condensers in parallel with the variable condensers in the intermediate and detector circuits and increases the inductance of the primary coil to its maximum value. Fig. 82 shows the composition of the three circuits for the various positions of the switch. It will be noticed that the inductance of the secondary circuit consists of two coils, this is to facilitate the coupling of the circuit to the primary and to the detector circuit. Both the coils are carried on a shaft which terminates in a handle seen to the right in Fig. 83 and the coupling between the circuits is thus varied simultaneously. On top of the tuner (Fig. 83) is a change-over switch which enables the detector to be connected in the third circuit for tuned reception or places it directly in connection with the antennæ circuit, which is the stand-by position; in this position the detector will respond to a comparatively large range of wave-lengths. When working on the stand-by position the multiple tuning-switch should be in No. 1 position, the small fixed capacity condenser will then act as a blocking condenser to the primary of the magnetic detector. Referring to the

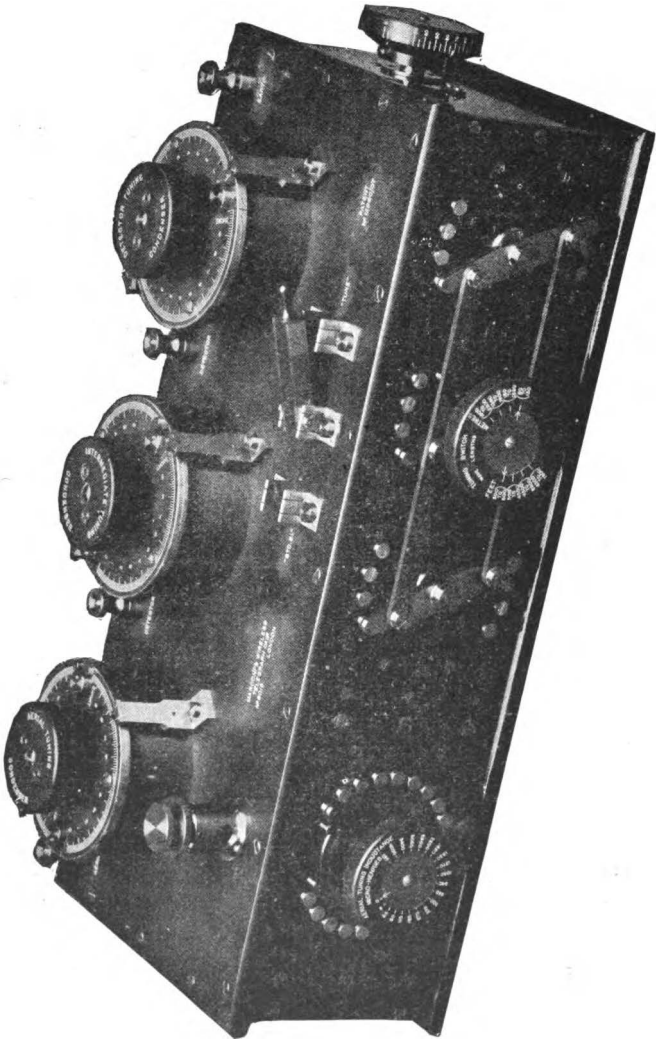

FIG. 83
Marconi multiple tuner

diagram of the tuner, 1 is a high self-inductive shunt to earth ; its purpose is to prevent the accumulation of an electro-static charge on the antennæ: 2 is a micrometer spark-gap and serves the same purpose as a lightning arrester and protects the primary circuit from the trasnmittter when it is in action. Terminals A and E are connected to the top and bottom plates of the earth arrester, when the transmitter is in action sparks pass across the gap and the primary circuit

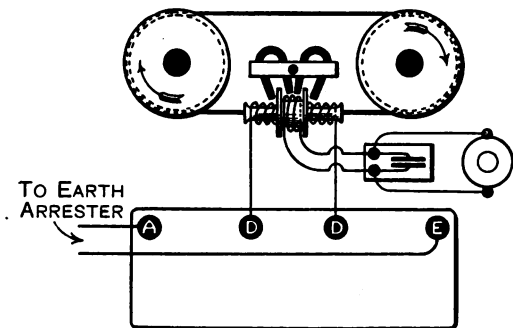

FIG. 84

Connections between multiple tuner and magnetic detector

of the tuner is thus shorted out. When the transmitter is not in use the circuit from antennæ to earth is complete through the primary coil of the tuner. It will thus be seen that the receiver can be left connected to the antennæ and a change-over switch is not needed, also it permits the receiving operator to break in or interrupt the sending operator during the course of transmission if necessary.

The terminals marked D, D are connected to the terminals marked A and E on the detector. Fig. 84 shows connection between tuner and detector. The

106 WIRELESS TELEGRAPHY

magnetic detector has been fully described in the chapter on detectors and it only remains to say that the telephone receiver is short-circuited before the power circuit of the transmitter is closed by means of an extra pair of contacts which are closed by a small arm which projects from the lever of the Morse key.

TELEPHONE CONDENSER

The telephone condenser shown in Fig. 85 is variable in seven steps by means of three plugs. This con-

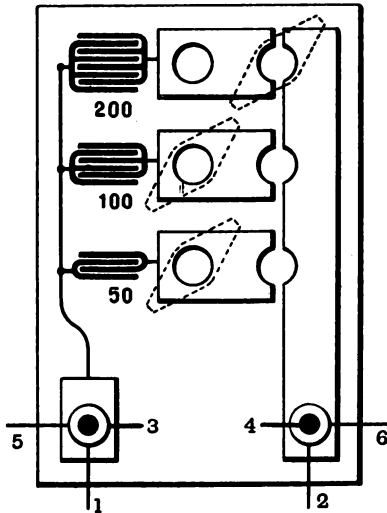

FIG. 85

Connections of telephone condenser

1 and 2 to secondary of detector. 3 and 4 to telephones. 5 and 6 to short-circuiting contacts on Morse key

denser, together with the telephones which have inductance and resistance form an oscillatory circuit,

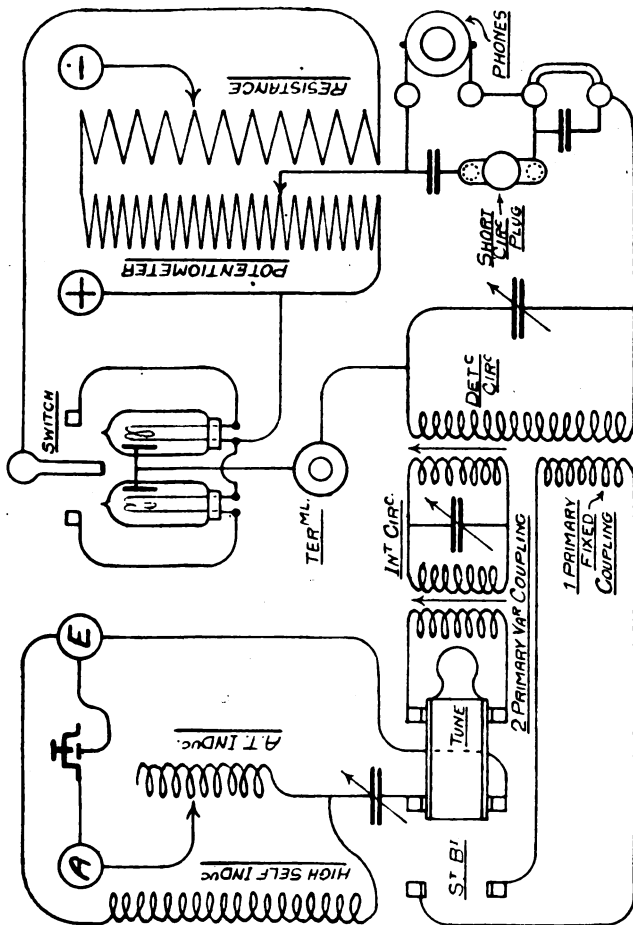

FIG. 86

Fleming valve tuner

108 WIRELESS TELEGRAPHY

and the purpose of the condenser is to enable us to tune the circuit to the *spark* frequency of the transmitter or to one of the harmonics of that frequency.

FLEMING VALVE TUNER

The action of the Fleming valve has already been described in a previous chapter, but the connections of the special tuner with which it is incorporated may be of interest. Like the multiple tuner, it is of the three circuit type, but the change-over switch simply substitutes different primary coils. The primary coil in use on the stand-by position is closely coupled to the detector circuit and when the switch is put over to the tune position a primary coil coupled to the intermediate circuit, the coupling of which can be varied, is substituted. The high self-inductive shunt and the micro-meter gap are connected in the same position and serve the same purpose as in the multiple tuner. Fig. 86 is a diagram of the connections. It will be seen that two valves are provided and a switch which changes the battery from one to the other. The purpose of the variable resistance is to regulate the current supplied to the filament of the valve.

CHAPTER VII

POULSEN SYSTEM

The Poulsen Arc—The Tikker Receiver—Photographic Recorder—High-Speed Transmitter—Tone Sender

THE Poulsen system is based on the discovery of Mr Duddell that if a direct current arc is shunted by a circuit containing capacity and inductance there will be established in the circuit electrical oscillations, the frequency of which depends upon the value of the inductance and capacity. The

reason of this is that unlike a metallic conductor the arc does not follow Ohm's law and the curve showing the relation between current and terminal voltage is not a straight rising line, but has what is termed a falling characteristic (Fig. 87)

—that is to say, if the current through the arc be increased the potential difference at its

terminals will drop. Suppose now that a circuit with capacity and inductance in series is placed across the terminals of an arc, the condenser will charge, and in doing so, the current through the arc being lessened, the potential difference at its terminals will increase and charge the condenser to a still higher voltage.

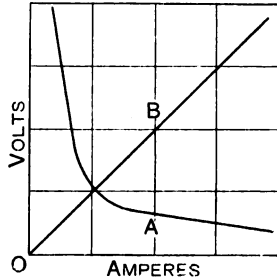

FIG. 87

A = Arc. B = Metallic conductor

After the capacity is fully charged the current through the arc will increase, and owing to the drop in voltage which it causes the condenser will discharge across the arc, and the discharge will, if the resistance is small, be oscillatory. In order to obtain oscillations of considerable energy Mr Duddell found that it was necessary to use a capacity of the order of 1 microfarad, and with a capacity of this magnitude it was not possible to obtain the very high frequencies needed for Radio-Telegraphy.

Poulsen's great discovery was the effect of a hydrogen atmosphere which by cooling the arc increased the steepness of its characteristic curve, and also the use of a very powerful magnetic field which enabled him to get a high terminal voltage. By the use of the arc burning in a hydrogen atmosphere, and the powerful transverse magnetic field, he was able to use a small capacity and thus get oscillations of the frequencies useful for Radio-Telegraphy and at the same time powerful. The practical construction of the Poulsen arc is as follows:—the anode is made of copper and the end takes the form of a beak (Fig. 88). The cathode is of carbon about one inch in diameter, the arc striking between the copper beak and the edge of the carbon. The carbon is fitted in a holder which is slowly rotated by means of a small motor, and as it burns away a fresh surface is presented and the length of the arc kept constant. The arc-length is also adjustable by means of a screw fitted to the copper electrode.

The electrodes are taken through insulating sleeves in the sides of a water-cooled metallic chamber which is also flanged on the outside to assist the cooling.

Through the sides of the chamber, and transversely to the electrodes, pass the pole pieces of a powerful electro-magnet which blows the arc out into a loop, the winding of the magnets being in series with the arc also serve as choking coils and prevent the oscillations from passing back into the supply circuit. The chamber in which the arc burns is supplied with

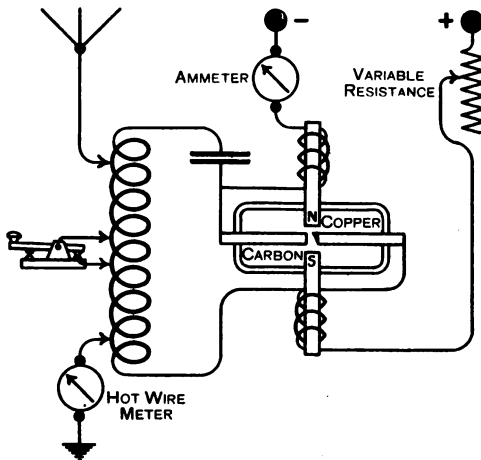

FIG. 88

Poulsen arc transmitter

hydrogen through a tube let into its base and after passing through the chamber escapes through an outlet at the top and is conveyed away by means of a tube connected to it. The arc is connected across a 500 volt direct-current supply and across it is shunted the primary circuit, which consists of a condenser and an inductance in series. The antennæ is connected to one point of the inductance and the earth wire to another. Signalling is effected by shorting through

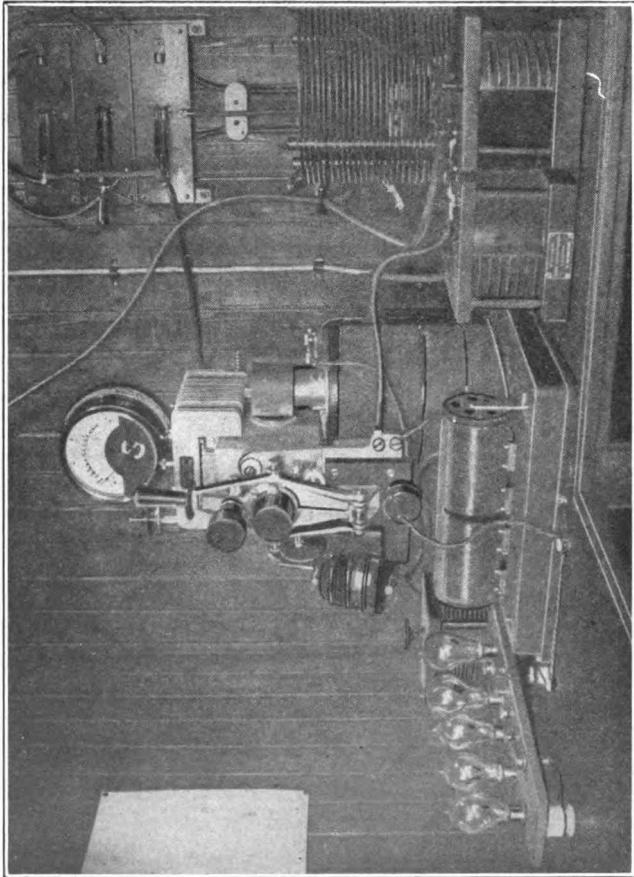

FIG. 89
Poulsen arc

the Morse key a turn or two of the inductance which alters the wave-length and throws the transmitter in and out of tune with the receiver, a difference of about 5 per cent. being sufficient. As energy is supplied to the antennæ at every swing the oscillations emitted from the Poulsen generator are continuous and undamped, or practically so. The receiving arrangement used in conjunction with the Poulsen transmitter is unlike that of any other system inasmuch as no detector is made use of, but the received energy accumulated in a condenser and discharged at intervals through the telephone by means of a piece of apparatus which the inventor has named a tikker.

Fig. 90 shows diagrammatically the receiving circuits. A is the primary coil with variable condenser across its terminals to adjust the tuning; coupled to this coil is the secondary circuit B, which consists of a coil and a variable condenser; across the terminals of this condenser is joined a mica condenser of fairly large capacity and the tikker, which is an intermittent contact formed by two gold-plated brass wires crossing each other at right angles, one of them being mounted at the end of a small electro-magnetic make and break similar in construction to a trembler bell. The tele-

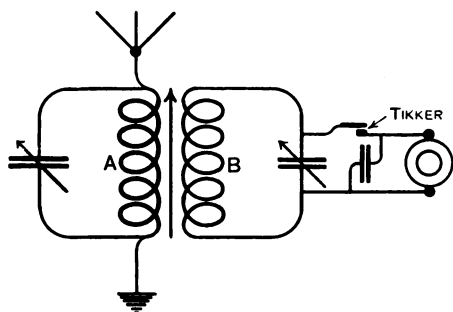

FIG. 90

Poulsen tikker receiver

phone has named a tikker. Fig. 90 shows diagrammatically the receiving circuits. A is the primary coil with variable condenser across its terminals to adjust the tuning; coupled to this coil is the secondary circuit B, which consists of a coil and a variable condenser; across the terminals of this condenser is joined a mica condenser of fairly large capacity and the tikker, which is an intermittent contact formed by two gold-plated brass wires crossing each other at right angles, one of them being mounted at the end of a small electro-magnetic make and break similar in construction to a trembler bell. The tele-

114 WIRELESS TELEGRAPHY

phone, which is of low resistance, is joined across the mica condenser. The action of the tuner is as follows :—

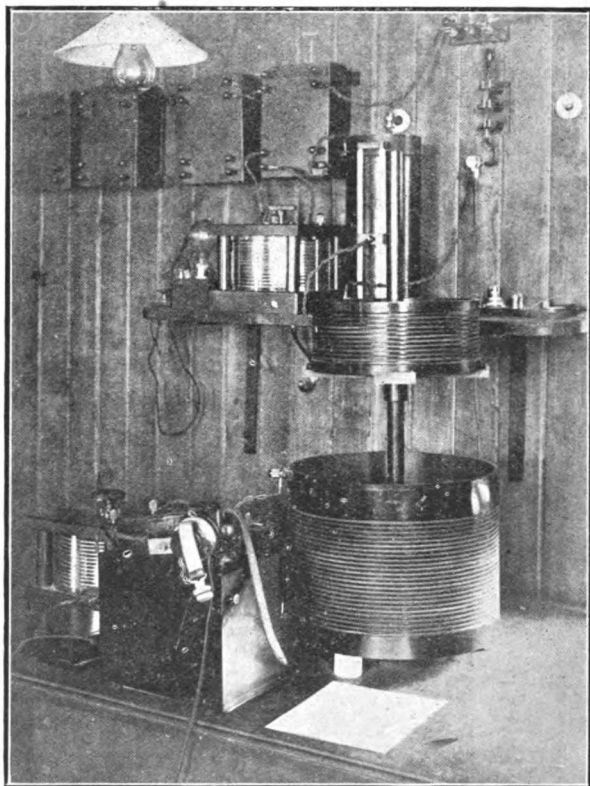

FIG. 91

Poulsen tapper receiver

the primary having been tuned to the sending-station and the secondary tuned to the primary ; during the intervals when the tapper contacts are open the

secondary circuit is left free to resonate up, and the energy of many oscillations thus accumulated when the tikker contacts close, the circuit, owing to the added capacity of the mica condenser, which is now in parallel, will oscillate to a lower frequency. The opening of the tikker contacts will be determined by the presence or absence of a current across them, as this determines the conductivity of the small gap between the wires as the tikker starts to open. It will thus be seen that when the current is passing through zero the mica condenser, charged as it is with the greater part of the energy, will be disconnected from the secondary circuit and discharge through the telephone.

The coupling between the primary and the secondary is very loose and full use is thus made of resonance, the tuning being so sharp that a difference of 4 or 5 per cent. in wave-length is sufficient to render the signals inaudible. The tikker method, although one of the most sensitive means known for detecting electrical oscillations, labours under the disadvantage that it is not able to receive signals from the ordinary spark transmitters which give out damped and discontinuous oscillations.

PHOTOGRAPHIC RECORDER

Valdenar Poulsen in conjunction with his assistants has devised a very sensitive recorder capable of recording signals at a high rate. It consists of a string galvanometer composed of a very powerful electromagnet between the poles of which is stretched an exceedingly fine gold wire. The image of the wire is by means of a microscope magnified and thrown on to

116 WIRELESS TELEGRAPHY

a moving strip of sensitised paper. If now signals actuate the thermo-detector it will pass a current through the fine wire to which it is joined, and the wire will be deflected and the position of its image on the

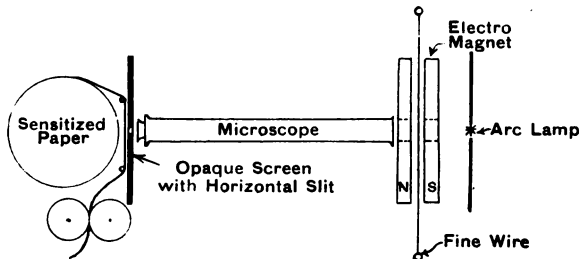

FIG. 92
Poulsen photographic recorder

tape will be altered ; it will thus be seen that the recording of a dot or a dash depends upon the time which the wire is displaced from its position or rest.

The tape after recording the signals passes through



FIG. 93
Specimen of slip—(104 words per minute)

a tank containing developer and then through one in which is contained the fixing solution. Fig. 92 shows the arrangement of the apparatus and Fig. 93 a specimen of the tape.

POULSEN HIGH-SPEED TRANSMITTER

The high-speed transmitter is arranged to take messages prepared on perforated slip by a modified

Wheatstone perforator. The perforator is modified by the removal of one punch each from the sets controlled by the dash lever and by the dot lever, so that a dash consists of a single perforation on the upper part of the slip and two centre perforations, whilst a dot consists of a single perforation in the lower part and a single centre perforation. The transmitter (designed by Professor Pedersen) is arranged in drum form, and

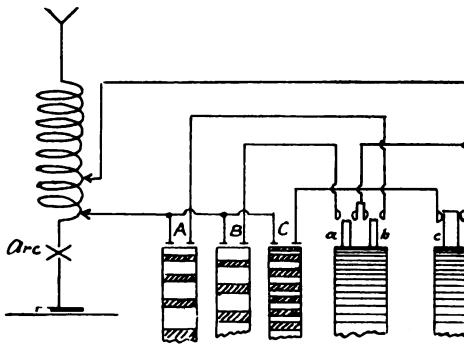

FIG. 94

the essential principle of its electrical action is as follows :—

A mark is signalled by short-circuiting a portion of the aerial inductance helix, and this short circuit involves the closing of two separate contacts in series. Any sparking that occurs is therefore at the latter of the two makes and the former of the two breaks. These sparking contacts, determining the final make and break of the short-circuit current, are heavy, and do not depend on the punched slip for their operation. The slip controls the first make and second break contacts only, which, as they are not subject to sparking,

118 WIRELESS TELEGRAPHY

may be of light construction. Fig. 94 is a diagrammatic representation of the transmitter. *A, B, C* are the

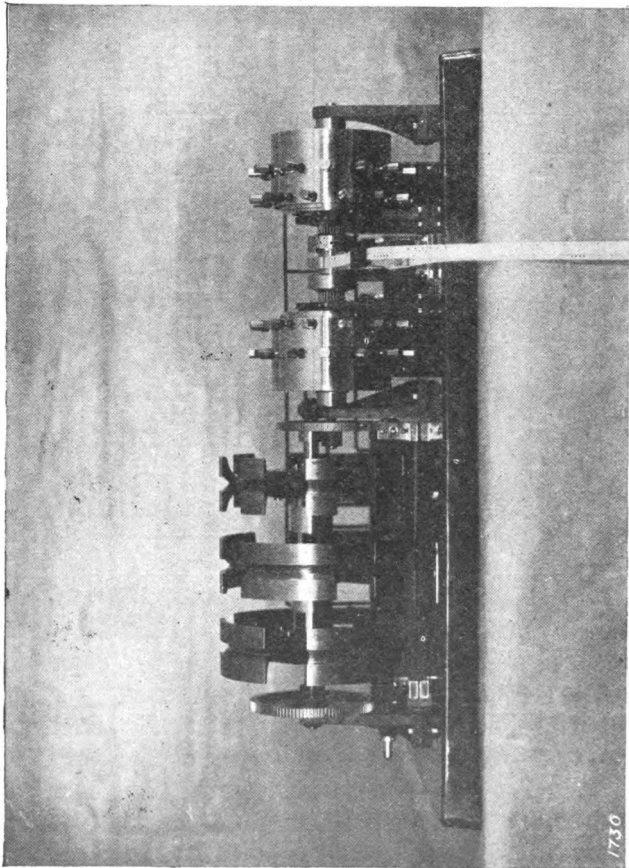

FIG. 95

heavy-contact drums ; while *a, b, c* are rows of radial pins thrust outwards by the operation of the punched

strip, and constituting the sparkless first line of contacts. *C* and *c* control the dots, while *A* and *a*, and

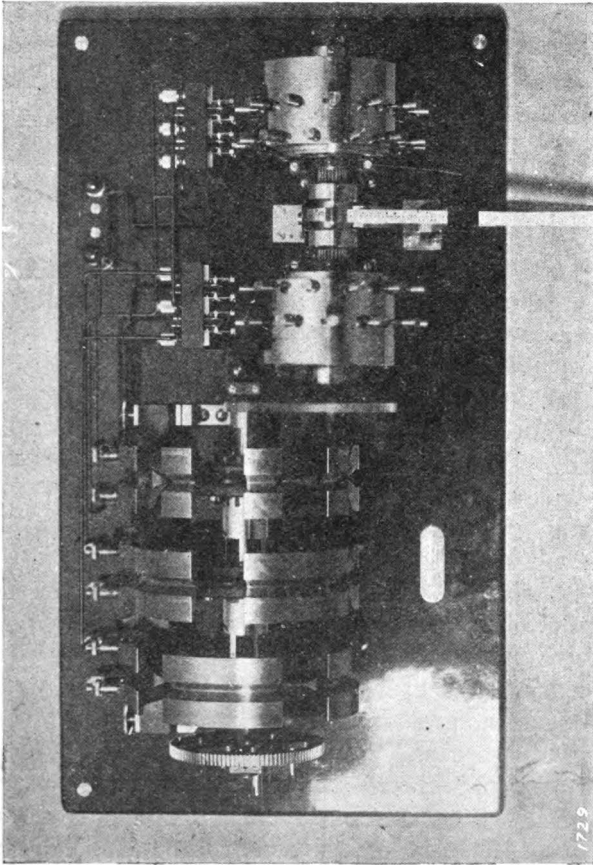

FIG. 96

B and *b* control the dashes. Dashes beginning on even centre perforations utilise *A*, *a*, while dashes on the

odd perforations utilise *B, b*. Figs. 95 and 96 show the appearance of a recent design of the machine.

The three drums *A, B, C* are fitted with copper-marking segments and glass-spacing segments, and copper brushes bear against them.¹ The pins *a, b, c*, projecting radially from the rotating drums or rings, are thrust outwards from the drum, so as to bridge the fixed spring contacts "knife-switch" fashion as they pass, whenever small levers controlled by the plunger-pairs are projected through the dot-and-dash perforations in the paper strip. It will thus be seen that the controlling contact pins *a, b, c* are set in position in advance, to accord with the dot-and-dash perforations in the punched tape, and retain their positions during a part of the evolution of the drums until they have passed the spring contacts. They are then automatically withdrawn gradually to the normal positions.

The machine has been practically operated up to speeds of 300 words per minute, and it then appears to operate as efficiently as at the lower speeds. The Company have a number of machines under construction, in which sundry improvements are embodied.

It should be mentioned that in one respect the high-speed transmitter operates differently from the Morse key. Whereas the latter "marks" with the longer wave and "spaces" with the shorter, the former reverses this procedure, and the dots and dashes on the received slip appear as short and long periods of zero deflection. That is, the receiving apparatus remains quiescent during the marking periods, and is deflected

¹ In the later form of transmitter shown in 6 and 7, air space insulation is provided between the segments.

during the spacing periods. The machine is covered by British patent No. 25190, A.D. 1909.

This description of the Poulsen high-speed transmitter is reproduced from *The P.O. Electrical Engineers' Journal*, by kind permission of the board of Editors.

THE TONE SENDER

For the continuous and undamped waves sent out by the Poulsen system to be heard by an ordinary spark receiver it is necessary that they should be cut up into rapidly alternating trains of marking and spacing waves. This is effected by connecting across the Morse key a rotary make and break driven at a high rate (900 to 1000 contacts per second). The signals heard when such an arrangement is in use have a high musical note, but are not so strong as with the ordinary arrangement used in conjunction with the tikker receiver.

CHAPTER VIII

TELEFUNKEN QUENCHED-SPARK SYSTEM

The Transmitter — The Receiver — Calling-up Apparatus —
Sound Intensifier

THE quenched-spark method of exciting electrical oscillations, of which the Telefunken system is the most

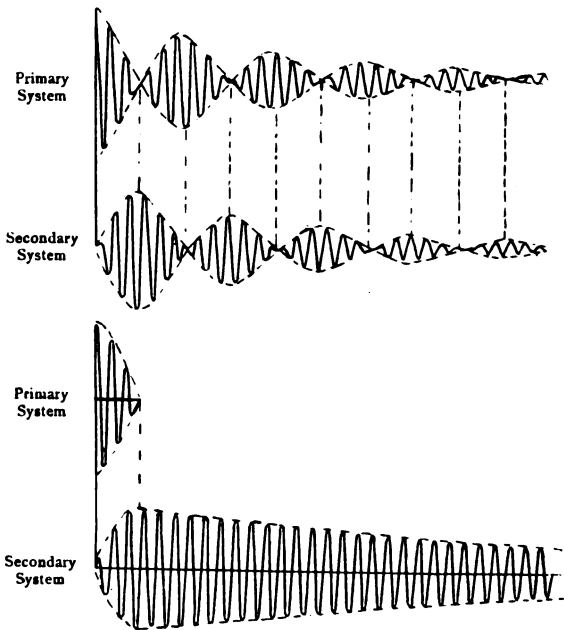

FIG. 97

widely used, is based on the experimental work of Professor Wien.

While making experiments on two coupled circuits the primary or exciting circuit of which contained a very short spark-gap, he found that in place of the usual coupled waves only one existed, the wave-length of which was determined solely by the capacity and inductance of the secondary circuit. This is no doubt due to the fact that, when the spark-gap length is very

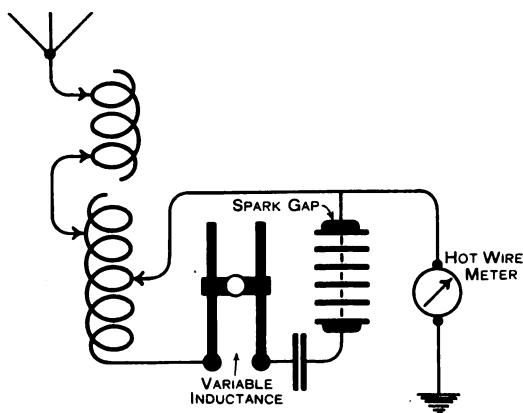

FIG. 98

Oscillatory circuits. Telefunken transmitter

short and the surface of the electrodes large, compared with it, the primary oscillations are rapidly damped out and cease to exist after two or three swings, and the energy being transferred to the secondary circuit and the coupling broken, the secondary circuit is left free to oscillate in its own natural frequency. Owing to the cooling of the gap and the consequent quick restoration of its high resistance there is no reflux back from the primary to the secondary as occurs in the ordinary coupled spark transmitters.

124 WIRELESS TELEGRAPHY

It will be seen that as the oscillation in the primary last for only a few swings the condenser losses in that

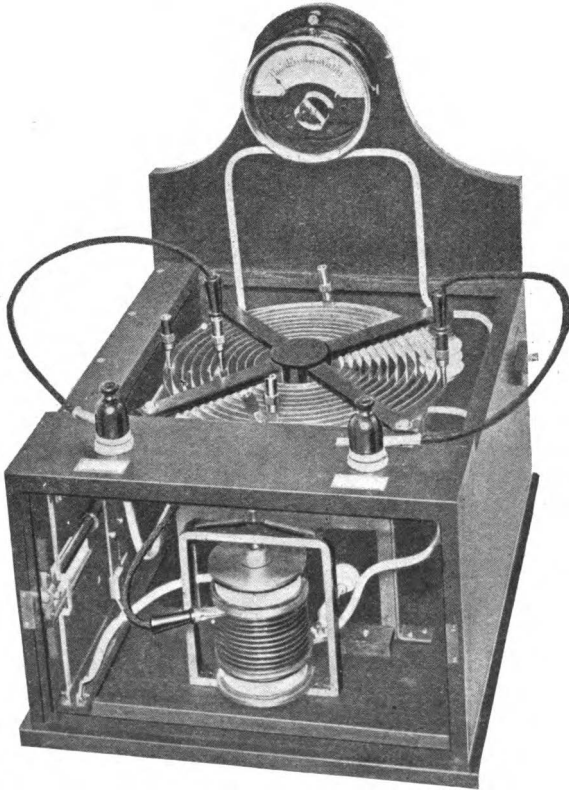

FIG. 99
Telefunken transmitter (oscillatory circuits)

circuit are a matter of comparatively small importance and it is therefore possible to use condensers having mica or paraffin paper as a dielectric, thus effecting

a great saving in space. The antennæ used with a quenched-spark transmitter is of the slow radiating type umbrella, or T-shaped, and the oscillations emitted are therefore feebly damped and persistent. Fig. 97

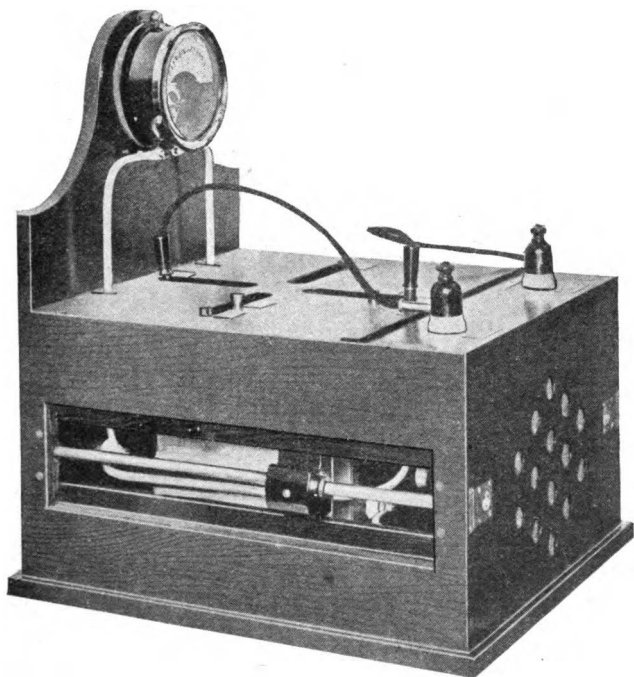

FIG. 100
Telefunken transmitter

shows the character of the oscillations emitted from an ordinary-spark transmitter and those emitted by a quenched-spark transmitter. The efficiency of this method of generating electrical oscillations is very high, 75 to 80 per cent. being the efficiency claimed fo

126 WIRELESS TELEGRAPHY

the larger installations. As an example of the Telefunken system a description of their I.T.K. set is given below. This set is built to give an oscillating energy in the antennæ of about 1 kilowatt. Fig. 98 shows the connections of the primary and secondary oscillat-

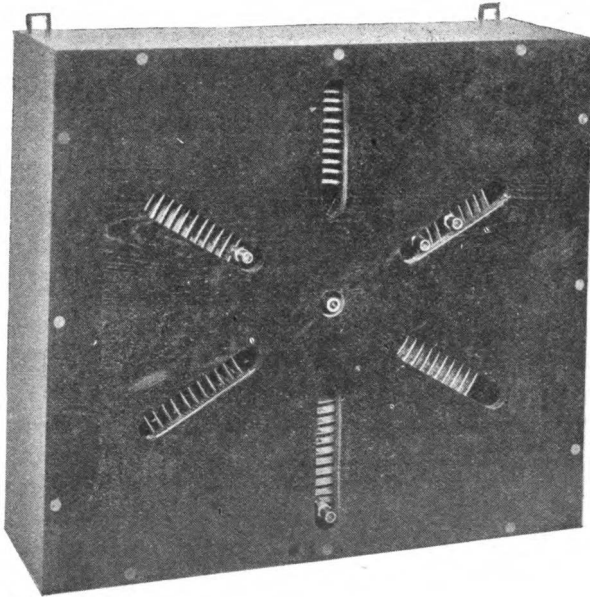

FIG. 101
Antennæ lengthening coil

ing circuits. The closed circuit consists of quenched spark-gap, condenser—which has paraffined paper as dielectric—continuously variable inductance and a portion of the flat spiral inductance all in series. To two points on this latter are connected the earth and antennæ leads, the latter through a lengthening coil and the former having included in it the usual hot wire

amperemeter. The leads from the secondary of the alternating-current transformer are connected across the condenser. Figs. 99 and 100 are photographs of

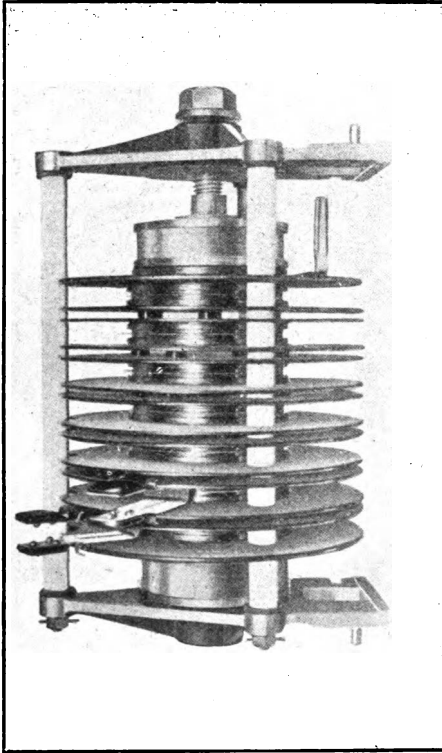

FIG. 102
Quenched spark-gap

the set. The handle to left of Fig. 100 varies the inductance of the primary circuit. Fig. 101 is the antennæ lengthening coil. When setting up a station the position of the clips for different wave-lengths are marked

128 WIRELESS TELEGRAPHY

and the inductance in primary circuit is then adjusted till the largest reading is shown on antennæ meter.

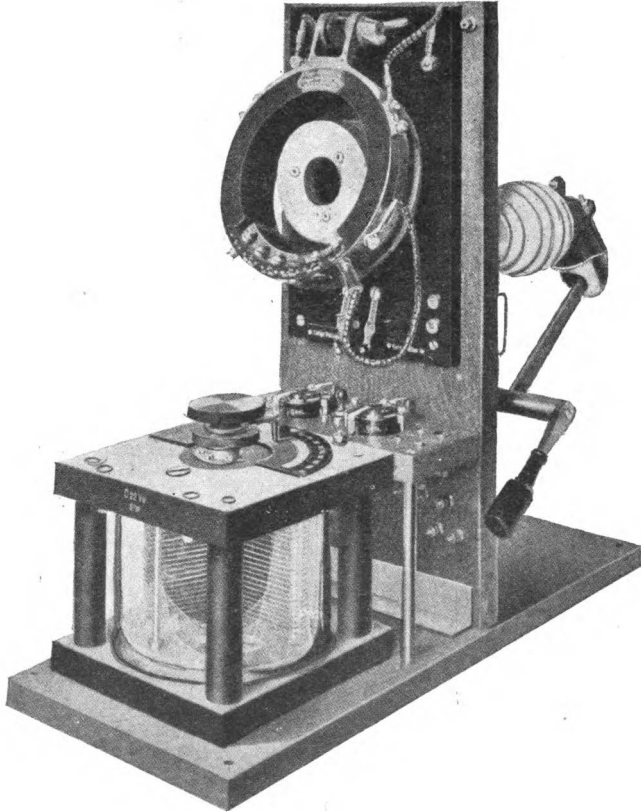

FIG. 103
Telefunken receiver

Fig. 103 shows the receiving apparatus and Fig. 104 is a diagram of the connections. It will be seen that there

are only two circuits in the tuner, the primary or antennæ circuit and the detector circuit. This latter, owing to the inclusion of the detector in it, is practically an aperiodic circuit. The only adjustment, therefore, is on the variable condenser in the antennæ circuit. Arrangements are made for the transference of this variable condenser from the position shown in diagram to one across the coil; the tuner thus having a con-

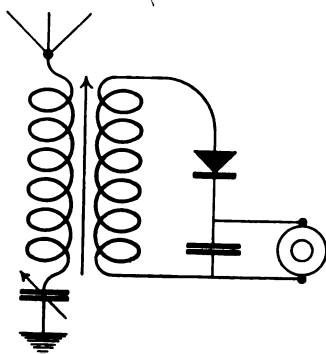

FIG. 104
Circuits of Telefunken receiver

siderable wave-length range. In certain cases for instance on a land station having a very large antennæ, say of the umbrella type, it would not be possible to employ such a simple receiver to advantage because, owing to the close coupling between antennæ and detector circuits, the enormous atmospheric disturbances sometimes met with would be carried with little diminution to the detector and cause a serious reduction in its sensitiveness and perhaps damage it. This can be mitigated by the employment of a receiver of the three circuit type, the intermediate circuit of which is

130 WIRELESS TELEGRAPHY

very feebly damoed and which is loosely coupled to

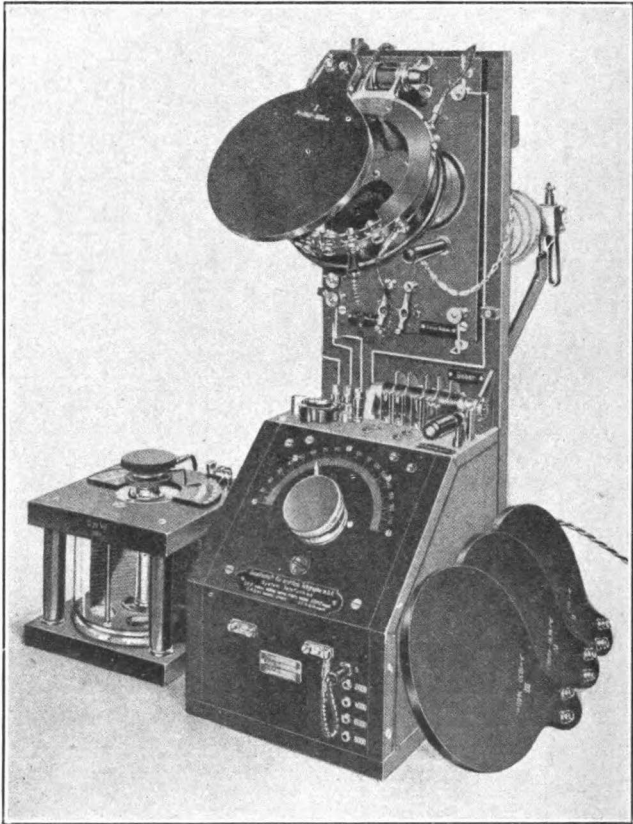

FIG. 105
Telefunken receiver (three circuit type)

the antennæ and not very closely to the detector circuit. Fig. 105 shows a Telefunken tuner of this

type. The coils of the intermediate circuit are interchangeable and a considerable range of wave-lengths can thus be covered.

CALLING-UP APPARATUS

The Telefunken Company supply with their stations a call-up device the construction of which is very ingenious. The following is a description of the apparatus:—the pointer of a well-balanced moving coil galvanometer, having a sensitiveness of 1×10^{-7} , is deflected by the current from the detector, if the current lasts for about ten seconds—*e.g.* if the transmitter sends an uninterrupted dash for ten seconds. If the duration of the dash is much shorter, as when Morse signals are being sent, a suitable deflection is not obtained owing to the inertia of the galvanometer. When the pointer is deflected it engages in a toothed wheel which is continuously revolved by clockwork and is depressed by it, thus closing a circuit containing a trembler bell which gives the alarm. The pointer is released by means of a lever movement when the call is answered by the operator. Fig. 106 shows the apparatus as supplied to ship stations mounted in cardan suspension.

The loss of the *Titanic* brought forcibly home to the minds of the people the necessity for some kind of call apparatus that would respond only to distress signals being installed on vessels carrying only one operator. It appears to the writer that the above apparatus would, if certain alterations were made in the distress signal, meet all requirements.

If instead of the present S.O.S. a long dash were

132 WIRELESS TELEGRAPHY

substituted, to be followed by the usual particulars as to the distressed vessels position, etc., the ringing of the alarm bell would call the attention of the operator, who would then take the particulars in the usual way.

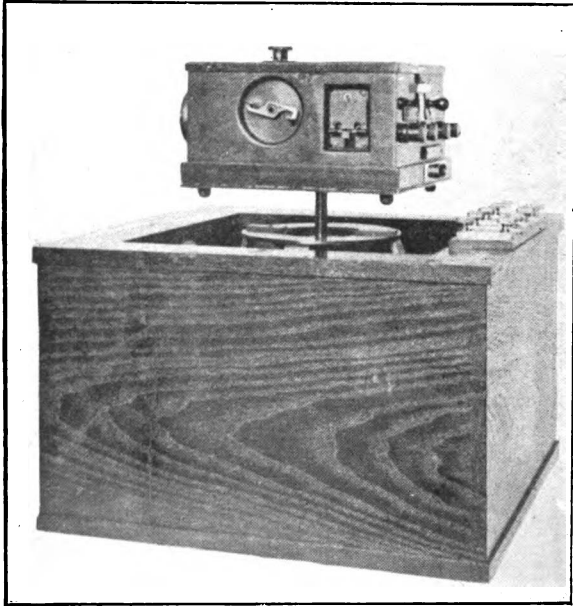

FIG. 106
Telefunken calling-up apparatus

Before any such device were adopted for the purpose it would, of course, have to undergo most searching tests as to its reliability.

TELEFUNKEN SOUND INTENSIFIER

The purpose of the sound intensifier is first, by means of mechanical tuning, to select signals of a

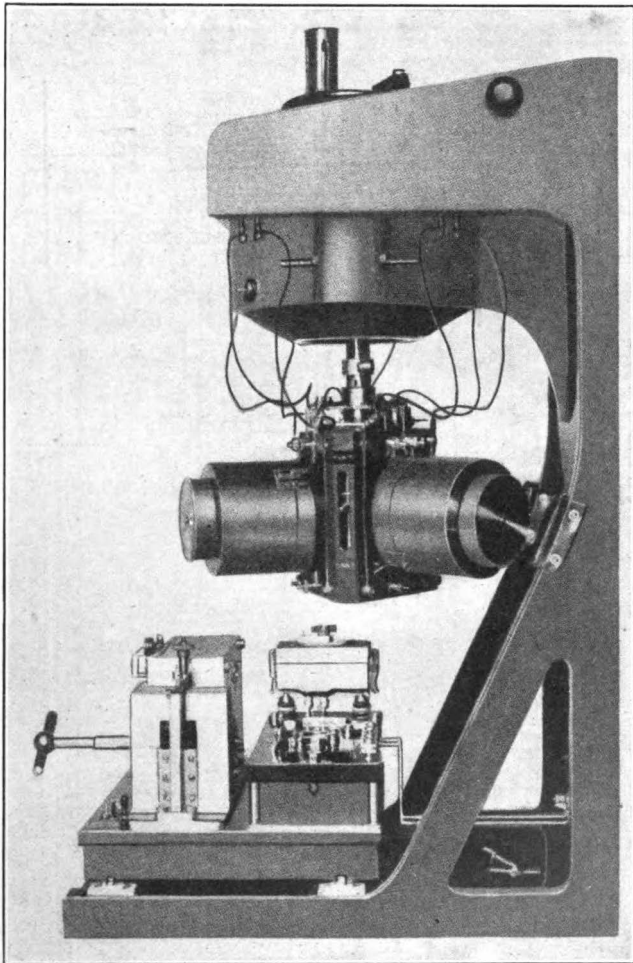

FIG. 107
Telefunken sound intensifier

given tone or spark frequency and then to intensify them. This is achieved in the following manner:—

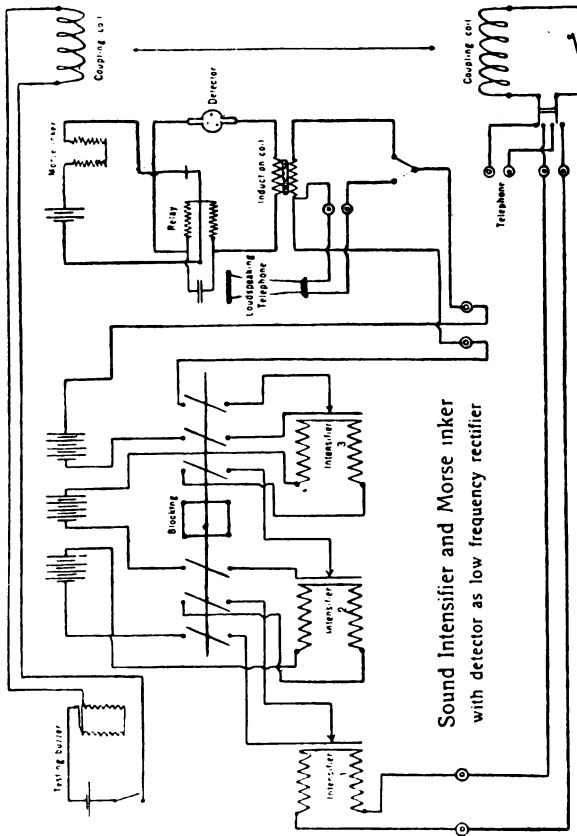

FIG. 108

the pulsating current which is given out by the detector when it is actuated by signals passes through the coils of an electric magnet wound to a high re-

sistance. The magnet is provided with a light armature with an accentuated natural period corresponding with that of the tone to be received. Against the armature is pressed a microphonic contact in series with which is a dry cell and the winding of a similar magnet, the armature of which is stimulated into vibrations of greater amplitude by the intensified current which is sent through its coils. It is the usual practice to step up the current three times and at the third intensification to pass the current through a loud-speaking telephone. With a triple intensification the current can be increased from 10^{-7} to 10^{-2} amperes and the signals rendered so loud as to be audible at a considerable distance from the telephone.

For ship working the intensifier is suspended in a well sprung and damped cardan suspension, and it is claimed that the apparatus requires little adjustment and remains constant for long periods. By the insertion of a small transformer and a rectifying detector it is also possible to work a Morse printer and thus obtain the advantage of a permanent record without sacrifice of distance. The diagram shows connections for reception either by printer or telephone.

CHAPTER IX

THE LEPEL SYSTEM

The Transmitter—Musical Note Device—The Receiver—
Modification for Receiving Undamped Waves

THE Lepele system, like the Telefunken, generates electrical oscillations by means of quenched sparks, but instead of a number of gaps in series only one is used and direct current instead of alternating. Fig. 109

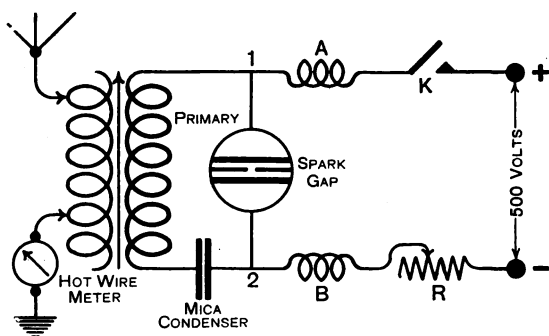

FIG. 109

Lepele quenched-spark transmitter

shows diagrammatically the arrangement of sending circuits as used by the Lepele syndicate.

Across a 500 volt direct-current supply is joined the spark-gap, the positive electrode being made of pure electrolytic copper, and hollow to admit of water cooling: the negative electrode is made of delta metal

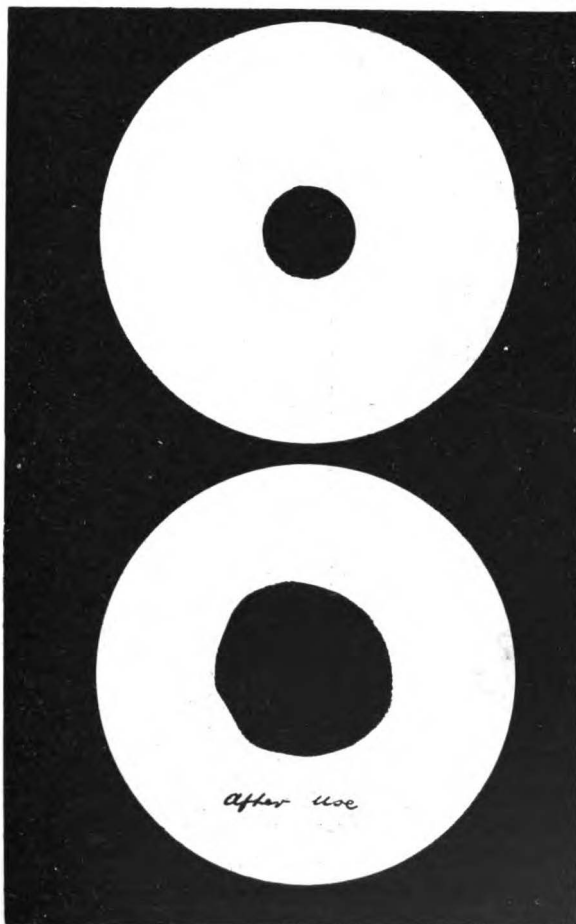

FIG. 110
Paper discs used in Lepele transmitter

and backs on to a water-cooled chamber. The electrodes are held apart by one or two paper discs (Fig. 110) having a circular hole punched out in the centre. By this method the spark-length is automatically set and the slow combustion of the paper allows a clean surface for the spark to pass, which greatly improves the regularity of the working. Across the spark-gap is shunted a circuit consisting of one or more turns of inductance which in the case of the Lepel system takes

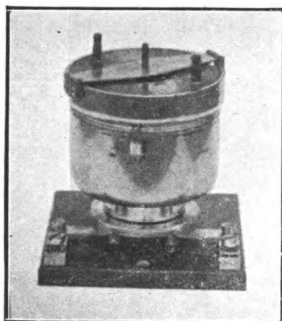

FIG. 111

Lepel spark-gap

the form of a flat copper tape of large surface wound on a cylindrical former, and a condenser made from copper foil with mica dielectric. The capacity of this condenser, it is found, should be kept rather large, something of the order of 100,000 centimetres being used. To the primary circuit is electro-magnetically coupled a secondary circuit, the ends of which are joined to antennæ and earth respectively. A and B (Fig. 109) are choking coils. K is the Morse key and R is resistance built up of iron filaments enclosed in glass bulbs containing a hydrogen atmosphere. This form of resistance, which the reader will no doubt recognise as being similar to those used in the Nernst lamp, constitutes a constant current device, and should the spark-gap from any cause become shorted the lamps at once increase their resistance and prevent the current from rising to dangerous proportions.

The oscillations emitted from an arrangement of

this kind are very feebly damped, the decrement being as low as $\cdot 04$, and are so nearly continuous that the effect on a receiver is that the signals are only audible as a faint blowing sound and probably could not be

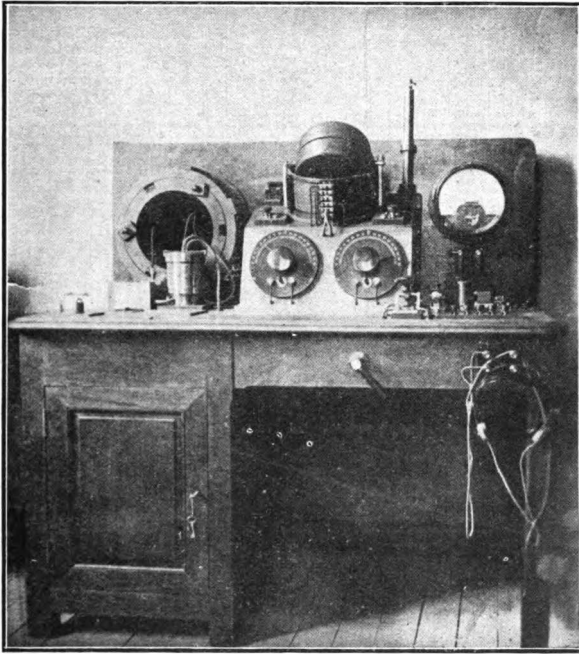

FIG. 112

Complete Lepele installation

detected at all at any great distance unless some form of interrupter was inserted in the receiver to cut up the current through the telephone. By an ingenious application of Mr Wm. Duddell's discovery that a direct-current arc would, if shunted by a circuit containing capacity and inductance, emit a musical

140 WIRELESS TELEGRAPHY

sound, the frequency of which corresponded to the electrical frequency of the circuit, the inventor has greatly extended the utility of the apparatus, inasmuch as by the use of the Duddell circuit the signals can be given out as pure musical notes and are thereby rendered distinctly audible in the receivers employed in ordinary spark installations. Each Lelup station is also fitted with a keyboard giving the operator a choice of eight notes so that it is possible to play simple

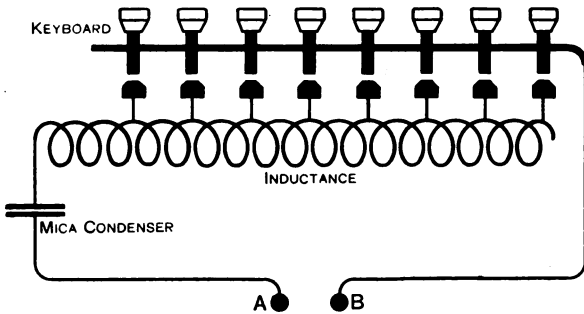

FIG. 113

Musical note apparatus. Terminals A and B are connected to 1 and 2, Fig. 109. The coil is not coupled to either primary or secondary

tunes with the same ease as signals are sent. The receiver is of the three-coil type and is shown in Fig. 112. The primary coil is connected to the antennæ and earth and has across its terminals a variable capacity by means of which the tuning is effected. The inductance of the primary coil is also variable in several steps. Coupled to the primary is the secondary circuit, which consists of a coil variable in steps and a variable condenser. The tertiary circuit, which contains the detector, is inductively coupled to the secondary.

142 WIRELESS TELEGRAPHY

undamped oscillations from a Poulsen transmitter, or from a Lebel set working without musical-note device. The change is effected by simply moving to one side or the other a two-way switch ; when it is desired to receive signals from a spark sender the switch is placed in a position such that the tertiary circuit is made up of the coil joined in series with a

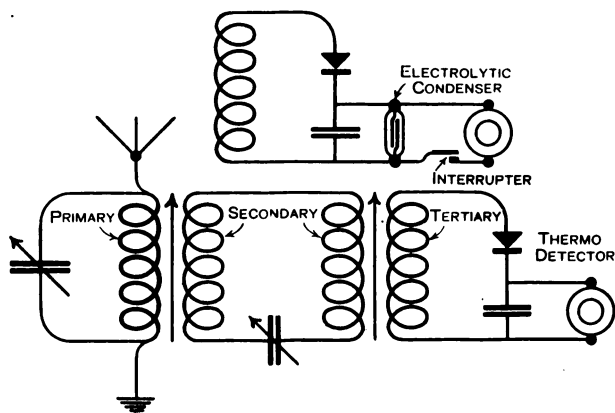

FIG. 115

Lebel receiver. Arrangement of circuits for reception of spark signals. Inset shows modification to receive undamped waves

small blocking condenser and the detector ; the phones being joined across the terminals of the condenser. When it is desired to receive the undamped waves the switch is placed in the alternative position, when the circuit is composed as follows :—In parallel with the blocking capacity is connected a piece of apparatus known as an electrolytic condenser. It consists of two pieces of foil about 3 centimetres in length by 1 in width immersed in an electrolyte and sealed into

a glass tube, the wires by which connection is made to the foil strips passing out through the walls of the tube. One lead of the telephone is also broken and a small

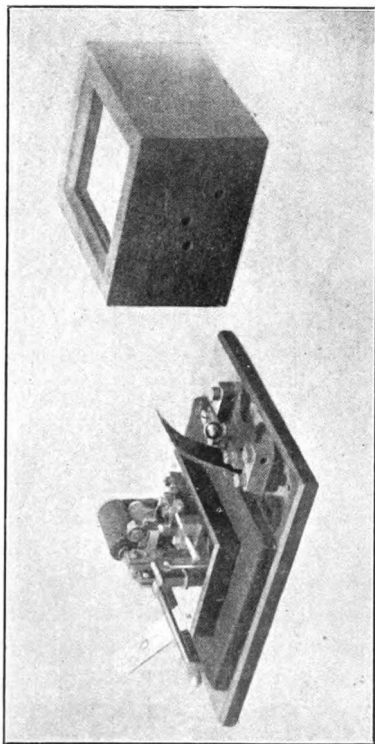

FIG. 116
The interrupter (cover removed)

intermittent contact, consisting of two gold wires crossing each other at right angles, inserted. The action of a receiver arranged in this way is as follows :— on the oscillations passing across the graphite-galena

144 WIRELESS TELEGRAPHY

junction it is heated and a small direct potential difference is created at its terminals. This potential difference acting on the electrolytic condenser polarises it—that is to say, a very thin film of hydrogen is deposited on the foil plates ; this film constitutes the dielectric of the condenser and being microscopically thin the capacity is enormous, something of the order of two microfarads. After polarising it, and thereby

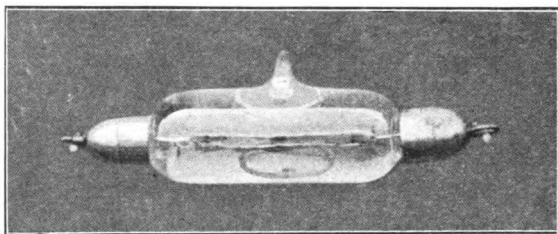

FIG. 117
Electrolytic condenser

making it a condenser, the thermo junction charges it, and this charge is sent through the telephone receiver every time the interrupter makes contact.

It will be seen that, like the Poulsen tikker arrangement, this is an integrating receiver—that is to say, the energy of the oscillations is collected over a given short period, determined by the speed at which the interrupter is running, and then discharged through the telephone, producing an enhanced effect.

CHAPTER X

GOLDSCHMIDT HIGH-FREQUENCY ALTERNATOR

A MACHINE which promises in the near future to revolutionise all existing methods of producing electrical oscillations is the Goldschmidt high-frequency alternator. For wireless telegraphy frequencies of from 40,000 upwards are needed and for communication over great distances large energy is also required. High frequency and large energy are contrary conditions and the frequency limit, depending as it does on the necessary cross-section of the winding, the insulation, width of pole pieces and the safe circumferential speed of the rotor, is soon reached and is of the order of 15,000 cycles per second. The principle on which Dr Goldschmidt's machine is based will be best understood in the following way:—suppose the current from an alternator giving, say, 15,000 cycles per second be sent through the stator of a similar and synchronous running machine this would then deliver an alternating current at 30,000 cycles per second, this going into the stator of a third machine. An alternating current of 45,000 cycles per second would result, and so on. It is, however, unnecessary to employ a number of machines, the frequency transformation being effected by a single alternator. Suppose a machine constructed to give an alternating current of 15,000 cycles, stator and rotor being identically wound, has

its stator excited by direct current (Fig. 118) the rotor will give an alternating current having a frequency of 15,000. The rotor is then short-circuited by means of capacity and inductance, forming a closed oscillating circuit tuned to this frequency. By reaction between rotor and stator, an alternating current of 30,000 cycles is set up in the stator circuit (which is tuned to this frequency), namely, 15,000 by induction and 15,000 due to the revolution, this again reacts on the rotor to which is added a circuit tuned to a frequency of

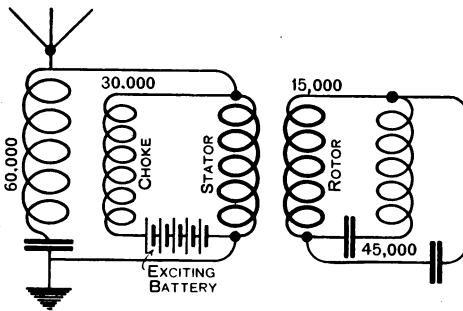

FIG. 118

45,000, and so on, the last circuit added containing the antennæ and earth. Fig. 119 shows such a machine arranged to give a frequency in the antennæ of 60,000 which

equals a wave-length of 5000 metres. It will be seen that the oscillations emitted by such a machine will be continuous and undamped and provided the machine runs at a constant speed there will be no fluctuation in the wave-length. It should be noted that the process is not a filtration of harmonics, as sometimes erroneously stated, but a true transformation of frequency, each frequency being only in existence on its own circuit. If the stator of the machine be excited by alternating instead of direct current the signals are heard in the receiver as a musical note,

GOLDSCHMIDT ALTERNATOR 147

with direct-current excitation it would of course be necessary to employ a receiver of the Poulsen tikker type. In the opinion of the company owning the Goldschmidt patents there will be no difficulty in constructing machines for any desired output, a machine having an output of $12\frac{1}{2}$ kw. at a frequency of 30,000, which is the frequency corresponding to a wave-length of 10,000 metres, and an output of 8 to 10 kw. for a wave-length of 5000 metres having already been constructed and operated successfully for a considerable time.

The highest frequency so far obtained is 100,000 cycles per second, which equals a wave-length of 3000 metres. The efficiency of these machines is remarkably high, at least for the long waves, the iron losses being kept low by minute subdivision

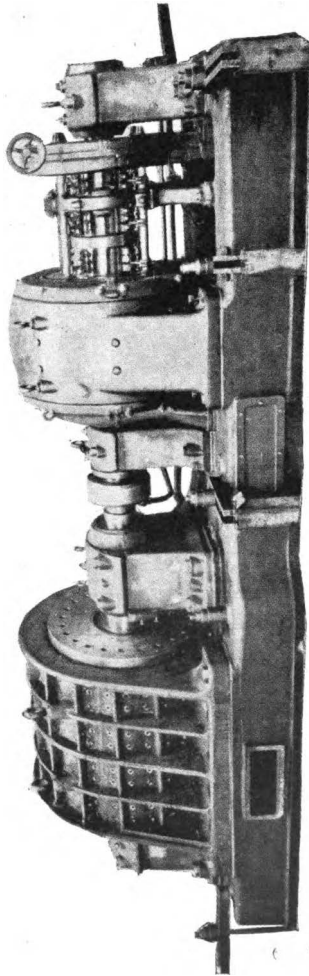

FIG. 119
Goldschmidt high-frequency alternator

148 WIRELESS TELEGRAPHY

of the cores. The efficiency of a machine giving a 10,000 metre wave is about 80 per cent.

For ship working, especially on small vessels where it is impossible to erect antennæ of large size, it would be necessary to employ frequencies varying from about 1,500,000 to 450,000 to cover the wave-lengths used, and at these enormously high frequencies it is possible that the efficiency of the machine might be so low owing to iron losses that it would not be serviceable. For large stations where it is possible to erect large antennæ it seems likely that the Goldschmidt high-frequency alternator or a machine similar to it will perhaps in the near future displace all other methods of generating electrical oscillations.

CHAPTER XI

PORTABLE INSTALLATIONS AND SMALL-POWER SETS

Marconi $\frac{1}{2}$ Kw. Set—Marconi Military Set—Telefunken Small-Power Ship Set—Telefunken Simplified Receiver—Telefunken Airship Station—Lepel Military Set

IN designing small-power sets and portable installations the chief considerations are light weight, compactness, the ease and speed with which the installation can be brought into operation, the limited amount of space available for their erection, simplicity of construction and manipulation and in many cases the cost is an important consideration. The larger companies now manufacture sets designed for use in almost all circumstances and we have found it somewhat difficult to select examples. In the following pages will be found a description of the Marconi $\frac{1}{2}$ kilowatt set, the Marconi cavalry set, small-power Telefunken ship's installation, simplified receiver for use on yachts and very small craft where a transmitter is unnecessary or impossible to install, also of the Telefunken airship installation and a short description of a Lepel military station.

MARCONI $\frac{1}{2}$ KILOWATT SET

This set is the result of much thought on the part of the Marconi Company's engineering staff to produce a small compact and efficient set suitable for cargo boats and other vessels where the ordinary standard ship equipments are too large.

150 WIRELESS TELEGRAPHY

The transmitter consists of rotary converter with starting switch, field regulating resistance and guard lamps, driven by the direct current from the ship's dynamo and supplying an alternating current to the alternating-current transformer. The Morse key, current-regulating device, ampere meter, fuses, and the primary winding of the transformer are connected in series and to the slip rings of the alternating-current side of the converter. The secondary winding of the transformer is connected through two air cone choking coils to the condenser which forms the capacity in the primary oscillatory circuit.

The primary oscillation circuit consists of glass plate condenser and stud disc discharger and the primary coil of the oscillation transformer. The secondary winding of the oscillation transformer is connected on one side to the antennæ through a variable tuning inductance and on the other side to the top plate of the earth spark-gap, the bottom plate of which is earthed.

The rotary converter is of the vertical type and occupies a minimum of floor space. It is designed to suit the direct-current supply available on the ship, has eight poles and runs at a speed of 2250 revolutions per minute, thus giving a spark frequency of 300 per second. The discharger box is made of aluminium and is fitted on top of the converter. It contains an eight stud disc, which is carried on the armature shaft by an insulating bush, the top of the box is made of ebonite, and carries the two electrodes.

These electrodes are designed to be independently adjusted, and both electrodes can be moved so as to regulate the time of the discharge in relation to the alternator. A scale of 180 degrees is fixed on top of

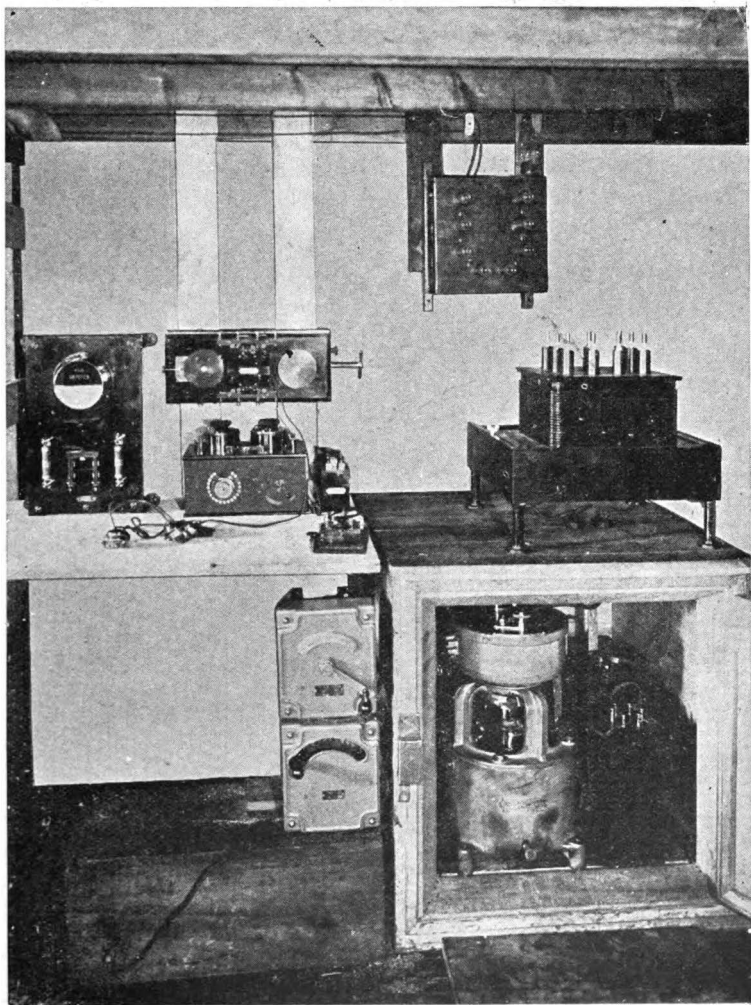

FIG. 120
Marconi $\frac{1}{4}$ kw. set

152 WIRELESS TELEGRAPHY

the discharger box. The phase displacement is shown by an index mark on the disc carrying the electrodes. When the index mark is at 0° on the scale the discharge will take place at the moment the alternator gives maximum voltage ; at 10° the discharge will take place 10° after the alternator has reached maximum voltage,

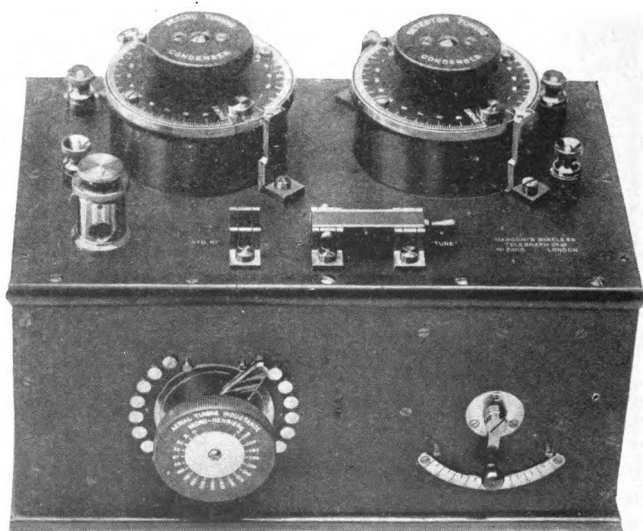

FIG. 121
Marconi two-circuit tuner

and so on. The primary of the oscillation transformer consists of about 7 turns of copper strip ; connection to it is made by means of clips and a ready means is thus provided for wave-length adjustment. The secondary winding consists of about 20 turns of stranded copper wire wound on a wooden former 12 inches square. The coupling between the coils is varied by

sliding the secondary coil over the primary. The transmitting apparatus, with the exception of the oscillation transformer, Morse key, starting switch and field regulator, are enclosed in a sound-proof cabinet from which they can be withdrawn for inspection or repair by means of a sliding base on which they are mounted. The tuner used is shown in Fig. 121. It has two circuits: the antennæ circuit, the tuning of which is effected by means of a variable inductance and a variable condenser; and the detector circuit, which is tuned by means of a variable condenser. A change-over switch is provided for changing the detector from stand-by to tune position, and means are also provided for varying the coupling between the coils. It will be seen that this tuner is similar to the multiple tuner, the intermediate circuit being omitted. Although the tuner is not so selective as the multiple tuner the omission of the intermediate circuit is no doubt fully compensated for by increased simplicity, which is of the first importance in the circumstances which it has been designed to meet.

The wave-length range is from 250 to 1600 metres, and the detector used is the magnetic.

MARCONI PORTABLE MILITARY SET

The photographs Figs. 122, 123 and 124 show a Marconi military set. In Fig. 122 the apparatus is seen packed for transport, Fig. 123 shows the station ready for use, and Fig. 124 the station in use. It will be seen that the complete installation, including mast, engine and dynamo, is carried on four saddles. The connections between the dynamo and transformer are

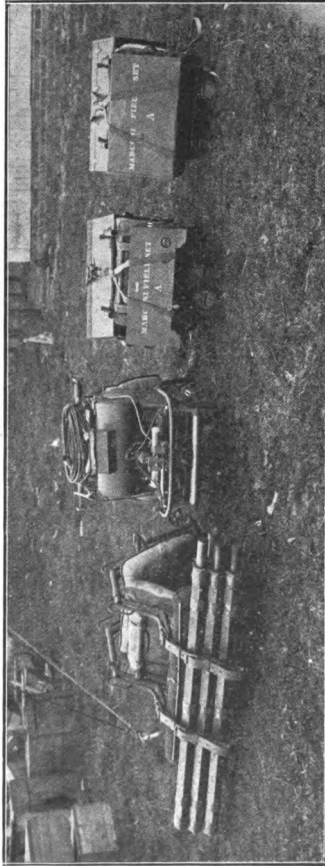

Photo

FIG. 122

Marconi field set packed for transport

Topical

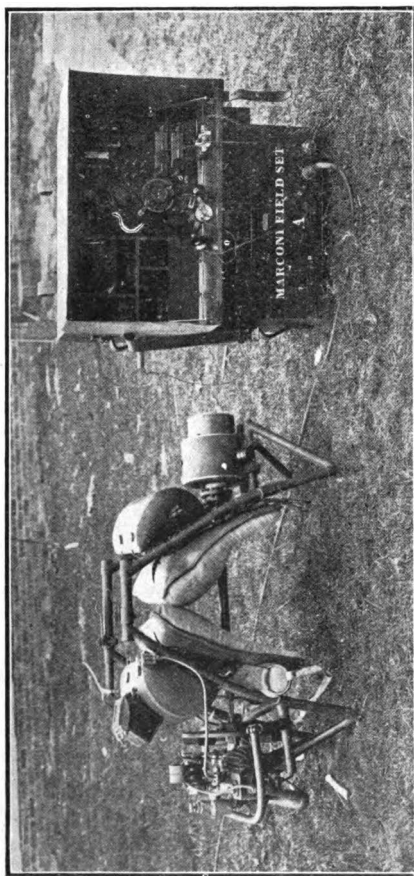

Topical

FIG. 123

Marconi field set ready for use

Photo

156 WIRELESS TELEGRAPHY

made by means of a flexible cable and plugs, and the earth connection by means of the strip of wire-netting

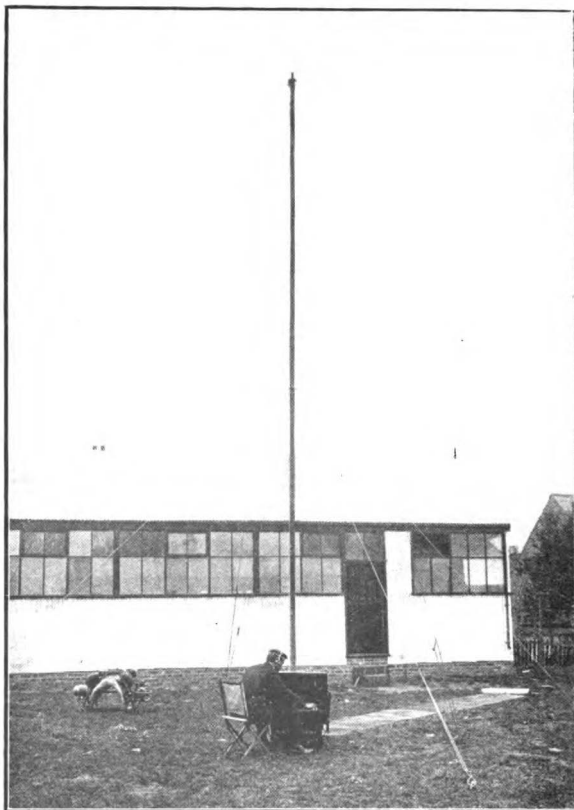

Photo

FIG. 124

Topical

Marconi field set in use

spread out on the ground, as shown in Fig. 124. The time required for the erection of one of these stations is very small, about twenty minutes being sufficient.

TELEFUNKEN SMALL-POWER SHIP'S INSTALLATION

Fig. 125 shows a small-power ship station capable

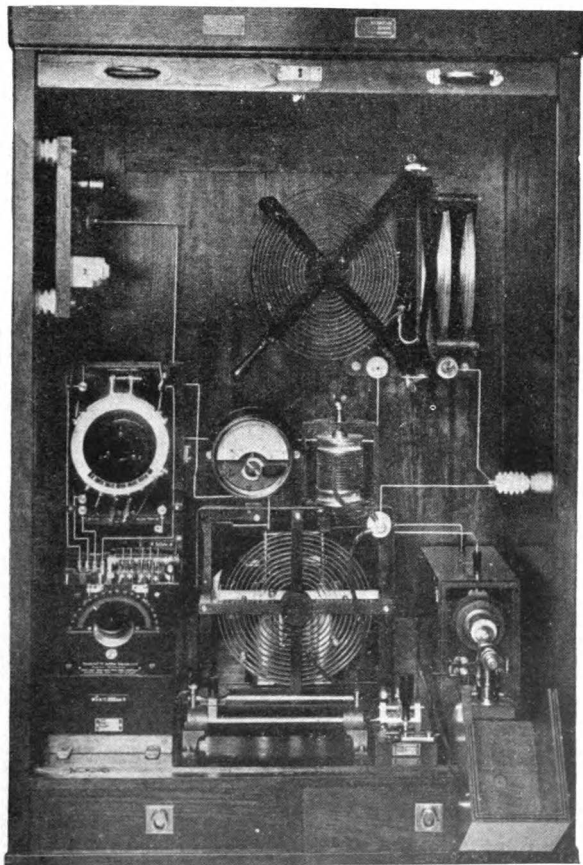

FIG. 125

Telefunken small-power ship's installation

of working over a distance of 100 miles or so.

158 WIRELESS TELEGRAPHY

It will be seen that the whole of the apparatus is

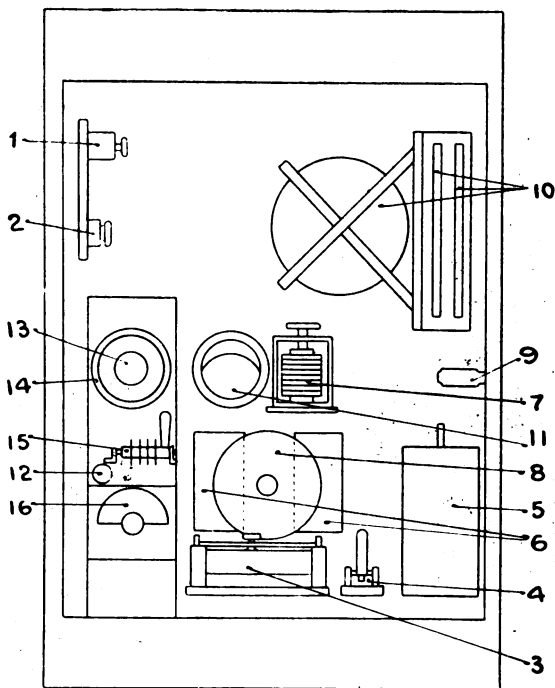

FIG. 126

Key to Fig. 125

- | | |
|------------------------|--|
| 1. D.C. switch | 9. Aerial lead insulators |
| 2. D.C. fuse | 10. Aerial tuning coils |
| 3. Variable resistance | 11. Ammeter |
| 4. Morse key | 12. Detector |
| 5. Induction coil | 13 and 14. Primary and secondary of receiver |
| 6. Leyden jars | 15. Multiple switch |
| 7. Spark-gap | 16. Variable condenser |
| 8. Inductance | |

mounted in a cabinet and occupies very little space. The primary circuit is made up of the Morse key,

variable resistance, and the primary of the induction coil joined in series across the supply mains. Across the secondary of the induction coil is the multiple spark-gap, consisting of six gaps between copper plates held apart by mica rings, and across this spark-gap is the primary oscillation circuit composed of Leyden jars and a portion of the flat spiral inductance. The antennæ, with a variable inductance working on the variometer plan in series with it, is connected to one point of the primary inductance and the earth wire to another. As explained in the preceding chapter, the oscillations in the primary circuit are rapidly damped, and owing to the cooling of the gap there is no reflux back from the antennæ circuit to the primary. Only one wave therefore exists, as after the primary has transferred its energy to the antennæ the coupling between them is broken and the secondary or antennæ circuit is left free to oscillate in its own natural period. The efficiency is remarkably high, being about 50 per cent., and the damping of the oscillations emitted is very low. The receiver consists of a two-circuit inductively coupled tuner with thermo-electric detector. The primary circuit is tuned by means of the variable capacity and by varying the inductance, the coil being variable in three steps. The secondary circuit contains the detector and therefore tuning is of little advantage owing to its resistance.

SIMPLIFIED TELEFUNKEN RECEIVER

This receiver has been designed to meet the demand for a receiving apparatus which would combine cheapness and simplicity in use with absolute reliability,

even when used by persons who have received no special training in the use of wireless telegraph apparatus.

The conditions which such an apparatus must fulfil in order to meet the technical and practical requirements are as follows:—

(1) The apparatus must be light in weight, of compact design, simple to operate, and cheap, both in original cost and in upkeep.

(2) The apparatus must have a wave-range which covers the wave-lengths used by lightships and coast signal stations (short waves, about 300 metres), the wave-lengths used on ship stations of the mercantile marine (medium waves, about 600 metres) and, finally, the wave-length used by high-power stations, such as Norddeich (long wave, about 2000 metres).

(3) It must be possible to adjust the receiver to the above-mentioned waves even when it is used in connection with the smallest aerials found in practice—*e.g.* on fishing vessels—and this adjustment must be carried out with a minimum loss of time and the smallest number of operations possible.

(4) A testing device must be provided by means of which it is possible for even the untrained operator to assure himself at any moment that the receiver is in good working order.

(5) It must be possible to replace all parts subject to wear and tear, quickly and easily.

The simplified receiver, type E 33, has been designed to meet this demand, and fulfils all the above-mentioned requirements. In its electrical qualities—*i.e.* sensitiveness, adjustability, damping—it is all that an apparatus, intended mainly for practical use in the hands of untrained operators, can be required to be.

The aural receiver E 33 is suitable, firstly for fishing vessels, small coasting steamers, yachts, motor and sailing vessels on which it is not considered worth while going to the expense of installing and operating a complete transmitting and receiving station. In such cases it provides a complete substitute for an expensive chronometer for ascertaining the position of the ship and also provides the possibility of receiving weather reports and warning of approaching storms, thus greatly increasing the safety of navigation.

This apparatus is also adapted for use in signal and pilot stations and meteorological and scientific institutions where a reliable system of time control for the regulation of clocks is of importance.

On board balloons and small airships the receiver would probably be found of as much importance as at sea for the purpose of ascertaining position and of receiving weather reports.

The receiver is contained in a wooden case, the outside dimensions of which are 8" × 8" × 8", the top of the case being formed by an ebonite plate (Fig. 127).

The following parts are mounted on this plate :—

(1) Rotating knob (d) with locking device (f) and pointer (z).

(2) Scale of degrees (g) with a triple wave scale (short waves—white, medium waves—red, long waves—yellow).

(3) Changing switch (u) with positions marked in three colours corresponding to 2.

(4) Detector (i) with cartridge.

(4a) Spare cartridge for the detector (i₁).

(5) Two telephone plug sockets (t).

(6) Rotating knob (p) for the testing device.

162 WIRELESS TELEGRAPHY

(7) Two terminals (n and m) for "aerial" and "earth."

Inside the wooden case are the various parts necessary for adjusting the wave-length and for tuning,

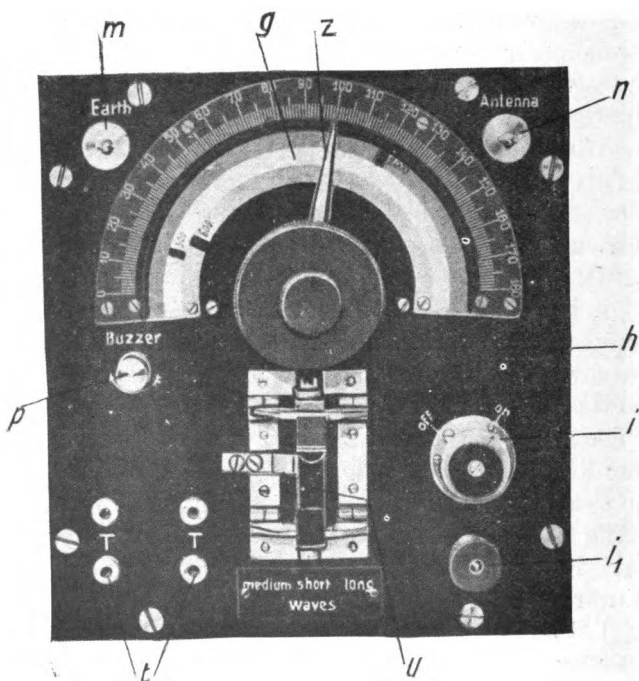

FIG. 127

such as variometer, condensers, buzzer, coils and dry cells, and the connecting wires.

By moving the changing switch (u) and the pointer (z) to the positions marked by the three colours ("short," "medium" and "long" waves) the oscillatory circuit of the receiver, consisting of the rotating

PORTABLE INSTALLATIONS 163

variometer and constant condenser inside the wooden case is tuned to the corresponding wave-length. A part of the energy collected in this oscillating circuit, which is connected with the antennæ is transferred to

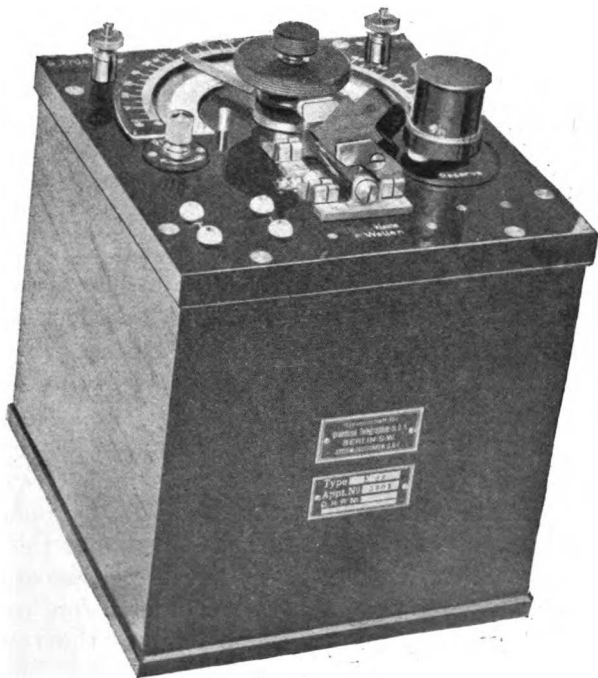

FIG. 127A

Simplified Telefunken receiver

the detector (i) by means of an aperiodic circuit tapped off the variometer. The detector converts the oscillations into an uni-directional current, and they become audible as signals in the telephone, which forms part of the detector circuit.

It is advisable that the receiver and antennæ should be erected by trained erectors as the antennæ leads have to be arranged for each individual vessel to meet the special conditions of the case. The capacity of the antennæ is dependent on the number, height and distance apart of the masts. The work of tuning up the apparatus to certain fixed wave-lengths, which are frequently used—*e.g.* 300, 600 and 2000 metres—should be carried out by skilled erectors at the time of the erection, and the exact positions for these wave-lengths marked on the coloured plates below the scale of degrees.

The exact position of these marks will depend on the capacity of the antennæ. When using the apparatus, if the wave-length of the signals to be received is known, the pointer is set to the position corresponding to the wave-length required. It should, however, be noted that the external influences, weather, etc., frequently render it necessary to adjust the pointer a few degrees above or below the normal position in order to attain the maximum intensity of the signals in the telephone.

In order to test the correct adjustment of the apparatus, and to ensure that antennæ, connections, detector and telephone are in good order before beginning to receive signals, the knob (p) of the testing device, which is on the left-hand side of the plate, should be turned momentarily in the direction of the arrow. If the apparatus is in order a buzzing sound will then be heard in the telephone. If this sound is not heard, or if it is very weak, the knob (r) of the detector (i) should be carefully turned until the buzzing is heard properly. As a rule nothing further is required to render the receiver ready for working.

PORTABLE INSTALLATIONS 165

Should the detector become injured by severe atmospheric discharges, the spare detector cartridge, which is supplied with every apparatus, should be inserted in place of the damaged one. This is a very simple matter, and is effected with very few operations.

TELEFUNKEN AIRSHIP STATION

In designing radio-telegraphic apparatus for airships and aeroplanes due consideration has to be given to the extremely limited space available on such craft, and the main points aimed at are small weight and dimensions.

In addition to the airship station which is described below in detail the Telefunken Company also build stations for aeroplanes. The total weight of these stations has been reduced to about 55 lbs. Experiments are now being carried on with these apparatus, and will enable a definite design to be decided upon very shortly. The apparatus of which the airship station consists are mounted in a wooden cabinet, which is divided by means of a vertical partition into an open front section and a closed back section.

In the front open half are all the separate parts of the transmitter and receiver which have to be operated or adjusted by hand, while the back closed half of the cabinet contains all those parts of the transmitter which need no attention, such as the self-induction and capacity.

A small winch is mounted on four porcelain insulators on the top of the cabinet. On this winch a phosphor-bronze aerial wire about 200 metres long is wound. The crank, pawl, brake, counter and drum of the winch

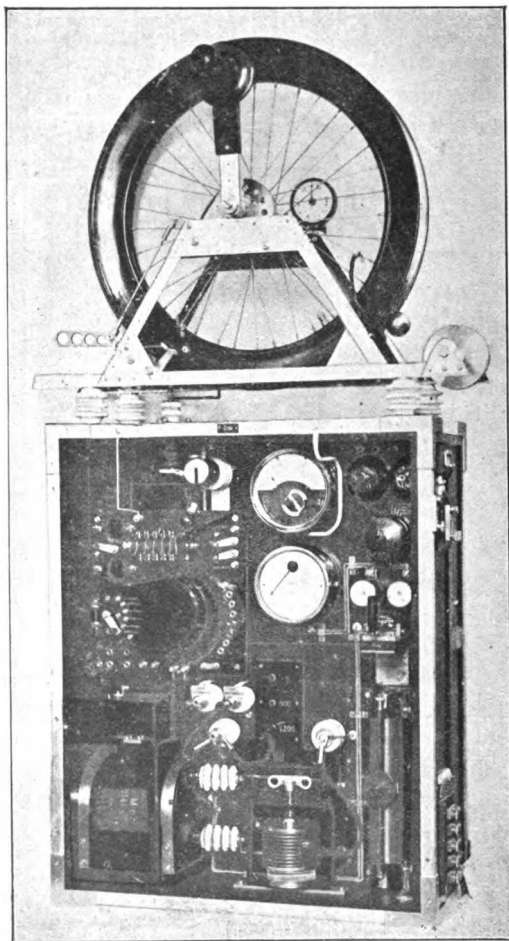

FIG. 123
Telefunken airship installation

are heavily insulated. Outside the cabinet on the right-hand side are the terminals for the connections from the source of power and for lighting the station. The external dimensions of the cabinet are : width about 600 cm., depth about 330 cm., and height about 760 cm., and the station requires a vertical space of about 1350 cm.

The bronze wire of about 3 mm. diameter wound on the winch serves as an aerial and can be wound off by means of the insulated hand crank to suit the wavelength chosen. The wire passes over insulated pulleys over the edge of the car, and hangs down freely. A counter shows the number of metres wound off.

An aerial change-over switch, in the cabinet, is arranged so that when in the transmitting position it interrupts the receiver circuits and when in the receiving position interrupts the main power circuit so that the sensitive receiving apparatus are not liable to be damaged by an accidental pressing of the key while receiving. The metal frame of the car, etc., forms the counterpoise.

The source of power is an alternating-current generator with direct coupled exciting machines. The output of the generator at about 3000 revols. per min. is about 500 watts, and the frequency is 500 per second. The generator is driven from the motor of the airship either by means of a belt or chain or by means of intermediate gearing with a throw-out clutch.

A voltmeter and a pressure speed regulator and the fuses are mounted in the cabinet.

The transmitter consists of the following:—transformer, quenched spark-gap, excitation capacity and

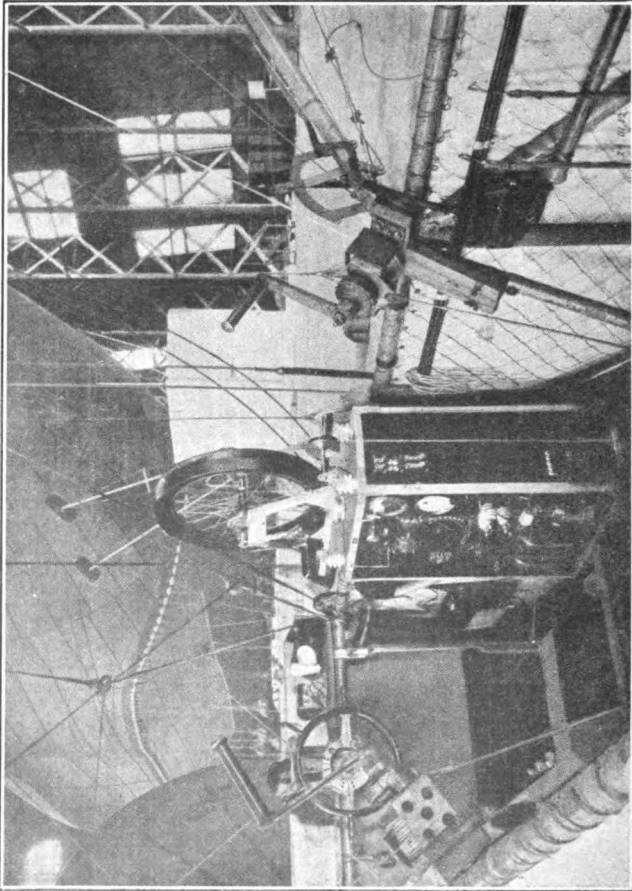

FIG. 129
Telefunken airship station

self-induction, aerial lengthening coil, ammeter, Morse key and a changing device for three different wave-lengths. The capacity self-induction and lengthening coil are in the back closed half of the cabinet, the other parts are conveniently arranged in the front half of the cabinet so as to be easily accessible.

The excitation circuit of the transmitter can be tuned to several waves, ranging from 300 metres to 600 metres. For the different wave-lengths corresponding aerial coils, fitted with connecting plugs for specified wave-lengths, are connected in the antennæ. The exact tuning is effected by winding off more or less of the antennæ wire. The antennæ wire is marked in different colours corresponding to the connections on the excitation and coupling coils.

If an airship is flying very low down only the short wave-lengths can be used.

The receiver is a complete aural receiver of a special type designed for airships. The separate parts of the receiver are as follows:—variable self-induction detector, telephone, blocking condenser, and a blocking switch for the detector. Two plug sockets are provided for the telephone. All these parts are mounted in the cabinet.

The whole of the self-induction which is used for increasing the natural wave-length of the aerial is also used for direct coupling the detector. The detector coupling turns can be varied by means of plugs. The number of turns for lengthening the aerial remains approximately constant for all wave-lengths, so that only the detector coupling turns need to be regulated.

The effective range of the station communicating

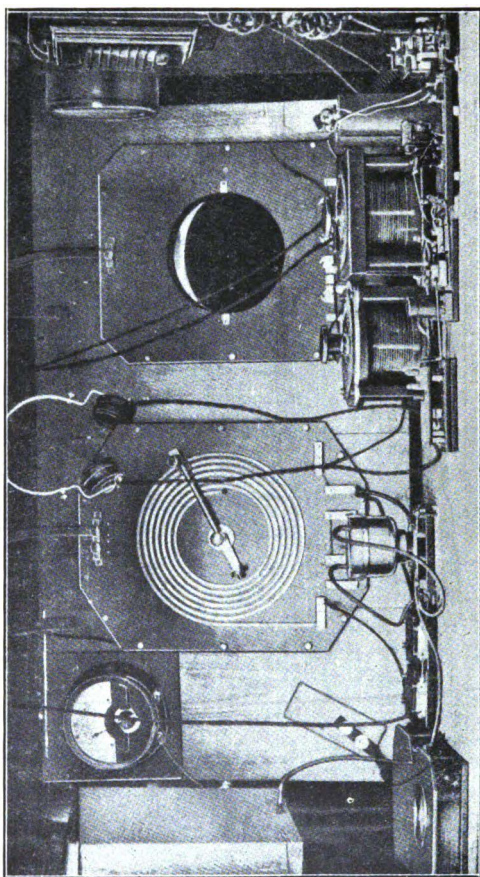

FIG. 130
Portable Lelpel installation

PORTABLE INSTALLATIONS 171

with a wheeled military station is about 100 to 200 kilometres.

The weight of the complete station is as follows :—

Apparatus cabinet and winch, about	. 155 lbs.
Alternator and exciting dynamo, about	. 120 „

Total weight, about 275 lbs.

LEPEL PORTABLE STATION

Fig. 130 shows a Lepel military set arranged for waggon transport. The flat spiral coil to the left of the photograph is the primary inductance which is varied by turning the handle. The quenched spark-gap is immediately in front of it. On the table to the left of the spark-gap is the small mica condenser which forms the primary capacity, and to the left of this are the two choke coils. The secondary coil is a flat spiral mounted on a leaf hinged at the bottom and the coupling is varied by means of the strap seen above the primary coil. The tuner is of the three circuit type and is seen to the right of the photograph together with the variable condenser, detector and blocking switch. The mast used in conjunction with this set is of the telescopic variety, made of steel tube and has a height of about 90 feet when fully extended.

CHAPTER XII

MEASUREMENTS

Capacity — Dielectric Losses in Condensers — Capacity of Antennæ — Insulation Resistance of Antennæ — High-Frequency Resistance — High-Frequency Currents — Wave Meters—Measurement of Wave-Length—Resonance Curves and Damping Decrements—The Marconi Decimeter—Logarithmic Chart—Inductance—Coefficient of Coupling—Calibration of Receiving Circuits—Earth Plate Resistance—Strength of Received Signals—Energy in Antennæ

THE capacity of a condenser varies directly as the area of the opposing surfaces and inversely as the thickness of the dielectric or distance between the plates. The nature of the dielectric also has considerable influence in determining the capacity of a condenser. Supposing, for instance, that two plates, each having an area of 1000 square centimetres and the distance between the plates being $\cdot 1$ of a centimetre, its capacity K can be calculated from the formula¹ $K = \frac{S}{4\pi t} k$ (where S is the area of one of the plates in square centimetres, $\pi = 3\cdot 1416$, t = thickness of dielectric and k = the dielectric constant which in the case of air is taken to be unity), and will be found to be 795 centimetres.

¹ The formula for capacity given above is based on the assumption that the lines of force between the plates are straight lines; it must only therefore be used when the thickness of dielectric is very small compared with the surface of the plates.

If now the space between the plates be filled with mica, the capacity will be greatly increased and in fact will be about five times as great as when the dielectric was air. This is due to the fact that various materials allow electro-static induction to take place across them in varying degree. Thus mica permits it to take place about five times as well as air.

The ratio that exists between the capacity of two condensers of equal size, one having air for a dielectric and the other some other material, is termed the dielectric constant for that material and is denoted by the letter k . At the end of this chapter will be found a table of dielectric constants of the more usual materials used in condenser making, but it should be noted that different specimens of the same material often exhibit marked differences in the value of their dielectric constants, and that therefore the formula given above should only be used to calculate the value of an air condenser. If, however, we possess a standard condenser it is a simple matter to ascertain the value of an unknown capacity. Referring to Fig. 131, K is the known capacity; K_1 is the capacity to be measured. R and R_1 are variable resistances,¹ which must, however, be non-inductive and of small capacity, and T

¹ These resistances, as is perhaps well known to our readers, are built up of a wire doubled back on itself to form a non-inductive winding. In the case of the higher resistances it is necessary to use a considerable length of wire, which results in the coil having considerable capacity, and when used with a quickly pulsating current the coil would behave exactly as a condenser; to obviate this, the coil should be built up of a large number of smaller non-inductive resistances joined in series. When this is done it will be seen that the capacity is reduced to a minimum, as we are in effect joining a number of capacities in series.

is a telephone receiver. To the points A and B an intermittent voltage is applied, which may conveniently

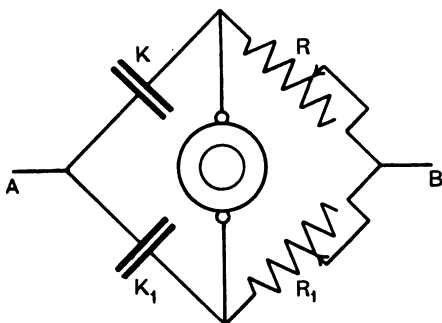

FIG. 131

be done by joining in series a dry cell and quick-running interrupter and connecting them across the points.

On adjusting the resistance a point will be found at which the sound in the telephone will disappear or

at least be a minimum. When this point is found a certain ratio exists between the condensers and the resistances such that $K : K_1 :: R : R_1$ —that is to say, as K is to K_1 , so is R to R_1 , and the value of the resistances in ohms being known and also the value of the standard condenser it is a quite easy matter to find the value of the unknown capacity. This method is known as the De Sauty bridge method, and is suitable for the measurement of capacities from a few hundred centimetres upwards provided that the capacity to be measured and the standard condenser do not differ by more than a small multiple. When the unknown capacity has a dielectric of different material to the standard it will sometimes be found impossible to obtain a complete cessation of sound in the phone owing to unequal absorption of the dielectrics, but in such cases the method can be depended upon to give results accurate to within a few per cent. Fig. 132 shows a convenient and practical form of the apparatus

devised by the writer ; in the box are three standard condensers whose values are 60,000, 10,000 and 1666 centimetres respectively. The box also contains a

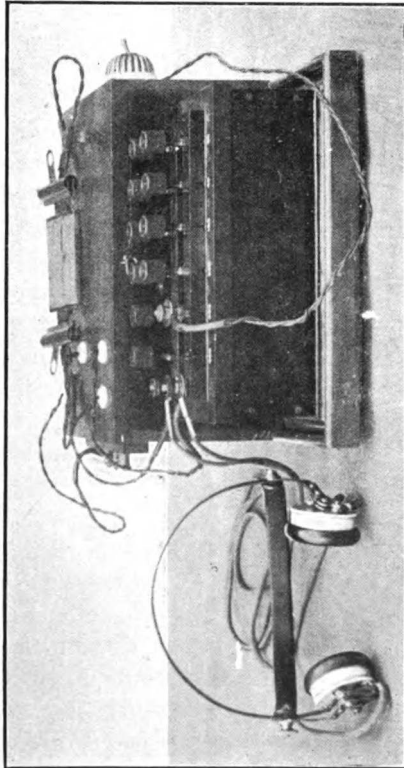

FIG. 132
Practical form of De Sauty bridge for capacity measurement

quick-running buzzer which supplies the intermittent voltage necessary. The resistance is a standard resistance box reading to 1100 ohms in steps of 1 : the condenser to be measured is inserted in the clips

on top of the box. Fig. 133 is a diagram of the connections. Another method suitable for the measurement of a small condenser is to join it in series with an inductance of known value and by means of a small Rhumkorff coil to cause the circuit so formed to oscillate, then by means of the wave meter the wave-length is ascertained and the value of the capacity in microfarads found from the formula.— $\lambda = 59.6 \sqrt{CL}$, where λ = wave-lengths in metres, C = capacity in microfarads and L = inductance in centimetres.

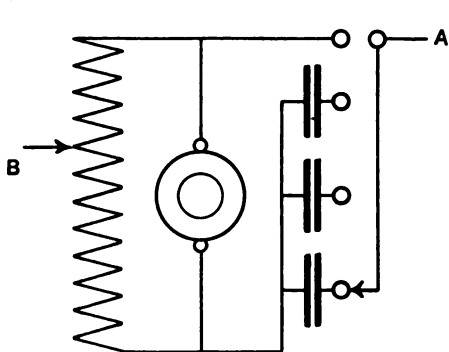

FIG. 133
Connections of De Sauty bridge shown in Fig. 132

DIELECTRIC CONSTANTS

<i>Substance</i>	<i>Dielectric Constant</i>
Sulphur	2.24
Ebonite	2.0
India-rubber	2.12
Gutta-percha	2.46
Paraffin	1.98
Shellac	2.95
Mica	6.0
Castor oil	4.78
Turpentine	2.15
Petroleum	2.07
Glass (according to quality)	6.6 to 9.8

A convenient standard inductance can be made by winding 8 turns of double silk-covered wire gauge number 18 on a cylindrical former 20 centimetres in diameter: this will have an inductance of 25,000 centimetres.

DIELECTRIC LOSSES IN CONDENSERS

We have already seen that the losses in an oscillating circuit are caused, first, by the resistance of the conductor forming the inductance and in the case of a circuit used to generate electrical oscillations by the resistance of the spark. The condenser unless it have air as dielectric will also dissipate energy, and it is therefore necessary to be able to measure this energy loss caused by the dielectric and thus judge of its suitability for the purpose. If we are in possession of a variable air condenser the capacity of which is great enough to cover the capacity of the condenser whose energy-absorbing powers we wish to ascertain the matter is comparatively simple and should be carried out as follows:—

The condenser under test is joined up with an inductance so as to form an oscillating circuit. Included in the circuit is a calibrated hot wire milliamperemeter. A second circuit, consisting of capacity, inductance (either or both of which are variable) and a spark-gap, and excited by means of an induction coil, is then set up and loosely coupled to it. The exciting circuit is then tuned by varying its capacity or inductance until the small hot wire meter in the first circuit gives its maximum reading. This will indicate that the two circuits are in resonance. The current in the circuit as shown by the meter is then noted. The

coupling between the circuits should be kept constant and the variable air condenser substituted for the condenser under test and its capacity varied till the meter again gives its maximum reading and indicates the attainment of resonance. Now obtain a variable non-inductive resistance and join it in circuit with the condenser and inductance and vary its resistance until

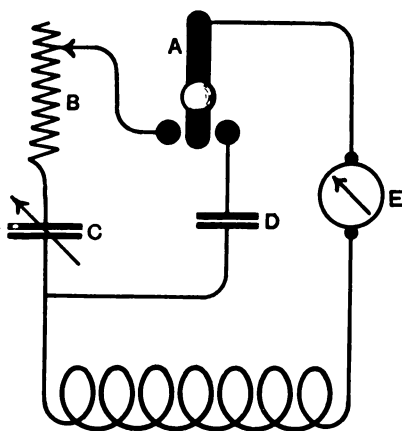

FIG. 134

A = Switch. B = Non-inductive resistance. C = Variable air condenser. D = Condenser to be tested. E = Hot wire meter

the meter shows the same reading as it did when the condenser to be tested was in circuit. It will be quite evident to the reader that the energy absorbed by the dielectric of the condenser under test is equal to the energy-absorption of the resistance which we have included in circuit with the air condenser which has been substituted for it, and can be found by the aid of the formula C^2R , where C^2 is the mean square value of the current and R is the equivalent resistance. Fig. 134 shows a convenient method of connecting up the circuit to make the test. A is a switch which in one position connects in circuit the condenser to be tested and in the second position the variable air condenser and non-inductive resistance.

The chief difficulty in carrying out this test arises

from the fact that the spark in the exciting circuit is sometimes difficult to maintain constant. Care must also be taken to prevent any brushing from the edges of the air condenser plates, as if this takes place the energy absorption may be considerable. A useful comparative test in certain circumstances can be made in the following way:—Connect the condenser under test in circuit instead of the usual condenser on the receiver, bring the circuit to resonance with a station sending out signals and measure the strength of the incoming oscillations as per instructions given in a later part of this chapter. Now insert a variable air condenser in its place and measure strength of incoming oscillations; we can now form an idea as to the energy-absorbing power of the dielectric by its effect in reducing the strength of the signals.

CAPACITY OF ANTENNÆ

Except in very simple cases, such as that of a single vertical wire, it is not possible to calculate with any accuracy the capacity of an antennæ. The capacity of a single vertical wire can be calculated from the

formula $C = \frac{l}{2 \log \epsilon \frac{2l}{d}}$, when $C = \text{Cap. in centimetres}$,

$l = \text{length of wire also in cm.}$, $d = \text{its diameter}$: as an example suppose the antennæ to consist of a single vertical wire of length 50 metres and diameter 3 millimetres, C will equal 5000 and d will equal $\cdot 3$,

$$\therefore C = \frac{5000}{2 \log \epsilon \frac{10000}{\cdot 3}} = \frac{5000}{20 \cdot 8} = 240 \text{ cm. approx.}$$

The addition of wires in parallel will not, however,

increase the capacity in direct proportion to the number of wires, owing to the fact that the wires exercise a screening effect on one another which renders the distribution of the lines of force unsymmetrical for each wire. The capacity may be said to increase roughly as the square root of the number of wires in parallel—thus four wires would give double the capacity of one wire, nine wires three times the capacity, and so on. Assuming the possession of a wave meter and a variable condenser the capacity of which is known

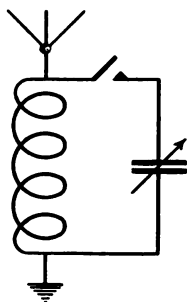

FIG. 135

it is quite a simple matter to measure the capacity of the antennæ: the procedure is as follows:—first add a coil of wire of a few turns to the antennæ and excite by means of a small spark coil; then by means of the wave meter measure the wave-length; having done this set the wave meter to double the wave-length and then by means of the switch (Fig. 135) join the variable condenser across the antennæ coil, adjust till it is in resonance with the wave

meter, the capacity of the antennæ will then be equal to one-third of the added capacity. As an example, supposing that the wave-length of the antennæ with the coil in series was 100 metres and that the amount of capacity necessary to bring the wave-length up to 200 metres was 600 cm., the capacity of the antennæ would be 200 cm.

INSULATION RESISTANCE OF ANTENNÆ

It is of the utmost importance that the antennæ should possess a high-insulation resistance, the measure-

ment of which is made as follows:—disconnect the antennæ from the circuit and connect it to one terminal of a very sensitive galvanometer which has previously been calibrated; the second terminal of the galvanometer is connected to one pole of a direct-current dynamo or battery of cells giving a voltage of from 200 to 500 volts; the other pole of the dynamo is connected to the earth plate. Observe the current indicated by the galvanometer and the insulation resistance of the antennæ can then by the aid of Ohm's law be found. Thus, supposing the voltage of the dynamo to be 500 volts and the current indicated by the galvanometer 2 microamperes, the insulation resistance will be found to be 250 megohms or 250,000,000 ohms. The insulation resistance will be found to vary greatly with the atmospheric conditions prevailing, thus it is much higher in fine dry weather than when the atmosphere is saturated with moisture.

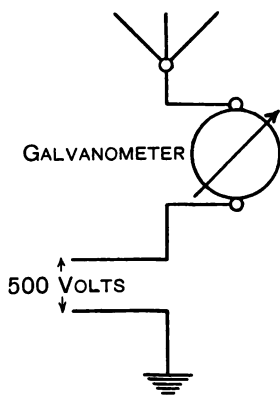

FIG. 136

It should be noted that although the antennæ may have a very high insulation resistance it is not necessarily well insulated for oscillatory currents, or for the very high potentials used in Radio-Telegraphy. To secure perfect insulation we must arrange that the antennæ does not run close to any earthed metal-work, and more especially that it does not run parallel to it. If this is not done, oscillations will be set

up in the earthed metal-work by induction from the antennæ and energy absorbed as effectually as if they were in actual metallic contact. It is for this reason that the guys supporting the mast of a Radio-Telegraph station are cut up into short lengths by means of insulators.

HIGH-FREQUENCY RESISTANCE

By Ohm's law the resistance of a conductor will vary as its length and inversely as its cross-sectional area, but this only applies to conductors carrying steady currents. The high-frequency resistance of a conductor is often very different from its resistance to steady or slowly alternating currents. The difference in the resistance will depend on the frequency of the alternations of current and upon the size or cross-section of the wire. A wire of large gauge will have a resistance many times higher for high-frequency currents than for a direct current; this is due to the concentration of the current on the outer skin and therefore to the reduction of the effective cross-section of the wire. If the wire were of a small gauge, say No. 38, the difference in value of the resistance for high and low frequencies would be very small, practically nil. For this reason many of the coils used in Radio-Telegraphy are made from laminated conductors—that is to say, a conductor built up of several hundred very small insulated wires. For the same reason they sometimes are made from tubes instead of solid wires. There is no convenient way for the operator to measure directly the high-frequency resistance, but if the coils are constructed as above they can be measured in the ordinary way on the

Wheatstone bridge and the high-frequency value will differ only very slightly from the value so obtained.

HIGH-FREQUENCY CURRENTS, MEASUREMENT OF

For the measurement of high-frequency currents the ordinary hot wire ammeter is of no use, for the reason that it is constructed on the shunt principle—that is to say, the greater portion of the current to be measured is diverted through the shunt, which is a stout copper wire or strip, and only a small known fraction passes through the wire of the meter. As explained in the chapter on high-frequency resistance, a thick wire has a much higher resistance to high-frequency currents than to steady or low-frequency currents, and therefore as the shunt consists of a stout wire its resistance would vary with the frequency of the current to be measured and it would thus be impossible to use such an instrument. A piece of apparatus known as a Reiss thermometer is, however, a suitable device with which to measure a high-frequency current. It consists of a bunch of fine bare wires connected between terminals and enclosed in a glass bulb; in connection with the bulb is a U-shaped stem containing a liquid coloured to make it easily visible. If now a direct current be passed through the bunch of fine wires they will be heated and in turn heat the air in the bulb, which will expand and drive the liquid up the tube. By passing various currents through the wires and noting the height to which the liquid rises in the tube for each current the instrument can be calibrated in amperes. The heater, being

formed of a number of fine wires in parallel, will have the same resistance to high and low frequency currents and is therefore suitable for the measurement of a high-frequency current.

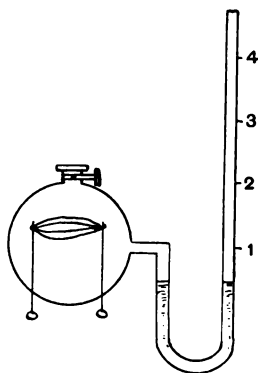

FIG. 137
Reiss thermometer

Fig. 137 shows a Reiss thermometer. If such an instrument is not available the high-frequency current can be roughly measured by inserting in the circuit a piece of fine wire and noting how many strands in parallel the current will melt. Having ascertained the number, take the same number and pass through them a direct current, increasing it till they melt and noting on the amperemeter,

which should be joined in the circuit with them, the current at which they melt. This current will be equal to the high-frequency current the value of which it is desired to know.

WAVE METERS

This important piece of apparatus consists essentially of an inductance and a capacity, either or both of which are variable, the frequencies or wave-lengths corresponding thereto for the various positions of the pointer on the condenser scale, or, if the inductance is variable, on the scale of the inductance, having been predetermined and either plotted as a curve or arranged in table form. In the commercial form it is usual to

have a fixed inductance or perhaps one variable in two



FIG. 138.—Marconi wave meter

or three steps and a condenser whose capacity is continuously variable between limits determined by its dimensions and the nature of its dielectric. Means must also be provided to make evident the attainment of resonance. The Marconi Company manufactures a very convenient and portable form of wave meter (Fig. 138). It consists of a coil of wire wound on a rectangular wooden frame and mounted in the lid of the carrying case, the ends of the coil are connected

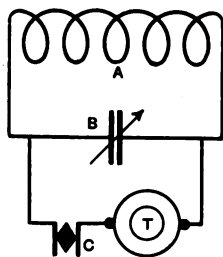

FIG. 139.—Connections of Marconi wave meter

186 WIRELESS TELEGRAPHY

to the terminals of a variable condenser, and across the same terminals are shunted a telephone receiver

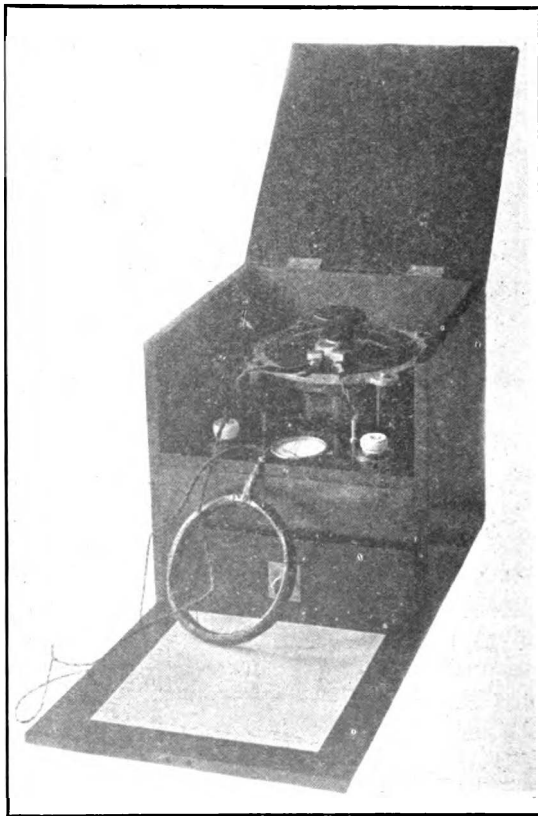

FIG. 140
Wave meter

and carborundum crystal ; the connections are shown diagrammatically in Fig. 139, where A is the coil, B the

condenser, C the carborundum crystal and T the telephone. To measure the wave-length of any given transmitter the key is closed and the phones of the wave meter being placed on the head of the observer the condenser is adjusted until the sound is at a maximum ; the wave-length is then read from the table in the lid of the box, which gives the wave-lengths corresponding to every degree of the condenser scale. Such an instrument as the above, although very convenient for the determination of wave-lengths, cannot be used for the measurement of the damping of the oscillations, as it is not possible for the ear to estimate the relative value of different currents which is necessary to the finding of the decrement of the oscillations.

A different pattern of wave meter must therefore be used. Fig. 140 shows an instrument suitable for the plotting of resonance curves and for the measurement of decrements.

It consists of the usual coil and variable capacity, but in place of the telephone and carborundum crystal is a small hot wire meter. This meter, however, is not put across the condenser, but in series with it and the coil (Fig. 141). The scale is calibrated by means of a direct current and therefore shows the R.M.S. value of the oscillations ; by squaring the readings on the scale, the mean square value can be obtained. Provision is also made for the insertion of a small resistance by means of which the damping of the wave meter itself can be eliminated, but as this is small it can as a rule be neglected.

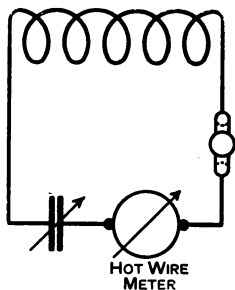

FIG. 141

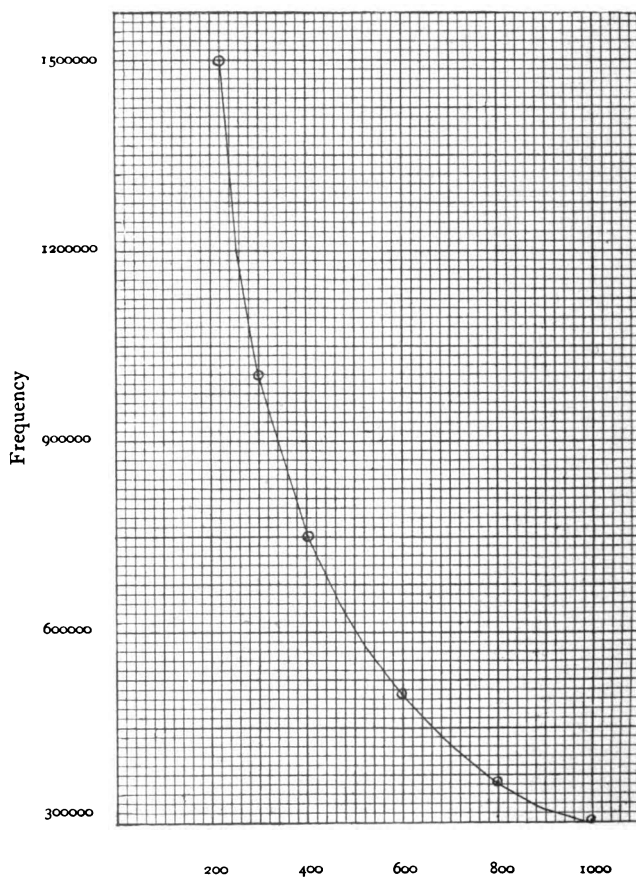

FIG. 142
Wave-length in metres

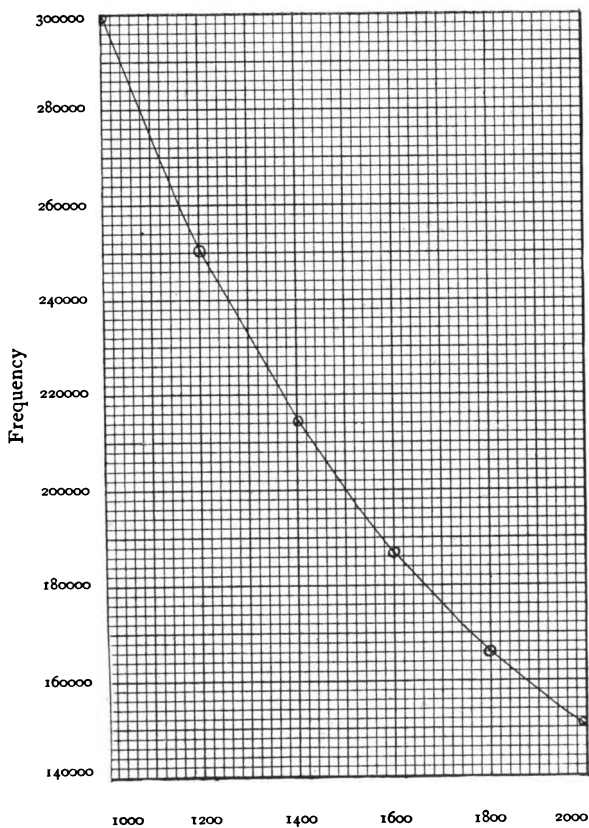

FIG. 143
Wave-length in metres

190 WIRELESS TELEGRAPHY

The frequency of the oscillations can be found from the formula $n = \frac{5.033 \times 10^6}{\sqrt{CL}}$, when n equals the frequency, C the capacity in microfarads and L the inductance

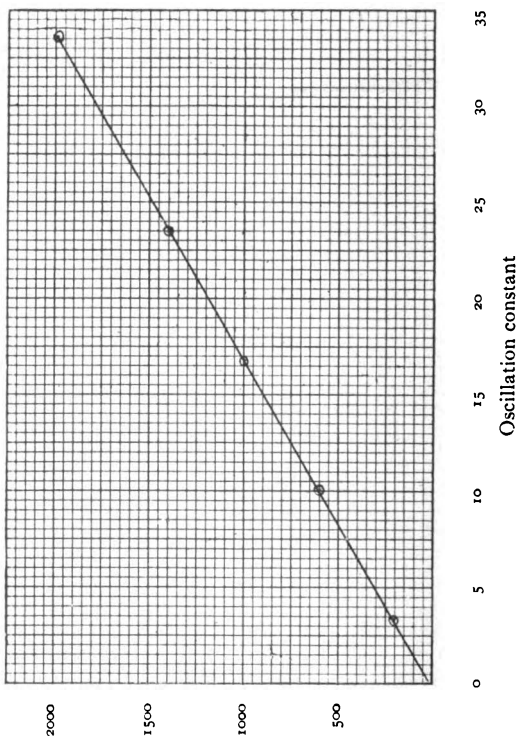

FIG. 144
Wave-length in metres

in centimetres. The appended curves show frequency and oscillation constant for wave-lengths up to 2000 metres.

RESONANCE CURVES AND DAMPING DECREMENTS

To plot a resonance curve the wave meter should be set up in proximity to the transmitter and the con-

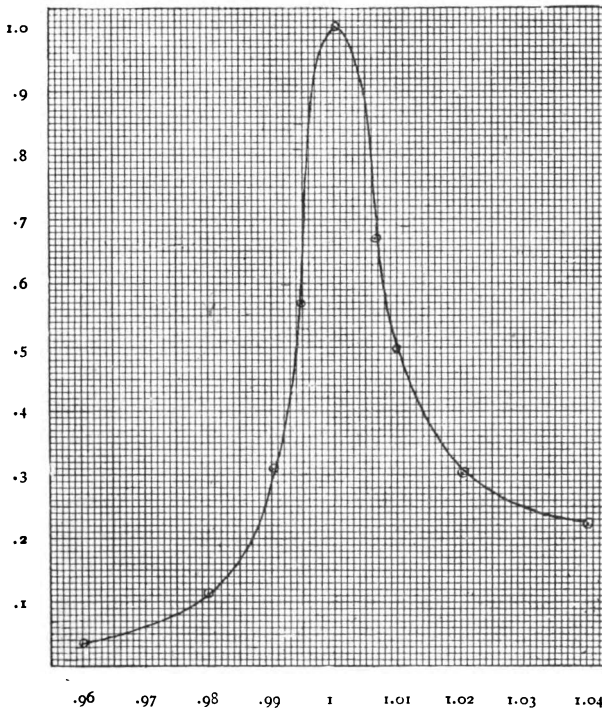

FIG. 145
Resonance curve

denser adjusted till resonance is obtained, which will be indicated by the hot wire meter giving its maximum reading. The coil of the wave meter must be placed in such a position that the reading on the meter comes

just within the scale, say three parts over. The resonance wave-length and the mean square value of the current at resonance are noted ; the mean squares of the currents for several wave-lengths differing not more than 5 or 6 per cent. from the resonance wave-length are then ascertained. Thus, supposing the latter to be 500 metres it would be necessary to set the wave meter at the following wave-lengths :— 475, 480, 485, 490 on one side and 505, 510, 515 and 520 on the other side of it, and to find the mean square value of the currents corresponding to them. Calling the resonance wave-length λ and the mean square value of the current at resonance also λ , the other wave-length and currents are reckoned as percentages and plotted as a curve which will assume the form shown in Fig. 145. From a curve so plotted it is possible to tell at a glance whether the oscillations given out by the transmitter under test are badly damped or only feebly damped. If they are badly damped the curve will not be very steep—that is to say, as the resonance point is receded from the falling off of the current will not be very marked ; but if the damping is small the curve will be very steep and any deviation from the resonance point will be accompanied by a big drop in current. The damping decrement can be found by the aid of the formula $\delta_1 + \delta_2 = \pi x \sqrt{\frac{y}{\lambda - y}}$; δ_1 is the symbol for the decrement of the oscillations, δ_2 for that part of it due to the wave meter itself, $\pi = 3.1416$, x the difference between unity and any value of the ratio between the resonance wave-length and any other and is read directly from the curve, and y is the ratio between the mean square value of

resonance current and any other current. This value is also to be read from the curve. For use in the above formula several values of x should be taken and the values of y corresponding to them, and as the curve is not symmetrical, the value of y should be the mean of readings taken from each side of the curve. The values of x and of y so taken are to be averaged and the average value is the one to be used in the formula. That part of the decrement due to the wave meter itself is very small and can therefore as a rule be neglected. In plotting the resonance curve of a coupled spark sender it will be found that the curve has a double hump due to the interaction of the primary and secondary circuits which produces oscillations of two frequencies, but the shorter wave-length need not be taken into account as its damping is greater than the longer one, on which account the longer one is always used for the reception of signals.

Another and simpler method of ascertaining the sum of the decrements is to set up the wave meter as before described to observe the wave-length and mean square value of the current at resonance, and then to observe the wave-length at which the mean square value of the current is reduced to half. From the formula $\delta_1 + \delta_2 = \pi \frac{\lambda - \lambda_1}{\lambda}$, where λ = resonance wave-length and λ_1 = the wave-length at which the mean square current is reduced to half, the sum of the decrements can then be found. For example, suppose that the resonance wave-length is 600 metres and that the mean square current is reduced to one-half when the wave meter is set at 594 metres, the sum of the decrements will approximately equal .063.

194 WIRELESS TELEGRAPHY

In making the measurement by this method it should be noted that the value of λ_1 to be used in the formula

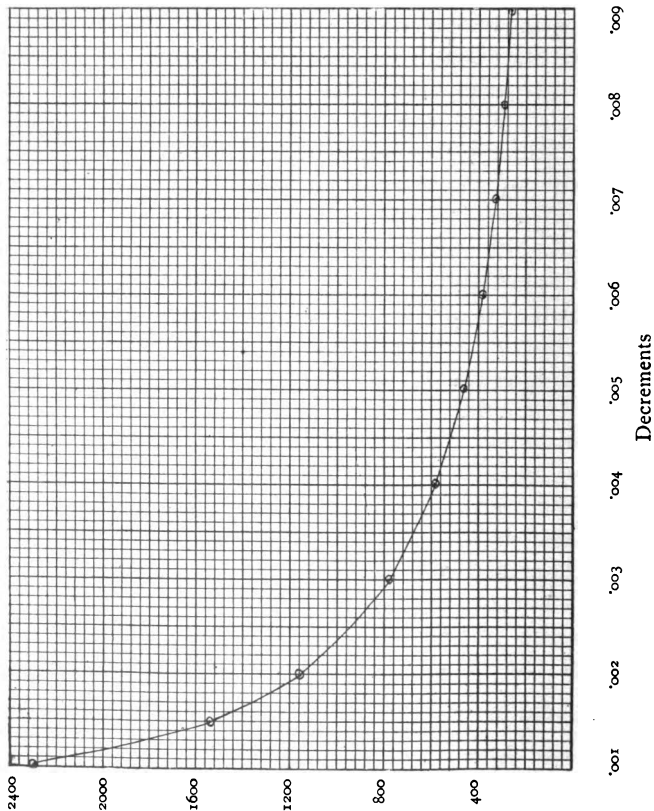

FIG. 146
Oscillations per train

is the mean of readings taken on each side of the resonance point.

CURVES SHOWING NUMBER OF OSCILLATIONS PER TRAIN DECREMENTS '001 TO '9

When the amplitude of a train of waves has fallen

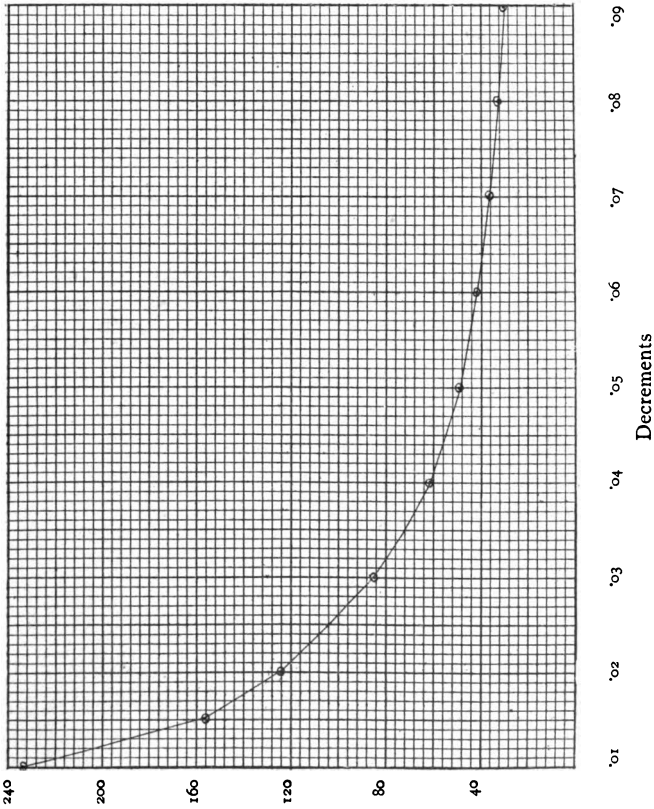

FIG. 147
Oscillations per train

to '01 of the initial or maximum amplitude, it has for

all practical purposes ceased to exist. If the decrement of the oscillation is known the number of

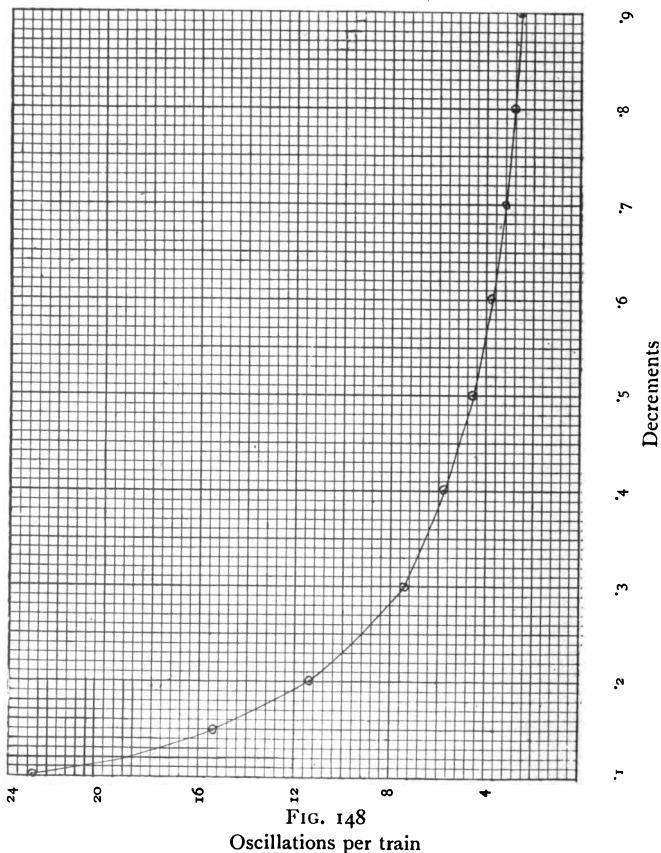

FIG. 148

oscillations per train can be found from the formula $N = \frac{4.605 + \delta}{\delta}$, where N = the oscillations per train, 4.605 = the nap. log. of 100 and δ = the decrement per

whole period. If the decrement is reckoned per half period, as is usually the case, the result must be divided by two. The appended curves will show at a glance the number of oscillations per train for decrements from $\cdot 001$ to $\cdot 9$.

THE MARCONI DECREMETER

The purpose of this instrument is to give a direct reading of the decrement of electro-magnetic oscillations without the necessity of plotting a resonance curve: this somewhat complicated process being replaced by a comparatively simple operation. The instrument

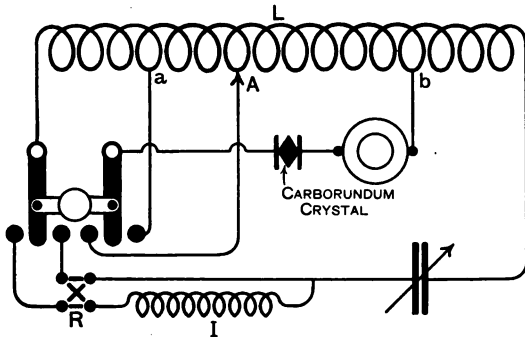

FIG. 149

Circuits of Marconi decrementer

which is diagrammatically shown in Fig. 149 consists of an oscillation circuit composed of a fixed inductance and variable capacity also a small inductance which may be added to or subtracted from the inductance by means of a double-pole double-throw switch. The indicating arrangement, which consists of a carborun-

dum crystal and telephone receiver, is tapped across the central portion of the fixed inductance.

If d be the logarithmic decrement and n_1 the frequency of the oscillations under test, and if D be that part of the decrement due to the wave meter circuit and a_1^2 the mean square current induced in it when brought to resonance with the circuit under test, while a_2^2 is the mean square current induced in it when its frequency is altered to n_2 , which must differ not more than five or six per cent. from the frequency n_1 of the circuit, then as is well known $d + D = \pi \left(1 - \frac{n_2}{n_1} \frac{a_2}{\sqrt{a_1^2 - a_2^2}} \right)$.

If not, the inductance m of the oscillation circuit of the wave meter which gives the frequency n_1 is altered by the addition or subtraction of a small inductance M to give the frequency n_2 , so that $\frac{n_2}{n_1} = \sqrt{\frac{m}{m \pm M}}$, and the detector which is normally connected across a length l of the inductance of the wave meter is, when the small inductance is added or subtracted, connected across a new length L such that the same effect is produced in the detector in the two cases, so that if the potential drop along the inductance is proportional to the length and if the current is proportional to the potential $\frac{a_2}{\sqrt{a_1^2 - a_2^2}} = \frac{l}{\sqrt{L^2 - l^2}}$ and the equation for the sum of the decrements becomes $d + D = \pi \left(1 - \sqrt{\frac{m}{m \pm M}} \right) \frac{l}{\sqrt{L^2 - l^2}}$, in which the capital letters represent constants of the instrument, so that only the inductance m and length l are required to determine the decrement d of the circuit under test; also if the small inductance M be made a known

proportion of the inductance m , which may be done if the adjustment of the circuit is effected by the variation of the capacity, then the term expressing the ratio of the frequencies $\frac{n_2}{n_1}$ becomes a constant, so that only the length l has to be measured to find the decrement of the circuit under test and the instrument becomes direct reading and may be calibrated in decrements.

To ascertain the decrement of any circuit the following procedure should be adopted:—

The decremeter is set up in the vicinity of the circuit under test and the condenser adjusted till the loudest sound is produced in the telephone, the double-pole switch being over to the right, thus making L and I (or L) the inductance of the oscillation circuit according to the position of the switch R and causing the length of inductance a, b to be included in the detector circuit. The double-pole switch is then moved over to the left, the result being to add or subtract the inductance I to or from the oscillation circuit and to alter the position of the inductance in the detector circuit to A, b. The switch is now thrown backwards and forwards and the position of the contact A on the inductance varied until an equally loud sound is produced in the telephones with the switch in either position; the variable l in the above equation is thus determined and the decrement can be read directly from the scale of the instrument.

200 WIRELESS TELEGRAPHY

LOGARITHMIC CHART FOR CALCULATING THE FREQUENCY AND WAVE-LENGTH OF OSCILLATING CIRCUITS¹

In the use of oscillations produced by the discharge of a condenser through an inductance, as in wireless telegraphy, for example, the frequency and wave-length of the oscillations are usually calculated from the values of the inductance and capacity. The formulæ used, although simple, become rather tedious if many calculations are required. To simplify and shorten this calculation the straight-line chart shown herewith was designed to give the result at one operation.

The formula for representing the frequency of a condenser discharge should really include the resistance of the oscillating circuit, but since the resistance over a considerable range has only a very slight effect on the frequency, and in any practical oscillating circuit the resistance must be kept low on account of the losses, it is usual and quite permissible to neglect the resistance.

The formula for frequency when the resistance is neglected is :

If the inductance is expressed in centimetres and the capacity in microfarads (1) $n = \frac{5.033 \times 10^6}{\sqrt{CL}}$, where n = the frequency, L the inductance and C the capacity.

The velocity of propagation of electric waves being the same as light—that is, 3×10^8 metres per second—the relation between frequency and wave-length is (2) $L = \frac{3 \times 10^8}{n}$, where L = wave-length in metres and n the frequency. The chart has been laid out from

¹ Based on an article in *The Indian Telegraphist*. (By permission.)

formulae (1) and (2). It consists of three logarithmic scales so proportioned and located with respect to each other as to give the required result by a single operation. As drawn they give directly the values of wave-length from 200 to 2000 metres, for inductance from 10 microhenries to 100 microhenries and capacities from 1000 to 10,000 centimetres. If preferred the middle scale could be marked out so as to give frequency instead of wave-length; likewise, if found more convenient, the inductance could be expressed in centimetres and capacity in microfarads. To use the chart a straight edge is placed so as to cross the selected value of the inductance on the upper scale and the selected value of capacity on the lower scale. The intersection of the straight edge with the middle scale then shows the wave-length. The chart can also be used to determine what inductance or capacity to use with a given inductance or capacity to produce a certain wave-length.

To find the required inductance place the straight edge so as to connect the value of the capacity on the lower scale with the wave-length on the middle scale.

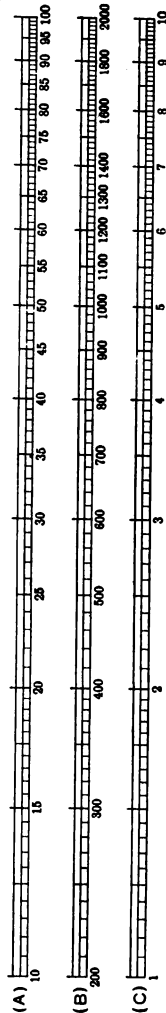

FIG. 150

A = Inductance in microhenries. B = Wave-length in metres. C = Capacity in jars. 1 jar = 1000 centimetres.

202 WIRELESS TELEGRAPHY

The inductance is then indicated by the point at which the straight edge crosses the upper scale. To find the capacity place rule so as to connect inductance on upper scale with wave-length on middle scale: the required capacity is then indicated by the point at which the lower scale is crossed by the straight edge.

INDUCTANCE

The unit of inductance is the henry, equal to 10^9 absolute units, and a coil of wire is said to possess unit inductance when the current through it varying at the rate of 1 ampere per second induces in it an electro-motive force of 1 volt. The henry is far too large a unit for the inductances employed in Radio-Telegraphy, it is therefore customary to use a sub-unit, the millihenry or the microhenry, which equal one-thousandth and one-millionth of a henry respectively: the inductance is also frequently expressed in absolute units or centimetres. The inductance of a circuit from which all magnetic material is absent depends on its geometric form, but if magnetic material is present, as when the coil is wound on an iron core, the inductance is also a function of the current. The inductance to some extent varies with the frequency of the current alternations, and the low-frequency or steady-current value is larger than the high-frequency value. The reason of this is, that as the frequency increases the current is no longer evenly distributed over the section of the wire, but tends to confine itself to the surface. Anything that upsets the equal distribution over the cross-section of the wire diminishes the inductance: the variation with

differing frequencies is very marked in a closely wound coil, especially if it has more than one layer. The calculation of the inductance of a coil from its dimensions is very difficult and can seldom be carried out with any degree of accuracy.

An easy method of ascertaining the high-frequency inductance of a coil is to join it in series with a known capacity and spark-gap, to excite the oscillatory circuit so formed by means of an induction coil and measure the wave-length. Then by the use of the formula $\lambda = 59.6 \sqrt{CL}$ (where λ = wave-length in metres, C = capacity in microfarads and L = inductance in centimetres) the value of the inductance can be found.

COEFFICIENT OF COUPLING

When two oscillatory circuits are coupled together we have seen that oscillations of two frequencies are set up, one having a frequency greater and one less than the natural frequency of the circuits when uncoupled. If the coupling is close the difference between the frequencies will be great, but as the coupling is made looser they approach, till with very loose coupling they merge into one. The coefficient of coupling denotes the ratio between the coefficient of the mutual inductance of the circuits and the square root of the product of the inductances of the two circuits taken separately. The closest coupling possible theoretically would be 1, but in practice this is never attainable, because the inductance in the radiating circuit is not concentrated in the coil which forms the secondary of the oscillation transformer, but is distributed over the whole length of the antennæ.

204 WIRELESS TELEGRAPHY

The coefficient of coupling can be ascertained by means of the wave meter ; the procedure is as follows :— first measure the two wave-lengths which result from the coupling of the circuits, then from the formula $K = \frac{\lambda_1^2 - \lambda_2^2}{\lambda_1^2 + \lambda_2^2}$, where K = coefficient of coupling and λ_1 and λ_2 the wave-lengths ; it is a simple matter to ascertain the coupling coefficient. As an example, suppose the shorter of the wave-lengths was 300 and the longer 600 metres K would equal $\cdot 6$; if the coefficient of coupling is greater than $\cdot 5$ the coupling is said to be close, and if below $\cdot 5$ it is said to be loose. In the example given the coupling is close because it exceeds $\cdot 5$.

CALIBRATION OF RECEIVING CIRCUITS

It is a great convenience to the operator to possess a calibration curve for his receiver, for suppose he is on the look-out for signals of a given wave-length the position of resonance for which is unknown to him, he must be continually searching round till communication is established, which in the case of a ship may be many hours or even a day or two supposing she is delayed by unforeseen circumstances ; whereas if he is in possession of the calibration curve he can at once adjust his circuits and then stand by.

Also assuming that the receiver is of the three circuit type, the calibrated intermediate circuit can be used as a wave meter to measure the wave-length of his own transmitter. To plot such a curve he should proceed as follows :—if the receiver consists of two circuits he should excite one of them by means of a

small induction coil, the second circuit meanwhile

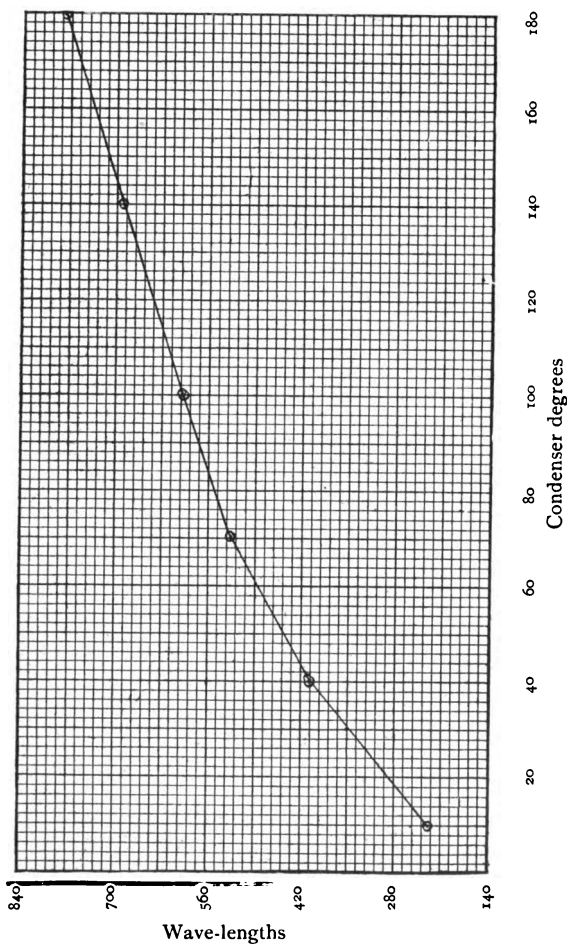

FIG. 151

being uncoupled, and setting the pointer of the variable condenser in various positions, say every twenty

degrees, or if it is the inductance that is variable the slider will be moved twenty or thirty turns at a time and by means of the wave meter the wave-lengths corresponding to these positions found, the second circuit is then treated in like manner and the values so found are plotted, as in Fig. 151. The curves will generally be found to be rather steep at the origin and then to flatten-off towards the end. In using the curves it should be noted that when the coupling is re-established between the circuits it will slightly modify the wave-lengths as shown on the curve, but the difference in adjustment required to bring the circuits absolutely into tune will be very small.

MEASUREMENT OF EARTH PLATE RESISTANCE

The measurement of earth plate resistance is carried out as follows :—

In laying down the earth wires half should be brought to one terminal in the cabin and the other half to another terminal (normally, of course, these terminals are connected together) ; between these terminals a galvanometer and battery are joined and the current noted, the resistance can then be found by the aid of Ohm's law $C = \frac{E}{R} \therefore R = \frac{E}{C}$, where C = current, as read from galvanometer, E = voltage of battery, and R = the total resistance of the circuit. If the internal resistance of the battery is subtracted from this the remainder will be the earth plate resistance. In making the measurement it is advisable to use large secondary cells, as the internal resistance of these is negligible.

STRENGTH OF RECEIVED SIGNALS

Assuming that the detector in use is of the thermo-electric type, the strength of incoming signals can be measured by means of a sensitive moving-coil galvanometer, which should be joined in place of the telephones. As, however, the signals are usually read from a telephone receiver and, as we have seen in a previous chapter, the telephone is most sensitive to certain frequencies, it will be seen that weak oscillations of the right frequency may produce a greater effect in the telephone than stronger oscillations of a different frequency. In the majority of cases also it is only a comparison of the strength of signals that is required, in which case the shunted telephone method will be found to answer the purpose; the procedure is as follows:—A resistance variable in small steps is joined in series with a switch across the telephone terminals of the receiver. The operator at the sending station depresses his key and the observer at the receiving end having tuned the signals in to their maximum strength closes the switch and so puts the resistance in shunt to the telephones. Starting with the maximum resistance he decreases it step by step until the signals are just audible; then, knowing the resistance of the telephones and the resistance of the shunt, the signal strength can be expressed as so many times audibility. For instance, supposing that the shunt resistance just equals that of the telephones, the current from the thermo-cell dividing as it does in inverse proportion to the resistances of the two branches of the circuit, it is evident that half flows through the telephone and half through the shunt, therefore the

208 WIRELESS TELEGRAPHY

strength of signals can be expressed as two. Now suppose that the shunt resistance was such that nine-tenths of the current flowed through it, the signal strength in that case would be ten.

ENERGY IN ANTENNÆ

The radiation from an open oscillatory circuit withdraws energy from it just as if a resistance were included

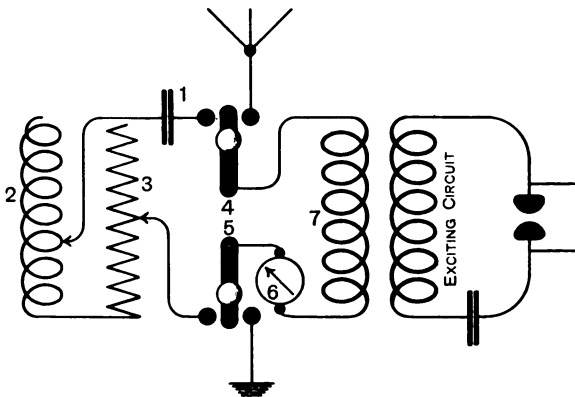

FIG. 152

Measurement of energy in antennæ

1. Condenser of capacity = to antennæ.
2. Inductance.
3. Non-inductive resistance.
- 4 and 5. Switches.
6. Hot wire amperemeter.
7. Secondary of oscillation transformer

in the circuit. To measure the energy in such a circuit, the following procedure should be adopted:—

In the antennæ circuit a calibrated hot wire amperemeter and two single-pole double-throw switches should be included, as in Fig. 152. An air condenser, having a capacity equal to the capacity of the antennæ,

and an inductance coil, having an inductance equal to the antennæ, should be connected together in series and with a variable non-inductive resistance, as in Fig. 152. The two switches should first be placed to the right so as to connect to antennæ and earth and the current registered on amperemeter noted. Next, place the switches over to the left and vary the non-inductive resistance till the same reading is obtained on the amperemeter. With the switches in this position it will be seen that the amperemeter is now in a closed or non-radiating circuit having the same frequency as the antennæ circuit, and that a resistance having an energy-absorbing power equal to the radiation from the antennæ has been included in the circuit. The amount of the resistance included in the circuit is sometimes called the radiation resistance of the antennæ, and simply means the resistance which, under given conditions, absorbs the same amount of energy as is radiated from the circuit. The energy radiated from the antennæ circuit can be found by multiplying the radiation resistance of the circuit by the mean square value of the current. The result so obtained is not quite accurate, as the antennæ wires and the earth connection have some resistance which is included in the radiation resistance when found by the above method; the amount of this would have to be ascertained and subtracted if we wished to get an absolutely accurate result.

CHAPTER XIII

DIAGRAMS

Their Interpretation and Preparation

A DIAGRAM is a drawing which expresses the electrical qualities of a piece of apparatus or of a circuit by means of conventional symbols. These symbols are not necessarily a picture of the apparatus represented, though in some cases they do bear a rough resemblance as in the case of the symbols used to show a fuse. For instance if we wish to represent a cell, instead of drawing the containing vessel and the elements of the cell, we should show it by means of the symbol 2, Fig. 153, the negative pole being represented by a short thick line and the positive pole by a longer and thinner line.

If we wish to show that a number of pieces of apparatus are connected together, we connect their terminals by lines ; the relative sizes of the connecting wires can if necessary be shown by using lines of different thickness. When two lines cross, but are not in electrical connection, one is looped over the other, as in 32, Fig. 153. 31, Fig. 153, indicates that the wires are in electrical connection at that point.

In the preparation of a diagram, the aim should always be to make it as clear as possible. To this end the same symbol for each piece of apparatus should

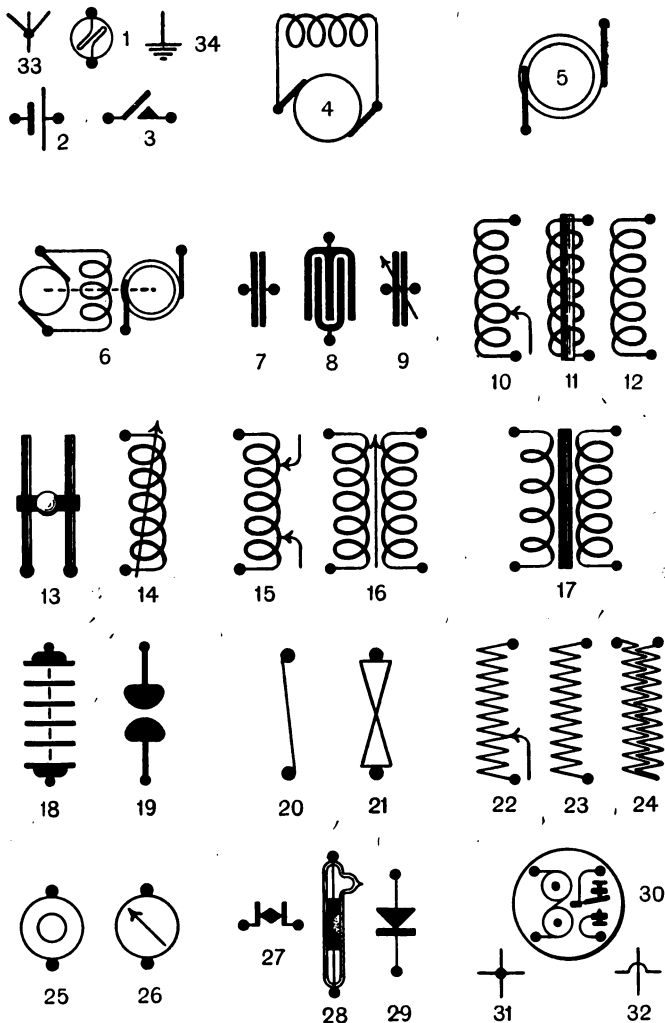

FIG. 153

- | | | |
|--|---|---|
| <p>1. Lamp resistance
 2. Cell
 3. Morse key or switch
 4. Shunt-wound dynamo or motor
 5. Alternator
 6. Rotary converter
 7. Condenser (fixed capacity)
 8. Condenser (fixed capacity)
 9. Variable condenser
 10. Inductance (variable in steps)
 11. Inductance with iron core</p> | <p>12. Inductance
 13. Sliding inductance
 14. Variometer (continuously variable inductance)
 15. Auto-transformer
 16. Oscillation transformer
 17. Alternating-current transformer
 18. Quenched spark-gap
 19. Spark-gap
 20 and 21. Fuses
 22. Variable resistance
 23. Non-variable resistance</p> | <p>24. Non-inductive resistance
 25. Telephone receiver
 26. Measuring instrument
 27. Carborundum detector
 28. Coherer
 29. Thermo-electric detector
 30. Relay
 31. Wires in electrical connection
 32. Wires crossing but not connected
 33. Antennae
 34. Earth connection</p> |
|--|---|---|

212 WIRELESS TELEGRAPHY

be used throughout. The lines connecting the various instruments should never be taken obliquely across the drawing, but always in a horizontal or vertical direction ; also, they should be so arranged as to keep the crossings at a minimum. Reference to the diagrams in this book will make clear what is meant.

The drawing should be so arranged as to fairly fill the whole space, this not only makes for clearness but improves its appearance.

The symbols given in Fig. 153 are those most commonly used to denote the various pieces of apparatus.

CHAPTER XIV

REGULATIONS AND INSTRUCTIONS FOR SHIPS AND STATIONS LICENSED BY H.M. POSTMASTER-GENERAL

Speed of Transmission—Power—Wave-Lengths—Obligation to Communicate—Priority of Messages—Calling—Preliminary Correspondence—Distress Signals—Admiralty Signalling—Controlling Station

SPEED OF TRANSMISSION

THE apparatus must be capable of transmitting and receiving at least twenty words per minute. The speed of transmission must under normal circumstances be not less than twelve words per minute, five letters counting one word.

POWER

New installations bringing into play an energy of more than 50 watts shall be equipped in such a way that it may be possible easily to obtain several ranges less than the normal range, the shortest being approximately 15 nautical miles. Installations already in existence bringing into play an energy of more than 50 watts shall be transformed as far as possible in such a manner as to satisfy the foregoing requirements. The power (measured at the terminals of the generator) must not in ordinary circumstances exceed 1 kilowatt. Larger power may be used if the ship is under necessity to communicate over a distance greater than 200

214 WIRELESS TELEGRAPHY

nautical miles from the nearest coast station, or if in consequence of exceptional circumstances communication can only be secured by increase of power.

WAVE-LENGTHS

Two wave-lengths, one of 600 and the other of 300 metres, are allowed for general public correspondence. Every coast station open to this service must be equipped in such a way as to be able to use these two wave-lengths, one of which will be indicated as the normal wave-length of the station. A coast station is sometimes authorised to use a wave-length not exceeding 600 or else exceeding 1600 metres for communication of a special kind.

Stations used exclusively for the despatch of signals intended to determine the position of ships must not use wave-lengths exceeding 150 metres. Every ship station must be equipped in such a way as to be able to use the 600 and 300 metre wave-lengths, the 600 metre being the normal wave-length, and which may not be exceeded in transmission.¹

During the whole time that it is open, every ship station must be able to receive calls made on its normal wave-length. Ships of small tonnage, on which it would be materially impossible to use a 600 metre wave for transmission, may be authorised to exclusively employ the 300 metre wave for the purpose, but must be able to receive by means of the 600 metre wave-length.

Communication between any two stations must be

¹ Except for long-distance communication in exceptional circumstances, when a wave-length of 1800 metres may be used.

REGULATIONS AND INSTRUCTIONS 215

carried out on both sides by means of the same wave-length. If in a particular case communication is difficult they may by mutual consent change to the other regulation wave-length. Both stations shall resume their normal wave-lengths when the exchange of messages is finished.

OBLIGATION TO COMMUNICATE WITH ALL SYSTEMS

All coast stations (except those exempted by their respective governments) are bound to interchange radio-telegrams with ships irrespective of the system of Radio-Telegraphy employed. Similarly ships are bound to interchange messages with coast stations without regard to system. British ships at present are not bound to exchange messages with other ships, whether British or foreign, except in cases of distress, when the obligation is universal, and such messages must be given priority.

MINIMUM POWER TO BE USED

All stations are bound to exchange messages with the minimum power consistent with effective communication.

PRIORITY OF MESSAGES

Priority must be assigned first of all to messages of distress, then to messages of the British Admiralty and other British Government departments and to the messages of other governments; then to service messages, and finally to ordinary correspondence. Ordinary messages take precedence according to their time of handing in.

CALLING

As a general rule, it is the ship which calls the coast station. Generally the ship should not call until within 75 per cent. of the normal range of the coast station ; the wave-length used must be the normal one of the coast station with whom communication is desired. Suppose a ship whose call signal is DHB wishes to call a station whose call is LNS, she would proceed as follows :—Having listened to ascertain that the station is not engaged the ship would signal — . — . — LNS LNS LNS — - - - DHB DHB DHB, and the coast station would reply thus : — . — . — DHB DHB DHB — - - - LNS — . — if she were ready to communicate ; and if she were not would reply assigning a time at which she would, in which case her reply would be as follows : — . — . — DHB DHB DHB — - - - LNS . - - - - 20 minutes . — . — .

If a station as the result of a thrice-repeated call does not reply the call may only be renewed after the lapse of fifteen minutes. (This rule does not apply to cases of distress.)

PRELIMINARY CORRESPONDENCE

The ship first signals :

- (1) Her approximate distance from the coast station in nautical miles.
- (2) The position of the ship given in a concise form and adapted to the circumstance of the individual case,

REGULATIONS AND INSTRUCTIONS 217

(3) The next port at which the ship will touch.

(4) The number of radio-telegrams if they are of normal length, or the number of words if they are of exceptional length.

The speed of the ship in nautical miles shall be given at the special request of the coast station.

DISTRESS SIGNAL

Ships in distress make use of the following signal :—
... — — — ... repeated at short intervals. As soon as a station receives the distress signal it must suspend all correspondence and not resume it until it has made sure that the communication consequent on the call for assistance has been completed. When a ship in distress adds, after a series of distress signals, the call sign of a particular station, the duty of answering the call rests with that station alone. Failing any mention of a particular station any station that receives the call is bound to answer it.

ADMIRALTY SIGNALLING

The signal — .. — .. — .. — indicates that a British man-of-war is calling a British coast station and has a message to transmit to the Admiralty. On receipt of such a signal, the station called must suspend all other business (except that which may concern a vessel in distress) in order to deal with the message from the man-of-war. Any other station (ship or shore) must suspend working so far as may

218 WIRELESS TELEGRAPHY

be necessary to ensure satisfactory communication between the man-of-war and the station called.

CONTROLLING STATION

The shore station is in all cases the controlling station, and arranges order of working.

CHAPTER XV

ABBREVIATIONS, CODES, ETC.

List of Abbreviations to be used in Radio-Telegraph Transmissions—International Morse Code—American Morse Code—Time Signals—Table to convert Course and Bearing into Degrees

LIST OF ABBREVIATIONS TO BE USED IN RADIO-TELEGRAPH TRANSMISSIONS

Abbreviation	Question	Answer or Advice
PRB	Do you wish to communicate with my station by means of the International Code ?	I wish to communicate with your station by means of the International Code.
QRA	What is the name of your station ?	This station is . . .
QRB	How far are you from my station ?	The distance between our stations is . . . nautical miles.
QRC	What are your true bearings ?	My true bearings are . . .
QRD	Whither are you bound ?	I am bound for . . .
QRF	Where are you coming from ?	I am coming from . . .
QRG	To what company or line of navigation do you belong ?	I belong to . . .

Abbreviation	Question	Answer or Advice
QRH	What is your wave-length ?	My wave-length is . . . metres.
QRJ	How many words have you to transmit ?	I have . . . words to transmit.
QRK	How are you receiving ?	I am receiving well.
QRL	Are you receiving badly ? Shall I transmit - - - — 20 times for you to adjust your apparatus ?	I am receiving badly. Transmit - - - — 20 times for me to adjust my apparatus.
QRM	Are you being interfered with ?	I am being interfered with.
QRN	Are atmospherics very strong ?	Atmospherics are very strong.
QRO	Shall I increase my power ?	Increase your power.
QRP	Shall I decrease my power ?	Decrease your power.
QRQ	Shall I transmit faster ?	Transmit faster.
QRS	Shall I transmit slower ?	Transmit slower.
QRT	Shall I stop transmitting ?	Stop transmitting.
QRU	Have you anything for me ?	I have nothing for you.
QRV	Are you ready ?	I am ready. All is in order.

ABBREVIATIONS, CODES, ETC. 221

Abbreviation	Question	Answer or Advice
QRW	Are you busy ?	I am busy with another station (or : with), please do not interrupt.
QRX	Shall I stand by ?	Stand by. I will call you at . . . o'clock (or : when I want you).
QRY	What is my turn ?	Your turn is No. . . .
QRZ	Are my signals weak ?	Your signals are weak.
QSA	Are my signals strong ?	Your signals are strong.
QSB	Is my tone bad ? Is my spark bad ?	The tone is bad. The spark is bad.
QSC	Is the spacing bad ?	The spacing is bad.
QSD	Let us compare watches. My time is . . . What is your time ?	The time is . . .
QSF	Are the radio-telegrams to be transmitted alternately or in series ?	Transmission will be in alternate order.
QSG		Transmission will be in series of five.
QSH		Transmission will be in series of ten.
QSJ	What is the charge per word for . . . ?	The charge per word is . . .

Abbreviation	Question	Answer or Advice
QSK	Is the last radio-telegram cancelled?	The last radio-telegram is cancelled.
QSL	Have you got the acknowledgment?	Please give acknowledgment.
QSM	What is your true course?	My true course is . . .
QSN	Are you communicating with land?	I am not communicating with land.
QSO	Are you in communication with another station (or: with . . .)?	I am in communication with . . . (through the medium of . . .).
QSP	Shall I signal to . . . that you are calling him?	Inform . . . that I am calling him.
QSQ	Am I being called by . . .?	You are being called by . . .
QSR	Will you despatch the radio-telegram . . .?	I will forward the radio-telegram.
QST	Have you received a general call?	Yes (or no), general call received.
QSU	Please call me when you have finished (or: at . . . o'clock)?	I will call you when I have finished.
QSV	Is public correspondence engaged?	Public correspondence is engaged. Do not interrupt.
QSW	Shall I increase the frequency of my sparks?	Increase your spark frequency.

ABBREVIATIONS, CODES, ETC. 223

Abbreviation	Question	Answer or Advice
QSY	Shall I transmit with a wave-length of . . . metres ?	Let us change to . . . metre wave-length.
QSX	Shall I diminish my spark frequency ?	Diminish your spark frequency.
QSZ		Send each word twice ; I have difficulty in receiving your signals.
QTA		Send each radio-telegram twice ; I have difficulty in receiving signals (or : Repeat last radio-telegram ; reception doubtful).
- - - - -		Call for all stations.
- - - - (T R)		Signal announcing the sending of indications concerning a ship station.
- - - - - (!)		Signal indicating that a station is about to send with high power.

EXAMPLES

Station

- A QRA ? = What is the name of your station ?
 B QRA Campania = This is the Campania.
 A QRG ? = To what Company do you belong ?
 B QRG Cunard QZR = I belong to Cunard Line. Your signals are weak.

Station A increases power of its transmitter and sends :

- A QRK ? = How are you receiving ?
 B QRK = I am receiving well.
 QRB 80 = Distance between our stations is 80 nautical miles.
 QRC 62 = My true bearing is 62 degrees, etc.

MORSE CODE SIGNALS

Letters

a	· —
ä	· — — —
à or å	· — — — — —
b	· — · —
c	· — — — ·
ch	· — — — — —
d	· — — ·
e	·
é	· — — — ·
f	· — — —
g	· — — — ·
h	· — — —
i	· ·
j	· — — — — —
k	· — — —
l	· — — — ·
m	· — — —
n	· — — ·
ñ	· — — — — —
o	· — — — — —
ö	· — — — — —
p	· — — — — ·
q	· — — — — —
r	· — — — ·
s	· — — ·
t	· —
u	· — — —
ü	· — — — — —
v	· — — — —
w	· — — — —
x	· — — — — —
y	· — — — — —
z	· — — — — ·

Spacing and length of signals:

1. A bar is equal to three dots.
2. The space between the signals which form the same letter is equal to 1 dot.
3. The space between two letters is equal to 3 dots.
4. The space between two words is equal to 5 dots.

Figures

1	· — — — — —
2	· — — — — —
3	· — — — — —
4	· — — — — —
5	· — — — — —
6	· — — — — —
7	· — — — — —
8	· — — — — —
9	· — — — — —
0	· — — — — —

Bar indicating fraction

ABBREVIATIONS, CODES, ETC. 225

The following signals may also be employed to express figures, but only in official repetitions and in the preamble, and in the text of telegrams written entirely in figures :—

1	—
2	— —
3	— — —
4	— — — —
5	— — — — —
6	— — — — — —
7	— — — — — — —
8	— — — — — — — —
9	— — — — — — — — —
0	— — — — — — — — — —

Bar indicating fraction — — — — —

Punctuation and other Signs

Full stop	(.)	— — — — —
Semicolon	(;)	— — — — — — —
Comma	(,)	— — — — — — —
Colon	(:)	— — — — — — —
Note of interrogation, or request for the repetition of anything transmitted which is not understood	(?)	— — — — — — —
Note of exclamation	(!)	— — — — — — —
Apostrophe	(')	— — — — — — —
Hyphen or dash	(-)	— — — — — — —
Parenthesis (before and after the words)	()	— — — — — — —
Inverted commas (before and after each word) or each passage placed between inverted commas	(“ et ”)	— — — — — — —
Underline (before and after the words or part of phrase)		— — — — — — —
Call (preliminary of every transmission)		— — — — — — —
<i>Double dash</i> (=) (signal separating the preamble from the address, the address from the text, and the text from the signature)		— — — — — — —
Understood		— — — — — — —
Error		— — — — — — —
<i>Cross</i> (end of transmission)	(+)	— — — — — — —
Invitation to transmit		— — — — — — —
Wait		— — — — — — —
“Received” signal		— — — — — — —
End of work		— — — — — — —

P

AMERICAN MORSE CODE

A	— —	O	— . —	1	— — — —
B	— — — —	P	— — — —	2	— — — —
C	— . — .	Q	— — — .	3	— — — —
D	— — —	R	— . — —	4	— — — —
E	—	S	— — —	5	— — — —
F	— — —	T	— — —	6	— — — —
G	— — — —	U	— — — —	7	— — — —
H	— . — .	V	— — — —	8	— — — —
I	— . —	W	— — — —	9	— — — —
J	— — — —	X	— — — —	0	— — — —
K	— — — —	Y	— . — —	.	— . — — — —
L	— — — —	Z	— — — —	?	— — — — —
M	— — — —	&	— . — —	!	— — — — —
N	— — —				

TIME SIGNALS

Time signals are sent out daily at noon and midnight Greenwich mean time by the German station at Norddeich (K.N.D.).

The signals consist of groups of dots (five dots to the group) sent out at seconds intervals. The order of signalling is as follows:—

Preliminary Signals

About 11 h.	53' 0"	Tuning Vs for about 1 or 2 minutes
	57' 50"	— — — —
	55"	KND
	58' 0"	MGZ (mittlerer Greenwicher Zeit)
	58' 40"	— — — —

Time Signals

11 h.	58' 46"	First dot of first group
	50"	Last ditto
	58' 56"	First dot of second group
	59' 0"	Last ditto
	59' 6"	First dot of third group
	10"	Last ditto

ABBREVIATIONS, CODES, ETC. 227

	59' 36"	First dot of fourth group
	40"	Last ditto
	59' 46"	First dot of fifth group
	50"	Last ditto
	59' 56"	First dot of sixth group
12 h.	0' 0"	Last ditto
About 12 h.	0' 5"	- - - - -

Sometimes followed by weather reports.

The wave-length used is about 1800 metres.

TABLE TO CONVERT COURSE AND BEARING INTO DEGREES

The true bearing of a ship from a coast station can be stated in degrees reckoned "clockwise" from north round through east, south and west. Thus, if the ship's bearing from the coast station is anything between north and east the number to be signalled would be between 0 and 90 (A, Fig. 154). Similarly if it is between east and south the number would be between 90 and 180 (B, Fig. 154). Between south and west the number would be between 180 and 270 (C, Fig. 154); between west and north the number would be between 270 and 360 (D, Fig. 154). Similarly if the ship's course is between north and east the number to be signalled is between 0 and 90; east and south, the number is between 90 and 180; south and west, the number will be between 180

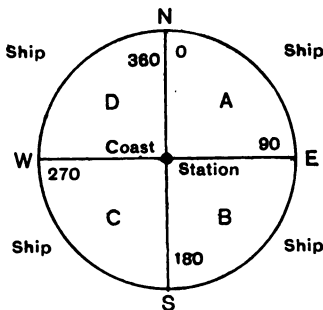

FIG. 154

228 WIRELESS TELEGRAPHY

and 270 ; west and north, the number is between 270 and 360.

To facilitate the conversion of bearings and course into the number of degrees to be signalled, a table is given in which either the bearing of the ship from the coast station or the bearing of the coast station from the ship can be looked out and the number of degrees to be signalled seen at a glance. The course must be looked out in the same column as the bearing of the ship from the coast station.

TABLE TO CONVERT BEARING AND COURSE INTO DEGREES

Course or Bearing of Ship from Coast Station		Bearing of Coast Station from Ship		Degrees to be Signalled
North	-	South	-	0°
N. 10° E.	-	S. 10° W.	-	10°
N. 20° E.	-	S. 20° W.	-	20°
30° -	-	30°	-	30°
40° -	-	40°	-	40°
50° -	-	50°	-	50°
60° -	-	60°	-	60°
70° -	-	70°	-	70°
80° -	-	80°	-	80°
East	-	West	-	90°
S. 80° E.	-	N. 80° W.	-	100°
S. 70° E.	-	70°	-	110°
60° -	-	60°	-	120°
50° -	-	50°	-	130°
40° -	-	40°	-	140°

ABBREVIATIONS, CODES, ETC. 229

Course or Bearing of Ship from Coast Station		Bearing of Coast Station from Ship	Degrees to be Signalled
30° -	-	30° -	150°
20° -	-	20° -	160°
10° -	-	10° -	170°
South	-	North	180°
S. 10° W.	-	N. 10° E.	190°
20° -	-	20° -	200°
30° -	-	30° -	210°
40° -	-	40° -	220°
50° -	-	50° -	230°
60° -	-	60° -	240°
70° -	-	70° -	250°
80° -	-	80° -	260°
West	-	East	270°
N. 80° W.	-	S. 80° E.	280°
70° -	-	70° -	290°
60° -	-	60° -	300°
50° -	-	50° -	310°
40° -	-	40° -	320°
30° -	-	30° -	330°
20° -	-	20° -	340°
10° -	-	10° -	350°
North	-	South	360° or 0°

CHAPTER XVI

LOCALISATION OF FAULTS

THE faults which may occur in the circuits of a wireless transmitter or receiver fall mainly under two heads : breaks or short-circuits.

As regards the transmitter, the indications as to the nature and whereabouts of the fault are so clear no difficulty should be experienced in quickly tracing and rectifying them. The indications on the receiver are not so clear, but if the circuits are examined in a systematic way no difficulty should be found in ascertaining what is the matter.

The fact that the Marconi $1\frac{1}{2}$ kw. set is in such general use practically, and also for examination purposes, has induced us to select it as an example for treatment, though much of what follows is of perfectly general application.

The transmitter of this set consists of five circuits—namely, the direct-current circuit, low tension alternating-current circuit, high tension alternating-current circuit, closed oscillatory circuit and open oscillatory circuit ; each of which we shall treat separately and in the order named.

DIRECT-CURRENT CIRCUIT

This circuit consists of D.C. side of rotary converter, starting switch and field regulating resistance, connected together, as shown in Figs. 61 and 66. Let us

suppose that the main switch having been closed and the handle of starter brought to first stop the machine fails to start, this may be due to a break either in the field or armature circuits. If the break (most probably due to the lifting of brushes on commutator) is in the armature circuit it will be indicated by the guard lamp on D.C. side of converter lighting brightly, because the full voltage of the direct-current supply is now across its terminals.

If the break is in the field circuit it will be indicated by the inability of the no-load release, which forms part of the field circuit, to attract and hold a small piece of iron—for instance, a latchkey, or blade of a penknife—applied to its poles. A break in the field circuit is also indicated by the vicious arcing which takes place between the arm of starting switch and first-contact piece of starter, when the former is allowed to move back to the off position. The break is most likely due to a terminal disconnection, and the two terminals on the field resistance, the two terminals beneath the no-load release, the terminal marked F on the starting switch and the field terminal on the rotary converter, should therefore be examined. If these are found to be all right each piece of apparatus in the circuit and each lead should be tested for continuity by means of the galvanometer and cell.

LOW TENSION ALTERNATING-CURRENT CIRCUIT

If after starting the machine the pilot lamp and A.C. guard lamp fail to light, this is a clear indication either that the filaments of the lamps are broken, the A.C. brushes lifted from the slip rings, or that the

leads connecting them have been disconnected or broken.

If (the pilot lamp being alight) there is no reading on the amperemeter and no spark when the Morse key is depressed, this indicates that there is a break in the circuit probably due to a blown fuse or to a terminal disconnection. The break should be located by means of the galvanometer and cell and is most conveniently done in the following way. First test between upper right-hand contact of double-pole switch on A.C. switchboard and bottom terminal of right-hand fuse ; a deflection will indicate that the circuit through the amperemeter and fuse is all right. Next test between left-hand upper contact of D.P. switch and bottom terminal of left-hand fuse ; a deflection will indicate that this section of the circuit is all right. The leads from the galvanometer and cell should now be connected to the bottom fuse terminals, and first the Morse key and then the magnetic key depressed ; if a deflection is obtained on the depression of one key, but not on the other, it will indicate that the contacts of the key failing to give a deflection are dirty or that some insulating material has been introduced between them. If a deflection cannot be obtained by the depression of either key it indicates either that both sets of contacts are dirty or that there is a break or disconnection in the section of the circuit between the two bottom terminals of A.C. switchboard. Examine all terminal connections and if necessary test each piece of apparatus and lead separately with galvanometer.

HIGH TENSION ALTERNATING-CURRENT CIRCUIT

The amperemeter, although not in this circuit, will again be found serviceable in indicating the existence and nature of faults. If, on closing the Morse key, the machine of course being in motion, only a very small reading is obtained on amperemeter (1 or 2 amps.), and no spark at discharger, the fault indicated is that no load is being taken from the secondary of the alternating-current transformer, which may be due either to a break in the connecting leads or in the secondary windings of the transformer, or more probably to a terminal disconnection. See that the secondary terminals are correctly connected to each other, and through air cone chokes to the spark-gap. The reason that only a small reading is obtained on amperemeter when no load is taken from the secondary of the transformer is that the primary windings are acting in the same way as the reactance regulator and reducing the current in the circuit. A short circuit on the transformer will be indicated by a reading equal or somewhat in excess of the normal reading and by the absence of a spark at the discharger. The short may be due to the spark-gap being closed or to a metallic connection being formed by the coming together of the connecting strips owing to the removal of the insulating material normally between them or to the short-circuiting of the condenser in the closed circuit.

CLOSED OSCILLATORY CIRCUIT

A break in the closed oscillatory circuit will be indicated by a silent discharge at the spark-gap, the amperemeter reading being about normal.

OPEN OSCILLATORY CIRCUIT

The most vulnerable part of this circuit is the antennæ, the insulation of which may be bad, or the antennæ itself, or some portion of it, may be blown adrift during a gale ; in either case failure of tuning lamp to give normal indication will show that something is wrong. A direct earth, as for instance when the antennæ is in contact with the mast or guys of the ship, may be tested for by disconnecting the earth wire and inserting galvanometer and cell, a deflection indicating that the antennæ is making earth.

In carrying out these tests the short-circuiting plug of the amperemeter must be removed, and care should be taken that the galvanometer is in good working order.

For the convenience of students the indications of the various faults on the transmitter have been tabulated, and should be committed to memory.

FAULTS ON TRANSMITTER MARCONI $1\frac{1}{2}$ KW. SET

Symptoms	Fault Indicated	Cure
Machine fails to start. D.C. guard lamp lights brightly.	Brushes on D.C. side of converter lifted.	Replace.

LOCALISATION OF FAULTS 235

Symptoms	Fault Indicated	Cure
Machine fails to start. Flash between arm of starting switch and first stop when handle released.	Break in field circuit.	Examine all terminal connections and test apparatus and leads with galvo. if necessary.
Pilot lamp on A.C. switchboard alight, no spark at discharger and no reading on amperemeter when Morse key depressed.	Break in low-tension A.C. circuit.	Trace with galvo. and repair
Pilot lamp alight, small reading on ampere-meter when Morse key closed.	Break on high-tension A.C. circuit.	Examine terminal connections and leads.
Pilot lamp alight, normal reading on amperemeter, no spark at discharger when Morse key closed.	Short on secondary of A.C. transformer.	Trace and remove.
Pilot lamp alight, normal reading on amperemeter, silent discharge at spark gap.	Break in closed oscillatory circuit.	Examine terminal connections.

NOTE.— Short - circuiting plug of amperemeter must be removed when carrying out these tests.

EMERGENCY TRANSMITTER

Faults in the accumulators have already been dealt with in Chapter II., and the circuits of the coil and switchboard can be tested for continuity by means of the galvanometer and cell. Reference to the diagrams in Chapter VI. will show the points between which to test.

THE RECEIVER

As we have already seen in Chapter V., the production of a sound in the telephones when the buzzer key is depressed is no guarantee that the receiving circuits are all right, and that signals emanating from a distant station could be received. The second buzzer test described in Chapter V. should therefore be applied. A fault which not infrequently occurs is the short-circuiting of the earth-arrester spark-gap due to the plates coming into contact or to the bridging of the gaps by particles of conducting matter.

A convenient way of testing for a shorted earth-arrester is to set the aerial tuning condenser at short (the change-over switch being on the standby position), and then if no sound is produced in the telephones by the buzzer when aerial tuning inductance is at zero, but a sound is produced when some of the inductance is inserted, the operator may be sure that the micrometer gap is screwed down or the earth-arrester gap shorted. The reason for this will be quite plain after a few minutes' study of the conditions prevailing. If (the condenser being at short and the inductance at zero) the earth-arrester gap is shorted we have in

parallel with the primary winding of the magnetic detector an alternative path for the oscillatory currents set up by the buzzer having a much lower inductance than that of the detector primary.

The oscillatory currents will divide in inverse proportion to the inductances of the paths, therefore they will be shunted out from the primary winding of the detector by the low self-inductive shunt which is across it. When some of the aerial tuning inductance is inserted the conditions are altered, and the inductance of the shunt is now greater than that of the primary winding, therefore the greater part of the oscillatory current passes through it and a sound is produced in the telephone receiver.

THE MAGNETIC DETECTOR

The faults most likely to occur are the breaking of one or other of the windings. The break may be located by means of the galvanometer and cell, and if it is not convenient to repair or substitute a fresh coil the operator should change over to the second set of coils on the detector.

THE TELEPHONES

The telephones are best tested by means of the galvanometer and cell. If a deflection is obtained but no sound is produced this indicates either that the diaphragms are jammed or that the magnet windings are short-circuited. Examine each receiver to see that the diaphragms are clear of the magnet poles, after which detach the wires from the telephone terminals and test

238 WIRELESS TELEGRAPHY

again each earpiece separately. If a sound is now produced the short circuit is in the flexible cords and others should be substituted. If no deflection is obtained on the galvanometer, and no sound produced, this indicates a break in the leads or in the winding of one of the phones. Test each earpiece separately and if only one of them is broken down working can be carried on by putting both leads on the damaged earpiece on one terminal. The operator should be careful to note that the contacts which short-circuit the telephones when transmitting do not remain closed when the Morse key is lifted.

INDEX

A

- Abbreviations for use in radio-telegraphic transmissions, 219
- Accumulators, 39
 - , Charging of, 40
 - , Faults in, 41
- Airship station (Telefunken), 165
- Alternating currents, 45
- Alternating-current transformer, 43
 - circuits, power in, 46
- American Morse code, 226
- Antennæ capacity, measurement of, 179
 - , Directive, 32
 - , Energy in, measurement of, 208
 - , Forms of, 29
 - , Insulation of, 34
 - —, Resistance, measurement of, 180

B

- Blocking switches, 83
- Brown, S. G., telephone relay, 78
- Buzzer (testing), 76

C

- Calibration of receiving circuits, 204
- Calling apparatus (Telefunken), 131
- Capacity of condensers, measurement of, 173
- Carborandum detector, 65
- Charging switchboard (Marconi), 98
- Choking coils, 13, 48

- Condensers, 3
 - , Arrangement of, 6
 - , Capacity of, 4
 - —, Measurement of, 173
 - , Construction of, 7
 - , Hydraulic model of, 9
 - , Losses in, 24, 177
 - for transmitter, 24
- Coherer (Lodge), 63
- (Marconi), 59
- Coupling, 22
- , Coefficient of, 203

D

- De Sauty bridge for capacity measurement, 173
- Detectors, 59
- Diagrams, 210
- Dielectric constant, 5
 - —, Table of, 176
 - losses, measurement of, 177

E

- Earth arrester, spark-gap, 94
 - connection, 35
- Electric oscillations, production of, 8
 - —, Frequency of, 9
 - waves, production of, 14
 - —, Velocity of, 15
- Electrolytic detector, 64
- Emergency transmitter (Marconi), 96

F

- Faults, localisation of, 230
- Fleming valve detector, 66, 108

- G
- Goldschmidt alternator, 145
- H
- Hertzian oscillator, 14
 High-frequency currents, 183
 — resistance, 182
- I
- Inductance, 11, 202
 Inductances, construction of, 26
 Induction coil, 36
 — —, Marconi 10-inch, 96
- L
- Lepel system, 136
 — electrolytic condenser, 144
 — modified receiver for un-
 damped waves, 142
 — musical note device, 140
 — portable set, 171
 Localisation of faults, 230
 Logarithmic chart for fre-
 quency and wave-length of
 oscillatory circuits, 200
 Logarithmic decrement, measure-
 ment of, 191
 Lodge Muirhead coherer, 63
 — syntonics jars, 16
- M
- Magnetic detector, 69
 — hysteresis, 70
 — key, 43
 Marconi system ($1\frac{1}{2}$ kw.), 85
 — cavalry set, 153
 — charging switchboard, 98
 — coherer, 59
 — decimeter, 197
 — directive antennæ, 32
 — emergency transmitter, 96
 — induction coil, 96
 — $\frac{1}{2}$ kw. set, 149
 — multiple tuner, 100
- Marconi magnetic detector, 69
 — tuner (two circuit), 152
 — wave meter, 187
 Measurements, 172
 Measurement of capacity, 172
 — — of antennæ, 179
 — — of coefficient of coupling, 203
 — — damping decrement, 191
 — — dielectric losses, 177
 — — earth plate resistance, 206
 — — energy in antennæ, 208
 — — high-frequency currents,
 183
 — — — resistance, 182
 — — inductance, 202
 — — insulation resistance of
 antennæ, 180
 — — strength of received
 signals, 207
 — — wave-length, 187
 Morse code, 224
 — —, American, 226
 — keys, 42
 Motor generators, 48
 — starting switch, 60
- P
- Portable installations, 146
 Poulsen system, 109
 — arc, 110
 — high-speed transmitter, 116
 — photographic receiver, 115
 — receiver, 113
 — tikker, 113
 — tone sender, 121
- Q
- Quenched-spark system (Tele-
 funken), 122
 — spark-gap (Telefunken), 127
 — — — (Lepel), 136
- R
- Reactance regulators, 48
 Receiver, the arrangement of
 circuits, 53

Receiver, directly coupled, 53
 —, Inductively coupled, 54
 Regulations, 213
 Resistance of spark-gaps, 27
 Resonance, 15
 — curves, 191
 Rotary converters, 47

S

Sound intensifier (Telefunken),
 132
 —, Velocity of, 1
 —, Wave-length of, 1
 Spark-gaps, 27
 —, Disruptive voltage of, 28
 —, Resistance of, 27

T

Table to convert Course and
 Bearing into Degrees, 227
 Telefunken quenched - spark
 system, 122
 — airship station, 165
 — calling apparatus, 131
 — quenched spark-gap, 127
 — receiver, 128
 — — (three circuit type), 130
 — simplified receiver, 159

Telefunken small-power ship set,
 157
 — sound intensifier, 132
 Telephone receiver, 73
 — relay (Brown), 78
 — condenser, 106
 Thermo-electric detectors, 67
 Tikker (Poulsen), 113
 Time signals, 226
 Transmitter, condensers for, 24
 —, Directly coupled circuits of,
 22
 —, Evolution of, 18
 —, Inductively coupled cir-
 cuits of, 22
 —, Lodge antennæ, 21
 —, Marconi plain aerial, 18
 —, Marconi $1\frac{1}{2}$ kw., 85

V

Variometer, 82
 Velocity of electric waves, 15
 — — sound waves, 1

W

Wave-length of sound, 1
 —, Measurement of, 187
 Wave meters, 185

THE RIVERSIDE PRESS LIMITED, EDINBURGH

A LIST OF BOOKS PUBLISHED BY
WHITTAKER & CO.,
 2, White Hart St., Paternoster Square, London, E.C

**A complete Catalogue giving full details of the following
 books will be sent post free on application. : : :**

	s.	d.
ADAMS, H. Practical Trigonometry, for the use of Engineers, Surveyers, &c. <i>net</i>	2	6
ALEXANDER, J. Model Engine Construction <i>net</i>	2	6
ALLSOP, F. C. Practical Electric Light Fitting <i>net</i>	4	6
ANDERSON, Sir W. Conversion of Heat into Work <i>net</i>	5	0
ARNOLD, J. O., and IBBOTSON, F. Steel Work Analysis <i>net</i>	10	6
ASHWORTH, J. R. Practical Exercises in Heat, Light and Sound... .. <i>net</i>	2	0
„ Practical Exercises in Magnetism and Electricity <i>net</i>	2	0
ATKINS, E. A. Practical Sheet and Plate Metal Work <i>net</i>	6	0
ATKINS, W. R. G. Researches in Plant Physiology		
BAMFORD, H. Moving Loads on Railway Under bridges <i>net</i>	4	6
BARR, J. R. Direct Current Electrical Engineering <i>net</i>	10	0
BARR, J. R. and ARCHIBALD, R. D. Design of Alternating Current Machinery <i>net</i>	12	6
BARTER, S. Manual Instruction—Woodwork <i>net</i>	6	0
„ Manual Instruction—Drawing <i>net</i>	3	6
BATSTONE, S. C. Electric Light Fitting, a Treatise on Wiring for Lighting, Heating, &c. <i>net</i>	5	0
BEAUMONT, R. Colour in Woven Design, a Treatise on Textile Colouring... .. <i>net</i>	18	0
BJORLING, P. R. Pipes and Tubes, their Construc- tion and Jointing <i>net</i>	3	6

Published by WHITTAKER & CO.,

		s.	d.
BLAKESLEY, T. H.	Geometrical Optics ...	<i>net</i>	2 6
BODMER, G. R.	Hydraulic Motors and Turbines	<i>net</i>	12 6
„	Inspection of Railway Material	<i>net</i>	4 6
BONNEY, G. E.	Electro Plater's Handbook	<i>net</i>	2 6
„	Electrical Experiments ...	<i>net</i>	2 6
„	Induction Coils ...	<i>net</i>	3 0
BOTTONE, S. R.	Guide to Electric Lighting	<i>net</i>	1 0
„	How to manage the Dynamo	<i>net</i>	0 9
„	Wireless Telegraphy and Hertzian Waves	<i>net</i>	2 6
„	Electrical Instrument Making for Amateurs	<i>net</i>	3 0
„	Electric Motors, how made and how used	<i>net</i>	2 6
„	Electricity and Magnetism	<i>net</i>	2 6
„	Electric Bells and all about them	<i>net</i>	2 0
„	Radiography, its Theory, Practice and Applications	<i>net</i>	3 6
„	Galvanic Batteries, their Theory, Construction and Use	<i>net</i>	4 6
„	Radium and all about it ...	<i>net</i>	1 0
BOYD, R. N.	Petroleum, its Uses, etc. ...	<i>net</i>	2 0
BRODIE, C. G.	Dissections Illustrated ...	<i>net</i>	10 6
BROWNE, A. J. JUKES.	Elementary Geology	<i>net</i>	2 6
BURNS, D., and KERR, G. L.	Modern Practice of Coal Mining. Parts	each <i>net</i>	2 0
CHAMBERS, G. F.	Astronomy, for General Readers	<i>net</i>	1 0
COOKE, C. J. B.	British Locomotives ...	<i>net</i>	6 0
COPPOCK, J. B.	Volumetric Analysis ...	<i>net</i>	2 0
CRAPPER, E. H.	Arithmetic of Alternating Currents.	<i>net</i>	2 6

2, White Hart Street, Paternoster Square. E.C.

Published by WHITTAKER & CO.,

	s.	d
CULLYER, J. Tables for Measuring and Manuring Land <i>net</i>	2	6
DAVIS, W. E. Quantities and Quantity Taking <i>net</i>	3	6
DENNING, D. Art and Craft of Cabinet Making <i>net</i>	4	6
DOMMETT, W. E. Submarines, Torpedoes and Mines <i>net</i>	1	6
„ Aeroplanes and Airships <i>net</i>	1	0
DOMMETT & JUDGE. High Speed Internal Com- bustion Engines		
DOW and GASTER. Modern Illuminants and Illu- minating Engineering <i>net</i>	12	6
EDGUMBE, K. Electrical Engineers' Pocket Book <i>net</i>	5	0
ELSDEN and GREENWELL. Roads, their Con- struction and Maintenance <i>net</i>	5	0
Engineer Draughtsmen's Work. Hints to Beginners in Drawing Offices <i>net</i>	1	6
Explosives Industry, Rise and Progress of the British <i>net</i>	15	0
FARROW, F. R. Specifications for Building Works and How to Write Them <i>net</i>	3	6
„ Stresses and Strains, their Cal- culation, etc. <i>net</i>	5	0
FLETCHER, B. F. and H. P. Architectural Hygiene, or Sanitary Science as applied to Buildings <i>net</i>	5	0
„ Carpentry and Joinery, a practical Handbook for Craftsmen and Students... .. <i>net</i>	6	0
FODEN, J. Mechanical Tables, showing the Diameters and Circumferences of Iron Bars, &c. <i>net</i>	1	6
GANARD, A. Gas, Oil and Petrol Engines, including Suction Gas Plant and Humphrey Pumps		
GASTER L. and DOW J. S. Modern Illuminants and Illuminating Engineering... .. <i>net</i>	12	6
GAY, A., and YEAMAN, C. H. Central Station Electricity Supply <i>net</i>	10	6
GRAY, J. Electrical Influence Machines (Wimshurst Machines) <i>net</i>	5	0
GREENWELL, A., and ELSDEN, J. V. Roads, their Construction and Maintenance <i>net</i>	5	0

2, White Hart Street, Paternoster Square, E.C.

Published by WHITTAKER & CO.,

		s.	d.
GRIFFITHS, A. B.	Treatise on Manures ...	<i>net</i>	6 0
GUTTMANN, O.	Manufacture of Explosives. 2 Vols.	<i>net</i>	36 0
„	Twenty Years' Progress in the Manu- facture of Explosives ...	<i>net</i>	3 0
HATCH, F. H.	Mineralogy, The Characters of Minerals, their Classification and Description	<i>net</i>	4 0
HAWKINS, C. C., and WALLIS, F.	The Dynamo, its Theory, Design and Manufacture. 2 Vols. each	<i>net</i>	10 6
HERBERT, T. E.	Telegraphy. An Exposition of the Telegraph System of the British Post Office	<i>net</i>	7 6
HIBBERT, W.	Magneto and Electric Ignition	<i>net</i>	2 0
HILLS, H. F.	Gas and Gas Fittings ...	<i>net</i>	5 0
HOBART, H. M.	Electric Motors—Continuous, Poly- phase and Single-Phase Motors	<i>net</i>	18 0
„	Continuous-Current Dynamo Design, Elementary Principles of	<i>net</i>	7 6
„	Table of Copper Wires ...	<i>net</i>	1 0
HOBART, H. M., and ELLIS, A. G.	Armature Con- struction	<i>net</i>	15 0
HOBART, H. M., and STEVENS, T.	Steam Turbine Engineering	<i>net</i>	21 0
HOBART, H. M., and TURNER, H. W.	Insulation of Electric Machines	<i>net</i>	10 6
HORNER, J. G.	Principles of Fitting ...	<i>net</i>	5 0
„	Helical Gears	<i>net</i>	5 0
„	English and American Lathes	<i>net</i>	6 0
„	Principles of Pattern Making	<i>net</i>	3 6
„	Metal Turning ...	<i>net</i>	3 6
„	Practical Ironfounding ...	<i>net</i>	5 0
IBBOTSON, F., and ARNOLD, J. O.	Steel Works Analysis	<i>net</i>	10 6

2, White Hart Street, Paternoster Square, E.C.

Published by WHITTAKER & CO.,

	s.	d.
JUDGE, A. W. The Design of Aeroplanes ...		
JUDGE & DOMMETT. High Speed Internal Combustion Engines		
JUKES-BROWNE, A. J. Elementary Geology <i>net</i>	2	6
KAPP, G. Transformers for Single and Multiphase Currents <i>net</i>	10	6
KERR & BURNS. Modern Practice of Coal Mining. Parts each <i>net</i>	2	0
KINGSLEY, R. G. Roses and Rose Growing <i>net</i>	6	0
LANDOLT, H. Optical Activity and Chemical Composition <i>net</i>	4	6
LELAND, C. G. Drawing and Designing ... <i>net</i>	2	0
„ Woodcarving <i>net</i>	4	0
„ Leather Work <i>net</i>	4	0
„ Metal Work—Repoussé <i>net</i>	4	0
„ Practical Education <i>net</i>	4	0
LODGE, Sir O. Lightning Conductors and Lightning Guards <i>net</i>	12	6
MACDONALD, G. W. Historical Papers on Modern Explosives <i>net</i>	7	6
MAGINNIS, A. J. The Atlantic Ferry, its Ships, Men and Working <i>net</i>	2	6
MARCHANT, W. H. Radio-Telegraphist's Guide and Log Book <i>net</i>	4	6
„ Wireless Telegraphy, a Practical Handwork for Operators and Students <i>net</i>	5	0
MASSEE, G. The Plant World, its Past, Present, and Future <i>net</i>	2	6
MAXIM, Sir H. Artificial and Natural Flight <i>net</i>	5	0
MAYCOCK, W. PERREN. First Book of Electricity and Magnetism <i>net</i>	2	6
„ Electric Lighting and Power Distribution. Vol. I. <i>net</i>	6	0
„ „ „ Vol. II. <i>net</i>	6	6

2, White Hart Street, Paternoster Square, E.C.

Published by WHITTAKER & CO.,

		s.	d.
MAYCOCK, W. PERREN.	Electric Wiring, Fittings Switches and Lamps ...	<i>net</i>	6 0
„	Alternating Current Work	<i>net</i>	6 0
„	Electric Wiring Diagrams	<i>net</i>	2 6
„	Electric Wiring Tables ...	<i>net</i>	3 0
„	Forms for Electric Wiring and Fittings Details ...	<i>net</i>	2 6
„	Electric Circuit Theory and Calculations ...	<i>net</i>	3 6
MIDDLETON, G. A. T.	Surveying and Surveying Instruments	<i>net</i>	5 0
MILLER, J. S.	Teacher's Handbook of Manual Training: Metal Work	<i>net</i>	3 6
MONTEVERDE, R. D.	Spanish Idioms with their English Equivalents	<i>net</i>	2 6
„	Commercial and Technical Terms in the English and Spanish Languages	<i>net</i>	2 0
MURDOCH, W. H. F.	Ventilation of Electrical Machinery ...	<i>net</i>	3 0
MURDOCH and OSCHWALD.	Electrical Measuring Instruments	<i>net</i>	10 6
ORFORD, H.	Lens Work for Amateurs ...	<i>net</i>	3 0
„	Modern Optical Instruments	<i>net</i>	2 6
OSBORNE, W. A.	German Grammar for Science Students... ..	<i>net</i>	2 6
OSCHWALD and MURDOCH,	Electrical Measuring Instruments	<i>net</i>	10 6
OULTON, L., and WILSON, N. J.	Practical Testing of Electric Machines	<i>net</i>	4 6
PENDRY, H. W.	Elementary Telegraphy	<i>net</i>	2 6
„	The Baudôt Printing Telegraph System	<i>net</i>	2 6

2, White Hart Street, Paternoster Square, E.C.

Published by WHITTAKER & CO.,

	s.	d.
PERKIN, F. M. Metric and British Systems of Weights and Measures <i>net</i>	1	6
POOLE, J. Practical Telephone Handbook and Guide to the Telephonic Exchange <i>net</i>	6	0
PUNGA, F. Single-Phase Commutator Motors <i>net</i>	4	6
PULL, E. Engineering Workshop Exercises <i>net</i>	2	0
RIDER, J. H. Electric Traction <i>net</i>	10	6
ROBERTS, C. W. Practical Advice for Marine Engineers <i>net</i>	3	0
" Drawing and Designing for Marine Engineering <i>net</i>	5	0
RUDORF, G. Periodic Classification and the Problem of Chemical Evolution <i>net</i>	4	6
RUSSELL, S. A. Electric Light Cables <i>net</i>	9	0
SALOMONS, Sir D. Management of Accumulators <i>net</i>	6	0
SCOTT, W. A. Handrailing for Geometrical Staircases. <i>net</i>	2	0
STEENBEEK, W. H. Engineers' and Erectors' Pocket Dictionary: English, German, Dutch... .. <i>net</i>	2	0
STEVENS, T., and HOBART, H. M. Steam Turbine Engineering <i>net</i>	21	0
STILL, A. Polyphase Currents <i>net</i>	6	0
SUTCLIFFE, G. L. Sanitary Fittings and Plumbing <i>net</i>	5	0
TAYLOR, J. T. Optics of Photography and Photographic Lenses <i>net</i>	3	6
THOMSON, M. Apothecaries' Hall Manual <i>net</i>	2	0
THURSTON, A. P. Elementary Aeronautics, or the Science and Practice of Aerial Machines <i>net</i>	3	6
TURNER, H. W., and HOBART, H. M. Insulation of Electric Machines <i>net</i>	10	6
TWELVETREES, W. N. Concrete-Steel, a Treatise on Reinforced Concrete Construction <i>net</i>	6	0

2, White Hart Street, Paternoster Square, E.C.

Published by WHITTAKER & CO.,

		s.	d.
TWELVETREE, W. N.	Concrete-Steel Buildings. Being a Continuation of the Treatise on Concrete-Steel ...	<i>net</i>	10 0
„	Practical Design of Reinforced Concrete Beams and Columns	<i>net</i>	6 0
„	Structural Iron and Steel...	<i>net</i>	6 0
„	Simplified Methods of Calculating Reinforced Concrete Beams	<i>net</i>	0 6
WAGSTAFF, W. H.	Metric System of Weights and Measures ...	<i>net</i>	1 6
WALKER, S. F.	Electricity in Homes and Work- shops ...	<i>net</i>	5 0
„	Electric Lighting for Marine Engineers ...	<i>net</i>	4 6
WALMISLEY, A. T.	Land Surveying and Levelling	<i>net</i>	6 0
„	Field Work and Instruments	<i>net</i>	5 0
WARDALE, W. T.	Village Electrical Installations ...	<i>net</i>	2 0
WEBBER, W. H. Y.	Gas Supply, in Principles and practice, a Guide for the Gas Fitter, Gas Engineer, and Gas Consumer ...	<i>net</i>	3 6
WHITE, W. J.	Wireless Telegraphy and Telephony	<i>net</i>	2 6
WHITTAKER'S	Arithmetic of Electrical Engineering	<i>net</i>	1 6
„	Electrical Engineer's Pocket Book	<i>net</i>	5 0
„	Mechanical Engineer's Pocket Book	<i>net</i>	3 6
WIGHT, J. T.	Elementary Graphic Statics	<i>net</i>	4 0
WILLIAMS, H.	Mechanical Refrigeration	<i>net</i>	9 0
WILSON, N. J., and OULTON, L.	Practical Testing of Electrical Machines ...	<i>net</i>	4 6
YATES, M.	Text Book of Botany. Part I. The Anatomy of Flowering Plants	<i>net</i>	2 6
YEAMAN, C. H., and GAY, A.	Central Station Electricity Supply ...	<i>net</i>	10 6

Catalogue of Scientific and Technical Books post free.

WHITTAKER & CO., 2, White Hart St., Paternoster Sq., London, E.C.